

Historic, archived document

Do not assume content reflects current scientific knowledge, policies, or practices.

6273

MICHELL'S
SEEDS
BULBS ~ PLANTS

X VEGETABLE
SEED PRIMS
HORTICULTURE

1934

HENRY F. MICHELL CO.
516 and 518 MARKET ST., PHILA., PA.

NURSERIES, TRIAL GROUNDS, GREENHOUSES, ANDALUSIA, PA.

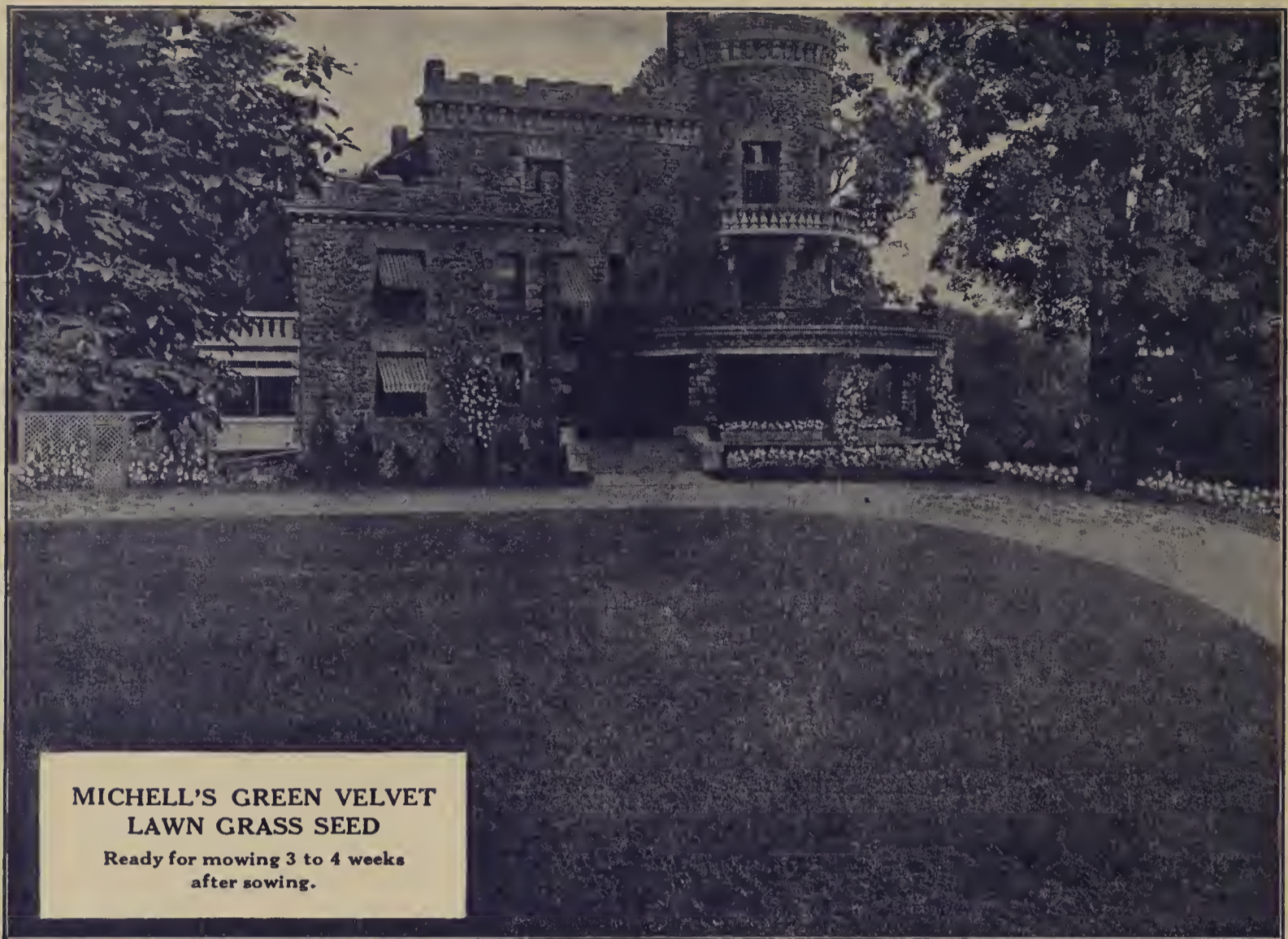

**MICHELL'S GREEN VELVET
LAWN GRASS SEED**

Ready for mowing 3 to 4 weeks
after sowing.

MICHELL'S GREEN VELVET LAWN GRASS SEED

Our Green Velvet Lawn Mixture is composed of only the finest, extra re-cleaned grasses, carefully blended and will produce a permanent evergreen lawn.

We recommend sowing 1 quart of seed to a space 10 x 10 feet, 1 peck to 1000 square feet, one bushel to 4000 square feet, 6 to 8 bushels per acre on new lawns; for reseeding, sow 4 to 5 bushels per acre.

**Price: 45c. per qt.; 4 qts., \$1.50; \$2.50 per pk.; bu. (20 lbs.), \$9.00;
\$44.00 per 100 lbs.; 1000 lbs., \$425.00**

We have been specializing in lawn grass seeds for **over 40 years** and no effort or expense is spared in order to obtain the highest quality seeds, which are all procured direct from the producing sections, both in Europe and America. Our grass seed representative makes frequent trips to the growing sections to inspect the various crops and to personally see that we get only the very choicest re-cleaned seed.



For complete list of Grasses see pages 4 to 7

HENRY F. MICHELL CO.
516 and 518 MARKET STREET
PHILADELPHIA, PA.

GENERAL INFORMATION AND SUGGESTIONS

CONDITIONS OF SALE.—All contracts, sales and acknowledgments of orders are contingent upon crop failures, our ability to import and make deliveries in conformity with the "Plant Quarantine Act," partial deliveries by growers or manufacturers, strikes, or other unavoidable causes beyond our control, clerical errors included; also unsatisfactory credit standing. All quotations are subject to market changes and goods being unsold on receipt of order. Henry F. Michell Co. give no warranty, expressed or implied, as to the description, purity or productiveness of any seeds, plants or bulbs they send out, and they cannot be in any way responsible for the crop. If the customer does not accept the goods on these terms, he must notify us at once and we will give instructions for the disposition of the goods.

ORDER EARLY.—We shall appreciate it if our customers will send us their orders for **seeds, plants, bulbs, etc.**, during January and February. Shipment need not be made until they want the goods.

PACKING CHARGES.—No charge is made for boxes or packing, except for two-bushel seamless sacks which are charged at market value (and as may otherwise be noted), these bags are returnable for credit at the price charged.

BUSINESS TERMS.—We especially invite charge accounts, which are more convenient than to remit for each order at the time it is sent us. When sending your first charge order, please send us the names and addresses of two or more business houses with whom you have had past or present credit relations; this saves considerable time in the execution of your first charge order.

As to our responsibility, we refer you to **Dun and Bradstreet's Mercantile Agency**, or any bank or trust company in the United States.

C. O. D. SHIPMENTS.—Goods can be sent C. O. D. (with the exception of perishable items, which include plants and cold storage bulbs; these cannot be sent C. O. D.). No C. O. D. shipments for any kind of goods can be made by express or freight out of town unless a partial remittance accompanies the order. No C. O. D. orders can be accepted where the amount is less than \$1.00. During April and May, owing to the heavy volume of business transacted, we are not in a position to accept order for shipment C. O. D., unless a partial payment has been made on account to assure acceptance at time of delivery.

CHANGES OF RESIDENCE.—In order that we may forward our Catalogs regularly, we would suggest that our customers inform us of a change of permanent residence.

SHIPPING INSTRUCTIONS.—Always state by what method you want goods forwarded, otherwise we will ship according to our best judgment.

FORWARDING SERVICE.—We pay postage charges on all orders for vegetable seeds, flower seeds and grass seeds in quantities up to five pounds (unless otherwise noted) to the first and second zones. If larger quantities of the above, also bulbs, plants and sundries are wanted by parcel post, remit for postage the amount named in connection with the item to the first and second zones; for other zones add additional postage, or at the rate quoted in table opposite. Agricultural Seeds, Implements, Fertilizers, and other heavy and bulky goods are sent by Express or Freight at purchaser's expense.

Plant orders should be separated from Seed orders, as they are usually filled and shipped separately.

Positions for Gardeners, Estate Superintendents, etc.
We have on our register the names of competent Gardeners, Superintendents, Greenskeepers, Farmers and Poultrymen who desire positions. We are always pleased to put them in communication with parties desiring services of such men.

For our customers who wish to engage a landscape or jobbing gardener, we maintain a list from which we can give you the names of one or more in your locality. We can recommend them for the work as they have always been reliable.

All Plants, Roots and Bulbs are forwarded by Express (or Parcel Post when possible) purchaser paying charges, unless otherwise noted.

For those of our customers who prefer to receive such goods by Parcel Post, we will be pleased to forward in this manner such plants as can be sent in this way at the following additional cost, which must be added to the value of each order for Plants, Roots or Bulbs unless otherwise noted.

To all points east of the Mississippi River, 15 per cent. extra.

To all points west of the Mississippi River, 25 per cent. extra.

SAFE ARRIVAL.—We guarantee the safe arrival of all goods sent to points within the United States except when shipped to points where there is no express or freight agent, to such points the purchaser must assume any claim for loss or damage.

LOCAL DELIVERY.—Our free delivery service covers Philadelphia and vicinity, also Camden, N. J., and nearby points.

Also note that we do not guarantee to maintain a daily delivery to these points.

Please note the free delivery service does not include bulky quantities of fertilizers in over ¼ ton quantities. Special arrangements can however be made for delivery of these.

Shipments of goods can also be made by package service from Market and Chestnut St. Ferries, Broad St. Station, Reading Terminal and B. & O. R. R., at 24th and Chestnut Sts.

The tariff for shipments that can be made by this method, packed in one piece is as follows:

10 lbs. and under, 12c. 26 lbs. to 40 lbs., 24c.
11 lbs. to 25 lbs., 18c. 41 lbs. to 50 lbs., 30c.

Shipments weighing more cannot be sent via Package Service.

<p>BELL Lombard 5620 to 5629</p>	<p>KEYSTONE Main 1631 1632</p>
--	--



Parcel Post Rates from Philadelphia (Subject to Change)

United States Parcel Post Rates (Seeds, plants and bulbs included) (Subject to Change.)	First pound or fraction	Each additional pound or fraction	Packages must not exceed 100 inches (length and girth combined)
Local Rate, Philadelphia.....	\$0.07	\$0.01	Limit of weight to all zones, 70 lbs. A fraction of a cent in the total amount of postage on any parcel shall be counted as a full cent.
1st Zone, within 50 miles of Philadelphia.....	.08	.01.1	
2d Zone, over 50 and under 150 miles.....	.08	.01.1	
3d Zone, over 150 and under 300 miles.....	.09	.02	
4th Zone, over 300 and under 600 miles.....	.10	.03.5	
5th Zone, over 600 and under 1000 miles.....	.11	.05.3	
6th Zone, over 1000 and under 1400 miles.....	.12	.07	
7th Zone, over 1400 and under 1800 miles.....	.14	.09	
8th Zone, over 1800 miles.....	.15	.11	

On Seeds, Bulbs, Plants or Roots not exceeding eight (8) ounces in weight, the postage charge is 1c. for each two (2) ounces or fraction thereof; on Sundries or other Merchandise not exceeding eight (8) ounces in weight, the postage charge is 1½c. for each two (2) ounces or fraction thereof. Seeds, Bulbs, Plants, Roots, Sundries, etc., weighing over eight (8) ounces are sent at zone rates.

If Special Delivery is wanted an additional 15c. is required on packages weighing up to two (2) pounds—25c. on packages weighing more than two (2) pounds and up to ten (10) pounds—35c. on packages weighing more than ten (10) pounds, which also includes special handling and transportation as first-class mail.

If remittance accompanies order, a sufficient amount should be included to cover the extra charges—if ordered to be sent by either of the methods as stated above.

Please note parcel post charges quoted by us are for delivery in the United States only.

HENRY F. MICHELL CO.

SEEDS BULBS, PLANTS, GARDEN SUPPLIES, FERTILIZERS, INSECT DESTROYERS, POULTRY SUPPLIES, ETC.

516 AND 518 MARKET ST., PHILA.

NURSERIES AND PLANT HOUSES, ANDALUSIA, PA.

WAREHOUSES 509-11-13 LUDLOW ST. AND AMERICAN AND DAUPHIN STS.

BELL AND KEYSTONE TELEPHONES

2 INDEX TO CONTENTS OF MICHELL'S 1934 CATALOG

VEGETABLE SEEDS		FLOWER SEEDS		FLOWER SEEDS—Con.		FLOWER SEEDS—Con.		BULBS AND PLANTS—Con.	
	Page		Page		Page		Page		Page
Anise	49, 75	Abutilon	13	Fern Spores	26	Potentilla	36	Begonias	81, 87, 93
Artichoke	49	Acanthus	13	Feverfew (Matricaria)	30	Pot Marigold (Calendula)	8, 19	Bellis	107
Asparagus	49	Achillea	13	Forget-Me-Not (Myosotis)	32	Primula	11, 36	Berberis	127, 131
Basil (Sweet)	49, 73, 75	Aconitum	13	Four O'Clock (Marvel of Peru)	30	Pueraria	37	Bignonia	125
Beans	46A, 47; 50 to 52	Acroclinium	26	Foxglove (Digitalis)	24	Pyrethrum	37	Bocconia	107
Beet	46A, 53	Adonis	13	Gaillardia	26	Ranunculus	37	Boltonia	107
Borage	53, 75	African Daisy (Arcotis)	15	Gas Plant (Dictamnus)	24	Reseda (Mignonette)	31	Boxwood	131
Broccoli	46A, 47, 54	Agathea	13	Gentiana	26	Rhodanthe	26	Bridal Wreath (Spirea)	130
Brussels Sprouts	54	Ageratum	13	Geranium	26	Ricinus	37	Brussels Sprouts	54, 76
Cabbage	47, 55	Agrostemma	13	Gerbera	27	Rock Cress (Arabis)	15	Buddleia	128
Caraway	54, 75	Alyssum	13	Geum	27	Rock Garden Seeds	12	Cabbage	55, 76
Cardoon	54	Amaranthus	13	Gilia	27	Rudbeckia	11, 37	Caladium	87
Carrot	54	Ampelopsis	13	Globe Amaranth	26	Salpiglossis	37	Calendula	93
Catnip	54, 75	Anchusa	15	Globularia	27	Salvia	11, 38	California Privet	131
Cauliflower	56	Anemone	15	Gloxinia	27	Saponaria	39	Callas	91
Celery	57	Anthemis	15	Godetia	27	Saxifraga	39	Calliandra	128
Celery	57	Antirrhinum	8, 14	Gomphrena	26	Scabiosa	38	Callirhoe	107
Chamomile	56, 75	Aquilegia	15	Gourd	27	Scarlet Flax (Linum)	30	Calluna	128
Chervil	56	Arabis	15	Grasses, Ornamental	27	Scarlet Runner Bean	18	Calycanthus	128
Chicory	56	Arctotis	15	Grevillea	27	Scarlet Sage (Salvia)	11, 38	Campanula	107
Chives	56, 75	Armeria	15	Gypsophila	27	Schizanthus	39	Candytuft (Hardy)	112
Citron	56, 64	Asclepias	15	Helenium	27	Sedum	39	Cannas	81
Collards	56	Asparagus	15	Helianthemum	27	Sensitive Plant	39	Carnations	108
Collections	48	Asperula	15	Helianthus	28	Shamrock	39	Caryopteris	108
Coriander	56, 75	Asters	8, 16, 17	Helichrysum	26	Shasta Daisy	10, 39	Cauliflower	56, 76
Corn Salad	57	Aubrietia	18	Heliopsis	27	Sidalea	39	Celastrus	125
Corn (Sugar)	46A, 58	Auricula	18	Heliotrope	28	Silene	39	Celery	57, 76
Cress (Garden)	57	Baby's Breath (Gypsophila)	27	Helleborus	27	Smilax	39	Centaurea	94, 108
Cress (Water)	57	Bachelor's Button (Centaurea)	21	Hesperis (Sweet Rocket)	43	Snapdragon (Antirrhinum)	8, 14	Cerastium	108
Cucumber	46A, 47, 59	Bachelor's Button (Comphrena)	26	Heuchera	28	Snow in Summer (Cerasium)	22	Cercis (Judas or Red Bud)	128
Dandelion	47, 59	Balloon Vine	18	Hibiscus	28	Snow on the Mountain (Euphorbia Var.)	25	Chelone	108
Dill	59, 75	Balsam	18	Hollyhock	28	Solanum	39	Chieranthus	108
Egg Plant	59	Balsam Apple	18	Honesty	28	Stachys	39	Chionanthus	128
Endive	47, 60	Baptisia	18	Hop Vine (Humulus)	28	Statice	39	Chives	56, 76
Fennel	47, 60, 75	Begonia	18	Humulus	28	Stevia	39	Chlidanthus	81, 91
Finocchio	47, 61, 75	Bellflower (Campanula)	8, 20	Hunnemannia	29	Stocks	40	Chrysanthemum	108, 109
Garlic	60, 65	Bellis (Daisy)	24	Hyacinth Bean (Dolichos)	25	Stokesia	40	Cinnamon Vine	91, 126
Herbs (Seed)	75	Blue Lace Flower	24	Iberis (Candytuft)	20	Strawflower (Helichrysum)	26	Clematis	108, 125
Horse Radish	60	Bocconia	18	Ice Plant (Mesembryan)	31	Streptocarpus	40	Clethra (Pepper Bush)	128
Kale	60	Brachycome	18	Impatiens	29	Sunflower (Helianthus)	28	Climbing Plants	125, 126
Kohl Rabi	60	Browallia	18	Incarvillea	29	Sweet Alyssum	13	Cobaea	94, 126
Lavender	60, 75	Butterfly Fl. (Schizanthus)	39	Ipomoea	29	Sweet Peas	11, 41, 42	Coleus	94
Lettuce	61, 62	Calceolaria	18	Iris	29	Sweet Rocket	43	Collections Hardy Perennials	124
Mangel Wurzel	53, 80	Calendula	8, 19	Japanese Ivy (Ampelopsis)	13	Sweet William	43	Columbine	105
Martynia	62	California Poppy (Eschscholtzia)	25	Job's Tears (Coix)	27	Tagetes	43	Cooperia	81, 91
Melons	46A, 46B, 63, 64	Calliopsis	19	Kenilworth Ivy (Linaria)	30	Thalictrum	43	Coreopsis	108
Mint	63, 75	Campanula	8, 20	Kochia	29	Thermopsis	43	Cornus (Dogwood)	128
Mushroom Spawn	64	Canary Bird Vine	19	Kudzu Vine (Pueraria)	37	Thunbergia	43	Cosmos	94
Mustard	66	Candytuft	20	Lady Slipper (Balsam)	18	Tithonia	43	Cotoneaster	128
Okra	66	Canna	19	Larkspur (Annual)	9, 29	Torenia	43	Crassula	96
Onions	47, 65	Canterbury Bell (Campanula)	20	Larkspur (Perennial)	9, 24	Transvaal Daisy (Gerbera)	27	Cytisus (Golden Chain)	128
Onion Sets	65	Cardinal Climber	19	Lathyrus	29	Tritoma	43	Dahlias	82 to 86A
Parsley	46B, 47, 66	Carnation	21	Lavender	29	Trollius	43	Daphne	128
Parsnip	66	Castor Beans (Ricinus)	37	Lemon Verbena	44	Tunica	43	Delphinium	110
Peanuts	70	Catananche	21	Leptosyne	30	Valeriana	43	Deutzia	128
Peas	46A, 67, 68	Celocia	21	Liatriis	30	Verbascum	44	Dianthus	110A
Pennyroyal	69, 75	Centaurea	21	Lily	30	Verbenca	44	Dictamnus	110A
Pepper	46B, 69	Cerastium	22	Linaria	30	Viola	45	Dielytia	110
Pop Corn	58	Chelone	22	Linum	30	Violet	45	Digitalis	110A
Potatoes	68	Chinese Woolflower (Celosia)	21	Lobelia	9, 30	Virginia Stock	45	Dogwood (Cornus)	128
Pumpkin	70	Chrysanthemum	22	Love-in-a-Mist (Nigella)	33	Wallflower	45	Doronicum	110A
Radish	46A, 71	Cineraria	22	Lupinus	9, 30	Wild Cucumber (Echinocystis)	25	Dracena	96
Rhubarb	70	Clarkia	22	Lychnis	30	Wild Flower Garden Mixture	45	Echinops	110A
Rocket or Rucola	47, 71	Clematis	22	Lythrum	30	Woolflower (Celosia)	21	Egg Plant	59, 76
Rosemary	71, 75	Cleome	22	Marigold	9, 31	Xeranthemum	26	Erica	128
Ruta Baga	46B, 75	Cobaea	22	Marvel of Peru	30	Zinnia	11, 46	Eryngium	110A
Saffron	71, 75	Cockscomb (Celosia)	21	Matricaria	30			Eupatorium	110A
Sage	71, 75	Coix (see Grasses)	27	Mathiola	31			Euonymus	126, 128
Salsify	72	Coleus	22	Maurandia	31			Euphorbia	111
Shallots	65	Collections of Flower Seeds	19	Mesembryanthemum	31			Erodium	110A
Sorrel	72	Columbine (Aquilegia)	15	Mexican Fire Plant (Euphorbia Heterophylla)	25			Evergreens	132
Spinach	72	Cone Flower (Rudbeckia)	37	Mignonette	31			Exochorda	128
Squash	47, 73	Convolvulus	23	Mimosa (Sensitive Plant)	39			Ferns	96, 110A
Summer Savory	72, 75	Coreopsis	23	Mimulus	31			Feverfew (Matricaria)	116
Sweet Basil	49, 73, 75	Cornflower (Centaurea)	21	Mixed Seed for Wild Garden	45			Ficus	96
Sweet Marjoram	73, 75	Cosmos	23	Momordica (Balsam Apple)	18			Forget-Me-Not	116
Swiss Chard	53, 73	Cowslip (Primula Veris)	36	Monarda	31			Forsythia (Golden Bells)	129
Thyme	73, 75	Cultural Leaflets	43	Monkshood (Aconitum)	13			Foxglove	110A
Tobacco	73	Cuphea	23	Moon Flower (Ipomoea)	29			Fruit Trees	135
Tomato	46A, 47, 74	Cyclamen	23	Morning Glory	23			Funkia	111
Turnip	47, 75	Cynoglossum	24	Mourning Bride (Scabiosa)	38			Gaillardia	111
Winter Savory	72, 75	Cyperus	24	Musa Ensete	31			Gardenia	96
		Cypress Vine	24	Myosotis	32			Gentiana	111
		Dahlia	24	Nasturtium	10, 32			Geraniums	94
		Daisy	24	Nemesia	33			Geum	111
		Delphinium	9, 24	Nepeta	33			Gladiolus	81, 88 to 89
		Dianthus	25	Nicotiana	33			Globularia	111
		Dictamnus	24	Nigella	33			Gloxinias	91
		Didiscus	24	Oenothera	33			Grasses (Ornamental)	111
		Digitalis	24	Ornamental Grasses	27			Gypsophila	111
		Dimorphotheca	25	Pansy	10, 33			Hedge Plants	131
		Dolichos	25	Papaver (Poppy)	35			Helienium	111
		Dracena	25	Pelargonium (Geranium)	26			Helianthemum	111
		Dusty Miller (Centaurea)	21	Pennisetum (see Grasses)	27			Helianthus	111
		Dusty Miller (Cineraria)	22	Penstemon	34A			Heliopsis	112
		Echinocystis	25	Periwinkle (Vinca)	44			Heliotrope	94
		Echinops	25	Petunia	10, 34			Helleborus	112
		Edelweiss	25	Phacelia	34A			Hemerocallis	112
		Erinys	25	Phlox	34A			Heuchera	112
		Eryngium	25	Physalis	34A			Hibiscus	112
		Eschscholtzia	25	Physostegia	34A			Hieracium	111
		Eupatorium	25	Pinks (Carnation)	21			Hollyhock	112
		Euphorbia	25	Pinks (Dianthus)	25			Honeysuckle	126, 129
		Everlastings	26	Platycodon	34A			Hop Vine	60, 76, 126
		Exacum	25	Polemonium	34A			Horse Radish	60, 76
				Polygonum	34A			Hyacinthus	91
				Poppy	35			Hydrangeas	129, 131
				Portulaca	36			Hypericum	112
								Iberis	112
								Ilex	129
								Incarvillea	112



MICHELL'S RELIABLE GRASS SEED

Advantages of Sowing Mixed Grass Seeds

It is a well known fact that a well balanced combination of grasses will give better results than a separate variety. Various grasses in mixture will help crowd out weeds. Often a separate variety of seed will not thrive on certain soil but where there is a combination of seeds, one or more varieties in the combination will surely thrive and our formulas are so well blended that they will give very satisfactory results. Liberal and frequent applications are advised, especially on new ground, in order to produce a satisfactory, velvety lawn, which is always much admired.

Quantity to Sow for Lawns. We recommend sowing one quart to a space 10 x 10 feet; one peck to 1000 square feet; half bushel to 2000 square feet; one bushel to 4000 square feet or 40 x 100 feet; six to eight bushels per acre on new ground without grass; for reseeding three to four bushels per acre. For Putting Greens we advise 100 lbs. of seed for greens 100 x 100 feet. For Fairways, 8 to 10 bushels per acre. For Pasture and Hay Fields, 4 to 5 bushels per acre, based on a 20 pound bushel.

Prices quoted on Mixed Grass Seeds are prepaid in quantities up to one peck to the first and second zones; please add 20c. per $\frac{1}{2}$ bu., 30c. per bu. for the above zones if wanted by parcel post; for other zones, see parcel post table, page 1.

MICHELL'S SUPERIOR BENT GRASS MIXTURE

This mixture is composed of the finest grasses obtainable, consisting chiefly of the leading varieties of Bent grasses, which are the foundation of the best Putting Greens. We recommend sowing this formula at the rate of one pound to a space 15 by 20 feet or 300 square feet. 90c. per lb.; 5 lbs., \$4.25; \$19.00 per 25 lbs.; 100 lbs., \$72.50.

Michell's Clover Lawn Grass Seed

The increasing demand for a grass seed mixture, containing a larger proportion of White Lawn Clover induced us to offer this brand; mixed with a liberal quantity of the best re-cleaned White Clover, which is peculiarly suited to take firm hold and grow quickly on hard or worn-out spots which sunburn easily. Splendid for seashore lawns. 30 lbs. per bu.

30c. per pt.; qt., 55c.; \$1.00 for 2 qts.; 4 qts., \$1.90; \$3.50 per pk.; bu., \$13.50; \$44.00 per 100 lbs.

Michell's Top Notch Lawn Grass Seed

The top notch of quality. A perfectly blended combination of quick growing, very compact, fine bladed grasses that will produce a perfect lasting turf in a few weeks. 25 lbs. per bu.

\$3.00 per pk.; bu., \$11.50; \$45.00 per 100 lbs.

Michell's Southern States Evergreen Lawn Grass Seed

In the southern states especially below Virginia, it is extremely hard to establish a permanent lawn, if the proper combination of grasses are not used; after exhaustive tests and experiments we are pleased to state that our Southern States Evergreen Grass Seed Mixture will come up to the most sanguine expectations. Especially for dry, hot localities. 20 lbs. per bu.

25c. per pt.; qt., 45c.; 85c. for 2 qts.; 4 qts., \$1.50; \$2.50 per pk.; bu., \$9.00; \$44.00 per 100 lbs.

Michell's Evergreen Lawn Grass Seed

This is composed of the finest native and foreign short growing and fine bladed grasses and will form a perfect turf. It weighs 20 lbs. per bushel, and every kernel is full of vitality.

20c. per pt.; qt., 35c.; 65c. for 2 qts.; 4 qts., \$1.25; \$2.00 per pk.; bu., \$7.00; \$33.50 per 100 lbs.



Michell's Green Velvet Lawn Grass Mixture

MICHELL'S RELIABLE GRASS SEEDS

See Page 4 for recommendations for quantities required to sow an acre.

Prices quoted on Mixed Grass Seeds are prepaid in quantities up to one peck to the first and second zones; please add 20c. per $\frac{1}{2}$ bu., 30c. per bu. for the above zones if wanted by parcel post; for other zones, see parcel post table page 1.

Michell's Green Velvet Lawn Grass Seed

The result of many years of untiring experimenting and will produce a perfect turf; composed of close growing, fine leaved hardy grasses, which will stand wear and tear, and outlive the severest winter, retaining at all times its lustrous green color. 20 lbs. per bu.

25c. per pt.; qt., 45c.; 85c. for 2 qts.; 4 qts., \$1.50; \$2.50 per pk.; bu., \$9.00; \$44.00 per 100 lbs.

Michell's Seashore Lawn Grass Seed

If 3 or 4 inches of top soil is spread over the surface, and well firmed, an application of Michell's Special Formula Seashore Lawn Mixture will produce a good lawn in 6 to 8 weeks. Our formula has been thoroughly tested out in various localities. 20 lbs. per bu.

45c. per qt.; 2 qts., 85c.; \$1.50 per 4 qts.; pk., \$2.50; \$9.00 per bu.; per 100 lbs., \$44.00.

Michell's Terrace or Embankment Grass Seed

It is usually difficult to establish turf on steep inclines or on terraces. This mixture is composed of deep rooting varieties which will give satisfactory results. 20 lbs. per bu.

25c. per pt.; qt., 45c.; 85c. for 2 qts.; 4 qts., \$1.50; \$2.50 per pk.; bu., \$9.00; \$44.00 per 100 lbs.

Michell's Special Standard Formula Lawn Grass Seed

As recommended by the New Jersey Agricultural Experiment Station.

	Lb.	10 lbs.	25 lbs.	100 lbs.
No. 1. With White Clover.....	\$0.50	\$4.50	\$10.00	\$37.50
No. 1A. Without Clover.....	.45	4.25	9.75	35.00
No. 2. For Fine Quality Turf....	.75	7.00	15.00	55.00
No. 3. Shaded Areas Mixture....	.45	4.25	9.75	35.00
No. 4. For Poor or Sandy Soil...	.50	4.50	10.00	37.50

Michell's Special Sod Grass Seed

A quick growing mixture, making a tough and heavy sod in a short time. 20 lbs. per bu.

25c. per pt.; qt., 45c.; 85c. for 2 qts.; 4 qts., \$1.50; \$2.50 per pk.; bu., \$9.00; \$44.00 per 100 lbs.

Michell's Fairmount Park Lawn Grass Seed

A mixture meeting the requirements of those desiring a moderately priced grass seed. 20 lbs. per bu.

15c. per pt.; qt., 25c.; 50c. for 2 qts.; 4 qts., 95c.; \$1.75 per pk.; bu., \$6.00; \$28.00 per 100 lbs.

Michell's Athletic Field Grass Seed

A special mixture of deep rooting, fine leaved grasses, especially suited for Baseball, Football and Cricket Grounds. 20 lbs. per bu.

\$2.00 per pk.; bu., \$7.00; \$33.50 per 100 lbs.



Michell's Shaded Lawn Grass Mixture

MICHELL'S RELIABLE GRASS SEEDS

See Page 4 for recommendations for quantities required to sow an acre.

Prices quoted on Mixed Grass Seeds are prepaid in quantities up to one peck to the first and second zones; please add 20c. per $\frac{1}{2}$ bu., 30c. per bu. for the above zones if wanted by parcel post; for other zones, see parcel post table page 1.

Michell's Shaded Lawn Grass Seed

Shaded locations have often been found difficult to keep in grass. We have combined a mixture of grasses that will produce a perfect sward in the most densely shaded place. It must be borne in mind that too much shade creates sour soil, and to guard against this apply hydrated lime at the rate of 50 pounds to each 1000 square feet. 20 lbs. per bu.

25c. per pt.; qt., 45c.; 85c. for 2 qts.; 4 qts., \$1.50; \$2.50 per pk.; bu., \$9.00; \$44.00 per 100 lbs.

Michell's Putting Greens Mixture

This is a quick-growing mixture of short, fine-bladed grasses. In sowing Putting Greens it is wise economy to be very liberal with the seed, as they are subjected to continuous hard use. We do not recommend less than 100 lbs. to a green 100 ft. square. 25 lbs. per bu.

40c. per pt.; qt., 75c.; \$1.40 for 2 qts.; 4 qts., \$2.40; \$4.50 per pk.; bu., \$16.50; \$65.00 per 100 lbs.

Michell's Fairways (Golf Course) Mixture

Composed of short-growing, deep-rooted varieties that resist wear. Fairways to retain their permanency should receive additional sowings during the season. 20 lbs. per bu.

\$2.00 per pk.; bu., \$7.00; \$33.50 per 100 lbs.

MISCELLANEOUS MIXTURES

Michell's Permanent Pasture Grass Seed

This mixture is a combination of hardy grasses which are the most nutritious for stock feeding or grazing. Sow 4 to 5 bu. per acre on new land or 2 bu. on established pastures. 20 lbs. per bu.

\$1.65 per pk.; bu., \$6.00; \$27.50 per 100 lbs.

Michell's Permanent Hayfield Grass Seed

Its main advantages are that certain grasses in this mixture will grow better in varying conditions of soil thus giving a full crop of hay on land that otherwise might produce but a half crop of timothy and clover. Sow 4 to 5 bu. per acre on new lands or 2 bu. on established fields. 20 lbs. per bu.

\$1.65 per pk.; bu., \$6.00; \$27.50 per 100 lbs.

See page 7 for Grass Seeds in separate varieties.



Michell's Putting Greens Mixture

SEPARATE VARIETIES

All strictly Recleaned and Carefully Tested for Purity and Germination.

On account of market fluctuations, on many varieties of grass seeds, prices on larger quantities than that named will be quoted on request.

Bent Grass, Certified Seaside (*Sometimes called Cocoos Bent*).

Very highest quality, grown in Coos County, Oregon, and certified and sealed in 50 lb. bags by the Oregon Department of Agriculture. True, Creeping variety of Bent, spreading rapidly by means of stolons or runners; makes an ideal, perfect putting green turf. Sow 75 to 100 lbs. on a green 100 feet square. \$1.40 per lb.; 5 lbs., \$6.75; \$13.00 per 10 lbs.; 25 lbs., \$30.00; \$52.50 per 50 lbs.; 100 lbs., \$100.00.

Bent Grass, Colonial or Velvet. A very fine bladed grass, producing a thick turf; especially valuable for putting greens. 20 lbs. per bu. \$1.40 per lb.; 10 lbs., \$13.00.

Bent Grass, Creeping (*South German*). Admirably adapted for lawns, also putting greens, tennis courts, etc. Sow 100 lbs. on a putting green 100 feet square. \$1.40 per lb.; 10 lbs., \$13.00.

Bent Grass, Rhode Island. For sowing at seashore resorts, on putting greens, tennis courts, etc. Sow 100 lbs. on a putting green 100 feet square. 20 lbs. per bu. \$1.40 per lb.; 10 lbs., \$13.00.

Bermuda Grass (*Cynodon Dactylon*). For sowing as far North as Washington, D. C., above which latitude it is not hardy. 35 lbs. per bu. 45c. per lb.; 10 lbs., \$4.00.

Blue Grass, Fancy Kentucky (*Poa Pratensis*). Superfine quality. Our stock of this is extra fine, thoroughly recleaned; sow 70 to 85 lbs. per acre on lawns, 50 to 70 lbs. on pasture fields. 14 lbs. per bu. 40c. per lb.; 10 lbs., \$3.50.

Blue Grass, Kentucky. Fine quality. 14 lbs. per bu. 35c. per lb.; 10 lbs., \$3.00.

Blue Grass, Canadian (*Poa Compressa*). Makes an ideal grass for the lawn, also pasture; highly relished by cattle; excellent also for sowing on embankments; sow in same proportions as Kentucky Blue. 14 lbs. per bu. 35c. per lb.; 10 lbs., \$3.00.

Crested Dogstail (*Cynosurus Cristatus*). Excellent as a pasture and lawn grass. Sow 80 to 100 lbs. per acre. 21 lbs. per bu. 35c. per lb.; 10 lbs., \$3.00.

Fescue, Chewing's New Zealand (*Festuca Chewing's*). Especially recommended for putting greens and lawns. 14 lbs. per bu. 40c. per lb.; 10 lbs., \$3.50.

Fescue, Fine Leaved (*Festuca Tenuifolia*). This grass is especially valuable for dry soils. Sow 70 to 85 lbs. per acre. 14 lbs. per bu. 40c. per lb.; 10 lbs., \$3.50.

Fescue, Genuine Red or Creeping (*Festuca Rubra*). Excellent for putting greens; also for sowing on sandy soil and in shaded places. 14 lbs. per bu. 50c. per lb.; 10 lbs., \$4.50.

Fescue, Hard (*Festuca Duriuscula*). A splendid grass for golf links, tennis courts, etc.; will resist droughts. Sow 80 to 100 lbs. per acre. 14 lbs. per bu. 35c. per lb.; 10 lbs., \$3.00.

Fescue, Meadow (*Festuca Pratensis*). An excellent hardy grass; valuable in mixtures for permanent pastures. Sow 100 lbs. per acre. 22 lbs. per bu. 25c. per lb.; 10 lbs., \$2.00.

Fescue, Red (*Festuca Rubra*). European. Valuable for putting greens; also for sowing on sandy soil and in shaded places. 14 lbs. per bu. 30c. per lb.; 10 lbs., \$2.50.

Fescue, Sheep's (*Festuca Ovina*). This makes an excellent grass for sowing on lawns, fields or pleasure grounds. Sow 80 to 100 lbs. per acre. 14 lbs. per bu. 35c. per lb.; 10 lbs., \$3.00.

Herd or Red Top, Unhulled (*Agrostis Vulgaris*). Sow 60 to 80 lbs. per acre on lawns, or 50 to 60 lbs. on pasture lands. 10 lbs. per bu. 20c. per lb.; 10 lbs., \$1.50.

Orchard Grass (*Dactylis Glomerata*). For early pasturing this is very desirable; also fine for sowing in shaded places. Sow 50 lbs. per acre. 14 lbs. per bu. 30c. per lb.; 10 lbs., \$2.75.

Red Top, Fancy Recleaned (*Agrostis Vulgaris*). This is one of the best grasses for sowing for immediate effect. Our stock is free from chaff and is absolutely pure. Sow 75 lbs. per acre. 32 lbs. per bu. 30c. per lb.; 10 lbs., \$2.50.

Rough Stalked Meadow (*Poa Trivialis*). A splendid grass for shady places and valuable for use in golf course turf formation. Sow 100 lbs. per acre. 14 lbs. per bu. 50c. per lb.; 10 lbs., \$4.00.

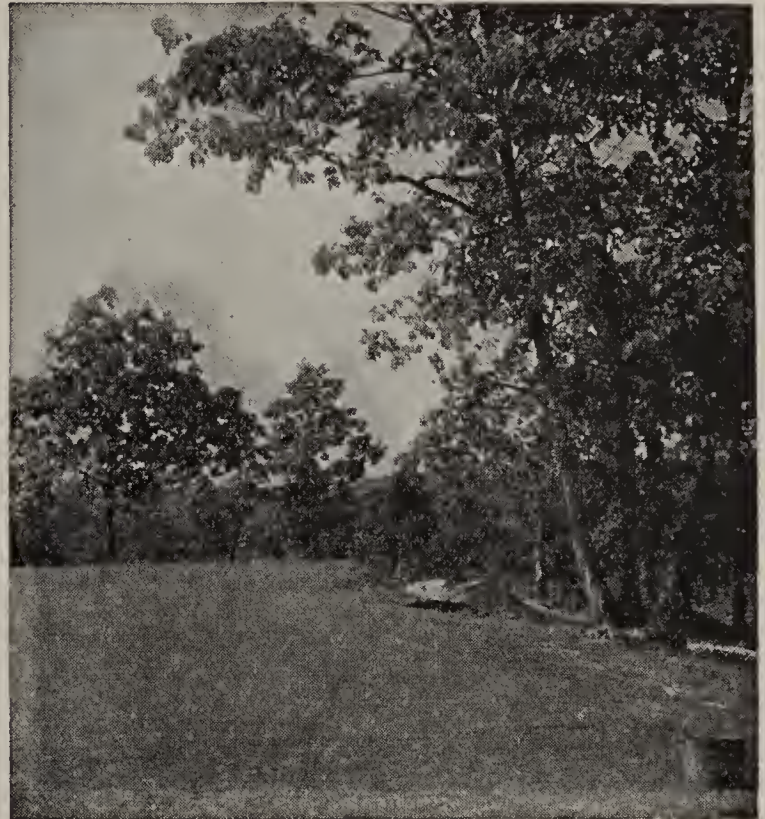

Rye Grass, Domestic. Valuable in lawn grass mixtures demanding immediate effect. Sow 100 lbs. per acre. 20 lbs. per bu. 20c. per lb.; 10 lbs., \$1.75.

Rye Grass, Pacey's English (*Lolium Perenne*). This makes the quickest returns in growth of any grass; is deep rooted and readily established. Sow 100 to 120 lbs. per acre. 24 lbs. per bu. 30c. per lb.; 10 lbs., \$2.75.

Rye Grass, English or Perennial. 24 lbs. per bu. 25c. per lb.; 10 lbs., \$2.25.

Rye Grass, Italian (*Lolium Italicum*). Imported. Very desirable for pasture; comes to maturity the first season; the ideal seed for southern lawns in Winter. Sow 100 lbs. per acre. 18 lbs. per bu. 25c. per lb.; 10 lbs., \$2.25.

Sudan Grass Seed (*Annual*). This belongs to the forage crops and is allied to the millets. Sow 16 to 24 lbs. per acre. 25c. per lb.; 10 lbs., \$2.25.

Timothy (*Phleum Pratense*). Sow 25 lbs. per acre alone. 45 lbs. per bu. 20c. per lb.; 10 lbs., \$1.25.

Wood Meadow (*Poa Nemoralis*). The best grass for sowing under trees where a lawn is desired. Sow 75 to 100 lbs. per acre. 14 lbs. per bu. 70c. per lb.; 10 lbs., \$6.75.

WHITE DUTCH LAWN CLOVER

Splendid for sowing among grass on lawns and other places where a thick, quick growth is desired; especially adapted for seashore lawns. Per oz., 10c.; 25c. per ¼ lb.; ½ lb., 40c.; 75c. per lb.; 5 lbs., \$3.50; \$6.75 for 10 lbs.; 25 lbs., \$16.25; \$63.00 per 100 lbs.

If wanted by Parcel Post, add for postage as follows: 10c. for 1 lb.; 15c. for 5 lbs.; 20c. for 10 lbs.; larger quantities by express or freight.

HYPER-HUMUS

Hyper-Humus is a pure, organic material prepared for the purpose of building up the soil. All lawns improve under Hyper-Humus treatment.

Per 5 lbs., 30c.; 50c. for 10 lbs.; 25 lbs., 75c.; \$1.25 per 50 lbs.; 100 lbs., \$2.00; \$9.50 per 500 lbs.; ½ ton, \$15.00; \$25.00 per ton. Carload lots in bulk, \$10.00 per ton, f. o. b. factory.

MICHELL'S NOVELTIES AND SPECIALTIES

IN FLOWER SEEDS FOR 1934

FOR GENERAL LIST OF FLOWER SEEDS SEE PAGES 13 TO 46

ANTIRRHINUM (Snapdragon)

NEW IMPROVED EARLY FLOWERING (1934 Novelty)

This new type commences to bloom three weeks earlier than all other varieties and more flowers are in full bloom at one time to a spike; habit of growth very uniform; height, 2½ feet.

	Large pkt.	Pkt.
Improved Brilliant Rose. Rose pink.....	\$0.50	\$0.15
Improved Golden King. Bright yellow.....	.50	.15
Improved Queen Victoria. Pure white.....	.50	.15
Improved Rose Queen. Soft pink.....	.50	.15
Improved Scarlet Defiance. Bright scarlet.....	.50	.15
Improved Choice Mixed.....	.50	.15

ASTER

FUSARIUM WILT-RESISTANT STRAINS

We take pleasure in offering the following varieties of Wilt-Resistant Asters. These we believe to be practically immune to this disease. We feel sure that by using this seed many disappointments due to crop failures will be eliminated.

Improved Queen of the Market. Crimson, Dark Blue.

Early Royal Branching. Azure Blue, Purple, Rose Pink, White, Mixed.

Improved Crego. Deep Rose, Shell Pink, Violet, White, Mixed.

Semple's Branching. Azure Blue, Deep Rose, Purple, Shell Pink, White, Mixed.

Ball's White. A splendid late, large flowered, long stemmed, branching type.

Heart of France. Ruby Red.

Any one of the above varieties, 25c. per pkt.; large pkt., 75c.; \$3.00 per oz.



Aster, New Super Giant, Los Angeles

1934 NOVELTY ASTER

NEW SUPER GIANT LOS ANGELES

A marvelous new Giants of California late type, the largest yet introduced; the flowers are not only very large, but most artistic, due to the unusual curling and interlacing of the petals. Color, pure shell-pink; stems unusually long; no disbudding necessary, due to its non-lateral habit. Pkt., 25c.; \$1.00 per large pkt.

CALENDULA, CHRYSANTHA

(Sunshine) Novelty

A new break in Calendulas which originated in Australia. The flowers bear a most striking resemblance to a Chrysanthemum; remarkable for its great length of stem and large double, clear buttercup yellow flowers. This variety is ideal as a cut flower for interior decorations. Pkt., 25c.; 75c. per large pkt.

CAMPANULA

NEW ANNUAL SINGLE

(Novelty)

A new annual Canterbury Bell which blooms from seed in less than six months. The plants grow from 2 to 2½ feet high and each plant produces from 6 to 8 spikes of bloom. Originator's stock seed in a selected mixture only. Pkt., 25c.; 75c. per large pkt.

*CANDYTUFT, MINIATURE GEM

(Hyacinth Flowered Type)

(Novelty)

A dainty miniature variety, 3½ inches in height, each plant producing from 4 to 6 spikes of pure white flowers; a perfect miniature gem for the rock garden. Originator's stock. Pkt., 15c.; 60c. per large pkt.



Campanula Annual Single



Delphinium, English Hollyhock

ENGLISH HOLLYHOCK DELPHINIUM

WATKIN SAMUEL'S WREXHAM STRAIN

The finest large flowered type to date; immense spikes.

	Large pkt.	Pkt.
Art Shades.....	\$1.25	\$0.50
Deep Blue Shades.....	1.25	.50
Light Blue Shades.....	1.25	.50
Selected Mixture.....	(1/8 oz., \$1.50) 1.00	.50

DELPHINIUM

BLACKMORE AND LANGDON'S

A new improved type of this splendid English variety; plants are of strong, vigorous growth and produce immense spikes of large flowers; every describable shade of blue is in this mixture. Pkt., 25c.; \$1.00 per large pkt.

DELPHINIUM, ICEBERG

A new pure white variety, which comes true from seed; a strong healthy grower, producing 4-foot spikes. A decided novelty and well worth growing. Pkt., 50c.; \$1.00 per large pkt.



Emperor Larkspur, Enchantress

**NEW EMPEROR LARKSPUR
ENCHANTRESS**

**Dwarf Branching, Double Stock Flowered
(Novelty)**

A splendid new variety, suitable for bedding or pots; color a charming soft salmon pink; plants are compact and grow 2 feet high, making an excellent garden plant. Pkt., 25c.; 60c. per large pkt.

LOBELIA, BLUE STONE

(Michell Novelty)

A splendid dwarf variety of very compact growth; plants completely covered with large, bright blue flowers; unsurpassed for borders or boxes. Pkt., 20c.; 75c. per large pkt.

LUPINUS, GIANT HARTWEGI

(Novelty)

A new improved strain of annual Lupinus; this type grows from 3 to 4 feet high and with the base-branching habit; each plant produces from 4 to 6 spikes of bloom, which are much larger than the old type. Choice mixture of colors. Pkt., 25c.; 60c. per large pkt.

NEW AFRICAN MARIGOLD

GUINEA GOLD

A very valuable novelty that has created a sensation as a most desirable cut flower; it is a distinct type, producing no singles whatsoever, the flowers coming 100% double and semi-double; in color a clear orange, flushed with gold; very loose petaled and lacks the odor of the regular African marigold. Pkt., 25c.; 60c. per large pkt.



Nasturtium, Golden Gleam

NASTURTIUM, GOLDEN GLEAM (Novelty)

This new type is of semi-trailing habit and a new development in Nasturtiums. Plants form a vigorous large bush which throws out short runners averaging 18 inches. The sweet scented, large double flowers are of a golden yellow color and average two to three inches across; they are borne on erect stiff stems six inches in length and stand well above the foliage, an arrangement which adds immeasurably to the showy appearance of the plant; they are also splendid for cutting. The seed we offer is strictly originator's stock. Pkt., 15c.; 25c. per large pkt.; oz., 75c.



Shasta Daisy, New Double Giant White

PANSY

MICHELL'S NEW SWISS GIANTS

This new strain has enormous flowers and contains many unusual colors, such as salmon, pink, red, etc., which are all beautifully blotched. Pkt., 50c.; \$1.25 per large pkt.

PETUNIA

MICHELL'S GIANT FRINGED

See Color Plate Opposite page 34.

A greatly improved strain of large flowering Petunia. The blooms are of immense size, beautifully fringed and ruffled and with a wonderful array of pleasing shades and veinings. Pkt., 25c.; 85c. per large pkt.



Petunia, Nana Compacta, Pink Gem

PETUNIA, NANA COMPACTA (DWARF)

PINK GEM (1934 Novelty)

This variety is the first of a distinct new race of miniature Petunias; plants grow in a neat compact form 5 to 6 inches high and 8 inches in diameter and are literally covered with deep pink blooms, 2 inches in diameter and as many as 25 to 30 in flower at one time. This miniature variety is indispensable for borders, window boxes, pots, rock gardens and for bedding; a very pleasing effect can be obtained by planting this variety with dwarf blue Ageratum. Pkt., 25c.; \$1.00 per large pkt.

PETUNIA, NANA COMPACTA (DWARF)

Mixed Colors

Same as the above, but containing a fine selection of colors, ranging from deep rose through to crimson and white. Pkt., 20c.; 75c. per large pkt.

BALCONY PETUNIA

Netted Blue Gem (1934 Novelty)

A new color in the balcony type; color steel blue, beautifully netted or veined; flowers large and cluster well together on the extra long branches, which makes it of special value for window boxes or baskets; will come practically 100 per cent true from seed and we predict that when once known will become a most popular balcony variety. Pkt., 25c.; \$1.00 per large pkt.

SHASTA DAISY

New Double Giant White (Perennial)

(Novelty)

A splendid new double variety; fine for cutting; the flowers are about 5 inches in diameter, on long, stiff stems and have the appearance of a giant Aster; will flower from seed in 5 months. Pkt., 25c.; 75c. per large pkt.

PRIMULA MALACOIDES

Dawkin's Carmine Pink (1934 Novelty)

Color a rich glowing carmine pink, quite distinct from any shade hitherto produced in Primula Malacoides; flowers large, on wiry stems of upright and graceful habit. The constitution of the plant is very strong; without doubt the best of all existing varieties. Original pkt., 75c.

RUDBECKIA, KELVEDON STAR

(Novelty)

A new strain which we recommend with confidence; a really good annual and a perfect long stemmed flower for cutting; very floriferous and sturdy habit of growth; flowers vary in form and coloring, but all have dark brown central discs, surrounded by mahogany zones on petals of orange. Seed started inside in March will commence to bloom outdoors in June; height, 3 feet. Original pkt., 40c.



Salvia, Fire King

SALVIA, DWARF FIRE KING

(Michell's Novelty)

A new extra early variety, flowering about four weeks earlier than other existing types; plants are of very compact habit; exceedingly dwarf and completely covered with medium sized, brilliant scarlet flowers. Pkt., 25c.; 75c. per large pkt.

SALVIA, BLUE BEDDER

(Novelty)

A new variety of Farinacea; very compact in form, of a deep blue shade and flowering very profusely. A perennial flowering from seed the first year. Pkt., 25c.; 60c. per large pkt.

**EARLY DWARF SPENCER SWEET PEA
"BO-PEEP"**

(1934 Novelty)

Bo-Peep is a dwarf erect early flowering Spencer Sweet Pea (not a Cupid) and on this account it makes a splendid pot plant, also an excellent plant for bedding or border work. The color is a salmon pink, very similar to the early variety Springsong and with flowers just as large; the stems run from 4 to 6 inches and the plants range from 12 to 24 inches in diameter. It is a profuse bloomer and its rich salmon pink color will lend itself admirably for color schemes in the garden, as it comes practically 100% true. Pkt., 25c.; 75c. per 1/2 oz.; oz., \$1.25.



Verbena, Beauty of Oxford Hybrids

VERBENA

BEAUTY OF OXFORD HYBRIDS

(Novelty)

This is a splendid giant hybrid, resulting from a cross between Luminosa and Beauty of Oxford; the color shades from clear rose pink to red, making this the brightest rose Verbena ever produced from seed; the individual florets measure over one inch in diameter. Originator's stock seed. Pkt., 25c.; 75c. per large pkt.

VERBENA GRANDIFLORA

LAVENDER GLORY (Novelty)

We feel that this novelty is undoubtedly the most glorious color in Verbenas, a true lavender with a medium size creamy white eye. The individual floret will cover a fifty cent piece. It is also distinctly and sweetly fragrant. Pkt., 25c.; 75c. per large pkt.

ZINNIA, LILLIPUT, VALENCIA

Beautiful miniature, perfectly double flowers; color, a new shade of burnt orange. Pkt., 10c.; 25c. per large pkt.; oz., \$1.25.



Early Dwarf Spencer Sweet Pea, "Bo-Peep"

For Novelties and Specialties see pages 8 to 11

Our flower seeds have a reputation for their superior quality and for the excellent results obtained by sowing them. It is our constant endeavor to supply only such varieties and strains as will give the best of satisfaction.

Throughout the following pages of Flower Seeds the different varieties are designated as Annuals, Biennials, Perennials, etc., and for the benefit of those who are not familiar with these terms, we wish to make the following brief explanation:

Annuals. These grow and bloom, mature their seed and then die in the same year, such as Asters, Balsams, Poppies, Sweet Peas, Morning Glories, etc., some of which may be sown in the house from March to May, or outdoors, after danger from frost is over.

Biennials. These grow from seed sown during midsummer, flowering the second year, after which they die; many of the varieties bloom the first season if sown early. In this class we have Pansies, English Daisies, Campanula Medium, Dianthus, etc.

Perennials. Those which live from year to year, such as Aquilegia, Delphinium, Foxgloves, etc. Seed may be sown outdoors from June to September and transplanted late in Fall into their permanent quarters, and protected during Winter with a light litter of straw or leaves. The hardy perennials not usually needing any protection after the first Winter; the half-hardy perennials require protection during the Winter, and the tender perennials during the Winter require greenhouse protection.

A COMPLETE INDEX OF FLOWER SEEDS WILL BE FOUND ON PAGE 2

ABUTILON (Flowering Maple)

Choice Mixed. Used for bedding out in the Summer; also for flowering indoors during the Winter; foliage of maple form; flowers bell-shaped; 3 feet. \$0.75 \$0.10

ACANTHUS (Bear's Breech)

Latifolius. Stately hardy perennial foliage plant; large decorative leaves; July and August; 3 feet.25 .10

ACHILLEA (Milfoil or Yarrow)

Ptarmica. Fl. Pl., "The Pearl." Pure white double flowers in great profusion all Summer; hardy perennial; 2 1/2 feet.75 .10
Millefolium Rubra. Bright magenta red; 3 feet.50 .10

ACONITUM (Monk's Hood or Helmet Flower)

Hardy perennial thriving best in semi-shady situations; effective in hardy borders; 3 feet; August-September.

Fischeri. An improved strain; compact habit with bright blue flowers. \$0.75 \$0.15
Napellus. Long spikes of blue flowers.50 .10
Wilsoni. Rich blue; 6 to 7 feet.75 .15

ACROCLINIUM (Everlasting Flower)

(See page 26)

ADONIS

*Vernalis. Finely cut foliage; bright yellow flowers; perennial; 1 foot.60 .10

AGATHEA

Coelestis (Blue Daisy or Marguerite). Greenhouse perennial, with beautiful blue flowers; 3 feet.40 .10

AGROSTEMMA (Mullein Pink)

Coronaria. Hardy perennial of easy culture; silvery foliage and bright crimson flowers; fine for cutting; 2 1/2 to 3 feet; June to August.25 .10
Coronaria Alba. Pure white.25 .10

ALYSSUM

One of the most popular garden flowers, remaining in bloom the entire season; suitable for beds and edging in Summer, or for growing in pots and boxes for Winter blooming. Large pkt. Pkt.

Lilac Queen. Of dwarf, compact growth; flowers pure lilac color; 4 inches; oz., 75c. \$0.25 \$0.10
Little Gem. Dwarf compact plants, densely covered with large white flowers; height, 4 inches. 1/4 lb., \$2.25; oz., 75c.25 .10
*Michell's Bouquet. Plants dwarf and compact; forms a perfect bouquet of miniature white flowers; a perfect gem for edging; oz., \$1.25.30 .10
Sweet (Maritimum). The well-known fragrant white variety; trailing, 6 inches. 1/4 lb., 90c.; oz., 30c.10
*Saxatile Compactum (Basket of Gold). An ideal hardy perennial plant, flowering in May; showy golden-yellow flowers; excellent for rockwork; height, 1 foot; oz., \$1.25.30 .10



Ageratum, Blue Ball

AGERATUM (Floss Flower)

One of the best bedding plants, being literally a mass of bloom from early Summer till frost.

Blue Cap (New). A splendid dwarf variety; very compact; flowers larger than Little Blue Star and deeper in color. \$0.75 \$0.15
*Blue Ball. Dwarf, ball-shaped plants; very large, blue flowers; 6 inches.40 .10
Blue Perfection. Large heads of deep blue flowers produced in abundance; 12 inches.25 .10
Imperial Dwarf Blue. Clear blue; compact growing plant; height, 9 inches. oz., 75c. .25 .10
Imperial Dwarf White. oz., 75c. .25 .10
Imperial Dwarf Mixed. oz., 60c. .25 .10
Little Blue Star. Plants densely covered with bright blue flowers; height, 5 inches.60 .15

AMARANTHUS

Decorative foliage plants, easily raised from seed, either by starting them early indoors or sown outdoors in May.

Molten Fire (Summer Poinsettia). Very ornamental and the most beautiful of all Amaranthus; very easily grown from seed; leaves dark bronze, center Poinsettia red. We offer seed from selected plants only. \$0.75 \$0.25
Sunrise. Foliage bronzy crimson, tipped carmine.40 .10
Tricolor Splendens (Joseph's Coat). Foliage green, variegated crimson and yellow; height, 2 feet.25 .10
Mixed. All sorts.25 .10

AMPELOPSIS (Boston or Japanese Ivy)

Veitchi. Hardy perennial climber with olive-green leaves, which turn to scarlet in the Autumn. The best climber for covering brick or stone walls; oz., 40c. \$0.25 \$0.10



ANTIRRHINUM (Snapdragon)

A splendid plant for beds or borders and one of our choicest cut flowers; extensively forced under glass during the Winter. For early flowering, sow indoors during February or March, seeds sown outdoors early in May will bloom in July.

SPECIAL FORCING VARIETIES

	Large pkt.	Pkt.
Bertha Baur (<i>Novelty</i>). A new lavender or orchid color; large spikes. (Large pkt. only).....	\$3.00	
Sonny (<i>Novelty</i>). Clear bright pink; compact flower heads. (Large pkt. only).....	3.00	
Cincinnati (<i>New</i>). Large flowering, fragrant light rose pink. (Large pkt. only).....	2.00	
Lucky Strike (<i>New</i>). The best large flowering white to date; stems 3 to 4 feet long. (Large pkt. only).....	2.00	
Allman's Pink . A decided improvement in this type; color is that of the Briarecliff Rose. (Large pkt. only).....	2.00	
Beaupre Beauty . A splendid new forcing variety, of a rose bronze shade. (Large pkt. only).....	2.00	
Happiness . Color, clear pink; flowers extra large. (Large pkt. only).....	1.25	
Afterglow . Golden bronze. (Large pkt. only).....	1.25	
Rose Queen . Dark pink. (Large pkt. only).....	1.25	
Ceylon Court . Canary yellow.....	1.25	\$0.25
Chapman's Pink	1.00	.25
Chapman's Yellow	1.00	.25
Cheviot Maid Supreme . An improvement on Cheviot Maid, deeper in color and longer stems. (Large pkt. only).....	1.25	
Cheviot Maid . Clear pink.....	1.00	.25
Geneva Pink . Glistening rose pink.....	.75	.25
Golden Pink Queen	1.00	.25
Helen . Lovely salmon color. (Large pkt. only)....	1.25	
Jennie Schneider . True pink Columbia rose color.....	.75	.25
Judd's Early Dark Pink	1.25	.25
Judd's Early Light Pink	1.25	.25
Orlando . Beautiful bronze color.....	.75	.25
Philadelphia Pink . Pure pink.....	.75	.25
Philadelphia Pink . (Originator's Stock).....	1.25	
Roman Gold . Deep golden yellow, suffused pink..	1.00	.25
Silver Pink (<i>Ramsburg's</i>). Flowers large.....	.75	.25
Sun Tan . Rose and tan color. (Large pkt. only)...	1.25	
Improved Sunburst . Color of Sunburst rose.....	1.25	.25
White Rock . An extra early, pure white.....	.75	.25
Special Forcing Mixed . A choice blending of colors.....	.75	.25



Michell's Giant Antirrhinums

NEW IMPROVED EARLY FLOWERING (1934 Novelty)

This new type commences to bloom three weeks earlier than all other varieties and more flowers are in full bloom at one time to a spike; habit of growth very uniform; height 2 1/2 feet.

	Large pkt.	Pkt.
Improved Brilliant Rose . Rose pink.....	\$0.50	\$0.15
Improved Golden King . Bright yellow.....	.50	.15
Improved Queen Victoria . Pure white.....	.50	.15
Improved Rose Queen . Soft pink.....	.50	.15
Improved Scarlet Defiance . Bright scarlet.....	.50	.15
Improved Choice Mixed50	.15

MAXIMUM VARIETIES

A recently introduced type with extra large flowers on strong stems. These are also forcing varieties.

	Large pkt.	Pkt.
Canary Bird . Canary yellow, golden yellow center..	\$0.50	\$0.15
Cattleya . Silvery rosy lilac.....	.50	.15
Copper King (<i>Indian Summer</i>). Coppery red.....	.50	.15
Snowflake . Pure white, yellow tube.....	.50	.15
Mixed . Maximum varieties.....	.40	.15

ANTIRRHINUM, TOM THUMB

Mixed Colors. These grow about 12 inches high... .30 .10

***ANTIRRHINUM, ROCK HYBRIDS**

Very early flowering, the plants are of dwarf, compact growth, and especially adapted for growing in Rock Gardens. Choice mixed colors. Pkt., 25c.; 75c. per large pkt.

MICHELL'S GIANT TALL ANTIRRHINUMS

Flowers very large, produced on long spikes and invaluable for cutting; height 2 1/2 to 3 feet.

	Large pkt.	Pkt.
Giant Brilliant Rose	\$0.30	\$0.10
Giant Crimson King . Rich dazzling crimson.....	.30	.10
Giant Golden King . Fine golden yellow.....	.30	.10
Giant Harmony . Orange shaded rose.....	.40	.10
Giant Othello . Rich dark maroon.....	.30	.10
Giant Pink Venus . Flesh pink, white tube.....	.30	.10
Giant Queen Victoria . Pure white.....	.30	.10
Collection , one packet each 6 colors, 50c.		
Giant Mixed . All colors.....oz., 90c.	.30	.10

ANTIRRHINUMS—Semi-Dwarf

The Semi-Dwarf sorts grow about 18 inches high, with large flowers over most of the stem; excellent for bedding.

	Large pkt.	Pkt.
Amber Queen . Canary yellow, overlaid chamois pink.....	\$0.40	\$0.10
Bronze Queen . Bronze shading to orange.....	.50	.10
Eclipse . Brilliant, crimson red.....	.60	.15
Fawn . Pink suffused yellow.....	.40	.10
Firebrand . Rich deep red.....	.40	.10
Gloria . Rich deep rose.....	.50	.10
Golden Queen . Golden yellow.....	.40	.10
Nelrose . Pure rose pink.....	.40	.10
Prima Donna . Apricot pink.....	.40	.10
Purity . Pure white.....	.40	.10
Mixed . All colors.....oz., \$1.00	.30	.10

ANCHUSA (Sea Bugloss)

	Large pkt.	Pkt.
Blue Bird. A new variety of dwarf, compact growth; flowers bright indigo blue.	\$0.30	\$0.10
Capensis (<i>Cape Forget-me-not</i>). A splendid blue annual variety, blooming all Summer; 18 inches. . .	.25	.10
Italica "Dropmore." A hardy perennial plant, with flowers of a lovely gentian blue; 3 to 4 feet.25	.10
*Myosotidiflora. Small Forget-me-not blue flowers; perennial; fine for the rockery; 15 inches.75	.25

ANEMONE (Wind Flower)

A dainty Spring flowering perennial, with cup-shaped blossoms; splendid for bouquets.

	Large pkt.	Pkt.
Coronaria. Mixed colors; 18 inches.	\$0.40	\$0.10
*Pulsatilla (<i>Pasque Flower</i>). Violet lilac; 1 foot.50	.15
St. Brigid or Poppy. Flowers large, semi-double and double, in many colors; 18 inches.75	.15

ANTHEMIS (Hardy Marguerite)

A handsome, hardy perennial, bearing all Summer, daisy-like flowers; excellent for cutting.

	Large pkt.	Pkt.
*Montana. Pure white; 12 inches.	\$0.50	\$0.10
Tinctoria Kelwayi. Bright yellow; 2 feet.40	.10

ARABIS (Rock Cress)

*Alpina. Early Spring flowering perennial; especially adapted for edging and rockery; pure white blossoms; April-May; 1 foot.25	.10
*Alpina Rosea. Bright rose; very dwarf; 8 inches. . .	1.00	.25



Aquilegia (Columbine) Long Spurred

AQUILEGIAS OR COLUMBINES

These are among the most beautiful of Spring and early Summer flowers; very effective when grown in the herbaceous border and groups among shrubbery. Graceful spurred flowers on stems 2 feet or more above the fern-like foliage.

	Large pkt.	Pkt.
*Alpina. Blue and white; fine for rock gardens; 18 inches.	\$0.50	\$0.10
Californica Hybrida. Mixed colors, principally yellow and orange shades; long spurs.50	.10
Canadensis. The scarlet and yellow native species. .	.60	.10
Chrysantha (<i>Golden Spurred</i>). Bright golden yellow. .	.50	.10
Coerulea (<i>Rocky Mountain Columbine</i>). Large flowers, violet blue and white.60	.10
Nivea Grandiflora. A beautiful large pure white. .	.40	.10
Rose Queen. Light to dark pink with white center and yellow anthers.75	.15
Double Mixed. All colors. oz., 75c.	.25	.10
Single Mixed. All colors. oz., 75c.	.25	.10

SELECT LONG SPURRED VARIETIES

These are unquestionably the finest types of this splendid garden perennial. The plants are of strong robust growth and very free flowering.

	Large pkt.	Pkt.
Blue Shades	\$0.75	\$0.25
Orange and Scarlet Shades75	.25
Pink and Rose Shades75	.25
Snow Queen. Pure white.....	.75	.25
Mrs. Scott Elliot's Select Strain. Choice mixed..	.85	.25
Hybrids. Mixed colors.....	.60	.10

ASPARAGUS

	100 seeds	Pkt.
Plumosus Nanus. An excellent plant for house or conservatory decoration or cutting on account of its graceful, finely cut foliage.	\$0.75	\$0.10
Sprengeri. One of the best plants to grow in hanging baskets or window boxes, vases, etc.50	.10

ASPERULA (Woodruff)

	Large pkt.	Pkt.
Tuberosa. Showy perennial; brilliant orange scarlet flowers; 2 feet.75	.15
Odorata. A pretty hardy perennial plant thriving in partial shade; flowers white; 1 foot; May.	\$0.30	\$0.10



Arctotis Grandis

ARCTOTIS (African Lilac Daisy)

	Large pkt.	Pkt.
Grandis. Large daisy-like flowers; pure white on the upper surface, reverse petals lilac; 3 feet.	\$0.25	\$0.10

ARMERIA (Sea Pink or Thrift)

Formosa. A pretty hardy perennial for edgings, with deep pink flowers; 2 feet.40	.10
Formosa, Bee's Ruby. Deep rose; 24 inches.75	.15
*Lauchiana. Flowers a bright rosy red; a good perennial rock plant; 6 inches.75	.15

ASCLEPIAS (Butterfly Weed)

Tuberosa. Showy perennial; brilliant orange scarlet flowers; 2 feet.75	.15
--	-----	-----

MICHELL'S SUPERB ASTERS

We can imagine no other flower which combines so much beauty with grace and usefulness and with which more brilliant effects can be achieved. From July until September this flower reigns supreme in the garden, not equalled by any other. For these obvious reasons we give a great deal of attention to these flowers, and are in a position to offer our patrons remarkably fine strains, producing perfect flowers of great beauty. All of the strains we offer are grown under our own supervision by specialists in this country. To have early flowers, sow the seed in the house, hotbed or cold frame, from March until May; otherwise sow outdoors after danger from frost has passed. To do well, Asters require a well pulverized soil, always kept open by continuous cultivation.

Special Note.—While this splendid Fall flower is very easily grown from seed, the greatest possible care should be exercised with the seed bed; old soil and boxes should never be used the second time without thoroughly sterilizing, to avoid the numerous diseases to which Asters are so susceptible. Barnyard manure should never be employed as a fertilizer; we recommend the use of fine ground bone meal and on no account should they be grown in the same location two years in succession.

1934 NOVELTY ASTER

New Super Giant Los Angeles

A marvelous new Giants of California late type, the largest yet introduced; the flowers are not only very large, but most artistic, due to the unusual curling and interlacing of the petals. Color, pure shell pink; stems unusually long; no disbudding is necessary, due to its non-lateral habit. Pkt., 25c.; \$1.00 per large pkt.

AMERICAN BEAUTY

This variety is similar in type of flower and growth to the well-known Late Branching Asters, but differs in that all the large blossoms are produced on much longer and heavier stems.

	Large pkt.	Pkt.		Large pkt.	Pkt.
Azure Fairy.....	\$0.50	\$0.15	Shell Pink.....	\$0.50	\$0.15
Carmine Rose....	.50	.15	White.....	.50	.15
Crimson.....	.50	.15	Mixed.....	.40	.15
Purple.....	.50	.15			

Collection, one packet each 6 colors, 75c.

BALL'S WHITE

A medium type, coming into flower between Royal and Late Branching; grows about 2 feet high, with full centered blossoms; ideal for cutting. Pkt., 25c.; 60c. per large pkt.

BOLTZE'S DWARF BOUQUET

Finest Mixed. A splendid dwarf variety, each plant forming a neat bouquet; excellent for pot culture as well as bedding. Pkt., 10c.; 50c. per large pkt.



Aster, California Giant



Giant California Sunshine Aster

SINGLE GIANT CALIFORNIA SUNSHINE

The plants of this new race grow 3 feet high and bear blossoms on long stems, making them fine for cutting; the individual blooms are enormous, being 4 to 5 inches across. In color, the duo-tone effect is wonderful, with the disk a lovely light yellow and the encircling guard petals in varying shades of apple blossom, deep rose, blue and lavender, there are produced most beautiful color contrasts. We offer seed in mixed colors only. Pkt., 25c.; 75c. per large pkt.

FUSARIUM WILT-RESISTANT STRAINS

We take pleasure in offering the following varieties of Wilt-Resistant Asters. These we believe to be practically immune to this disease. We feel sure that by using this seed many disappointments due to crop failures will be eliminated.

- Improved Queen of the Market.** Crimson, Dark Blue.
- Early Royal Branching.** Azure Blue, Purple, Rose Pink, White, Mixed.
- Improved Crego.** Deep Rose, Shell Pink, Violet, White, Mixed.
- Simple's Branching.** Azure Blue, Deep Rose, Purple, Shell Pink, White, Mixed.
- Ball's White.** A splendid late, large flowered, long stemmed branching type.
- Heart of France.** Ruby Red.

Any of the above varieties, 25c. per pkt.; large pkt., 75c.; \$3.00 per oz.

CALIFORNIA GIANT

The flowers of this variety are of the Crego type, and with the habit of growth and long stems of the Beauty type. Flowers large and stand up well after being cut. Their immense size and beauty as well as their long stems make them very attractive.

	Large pkt.	Pkt.
Dark Purple.....	\$0.75	\$0.25
Deep Rose.....	.75	.25
Light Blue.....	.75	.25
Peach Blossom.....	.75	.25
White.....	.75	.25
Mixed Colors.....	.60	.15

Collection, one packet each of above 5 colors, \$1.00.

CREGO'S GIANT COMET ASTERS

The twisted and curled petals give the flower the appearance of a huge chrysanthemum. The flowers are very large, often measuring 5 inches in diameter.

	Oz.	Large pkt.	Pkt.
Azure Blue	\$2.00	\$0.50	\$0.10
Crimson	2.00	.50	.10
Lavender	2.00	.50	.10
Purple	2.00	.50	.10
Rose Pink	2.00	.50	.10
Shell Pink	2.00	.50	.10
White	2.00	.50	.10
Mixed	1.75	.40	.10

Collection, one packet each 6 colors, 50c.

HEART OF FRANCE

The flowers are large and full to the center; opens ruby red, deepening with age. Plants are of branching type. Pkt., 15c.; 50c. per large pkt.; oz., \$2.25.

KING

A distinct type; plants of strong, sturdy habit, fully 18 inches high; flowers of large size and with long, narrow petals, which are more or less quilled. Choice mixed colors. Pkt., 10c.; 40c. per large pkt.; oz., \$1.50.

MICHELL'S IMPROVED SEMPLE'S BRANCHING

This is the finest late blooming Aster. The deep, heavy incurved flowers are borne on rigid stems often 2 feet and more in length. Our Improved Strain has been secured after many years of careful selection. An excellent variety for cutting or bedding.

	Oz.	Large pkt.	Pkt.
Crimson	\$1.50	\$0.40	\$0.10
Deep Rose	1.50	.40	.10
Lavender	1.50	.40	.10
Lavender Pink	1.50	.40	.10
Purple	1.50	.40	.10
Shell Pink	1.50	.40	.10
White	1.50	.40	.10
Choice Mixed	1.50	.40	.10

Collection, one packet each 6 colors, 50c.

MICHELL'S PINK SUPERB

The flowers are of immense size, petals long and broad, those in the center lie curled and incurved, completely covering the crown; color, a beautiful shade of pink. Per pkt., 25c.; 60c. per large pkt.; oz., \$3.00.

Aster Collection

One packet each, 6 varieties, Early and Late, 50c.



New Giant Peony Flowered Aster

NEW GIANT PEONY FLOWERED

This is an exceptionally fine strain; the flowers are of immense size, very double and borne on long stout stems, quite free from laterals. They are good shippers and keep longer after cutting than any other Aster.

	Oz.	Large pkt.	Pkt.
Azure Fairy. Clear azure blue	\$3.75	\$0.75	\$0.25
Maiden's Blush. Delicate flesh color	3.75	.75	.25
Swansdown. Pure white	3.75	.75	.25

QUEEN OF THE MARKET

Very desirable on account of its earliness and the freedom in which it blooms. Well-formed flowers are produced on 12-inch stems in the greatest profusion early in July.

	Oz.	Large pkt.	Pkt.
Blush Pink	\$1.50	\$0.40	\$0.10
Crimson	1.50	.40	.10
Dark Blue	1.50	.40	.10
Light Blue	1.50	.40	.10
Rose, Pink	1.50	.40	.10
White	1.50	.40	.10
Choice Mixed	1.50	.40	.10

Collection, one packet each of above 6 colors, 50c.

EARLY ROYAL BRANCHING ASTERS

An excellent strain of Early Branching Aster, of the same form and having the same good qualities as the Late Branching variety, but coming into bloom in July or early August.

	Oz.	Large pkt.	Pkt.
Lavender	\$2.25	\$0.50	\$0.10
Purple	2.25	.50	.10
Rose Pink	2.25	.50	.10
Shell Pink	2.25	.50	.10
White	2.25	.50	.10
Mixed	2.00	.50	.10

PERENNIAL ASTER

(Michaelmas Daisy)

One of the showiest of our late flowering, perennial plants; star-like, single flowers; if sown early in Spring will flower the first season.

	Large pkt.	Pkt.
Choice Mixed. Many beautiful shades; 3 feet	\$.60	\$0.10

ASTER ALPINUS

*Alpinus. Purple with large yellow center; 1 foot	.60	.15
*Alpinus Albus. White with large yellow center; 1 foot	.60	.15

Both of the above varieties are excellent for the perennial rock garden.



Improved Semple's Branching Aster



Begonia Semperflorens, Darling

BEGONIA (Semperflorens Type)

The following varieties are unsurpassed for bedding plants, thriving equally well in partially shaded or sunny locations. As pot plants for winter flowering they are superb.

- Darling (Latest Novelty).** This novelty of one of the best known German growers we cannot recommend too highly; plants are of ball shape and dwarf habit; grows about 8 inches high; flowers large and of a brilliant carmine rose; most effective for beds and borders and is also well adapted for growing in pots. Originator's stock..... \$1.00 \$0.35
- Glow (Novelty).** One of the newer introductions and a great favorite in Europe. Flowers dark red, foliage deep bronze; free blooming; compact growth; height about 10 inches. Originator's stock..... 1.00 .25
- Albert Martin.** Bright crimson scarlet; dark foliage; extra large flowers..... .75 .25
- Christmas Cheer.** Flowers bright crimson scarlet and produced in immense quantities; fine for Christmas forcing..... 1.00 .25
- Erfordia.** Delicate pink; one of the choicest..... .75 .15
- Glory of Erfurt (Improved).** Large, rosy carmine; splendid bedder..... 1.25 .25
- Gustav Knaake.** Large flowering pink with salmon shadings; splendid for pot culture..... .75 .25
- Salmon Queen.** Flowers brilliant salmon red; foliage dark green..... .75 .20
- Vernon.** Deep red flowers and bronzy-red foliage... .50 .20
- Choice Mixed.** All colors..... .50 .20

BEGONIA, GRACILIS

One of the finest outdoor flowering Begonias; plants are literally covered with flowers throughout the summer; height, 1 foot. Large pkt. Pkt.

- Gracilis Alba.** Pure white..... \$0.40 \$0.15
- Gracilis Luminosa.** Brilliant fiery dark scarlet... .75 .20
- Gracilis Prima Donna.** Rose, shading to carmine. .75 .20
- Gracilis Rosea.** Light pink..... .40 .15

BEGONIA, TUBEROUS ROOTED

These are very popular because they are of easy culture and extremely showy; thrive in semi-shady situations. Large pkt. Pkt.

- Double Choice Mixed**..... \$1.25 \$0.50
- Single Choice Mixed**..... 1.25 .15

AUBRIETIA (Rainbow Rock Cress)

A dwarf, spring flowering perennial, growing about 6 inches high; fine for rockeries. Large pkt. Pkt.

- ***Bougainvillei.** Dark blue..... \$0.75 \$0.15
- ***Deltoides.** Lavender blue..... .60 .15
- ***Leichtlini.** Rosy purple..... .75 .15
- ***New Large Flowering Hybrids.** Mixed..... .75 .15

AURICULA (Primula Auricula)

***Choice Mixed.** Beautiful low growing, early spring flowering plants; fine for borders, pot culture, etc.; half-hardy perennial; 6 inches; May..... .75 .10

BABY'S BREATH. See Gypsophila

BACHELOR'S BUTTON. See Centaurea and Gomphrena

BALLOON VINE (Love-in-a-Puff)

A rapid growing annual climber; white flowers, followed by seed pods..... Oz. Pkt. \$0.25 \$0.10

DOUBLE BALSAM (Lady's Slipper)

An old and popular garden flower of easy culture; gorgeous masses of brilliant colored double flowers are produced in the greatest profusion; height, 2 feet. Oz. Large pkt. Pkt.

- Camellia Flowered, Choicest Mixed**..... \$0.60 \$0.25 \$0.10

BALSAM APPLE (Mormordica)

Remarkably handsome climbing annuals, bearing ornamental orange-colored fruit..... Large pkt. Pkt. oz., 50c. \$0.25 \$0.10

BAPTISIA (False Indigo)

Australis. A strong growing perennial plant 3 feet high; dark green, deeply cut foliage and spikes of dark blue, pea-shaped flowers in June and July.... .50 .10

BEAN (Runner)

Scarlet. A rapid climber, flowering profusely; grows 10 to 15 ft. high. Per lb., 40c.; 75c. per 2 lbs.; pkt., 5c.

BELLIS PERENNIS. See Daisy

BLUE LACE FLOWER. See Didiscus

BOCCONIA (Plume Poppy)

Cordata. A splendid, hardy perennial, with glaucous green foliage, and bearing freely, spikes 2 to 3 feet long of creamy white flowers; 5 feet..... Large pkt. Pkt. \$0.25 \$0.10

BRACHYCOME (Swan River Daisy)

Iberidifolia. Choice mixed; annual; 12 inches..... oz., \$1.00 .25 .10

BROWALLIA

One of our favorite bedding plants, producing beautiful flowers during the summer and autumn months; blooms finely in the winter if the plants are lifted in the autumn and cut back; 18 inches. Large pkt. Pkt.

- Elata Coerulea.** Large sky-blue flowers..... \$0.30 \$0.10
- Speciosa Major.** Large flowers of brilliant ultramarine blue..... .75 .20

CALCEOLARIA

Excellent plants for decorating the greenhouse or conservatory; produces a mass of pocket-like flowers through the spring and summer. Large pkt. Pkt.

- Albert Kent Hybrids.** A splendid English variety for either greenhouse or outdoor culture; flowers medium in size and produced in large graceful clusters in an excellent mixture..... \$1.25 \$0.50
- Hybrida Grandiflora Tall Mixed.** Large, self-colored flowers from a choice collection; 18 inches... .85 .25
- Hybrida Grandiflora Pumila Compacta.** Of dwarf, compact growth; immense trusses of large self-colored and spotted flowers; 1 foot..... .85 .25
- Rugosa Mixed (Shrubby).** Small flowering varieties for bedding..... .85 .25

CALENDULA (Pot Marigold)

Free flowering showy annuals of easy culture, producing a fine effect in beds or mixed borders; valuable also for pot culture for Winter and Spring blooming; 1 foot.

	Oz.	Large Pkt.	Pkt.
Chrysantha (Sunshine) (Novelty). A new Calendula, which originated in Australia; the flowers bear a striking resemblance to a Chrysanthemum; long stems and large double, clear buttercup-yellow flowers; ideal as a cut flower for interior decorations.		\$0.75	\$0.25
Campfire (Sensation). A splendid new variety of this popular flower; color, brilliant orange, with a scarlet sheen and full yellow center.50	.15
Radio. A late English introduction, a distinct new break; flowers very full, petals quilled; color, rich glowing orange.40	.15
Masterpiece. Fine deep orange, with brown center; of vigorous growth; extra long stems		.60	.25
Michell's Special Forcing, Orange.	\$1.50	.50	.15
Ball's Gold. An extra long stemmed, deep golden yellow.	2.00	.50	.15
Ball's Lemon Queen. Medium deep yellow, with an attractive dark brown center.	2.00	.50	.15
Ball's Orange. Bright, glowing orange.	2.00	.50	.15
Ball's Supreme. Cadmium orange, dark brown center.60	.25
Lemon King. Lemon-yellow.40	.25	.10
Orange King. Rich dark orange.40	.25	.10
Pure Gold. Pure golden yellow.40	.25	.10
Mixed Colors.30		.10

CALIFORNIA POPPY. See *Eschscholtzia*



Calliopsis, Golden Wave



Calendula, Ball's Orange

CALLIOPSIS

ANNUAL VARIETIES

Showy and easily grown annuals; perfect little bushes, which are a mass of bloom from early Summer until cut down by frost; excellent for cutting.

	Oz.	Large Pkt.	Pkt.
Golden Wave (Drummondii). Large yellow flowers with dark brown centers; 1 foot.	\$0.50	\$0.25	\$0.10
Choice Mixed. All varieties and colors.40	.25	.10

COREOPSIS, PERENNIAL. See page 23

CAMPANULA. See next page

CANARY BIRD VINE

(*Tropaeolum Canariense*)

One of the most charming annual climbers, bearing hundreds of pretty, fringed, bright yellow flowers; good for shade. Pkt., 10c.; 40c. per oz.

CANDYTUFT. See next page

CANNA (Indian Shot)

Although these are generally planted from roots, they may be grown with comparative ease from seed. Scrape or file the edge of seed and soak in warm water until they show signs of swelling, then sow in sandy loam and place in a hotbed.

	Oz.	Pkt.
Crozy's Dwarf Mixed. From the finest sorts.	\$0.30	\$0.10

CARDINAL CLIMBER

(*Ipomoea Quamoclit Hybrida*)

A rapid grower and free bloomer; the vines branch freely, growing to a height of 20 to 30 feet. Leaves dark green and deeply lacinated; bears a profusion of fiery, cardinal red flowers. In order to have good germination of the seed, a small notch should be filed or cut in each seed. Per pkt., 10c.; 30c. per large pkt.

Michell's Popular Collections

No. 1.	One packet each 6 choice annuals.	\$0.50
No. 2.	One packet each 13 choice annuals.	1.00
No. 3.	One packet each 6 choice perennials.50
No. 4.	One packet each 13 choice perennials.	1.00

CAMPANULA (Canterbury Bell)

New Annual Single

A new variety which blooms from seed in less than six months; plants grow from 2 to 2½ feet high and each plant produces from 6 to 8 spikes of bloom. Originator's stock seed in a selected mixture only. Pkt., 25c.; 75c. per large pkt.

CAMPANULA MEDIUM (Canterbury Bell)

Showy, hardy biennial, growing about 3 feet high with large bell-shaped flowers. Sow from June 1st till September 1st; when strong enough transplant to a distance of 6 inches apart; after frost has set in protect with leaves and straw. They flower the following Summer, after which they die.

	Oz.	Large Pkt.	Pkt.
Single Blue.....	\$0.75	\$0.25	\$0.10
Single Pink.....	.75	.25	.10
Single White.....	.75	.25	.10
Single Mixed.....	.60	.25	.10
Double Blue.....		.50	.10
Double Pink.....		.50	.10
Double White.....		.50	.10
Double Mixed.....	1.50	.40	.10

CAMPANULAS OR BELLFLOWERS

(Perennial Varieties)

Well known hardy perennials, bearing a profusion of beautiful bell-shaped flowers; thrive best in light rich soil.

	Large pkt.	Pkt.
* <i>Carpatica Blue (Carpathian Hare Bell)</i> . Flowers clear blue; fine for edging; 6 inches.....	\$0.40	\$0.10
* <i>Carpatica Alba</i> . Pure white.....	.40	.10
<i>Latifolia Macrantha</i> . Handsome large, purplish-blue flowers; 2 feet.....	.60	.10
<i>Persicifolia Grandiflora, Blue (Peach Bells)</i> . Spikes 4 feet tall, with immense blue bell-shaped flowers..	.60	.15
<i>Persicifolia Grandiflora, Alba</i> . Pure white.....	.60	.15
<i>Persicifolia Fl. Pl. Moerheimi</i> . Semi-double, pure white; 2 feet.....	1.00	.25
<i>Persicifolia Telham Beauty</i> . Large china blue bells; 2½ feet.....	1.25	.35
<i>Pyramidalis Blue (Chimney Bellflower)</i> . Perfect pyramids 5 feet high, with large bell-shaped flowers	.50	.10
<i>Pyramidalis Alba</i> . White.....	.50	.10
<i>Pyramidalis Mixed</i>40	.10



Campanula Medium, Calycanthema

CAMPANULA MEDIUM CALYCANTHEMA

(Cup and Saucer Canterbury Bell)

These produce beautiful large single flowers resembling a cup and saucer.

	Large pkt.	Pkt.	Large pkt.	Pkt.
Blue.....	\$0.50	\$0.10	Pink.....	\$0.50 \$0.10
Lilac.....	.50	.10	White.....	.50 .10
			Mixed, ¼ oz., 60c.	.40 .10

CANDYTUFT (Iberis)

Dwarf, profuse flowering garden annuals of easy culture; useful for bedding or borders; blooms within eight weeks after sowing; excellent for cutting; height, 1 foot.

	Large Pkt.	Pkt.
* <i>Miniature Gem (Hyacinth Flowered Type)</i> . (Novelty.) A dainty miniature variety, 3½ inches in height; each plant producing from 4 to 6 spikes of pure white flowers; a perfect gem for the rock garden. Originator's stock	\$0.60	\$0.15
<i>Carmine</i>	\$0.50	.25 .10
<i>Crimson</i>50	.25 .10
<i>Empress, or Hyacinth Flowered</i> . An excellent variety with long trusses of pure white flowers.....	.50	.25 .10
<i>Lavender</i>50	.25 .10
<i>Michell's Giant White</i> . Produces immense pure white spikes of bloom; individual bracts are large; fine for forcing under glass for cutting and for pot culture.....	1.00	.30 .10
<i>Pink</i>50	.25 .10
<i>Purple</i> . Deep rich purple.....	.50	.25 .10
<i>Rose Cardinal</i> . Rosy red.....	.75	.25 .10
<i>Choice Mixed</i> . All colors.....	.40	.25 .10
<i>Collection</i> . One packet each, 6 colors.....		.50
* <i>Gibraltarica</i> . Perennial variety; lilac shading to white.....	.40	.10
* <i>Sempervirens</i> . Dwarf spring flowering perennial; flowers glistening white; fine for rockeries; May; 1 foot.....	.60	.10



Candytuft, Michell's Giant White

CARNATION (Annual Varieties)

These are general favorites for their richness of color and delightful fragrance; they are desirable for greenhouse culture in Winter as well as for the garden in Summer.

Rasse Teicher. A new European variety, producing extraordinary large blooms, in a fine range of colors; excellent for cutting; choice mixture. \$1.00 \$0.25

CHABAUD'S GIANT CARNATION

Blooms in five months after being sown and continues to bloom throughout the Summer; flowers of fine substance and usually produce 90 per cent double flowers.

Jeane Dionis. Pure white. \$0.60 \$0.15
Sparkler. Brilliant cardinal red.60 .15
The Pearl. Beautiful rose pink.60 .15
Choice Mixed.50 .15

MARGUERITE CARNATIONS

These are the most satisfactory of the annual pinks, and will bloom in four months after sowing the seed. The flowers are large, fragrant and are produced continuously. If slightly protected they will survive an ordinary Winter and bloom the following Spring.

Choice Mixed. oz., \$2.00 \$0.40 \$0.10

CARNATION (PERENNIAL VARIETIES)

The Grenadin carnation is a splendid early blooming, large flowering type; fine for cut flowers.

Grenadin Black King. A fine dark red. \$0.75 \$0.25
 " **Cardinal.** Brilliant scarlet.75 .25
 " **Triumph Pink.** Pure rose pink.75 .25
 " **White.** Snow white.75 .25
 " **White Gold.** Soft yellow.75 .25
 " **Mixed.**60 .25
Double Border. Dwarf fine mixed.50 .10
Early Vienna Mixed. Large double flowers.50 .10

Ask for our Cultural Leaflet No. 213 on the Growing of Carnations.

CATANANCHE

Coerulea. Perennial; blue with dark eye; excellent for cutting; 2 1/2 feet. \$0.50 \$0.10

CELOSIA CRISTATA (Crested Cockscomb)

Very desirable annuals of easy culture, producing large, brilliant comb-like heads; excellent border plants; 1 to 1 1/2 feet.

Giant Empress. Dwarf; rich crimson. \$0.60 \$0.10
Glasgow Prize. Dwarf; dark crimson.60 .10
Choice Mixed. Dwarf varieties. oz., \$1.50 .40 .10

CELOSIA PLUMOSA (Feathered Cockscomb)

A splendid decorative plant for the garden. The feathery plumes are produced on long stems and are excellent for cutting. Can also be cut and dried for Winter bouquets.

Heatherdell (New Ostrich Plume). A fine new variety, with great trusses of feathered and inter-laced plumes, in a fine range of red, pink and yellow shades mixed; especially adapted for pot culture. . . \$1.00 \$0.25

Childsi (Chinese Woolflower). Plants grow 2 1/2 feet high and produce a large number of ball shaped scarlet flowers, resembling silky wool.50 .10

Childsi, Pink. Same type as above; flowers delicate pink.50 .10

Chrysantheflora. Immense round heads of flowers, in a great variety of colors.50 .15

Golden Plume. Bright golden yellow plumes.25 .10

Pride of Castle Gould. Immense flower heads that closely resemble ostrich plumes. Colors are blood-red, carmine, yellow, orange, golden, orange-scarlet, etc., in mixture.75 .15

Scarlet.25 .10

Rosea. Bright rose.25 .10

Thompson's Superb (Triomphe de l'Exposition). A strain with bronze colored foliage and graceful feathery plumes of brilliant crimson; 3 feet.25 .10

Choicest Mixed. All colors. oz., 75c. .25 .10



Centaurea Imperialis

CENTAUREAS

CENTAUREA CYANUS

(Cornflower or Bachelor's Button)

Also known as Blue Bottle, Ragged Sailor, Bluet, etc.; an old favorite garden annual; excellent for cutting; 2 feet.

	Oz.	Large pkt.	Pkt.
Double Blue.	\$0.60	\$0.25	\$0.10
Double Rose.60	.25	.10
Double Rosy Red.60	.25	.10
Double White.60	.25	.10
Double Mixed.40	.25	.10

CENTAUREA IMPERIALIS

(Giant Cornflower, or Sweet Sultan)

The finest of all Sweet Sultans for cut flower purposes; gigantic, beautiful sweet-scented flowers borne on long stems; 2 to 3 feet.

	Oz.	Large pkt.	Pkt.
Brilliant Pink.	\$0.90	\$0.30	\$0.10
Deep Rose.90	.30	.10
Lavender.90	.30	.10
Lilac.90	.30	.10
Purple.90	.30	.10
White.90	.30	.10
Choice Mixed.75	.25	.10
Collection. One packet each above 6 colors.50

WHITE LEAVED CENTAUREA (Dusty Miller)

Grown for their silvery foliage as edging plants, also for vases, hanging baskets, etc.

Candidissima. Broad cut leaves of silvery gray. . . \$0.50 \$0.10
Gymnocarpa. Fine cut silvery gray foliage.25 .10

VARIOUS CENTAUREAS

	Large pkt.	Pkt.
Americana. Handsome, large thistle-like blooms of a rosy lavender color; 3 feet.	\$0.25	\$0.10
Suaveolens (Yellow Sweet Sultan). Showy, bright yellow fragrant blossoms.25	.10
Dealbata. Perennial; bright rose colored; 18 in.50	.10
Macrocephala. Perennial; golden yellow; 3 feet.30	.10
Montana (Hardy Cornflower). Violet blue; 2 feet.30	.10

CERASTIUM (Snow in Summer)

Large pkt. Pkt.
 ***Tomentosum.** Dwarf, white-leaved edging plant;
 flowers white; perennial; 1 foot. \$0.50 \$0.10

CHEIRANTHUS

Large pkt. Pkt.
 ***Allionii (Siberian Wallflower).** A biennial, but best
 treated as an annual; brilliant orange flowers. \$0.30 \$0.10
Linifolius (Alpine Wallflower). Compact plants
 covered with lilac flowers.40 .10

CHELONE

A very showy perennial bedding plant, June to August, 4 ft.
 Large pkt. Pkt.
Hybrida Torreyi. Brilliant scarlet \$0.30 \$0.10
Hybrida Mixed. Various colors.30 .10

CHRYSANTHEMUM (Annual Varieties)

Exquisitely colored daisy-like flowers with finely cut foliage.
 The following single sorts are of easy culture and splendid for
 cutting. Large pkt. Pkt.
Eastern Star. Primrose, brown eye. \$0.25 \$0.10
Evening Star. Rich golden yellow.25 .10
Morning Star. Canary yellow.25 .10
Northern Star. Giant white, yellow eye.25 .10
Single Mixed. oz., 40c. .25 .10
Double Mixed. oz., 40c. .25 .10

CHRYSANTHEMUM (Perennial Varieties)

Geisha (Cascade or Japanese Balcony). This splendid variety
 makes good pot plants and is also suitable for hanging baskets
 and porch boxes; masses of single flowers in many delicate shades
 of pink, rose, yellow and white and are excellent for cutting.
 Seed sown in March will flower in September and October.
 Mixed colors only. Pkt., 25c.; 75c. per large pkt.
 Large pkt. Pkt.
Colossal Queen. A magnificent variety, extra large,
 pure white flowers; splendid for cutting. \$0.40 \$0.15
Early Flowering Double and Semi-double Mixed.
 A perennial variety, which can also be treated as an
 annual, blooming the first year from seed.75 .25
Japanese Hybrids. Large flowers of the finest single
 types; an extra choice mixture; seed sown in spring
 will produce flowering plants by fall; 2 feet.75 .15
King Edward VII. Flowers extra large, pure white;
 very free flowering.30 .10
Shasta Daisy, New Giant Double White (Novelty).
 A splendid new double perennial; fine for cutting;
 flowers extra large. See illustration page 11.75 .25
Shasta Daisy, "Alaska." Extra large flowers, of
 pure glistening white; 2 feet.40 .10

CLARKIA ELEGANS

A popular annual of easy culture and much used for cutting,
 both indoors and out. Large pkt. Pkt.
Double Purple Prince. Rich purple. \$0.30 \$0.10
 " **Salmon Queen.** Brilliant salmon.30 .10
 " **Scarlet Queen.** Fiery scarlet.30 .10
 " **Vesuvius.** Orange scarlet.30 .10
 " **White.**30 .10
Double Mixed. All colors.25 .10
Single Mixed. All colors.25 .10

CLEMATIS

Paniculata (Japanese Virgin's Bower). A very popu-
 lar hardy climber; the white, star-shaped flowers
 come in masses of bloom in September. Sow seed
 in the Autumn and leave outdoors over Winter.25 .10

CLEOME (Spider Plant)

Pungens. An attractive annual plant with curious
 heads of pink flowers.25 .10

COBAEA SCANDENS (Cup and Saucer Vine)

Well-known climber of rapid growth, producing large, bell-
 shaped blossoms; in sowing, place the seeds edgewise, and merely
 cover with light soil. Large pkt. Pkt.
Purple. oz., 75c. \$0.25 \$0.10
White.30 .10



Cineraria, Multiflora "Weissenseer"

CINERARIA

Most ornamental plants for conservatory or house decoration;
 seed may be sown from May to September for a succession. Our
 strains cannot be surpassed; immense trusses of large flowers.

CREMER'S PRIZE STRAIN

(Novelty) (Wilt Resistant)

This splendid new strain is the result of a cross between
 Cineraria Multiflora Nana, Hybrida Grandiflora and Stellata;
 the flowers are larger than the Multiflora; plants very compact in
 habit with small leaves. Choice mixed colors. Original large
 pkt. only, \$3.00 each.

MULTIFLORA "WEISSENSEER" (White Sea)

A new variety with flowers almost twice the size of the regular
 Multiflora strain; in color, a splendid range of blue, rose and white
 shades, with each individual flower having a decided white zone
 center; plant is of dwarf habit; a most attractive pot plant.
 Originator's stock seed only. Pkt., 50c.; \$1.25 per large pkt.

MULTIFLORA GRANDIFLORA MAXIMA

Flowers extra large, measuring 2 to 3 inches in diameter and
 produced in quantities of 100 blooms and over to a plant; mixed
 colors only. Pkt., 50c.; \$1.00 per large pkt.

MULTIFLORA NANA (Berlin Market Strain)

Very dwarf and compact; flowers of large size, produced in
 great profusion and in a range of the best colors and shades.

Large pkt. Pkt.
Azure Blue. \$0.85 \$0.50
Dark Blue.85 .50
Dark Red.85 .50
Rose.85 .50
Mixed Colors.85 .50

CINERARIA, GRANDIFLORA PRIZE

Large pkt. Pkt.
Dwarf. Mixed colors. \$0.85 \$0.35
Medium Tall. Mixed colors.85 .35
Matador. Large flowering scarlet.85 .35
Stellata Hybrida (Star Cineraria). Tall mixed.75 .25

WHITE LEAVED CINERARIA (Dusty Miller)

Large pkt. Pkt.
Maritima Candidissima. Silvery green, laciniated
 foliage; good for edging. \$0.25 \$0.10

COLEUS

Large Leaved Varieties

Popular bedding plants with beautifully colored foliage; easily
 grown from seed if kept in a warm temperature.

Large pkt. Pkt.
Rainbow Mixture. An excellent mixture. \$1.00 \$0.35
Choice Mixed.75 .25



Double Flowering Coreopsis

COREOPSIS

One of our most popular perennials; the attractive flowers are borne in great profusion and are excellent for cutting.

	Oz.	Large Pkt.	Pkt.
Lanceolata Grandiflora. Single golden yellow flowers of graceful form.....	\$0.50	\$0.25	\$0.10
Lanceolata Grandiflora Fl. Pl. (<i>Double Flowering Coreopsis</i>). Similar in habit to the above; flowers double and semi-double; splendid for cutting.....		.30	.10

COSMOS

One of the most beautiful and useful of hardy annuals, producing large showy flowers in great profusion; excellent for cutting.

SINGLE EARLY FLOWERING COSMOS

This new Early Flowering Strain will begin blooming as early as July and will continue until frost; flowers large, often measuring 3 inches across; 4 feet.

	Oz.	Large pkt.	Pkt.
Extra Early Express Pink. An extra early dwarf variety, 2 to 3 feet high; medium size, bright pink flowers.....		\$0.40	\$0.15
Extra Early Express Mixed40	.15
Crimson	\$0.60	.25	.10
Pink60	.25	.10
White60	.25	.10
Mixed50	.25	.10

DOUBLE EARLY FLOWERING COSMOS

This new Early Flowering Strain will begin blooming in July and continue until frost.

	Oz.	Large pkt.	Pkt.
Double Early Flowering, Crimson	\$0.60	\$0.25	
“ “ “ Pink60	.25	
“ “ “ White60	.25	
“ “ “ Mixed50	.25	

DOUBLE LATE FLOWERING COSMOS

These, which are of recent introduction, are becoming more popular each season. Excellent for cutting.

	Oz.	Large pkt.	Pkt.
Double Crested Crimson	\$0.50	\$0.15	
Double Crested Pink Beauty50	.15	
Double Crested White Queen. Pure white.....	.50	.15	
Double Crested Mixed40	.15	

SINGLE LATE FLOWERING COSMOS

Large flowers of perfect form, on long stems and lasting until frost; 5 to 6 feet.

	Oz.	Large pkt.	Pkt.
Giant Crimson	\$0.50	\$0.25	\$0.10
“ Pink50	.25	.10
“ White50	.25	.10
“ Mixed40	.25	.10
Giant Lady Lenox. Shell pink.....	.50	.25	.10
Giant White Lady50	.25	.10
Klondyke. Golden yellow flowers; 2 ft.....	1.25	.30	.10

CONVOLVULUS (Morning Glory)

MAJOR, OR TALL VARIETIES

One of the most popular annual climbers, growing about 15 feet in height and thriving in almost any situation.

Japanese Imperial. Flowers of immense size and of a great variety of colors.....	Oz. \$0.25	Pkt. \$0.10
Japanese Imperial Fringed. Large fringed flowers of many beautiful colors and shades.....	.30	.10
Mixed. The old fashioned variety.....	.20	.10

CUPHEA (Cigar Plant)

Large pkt. Pkt.

Platycentra. A pretty half-hardy perennial; fine for the border or as a pot plant; long, tube-shaped scarlet flowers with black and white lip.....

CYCLAMEN

Beautiful Winter and Spring flowering plants for the window and greenhouse. Not only are the flowers of striking beauty, but the foliage is also highly ornamental.

MICHELL'S GIANT SHOW

Grown for us by a specialist who has received numerous first prizes for the large size and beautiful coloring of the flowers.

	100 seeds	Pkt.
Orange Beauty (Novelty). Orange vermilion.....	\$3.00	\$0.50
America. Salmon scarlet.....	2.50	.50
Bonfire (Novelty). Brilliant scarlet.....	2.50	.50
Bright Red	2.00	.50
Dark Blood Red	2.00	.50
Glory of Wandsbek. Salmon red.....	2.25	.50
Improved Salmon Rose	2.50	.50
Lavender. Bright lavender.....	2.00	.50
Mozart (Novelty). Deep pink.....	3.00	.50
Rose of Zehlfendorf. Salmon pink.....	2.25	.50
Pure White	2.00	.50
Rose of Marienthal. Bright pink.....	2.00	.50
Safranin Red	2.25	.50
Salmon Purple	2.25	.50
White with Carmine Eye	2.00	.50
Mixed. All colors.....	2.00	.40



Michell's Giant Flowering Cosmos



CYNOGLOSSUM (Chinese Forget-Me-Not)

Large pkt. Pkt.

Amabile. An annual of easy culture, producing sprays of intense blue Forget-me-not-like flowers, which are very fragrant; 2 feet. \$0.25 \$0.10

CYPERUS (Umbrella Plant)

Alternifolius. An elegant plant for growing in water or damp places; useful as a pot plant.50 .10

CYPRESS VINE (Ipomoea Quamoclit)

A very graceful twining annual climber, with delicate fern-like foliage. Seed should be soaked for a few hours in warm water before sowing; 15 feet. Oz. Large pkt. Pkt. Mixed. \$0.40 \$0.25 \$0.10

DAHLIAS (From Seed)

There is no more fascinating flower to raise from seed than the Dahlia, for the result is a series of surprises.

DOUBLE FLOWERING VARIETIES

Large pkt. Pkt.

California Giants. A selection from named varieties, grown by a celebrated producer in California. \$1.25 \$0.50
Cactus. Choice mixed, from the best varieties.75 .10
Large Flowering (Show Type). Mixed; extra fine. . . .60 .10
Pompon. A choice mixture from 15 leading and distinct varieties.1.00 .25
Unwin's Dwarf Hybrids Mixed (Novelty). Miniature, early flowering semi-double hybrids, 18 to 24 inches high, in a wide range of colors; splendid for bedding; requires no stakes and may be planted 18 to 20 inches apart.75 .25

SINGLE FLOWERING VARIETIES

Coltness, Scarlet Gem. A splendid dwarf bedding type; plants are covered with bright, single scarlet flowers.75 .25
Coltness Hybrids. Choice mixed colors.75 .25
Giant Perfection. Immense single flowers of various colors and shades.30 .10

DAISY, ENGLISH DOUBLE (Bellis Perennis)

These are favorite perennials; seed may be sown any time from Spring till August, transplanted in the Fall and protected during the Winter, and they will flower the following Spring. The Monstrosa varieties surpass all other strains in robust growth and in the abundance of extra large double flowers. Large pkt. Pkt.

***Monstrosa, Etna.** Dark red. \$0.75 \$0.25
 ***Monstrosa, Pink.**60 .25
 ***Monstrosa, White.**60 .25
 ***Monstrosa, Mixed.**60 .25
 ***Double Mixed.** Extra fine.50 .10

DIANTHUS. See next page.

DICTAMNUS (Gas Plant)

Large pkt. Pkt.

Fraxinella. Showy, bushy perennials, 2½ feet high; purple red flowers; June and July. \$0.60 \$0.10

DIDISCUS

Coeruleus (Blue Lace Flower). An easily grown annual which is becoming very popular; the plant grows about 18 inches high and produces attractive, umbel-shaped flowers of lace-like appearance; the color is a delicate azure blue; excellent for cutting. Per pkt., 10c.; 40c. per large pkt.

DIGITALIS (Foxglove)

Ornamental hardy plants, succeeding almost anywhere; long spikes of beautiful, tubular-shaped flowers; 4 to 5 feet.

Giant Shirley Mixed. A splendid giant strain, growing 3 to 5 feet high, with enormous spiked flowers. Large Pkt. Pkt. Oz. \$0.40 \$0.10
Gloxiniaeflora, Pink. \$0.90 .30 .10
 " **Purple**90 .30 .10
 " **White**90 .30 .10
 " **Mixed**75 .25 .10
Grandiflora. Light yellow. 1.25 .30 .10
Maculata Superba. A beautiful spotted variety. 1.25 .30 .15
Monstrosa. Mammoth spikes; various colors 1.25 .30 .15



Delphinium, Blackmore and Langdon's

DELPHINIUM (Hardy Perennial Larkspur)

One of the finest hardy perennials. Very effective in beds, masses or borders. To prolong the season of bloom, cut the old flower stems off after they have faded and new shoots will produce flower heads successively.

Large Pkt. Pkt.

English Hollyhock (Watkin Samuel's Wrexham Strain). The finest large flowered type to date; immense spikes. Large Pkt. Pkt.
Art Shades. \$1.25 \$0.50
Deep Blue Shades. 1.25 .50
Light Blue Shades. 1.25 .50
Selected Mixture. (1/8 oz., \$1.50) 1.00 .50
Blackmore and Langdon's. A selected English variety; immense spikes; very large flowers; choice mixture. 1.00 .25
Belladonna. One of the most continuous blooming varieties; immense spikes of clear turquoise blue; 5 feet.60 .25
Bellamosum. A rich, deep blue form of the popular light blue Belladonna.60 .25
Cardinale. Very large flowers; color brilliant scarlet; 3 to 4 feet.75 .25
Chinese Grandiflorum Blue. A dwarf strain with loose branches and sprays of bright blue flowers; 2 feet (oz., \$1.25).30 .10
Chinese Grandiflorum Album. Pure white flowers (oz., \$1.25).30 .10
Gold Medal Hybrids. Produces long spikes of large flowers. An extra fine strain containing many shades of blue (oz., \$1.50).40 .10
Iceberg. A new pure white variety, which comes true from seed; strong, healthy grower, producing 4 foot spikes; a decided novelty. 1.00 .50
Blue Butterfly. An annual variety of an exquisite deep blue (oz., \$2.25).40 .15
White Butterfly. Annual variety (oz., \$2.25).40 .15



Hardy Garden Pinks

DIANTHUS (Pinks)

Easily raised from seed, flower abundantly and continuously until frost; very effective in the garden and splendid for cutting.

DIANTHUS, SWEET WIVELSFIELD

This new annual is a hybrid, being a cross between Dianthus Alwoodi and Sweet William; seed started indoors in January and planted out in April will commence to flower in May, blooming profusely all Summer in a great variation of colors. \$0.50 \$0.15

DOUBLE ANNUAL SORTS

- *Chinensis, Tom Thumb, Brilliant. Double scarlet; a beautiful little edging or border plant which should be better known; a perfect gem for the rock garden. \$0.60 \$0.15
- Chinensis (China or India Pink). All colors mixed. oz., 60c. .25 .10
- Fringed. Large flowers; mixed. oz., \$1.00 .25 .10
- Japan Pink. Choice mixed. oz., 75c. .25 .10

SINGLE ANNUAL SORTS

- Japan Pink. All colors mixed. oz., 75c. .25 .10

HARDY GARDEN PINKS

Elegant Summer flowering border plants, producing a wealth of deliciously fragrant flowers. Large pkt. Pkt.

- *Alwoodi Alpinus. A perfect gem for the rock garden; 4 to 6 inches high; choice colors. (100 seeds, \$1.50) \$0.75
- *Plumarius Cyclops. Single perpetual Grass Pinks; assorted colors with blood red eye. \$0.40 .15
- *Caesius (Cheddar Pink). Produces masses of pink flowers; splendid for rockeries.40 .10
- Clove Scented. Double and semi-double varieties, in beautiful colors; fragrant.50 .10
- *Deltoides, Brilliant (Maiden Pink). Dwarf brilliant carmine.60 .15
- Double Scotch. Choice colors.50 .10
- Latifolius Atrococcineus Fl. Pl. (Everblooming Hybrid Sweet William). Free flowering; velvety crimson scarlet; double.30 .10
- Pheasant's Eye. Single fringed flowers; mixed colors oz., 75c. .25 .10
- *Dianthus, Rock Garden Species. A special mixture of 25 rare varieties well adapted for rock gardens.75 .25

DIMORPHOTHECA

- Aurantiaca (African Orange Daisy). One of the showiest garden annuals; bushy plants with orange-gold daisy-like blooms on long stems. \$0.30 \$0.10
- Aurantiaca Hybrida. A splendid mixture of colors and shades.30 .10

DOLICHOS (Hyacinth Bean)

- Rapid growing annual climber, bearing a profusion of bean-like flowers; excellent for arbors, trellises, etc. Oz. Pkt.
- Choice Mixed. \$0.20 \$0.10

DRACAENA

Ornamental plants for vases or conservatory decoration.

- Australis. Broad green leaves. \$0.30 \$0.10
- Indivisa. Narrow green leaves. oz., 60c. .25 .10

DUSTY MILLER. See Centaurea and Cineraria Maritima

ECHINOCYSTIS (Wild Cucumber Vine)

- Lobata. One of the quickest growing vines, excellent for covering trellises, fences, etc. oz., 30c. .10

ECHINOPS (Globe Thistle)

- Ritro. Hardy perennial with thistle-like leaves and round heads of steel blue flowers; 5 feet.25 .10

EDELWEISS (Leontopodium)

- *Alpinum. A splendid perennial rock plant, with silvery white flowers. 1.00 .25

ERIGERON (Flea Bane)

- Speciosus Hybridus Grandiflorus. A Summer flowering perennial plant, with large rosy lilac, aster-like flowers; 2 feet.50 .10

ERINUS

- *Alpinus, Mixed. A fine Spring blooming perennial rock plant. 1.00 .25

ERYNGIUM (Sea Holly)

A handsome ornamental perennial plant, with round heads of flowers, which can be cut and dried for Winter bouquets.

- Amethystinum. Metallic blue flowers; 3 feet. . . . \$0.60 \$0.15
- Planum. Pale blue; 4 feet.25 .10

ESCHSCHOLTZIA (California Poppy)

An elegant hardy annual with fine cut foliage and large Poppy-like flowers; in bloom from June until frost; fine for borders or large beds; 1 foot. Large pkt. Pkt.

- Californica. Pure yellow. oz., 40c. \$0.25 \$0.10
- Golden West. Large golden yellow flowers. oz., 40c. .25 .10
- Mauve Beauty. Lavender mauve. oz., \$1.00 .30 .10
- Rose Cardinal. Carmine rose. oz., 40c. .25 .10
- Vesuvius. Rich wallflower or coppery red. oz., 90c. .30 .10
- White. oz., 40c. .25 .10
- Choice Mixed. oz., 40c. .25 .10
- Collection, one packet each, 6 varieties.50

EUPATORIUM

- Fraseri. A fine hardy perennial, thriving in almost any situation; feathery white flowers; excellent for cutting; 3 feet.30 .10

EUPHORBIA

Annual plants suitable for beds of tall growing plants or mixed borders; showy ornamental foliage; height, 2 to 3 feet. Large pkt. Pkt.

- Heterophylla (Mexican Fire Plant). Glossy green leaves turning to orange scarlet in mid-season. . . . \$0.30 \$0.10
- Variegata (Snow on the Mountain). Foliage veined and margined with white. oz., 60c. .25 .10

EXACUM

- Affine. Fragrant, light blue flowers; plants very dwarf; excellent for pots and baskets. 1.25 .50

EVERLASTING FLOWERS

These should be grown in every garden, not only for Summer blooming, but also as dried cut flowers for Winter decoration.

ACROCLINIUM

Showy, free-flowering annual plants; excellent for cutting; 1 foot. Large pkt. Pkt.
Double Rose Pink.....\$0.25 \$0.10
Double White......25 .10
Double Mixed......25 .10

GOMPHRENA (Globe Amaranth)

Also called "Bachelor's Buttons"; a showy annual everlasting.
 Oz. Large pkt. Pkt.
Golden Yellow.....\$0.75 \$0.30 \$0.10
Nana Compacta. Dwarf red; 1 foot..... .50 .25 .10
Mixed. All colors; 2 feet..... .50 .25 .10

HELICHRYSUM MONSTROSUM (Strawflower)

One of the best and most popular of the everlasting flowers; large double flowers; 2 feet. Oz. Large pkt. Pkt.
Rose Queen. Immense flowers of a rich deep rose.....\$0.90 \$0.30 \$0.10
Buttercup. Canary yellow..... .90 .30 .10
Fireball. Crimson..... .90 .30 .10
Golden Ball. Golden yellow..... .90 .30 .10
Rose Carmine......90 .30 .10
Salmon Pink......90 .30 .10
Silver Ball. White......90 .30 .10
Violet......90 .30 .10
Choice Mixed......75 .25 .10
 Collection, one packet each six colors, 50c.

RHODANTHE (Swan River Everlasting)

Large pkt. Pkt.
Mixed Colors. A beautiful annual, for the garden or for pot culture; 1 foot.....\$0.25 \$0.10

XERANTHEMUM (Immortelle)

Double Mixed. Showy annual, producing a profusion of flowers..... .25 .10

FERN SPORES

The following are not hardy and only suitable for house or greenhouse culture.

Large pkt. Pkt.
Adiantum (Maiden Hair). Mixed.....\$1.00 \$0.15
Pteris Varieties. Mixed.....1.00 .15
All Sorts Mixed. Choice collection.....1.00 .15
 We can also furnish all other good varieties of fern spores.



Gaillardia, Grandiflora Portola Hybrids



Helichrysum Monstrosum

FEVERFEW. See *Matricaria*
FORGET-ME-NOT. See *Myosotis*
FOUR O'CLOCK. See *Marvel of Peru*
FOXGLOVE. See *Digitalis*

GAILLARDIA (Blanket Flower)

ANNUAL VARIETIES

Splendid showy annuals for beds or borders, excellent for cutting; blooms continuously from early Summer until November; 15 to 18 inches. Large pkt. Pkt.
Picta Lorenziana. Double mixed.....oz., 60c.\$0.25 \$0.10
Picta Mixed. Single sorts.....oz., 60c. .25 .10

PERENNIAL VARIETIES

One of the most showy of hardy perennials, blooming the first year from seed if sown early; 2 feet. Large pkt. Pkt.
Grandiflora Portola Hybrids. Flowers of immense size; colors range through shades of bronzy red with golden tipped petals.....\$0.50 \$0.15
Grandiflora Tangerine. Giant orange flowers, overlaid with red......60 .25
Grandiflora Compacta. A compact variety; choice mixed colors; 12 to 15 inches.....oz., \$1.25 .30 .10
Grandiflora Sanguinea. Blood red flowers......30 .10
Grandiflora Semi-Double. Mixed......30 .10
Grandiflora Superba. Mixed colors.....oz., 75c. .25 .10

GENTIANA (Blue Gentian)

***Acaulis.** Dwarf hardy perennial; deep blue flowers; suited to moist, shady situations......75 .10

GERANIUM

100 seeds Pkt.
Apple Scented. Highly esteemed on account of its fern-like fragrant foliage; 1 foot.....\$0.75 \$0.10
Pelargonium (Lady Washington). Seed saved from the largest flowered show varieties..... 3.50 .25
 Large pkt. Pkt.
Zonale Mixed. A superb strain of the largest and finest varieties; 1 to 2 feet.....\$0.50 \$0.10

GERBERA (Transvaal Daisy) 100 Seeds Pkt.

Jamesoni Hybrida. Splendid greenhouse perennial with large, fine-leaved, daisy-like flowers. These hybrids include a wonderful range of brilliant colors and shades; splendid for pot plants or cutting. . . . \$0.60 \$0.25

GEUM

Beautiful hardy perennials bearing large, showy double flowers all through the Summer; fine for bouquets; 1 1/2 feet.

	Large pkt.	Pkt.
Atrosanguineum Fl. Pl. Dark crimson.	\$0.50	\$0.10
Borisii. Brilliant scarlet, with neat tops of evergreen foliage; 16 inches.75	.25
Lady Stratheden. Golden yellow.75	.25
Mrs. Bradshaw. Brilliant scarlet.60	.15

GILIA

Capitata. A very graceful annual, growing about 2 feet high; lavender-blue flowers; excellent for cutting.25 .10

GLOBULARIA (Globe Daisy)

Tricosantha. Shrubby perennial plants, with fluffy balls of pale blue flowers; 12 inches. 1.00 .25

GLOXINIA

Hybrida Grandiflora. Excellent greenhouse plants with flowers of the richest colors. Our seed is saved from selected plants of a collection grown by a celebrated German specialist.85 .25

GODETIA (Satin Flower)

Beautiful and easily grown annuals producing a profusion of flowers of satiny texture.

	Large pkt.	Pkt.
Azaleaflora. Dwarf double; bright carmine color; excellent for pot culture and can really be called a miniature Azalea.	\$0.40	\$0.15
Choice Mixed. All colors.25	.10

GOMPHRENA (Globe Amaranth)

See Everlastings, page 26.

GOURD (Ornamental)

Rapid growing, interesting annual climbers with ornamental foliage and singular shaped fruit; 15 to 20 feet.

	Oz.	Large pkt.	Pkt.
Large Sorts Mixed	\$0.40	\$0.25	\$0.10
Small Sorts Mixed40	.25	.10

GRASSES (Ornamental)

These are very interesting and useful, either for growing in clumps, mixed borders or in shrubberies. Also when dried they are fine for winter bouquets and decorations, for which purpose they should be gathered before fully matured.

COIX LACHRYMAE (Job's Tears)

A strong, broad leaved ornamental grass, with large shining, pearly seeds; annual; 2 to 3 feet. . . oz., 20c. \$0.10

PENNISSETUM

Longistylum. Graceful greenish-white plumes; fine for bordering beds; 2 feet; annual.	\$0.25	.10
Ruppelianum (Purple Fountain Grass). Excellent as an edging to beds of tall plants; purple plumes; 3 feet; annual.25	.10

GREVILLEA (Silk Oak)

Robusta. A beautiful and graceful decorative plant with fern-like foliage; excellent for table decoration. (oz., \$1.00)30 .10



Gypsophila, Elegans Alba Grandiflora

GYPSOPHILA (Baby's Breath)

Pretty, free-flowering plants of easy culture; excellent for cutting to mix with other flowers; 2 feet.

	Oz.	Large pkt.	Pkt.
Elegans Alba Grandiflora (True Paris Market Strain). A splendid annual variety; delicate sprays of pure white flowers.	\$0.25		\$0.10
Elegans Carminea. Bright carmine rose.30		.10
Elegans Rosea. Pink.30		.10
Paniculata. Hardy perennial variety; flowers in graceful sprays of white.60	\$0.25	.10
Paniculata Fl. Pl. Perennial, with a profusion of double white flowers and coming 30 to 40 per cent true.75	.20
*Repens. A pretty dwarf, trailing perennial plant for the rockery; tiny white flowers.40	.10
*Repens Rosea. Pinkish white flowers.40	.10

HELENIUM (Sneeze Wort)

Autumnale Superbum. Hardy perennial; large heads of golden yellow flowers; blooms in late Summer and Autumn; 3 feet. \$0.60 \$0.10

HELIANTHEMUM (Rock, or Sun Rose)

***Mutabile.** A very pretty perennial for the rockery; completely covered with masses of bloom from May to June; choice mixed varieties; 8 inches.40 .15

HELIANTHUS. See Next Page

HELICHRYSUM (Strawflower)

See Everlastings, page 26.

HELIOPSIS (Orange Sunflower)

A handsome hardy perennial; excellent for cutting.

Pitcheriana. Deep yellow; 3 to 4 feet.25	.10
Scabra Zinniaeflora. Semi-double, yellow; 3 feet.30	.10
Soleil d'Or. Double golden yellow; 5 feet.30	.10

HELLEBORUS

Niger (Christmas Rose). Perennial; 15 inches; seed germinates slowly.40 .10

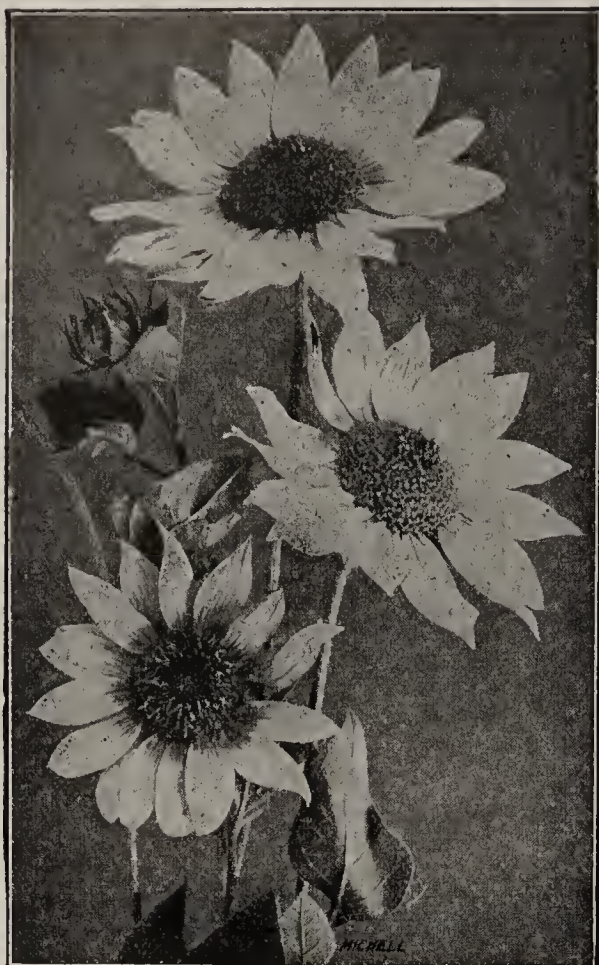

Helianthus (Sunflower), Stella

HELIANTHUS (Sunflower)

Well known and popular plants, the small flowering sorts being useful for cutting; the tall varieties are valuable for backgrounds.

ANNUAL VARIETIES

Small Flowered Sorts

	Large pkt.	Pkt.
Cut-and-Come-Again. Single golden yellow flowers, with petals twisted like a Cactus Dahlia. .oz., 40c.	\$0.25	\$0.10
Stella. Single, golden yellow flowers with black centers; invaluable for cutting; 4 feet. . . .oz., 40c.	.25	.10

Large Flowered Sorts

Chrysanthemum Flowered. Large double golden yellow flowers, resembling Chrysanthemums; 7 feet.oz., 60c.	.25	.10
Double Globe (Globosus Fistulosus). Large double yellow flowers; height, 6 feet.oz., 40c.	.25	.10
Dwarf Double (Globe of Gold). Yellow flowers; 3 feet.oz., 40c.	.25	.10
New Red. Extra large flowers, some of which are rich chestnut red, others tipped with yellow. . . .oz., 60c.	.25	.10
Russian Mammoth. Immense single yellow flowers on tall heavy stalks; 6 feet.oz., 15c.	.10	

PERENNIAL VARIETIES

Maximilianus. Early flowering yellow; 3 feet.75	.15
Perennial Varieties Mixed. 3 to 4 feet.75	.15

HELIOTROPE

A well-known and highly prized plant on account of the delightful fragrance of the flowers; seed started indoors in the Spring will make fine plants for Summer blooming; can also be sown outdoors in May; excellent for pots, or for bedding; 18 inches.

	Large pkt.	Pkt.
Lemoine's Giant. Produces very large heads of flowers; mixed colors.	\$0.60	\$0.15
Regal. Of dwarf compact growth; immense flowers, all shades.60	.15
Choice Mixed. In great variety.40	.10

HEUCHERA (Coral Bells or Alum Root)

A fine hardy perennial and excellent for cutting.

	Large pkt.	Pkt.
Brizoides. Bright rose color; 2½ feet.	\$0.75	\$0.15
Sanguinea. Vivid crimson flowers; 1 foot.75	.15

HIBISCUS (Marshmallow)

Giant Mixed. Showy ornamental perennial plants for mixed beds or shrubbery borders.25	.10
--	-----	-----

HOLLYHOCK

A popular and desirable hardy perennial plant succeeding best in rich well-drained soil; excellent for planting among shrubbery or forming a background for other flowers; seed sown any time before midsummer will produce fine plants for blooming the following summer; 6 to 7 feet.

Triumph (New). A splendid type of branching habit, 4 to 5 feet high and flowering 10 days earlier than the regular type; choice mixed colors. Pkt., 25c.; 75c. per large pkt.

Allegheny. Semi-double, mammoth flowers; petals fringed; mixed. Pkt., 10c.; 30c. per large pkt.; oz., \$1.25.

Chater's Double Maroon. Pkt., 10c.; 50c. per large pkt.; oz., \$2.00.

Chater's Double Newport Pink. Pure pink. Pkt., 10c.; 50c. per large pkt.; oz., \$2.25.

Chater's Double Pink. Pkt., 10c.; 50c. per large pkt.; oz., \$2.00.

Chater's Double Red. Pkt., 10c.; 50c. per large pkt.; oz., \$2.00.

Chater's Double Salmon. Pkt., 10c.; 50c. per large pkt.; oz., \$2.00.

Chater's Double White. Pkt., 10c.; 50c. per large pkt.; oz., \$2.00.

Chater's Double Yellow. Pkt., 10c.; 50c. per large pkt.; oz., \$2.00.

Chater's Double Mixed. Pkt., 10c.; 40c. per large pkt.; oz., \$1.50.

Collection, one packet each 6 colors, 50c.



Hollyhock, Chater's Double

ANNUAL EVER-BLOOMING HOLLYHOCK

While these are also hardy perennial varieties, if seed is sown in the house in March or April they will bloom the first season. **Double Ever-blooming Mixed.** Pkt., 10c.; 40c. per large pkt.; oz., \$1.50.

SINGLE HOLLYHOCK

	Oz.	Large pkt.	Pkt.
Chamois.	\$1.50	\$0.40	\$0.10
Mauve.	1.50	.40	.10
Pink.	1.50	.40	.10
Rose.	1.50	.40	.10
Scarlet.	1.50	.40	.10
White.	1.50	.40	.10
Yellow.	1.50	.40	.10
Mixed.75	.25	.10

HONESTY (Moonwort)

Biennis Alba. Hardy biennial admired for its silvery seed pods; beautiful and curious; 2 feet . . . \$0.30 \$0.10

HUMULUS (Japanese Hop)

	Oz.	Large pkt.	Pkt.
Japonicus Variegatus. A rapid growing annual climber; leaves beautifully mottled and splashed silvery white, light and dark green, excellent for covering verandas, trellises, etc.	\$1.00	\$0.25	\$0.10



Larkspur, Tall Double Stock Flowered

LARKSPUR (Annual)

Of easy culture; seed sown early in Spring will produce blooming plants by July; fern-like foliage and slender spikes with double rosette flowers; fine for cutting or garden decoration.

**EMPEROR DWARF BRANCHING
Double Stock Flowered**

- | | | |
|--|------------|--------|
| | Large pkt. | Pkt. |
| Enchantress (Novelty). A splendid new variety suitable for bedding or pots; colors, soft salmon pink; plants compact and about 2 feet high, making an excellent garden plant..... | \$0.60 | \$0.25 |
| Pink Delight. For bedding or pots; compact growth; color, soft rose-pink; 2 feet..... | .40 | .15 |

GIANT IMPERIAL

This new group of Larkspur is identical in branching habit with the Giant Imperial Stock; flowers very double; plants of strong, robust growth.

- | | | |
|---|------------|--------|
| | Large pkt. | Pkt. |
| Blue Spire. An intense deep oxford blue..... | \$0.40 | \$0.15 |
| Lilac Spire. Bright lilac..... | .40 | .15 |
| White Spire. A dazzling pure white..... | .40 | .15 |
| Carmine King. Rich carmine..... | .40 | .15 |
| Exquisite Rose. A beautiful shade of rose pink.... | .40 | .15 |
| Choice Mixed | .40 | .15 |

TALL DOUBLE STOCK FLOWERED

Plants branch freely, bearing long spikes of beautiful double flowers; height, 2 1/2 feet. Oz. Large pkt. Pkt.

- | | | |
|--|--------|---------|
| Los Angeles. This splendid variety is the best of its color, a pleasing rich salmon overlaid with brilliant rose..... | \$0.40 | \$0.15 |
| Exquisite Pink. An extra fine variety; a beautiful soft pink shade..... | .25 | .10 |
| Dark Blue | \$0.75 | .25 .10 |
| Lilac | .75 | .25 .10 |
| Lustrous Carmine (Newport Pink) | .75 | .25 .10 |
| Shell Pink | .75 | .25 .10 |
| Sky Blue | .75 | .25 .10 |
| White | .75 | .25 .10 |
| Mixed. All colors..... | .60 | .25 .10 |

IMPROVED GIANT HYACINTH FLOWERED

These grow about 4 feet in height and are especially adapted for growing under glass. Oz. Large pkt. Pkt.

- | | | |
|------------------------|--------|---------------|
| Dark Blue | \$1.00 | \$0.30 \$0.10 |
| Lilac | 1.00 | .30 .10 |
| Pink | 1.00 | .30 .10 |
| White | 1.00 | .30 .10 |
| Mixed | .75 | .25 .10 |

TALL BRANCHING SINGLE

- | | | |
|---------------------------|--------|--------|
| Mixed colors | \$0.25 | \$0.10 |
|---------------------------|--------|--------|

DWARF DOUBLE ROCKET

- | | | |
|--|--------|---------------|
| Mixed. A compact bushy plant; 1 foot..... | \$0.75 | \$0.25 \$0.10 |
|--|--------|---------------|

LATHYRUS LATIFOLIUS

(Everlasting or Perennial Pea)

Showy hardy perennial climber, for covering walls, stumps, fences, etc. Free flowering, excellent for cutting; 6 to 8 feet. Oz. Large pkt. Pkt.

- | | | |
|---|--------|---------------|
| Crimson. Brilliant..... | \$1.25 | \$0.30 \$0.10 |
| Pink Beauty. Bright rosy-pink..... | 1.25 | .30 .10 |
| White | 1.25 | .30 .10 |
| Choice Mixed. All colors..... | 1.00 | .25 .10 |

LAVENDER (Lavendula Vera)

- | | | |
|---|-----------|---------------|
| Well-known, hardy perennial, bearing long spikes of fragrant blue flowers; 18 inches | oz., 75c. | \$0.25 \$0.10 |
|---|-----------|---------------|

HUNNEMANNIA (Giant Yellow Tulip Poppy)

Large pkt. Pkt.

- | | | |
|---|-------------|---------------|
| Fumariaefolia. Seed sown outdoors in May, produces large quantities of giant yellow tulip-like flowers during end of July, continuing for the balance of the season; height, 1 foot..... | oz., \$1.00 | \$0.25 \$0.10 |
|---|-------------|---------------|

IMPATIENS (Sultan's Balsam)

A charming plant for house and conservatory decorations, flowering profusely and almost continuously. Large pkt. Pkt.

- | | | |
|--|--------|--------|
| Holstii. Flowers large; vermilion red..... | \$0.75 | \$0.20 |
| Holstii, "New Hybrids." Choice mixed colors.... | .75 | .15 |
| Sultani. Bright rose..... | .75 | .15 |
| Sultani Hybrids. Various colors..... | .75 | .15 |

INCARVILLEA

- | | | |
|---|-----|-----|
| Delavayi (Hardy Gloxinia). A good plant for the hardy border; masses of showy Gloxinia-like flowers; should be protected over the Winter; perennial; 2 feet..... | .75 | .25 |
|---|-----|-----|

IPOMOEA

- | | | |
|---|-------------|---------|
| Heavenly Blue (Rubra Coerulea). Beautiful large sky-blue flowers..... | oz., \$1.00 | .30 .10 |
| Noctiflora (Moon Flower). At night and during dull days the plants are covered with an abundance of large pure white fragrant flowers..... | oz., 50c. | .25 .10 |
| Setosa (Brazilian Morning Glory). Large leaves and bright rose-colored flowers..... | oz., 50c. | .25 .10 |
| Mixed. Various colors..... | oz., 50c. | .25 .10 |

IRIS (Flowering Flag)

- | | | |
|--|-----|-----|
| Kaempferi (Japanese Iris). Perennial; blooms the second year from seed; mixed colors; 3 feet..... | .25 | .10 |
|--|-----|-----|

JOB'S TEARS. See Grasses, Page 27

KENILWORTH IVY. See Linaria

KOCHIA (Summer Cypress)

- | | | |
|---|-----------|---------|
| Childsii. An easily grown annual, which forms a cypress-like hedge, with feathery green foliage; at the approach of autumn the foliage turns to a deep red color; 2 to 3 feet..... | oz., 40c. | .25 .10 |
|---|-----------|---------|

LADY SLIPPER. See Balsam

LEPTOSYNE

One of the quickest growing annuals, blooming in 5 weeks after sowing the seed; excellent for cutting.

	Large pkt.	Pkt.
Maritima. Large lemon yellow Marguerite-like flowers; 3 feet.....	\$0.30	\$0.10
Stillmani. Golden yellow; 18 inches.....	.30	.10

LIATRIS (Blazing Star)

Pycnostachya. A showy hardy perennial border plant, with long spikes of violet purple flowers; 4 feet.....	.40	.15
Scariosa. An improved strain, with larger flowers and more spreading habit than the above; color, clear rose purple.....	.50	.15

LILY

Philippinense Formosanum. Resembles an Easter lily; will bloom in 6 to 8 months from time seed is sown; 3 feet.....	.60	.25
Regale (Lil. Myriophyllum). Perfectly hardy and also excellent for forcing; flowers waxy white; very fragrant.....	.40	.15

LINARIA

*Alpina. Purple, blotched orange; perennial; 4 inches.....	1.00	.25
Cymbalaria (Kenilworth Ivy). A perennial trailing plant with violet flowers; useful for baskets, vases, pots and rock work.....	.60	.10
Maroccana Hybrids Mixed (Toad Flax). A very showy annual; 12 inches.....	.25	.10

LINUM (Flax)

Flavum. Perennial yellow Flax; 2 feet.....	.60	.15
Perenne. Hardy perennial variety, with bright blue flowers; 1 1/2 feet..... oz., 75c.	.25	.10
Rubrum. Large flowered scarlet Flax; annual; 16 inches.....	.25	.10

LOBELIA

No garden is complete without an edging of blue Lobelia and for a long season of bloom there is nothing that can take its place; also desirable for pots, hanging baskets, etc.

	Large pkt.	Pkt.
Michell's Blue Stone. A splendid dwarf variety of compact growth; plants are completely covered with large, bright blue flowers; fine for borders or boxes.....	\$0.75	\$0.20
Crystal Palace Compacta. Very compact; deep blue; the best for edging.....	.60	.10
Crystal Palace Speciosa. Of trailing habit; deep ultramarine blue; fine for vases.....	.40	.10
Emperor William. Flowers sky blue; plants compact.....	.50	.10
Sapphire. A beautiful trailing variety, of strong growth; the flowers are unusually large; color, deep blue with large clearly defined white eye.....	.75	.20
Mixed. All colors.....	.40	.10
Cardinalis (Cardinal Flower). Hardy perennial, with long spikes of cardinal red flowers.....	.75	.10

LYCHNIS

Elegant hardy perennials of easy culture, for massing in large beds or borders.

	Large pkt.	Pkt.
Arkwrightii. Splendid hybrids; free flowering.....	\$0.50	\$0.25
Chalcedonica (Rose Champion). Fine scarlet cross-like flowers; 2 feet; July..... oz., 75c.	.25	.10
Haageana. Brilliant, large, orange, scarlet, pink and crimson flowers in mixture; 1 foot; July.....	.50	.10
*Viscaria Splendens. Bright rose red, very showy; fine for the rockery; 1 foot.....	.25	.10

LYTHRUM (Loose-Strife)

Roseum Superbum. A fine hardy perennial, producing spikes of rosy-pink flowers, from July to September; 3 feet.....	.25	.10
--	-----	-----



Annual Lupinus

LUPINUS (Lupin) ANNUAL VARIETIES

Free flowering, easily grown plants, with long spikes of pea-shaped flowers; valuable for mixed borders, beds and for cutting; 2 feet.

Giant Hartwegi (Novelty). A new improved strain of annual Lupinus; this type grows 3 to 4 feet high and with the base branching habit; each plant produces from 4 to 6 spikes of bloom which are much larger than the old type. Choice mixture of colors. Pkt., 25c.; 60c. per large pkt.

	Oz.	Large pkt.	Pkt.
Rich Blue	\$0.40	\$0.25	\$0.10
Pink40	.25	.10
Sky Blue40	.25	.10
White40	.25	.10
Mixed. All colors.....	.40	.25	.10

PERENNIAL VARIETIES

Hardy perennials of easy culture; graceful spikes of pea-shaped flowers; fine for cutting; May and June; 2 to 3 feet.

	Large pkt.	Pkt.
Polyphyllus Salmon Queen (Novelty). This beautiful new variety is a strain of salmon shades, coming fairly true.....	\$0.75	\$0.25
Polyphyllus Blue25	.10
Polyphyllus Luteus. Yellow shades.....	.50	.15
Polyphyllus Moerheimi. Pink and white.....	.40	.15
Polyphyllus Roseus. Pink.....	.30	.10
Polyphyllus White25	.10
Polyphyllus Mixed oz., 40c.	.25	.10
Polyphyllus, New Hybrids Mixed oz., \$1.75	.50	.10

MARVEL OF PERU (Four O'Clock)

Choice Mixed. Free flowering, garden favorites; Oz. Pkt. very showy; flowers in many bright colors; 2 feet... \$0.25 \$0.10

MATRICARIA (Feverfew)

	Large pkt.	Pkt.
Double White. Hardy annual, for bedding or pot culture; white flowers; 18 inches..... oz., 75c.	\$0.25	\$0.10
Golden Ball. Dense habit; bright yellow flowers; perennial.....	.60	.10

MARIGOLD (Tagetes)

These are old favorite free flowering annuals with rich and showy flowers blooming all Summer. The Tall African varieties are well adapted for large beds or mixed borders while the Dwarf French varieties are better suited for bedding purposes.

AFRICAN VARIETIES

Tall growing, from 2 1/2 to 3 feet high.

Guinea Gold. A very valuable novelty that has created a sensation as a most desirable cut flower; it is a distinct type, producing no singles whatsoever, the flowers coming 100% double and semi-double; color, clear orange, flushed with gold; very loose petaled and lacks the odor of the regular African Marigold. Pkt., 25c.; 60c. per large pkt. Large pkt. Pkt.

Alldouble Orange. This new variety will produce a large percentage of double flowers, of a bright orange shade. \$0.50 \$0.15
El Dorado. All shades of yellow. oz., 75c. .25 .10
Lemon Queen. Soft lemon yellow. oz., \$1.25 .30 .10
Orange Prince. Large flowers of a deep golden orange color; very showy. oz., \$1.25 .30 .10
Large African. Tall double mixed. oz., 75c. .25 .10

FRENCH VARIETIES

Fire Cross. This new dwarf single variety is the best of its type; color, deep orange yellow, each petal marked with a crimson maroon blotch. .25 .10
Robert Beist. Very large dark maroon flowers. .25 .10
Dwarf Gold Striped. Double brownish red striped golden yellow; 1 foot. oz., 75c. .25 .10
Golden Ball. Very compact; flowers large, golden yellow. oz., 75c. .25 .10
Legion of Honor (Little Brownie). Single flowers; golden yellow with a large spot of crimson velvet; 9 inches; early flowering. oz., 60c. .25 .10
Lemon Ball. Pale sulphur yellow; plants very compact. oz., 75c. .25 .10
Mahogany. Rich mahogany brown. oz., 75c. .25 .10
Dwarf Double French Mixed. 1 foot. oz., 60c. .25 .10
***Lilliput Mixed.** Very dwarf; excellent for pots; 8 inches. oz., 60c. .25 .10
Signata Pumila (Tagetes). Golden yellow; this type is splendid for edging; 10 inches. oz., 75c. .25 .10
Tall Single French, Josephine. Dark brown with gold edges. oz., 75c. .25 .10
Tall Double French Mixed. oz., 75c. .25 .10



Marigold, Guinea Gold

MATTHIOLA

Bicornis (Evening Scented Stock). A desirable annual on account of its delightful fragrance during the evening; color, purplish lilac. Large pkt. Pkt. \$0.25 \$0.10

MAURANDIA

Choice Mixed. A climber of rapid growth for garden or greenhouse; excellent for basket, vases or trellises; tube-shaped flowers; 10 feet. .75 .10

MESEMBRYANTHEMUM

Crystallinum (Ice Plant). Dwarf trailing annual for rockeries, edgings and vases. Singular icy foliage; flowers white. .25 .10

MEXICAN FIRE PLANT

See Euphorbia Heterophylla

MIMULUS

Showy, profuse flowering plants; fine for greenhouse or moist, shady situations.

***Red Emperor (Novelty).** A new red variety which is a perfect gem for the rockery; masses of bright, crimson scarlet flowers; plants dwarf and compact. Original packets only, 35c. Large pkt. Pkt.

***Tigrinus (Monkey Flower).** Fine mixed tigered and spotted varieties; 1 foot. \$0.50 \$0.10

MONARDA (Bergamot)

Didyma Hybrida Mixed (Bee Balm). Showy ornamental perennial plants with fragrant foliage; 3 feet. .75 .25

MOONFLOWER. See Ipomoea

MORNING GLORY. See Convolvulus

MUSA ENSETE (Abyssinian Banana)

A handsome tropical plant for planting individually or for the center of beds; foliage broad and massive and very effective; 10 to 15 feet. Seeds should be started in hotbed or bottom heat in greenhouse. Per 10 seeds, 35c.; 75c. per 25 seeds.

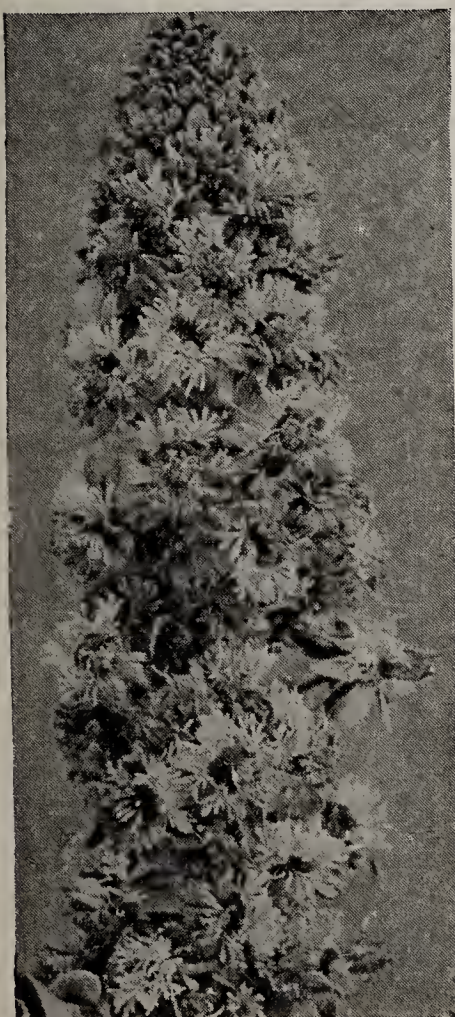

Mignonette, Michell's Colossal

MIGNONETTE

No garden is complete without this fragrant flower; can also be grown in pots for Winter and early Spring flowering.

Large pkt. Pkt.

Allen's Defiance. Spikes invariably attain a height of 12 to 15 inches; fragrant. oz., 60c. \$0.25 \$0.10

Goliath. Giant spikes of red flowers. oz., \$1.50 .30 .10

Machet. Large, sweet scented flowers. oz., 75c. .25 .10

Michell's Colossal. Foliage, stalks and flowers are very robust. The flower-spikes often average 18 inches; very fragrant. .75 .15

New York Market. A specially selected strain. .40 .15

White Goliath. An extra fine white sort. .40 .10

Sweet Scented. The popular garden sort. oz., 25c. .10

MYOSOTIS (Forget-Me-Not)

Beautiful, half hardy perennials, succeeding best in moist shady situations. Sown in the Spring they will flower in the Fall; if wanted for early Spring flowering seed should be sown in frames in July or August.

	Large pkt.	Pkt.
Alpestris Victoria. Of bushy habit, bearing large bright blue flowers; very fine; 6 inches.....	\$0.50	\$0.10
Eliza Fanrobert. Of strong growth with clusters of large, bright blue flowers; 10 inches.....	.40	.10
Grandiflora Alba. Large white flowers; 8 inches..	.30	.10
Grandiflora Rosea. Large pink flowers; 8 inches..	.30	.10
Michell's Winter Flowering. The finest variety for forcing; long stems, deep blue flowers.....	.75	.15
Palustris Semperflorens. Dwarf; blooms the entire season; deep blue.....	.50	.10
Ruth Fischer (Hybrida). An extra fine upright growing, free blooming variety, with bright blue flowers; splendid for pots.....	.75	.25
Choice Mixedoz., 75c.	.25	.10

MICHELL'S GIANT FLOWERING NASTURTIUMS

Nasturtiums are among the best known and most popular of hardy annuals. Easily grown, and producing a great profusion of brightly colored flowers from within a few weeks after they are sown until they are killed by frost; they succeed best in rather light, well-drained soil.

DWARF OR BEDDING (Tom Thumb)

Of dwarf, compact growth; excellent for borders or for bedding, forming plants about 1 foot high by 1 foot across.

	¼ lb.	Oz.	Pkt.
Queen of Tom Thumbs, Mixed. Silver variegated foliage; flowers in a great variety of colors.....	\$0.75	\$0.25	\$0.10
Michell's Giant Flowering Mixed Dwarf. This is one of the finest mixtures, composed of the largest and best named varieties and cannot be surpassed for brilliancy of color. Per lb., \$2.00.....	.60	.25	.10



Myosotis—Alpestris Victoria

NASTURTIUM, GOLDEN GLEAM (Novelty)

This new type is of semi-trailing habit and is a new development in Nasturtiums; the plant forms a vigorous large bush which throws out short runners, averaging 18 inches; the sweet scented, large double flowers are of a golden yellow color and average 2 to 3 inches across; they are borne on erect stiff stems six inches in length and stand well above the foliage, an arrangement which adds immeasurably to the showy appearance of the plant; they are also splendid for cutting. The seed we offer is strictly originator's stock. Pkt., 15c.; 25c. per large pkt.; oz., 75c.



Michell's Giant Flowering Dwarf Nasturtiums

TALL OR CLIMBING NASTURTIUMS

For covering trellises, fences, arbors, piazzas, trailing from vases, over rock-work, etc., nothing can equal the gorgeous effect produced by their great quantities of bloom from early summer until frost; the seed pods can be gathered while green and tender for pickling. Height, 8 to 10 feet.

Michell's Giant Flowering Mixed Tall. This mixture cannot be excelled for large size and beautiful colors of the flowers. Composed of the largest and finest varieties. Pkt., 10c.; 25c. per oz.; ¼ lb., 60c.; \$2.00 per lb.

LOBB'S CLIMBING NASTURTIUMS

(*Tropaeolum Lobbianum*)

Excellent for window boxes, vases, hanging baskets and rockeries; 8 to 10 feet.

Choice Mixed. Lobb's varieties, all colors. Pkt., 10c.; 25c. per oz.; ¼ lb., 60c.; \$2.00 per lb.

NEMESIA

Blue Gem. Flowers bright blue; of compact growth. Large pkt. Pkt. \$0.60 \$0.15
Strumosa Suttoni. A splendid annual, with large flowers varying in color from creamy white to deep orange and carmine; fine for bedding; 18 inches... .60 .15

NEPETA

***Mussini.** A favorite perennial rock plant with blue-gray foliage and pale mauve flowers; 9 inches... .75 .20

NICOTIANA (Flowering Tobacco)

Extremely showy annual plants, giving a continuous display of brilliant flowers; 2 to 3 feet.

Affinis. Fragrant, tubular, pure white flowers. Large pkt. Pkt. \$0.25 \$0.10
Affinis Hybrida. Large, sweet-scented flowers in a variety of colors... .25 .10
Sanderae. Flowers of the most handsome carmine-red color; very fragrant... .25 .10

NIGELLA (Love in a Mist)

Miss Jekyll. Lovely garden annuals, with finely cut green foliage, and curious looking seeds and seed pods; double flowers of a clear cornflower blue; excellent for cutting; 18 inches... \$0.25 \$0.10

OENOTHERA (Evening Primrose)

Beautiful hardy perennials of easy culture; the plants continue in bloom throughout the Summer.

***Missouriensis.** A prostrate growing variety, with large, bright yellow flowers. Large pkt. Pkt. \$0.75 \$0.15
Youngi. A showy variety, with large yellow flowers; 3 feet... .75 .15

ORNAMENTAL GRASSES. See page 27

MICHELL'S GIANT PANSIES

Strictly considered this is a biennial, but the fact that it flowers the first season from seed recommends it for an annual. There are actually three seasons in which pansies can be planted. If started in the house from February until April pansies will begin to bloom from July on; sown outdoors in May beautiful flowers are produced in the Fall; sown in frames during July and August and transplanted later gives us the main crop of flowers the following Spring.



Michell's Swiss Giant Pansy

PANSIES IN MIXTURE

Michell's New Swiss Giants. A new strain with enormous flowers and containing many unusual colors, such as salmon, pink, red, blue, yellow, etc., all beautifully blotched. Large pkt. Pkt. \$1.25 \$0.50
Alpenglow. A fine range of cardinal red shades with dark blotches... .75 .25
Lake of Thun (Ullswater). A distinct variety; color, marine blue with deep blue blotches... .75 .25
Rhinegold. Deep golden yellow with black blotches on the three lower petals... .75 .25
Roggli (Improved Swiss Giants). Flowers of large size and with overlapping petals, many brilliant colors and shades; excellent for greenhouse culture. 1/8 oz., \$1.50 .75 .25
Michell's Giant Exhibition. This mixture is made up of the finest strains in existence; dwarf habit; flowers of immense size, very heavy texture and of the most brilliant colors. Per oz., \$10.00; \$3.00 per 1/4 oz.; per 1/8 oz., \$1.75... .75 .25

PANSIES IN MIXTURE

(Continued)

Giant Trimardeau. Large flowering, in a good range of colors... 1/4 oz., \$1.00 Large pkt. Pkt. \$0.40 \$0.10
Mad. Perret. Early flowering; beautiful rich red and rose shades... 1/4 oz., \$1.00 .50 .25
Masterpiece (Frisled Pansy). Giant curled, sometimes called double; a fine range of beautiful colors, mostly red and brown... .75 .25
Triumph of the Giants Mixed. Immense flowers; colors run mostly to dark rich and rare shades. Per oz., \$11.00; \$3.25 per 1/4 oz.; per 1/8 oz., \$2.00... .85 .50
Fine English Mixed... oz., \$1.50 .40 .10

GIANT PANSIES OR BEDDING STRAIN

(Separate Colors)

A strain secured from the leading pansy specialists and not to be compared with the ordinary Giant Trimardeau, as the flowers are of much heavier texture.

Large pkt. Pkt.
Giant Prize, Azure Blue. Violet blue... 1/4 oz. \$1.00 \$0.50 \$0.15
Giant Prize, Black Blue. Dark velvety... 1.00 .50 .15
Giant Prize, Emperor William. Ultramarine blue... 1.00 .50 .15
Giant Prize, Hortensia Red. Scarlet... 1.00 .50 .15
Giant Prize, King of the Blacks... 1.00 .50 .15
Giant Prize, Lord Beaconsfield. Violet... 1.00 .50 .15
Giant Prize, Peacock. Upper petals blue, lower petals deep claret with white margin. 1.00 .50 .15
Giant Prize, Snow Queen. Pure white... 1.00 .50 .15
Giant Prize, White, with dark eye... 1.00 .50 .15
Giant Prize, Pure Yellow... 1.00 .50 .15
Giant Prize, Yellow, with dark eye... 1.00 .50 .15
Giant Prize, Mrs. P. S. DuPont. A real novel color, golden apricot with creamy tint, flushed salmon; desirable for the rock garden... .75 .25

SPECIAL OFFER.—We will send 6 packets of any of the above varieties of Giant Pansies (not including Mrs. P. S. DuPont) for 75c.; or the whole 12 pkts. for \$1.40.

Ask for Cultural Leaflet No. 209 on the Growing of Pansies

MICHELL'S PETUNIAS

For freedom of bloom, variety of color and effectiveness the Petunia has few equals, either for the flower garden, porches or window boxes; they commence blooming early and continue until killed by frost. We call especial attention to our Large Flowering strains, which for size and brilliancy of coloring cannot be surpassed.

GIANT FLOWERING SINGLE

	Large pkt.	Pkt.
Giant Fringed Choice Mixed. Flowers large, beautifully fringed and ruffled and in a fine range of colors. See color plate opposite.....	\$0.85	\$0.25
New Dwarf California Giants (<i>Ramona Strain</i>). A splendid new dwarf strain of the well known California Giants; very compact; excellent for pots.	.85	.25
California Giants. One of the largest varieties; bright and desirable colors; strong robust plants...	.50	.25
Diener's Ruffled Monsters. Extra large flowers in a wide range of colors; dwarf habit.....	.75	.25
Diener's Pink Glory. Same type as above; flowers a beautiful shade of rose pink.....	.75	.25
Floretta (<i>New</i>). Large flowered single fringed; color, beautiful steel blue, veined black.....	.85	.25
Purple Prince. A splendid velvety purple, large flowering variety.....	.75	.25
Setting Sun (<i>Novelty</i>). An especially fine dwarf, brilliant rose-pink; compact habit; 12 inches high; flowers beautifully fringed and measure 3 inches across; comes true from seed.....	1.25	.25
Theodosia. A large flowered fringed variety; rosy pink with a clear golden center.....	.85	.25
Violet King. Beautiful velvety violet blue; immense fringed flowers.....	.85	.25
Yellow Throated Mixture. A re-selected mixture of giant fringed Petunia; pleasing light shades, all having yellow throats.....	1.00	.25
Large Flowering Hybrids. An excellent mixture of large flowering sorts.....	.60	.20

SINGLE SMALL FLOWERING

	Large pkt.	Pkt.
Bluebird. An excellent bedding variety; medium sized flowers of a deep blue color.....	\$0.50	\$0.15
Dwarf Inimitable. Dwarf, compact habit; profuse bloomer; flowers striped and blotched.....	.50	.10
General Dodds. A splendid bedding variety; color, a rich velvety blood-red.....	.50	.10
Rosy Morn (<i>Improved</i>). Dwarf, bushy plants, bearing in great profusion brilliant rose-colored flowers with a white throat; excellent for pot culture....	.50	.10
Rose of Heaven. Rich, brilliant rose color; a very effective variety.....	.60	.10
Silver Blue (<i>Heavenly Blue</i>). Makes a splendid bedding variety when combined with Rosy Morn.....	.50	.15
Snowball. A fine, compact sort, producing a profusion of satiny white flowers.....	.50	.10
Star (<i>Howard's</i>) (<i>Improved</i>). Produces a profusion of crimson-maroon flowers, with a distinct five-pointed white star.....	.60	.15
Violet Gem. Plants of erect, dwarf type; beautiful deep violet flowers.....	.60	.15
Choice Mixedoz., \$1.50	.40	.10

PORTLAND PETUNIAS

For planting of veranda boxes and for choice potted plants, or for bedding out, these Petunias in select colors never fail to please.

	Large pkt.	Pkt.
Elk's Pride. Large size; deep royal purple.....	\$0.75	\$0.25
Pink Triumph. Clear, bright pink, delicately fringed.....	1.00	.25
Pride of Portland. Large, deep rose pink, fringed flowers.....	.75	.25
Scarlet Beauty. Flowers fringed; color, shading from cherry red to deep maroon.....	.75	.25
White Beauty. Pure white flowers with finely fringed edges.....	.75	.25
Mixed Colors75	.25

NANA COMPACTA PETUNIA

Dwarf (1934 Novelty)

Pink Gem. This variety is the first of a distinct new race of miniature Petunias; plants grow in a neat compact form 5 to 6 inches high and 8 inches in diameter, and are literally covered with deep pink blooms, 2 inches in diameter and as many as 25 to 30 in flower at one time. This miniature variety is indispensable in borders, window boxes, pots, rock gardens and for bedding; a very pleasing effect can be obtained by planting this variety with dwarf blue Ageratum. Pkt., 25c.; \$1.00 per large pkt.

Mixed Colors. Same as the above, but containing a fine selection of colors, ranging from deep rose through to crimson and white. Pkt., 20c.; 75c. per large pkt.

BALCONY PETUNIAS

A splendid large flowering, free blooming type, suitable for vases, window or porch boxes; also valuable for bedding.

Netted Blue Gem (*1934 Novelty*). A new color in the balcony type; color steel blue, beautifully netted or veined; flowers large and cluster well together on the extra long branches, which makes it of special value for window boxes or baskets; will come practically 100 per cent true from seed and we predict that when once known will become a most popular balcony variety. Pkt., 25c.; \$1.00 per large pkt.

	Large pkt.	Pkt.
Blue. Rich indigo blue.....	\$0.75	\$0.15
Crimson. Rich velvety crimson.....	.60	.15
Rose. Brilliant rose pink.....	.60	.15
White. Pure white.....	.60	.15
Mixed Colors60	.15

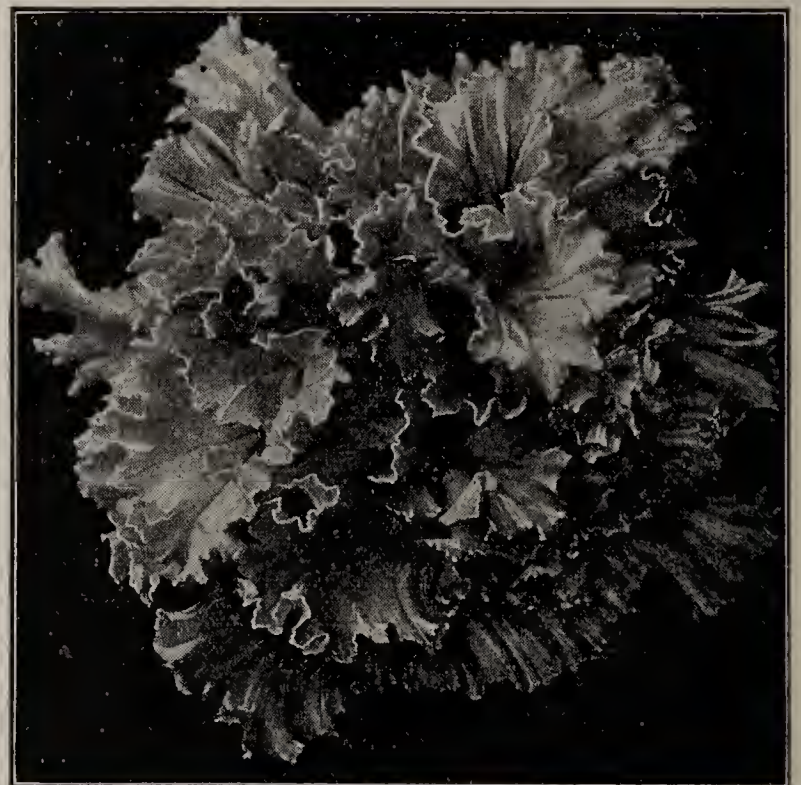

Double Fringed Petunia

LARGE DOUBLE FLOWERING

Our strain of Double Fringed Petunias is one of the best on the market, producing a maximum of double flowers. It is of course to be understood that the seed of the double varieties is obtained by hybridization, therefore will not produce all double flowers; it is well to note, when transplanting double petunias it is advisable not to discard the smaller plants as these usually produce the best double flowers.

Double Fringed White. Extra large, pure white fringed flowers. Per 500 seeds, \$2.00.....	\$0.50
Double Fringed Mixed. Flowers of large size, beautifully fringed and embracing a splendid variety of colors. Per 500 seeds, \$1.50.....	.50
Choice Double Mixed. A good mixture.....	.25



**MICHELL'S
GIANT FRINGED PETUNIAS
CHOICE MIXTURE**

Flowers large, beautifully fringed and ruffled and in a fine range of colors. Pkt., 25c.; 85c. per large pkt. Can be supplied in mixed colors only.



Phlox Drummondii, Grandiflora

PHLOX DRUMMONDII

One of our finest hardy annuals and should occupy a prominent place in every garden; it is easy to grow and unequalled for its profusion of bloom, which will continue until frost; for bedding or massing nothing can surpass them for their brilliancy and richness of color.

DWARF OR COMPACT VARIETIES

The plants grow very symmetrical, in neat little bushes, 6 to 8 inches high and are covered with flowers during the whole Summer and Fall. Excellent for bedding or edging.

	Large pkt.	Pkt.
Cecily, Mixed. A large flowering, dwarf compact variety, of many colors and shades.....	\$0.60	\$0.10
Fireball. Brilliant scarlet.....	.60	.10
Pink60	.10
Snowball. Pure white.....	.60	.10
Choice Mixed 1/4 oz., \$1.00	.50	.10

GRANDIFLORA VARIETIES

An improved strain with large heads of bloom, as well as large individual flowers; 12 to 15 inches.

	Large pkt.	Pkt.
Alba. Pure white.....	\$0.40	\$0.10
Chamois Rose. Shell pink.....	.40	.10
Coccinea. Brilliant scarlet.....	.40	.10
Lilac40	.10
Pink40	.10
Yellow40	.10
Choice Mixed. All colors..... oz., \$1.25	.30	.10
Collection, one packet each above 6 colors.....		.50
Cuspidata (Star of Quedlinburg). Extra fine, star-flowered mixture..... oz., \$1.50	.40	.10

PHLOX (Hardy)

Decussata, Mixed. Tall growing, perfectly hardy plants, with immense trusses of large flowers in all bright colors..... 1/4 oz., 75c. .60 .10
Sow seed of Hardy Phlox late in the Fall and they will germinate in the Spring.

PENTSTEMON (Beard Tongue)

Beautiful perennial plants for the hardy border.

	Large pkt.	Pkt.
Sensation. Large spikes of gloxinia-like flowers of the most brilliant and varied colors; 2 feet; requires protection.....	\$0.75	\$0.15
New Hybrids, Mixed. Produces large spikes; 3 feet.	.50	.10

PHACELIA (California Blue Bell)

Campanularia. A splendid annual, one of the earliest to bloom; color gentian blue; excellent for borders; 9 inches..... oz., 75c.	.25	.10
--	-----	-----

PHYSALIS (Chinese Lantern Plant)

Francheti. Dense bushes about 2 feet high, producing freely, bright orange-scarlet, lantern-like fruits; perennial.....	.30	.10
--	-----	-----

PHYSOSTEGIA (False Dragon Head)

A very pretty perennial; dense bushes, bearing freely, delicate tubular flowers; 3 to 4 feet; July-August.

	Large pkt.	Pkt.
Virginica. Pink.....	\$0.40	\$0.10
Virginica Alba. White.....	.40	.10

PLATYCODON (Japanese Balloon Flower)

One of the best hardy perennials, bearing a profusion of large, bell-shaped flowers the whole season. Excellent for planting in borders or among shrubbery; 2 to 3 feet.

	Large pkt.	Pkt.
Grandiflorum. Blue.....	\$0.40	\$0.10
Grandiflorum Album. Pure white.....	.40	.10
Mariesi. Dwarf, dark blue; 16 inches.....	.75	.15
Mariesi Alba. White and faint blue; 16 inches.....	.75	.15

POLEMONIUM (Jacob's Ladder)

A good hardy perennial, with bell-shaped flowers; 2 1/2 feet.

	Large pkt.	Pkt.
Coeruleum Blue oz., 75c.	\$0.25	\$0.10
Coeruleum Album. White..... oz., 75c.	.25	.10

POLYANTHUS (Primula Elatior)

Beautiful spring-flowering hardy perennials either for pot culture or for the garden; succeeds best in partial shade; 9 inches.

	Large pkt.	Pkt.
Gold Laced. Flowers of brilliant colors with distinct yellow edge.....	\$0.75	\$0.15
English Mixed. All colors.....	.60	.10



Pentstemon, New Hybrids

One of our favorite and most popular flowers, producing, during the blooming period, a profusion of brilliant colors and shades. Seeds should be sown as early in the Spring as possible, where they are to remain, as they do not stand transplanting. Sow very thinly and barely cover the seed, press down firmly and they will come up in a few days. Several sowings of the annual varieties may be made at intervals to have a succession of bloom.

SINGLE ANNUAL POPPIES

	Oz.	Large Pkt.	Pkt.
King Edward. A large flowering variety, growing about 2½ feet high; deep scarlet, shaded crimson, with dark blotch at base.	\$0.40	\$0.25	\$0.10
Michell's Shirley. An improved strain of this lovely race of poppies varying in color from pure white and delicate pink to rosy carmine and deep crimson, in mixture.40	.25	.10
Shirley, Wild Rose Pink. Beautiful rich pink, that comes almost true from seed.75	.25	.10
Oriental Scarlet. This is an exact duplicate of the popular perennial type, but is an annual and flowers profusely the first season from seed.	1.00	.30	.10

FLANDERS POPPY

This is the well known poppy of Flanders field so often mentioned in songs and stories of the Great War. Medium size bright scarlet flowers. Very showy when planted in masses.

	.40	.25	.10
--	-----	-----	-----

AMERICAN LEGION POPPY

This new single poppy of the Shirley type is a dazzling orange-scarlet of immense size, borne on long, stout stems.

	.75	.25	.10
--	-----	-----	-----

DOUBLE ANNUAL POPPIES

	Oz.	Large Pkt.	Pkt.
Carnation Flowered. Flowers of large globular form with fringed petals; mixed colors; 2 feet.	\$0.25		\$0.10
Mikado (Striped Japanese). Double fringed flowers, white tipped with rose; 18 inches.40	\$0.25	.10
Peony Flowered Mixed. Large double flowers resembling a Peony.25		.10
Improved Shirley, May Queen. A re-selected strain; large double flowers; mixed colors.30	.10
Collection, one packet each, 6 annual varieties, single and double, 50c.			



Single Shirley Poppies

ICELAND POPPIES (Papaver Nudicaule)

While these are hardy perennials, they flower the first year from Spring sown seed. They are of graceful habit, with fern-like foliage; the satin-like flowers are borne in endless profusion and are excellent for cutting; 1 foot.

	Large pkt.	Pkt.
*Alpinum Mixed. Dwarf Alpine variety; splendid for the rockery; 8 inches.	\$0.75	\$0.25
El Monte. This variety is a California introduction; very large flowers and comes true from seed; strong wiry stems for cutting; mixed colors.75	.25
Coonara Pink Shades. A fine strain in beautiful pink art shades; long stems and large flowers, no washy shades; a splendid novelty.75	.25
Orange Scarlet40	.10
White40	.10
Yellow40	.10
Single Mixed. Colors range from white and yellow to deep orange scarlet. ¼ oz., 60c.	.30	.10
Sunbeam. Splendid new shades in mixture.40	.15

ORIENTAL POPPIES

These are always popular in any perennial bed. The seeds should be sown in early Spring in the open ground.

	Large pkt.	Pkt.
Oriente. Extra large flowers; deep scarlet; ¼ oz., 60c.	\$0.40	\$0.10
Oriente, Mrs. Perry. Rich salmon pink.75	.10
Oriente Hybrids. Flowers of large size; mixed colors. ¼ oz., 60c.	.40	.10



Oriental Poppy



Portulaca, Single and Double

PORTULACA (Sun Plant)

Brilliant hardy annual, of easy culture; excellent for massing in beds, edging or rock work, thriving best in a light, sandy soil and a sunny situation; flowers of the brightest colors.

	Large pkt.	Pkt.
*Double Mixed. All colors.....	¼ oz., 75c.	\$0.50 \$0.10
*Single Mixed. All colors.....	oz., 75c.	.25 .10

POTENTILLA

Mixed. A most effective perennial plant; flowers resemble Geum..... .30 .10

PRIMULA FRINGED CHINESE PRIMROSE

These are among our finest Winter and Spring blooming pot plants for decoration in the home or conservatory. Our seed has been grown for us by Primula Specialists and cannot be excelled for size and brilliancy of colors.

Large pkt. Pkt.
Michell's Prize Mixture. This mixture contains only the finest sorts selected from the best strains.. \$0.85 \$0.25

PRIMULA OBCONICA

A beautiful and continuous blooming variety with handsome spikes of flowers; elegant plants for greenhouse or light window of dwelling house.

	Large pkt.	Pkt.
Fasbender. A new strain of the Gigantea type; giant deep crimson flowers.....	\$1.25	\$0.50
Mueller and Mohnstein. Shades of crimson and rose	1.25	.50
Gigantea MONSTER. An extra large flowering strain of this popular Primula.		
“ Apple Blossom. Soft pink.....	1.25	.40
“ Kermesina. Deep crimson.....	1.25	.40
“ Rose Queen. Clear rose pink.....	1.75	.50
“ Salmon Queen.	1.25	.40
“ Mixed Colors.	1.25	.40
Grandiflora Hybrida. Mixed.....	.75	.20

Ask for our Cultural Leaflet No. 206 on the growing of Primulas.

See pages 8 to 11 for Novelties and Specialties in Flower Seeds

PRIMULA MALACOIDES

Dawkin's Carmine Pink (1934 Novelty). The color of this new variety is a rich glowing carmine pink, quite distinct from any shade hitherto produced in Primula Malacoides; flowers large, on wiry stems of upright and graceful habit. The constitution of the plant is very strong, without doubt the best of all existing varieties. Original pkt. only, 75c.

	Large pkt.	Pkt.
Lilac (Improved Baby Primrose). Tall, graceful spikes of delicate lilac flowers.....	\$0.75	\$0.20
Courtland Seedling. Brilliant, clear lilac pink; vigorous grower.....	1.00	.25
Princess Patricia. Beautiful lavender pink; flowers finely laced.....	1.00	.25
Pink Beauty. Deep rosy pink; large.....	.75	.25

PRIMULA KEWENSIS

(Verbena Scented Yellow Primrose)

Very attractive yellow flowers on long stems; very fragrant. Pkt., 25c.; 75c. per large pkt.

HARDY PRIMROSES

The following varieties of Hardy Primulas are very popular; however, it is to be noted that the germination of the seed is very slow.

	Large pkt.	Pkt.
Beesiana. Purple, yellow eye; 16 inches.....	\$0.75	\$0.25
Bulleyana. Bud terra cotta, flowers yellow; 2 feet.	.75	.25
* Japonica. One of the best hardy primroses for the garden; mixed colors.....	.75	.10
* Veris (English Cowslip). Fragrant flowers of various colors, mixed; 6 inches.....	.60	.10
* Veris, Giant Munstead Strain. Flowers large, beautiful shades, including yellow and white; 12 inches.....	.75	.25
* Vulgaris (English Primrose). Canary yellow; very fragrant.....	.75	.10



Primula Obconica Gigantea

PUERARIA THUNBERGIANA

(Japanese Kudzu Vine)

Large pkt. Pkt.

One of the fastest growing hardy climbing plants; grows 8 to 10 feet the first year from seed; its foliage is large and covers well; rosy purple pea-shaped blossoms toward the end of August. \$0.25 \$0.10

PYRETHRUM

FOLIAGE VARIETY FOR BEDDING

Used for edging of ornamental beds; leaves finely cut.

Large pkt. Pkt.

Aureum (*Golden Feather*). Bright golden yellow foliage, 1 foot. oz., 60c. \$0.25 \$0.10

PERENNIAL VARIETIES

Undoubtedly one of the best hardy perennials, both for garden work and cut flower purposes; a row of twenty-five plants will prove very useful; absolutely hardy and of very easy culture; 30 inches.

Large pkt. Pkt.

Atrosanguineum. Dark red shades. \$0.75 \$0.25
Roseum. Flowers bright rose color; July; 2 feet.60 .10
Uliginosum (*Giant White Daisy*). Large, single white flowers; September; 3 to 4 feet.60 .10
Hybridum Single Mixed. Large flowers ranging in color from light pink to deep red, with bright yellow centers; July; 2 feet.50 .10
Hybridum Double Mixed75 .25

RANUNCULUS

Asiaticus Superbus. A perennial plant, suitable for beds and borders, or for pots; fine for cutting; mixed colors; 1 foot.25 .10

RESEDA. (See Mignonette)

RHODANTHE (Everlasting Flower). See page 26



Pyrethrum Hybridum

RICINUS (Castor Oil Bean)

Large, rapid growing ornamental foliage plants; produce a fine effect in center of beds or singly on lawns.

Oz. Pkt.

Red Spire. A very effective variety, with bronzy green foliage and rosy crimson seed spikes; 6 feet. . \$0.30 \$0.15
Cambodgensis. Leaves dark bronzy-maroon; 5 feet. . .25 .10
Gibsoni. Deep red foliage; 5 feet.25 .10
Sanguineus. Blood-red stalks and red fruit; 8 feet. .25 .10
Zanzibariensis. Enormous leaves, varying in color from light green to purplish red; 12 feet.25 .10
Mixed. All sorts.20 .10

RUDBECKIA (Coneflower)

Kelvedon Star (*1934 Novelty*). A new strain which we recommend with confidence; a really good annual and a perfect, long stemmed flower for cutting; very floriferous and of sturdy habit of growth; colors vary, but all have brown central discs, surrounded by a mahogany zone on petals of deep orange; seed started inside in March will commence to bloom in June; 3 feet. Original pkt., 40c.

Large pkt. Pkt.

My Joy. A new annual variety; bright orange yellow with small cone center and not over 5 inches in diameter; free flowering; splendid for cutting. . . \$0.60 \$0.15
Bicolor Superba. A free-flowering annual; produces a profusion of yellow flowers with brown disc in center; 2 feet.25 .10
Newmani. Large yellow flowers with black center; perennial; very showy; 3 feet.40 .10
Purpurea (*Giant Purple Coneflower*). Hardy perennial; reddish purple flowers; with dark brown disc; 4 feet.40 .10

SALPIGLOSSIS (Painted Tongue)

Easy growing annual plants which have become great favorites, not only because of its easy culture, but mainly for its beautifully tinted and veined flowers; blooms from early Summer until late Fall; 18 inches.

Large pkt. Pkt.

Crimson and Gold. \$0.50 \$0.10
Primrose50 .10
Purple and Gold50 .10
Rose and Gold50 .10
Scarlet and Gold50 .10
White and Gold50 .10
Emperor Mixed. A type having only one main stem, and bearing on its summit a large number of beautiful flowers, each one richly veined with gold.40 .10
Collection. One packet each above, 6 colors.50



Salpiglossis



Salvia, America

SALVIA (Scarlet Sage)

The Salvia is among our most popular and useful bedding plants. There is nothing more effective in the midsummer or Fall than these bright scarlet flowers. Seeds should be started either in the house or in hotbeds from February till April. Seed may also be sown in the open ground in May.

Large pkt. Pkt.

- Dwarf Fire King** (*Michell's Novelty*). A new extra early variety, flowering about four weeks earlier than other existing types; plants are of very compact habit, exceedingly dwarf and completely covered with medium sized, brilliant scarlet flowers... \$0.75 \$0.25
- America or Globe of Fire**. Of dwarf, bushy, compact growth and very uniform in height and shape, spikes of brilliant scarlet flowers... 1/4 oz., \$1.50 .75 .25
- Bonfire** (*Clara Bedman*). Compact bushy plants, 2 feet high, producing innumerable erect spikes of the most brilliant scarlet flowers... 1/4 oz., \$1.00 .60 .10
- Splendens**. Tall growing plants with bright scarlet flowers; height, 3 feet... 1/4 oz., 75c. .50 .10
- Zurich**. One of the earliest flowering of all salvias; of dwarf, bushy growth with an abundance of bright scarlet flowers; 18 inches... 1/4 oz., \$1.00 .60 .15
- Patens**. Bright blue flowers of large size; 2 feet... .75 .15

SALVIA, PERENNIAL VARIETIES

- Blue Bedder** (*Novelty*). A new variety of Farinacea; very compact form, of a deep blue shade and flowering very profusely from seed the first year... .60 .25
- Azurea Grandiflora**. Produces spikes of sky blue flowers during August and September; 3 to 4 feet... .60 .15
- Farinacea**. A perennial variety, but best treated as an annual; color, light blue; 2 feet... .60 .10

SCABIOSA (Mourning Bride)

GRANDIFLORA VARIETIES (Annual)

Magnificent annuals of easy cultivation, blooming freely through the Summer and Autumn; very effective for beds or borders; invaluable for cutting; 2 feet. Large pkt. Pkt.

- Giant Loveliness**. Flowers range through various tones of delicate salmon rose, a new color in the annual Scabiosa; excellent for cutting; very fragrant. \$0.40 \$0.15
- Peach Blossom**. Peach blossom pink... .25 .10
- Azure Fairy**. Clear lavender blue... .25 .10
- Cherry Red**... .25 .10
- Flesh Pink**. Delicate shade... .25 .10
- King of the Blacks**. Deep purple... .25 .10
- Rose**. Soft rose color... .25 .10
- White** (*Shasta*)... .25 .10
- Collection**. One packet each 6 colors... .50
- Finest Mixed**... oz., 60c. .25 .10
- Dwarf Double Mixed**. Plants grow but 12 inches high; all colors... oz., 60c. .25 .10

HARDY PERENNIAL VARIETIES

Handsome perennial border plants flowering the entire season.

The seed of perennial Scabiosa is of slow germination; we would suggest sowing in peat moss and sand, making sure to keep moist and shaded. Large pkt. Pkt.

- Caucasica, Giant Hybrids** (*Isaac House Strain*). A splendid improvement in the Caucasica type, flowers larger and with longer stems; colors range from light lavender to dark blue; excellent for cutting... \$0.75 \$0.25
- Columbaria Anthemifolia**. A low growing variety, with flowers measuring 2 to 2 1/2 inches across; color a delightful shade of pink; splendid for cutting... .75 .25
- Caucasica**. Soft blue; 3 feet... .60 .10
- Caucasica Alba**. Pure white... .60 .10
- Japonica**. Flowers beautiful clear blue... .25 .10



Scabiosa, Giant Loveliness

SAPONARIA (Bouncing Bet)

	Large pkt.	Pkt.
* <i>Ocymoides</i> . Splendid hardy perennial rock plant; bright rose colored flowers; 9 inches.....	\$0.25	\$0.10
<i>Vaccaria Rosea</i> . A profuse blooming annual with beautiful pink, feathery flowers; 2 feet....	oz., 30c.	.10
<i>Vaccaria Alba</i> . White.....	oz., 30c.	.10

SAXIFRAGA

* <i>Decipiens Hybrids, Mixed</i> . A charming little perennial plant; excellent for the rockery.....	.75	.25
<i>Megasea Species</i> . Large leathery leaves; short stemmed racemes of flowers; 1 foot.....	1.00	.25

SCHIZANTHUS (Butterfly Flower)

One of our finest hardy annuals; of easy culture in any good garden soil; showy flowers of various colors, closely resembling some species of Orchids; also useful as pot plants for late Winter and Spring blooming; for this purpose sow in Autumn.

	Large pkt.	Pkt.
<i>Garraway's Hybrids</i> . Flowers large, with markings on a white, buff, rose, blue or purple ground....	\$0.60	\$0.25
<i>Hybridus Grandiflorus</i> . Compact, pyramidal plants, with large flowers of many shades; 12 inches.	.30	.10
<i>Wisetonensis</i> . Largely used as a pot plant for the house or conservatory; flowers range from white with yellow center to pink with brown center; 1½ feet.....	.40	.10

SEDUM (Stonecrop)

* <i>Acre</i> . The well known yellow variety; very useful in the rock garden; perennial.....	1.00	.25
---	------	-----

SENSITIVE PLANT (Mimosa)

<i>Pudica</i> . Curious and interesting annual plants with pinkish white flowers; the leaves close or droop when touched or shaken; 18 inches.....	.25	.10
--	-----	-----

SHAMROCK

Dainty little house plants, easily grown from seed.		
<i>True Irish</i> . Small leaved variety.....	.25	.10

SHASTA DAISY

<i>Alaska</i> . Pure white, extra large flowers; excellent for cutting; perennial; 2 feet.....	.40	.10
<i>New Giant Double White</i> . Perennial, a splendid new double variety, fine for cutting; flowers are about 5 inches in diameter, on long stiff stems and have the appearance of a giant Aster; will flower from seed in 5 months.....	.75	.25

SIDALCEA

<i>Rosy Gem</i> . A handsome perennial, with long spikes of rosy pink flowers; 18 inches.....	.40	.10
---	-----	-----

SILENE (Catchfly)

Attractive and profuse blooming perennial plants.		
<i>Orientalis</i> . Dark rose; 30 inches.....	.25	.10
* <i>Saxifraga</i> . White; 10 inches.....	.40	.10
* <i>Schafta</i> . Rose, 8 inches.....	.40	.10

SMILAX

A greenhouse climber; foliage light green and very graceful; seed should be soaked 24 hours in warm water before sowing; 10 feet.....	oz., 75c.	.25 .10
---	-----------	---------

SNAPDRAGON. See Antirrhinum

SOLANUM

<i>Christmas Pepper</i> . An improved variety, producing quantities of miniature peppers, ranging in color from purple to brilliant red.....	.60	.25
<i>Cleveland Cherry</i> . Ornamental pot plants for Winter decoration; of dwarf, branching habit; produces a great profusion of scarlet berries; 1 foot.....	.40	.25



Shasta Daisy, Alaska

STACHYS

	Large pkt.	Pkt.
<i>Lanata</i> . A perennial plant, with bright silvery leaves and clusters of purple flowers; 24 inches....	\$0.25	\$0.10

STATICE (Sea Lavender)

Splendid plants, either for the border or rockery, producing all Summer, panicles of small flowers, which can be dried and used for Winter bouquets; 2 feet.

ANNUAL VARIETIES

	Large pkt.	Pkt.
<i>Sinuata Bonduelli</i> . Golden yellow.....	\$0.25	\$0.10
" <i>Blue</i>25	.10
" <i>Lavender</i>25	.10
" <i>Rosea Superba</i>25	.10
" <i>White</i>25	.10
" <i>Mixed</i> . All colors.....	.25	.10
<i>Suworowi</i> (<i>Russian or Rat Tail Statice</i>). Flowers bright rose color.....	.30	.10

PERENNIAL VARIETIES

<i>Dumosa (Novelty)</i> . A new variety, growing 2½ feet high and producing dense clusters of very pretty silvery gray flowers.....	1.00	.25
<i>Caspia</i> . The most beautiful of all perennial Sea Lavenders; very vigorous habit, with 3 foot stems, carrying innumerable lilac flowers; wonderful subjects for effective table decoration.....	.75	.25
<i>Incana Hybrida</i> . Dwarf.....	.25	.10
<i>Latifolia</i> . Perennial; large deep-blue flowers.....	.40	.10

STEVIA

<i>Serrata</i> . Free blooming plants for Summer or Winter, bearing a profusion of fragrant white flowers; excellent for cutting; 2 feet.....	.50	.10
---	-----	-----



Early Giant Imperial Stock

**NEW STOCK
GIANTS OF CALIFORNIA**

Santa Maria

A new giant double pure white variety, of exceptional merit; giant flowers on a long flowering truss; of splendid branching habit; the long stems of Santa Maria make it a very desirable cut flower. This stock will produce a very high percentage of doubles. Pkt., 25c.; \$1.00 per large pkt.

**EARLY GIANT IMPERIAL STOCK
(Improved Bismarck)**

A splendid addition to the early forcing class; of tall, branching habit, 24 to 30 inches high and produce a very high percentage of double flowers.

	Large pkt.	Pkt.
Antique Copper (<i>New</i>). Rich hellebore red, a new and attractive shade.....	\$0.50	\$0.25
Apple Blossom . Blush pink.....	.50	.25
Canary Yellow (<i>Golden Ball</i>).....	.50	.25
Chamois . Ivory tinted old rose.....	.50	.25
Elks Pride . A new shade in this early group, an intense royal purple.....	.50	.25
Fiery Blood Red . Extra fine.....	.50	.25
Golden Rose50	.25
Lavender50	.25
Lilac50	.25
Rose . Deep rose pink.....	.50	.25
White50	.25
Mixed Colors50	.25

MICHELL'S EARLY FLOWERING "NICE" STOCK

An early flowering strain of branching habit; remarkably free bloomer; large, double fragrant flowers; fine for garden bedding or cutting. For Winter blooming, sow from July to September.

	Large pkt.	Pkt.
Beauty of Nice . Charming delicate pink.....	\$0.50	\$0.15
Crimson King . Deep red.....	.50	.15
Midsummer Night . Deep, dark violet.....	.50	.15
Monte Carlo . Canary yellow.....	.50	.15
Mont Blanc . Pure white.....	.50	.15
Old Rose . An extra fine variety.....	.50	.15
Queen Alexandra . Delicate lavender.....	.50	.15
Choice Mixed . All colors.....	.50	.15

LARGE FLOWERED DWARF TEN-WEEK STOCK

This is the leading variety for bedding out, for Summer blooming; also fine for pots.

	Large pkt.	Pkt.		Large pkt.	Pkt.
Blood Red	\$0.40	\$0.10	Pink	\$0.40	\$0.10
Crimson40	.10	White40	.10
Dark Blue40	.10	Yellow40	.10
Light Blue40	.10	Mixed40	.10

Michell's "Distinctive" Stocks

The stock is one of the most popular and highly prized of our cultivated flowers; charming colors, delightful fragrance and of free blooming character. The seeds we offer are hand-saved from pot-grown specimens and will produce a large percentage of double flowers. The Early Giant Imperial and Early Flowering Nice stocks must be started early indoors if wanted for outdoor blooming.

NEW GIANT DOUBLE EXCELSIOR

Column Type, Non-Branching

This new type of stocks produces one enormous spike 2 to 3 feet in height and is especially adapted for greenhouse culture, as the plants can be grown close together; blooms about ten days earlier than Bismarck and produces a high percentage of doubles. We offer a select list of the most popular colors.

	Large pkt.	Pkt.
Light Blue	\$1.00	\$0.25
Purple	1.00	.25
Rose	1.00	.25
Ruby . Rich dark ruby red.....	1.00	.25
Silvery Lilac	1.00	.25
White	1.00	.25
Mixed Colors	1.00	.25

STOKESIA (Cornflower or Stokes' Aster)

Cyanea. Plants grow about 18 to 24 inches high, bearing freely from July to October handsome, lavender blue, Centaurea-like blossoms, each measuring from 4 to 5 inches across; of easy culture, and one of the most desirable plants for the hardy border; excellent for cutting.....

Large pkt.	Pkt.
\$0.60	\$0.10

STRAWFLOWER (Helichrysum)

See Everlastings, page 26

STREPTOCARPUS

Hybrids (Gold Medal Strain). Fine greenhouse plants, producing a dense cluster of trumpet shaped flowers, in a fine range of colors; seed sown in January and February, plants will flower in July.....

1.25	.50
------	-----

SUNFLOWER. See Helianthus

Summer Flowering Varieties

These are distinguished from the old-fashioned Grandiflora sorts by the enormous flowers with crinkled and wavy petals, and also from the fact that they usually bear four blossoms on a stem. The plants are of robust growth and bear the flowers on long stems. On account of their superiority over the Grandiflora sorts, we have discontinued listing the latter. The varieties we list are selected from a long list and are considered to be the best up-to-date varieties.

BLUE AND PURPLE

	Oz.	¼ lb.	Lb.
Fortune. Rich dark blue.....	\$0.30	\$0.85	\$3.00
Royal Purple. Rich purple; one of the finest varieties.....	.30	.85	3.00
Wedgewood. A lovely self-blue.....	.30	.85	3.00

DEEP PINK OR ROSE

Fluffy Ruffles. New giant ruffled type; rich rose pink with soft salmon shading (Pkt., 15c.).....	.40	1.25	4.50
Hawlmarmk Pink. Rose pink flushed and shaded with salmon.....	.30	.85	3.00
Pinkie. Rose pink; extraordinary large flowers.....	.30	.85	3.00

LAVENDER

Austin Frederick Improved. Giant light lavender.....	.30	.85	3.00
Gleneagles. Large lavender.....	.30	.85	3.00
Asta Ohn Spencer. Rich lavender.....	.30	.85	3.00
Hawlmarmk Lavender. Splendid large lavender.....	.30	.85	3.00

LIGHT PINK

Blanche Ferry Spencer. Large flowers; pink and white.....	.30	.85	3.00
Countess Spencer. A lovely clear pink shading deeper at the edge.....	.30	.85	3.00
Daisybud. Harmonious shades of apple blossom tints with suffusion of cream pink..	.30	.85	3.00
Elfrida Pearson. Large shell pink.....	.30	.85	3.00
Hercules. Giant pure pink.....	.30	.85	3.00
Miss California. Orange-salmon and carmine pink.....	.30	.85	3.00

ORANGE AND SALMON

Barbara. Superbly self-colored salmon....	.30	.85	3.00
Helen Lewis. Orange pink; wings orange salmon.....	.30	.85	3.00
Tangerine Improved. Brilliant tangerine orange.....	.30	.85	3.00

PRIMROSE OR LIGHT YELLOW

Daffodil. The best yellow yet introduced..	.30	.85	3.00
---	-----	-----	------

SCARLET

Fiery Cross. Large; intense orange scarlet...	.30	.85	3.00
Huntsman. Bright scarlet.....	.30	.85	3.00
King Edward Spencer. Rich, crimson scarlet; large.....	.30	.85	3.00
Royal Salute. Deep cerise.....	.30	.85	3.00

WHITE

Avalanche. Glistening pure white.....	.30	.85	3.00
Constance Hinton. Large flowering white; black seeded.....	.30	.85	3.00
King White. Gigantic flowers; pure white..	.30	.85	3.00
Snowball. Undoubtedly the finest pure white variety.....	.30	.85	3.00

Price, any of the above varieties, except where noted, 10c. per packet.



Spencer or Orchid Sweet Pea

MICHELL'S SUPERB SPENCER MIXTURE

A mixture that cannot be surpassed. Blended by ourselves from only the Giant Waved Spencer varieties in proper proportions of bright colors and including a number of new hybrids of exquisite colors and shades. Per pkt., 10c.; 25c. per oz.; ¼ lb., 60c.; \$2.00 per lb.

COLLECTIONS OF SPENCER OR ORCHID SWEET PEAS

One pkt. each 12 named varieties our selection, \$1.00.
One pkt. each 6 named varieties our selection, 50c.

Our Booklet "How to Grow Sweet Peas" included in all orders if requested.

For Early or Winter Flowering Spencer Sweet Peas, see page 42.

MICHELL'S EARLY OR WINTER FLOWERING SPENCER SWEET PEAS

While these are especially adapted for forcing under glass for Winter and early Spring blooming, they are also valuable for outdoor culture, coming into bloom five or six weeks earlier than the regular Spencer or Orchid flowering type, and if the flowers are kept cut, they will continue to bloom for a long time.

NOVELTY VARIETIES FOR SPRING 1934

EARLY DWARF SPENCER

Bo-Peep (1934 Novelty)

Bo-Peep is a dwarf erect early flowering Spencer Sweet Pea (not a Cupid) and on this account it makes a splendid pot plant, also an excellent plant for bedding or border work. The color is a salmon pink, very similar to the early variety Springsong and with flowers just as large; the stems run from 4 to 6 inches and the plants range from 12 to 24 inches in diameter. It is a profuse bloomer and its rich salmon pink color will lend itself admirably for color schemes in the garden, as it comes practically 100% true. Pkt., 25c.; 75c. per 1/2 oz.; oz., \$1.25.

Sensation (Duplex). We are proud to introduce this new early flowering variety as an exceptionally fine novelty; the large duplex petaled flowers give the blooms the appearance of being double. Color, clear-toned, luminous Geranium pink, which is a new shade in the early varieties and excellent under artificial light; the flowers, usually borne in fours, are large and well placed. Pkt., 25c.; \$1.75 per 1/2 oz.; oz., \$3.00.

Eleanor Blue. Another good novelty in the new and popular Eleanor blue shade, a clear light blue with a silver sheen; flowers large, frilled and of perfect Spencer form, with fours predominating, and pleasingly fragrant. Pkt., 25c.; \$1.00 per 1/2 oz.; oz., \$1.75.

Susanna. Large flowers of a rich carmine color, on long stems; an improvement over existing varieties in this color. Pkt., 25c.; \$1.00 per 1/2 oz.; oz., \$1.75.

NEW VARIETIES OF RECENT INTRODUCTION

	Pkt.	1/2 oz.	Oz.
Fragrance. This delightfully fragrant new variety is in our opinion superior to all other lavenders; color a clear lavender self; flowers extra large, on long stems.....	\$0.25	\$0.75	\$1.25
Miss Annie Laurie. A splendid novelty in the richest tone of pure rose-pink ever introduced in a Sweet Pea. It has long stems with four large flowers.....	.25	.75	1.25
Fascination. A wonderful early variety with the salmon rose-pink color of the famous late Hawlmark pink, plus the long, strong stem of the Early Jeanne Mamitsch.....	.25	.60	1.00
Satin Rose. Color, an exquisite blend of rose and amber, with a touch of salmon.....	.25	.60	1.00
Michell's Rose Wonder. A beautiful, clear rose-pink color on a light ground.....	.25	.75	1.25
Blue Bonnet. Color a fine deep blue, without the slightest trace of mauve.....	.25	.60	1.00
Hope. The finest black seeded, pure white to date; flowers of mammoth size, well waved.....	.25	.60	1.00
Lady Gay. Beautiful soft shrimp pink.....	.25	.60	1.00
Peaches. A new shade of bright apricot rose, with a touch of lemon in the keel.....	.25	.60	1.00
Valencia. A bright orange in color and absolutely sun-proof; stems long.....	.25	.60	1.00
White Harmony. Black seeded; flowers pure paper white of grand substance.....	.25	.60	1.00

GENERAL LIST

Amethyst. An early royal purple.....	.15	.40	.75
Aviator. Dazzling crimson scarlet.....	.15	.40	.75
Ball's Blue. Clear even blue.....	.15	.40	.75
Ball's Orange. Intensive glowing orange...	.15	.60	1.00
Ball's Rose. Rich deep rose.....	.15	.40	.75
Blue Bird. A charming shade of blue.....	.15	.40	.75
Burpee's Orange. Clear glistening orange..	.15	.40	.75
Columbia. Salmon standard; white wings..	.15	.40	.75

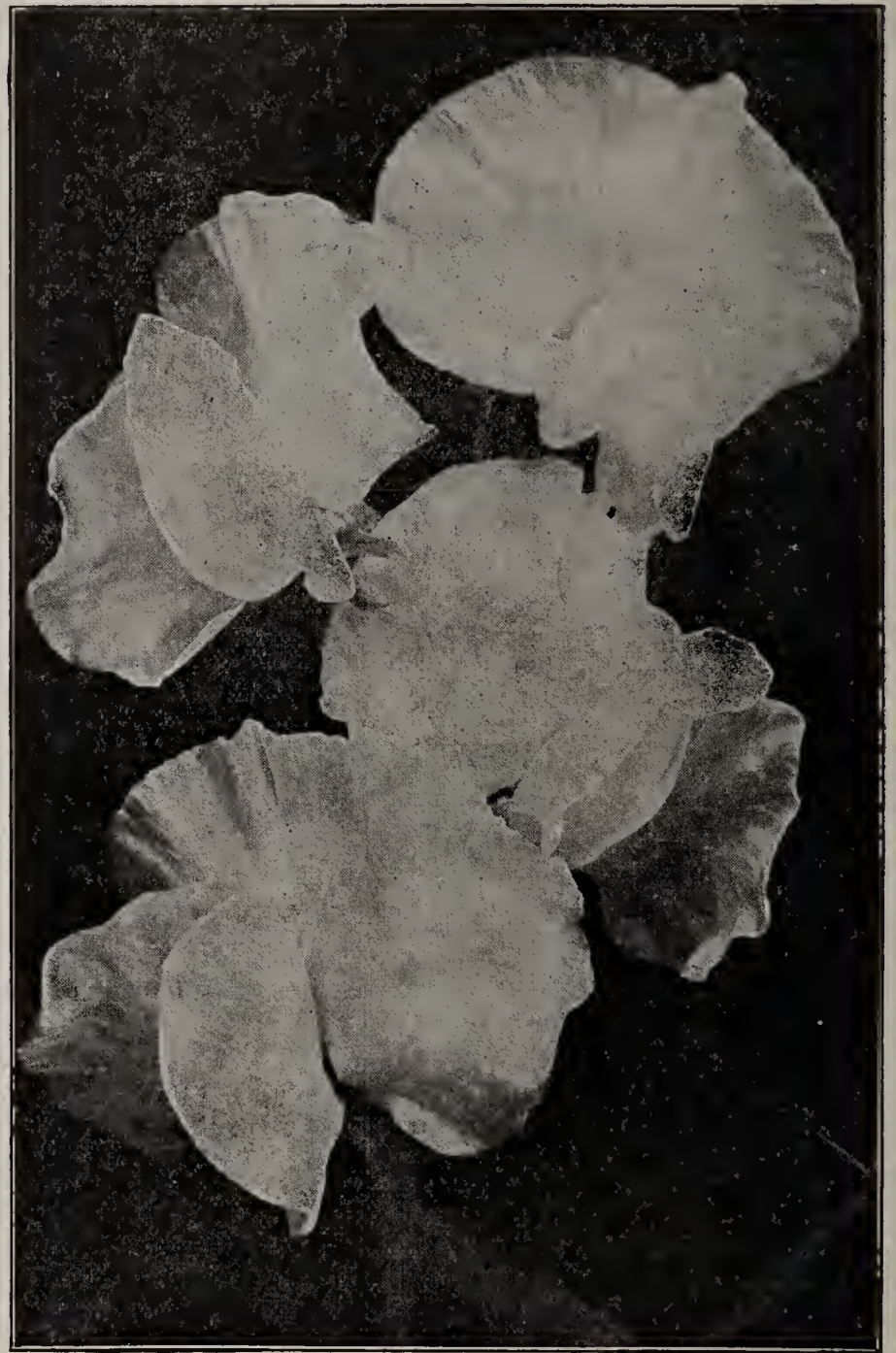

New Sweet Pea, White Harmony

	Pkt.	1/2 oz.	Oz.
Eldorado. Pure orange salmon.....	\$0.15	\$0.40	\$0.75
Flamingo. Orange and salmon.....	.15	.40	.75
Florence Michell. An extra fine deep blue.....	.15	.60	1.00
Giant Rose. Rich rose-pink.....	.15	.40	.75
Glitters (Early Royal Scot). Fiery orange..	.15	.40	.75
Grenadier. Dazzling scarlet.....	.15	.60	1.00
Harmony. A beautiful clear lavender.....	.15	.40	.75
Heatherbell. Mauve lavender.....	.15	.40	.75
Jeanne Mamitsch. Rose-pink.....	.15	.40	.75
Lavender King. Rich, deep lavender.....	.15	.40	.75
Madonna. Giant white; black seeded.....	.15	.40	.75
Majestic Rose. Deep, brilliant rose-pink..	.15	.60	1.00
Mrs. Herbert Hoover. Flowers clear blue..	.15	.40	.75
Pink Profusion. Rich pink.....	.15	.40	.75
Rose Queen. Flowers of large size, and usually four flowers are produced on a stem. Color a most attractive shade of rose-pink..	.15	.60	1.00
Snowstorm (Improved). White; extra large..	.15	.40	.75
Zvolanek's Rose. Extra large; rose-pink....	.15	.40	.75
Mixed Colors. Winter Flowering Spencer....	.10	.30	.50

SWEET ROCKET (Hesperis)

Mixed. An excellent perennial for naturalizing among shrubbery or for planting in a permanent border; fragrant white and purple flowers in mixture; 2 to 3 feet. \$0.25 \$0.10

SWEET WILLIAM (Dianthus Barbatus)

One of the finest hardy perennial garden plants; of easy culture, thriving in any good garden soil. The plants grow about 1½ feet high, and form fine clumps; produces fine effects in beds and borders.

	Large pkt.	Pkt.
Auricula Flowered. A beautiful class of "eyed" single varieties; all colors mixed. oz., 75c.	\$0.25	\$0.10
Single Crimson oz., 75c.	.25	.10
" Newport Pink. Salmon pink oz., \$1.25	.40	.15
" Scarlet Beauty. Deep scarlet oz., \$1.25	.40	.15
" Velvety Maroon oz., 75c.	.25	.10
" White oz., 75c.	.25	.10
" Mixed. All colors oz., 50c.	.25	.10
Double Mixed oz., 90c.	.25	.10
Annual Single Mixed oz., \$2.00	.50	.10

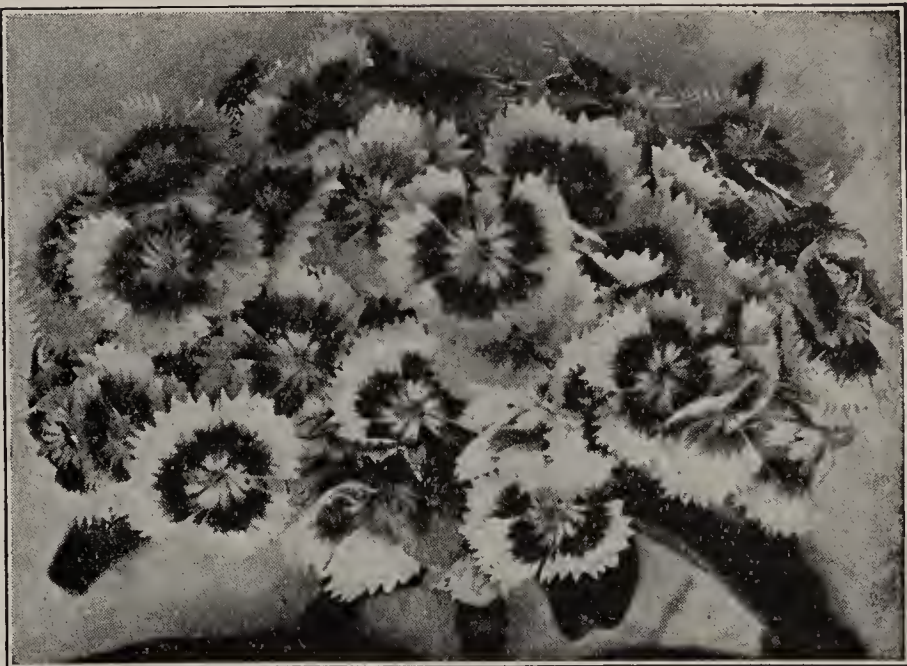

Single Sweet William

TAGETES (Single Marigold)

Signata Pumila. A dwarf, compact bushy annual Marigold; a fine bedding plant; flowers golden yellow; fern-like foliage. \$0.25 \$0.10

THALICTRUM (Meadow Rue)

Very graceful perennial plants with finely cut foliage; excellent for the hardy border.

	Large pkt.	Pkt.
Aquilegifolium. Columbine-like foliage; feathery white flowers. \$0.60	\$0.10	
Dipterocarpum. Rosy purple, with yellow anthers.75	.10
Flavum. Yellow; June; 4 feet.30	.10
Glaucum. Bronze yellow; June; 4 feet.30	.10



Tritoma, Hybrida

TRITOMA (Red Hot Poker)

Hybrida Mixed. A free blooming hardy perennial; large spikes of flowers; 2 feet. \$0.50 \$0.10

THERMOPSIS

Caroliniana. A splendid perennial, 3 to 5 feet high and producing racemes of yellow, lupin-like flowers, 6 to 12 inches long. \$1.00 \$0.25

THUNBERGIA (Black-Eyed Susan)

Mixed. Rapid growing annual climbers, making a pretty vine for trellises, fences, rockwork, etc.; also for window boxes, hanging baskets and vases. oz., \$1.00 .25 .10

TITHONIA

Speciosa (Mexican Sunflower). A native of Mexico; the flowers are large and remind one of a large single Zinnia; color dazzling orange scarlet; an excellent cut flower.40 .10

TORENIA

Fournieri Grandiflora. Showy annuals, flowering all Summer; splendid for vases, hanging baskets, borders, etc.; flowers sky blue with yellow center; 12 inches.60 .10

TROLLIUS (Globe Flower)

Hardy perennial with large, buttercup-like flowers.
Europaeus. Bright yellow; 20 inches75 .25
Ledebouri. Golden orange; 2 feet. 1.00 .25
Hybridus. Bright yellow; 2 feet. 1.00 .25

TUNICA

***Saxifraga.** A low growing hardy perennial, with slender foliage; innumerable tiny star-like, pale pink flowers; an excellent rock plant; 4 to 6 inches.30 .10

VALERIANA (Garden Heliotrope)

Mixed Colors. Hardy perennial border plants; large fragrant flowers, odor resembling that of the heliotrope; 2 to 3 feet.25 .10

MICHELL'S CULTURAL LEAFLETS

We have prepared the following Cultural Leaflets especially for the benefit of the amateur, or, in fact, for any who may want them, giving instructions how to grow the varieties named successfully from seed. These leaflets are free.

201. Antirrhinum.	208. Zinnia.	215. Cyclamen.
202. Aster.	209. Pansy.	216. Larkspur
203. Cineraria.	210. Salvia.	(Annual)
204. Mignonette.	211. Stock.	217. Lupinus.
205. Petunia.	212. Perennials.	218. Phlox Drum.
206. Primula.	213. Carnation.	219. Nasturtium.
207. Verbena.	214. Cosmos.	220. Begonia.

MICHELL'S VERBENAS

One of the most popular garden annuals for beds and massing and for a gorgeous display during the Summer months cannot be excelled, commencing to flower in July and continuing until frost.

- Large pkt. Pkt.
- Beauty of Oxford Hybrids (Novelty).** This is a splendid giant hybrid resulting from a cross between Luminosa and Beauty of Oxford; the color shades from clear rose pink to rose red, making this the brightest rose Verbena ever produced from seed; the individual florets measure over one inch in diameter. See illustration, page 11. (Originator's stock seed) \$0.75 \$0.25
 - Grandiflora, Lavender Glory (Novelty).** A truly magnificent lavender colored variety of gigantic size; undoubtedly the most glorious color in Verbenas, being a true lavender, with a medium size creamy white eye; the individual floret will cover a fifty-cent piece; very fragrant. .75 .25
 - Newport Salmon (Michell Novelty).** A splendid giant flowering, true salmon-pink with white eye; extra large florets; comes absolutely true from seed. .60 .15
 - Dwarf Compact Fireball.** Grows about 6 inches high and is literally covered with bright scarlet blooms; excellent for borders, beds or pot plants. .75 .25
 - Luminosa.** Gigantic blooms of flame pink, toning to softer shades of pink and coral, a beautiful combination. .50 .15
 - Etna.** The finest and brightest color in Verbenas, an intense Geranium red, with a small yellow eye; very large. .50 .15
 - Lucifer.** Flowers of large size; color an intense deep cardinal scarlet throughout. .50 .15
 - Royale.** Rich, deep royal blue flowers of enormous size, with creamy yellow eye. .50 .15
 - Erinoides (Moss Verbena).** Produces a mass of moss-like foliage, spreading over the ground; for beds, baskets or rockeries; flowers purple. .40 .10
 - Lemon Scented (Aloysia Citriodora).** An old favorite garden plant with delightful lemon-scented foliage. .75 .10
 - Venosa (Hardy Garden Verbena).** Heliotrope blue; fine for bedding. .40 .10

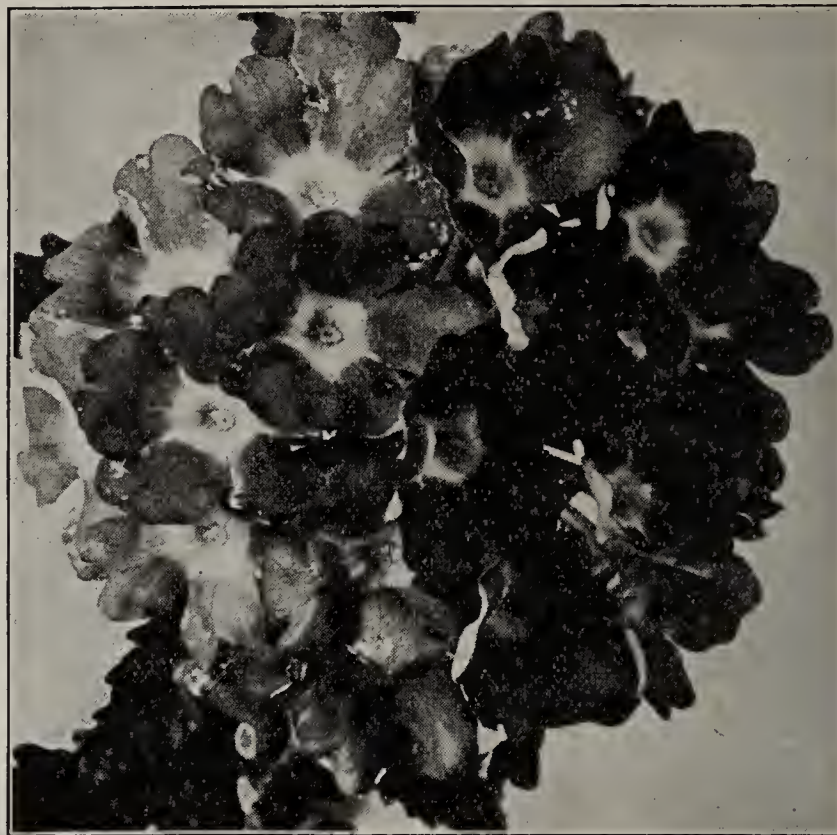

Verbena, Lavender Glory

MICHELL'S VERBENAS

(Continued)

Our Mammoth Fancy strain produces trusses of large flowers of the most brilliant colors and shades.

	Oz.	Large pkt.	Pkt.
Mammoth Fancy Golden Queen. Pure			
yellow.....	\$2.25	\$0.50	\$0.10
" " Helen Willmott. Pink	2.25	.50	.10
" " Purple Mantle. Purple.	2.25	.50	.10
" " Blue shades.....	2.25	.50	.10
" " Pink shades.....	2.25	.50	.10
" " Scarlet shades.....	2.25	.50	.10
" " Striped.....	2.25	.50	.10
" " Pure White.....	2.25	.50	.10
" " Yellow shades.....	2.25	.50	.10
" " Mixed.....	1.50	.40	.10
Collection. One packet each 6 colors.....			.50

VERBASCUM

A stately hardy perennial plant for borders.

	Large pkt.	Pkt.
Olympicum. Silvery foliage, golden yellow flowers; 6 feet.....	\$0.60	\$0.15
Phoeniceum Hybrids Mixed. 2 feet.....	.25	.10

VERONICA (Speedwell)

An elegant hardy perennial plant of easy culture and free-flowering habit; of value as a cut flower or for the garden.

	Large pkt.	Pkt.
Longifolia Subsessilis. Rich blue flowers; 2 feet. .	\$0.50	\$0.10
*Repens. A splendid dwarf perennial rock plant, with masses of bright blue flowers; 4 inches.....	.75	.25
Spicata. Bright blue flowers; 18 inches.....	.50	.10

VINCA (Madagascar Periwinkle)

Dwarf bedding plants, easily raised from seed; deep green glossy foliage and bright single blossoms of striking beauty; also suitable for pot plants; sow early.

	Large pkt.	Pkt.
Alba. White with rose eye.....	\$0.40	\$0.10
Alba Pura. Pure white.....	.40	.10
Rosea. Rose with dark eye.....	.40	.10
Mixed.....	oz., \$1.25	.30 .10



Vinca

***VIOLA**



Viola, Arkwright Ruby

Arkwright Ruby (*Novelty*). This new variety is of the large flowered type; color a beautiful bright rosy crimson, with terra cotta shadings, making it a very outstanding variety, with the added attraction of being very fragrant. Pkt., 50c.; \$1.00 per large pkt.

Yellow Queen (*Novelty*). Another large flowered type; color deep pure yellow and coming practically 100% true from seed; plants are of robust habit and of a very free flowering nature; a decided acquisition to the Viola group. Pkt., 50c.; \$1.00 per large pkt.

Large pkt. Pkt.

Jersey Gem. This is the most popular and free blooming of all Violas; color a pure rich violet; of dwarf habit and continuously in bloom. \$1.00 \$0.50

***VIOLA BOSNIACA (Johnny Jump-Up)**

Free bloomer; small leaves; purple flowers.60 .10

***VIOLA CORNUTA (Tufted Pansies)**

These resemble pansies in shape and form and while not quite as large, they bloom more profusely and for a longer time. Seed sown in April produce flowering plants by June.

Large pkt. Pkt.

- Admiration.** Dark blue. \$0.60 \$0.10
- Apricot Queen.** One of the finest of the Violas; color a beautiful rich apricot yellow, tinged orange; flowers large; free bloomer.75 .25
- G. Wermig.** Rich violet blue; 8 inches.75 .25
- Mauve Queen.** Lovely mauve color.60 .10
- Papilio.** Blue and white; 6 inches.60 .15
- Perfection.** Light blue.50 .10
- Rose Queen.** Compact, dwarf habit; rosy pink flowers; ideal for the rock garden.75 .20
- White Perfection.** Large white.50 .10
- W. H. Woodgate.** Large, bright amethyst violet; 8 inches. 1.00 .25
- Yellow Perfection.** Golden yellow.50 .10
- Mixed.** All colors.50 .10

***VIOLA (Scotch Bedding Pansies)**

Produces larger flowers than Viola Cornuta.

Mixed Colors. 1.00 .25

***VIOLET Sweet Scented (Viola Odorata)**

Single Blue Czar (Hardy Garden Violet). Seed is of slow germination and should be sown in the Fall and left outdoors over Winter.75 .10

VIRGINIAN STOCK

Mixed. An easy growing border annual. . . . oz., 40c. .25 .10

WALLFLOWER

Half-hardy perennials of delicious fragrance. They should be protected in a cold frame in the Winter and planted out in the Spring; 2 feet.

- Double Brown**. Large pkt. Pkt. \$0.60 \$0.10
- “ Yellow**.60 .10
- “ Mixed.** All colors.60 .10
- Early Flowering Double Mixed.** An extra early variety flowering from seed in 90 days.50 .10
- Single Mixed**. oz., 40c. .25 .10
- Paris Extra Early Mixed.** A single-flowering variety, which may be treated as an annual, flowering the first year from seed; 1½ feet. oz., 60c. .25 .10

ANNUAL MIXED OR WILD FLOWER GARDEN SEED

This mixture embraces a large number of varieties of easy-growing, beautiful and interesting annual flowers, which will furnish a profusion of bloom throughout the entire Summer and Autumn; many of the varieties will be found useful for cutting. Pkt., 10c.; 25c. per oz.; ¼ lb., 60c.; \$2.00 per lb.

XERANTHEMUM (Everlasting Flower)

See page 26.

See pages 8 to 11 for Novelties and Specialties in Flower Seeds.



Double Wallflower

46 MICHELL'S ZINNIAS (Youth and Old Age)

One of the most showy and satisfactory of our hardy annuals for beds, mixed borders and for cutting purposes; easy to grow in any good garden soil. They commence flowering early in the Summer and continue until frost.

GIANT DAHLIA FLOWERED ZINNIAS

See Color Plate Opposite

Plants of vigorous habit, from 2½ to 3 feet high; mammoth flowers 4 to 6 inches across and 2½ to 3 inches deep and so closely resembling decorative Dahlias, that when placed by their side, it is difficult to distinguish one from the other. This new type is also valuable for growing under glass for cutting.

	Oz.	¼ oz.	Large Pkt.	Pkt.
Buttercup. Immense deep creamy yellow.	\$2.00	\$0.60	\$0.40	\$0.15
Crimson Giant	2.00	.60	.40	.15
Dream. Deep lavender turning to purple.	2.00	.60	.40	.15
Exquisite. Light rose, center deep rose.	2.00	.60	.40	.15
Golden Dawn. Bright golden yellow...	2.00	.60	.40	.15
Golden State. Orange yellow.....	2.00	.60	.40	.15
Luminosa. A new shade of bright pink.	2.00	.60	.40	.15
Old Rose	2.00	.60	.40	.15
Oriole. Orange and gold.....	2.00	.60	.40	.15
Polar Bear. Pure white.....	2.00	.60	.40	.15
Purple Prince. Large deep purple.....	2.00	.60	.40	.15
Scarlet Flame. Scarlet with blending of orange.....	2.00	.60	.40	.15
Mixed Colors	1.25	.40	.30	.10
Collection, one packet each 12 colors.....				1.50
“ one packet each 6 colors.....				.75
“ one large packet each 12 colors.....				3.75

ZINNIA ELEGANS, LILLIPUT

Of compact habit not over 15 inches high; beautiful miniature, perfectly double flowers; splendid for bedding and good for cutting.

	Oz.	Large pkt.	Pkt.
Canary Yellow	\$1.25	\$0.25	\$0.10
Crimson Gem	1.25	.25	.10
Golden Gem	1.25	.25	.10
Salmon Rose	1.25	.25	.10
Scarlet Gem (Red Riding Hood)	1.25	.25	.10
Valencia. A new shade of burnt orange.....	1.25	.25	.10
White Gem	1.25	.25	.10
Mixed Colors	1.00	.25	.10
Collection, one packet each 6 colors, 50c.			



Zinnia Pumila, Picotee "Delight"

VARIOUS ZINNIAS

	Oz.	Large pkt.	Pkt.
Pumila Picotee "Delight." An extra select variety in light and deep salmon shades; petals ruffled and curled.....		\$0.60	\$0.15
Scabious Flowered (New). Medium sized flowers, resembling the annual Scabiosa; fine for cutting; choice mixed colors.....		.75	.25
Curled and Crested Mixed. Petals curiously twisted and curled; a distinct variety in a good range of colors.....	\$1.00	.30	.10
Giant Picotee, Golden Pheasant. Desirable for bedding or cutting; gold ground, each petal tipped with maroon.....	2.00	.50	.15
Giant Picotee, Mixed. Large double flowers of many colors and shades.....	2.00	.50	.15
Haageana (Mexican Hybrids). Double mixed		.60	.15

ROBUSTA OR GIANT DOUBLE ZINNIAS

Plants grow to a height of 2½ to 3 feet with immense perfectly double flowers; splendid for cutting or garden effect.

	Oz.	Large pkt.	Pkt.
Buttercup. Deep yellow.....	\$1.25	\$0.30	\$0.10
Crimson	1.25	.30	.10
Flesh Color	1.25	.30	.10
Golden Yellow	1.25	.30	.10
Orange	1.25	.30	.10
Purple	1.25	.30	.10
Rose King. Carmine rose.....	1.25	.30	.10
Salmon	1.25	.30	.10
Scarlet	1.25	.30	.10
Shrimp Pink	1.25	.30	.10
Sulphur Yellow	1.25	.30	.10
Violet	1.25	.30	.10
White	1.25	.30	.10
Mixed75	.25	.10
Collection, one packet each, 12 colors.....			1.00
Collection, one packet each, 6 colors.....			.50

DWARF DOUBLE ZINNIAS

Compact bushes not over two feet in height, large double flowers.

	Oz.	Large pkt.	Pkt.
Crimson	\$0.75	\$0.25	\$0.10
Pink75	.25	.10
Salmon Rose75	.25	.10
Scarlet75	.25	.10
White75	.25	.10
Yellow75	.25	.10
Mixed60	.25	.10



Lilliput Zinnias

Michell's Zinnias, Giant Dahlia Flowered



(A) Golden State
(B) Old Rose
(C) Crimson Giant
Buttercup—Creamy yellow
Dream—Lavender turning to purple
Exquisite—Rose color
Golden Dawn—Golden yellow
Luminosa—Bright pink
Oriole—Orange and gold
Polar Bear—Pure white
Purple Prince—Deep purple
Scarlet Flame—Bright scarlet
Pkt. 15c; 40c per large pkt.
Collection, 1pkt. each 12 colors \$1.50
Collection, 1 large pkt. each 12 colors
\$3.75
MIXED COLORS
Pkt. 10c; 30c per large pkt.; oz., \$1.25

IN VEGETABLE SEEDS FOR 1934

In line with our usual custom, we have taken from our general list certain novelties and specially meritorious varieties of vegetable seeds to which we call, on this and the two succeeding pages, special attention. Planters will do well to include these sorts in their seed order.

Prices quoted on Beans, Sugar Corn and Peas are prepaid on quantities up to 5 lbs., to the first and second zones, for other zones see parcel post table on page 1. Larger quantities shipped at purchaser's expense.

GIANT PODDED ASPARAGUS BEAN

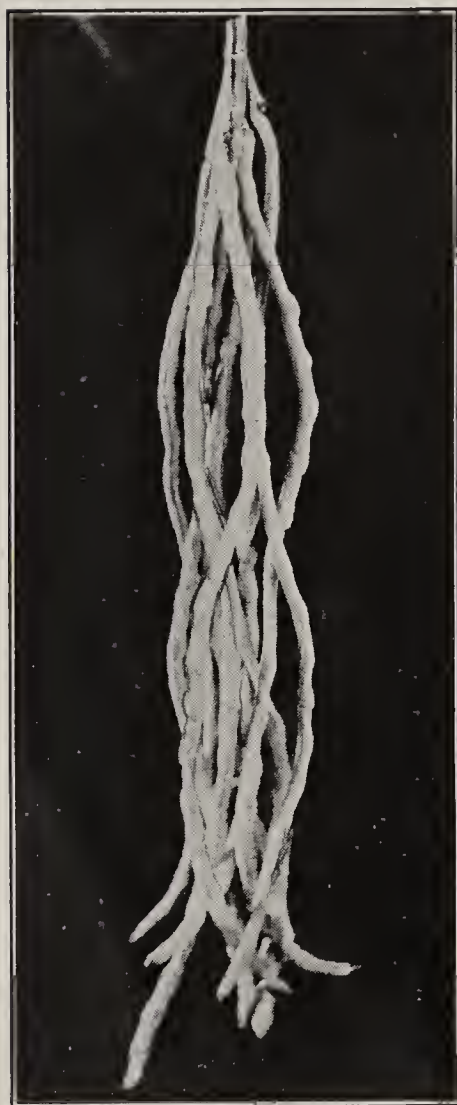

Giant Podded Asparagus Bean

Also known as the
Yard Long Bean

A green-podded snap pole bean; vines are vigorous growers and produce an enormous crop of long green pods, measuring 2 feet or more in length, which are tender and of excellent quality. Ready in about 80 days after planting.

Pkt., 15c.; 55c. per ½ lb.; lb., \$1.00.

BEAN, DWARF
GREEN POD
BOUNTIFUL

See color plate opposite.

One of the best flat, green-podded bush beans; the plants are of very vigorous growth, early, a continuous bearer and very prolific; entirely stringless, very tender and of delicious flavor; pods 5 to 7 inches long. Valuable also as a dry shelled bean. Pkt., 10c.; 25c. per ½ lb.; lb., 40c.; 75c. per 2 lbs.; 5 lbs., \$1.75; \$3.30 per 10 lbs.; 25 lbs., \$7.00.

BEET

Michell's "Winter Keeper"

See color plate opposite.

This grand beet is almost globe-shaped, tapering slightly toward the root. The dark blood-red flesh is always tender; the hard, stringy, woodenlike substance, so common in many varieties, is entirely absent in this sort. It is ideal as a late Summer cropper, or for use during Winter and Spring, until new beets are on the market again. Pkt., 10c.; 30c. per oz.; ¼ lb., 70c.; \$2.25 per lb., postpaid.

BROCCOLI, EARLY GREEN CALABRESE

This is the variety so much sought by the Italian trade and has become quite popular in our American gardens; forms a fair size, green head; after this is cut from the main stalk, new sprouts develop, which form small heads of a loose nature. In order to get an early crop, sow seed in cold frames, transplanting at the proper time; ready for use in about four months from sowing of seed. Prepare this delicious vegetable same as you would cauliflower. Pkt., 15c.; 35c. per ½ oz.; oz., 65c.; \$2.25 per ¼ lb., postpaid.

JAPANESE
CLIMBING
CUCUMBER

The vines attain almost twice the length of other varieties and can be successfully grown on fences, poles or trellises. The extra long, light-green fruits are produced in abundance; flesh thick and firm, never bitter; a superb variety for slicing; when young make fine pickles. The fruits are raised well above the ground, so seldom suffer from wet weather or insects. Pkt., 15c.; 40c. per oz.; ¼ lb., \$1.00, prepaid.



SUGAR CORN

PHILADELPHIA FAVORITE

A grand variety of Penna. origin and marketed in Philadelphia and vicinity for a number of years. Stalks grow to a height of 4½ to 5 feet and produce two to three nice ears to a stalk, averaging 8 to 9 inches in length and which are covered tightly with a dark green husk; kernels pearly white and deliciously sweet; matures in 75 to 78 days, depending on location. Pkt., 10c.; 25c. per ½ lb.; lb., 40c.; 75c. per 2 lbs.; 5 lbs., \$1.75; \$3.30 per 10 lbs.; 25 lbs., \$7.50.

WATERMELON, TANGERINE

A fine melon for the market or home garden; oval in shape, with mottled stripes of light green; flesh a decided pink and of finest quality. When the thin rind is broken, the flesh separates the same as a tangerine. Pkt., 15c.; 35c. per oz.; ¼ lb., \$1.00, prepaid.

PEAS, EXTRA EARLY EIGHT WEEKS

This is one of the earliest dwarf Peas in cultivation, commencing to bear 6½ weeks after planting. They usually grow to a height of from 12 to 15 inches; on account of their dwarf habit they can be planted closer than most other varieties, yielding a greater quantity of peas from a comparatively small space of ground than from almost any other variety. The pods are of medium size and well filled with peas of extra fine quality. Pkt., 10c.; 25c. per ½ lb.; lb., 40c.; 75c. per 2 lbs.; 5 lbs., \$1.75; \$3.30 per 10 lbs.; 25 lbs., \$7.50.

RADISH, ICICLE

See color plate opposite.

This is one of the finest of all long radishes; long, slender root which remains crisp even when well developed; matures early and is good for either Spring or Fall sowing. Pkt., 10c.; 15c. per oz.; ¼ lb., 40c.; \$1.25 per lb., postpaid.

TOMATO, CRIMSON CUSHION
OR BEEFSTEAK

See color plate opposite.

A vigorous grower; heavy, dark green foliage; fruits large, crimson scarlet, solid and suitable for slicing or canning. This is a variety that will grow and produce in most any locality. Pkt., 10c.; 35c. per ½ oz.; oz., 60c.; \$1.85 per ¼ lb., postpaid.

MICHELL'S

Reliable
VEGETABLE SEEDS

ICICLE RADISH
IMPROVED
STRAIN

TOMATO
CRIMSON CUSHION
or BEEFSTEAK

BEET
MICHELL'S
WINTER KEEPER

DWARF BEAN

Bountiful

BEET

Michell's Winter
Keeper

RADISH

Icicle

TOMATO

Crimson Cushion,
or Beefsteak

For description and prices,
see opposite page

DWARF BEAN
BOUNTIFUL



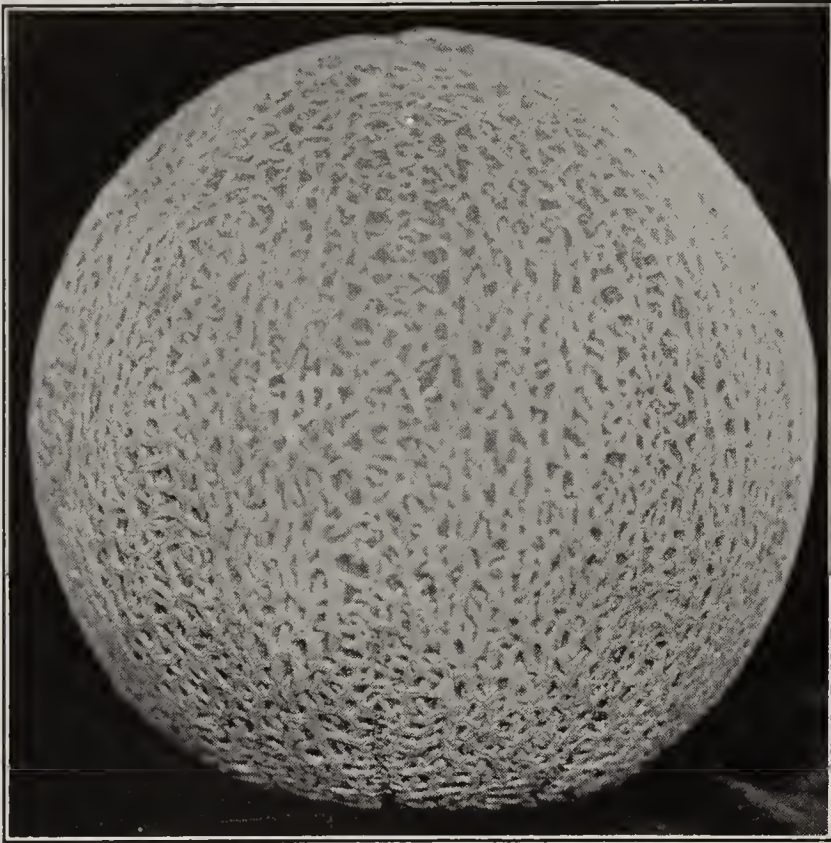

Muskmelon, Honey Rock

MUSKMELON

HONEY ROCK

A New Introduction

A wonderful melon of excellent flavor; medium in size, round as a ball and with a very coarse netting; flesh is thick and of a deep orange color; they ripen early and have proven to be very productive. Pkt., 10c.; 25c. per oz.; ¼ lb., 75c., postpaid.

WATERMELON

PRIDE OF MUSCATINE

A New Melon (Wilt-Resistant)

This variety will be welcomed in sections where melon wilt prevails; it is more immune from this plant disease than any variety we know of. A long dark green variety, with red flesh and exceptionally sweet. Pkt., 10c.; 25c. per oz.; ¼ lb., 70c.; \$2.00 per lb., prepaid.

PARSLEY, TOM THUMB

A very fine extra curled variety of very dwarf habit, growing uniform in shape and compactness. Excellent for home garden use; also suitable for edging borders and decorative purposes. Pkt., 15c.; 25c. per oz.; ¼ lb., 75c.; \$2.00 per lb., prepaid.

RUTA BAGA

AMERICAN PURPLE TOP YELLOW

(Special Strain)

This special strain is at least 8 to 10 days earlier than our usual strain; the roots are mostly round, with a small tap root, yellow in color with purple crown; flesh amber colored, sweet and free from fiber; tops are of medium size and of a smoky green color. This strain is of very rapid growth, seed can be sown much later than other strains and yet develop a nice large root before freezing weather. Pkt., 15c.; 35c. per oz.; ¼ lb., \$1.00; \$3.50 per lb., prepaid.

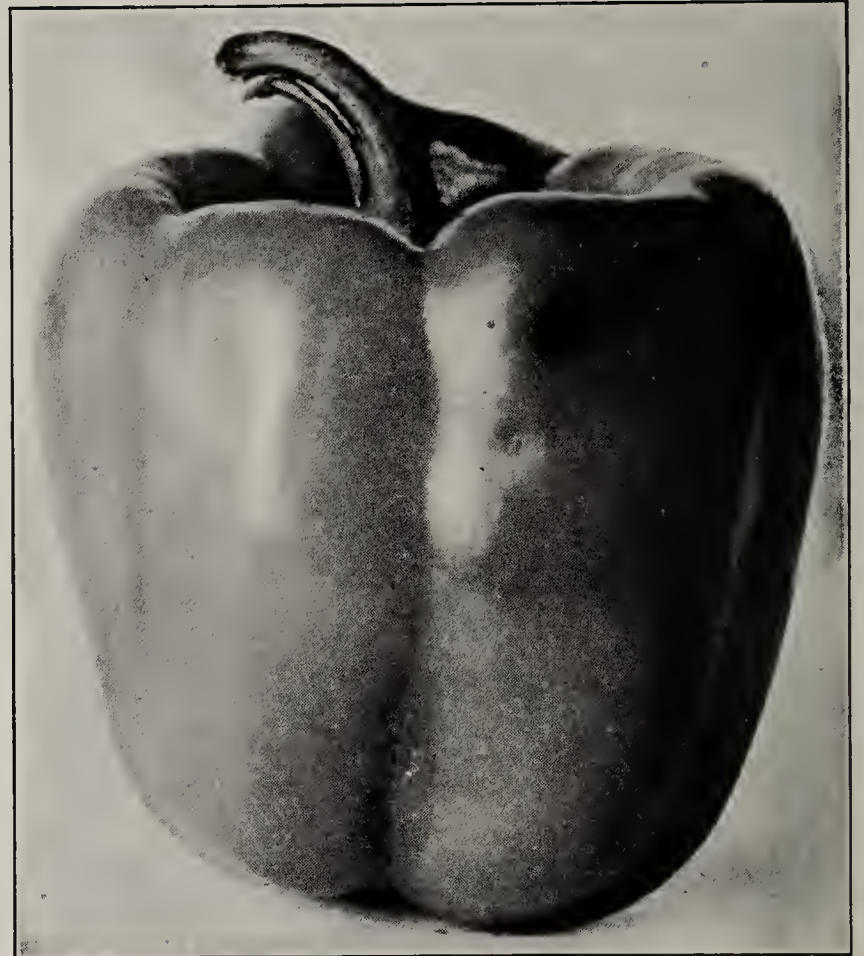

California Wonder Pepper

CALIFORNIA WONDER PEPPER

A new variety of great merit; plants are sturdy, bearing nice, heavy fruit of a glossy green color, later turning to vivid red. The flesh is thick and can be eaten like an apple. A great producer in the latitude of Philadelphia and points South. Pkt., 10c.; 35c. per ½ oz.; oz., 60c.; \$2.00 per ¼ lb., prepaid.

See page 2 for complete index of Vegetable Seeds.



American Purple Top Yellow Ruta Baga

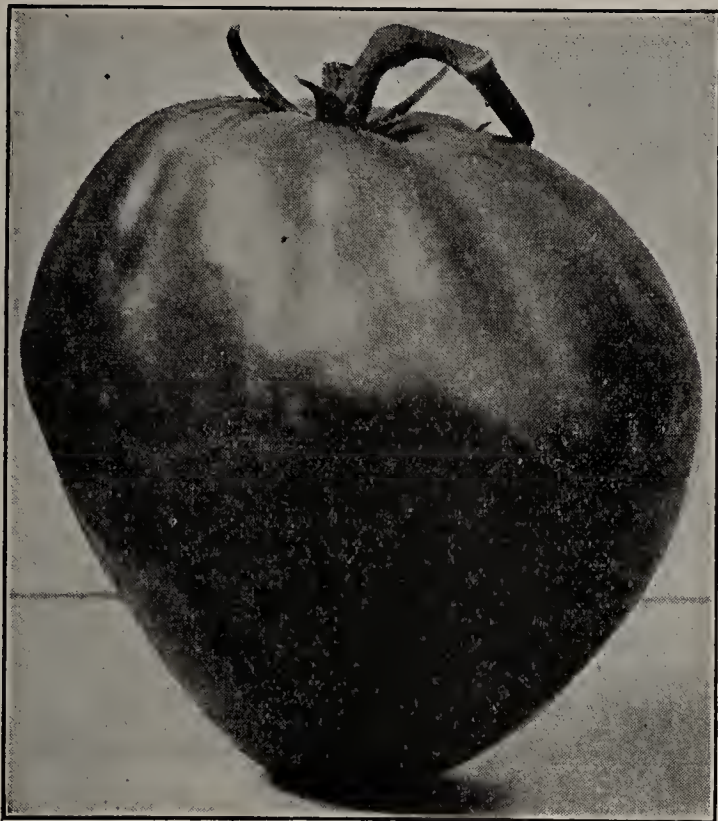

Oxheart Tomato

NOTE—All seeds on this page (excepting Beans) sent prepaid at quoted prices.

OXHEART TOMATO

A main crop, pink fruited sort, which has become very popular in certain sections due to its shape (that of a heart) and its great solidity; being a shy seeder makes it very meaty, very little acid and of fine quality; some of the fruits grow to an enormous size. Pkt., 15c.; 45c. per 1/2 oz.; oz., 85c.; \$3.00 per 1/4 lb.



JAPANESE FOLIAGE TURNIP

A Two-Purpose Turnip

The root or bulb as well as the top is edible; we recommend this new variety very highly; produces a nice size white root of good quality; the foliage or top grows erect, is clean and practically free from insects; the top when cooked is very juicy, tender and of a mild turnip flavor; it will make a crop in spite of dry weather. Pkt., 10c.; 15c. per oz.; 1/4 lb., 35c.; \$1.00 per lb.; 5 lbs., \$4.50.

ITALIAN AND AMERICAN VEGETABLES

Especially selected varieties which are used extensively by the Italian people.

DWARF BEAN (Fagiuoli Nana)

Dwarf Horticultural. One of the best early shell beans grown; the thick, flat, stringless pods are colored red and green; the bean is large, round and speckled. Pkt., 10c.; 25c. per 1/2 lb.; lb., 40c.; 75c. per 2 lbs.; 5 lbs., \$1.75; \$3.30 per 10 lbs.; 25 lbs., \$7.00.

BROCCOLI (Brocoli)

Early Green Calabrese. The variety so much sought for by the Italian people and has become quite popular in our American gardens; forms a fair sized green head; after this is cut from main stalk, new sprouts develop, which form small heads of a looser nature. Pkt., 15c.; 35c. per 1/2 oz.; oz., 65c.; \$2.25 per 1/4 lb.

CABBAGE (Cavola Cappuccio)

Perfection Drumhead Savoy. A crimped-leaved sort; color deep, glossy green; the head is almost round and distinctly flavored. Pkt., 10c.; 25c. per 1/2 oz.; oz., 40c.; \$1.10 per 1/4 lb.

CUCUMBER (Citriolo)

Early Market. A new variety worthy of a trial in your garden. Plant this one and you will have cucumbers before your neighbors. An attractive dark green variety, uniform in shape and size; averages 8 inches in length; excellent for slicing. Pkt., 10c.; 25c. per oz.; 1/4 lb., 55c.



Squash, Coccozelle

DANDELION

(Dente di leone)

Thick Leaved or Cabbaging. A valuable vegetable grown in quantities for the New England markets, where it is prized as the first Spring greens. The leaves are boiled and served hot or cold. Pkt., 10c.; 35c. per 1/2 oz.; oz., 60c.; \$2.25 per 1/4 lb.

ENDIVE (Indivia)

Escarolle or Full Heart Batavian. Leaves broad, light green, nearly plain. Pkt., 10c.; 30c. per oz.; 1/4 lb., 75c.

FLORENCE FENNEL

(Finocchio)

A delicious Italian vegetable which tastes quite like Celery, but is a little sweeter and more delicate in flavor. The enlarged leaf bases are usually boiled in preparation for the table. Pkt., 10c.; 25c. per oz.



Finocchio or Florence Fennel

ONION (Cipolla)

White Barletta or Marvel of Pompeii. An extra early, small round variety, used principally for pickling, also for bunching. Pkt., 10c.; 25c. per oz.; 1/4 lb., 75c.; \$2.75 per lb.

PARSLEY (Prezzemolo)

Plain or Single. Plant very hardy, leaves not curled. Pkt., 10c.; 15c. per oz.; 1/4 lb., 40c.; \$1.25 per lb.

ITALIAN ROCKET OR RUCOLA

Greatly relished in salads and quite tasty in soups; the leaves resemble sorrel; slightly pungent, but flavor is distinct and appetizing. Pkt., 15c.; 45c. per oz.; 1/4 lb., \$1.40.

SQUASH (Zucca)

Cocozelle or Italian. This is a bush variety with smooth fruits, dark green in color, striped deeper. Pkt., 10c.; 20c. per oz.; 1/4 lb., 45c.; \$1.50 per lb.

TOMATO, ITALIAN SALAD

A new variety from Italy for the American people; this fine red, plum-shaped salad tomato has become quite popular, due to the fact that it is practically free from acid, very few seeds and has a flavor all its own. When served in halves or quarters on a lettuce leaf with the usual fixings it makes a very attractive dish. Pkt., 20c.; 60c. per 1/2 oz.; oz., \$1.00.



It will be observed that the varieties offered in these collections are such as can be planted as late as most gardening can be undertaken. The "Collection Idea" of Vegetable Seeds is gaining in popular favor; many persons, even the experienced gardeners, do not know the best varieties to order. These collections have also a decided feature of advantage, as they save time and money; they cover the most popular kinds of vegetables used in every household and we are sure our customers will find them made up with the thought of being entirely practical. As these collections are put up previous to the busy season we cannot make any changes in the varieties or quantities. The collections named below if bought separately would cost considerably more.

Michell's City Garden Collection

14 Varieties Postpaid for \$1.00

- | | | |
|-------------------------------------|--------------------------------------|--|
| 1 Pkt. Beans. Stringless Green Pod. | 1 Pkt. Corn (Sugar). Golden Bantam. | 1 Pkt. Radish. Round Red. |
| 1 Pkt. Beans. Dwarf Golden Wax. | 1 Pkt. Lettuce. Big Boston. | 1 Pkt. Squash. White Bush. |
| 1 Pkt. Beans. Fordhook Bush Lima. | 1 Pkt. Onion. Danver's Yellow Globe. | 1 Pkt. Tomato. Earliana. |
| 1 Pkt. Beet. Crosby's Egyptian. | 1 Pkt. Parsley. Moss Curled. | 1 Pkt. Turnip. Purple Top White Globe. |
| 1 Pkt. Carrot. Danver's Half Long. | 1 Pkt. Peas. Dandy Extra Early. | |

Michell's Suburban Garden Collection

22 Varieties Postpaid for \$2.50

- | | | |
|---|--------------------------------------|--|
| ½ Lb. Beans. Stringless Green Pod. | 1 Pkt. Kale. Dwarf Green Curled. | 1 Pkt. Radish. Round Red. |
| ½ Lb. Beans. Dwarf Golden Wax. | 1 Pkt. Kohl Rabi. White Vienna. | 1 Pkt. Salsify. Sandwich Island. |
| ½ Lb. Beans. Fordhook Bush Lima. | 1 Pkt. Lettuce. Big Boston. | 1 Oz. Spinach. Bloomsdale. |
| 1 Pkt. Beet. Crosby's Egyptian. | 1 Pkt. Onion. Danver's Yellow Globe. | 1 Pkt. Squash. White Bush. |
| 1 Pkt. Cabbage. Early Jersey Wakefield. | 1 Pkt. Parsley. Moss Curled. | 1 Pkt. Swiss Chard. Lucullus. |
| 1 Pkt. Carrot. Danver's Half Long. | 1 Pkt. Parsnip. Hollow Crown. | 1 Pkt. Tomato. Earliana. |
| 1 Pkt. Cucumber. White Spine. | ½ Lb. Peas. Dandy Extra Early. | 1 Pkt. Turnip. Purple Top White Globe. |
| ½ Lb. Corn (Sugar). Stabler's Early. | | |

Michell's Country Garden Collection

32 Varieties Postpaid for \$5.00

- | | | |
|---|--|--------------------------------------|
| 1 Lb. Beans. Stringless Green Pod. | ½ Lb. Corn (Sugar). Stowell's Evergreen. | 1 Pkt. Onion. Danver's Yellow Globe. |
| 1 Lb. Beans. Dwarf Golden Wax. | 1 Pkt. Cucumber. White Spine. | 1 Pkt. Onion. Silver Skin. |
| 1 Lb. Beans. Fordhook Bush Lima. | 1 Pkt. Endive. Green Curled. | 1 Pkt. Parsley. Moss Curled. |
| 1 Lb. Beans. King of Garden Pole Lima. | 1 Pkt. Kale. Green Curled. | 1 Lb. Peas. Dandy Extra Early. |
| 1 Oz. Beet. Crosby's Egyptian. | 1 Pkt. Kohl Rabi. White Vienna. | 1 Lb. Peas. Dwarf Champion. |
| 1 Pkt. Cabbage. Early Jersey Wakefield. | 1 Pkt. Leek. Carentan. | 1 Oz. Radish. Round Red. |
| 1 Pkt. Cabbage. Late Flat Dutch. | 1 Pkt. Lettuce. Big Boston. | 1 Oz. Radish. Round White. |
| 1 Oz. Carrot. Danver's Half Long. | 1 Pkt. Lettuce. Curled Silesian. | 1 Oz. Spinach. Bloomsdale. |
| 1 Pkt. Celery. White Plume. | 1 Pkt. Lettuce. Cos or Romaine. | 1 Pkt. Squash. White Bush. |
| ½ Lb. Corn (Sugar). Golden Bantam. | 1 Pkt. Muskmelon. Rocky Ford. | 1 Oz. Swiss Chard. Lucullus. |
| ½ Lb. Corn (Sugar). Stabler's Early. | 1 Pkt. Watermelon. Dixie. | |

Michell's Practical Garden Pointers. A publication we have compiled that contains valuable information on the culture of Vegetables, Flowers, etc., also Garden Plans, will be sent free with any of the above collections.

ANISE (Herb)

Seed is used for flavoring. Pkt., 10c.; 35c. per oz.



ARTICHOKE

Artichaut (Fr.); Artischoke (Ger.); Articiocca (Ital.)

One oz. will produce about 500 plants.

Sow seed in January in the greenhouse, or in hotbeds in March. Transplant when large enough, in rows 3 feet apart, 2 feet apart in the row. Protect the plants in Winter by taking them in a cellar or putting in a cold frame; may be left outdoors if protected by straw or leaves.

Green Globe. Pkt., 15c.; 30c. per 1/2 oz.; oz., 50c.; \$2.00 per 1/4 lb.

ARTICHOKE PLANTS

(Ready in April)

Green Globe. We grow a large stock of these, for those who do not care to bother with them from seed, thus an early crop may be assured. Pot grown, \$1.50 per doz.; 25 for \$3.00; \$10.00 per 100 (by express only).

ARTICHOKE ROOTS

Jerusalem (Ready in April)

Used for table and stock feeding. Cut the tubers to single eyes and plant like potatoes, 3 to 4 feet apart each way, three or four tubers in a hill. Leave the tubers in the ground and dig as wanted. 20c. per lb. (by parcel post, 30c.); 75c. per 5 lbs. (by parcel post, 90c.); 10 lbs., \$1.20 (by parcel post, \$1.40); \$2.75 per 25 lbs.; 50 lbs., \$4.50.

ASPARAGUS ROOTS

(Ready about March 20th)

4000 to 6000 roots are required for an acre

	2-Year-Old Roots		
	Per 50	100	1000
Palmetto or Eclipse	\$0.70	\$1.25	\$10.00
Giant Washington85	1.50	12.00

If above are wanted by parcel post, add 10c. per 50; 15c. per 100 for postage.

ACCESSORIES TO ASPARAGUS GROWING

ASPARAGUS BUNCHER

Even where one has a limited amount of asparagus to market, it pays to use a buncher. Price, with knife guard, \$4.50 (by P. P., \$4.70).

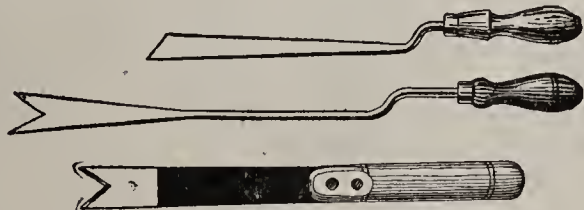

ASPARAGUS KNIVES

	By P.P.	
	Each	Each
No. 1 (top illustration).....	\$0.50	\$0.60
No. 3 (center illustration).....	.50	.60
No. 2311 (bottom illustration).....	.40	.50

ASPARAGUS TAPE

Fast red, 1000-yd. spool, \$4.00 (by P. P., \$4.15).
Green, 1000-yd. spool, \$3.00 (by P. P., \$3.15).

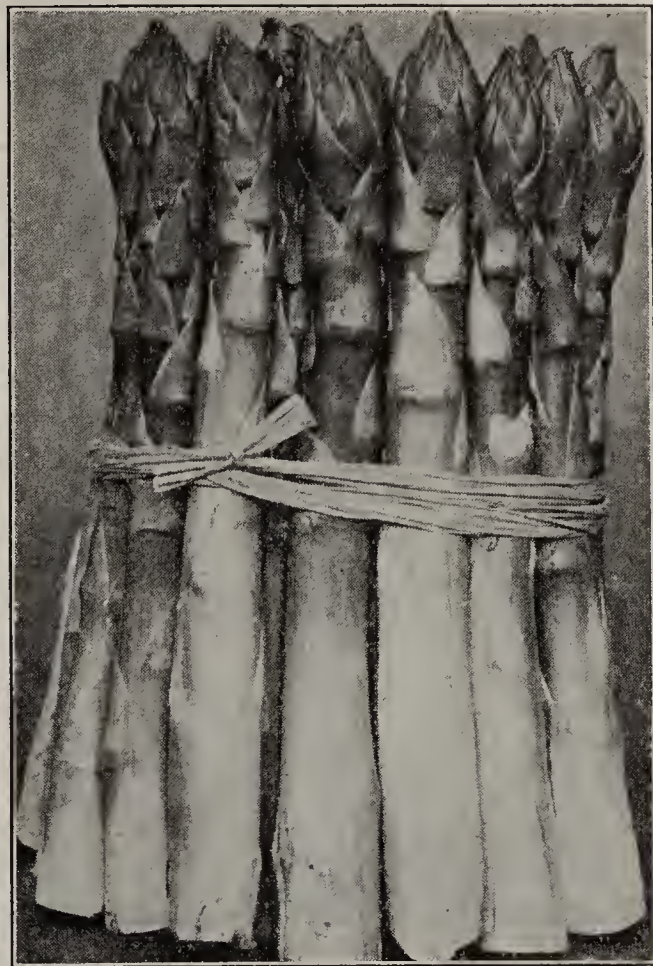

Giant Washington Asparagus

ASPARAGUS

Asperge (Fr.); Spargel (Ger.); Sparagio (Ital.)

Sow 5 lbs. per acre for roots, or 1 oz. to 50 feet.

A well-cared-for bed improves with age and lasts for many years. It may be established from seed, but much time is saved by planting roots. Seeds should be sown thinly in early Spring in rows 1 to 2 feet apart. Thin out the weakest plants so the remainder will be 4 inches apart. When one or two years old, transplant in the permanent bed in rows 3 feet apart, setting the roots 1 foot to 1 1/2 feet apart, from where it can be cut three years later. "Michell's Practical Garden Pointers" gives full information and is mailed free.

Palmetto or Eclipse. One of the earliest; very prolific and finely flavored. Color, green. 15c. per oz.; 1/4 lb., 35c.; \$1.00 per lb.

Giant Washington. A rust-resisting variety; long stout spears, of a dark green color, with a rich purple tinge. Pkt., 10c.; 15c. per oz.; 1/4 lb., 40c.; \$1.25 per lb.

BASIL, Sweet (Herb)

Pkt., 10c.; 25c. per 1/2 oz.; oz., 40c.

Raffia. Ideal for tying asparagus in bunches. Natural, 40c. per lb. (by parcel post, 50c.); 5 lbs., for \$1.90 (by parcel post, \$2.05). Green, 75c. per lb. (by parcel post, 85c.); 5 lbs., \$3.50 (by parcel post, \$3.65).

Raffia Tape. A linen and paper composition; Nile green color. 75c. per bolt of 250 yards (by parcel post, 85c.); 6 bolts, \$4.25 (by parcel post, \$4.45).

Jute Twine. For tying asparagus, 2 and 3-ply; soft and pliable. Per ball, 15c. (by parcel post, 25c.); 25c. per lb. (by parcel post, 40c.).

Asparagus Salt. Applied in the Spring for destroying weeds, 800 lbs. per acre. \$2.00 per 100 lbs.; 200 lbs., \$3.50; \$16.00 per 1/2 ton; ton, \$30.00.

Asparagus Fertilizer. Compounded after a formula recommended by a leading asparagus grower; apply 800 lbs. per acre. \$2.50 per 100 lbs.; 200 lbs., \$4.50; \$21.50 per 1/2 ton; ton, \$40.00.

ASPARAGUS PRODUCTION By Hexamer

A practical treatise on the planting, cultivation, marketing etc., of this important vegetable. Price, \$1.10.

MICHELL'S DWARF BEANS

Haricots Nains (Fr.); Buschbohnen (Ger.); Fagioli Nani (Ital.). Plant 90 lbs. per acre. 2 lbs. will plant a 100-foot row.

Cultural Directions.—A rich, sandy loam suits beans to perfection. Toward the end of April, or still better in May, sowings may be made and may be repeated every two weeks until August. Have the rows about two feet apart. Sow quite thinly in the row and about two inches deep, thin out to stand four to six inches apart in the rows.

Prices quoted on Beans are prepaid in quantities up to 5 lbs. to the first and second zones; for other zones see parcel post table on page 1. Larger quantities shipped at purchaser's expense.

GREEN-PODDED VARIETIES

Bountiful. A flat podded sort; stringless, tender and a prolific bearer. Pkt., 10c.; 25c. per $\frac{1}{2}$ lb.; lb., 40c.; 75c. per 2 lbs.; 5 lbs., \$1.75; \$3.30 per 10 lbs.; 25 lbs., \$7.00.

Early Mohawk. This variety can be planted before any other sort, being quite hardy; large cropper; flat pod. Pkt., 10c.; 30c. per $\frac{1}{2}$ lb.; lb., 50c.; 95c. per 2 lbs.; 5 lbs., \$2.25; \$4.00 per 10 lbs.; 25 lbs., \$8.75.

Early Red Valentine. An extra early variety, maturing a crop in 40 to 50 days, a large portion of which can be picked at one time; pods 5 to 6 inches long, round, thick, tender and of good quality. Pkt., 10c.; 25c. per $\frac{1}{2}$ lb.; lb., 40c.; 75c. per 2 lbs.; 5 lbs., \$1.75; \$3.30 per 10 lbs.; 25 lbs., \$7.00.

Improved Stringless Green Pod. A round podded sort; early, prolific and a continuous bearer; pods measure 5 to 6 inches, very meaty; even when the pods become quite old they retain their stringless qualities. Pkt., 10c.; 25c. per $\frac{1}{2}$ lb.; lb., 40c.; 75c. per 2 lbs.; 5 lbs., \$1.75; \$3.30 per 10 lbs.; 25 lbs., \$7.00.

Mammoth or Giant Stringless. Of vigorous habit; great producer of large, round pods, from $5\frac{1}{2}$ to $6\frac{1}{2}$ inches long, a good one for the market or home garden. Pkt., 10c.; 25c. per $\frac{1}{2}$ lb.; lb., 40c.; 75c. per 2 lbs.; 5 lbs., \$1.75; \$3.30 per 10 lbs.; 25 lbs., \$7.00.

Masterpiece. A large, flat-podded variety, especially adapted for growing under glass, though it may be grown successfully outdoors. Pkt., 15c.; 35c. per $\frac{1}{2}$ lb.; lb., 60c.; \$1.15 per 2 lbs.; 5 lbs., \$2.75; \$5.00 per 10 lbs.; 25 lbs., \$11.25.

Stringless Black Valentine. An improvement over the old strain of Black Valentine; pods long and slender, semi-round and absolutely stringless. Pkt., 10c.; 25c. per $\frac{1}{2}$ lb.; lb., 40c.; 75c. per 2 lbs.; 5 lbs., \$1.75; \$3.30 per 10 lbs.; 25 lbs., \$7.00.

Triumph of the Frames. Splendid for forcing under glass, producing long, narrow, tender pods. Pkt., 15c.; 60c. per lb.; 2 lbs., \$1.15; \$2.75 per 5 lbs.; 10 lbs., \$5.30.

DWARF VARIETIES OF SHELL BEANS

For Winter Use

For soups, baked beans, etc., these are always useful. They can be used in the green state like other sorts when picked very young, but for the first named purpose they are the best. Plant when ground is warm in Spring and up to July 1st, in rows 2 feet apart, beans 3 inches apart in the row.

Boston Navy or Pea. A snowy white variety of small size. Pkt., 10c.; 20c. per $\frac{1}{2}$ lb.; lb., 30c.; 55c. per 2 lbs.; 5 lbs., \$1.25; \$2.20 per 10 lbs.; 25 lbs., \$4.25.

Long Pod Broad. An English bean used in the dry state shelled. Plant in rows about 3 feet apart, 8 inches apart in the row. Pkt., 10c.; 30c. per $\frac{1}{2}$ lb.; lb., 50c.; 95c. per 2 lbs.; 5 lbs., \$2.25; \$4.00 per 10 lbs.; 25 lbs., \$8.75.

Dwarf Horticultural. One of the best early shell beans; the thick, flat, stringless pods are colored red and green; the bean is large, round and speckled. Pkt., 10c.; 25c. per $\frac{1}{2}$ lb.; lb., 40c.; 75c. per 2 lbs.; 5 lbs., \$1.75; \$3.30 per 10 lbs.; 25 lbs., \$7.00.

Red Kidney. Pods long, kidney-shaped, light red in color and of good quality. Pkt., 10c.; 20c. per $\frac{1}{2}$ lb.; lb., 30c.; 55c. per 2 lbs.; 5 lbs., \$1.25; \$2.20 per 10 lbs.; 25 lbs., \$4.25.

White Marrowfat. Somewhat larger than the Boston Navy or Pea and extensively planted for shelling for Winter or for using in the green state. Pkt., 10c.; 20c. per $\frac{1}{2}$ lb.; lb., 30c.; 55c. per 2 lbs.; 5 lbs., \$1.25; \$2.20 per 10 lbs.; 25 lbs., \$4.25.

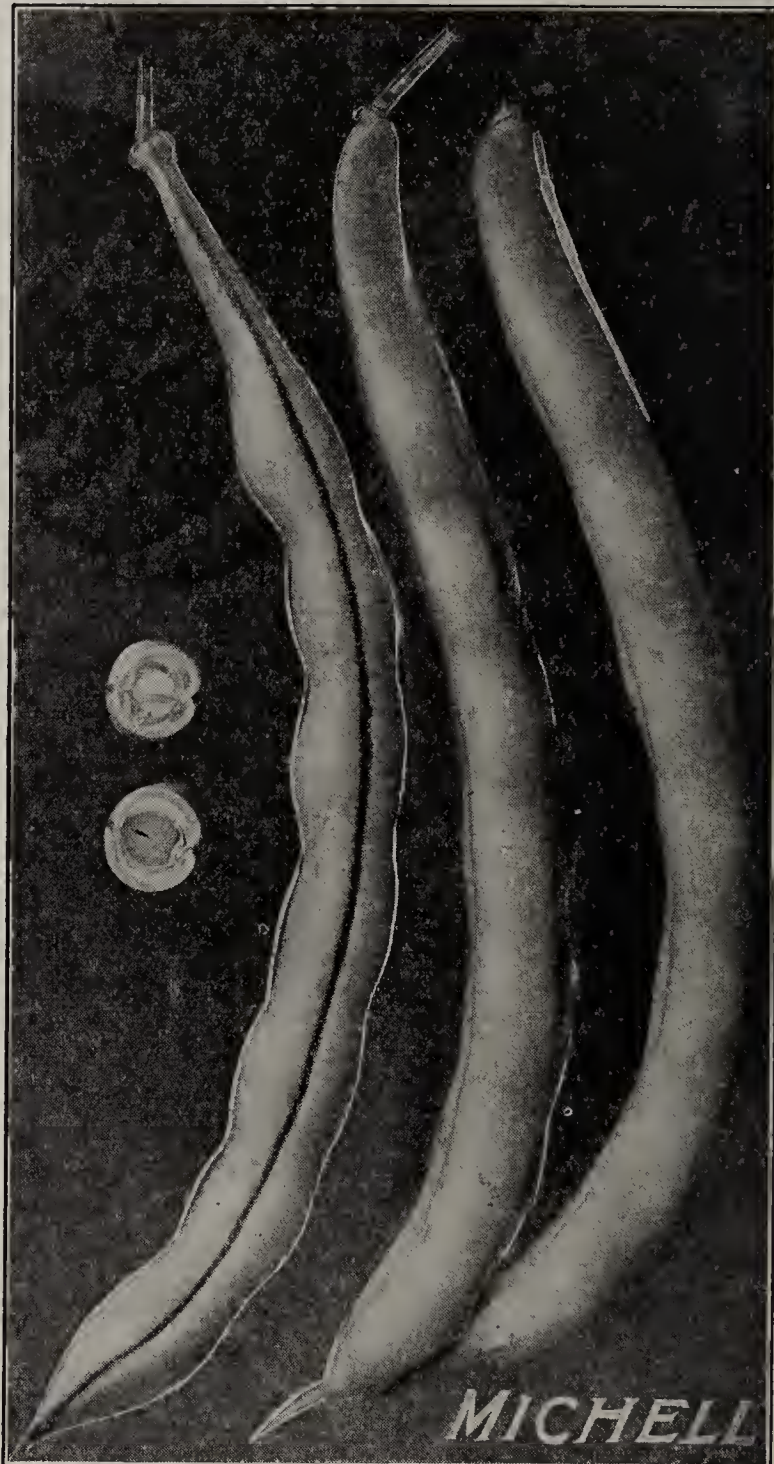

Bean, Improved Stringless Green Pod

FAVORITE COLLECTION. Three of the best Green Pod Beans—Extra Early Red Valentine; Bountiful; Improved Stringless Green Pod. Plant at intervals of 2 weeks, in rotation as given. Specially priced, 1 pkt. of each for 25c.; 1 lb. of each for \$1.00, prepaid.

If you want your bean patch to yield earlier and better
**Inoculate the seed before planting with
STIMUGERM**

When ordering be sure and specify wanted for garden beans, as each leguminous crop requires a separate culture.

See page 77.

Prices quoted on Beans are prepaid in quantities up to 5 lbs., to the first and second zones; for other zones, see parcel post table on page 1. Larger quantities shipped at purchaser's expense.

YELLOW-PODDED VARIETIES

Improved Rust-Proof Golden Wax. A very desirable variety for the home garden; vigorous grower and rust-resisting, making it one of the best of the wax beans; pods flat, medium length, good quality. Pkt., 10c.; 25c. per ½ lb.; lb., 40c.; 75c. per 2 lbs.; 5 lbs., \$1.75; \$3.30 per 10 lbs.; 25 lbs., \$7.00.

Pencil Pod Black Wax. A round-podded, hardy sort, entirely stringless, very early. Pkt., 10c.; 25c. per ½ lb.; lb., 40c.; 75c. per 2 lbs.; 5 lbs., \$1.75; \$3.30 per 10 lbs.; 25 lbs., \$7.00.

Round-Podded Kidney Wax. A vigorous grower; fleshy pods, stringless and rust-proof. Pkt., 10c.; 25c. per ½ lb.; lb., 40c.; 75c. per 2 lbs.; 5 lbs., \$1.75; \$3.30 per 10 lbs.; 25 lbs., \$7.00.

Stringless Refugee Wax. Round-podded, entirely stringless and of exceptional flavor. Pkt., 10c.; 25c. per ½ lb.; lb., 40c.; 75c. per 2 lbs.; 5 lbs., \$1.75; \$3.30 per 10 lbs.; 25 lbs., \$7.00.

Sure Crop Stringless Wax. Very productive, hardy and may be planted early; long, thick, flat pods of excellent quality. Pkt., 10c.; 25c. per ½ lb.; lb., 40c.; 75c. per lb.; 5 lbs., \$1.75; \$3.30 per 10 lbs.; 25 lbs., \$7.00.

Wardwell's Kidney Wax. A favorite market bean; long, thick, flat pods in great abundance; one of the best medium early sorts; free from rust. Pkt., 10c.; 25c. per ½ lb.; lb., 40c.; 75c. per 2 lbs.; 5 lbs., \$1.75; \$3.30 per 10 lbs.; 25 lbs., \$7.00.

MICHELL'S POLE OR RUNNING BEANS

Haricots a Rames (Fr.); Stangenbohnen (Ger.); Fagioli (Ital.)

When all danger of frost or cold nights is over, plant in hills 4 feet apart each way, about 4 or 5 beans to the hill, eyes downward. When up and established, thin out to 3 plants in a hill. Plant about 20 lbs. to the acre.

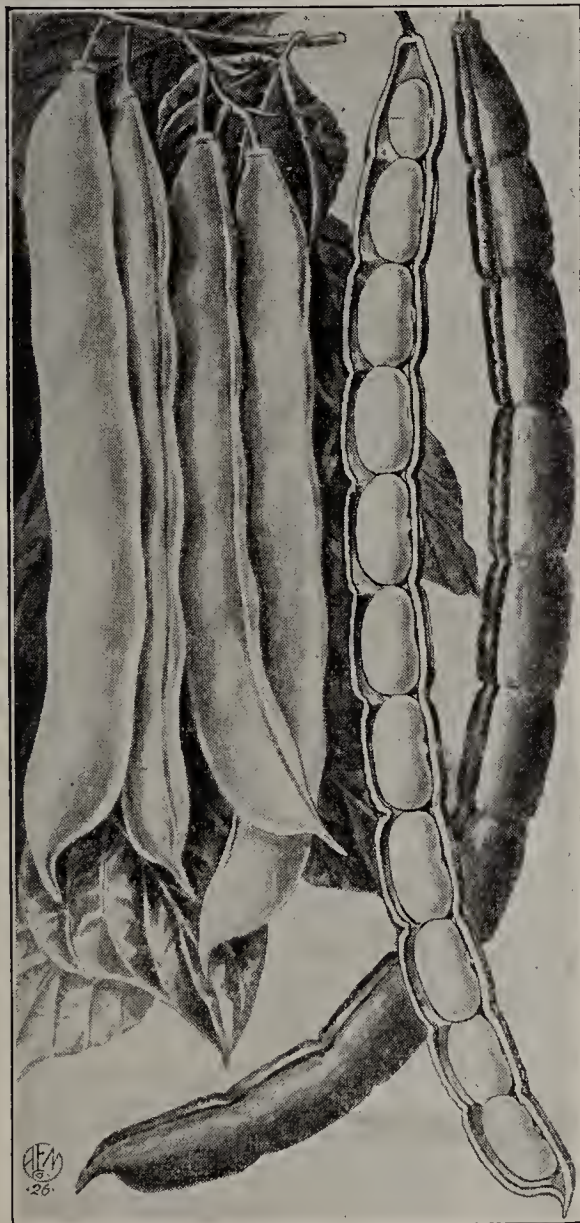

Golden Cluster

Kentucky Wonder

Pole Beans are not accorded in the North the same attention they deserve and receive in the southern part of the United States, where they are found in practically every garden.

They are frequently more tender, and yield larger crops than dwarf sorts. One planting lasts usually for the season.

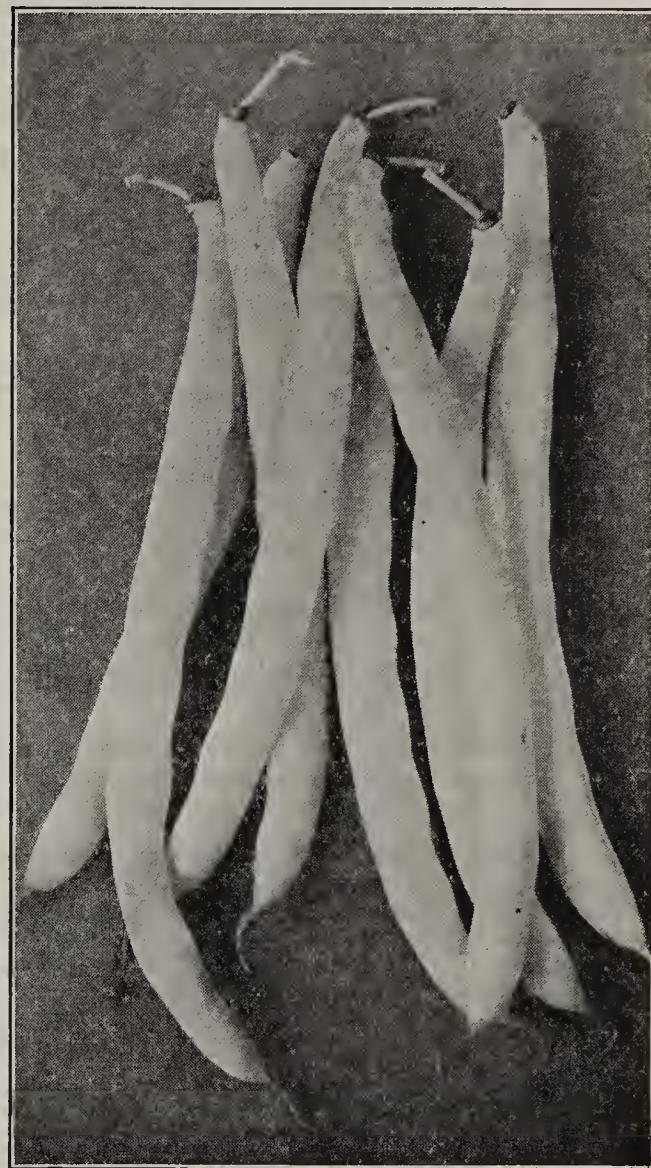

Stringless Refugee Wax Bean

GREEN-PODDED VARIETIES

Giant Podded Asparagus (Yard Long). Produces an enormous crop of long pods, measuring 2 feet or more in length, which are tender and of excellent quality. Pkt., 15c.; 55c. per ½ lb.; lb., \$1.00.

Horticultural or Speckled Cranberry. Long, pale green pods, which become streaked with red when matured. Pkt., 10c.; 25c. per ½ lb.; lb., 40c.; 75c. per 2 lbs.; 5 lbs., \$1.75; \$3.30 per 10 lbs.; 25 lbs., \$7.00.

Kentucky Wonder or Old Homestead. In the South this variety is grown more extensively probably than any other; a tremendous yielder of long round pods, very tender and practically stringless. Quite early, being ready for picking about 85 days from planting. Pkt., 10c.; 25c. per ½ lb.; lb., 40c.; 75c. per 2 lbs.; 5 lbs., \$1.75; \$3.30 per 10 lbs.; 25 lbs., \$7.00.

Lazy Wife. The best late, green podded pole bean; pods broad, thick, very fleshy and stringless; very prolific. Pkt., 10c.; 25c. per ½ lb.; lb., 40c.; 75c. per 2 lbs.; 5 lbs., \$1.75; \$3.30 per 10 lbs.; 25 lbs., \$7.00.

Scarlet Runner. While used principally for its flowering qualities, this makes a splendid Winter shell bean. The bright red flowers are an attraction when the vine is used for covering arbors, trellises, fences, etc. Pkt., 10c.; 25c. per ½ lb.; lb., 40c.; 75c. per 2 lbs.; 5 lbs., \$1.75; \$3.30 per 10 lbs.

YELLOW-PODDED VARIETIES

Golden Cluster Wax. Deep yellow, flat pods, frequently 8 inches long; quite stringless and matures in about 85 days. A heavy yielder, the pods being borne in large clusters. One of the best of the pole beans and a splendid variety for the home garden. Pkt., 10c.; 25c. per ½ lb.; lb., 40c.; 75c. per 2 lbs.; 5 lbs., \$1.75; \$3.30 per 10 lbs.; 25 lbs., \$7.00.

Kentucky Wonder Wax. A very prolific sort, producing long, thick and almost straight pods, which are of a light yellow color and of excellent quality. Pkt., 10c.; 25c. per ½ lb.; lb., 40c.; 75c. per 2 lbs.; 5 lbs., \$1.75; \$3.30 per 10 lbs.; 25 lbs., \$7.00.

SEMESAN

Disinfection of bean seeds by dusting with Semesan destroys surface-borne seed diseases and increases stand and yield. See page 77.

MICHELL'S LIMA BEANS

Haricots a rames (Fr.); Stangenbohnen (Ger.); Fagioli di Lima (Ital.)

Prices quoted on Beans are prepaid in quantities up to 5 lbs., to the first and second zones; for other zones, see parcel post table on page 1. Larger quantities shipped at purchaser's expense.

POLE VARIETIES

2 pounds will plant 100 hills; 25 to 30 pounds per acre.

Plant when all danger of frost or cold nights is over with the eye of the bean down. Put a liberal number in a hill, as this is cheaper than replanting. When up and established, thin out to 3 or 4 plants in a hill. The poles should be set as soon as the garden is made, in rows about 3 feet apart, with the poles about 3 feet apart in the row.

It is a good plan to put a small shovelful of well-rotted cow manure in each hill when the poles are set, so the beans when started will make rapid growth and mature early.

Carpinteria. A variety that retains its green color in all stages of growth, even after being dried; with this it combines wonderful prolificness, flavor and size; a good early variety; 4 to 5 beans in a pod. Pkt., 10c.; 25c. per $\frac{1}{2}$ lb.; lb., 40c.; 75c. per 2 lbs.; 5 lbs., \$1.75; \$3.30 per 10 lbs.; 25 lbs., \$7.00.

Dreer's Improved. Also known as Challenger or Potato Lima. Although somewhat smaller than other limas, it is very early, prolific and of delicious flavor. Pkt., 10c.; 25c. per $\frac{1}{2}$ lb.; lb., 45c.; 85c. per 2 lbs.; 5 lbs., \$2.00; \$3.70 per 10 lbs.; 25 lbs., \$8.25.

Giant Podded. Produces a heavy, stocky vine, well filled with gigantic pods, in clusters, producing a nice size white bean. Pkt., 10c.; 25c. per $\frac{1}{2}$ lb.; lb., 40c.; 75c. per 2 lbs.; 5 lbs., \$1.75; \$3.30 per 10 lbs.; 25 lbs., \$7.00.

King of the Garden. An old-time favorite, but still popular with the amateur as well as the market gardener; of sturdy growth, exceedingly productive and of good flavor. Pkt., 10c.; 25c. per $\frac{1}{2}$ lb.; lb., 40c.; 75c. per 2 lbs.; 5 lbs., \$1.75; \$3.30 per 10 lbs.; 25 lbs., \$7.00.

Michell's Evergreen. Any one wishing an exceptionally early pole lima should plant this one. It is remarkable for its productiveness and good flavor; continues bearing until frost. Pkt., 10c.; 25c. per $\frac{1}{2}$ lb.; lb., 40c.; 2 lbs., 75c.; \$1.75 per 5 lbs.; 10 lbs., \$3.30; \$7.00 per 25 lbs.

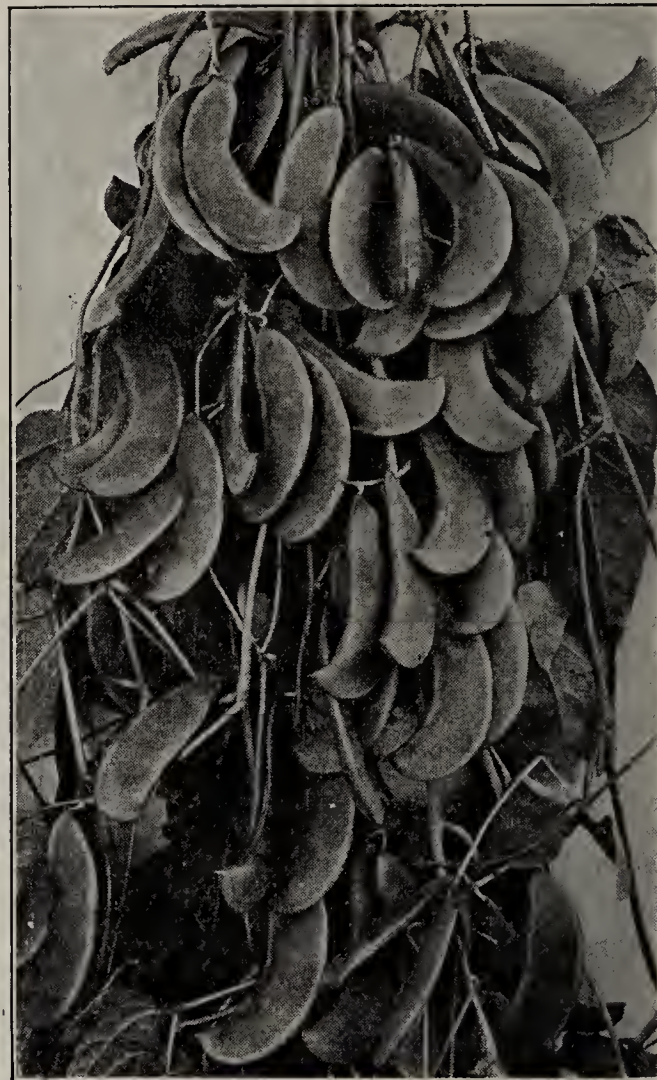

Michell's Evergreen Lima

See page 48 for complete collections of Vegetable Seeds.



Fordhook Bush Lima

BUSH OR DWARF VARIETIES

One pound will plant 50 feet of row.

Bush Limas should be planted for early crops, as they come into bearing much sooner, although they are not so prolific as the pole varieties. They are usually planted in rows about 3 feet apart, while the beans are put in hills about 2 feet apart, about 3 beans to the hill.

Burpee's Improved Bush Lima. A great improvement over the old strain of Burpee's Bush Lima; the bean is thicker, sweeter, and more prolific. Pkt., 10c.; 25c. per $\frac{1}{2}$ lb.; lb., 45c.; 85c. per 2 lbs.; 5 lbs., \$2.00; \$3.70 per 10 lbs.; 25 lbs., \$8.25.

Fordhook. This is the best type of bush lima in cultivation; of distinct upright vigorous growth; pods are borne in clusters well above the ground and frequently contain as many as 4 thick luscious beans. It matures very early and continues in bearing till frost. Pkt., 10c.; 30c. per $\frac{1}{2}$ lb.; lb., 50c.; 95c. per 2 lbs.; 5 lbs., \$2.25; \$4.30 per 10 lbs.; 25 lbs., \$9.50.

Hendersons. A dwarf, compact growing variety, with large clusters of pods, containing very small flat beans; a favorite sort for canning, but cannot be recommended for flavor. Pkt., 10c.; 25c. per $\frac{1}{2}$ lb.; lb., 35c.; 65c. per 2 lbs.; 5 lbs., \$1.50; \$2.70 per 10 lbs.; 25 lbs., \$6.25.

Wilson's Improved. Claimed to be two weeks earlier than Burpee's Improved Bush Lima; it also is much more prolific, though the pod nor the bean is quite as large. Pkt., 10c.; 25c. per $\frac{1}{2}$ lb.; lb., 45c.; 85c. per 2 lbs.; 5 lbs., \$2.00; \$3.70 per 10 lbs.; 25 lbs., \$8.25.

Cedar Bean Poles (Pointed). Extra selected quality, about 10 feet long. 12 for \$2.25; 25 for \$4.00; 50 for \$7.75; \$15.00 per 100.

NITROGEN BACTERIA FOR BEANS

Stimugerm. If you want your bean patch to yield earlier and better, inoculate the seed before planting with nitrogen bacteria. See page 77. When ordering, be sure and specify wanted for garden beans, as each leguminous crop requires a separate culture.

Betterave (Fr.); Salatrube (Ger.); Barbabietola (Ital.). One ounce will sow a row 50 ft. long; 5 lbs. per acre.

Sow in drills one foot apart and one inch deep, as early as the ground can be worked; when the plants are large enough thin out to stand four inches apart in the row. For an early crop in hotbeds the seed should be sown in early March, while for a Winter supply sow about July 10th outdoors. Prices of all seeds on this page include mailing charges.

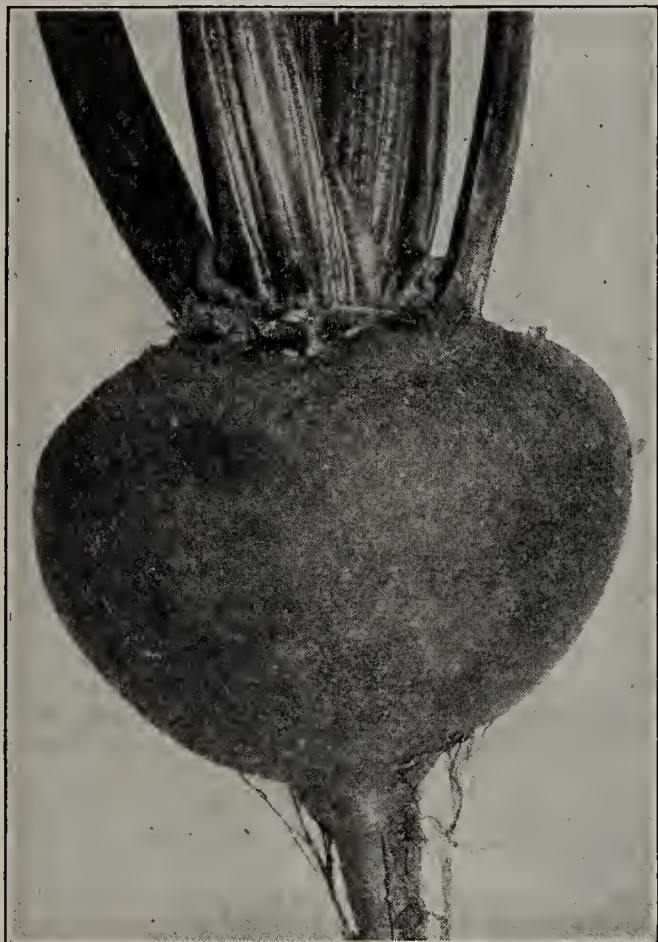

Beet, Crosby's Egyptian (Special Strain)

- Arlington Favorite.** Extra early; exceedingly sweet; rich blood red. Pkt., 10c.; 15c. per oz.; $\frac{1}{4}$ lb., 35c.; \$1.00 per lb.
- Bassano Extra Early.** A flat variety; flesh white and rose colored. Pkt., 10c.; 15c. per oz.; $\frac{1}{4}$ lb., 35c.; \$1.00 per lb.
- Bastian's Early Blood Turnip.** The best beet for market and family use; grows quite large; turnip-shaped. Pkt., 10c.; 15c. per oz.; $\frac{1}{4}$ lb., 35c.; \$1.00 per lb.
- Bastian's Half Long Blood.** Used extensively for Winter use. Pkt., 10c.; 25c. per oz.; $\frac{1}{4}$ lb., 45c.; \$1.50 per lb.
- Crimson Globe.** Almost round in shape, a rich deep red color; has a distinct delicious flavor and is very tender. Pkt., 10c.; 20c. per oz.; $\frac{1}{4}$ lb., 45c.; \$1.25 per lb.
- Crosby's Egyptian (Usual Strain).** Especially desirable on account of its rich blood-red color throughout. An early variety and one of the best all around table beets. Pkt., 10c.; 20c. per oz.; $\frac{1}{4}$ lb., 45c.; \$1.25 per lb.
- Crosby's Egyptian (Special Strain).** A special selection of the usual strain; repeated tests have proven it to be a darker red and much earlier. Pkt., 15c.; 25c. per oz.; $\frac{1}{4}$ lb., 55c.; \$1.50 per lb.
- Detroit Dark Red (Michell's Special Strain).** The seed of this variety is a careful re-selection from the choicest, most uniform roots; it will be found superior to the usual type of Detroit Beet. Pkt., 15c.; 25c. per oz.; $\frac{1}{4}$ lb., 55c.; \$1.50 per lb.
- Detroit Dark Red (Usual Strain).** Pkt., 10c.; 20c. per oz.; $\frac{1}{4}$ lb., 45c.; \$1.25 per lb.
- Early Wonder.** An extra early variety; globe shaped; flesh deep blood red and very tender. Pkt., 10c.; 20c. per oz.; $\frac{1}{4}$ lb., 45c.; \$1.25 per lb.
- Eclipse.** Perfectly smooth and round; skin and flesh intense red. An excellent sort for forcing or for planting in the garden. Pkt., 10c.; 20c. per oz.; $\frac{1}{4}$ lb., 45c.; \$1.25 per lb.
- Lentz Early.** Fine for sowing in hotbeds and outdoors early; inside color red, with zone of lighter shades. Pkt., 10c.; 20c. per oz.; $\frac{1}{4}$ lb., 45c.; \$1.25 per lb.
- Michell's Ideal.** A splendid turnip-shaped beet of rich, blood-red color; fine grained and very tender. Pkt., 10c.; 25c. per oz.; $\frac{1}{4}$ lb., 55c.; \$1.50 per lb.
- Michell's Winter Keeper.** Globe shaped; rich red, tender and sweet; one of the best Winter varieties. Pkt., 10c.; 30c. per oz.; $\frac{1}{4}$ lb., 70c.; \$2.25 per lb.

MANGEL-WURZEL

Sow 5 lbs. per acre in April and May in thoroughly plowed, well-manured soil, in drills about 24 inches apart. Thin out to 12 inches apart in the row and keep the weeds down by frequent hoeing and cultivating. Low ground is best adapted for Mangel-Wurzels. They provide excellent Winter food for cattle, sheep, hogs and poultry.

Golden Tankard. The best long yellow mangel in cultivation. Matures earlier than other large sorts. Per oz., 10c.; 30c. per $\frac{1}{4}$ lb.; lb., 90c.; \$4.25 per 5 lbs.; 10 lbs., \$8.00.

Lane's Improved White Sugar. This variety attains an enormous size, growing considerably above the ground; one of the best for stock feeding. Per oz., 10c.; 30c. per $\frac{1}{4}$ lb.; lb., 90c.; \$4.25 per 5 lbs.; \$8.00 per 10 lbs.

Mammoth Long Red. An enormously productive variety, yielding from 50 to 75 tons to the acre, a single root often weighing from 20 to 40 pounds; the best long red mangel. Per oz., 10c.; 30c. per $\frac{1}{4}$ lb.; lb., 90c.; \$4.25 per 5 lbs.; \$8.00 per 10 lbs.

SWISS CHARD (Spinach Beet)

Poireau (Fr.); Mangold Kohl (Ger.); Bieta (Ital.)

1 oz. will sow a row about 50 feet long

Readily grown from seed, when it can be used five weeks after sowing and is a continuous crop until killed by frost. The plant is cultivated for the leaves which are used for greens; the outer leaves only should be carefully pulled from the plant and the foliage part separated from the rib in preparing to cook. The former when cooked is served like spinach, which it resembles in taste; the ribs when boiled and served with melted butter are the equal of finest asparagus.

Dark Green Curled. Large, smooth dark green leaves with silvery white stem; tender and of fine flavor. Pkt., 10c.; 15c. per oz.; $\frac{1}{4}$ lb., 35c.; \$1.20 per lb.

Giant Lucullus. Very tall growing; crinkly leaves often two feet long; a beautiful ornamental plant for any garden. Pkt., 10c.; 15c. per oz.; $\frac{1}{4}$ lb., 40c.; \$1.25 per lb.

BORAGE (Herb)

Leaves used as a salad. Pkt., 10c.; 30c. per oz.



Dark Green Curled Swiss Chard



Early Green Calabrese Broccoli

BROCCOLI

Broccoli (Fr.); Sparkelkohl (Ger.); Broccoli (Ital.).

One ounce will produce 3000 plants.

A vegetable resembling cauliflower and often grown where the latter does not thrive. Cultural method is much the same.

Early Green Calabrese. This is the variety so much sought by the Italian trade and has become quite popular in our American gardens; forms a fair size green head; after this is cut from main stalk, new sprouts develop, which form small heads of a looser nature. Pkt., 15c.; 35c. per $\frac{1}{2}$ oz.; oz., 65c.; \$2.25 per $\frac{1}{4}$ lb.

White Cape. Pkt., 10c.; 30c. per $\frac{1}{2}$ oz.; oz., 50c.; \$1.60 per $\frac{1}{4}$ lb.

MICHELL'S CHOICE CARROT SEEDS

Carotte (Fr.); Mohruben (Ger.); Carota (Ital.). One ounce will sow 100 ft. of drill; 3 to 4 lbs. per acre.

For an early crop sow as soon as danger from frost is over in rows 1 foot apart; when 2 inches high, thin out to stand 2 inches apart in the row. For a late crop sow in May or June. The long sorts should be sown early; the half-long and round sorts can be sown later.

Chantenay Half Long (Usual Strain). Orange scarlet color; very productive; especially desirable for market or home use; flesh tender, and fine grained; 5 inches long, stump-rooted. Pkt., 10c.; 25c. per oz.; $\frac{1}{4}$ lb., 60c.; \$2.00 per lb.

Chantenay Half Long (Special Strain). Selected for earliness and uniformity; its tenderness and fine flavor have proven it a superior stock. Pkt., 15c.; 30c. per oz.; $\frac{1}{4}$ lb., 75c.; \$2.50 per lb.

Coreless, or Nantes Half Long. One of the finest medium sized varieties; blunt pointed, smooth; bright orange in color; excellent quality. Pkt., 10c.; 25c. per oz.; $\frac{1}{4}$ lb., 60c.; \$2.00 per lb.

Danvers Half Long. The best variety for general crop; rich orange color; heavy yielder and splendid keeper; a first-class carrot for all soils and valuable both for table and stock; 6 to 7 inches long, stump-rooted. Pkt., 10c.; 25c. per oz.; $\frac{1}{4}$ lb., 60c.; \$2.00 per lb.

Early Scarlet Horn. A favorite early red variety; fine grain and good flavor; stump-rooted, about 6 inches long; ideal for soups. Pkt., 10c.; 25c. per oz.; $\frac{1}{4}$ lb., 60c.; \$2.00 per lb.

Guerande or Oxheart. A desirable variety on soils too hard and stiff for the longer growing sorts, as it is not over 3 to 4 inches long. Rich orange color and fine flavored. Pkt., 10c.; 20c. per oz.; $\frac{1}{4}$ lb., 55c.; \$1.75 per lb.

Improved Long Orange. Deep orange color; 10 inches long; yields heavily; fair table quality; best for stock feeding. Pkt., 10c.; 20c. per oz.; $\frac{1}{4}$ lb., 45c.; \$1.25 per lb.

Rubicon Half Long. One of the best in shape; deep orange red flesh, of finest quality; stump-rooted; earlier than the Danvers and not quite so long; well adapted for early forcing and for growing outside. Pkt., 10c.; 25c. per oz.; $\frac{1}{4}$ lb., 60c.; \$2.00 per lb.

Very Early Short Horn or French Forcing. An early forcing variety; small round root, not much larger than a radish. It may be sown outdoors as well as under glass. Pkt., 10c.; 25c. per oz.; $\frac{1}{4}$ lb., 60c.; \$2.00 per lb.

White Belgian. Used principally for stock, not being desirable for table; produces a long thick white root. Pkt., 10c.; 15c. per oz.; $\frac{1}{4}$ lb., 40c.; \$1.25 per lb.

BRUSSELS SPROUTS

Chou de Bruxelles (Fr.); Rosekohl (Ger.); Berza de Brussels (Ital.)

One ounce will produce about 3000 plants

Sow seed about May 15th; transplant when about 4 ins. high in rows 3 feet apart, 2 feet apart in the row. When heads begin to crowd, the lower leaves should be broken from the stem of the plant to give them plenty of room. They are best for cooking after they have had a slight frost.

Michell's Mammoth Fancy. We have an exceptionally fine strain of these sprouts recommended by an old time gardener who has been improving them from year to year; a compact, dwarf type; stems covered with fancy, solid sprouts. Pkt., 15c.; 25c. per $\frac{1}{2}$ oz.; oz., 45c.; \$1.35 per $\frac{1}{4}$ lb.

Long Island Half Dwarf. Compact heads; very productive. Pkt., 10c.; 30c. per oz.; $\frac{1}{4}$ lb., \$1.00.

Matchless Improved. Pkt., 10c.; 30c. per oz.; $\frac{1}{4}$ lb., \$1.00.

BRUSSELS SPROUTS PLANTS (Ready in July)

25 for 30c. (by parcel post, 40c.); \$1.00 per 100 (by parcel post, \$1.15); per 1000, \$6.50.

CARAWAY (Herb)

For flavoring, etc. Pkt., 10c.; 25c. per oz.

CARDOON

Large Solid. A tall growing variety; stalks thick and broad; leaves when blanched like celery and cooked are tender and of delicious flavor. Pkt., 10c.; 20c. per $\frac{1}{2}$ oz.; oz., 35c.; \$1.00 per $\frac{1}{4}$ lb.

CATNIP (Herb)

For making tea; a cat tonic, etc. Pkt., 20c.

All seeds on this page mailed post free at prices quoted.



Chantenay Half Long Carrot (Special Strain)

Chou pomme (Fr.); Kopf Kohl (Ger.); Cavolo Cappuccio (Ital.)

One ounce will produce about 3000 plants; 4 oz. will produce enough for an acre.

Our strains are the very best to be had, selected from specimen heads in well rogued fields. Sow seeds of the early varieties in February in hotbeds and transplant latter part of April or early in May to open ground, or an early sowing in open ground can be made as soon as weather will permit. Set the plants in rows 2 feet apart and 12 to 18 inches apart in the row. The second early varieties sow in April and transplant in May; late varieties, sow in May and transplant in July, setting plants in rows 3 feet apart and 2 feet in rows. Never plant cabbage in the same location two years in succession.

All seeds on this page mailed postage free.

EARLY VARIETIES

All Head. The largest of the early cabbages. The head is roundish flat and remarkably solid; excellent for Winter as well as early Spring. Pkt., 10c.; 20c. per 1/2 oz.; oz., 35c.; \$1.00 per 1/4 lb.

Babyhead. An excellent variety, characterized especially by its extreme earliness and the small size of the head, which is usually less than six inches across, round, firm and of splendid cooking quality; has a short stem and few small outer leaves; plants may be set as close as 8 to 10 inches apart. It is an ideal variety for growing under glass and early open ground planting. Pkt., 15c.; 35c. per 1/2 oz.; oz., 60c.; \$1.75 per 1/4 lb.

Charleston or Large Wakefield. Similar to the Early Wakefield, but the heads are more blunt, equally as solid, grows almost twice the size and matures one week later. Pkt., 10c.; 20c. per 1/2 oz.; oz., 35c.; \$1.00 per 1/4 lb.

Copenhagen Market. An early, round-headed variety, following the Golden Acre. The heads frequently weigh as much as 10 lbs. Our stock is imported and the best the market affords. Pkt., 10c.; 25c. per 1/2 oz.; oz., 40c.; \$1.25 per 1/4 lb.

Extra Early Jersey Wakefield. One of the finest types of early cabbage; produces uniform pointed heads. The outer leaves form a protection for the heads, which enables it to be set out earlier than other sorts. Pkt., 10c.; 25c. per 1/2 oz.; oz., 40c.; \$1.25 per 1/4 lb.

Golden Acre. Early, solid and uniform; a new acquisition to the cabbage family; the plant is dwarf in habit; heads medium size averaging 5 lbs., round, solid and grows but few outer leaves; suitable for close planting. Follows the Babyhead in earliness yet ten days earlier than Copenhagen Market. Pkt., 10c.; 30c. per 1/2 oz.; oz., 50c.; \$1.50 per 1/4 lb.

Henderson's Early Summer. Heads of medium size, roundish-flat and solid. A fine variety for following the early types. Pkt., 10c.; 20c. per 1/2 oz.; oz., 35c.; 90c. per 1/4 lb.



Golden Acre Cabbage



Late Flat Dutch Cabbage

LATE OR WINTER VARIETIES

All Seasons (Vandergaw). A very large head, round and solid. Valuable for late Summer or Winter use. Pkt., 10c.; 20c. per 1/2 oz.; oz., 35c.; \$1.00 per 1/4 lb.

Danish Ball Head. This excellent Winter cabbage is unequalled for its keeping qualities, massiveness and weight. For boiling, cole slaw, sauer kraut, etc., it is ideal, being crisp, tender and sweet. Does well under most any condition of moisture or drought; heads seldom burst. Pkt., 10c.; 25c. per 1/2 oz.; oz., 40c.; \$1.10 per 1/4 lb.

Danish Roundhead (Short Stem). The heads of this variety are exceptionally hard; excellent for sauer kraut as well as for Winter storing. Pkt., 10c.; 25c. per 1/2 oz.; oz., 40c.; \$1.10 per 1/4 lb.

Late Flat Dutch. This has been selected especially for our trade, the seed being taken from the finest types of heads which are selected for solidity and uniformity. Heads large and quality unsurpassed. Pkt., 10c.; 20c. per 1/2 oz.; oz., 35c.; \$1.00 per 1/4 lb.

Perfection Drumhead Savoy. A beautiful crimped-leaved sort; color, a deep glossy green. The head is almost round. Savoy cabbage is distinctly flavored, being much sweeter than the other kinds. Pkt., 10c.; 25c. per 1/2 oz.; oz., 40c.; \$1.10 per 1/4 lb.

Red Dutch. A red variety, used extensively for pickling. For cole slaw it has merits over the white kinds. It is principally used for Winter, keeping well until Spring. Pkt., 10c.; 20c. per 1/2 oz.; oz., 35c.; \$1.00 per 1/4 lb.

CHINESE OR CELERY CABBAGE

Pe Tsai. This resembles in appearance and growth a head of Cos Romaine or Celery lettuce. The heads are firm, almost like cabbage. The flavor is delightful, not at all like cabbage, but rather on the order of Witloof Chicory or French Endive. The plants are handled much like lettuce, except that they should be set from 15 to 18 inches apart, the rows 2 to 2 1/2 feet apart. Pkt., 10c.; 20c. per 1/2 oz.; oz., 35c.; \$1.00 per 1/4 lb.

Wong Bok. Easily grown and can be served in numerous ways. Does not grow quite as tall as the Pe Tsai, but is thicker through; the heads are elongated, self-folding and require no blanching; it resembles Romaine lettuce. In order to get proper results, seed should not be sown until after August 1st. Pkt., 10c.; 25c. per 1/2 oz.; oz., 40c.; \$1.25 per 1/4 lb.

CABBAGE PLANTS

		100	By P.P.	1000
Early Sorts.	Hotbed grown.....	\$0.75	\$0.85	\$6.50
Early Sorts.	Cold-frame grown.....	1.00	1.10	8.50
Late Sorts.	Field grown.....	.75	.85	5.50

Choux Fleurs (Fr.); Blumenkohl (Ger.); Cavol Fiora (Ital.)

One ounce of seed will produce about 3000 plants

Sow seed in hotbeds or window boxes in February or March and transplant in cold frames. When hard frosts are over, plant outdoors. For second crop, sow in April and set out in May. For late crop, sow in June and set out in July. Plants should be set in rows 3 feet apart, 2 feet apart in the row.

Danish Giant, or Dry Weather. An ideal variety for Summer use; stands drought and heat better than other sorts; heads snow white and of enormous size; later than other sorts. Pkt., 25c.; 50c. per large pkt.; $\frac{1}{4}$ oz., \$1.25; \$2.00 per $\frac{1}{2}$ oz.; oz., \$3.50.

Early Snowball. For either forcing under glass in cold frames or outdoor Spring planting; produces magnificent medium size white heads. Pkt., 25c.; 50c. per large pkt.; $\frac{1}{4}$ oz., \$1.25; \$2.00 per $\frac{1}{2}$ oz.; oz., \$3.50.

Half Early Paris. A small head; suited to growing outdoors only. Pkt., 15c.; 50c. per $\frac{1}{4}$ oz.; 85c. per $\frac{1}{2}$ oz.; oz., \$1.50.

Michell's Earliest Snowstorm. Colossal heads of purest white, averaging often 10 inches in diameter; especially desirable for its earliness under glass, but does equally well in late Spring, Summer, or Autumn outdoors. Pkt., 25c.; 50c. per large pkt.; $\frac{1}{4}$ oz., \$1.25; \$2.00 per $\frac{1}{2}$ oz.; oz., \$3.50.

Early Selected Erfurt. One of the earliest varieties; produces medium sized heads. Pkt., 20c.; 45c. per large pkt.; $\frac{1}{4}$ oz., \$1.10; \$1.75 per $\frac{1}{2}$ oz.; oz., \$3.00.

CAULIFLOWER PLANTS (Ready April 1st)

Snowball variety only. Pot-grown plants. 10c. each; doz., \$1.00; \$6.00 per 100. Not mailable.

CHAMOMILE (Herb)

Has medicinal qualities. Pkt., 10c.; 25c. per $\frac{1}{2}$ oz.; per oz., 45c.



Double Curled Chervil

CHERVIL

One ounce will sow a row
50 feet long

An aromatic plant used extensively in Europe as a salad garnishing and seasoner. Sow in rows like parsley, which it somewhat resembles. For a continuous crop, sow every two weeks; if one has heated frames or a greenhouse it can be sown under glass all Winter or in hotbeds in February. It can be cut 4 to 5 weeks after sowing.

Double Curled. Pkt., 10c.; 25c. per oz.; $\frac{1}{4}$ lb., 85c.

CHICORY

One ounce will sow a row 100 feet long

Witloof. The roots are easily produced from seed, sown in May or June, in rows 12 inches apart; thin out the plants to 2 or 3 inches. They are taken up after a few hard frosts and cared for the same as Turnips or similar crops. Used only as a Winter vegetable, the top part only being edible. Plant under a bench in the greenhouse or a light, dry, warm portion of a cellar in a bed of rich garden soil 12 inches deep. Place about 6 inches apart each way. The top growth remains intact, and may be cut any time after 5 inches growth. Roots should be set in the soil the same depth as they were originally in the garden. A continuous supply of this delicious Winter vegetable can be had all Winter. A cold frame makes also an ideal place for forcing them in the late Winter or early Spring months. Pkt., 10c.; 20c. per oz.; $\frac{1}{4}$ lb., 60c.; \$2.00 per lb.

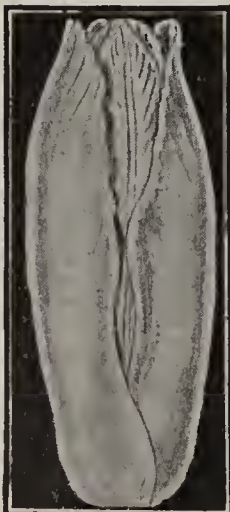

Witloof

NOTE—All seeds on this page sent postpaid at quoted prices.



Michell's Earliest Snowstorm Cauliflower

CAULIFLOWER AND BROCCOLI CULTURE

By Bouquet

Price, \$1.25

CHIVES (Schnittlauch)

Indispensable for flavoring certain dishes, imparting a mild taste of onion. The plants are hardy and will last for years; don't cut the plant too close when gathering. For Winter use, lift and plant in a pot or box and place in a sunny window in the kitchen.

Seed. Pkt., 15c.; 35c. per $\frac{1}{2}$ oz.; oz., 60c.

Strong Plants. 3 for 50c. (by parcel post, 60c.); \$1.50 per doz. (by parcel post, \$1.65); per 100, \$10.00.

CITRON

This will be found described under the heading of melons. Pkt., 10c.; 15c. per oz.; $\frac{1}{4}$ lb., 40c.; \$1.25 per lb.

COLLARDS

One ounce of seed will
produce 3000 plants

These are extensively grown in the South and used as greens during the Winter months. In that latitude the plant is practically hardy; the lower leaves are pulled off and used, when new ones then form on the upper part of the stem, which increases in height. Planted much like cabbage.

Georgia or Southern. Pkt., 10c.; 15c. per oz.; $\frac{1}{4}$ lb., 35c.; \$1.10 per lb.



Collards

CORIANDER (Herb)

For flavoring, etc. Pkt., 10c.; 25c. per oz.

Celeri (Fr.); Sellerie (Ger.); Sedano (Ital.)

One ounce of seed will produce 3000 to 5000 plants; half pound is sufficient for one acre.

Sow in hotbeds in March or in open ground in April. See that no weeds infest the seed bed; when 3 inches high transplant in a bed outdoors in rows 3 inches apart each way; let them remain there until July when they should be planted where they are to mature, in rows 3 feet apart, 6 inches apart in the row. Celery Plants if topped a few times before and when transplanted into their permanent growing place will make shorter, stockier plants. Seeds offered on this page mailed postpaid at quoted prices.



Celery, Easy Blanching (Penna. Grown)

EARLY VARIETIES

Easy Blanching (Penna. Grown, Special Strain). A very much improved type. Flavor delicious, stalk very large and fine grained. Plants set out in June are fully matured and ready for use the early part of September. The seed is grown for us by one of the leading Market Gardeners of Penna., who has made a specialty of celery for many years. Pkt., 15c.; 75c. per 1/2 oz.; oz., \$1.25; \$4.25 per 1/4 lb.

Easy Blanching (Usual Strain). A splendid early variety, being ready in October; produces enormous stalks which are very crisp. Pkt., 10c.; 30c. per 1/2 oz.; oz., 50c.; \$1.60 per 1/4 lb.

Golden Plume (Usual Strain). Matures very early, blanches very quickly, of finest flavor and without strings; crisp and tender. Pkt., 10c.; 40c. per 1/2 oz.; oz., 70c.; \$2.25 per 1/4 lb.

Golden Plume (Special Strain). This strain has proven worthy of especial mention, as to earliness, type and general appearance, in other words it is perfection; a trial will convince you. Pkt., 20c.; \$1.00 per 1/2 oz.; oz., \$1.75; \$6.00 per 1/4 lb.

Golden Self Blanching (French Grown Seed). One of the earliest and most productive sorts. The beautiful golden-colored stalks attain a height of 18 inches, which are never pithy and of excellent flavor; ready in October, but may be kept for early Winter use. Pkt., 15c.; 75c. per 1/2 oz.; oz., \$1.25; \$4.00 per 1/4 lb.

Golden Self Blanching (American Grown Seed). Pkt., 10c.; 40c. per 1/2 oz.; oz., 65c.; \$2.25 per 1/4 lb.



Garden Cress

GARDEN CRESS

Sow thickly in early Spring in drills one foot apart and follow every two weeks, up to August 1st, with a new sowing. Its pungent taste is acceptable to most any one who is fond of garden greens. It is eaten prepared with either a little salt and vinegar, or without. Makes a very tasty salad.

Extra Curled. Pkt., 10c.; 15c. per oz.; 35c. per 1/4 lb.; lb., \$1.10.

WATER CRESS

This may be sown early in Spring near the brink of a pond of spring water or stream of running water. Scatter the seed and it will sprout and grow with wondrous rapidity; once established it remains for years, reseeding itself.

True Erfurt. Pkt., 10c.; 25c. per 1/2 oz.; oz., 45c.; \$1.50 per 1/4 lb.



Water Cress

Pink Plume. A very solid, crisp, desirable sort; the stalks when blanched are a beautiful rose-pink. Pkt., 10c.; 40c. per 1/2 oz.; oz., 65c.; \$2.25 per 1/4 lb.

White Plume. The standard early celery for market and the home garden. The stalks and heart, which blanch very quickly to almost a pure white, are very crisp and brittle; it can be used early in November. Pkt., 10c.; 25c. per 1/2 oz.; oz., 40c.; \$1.25 per 1/4 lb.

LATE WINTER VARIETIES

Emperor. Dwarf growing; very brittle and of extra fine flavor; a good Winter keeper. Pkt., 10c.; 25c. per 1/2 oz.; oz., 40c.; \$1.25 per 1/4 lb.

Giant Pascal. This is in its prime for use during February and March, and can be used well up into Spring. Pkt., 10c.; 25c. per 1/2 oz.; oz., 40c.; \$1.25 per 1/4 lb.

Winter King. Perfectly solid, crisp and of delicious flavor; good keeper. Pkt., 10c.; 25c. per 1/2 oz.; oz., 40c.; \$1.25 per 1/4 lb.

Winter Queen. A medium tall, solid variety; will retain its qualities long through the Winter. The heart is very full and large. Pkt., 10c.; 25c. per 1/2 oz.; oz., 40c.; \$1.25 per 1/4 lb.

CELERY PLANTS (Ready in July)

Leading varieties. Per 100, 75c. (by parcel post, 90c.); \$6.00 per 1000.

CELERICAC

This vegetable is used for two purposes, the leaves are cut when young and used to flavor soups and meats; the roots are boiled, sliced, cooled, and served as a salad.

Giant Prague. Pkt., 10c.; 25c. per 1/2 oz.; oz., 40c.; \$1.25 per 1/4 lb.

CELERY FOR FLAVORING (Not for Sowing)

1/4 lb., 25c.; 85c. per lb.

CELERY PAPER

For Winter protection; 500 sq. ft. per roll. Price, \$2.00 per roll.

CELERY TAPE

Fast red, in 1000-yard spools, \$4.00 per spool (by parcel post, \$4.15). Green, in 1000-yard spools, \$3.00 per spool (by parcel post, \$3.15).

CORN SALAD (Fetticus)

Mache Ronde (Fr.); Ackersalat (Ger.)

This is principally sown for a supply of greens during Winter and early Spring months. Sow thinly in drills early in the Spring or during August and September; when cold weather approaches, cover with a litter of leaves or long manure or straw; upon the approach of Spring the covering can be taken off entirely.

Large Leaved, Round Seeded. Pkt., 10c.; 20c. per oz.; 1/4 lb., 60c.; \$2.00 per lb.

MICHELL'S SELECTED SUGAR CORN

Mais (Fr.); Welschkorn (Ger.); Grano Turco (Ital.)

1 lb. will plant about 150 hills; 12 to 15 lbs. will plant an acre.

Plant once a week from the time the ground is permanently warm until July 15th, 6 to 8 grains, in hills three feet apart each way, or in rows three feet apart; if the latter, thin out so the plants stand 12 inches apart; if left in hills, thin out when 4 inches high to 3 to 4 plants to the hill. Early varieties should be planted for a late crop to be sure of maturity.

Prices quoted on Sugar Corn are prepaid in quantities up to 5 lbs. to the first and second zones; for other zones, see parcel post table on page 1. Larger quantities shipped at purchasers' expense.

EARLY VARIETIES

Adams Extra Early. Pure white medium sized ears, not entirely sweet. Pkt., 10c.; 20c. per $\frac{1}{2}$ lb.; lb., 30c.; 55c. per 2 lbs.; 5 lbs., \$1.25; \$2.20 per 10 lbs.; 25 lbs., \$4.50.

Early Mayflower. Slightly earlier than Golden Bantam; ears long and well filled for an early corn; grains tender and of excellent flavor. Pkt., 10c.; 20c. per $\frac{1}{2}$ lb.; lb., 35c.; 65c. per 2 lbs.; 5 lbs., \$1.50; \$2.80 per 10 lbs.; 25 lbs., \$6.50.

Golden Bantam. While yellow in color this is one of the sweetest and earliest varieties. Ears medium size; kernels tender and delicious; plant is of dwarf growth; we recommend it very highly for the home garden. Pkt., 10c.; 20c. per $\frac{1}{2}$ lb.; lb., 35c.; 65c. per 2 lbs.; 5 lbs., \$1.50; \$2.80 per 10 lbs.; 25 lbs., \$6.50.

Golden Giant. Ears about 11 inches long, well filled out from butt to tip and very symmetrical. Deep golden yellow grains. Pkt., 10c.; 20c. per $\frac{1}{2}$ lb.; lb., 35c.; 65c. per 2 lbs.; 5 lbs., \$1.50; \$2.80 per 10 lbs.; 25 lbs., \$6.50.

Golden Sunshine. Especially desirable for its extreme earliness, maturing a week or ten days before Golden Bantam; dwarfer in habit; ears $6\frac{1}{2}$ inches long and containing 12 rows of broad, yellow sweet grains. Pkt., 10c.; 25c. per $\frac{1}{2}$ lb.; lb., 40c.; 75c. per 2 lbs.; 5 lbs., \$1.75; \$3.30 per 10 lbs.; 25 lbs., \$7.50.

MEDIUM VARIETIES

Bantam Evergreen. A yellow variety noted for its excellent qualities; much larger than Golden Bantam, claimed to be more productive and much earlier; a splendid variety for mid and late season planting. Pkt., 10c.; 20c. per $\frac{1}{2}$ lb.; lb., 30c.; 55c. per 2 lbs.; 5 lbs., \$1.25; \$2.20 per 10 lbs.; 25 lbs., \$4.50.

Black Mexican. A medium early variety; while the grains are young they cook white, as they become older it cooks a violet shade on the outside, but in either stage of growth it is desirable; ears are of medium size. Pkt., 10c.; 20c. per $\frac{1}{2}$ lb.; lb., 35c.; 2 lbs., 65c.; 5 lbs., \$1.50; \$2.80 per 10 lbs.; 25 lbs., \$6.50.

Early Evergreen. This variety is closely allied to Stowell's in shape and flavor, but is much earlier; produces large well-shaped ears, with deep grains. Pkt., 10c.; 20c. per $\frac{1}{2}$ lb.; lb., 35c.; 65c. per 2 lbs.; 5 lbs., \$1.50; \$2.80 per 10 lbs.; 25 lbs., \$6.50.

Howling Mob. A splendid sort for the market gardener, as well as for home use. Might be classed worm-proof, since the husk covers the ear completely. Pkt., 10c.; 20c. per $\frac{1}{2}$ lb.; lb., 35c.; 65c. per 2 lbs.; 5 lbs., \$1.50; \$2.80 per 10 lbs.; 25 lbs., \$6.50.

Kendel's Early Giant. Large ears, deep grain, well flavored and extra sweet; ears very cylindrical. An ideal sort for the first and last planting. Pkt., 10c.; 20c. per $\frac{1}{2}$ lb.; lb., 35c.; 65c. per 2 lbs.; 5 lbs., \$1.50; \$2.80 per 10 lbs.; 25 lbs., \$6.50.

Michell's Delicious. Ever since we acquired control of this variety we have placed it with our best sugar corn grower with instructions to grow it for us exclusively and keep reselecting it. The ears are well filled, medium in size and mature after the early varieties. Pkt., 10c.; 20c. per $\frac{1}{2}$ lb.; lb., 35c.; 65c. per 2 lbs.; 5 lbs., \$1.50; \$2.80 per 10 lbs.; 25 lbs., \$6.50.

Philadelphia Favorite. A grand variety of Penna. origin and marketed in Philadelphia and vicinity for a number of years. Stalks grow to a height of $4\frac{1}{2}$ to 5 feet and produce 2 to 3 nice ears to the stalk, averaging 8 to 9 inches in length; kernels pearly white and deliciously sweet; matures in 75 to 78 days, depending on location. Pkt., 10c.; 25c. per $\frac{1}{2}$ lb.; lb., 40c.; 75c. per 2 lbs.; 5 lbs., \$1.75; \$3.30 per 10 lbs.; 25 lbs., \$7.50.

Stabler's Extra Early. This is the standard sort for the home garden. The large ears are well arrayed with even grains, which cook pure white and are very tender. Pkt., 10c.; 20c. per $\frac{1}{2}$ lb.; lb., 35c.; 65c. per 2 lbs.; 5 lbs., \$1.50; \$2.80 per 10 lbs.; 25 lbs., \$6.50.

LATE VARIETIES

Country Gentleman. A distinct sort, with deep, fine grains which are staged irregularly on the cob. In sweetness it is unapproached; ears large and borne on stalks about 6 feet high; a very productive and desirable variety. Pkt., 10c.; 20c. per $\frac{1}{2}$ lb.; lb., 35c.; 2 lbs., 65c.; \$1.50 per 5 lbs.; 10 lbs., \$2.80; \$6.50 per 25 lbs.

Late Mammoth. Gigantic ears of extra fine quality, produced in great quantity. The latest maturing and largest of all sweet corns. Pkt., 10c.; 20c. per $\frac{1}{2}$ lb.; lb., 35c.; 65c. per 2 lbs.; 5 lbs., \$1.50; \$2.80 per 10 lbs.; 25 lbs., \$6.50.

Little Gem or Shoe Peg (Ne Plus Ultra). This variety is closely allied to Country Gentleman. Pkt., 10c.; 20c. per $\frac{1}{2}$ lb.; lb., 35c.; 65c. per 2 lbs.; 5 lbs., \$1.50; \$2.80 per 10 lbs.; 25 lbs., \$6.50.

Stowell's Evergreen. The best late corn grown. Ears extra large, and produced in abundance; stalks often grow to a height of 7 feet. In sweetness it is unexcelled and for this reason it is the great favorite of the market and home gardener. Pkt., 10c.; 20c. per $\frac{1}{2}$ lb.; lb., 35c.; 65c. per 2 lbs.; 5 lbs., \$1.50; \$2.80 per 10 lbs.; 25 lbs., \$6.50.



Sugar Corn, Philadelphia Favorite

Popular Collection—Choicest Sugar Corn

Early Mayflower.—Early.

Howling Mob.—Early.

Stowell's Evergreen.—Late.

Plant every two weeks, in rotation as given. Specially priced as follows: 1 pkt. of each, for 25c.; 1 lb. of each, for 90c., postpaid.

POP CORN (Shelled)

Queen's Golden. Pops white. Lb., 15c. (by parcel post, 25c.); 40c. for 3 lbs. (by parcel post, 55c.).

Snowflake. Lb., 15c. (by parcel post, 25c.); 40c. for 3 lbs. (by parcel post, 55c.).

CORN POPPERS

Made of the best quality wire. Price includes handle and lid. 1 qt. size, 25c. each; 2 qt. size, 50c. each.

Concombre (Fr.); Gurken (Ger.); Cetriolo (Ital.). One ounce of seed will plant 60 hills; 2 to 3 pounds per acre.

Plant when the ground has become thoroughly warmed, in hills 4 feet each way, 8 seeds in a hill; when the second set of leaves have formed thin out to 4 plants in a hill. A type of beetle attacks this crop occasionally, which can be conquered by spraying the vines with Arsenate of Lead; when this is used always wash the fruits thoroughly before using. If the foliage is attacked beneath, by aphid or green fly, a spraying with Black Leaf 40 is usually very effective.



Cucumber, Improved Long Green

Arlington White Spine. This variety is perfect in form, color, size and productiveness and is therefore the leading sort, not only for the home or market garden, but also with those who make a specialty of growing them under glass. Fruits smooth, deep green to the tip and measure uniformly 8 inches in length. It has few seeds, making it a valuable variety for slicing or pickling. Pkt., 10c.; 20c. per oz.; ¼ lb., 45c.

Davis Perfect. Fruits uniform in shape and size, often measuring 10 to 12 inches in length. Color dark green all over, quite smooth and very productive. Pkt., 10c.; 20c. per oz.; ¼ lb., 45c.

Early Fortune. One of the finest cucumbers of the White Spine type; medium length and dark green in color, which it holds for a long time after picking; flesh white and very crisp. Pkt., 10c.; 20c. per oz.; ¼ lb., 45c.

Early Market. A new variety of uniform shape and size, averaging 8 inches in length, dark green; excellent for slicing. Pkt., 10c.; 25c. per oz.; ¼ lb., 55c.

Gherkin or Burr. For pickling only; the small fruits are about 2 inches long, thick, rounded form; very prickly when green. Pkt., 10c.; 25c. per oz.; ¼ lb., 55c.

Improved Long Green. A well known standard variety, used principally for slicing. Its dark color makes it desirable for market. The vines are vigorous and productive; the fruits are formed almost as early as the short sorts and average 12 inches in length. Pkt., 10c.; 20c. per oz.; ¼ lb., 45c.

Japanese Climbing. A trellis variety used for shade as well as eating purposes. The vine is very ornamental and produces extra long light green fruits in abundance. See illustration page 46A. Pkt., 15c.; 40c. per oz.; ¼ lb., \$1.00.

Jersey Pickle or Green Prolific. This sort can be used for slicing, but is best for pickling on account of its size, which averages 5 inches in length; makes ideal "Dill Pickles" as sold extensively in the delicatessen stores. Pkt., 10c.; 20c. per oz.; ¼ lb., 45c.

ENGLISH FORCING CUCUMBERS

These are splendid for growing in hotbed frames during the Summer months, in preference to the open garden ground. They may also be grown under glass in greenhouses during the Winter, producing enormous fruits, generally 18 to 24 inches long and 3 inches in diameter. They have a delicate flavor and possess very few seeds; for slicing, no other sorts can approach them.

	Pkt.	100 10 seeds	Seeds
Lockie's Perfection. A favorite standard variety..	\$0.25		\$2.25
Sion House25		2.25
Telegraph. Smooth fruits, 14 to 16 inches long...	.25		2.25
Tender and True. Long, smooth, dark in color....	.25		2.25

NOTE—All seeds on this page sent postpaid at quoted prices.

DANDELION

Pissenlit (Fr.); Loewenzahn (Ger.); Dente di leone (Ital.)

A valuable vegetable, prized as the first Spring greens. The leaves are boiled and served hot or cold. Seed should be sown in Spring, in a bed where the plants should remain for the season; late in the Fall cover the bed with a movable sash, or leaves, or salt hay for protection.

Thick Leaved or Cabbaging. Pkt., 10c.; 35c. per ½ oz.; oz., 60c.; \$2.25 per ¼ lb.

DILL (Herb)

Used extensively for culinary purposes and for putting with cucumbers when pickling. Pkt., 10c.; 25c. per oz.; ¼ lb., 75c.

EGG PLANT

Aubergine (Fr.); Eierpflanze (Ger.); Petonciano (Ital.)

One ounce will produce 1000 to 2000 plants

Sow seed in March in hotbeds, and when 3 inches high transplant into boxes or small pots. Plant outdoors in May or June or after the weather has become permanently warm, in rows 3 feet apart, with the plants set 2 feet apart in the row.

Black Beauty. An extra early, large variety, almost black in color, very prolific and with few seeds. Pkt., 10c.; 35c. per ½ oz.; oz., 60c.; \$1.75 per ¼ lb.

Florida High Bush. Plants grow very erect and bear good sized purple fruits well above the ground. Pkt., 10c.; 35c. per ½ oz.; oz., 60c.; \$1.75 per ¼ lb.

New York Improved. An old standard; quite large and more elongated than the Black Beauty, with a rich purple color. Pkt., 10c.; 35c. per ½ oz.; oz., 60c.; \$1.75 per ¼ lb.

EGG PLANT PLANTS

(Ready May 15)

New York Improved and Black Beauty. Pot-grown. Per doz., 75c.; \$6.00 per 100. Not mailable.

TESTIMONIAL

Kingston, N. H.

We are increasing our order of seeds with you, due to your past courtesies. It has saved us much time and money to be able to buy from one Seed House with perfect assurance of good seeds.

A. E. Bartlett.

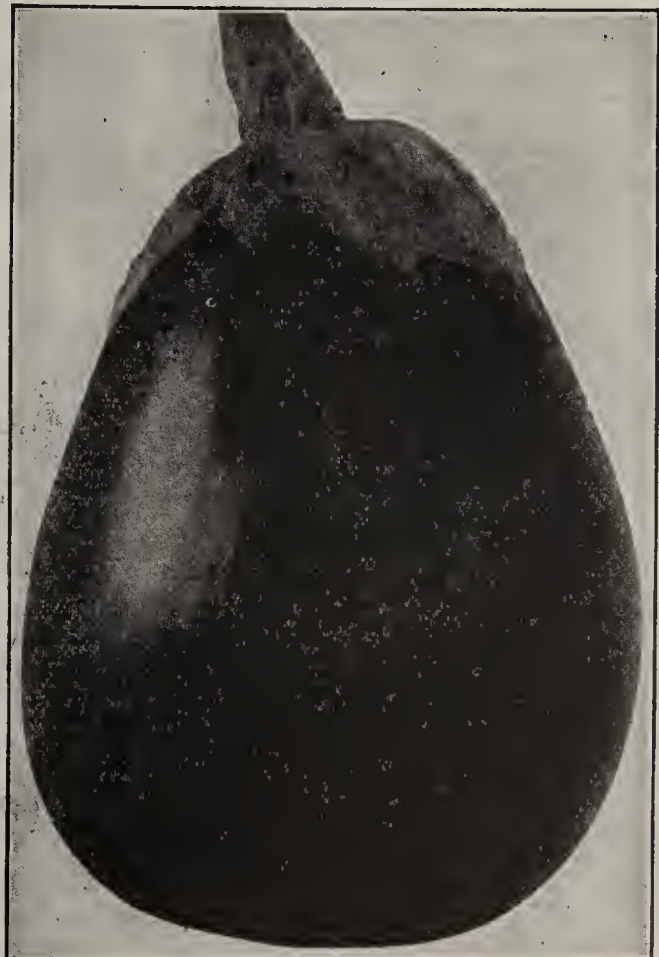

Egg Plant, Black Beauty

ENDIVE

Chircoree (Fr.); Endivien (Ger.); Indivia (Ital.)

One ounce will sow a row of 200 feet.

Sow from June to August in shallow drills; when 2 inches high thin out to 10 inches apart. When well developed, tie the plants together at the top to blanch the inner leaves, do not tie up when the leaves are wet. If the plants are protected they may be left outdoors till Christmas. If wanted for later use they may be lifted late in autumn and placed in a dry, cool cellar, covering the roots with soil.

Full Heart Batavian (*Escarolle*). Leaves broad, light green, nearly plain. Pkt., 10c.; 30c. per oz.; $\frac{1}{4}$ lb., 75c.

Giant Fringed (*Oyster Endive*). A variety with a large white heart and broad fringed leaves; heads measure 15 inches in diameter. Pkt., 10c.; 25c. per oz.; $\frac{1}{4}$ lb., 65c.

Improved Green Curled. An improvement over the common green variety, producing a larger head and thicker leaves. Pkt., 10c.; 25c. per oz.; $\frac{1}{4}$ lb., 65c.

White Curled (*Self-blanching*). This is the finest White Curled variety; always crisp and tender. Pkt., 10c.; 25c. per oz.; $\frac{1}{4}$ lb., 65c.



Improved Green Curled Endive

FENNEL (Herb)

Finnocchio, or Florence. See illustration, page 47. Pkt., 10c.; 25c. per oz.

Sweet. Pkt., 10c.; 25c. per oz.

HERBS

Complete list on page 75.

HOP VINE

Besides being used in culinary and medicinal ways, this makes a valuable shade plant. Hardy and rarely Winter kills. The hops are gathered about September and stored for use on a dry floor, or hung in bags.

Green Variety, Pot Grown Plants. 4 for \$1.00 (by P. P., \$1.10); \$2.50 per doz.; per 100, \$18.00.

HORSERADISH ROOTS

(Ready in March)

Set the roots in rows $2\frac{1}{2}$ feet apart, $1\frac{1}{2}$ feet apart in the row. Late in the Fall lift as many roots as you think you will use, cut off the top and place in a cool cellar, covered with soil or sand.

Maliner Kren. A quick-growing variety and far superior to the common variety. Large cuttings, 25c. per doz. (by parcel post, 35c.); per 100, \$1.35 (by parcel post, \$1.50); \$9.00 per 1000.

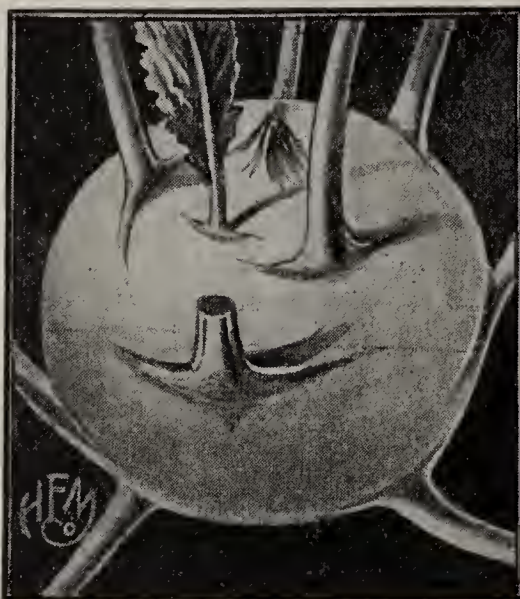

Kohl-Rabi

GARLIC SETS

Ail (Fr.); Knoblauch (Ger.); Aglio (Ital.)

One pound will plant 200 feet of drill.

A hardy flavoring onion, used extensively in the French method of cooking. 30c. per lb. (by parcel post, 40c.); 5 lbs. for \$1.40 (by parcel post, \$1.55); \$2.50 per 10 lbs. (by parcel post, \$2.70).

KOHL-RABI

Chou Rave (Fr.); Kohl Rabi (Ger.); Cavolo rapa (Ital.)

One ounce will sow about 200 feet of drill.

We would suggest to those who have not given this a trial that they do so. Sow seed in the early Spring in hotbeds or outdoors and transplant when 3 inches high, in rows 18 inches apart, 6 inches in the row. The edible part is the root and should be used when it attains a size of $2\frac{1}{2}$ inches in diameter or less, when it is extremely tender and delicious. Prepared and served like turnips, except that a few of the bottom leaves can be cooked with the root.

Early White Vienna. This variety is suited for sowing under glass or for outdoors. The top is very short, thus allowing all the development to go to the root, insuring early maturity. Pkt., 10c.; 30c. per oz.; $\frac{1}{4}$ lb., 85c.

Purple Vienna. Flesh white, skin a bluish color. Principally used for outdoor sowing. Pkt., 10c.; 30c. per oz.; $\frac{1}{4}$ lb., 85c.

KALE OR BORECOLE

Chou Vert (Fr.); Blatterkohl (Ger.); Cavolo Verde (Ital.)

One ounce will sow a drill 150 ft. long.

For early use it may be sown in May; when desired for Winter use, sow in September, broadcast or in rows 2 ft. apart. Cover for protection against severe freezing and snow. Do not handle while in a frozen condition. One of the finest nutritious greens for Winter and early Spring use.

Dwarf Green Curled. Very dwarf and compact, rarely attaining a height of over 6 inches; color, dark green and very curly. Pkt., 10c.; 20c. per oz.; $\frac{1}{4}$ lb., 45c.; \$1.50 per lb.

Imperial Long Standing. The outer edges of leaves are very crimped, inside smooth, dark green with bluish cast. Hardy and productive. Pkt., 10c.; 15c. per oz.; $\frac{1}{4}$ lb., 45c.; \$1.40 per lb.

Siberian. A very hardy variety; leaves large and cook very tender. Pkt., 10c.; 15c. per oz.; $\frac{1}{4}$ lb., 45c.; \$1.40 per lb.

LAVENDER (Herb)

Seed. Pkt., 10c.; 45c. per oz.

LAVENDER PLANTS

Pot grown. 4 for \$1.00 (by parcel post, \$1.10); \$2.50 per doz.; per 100, \$18.00.



Kale, Dwarf Green Curled

All prices on this page include postage

Latue (Fr.); Lattich Salat (Ger.); Lattuga (Ital.)
 One ounce of seed will produce about 2500 plants



Iceberg Lettuce

HEADING VARIETIES

For the first outdoor crop seed is usually sown in hotbeds in February or March and transplanted to the garden in April in rows 1½ feet apart, 8 to 12 inches apart in the row. For a succession, sow in drills in the open ground at intervals of two or three weeks and thin out to 8 inches apart. For plants to force in hotbeds from November until Spring, sow seed in hotbeds in the Fall. Where it is difficult to have the heading varieties develop properly on account of soil condition, we recommend the use of the loose leaf varieties.

All Heart. An excellent lettuce for either Spring or Summer use. The head, while large, has a loose heart, which is of a decided buttery flavor; can be used for sowing in frames, or in Spring and early Summer outdoors. Pkt., 10c.; 25c. per oz.; ¼ lb., 75c.

All Right. A fine variety for an early Spring crop in the hotbed or outdoors and for sowing in August for late Autumn under sash or outside; it is not affected by cold, which, with some sorts turns them brown; on the other hand, this variety retains a rich green color. Heads are large, solid and with a rich buttery heart of light yellow. Pkt., 10c.; 25c. per oz.; ¼ lb., 75c.



A Frame of May King Lettuce

Big Boston. A large, flat, cabbage-headed variety; splendid for midsummer or Fall use, or under glass in the early Spring and Autumn; a delightful shade of light green, tinged light brown on the outer leaves. Pkt., 10c.; 25c. per oz.; ¼ lb., 75c.

Boston Market (White Seeded Tennisball). Early, small heading variety; one of the best for forcing; the heart is very solid and crisp. Pkt., 10c.; 25c. per oz.; ¼ lb., 75c.

Davey's Improved Big Boston. Heads are similar in size and compactness to Big Boston, but slightly earlier and minus the brown tinge on outer edge of leaves. Pkt., 10c.; 25c. per oz.; ¼ lb., 85c.

Dutch Butter. A medium-sized head; light green leaves, with delicate yellow heart. The outer leaves are tinged brown on the edges. Pkt., 10c.; 25c. per oz.; ¼ lb., 75c.

Iceberg. A splendid variety, producing large, solid cabbage-like heads; firm, crisp and of fine flavor; leaves curly, slightly tinged red. Pkt., 10c.; 25c. per oz.; ¼ lb., 85c.

Improved Hanson. Tremendous solid heads; the outer leaves are curled, the interior is almost white and very tender; resists the heat well, therefore excellent for Summer use. Pkt., 10c.; 25c. per oz.; ¼ lb., 75c.

Mammoth Salamander. One of the best midsummer varieties, resisting heat and drought, and remains in heading condition longer than many others. Pkt., 10c.; 25c. per oz.; ¼ lb., 75c.



Michell's Number One Lettuce

May King. The first solid head lettuce to mature outdoors; it is of good size, with tender, full heart. Suitable for sowing under sash in early Spring. Pkt., 10c.; 25c. per oz.; ¼ lb., 75c.

Mignonette. A compact variety; heads small, leaves curly and edges tinted brown; a sure header and of good quality. Pkt., 10c.; 25c. per oz.; ¼ lb., 85c.

Michell's Number One. A good variety for Summer use, as it resists the hot sun better than most sorts; tender and of a delicious buttery flavor; heads unusually large; we do not recommend it for forcing. Pkt., 10c.; 25c. per oz.; ¼ lb., 75c.

New York or Wonderful. Of the cabbage-headed sorts this is a leader; color, dark green, with white interior; heads large with curled outer leaves; a popular kind for Summer. Pkt., 10c.; 30c. per oz.; ¼ lb., 90c.

Prize Head. A splendid loosely-formed head, claimed to do well where all others fail; desirable for outdoor planting only; has a dark tinge on the outer leaves. Pkt., 10c.; 25c. per oz.; ¼ lb., 75c.

Unrivalled. Very large, light green and of a crisp nature; very desirable for Summer use. Pkt., 10c.; 25c. per oz.; ¼ lb., 85c.

Wayahead. The earliest hard heading lettuce in cultivation, doing well either under glass or in the open, in Spring or Autumn. Pkt., 10c.; 25c. per oz.; ¼ lb., 75c.

White Big Boston. A new heading variety, which resembles Big Boston in size, solidity and general appearance, excepting it is minus the red edge so common in that variety. This variety is preferable in some sections. Pkt., 10c.; 30c. per oz.; ¼ lb., 90c.



Lettuce, Grand Rapids

LOOSE LEAF OR CUTTING VARIETIES

For early or midsummer use, seed should be sown very thickly. When pulling the young plants try to do so with an effort to thin out the bed, thus allowing the remaining plants to become large. This class of lettuce is always tender.

Black Seeded Simpson. Ideal for midsummer use, as it withstands the most trying conditions of heat and drought. When matured, presents a formidable loose head with finely fringed leaves. Pkt., 10c.; 25c. per oz.; ¼ lb., 75c.

Early Curled Silesian. This variety should be cut instead of pulled, as it makes new growth from the same root. A light green color, and when given plenty of room will form a large loose head. Pkt., 10c.; 25c. per oz.; ¼ lb., 75c.

Early Curled Simpson. A splendid curly-leaved sort; loose heads and very tender. Pkt., 10c.; 25c. per oz.; ¼ lb., 75c.

Grand Rapids. The leading variety in this class for forcing under glass, but it may also be grown successfully outdoors. The leaves are very curly, crisp and brittle and have a palatable flavor. Pkt., 10c.; 25c. per oz.; ¼ lb., 75c.

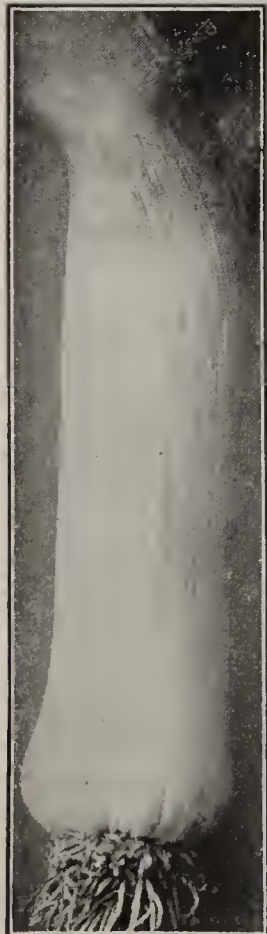

Leek

LEEK

Poireau (Fr.); Lauch (Ger.); Porro (Ital.)

One ounce of seed will sow about
100 feet of drill

Allied to the onion family but producing no bulb; the stalks are cut and used for flavoring soups; also they are boiled and served with melted butter, and make a very palatable dish on account of their mild flavor. Sow seed in April in rows 1 foot apart, covering the seed about an inch; when about 4 inches high transplant where it is to develop, in rich soil in rows 18 inches apart, 6 inches in the row.

American Flag. Popular for the home garden. Makes a longer but narrower stalk than others. Pkt., 10c.; 30c. per oz.; ¼ lb., 85c.

Giant Carentan. A variety which produces colossal stalks of tender quality; splendid for exhibition purposes. Pkt., 10c.; 30c. per oz.; ¼ lb., 85c.

ROMAINE OR COS LETTUCE

Of French origin, this type, as will be seen by the illustration, differs greatly from the American varieties by its peculiar upright growth. To have it tender the heads must be tied together at the top so that the inner leaves blanch; it has a decided flavor. It is best adapted to outdoor planting and stands the heat well.

Kingsholm. The largest and best heading variety of this type, the inner leaves blanch almost pure white and have little or no rib, the heads are very full throughout and therefore contain more edible part. Pkt., 10c.; 25c. per oz.; ¼ lb., 85c.



Lettuce, Kingsholm Cos

LETTUCE PLANTS

We can supply these in heading varieties only, of our selection. 25 for 25c. (by parcel post, 40c.); 75c. per 100 (by parcel post, 95c.); per 1000, \$6.00.

MANGEL-WURZEL. See page 53



MARTYNIA (Unicorn Plant)

A bushy plant growing 2 feet in height, bearing clusters of pink flowers resembling gloxinias, which are followed by curled seed pods, which when picked may be pickled the same as cucumbers, making a very tasty relish. Sow seeds in April outdoors and transplant so the plants stand 2 feet apart each way.

Proboscidea. Pkt., 10c.; 25c. per ½ oz.; oz., 45c.

Melon Muscade (Fr.); Melone (Ger.); Popone Melone (Ital.)

One ounce will plant about 50 hills; 2 to 3 lbs. are required for an acre.

While these do best in a light sandy loam, any good well-prepared garden soil suits them. Plant when the ground has become permanently warm, in hills 6 feet apart each way, 8 to 10 seeds in a hill. After the second tier of leaves has formed, thin out to 4 plants in a hill. Watch carefully for insects of various kinds, especially the melon louse that works under the leaf and shrivels it, causing the plant to die. To fight this successfully, raise up the vines and spray underneath with Arsenate of Lead, or some of the various Nikoteen preparations.

Delicious Gold Lined. Flesh thick, fine grained and sweet; color green with a gold margin next to the seed cavity; slightly oval and heavily netted. Pkt., 10c.; 20c. per oz.; $\frac{1}{4}$ lb., 60c.

Emerald Gem. Flat shape; the flesh, which is thicker than any other melon of the same shape, is a rich salmon shade and ripens extremely close to the rind; exceedingly sweet. Pkt., 10c.; 20c. per oz.; $\frac{1}{4}$ lb., 60c.

Fordhook. Of flat shape like Emerald Gem, on which it is an improvement. Flesh a beautiful salmon orange, very sweet; fruits large, often weighing 2 lbs. each; an early variety, and very prolific. The netted rind is very thin, and the melon can be eaten very close thereto. Pkt., 10c.; 20c. per oz.; $\frac{1}{4}$ lb., 60c.

Hale's Best. The chief value of this variety is its earliness and fine quality; oval in shape, heavily netted; salmon color flesh; an excellent variety for long distance shipping. Pkt., 10c.; 25c. per oz.; $\frac{1}{4}$ lb., 75c.

Hearts of Gold. A splendid mid-season variety; fruit round, distinctly ribbed; flesh, which is a deep salmon color, is thick and can be eaten very close to the rind, excellent flavor. Pkt., 10c.; 25c. per oz.; $\frac{1}{4}$ lb., 75c.

Honey Dew. A late maturer; large in size, being 6 inches in diameter and from 7 to 8 inches long; skin smooth with an occasional net and creamy white. The thick flesh is emerald green, melting, and of a wonderfully delicious flavor, sweet as honey. The ripe melons can be kept in a suitable place for several weeks before using. Pkt., 10c.; 25c. per oz.; $\frac{1}{4}$ lb., 75c.

All seeds on this page mailed postpaid at prices quoted.

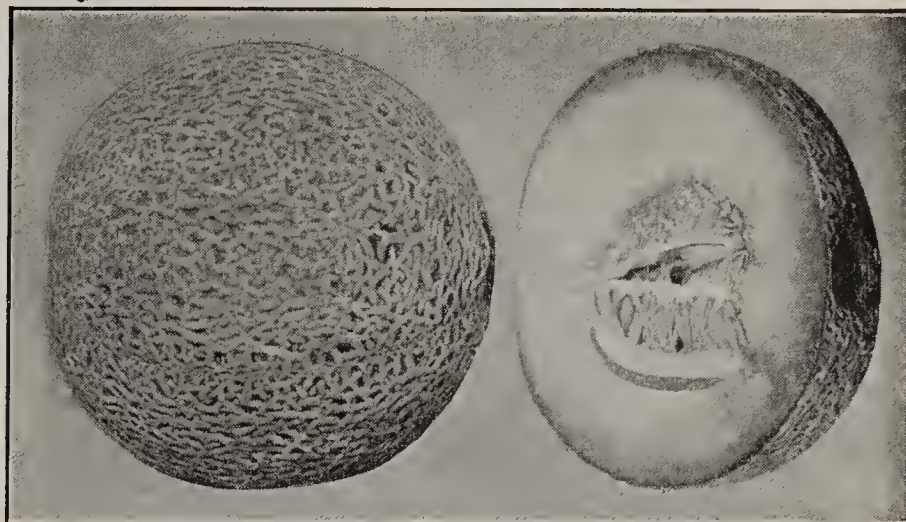

Hearts of Gold Muskmelon

Honey Rock. A new introduction. A wonderful melon of excellent flavor; medium in size, round as a ball and with a very coarse netting; flesh thick and of a deep orange color; they ripen early and have proved to be very productive. See illustration, page 46B. Pkt., 10c.; 25c. per oz.; $\frac{1}{4}$ lb., 75c.

Jenny Lind. A small, flat, early sort, heavily netted and ribbed; green flesh; a good home garden melon; edible in about 87 days from time of planting. Pkt., 10c.; 25c. per oz.; $\frac{1}{4}$ lb., 75c.

Michell's Delicious. This deservedly enjoys a good name, large in size, often weighing 15 to 20 lbs. The flesh is deep orange-salmon and of splendid quality. Pkt., 15c.; 25c. per $\frac{1}{2}$ oz.; 40c. per oz.; per $\frac{1}{4}$ lb., \$1.35.

New Surprise. A large variety, often weighing 8 to 9 pounds; rather oval in shape, with very prominent ribs; the skin which is a green color is slightly netted; as it ripens, it turns to a cream color; flesh bright salmon color, thick, sweet and spicy. Pkt., 10c.; 25c. per oz.; $\frac{1}{4}$ lb., 75c.

Rockyford. A medium early variety, suitable for growing in all sections; the fruit is oval in shape and covered with a fine netting; flesh green, very sweet and highly flavored. Pkt., 10c.; 20c. per oz.; $\frac{1}{4}$ lb., 60c.

FORCING MELONS (English Varieties)

Forcing melons can be grown successfully outside in hotbeds. Sow seed in pots in March and transplant to hotbed when three leaves have developed; these will ripen fruit in June and July. For indoor use treat same as forcing cucumber.

Blenheim Orange, Windsor Castle. Each variety per pkt., 25c.; 65c. per 3 pkts.

Sutton's A1. In original packets, \$1.25 per pkt.

MELON NETS. For supporting forcing melons in greenhouses; made very strong; will last for a number of crops. \$2.50 per doz.; per 100, \$18.00.

MINT (Herb)

Pkt., 25c.; 65c. for 3 pkts.

MINT PLANTS (Pot Grown)

Peppermint. 3 for 50c. (by parcel post, 60c.); doz., \$1.50; \$10.00 per 100.

Spearmint. 3 for 50c. (by parcel post, 60c.); doz., \$1.50; \$10.00 per 100.

TESTIMONIAL

Audubon, Pa.

I have used your Vegetable Seeds last year and I have had the best of results from them. I will use none but your seeds from now on.

J. A. McCall



MICHELL'S CHOICE STRAIN WATERMELON

Melon d'eau (Fr.); Wasser Melone (Ger.); Melone d'aqua (Ital.)
 One ounce will plant 30 hills, four pounds are required for an acre.

Plant in hills 8 to 10 feet apart each way; scatter 8 to 10 seeds in each hill, covering half an inch deep; when well established thin out to three or four of the strongest plants to each hill. A little land plaster dusted over the young plants will keep beetles away. Watermelons should not be planted until after the soil has become thoroughly warm. We offer only the varieties which from experience we know are the better ones.



Watermelon, Harris' Earliest

Dixie. This is an old-time favorite, roundish-long in shape. The skin is dark green, mottled light; the flesh is very sweet and ripens close to the rind. Pkt., 10c.; 15c. per oz.; ¼ lb., 40c.; \$1.25 per lb.

Halbert Honey. The long fruits with blunt ends are very large, often weighing 50 lbs.; the rind is very thin, dark green, while the flesh is a rich crimson and very sweet. It is very prolific and is altogether a first-rater. Pkt., 10c.; 15c. per oz.; ¼ lb., 40c.; \$1.25 per lb.

Harris' Earliest. Ripens very early and on this account is one of the best to raise in the northern states. Fruit oblong and marbled with light and dark green; flesh bright red and of good quality. Pkt., 10c.; 15c. per oz.; ¼ lb., 40c.; \$1.25 per lb.



Watermelon, Kleckley Sweets

Kleckley Sweets. A sweet one, to be sure, with a luscious tenderness all its own. It is not a shipping variety, as the rind is too close to the ripe, fluffy, rich red meat, when in condition to use. The melons average about 20 inches long and ripen quite early. Pkt., 10c.; 15c. per oz.; ¼ lb., 40c.; \$1.25 per lb.

Pride of Muscatine (Wilt Resistant). A new melon that will be welcomed in sections where melon wilt prevails. It is more immune from this plant disease than any variety we know of. A long, dark green variety with red flesh and exceptionally sweet. Pkt., 10c.; 25c. per oz.; ¼ lb., 70c.; \$2.00 per lb.

Tangerine. A fine melon for the home garden; oval in shape with mottled stripes of light green; flesh pink and of fine quality. When the rind is broken the flesh separates the same as a tangerine. Pkt., 15c.; 35c. per oz.; ¼ lb., \$1.00.

Tom Watson. A handsome large fruit, frequently 2 feet long and 12 inches in diameter; dark green rind, bright scarlet flesh, which is of splendid texture and flavor; the sugary meat really melts in your mouth. Nothing can touch it in the melon line for shipping qualities. The rind being tough, it will resist plenty of abuse. Pkt., 10c.; 15c. per oz.; ¼ lb., 40c.; \$1.25 per lb.

Watermelon seed for medicinal purposes, 30c. per lb.

PRESERVING MELON OR CITRON

California Red Seeded. A large-fruited variety; pure white flesh and thin rind. This is expensive when bought, yet can be grown and preserved by any energetic housewife, who will then also know it to be absolutely pure and good. It is planted like watermelon. Pkt., 10c.; 15c. per oz.; ¼ lb., 40c.; \$1.25 per lb.

MICHELL'S MUSHROOM SPAWN

A fine crop of mushrooms can be produced with very little labor or expense, provided a suitable location can be obtained. Cellars, sheds or greenhouses can be used for their culture.

PURE SPORE CULTURE SPAWN

This spawn is made in quart milk bottles under absolutely sterile conditions, so that every mould, weed seed or insect is destroyed and each bottle contains nothing but pure spawn. One carton equals 5 bricks of ordinary spawn and is sufficient to spawn about 40 square feet. The spawn is dried thoroughly and wrapped in paper, with full directions how to grow mushrooms and packed in cartons.

Prices

Per carton.....	\$1.00	25 cartons.....	\$21.25
12 cartons.....	10.75	60 cartons.....	48.00

If wanted by P. P., allow 10c. per carton for postage.

PURE CULTURE BRICK SPAWN

One brick will spawn 8 to 10 square feet. Ask for our Free Leaflet on Mushroom Culture.

Pure White

Per brick.....	\$0.35	Per 10 bricks.....	\$2.75
Per 5 bricks.....	1.50	Per 25 bricks.....	6.50
Per 50 bricks.....	\$12.50		

If wanted by P. P., allow for postage at the rate of 10c. per brick; 15c. per 5 bricks; 25c. per 10 bricks.

BOOKS ON GROWING MUSHROOMS

Mushroom Growing (Duggar). 260 pages.....\$2.00
 Mushrooms, How to Grow (Falconer). 169 pages..... 1.75

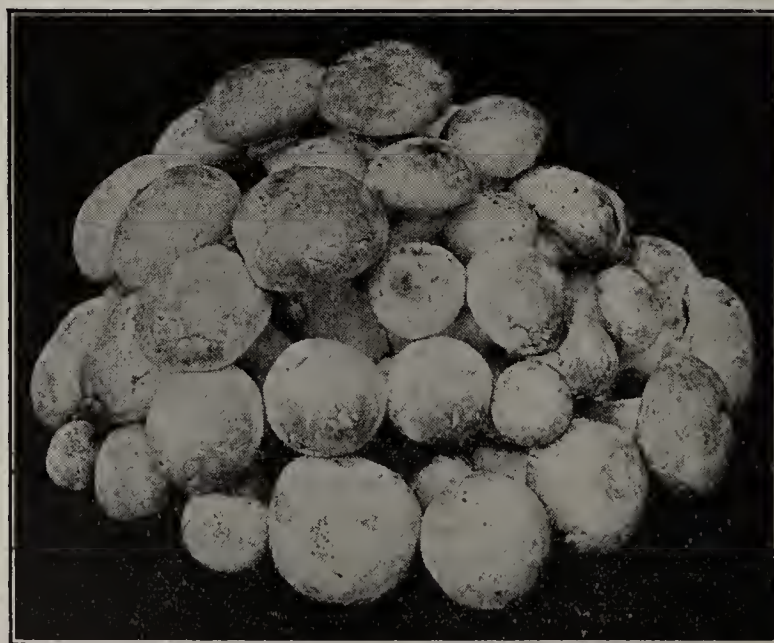

Michell's Mushroom Spawn

MUSHROOM OR HOTBED THERMOMETERS

No. 20450. Iron Point, oxidized finish. Price, \$2.25 (by P.P., \$2.40). Thermometers should, wherever possible, be sent by express. We do not guarantee safe arrival if forwarded by parcel post.

Ognon (Fr.); Zwiebel (Ger.); Cipolla (Ital.)

To grow full-size onions, one ounce of seed will sow a 100 foot row; 5 to 6 pounds are required per acre. If it is desired to grow onion sets, sow 40 to 50 pounds per acre.

Sow in the early Spring in rows 2 feet or less apart, according to cultivation method employed. The seed should be firmed in the soil. If it is desired to grow full size onions the first year, thin out when 3 inches high, so that they stand about 2 or 3 inches apart. White onions are mildest in flavor and are recommended for early use. The yellow sorts are best for Winter keeping.

Ailsa Craig. The largest of all onions, often weighing 3 lbs. and over, each. Globe-shaped, slightly pointed at top and base; color a beautiful straw yellow. To obtain best results sow seed in hotbed and later transplant where they are to grow; in planting place 4 to 6 inches apart and thus procure gigantic specimens. Pkt., 10c.; 30c. per oz.; ¼ lb., 85c.; \$3.00 per lb.

Bermuda White. Although known as the Bermuda White it is a light yellow or straw color; early and if transplanted about 4 inches apart, will produce immense flat bulbs. In the raw state it is very mild, while when cooked, the flesh is tender and of a delicious flavor; an elegant variety for slicing. Pkt., 10c.; 25c. per ½ oz.; oz., 40c.; \$1.25 per ¼ lb.

Large Red Wethersfield. A flat, large growing variety; an excellent Winter keeper; flavor much like the yellow sorts; full-size onions can be grown in one season. Pkt., 10c.; 25c. per oz.; ¼ lb., 70c.; \$2.50 per lb.

Prizetaker. A mammoth yellow variety; if sown thinly it produces full-size onions in one season from seed, rivaling the Bermuda varieties for size and flavor, often weighing 3 lbs. or more each. Pkt., 10c.; 30c. per oz.; ¼ lb., 85c.; \$3.00 per lb.

Southport White Globe. A beautiful type of an almost round onion, growing to an enormous size. The flesh when cooked is of a rich milky color, of tender and delicious flavor and in the raw state it is one of the mildest. Pkt., 10c.; 25c. per oz.; ¼ lb., 75c.; \$2.75 per lb.

Southport Yellow Globe. Similar to the Danvers except larger in size, more like the Prizetaker. This is probably one of the most uniform growing varieties, every bulb being almost perfectly round and of the same size; light straw colored skin. Pkt., 10c.; 20c. per oz.; ¼ lb., 60c.; \$2.25 per lb.

White Barletta. An extra early small round variety, used principally for pickling, also for bunching. Pkt., 10c.; 25c. per oz.; ¼ lb., 75c.; \$2.75 per lb.

White Portugal or Silver Skin. The standard white onion for market or home use; mild flavor; semi-globe shaped and very uniform in growth and size. Pkt., 10c.; 25c. per oz.; ¼ lb., 75c.; \$2.75 per lb.

Yellow Globe Danvers. This almost round-shaped onion is extensively sown by the private and market gardener on account of its good keeping qualities. It is a dark straw color and always produces a good crop, growing to a large size. Pkt., 10c.; 25c. per oz.; ¼ lb., 75c.; \$2.75 per lb.

Yellow Strasburg. A dark straw color skinned sort; almost flat in shape, but a large onion. Its fine keeping qualities are what recommend it to the home as well as the market gardener. For a yellow sort it is rather mildly flavored; for growing sets, more of this variety is sold than any other. Pkt., 10c.; 25c. per oz.; ¼ lb., 70c.; \$2.50 per lb.



Onion, Prizetaker

ONION SETS

One quart will plant a row about 50 feet.

Plant as soon as the ground can be worked. Press the bulb in the ground lightly (do not cover), in rows 12 inches apart, 2 inches apart in the row, so that all the development goes in the onion; on signs of their going to seed, bend the top over, but do not break it off. The advantage in planting onion sets lies in the fact that the young onion is ready often 5 weeks from the time of planting, while those grown from seed cannot be used until well in the Autumn.

Shipped on Local Orders about March 10, unless otherwise requested.

If Onion Sets are wanted by parcel post, add 5c. per pt.; 10c. per qt.; 15c. per 4 qts.; 25c. per peck for postage.

	Pt.	Qt.	4 qts.	Peck
Yellow.....	\$0.15	\$0.25	\$0.90	\$1.45
White.....	.20	.30	1.10	1.85
Red.....	.15	.25	.90	1.45
		Lb.	5 lbs.	10 lbs.
White Multiplier.....	\$0.30		\$1.40	\$2.50
Potato Onions.....	.30		1.40	2.50
Shallots.....	.30		1.40	2.50
Garlic Sets.....	.30		1.40	2.50

If the above are wanted by parcel post, add 10c. per lb.; 15c. for 5 lbs.; 20c. for 10 lbs., for postage.

Tree or Top Onions. Ready latter part of August.

We give 32 lbs. per bushel on Onion Sets.

Prices quoted above are subject to market change.

Prices on larger quantities of Onion Sets will be quoted on request.



We make a specialty of choice Onion Sets.

Onion Culture (Greiner)

A book for the home garden or market; 140 pages. Price, \$1.10

MUSTARD

One ounce will sow a row 75 feet long.

Makes a delicious green salad, pungent in taste, highly palatable and healthy. Sow every two weeks in rows the same as spinach. Fine Winter greens if sown in a heated frame or greenhouse, also fine if served with lettuce for flavoring. If the plant is allowed to stand, the seed can be harvested and used for other culinary purposes.



Mustard, Southern Giant Curled

Fordhook Fancy. Produces a large crop of leaves, resembling an ostrich plume and which are of mild flavor. Pkt., 10c.; 15c. per oz.; ¼ lb., 40c.; \$1.25 per lb.

Southern Giant Curled The best of the curled mustards; sweet flavor; matures very early and produces abundant foliage. Pkt., 10c.; 15c. per oz.; ¼ lb., 35c.; \$1.00 per lb.

OKRA OR GUMBO

Gombo (Fr.); Ocher (Ger.); Ocra (Ital.)

One oz. will sow a row about 100 feet long.

The seed is sown thickly, after the frost and cold have disappeared, in rows, 3 feet apart; when about 6 inches high the plants should be thinned out to stand 12 inches apart in the row. The pod is used when young and tender, sliced in soups and stews; what is not utilized during the Summer may be harvested, cut in slices and dried in the sun, and put away for use during the Winter.

Perkin's Long Pod. A dwarf type, setting pods when the plants are only a foot high; can be planted somewhat earlier than other sorts. The pods are exceedingly long, tender and of a dark green color. Pkt., 10c.; 15c. per oz.; ¼ lb., 35c.; \$1.00 per lb.

White Velvet or Creole. The pods of this variety are very free from ridges, being almost perfectly smooth; they are tender and very light green, almost white in color. Pkt., 10c.; 15c. per oz.; ¼ lb., 35c.; \$1.00 per lb.



OKRA or GUMBO

PARSNIP

Panais (Fr.); Pastinake (Ger.); Pastinaca (Ital.)

One ounce will sow a row 150 feet long; 5 lbs. per acre.

Sow early in Spring in drills about 24 inches apart, covering the seed lightly; when plants are 2 or 3 inches high, thin out so the roots will develop; cultivate well during the growing season.

Improved Sugar or Hollow Crown. A very thick, broad-topped root, which makes it lift easily. Flesh is very fine grained and sweet, while the outer surface is smooth and almost white. Pkt., 10c.; 15c. per oz.; ¼ lb., 40c.; \$1.25 per lb.

All seeds (not plants) on this page mailed free at prices quoted.



Double Curled Parsley

PARSLEY

Persil (Fr.); Petersilie (Ger.); Prezemolo (Ital.)

One ounce will sow a row 100 ft. long.

After soaking the seed for a few hours in warm water, it should be sown in rows 18 inches apart and when 2 inches high thinned out so the plants will stand 4 inches apart in the row. It takes parsley seed from 3 to 6 weeks ordinarily to germinate, so that a little patience in growing this is necessary.

Champion Moss Curled. The attractive curled leaf of a dark green color and long stems, making it suitable for bunching, are outstanding features of this variety. Pkt., 10c.; 15c. per oz.; ¼ lb., 40c.; \$1.25 per lb.

Double Curled or Covent Garden. The nicely curled leaf of a deep green color makes it an elegant variety for garnishing steaks and salads; dwarf in habit. Pkt., 10c.; 20c. per oz.; ¼ lb., 50c.; \$1.50 per lb.

Hamburg or Rooted. The fleshy roots are used for flavoring soups, stews, etc. Pkt., 10c.; 15c. per oz.; ¼ lb., 40c.; \$1.25 per lb.

Plain or Single. Leaves not curled. Pkt., 10c.; 15c. per oz.; ¼ lb., 40c.; \$1.25 per lb.

Tom Thumb. A very fine extra curled parsley of dwarf habit; growing uniform in shape and compactness; best for home garden use, also suitable for edging borders and for decorative purposes. Pkt., 15c.; 25c. per oz.; ¼ lb., 75c.; \$2.00 per lb.

PARSLEY PLANTS (Ready in April)

Large specimens; pot-grown ready for use. Per doz., \$1.00; \$7.00 per 100. Not mailable.

VEGETABLES YOUR BEST FOOD

Our health depends a great deal on what we eat. The average American meal consists of acid-forming foods and so refined that the best elements are lost and therefore detrimental. Vegetables are your best food; eat more of them.



Pois (Fr.); Erbsen (Ger.); Pisello (Ital.). 2 lbs. will plant 100 ft. of row; 90 to 120 lbs. per acre.

The smooth-seeded varieties may be sown as soon as the ground can be worked; the wrinkled sorts when the ground has become warmer. Sow in single or double rows, 2 to 4 feet apart according to the variety. To have a continuous crop, sow weekly up to May 15th, then discontinue until August 1st, when the early varieties may be sown for a Fall crop.

Prices quoted on Peas are prepaid in quantities up to 5 lbs., to the first and second zones; for other zones, see parcel post table on page 1. Larger quantities shipped at purchaser's expense.



Gradus Peas

Special Extra Early. Of the smooth-seeded sorts this is the peer. Extremely early, lusciously sweet and very tender; a grand yielder; height, 24 inches. Pkt., 10c.; 25c. per ½ lb.; lb., 40c.; 75c. per 2 lbs.; 5 lbs., \$1.75; \$3.30 per 10 lbs.; 25 lbs., \$7.50.

Sutton's Excelsior. This variety is quite hardy and can be planted earlier than most other wrinkled sorts; very early; long, broad pods, well filled; height, 16 inches. Pkt., 10c.; 25c. per ½ lb.; lb., 40c.; 75c. per 2 lbs.; 5 lbs., \$1.75; \$3.30 per 10 lbs.; 25 lbs., \$7.50.

Thos. Laxton. Heavy producer; wrinkled, exceedingly early; pods are large and filled with large peas of excellent flavor. Its heavy cropping qualities make it suitable for an early crop in the private garden; height, 36 inches. Pkt., 10c.; 25c. per ½ lb.; lb., 40c.; 75c. per 2 lbs.; 5 lbs., \$1.75; \$3.30 per 10 lbs.; 25 lbs., \$7.50.

PRIZE COLLECTION

The best selection of Garden Peas, which will give a continuous supply. This collection should be sown at one time, as soon as danger of freezing is over.

Dandy Extra Early

Early Eight Weeks

Tall Telephone

Price, 1 pkt. of each for 25c.; 1 lb. of each for \$1.00, postpaid.

EXTRA EARLY VARIETIES

Alaska. Smooth seeded; very early; height, 2½ feet. Pkt., 10c.; 20c. per ½ lb.; lb., 35c.; 65c. per 2 lbs.; 5 lbs., \$1.50; \$2.80 per 10 lbs.; 25 lbs., \$6.50.

Dandy Extra Early. A selection of the Eureka, but far superior; smooth seeded; very prolific and desirable for the kitchen and market garden; height, 24 inches. Pkt., 10c.; 20c. per ½ lb.; 35c. per lb.; 2 lbs., 65c.; \$1.50 per 5 lbs.; 10 lbs., \$2.80; \$6.50 per 25 lbs.

Early June. A green seeded, smooth pea, desirable for first planting; height, 2½ feet. Pkt., 10c.; 20c. per ½ lb.; lb., 35c.; 65c. per 2 lbs.; 5 lbs., \$1.50; \$2.80 per 10 lbs.; 25 lbs., \$6.50.

Early Eight Weeks. A wrinkled variety, growing 12 to 15 inches high and commencing to bear 6½ weeks after planting; a heavy cropper and especially desirable where room is scarce. Pkt., 10c.; 25c. per ½ lb.; lb., 40c.; 75c. per 2 lbs.; 5 lbs., \$1.75; \$3.30 per 10 lbs.; 25 lbs., \$7.50.

Gradus or Prosperity. Never was there a pea offered which is so largely demanded as this very early sort. It is exceedingly luscious, wrinkled and a producer of gigantic pods and peas; height, 36 inches. Pkt., 10c.; 25c. per ½ lb.; lb., 40c.; 75c. per 2 lbs.; 5 lbs., \$1.75; \$3.30 per 10 lbs.; 25 lbs., \$7.50.

Laxtonian. An extra fine early, dwarf sort; pods are large and well filled with peas of extra fine quality; height, 18 inches. Pkt., 10c.; 25c. per ½ lb.; lb., 40c.; 75c. per 2 lbs.; 5 lbs., \$1.75; \$3.30 per 10 lbs.; 25 lbs., \$7.50.

Little Marvel. Wrinkled, dwarf, 18 to 20 inches; prolific and sweet. Pkt., 10c.; 25c. per ½ lb.; lb., 40c.; 75c. per 2 lbs.; 5 lbs., \$1.75; \$3.30 per 10 lbs.; 25 lbs., \$7.50.

Nott's Excelsior. A splendid early wrinkled pea, producing heavy crops of full pods very early; height, 15 inches. Pkt., 10c.; 25c. per ½ lb.; lb., 40c.; 75c. per 2 lbs.; 5 lbs., \$1.75; \$3.30 per 10 lbs.; 25 lbs., \$7.50.



Peas, Little Marvel

Prices quoted on Peas are prepaid in quantities up to 5 lbs., to the first and second zones; for other zones, see parcel post table on page 1. Larger quantities shipped at purchaser's expense.

SECOND EARLY VARIETIES

Bliss Abundance. Produces very large pods containing six or more peas of delicious flavor; wrinkled; height, 20 inches. Pkt., 10c.; 20c. per ½ lb.; lb., 35c.; 65c. per 2 lbs.; 5 lbs., \$1.50; \$2.80 per 10 lbs.; 25 lbs., \$6.50.

Dwarf Telephone. One of the best medium early sorts; large pods, peas wrinkled and very sweet; height, 18 inches. Pkt., 10c.; 25c. per ½ lb.; lb., 40c.; 75c. per 2 lbs.; 5 lbs., \$1.75; \$3.30 per 10 lbs.; 25 lbs., \$7.50.

Potlatch. A wrinkled variety, similar to Dwarf Telephone; pods well filled with peas; height, 18 inches. Pkt., 10c.; 25c. per ½ lb.; lb., 40c.; 75c. per 2 lbs.; 5 lbs., \$1.75; \$3.30 per 10 lbs.; 25 lbs., \$7.50.

GENERAL OR LATER CROP VARIETIES

Champion of England. A very tall, rank grower, but a wonderful yielder of delicious quality peas; seed wrinkled; height, 5 feet. Pkt., 10c.; 20c. per ½ lb.; lb., 35c.; 65c. per 2 lbs.; 5 lbs., \$1.50; \$2.80 per 10 lbs.; 25 lbs., \$6.50.

Dwarf Champion. Possesses most all the good qualities of the famous Champion of England, and has the further advantage of being dwarf; a very delicious pea; height, 2 feet. Pkt., 10c.; 20c. per ½ lb.; lb., 35c.; 65c. per 2 lbs.; 5 lbs., \$1.50; \$2.80 per 10 lbs.; 25 lbs., \$6.50.

Telephone (Tall). The finest late wrinkled pea grown; exceedingly sweet; an abundant producer; height, 3½ feet. Pkt., 10c.; 25c. per ½ lb.; lb., 40c.; 75c. per 2 lbs.; 5 lbs., \$1.75; \$3.30 per 10 lbs.; 25 lbs., \$7.50.

Yankee Prince. A large podded wrinkled sort; heavy yielder; pods often measure 6 inches in length; height, 4 feet. Pkt., 10c.; 25c. per ½ lb.; lb., 40c.; 75c. per 2 lbs.; 5 lbs., \$1.75; \$3.30 per 10 lbs.; 25 lbs., \$7.50.

SUGAR OR EDIBLE POD PEAS

This type produces large, well-filled pods. They are cooked with the peas intact; very tender and exceedingly sweet.

Dwarf Gray Sugar. Gray seed; height, 2 feet. Pkt., 10c.; 25c. per ½ lb.; lb., 40c.; 75c. per 2 lbs.; 5 lbs., \$1.75; \$3.30 per 10 lbs.; 25 lbs., \$7.50.

Tall Luscious Sugar. Gray seed; height, 4 feet. Pkt., 10c.; 25c. per ½ lb.; lb., 45c.; 85c. per 2 lbs.; 5 lbs., \$2.00; \$3.80 per 10 lbs.; 25 lbs., \$9.00.

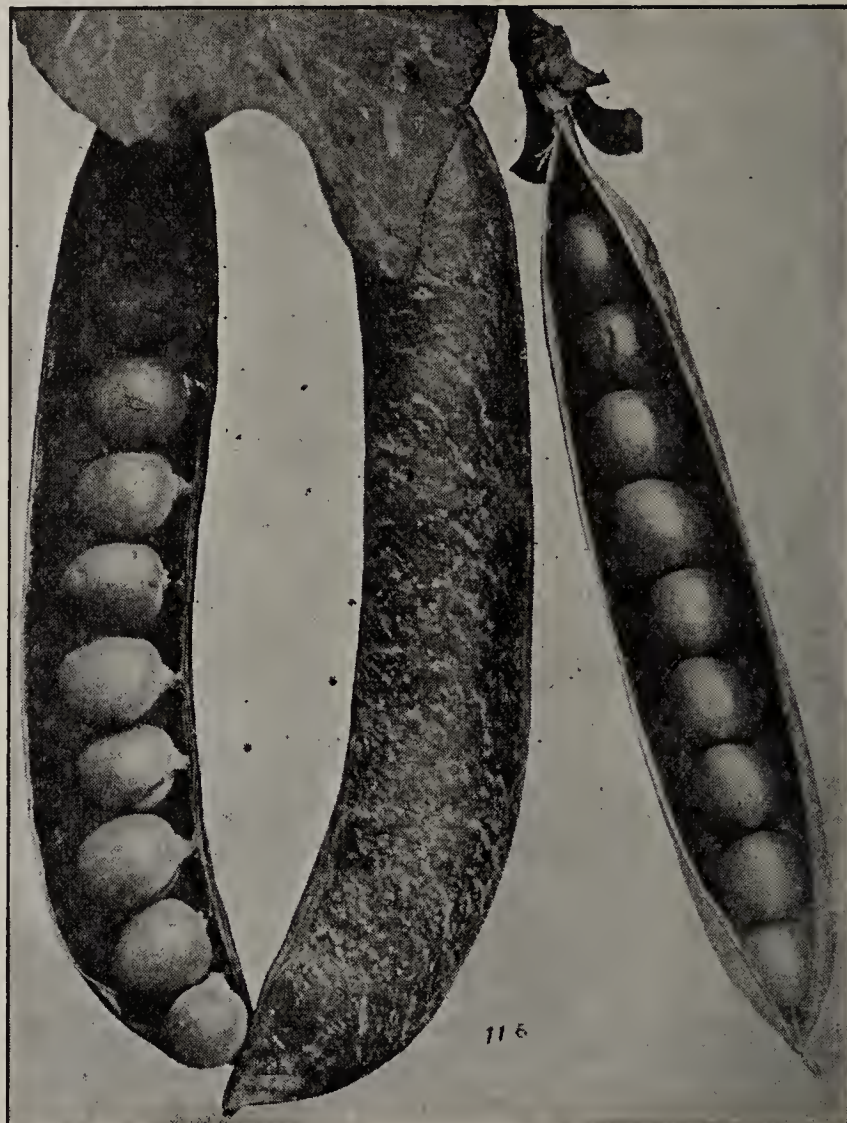

Tall Telephone Peas

MICHELL'S MAINE-GROWN SEED POTATOES

Pomme de Terre (Fr.); Kartoffel (Ger.); Patata (Ital.)

TIME OF SHIPMENT.—Potato shipping with us commences about March 15th (weather permitting), unless otherwise requested. We can ship at customer's risk any time during cold weather. **Plant 12 to 14 bushels per acre.**

Our potatoes are put up in sacks of 2½ bushels each.

Beats Them All (Michell's). This famous variety has given the best results wherever tried, yielding more than any other early potato; quality fine; extremely early, coming in about one week or ten days earlier than Early Rose. Oblong in shape.

Early Rose (Houlton or Maine). A leading variety for earliness, quality and productiveness; pink skin, oblong shape.

Green Mountain. An excellent general crop variety; white, roundish flat.

Irish Cobbler. A splendid sort, almost round in shape.

Jersey Red Skin. These are especially adapted for planting in light, sandy soil late in June and in early July. They are oval shaped, medium size and cook pure white.

Russet. A splendid late variety, claimed to be absolutely rust and blight proof; medium size, oval or flat in shape.

Prices on Seed Potatoes are established about March 1st.

SWEET POTATO PLANTS (Ready in May)

Yellow and Red Nansemond. Per 100, 75c. (by parcel post, 90c.); \$5.00 per 1000. Not less than 100 plants of a variety can be furnished.

We regret we cannot supply tubers of sweet potatoes.

CONCAVE POTATO KNIFE

Made of best steel with concave blade. Price, 25c. each.

SEMESAN BEL (Du Bay)

For treating seed potatoes before planting

Simply mix, dip, drain, dry and your seed potatoes are ready for planting; may be used on either whole or cut seed pieces; effectively controls such seed-borne disease organisms as scab, rhizoctonia and black-leg. By controlling these diseases, germination is generally increased, stand improved and the resulting crop bigger and of better quality. One pound treats 16 to 20 bushels of seed. Per 4 oz., 50c.; \$1.75 per lb.; 5 lbs., \$8.00; \$31.25 per 25 lbs.; 100 lbs., \$120.00.

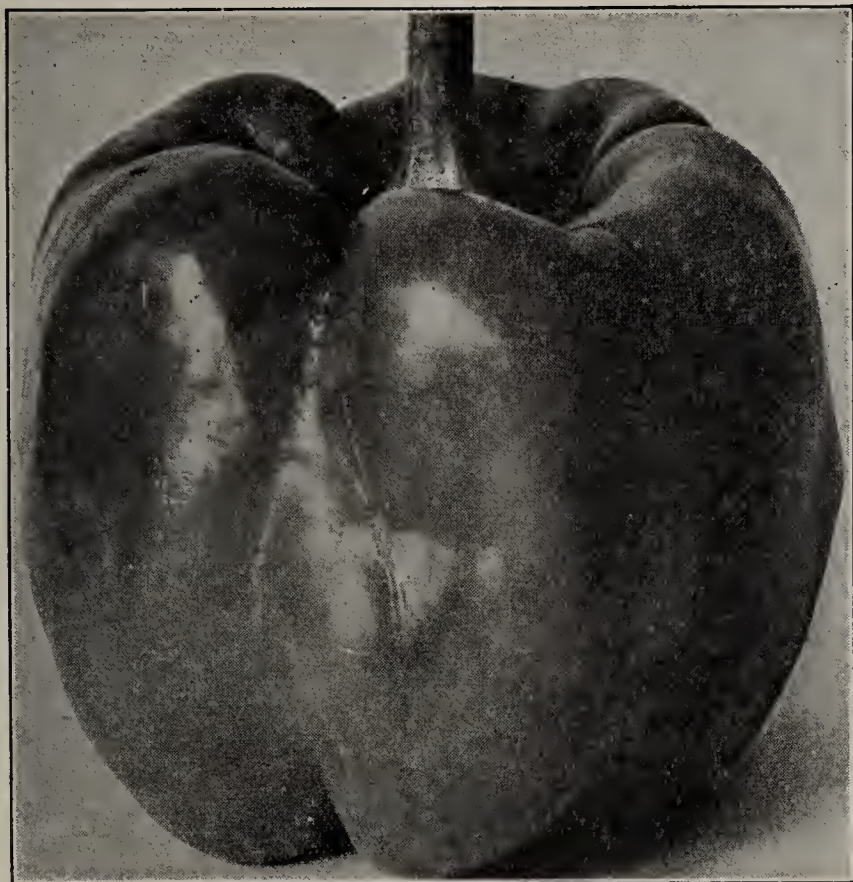

Harris' Early Giant Pepper

PEPPER

Piment (Fr.); Pfeffer (Ger.); Peperone (Ital.).

One ounce produces about 1200 plants.

Sow the seed in a hotbed or window box about March 1st. Transplant to the open ground when all danger from frost is over, in rows 3 feet apart, 18 inches apart in the row.

Bell or Bull Nose. One of the earliest varieties and very hardy; plants sturdy and produce great numbers of green fruit, turning later to vivid scarlet; flesh fairly thick and slightly hot or pungent. Pkt., 10c.; 25c. per 1/2 oz.; oz., 40c.; \$1.25 per 1/4 lb.

California Wonder. A new variety of great merit; glossy green turning later to vivid red; the flesh is thick and can be eaten like an apple. Pkt., 10c.; 35c. per 1/2 oz.; oz., 60c.; \$2.00 per 1/4 lb.

Chinese Giant. A monster pepper; perfectly sweet, green fruit turning bright scarlet; matures late; fine for stuffed mangoes. Pkt., 10c.; 35c. per 1/2 oz.; oz., 60c.; \$2.00 per 1/4 lb.

Golden Dawn. A large yellow variety shaped like the Chinese Giant; very sweet. Pkt., 10c.; 40c. per 1/2 oz.; oz., 65c.; \$2.25 per 1/4 lb.

Harris' Early Giant. A new early variety of large size; deep green turning to red; flesh thick and of a sweet pleasant flavor. Pkt., 10c.; 35c. per 1/2 oz.; oz., 60c.; \$2.00 per 1/4 lb.

Long Red Cayenne. A long red variety; very hot and used principally for bunching with potherbs. Pkt., 10c.; 25c. per 1/2 oz.; oz., 45c.; \$1.50 per 1/4 lb.

Hungarian Wax. Golden yellow when young, turning later to scarlet; fruits about 2 1/2 inches in diameter and 4 to 5 inches long; very hot and used principally for pickling. Pkt., 10c.; 35c. per 1/2 oz.; oz., 65c.; \$2.25 per 1/4 lb.



Pepper, Red Chili

Neapolitan. Early, large size, thick meated, mild flavor, bright red when ripe. Pkt., 10c.; 25c. per 1/2 oz.; per oz., 45c.; \$1.25 per 1/4 lb.

Pimiento. A splendid uniformly shaped, sweet variety; green fruit changing to red when fully ripe. Pkt., 10c.; 25c. per 1/2 oz.; oz., 45c.; \$1.50 per 1/4 lb.

Red Chili. The small narrow red pods are very hot; used for seasoning. Pkt., 10c.; 30c. per 1/2 oz.; oz., 55c.; \$1.85 per 1/4 lb.

Ruby Giant. Very large; adapted for stuffing; mild flavor. Pkt., 10c.; 25c. per 1/2 oz.; oz., 45c.; \$1.60 per 1/4 lb.

Ruby King. From 5 to 6 inches long and about 3 inches in diameter; green turning to red as they mature; flesh fairly thick and mild in flavor. Pkt., 10c.; 30c. per 1/2 oz.; oz., 50c.; \$1.50 per 1/4 lb.

Tomato, or Squash. Upright growth; fruit small and shaped like a tomato; mild flavor. Pkt., 10c.; 25c. per 1/2 oz.; oz., 45c.; \$1.60 per 1/4 lb.

World Beater. This variety is very similar to Ruby Giant, but grows slightly larger; very meaty. Choice seed, grown in New Jersey. Pkt., 10c.; 25c. per 1/2 oz.; oz., 45c.; \$1.60 per 1/4 lb.

PEPPER PLANTS (Ready in May)

Pot Grown Plants. Per doz., 75c.; \$6.00 per 100. Not available.

PENNYROYAL (Herb)

Pkt., 15c.; 45c. per 1/2 oz.; oz., 75c.

TESTIMONIAL

Aurora, Ill.

Enclosed is an order for seeds, overlooked in my last order. Your other seeds were 100 per cent.

P. Bullinger

NOTE—All seed offered on this page mailed free at quoted prices.



Pepper, World Beater

MICHELL'S PUMPKINS

Potiron (Fr.); Kurbis (Ger.); Zucca (Ital.)

One ounce will plant 25 to 50 hills; 4 to 5 lbs. for an acre.

Plant any time after the ground has become permanently warm, about four seeds to the hill, the latter to be about 8 feet apart each day. To obtain strong vines, they may be pinched back somewhat and if large specimens are desired, leave but one or two pumpkins on a vine. Do not plant near other vine crops, as they may hybridize the latter and spoil the taste; they can also be planted among corn after the last working.

Connecticut or Common Field. Shape almost round; fruits produced in great abundance; flesh coarse and suitable only for stock feeding; color light yellow. Pkt., 10c.; 15c. per oz.; $\frac{1}{4}$ lb., 35c.; \$1.00 per lb.

Japanese Pie. A crook-necked variety; deep green with darker stripes, which turn to a rich golden yellow. The fruit sets and matures early. The name given to it is derived from the seed, which is curiously marked like Japanese letters of the alphabet. Pkt., 10c.; 20c. per oz.; $\frac{1}{4}$ lb., 50c.; \$1.50 per lb.

King of the Mammoths. This variety grows to an enormous size; orange-salmon skin, bright yellow flesh, fine grained and of excellent quality for pies. Pkt., 10c.; 20c. per oz.; $\frac{1}{4}$ lb., 60c.; \$2.00 per lb.

Large Cheese. A very large, flat ribbed fruit, of a beautiful, buff yellow color; the interior is of fine quality. An enormous producer; ideal for market, home gardens and canning purposes. Pkt., 10c.; 15c. per oz.; $\frac{1}{4}$ lb., 35c.; \$1.00 per lb.

Mammoth Cashaw or Golden Crook Neck. Very meaty, suitable for pie or stock feeding purposes; flesh golden yellow and very tender. Pkt., 10c.; 15c. per oz.; $\frac{1}{4}$ lb., 45c.; \$1.50 per lb.

NOTE—All seeds on this page sent postpaid at quoted prices.



Pumpkin, King of the Mammoths

Tennessee Sweet Potato. An oblong-shaped, medium-sized fruit, with a very light buff yellow skin. For pies it is delicious, while for cooking for table use it is dry and tasty. Pkt., 10c.; 15c. per oz.; $\frac{1}{4}$ lb., 45c.; \$1.50 per lb.

Winter Luxury. Known as the New England pie pumpkin. The skin is a russet yellow, while the flesh is golden orange when ripe. This is also used for making Jack-o-Lanterns, for which purpose it is well suited, on account of its very round and symmetrical shape. Pkt., 10c.; 15c. per oz.; $\frac{1}{4}$ lb., 45c.; \$1.50 per lb.

Pumpkin Seed for medicinal purposes, 40c. per lb.

PEANUTS

Arachide (Fr.); Erdnuss (Ger.); Cece de terra (Ital.)

One bushel nuts unshelled will plant an acre, but shell must be removed beforehand.

It is generally believed peanuts cannot be grown anywhere north of Virginia, but this is a mistake; most any well-drained garden soil suits them, where they will yield a big crop. The peanut plant rather enriches the soil instead of impoverishing it, as it is an abundant gatherer of free nitrogen.

Selected Virginia. $\frac{1}{2}$ lb., 20c.; 35c. per lb.; 5 lbs., \$1.50; \$2.50 per 10 lbs.



RHUBARB

Rhubarbe (Fr.); Rhabarber (Ger.); Rabarbaro (Ital.)

One ounce will sow a row 125 feet long.

Seed should be sown early in the Spring, in shallow drills 1 foot apart; thin out to stand 4 to 5 inches apart in the row. In the Fall or following Spring the roots should be transplanted into permanent beds and placed 3 feet apart each way; the year following that, or two years after sowing the seed, the rhubarb may be used. Roots may be planted in the Spring up to May 15th.

Victoria. Immense long stalks of a cherry-red color; a most popular variety. Pkt., 10c.; 30c. per oz.; $\frac{1}{4}$ lb., 85c.



Rhubarb

RHUBARB ROOTS

Ready April 1st for Spring planting; October 1st for Fall planting.

Victoria. 3 for 50c. (by parcel post, 60c.); \$1.50 per doz. (by parcel post, \$1.75); per 100, \$10.00.

Radis (Fr.); Radies (Ger.); Ravanelli (Ital.)

One ounce of seed will sow a row about 75 feet long; 8 to 10 lbs. are required for an acre.

Radishes should be sown in good rich ground, where they can make rapid growth, for then only do they produce the best results. Early sowings can be made as soon as frost is out of the ground. The Winter radishes are sown in July and are developed by Autumn, at which time they may be taken up and stored in a cool cellar and covered with sand.

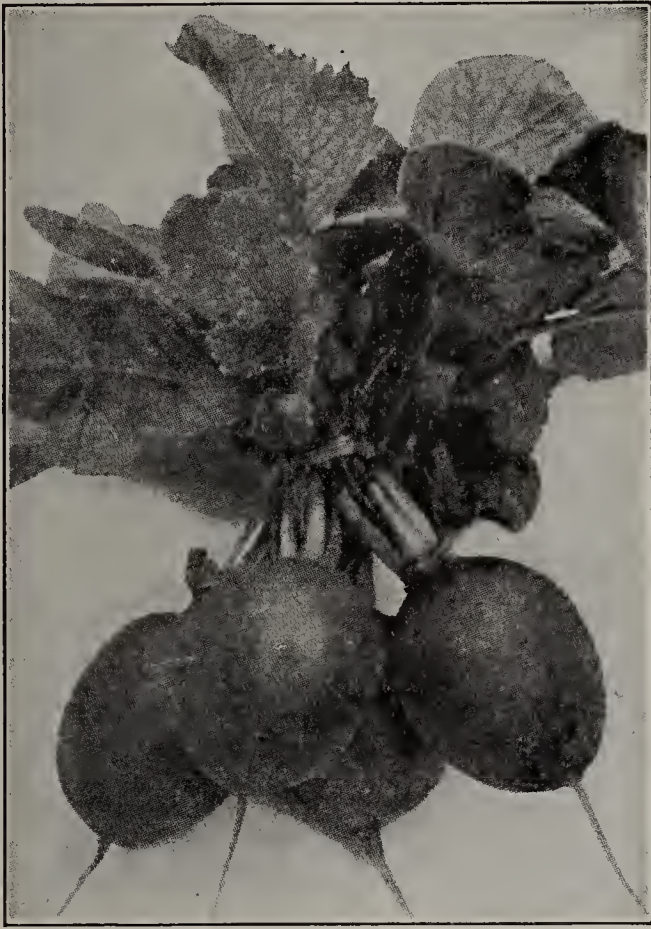

Radish, Early Scarlet or Cardinal Globe

EARLY VARIETIES

Crimson Giant. Early, globe shaped and of large size; crisp, solid flesh; remains a long time without getting pithy. Pkt., 10c.; 20c. per oz.; $\frac{1}{4}$ lb., 45c.; \$1.50 per lb.

Early Scarlet or Cardinal Globe (For outside sowing). This popular radish will be welcomed readily in an improved form. The color and shape, a vivid scarlet oval form, are perfect. Pkt., 10c.; 15c. per oz.; $\frac{1}{4}$ lb., 40c.; \$1.25 per lb.

Early Scarlet Globe (Short Top, Special Forcing). A popular variety for hotbed or greenhouse; also valuable for outdoor planting, very early, crisp and mild. Pkt., 15c.; 30c. per oz.; $\frac{1}{4}$ lb., 75c.; \$2.25 per lb.

French Breakfast. Oblong shape; rapid grower; very mild and tender; of a beautiful scarlet color, tipped with white; good for open ground or forcing. Pkt., 10c.; 15c. per oz.; $\frac{1}{4}$ lb., 40c.; \$1.25 per lb.

Icicle. A magnificent white variety of fine taste; grows 3 $\frac{1}{2}$ to 4 in. long in 22 days. Valuable for forcing as well as for open ground. Pkt., 10c.; 15c. per oz.; $\frac{1}{4}$ lb., 40c.; \$1.25 per lb.

Long Scarlet Short Top. A favorite variety; long, bright scarlet with small top; excellent quality. Pkt., 10c.; 15c. per oz.; $\frac{1}{4}$ lb., 40c.; \$1.25 per lb.

Round Red or Button. One of the earliest varieties, maturing very quickly; splendid for hotbed or garden culture; flesh white, mild and tender. Pkt., 10c.; 15c. per oz.; $\frac{1}{4}$ lb., 40c.; \$1.25 per lb.

Philadelphia White Box. A selection of the old reliable White Box radish; more perfect form, producing shorter tops and does not have a tendency to grow long in shape. Pkt., 10c.; 15c. per oz.; $\frac{1}{4}$ lb., 40c.; \$1.25 per lb.

Scarlet Turnip, White Tipped. Fine early scarlet variety with white tip. Pkt., 10c.; 15c. per oz.; $\frac{1}{4}$ lb., 40c.; \$1.25 per lb.

SUMMER AND WINTER VARIETIES

Celestial, or White Chinese. Large size; pure white; excellent keeper. Pkt., 10c.; 20c. per oz.; $\frac{1}{4}$ lb., 45c.; \$1.50 per lb.

China Rose. Bright rose color; flesh firm; one of the best for Winter use. Half-long in shape with a scarlet blunt tip. Pkt., 10c.; 20c. per oz.; $\frac{1}{4}$ lb., 45c.; \$1.50 per lb.

Long Black Spanish. Of large size; skin black, flesh white; very firm. Pkt., 10c.; 20c. per oz.; $\frac{1}{4}$ lb., 45c.; \$1.50 per lb.

White Strasburg. Oblong; of a pure white color and mild flavor; a splendid variety for Summer. Pkt., 10c.; 20c. per oz.; $\frac{1}{4}$ lb., 45c.; \$1.50 per lb.

ITALIAN ROCKET OR RUCOLA

Greatly relished in salads and quite tasty in soups; the leaves, which are of a dark green color, greatly resemble sorrel; slightly pungent, but flavor is distinct and appetizing. Pkt., 15c.; 45c. per oz.; $\frac{1}{4}$ lb., \$1.40.

ROSEMARY (Herb)

Pkt., 15c.; 40c. per $\frac{1}{2}$ oz.; oz., 75c.

RUTA BAGA. See page 75.

SAFFRON (Herb)

Pkt., 10c.; 30c. per $\frac{1}{2}$ oz.; oz., 50c.

SAGE (Herb)

Pkt., 10c.; 25c. per $\frac{1}{2}$ oz.; oz., 40c.

All seeds on this page mailed post free at prices quoted.

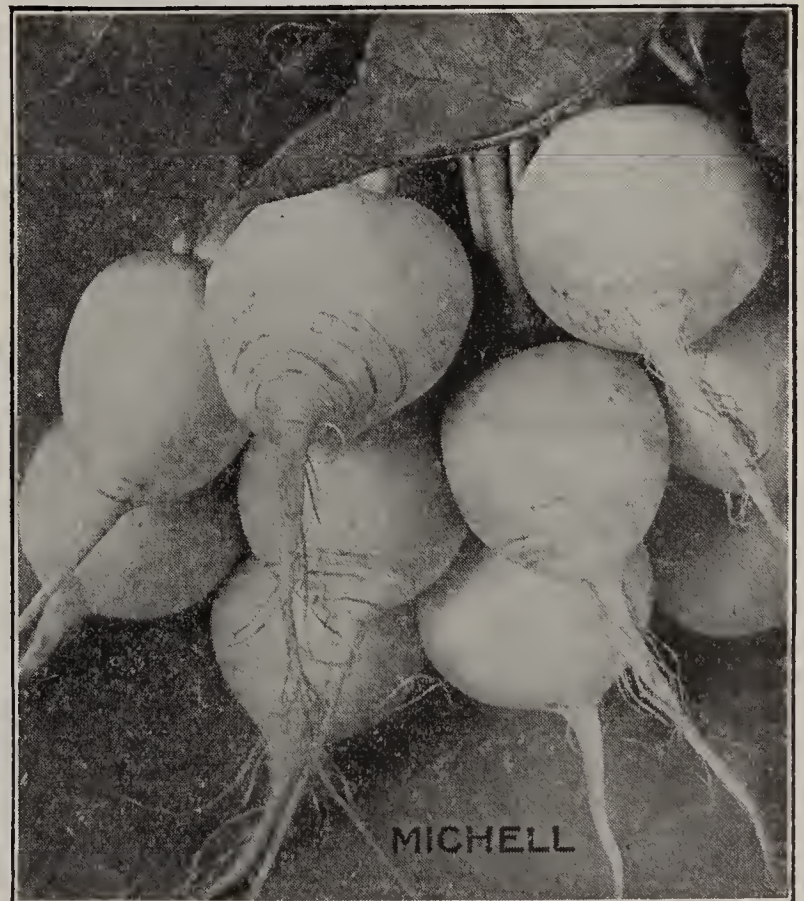

Radish, Philadelphia White Box



SALSIFY (Oyster Plant)

Salsifis (Fr.); Hafer Wurzel (Ger.); Salsafia (Ital.)

One ounce of seed to 50 feet of drill; 10 lbs. per acre.

Sow in early Spring, in drills fifteen inches apart and one to two inches deep; when about 4 inches high, thin to three inches apart. Soil should be deep and mellow in order that the root may grow straight down. Store same as carrots for Winter use, or they can be left in the ground until Spring.

Mammoth Sandwich Island. Of enormous size, very tender and delicious. Pkt., 10c.; 25c. per oz.; $\frac{1}{4}$ lb., 75c.; \$2.75 per lb.

SAVORY (Herb)

Summer. Pkt., 10c.; 25c. per $\frac{1}{2}$ oz.; oz., 40c.

Winter. Pkt., 10c.; 35c. per $\frac{1}{2}$ oz.; oz., 60c.

SHALLOTS See page 65.

SORREL

Oseille (Fr.); Sauerampfer (Ger.); Acetosa (Ital.)

Broad Leaved French. Relished principally by the French people, who use it as a spinach dressing, also as a salad; has an acid flavor. Sow seed in the Spring in good light soil in shallow drills 1 foot apart; thin out to 4 inches apart in the row. The seed stalks should be cut off when they appear. Pkt., 10c.; 20c. per oz.; $\frac{1}{4}$ lb., 65c.; \$2.00 per lb.

TESTIMONIAL

Paris, France

I wish to acknowledge your letter of March 21st and the package of seeds, etc., which came in due time and in good condition. Thank you for your prompt attention in filling my order.

Lucie Holt Le Son



Spinach, New Zealand

SPINACH

Epinard (Fr.); Spinat (Ger.); Spinaccio (Ital.)

One ounce will sow a row about 75 feet long; 10 to 12 pounds are required for an acre.

Sow for Spring use, in drills one foot apart (covering the seed about one-half inch) as early as the ground can be worked and continue to sow every two weeks till May 15th. Spinach seed seldom germinates during June, July or August, so we do not recommend sowing again until September, which is the season to provide an early Winter and Spring crop. On the approach of cold weather cover with long manure, straw or other litter. Spinach can also be grown successfully under hotbed sash.



Spinach, Bloomsdale Long Standing Savoy

Bloomsdale Long Standing Savoy. The long standing characteristics of this variety make it valuable for Spring sowing; it will stand considerable heat before bolting to seed, the leaves are thick, crimped and fleshy. 10c. per oz.; $\frac{1}{4}$ lb., 25c.; 65c. per lb.; 5 lbs., \$3.00; \$5.50 per 10 lbs.

King of Denmark. A new and remarkable variety; stands a long while without running to seed; large yielder and of excellent quality. The leaves are large, rounded, slightly blistered and deep green. 10c. per oz.; $\frac{1}{4}$ lb., 25c.; 65c. per lb.; 5 lbs., \$3.00; \$5.50 per 10 lbs.

Long Season. Large plants and leaves, which are strong, robust and crinkled; will resist a great deal of heat without shooting to seed. 10c. per oz.; $\frac{1}{4}$ lb., 25c.; 60c. per lb.; 5 lbs. for \$2.75; \$5.00 per 10 lbs.

Market Gardeners. This variety is the highest perfection of the Spinach family, a decided improvement on all other kinds. Leaves broad, heavy and of a dark green, glossy color, heavily blistered; will stand a week or ten days longer without shooting to seed than any variety we know of. 10c. per oz.; $\frac{1}{4}$ lb., 25c.; 65c. per lb.; 5 lbs., \$3.00; \$5.50 per 10 lbs.

New Zealand. This variety endures heat and drought; excellent for Summer use; leaves small and thick. Heavy yielder, growing upright; one sowing can be picked from throughout the entire Summer. A very distinct variety. In order to get a successful germination of seed, it should be soaked in warm water for about 12 hours before sowing. Do not confuse this variety with other sorts, as the seed should be sown about May 15th. Pkt., 10c.; 15c. per oz.; $\frac{1}{4}$ lb., 35c.; \$1.00 per lb.

All seeds on this page mailed postpaid at prices quoted.



Squash, Mammoth White Bush

SQUASH

Courge (Fr.); Kurbis (Ger.); Zucca (Ital.)

One ounce will plant 20 to 50 hills, 3 to 4 lbs. for one acre.

This vegetable is a popular one for Summer and Winter use and being susceptible to cold it should not be planted until the ground is thoroughly warm. The bush sorts should be planted in hills 4 to 5 feet apart each way; the running varieties 8 to 12 feet apart. Place 8 to 10 seeds in a hill, and when the third stage of leaves are set, thin out to about 4 plants in a hill.

SUMMER VARIETIES

Cocozelle or Italian. A bush variety with long, smooth fruits, dark green, striped lighter; elegant for slicing and frying as you do eggplant. Pkt., 10c.; 20c. per oz.; ¼ lb., 45c.; \$1.50 per lb.

Giant Yellow Summer Crookneck. Shaped like a club with a bent neck. The skin is very rough and warted and of an orange yellow color. This is a running variety. Pkt., 10c.; 20c. per oz.; ¼ lb., 45c.; \$1.50 per lb.

Large Yellow Bush. An improvement on the Golden Custard variety, at least 4 to 5 days earlier and of much finer quality; of scalloped type, beautiful creamy color; ready for the table in about 95 days. Pkt., 10c.; 15c. per oz.; ¼ lb., 35c.; \$1.25 per lb.

Mammoth White Bush. Of round scalloped form with an ivory white skin; has an abundance of meat of very fine flavor; one of the earliest to mature and is very prolific. Pkt., 10c.; 20c. per oz.; ¼ lb., 45c.; \$1.50 per lb.

Zucchini. An Italian variety of the Cocozelle type; fruits 12 to 14 inches long; skin green, mottled yellow when matured; delicious flavor. Pkt., 10c.; 20c. per oz.; ¼ lb., 45c.; \$1.50 per lb.

SWISS CHARD

Dark Green Curled. Pkt., 10c.; 15c. per oz.; ¼ lb., 35c.; \$1.20 per lb.

Giant Lucullus. Pkt., 10c.; 15c. per oz.; ¼ lb., 40c.; \$1.25 per lb. See page 53.

SWEET BASIL (Herb)

Used for soups and stews. Pkt., 10c.; 25c. per ½ oz.; oz., 40c.

SWEET MARJORAM (Herb)

Leaves and shoots are used for seasoning. Pkt., 10c.; 30c. per ½ oz.; oz., 50c.

TARRAGON

Fine for flavoring. Pot-grown plants 4 for \$1.00 (by parcel post, \$1.10); \$2.50 per doz.; per 100, \$18.00.

THYME (Herb)

For sauces and dressings. Seed. Pkt., 15c.; 40c. per ½ oz.; oz., 75c.; \$2.60 per ¼ lb.

THYME PLANTS

Pot grown. 6 for \$1.00 (by parcel post, \$1.15); \$1.50 per doz.; per 100, \$10.00.

FALL AND WINTER VARIETIES

Blue Hubbard. A new variety and a selection from the original Hubbard. The fruit is of a gray blue color; grows large, is a remarkably good keeper and of excellent quality. Pkt., 10c.; 20c. per oz.; ¼ lb., 65c.; \$2.25 per lb.

Boston Marrow. Shaped similar to Hubbard; color, golden orange; fine for canning for Winter use, cooked as a vegetable or in pie. Pkt., 10c.; 15c. per oz.; ¼ lb., 35c.; \$1.25 per lb.

Delicious. Well named, as it has the finest flavor of any squash; of oblong shape, with deep green skin and thin rind, and with a very small seed cavity. One of the best Winter keepers. Pkt., 10c.; 20c. per oz.; ¼ lb., 45c.; \$1.50 per lb.

Golden Hubbard. Used extensively for pie, but served as a vegetable, it is very dry and delicious; outside deep orange red. Pkt., 10c.; 20c. per oz.; ¼ lb., 50c.; \$1.75 per lb.

Hubbard (True). Fruits large, olive-shaped, with dark green skin and rich flesh; fine quality; excellent keeper. Pkt., 10c.; 20c. per oz.; ¼ lb., 50c.; \$1.75 per lb.

Vegetable Marrow. A long, greenish white variety; fine for cooking; sweet and tender. A favorite squash with the English people. Pkt., 10c.; 15c. per oz.; ¼ lb., 35c.; \$1.25 per lb.



Squash, Boston Marrow

TOBACCO

Many people like to have a few plants of this in the garden; it attracts butterflies. The flower is very sweet scented, while the leaves may be dried, cured and made into smoking tobacco and cigars. Sow in a box indoors and set outdoors in May.

	Pkt.	½ oz.	Oz.
Connecticut Seed Leaf.....	\$0.10	\$0.25	\$0.45
Havana.....	.10	.30	.50
Pennsylvania Seed Leaf.....	.10	.25	.45

All seeds (not plants) on this page sent postpaid at prices quoted.

MICHELL'S SELECT TOMATO SEED

Pomme d'Amour (Fr.); Liebsapfel (Ger.); Pomo d'oro (Ital.)

One ounce will produce 3500 plants; $\frac{1}{4}$ lb. will provide enough plants for an acre.

Sow in the house or hotbed about March 1st; transplant when 3 inches high and again later to produce vigorous specimens. Set plants outdoors about May 1st in rows 3 feet apart, 18 inches in the row, or in hills 4 feet apart each way. Properly grown tomato plants should be supported. **Note.**—All seeds on this page mailed postpaid at prices quoted.

Beauty. One of the largest purplish pink varieties; solid and meaty. Pkt., 10c.; 25c. per $\frac{1}{2}$ oz.; oz., 40c.; \$1.25 per $\frac{1}{4}$ lb.

Bonny Best. One of the most prolific of early tomatoes; the size is not so large, but is very solid and evenly formed; color, bright red. Pkt., 10c.; 25c. per $\frac{1}{2}$ oz.; oz., 40c.; \$1.25 per $\frac{1}{4}$ lb.

Break O'Day. A development of the U. S. Dept. of Agriculture and a disease resistant variety; the vines being of open habit, permits the sun to ripen the fruit much earlier than some varieties; globular in shape, large, smooth, meaty and of a good red color. Pkt., 10c.; 30c. per $\frac{1}{2}$ oz.; oz., 50c.; \$1.75 per $\frac{1}{4}$ lb.

Chalk's Early Jewel. Extra early, bright red, fine flavor, very productive. 10c. per pkt.; $\frac{1}{2}$ oz., 25c.; 40c. per oz.; $\frac{1}{4}$ lb., \$1.25.

Crimson Cushion or Beefsteak. A vigorous grower, producing immense solid fruits, suitable for slicing or canning; very meaty. Pkt., 10c.; 35c. per $\frac{1}{2}$ oz.; oz., 60c.; \$1.85 per $\frac{1}{4}$ lb.

Dwarf Champion. The plant looks like a miniature tree; dwarf and compact; red with a purplish cast; solid; late maturer. Pkt., 10c.; 30c. per $\frac{1}{2}$ oz.; oz., 50c.; \$1.75 per $\frac{1}{4}$ lb.

Dwarf Stone. A dwarf, compact plant; medium-sized, very solid fruit. Color, bright red; late cropper. Pkt., 10c.; 30c. per $\frac{1}{2}$ oz.; oz., 50c.; \$1.75 per $\frac{1}{4}$ lb.

Earliana (Penn State). One of the earliest bright red varieties; compact in growth, good yielder, fruit solid, uniform and of excellent quality. Pkt., 10c.; 25c. per $\frac{1}{2}$ oz.; oz., 45c.; \$1.50 per $\frac{1}{4}$ lb.

Early Detroit. A productive, early purple sort; large and smooth. Pkt., 10c.; 25c. per $\frac{1}{2}$ oz.; oz., 45c.; \$1.50 per $\frac{1}{4}$ lb.

Golden Ponderosa. The best large golden yellow variety; early, smooth and of excellent quality; similar in shape to the regular Ponderosa. Pkt., 15c.; 35c. per $\frac{1}{2}$ oz.; oz., 65c.; \$2.25 per $\frac{1}{4}$ lb.

Golden Queen. Medium yellow fruit; very sweet, almost free from acid; splendid for preserving or for slicing. Pkt., 10c.; 30c. per $\frac{1}{2}$ oz.; per oz., 55c.; \$1.75 per $\frac{1}{4}$ lb.

Greater Baltimore. A main crop variety; fruit large and of a brilliant red color; ripens evenly to the stem. Pkt., 10c.; 25c. per $\frac{1}{2}$ oz.; oz., 40c.; \$1.30 per $\frac{1}{4}$ lb.

Italian Salad. A new variety from Italy for the American people; this fine red, plum-shaped salad tomato has become quite popular, due to the fact that it is practically free from acid, very few seeds and has a flavor all its own. When served in halves or quarters on a lettuce leaf with the usual fixings it makes a very attractive dish. The plant bears very profusely until frost. Pkt., 20c.; 60c. per $\frac{1}{2}$ oz.; oz., \$1.00.

John Baer. Produces fruit in clusters, of good size, a beautiful red in color and nearly round in shape. Pkt., 10c.; 25c. per $\frac{1}{2}$ oz.; oz., 40c.; \$1.25 per $\frac{1}{4}$ lb.

June Pink. A large variety; purplish red flesh; solid and of fine texture. Pkt., 10c.; 25c. per $\frac{1}{2}$ oz.; oz., 45c.; \$1.50 per $\frac{1}{4}$ lb.

Livingston's Globe, A smooth pink variety; medium early; fair size, solid, and meaty; fruit set in clusters of five to seven. Pkt., 10c.; 30c. per $\frac{1}{2}$ oz.; per oz., 50c.; \$1.75 per $\frac{1}{4}$ lb.

Marglobe (Usual Strain). A variety of special merit, the origin of which is credited to the U. S. Dept. of Agriculture, it is practically immune from the many tomato diseases; color, a handsome scarlet, making it a suitable variety for all purposes; an excellent variety to follow our Penn State Earliana. Pkt., 10c.; 30c. per $\frac{1}{2}$ oz.; oz., 55c.; \$1.75 per $\frac{1}{4}$ lb.

Marglobe (Special Strain). We offer in this special strain an extra fine selection of the originator's stock. Pkt., 20c.; 75c. per $\frac{1}{2}$ oz.; oz., \$1.25; \$3.25 per $\frac{1}{4}$ lb.

Matchless. Large red fruit; a general crop variety. Pkt., 10c.; 30c. per $\frac{1}{2}$ oz.; oz., 50c.; \$1.60 per $\frac{1}{4}$ lb.

Michell's Crackerjack. One of the best early tomatoes for the home garden; quite free from acid; rich red and produced in clusters. Pkt., 10c.; 35c. per $\frac{1}{2}$ oz.; oz., 60c.; \$2.00 per $\frac{1}{4}$ lb.

Oxheart. A main crop, pink fruited sort, popular in certain sections, due to its shape (that of a heart) and its great solidity; being a shy seeder, makes it very meaty; very little acid, quality fine; some of the fruits grow to an enormous size. See illustration, page 47. Pkt., 15c.; 45c. per $\frac{1}{2}$ oz.; oz., 85c.; \$3.00 per $\frac{1}{4}$ lb.



Tomato, Pritchard or Scarlet Topper

Ponderosa. The largest tomato in existence; a beautiful deep pink; rather uneven at times in shape. Pkt., 15c.; 35c. per $\frac{1}{2}$ oz.; per oz., 60c.; \$2.00 per $\frac{1}{4}$ lb.

Red Rock. One of the most solid varieties; of a brilliant red color; a fine one for the home or market garden. Pkt., 10c.; 25c. per $\frac{1}{2}$ oz.; per oz., 40c.; \$1.30 per $\frac{1}{4}$ lb.

Pritchard or Scarlet Topper (Usual Strain). An early variety, originated by the late Dr. Pritchard of the U. S. Dept. of Agriculture. Undoubtedly the best of all recent introductions; the shape and outside color compare favorably with Break O'Day; the inside color is darker red; a good canning sort, as well as a fine variety for slicing. Pkt., 10c.; 35c. per $\frac{1}{2}$ oz.; oz., 60c.; \$1.85 per $\frac{1}{4}$ lb.

Pritchard or Scarlet Topper (Special Strain). The seed of this strain is produced by our best local tomato grower and is superior to other strains. By constant selection, it has proven to be a few days earlier than our usual strain. Pkt., 15c.; 50c. per $\frac{1}{2}$ oz.; oz., 85c.; \$2.75 per $\frac{1}{4}$ lb.

Stone. An old-time favorite; large handsome red fruit with smooth skin; recommended for a main crop. Pkt., 10c.; 25c. per $\frac{1}{2}$ oz.; per oz., 40c.; \$1.30 per $\frac{1}{4}$ lb.

FORCING TOMATOES

	Pkt.	$\frac{1}{2}$ oz.	Oz.	$\frac{1}{4}$ lb.
Bides Recruit. Medium size, bright red.	\$0.20	\$0.35	\$0.60	
Comet. Deep scarlet; medium size.	.10	.35	.50	\$1.85
Lloyd Forcing. Red; very productive.	1.00	2.50	4.00	
Sutton's Perfection (Imported). Original pkt.,	\$1.25;	\$3.60		
for 3 pkts.				

SMALL FRUITED TOMATOES

Red Cherry.	Pkt., 15c.; 35c. per $\frac{1}{2}$ oz.; oz., 65c.
Red Peach.	Pkt., 15c.; 35c. per $\frac{1}{2}$ oz.; oz., 65c.
Yellow Plum.	Pkt., 15c.; 35c. per $\frac{1}{2}$ oz.; oz., 65c.
Strawberry or Husk.	Pkt., 15c.; 35c. per $\frac{1}{2}$ oz.; oz., 65c.

TOMATO PLANTS (Ready in April)

Pot Grown. Per doz., 75c.; \$5.50 per 100 (not mailable).

Herbst Ruben (Ger.); Navet (Fr.); Navone, Rapa (Ital.)

One ounce of seed for 100 feet of drill; two lbs. per acre, broadcast

For early use sow the small sorts as soon as the ground can be worked in the Spring in drills 14 inches apart. As the seed is fine it should be covered but slightly, except in very dry weather. Do not sow too thickly, so the roots can develop. For Fall and Winter use sow broadcast from the middle of July to the middle of August.



Turnips

TURNIP

- Aberdeen.** A globe-shaped yellow variety; a good Winter keeper. Pkt., 10c.; 15c. per oz.; ¼ lb., 35c.; \$1.00 per lb.; 5 lbs., \$4.50.
- Cow Horn.** A long white variety. Pkt., 10c.; 15c. per oz.; ¼ lb., 35c.; 85c. per lb.; 5 lbs., \$3.75.
- Early Purple Top Flat.** One of the most popular of the early varieties; root clear white, purple top; good quality. Pkt., 10c.; 15c. per oz.; ¼ lb., 35c.; \$1.00 per lb.; 5 lbs., \$4.50.
- Early White Flat Dutch (Strap Leaf).** An attractive variety, producing a medium size root; very early and of fine quality. Pkt., 10c.; 15c. per oz.; ¼ lb., 35c.; \$1.00 per lb.; 5 lbs., \$4.50.

- Japanese Foliage.** A two-purpose variety; the root or bulb as well as the top is edible; the top when cooked is very juicy; tender and of a mild turnip flavor. See illustration, page 47. Pkt., 10c.; 15c. per oz.; ¼ lb., 35c.; \$1.00 per lb.; 5 lbs., \$4.50.
- Purple Top White Globe.** Large root, skin purple at top, white at bottom; a good table and market variety. Pkt., 10c.; 15c. per oz.; ¼ lb., 35c.; \$1.00 per lb.; 5 lbs., \$4.50.
- Snowball.** A pure white globe variety; very early. Pkt., 10c.; 15c. per oz.; ¼ lb., 35c.; \$1.00 per lb.; 5 lbs., \$4.50.
- Southern Seven Top.** For Winter greens chiefly; extensively sown in the South. Pkt., 10c.; 15c. per oz.; ¼ lb., 35c.; 85c. per lb.; 5 lbs., \$3.75.
- Yellow Globe or Amber.** Shaped like the Purple Top Globe, but the color is like that of a Yellow Ruta Baga. Pkt., 10c.; 15c. per oz.; ¼ lb., 35c.; \$1.00 per lb.; 5 lbs., \$4.50.

RUTA BAGA

Ruta Bagas should be sown in drills about 30 inches apart and when 3 inches high thinned out to get the greatest root development. They need to be cultivated liberally and hilled up when about 6 inches high.

Customers frequently complain that Ruta Bagas grow too long in shape, rather than in a round form. Careful inquiry has developed the fact that this is caused by sowing the seed too early.

In the locality of Philadelphia and New York the seed should be sown from July 15th to August 1st. Seed sown earlier than this invariably produces the long shaped roots with long stems.

American Purple Top Yellow (Special Strain). This strain is at least 8 to 10 days earlier than our usual strain; the roots are mostly round with a small tap root, yellow in color, with purple crown; flesh amber colored, sweet and free from fiber; tops medium size and of a smoky green color. This strain is of very rapid growth; seed can be sown much later than other strains and yet develop a large root before freezing weather. Pkt., 15c.; 35c. per oz.; ¼ lb., \$1.00; \$3.50 per lb.

Purple Top Yellow (Usual Strain). Top is purple, the bottom yellow. It brings a high price when sold in the market on account of its shape. Pkt., 10c.; 15c. per oz.; ¼ lb., 35c.; \$1.00 per lb.; 5 lbs., \$4.50.

NOTE—All seed offered on this page mailed free at quoted prices.

SEEDS OF CULINARY AND MEDICINAL HERBS

There is an increasing interest in herbs today and Herb Gardens are becoming quite popular; the majority of them are very easy to grow and therefore should be grown more extensively than they are.

For Winter use, they should be cut just as they come into flower, tied in bunches and hung in a light, airy place indoors, where they can be available any time.

	Pkt.	½ oz.	Oz.		Pkt.	½ oz.	Oz.		Pkt.	½ oz.	Oz.
Anise.....	\$0.10		\$0.35	Dill (¼ lb., 75c.).....	\$0.10		\$0.25	Saffron.....	\$0.10	\$0.30	\$0.50
Basil, Sweet.....	.10	\$0.25	.40	Fennel, Sweet.....	.10		.25	*Sage.....	.10	.25	.40
Borage.....	.10		.30	Finocchio, or Flor- ence Fennel.....	.10		.25	Savory, Summer.....	.10	.25	.40
Caraway.....	.10		.25	*Lavender.....	.10		.45	*Savory, Winter.....	.10	.35	.60
*Catnip.....	.20			*Mint, Peppermint...25			Sweet Marjoram.....	.10	.30	.50
*Chamomile.....	.10	.25	.45	*Pennyroyal.....	.15	\$0.45	.75	*Thyme. Broad leaved.	.15	.40	.75
*Chives.....	.15	.35	.60	*Rosemary.....	.15	.40	.75	*Varieties are hardy or perennial, while others must be sown each season.			
Coriander.....	.10		.25								

COLLECTIONS OF HERBS

In order to meet the demand for a few of the most popular varieties in annual and perennial sorts we offer the following collections:

ANNUALS

- Anise
 - Caraway
 - Coriander
 - Summer Savory
 - Sweet Basil
 - Sweet Marjoram
- One pkt. each of the 6 varieties, for 50c.

PERENNIALS

- Chives
 - Mint
 - Rosemary
 - Sage
 - Thyme
 - Winter Savory
- One pkt. each of the 6 varieties, for 75c.



VEGETABLE AND HERB PLANTS AND ROOTS

We have fresh supplies of this stock in daily, during the season of planting; we grow them at our own nurseries, and in extra good quality.

ARTICHOKES (Ready in April)

Green Globe. Pot Grown. \$1.50 per doz.; 25 for \$3.00; \$10.00 per 100 (by express only).

Jerusalem. Used for table and stock feeding. 20c. per lb. (by P. P., 30c.); 75c. per 5 lbs. (by P. P., 90c.); 10 lbs., \$1.20 (by P. P., \$1.40); \$2.75 per 25 lbs.; 50 lbs., \$4.50.

ASPARAGUS ROOTS (Ready about March 20th)

The two-year-old-roots usually produce two years after planting; our stock is especially fine in quality.

2-Year-Old Roots	50	100	1000
Palmetto or Eclipse	\$.70	\$1.25	\$10.00
Giant Washington	.85	1.50	12.00

If above are wanted by parcel post add 10c. for 50; 15c. per 100 for postage.

BRUSSELS SPROUTS (Ready in July)

Matchless Improved (Hotbed Grown). 25 for 30c. (by P. P., 40c.); \$1.00 per 100 (by P. P., \$1.15); per 1000, \$6.50.

CABBAGE PLANTS

Early Sorts. From Hotbeds. Wakefield and All Head only. Ready April 15th. 75c. per 100 (by P. P., 85c.); per 1000, \$6.50.

Early Sorts. Cold frame plants. Ready April 1st. \$1.00 per 100 (by P. P., \$1.10); per 1000, \$8.50.

Late Sorts. Ready July 1st, in Late Flat Dutch, Danish Ball Head and Red Dutch Drumhead varieties only. Per 100, 75c. (by P. P., 85c.); \$5.50 per 1000.

CAULIFLOWER PLANTS

(Ready April 1st)

Snowball variety only. Pot-grown, 10c. each; doz., \$1.00; \$6.00 per 100. Not mailable.

CELERY PLANTS (Ready in July)

White Plume, Giant Pascal, Winter Queen and Golden Self Blanching. 75c. per 100 (by P. P., 90c.); per 1000, \$6.00.

CHIVES (Ready in April)

Strong Plants. 3 for 50c. (by P. P., 60c.); doz., \$1.50 (by P. P., \$1.65); \$10.00 per 100.

EGG PLANTS (Ready after May 15th)

Pot-grown stock only.

New York Improved and Black Beauty. Per doz., 75c.; \$6.00 per 100. Not mailable.

HOP VINE (Hardy)

This makes a valuable shade plant, grown on arbors, trellises, etc.

Strong Pot-grown Plants. 4 for \$1.00 (by P. P., \$1.10); doz., \$2.50; \$18.00 per 100.

HORSERADISH ROOTS (Ready in March)

Maliner Kren (Bohemian). Large, strong cuttings, 25c. per doz. (by P. P., 35c.); per 100, \$1.35 (by P. P., \$1.50); \$9.00 per 1000.

LAVENDER (Ready in April)

Pot-grown plants, 4 for \$1.00 (by P. P., \$1.10); per doz., \$2.50; \$18.00 per 100.

LETTUCE PLANTS

Heading varieties; our selection only. 25 for 25c. (by P. P., 40c.); 75c. per 100 (by P. P., 95c.); per 1000, \$6.00.

MINT (Hardy) (Ready in April)

Peppermint **Spearmint**
Pot-grown plants. 3 for 50c. (by P. P., 60c.); per doz., \$1.50; \$10.00 per 100.

PARSLEY PLANTS (Ready in April)

Pot-grown. Per doz., \$1.00; \$7.00 per 100. Not mailable.

PEPPER PLANTS (Ready in May)

Bull Nose and Ruby King varieties only. Pot-grown plants. Per doz., 75c.; \$6.00 per 100. Not mailable.

RHUBARB ROOTS (Ready April 1st)

Victoria. 3 for 50c. (by P. P., 60c.); \$1.50 per doz. (by P. P., \$1.75); per 100, \$10.00.

ROSEMARY (Perennial) (Ready in April)

Pot-grown plants. 4 for \$1.00 (by P. P., \$1.10); doz., \$2.50; \$18.00 per 100.

SAGE (Hardy) (Ready in April)

Holt's Mammoth. Pot-grown plants. 6 for \$1.00 (by P. P., \$1.15); per doz., \$1.50 (by P. P., \$1.80); \$10.00 per 100.

SWEET POTATO PLANTS (Ready in May)

Yellow and Red Nansemond. 75c. per 100 (by P. P., 90c.); 1000, \$5.00. Not less than 100 plants of a variety can be furnished.

TARRAGON (Ready in April)

Hardy if given protection in Winter. Pot-grown plants. 4 for \$1.00 (by P. P., \$1.10); per doz., \$2.50; \$18.00 per 100.

THYME (Hardy) (Ready in April)

English Broad Leaved. This is almost an indispensable herb. Pot-grown plants. 6 for \$1.00 (by P. P., \$1.15); per doz., \$1.50; \$10.00 per 100.

TOMATO PLANTS (Ready after April 15th)

Pot-grown Plants in the following varieties only: **Crimson Cushion or Beefsteak, Earliana, Stone, Dwarf Stone, Ponderosa, Crack-erjack.** Per doz., 75c.; \$5.50 per 100. Not mailable.

NOTE—Mailing charges include packing costs and safe delivery or insurance. Also please note the smallest number or quantity of vegetable plants that can be supplied, is offered or specified here.



SPECIAL NOTICE

We regret that it is not practicable to ship Pot Grown Plants of Cauliflower, Pepper, Parsley, Egg Plants and Tomatoes via Parcel Post.

The foliage of these plants is very soft and tender and from experience (largely because of delays in the mail service) they reach their destination in a worthless condition.

Nor can we ship any of the above-mentioned plants outside the Beetle zone.

**Control Seed-borne Diseases of Farm and Garden Crops; Stimulate Germination—
Improve Stands; Generally Produce Increased Yields of Higher Quality**

NEW IMPROVED CERESAN

A new low cost grain disinfectant

Unusually effective in controlling burnt or stinking smut of wheat, covered smut and stripe of barley and oat smuts; frequently improves the stand and yield of grain 1 to 5 bushels per acre; seed should be treated 24 hours before planting. Does not reduce drilling rate nor damage drill. One pound treats 32 bushels of wheat, oats or barley.

Prices for New Improved Ceresan

1 lb.....\$0.75 | 5 lbs.....\$3.00

CERESAN (Regular)

Long a standard treatment for oats, barley, sorghums, millet, flax, peas, cotton and narcissus. Easy to apply, economical to use.

Prices for Ceresan (Regular)

1 lb.....\$0.75 | 25 lbs.....\$12.50
5 lbs.....3.00 | 100 lbs.....49.00

NEW IMPROVED SEMESAN JR.

for seed field and sweet corn

The New Improved Semesan Jr. formula is completely new and is the smoothest seed corn dust ever developed. Its use protects the seed from rotting in the ground and makes possible earlier planting which generally results in increased yields. Improved germination, better stands, control of certain diseases, increased yields are the benefits which thousands of farmers are reaping, *at a cost of less than 3c. an acre.*

Prices for New Improved Semesan Jr.

4 oz.....\$0.50 | 5 lbs.....\$7.00
1 lb.....1.50 | 25 lbs.....28.75
100 lbs.....\$110.00

NEW IMPROVED SEMESAN BEL

for seed white and sweet potatoes

Simply mix, dip, drain, dry and your seed potatoes are ready for planting. May be used on either whole or cut seed pieces; effectively controls such seed-borne disease organisms as scab, rhizoctonia and black-leg. By controlling these diseases, germination is generally increased, stand improved and the resultant crop bigger and of better quality. One pound treats 16 to 20 bushels of seed.

Prices for New Improved Semesan Bel

4 oz.....\$0.50 | 5 lbs.....\$8.00
1 lb.....1.75 | 25 lbs.....31.25
100 lbs.....\$120.00

SEMESAN

for flower and vegetable seeds, also for lawns

Semesan may be applied in dust or liquid form to the seed before planting. It is harmless to the seed but deadly to disease organisms that may be on the seed. Semesan is such a powerful and effective disinfectant that seed treatment with it is ridiculously low in cost, ranging from ¼c. to 1c. per pound of seed. One ounce treats 15 lbs. of seed. Effective in controlling damping off and such devastating gladiolus diseases as hard rot and scab. Also the most effective means of controlling "Brown Patch" which attacks the turf of golf courses, tennis courts and lawns.

Prices for Semesan

2 oz.....\$0.50 | 5 lbs.....\$11.75
1 lb.....2.50 | 25 lbs.....46.25
100 lbs.....\$180.00

DuBay Seed Disinfectants, like many agricultural chemicals, are poisonous in nature and owing to present Postal Regulations cannot be sent through the mails but must be sent by express or freight.

STIMUGERM

The Best Inoculation for All Legume Seeds Means Better Crops, Better Soils, Less Fertilizer Expense.

Alfalfa, Clovers, Soy Beans, Cow Peas, Vetch, Peanuts, all thrive into bumper crops when properly inoculated with STIMUGERM pure-bred cultures.

WHAT STIMUGERM JELLY IS

STIMUGERM JELLY is a pure culture of nitrogen fixing bacteria, selected for maximum vitality and ability to transform nitrogen from the air into soluble nitrates and deposit them in the soil.

EVERY BOTTLE IS DATED and guaranteed for one year.

PRICES

Alfalfa and Mixed Clovers

½ bu. unit.....\$0.35
1 bu. unit......65
2 ½ bu. unit.....1.40

SPECIAL SOY BEANS AND COW PEAS

1 bu. unit.....\$0.35
2 bu. unit......65
5 bu. unit.....1.40

VETCH, PEAS AND BEANS

1 bu. unit.....\$0.35
2 bu. unit......65
5 bu. unit.....1.40

Special Garden Size, for Garden Peas, Beans and Sweet Peas,

25c.

When ordering, be sure to state what crops you wish to inoculate, also number of bushels you will sow.

ANSUL FORMALDEHYDE DUST

For Controlling "Damping Off" of Flower and Vegetable Seedlings; also for dusting Potatoes and any grain seeds before planting

Treatment is safe, economical and easy to apply. No steam sterilization or seed treatment is necessary

Ansul Formaldehyde Dust is a seed and soil treating compound which controls seed-borne diseases and when applied to the soil controls "damping off" and other root rots of vegetable and floral seedlings. The sterilization of soil and seed with Formaldehyde is not new; in fact, it is one of the oldest disinfectants known. However, it is not easy to apply in the liquid form and, too, the method of treatment does not fit into the grower's program. The wetting of the soil and the long wait are undesirable. The Ansul Formaldehyde Dust treatment, the mixing of the soil and the planting of the seed are all one operation. It is also excellent for dusting potatoes and any grain seeds before planting to help control fungus diseases.

PRICE

1 lb. can.....\$0.75
5 lb. can.....2.00
25 lb. drum.....5.50

78 MICHELL'S SELECTED HAND PICKED FIELD CORN

Plant 8 to 10 qts. per acre in hills for shelled corn or for silo, or sow $1\frac{1}{2}$ to 2 bushels broadcast for fodder.

Our strains of corn are not the common kinds usually found in abundance on the market; we give very careful attention to selected stock, in all lines of farm seeds. This is particularly true of field corn where re-selection means the limit of crop with little or no increase in cost. Our stock is selected for size of ear and fodder, uniformity of kernel and the careful finish of the tip and butt, all of which means a considerable increase in production.

Champion White Pearl. An immense yielder, maturing in about 115 days; kernels deep set and snowy white; the merits of this corn are surprising.

Early Canada Flint (Eight Rowed). A medium broad grained variety, perfectly smooth on the end and very hard. Makes a desirable sort for late planting. The cobs are very thin when shelled; excellent for pigeon and poultry feed.

Golden Beauty. The broad, massive golden yellow dented grains are arranged very evenly on gigantic ears. Fodder is enormous, often growing 12 feet high; matures late, but yields wonderful crops; desirable for silo and ensilage purposes.

Improved Golden Dent. A high yielding variety of yellow dent noted for heavy production of both grain and silage. A hardy, resistant corn, producing a good ear on every stalk, with few nubbins. Ears large, rows straight, butts and tips well filled. Grains square cut, moderate in depth, with uniform dimpled dent, easily distinguishing it from other varieties. Fodder heavy and leafy, 10 to 12 ft. tall; on fertile soil capable of yielding 90 bushels shelled corn or 20 tons silage per acre.

Lancaster County Sure Crop. One of the best all-around general purpose varieties and has proved to be a most reliable and profitable corn for either husking or ensilage purposes. Grows quite tall; a sure cropper, producing a big ear on every stalk, very few nubbins; will yield good crops on land that is not so fertile; ears long, cob thin; top of grain rich yellow, when shelled the grain has a reddish yellow cast; matures early; husks very easily.

Leaming Early Dent. Beautiful long ears of deep, uniform kernels. The cob when shelled is very small. The stalks grow about 7 feet high, very leafy, excellent for fodder and on the average will produce two ears to the stalk; ripens in 90 days and occasionally crops 100 bushels to the acre.

Reid's Yellow Dent. A splendid late variety with an average record of 100 bushels per acre; small cob, deep bright yellow grain.

Price for any of the above varieties of Field Corn 20c. per qt. (by parcel post, 30c.); larger quantity, price on application.

BARLEY

The straw is good for green feed or when cured as hay. The grain in the hull is excellent poultry feed. If wanted for hay it should be cut while the grain-head is in a soft or milky condition. Sow broadcast $1\frac{1}{2}$ to 2 bushels per acre from May 15th to July 1st. 48 lbs. per bushel. Makes an ideal nurse crop for Spring sown Alfalfa, frequently yields 50 bushels per acre. 20c. per qt. (by parcel post, 30c.); larger quantity, price upon application.

BEANS, SOJA OR SOY

This valuable plant enriches the ground in which it is planted by the free nitrogen gathered from the air and which is deposited in the ground by the roots. Fodder is relished in either green or dry form by cattle. Sow $1\frac{1}{2}$ bushels per acre alone, or $\frac{1}{2}$ bushel Soja Beans with one bushel Cow Peas. Sow in drills $2\frac{1}{2}$ feet apart, any time from the first to the last of May. If wanted for silo it will be ready for harvest about the first of September, when the pods will be well filled; yields as high as 20 tons of green food per acre. 60 lbs. per bushel.

Mammoth Yellow (Late). 20c. per qt. (by parcel post, 35c.).

Wilson (Early). 20c. per qt. (by parcel post, 35c.); larger quantity, price upon application.

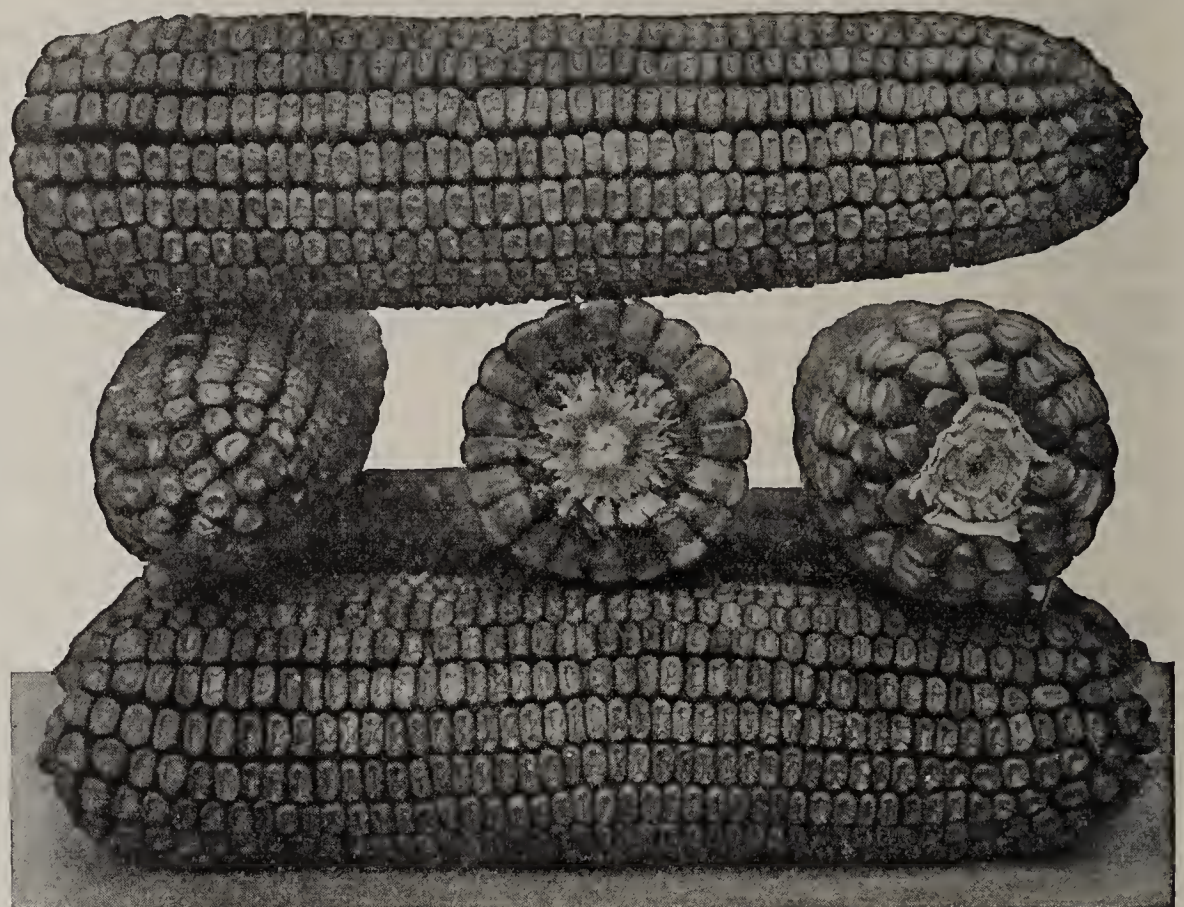

STANLEY'S CROW REPELLANT

Protects your corn during the period when it is most easily damaged, by ridding your crop of Crows, Pheasants, Black-birds and other corn pulling birds and animal pests; also protects seed from rotting in the ground; insures larger yields; is non-poisonous. Per $\frac{1}{2}$ pt., 60c.; \$1.00 per pt.; qt., \$1.75. One pint is sufficient for two bushels of seed corn.

For Corn Planters, see page 137.

BROOM CORN

Sow in May, about ten pounds per acre, in drills 3 feet apart. Plants should be thinned out to stand 3 inches apart in the row.

Evergreen. Produces extremely straight brush retaining its green color well after ripening, thus commanding the highest market prices. Yields 1000 lbs. of salable brush per acre. Bushel 50 lbs. 20c. per lb. (by parcel post, 30c.); larger quantity, price upon application.

BUCKWHEAT

Japanese. In the locality of Philadelphia this is sown any time from June 1st to July 15th, one bushel of 48 lbs. broadcast to the acre. Makes a very fine quality of flour and is also largely used for poultry food. Buckwheat frequently yields as much as 80 bushels to the acre. 15c. per qt. (by parcel post, 25c.); larger quantity, price upon application.

CORN, WHITE KAFFIR (for Seed)

The grain is used for feeding poultry and the fodder for cattle. Grows from 4 to 6 feet high, the grain being produced on the top of stalk in the shape of a brush; frequently as many as four heads of grain will be found on a single stalk. It usually ripens after the first few frosts; produces enormous crops. Can be sown as late as July at the rate of 10 lbs. per acre in drills. (Bu. 56 lbs.) 15c. per lb. (by parcel post, 25c.); larger quantity, price upon application.

Two bushel seamless sacks, used in shipping farm seeds, in one bushel lots and over, are charged for at 35c. each; returnable at price charged if in good condition and prepaid.



RECLEANED CLOVERS

Prices quoted are subject to market changes

Alfalfa or Lucerne (*Medicago-Sativa*). A valuable forage crop. Sow during May, August and September, for best results, although it can be sown at other times with a possible chance of doing well. Sow not less than $\frac{1}{2}$ bushel (30 lbs.) per acre, preferably with no other crop. Our seed is always over 99 per cent pure, and will invariably give the best results. Our Special Instructions on growing Alfalfa is free for the asking. **Choice Non-Irrigated Western Grown Seed.** 35c. per lb. (by parcel post, 45c.).

Grimm Alfalfa. Claimed to be hardy in any and all regions; a heavy yielder and of deep rooting ability. It requires about 15 to 20 lbs. of Grimm Alfalfa to properly seed an acre. 45c. per lb. (by parcel post, 55c.).

Alsike or Swedish Clover (*Trifolium Hybridum*). One of the best for mixing with timothy; perfectly hardy in every climate or soil condition; grows from 1 to 2 feet high; sow early in the Spring or late Summer and early Autumn, 10 to 15 lbs. per acre alone, or 8 lbs. per acre with Timothy. 30c. per lb. (by parcel post, 40c.).

Bokhara or Sweet Clover (*Melilotus Alba*). While extensively used as a bee food, this is a valuable variety for soiling (green manure); for sowing in Spring on lands which are later to be sown in Alfalfa, this is excellent. It grows from 3 to 5 feet high, according to soil and location; can be cut as often as three times in a season if wanted for forage. Sow 15 lbs. per acre in early Spring, alone, or 10 lbs. per acre with other crops. We handle only the true white flowering hardy variety. **Choice Hulled Seed.** 15c. per lb. (by parcel post, 25c.).

Crimson Clover (*Trifolium Incarnatum*). Used principally for soiling or green manuring. If desired for feed, cut it just before it flowers. When desired for green manure, it should be allowed to mature; its height is from 1 to 2 feet. Sow any time from April to October, the earlier the better, 20 lbs. to the acre. If sown in early Spring it can be plowed down the first year. Late Summer or Fall seeding is usually practiced. It is not hardy for more than one season and must be sown each year. 20c. per lb. (by parcel post, 30c.).

Mammoth Red Clover (*Trifolium Pratense Perenne*). Sometimes called Sapling or Pea Vine Clover and English Cow Grass. This differs from the "Medium," being of a ranker growth and yielding more fodder per acre. Sow in early Spring or in July and August, using 20 lbs. per acre alone, or with other crops 10 lbs. per acre. It can be cut several times in a season. 30c. per lb. (by parcel post, 40c.).

Red Clover, Medium (*Trifolium Pratense*). More widely known and used than any other; used principally for hay purposes. Height from 18 inches to 2½ feet. Sow early in the Spring or in late Summer—July and August; if alone, 20 lbs. per acre; if with other crops, 10 lbs. per acre. A red clover field can be cut twice a season. 25c. per lb. (by parcel post, 35c.).

White Dutch or Lawn Clover (*Trifolium Repens*). This is valuable for pasturage as well as for lawns; it succeeds where other clovers and grasses fail and it seldom dies out. It can be sown at all seasons, although early Spring is best. Sow 10 to 12 lbs. per acre if alone, or 5 lbs. if sown on old turf or with other crops. Per oz., 10c.; 25c. per $\frac{1}{4}$ lb.; $\frac{1}{2}$ lb., 40c.; 75c. per lb. (by parcel post, 85c.); 5 lbs., \$3.50 (by parcel post, \$3.65); \$6.75 per 10 lbs. (by parcel post, \$6.95); 25 lbs., \$16.25; \$63.00 per 100 lbs.

Prices on Clovers (excepting White Dutch), for quantities larger than 5 lbs., will be quoted on request.

CANADIAN FIELD PEAS

These are used for various purposes, chief among them being a very early green food; when used this way they are sown with oats about April 1st at the rate of 1½ bushels of Peas and 1½ bushels of Oats to the acre either drilled or broadcast. They may be sown successively up to July if one has the available land. Peas may also be sown alone at the rate of 3 bushels per acre and furnish excellent hay. The dried peas are extensively fed to pigeons, while when ground as meal are an excellent addition to the regular soft food of cows, sheep and horses. 25c. per qt. (by parcel post, 40c.); larger quantity, price upon application.

COW PEAS

Cow peas are one of the best, largest yielding and most nutritious of the farm crops; they provide the most inexpensive methods of bringing soil back to a stage of fertility. They grow in the poorest kind of soil, leaving it very rich in ammonia. In the latitude of Philadelphia sow from May 1st to July 1st, two bushels per acre broadcast, or one bushel per acre in drills. For a large crop sow the seed as late as possible.

Black. One of the popular varieties extensively grown; very prolific and matures early. 25c. per qt. (by parcel post, 40c.); larger quantity, price upon application.

Whippoorwill. Medium early; upright growing; a variety more extensively used than any other. 25c. per qt. (by parcel post, 40c.); larger quantity, price upon application.

FLAX

This is grown for the fibre from which linen thread is made and also for the seed from which that indispensable product, "Linseed Oil," is made. When ground it makes an excellent tonic when fed to horses, cattle and poultry. If grown to harvest seed, sow 1 bushel to the acre from May 15th to June 15th. If desired for the fibre, sow 1½ to 2 bushels per acre (56 lbs. per bushel). 20c. per lb. (by parcel post, 30c.); larger quantity, price upon application.

MILLET

Can be sown as late as July 15th and yield a tremendous crop. Also desirable for green manuring, when it should be turned under when about 10 inches high. Makes an excellent green food for stock. If used for hay it should be cut just as it matures.

Hungarian. The seed produces hay not so fine in quality as the "Golden," also fully a foot less in height; it can, however, be sown some 2 weeks later. Sow 1 bushel (50 lb.) per acre. 15c. per lb. (by parcel post, 25c.); larger quantity, price upon application.

Japanese Barnyard. This wonderful variety yields possibly more fodder than any other forage plant. Frequently as high as 12 tons of green food has been obtained from an acre. If sown early in May it may be cut twice in one season. Sow 12 lbs. per acre, broadcast, any time from May 1st to June 15th. 15c. per lb. (by parcel post, 25c.); larger quantity, price upon application.

Tennessee Golden. This requires a longer season to mature than the other sorts; it produces a very fine quality of hay and makes a larger seed head. Sow 1 bu. (50 lbs.) broadcast to the acre, from April 10th to July 10th. 15c. per lb. (by parcel post, 25c.); larger quantity, price upon application.

MANGEL WURZEL

Sow 5 lbs. per acre in April and May in thoroughly plowed, well-manured soil, in drills about 24 inches apart. Thin out to 12 inches apart in the row.

Golden Tankard. Per oz., 10c.; 30c. per $\frac{1}{4}$ lb.; lb., 90c.; \$4.25 per 5 lbs.; 10 lbs., \$8.00.

Lane's Improved White Sugar. Per oz., 10c.; 30c. per $\frac{1}{4}$ lb.; lb., 90c.; \$4.25 per 5 lbs.; 10 lbs., \$8.00.

Mammoth Long Red. Per oz., 10c.; 30c. per $\frac{1}{4}$ lb.; lb., 90c.; \$4.25 per 5 lbs.; \$8.00 per 10 lbs.

See also page 53.

SEED OATS

We make quite a specialty of these, having them grown especially on contract for us; they are large, plump, free from weed seeds or other foreign substance, and of high vitality. Sow at the rate of $2\frac{1}{2}$ to 3 bushels per acre alone or $1\frac{1}{2}$ bushels with peas during April for best results.

Storm King (Pedigree Stock). Our strain of this variety was brought from Russia several years ago and is the finest and plumpiest oats we have ever seen. Straw very stiff, often measuring five feet in height. Often yields 85 bushels per acre. Price, 20c. per qt. (by parcel post, 30c.); larger quantity, price upon application.

Swedish or Washington. The long, erect straw is noted for its ability to stand up in rough weather; grains are very plump and nearly pure white in color. Price, 15c. per qt. (by parcel post, 25c.); larger quantity, price upon application.

Welcome. A well-known and extensively grown variety; extra strong straight straw; large plump grains. Price, 15c. per qt. (by parcel post, 25c.); larger quantity, price upon application.

RAPE

Dwarf Essex. This can be pastured 8 weeks after sowing; sow in succession, as the stock eat it close to the ground and it will not stand pasturing any great length of time. Sow 6 lbs. per acre broadcast, from April 1st to October 1st. It produces enormous crops and is ideal green manure. 15c. per lb. (by parcel post, 25c.); larger quantity, price upon application.

SUDAN GRASS

An annual, and must be sown each year. Resembles millet somewhat; stock seems to relish it; will yield from 2 to 4 tons per acre. Sow in drills or broadcast 16 to 24 lbs. per acre; several cuttings can be made from a sowing in one season. Thrives well in a season of drought. Price, 25c. per lb. (by parcel post, 35c.); larger quantity, price upon application.

SUGAR CANE or SORGHUM

Early Amber. Either green or in a cured state this makes ideal cattle food. The seed can be threshed out of the stalks and used as poultry feed. It is a tremendous producer, growing often 12 feet high; it stands the hot, dry weather and can be cut several times in one season. Sow 25 lbs. of seed to the acre in drills $3\frac{1}{2}$ feet apart; 1 or 2 bushels broadcast. 50 lbs. per bushel. 15c. per qt. (by parcel post, 25c.); larger quantity, price upon application.

SUNFLOWER

Mammoth Russian. This makes a splendid poultry food, especially for Winter use, on account of its heating and fattening qualities; will yield sometimes as high as sixty bushels per acre. Sow 10 qts. per acre in drills 3 feet apart, dropping the seed about every 4 inches. Prices (subject to change); 15c. per lb. (by parcel post, 25c.); 40c. per 3 lbs. (by parcel post, 50c.); 5 lbs., 65c. (by parcel post, 80c.); \$1.25 per 10 lbs. (by parcel post, \$1.45); 25 lbs., \$3.00.



Spring Rye

RYE (for Seeding)

Spring. An excellent early green food, or for pasture; the grain is used for feeding and other purposes, while the straw is a very fine quality, making a larger yield than the Winter rye. Sow from May 1st to June 1st; $1\frac{1}{2}$ bushels to the acre. 56 lbs. per bu. Don't sow Winter Rye in Spring as it will not grow at that season. 20c. per qt. (by parcel post, 30c.); larger quantity, price upon application.

Pennsylvania White Winter. Winter rye will not mature if sown in Spring. 15c. per qt. (by parcel post, 25c.); larger quantity, price upon application.

Rosen Winter Rye. An improvement on the Pennsylvania White Winter Rye. 15c. per qt. (by parcel post, 25c.); larger quantity, price upon application.

TIMOTHY SEED

Our stocks of this important hay producing seed are especially fine; thoroughly re-cleaned, and free from weeds. If sown alone it requires 25 lbs. to seed an acre; if sown with wheat 12 to 15 pounds are the usual quantities. 45 lbs. per bu. 15c. per lb. (by parcel post, 25c.); larger quantity, price upon application.

VETCHES or TARES

Winter Vetch (*Vicia Villosa*). Sometimes called Sand or Hairy Vetch. Our stock of this is the true type, imported by us direct from Russia, which will absolutely live throughout the Winter. Sow from August 1st to October 1st, but the earlier the better broadcast, 1 bushel per acre, to which we suggest adding a bushel of Winter rye or wheat. In the Spring it can be plowed under as green manure, or when in flower cut for hay. Price, 25c. per lb. (by parcel post, 35c.); larger quantity, price upon application.

Spring Vetch (*Vicia Sativa*). The seed of this is larger than the "Winter" and of a brownish gray color. It is not hardy and must therefore, be sown in the Spring during May or June, 1 to 2 bushels per acre if broadcast, and 1 bushel if in drills, with either Spring wheat, Spring rye or oats, for support. Has the same desirable features as the Winter vetch. Price, 20c. per lb. (by parcel post, 30c.); larger quantity, price upon application.

SPRING WHEAT

Saskatchewan Fife. A favorite sort in this locality and is used on account of its prolific, vigorous growth and early qualities. It often produces 50 bushels per acre. Sow in April or May, $1\frac{1}{2}$ to 2 bushels per acre, broadcast or in drills. Price, 20c. per qt. (by parcel post, 35c.); larger quantity, price upon application.

Michell's Reliable Grass Seeds are offered on pages 4 to 7.

Enhance the beauty of your garden by giving it a New Deal and plant Michell's Choice Bulbs and Roots. They will furnish that deft touch which bespeaks completeness. Our list, carefully compiled, is in keeping with these times, or "Quality at Moderate Prices." The Novelties listed herewith request a place in your garden. Why not favor them with it?

TUBEROUS ROOTED BEGONIAS

"A shade loving plant." Transform the densely shaded and moist spots in your garden to a bower of enhancing beauty with a clump of assorted Tuberous Rooted Begonia Bulbs.

They are at their best in such corners, producing blooms two to four inches in size. Our bulbs are large and produced from the finest strain.

	Each	Doz.	100
Single Mixed.....	\$0.20	\$2.00	\$14.00
Double Mixed.....	.25	2.50	16.00
Crispa Mixed.....	.25	2.50	16.00

CHLIDANTHUS FRAGRANS

(Fragrant Lily)

An old time favorite which had disappeared from our midst. It can be grown as a pot plant or in the garden; it produces miniature Amaryllis-like flowers, which are a clear rich yellow; the blooms are very fragrant, the odor being most pleasing. To grow in pots the bulbs should be potted in early Spring and placed in a warm conservatory or window garden. For outdoor planting set bulbs out when all danger of frost is past.

It adds beauty to a rockery or border when planted in clumps of 6 or more. Bulbs must be taken up in the Fall and stored in a cool, dry temperature. 25c. each; doz., \$2.50; \$16.00 per 100.

LILIUM PHILIPPINENSE FORMOSANUM

Lilies give stateliness to your garden and are the outstanding attraction when in bloom. We recommend this recent introduction as one of the finest acquisitions. It is a wonderful lily, producing large blooms of pure white, tinted with rose on the outside; the size and its form resemble the Easter lily, with a similar enhancing fragrance; it is a profuse bloomer and invaluable as a cut flower; perfectly hardy in cold climates, if given a mulch in the late Fall. 30c. each; doz., \$2.50; \$16.00 per 100.

COOPERIA PEDUNCULATA

(Giant Prairie Lily)

Another old time favorite, which has become exceedingly scarce. It is unsurpassed when used in a clump of 8 to 12 bulbs, among shrubbery, in the border or rockery; they bloom profusely towards evening, producing large, very fragrant pure white flowers, tinged red on the outside. Bulbs should be lifted in the Fall and stored in a dry and cool temperature. 20c. each; doz., \$2.00; \$14.00 per 100.

GLADIOLUS GEMS FOR YOUR GARDEN

Belinde. Large, delicate creamy yellow blooms on long spikes; flowers well placed. 3 for 30c.; \$1.00 per doz.; per 100, \$7.00.

Betty Nuthall. Winner of numerous awards. A new style and arrangement; color light salmon pink, with pale orange throat. 3 for 30c.; \$1.00 per doz.; per 100, \$7.00.

Chas. Dickens. Attractive, tall and vigorous; blooms large and 10 to 12 open at one time; color deep violet-red, with darker blotch. 3 for 30c.; \$1.00 per doz.; per 100, \$7.00.

Heavenly Blue. Visualize large blooms of a delicate sky blue texture, many of which open at one time; tall straight spikes. 20c. each; doz., \$2.00; \$12.00 per 100.

Marmora. A new shade, lavender gray; flowers extra large on long stiff stems, many open at one time; truly a variety that is different. 20c. each; doz., \$2.00; \$12.00 per 100.

Mrs. F. C. Hornberger. One of the finest pure whites introduced; the large blooms are well placed on a strong spike. The pure white blooms have a cream throat, enhancing their beauty. 3 for 30c.; \$1.00 per doz.; per 100, \$7.00.

Mrs. P. W. Sisson. A gem in every respect; color cameo-pink with carmine blotch; flowers are large, well placed and very attractive. 3 for 30c.; \$1.00 per doz.; per 100, \$7.00.

Pfitzer's Triumph. The sensation at all "Glad" shows. Enormous blooms of bright salmon orange, with very small deeper throat blotch; due to the gigantic size of blooms this variety requires staking. 15c. each; doz., \$1.50; \$10.00 per 100.

MICHELL'S LARGE FLOWERING CANNAS

Cannas can be used both for bedding and border planting, producing effective results, blooming from early Summer until frost. The heights given are as they average in the Nurseries; this may vary, depending on soil, weather and climatic conditions.

If Canna Roots are wanted by parcel post, please add 20c. per dozen for postage. Single roots mailed free.

NEW CANNAS PLANTS ONLY

Antoine Wintzer. Dazzling crimson scarlet; trusses are large and individual florets are immense; should be in every garden; green foliage; 4½ feet.

Mrs. Herbert Hoover. Deep watermelon red; individual flowers are very large; deep green foliage; 4 feet.

Rosamond Coles. Buds saffron orange, opening to vermilion scarlet, edged yellow; flowers large; 5 feet.

Above varieties furnished in strong 4 inch pot plants only. 35c. each; doz., \$3.50; \$25.00 per 100.

Alphonse Bouvier. Rich velvety red; green foliage; 5 feet. Roots, 3 for 25c.; 75c. per doz.; per 100, \$5.00.

Ambassador. Brilliant cherry red flowers; bronze foliage; 3½ feet. Roots, 3 for 25c.; 90c. per doz.; per 100, \$6.00.

Apricot. Color, buff yellow base, with salmon pink; green foliage; 4 feet. Roots, 3 for 25c.; 75c. per doz.; per 100, \$5.00.

City of Portland. A glowing pink; height, 3½ feet; foliage green. Roots, 3 for 25c.; 90c. per doz.; per 100, \$6.00.

Eureka. The best white variety; free bloomer; green foliage; 4 feet. Roots, 3 for 25c.; 90c. per doz.; per 100, \$6.00.

Golden Eagle. Clear golden yellow, showy trusses; green foliage; 4 feet. Roots, 3 for 25c.; 90c. per doz.; per 100, \$6.00.

Hungaria. Plant dwarf and compact; flowers rich peach blossom pink; foliage green and very massive; height, 3½ feet. Roots, 3 for 25c.; 90c. per doz.; per 100, \$6.00.

King Humbert. Its majestic growth is enhanced by its massive truss of coppery scarlet flowers; foliage is deep bronze; 4½ feet. Roots, 3 for 25c.; 90c. per doz.; per 100, \$6.00.

King Midas. Large flowers of glittering gamboge-yellow; 5 feet. Roots, 3 for 25c.; 90c. per doz.; per 100, \$6.00.

Mme. Crozy. Scarlet, bordered golden yellow; green foliage; 3 feet. Roots, 3 for 25c.; 75c. per doz.; per 100, \$5.00.

Mrs. Alfred F. Conard. Color delightful salmon pink, which becomes more brilliant as the flower develops; foliage light green; 4 feet. Roots, 3 for 25c.; 90c. per doz.; per 100, \$6.00.

Mrs. Pierre S. duPont. A very showy variety; blooms from June until frost. Color, a vivid watermelon pink, each individual flower is very large; one plant will make several heads of bloom. Plants only, 35c. each; doz., \$3.50; \$25.00 per 100.

Richard Wallace. Large, showy, pure canary yellow flowers carried on good stems; green foliage; 4½ feet. Roots, 3 for 25c.; 75c. per doz.; per 100, \$5.00.

The President. Rich glowing scarlet; superior in quantity and quality of bloom to any other red variety; green foliage; 4 feet. Roots, 3 for 25c.; 90c. per doz.; per 100, \$6.00.

Wyoming. Immense spikes of orange flowers; bronze foliage; 6 feet. Roots, 3 for 25c.; 75c. per doz.; per 100, \$5.00.

Yellow King Humbert (Queen Helen). Green foliage, about 4½ feet high, with masses of golden yellow flowers, dotted red; occasionally some will be streaked red. Roots, 3 for 25c.; 90c. per doz.; per 100, \$6.00.

Mixed Cannas. All colors. Roots, 3 for 20c.; 65c. per doz.; per 100, \$4.50.

PRICES OF CANNA PLANTS

If plants are wanted they are ready about May 10th, and will be supplied at the following prices, 3 for \$1.00; doz., \$3.00; \$20.00 per 100. Please specify if roots or plants are wanted.

Time of Shipment. Unless specially requested, tubers will be shipped March 15th to June 1st; plants May 15th to June 15th.

Culture. Dahlias are at their best during the latter part of September or early in October. To get exhibition blooms, disbud plants up to August 1st. Spade or plow the soil 12 to 18 inches deep; fertilize with well-rotted stable manure or hyper-humus; scatter about $\frac{1}{4}$ lb. of bone meal around each hill when planting. If soil is very heavy, incorporate a liberal quantity of granulated peat moss. About August 1st, apply about $\frac{1}{2}$ lb. bone meal to each plant and work in thoroughly; sheep manure or potato fertilizer can be substituted for bone meal at this time to good advantage.

HOW TO KEEP DAHLIA TUBERS AFTER THEY ARE SHIPPED TO YOU IF TOO EARLY TO PLANT

Open package and leave tubers in packing material you receive them in. Do not expose to air or moisten too much; keep in a cool place, but not where they will freeze.

Free on request, our booklet on the culture of Cannas, Dahlias and Gladiolus.

NEW INTRODUCTIONS 1934 HONOR ROLL VARIETIES

I D Informal Decorative varieties. *F D* Formal Decorative varieties. *S C* Semi-Cactus varieties.

CHAUTAUQUA SUNSET (F D)

A magnificent combination of sunset colors, gold, orange and peach red; foliage dark green. A gorgeous flower, which will be an exhibition dahlia when better known. Plants only, \$5.00 each.

ELEANOR ROOSEVELT (I D)

This enormous pure white variety was the sensation of the New York Show. Despite its size, it has beauty and grace; a prolific bloomer, with an excellent stem and fine bush growth. Named by special permission of Mrs. Franklin D. Roosevelt. Plants only, \$7.50 each.

ELISSA LANDI (F D)

Petals slightly wavy; although not a huge dahlia, it is heavy with thick petals and produces 9-inch blooms. It is a bright coral self color, very attractive; does not fade or burn. Roots, \$10.00 each. Plants, \$5.00 each.

GRANDEE (I D)

Light nopal red shaded orange yellow. For size and quality this dahlia is unsurpassed; it will produce blooms up to 15 inches, without forcing or shading, on plants 4 feet tall. Winner of the 1933 American Home Achievement Medal at San Francisco and for the largest flower at the California Flower Festival. Roots, \$15.00. Plants, \$7.50.

THE FIREMAN (I D)

A flashy and striking dahlia, the winner of many awards last Fall. Color a flashy cardinal red, with golden flushes and golden tips at center of the flower. Why not try it? Roots, \$10.00 each. Plants, \$5.00 each.

RECENT INTRODUCTIONS

Cameo (I D). True coral pink, deepening towards center, petals overlaid with glistening golden sheen, reverse of petals deep rose pink, fine exhibition flower. Plants only, \$2.50 each.

Jane Dixon (F D). A lovely shade of salmon orange of great depth; a true Autumn shade, reverse coral, high center, which remains tightly closed the entire season; free and early bloomer. Roots, \$5.00 each. Plants, \$2.50 each.

Judge Wm. T. Boyle (I D). Color, scarlet to flame scarlet and attracts instant attention; blooms average 9 x 4 $\frac{1}{2}$ inches, with petaloides of yellow and scarlet striped; bush strong and stocky, with dark green foliage of leathery texture and beautiful lustre, a wonderful setting for the scarlet blooms; average height, 3 $\frac{1}{2}$ feet. Roots, \$5.00 each.

Lorraine Marion Murphy (I D). Bright and glowing two-tone pink, the center of petals shading lighter than edges; blooms large and well formed, centers full; a vigorous grower, strong stems of medium height. Roots, \$3.00 each. Plants, \$1.50 each.

Maiden's Blush (F D). Color, a delicate shade of cream, tinged rose; perfect flowers of medium size, facing upwards; a variety highly recommended for the garden; grows 3 feet in height. Roots, \$4.00 each. Plants, \$2.00 each.

Mercury (F D). A beautiful combination of orange-buff and begonia-rose, blended and striped in a manner hard to describe; petals are of good substance and set quite formal, to make a very attractive flower facing, on fine stems; bush is strong and open; height, 3 $\frac{1}{2}$ feet. Roots, \$2.50 each.

Mrs. Alfred Stengel (F D). A new shade of soft primrose yellow; blooms very large and carried on long heavy stems; bush growth tall and vigorous. Roots, \$3.00 each. Plants, \$1.50 each.

Mrs. E. S. Newbold (F D). Greatly admired by lovers of pink dahlias; color, attractive soft mallow pink; blooms large, centers full, long strong stems. Roots, \$2.00 each. Plants, \$1.00 each.

Mrs. George M. Degerberg (I D). Color, dark garnet that does not fade in the sun; blooms medium to large, of pleasing form with high built center and carried gracefully on vigorous stems, without a doubt the best in this color. Roots, \$3.00 each. Plants, \$1.50 each.

Mrs. Grace H. Middleton (I D). Deep velvety garnet red; large blooms with high and full center, petals long and wavy; strong stems of medium height, carrying blooms erect; fine for exhibition. Roots, \$3.00 each. Plants, \$1.50 each.

Mrs. J. J. Fernley (F D). Soft lavender pink on outer petals, with cream center; blooms of medium size in diameter but very deep and well built; stems good, bushes large and free flowering. Roots, \$2.00 each. Plants, \$1.00 each.

Mrs. M. A. House (F D). A seedling of Jersey Beauty; color a beautiful salmon and rose; an excellent exhibition variety and a wonderful keeper. Roots, \$4.00 each. Plants, \$2.00 each.

Mrs. Max Matthes (F D). Large, full well formed flowers, with lasting deep center; color, salmon bronze; bushes tall and vigorous, with thick leathery foliage. Roots, \$3.00 each. Plants, \$1.50 each.

Mrs. Stevens Heckscher (I D). Golden yellow, shaded salmon; blooms of medium size, on short heavy stems; bush growth strong. Roots, \$2.00 each. Plants, \$1.00 each.

Myra Howard (I D). The color is a glowing combination of saffron and gold with tints of salmon; a giant deep flower and distinct in form and color. Roots, \$4.00 each. Plants, \$2.00 each.

Ray Warner (F D). Considered the most beautiful luminous pink in Dahlias; a cross between Jersey Beauty and Little Jewel. Of dwarf habit, rapid grower and profuse bloomer. Flowers of medium size, 7 to 8 inches in diameter; excellent for artistic decorating. Roots, \$5.00 each. Plants, \$1.25 each.

Robert Emmet (I D). Velvety cardinal red, of giant size and beauty; foliage dark green and insect-resisting; long stiff stems, profuse bloomer. Plants only, \$3.75 each.

Satan (S C). A sensation for its striking beauty, formation and coloring. Here is really an outstanding variety; blooms average 10 to 12 inches in diameter and 6 inches in depth; color, flaming scarlet with orange salmon at base of each petal; flowers last a long time when cut. Roots, \$5.00 each. Plants, \$2.50 each.

World's Fair (I D). A beautiful orchid pink, shown at Century of Progress Dahlia Show for the first time. Blooms average 8 to 10 inches and grow high above foliage, on long stiff stems; a sturdy grower; very prolific. This is a new color in dahlias. Roots, \$7.50 each. Plants, \$3.75 each.

MICHELL'S DAHLIA COLLECTIONS

Furnished in strong roots.

Buy your Dahlias from Specialists. It has been our privilege to bring new introductions before the public, which have been well received. To stimulate larger plantings we offer the following collections as an inducement for you to obtain an assortment of meritorious varieties at a very reasonable price. When ordering these collections, please stipulate name and number and when delivery is desired.

No. 1. Supreme Collection, \$16.00

Value, \$22.00

American Legion.
Burr McIntosh.

Champoeg.
White Wonder.

No. 2. Perfection Collection, \$12.50

Value, \$16.00

Full Moon.
Haddon Belle.

Horace Adams.
Splendor.

No. 3. Majestic Collection, \$10.00

Value, \$13.00

Alice Stellick.
Mrs. Joseph Hurley.
Mrs. Walter M. Jeffords.

Mrs. William Closson Purdy
Ray Warner.

No. 4. Aristocrat Collection, \$8.00

Value, \$11.00

Judge Wm. T. Boyle.
Mercury.

Mrs. John W. Stockwell.

No. 5. Hi-Spot Collection, \$5.00

Value, \$9.50

Baron von Steuben.
Chemar's Eureka.
Elizabeth Dinsmore.
Hunting Hill.
King Midas.
Mardi Gras.

Minnie Eastman.
Mrs. Eleanor Martin.
Penn Charter.
Rotarian.
Salmon Supreme.
Sanhican's Queen.

No. 6. Harmony Collection, \$4.00

Value, \$6.25

Commander Hugo Eckener.
Dr. H. Wesley Jack.
Hyperion.

Kathleen Norris.
Mrs. F. J. Michell, Jr.
Mrs. G. Berry Beaumont.

No. 7. Beauty Collection, \$2.00

Value, \$3.40

Barbara Redfern.
Calvin Coolidge, Jr.
Fordhook Victory.

Fort Monmouth.
Galli-Curci.
Mabel Thatcher.

No. 8. Garden Collection, \$1.00

Value, \$1.90

Alice Whittier.
Dakota.
Jane Cowl.

Jean Kerr.
Jersey Beacon.
Jersey Beauty.

Color Plate Collection

Pompon Dahlias

One each of the following varieties, \$3.75

Anna Kristina.
Bantam.
Bob White.
Candy Kid.
Dee Dee.
Donald Gordon.

Glow.
Hazel Dell.
Libbie Rohr.
Mary Munns.
Peggy Ann.
Sunset.

DECORATIVE TYPES

I D Informal Decorative varieties. *F D* Formal Decorative varieties.

Alice Stellick (*I D*). A bright crimson carmine with a distinct white stripe in center of each petal, which curl and twist, enhancing its beauty. Roots, \$2.00 each.

Altamont (*I D*). Strong stems; color rose pink, deepening towards center; a fine cut flower. Roots, 35c. each.

American Legion (*I D*). One of the largest dahlias. A giant clear yellow; the winner of numerous awards. We have an unusually fine stock of roots. Roots, \$5.00 each. Plants, \$2.50 each.

Andrea Erickson (*I D*). Pure white; petals pointed and irregularly placed; early and free bloomer; flowers are carried on long, stiff stems. Roots, \$2.00 each. Plants, \$1.00 each.

Asbury Park (*F D*). Massive blooms on stiff stems, well above foliage; color, copper salmon or old rose, or one entire shade throughout the flower. Roots, \$2.00 each. Plants, \$1.00 each.

Avalon (*F D*). Immense flowers of a beautiful chrome yellow; long stems; an ideal variety. Roots, 35c. each.

Aztec Glory (*I D*). Flowers large, of fine form and carried on good stems; color, a bright, attractive lemon yellow; a fine exhibition variety. Roots, 75c. each.

Bagdad (*I D*). Beautiful scarlet flame; of great size and depth; bush growth good; free and early bloomer; long stems hold the blooms high above the bush; flowers face forward. Should be in every exhibition. Roots, \$1.00 each. Plants, 50c. each.

Barbara Redfern (*I D*). A combination of old rose and gold; petals long with slight twist. Roots, 40c. each.

Baron von Steuben (*I D*). An unusual large flower, in a combination of lustrous purple, maroon and deep carmine, with a silvery overcast, making it an outstanding variety. Roots, \$1.00 each. Plants, 50c. each.

Burr McIntosh (*I D*). Striking primrose yellow, with faint pink suffusion; massive flowers on long wiry stems; free bloomer. Roots, \$7.50 each. Plants, \$3.75 each.

Calvin Coolidge, Jr. (*F D*). Color, rose pink, suffused with salmon, shading deeper towards the center, while the petals are distinctly edged with gold. Roots, 75c. each.

Champoeg (*F D*). Exhibition size blooms; color, lemon yellow, with a suffusion of deep rose pink; free flowering and early; stiff stems. Roots, \$2.00 each. Plants, \$1.00 each.

Chemar's Eureka (*F D*). Very beautiful white, faintly tinged lavender on edges of petals; free flowering; a splendid keeper when cut. Roots, 75c. each.

City of Trenton (*I D*). A first class exhibition dahlia, producing Autumn-colored flowers up to 12 inches across, with full centers, petals curl gracefully. Roots, 50c. each.

Color Sergeant (*I D*). Color, a rich, deep salmon-bronze of one shade. Excellent habit of growth, with perfect stems. Roots, 75c. each.

Coquette (*I D*). Velvety red, blending with gold, shading to gold color at points, back of petals gold. Roots, 50c. each.

Dakota (*D*). An old favorite, rich coral red with coppery suffusion. Roots, 35c. each.

Dorothy Stone (*I D*). Huge, true deep pink, very full center, petals thick and evenly placed; profuse bloomer. Roots, \$1.00 each. Plants, 50c. each.

Dr. H. Wesley Jack (*F D*). A fine variety, producing on long, stiff stems, attractive, large flowers; color, creamy white, tinted pink on outer edge of petals. Roots, \$1.50 each.

Dr. John H. Carman (*F D*). Vigorous grower; large flowers; color tyrian rose, shaded silver. Roots, 50c. each.

Dr. Milpauch (*F D*). Deep velvety red; tall grower, stems sturdy; free bloomer. Roots, 35c. each.

DECORATIVE TYPES

I D Informal Decorative varieties. *F D* Formal Decorative varieties.



Decorative Dahlia, *Hunting Hill*

- Dwight W. Morrow** (*I D*). Rich deep carmine red; a giant exhibition variety and destined to lead its class. Roots, \$2.00 each. Plants, \$1.00 each.
- Elite Glory** (*F D*). Flowers a brilliant rich red and remain in good condition a long while after being cut; strong grower. Roots, 50c. each.
- Elizabeth Dinsmore**. An excellent variety for the garden or for house decoration; color, brilliant orange with salmon shadings, a bright color combination. Roots, \$1.00 each. Plants, 50c. each.
- Eliza London Shepard** (*I D*). Clear, glistening golden orange, reflex darker; flowers are of beautiful form and full to the center to the end of the season; stems long. Roots, \$1.00 each. Plants, 50c. each.
- Emanuel's Beauty** (*F D*). Evenly formed, large bold flowers; color a pleasing combination of lemon yellow with scarlet suffusion. Roots, \$1.00 each.
- E. T. Bedford** (*F D*). A fine cut flower variety; color lavender splashed white. Roots, 35c. each.
- Florence Michell** (*F D*). Color, creamy white with suggestion of shell pink; petals long and nicely formed. Roots, 75c. each.
- Fordhook Victory** (*I D*). Blooms large, centers full; color a silvery tyrian rose; bush growth good. Roots, 50c. each.
- Fort Monmouth** (*I D*). Rich crimson maroon, shading to bluish violet at tips; giant flowers, well formed; free bloomer; splendid keeper. Roots, 60c. each.
- Fort Washington** (*F D*). A very fine dark red. Roots, 75c. each.
- Full Moon** (*I D*). Clear canary yellow; large flowers with broad flat petals; an exceptional free bloomer; bush medium. Roots, \$4.00 each. Plants, \$2.00 each.
- Galli Curci** (*I D*). A strong semi-dwarf grower; blooms large, unusually deep and carried on long stems; petals long, pointed and wavy; color, brilliant salmon orange with gold suffusion. Roots, 75c. each.
- Girl of Hillcrest** (*I D*). Apricot buff or cadmium orange; a vigorous grower; prolific bloomer; flowers large. Roots, \$2.00. Plants, \$1.00 each.
- Gladys Sherwood** (*I D*). A variety still in demand; blooms white, very large and of good form. Roots, 35c. each.
- Grenadier** (*D*). Fine for basket designs or cutting; blooms a pleasing magenta, splashed with white. Roots, 35c. each.
- Haddon Belle** (*F D*). Lavender, shaded magenta, with silvery rose pencilling, inner petals tightly quilled; entire flower overcast with silvery rose sheen; flowers large, on long, stiff stems, with leathery foliage. Roots, \$2.00 each. Plants, \$1.00 each.
- Haddon Hall** (*F D*). Amber yellow with carmine suffusion toward outer edge of petals, best describes this flower; a vigorous grower and persistent bloomer. Roots, 75c. each.
- Harry Mayer** (*F D*). A fine exhibition variety, that has size and form; color soft lilac with a rose pink reverse. Roots, 40c. each.
- Henry F. Michell** (*F D*). Immense flowers, brilliant scarlet; tall grower. Roots, 75c. each.
- Hallopockeney** (*F D*). Creamy white in center, petals striped, blended and heavily marked carmine, tips of petals lighter; a profuse bloomer and fine keeper. Roots, 50c. each.
- Hunting Hill**. A very fine garden type; color, clear yellow. Roots, 75c. each.
- Hyperion** (*F D*). A beautiful shade of yellow, with a slight suffusion of vermilion red over the outer petals; the immense blooms are very finely formed. Roots, \$1.00 each.
- Ida Perkins** (*F D*). One of the finest large white varieties, fine form and full centers; blooms early. Roots, 50c. each.
- Imperial Pink** (*I D*). Large deep blooms, tight center; light rose pink, shading to gold at base; tall strong grower. Roots, \$2.00 each. Plants, \$1.00 each.
- Jane Cowl** (*I D*). Massive blooms, bronzy buff and old gold, blending darker; stems unusually strong. Roots, 35c. each.
- Jane Dew** (*I D*). A beautiful dahlia; color clear mallow pink, long broad petals; a real exhibition variety. Plants only, \$2.50 each.
- Janet Southwick** (*I D*). An "honor roll variety"; color deep tyrian rose or Burgundy red; clean grower; medium height; petals are of the staghorn type. Roots, \$3.00 each. Plants, \$1.50 each.
- Jean Kerr** (*F D*). A fine white dahlia; medium size, fine for bedding and cutting. Roots, 25c. each.
- Jerome Kern** (*I D*). A prize winner that is outstanding and different in every respect from other dahlias; color soft shrimp pink with gold and bronze shadings at the center; the petals curl clear back to stem a mass of curls. Roots, \$7.50 each. Plants, \$3.75 each.
- Jersey Beacon** (*F D*). Bright scarlet, with buff reflex, giving a two toned effect; free bloomer. Roots, 35c. each.
- Jersey Beauty**. Blooms high above the foliage on strong stems; flowers are immense, glowing pink. Roots, 25c. each.
- Jersey's Majestic** (*I D*). Strong, vigorous grower; color copper, suffused with a golden sheen, reverse of petals amaranth pink, thus giving the flower a hue of pinkish copper. Roots, \$5.00 each. Plants, \$2.50 each.
- Kathleen Norris** (*I D*). True rose pink deepening to mallow pink, tight center; good bloomer; excellent keeper. Roots, 75c. each.
- Kemp's Violet Wonder** (*I D*). Bright violet purple; large, well formed flowers. Roots, 75c. each.
- Kentucky** (*I D*). Pure salmon pink, similar in habit and form to Jersey Beauty. Roots, 35c. each.
- King Midas** (*I D*). Mammoth golden yellow blooms; strong, vigorous grower. Roots, 75c. each.
- Lady Drummond Hay** (*F D*). Beautiful orange flame; vigorous grower, on long stiff stems. Roots, \$1.00 each.
- Long Hill** (*I D*). A massive flower of gold and rose shadings, with a yellow center and rose reverse; strong grower and prolific bloomer. Plants only, \$2.50 each.

DECORATIVE TYPES

I D Informal Decorative varieties. *F D* Formal Decorative varieties.

- Mabel Thatcher** (*D*). Large blooms on strong stems; color a beautiful cream, hard to describe. Roots, 40c. each.
- Mardi Gras** (*D*). Large, well formed flowers with good stems; color of American Beauty rose. Roots, 75c. each.
- Marlton** (*F D*). Garnet and white, petals nicely arranged, the center ones nearly white, outer ones garnet. Roots, 75c. each.
- Merritt** (*D*). Clear yellow of good form and habit; very free bloomer. Roots, 40c. each.
- Monmouth Champion** (*F D*). Brilliant orange flame; strong grower. Roots, 75c. each.
- Mrs. Alfred B. Seal** (*I D*). Old rose and lavender; strong grower; large, perfectly formed flowers with good center. Roots, 60c. each.
- Mrs. Bruce Ford** (*I D*). Large deep flower, long pointed and tight center, remaining full until frost; a combination of colors never before seen in Dahlias, cherry red with a dash of yellow at base of petals; the reverse and formation of petals at center of bloom produce a gorgeous orchid sheen. Roots, \$2.00 each. Plants, \$1.00 each.
- Mrs. Clarence H. Geist** (*I D*). Color, creamy white blending to lavender pink, with yellow at base of petals. Very large; stiff stems. Roots, 75c. each.
- Mrs. Coleman du Pont** (*I D*). Color, yellow with vermilion suffusion; flowers large on strong stems. Roots, \$1.00 each.
- Mrs. Edgar V. Seeler** (*I D*). A combination of orchid pink shaded lavender; a very deep flower, the petals of which are gold at base and tipped with gold at points; a most striking flower, hard to describe. Roots, \$2.00 each. Plants, \$1.00 each.
- Mrs. Eleanor Martin** (*I D*). Color, a beautiful mulberry, suffused gold; flowers of elegant form. Roots, 50c. each.
- Mrs. Frederick J. Michell, Jr.** (*I D*). Magnificent blooms, deep true pink, petals also blended a lighter pink in a way difficult to describe. An exhibition variety. Roots, \$1.00 each.
- Mrs. Florence M. Gray** (*I D*). Golden apricot suffused pink, with light lavender blending, petals recurved, reverse shaded lavender pink; large flower. Roots, \$2.00 each. Plants, \$1.00 each.
- Mrs. Geo. W. Elkins, Jr.** (*I D*). Old gold, suffused salmon pink. Roots, 75c. each.
- Mrs. I. DeVer Warner** (*F D*). Mauve pink, early and free bloomer. Roots, 25c. each.
- Mrs. James M. R. Sinkler** (*I D*). Magnificent, dark maroon red, blending to velvety ox-blood red, with an occasional tipping of bright yellow on petals and in center. Roots, \$2.00 each. Plants, \$1.00 each.
- Mrs. J. Howard Sheble** (*F D*). A new shade of pink in dahlias; soft, bright orchid pink, without lavender tracings, blending to cream at tips of petals. Roots, \$2.00 each. Plants, \$1.00 each.
- Mrs. J. J. Greer** (*F D*). Mauve pink; finely formed, deep flower with tight center, an improvement in this color over anything recently introduced. Roots, \$2.00 each. Plants, \$1.00 each.
- Mrs. John W. Stockwell** (*I D*). The large, full flowers have slightly curled petals, giving a graceful and refined appearance to the bloom; color, amaranth pink, shading to rose pink at base of petals; the blooms average 9 inches with always a full center; a fine, healthy open bush, 6 to 7 feet high; stems long and straight. Roots, \$3.50 each.
- Mrs. Joseph Hurley** (*I D*). A magnificent exhibition flower of perfect form and full center, best described as scarlet red, petals edged light purple, base of petals faintly suffused old gold. Roots, \$2.00 each. Plants, \$1.00 each.
- Mrs. Wm. Closson Purdy** (*F D*). A lovely flower of mallow purple, petals beautifully and evenly arranged, giving refinement to the large blooms. Bush tall with long wiry stems. Roots, \$2.00 each.
- Mrs. Wm. Ross Harper** (*F D*). A large flower with an unusual and striking formation. The scarlet petals are involute and nicely arranged to form an immense flower. The sturdy bush is of medium height; the stems are strong and straight, holding the blossoms facing. Roots, \$2.00 each.
- Mrs. Walter M. Jeffords** (*F D*). Color clear primrose base with vermilion showing at the ends of the petals and sometimes blushing toward the center with the same color. Roots, \$2.00 each. Plants, \$1.00 each.
- Old Hickory** (*F D*). Large blooms, centers full; color madder red with apricot suffusion. Roots, 50c. each.

An exceedingly large Dahlia list is confusing to a buyer. Our list is therefore confined to varieties that we have found are reliable and satisfactory. It shall be our pleasure to assist you in offering suggestions or making selections to fit your requirements.

We call your attention to our new 1934 introductions; see page 82 for full information.

- Omar Khayyam** (*F D*). A sensational variety; the unusual coloring—Chinese red at base of petals, shading to bright orange and tipped lighter—make a wonderful soft color effect; tall, healthy grower. Roots, \$2.00 each. Plants, \$1.00 each.
- Pastel Glow** (*I D*). Large, deep high centered flower of glowing pastel pink; especially attractive under artificial light. Roots, \$7.50 each. Plants, \$3.50 each.
- Penn Charter** (*F D*). Strong grower; deep flowers of great beauty; color rich gold blended with apricot, a brilliant color. Roots, \$1.00 each.
- Pride of California** (*D*). A brilliant, glowing cardinal red; flowers large; a good cut flower. Roots, 25c. each.
- Pride of Fort Morgan** (*F D*). Rich carmine red; sturdy grower; profuse bloomer. Roots, 60c. each.
- Prince of Persia** (*I D*) (*New*). Very dark red with velvety markings; immense blooms, very deep, often a foot across. Roots, \$2.00 each. Plants, \$1.00 each.
- Robert Leeds** (*I D*). Massive flowers of a rich, royal purple color; blooms large. Roots, \$1.00 each.
- Robin Hood** (*I D*). Ox-blood red, a very attractive variety; petals very wavy and look like velvet; exceptional free bloomer. Roots, \$2.50 each. Plants, \$1.25 each.
- Rose Fallon** (*F D*). Massive flowers of a pleasing dark orange, tinted with amber and salmon. Roots, 35c. each.
- Rotarian** (*D*). Awarded a Certificate of Merit. Color large purplish maroon. Roots, 50c. each.
- Sagamore** (*F D*). Rich amber gold, shaded toward the center with salmon rose or orange buff. Roots, 25c. each.
- Salmon Supreme** (*F D*). Color a glistening salmon orange pink; a very popular dahlia, held erect on good stiff stems and admired by everyone. Roots, \$1.00 each.
- Sanhican's Queen** (*F D*). A blending of apricot, with a faint brushing of carmine rose, deepening toward the center. Roots, 75c. each.
- Seal's Californian** (*F D*). Beautifully formed; color yellow and rose, broad petals. Roots, 50c. each.
- Somerset** (*I D*). Free and early bloomer; color, salmon and old rose, blending deeper with age, with an occasional touch of lavender on reverse. Roots, 35c. each.
- Splendora** (*F D*). Large blooms facing forward; bordeaux red, shading to rhodamine purple; centers perfect, long and deep, which remain full the entire season; profuse bloomer; bush growth medium; foliage leathery; entire flower overcast with a ruby black sheen. Roots, \$4.00 each. Plants, \$2.00 each.
- Susan G. Tevis** (*I D*). Lilac with bluish sheen, narrow, flat, pointed petals. Roots, 50c. each.
- The Commodore** (*D*). One of the largest and most spectacular yellow dahlias, many of the blooms attaining 12 inches across and of good depth; color a brilliant lemon yellow, petals long and broad; exceedingly free bloomer. Roots, \$2.00 each. Plants, \$1.00 each.
- The Lemonade** (*I D*). A fine cut flower; large blooms, clear sulphur yellow color. Roots, 50c. each.
- The World** (*F D*). Rich, deep rosy magenta overlaid garnet, with silver shadings on edges. Roots, 50c. each.
- Thomas A. Edison** (*F D*). Royal purple exhibition variety, named by permission of the Famous Electrical Wizard. Roots, 75c. each.
- Three Cheers** (*F D*). A flower that merits such a name, tyrian rose, striped white; this bicolor variety is always true to form; its beautiful combination of shades will arrest everyone's attention, whether in a garden or exhibition hall. Roots, \$1.50 each. Plants, \$1.00 each.
- Treasure Island** (*F D*). Bright apricot with gold and rose suffusion and shadings; flowers measure 10 inches across. Roots, 50c. each.
- White Wonder** (*I D*). Giant blooms, pure white, with long, pointed twisted and curled petals; strong, vigorous bush growth. A hit of 1933. Roots, \$7.50 each. Plants, \$3.75 each.

The dahlia as a cut flower enhances the beauty of any decoration you may make. It is a prolific bloomer, a single bush producing blooms for many weeks. The best time to cut flowers is in the early morning, mature flowers should be selected, the stems cut slantwise with a sharp knife, the lower leaves should be stripped off and the ends of the stems either burned or dipped in boiling water for half a minute. The dahlias should then be placed in deep containers full of cold water and put in a cool place, free of drafts; if the ends of stems have become dry they should be cut before placing in water.

POMPON VARIETIES

A miniature form of Ball Dahlias; very popular and used extensively for table decorations.

MICHELL'S COLOR PLATE POMPON DAHLIAS

- No. 1. Candy Kid.** Coral pink, shaded lavender. Roots 35c. each.
No. 2. Libbie Rohr. Cerise purple; very long stems. Roots, 50c. each.
No. 3. Bob White. Milk white; profuse bloomer. Roots 25c. each.
No. 4. Dee Dee. A perfectly formed, pure lavender. Roots, 25c. each.
No. 5. Sunset. A delightful orange. Roots, 25c. each.
No. 6. Peggy Ann. Yellow, edged and shaded brownish red towards center. Roots, 50c. each.
No. 7. Anna Kristina. Golden yellow, shading deeper at center. Roots, 35c. each.
No. 8. Glow. Light rose or coral color. Roots, 35c. each.
No. 9. Hazel Dell. Clear pink, with cerise edge. Roots, 35c. each.
No. 10. Mary Munns. Fuchsia color, with a dark orchid sheen. Roots, 35c. each.
No. 11. Bantam. Brownish red; very dainty and well formed. Roots, 35c. each.
No. 12. Donald Gordon. Burnt orange; small and compact. Roots, 35c. each.
Collection. One root each of above 12 varieties for \$3.75.

- Edith Mueller.** Bright tyrian rose with silvery reverse; profuse bloomer. Roots, 40c. each.
Goldilocks. Pure gold, deepening at center. Roots, 35c. each.
Honey. Primrose yellow with faint suffusion of red on edges of petals. Roots, 50c. each.
Jack. Color purple garnet; blooms perfectly formed throughout the season; an incessant bloomer. On "1934 Honor Roll." Plants only, \$1.00 each.
Jill. Soft yellow, suffused and tipped carmine, a bright colorful variety, with small uniform blooms; long stems and free blooming. Plants only, \$1.00 each.
Johnny. The smallest pompon grown; color dark red or maroon. Roots, 35c. each.
Little Edith. Primrose yellow, tipped bright carmine. Roots, 25c. each.
Pink Beauty. A choice variety; color a very fine soft pink. Roots, 35c. each.
Snowlad. Pure white; free bloomer. Roots, 25c. each.
Sunset. Delightful orange; very popular. Roots, 35c. each.
Yellow Gem. Clear canary yellow. Roots, 25c. each.

MINIATURE DAHLIAS

This class embraces small decorative and intermediate sorts between Pompon and Ball types. They are excellent for basket arrangement, or for cut flowers.

- Carla (S C).** Buff, heavily shaded old rose and suffused with violet rose. Plants only, \$1.00 each.
Garden Love. Yellow and pale red. Roots, 75c. each. Plants, 50c. each.
Jean (I D). Apricot buff suffused lilac rose; very pretty and artistic. Plants only, \$1.00 each.
Kitty Bellaire (Cactus). Deep maroon; tiny flower, very graceful. Roots, 50c. each.
Lady Mary Hope. Amber and orange, tipped white. Roots, \$1.00 each. Plants, 50c. each.
Little Jewel. Peach blossom pink. Roots, 25c. each.
Mt. Whitney Sunset (New) (F D). Amber yellow with jasper red markings on each petal. A Roll of Honor variety that is beautiful in every respect. Plants only, \$1.00 each.
Tiny. Peach color with a bright golden center; very artistic. Roots, 75c. each. Plants, 50c. each.
Tricolor (F D). Yellow tipped cardinal; very choice. Roots, 50c. each.

LARGE SINGLE VARIETIES

Open centered flowers with only one row of ray florets, regardless of form or number of florets.

- Doris.** Deep velvety carmine, tipped pure white; very spectacular. Roots, 35c. each.
Fragrance. Each petal is snow white with a broad margin of bright scarlet. Roots, 35c. each.
Garnet Poinsettia. Rich glowing garnet, with rich glistening sheen. Roots, 35c. each.
Lois. A charming variety of the new introductions. Color violet rose with yellow center. Roots, 75c. each. Plants, 50c. each.

ORCHID FLOWERING VARIETIES

This new race is excellent for landscape effect, gardens, table or other dainty decorations. Blooms often average 4 to 5 inches in diameter; bush growth, 2 to 3 feet in height. We recommend the following varieties.

- Beaver.** Crimson maroon, with light tipped narrow florets. Roots, 50c. each.
Everest. Pure white throughout. Roots, 50c. each.
Mavis. White lilac ground, with deep, reddish purple reverse. Roots, 50c. each.
Pinkie. Rose, mottled white. Roots 50c. each.
Starfish. Pale flesh ground, with ruby reverse. Roots, 50c. each.

MIGNON OR BEDDING VARIETIES

This type is a single or duplex type of miniature dahlia. Plants are dwarf, averaging 18 inches to 2 feet in height, which are covered with blooms. Excellent for mass or border planting and flowers are very effective when used for table decoration.

- Ada.** Beautiful clear yellow. Plants only, 50c. each.
Bishop of Landaff. Brilliant rich red, with a dark bronze colored lacy foliage. Roots, 75c. each. Plants, 50c. each.
Coltness Gem. Single crimson scarlet flowers of perfect form, borne in great profusion. Plants only, 50c. each.
Diamond. Single, orange buff flushed apricot; a fine combination of shading. Plants only, 50c. each.
King Cup. Pale yellow flowers, with lacy foliage. Roots, 75c. each. Plants, 50c. each.
Lady Aileen. Clear rosy pink, with a darker ring at base. Roots 75c. each. Plants, 50c. each.
Muriel Lawrie. Rosy pink, flowers slightly larger than Coltness Gem and borne in great profusion. Plants only, 75c. each.
Princess Marie Jose. Lovely satin pink. Roots, 75c. each. Plants, 50c. each.

BALL VARIETIES

This class is very fine for cut flower purposes.

- American Beauty.** An extra large flowering red variety. Roots, 25c. each.
Gold Medal. Deep golden yellow, tipped and suffused oriental red; very fine for cutting. Roots, 30c. each.
Maud Adams. Clear shell pink; an old favorite hard to surpass. Roots, 25c. each.
Mrs. G. C. Anderson. An excellent cut flower variety on long stems; color, deep garnet. Roots, 25c. each.

PEONY VARIETIES

These are open center flowers, with small florets around disc.
Commander Hugo Eckener. Rich velvety red, reverse of petals veined silvery white, petals slightly reflexed; an exceedingly attractive variety. Roots, \$1.00 each. Plants, 50c. each.

DAHLIAS TO COLOR

Though named sorts, these are not labeled to variety; extra large divisions or clumps furnished in the following colors:

	Each	3 for	Doz.
Pink	\$0.20	\$0.50	\$1.75
Red20	.50	1.75
White20	.50	1.75
Yellow20	.50	1.75

MICHELL'S POMPON DAHLIAS



- 1. Candy Kid
- 2. Libbie Rohr
- 3. Bob White

- 4. Dee-Dee
- 5. Sunset
- 6. Peggy Ann

- 7. Anna Kristina
- 8. Glow
- 9. Hazel Dell

- 10. Mary Munns
- 11. Bantam
- 12. Donald Gordon

For description and prices see opposite page

CACTUS TYPES

SC Semi-Cactus varieties. *IC* Incurved Cactus varieties. *RC* Recurved and Straight Cactus varieties.

Alice Whittier (*SC*). Primrose yellow; large flower on long stems. Roots, 35c. each.

Ambassador (*C*). A good cut flower; color soft yellow buff, shaded salmon pink. Roots, 40c. each.

Cigarette. Creamy white heavily edged orange red; petals long and inclined to roll, forming a deep flower. Roots, 35c. each.

Colonial Dame (*SC*). True lavender, shading almost to blue in sunlight, a live, clean-cut color; it has all the daintiness of an old-fashioned beauty. Roots, \$5.00 each. Plants, \$2.50 each.

Countess of Lonsdale (*C*). Old rose to salmon; hard to surpass as a cut flower. Roots, 35c. each.

Edna Ferber (*SC*). Flowers very large; color, coral shading to old gold at base of petals. Roots, 75c. each.

Elite Gem (*C*). Spinal pink blush on primuline yellow at base; a beautiful cut flower. Roots, 75c. each.

Ella May (*C*). Flowers large and deep with full centers; color, rich crimson carmine. Roots, 50c. each.

Emma Marie (*SC*). Clear violet rose with creamy white center; a wonderful cut flower. Roots, 35c. each.

F. J. Michell, Sr. (*SC*). A beautiful amber color; flowers large, well formed on excellent stems. Roots, \$1.00 each.

Frau O'Bracht (*C*). Clear primrose; finely formed flowers on stiff stems; good for exhibition or cutting. Roots, \$1.50 each. Plants, 75c. each.

Golden Sonne. Rich golden yellow, with soft rose suffusion; flowers extra large and graceful. Roots, 50c. each.

Harry Strutt (*IC*). Large, clear spectrum red; a reliable cactus; good cut flower. Roots, 35c. each.

Horace Adams (*SC*). Color yellow suffused orange, brilliant under artificial light. Pacific Coast Blue Ribbon Winner. Roots, \$4.00 each. Plants, \$2.00 each.

Ian (*C*). Large, deep clear yellow, shading pink on outer petals; a free bloomer and good keeper. Roots, 75c. each.

Jean Trimbee (*SC*). Petunia violet; petals finely formed, curled and twisted; vigorous grower. Roots, \$2.00 each. Plants, \$1.00 each.

Jersey's Melody (*SC*). A beautiful shade of tyrian rose, shading to silver on tips, with a silver reverse, a striking color; flowers of fine form on long, stiff stems. Roots, \$2.00 each. Plants, \$1.00 each.

Joppa (*SC*). Golden apricot suffused salmon rose, very finely formed; tall grower. Roots, 35c. each.

Karl Bonawitz (*SC*). Truly a great flower, brilliant velvety carmine in color; should be in every collection. Roots, \$2.00 each. Plants, \$1.00 each.

La Fiesta (*SC*). Buttercup yellow, penciled red; color variations are interesting, at times the red blends with yellow in such a manner as to give the flower a salmon pink tone; the curl and twist of its lacy petals give this flower the appearance of a large chrysanthemum. A prize winner at many shows, its large blooms being decidedly different. Roots, \$5.00 each. Plants, \$2.50 each.

Marguerite Bouchon (*C*). Free blooming, rose and white; an old favorite still in demand. Roots, 35c. each.



Dahlia, Mrs. William M. Potts

Meta Scammell (*SC*). Clear amaranth pink; a gorgeous cut flower; very artistic. Roots, 75c. each.

Minnie Eastman (*SC*). A beautiful variety of a bright flame color with undershadows of deep yellow; stems long and erect. Roots, 75c. each.

Mrs. G. Berry Beaumont (*SC*). A new and very attractive variety; flowers of large size, fine form and produced on long stems. Color, outside petals brilliant rose, tinged with orchid, tinting to ivory in the center. Roots, \$1.00 each.

Mrs. William M. Potts (*SC*). A variety best described as buttercup, tipped and blended carmine, reverse of petals striped and blended violet rose. Very large flowers with tight centers on long stems; profuse bloomer. Plants only, \$1.75 each.

Ohio Glory (*SC*). Deep glowing rose pink, or bright purplish color; large flower; prolific and disease resistant. Roots, 40c. each.

Rheinischer Frohsinn (*IC*). Long incurved petals, white at base, suffusing to luminous carmine rose; a real cut flower. Roots, 40c. each.

Robert E. Lee (*SC*). Bright cardinal red, reflex lighter, a meritorious red or crimson, that does not burn or fade; flowers always full to center. Roots, \$1.00 each.

Rudy Vallee (*SC*). A very large and full centered flower; when first opening they show chrome yellow at center with a graduation of coppery red; as flower expands it finally becomes a solid coppery orange red when in full bloom. Roots, \$4.00 each. Plants, \$2.00 each.

Sophy Morey (*C*). A wonderful cut flower; color white, heavily overlaid lavender. Roots, 40c. each.

Star of Bethlehem (*SC*). Color, pure white with petals finely pointed at tips, with a very high full center, giving a star effect. Truly a wonderful dahlia, in a class by itself. Roots, \$1.50 each. Plants, 75c. each.

Theodore Roosevelt (*IC*). Lemon yellow, deepening towards the center. Roots, 35c. each.

AMARYLLIS

Cultural Directions. There are few bulbs which will give the amateur gardener (or even the professional) more for his money or time than the Amaryllis.

Place the bulbs, when they are procurable (usually from Fall until Spring), in pots 4 to 6 inches or more in diameter, and cover only to the shoulder of the bulb, leaving the neck protruding. Use a rich sandy loam mixed with some bone meal or Sheep Manure. Water sparingly at first, but increase as the growth increases. A temperature of from 50 to 60 degrees is the most suitable. The flower spikes, often 3 to a bulb, will develop quickly, and each bears several of the immense, beautifully colored, lily-like flowers.

After blooming, it takes the foliage a considerable time to complete its growth, and the plants should be well cared for during that period, to insure next year's blooming. Dry off gradually and after the leaves turn yellow, keep the pots in a cool and dark place for about 4 or 5 months, when they can be started again as described above.

If wanted by Parcel Post, add 20c. per doz. for postage.

GIANT AMERICAN HYBRIDS

Our famous strain in separate colors.

	Each	Doz.	100
Crimson and Scarlet Shades			
Large selected bulbs	\$0.60	\$6.50	\$50.00
Choice mammoth bulbs	1.00	10.00	75.00
Pink, Rose and Carmine Shades			
Large selected bulbs	\$0.60	\$6.50	\$50.00
Choice mammoth bulbs	1.00	10.00	75.00
White with Scarlet Markings			
Large selected bulbs	\$0.60	\$6.50	\$50.00
Choice mammoth bulbs	1.00	10.00	75.00
Choice Assorted Shades			
Large selected bulbs	\$0.60	\$6.50	\$50.00
Choice mammoth bulbs	1.00	10.00	75.00

Pure White. Very scarce and rare. Blooms are pure white, often 8 to 10 inches wide and of heavy texture.
Large bulbs, \$1.50 each; doz., \$15.00

	Each	Doz.	100
Hippeastrum Equestre. Large flowers of a brilliant orange scarlet, with white throat.	\$0.30	\$3.00	\$20.00

FANCY LEAVED CALADIUMS

These are grown for us by one of the leading Hybridizers. They are charming conservatory plants. Being of a tropical nature, they like a warm temperature. They do quite well outdoors during the Summer, if planted in a shaded place. The foliage covers a wide range of colors, making a grand display. The bulbs should be started in moss with plenty of bottom heat.

Ask for leaflet on their culture and care.

CHOICE NEW AND RARE NAMED VARIETIES

35c. each; doz., \$3.50 (by parcel post, \$3.60); \$25.00 per 100.

STANDARD NAMED HIGHLY COLORED VARIETIES

25c. each; doz., \$2.50 (by parcel post, \$2.60); \$17.00 per 100.

MIXED VARIETIES

An assortment especially blended for us. 20c. each; doz., \$2.00 (by parcel post, \$2.10); \$12.00 per 100.

Note. It often happens that the finest colored varieties do not produce the largest bulbs. The bulbs we furnish can be depended upon for best results.

MICHELL'S SUPERB TUBEROUS ROOTED BEGONIAS

Our strain is the finest grown; enormous flowers of the most exquisite coloring produced in great abundance. These can be grown in porch or window boxes, or in the garden in semi-shady places; can be started in pots indoors very easily. Plant outdoors in May, in a light, well drained soil, where they will flower uninterruptedly from latter part of June till frost.

If wanted by Parcel Post, add 10c. per doz.; 20c. per 100, for postage. Single bulbs mailed free.

SINGLE BEGONIA. (Large Bulbs)

	Each	Doz.	100		Each	Doz.	100
Crimson	\$0.20	\$2.00	\$14.00	Scarlet	\$0.20	\$2.00	\$14.00
Orange	.20	2.00	14.00	White	.20	2.00	14.00
Pink and Rose	.20	2.00	14.00	Yellow	.20	2.00	14.00
Salmon	.20	2.00	14.00	Mixed	.20	2.00	14.00

DOUBLE BEGONIAS. (Large Bulbs)

	Each	Doz.	100		Each	Doz.	100
Crimson	\$0.25	\$2.50	\$16.00	Scarlet	\$0.25	\$2.50	\$16.00
Orange	.25	2.50	16.00	White	.25	2.50	16.00
Pink and Rose	.25	2.50	16.00	Yellow	.25	2.50	16.00
Salmon	.25	2.50	16.00	Mixed	.25	2.50	16.00

BEGONIA CRISPA. (Large Bulbs)

The edge of each flower petal is exquisitely frilled.

	Each	Doz.	100		Each	Doz.	100
Orange	\$0.25	\$2.50	\$16.00	Scarlet	\$0.25	\$2.50	\$16.00
Pink and Rose	.25	2.50	16.00	White	.25	2.50	16.00
Salmon	.25	2.50	16.00	Yellow	.25	2.50	16.00
				Mixed	.25	2.50	16.00

BEGONIA LLOYDII, Hanging Basket Type

Unsurpassed for vases, hanging baskets, porch and window boxes.

	Each	Doz.	100
Mixed Colors	\$0.25	\$2.50	\$16.00

CALADIUM ESCULENTUM (Elephant's Ear)

As centerpieces in flower beds or for specimens on the lawn Caladiums are fine. Do not plant outdoors until after May 1st, but to get them in early growth, they may be started indoors.

	Each	By P.P.	Doz.	By P.P.	100
Jumbo Bulbs, 15-17 in. circum.	\$0.70	\$0.80	\$7.50	\$7.85	\$55.00
Monster Bulbs, 12 in. circum. up	.35	.45	3.50	3.75	25.00
Mammoth Bulbs, 9-11 in. circum.					
3 for 40c.		.50	1.35	1.55	9.50
First Size Bulbs, 7-9 in. circum.,					
3 for 25c.		.35	.90	1.05	6.00



Fancy Leaved Caladiums

MICHELL'S GORGEOUS GLADIOLUS

There is no other Summer flowering bulb that is enjoying so great popularity as that of the Gladiolus. Their adaptability to garden decoration or to use as cut flowers during the Summer and early Autumn is surpassed by no other flower. They are not only showy in the garden, but when cut with the first flower open will last for 10 days in the house. They thrive in almost any good garden soil but better results may be had if soil is well prepared and enriched with some of our pulverized manures. Great improvements have been made in the size, color and beauty of these flowers. Our list comprises the best of recent introductions as well as the most popular of the standard varieties. Plant bulbs 4 inches deep and from 4 to 6 inches apart.

If Gladiolus Bulbs are wanted by Parcel Post, add 10c. per doz., 25c. per 100, for postage to the first and second zones; for other zones, see parcel post table page 1; larger quantities by express.

MICHELL'S COLOR PLATE GLADIOLUS

	Each	Doz.	100
No. 1.—Mrs. P. W. Sisson. Cameo pink with carmine blotch; flowers large and well placed, many open at a time. A gorgeous variety and excellent keeper when cut.....3 for 30c.		\$1.00	\$7.00
No. 2.—Ruth Huntington. Violet-lilac with deeper markings on lower petals; large, strong grower; spikes well formed; should be in every collection.....3 for 25c.		.75	5.00
No. 3.—Gold Eagle. Extra early; deep rich yellow, slightly ruffled.....3 for 25c.		.75	5.00
No. 4.—E. J. Shaylor. A tall, strong growing variety with large flowers; color, a beautiful shade of pure deep rose-pink with well ruffled edges; one of the best of its color.....3 for 20c.		.60	4.00
No. 5.—Mrs. F. C. Hornberger. Large blooms well placed on strong spikes; color pure white with cream throat; one of the finest in this color and type.....3 for 30c.		1.00	7.00
No. 6.—Belinde. Long spikes well filled with large, delicate creamy yellow blooms.....3 for 30c.		1.00	7.00
No. 7.—Dr. F. E. Bennett. Peach red, overlaid flame color, throat finely stippled ruby and white.....3 for 25c.		.75	5.00
No. 8.—Persia. Deep crimson, almost black; medium size flowers well placed; exceedingly popular; should be in every collection.....3 for 25c.		.75	5.00
No. 9.—Mad. von Konijnenburg. Light violet or lavender blue, at least the nearest blue to date; early midseason; tall grower.....	\$0.15	1.25	8.00
No. 10.—Mrs. F. C. Peters. One of the best of the recent introductions. A beautiful shade of rose-lilac with soft crimson blotch. Very large flowers on long stems.....3 for 25c.		.75	5.00

COLOR PLATE COLLECTION

		By P.P.
1 each of above 10 varieties, 10 bulbs.....	\$0.85	\$0.95
3 each of above 10 varieties, 30 bulbs.....	2.25	2.40
6 each of above 10 varieties, 60 bulbs.....	4.25	4.45
12 each of above 10 varieties, 120 bulbs.....	8.00	8.25
25 each of above 10 varieties, 250 bulbs.....	14.00	14.35



Gladiolus, Mrs. Frank Pendleton, Jr.

BLUE, LILAC AND PURPLE SHADES

	Each	Doz.	100
Anna Eberius. An extra fine variety; color rich velvety purple with a deep purplish red blotch on the lower petals; flowers large, on long spikes.....3 for 20c.		\$0.60	\$4.00
Berty Snow. Pinkish lavender; large flower well placed and produced on a long spike. 3 for 30c.		1.00	7.00
Byron L. Smith. Lavender pink on white ground. Often referred to as the "Orchid Colored Glad." Of good form; stems are rather slender, which adds to its grace. 3 for 20c.		.60	4.00
Captain Boynton. White suffused lavender, blotched deeper in throat, a very attractive variety.....3 for 20c.		.60	4.00
Chas. Dickens. An attractive tall vigorous grower; large violet red blooms, with darker blotch; 10 to 12 flowers open at one time. 3 for 30c.		1.00	7.00
Heavenly Blue. Tall straight spikes; flowers well placed and of a delicate sky blue; many flowers open at one time.....	\$0.20	2.00	12.00
Mad. von Konijnenburg. See description above.....	\$0.15	\$1.25	\$8.00
Marmora. Extra large, lavender-gray flowers; on long stems; many flowers open at one time; a very attractive variety.....	.20	2.00	12.00
Minuet. This variety has created a sensation in the show room for several seasons; color, light lavender, with four to six large, heavy blooms open at one time.....	.30	1.00	7.00
Ruth Huntington. See description above. 3 for 25c.		.75	5.00
Veilchenblau. The first large, violet blue variety and a great favorite; the color suggests that of the Iris; lower petals have a darker blotch.....	.15	1.50	10.00

When cutting Gladiolus for the house, they should be cut as soon as the first one or two lower flowers are open; the remainder will open. Remove the flowers as they fade, cut off a little of the stem and change the water every day; this will prolong the blooming period.

①



⑤



⑥



②



⑩



⑦



③



⑧



④



⑨



MICHELL'S EXHIBITION GLADIOLUS

- | | |
|------------------------------|------------------------------|
| No. 1. Mrs. P. W. Sisson | No. 6. Belinde |
| No. 2. Ruth Huntington | No. 7. Dr. F. E. Bennett |
| No. 3. Gold Eagle | No. 8. Persia |
| No. 4. E. J. Shaylor | No. 9. Mad. von Konijnenburg |
| No. 5. Mrs. F. C. Hornberger | No. 10. Mrs. F. C. Peters |

For description and prices see opposite page

MICHELL'S GORGEOUS GLADIOLUS

If Gladiolus Bulbs are wanted by Parcel Post, add 10c. per doz., 25c. per 100, for postage to the first and second zones; for other zones, see parcel post table, page 1; larger quantities by express.

PINK SHADES

Doz. 100

America. A beautiful flesh pink, tinged with lavender; flowers large, petals round, thick and strong; will last a long time after being cut; free bloomer	3 for 20c.	\$0.60	\$4.00
Annie Laurie. Heavily ruffled; delicate pink overlaid with light rose; strong grower; 4 to 6 flowers open at one time. A distinctive variety, excellent for the garden, also for all forms of decorations	3 for 20c.	.60	4.00
Betty Nuthall. One of the finest varieties of recent introduction; color, a soft tone of light salmon-pink with pale orange throat.	3 for 30c.	1.00	7.00
E. J. Shaylor. See description, page 88.	3 for 20c.	.60	4.00
Evelyn Kirtland. Color, a beautiful Geranium pink, darker at the edges, scarlet blotches on lower petals; well arranged flowers on tall spikes	3 for 20c.	.60	4.00
Giant Nymph. Light pink suffused with cream yellow; large flowers on strong spikes	3 for 20c.	.60	4.00
Halley. Large, well expanded flowers; salmon pink, blotched yellow, with carmine markings; very early	3 for 20c.	.60	4.00
Le Marechal Foch. Flowers immense and beautifully ruffled; color, pale pink, flaked and striped deeper at edges of petals.	3 for 20c.	.60	4.00
Los Angeles. A soft shade of pink, feathered cerise at throat; tall and graceful; blooms for a long period, producing 2 to 3 flowering spikes from the same bulb	3 for 20c.	.60	4.00
Mrs. Dr. Norton. Large flowers on graceful spikes, with 4 to 8 flowers open at one time. Color, white, with edges of petals suffused with soft La France pink; tall grower; splendid cut flower	3 for 20c.	.60	4.00
Mrs. F. C. Peters. See description, page 88.	3 for 25c.	.75	5.00
Mrs. Frank Pendleton, Jr. Flowers very large, lovely flushed salmon-pink, carmine blotches in throat; the blooms are wide open on very wiry stems	3 for 20c.	.60	4.00
Mrs. Leon Douglas. Flowers of enormous size; color, Begonia-rose, striped with flame scarlet, lower petal lemon, speckled ruby	3 for 25c.	.75	5.00
Mrs. P. W. Sisson. See description, page 88.	3 for 30c.	1.00	7.00
Nancy Hanks. Apricot shading to orange pink, with heavy red penciling on lip; blooms are large and well placed	3 for 25c.	.90	6.00
1910 Rose. Rose pink with white stripe on lower petals; early bloomer and an excellent cut flower variety	3 for 20c.	.60	4.00
Panama. Color, clear pink with rose center; extra fine flowers on long spikes	3 for 25c.	.75	5.00
W. H. Phipps. La France pink, overlaid light rose salmon; one of the finest exhibition varieties	3 for 25c.	.75	5.00

YELLOW SHADES

Belinde. See description, page 88.	3 for 30c.	1.00	7.00
Gold Eagle. See description, page 88.	3 for 25c.	.75	5.00
Golden Dream. Clear deep yellow; long stems; a very fine, new introduction	3 for 25c.	.75	5.00
Golden Measure. Tall spike with many large, pure golden yellow flowers, several of the flowers are in bloom at one time; a winner at exhibitions	3 for 25c.	.75	5.00
Schwaben. Soft pure yellow with purple blotch on lower petals; heavy spike and foliage; an old favorite	3 for 25c.	.75	5.00



Gladiolus, Mrs. F. C. Peters

See color plate of Gladiolus opposite page 88.

If Gladiolus Bulbs are wanted by Parcel Post, add 10c. per doz., 25c. per 100, for postage to the first and second zones; for other zones, see parcel post table page 1; larger quantities by express.



Gladiolus L'Immaculee

RED AND SCARLET SHADES

	Each	Doz.	100
Caruso. Very early; extra large orange red with a beautiful blotch in throat. 3 for 30c.		\$1.00	\$7.00
Crimson Glow. One of the best scarlet varieties, throat overlaid with a velvety scarlet blotch. Large wide open flowers; good form and keeps well as a cut flower. 3 for 20c.		.60	4.00
Dr. F. E. Bennett. See description page 88. 3 for 25c.		.75	5.00
Early Sunrise. A large flowering variety; color iridescent shade of light red, with golden sheen in throat; early flowering and fine for forcing. 3 for 30c.		1.00	7.00
Mrs. Francis King. A beautiful flame pink with lighter throat. Immense flowers on long spikes; an old favorite cut flower variety. 3 for 20c.		.60	4.00
Paul Pfitzer. The best dark violet red offered; brilliant, large heavily ruffled flowers; vigorous grower; should be in every collection. \$0.15	1.50	10.00	
Persia. See description page 88. 3 for 25c.		.75	5.00
Pfitzer's Triumph. Enormous blooms of bright salmon orange, with very small deeper throat blotch; on account of the gigantic flowers, the stems require staking. This variety is a sensation at all shows and is ideal for exhibition purposes. .15	1.50	10.00	
Virginia or Scarlet Princes. Intense scarlet, slightly deeper in throat; extra fine, early and much in demand. 3 for 20c.		.60	4.00

WHITE SHADES

	Doz.	100
L'Immaculee. Pure white; early; large spikes; strong grower; fine for cutting, many blooms open at one time. 3 for 25c. \$0.75	\$5.00	
Lily White. Large flowers; excellent grower and heavy propagator; very early. A fine cut flower for the garden. 3 for 20c.	.60	4.00
Mary Pickford. Delicate creamy white, throat finest sulphur yellow; very distinct and beautiful. 3 for 20c.	.60	4.00
Mrs. F. C. Hornberger. See description page 88. 3 for 30c.	1.00	7.00
Peace. Enormous pure white flowers with lilac feather on the lower petal; plant robust; recommended for late planting. 3 for 20c.	.60	4.00

UNNAMED GLADIOLUS (In Separate Colors)

This assortment is made up of good varieties, especially blended for color and shadings. Only choice types and varieties are used.

	Doz.	100
White and Light	\$0.60	\$4.00
Yellow and Orange65	4.50
Red60	4.00
Pink60	4.00

MIXTURES OF GLADIOLUS

Michell's Giant Exhibition. Every bulb for this mixture has been selected with the utmost care for coloring and size of flower; no other mixture can boast of such careful selection. Per doz., 50c.; \$3.25 per 100; per 1000, \$27.50.

PRIMULINUS VARIETIES

This class of gladiolus is very popular for its early blooming qualities and the artistic shadings and markings of its blooms. Especially valuable for cutting for vases and table decorations for which they excel all other gladiolus.

	Doz.	100
Alice Tiplady. A beautiful and showy large flowering variety; color, orange saffron. \$0.55	\$3.50	
Maiden's Blush. Beautifully formed flowers on long stems; color, enchantress pink; a very dainty flower on graceful spikes; early flowering. .55	3.50	
Orange Queen. Large, wide open flowers of a warm tint of purest apricot. 3 for 25c.	.75	5.00
Souvenir. A beautiful and attractive variety; color, golden yellow; tall-stemmed large flowers facing forward; early flowering. 3 for 20c.	.60	4.00
Primulinus Major Hybrids, Mixed. This mixture is made up from the newest hybrids and contains the most beautiful and delicate tints, making the most harmonious blendings. \$27.50 per 1000	.50	3.25

We shall be pleased to supply any varieties of Gladiolus not listed. Send us a list of your requirements.

MICHELL'S HARDY GARDEN LILIES

A garden is not complete without a planting of Hardy Lilies; they do exceedingly well in the herbaceous border; the varieties listed can be planted in the early Spring months and it is recommended that they be planted among hardy perennials, as the shade from the surrounding plants is necessary for their welfare.

Cultural Directions.—All Hardy Lilies should be planted from 6 to 8 inches deep, the Japan varieties even 12 inches deep; the bulbs should be completely enveloped in sand, no manure should come in contact with the bulbs, but may be placed 4 to 6 inches underneath. All loose petaled bulbs should be planted on their side instead of upright. Cover with leaves or litter during Winter. Our Bulb Growing Guide gives full instructions on the growing of Lilies; ask for free copy.

If Lily Bulbs are wanted by Parcel Post, add 25c. per doz. for postage.



Lily, Rubrum

JAPANESE LILIES

Auratum (Golden Banded Lily). Enormous, measuring frequently 8 to 12 inches across; pure white, spotted crimson, each petal marked in the center with a band of yellow. Flowers in August; delightfully fragrant.

	Each	Doz.	100
Large Bulbs, 8 to 9 inch circum.....	\$0.25	\$2.75	\$18.00
Mammoth Bulbs, 9 to 11 inch circum.....	.35	3.50	25.00
Monster Bulbs, 11 to 13 inch circum.....	.45	4.50	35.00
Jumbo Bulbs, 13 to 15 inch circum.....	.75	8.00	60.00

Speciosum Album. The best late flowering pure white hardy garden lily; of easy culture. The graceful stems and foliage are set off to wonderful advantage by the pure white blooms.

	Each	Doz.	100
Large Bulbs, 8 to 9 inch circum.....	\$0.35	\$3.25	\$22.50
Mammoth Bulbs, 9 to 11 inch circum.....	.45	4.25	32.50
Monster Bulbs, 10 to 12 inch circum.....	.60	6.00	45.00

Speciosum Magnificum. An enormous flower; rich deep pink spotted crimson; height, 3 feet; flowers in August.

	Each	Doz.	100
Large Bulbs, 8 to 9 inch circum.....	\$0.30	\$3.00	\$20.00
Mammoth Bulbs, 9 to 11 inch circum.....	.40	4.00	30.00
Monster Bulbs, 11 to 13 inch circum.....	.50	5.50	40.00
Jumbo Bulbs, 13 to 15 inch circum.....	.85	9.00	65.00

Speciosum Melpomene. Deep pink, spotted red.

	Each	Doz.	100
Large Bulbs, 8 to 9 inch circum.....	\$0.30	\$3.00	\$20.00
Mammoth Bulbs, 9 to 11 inch circum.....	.40	4.00	30.00
Monster Bulbs, 11 to 13 inch circum.....	.50	5.50	40.00
Jumbo Bulbs, 13 to 15 inch circum.....	.85	9.00	65.00

Speciosum Rubrum or Roseum. Delicate pink, almost white, spotted red; one of the old garden favorites; height, 3 feet; flowers in August and September.

	Each	Doz.	100
Large Bulbs, 8 to 9 inch circum.....	\$0.30	\$3.00	\$20.00
Mammoth Bulbs, 9 to 11 inch circum.....	.40	4.00	30.00
Monster Bulbs, 11 to 13 inch circum.....	.50	5.50	40.00
Jumbo Bulbs, 13 to 15 inch circum.....	.85	9.00	65.00

Henryi (Yellow Speciosum Lily). Tall grower, often 7 feet; produces flowers of a distinct orange yellow in great profusion; July-August.

Rubellum. Beautiful rose color, with yellow anthers; 1 1/2 feet; June.

Tigrinum Flore Plena (Tiger Lily). Orange spotted black; double.

Tigrinum Splendens. Single.

LILIUM PHILIPPINENSE FORMOSANUM

A gorgeous lily; profuse bloomer, easy to grow; one of the finest garden lilies recently introduced; bush growth is graceful, foliage long and grassy; flowers pure white and resemble an Easter lily, both in size and form; very fragrant; when flower first opens it is slightly colored externally with reddish brown, this coloration fades as the flower matures. As it is a stem rooting variety, it should be planted about 8 inches deep. It likes a sunny location and will do best in a soil free from lime. 30c. each; doz., \$2.50; \$16.00 per 100.

REGALE LILY (LILIUM MYRIOPHYLLUM)

One of the finest garden lilies introduced; sturdy stems 3 to 5 feet high, producing an abundance of large, beautiful flowers, centers of which are flushed bright golden yellow, shading off to creamy white at outer edges; externally the flowers are streaked with brown, shaded a delightful pearly tint. Should be planted in Fall or early Spring, 8 to 9 inches deep; commences flowering in July. This variety has also been used for forcing with very good results.

	Each	Doz.	100
Large Bulbs, 8 to 9 inch circum.....	\$0.35	\$3.50	\$25.00
Mammoth Bulbs, 9 inches and up.....	.45	4.75	35.00
Monster Bulbs, 10 inches and up.....	.60	6.00	45.00
Jumbo Bulbs, 12 inch circum.....	1.00	10.00	75.00

COLLECTION HARDY LILIES

Mammoth Bulbs. See Color Plate opposite.
1 each, 5 varieties, 5 bulbs, \$1.75, postpaid.
6 each, 5 varieties, 30 bulbs, 9.50, postpaid.

Testimonial

Bridgehampton, N. Y.

I wish to thank you for sending the fine Regale lilies; they are perfectly beautiful and have been greatly admired.

O. L. Lafrantz.



1

2

3

5

4

MICHELL'S HARDY LILIES

Mammoth Bulbs

- 1. MAGNIFICUM
- 2. RUBELLUM
- 3. REGALE
- 4. HENRYI
- 5. AURATUM

For description and prices
see opposite page.

MICHELL'S HARDY GARDEN LILIES

If Lily Bulbs are wanted by Parcel Post, add 25c. per doz. for postage

MISCELLANEOUS JAPANESE LILIES

	Each	Doz.	100
Auratum Platyphyllum (<i>Macranthum</i>). Giant Golden Banded Lily; 4 to 5 feet; August	\$0.45	\$4.25	\$32.50
Batemani. Apricot colored; 3 feet; July..	.35	3.75	27.50
Hansoni. Often grows from 3 to 5 feet high; reddish orange, 8 to 12 in a cluster; June..	.60	6.00	45.00
Krameri. Blush pink; 3 feet; June-July....	.40	4.00	30.00



Lily, Elegans



Lily of the Valley

AMERICAN OR NATIVE LILIES

	Each	Doz.	100
Canadense (<i>Canadian Bellflower Lily</i>). Bright yellow flowers, spotted black inside; 3 to 5 feet; June-July.....	\$0.30	\$3.00	\$20.00
Canadense Rubrum. Same type as above; crimson with black spots; 3 to 4 feet; Au- gust35	3.50	25.00
Davuricum. Upright scarlet flowers; 2 to 3 feet; June-July.....	.35	3.50	25.00
* Elegans Atrosanguineum. Velvety crim- son; 1 foot; June-July.....	.35	3.50	25.00
* Elegans, Leonard Joerg. Rich apricot pink	.30	3.25	22.50
* Elegans Mixed. Shades of orange; 2 feet; June-July.....	.20	2.00	14.00
Pardalinum. Orange, spotted crimson; 4 to 6 feet; July.....	.35	2.50	25.00
Superbum (<i>Turk's Cap Lily</i>). Grows from 4 to 5 feet high and produces from 15 to 25 orange red flowers on a stalk; August..	.30	3.00	20.00
Szovietzianum Colchicum. Drooping frag- rant flowers; color, deep straw, spotted black; 4 to 6 feet; June.....	1.00	10.00	75.00
* Tenuifolium. Bright scarlet; 1½ feet; June	.20	2.00	15.00
Testaceum (<i>Nankeen Lily</i>). A choice va- riety; white outside, dusky orange or pale apricot within; 3 to 6 feet; June-July....	1.75	17.50	130.00
* Umbellatum. Orange scarlet; 2 feet; June	.35	3.25	22.50

The varieties marked * are excellent for the rockery.

LILY OF THE VALLEY MICHELL'S SUPERB EXHIBITION TYPE

Cold Storage

The hit of recent Spring Flower Shows; the finest strain pro-
duced; pips are unusually large, producing giant spikes with mass-
ive bells. By all means grow a succession of these pips for a con-
tinuous display.

Doz.....	\$1.25	250.....	\$20.00
25.....	2.50	500.....	38.50
100.....	9.00	1000.....	75.00

Michell's Fancy Flowering

Doz.....	\$1.00	250.....	\$16.00
25.....	1.85	500.....	31.00
100.....	7.00	1000.....	60.00

Bundles or Clumps. For outdoor planting only. Bundles con-
tain 12 good size pips, with good root growth, all of which will
flower with the proper care. They are especially imported from
abroad, the best of the stock being selected for us. We can
make shipment of these up to May 1st. 50c. per bundle (by
P. P., 60c.); doz. bundles, \$5.50 (by P. P., \$5.75); \$40.00 per
100 bundles.

Testimonial

Newark, N. J.

I bought some Lily bulbs from you; have just had one Jap-
anese (Golden Banded) lily in bloom and the plant had 8
blossoms on it, each about 10 inches in diameter.

A. Kemp.



CALLA ELLIOTTIANA

CALLAS

Splendid as a pot-plant for the window garden or for growing outdoors, preferring a shaded location. May be started inside any time prior to May 1st, after which they can be safely planted out.

Elliottiana. Yellow flower as large as the common white Calla; spotted leaf.

	Each	Doz.	100
Mammoth Bulbs.....	\$0.30	\$2.75	\$20.00
Monster Bulbs.....	.40	4.00	30.00
Jumbo Bulbs.....	.50	5.50	40.00

Spotted. Flowers white; foliage green, spotted white.....

	Each	Doz.	100
.....	.30	2.75	20.00

If wanted by parcel post, add 15c. per doz. for postage.

CHLIDANTHUS FRAGRANS

(Fragrant Lily)

An old-time favorite which had disappeared from our midst. It can be grown as a pot plant or in the garden. It produces miniature Amaryllis-like flowers, which are a clear rich yellow in color; the blooms are very fragrant and the odor most pleasing. To grow in pots, the bulbs should be potted in early Spring and placed in a warm conservatory or window garden. For outdoor planting, set bulbs out when all danger of frost is past. It adds its beauty to a rockery or border planting when planted in clumps of 6 or more. Bulbs must be taken up in the Fall and stored in a cool dry temperature. 25c. each; doz., \$2.50 (by P. P., \$2.65); \$16.00 per 100.

COOPERIA PEDUNCULATA

(Giant Prairie Lily)

Another old-time favorite which has become exceedingly scarce. It is unsurpassed when used in a clump of 8 to 12 bulbs, among shrubbery in the border or in the rockery. They bloom profusely towards evening, producing large, very fragrant, pure white flowers, tinged red on the outside. Bulbs should be lifted in the Fall and stored in a dry and cool temperature. 20c. each; doz., \$2.00 (by P. P., \$2.10); \$14.00 per 100.

CINNAMON VINE

Free growing climber, with small white flowers deliciously scented; makes a quick, dense shade. Monster roots, 3 for 30c.; doz., \$1.00 (by parcel post, \$1.10); \$7.50 per 100.

GLOXINIAS (Ready in January)

A gorgeous plant for either the conservatory or garden. They prefer a moist soil and a shady situation. Bulbs may be started as early as January, but should not be set outdoors until after May 15th. We offer extra fine large bulbs.

If wanted by Parcel Post, add 25c. per 100 for postage.

	Each	Doz.	100
Emperor Frederick. Red striped white; monster flowers.....	\$0.35	\$3.75	\$27.50
Emperor William. Purple striped white..	.35	3.75	27.50
Purple35	3.75	27.50
Rose35	3.75	27.50
Tigered and Spotted35	3.75	27.50
White35	3.75	27.50
Choice Mixed Colors35	3.75	27.50



Summer Hyacinth (Hyacinthus Candicans)

HYACINTHUS CANDICANS

(Summer-Flowering Hyacinth)

An ornamental mid-Summer flowering plant, producing from 20 to 100 large bell-shaped flowers of a creamy white color, clustered on spikes about 2 to 3 feet long. Plant bulbs about 6 inches deep, in a sunny location and in well drained rich soil. The bulbs will produce a succession of spikes for 2 or 3 months, particularly if the spikes are cut off as the flowers fade. 15c. each; doz., \$1.35; \$9.00 per 100.

ISMENE CALATHINA

(Pancratium Lily or Peruvian Daffodil)

A choice flowering bulb, blooming profusely during the Summer. Clusters of large, striking, fragrant pearly white flowers. Bulbs should be kept warm and dry and planted out the middle of May; they will commence flowering in July. Before freezing weather sets in they should be lifted and kept in a warm, dry place. Large bulbs, 20c. each; doz., \$2.00 (by parcel post, \$2.15); \$12.00 per 100.



Montbretias

MONTBRETIAS

Montbretias resemble miniature gladiolus, are fine for cutting and excellent for border planting. They prefer a light, loamy soil, well enriched with leaf mould, but no manure or chemical fertilizer should touch the roots; a little bone meal and a light top dressing of lime should prove beneficial. They will thrive either in partial shade or full sunlight, but see that the moisture supply is good at all times.

If wanted by Parcel Post, add 15c. per 100 for postage.

	Doz.	100
Fire King. Fiery red.....	\$0.75	\$5.00
George Davison. Pure golden yellow.....	1.00	7.00
His Majesty. Rich yellow center, shading to brilliant scarlet.....	3.25	22.00
King Edmund. Rich golden yellow, with brown markings in throat.....	1.00	7.00
Queen Alexandra. Light golden orange, with crimson bars.....	1.75	12.00
Rosea. Bright salmon rose.....	1.00	7.00
Star of the East. Immense flowers, averaging five inches across; color, pale orange yellow, with lemon yellow eye. One of the finest varieties we can recommend.....	4.25	32.50
Una. Light orange, with crimson reverse, inner surface marked crimson.....	1.75	12.00
Choice Mixed55	3.50

MADEIRA OR MEXICAN VINE

Also known as "Climbing Mignonette." A beautiful and popular vine, growing rapidly and much prized for porches and arbors, leaves heart-shaped and of a light green color; racemes of feathery white fragrant flowers are produced in profusion. Should be protected with litter during the Winter. Extra large selected tubers. 3 for 30c.; doz., \$1.00 (by parcel post, \$1.10); \$7.50 per 100.

OXALIS (Summer Blooming)

Valuable for edging the borders of walks or flower beds.

	Mammoth Bulbs	Doz.	100	By P.P.
Deppei. Small white flowers.....		\$0.20	\$1.25	\$1.40
Lasiandra. Rosy pink; beautiful cut foliage..		.20	1.25	1.40
Shamrock. Clover like foliage; pink flowers..		.20	1.25	1.40

TIGRIDIA PAVONIA (Mexican Shell Flower)

An excellent flowering bulb for the garden, known as the "Tiger or Shell Flower." Colors vary from pure white to gold and vivid scarlet, all are deeply blotched and speckled with crimson maroon. Plant in May, 6 inches apart and 3 to 6 inches deep; they require treatment similar to gladiolus.

	Doz.	By P.P.	100
Hybrida Mixed	\$1.50	\$1.65	\$12.00

TUBEROSES

One of the most fragrant and popular of Summer flowering bulbs. For flowering in the open, plant about the middle of May.

- Double Pearl.** Pure white, first size bulbs, 55c. per doz. (by parcel post, 65c.); per 100, \$3.75.
- Double Pearl Mammoth.** Extra large selected bulbs. 3 for 30c.; \$1.00 per doz. (by parcel post, \$1.10); per 100, \$7.00.
- Albino, or Mexican.** Single white, blooming in July and August. A very free-flowering variety. The odor is less pronounced than in the double varieties. 55c. per doz. (by parcel post, 65c.); per 100, \$3.75.



ZEPHYRANTHES (Fairy Lily)

This is a small flowering type of dwarf growing Amaryllis, flowering in profusion during the Summer; also suitable for pot culture.

	Doz.	100	1000
Carinata. Pink; very large and showy....	\$1.00	\$7.00	\$65.00
Robustus. A tall handsome variety, with large lavender flowers.....	1.25	8.00	75.00
Treata Alba. Pure white.....	.60	4.00	35.00
Treata Rosea. Clear rose.....	.90	6.00	55.00

If wanted by parcel post, please add 10c. per doz. for postage.

PLEASE READ CAREFULLY BEFORE ORDERING PLANTS FROM THIS CATALOG

So far as possible, when there are other goods on your order, please write the portion applying to plants on a separate sheet.

Plant orders are filled and shipped at what we consider the proper season for planting, unless otherwise instructed by customers.

Shipments for Southern States or localities, where cold weather is not a permanent thing, are made as soon as possible, unless otherwise instructed.

Shipments are best made by express, except orders for small plants or few in number. These can be sent via parcel post, if sufficient remittance on cash orders accompanies same.

In some cases the parcel post charges may be slightly in our favor, in the other instances they will be in favor of the buyer, although our customers should not overlook that it requires expert packing for safe arrival of shipments via parcel post.

Please Note:—Orders for less than the number of Plants listed cannot be filled, unless they are offered at our counter and are taken with. Prices are especially established for these.

SHIPPING TIME

In average seasons, applying to orders booked for Spring.

Hedge, Small Fruits, Trees, Flowering and Ornamental Shrubs.—Sometimes late in March, generally during April and lasting until growth is too far advanced for transplanting with safety or assurance of stock surviving.

Herbaceous Perennials.—April and continuing until either stock is exhausted or until season is too far advanced. Most perennials are pot-grown and can be planted safely at any season, as long as they are procurable.

Roses.—May is the best month for these, unless April is warm and settled.

Bedding Plants.—Geraniums, Cannas, Salvia, etc., are usually shipped beginning May 10th.

SPECIAL CAUTION

NOTICE—On receiving Plants, unpack them, plant and water thoroughly immediately. If they cannot be planted at once, at least unpack and water them. Newly planted stock, no matter how moist it may appear, should at planting time and every day (in the evening) for a week thereafter, be watered thoroughly, unless we have rain each day during the period. Most losses, through Plants, Shrubs, Trees, Hedges, etc., dying, are caused by their not being watered sufficiently and regularly at planting time.

SPECIAL NOTICE ON GUARANTEE

We spare no effort to supply all Plants, Trees, etc., of the best quality in first-class living condition. On account of the many causes beyond our control, we regret we cannot guarantee this stock to live and establish itself, as that is entirely within the power of the buyer or planter.

MICHELL'S CHOICE BEDDING PLANTS



Aster, Giant Branching

AMARANTHUS

Molten Fire (*Summer Poinsettia*). Very ornamental and the most beautiful of all Amaranthus; leaves dark bronze, center Poinsettia red. We offer selected plants. 6 for 75c.; doz., \$1.25; \$9.00 per 100.

ASTERS (Giant Branching)

We grow a large stock in separate colors; **Pink, Crimson, White and Blue.** Extra strong plants. Per doz., \$1.50; \$10.00 per 100.

BEGONIAS (Fibrous Rooted)

Gracilis Luminosa. A splendid variety with bronzy red foliage and brilliant scarlet flowers; very free blooming. 4-inch pot-plants, 6 for \$1.75; doz., \$3.50; \$25.00 per 100.

Prima Donna. One of the best bedding Begonias, having lovely rose-colored flowers shading to carmine. 4-inch pot-plants, 3 for \$1.00; doz., \$3.00; \$20.00 per 100.

ACHRYANTHES

Excellent for edging beds of various kinds; makes a fine show against a green or yellow background.

Brilliantissima. Crimson foliage; very bright. Extra strong plants, 6 for \$1.50; doz., \$2.50; \$15.00 per 100.

AGERATUM (Floss Flower)

These are one of the freest of flowering annuals and can be adapted to many purposes. As an edging in a garden border few plants surpass it.

Henry F. Michell. It is the dwarfiest growing and largest flowering variety in existence; produces immense quantities of most beautiful clear blue flower heads all Summer.

Blue Perfection. Large heads of deep blue flowers produced in abundance; 12 inches.

Price of Ageratums, 4 for \$1.00; doz., \$2.50; \$15.00 per 100.

ALYSSUM

Little Gem. Pure white flowers; dwarf compact plant; desirable for edging, flowering all season; 6 inches high. Per doz., \$1.50; \$10.00 per 100.

ANTIRRHINUM (Snapdragon)

A very effective plant for massive bedding or border planting, also much used in Italian Gardens. If flowers are cut off after blooming they will continue to flower until frost. In separate colors as follows:

Giant White, Pink, Yellow and Scarlet. Extra strong plants, 4 for \$1.00; doz., \$2.50; \$15.00 per 100.

CALENDULA (Pot Marigold)

These somewhat resemble a double daisy; are fine for cutting, border planting or as a background.

Chrysantha. A new break in Calendulas which originated in Australia. The flowers bear a most striking resemblance to a Chrysanthemum; remarkable for its great length of stem and large double, clear buttercup-yellow flowers. This variety is ideal as a cut flower for interior decorations.

Orange King. Very deep orange. 4 for \$1.00; doz., \$2.50; \$15.00 per 100.

NOTE—Please read carefully instructions on page 93 before ordering plants.

CENTAUREA CYANUS (Cornflower)

These are also known as Bachelor's Buttons, and were always found in old-fashioned gardens. They are easily grown and are excellent for cutting. 4 for \$1.00; \$2.50 per doz.; per 100, \$15.00.

CENTAUREA GYMNOCARPA

(White-leaved Centaurea or Dusty Miller)

Grown for their silvery foliage as edging plants; also fine for bedding, vases, hanging baskets, etc. As a border for a bed of Scarlet Sage they are very showy. \$1.50 per doz.; per 100, \$10.00.

COBEA SCANDENS

A beautiful blue, cup-shaped flowering annual climber; very desirable for lattice covering, etc. Strong plants, 4-inch pots, 40c. each; per dozen, \$4.00.

COLEUS

The popular bedding plant, with beautifully colored foliage; used extensively for edging Canna and Geranium beds.

Golden Bedder. Rich canary yellow foliage.

Queen Victoria. Red foliage with yellow edge.

Verschaffelti. Dark crimson foliage.

Per dozen, \$1.50; \$10.00 per 100.

COSMOS

Michell's Giant Flowering Strain, producing enormous, long-stemmed flowers late in the Autumn.

Pink, White, Red, each color separate. Per doz., \$1.50; \$10.00 per 100.

GERANIUMS

Beaute Poitevine. Salmon pink; very double.

Breem's Charm (New). Bright scarlet; very compact grower and very free flowering.

Fiat (New). Beautiful salmon-pink.

Helen Michell. Bright rich scarlet; gigantic flower

Mme. Buchner. Double pure white.

Rose Scented. The old-fashioned sweet scented variety.

Sensation (New). Bright scarlet, in flower during the entire season; compact, medium dwarf with enormous flowers.

Price of any of the above Geraniums, extra fine stock, 3 for \$1.00; doz., \$3.00; \$20.00 per 100.

HELIOTROPE (Cherry Pie)

A great favorite in the old-fashioned gardens, principally on account of their delightful fragrance. We offer two varieties which are the finest to date.

Centefleur. A vigorous grower, producing large trusses of deep blue flowers with a conspicuous white eye.

Royal Fragrance. The latest introduction, truly a wonderful Heliotrope. A dwarf grower, about 10 inches high, bearing immense trusses of deep violet-blue flowers, marvelously fragrant. Grown in a solid bed it makes a wonderful show, blooming continuously from early July until frost, perfuming the whole garden. 3 for \$1.00; doz., \$3.00; \$20.00 per 100.

HYDRANGEAS (See pages 129 and 131)

LANTANA

There are few Summer-flowering plants that give more satisfaction than Lantanas; they bloom continuously throughout the Summer and are coming into great favor on account of their bright, showy colors.

M. Schmidt. Rich orange turning to crimson; dwarf and bushy.

Radiation. Rich orange flowers turning to crimson as they mature; a wonderful bedding plant, as it is very dwarf and covered with flowers throughout the Summer.

6 for \$1.75; doz., \$3.00; \$20.00 per 100.

LEMON VERBENA

Pointed green lemon-scented foliage; fine for mixing among cut flowers. 3 for \$1.00; doz., \$3.00; \$20.00 per 100.

LOBELIA

Compacta. Blue flowering plant, for edging and hanging baskets. Per doz., \$1.50; \$10.00 per 100.

PLEASE NOTE—Bedding plants cannot be sent by parcel post as they cannot be packed satisfactorily to ensure safe carriage by this method; we therefore recommend shipping by express.



New Scarlet Geranium, Sensation

MARIGOLD

These are favorites in all old-fashioned gardens; in bloom from early Summer until frost. Grown from selected seed; flowers grow to enormous size.

Legion of Honor (Little Brownie). Single flowers; golden yellow with a large spot of crimson velvet; 9 inches; early flowering.

Lemon Queen. Bright yellow. **Orange King.** Deep orange. Per doz., \$1.50; \$10.00 per 100.

MOON VINE

Ipomoea Noctiflora. A pure white variety blooming toward evening and in the forenoon; the flowers are frequently 6 inches in diameter. Extra strong plants, 40c. each; doz., \$4.00; \$25.00 per 100.

PASSIFLORA (Passion Flower)

Pfordti. An attractive climber for outdoor planting in Summer, bearing a profusion of light blue flowers suffused with pink. Price, 40c. each (by P. P., 50c.).

PETUNIAS

Of the annual flowers, this is probably the most universally used; it can be put to a variety of uses, for bedding, baskets, window boxes or urns; they flower continuously.

Giant Single Strain. Mixed colors.

Pink Gem. (New) A dwarf Rosy Morn, growing only 8 to 10 inches and often having from 20 to 30 flowers on one plant.

An excellent new bedding Petunia.

Rosy Morn. Dwarf; brilliant rose color with white throat.

Double Petunias. Choice mixed colors.

3 for \$1.00; doz., \$3.00; \$20.00 per 100.

Note regarding Quality of our Bedding Plants.—This stock is grown with a view to making shipment via local express or American Railway Express and with this in mind we grow our plants in larger size pots, which develops a heavier plant than is required by the mail-order trade; send us a trial order and note the difference in quality.

PHLOX DRUMMONDI

These are a splendid bedding or border plant.

Dwarf. Red, white, pink, each separate. 6 for \$1.50; doz., \$3.00; \$20.00 per 100.

SALPIGLOSSIS (Painted Tongue)

Easy growing annual plants which have become great favorites, not only because of its easy culture, but mainly for its beautifully tinted and veined flowers; blooms from early Summer until late Fall; 18 inches. 4 for \$1.00; per doz., \$2.50; \$15.00 per 100.

SALVIA (Scarlet Sage)

No show of flowers can equal that produced by Scarlet Sage; it makes a blaze of color when massed or planted in beds that can be recognized at a great distance.

America. The best of all the Scarlet Sages; the earliest and most continuous bloomer, as well as the most uniform in habit of growth.

Strong plants, 3 for \$1.00; doz., \$3.00; \$20.00 per 100.

SCABIOSA (Mourning Bride)

Magnificent hardy annuals of easy cultivation, blooming freely through the Summer and Autumn. They are very decorative for beds or borders in the garden and are invaluable for cutting. 4 for \$1.00; per doz., \$2.50; \$15.00 per 100.

VINCA ROSEA

This is the flowering type used for bedding or vases; a bed or border planted with these is a beautiful sight; for either full sun or in partial shade they are well adapted. Pink, white, white with pink eye, each color separate. 4 for \$1.00; doz., \$2.50; \$15.00 per 100.

VINCA MAJOR VARIEGATA

A trailing plant used for hanging baskets and window boxes, green foliage mottled white. Extra strong pot-plants, per doz.; \$4.00; \$30.00 per 100.



Lilliput Zinnias



Verbena, Michell's Mammoth Fancy

VERBENAS

MICHELL'S MAMMOTH FANCY STRAIN

Used for edging borders, or for window boxes and vases.

Cerise Beauty of Oxford.

Pink Beauty of Oxford.

Helen Wilmott. Salmon.

Comet. Solid crimson.

Scarlet King.

Delta. Lavender.

Mayflower. Light pink.

Firefly. Bright red.

Gigantea Alba. Pure white.

Grandiflora Royal. Deep rich blue, cream eye.

True Purple.

4 for \$1.00; doz., \$2.50; \$15.00 per 100.

VERBENA VENOSA (HARDY GARDEN VERBENA)

Becoming very popular as a bedding plant. A strong, thrifty grower about 1 foot high, producing freely bright, heliotrope-colored flowers from early Summer until frost. 3 for \$1.00; per doz., \$3.00; \$18.00 per 100.

ZINNIAS

Michell's Giant Dahlia Flowered. Distinct from the ordinary Giant flowering class; extra large and of a true Dahlia flowered type. Plants grow from 2½ to 3 feet high. Separate colors, Orange-Yellow, Old Rose, Orange and Gold, Scarlet and Mixed.

Elegans, Lilliput. Of compact habit, not over 15 inches high; beautiful miniature, perfectly double flowers, splendid for bedding and cutting. Separate colors, Yellow, Orange, Salmon-Rose, Scarlet and Mixed.

Price of Zinnias, \$1.50 per doz.; per 100, \$10.00.

NOTE—Please read carefully instructions on page 93 before ordering plants.

ASPARAGUS

Plumosus Nanus (*Asparagus Fern*). Highly desirable for fern dishes, bouquet greens, garlands, etc.

Sprengeri (*Emerald Feather*). Excellent for hanging-baskets, brackets and cutting. One of the best plants for the window box. 3-inch pots, 6 for \$1.50; doz., \$2.50; \$15.00 per 100. 4-inch pots, 50c. each; doz., \$5.00.

CRASSULA ARBORESCENS

Frequently called Japanese Rubber plant. Heavy stems with thick fleshy leaves about 3 inches long; a very popular house plant, either as specimens or for indoor rock and miniature gardens. Strong plants, 3-inch pots, 50c. each; 4-inch pots, \$1.00 each; 5-inch pots, \$1.50 each.

DRACAENA

Godseffiana. Entirely different from all other Dracaenas; of free branching habit, making bushy and graceful plants; dark green leathery foliage dotted with spots of creamy-white. 3-inch pots, 50c. each.

Indivisa. Attractive, used as a center piece for a round bed, urn or vase and in cemetery work. Strong, 4-inch pot-plants, 50c. each; 5-inch pot-plants, \$1.00 each; 6-inch pot-plants, \$1.50 each.

Massangeana. An excellent house plant with broad, dark green foliage and a broad golden yellow band through the center of each leaf. Strong plants, 4-inch pots, 75c. each; 6-inch pots, \$2.00 each.



Fern, Nephrolepis, Teddy, Jr.

FERNS

The varieties we offer here are the best of their class and all are good house plants.

Nephrolepis, Dwarf Boston. A dwarf form of the original Boston Fern, makes a more shapely plant.

“ **Scotti**. An old favorite; dwarf and bushy.

“ **Teddy, Jr.** A dwarf form of the Roosevelt fern; very bushy.

“ **Verona**. The best of the crested or Lace Ferns.

Any of the above Ferns, 4-inch pots, 50c. each; 6-inch pots, \$1.00 each.

FICUS (Rubber Plant)

Elastica Craigi. A much improved form of the well-known Rubber plant, a stockier grower, the leaves being closer together, making a much more shapely plant. 6-inch pots, \$1.50 each.

GARDENIA (Cape Jessamine)

Veitchi. Beautiful evergreen greenhouse shrubs, with delightfully fragrant, pure white, waxy flowers; in bloom from April to June. Strong 5-inch pot-plants, \$1.00 each.



Asparagus, Plumosus

PANDANUS

We highly recommend this plant where a good many varieties of other decorative plants will not do. They will thrive even in dark places such as reception halls, living rooms, etc.

Veitchi. Highly colored plants. 4-inch pots, 75c. each; 6-inch pots, \$2.00 each; 8-inch pots, extra heavy, \$4.00 each.

SANSEVIERIA ZEYLANICA LAURENTI

This variety, in addition to the variegation shown in the ordinary sort, has a band of yellow on each edge of the leaves, which adds greatly to its decorative effect. 4-inch pot-plants, 75c. each; 6-inch pot-plants, \$2.00 each.



Sansevieria Zeylanica Laurenti

Ready for shipment about May 1st

The Roses we are offering are all strong 2-year field grown plants that were dug last Fall and potted into 6-inch pots, then stored in cold frames without any artificial heat. During the latter part of March these potted plants are moved to beds in the open air where they receive no further protection. Under this treatment the plants develop in a natural way and are not only superior to stock which has been developed into full growth under glass, but also better for Spring planting than plants which have been carried in cellars, in cold storage or kept dormant in any other way until planting time in late April or May. Roses thrive best in an open sunny position and they should be planted away from all trees and shrubs so that the roots will have the full benefit of the nourishment in the soil. Roses are gross feeders and consequently require a rich soil. Select a well drained position where the soil is good and dig in a liberal amount of well decomposed stable manure, thoroughly mixing it with the soil. For best results the beds should be made from 4 to 5 feet wide, planting the Hybrid Teas 18 inches apart and the stronger growing Hybrid Perpetuals 2 feet apart, planting all about 8 inches or 10 inches from the edge of the beds. The pot grown plants we send out have already been pruned and arrive with a ball of earth around the roots; this ball should not be disturbed but should be thoroughly wet when planted. Budded Roses should be planted so that the bud is about 2 inches below the surface of the ground; firm the soil well around the roots and give a thorough watering. Throughout the Summer, the surface of the bed should be frequently cultivated, or a good mulch of our granulated Peat Moss will be found very beneficial, as it not only keeps the ground cool and moist but it prevents the growth of weeds. The best method of protecting Roses for the Winter in this locality is to draw up a mound of soil around the base of the plant to a height of 8 to 10 inches, thereby protecting the buds at the base of the plants from the alternate freezing and thawing which is so injurious. When Roses are growing freely they are less liable to insect pests or fungous diseases than if they are starved or otherwise neglected. A weekly application of Aphistrogen or Fungtrogen and Insectrogen will keep the plants free of most all insect pests and mildew as well as fungous diseases; these splendid preparations are from the formula of Edwin M. Rosenbluth, the eminent rosarian of Philadelphia; they will be found offered on page 179.

GENERAL LIST OF MICHELL'S SELECT HYBRID TEA ROSES

Under this heading we offer only the best and well tried varieties for outdoor planting and our customers will make no mistake in selecting any of these for their gardens. For best results Hybrid Tea Roses should be severely pruned, the stronger shoots should be cut back to from 8 to 12 inches in height, while all weak thin wood should be removed entirely.



Hybrid Tea Rose, Briarcliff

Angele Pernet. A most unusual color in Roses. Long pointed buds opening into semi-double fragrant flowers of a coppery, orange-yellow. 75c. each.

Autumn. Novel and distinct in coloring, burnt orange streaked with red. \$1.00 each.

Betty. A superb rose with blooms of good size, full and globular, with a delightful fragrance. The color is a coppery-rose, over-spread with golden-yellow. An excellent Autumn blooming variety. 75c. each.

Betty Uprichard. Well formed, medium sized flowers of a pleasing combination of colors, the inside of petals being salmon-pink, the outside carmine with copper and orange suffusion. 75c. each.

Briarcliff. A wonderful improvement on the favorite pink variety, Columbia; splendid buds opening into flowers with high pointed centers of a beautiful bright clear rose-pink, sweetly scented; vigorous and free flowering. 75c. each.

Caledonia. The most desirable white; exceptionally long pointed bud opening to a very double, high centered, long lasting, very large, moderately fragrant flower. Continuous free bloomer. 75c. each.

Charles P. Kilham. Large, beautifully shaped blooms of brilliant orange-red, suffused with scarlet; slightly fragrant. Healthy foliage and a vigorous grower. 75c. each.

Columbia. One of the most popular roses, being a vigorous grower and very free flowering. The flowers are of a pleasing shade of rose pink, large, fragrant and perfect in form. 75c. each.

Dame Edith Helen. Shapely buds and substantial high centered blooms of clear pink, sweetly scented. A strong grower and very free flowering. See color plate opposite page 98. 75c. each.

Duchess of Athol. The coloring of this new variety is uncommon and delightful, golden-orange flushed with peach-pink. A vigorous grower and free bloomer. 75c. each.

Duchess of Wellington. Intense saffron yellow changing to coppery yellow. Flowers large, moderately full, of the Killarney type, beautiful buds and delightfully fragrant. A superb yellow rose and a splendid grower. 75c. each.

Edel. A British introduction of exhibition quality, producing large beautifully formed flowers of ivory-white passing to pure white. A strong grower of uniform habit, very free-flowering, opening in all weathers and delightfully fragrant. 75c. each.

Edith Nellie Perkins. A Rose of outstanding merit, vigorous in growth and free flowering. Long, pointed bud; flower of good size, long lasting and fragrant, double; outside of petals orient-red shaded cerise-orange, inside salmon-pink. \$1.00 each.

E. G. Hill. A new red variety, which has gained great popularity as a Winter cut-flower, but is equally good for the garden. The color is a bright scarlet shading to a deeper red as they develop; high centered, full double flowers; a vigorous grower and free flowering. 75c. each.

Eldorado. A beautiful clear yellow; very free flowering and fragrant. 75c. each.

Etoile de Hollande Brilliant red flowers of large size, perfect in half open state, showing clean, attractive centers when fully open; petals enormous; very fragrant. A strong, vigorous and healthy grower; very free flowering. 75c. each.

NOTE REDUCED PRICES. All varieties listed on this page at 75c. each will be supplied at \$7.50 per doz.; \$60.00 per 100 and those listed at \$1.00 each will be supplied at \$10.00 per doz.; \$80.00 per 100; 6 or more plants will be supplied at the dozen rate and 25 or more at the 100 rate. (wc)

GENERAL LIST OF MICHELL'S SELECT HYBRID TEA ROSES

Françis Scott Key. Large double flowers of rich crimson-red; a strong grower and very free flowering. 75c. each.

Gen. MacArthur. A well-known rose, being one of the earliest and most perpetual flowering sorts. The blooms are large, full and delightfully fragrant. In color it is a rich crimson scarlet; growth is vigorous. 75c. each.

Golden Dawn. The ideal yellow garden Rose. The ovoid lemon-yellow bud is heavily splashed with crimson before opening and develops into a well-formed, sweetly scented, large, double, sunflower-yellow flower that reminds one of the old favorite Marechal Niel. Vigorous and free flowering. \$1.00 each.

Golden Gleam. Exquisite, long shaped buds of buttercup-yellow, heavily marked with carmine-scarlet. The open flower is clear yellow without shading and comes on strong stems. A fine Rose for specimen blooms. There is a slight fruity fragrance. 75c. each.

Golden Ophelia. Golden yellow in center shading to pale yellow on the outer petals. This is a seedling of the well-known variety Ophelia, possessing its many good qualities. 75c. each.

Gruss an Teplitz. This is a rose for everybody, being the most profuse blooming crimson rose in existence. The color is of the richest scarlet, shading to a velvety crimson; very fragrant. It will succeed under the most ordinary conditions, doing well where other roses fail. 75c. each.

Hadley. One of the very best garden roses; deep rich velvety crimson in color and one of the most fragrant roses in our collection. Free bloomer with long stiff stems. 75c. each.

Hoosier Beauty. Glowing crimson-scarlet with darker shadings; buds of good length and splendid shape, opening into a magnificent and delightfully fragrant bloom. A strong, clean grower and very free flowering. 75c. each.

Imperial Potentate. Large ovoid bud; shapely flower, large, high centered, long lasting, sweet scented, deep lively rose-pink; vigorous grower and free flowering. 75c. each.

Impress. Very large, full, absolutely perfect blooms that last in perfection a long time; color salmon-cerise, suffused with a luminous golden sheen; the bud is large, of ovoid form, cardinal red, shaded orange. A strong grower; a free and continuous bloomer. \$1.00 each.

Joanna Hill. A new yellow rose with large, long pointed buds, which open to large full, semi-double flowers of a clear yellow, with orange-yellow center. A vigorous, upright grower and profuse bloomer. 75c. each.

Jonkheer J. L. Mock. A favorite with hundreds of Rose lovers. The flowers are large and of more than ordinary beauty. The deep imperial pink on the outside of the petals and the shining silvery pink on the inside make a double colored bloom. 75c. each.

Jules Gaujard. Beautiful, large, very lasting, cupped, intensely fragrant, glistening cochineal crimson flower, which, as it fully develops, passes to a pretty shade of orange-rose. A strong growing, free flowering, greatly admired garden rose. \$1.00 each.

Kaiserin Augusta Victoria. An old variety but still one of the best and it should be in every collection. In color it is a soft pearly white tinted with lemon. 75c. each.

Lady Alice Stanley. A rose that is admired by every one, not only for its freedom of bloom and fragrance, but also for its color, which is a beautiful shade of coral-rose on the outside of the petals with purple flesh on the inside. 75c. each.

Lady Ashtown. Extremely beautiful flowers of pale carmine-pink, shading to golden yellow at the base of the petals. The blooms are large, globular, and well formed, rather higher in the center than at the edge. 75c. each.

Lady Forteviot. Large, lasting, extremely fragrant, golden yellow flower, flushed with cardinal-red, borne several together on long stems; free and continuous bloomer. \$1.00 each.



Hybrid Tea Rose, Mme. Jules Bouche

Lady Hillingdon. One of the best Tea Roses of its color, deep apricot yellow throughout. It varies from medium to large size and is very beautiful both in bud and in flower. The plant is hardy, a strong grower and very floriferous. 75c. each.

Lady Margaret Stewart. A lovely new Rose which has won praise from all who have grown it. The bud is long, opening to a full double flower of pleasing fragrance, golden-yellow, shaded and veined with orange and red. Handsome, healthy foliage. 75c. each.

Los Angeles. One of the finest Roses ever introduced. In color a luminous flame pink toned with coral and shaded with translucent gold at the base of the petals. The buds are long, pointed and extend into a flower of mammoth proportions. The growth is vigorous to a degree. The beauty of the form and ever-increasing wealth of color are maintained from the incipient bud until the last petal drops. 75c. each.

Lucie Marie. Very long pointed buds, deep yellow, splashed rosy-red; as the outer petals unfold the inner face is yellow with coppery venation, with the petals lightly tipped with pink, slightly fragrant. A strong vigorous grower with dark leathery foliage. A most distinct and interesting bedding variety. \$1.00 each.

Mme. Butterfly. While this is a sport of Ophelia, it shows an even better growth, with more and larger flowers, in a brilliant pink, suffused apricot and gold. These flowers are in the ideal Rose form, of good texture and fragrance, and are unusually enduring. The plant is free and fine in growth and habit. 75c. each.

Mme. Caroline Testout. One of the most popular and valuable bedding varieties; large globular flowers of bright satiny rose with brighter center. Strong vigorous grower; very free flowering and fragrant; particularly fine in Autumn. 75c. each.

Mme. Edouard Herriot. This is the celebrated "Daily Mail" rose which has been so extensively advertised. In color it is coral red, shaded yellow and bright rosy scarlet, with yellow at the base; a wonderful combination of most pleasing colors. 75c. each.

Mme. Jules Bouche. Beautiful white flowers, sometimes shading to light blush in the center. One of the best white bedding Roses to date. 75c. each.

NOTE REDUCED PRICES. All varieties listed on this page at 75c. each will be supplied at \$7.50 per doz.; \$60.00 per 100 and the varieties listed at \$1.00 each will be supplied at \$10.00 per doz.; \$80.00 per 100; 6 or more plants will be supplied at the dozen rate and 25 or more at the 100 rate.

(wc)

MICHELL'S "GORGEOUS EVERBLOOMING" HARDY HYBRID TEA ROSES



Miss Rowena Thom

Radiance

Dame Edith Helen

Michell's Gorgeous Everblooming Hardy Hybrid Tea Roses, in extra strong pot-grown plants, that will bloom profusely this year:

	Each	Doz.	100
Dame Edith Helen	\$0.75	\$7.50	\$60.00
Miss Rowena Thom	.75	7.50	60.00
Radiance	.75	7.50	60.00

GENERAL LIST OF MICHELL'S SELECT HYBRID TEA ROSES

Mme. Nicolas Aussel. In color a bright coppery-red, in the very long, shapely, tapering bud that develops into a large, fragrant, full double flower of an exquisite opalescent salmon-pink. Growth vigorous and healthy, free and continuous bloomer. Awarded a Gold Medal as the most beautiful Rose in France during a contest in 1931. \$1.00 each.

Margaret McGredy. Bud very large and long pointed; flower large, shapely, long lasting, very double, fragrant and brilliantly colored. A rich shade of Oriental-red passing as it ages to carmine-rose; vigorous and free flowering. 75c. each.

May Wettren. A magnificently formed bud and flower of moderate fullness and artistic coloring. The flowers are composed of immense, deep, wide petals of very solid texture, their formation making a beautifully built long bud and high pointed flower, in which the inner face of the petals evolves from a bright salmon-pink in the bud to deep flesh-pink, then to bright pink in the developed flower. 75c. each.

Mevrouw G. A. Van Rossem. A beautiful rose with unique color combination, a blending of dark orange and apricot on a yellow ground with touches of bronze on the reverse of the petals. The flowers are sweet scented, large and of perfect form. 75c. each.

Miss Rowena Thom. Large, long pointed buds developing into perfect flowers; color, a blending of fiery rose and rosy mauve, together with old gold. A vigorous upright grower and a profuse bloomer. See color plate opposite page 98. 75c. each.

Mrs. Aaron Ward. A very free blooming variety of vigorous but compact growth. The flowers, which are of splendid form, are full double and are equally attractive when in full bloom as in the bud state. The color is a distinct Indian yellow which under certain conditions becomes yellow tinted white. A favorite everywhere. 75c. each.

Mrs. A. R. Barraclough. One of the finest recent introductions; very large pointed buds of a pleasing carmine-pink shaded with clear light yellow at the base of the petals, opening into a full double flower; very fragrant. 75c. each.

Mrs. Erskine Pembroke Thom. The best yellow bedding Rose to date, long shapely buds of large size develop into full double flowers, deep lemon yellow in color and sweetly scented. A clean vigorous grower with disease-resisting foliage; very free flowering. 75c. each.

Mrs. Henry Bowles. One of the best bedding varieties, always in flower and perfect in all stages of development; the color is a brilliant pink with salmon shadings. 75c. each.

Mrs. Henry Morse. One of the best light pink varieties; high centered flowers of two contrasting tones of pink; very free flowering and fragrant. 75c. each.

Mrs. J. D. Eisele. (U. S. Plant Patent No. 67.) The buds, the expanding flowers, as well as the fully developed blooms, of this Rose are absolutely perfect in every stage of development. This is due to the unfurling petals of the long pointed buds which are arranged in spiral form, reflexing as they unfold, giving the fully developed flower, which is from five to six inches in diameter, the most perfect Camellia-like formation. Aside from its beautiful shape it is a Rose of exceptional keeping qualities, the cut blooms lasting fully a week in good condition. In color it is a luscious shade of cherry-rose overlaid with a scarlet glow, this brilliancy being particularly intense under artificial light. We have in this Rose the most delightful fragrance, to such an extent that only a few flowers in a vase will serve to permeate the entire atmosphere of the room with their sweet fruity odor, resembling that of the noted old Tea Roses of fifty years ago. Growth strong, vigorous, erect, of branching habit, very free and a continuous bloomer. \$1.50 each, \$15.00 per dozen.

Mrs. John Bell. A vivid brilliant shade of cochineal-carmine with large, long pointed bud and full double, cupped, moderately fragrant flower. Vigorous, free flowering habit. 75c. each.



Hybrid Tea Rose, Pink Pearl

Mrs. Sam. McGredy. The color of this beautiful variety is quite distinct from anything yet seen in Roses, a wonderful dual combination of vivid shades. A beautiful scarlet coppery-orange is heavily flushed with Lincoln-red on the outside of the petals and these colors together give a rich and dazzling effect. The flowers are of large size and beautiful form and they possess the proper fullness to make them useful for all purposes. They are freely produced and delicately perfumed. The plant has a vigorous and exceptionally free habit; one of the best all-purpose Roses. \$1.00 each.

Mrs. Wakefield Christie-Miller. Large, globular, peony-flowered blooms of pearly blush, shaded salmon-pink, the outside of the petals being vermilion and rose, which lovely combination is not affected by the hottest sun. Plants strong, of erect and vigorous growth, and with a blooming habit taking it clear through the season and until late Autumn. Should be in every selection for the garden. 75c. each.

Olympiad. One of the most brilliant. Dark lustrous Oriental scarlet, accentuated by a bright golden base. Awarded Gold Medals at the great Atlantic City Pageant, September, 1931, at the International Show in New York and Sweepstakes prize at Philadelphia Show in March, 1932. \$1.00 each.

Pink Pearl. Brilliant cerise-pink, the base of the petals touched with gold, lighting up the flower wonderfully; the flowers are full double, of perfect form, very sweet scented and produced freely. 75c. each.

President Hoover. A wonderful new rose with a splendid color combination, cerise-pink, flame, scarlet and yellow. Long pointed buds, moderately fragrant, free flowering and a good grower. 75c. each.

Radiance. A Rose of American origin and to our mind one of the very best varieties in cultivation today. It is an ideal bedder, producing large flowers throughout the Summer when many other varieties are out of bloom; in color a beautiful even shade of pink. This Rose should be in every garden. See color plate opposite page 98. 75c. each.

Red Radiance. A counterpart of Radiance from which it is a "sport," possessing all of the good points of that valuable variety, but differing in color, which is bright cerise-red. 75c. each.

NOTE REDUCED PRICES. All varieties listed on this page at 75c. each will be supplied at \$7.50 per doz.; \$60.00 per 100 and those listed at \$1.00 each will be supplied at \$10.00 per doz.; \$80.00 per 100; 6 or more plants will be supplied at the dozen rate and 25 or more at the 100 rate.

GENERAL LIST OF MICHELL'S SELECT HYBRID TEA ROSES

Rev. F. Page Roberts. Long-pointed, coppery-red buds opening into golden-yellow flowers, stained with red on the outside; fully double, very large and fragrant. A strong branching plant with good healthy foliage. 75c. each.

Rosella Sweet. Large ovoid bud developing to a splendid large, well-formed, attractive flower of a luminous capucine-yellow, with delicate salmon-pink suffusion and with a delicious fragrance. The fine flowers are borne singly on strong stiff stems; the plant is of vigorous upright habit with healthy dark green glossy foliage. \$1.00 each.

Rose Marie. One of the best bedding roses. It produces beautiful long buds which open into large flowers of perfect form and of a pleasing clear rose-pink in color. 75c. each.

Roslyn. Full golden-yellow flowers, deeper in the center with orange splashings on the reverse of the petals. Can be cut with long stems; fragrant. \$1.00 each.

Schwabenland. There are many pink Roses but none just like this new variety, either in color or in the splendid formation of its blooms. The flowers are large, over five inches in diameter, with a high spiral center, the petals having a peculiar twist or curl. In color it is a luminous, rich rose-pink, retaining its brightness until the petals drop; the flowers are carried singly on long stiff stems. A strong, healthy, hardy, vigorous grower and free flowering. \$1.00 each.

Sensation. Splendid large crimson-scarlet, perfect in its long pointed bud as well as in the fully developed, sweetly scented, double flower. A strong vigorous grower. 75c. each.

Souvenir de Claudius Pernet. A most vigorous grower of erect branching habit; beautiful, brilliant green foliage; long pointed buds of exquisite shape, carried on long, stiff stems. Very large full flowers with elongated deep petals, a beautifully formed bloom. Color, a most striking sunflower-yellow, deeper in the center without any color blending and which is retained without fading even in the warmest weather. 75c. each.

Souv. de Georges Pernet. A strong vigorous grower and free bloomer. The flowers are large; globular in form; color, Orient red shading to a cochineal-carmine at the end of the petals, the whole being suffused with a golden sheen. 75c. each.

Sunburst. A vigorous grower with erect or slightly spreading habit and dark bronzy foliage. The flowers are of medium size, full and of fine elongated cup form; color a superb cadmium-yellow passing to yellow-orange in the center. 75c. each.

Talisman. A new American rose of exceptional coloring; the outside of the petals is bright yellow, gold and pink; as the flower opens it becomes bright apricot, gold and rose-pink. The bud is long, pointed and opens into a full double flower. A strong grower with glossy foliage and very free flowering. Price, strong 2-year-old plants, 75c. each.

Ville de Paris. Pure yellow without a trace of any other color, standing up under all weather conditions; round buds and large globular flowers, somewhat similar to Radiance, fairly double and splendid for cutting. Plant is tall, upright and a free bloomer. 75c. each.

Wilhelm Kordes. Unique and entirely distinct in color; a rich capucine-red with coppery suffusion overlying a golden-salmon ground, long pointed buds, opening to high centered very fragrant flowers. 75c. each.

HARDY HYBRID PERPETUAL ROSES

Before the development of the Hybrid Teas, this was the most popular type for garden planting and even now they should not be overlooked, but should be used extensively in conjunction with the other sorts. They are perfectly hardy and of vigorous growth, blooming tremendously in June and sometimes sparingly in Autumn. Hybrid Perpetuals are taller in growth and need more space than the Hybrid Teas; in pruning cut away all weak growth, and if quality of bloom is desired, cut back the strong canes to within 8 or 9 inches of the ground, but if quantity of bloom for garden effect is desired, leave these canes from 2 to 3 feet high, according to their strength.

American Beauty. Very large flowers, deep pink to carmine-cerise, delicately veined with darker red. A strong grower and deliciously fragrant. 75c. each.

Frau Karl Druschki. This is the queen of all white roses both in size and purity. The flower is very double and opens to a pure snow white. The growth is vigorous and the plant is a most prolific bloomer during the month of June. Scattering flowers often appear in the Fall. 75c. each.

George Ahrends. One of the best pink Hybrid Perpetual Roses. The flowers are large and a beautiful pure delicate pink; a strong grower and very free flowering. This variety is sometimes called "Pink Druschki." 75c. each.

Gen. Jacqueminot. The old favorite "Jack" rose is still popular. The blooms are large, full and globular, having an excellent cup-shaped form; in color they are brilliant scarlet crimson, with deep veining toward the base of the petals. 75c. each.

Mme. Albert Barbier. This remarkable variety in its habit of flowering is as free as many of the popular Hybrid Tea Roses. Growth strong and vigorous, the buds are long and well formed, of a pearly-white suffused with soft, salmony-flesh and develop into large, full double imbricated flowers of splendid form, which as they expand show a golden-apricot suffused center. A gem in every respect. 75c. each.

Magna Charta. An old variety of great merit. The blooms are of large size, in color a bright pink suffused with carmine. It is very fragrant and free flowering. 75c. each.

Mrs. John Laing. Beautifully formed shell-pink flowers; exceedingly fragrant and borne on strong stems; splendid for cutting. A good grower and one of the most popular roses. 75c. each.

Paul Neyron. Probably the largest rose in cultivation; in color a clear pink shading to soft rose and having a delightful fragrance. A strong vigorous grower. 75c. each.

Ulrich Brunner. Bright cherry red flowers of large size and good form, produced freely on long stems. An old favorite and very desirable. 75c. each.



Hybrid Perpetual Rose, Ulrich Brunner

NOTE REDUCED PRICES. All varieties listed on this page at 75c. each will be supplied at \$7.50 per doz.; \$60.00 per 100 and the varieties listed at \$1.00 each will be supplied at \$10.00 per doz.; \$80.00 per 100; 6 or more plants will be supplied at the dozen rate and 25 or more at the 100 rate. (wc)

HARDY CLIMBING AND RAMBLER ROSES

As an ornamental plant for covering verandas, porches, side walls, pillars, fences, etc., these are unequalled, calling forth more admiration than anything else that can be used. They require no pruning in the Spring beyond the cutting out of very old or dead wood and shortening of the laterals and long canes to make the growth conform to the space to be covered, but a severe pruning in July directly after they have finished flowering is beneficial. Cutting away at that time all old flowering wood will encourage a vigorous growth which will give an abundance of flowers the following season.

Albertine. A most pleasing shade of cameo-pink with salmon suffusion; moderately double, sweetly scented flowers, produced early in the season; healthy, glossy foliage. 75c. each.

Alida Lovett. An extra strong sort, producing bright, shell-pink flowers, tinted yellow at the base and of Hybrid Tea shape and size. 75c. each.

American Pillar. The large single flowers are a lovely shade of cherry pink, with a clear white eye surrounding numerous golden yellow stamens. 75c. each.

Bess Lovett. Resembles Climbing American Beauty in shape of flowers but much brighter in color, being a clear bright red, double, full cupped form and of notable lasting quality. 75c. each.

Chaplin's Pink Climber. A striking novelty, similar in size and form to Paul's Scarlet Climber but in color a rich, lively pink. We believe this to be one of the best climbing Roses to date. 75c. each.

Christine Wright. A beautiful rose of strong climbing habit, producing double flowers 3 to 4 inches in diameter, singly and in clusters, of a wild rose pink. 75c. each.

Climbing American Beauty. The name of this rose is rather misleading, yet on its own merits it is a splendid climber. It has but one blooming season, June, when it bears abundantly, bright self-colored, medium pink flowers of moderate size. 75c. each.

Dr. W. Van Fleet. One of the most important climbing roses, having perfectly formed buds, long pointed, flesh pink in color and very solid. The full bloom flowers are very large, borne on long stems, fragrant and fine for cutting. 75c. each.

Dorothy Perkins. Beautiful shell pink, fragrant and full, blooming in clusters in June. The most popular of all climbing roses during the past few years. This is a very good rose for covering stone walls, fences, embankments and arbors. 75c. each.

Emily Gray. A real yellow climbing rose, producing long pointed buds opening to large orange-yellow flowers with stems long enough for cutting. These stems are crimson-red in color, contrasting beautifully with the dark green, glossy, holly-like foliage. 75c. each.

Excelsa. Here we have a worthy successor to Crimson Rambler, being equally as free flowering as that variety but without its unsatisfactory foliage. Really the best double red rambler. 75c. each.

Gardenia. Buds bright yellow, opening to double flowers of cream color; incurves towards evening to the shape and color of a Cape Jessamine, hence its name. 75c. each.

Jacotte. A wonderful new yellow climbing rose with bright glossy green foliage and sweet-scented orange-yellow flowers. 75c. each.

Mme. Gregoire Staechelin. The new climbing Rose from Spain; gorgeously colored and exquisitely perfumed; its color is iridescent, pearl-pink with claret-carmine markings on the outer petals. Perfectly hardy, and has large, disease-resistant foliage. 75c. each.

Mary Lovett. One of the best white climbing Roses, producing fragrant white flowers on long, strong stems. Very free flowering. 75c. each.



An Arch of Climbing Roses

Mary Wallace. Long pointed buds and very large, cupped semi-double flowers, clear rose-pink in color. A strong grower and very free flowering. 75c. each.

Paul's Scarlet Climber. No other rose in any class can compare with it for brilliancy of color, which is a vivid scarlet that is maintained without burning or bleaching until the petals fall. 75c. each.

Phyllis Bide. A dainty, exquisitely formed small bud and flower with reflexed petals; color pale yellow, tinted with tones of pink and deep rosy tips. Its graceful sprays of interesting pretty flowers appear intermittently throughout the season. Particularly nice as a pillar Rose and admired by everyone. 75c. each.

Primrose. A real hardy yellow rambler, in color a light primrose-yellow, holding this color until the petals drop. The flowers are about 2½ inches in diameter and are borne in trusses of from two to five on long stems. 75c. each.

Silver Moon. An indispensable hardy climber, having long, well-shaped buds, creamy yellow on first appearance, opening into immense Clematis-like flowers of a waxy whiteness. The center is a mass of bright yellow stamens, making a wonderful contrast. 75c. each.

Tausendschoen. The individual flowers are of a most elegant and graceful form. In color it is a most delicate shade of soft pink when first opening, changing to carmine on the reverse of the petals when fully expanded. The flowers are produced in trusses, each truss almost a bouquet in itself. 75c. each.

The Beacon. A distinct and effective bright fiery red with white eye, single and semi-double flowers, produced in large clusters; handsome foliage. 75c. each.

White Dorothy. A handsome pure white sport from the old favorite Dorothy Perkins, and it has all of the finer qualities found in that charming variety. 75c. each.

ROSE INSURANCE

Can be best supplied if you use the celebrated formulas of Edwin M. Rosenbluth in **Fungtrogen**, **Insectrogen** or **Aphistrogen**, see page 179.

NOTE REDUCED PRICES. All varieties listed on this page at 75c. each will be supplied at \$7.50 per doz.; \$60.00 per 100 and those listed at \$1.00 each will be supplied at \$10.00 per doz.; \$80.00 per 100; 6 or more plants will be supplied at the dozen rate and 25 or more at the 100 rate. (wc)



Climbing Hybrid Tea Rose, Lady Ashtown

CLIMBING HYBRID TEA ROSES

These are not quite as free flowering as the bush type of Hybrid Tea Roses, but they produce a large crop of beautiful flowers in June with a quite liberal scattering of flowers throughout the season. In pruning these cut out all small thin wood and cut the strong shoots back to prominent eyes.

Climbing Gruss an Teplitz. An exact counterpart of this most popular bush rose, excepting that it is of a vigorous climbing habit. The flowers are crimson-scarlet and produced in great quantities. \$1.00 each.

Climbing Hoosier Beauty. A climbing form of this beautiful Rose. Brilliant crimson scarlet flowers of exquisite form; long bud and very fragrant. \$1.00 each.

Climbing K. A. Victoria. A climbing form of this popular white Rose. \$1.00 each.

Climbing Lady Ashtown. The best of all climbing H. T. varieties; a wonderful grower, producing throughout the entire season, numerous soft rose-colored flowers; fine for cutting. \$1.00 each.

Climbing Lady Hillingdon. Like the parent the flowers are of a deep clear apricot throughout. It is of a strong climbing habit and very free flowering. One of the best Autumn bloomers. \$1.00 each.

Climbing Los Angeles. A decided acquisition to the list of Climbing Hybrid Tea Roses. A sport from this most popular variety, producing freely beautiful flowers of a luminous flame-pink toned with coral, shading to yellow at the base of the petals. \$1.00 each.

Climbing Mme. Edouard Herriot. A climbing form of the popular coral-pink Daily Mail Rose. \$1.00 each.

Climbing Mrs. Aaron Ward. A climbing form of this popular Indian-yellow variety. \$1.00 each.

Climbing Radiance. Identical with its popular parent but of a climbing habit. A very good pillar Rose. \$1.00 each.

Climbing Rose Marie. A climbing form of the attractive rose-pink bedding variety. \$1.00 each.

Climbing Sunburst. A true Sunburst of climbing habit. \$1.00 each.

Climbing Talisman. A climbing form of this exceedingly popular Rose. \$1.00 each.

Kitty Kininmonth. An attractive bright fadeless pink with large buds and very large cupped flowers; very vigorous. \$1.00 each.

Miss Marion Manifold. A brilliant rich crimson. \$1.00 each.

THREE NEW AMERICAN HARDY CLIMBING ROSES

BLAZE

U. S. Plant Patent No. 10

The New Hardy Everblooming Scarlet Climbing Rose

A marvelous new hardy climbing Rose which inherits the blazing color of Paul's Scarlet Climber and the everblooming habit of Gruss an Teplitz, thus combining the most attractive features of both of its parents. It is a very vigorous climbing variety which will grow to considerable height and produce flowers on both the old and new growth. A rose that is sure to become very popular.

Strong two-year-old plants \$2.00 each; \$20.00 per dozen.

GOLDEN CLIMBER

U. S. Plant Patent No. 28

(Mrs. Arthur Curtiss James)

A new departure in hardy climbing Roses, the first true golden yellow climber of quality bloom, able to withstand sub-zero temperature without injury.

The most interesting and unusual feature is that the resistance to sub-zero temperature is combined with blooms of Hybrid Tea type and quality, most always solitary on long stems often 18 inches in length.

The plant does not bloom itself out in one short outburst but the buds appear and bloom in succession for a long season; after the first bloom the plants show continued floral activity and recurrent blooms come forth, when the plants are well established.

The color in the bud is true golden yellow with heavy markings of orange-scarlet showing between the sepals; these splashes gradually disappear and the full open flower is solid golden-yellow, semi-double with a heavy cushion of yellow stamens, the petals are unevenly ruffled, beautifully crinkled and informally curled. The Roses are long lasting as cut-flowers or on the bush and exhale at all times a delightfully delicate fragrance. Of extreme vigor and handsome foliage the plant will soon cover a large area, whether on a fence, trellis, wall or pergola.

Strong two-year-old plants, \$2.00 each; \$20.00 per dozen.

THE NEW DAWN

U. S. Plant Patent No. 1.

(The Everblooming Dr. Van W. Fleet)

This new Rose is a sport from Dr. Van Fleet which is universally acknowledged to be one of the best and most popular American Climbing Roses. This new variety is identical in every way with its parent in size and formation of its long pointed flesh pink buds and double flowers, but blooms continuously throughout the Summer and Autumn months.

Strong two-year-old plants \$1.50 each; \$15.00 per dozen.

ROSA HUGONIS (Golden Rose of China)

This Chinese native is a notable contribution to American gardens. Every branch of the previous year's growth is, in late April or early May, closely set on both sides to the very tip with exquisitely beautiful, single, clear yellow flowers. The long, arching sprays make Hugonis not only a beautiful shrub, to be planted, if one so prefers, with other shrubs, but when cut are charming as table decoration.

This "Golden Rose of China" is ruggedly hardy everywhere in America. It needs neither protection nor pruning, save in the occasional cutting out of the older shoots. Do not plant it among Roses as it is too vigorous in growth to fit in such a planting. 75c. each.

ROSA ROULETTI (Rock Garden Rose)

A unique little Rose discovered in Switzerland; very dwarf and blooming from May until November; tiny, double, rose-pink flowers less than one-half inch in diameter. \$1.00 each.

NOTE REDUCED PRICES. All varieties listed on this page at 75c. each will be supplied at \$7.50 per doz.; \$60.00 per 100 and the varieties listed at \$1.00 each will be supplied at \$10.00 per doz.; \$80.00 per 100; 6 or more plants will be supplied at the dozen rate and 25 or more at the 100 rate. (wc)



Rock gardens are yearly increasing in popularity, as rockery building is a fascinating pastime, and if one has only a few square yards of ground this will be found sufficient to grow quite a variety of plants, affording a great deal of pleasure in caring for them and watching the rockery develop.

One of the most interesting points of the rockery or rock garden is that each of us may build it according to our own ideas, providing it is correctly built as to drainage and the proper placing of the rocks in order to keep the soil in place.

The rock garden may be of any size from an unpretentious mound of soil with rocks cropping out here and there, to a miniature mountain range or a rock-strewn valley with a small stream running through the center. Before building the rock garden, the location should be selected in an open sunny place or one in partial shade, according to the variety of plants desired; some do best in full sunlight while others require some shade. In either location the ground must be well drained.

The next step is to plan the rockery as to size and shape. Do not use too much stone, too little is better than too much, and use stones of a good size; small stones are of no use except for filling in or drainage. Place the stones so that they will keep the soil from washing when watering or during heavy rains.

Place the plants in the pockets of soil or in the open spaces between the rocks. Be sure, however, that the soil is firm around the roots of the plants.

Below will be found a list of plants we offer suitable for rock garden planting.

ACHILLEA—*Millefolium Cerise Queen* (*Rosy Milfoil*). Finely cut, deep green foliage; flowers cherry red in dense heads.

—*Ptarmica Boule de Neige* (*Ball of Snow*). An improvement on The Pearl; the flowers are of more perfect form.

—*The Pearl*. A mass of double pure white flowers throughout the entire Summer; one of the best for cutting.

—*Tomentosa* (*Wooley Yarrow*). Handsome cut foliage with bright yellow flowers. June; 12 inches.

AETHIONEMA—*Persicum* (*Lebanon Candytuft*). Beautiful shrubby alpines of spreading habit. Rose-colored flowers from May to August. 3 for \$1.00 (by P. P., \$1.10); \$3.50 per doz.

ALYSSUM—*Saxatile Compactum*. Grows about 10 inches high and producing in May masses of golden yellow flowers.

ANCHUSA—*Myosotidiflora*. A distinct dwarf variety from the Caucasian Mountains, with clusters of pretty blue forget-me-not-like flowers, in May. 12 inches.

ANEMONE—*Hupehensis*. Wonderfully free flowering from early August until late Autumn. A pleasing mauve-rose.

—*Pulsatilla*. An interesting plant for the rockery or border, producing violet or purple flowers, during April and May; 9 to 12 inches.

AQUILEGIA—*Michell's Long Spurred Hybrids*. The flowers of largest size vary in color through charming tones of cream, pink, lavender, blue, white, red, etc.

—*Alpina*. A rich blue variety; 2 feet.

—*Canadensis* (*Common American Columbine*). The native bright red and yellow variety, and one of the brightest.

—*Chrysantha* (*Golden Columbine*). Bright yellow, long-spurred flowers.

—*Coerulea* (*Rocky Mountain Columbine*). Bright blue and white long-spurred flowers.

—*Nivea Grandiflora*. A fine white, strong growing and very free flowering.

AQUILEGIA—*Rose Queen*. A newer variety of a pleasing shade of delicate pink, long-spurred flowers.

ARABIS—*Alpina* (*Rock Cress*). One of the most desirable of the very early Spring-flowering plants, completely covered with pure white flowers. Last for a long time in bloom.

ARENARIA—*Montana* (*Sandwort*). A very desirable creeping plant, forming a dense carpet of foliage, covered with attractive white flowers in Spring.

ARMERIA. Attractive dwarf plants forming evergreen tufts from which appear innumerable flowers on stiff, wiry stems.

—*Lauchiana Rosea*. Bright rose.

ASCLEPIAS—*Tuberosa*. Very showy native plants, producing their flowers of brilliant orange-scarlet during July and August.

ASTER—*Alpinus*. Grows 6 to 10 inches high and bears large, showy bluish-purple flowers in May and June.

—*Alpinus Albus*. Identical to the above, but with pure white flowers.

—*Mauve Cushion*. It forms a circular cushion-like plant with flowers of delicate, soft mauve which are produced in such lavish profusion as to completely cover the plant; blooms in October and November.

—*Sub-coeruleus*. Forms a dense tuft of leaves from which spring many leafless stems 12 inches high, bearing in June and July large, bluish-violet flowers.

AUBRIETIA—*Deltoides* (*Rainbow Rock Cress*). Neat compact plants covered with closely set lilac flowers.

CAMPANULA—*Carpatica* (*Carpathian Hare-bell*). A pretty compact growing variety with flowers of clear blue on erect wiry stems, from July to October. An ideal edging for the border or rockery.

—*Alba*. A pure white form of the above.

—*Garganica*. Forms a low spreading tuft, covered in June with star-shaped light blue flowers with white eyes.

Price, any of the above (except where noted), 4 for \$1.00 (by P. P., \$1.10); \$2.50 per doz.; per 100, \$15.00.

- CERASTIUM—Biebersteini** (*Snow in Summer*). A desirable low-growing plant; silvery foliage and pure white flowers in June.
- CHRYSANTHEMUM—Arcticum** (*The Arctic Daisy*). One of the most attractive Fall-flowering perennials. It forms a rosette-like clump of pretty dark green foliage and early in the Fall sends up multitudes of large pure white flowers.
- DELPHINIUM—Chinense**. A very pretty dwarf species, with fine feathery foliage and intense gentian-blue flowers.
- Album**. A pure white form of the above.
- DIANTHUS (Pinks)—Deltoides** (*Maiden Pink*). A continuous flowering variety with pink flowers.
- Deltoides Alba**. White flowers.
- Latifolius Atrococcineus Fl. Pl.** (*Everblooming Hybrid Sweet William*). A splendid variety with brilliant crimson, double flowers. Blooms continuously during the entire season.
- DIELYTRA—Eximea** (*Fringed Bleeding Heart*). A dwarf variety with ornamental cut foliage and showy pink flowers until August.
- ERODIUM—Chamaedryoides**. A tiny alpine plant in flower throughout the season. Forms tufts of pretty glossy leaves covered with delicate pink, veined flowers on 2-inch stems. 50c. each (by P. P., 60c.); per doz., \$5.00.
- EUPHORBIA—Corollata** (*Flowering Spurge*). A very desirable native plant, growing about 18 inches high and bearing from June to August umbels of pure white flowers, small green eye.
- Polychroma**. An elegant border plant and very attractive when covered with masses of yellow flower-like bracts in May.
- HARDY FERNS—Adiantum Pedatum** (*Maidenhair Fern*). 12 inches.
- Aspidium Acrostichoides** (*Christmas Fern*). 12 inches.
- Goldianum** (*Shield Fern*). 24–36 inches.
- Asplenium Filix Foemina** (*Lady Fern*). 12–15 inches.
- Cystopteris Bulbifera** (*Bublet Bladder Fern*). 24 inches.
- Dicksonia Punctilobula** (*Gossamer Fern*). 18 inches.
- Onoclea Struthiopteris** (*Ostrich Fern*). 24–36 inches.
- Sensibilis** (*Sensitive Fern*). 12 inches.
- Osmunda—Cinnamonea** (*Cinnamon Fern*). 24 inches.
- Claytoniana**. 24 inches.
- Woodsia Illvensis**. Excellent for rock-work, requiring little soil and thriving best in the sunniest corner. 6 inches.
- GEUM—Coccineum Mrs. Bradshaw**. Twice the size of the old double scarlet with huge frilled petals. 6 to 10 inches.
- Lady Stratheden**. Exactly the same habit of growth as Mrs. Bradshaw, but producing large, double golden yellow flowers.
- GYPSOPHILA—Repens**. A beautiful trailing plant for the rockery with clouds of small pink and white flowers during July and August.
- HELIANTHEMUM—Perry's Hybrids** (*Rock or Sun Rose*). Low growing evergreen plants, forming broad clumps, which during their flowering season, July to September, are a mass of bloom.
- HEUCHERA—Sanguinea**. Bright crimson flowers, borne in graceful sprays; excellent for cutting. 3 for \$1.00 (by P. P., \$1.10); \$3.00 per doz.; per 100, \$18.00.
- IBERIS—Little Gem**. Pure white flowers; 1 foot.
- IRIS CRISTATA** (*Crested Dwarf Iris*). A tiny native species growing from 4 to 6 inches high with delicate, richly marked pale lilac flowers, blooms late in May and June.
- IRIS PUMILA—Cyanea**. Rich violet purple.
- Floribunda**. Creamy yellow.
- Schneekuppe**. Pure white.
- LINUM—Perenne**. A desirable plant for the hardy border or rockery; light graceful foliage and large blue flowers all Summer.
- LYCHNIS—Viscaria**. Forms a dense tuft of evergreen foliage, and in June sends up spikes of handsome, double deep red flowers.
- LYSIMACHIA—Nummularia** (*Creeping Jenny, or Money-wort*). Valuable for planting under trees or shrubs where grass will not grow, where it quickly forms a dense carpet.
- MERTENSIA—Virginica** (*Blue Bells*). An early Spring flowering plant growing 1 to 1½ feet high with drooping panicles of handsome light blue flowers fading to clear pink; May and June.
- MYOSOTIS—Palustris Semperflorens** (*Perpetual Flowering Forget-me-not*). Blue with yellow throat; damp places.
- NEPETA—Mussini**. A compact grower, forming tufts of small violet-blue flowers during July and August.
- NIEMBERGIA—Rivularis** (*Cup Flower*). A lovely dwarf creeping plant with large cup-shaped flowers from June to September.
- OENOTHERA**—The evening Primroses are elegant subjects for growing in an exposed sunny position.
- Missouriensis**. Large golden-yellow. 1 foot.
- Youngi**. Bright yellow flowers. 18 inches.
- PAPAVER—Alpinum** (*Alpine Poppy*). Like a small and more delicate Iceland Poppy in various shades of pink, white, orange and yellow, often delicately fringed. 3 for \$1.00 (by P. P., \$1.10); \$3.50 per doz.
- PHLOX—Amoena**. A beautiful plant, with soft rose-colored flowers in April or May. 4 inches high.
- Divaricata Canadensis**. A patch of these makes a Spring show hard to describe. The large heads of fragrant lavender flowers appear the latter part of April and in May.
- PHLOX SUBULATA** (*Moss Pink*). Moss evergreen-like foliage, tucking close to the ground and covered completely with white star-like flowers in May.
- Alba**. Pure white flowers.
- Rosea**. The same as above but with pink flowers.
- Vivid**. A new introduction with bright rose-colored flowers.
- PLUMBAGO—Larpentae**. One of the most desirable border and rock plants; it is of dwarf, spreading habit, growing 6 to 8 inches high, covered with deep blue flowers during the Summer and Fall.
- PRIMULA—Veris** (*English Cowslip*). Various shades of red and yellow; a splendid plant for the Spring blooming garden.
- Vulgaris** (*English Primrose*). Beautiful light canary yellow; long flower stems with large trusses.
- 3 for \$1.00 (by P. P., \$1.10); \$3.00 per doz.; per 100, \$18.00.
- RANUNCULUS—Repens Fl. Pl.** (*Bachelor's Buttons*). A pretty double flowering, bright golden buttercup, bearing masses of flowers during May and June.
- ROSA—Rouletti** (*Rock Garden Rose*). A unique rose from Switzerland; double, rose-pink flowers less than one-half inch in diameter. \$1.00 each (by P. P., \$1.10).
- SAPONARIA—Ocymoides Splendens** (*Soap Wort*). A good rock plant, producing masses of bright rose-pink flowers.
- SAXIFRAGA—Cordifolia**. Rosy-pink flowers. 3 for \$1.00 (by P. P., \$1.10); \$3.50 per doz.; per 100, \$25.00.
- SEDUM—Acre** (*Golden Moss*). Much used for covering; has green foliage and bright yellow flowers.
- Album**. Dark green foliage with pure white flowers in June.
- Ibericum**. Numerous deep rose-pink flowers; green foliage.
- Lydiu Glaucum**. Glauous green foliage and pink flowers.
- Oppositifolium**. Pinkish white flowers and dark green foliage.
- Sieboldi**. Round succulent glaucous foliage with bright pink flowers during August and September.
- Stahli**. A species with compact crimson foliage in the Autumn.
- SEMPERVIVUM** (*House Leek*). Most attractive, hardy succulent plants for the rock garden and rock wall. The small clumps spread slowly, filling pockets and crevices between the rocks.
- Arachnoideum**. Rosettes cobwebbed; flowers pale purple.
- Fimbriatum**. Medium rosettes, tipped red.
- Globiferum**. Flattened rosettes, two to three inches in diameter, of gray-green leaves, lightly tipped brown; pale yellow flowers.
- Sobiliferum**. Flat compact growth with incurving petals turning to red and brown in the Autumn.
- Tectorum**. Broad rosettes, the leaves having reddish-brown tips, flowers deep pink.
- STATICE—Latifolia** (*Great Sea Lavender*). Handsome plants with heads of dark blue flowers; invaluable for cutting.
- STOKESIA—Cyanea**. Very light blue.
- Cyanea Alba**. Pure white.
- THYMUS—Citriodorus** (*Lemon-Scented Thyme*).
- Languinosus** (*Wooley Leaved Thyme*). Grayish foliage and rosy-lilac flowers.
- Album** (*White Mountain Thyme*). Forms a dense mass of dark green foliage and clouds of white flowers, during June and July. 3 to 4 inches.
- Coccineum**. Plants become completely covered with brilliant crimson-scarlet flowers.
- TRILLIUM—Grandiflorum** (*Wood Lily, or Wake Robin*). The largest white; probably the handsomest. 6 for \$1.00 (by P. P., \$1.10); \$1.50 per doz.; per 100, \$10.00.
- TUNICA—Saxifraga**. A pretty tufted plant with small pink flowers in the greatest profusion during the entire Summer.
- VERONICA—Incana**. Bright silvery foliage with spikes of Amethyst-blue flowers during July and August; 12 inches.
- Rupestris, True Blue**. Literally covers itself with blossoms of intense blue during June and July. 12 inches.
- Spicata**. Long spikes of bright blue flowers during June and July; 18 inches. An excellent border plant.
- VINCA—Minor**. Green foliage, lavender flowers. Extra strong plants. 6 for \$1.00 (by P. P., \$1.10); \$1.50 per doz.; per 100, \$10.00.

Price, any of the above (except where noted), 4 for \$1.00 (by P. P., \$1.10); \$2.50 per doz.; per 100, \$15.00.

All of the old-fashioned flowers which were the delight of our grandmothers are to be found in this class of plants. They are all perfectly hardy and die down in the Fall, appearing again in the Spring with renewed vigor.

There is an ever-increasing demand for hardy perennial plants, as they are of easy culture and there is not a time during the whole season when some are not in bloom. Each variety has a fixed time for flowering so that by making a judicious selection a succession of blooms may be had from early Spring until late Autumn. There is no set rule for the planting of perennials. The amount of room at one's disposal, the location and also the individual taste of the planter must be taken into consideration. Probably the most satisfactory results are obtained from a hardy border backed by a hedge or a fence, planting some of the taller growing sorts such as Hollyhocks, Hardy Asters, Bocconias, Helianthus and Boltonias in the back, graduating the shorter growing sorts toward the front and finishing the border with an edging of *Plumbago Larpentae*, *Phlox Subulata*, *Arabis* and other of the dwarf growers.

Our booklet, "The Hardy Flower Garden," is an instructive publication and will be sent free on request.



Achillea, Boule de Neige

SPECIAL NOTICE ON GUARANTEE.—We spare no effort to supply all plants, trees, etc., of the best quality in first-class living condition. On account of the many causes beyond our control we regret we cannot guarantee this stock to live and establish itself, as that is entirely within the power of the buyer or planter.

ALYSSUM

Saxatile Compactum. An excellent low spreading plant for rockery or border, growing about 10 inches high and producing in May masses of golden-yellow flowers. 4 for \$1.00 (by P. P., \$1.10); \$2.50 per doz.; per 100, \$15.00.

ANCHUSA (Sea Bugloss)

Italica "Dropmore Variety." Plants grow 4 feet high in pyramidal shape, branch freely and are loaded with bright blue, Forget-me-not-like flowers in June; very showy and valuable. 4 for \$1.00 (by P. P., \$1.10); \$2.50 per doz.; per 100, \$15.00.

Myosotidiflora. A distinct dwarf variety from the Caucasian Mountains, with clusters of pretty blue Forget-me-not-like flowers in May; 1 foot. 4 for \$1.00 (by P. P., \$1.10); \$2.50 per doz.; per 100, \$15.00.

ANTHEMIS (Marguerite)

Perry's Variety (Improved Golden Marguerite). A wonderful improvement over the well known *Anthemis Tinctoria*, large, well shaped flowers, nearly 3 inches across, from June to October. The well proportioned plants with delicate fern-like foliage are most attractive and become covered with bright golden-yellow flowers which are valuable for cutting; 15-18 inches. 4 for \$1.00 (by P. P., \$1.10); \$2.50 per doz.; per 100, \$15.00.

See pages 102 and 103 for complete list of Rock Garden Plants

ACHILLEA (Milfoil or Yarrow)

Filipendulina (Fern-leaved Yarrow). Finely cut foliage and brilliant yellow heads of flowers, lasting in full beauty all Summer; 4 to 5 feet.

Millefolium Cerise Queen (Rosy Milfoil). Finely cut, deep green foliage; flowers cherry red in dense heads; 18 inches high.

Ptarmica Boule de Neige (Ball of Snow). An improvement on The Pearl; the flowers, while not quite so large, are of more perfect form, with fuller centers, which makes it appear purer in color.

— **The Pearl.** A mass of double pure white flowers throughout the entire Summer. The strong, erect stems make it one of the best Summer flowers for cutting.

Tomentosa (Wooley Yarrow). Handsome cut foliage with bright yellow flowers. June; 12 inches. 4 for \$1.00 (by P. P., \$1.10); \$2.50 per doz.; per 100, \$15.00.

ACONITUM (Monkshood or Helmet Flower)

Fischeri. A dwarf variety growing 18 inches high, with large, pale blue flowers in September and October.

Spark's Variety. The darkest blue of all; flowers in June; 3 feet.

Wilsoni. Tall growing; very late Fall; violet-blue flowers.

Price, 3 for \$1.00 (by P. P., \$1.10); \$3.00 per doz.; per 100, \$18.00.

AETHIONEMA (Lebanon Candytuft)

Persicum. Beautiful shrubby alpines of spreading habit. Rose-colored flowers from May until August; suitable for the border or rockery. 3 for \$1.00 (by P. P., \$1.10); \$3.50 per doz.

AGROSTEMMA (Rose Champion)

Stout, erect-growing plants, with silvery foliage, which contrasts well with the showy flowers produced during June and July.

Coronaria (Mullein Pink). Bright rosy crimson; 2½ to 3 feet.

— **Alba.** A pure white variety.

Price, 4 for \$1.00 (by P. P., \$1.10); \$2.50 per doz.; per 100, \$15.00.



Aconitum

ANEMONE (Windflower)

As a last greeting of Autumn these gay flowers appear in wondrous brilliancy and produce a wealth of bloom until cut down by hard frost.

Plants vary from 2 to 3 feet high, and are ideal for cutting; the flowers appear in August and remain till frost. They require Winter protection with leaves, straw or long manure, which amply repays one for the extra trouble taken.

Japonica, Geante Blanche. Large double, silvery white.

—**Louise Uhink.** Early, double white.

—**Mont Rose.** Free flowering double pink.

—**Queen Charlotte.** Very large semi-double flowers of La France pink, a color that is rare among hardy plants.

—**Whirlwind.** Large, semi-double pure white flowers, very free.

—**Rubra.** A lovely rosy-red with bright yellow stamens.

Hupehensis. A native of central China, resembling Anemone Japonica in a miniature way. The plant grows from 10 to 12 inches in height and is wonderfully free flowering from early August until late Autumn. A pleasing mauve rose in color.

Pulsatilla (Pasque Flower). An interesting plant for the rockery or border, producing violet or purple flowers during April and May; 9 to 12 inches.

Price of Anemones, 4 for \$1.00 (by P. P., \$1.10); \$2.50 per doz.; per 100, \$15.00.

ARABIS (Rock Cress)

Alpina. One of the most desirable of the very early Spring-flowering plants that is especially adapted for edging and for the rock garden, but does equally well in the border, forming a dense carpet, completely covered with pure white flowers. Lasts for a long time in bloom. 4 for \$1.00 (by P. P., \$1.10); \$2.50 per doz.; per 100, \$15.00.

ARENARIA (Sandwort)

Montana. A very desirable creeping plant, forming a dense carpet of foliage, covered with attractive white flowers in Spring. Excellent for the rockery. 4 for \$1.00 (by P. P., \$1.10); \$2.50 per doz.; per 100, \$15.00.

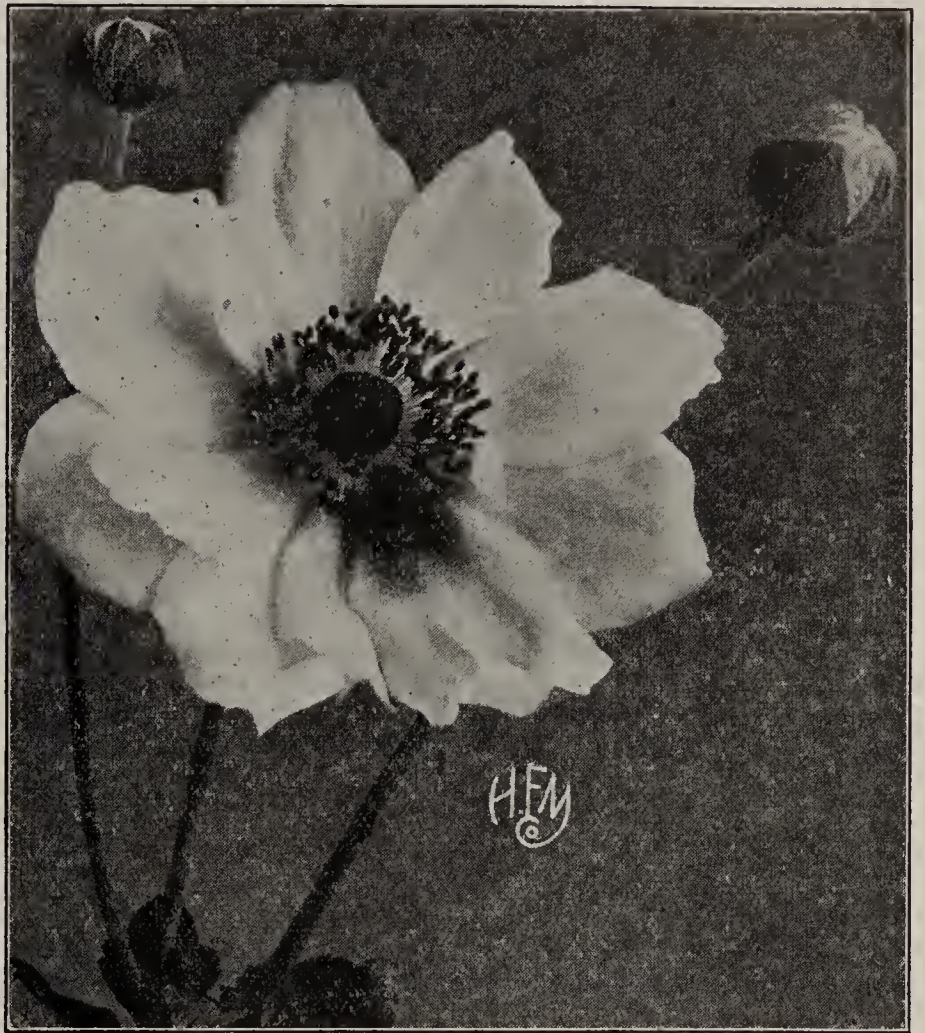

Anemone—Japonica

AQUILEGIA (Columbine)

For Spring blooming these are invaluable, producing their graceful spurred flowers on stems rising 2 feet over their attractive foliage, during May and June.

Michell's Long Spurred Hybrids. The plants are of strong, thrifty growth and the flowers of largest size and can be supplied in separate shades, blue, pink and red and orange.

Alpina. A very effective rich blue variety; splendid for rock gardens; 2 feet.

Canadensis (Common American Columbine). The native bright red and yellow variety, and one of the brightest.

Chrysantha (Golden Columbine). Bright yellow, long-spurred flowers.

Coerulea (Rocky Mountain Columbine). Bright blue and white long-spurred flowers.

Mrs. Scott Elliott Hybrids. The most famous of these beautiful flowers; wonderful colors and very long spurs.

Nivea Grandiflora. A fine white; strong growing and very free flowering.

Rose Queen. A new variety of a pleasing shade of delicate pink, long-spurred flowers.

Snow Queen. A pure white, long-spurred type.

Price of Aquilegias, 4 for \$1.00 (by P. P., \$1.10); \$2.50 per doz.; per 100, \$15.00.

ARMERIA (Sea Pink or Thrift)

Attractive dwarf plants that will succeed in any soil, forming evergreen tufts of bright green foliage, from which innumerable flowers appear in dense heads, on stiff, wiry stems, from 9 to 12 inches high. They flower more or less continuously from early Spring until late in the Fall. Very useful in the rockery.

Cephalotes, Bee's Ruby. Has stout stems with large globular heads of brilliant ruby-red flowers. 50c. each (by P. P., 60c.); per doz., \$5.00.

Lauchiana Rosea. Bright rose.

Maritima Splendens. Pale pink.

4 for \$1.00 (by P. P., \$1.10); \$2.50 per doz.; per 100, \$15.00.



Aquilegia (Columbine) Long Spurred

ARTEMISIA

A most useful class of plants either for the border or for filling in within the shrubbery. With the exception of the variety *Lactiflora*, they are not remarkable for their flowers; the foliage of the sorts offered is very ornamental.

Abrotanum (*Old Man, or Southern-wood*). Dark green, finely cut foliage, with pleasant aromatic odor; 2 feet.

Frigida (*Fringed Wormwood*). A shrubby little plant, growing from 8 to 12 inches high, with finely cut silvery foliage; a fine border plant.

Lactiflora. A variety of great merit; flowers white, in much branched panicles; very fragrant; 4 ft.; Aug., Sept. Should be planted in fertile, moist soil.

Pedemontana. A handsome variety with finely cut silvery foliage.

Silver King. A new variety with beautiful, bright silvery foliage, which can be cut and dried, and which will retain its silver color all Winter. 50c. each; per doz., \$5.00.

Stelleriana (*Old Woman*). Deeply cut silvery foliage; much used in carpet bedding; 18 inches.

Price of Artemisias (except where noted), 4 for \$1.00 (by P. P., \$1.10); \$2.50 per doz.; per 100, \$15.00.

ASCLEPIAS (Butterfly Weed)

Tuberosa. Very showy native plants, about 2 feet high, producing their flowers of brilliant orange-scarlet during July and August. 4 for \$1.00 (by P. P., \$1.10); \$2.50 per doz.; per 100, \$15.00.

DWARF ALPINE ASTER

Alpinus. Indispensable for the rockery or edge of hardy borders; grows 6 to 10 inches high and bears large, showy bluish-purple flowers in May and June.

Alpinus Albus. Identical to the above, but with pure white flowers.

Sub-coeruleus. Forms a dense tuft of leaves from which spring many leafless stems 12 inches high, bearing in June and July large, bluish-violet flowers.

Price of Alpine Asters, 4 for \$1.00 (by P. P., \$1.10); \$2.50 per doz.; per 100, \$18.00.

ASTER FRIKARTI (Wonder of Stafa)

A new everblooming perennial, blooms from June until frost. Flowers of a clear azure-blue, about 3 inches in diameter on long stems. 50c. each (by P. P., 60c.); per doz., \$5.00.



Hardy Aster



Artemisia Lactiflora

HARDY ASTERS (Michaelmas Daisies)

Anita Ballard. Light Lobelia blue, shading to lighter center. Early and free. 3 feet.

Autumn Beauty. An exquisite shade of light blue; very large flowers, commencing to bloom in the late Summer and continuing almost up to frost time; height, about 4 feet.

Barrs Pink. A strong vigorous grower, forming shapely plants from four to five feet high with beautiful pink flowers.

Blue Gem. One of the most decorative free-flowering rich blue varieties, probably the nearest approach to a true blue. 3 feet.

Glory of Colwall. A splendid improvement on the variety Beauty of Colwall, with good-sized, nearly double, ageratumb-like flowers; remarkably free flowering; 2½ feet.

Hybridus Luteus (*New*). Masses of small golden-yellow flowers during August and September; 2½ feet. 50c. each (by P. P., 60c.); per doz., \$5.00.

Miss Eisele. Very large flowers of a beautiful lavender blue; one of the best; 3 feet.

Novae Angliae. Bright violet-purple flowers in abundance during the early Autumn; 4 feet.

Novi Belgii Climax. Of strong, vigorous habit, 5 feet high; branched pyramidal-shaped flower stems; lavender-blue flowers. August-October.

Perry's White. A strong grower whose branches in the early Autumn are literally covered with large white flowers with a golden center. 4 feet.

Queen Mary. The best of the Novi Belgii type, graceful flowers, 2½ inches in diameter, arranged loosely in branching panicles of a particularly pleasing blue, tinted lavender; 3½ feet high.

Roseum Superbum. This is one of the best hardy Asters we have ever seen. The color is almost red; profuse bloomer.

Sam Banham. Very large and graceful pure white flowers. One of the earliest to bloom; 3 feet.

Skylands Queen (*New*). Large, light blue flowers; dwarf and spreading; August. 50c. each (by P. P., 60c.); per doz., \$5.00.

St. Egwin. Densely branched, producing beautiful pink flowers; 3 feet; September.

Tataricus. Large flowers of bluish violet, very late. 6 feet. Price (except where noted), 4 for \$1.00 (by P. P., \$1.10); \$2.50 per doz.; per 100, \$15.00.

JAPANESE HARDY ASTERS

Mauve Cushion. An entirely distinct species. Forms a circular cushion-like plant 2½ feet across, rarely exceeding 9 inches in height. Flowers delicate, soft mauve, with silvery white reflection and over 1¼ inches in diameter and completely cover the plant; blooms begin to expand early in October, but are not at their best until November. 4 for \$1.00 (by P. P., \$1.10); \$2.50 per doz.



Campanula—Media

ASTILBE ARENSI

The plants are of vigorous growth, 2½ to 3½ feet high. They prefer a half-shady, moist position in any ordinary garden soil.

Amethyst. Well-branched spikes of deep violet-purple; end of June; 3 feet.

Deutschland. Beautiful trusses of snow-white flowers.

Gloria Superba. Deep rose-pink flowers; very showy.

Kriemhilde. A new variety with feathered spikes of salmon-pink flowers; fine for cutting and very attractive in the garden.

Peachblossom. A beautiful peach blossom pink. A very compact grower and very free flowering.

Pink Pearl. Dense panicles of small pearl-like flowers; delicate light pink.

Rhineland. The compact spikes of flowers are bright crimson shaded salmon.

Rose Pearl. Shell pink; an excellent variety for the garden.

Vesta. Very graceful plumes of light lilac-rose.

2 for \$1.00 (by P. P., \$1.10); \$5.00 per doz.

AUBRIETIA (Rainbow Rock Cress)

Deltoides. Neat compact plants covered with closely set lilac flowers. Excellent for the rockery. 4 for \$1.00 (by P. P., \$1.10); \$2.50 per doz.; per 100, \$15.00.

BELLIS PERENNIS (English Daisy)

Improved double flowering, pink and white, separate colors. 5 for \$1.00 (by P. P., \$1.10); \$2.00 per doz.; per 100, \$12.00.

BOCCONIA

(Plume Poppy, or Tree Celandine)

Cordata. A noble, hardy perennial, beautiful in foliage and flower; admirably adapted for planting in the shrubby borders, center of beds and in bold groups in almost any position. It will grow in any soil or situation, attaining from 6 to 8 feet in height; flowers in terminal panicles, of a creamy-white color during July and August. 4 for \$1.00 (by P. P., \$1.10); \$2.50 per doz.; per 100, \$15.00.

BOLTONIA (False Chamomile)

Among the showiest of our native hardy perennial plants, with large single, Aster-like flowers.

Asteroides. Pure white; very effective; 5 to 7 feet.

Latisquama. Pink, slightly tinged with lavender, 4 to 6 feet.

4 for \$1.00 (by P. P., \$1.10); \$2.50 per doz.; per 100, \$15.00.

CALLIRHOE (Poppy Mallow)

Involucrata. An excellent trailing plant with finely divided foliage and large saucer-shaped flowers of bright, rosy-crimson with white centres, produced freely during Summer and Fall.

4 for \$1.00 (by P. P., \$1.10); \$2.50 per doz.; per 100, \$15.00.

CAMPANULA (Bell Flower)

Showy perennial plants of special merit. In every well-ordered hardy garden Campanulas should have a prominent place. They delight in good rich loam, preferring a semi-shaded place.

Calycanthemum (Cup and Saucer). Pink, white and blue, each color separate; height, 18 inches; June-July.

Carpatica (Carpathian Hare-bell). A pretty compact growing variety with flowers of clear blue on erect wiry stems, from July until October. An ideal edging for the border or rockery.

—**Alba.** A pure white form of the above.

Garganica. Forms a low spreading tuft, covered in June with star-shaped light blue flowers with white eyes. An excellent rock plant.

Glomerata Superba. Flowers dark violet; late flowering.

Media (Old-fashioned Canterbury Bells). Flowers freely in June; 3 to 4 feet high. Blue, pink and white, in separate colors.

Persicifolia (Peach Bells). Bright blue flowers during June and July; 2 feet.

—**Alba.** A pure white form of the above.

Pyramidalis (Chimney Bell Flower). The most conspicuous of all Campanulas, forming a perfect pyramid 4 to 6 feet high of porcelain blue flowers in August.

—**Alba.** A pure white form of the above.

Rapunculoides. Strong growing; flowers purplish blue.

Rotundifolia (Blue Bells of Scotland). The true Harebell; clear blue flowers from June to August.

Trachelium (Coventry Bells). Purple flowers; June and July; 3 feet.

Any of the above, 4 for \$1.00 (by P. P., \$1.10); \$2.50 per doz.; per 100, \$15.00.



Astilbe



Hardy Carnation

NEW HARDY CARNATIONS

A beautiful strain resembling the indoor Carnation, flowering freely during the entire Summer; long stems, excellent for cutting.

Beatrix. Light salmon-pink; in bloom from May to November.

Giant Pink. Delicate pink.

Grenadin Red. Bright red.

—**White.** Pure white.

Prince Bismarck. Deep rosy-pink.

3 for \$1.00 (by P. P., \$1.10); \$3.00 per doz.; per 100, \$20.00.

HARDY BORDER CARNATIONS

Choice mixed seedlings produced from seed. We supply strong plants that will furnish an abundance of double flowers this season. 4 for \$1.00 (by P. P., \$1.10); \$2.50 per doz.; per 100, \$15.00.

HARDY CARNATIONS

DIANTHUS PLUMARIUS (New Varieties)

Bristol Jewel. Semi-double; nicely formed white, prettily flaked with crimson and distinct crimson eye.

Bristol Maid. Very large, double, well formed flower of a delightful shade of rose-pink.

Bristol Purity. Pure white double flowers; of compact habit, extremely free and early.

3 for \$1.00 (by P. P., \$1.10); \$3.00 per doz.; per 100, \$20.00.

CARYOPTERIS (Blue Spirea)

Handsome, free flowering perennials, of bushy habit; very valuable for their late blooming season. For bedding or pot culture.

Mastacanthus. Rich violet flowers produced in great profusion the whole length of the branches. 2 to 3 feet. September and October. 3 for \$1.00 (by P. P., \$1.10); \$3.50 per doz.; per 100, \$20.00.

CENTAUREA (Hard Heads or Knapweed)

Of easy culture, delighting in an open, sunny position, producing a wealth of bloom, which not only makes a fine display in the border, but is excellent for cutting.

Montana (Perennial Corn Flower). Grows 2 feet high, bearing large violet blue flowers from July to September.

—**Alba.** A pure white form of the above.

4 for \$1.00 (by P. P., \$1.15); \$2.50 per doz.; per 100, \$15.00.

CERASTIUM (Snow-in-Summer)

Biebersteini. Pure white flowers and silvery foliage. A compact grower and fine for the rock garden.

Tomentosum. A desirable low growing plant with silvery foliage and white flowers in June; suitable for the rockery, sunny spots or for covering graves.

4 for \$1.00 (by P. P., \$1.10); \$2.50 per doz.; per 100, \$15.00.

CHELONE (Shell Flower)

Handsome perennials growing about two feet high and bearing numerous spikes of large flower heads during the Summer.

Lyoni. Heads of showy purplish-red flowers. 4 for \$1.00 (by P. P., \$1.10); \$2.50 per doz.; per 100, \$15.00.

CHIERANTHUS

Allioni (Siberian Wallflower). An excellent rock plant growing about 12 inches high and producing an abundance of brilliant orange flowers in June. 4 for \$1.00 (by P. P., \$1.10); \$2.50 per doz.; per 100, \$15.00.

CHRYSANTHEMUM

Shasta Daisy (Alaska). A decided improvement on the original, with blooms $4\frac{1}{2}$ to 5 inches across, of pure glistening white. Very free-flowering and in bloom all Summer and Fall.

Arcticum (The Arctic Daisy). One of the most attractive Fall-flowering perennials. It forms a rosette-like clump of pretty dark green foliage during the Summer, and early in the Fall sends up multitudes of large pure white flowers, which continue throughout October and frequently into November.

Coreanum (Korean Chrysanthemum). A remarkable new perennial from Korea, of ironclad hardiness. Large white flowers, with golden center, often turning to a light pink in frosty weather; in bloom from October to December.

Etoile D'Or. Another of the large flowering English type, producing the largest and best flowers of any from June to September.

Supreme. Large white flowers; fine for cutting; 3 feet.

4 for \$1.00 (by P. P., \$1.10); \$2.50 per doz.; per 100, \$15.00.

SHRUBBY CLEMATIS

Davidiana. A most desirable variety with fresh, bright green foliage and bell-shaped flowers, of deep lavender blue during August and September; very fragrant.

3 for \$1.00 (by P. P., \$1.10); \$3.50 per doz.

COREOPSIS

Lanceolata Grandiflora. Flowers rich golden yellow and of graceful form; fine for cutting. A few plants make a handsome display, either planted individually or in clumps; dozens of flowers are produced on a single plant, and where quantity and quality are wanted Coreopsis should be planted; June till October. 4 for \$1.00 (by P. P., \$1.10); \$2.50 per doz.; per 100, \$15.00.



Coreopsis, Lanceolata Grandiflora

HARDY GARDEN CHRYSANTHEMUMS

These showy and effective favorites are now universally popular. When planted outside they extend the flowering season of your perennial garden, blooming profusely in October after other flowers have been browned by early frosts, which do not affect the Chrysanthemums, producing a wealth of bloom especially fine for cutting. They should be planted in a well drained position either in the hardy border or at the edge of a shrubbery border. The planting should be done early in the Spring, so that the plants will have the entire Summer to establish themselves, and late in the Autumn, after they have finished flowering, and the tops have been cut off they should have a covering of leaves or loose litter as a Winter protection, but do not cover with manure. Early in the Spring after danger of severe freezing is over and before any growth starts, the covering should be removed.

Adironda. Small, compact, aster-flowered variety of medium height, covered with beautiful bronze flowers early in the season.

Autumn Glow. Large rosy-crimson flowers.

Baby. Clear bright yellow, very small button.

Baby Margaret. Pure white button.

Boston. A strong upright grower; clear bronze; aster flowered.

Chaldon. Reddish crimson with golden tips; aster flowered.

Champagne. Bright ruby-red, wonderfully colored; aster flowered.

Cometo. Early, large, pink button.

Comoleta. Early, aster flowered, excellent yellow.

Elkton. Profuse, very compact with large flowers, blush white, tinged with lavender.

Firelight. Early bright red; aster flowered.

Frances Whittlesey. Splendid garnet and bronze; aster flowered.

Golden Climax. Orange yellow button.

Golden Queen. Large yellow flowers.

Iva. Very small deep bronze.

Lady Schmidt. Beautiful lilac-rose, Anemone flowered with golden centers. Sweetly scented, giving an abundance of flowers from October until killing frost.

L'Argenteuillais. Deep chestnut shaded crimson; a very strong grower and free bloomer; aster flowered.

La Garonne. Rose and buff; very attractive aster.

Lilian Doty. A strong upright grower, producing beautiful sprays of clear light pink flowers; aster flowered.

Little Bob. Bronze button variety.

Little Dot. Rich mahogany-crimson button.

Mrs. H. E. Kidder. Large early yellow aster.

Mrs. H. Harrison. Medium height, producing large clusters of full double pink flowers with cream-pink center.

Mrs. J. Willis Martin. Crushed strawberry in color. One of the most beautiful varieties.

Muldoon. Small, free purplish amaranth aster.

Murillo. One of the best pink hardy chrysanthemums; medium early; aster flowered.

Oconto. A Japanese variety with pure white flowers on strong stiff stems; aster flowered.

Old Homestead. Buff-pink; one of the best.

Ouray. An early flowering variety of medium height, bearing flowers of good size on long stiff stems. Color is a very brilliant deep scarlet with coppery suffusion.

Philadelphia. Early, deep rose-pink; aster flowered.

Provence. Early light pink aster.

Rodell. Dwarf yellow button.

Ruth Cumming. Early terra cotta aster.

Ruth Hatton. Early white aster.

Skibo. A very early flowering pompon type of medium height, opening bronze, turning to a deep yellow with a small bronzy center.

Summer Gold. Early flowering with golden yellow flowers of medium size.

Uvalda. The earliest white, sometimes showing a tinge of pink but turning pure white as the flowers develop.

White Doty. A sport of the popular variety Lilian Doty and identical in every way, except color which is pure white.

Wm. Sobey. Midseason; a fine yellow button.

Winnetka. Pure white; very free flowering.

Yellow Doty. One of the most robust growers in our collection, producing an abundance of bright golden-yellow flowers.

Yellow Normandie. One of the earliest to bloom; a beautiful yellow aster flowered variety.

Zelia. Early, fine aster flowered orange bronze.



Hardy Chrysanthemum

SINGLE FLOWERING VARIETIES

A great many prefer the single flowering varieties as they are very free flowering and possess a grace that appeals.

Alice Howell. Early, orange yellow or bronze.

Attraction. Free, compact pale rose.

Buff Beauty. Early, pale buff.

Cosmos. Deep purplish carmine.

Dainty. Early, free orange.

Dazzler. The greatest single scarlet.

Donald Wells. The best single white.

Gold Lace. Early, free small yellow.

Mrs. Albert Phillips. Deep lavender pink.

Mrs. Max Behr. Glistening chestnut scarlet.

Mrs. W. E. Buckingham. Midseason; a beautiful shade of pink.

Pink Beauty. Very good single pink.

Shirley Terra Cotta. Orange red.

Price of Hardy Chrysanthemums, 4 for \$1.00 (by P. P., \$1.10); \$2.50 per doz. (by P. P., \$2.75); per 100, \$15.00

For a plentiful supply of lovely blue cut-flowers plant Delphiniums. See page 110

(wc)



Michell's New and Modern Hybrid Delphiniums

MICHELL'S MODERN HYBRID DELPHINIUMS

In every garden of distinction you will find a generous use of the Modern Delphinium. No garden is complete without them. Theirs is an incredible beauty, at home in the small back yard garden as well as in the more pretentious formal herbaceous plantings.

A beauty majestic in the towering splendor of their perfect spikes, their range of exquisite colorings of blues, purples and mauves, and all the subtle nuances relating these shades.

The plants we offer are carefully selected seedlings of the English Prize Winning strains checked as to type, while in bloom. At the leading shows last year these same plants were the outstanding sensation and we are truly proud to serve our discriminating clientele with these New Modern Delphiniums.

Order Early. *Delphiniums start their growth before the last snow has melted. Early plantings will make the strongest blooms.*

The plants of these wonderful Hybrids are shipped balled and burlapped, therefore arriving at your home in a condition for uninterrupted growth. The other varieties are shipped out of pots with a full ball of earth.

Make your garden a triumphant thing of beauty this year with Michell's New Modern Delphiniums.

NAMED VARIETIES OF MICHELL'S NEW MODERN DELPHINIUMS

	Each
Advancement. Colors of striking beauty. Rich mauve.	\$5.00
Watkin Samuels. Rich blue and mauve.	5.00
Blue Queen. Azure blue with blackish brown center; single.	1.50
Clive Greaves. Rich porcelain blue flowers of good form.	5.00
Constance. A lovely blue single, white eye.	1.50
Countess Cowley. Light blue and mauve, with black eye; semi-double flowers of wonderfully fine form.	3.00
Edward Bromet. The purplish blue ground is rich and the white eye extremely large. 5 ft.	2.50
Glory. Mauve, shaded rose. 4 ft.	1.50
Great Strides. Pale blue, shaded mauve, white eye.	3.00
Happy Thought. Medium blue, shaded pansy violet. 5 ft.	3.00
Mrs. A. J. Watson. Deep mauve shade with black center.	2.00
Mrs. Norman Holden. Large semi-double flowers of mauve and blue with large black eye. A splendid variety. 5 ft.	3.00
Mrs. Shirley. Lovely lilac mauve, white and sulphur eye.	2.00
Mrs. Townley Parker. Sky blue single, white eye.	1.50
Norah Phillips. A gorgeous effect of deep blue and purple florets on a tapering spike of 6 feet.	5.00
R. A. Pilkington. Rich violet, edged dark blue. Eye is brown and spike well formed. 5 ft.	3.00
The Bishop. Bright royal blue, white center. 5 ft.	3.00
The Shah. A deep rosy lavender self with dark eye. 5 ft.	3.00

MICHELL'S NEW DELPHINIUMS IN COLOR GROUPS

A welcome innovation is the following offer of the Hollyhock Delphiniums released in four separate color groups. These plants are grown from the identical strains which comprise our well-known Named Delphiniums. The plants are all heavy field grown material, and are also shipped balled and burlapped. For exhibition material our Delphiniums are unsurpassed. Offered in the following color groups:

Light Shades, Mauve Shades, Intermediate Shades, Dark Shades, Mixture. Price: \$1.25 each; doz., \$13.50; \$100.00 per 100.

STANDARD VARIETIES OF HARDY DELPHINIUMS

Belladonna. The clear turquoise-blue of its flowers is not equalled for delicacy and beauty by any other flower.

Bellamosum. A dark blue form of Belladonna with which it is identical excepting in color, which is a rich deep blue.

Chinense. A very pretty dwarf species, with fine feathery foliage and intense gentian-blue flowers in open panicles.

Album. A pure white form of the above.

Price, any of the above, 4 for \$1.00 (by P. P., \$1.15); \$2.50 per doz.; per 100, \$15.00.

Michell's Gold Medal Hybrids. The plants are of strong, vigorous habit, with large flowers on spikes two feet and over long, the majority running in the lighter shades of blue. We can supply them in mixture only.

Price, 3 for \$1.00 (by P. P., \$1.15); \$3.00 per doz.; per 100, \$20.00.

DIELYTRA or DICENTRA

Eximeia (Fringed Bleeding Heart). A dwarf growing variety with beautiful, finely cut foliage and showy racemes of pretty pink flowers throughout the season. 4 for \$1.00 (by P. P., \$1.10); \$2.50 per doz.; per 100, \$15.00.

Spectabilis (Bleeding Heart or Seal Flower). We are fortunate in again being able to offer this old-fashioned favorite; its long sprays of graceful, heart-shaped flowers are always attractive. A most satisfactory plant for the hardy border, especially when it can be planted in the shade. 2 for \$1.00 (by P. P., \$1.10); \$5.00 per doz.; per 100, \$40.00.



Dielytra Spectabilis

1

2

3

4

Nos. 1 and 2
**MICHELL'S
 ENGLISH HYBRID
 DELPHINIUMS**
 (Hardy Larkspurs)

Extra heavy plants in the following
 color groups: Light Shades, Mauve
 Shades, Intermediate Shades, Dark
 Shades, Mixture. Price: \$1.25 each;
 doz., \$13.50; \$100.00 per 100.
 1 year old plants in mixed colors only
 3 for \$1.00 (by parcel post, \$1.10)
 \$3.00 per dozen per 100, \$20.00

Nos. 3 and 4
MICHELL'S DIGITALIS
 (Foxglove)
GIANT SHIRLEY
 Mixed Colors Only

4 for \$1.00 (by parcel post, \$1.10)
 \$2.50 per dozen per 100, \$15.00

DIANTHUS (Pinks)

These are brilliantly colored flowers, which appear in great numbers on the plant and have a rich clove scent. For table bowls, as a cut flower, they are much in use. For edging hardy borders, garden walks, or planted in rock gardens, they fill an important place. They are at their height of bloom in June.

Caesius (*Cheddar Pink*). Compact cushions of blue-gray foliage with sweetly scented rose-pink flowers during May and June.

Deltoides (*Maiden Pink*). A continuous flowering variety with pink flowers. Especially suited for rock work.

Deltoides Alba. White flowers.

Latifolius Atrococcineus Fl. Pl. (*Everblooming Hybrid Sweet William*). A splendid variety with brilliant crimson, double flowers. Blooms continuously during the entire season.

Sweet Wivelsfield. This new variety is a hybrid, being a cross between *Dianthus Allwoodi* and the *Sweet William*; in bloom continuously from May until frost, in a great variation of colors.

Any of the above, 4 for \$1.00 (by P. P., \$1.10); \$2.50 per doz.; per 100, \$15.00.

Hardy GARDEN PINKS (See page 116)

DICTAMNUS (Gas Plant)

Fraxinella Rubra. A very showy border perennial, forming a bush about 2½ feet high, having fragrant foliage and spikes of rosy-pink flowers with deeper veins, during July and August.

Fraxinella Alba. The white flowered variety of the above.
3 for \$1.00 (by P. P., \$1.10); \$3.00 per doz.

DIGITALIS (Foxglove)

The Foxgloves, old-fashioned, dignified and stately, are wholesome company in any garden. The strong flower stalks, frequently from 4 to 6 feet high, rising from a luxuriant mass of leaves, always give an appearance of strength to the hardy border and during their period of flowering dominate the whole garden.

Ambigua or Grandiflora. Showy flowers of pale yellow, veined brown; 2 to 3 feet.

Giant Shirley. These are a genuine "Shirley" production of extraordinary size and vigor. The flower heads are over 3 feet long, crowded with large bell-shaped blossoms, ranging in color from white and shell-pink to deepest rose, many attractively dotted with crimson and chocolate. We offer these in mixed colors only.

Gloxiniaeflora. White, Pink, Purple. Each separate.

4 for \$1.00 (by P. P., \$1.10); \$2.50 per doz.; per 100, \$15.00.

DORONICUM (Leopard's Bane)

Excelsum. A very showy daisy-like flower of clear bright yellow, blooming in April and May; splendid for cutting. 3 for \$1.00 (by P. P., \$1.10); per doz., \$3.00; per 100, \$18.00.

ECHINOPS (Globe Thistle)

Ritro. Deep metallic-blue flowers; 3 feet.

4 for \$1.00 (by P. P., \$1.10); \$2.50 per doz.; per 100, \$15.00.

ERODIUM

Chamaedryoides Roseum. A tiny alpine plant in flower throughout the season. Forms tufts of pretty glossy leaves covered with delicate pink, veined flowers on 2-inch stems. Plant in full sun. 50c. each (by P. P., 60c.); per doz., \$5.00.

ERYNGIUM (Sea Holly)

Handsome ornamental plants, growing from 2 to 3 feet high. Effective in flower and shrubby border, woodlands, wild gardens, etc.; the flower heads, which are produced from July to September, are useful to cut for vases or to dry for winter bouquets.

Amethystinum. The finely cut, spiny foliage and the beautiful thistle-like heads are of glistening amethystine-blue.

Planum. Steel blue.

4 for \$1.00 (by P. P., \$1.10); \$2.50 per doz.; per 100, \$15.00.

EUPATORIUM

Ageratoides (*Thorough Wort*). A useful border plant, 3 feet high, with minute white flowers in dense heads; fine for cutting; August and September.

Coelestinum. A pretty hardy plant, with light blue flowers similar to the *Ageratum*. This is a particularly fine thing in hardy perennials; a splendid cut flower. 18 to 24 inches.

4 for \$1.00 (by P. P., \$1.10); \$2.50 per doz.; per 100, \$15.00.

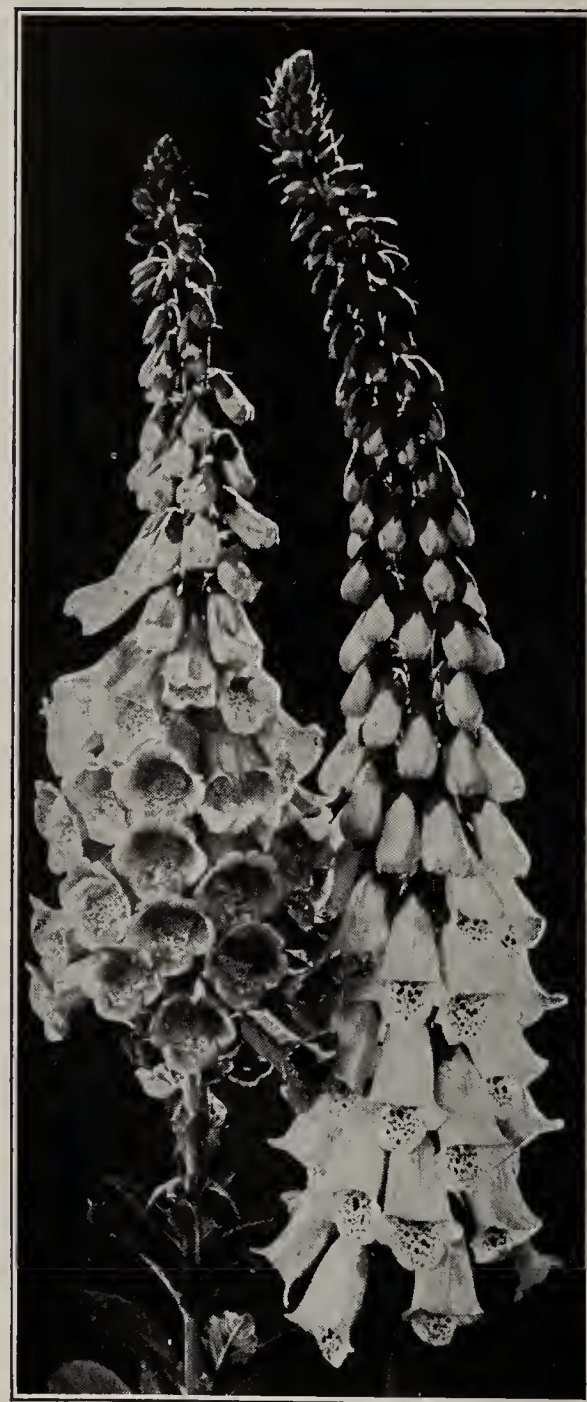

Digitalis (Foxglove)

HARDY FERNS

Many persons are perplexed to know what is best suited for planting in densely shaded borders, particularly around porches. Nothing in the world produces such a permanent and satisfactory effect as Ferns. The graceful plants grow on an average from 1 to 2 feet high, according to the variety, and the clumps increase in size and beauty each year. They die down in the Winter and break forth again in May.

ADIANTUM Pedatum (*Maidenhair Fern*). 12 inch.

ASPIDIUM Acrostichoides (*Christmas Fern*). 12 inch.

—**Goldianum** (*Shield Fern*). 24–36 inch.

ASPLENIUM Filix foemina (*Lady Fern*). 12–15 inch.

CYSTOPTERIS Bulbifera (*Bulblet Bladder Fern*). 24 inch.

DICKSONIA Punctilobula (*Gossamer Fern*). 18 inch.

ONOCLEA Struthiopteris (*Ostrich Fern*). 24–36 inch.

—**Sensibilis** (*Sensitive Fern*). 12 inch.

OSMUNDA Cinnamonea (*Cinnamon Fern*). 24 inch.

—**Claytoniana**. 24 inch.

WOODSIA Illvensis. Excellent for rock-work, requiring little soil and thriving best in the sunniest corner. 6 inch.

Price, any of above, in large plants, 4 for \$1.00 (by P. P., \$1.10); \$2.50 per doz.; per 100, \$18.00.

EUPHORBIA (Milk Wort)

Corollata (*Flowering Spurge*). A very showy and desirable native plant, growing about 18 inches high and bearing from June to August umbels of pure white flowers with a small green eye. Desirable for cutting.

Polychroma. An elegant border plant and very attractive when covered with masses of yellow flower-like bracts in May.

Price, 4 for \$1.00 (by P. P., \$1.10); \$2.50 per doz.; per 100, \$15.00.

FUNKIA (Plantain Lily; Day Lily)

Japanese perennials producing attractive clumps of foliage and interesting lily-like blossoms. A continuous row along a walk gives a strong and pleasing character. Delight in moist, shady situations.

Coerulea. Blue flowers, broad green leaves; June; 4 feet.

Subcordata Grandiflora. Very large, pure white, lily-shaped, fragrant flowers in August and September; 2½ to 3 feet.

Undulata Media Picta. Green and white variegated foliage; purple flowers. Makes a fine edging; July; 2 feet.

Price, 4 for \$1.00 (by P. P., \$1.10); \$2.50 per doz.; per 100, \$15.00.

GAILLARDIA (Blanket Flower)

Beautiful flowers are borne in profusion and make a striking effect. They last a long while as a cut flower, and are abundant from June until frost. Height, about 2 feet.

Grandiflora. Dark brown center, petals on the outer edge are yellow, and the center is surrounded with a rich orange disc.

— **Portola Hybrids**. Flowers of immense size; ranging through shades of bronzy red with golden tipped petals.

— **Tangerine**. Giant orange flowers, overlaid with red.

4 for \$1.00 (by P. P., \$1.10); \$2.50 per doz.; per 100, \$15.00.

GENTIANA

Andrewsi (*Blue Gentian*). Our native species; flowers beautiful deep blue; August and September; grows about 2½ feet high and requires rich moist soil. 3 for \$1.00 (by P. P., \$1.10); \$3.00 per doz.

GEUM (Avens)

Well-known plants noted for their rich coloring and freedom of flowering. Useful for cutting and the rockery or border. May to July.

Borisii (*New*). Large rich orange-scarlet flowers, blooming all Summer; one of the best Geums. 50c. each; per doz., \$5.00.

Coccineum, Mrs. Bradshaw. Twice the size of the old double scarlet with huge frilled petals, giving a full, double appearance. 6 to 10 inches.

Lady Stratheden. Large double flowers of a rich golden-yellow.

Price, 4 for \$1.00 (by P. P., \$1.10); \$2.50 per doz.; per 100, \$15.00.

GRASSES (Hardy Ornamental)

The generous beautiful effect produced by the hardy Grasses is hard to describe. Plantings must be seen to be appreciated. Excellent as individual specimens.

Elymus Glaucus (*Blue Lime Grass*). A graceful growing type with narrow silvery blue foliage; a dwarf compact grower; height, 3 feet.

Erianthus Ravennae (*Plume Grass or Hardy Pampas*). Deep green narrow foliage, growing about 10 feet high.

Eulalia Gracillima Univittata (*Japan Rush*). Graceful narrow foliage, growing 5 to 6 feet. Green, with silvery rib.

Eulalia Japonica Variegata. An attractive variety with a variation of markings of white, green, sometimes light pink and yellow; 4 to 5 feet high.

Eulalia Japonica. Like the variegated variety, except that it is entirely green.

Eulalia Japonica Zebrina. Dark green foliage, crossmarked horizontally golden yellow. One of the best of hardy Grasses.

Phalaris Arundinacea Variegata (*Variegated Ribbon Grass or Gardener's Garter*). This sort is especially suited for edging taller varieties, as it grows somewhat dwarf. The foliage is somewhat broad, variegated white and green. 12 to 15 inches.

Pennisetum Japonicum (*Hardy Fountain Grass*). One of the most valuable hardy Grasses, either for beds, mixed borders or as individual specimens. Height, 4 feet.

Prices of Hardy Grasses, 4 for \$1.00 (by P. P., \$1.10); \$2.50 per doz.; per 100, \$15.00.

GLOBULARIA

Nudicaule. Small blue florets, globular heads, deep blue in color, a neat plant for the border.

Trichosanthis (*Globe Daisy*). A dwarf tufted little plant with beautiful lavender flower heads. Does well in front of a well drained border and is a brilliant picture in the rock garden.

4 for \$1.00 (by P. P., \$1.10); \$2.50 per doz.

GYPSOPHILA (Baby's Breath)

During August and September this is a mass of delicate flowers. These may be used as fresh cut flowers, also for a semi-everlasting effect. They keep for months without water.

Bristol Fairy. A wonderful improvement over *Paniculata* Fl. Pl. It is a distinct new form, producing immense panicles of pure white double flowers very early in the season and continuing until frost. We offer strong plants that will flower this season. 3 for \$1.00 (by P. P., \$1.10); \$3.50 per doz.

Paniculata. Feathery sprays of white flowers; useful for effects in bouquets.

Repens. A beautiful trailing plant for the rockery, with clouds of small white and pink flowers during July and August.

4 for \$1.00 (by P. P., \$1.10); \$2.50 per doz.; per 100, \$15.00.

HIERACEUM

Villosum. Silvery wooly leaves and bright yellow flowers; a very effective plant. 4 for \$1.00 (by P. P., \$1.10); \$2.50 per doz.

HELENIUM (Sneezewort)

These desirable perennials succeed in almost any soil, in a sunny location. The flowers are splendid for cutting.

Autumnale Rubrum. Bright, terra-cotta red; 4 feet.

Autumnale Superbum. Golden-yellow flowers in late Summer and Fall; 5 to 6 feet.

Riverton Beauty. Rich lemon-yellow, with large purplish-black cone; August and September; 4 feet.

Riverton Gem. Old gold, changing to Wallflower red; August and September; 3½ feet.

Price, 3 for \$1.00 (by P. P., \$1.10); \$3.00 per doz.; \$18.00 per 100.

FOUR NEW HELENIUMS

Distinct and attractive additions to this popular class of Summer and Fall flowering plants.

Bruneum Coccineo. Erect branching habit, flowers of a dark, bronzy, brownish-red; one of the earliest to flower; 2½ feet.

Gaillardiaeflorum. Glowing bronzy-red petals with just a tip of golden-yellow; 3 feet.

Golden Youth. Pure golden-yellow; early flowering; 2½ feet.

Nanum Luteum. Very erect, strong branching habit; large pure yellow flowers; 3 feet.

50c. each (by P. P., 60c.); per doz., \$5.00.

HELIANTHEMUM (Rock or Sun Rose)

Perry's Hybrids. Low growing evergreen plants, forming broad clumps, which during their flowering season, July to September, are hidden by a mass of bloom. Very suitable for the front of the border, the rockery or a dry sunny bank. 4 for \$1.00 (by P. P., \$1.10); \$2.50 per doz.; per 100, \$15.00.

HELIANTHUS (Hardy Sunflower)

Very effective in borders, among shrubbery or as clumps on the lawn, etc. They produce masses of flowers during Summer until frost, which are splendid for cutting and decorative purposes.

Maximiliana. The latest of all, blooming profusely in October; the fine golden-yellow flowers appear in long, graceful sprays; splendid for cutting; 5 to 7 feet.

Multiflorus Fl. Pl. Large, double golden-yellow; July-August; 4 feet.

Orgyalis. A tall variety bearing single yellow flowers of medium size during September; 6 feet.

Rigidus Japonicus. One of the most desirable varieties, beginning to bloom early in July and continuing until Fall; flowers golden-yellow with dark center; 5 feet.

Price, 4 for \$1.00 (by P. P., \$1.10); \$2.50 per doz.; per 100 \$15.00.

HELIOPSIS (Orange Sunflower)

This genus is very similar to the Helianthus. They are tall-growing plants, well suited for the back of flower borders, where they flower beautifully throughout the Summer.

Pitcheriana. One of the best hardy plants for the perennial border. Daisy-shaped flowers of deep orange color, on good stems for cutting. 2 to 3 feet.

Scabra Excelsa. A new variety with very rich chrome-yellow flowers, turning to a bright yellow as they mature. These are almost double, having from 4 to 5 rows of petals, and are produced very profusely. The plant is of robust growth, about 3 feet high. Mid-July to the end of August.

Price, 4 for \$1.00 (by P. P., \$1.10); \$2.50 per doz.; \$15.00 per 100.

HELLEBORUS NIGER (Christmas Rose)

Particularly valuable hardy plants on account of their very early flowering, usually coming into bloom, in sheltered, well drained, partially shaded positions during February or March. Flowers white flushed with purple and about 2 inches in diameter; 12 inches high. \$1.00 each.

HEMEROCALLIS (Yellow Day Lily)

Lily-like plants, flowering in great profusion during the Summer, making a fine cut bloom.

Dr. Regel. Handsome, rich orange-yellow flowers in May. Very fragrant and fine for cutting.

Flava (Yellow Day Lily). Deep lemon-yellow flowers during June and July; very fragrant; 2½ to 3 feet.

Fulva (Tawny Day Lily). Trumpet-shaped flowers; coppery orange shaded crimson; June and July.

Kwanso Flore Pleno (Double). Coppery red; July; 3 feet high. 3 for \$1.00 (by P. P., \$1.10); \$2.50 per doz.; per 100, \$15.00.

**THE NEW BETSCHER HYBRID
HEMEROCALLIS**

Goldeni. The many fine deep orange flowers are produced freely in early July; quite vigorous in growth and a most effective garden variety; 3 feet. \$1.00 each.

Gypsy. Brilliant deep orange flowers on 3-foot slender stems during July. A showy plant for the small border. \$1.00 each.

Mrs. W. H. Wyman. Lovely light yellow flowers on 4-foot stems in August. Very free flowering and lasting a long time. \$1.00 each.

HEUCHERA (Alum Root or Coral Bells)

Cascade. Light pink flowers; Begonia-like foliage.

Edge Hall. Flesh pink bells.

Sanguinea. Bright crimson flowers, borne in graceful sprays; excellent for cutting.

3 for \$1.00 (by P. P., \$1.10); \$3.00 per doz.; per 100, \$18.00.

HOLLYHOCKS (Double)

These thrive best in soil that is not too wet, which should be enriched with well-rotted stable or sheep manure. While perfectly hardy, we recommend protecting them slightly during the Winter with leaves, long manure or straw. To guard against fungus or rust we recommend spraying the plants in early Spring with Pyrox or Bordeaux Mixture.

Our strain of these is very fine, and we offer the following colors in double flowering only (each separate):

Yellow, Crimson, Pink, White.

Allegheny. Large flowers having loosely arranged fringed petals, varying in color from pale pink to deep red. We can supply these in mixed colors only.

Single. The artistic single Hollyhock is becoming more popular each season. They are of stronger growth than the double flowering type and consequently make a better showing. We can supply these in mixed colors only.

Price of Hollyhocks, 4 for \$1.00 (by P. P., \$1.10); \$2.50 per doz.; per 100, \$15.00.



Hemerocallis

HIBISCUS (Mallow)

Giant Flowering. A wonderfully improved form of our greatly admired Marsh Mallows. They are unusually attractive and form real show plants during their flowering season. They attain a height of 6 to 7 feet, have beautiful lacinated foliage and monstrous flowers, measuring from 6 to 8 inches in diameter. We offer these in separate colors, Pink, Red and White. 3 for \$1.00 (by P. P., \$1.10); \$2.50 per doz.; per 100, \$15.00.

HYPERICUM (St. John's Wort)

Moserianum. A most desirable border plant, of free and graceful habit, producing long, slender, much-branched stems, leafy to the base and all drooping towards the ends, apparently from the weight of the flowers and buds, although the flowers face, so none of their beauty is lost. Free-flowering, of large size, measuring from 2 to 2½ inches in diameter; color rich golden yellow, which is rendered still more effective by the numerous yellow stems and crimson anthers; blooms continuously. 2 feet.

Patulum Henryi. One of the newer varieties of St. John's Wort, of shrubby habit, growing from 2 to 3 feet high, producing masses of large clear yellow flowers during July and August and retaining its neat foliage until late in the Autumn.

—**Grandiflorum.** A very vigorous growing introduction from China with large broad petalled flowers of a bright yellow. 4 for \$1.00 (by P. P., \$1.10); \$2.50 per doz.; per 100, \$15.00.

IBERIS (Hardy Candytuft)

The Hardy Candytufts are low-growing plants, with ever-green foliage. In Spring and early Summer they are completely covered with dense heads of pure white flowers. For borders and rockeries they are unsurpassed.

Little Gem. Dwarf; pure white flowers in June; its uniform neat habit makes it one of our best rock or edging plants. 4 for \$1.00 (by P. P., \$1.10); \$2.50 per doz.; per 100, \$15.00.

INCARVILLEA (Trumpet Flower)

Fleshy rooted perennials of striking beauty. They have coarsely toothed or pinnate leaves and showy trumpet-shaped flowers borne in terminal racemes. Choice plants for the sunny border; should be well protected with leaves during the Winter.

Grand Brevipes. Large brilliant crimson-rose flowers.

Grand Amaranth. A true amaranth. A distinct beauty.

Delavayi. Large Gloxinia-like, rose-colored flowers during June and July.

3 for \$1.00 (by P. P., \$1.10); \$3.50 per doz.



Iris Germanica

IRIS GERMANICA (Fleur de Lis) SUPERB NEW AND RARE VARIETIES

- Allies** (*Vilmorin*, 1925). Standards deep violet rose shaded copper, falls deep rich velvety red-purple. \$1.00 each.
- Ambassadeur** (*Vilmorin*, 1920). Overlapping standards dull purplish bronze; lovely flaring falls, deep velvety maroon; beard and styles yellow; 4 feet. 25c. each.
- Aphrodite** (*Dykes*, 1922). A pure, bright violet-pink self color, falls and standards being identical in tone. 50c. each.
- Asia** (*Yeld*, 1916). Standards pale silvery lavender, suffused yellow and gold at the base; falls pale reddish purple, lighter at the margin; beard bright golden-yellow; 4½ feet. 50c. each.
- Ballerine** (*Vilmorin*, 1920). Standards light violet-blue; falls a deeper shade than the standards. 3 to 4 feet. 25c. each.
- B. Y. Morrison** (*Sturtevant*, 1917). Standards pale lavender-violet; falls velvety raisin purple with broad lavender border, very distinct; 33 inches. 25c. each.
- Canopus** (*Bliss*, 1921). Standards light purple, arched; falls velvety prune purple. Very free flowering; 3 feet. 50c. each.
- Cardinal** (*Bliss*, 1922). Standards a distinctive shade of lavender overlaid with rose; falls rich velvety prune purple of wonderful glossy texture. \$1.00 each.
- Cecil Minturn** (*Farr*, 1922). Uniform shade of cattleya rose. Free flowering; 2 feet. 25c. each.
- Coppersmith** (*Shull*, 1926). Standards crimson-purple, falls rich Dahlia carmine, producing a wonderfully rich copper-red velvet effect in the sun. 42 inches. \$1.00 each.
- Coronation** (*Moore*, 1927). A beautiful rich golden-yellow without veining; does not fade. 44 inches. \$1.00 each.
- Crusader** (*Foster*, 1913). Standards light blue; falls deep violet blue with orange-yellow beard; 42 inches. 25c. each.
- Dolly Madison** (*Williamson*, 1927). Standards mauvette, shading to yellow at the base; falls broad and flaring, lilac haft maroon veined, bright orange beard. \$1.00 each.
- Dream** (*Sturtevant*, 1918). A clear, even pink, a delicate and beautiful Iris; 3 feet. 25c. each.
- Frieda Mohr** (*Mohr*, 1926). Standards light pinkish-lilac with deep lilac-rose falls; 48 inches. \$1.00 each.
- George J. Tribolet** (*Williamson*, 1926). A fine velvety blackish red-purple with a coppery suffusion. Flowers are large and borne freely on well-branched stalks; 40 inches. 50c. each.
- Germaine Perthuis** (*Millet*). Standards a pleasing shade of violet-purple, toned lighter; falls rich Bishop's violet. Enormous flowers on firm 3 ft. stems. \$1.00 each.
- Glowing Embers** (*Sturtevant*, 1923). Standards light brownish lavender; falls rich velvety pansy purple, orange beards and yellow netted hafts; 42 inches. 50c. each.
- Gold Imperial** (*Sturtevant*, 1924). Chrome yellow throughout except for orange beard; 33 inches. 50c. each.
- Harriet Presby** (*Presby*, 1922). A very tall rosy-violet, lighted with orange apricot reticulations on the haft; 4 ft. 50c. each.
- Imperator** (*Cayeaux*, 1923). Standards clear violet; falls deep velvety rose red; 40 inches. 35c. each.
- Jacqueline Guillot** (*Cayeaux*, 1924). An enormous bloom on stout branching stems; color soft lavender violet with a lustrous surface. Prolific bloomer. 35c. each.
- Lady Foster** (*Foster*, 1913). Standards pale blue; falls light bluish violet, veined old gold; 40 inches. 25c. each.
- Lord of June** (*Yeld*, 1911). Standards lavender blue; falls rich violet blue. Fine fragrance. 25c. each.
- Magnifica** (*Vilmorin*, 1920). Standards light violet blue; falls dark reddish-violet with brown stripes at base; 4 feet. 25c. each.
- Majestic** (*Bliss*, 1924). Immense standards, light lavender to mauve, stained light bronze at the base. The falls are of a very rich velvety raisin purple in color; 3½ ft. tall. 25c. each.
- Medrano** (*Vilmorin*, 1920). Rich rose purple, the falls encrusted with dark maroon, flecked with buff and lavender. 25c. each.
- Mildred Presby** (*Farr*, 1923). Standards white, faintly flushed pale, rosy lavender; falls dark velvety pansy violet with a very narrow edge of lavender white. 50c. each.
- Moonlight** (*Dykes*, 1923). Warm French gray, tinted blue, touched with green and yellow lights, broad lemon-yellow beard; scented; 36 inches. 50c. each.
- Mother of Pearl** (*Sturtevant*, 1921). Pale bluish lavender of exceptional substance and texture; 4 feet. 25c. each.
- Morning Splendor** (*Shull*, 1922). An exceedingly large deep claret-red of wonderful form and substance; 42 inches. 50c. each.
- Mrs. Marion Cran** (*Perry*, 1923). Brilliant bright rose. A huge fine-shaped flower of heavy substance on tall stout stems. The largest pink Iris and one of the best. \$1.00 each.
- Ochracea** (*Syn, Sunset*) (*Denis*, 1919). Fine form and substance; old gold flower with falls flushed blue. 25c. each.
- Old Ivory** (*Sturtevant*, 1924). A very soft creamy-yellow, as the name implies; the haft markings are cinnamon-brown. Flowers of fine form. 36 inches. 50c. each.
- Opera** (*Vilmorin*, 1916). Standards reddish lilac; falls purple violet, dark and velvety. 25c. each.
- Pioneer** (*Bliss*, 1924). Standards are large and incurved, bright red-purple; falls are very broad, of a deep, glowing red-purple, set off by bright orange beard; 3½ feet. 50c. each.
- Primrose** (*Sturtevant*, 1923). A beautiful self yellow of deep pure tone with fine finished flowers; 30 inches. 50c. each.
- Princess Osra** (*Bliss*, 1922). Color clear white, with standards flushed and dotted at the edges, forming a wide border of wisteria-violet; orange beard; 33 inches. 50c. each.
- Prospero** (*Yeld*, 1920). Standards pale lavender flushed with yellow; falls deep ruby-purple. 35c. each.
- Queen Caterina** (*Sturtevant*, 1917). A large iridescent pale lavender violet with yellow beard; 3 feet. 25c. each.
- Santa Barbara** (*Mohr*, 1925). Probably the finest pure lavender-blue; well branched stalk and vigorous growth. A very outstanding variety. 48 inches. 50c. each.
- Seminole** (*Farr*, 1920). Standards dark violet-rose; falls rich velvety crimson; brilliant orange beard; 2 feet. 25c. each.
- Souv. de Leotitia Michaud** (*Millet*, 1923). Standards lobelia blue shading to pale blue; falls the same color, beautifully veined yellow. 48 inches. \$1.00 each.
- Souv. de Mme. Gaudichau** (*Millet*, 1914). A brilliant velvety black purple. Free blooming; 40 inches. 25c. each.
- Susan Bliss** (*Bliss*, 1922). A uniform shade of deep rose-pink. The flower's exquisitely shaped and of splendid substance, opening 3 or 4 at a time; 3½ feet. 35c. each.
- Swazi** (*Bliss*, 1922). Standards bluish-violet; falls velvety blackish-violet, the whole a very rich color; 42 inches. \$1.00 each.
- Taj Mahal** (*Sturtevant*, 1920). A very fine white having a smooth, lustrous texture; 3 feet. 25c. each.
- Tropic Seas** (*Shull*, 1924). A very deep blue-purple, illuminated conspicuously by a rich golden beard; 50 inches. 50c. each.
- True Charm** (*Sturtevant*). Blooms white with margins delicately etched with blue-lavender; 40 inches. 50c. each.
- White Knight**. A beautiful pure white Iris of fine form and delicately scented. 25c. each.
- Wild Rose** (*Sturtevant*, 1921). An adorable pink, having a smooth, satiny texture. 35c. each.
- Yolande** (*Millet*, 1923). Enormous dark velvety blue, of great substance and beautifully formed; 40 inches. 50c. each.

IRIS KAEMPFERI (Japanese Iris)

The King of all Iris and in popularity they can be classed with the hardy Phlox and Peonies; coming into flower about the middle of June, they continue for five or six weeks and are particularly welcome at this time. They succeed in almost any soil and like plenty of water when forming their flower buds.

SIX NEW JAPANESE IRIS

These six varieties were selected from fifty new varieties, recently purchased for trial and were selected for their outstanding qualities.

Caroline G. Childs. Single white, veined blue-violet, inner petals purple and white.

La Favorite. Fine large double white, veined blue with a rich purple center.

Mrs. J. A. Hayden. White ground, edged and shaded pale violet; double.

Plume. White, lightly veined blue; high center petals delicate mauve and blue.

Rose Anna. Double; ivory-white with heavy ruby-red veins and conspicuous yellow blotch, stigmas dark plum.

Yezonshitai. Reddish-lavender, shaded purple, beautifully veined white with yellow blotch in center; single.

Price of any of the above new varieties, 50c. each (by P. P., 60c.); per doz., \$5.00.

CHOICE STANDARD VARIETIES

Astarte. Double; beautiful dark violet.

Azure. Double; immense flower, exquisitely waved; mauve-blue with darker halo surrounding yellow blotch at base of petals.

Circe. Double; dark violet-blue, delicately veined with white.

Eleanor Parry. Double; claret-red flamed white and blue. Compact, medium size.

Eumee. Single; deep violet-blue.

Gekka-No-Nami. The best early white, very free; pure glistening white with creamy center.

Gold Bound. A fine double pure white, enriched by a creamy glow from the gold banded center.

Helene. Double; blue ground, slightly veined with dark blue.

Hercules. Double; clear lilac-blue.

Kagaribi. A very beautiful all lavender flower, except a yellow spot in the center of each of its six petals. An exceptionally well formed flower.

Koko-No-Iro. Rich violet-purple, with white petaloids tipped violet. Enormous double flowers.

Kuma Fungin (Excited Bear). Falls purple-blue, stigmas lighter, long orange bars, six petals, very tall grower.

Mahogany. Large double flowers; the latest to bloom; color, purple mahogany-red, the erect petals being prettily crested.

Melpomene. Double; soft blue distinctly veined with dark blue.

Mount Hood. Double; light blue shaded darker, bright orange center.

Patrocle. Single, superb deep reddish-violet.

Pres. Harding. Double, heavy thick petaled flowers produced when all other Japanese Iris have finished flowering. Flower very massive; fine light blue with darker shadings. One of the best Japanese Iris in cultivation.

Proserpine. Single, bright rich blue, produced by sanding of velvety blue on white.

Purple and Gold. Enormous double flowers, ten inches across; early and free blooming; color, rich violet purple with white petaloids, tipped violet; the conspicuous golden throat extends outward in sharp bluish white rays.

Reine de Bulgarie. Soft lilac, lemon yellow throat; very good.

Ski-No-Ryo. Double, blue and white.

Templeton. Double; light violet, mottled reddish-pink and white. Very fine form.

Uchiu. Double flowers of the largest size, beautiful blue with golden center.

Victor. Double; silvery white, traced and marbled ultramarine blue.

Price, any of the above named sorts of Japanese Iris, 3 for \$1.00 (by P. P., \$1.10); \$3.50 per doz.; \$25.00 per 100.

Mixed Japanese Iris. All colors and shades. 4 for \$1.00 (by P. P., \$1.10); \$2.50 per doz.; per 100, \$15.00.



Iris Kaempferi

IRIS GERMANICA (Fleur de Lis, Flags)**CHOICE STANDARD VARIETIES**

Afterglow (Sturtevant, 1917). Misty lavender lit with yellow at the center. Its name fits it perfectly as it has the soft tints of the evening sky after the sun has disappeared; 3 to 5 feet.

Alcazar (Vilmorin, 1910). Standards light bluish violet; falls deep purple, bronze veined at the throat.

Colonel Candelot (Millet, 1907). Standards bronze overlaid with red lavender; falls rich velvety crimson, yellow beard.

Fro. Standards deep gold; falls chestnut brown.

Lent A. Williamson (Williamson, 1918). Standards lavender violet; falls velvety pansy purple, brilliant orange beard. Massive flowers of wonderful texture.

Monsignor. Standards satiny violet; falls velvety purple crimson, with lighter margin; very large flower.

Mrs. Alan Gray. Standards and falls delicate pale rosy mauve.

Navajo. Standards light bronzy yellow, shaded lavender; falls deep maroon, veined white and yellow; stigmas yellow; deep orange beard.

Nibelungen. Standards fawn yellow; falls violet purple with fawn margin; a handsome, large flowering variety.

Pallida Dalmatica. Standards and falls clear lavender blue shading to pale silvery blue at the base; sweetly scented.

Powhatan. Standards light bishop violet with deeper border; falls deep purple, shaded crimson; horizontal spreading flower.

Shekinah (Sturtevant, 1918). Soft lemon yellow deepening to rich yellow around its bright orange beard; 3 feet.

Sherwin-Wright. Rich golden-yellow without markings and a strong grower make this the best clear yellow Iris to date.

Walhalla. Standards light, lavender blue; falls satiny violet blue.

Wyomissing. Standards creamy white, suffused soft rose; falls deep rose base, shading to flesh colored border.

Price, any of the above Iris, 4 for \$1.00 (by P. P., \$1.10); \$2.50 per doz.; \$15.00 per 100.

Mixed German Iris. 6 for \$1.00 (by P. P., \$1.10); per doz., \$1.50 (by P. P., \$1.65); \$10.00 per 100.

IRIS CRISTATA (Crested Dwarf Iris)

A tiny native species growing from 4 to 6 inches high, with delicate, pale lilac flowers in May and June.

IRIS, INTERMEDIA

These bloom earlier than *Iris Germanica*.

Florentina. Very early, large, nearly pure white flowers; delightfully sweet scented. 30 inches.

Heige. Standards creamy-yellow, falls deeper, veined yellow.

Kharpot. Standards violet; falls deep purple violet, very long; beard white, very large flower. 30 inches.

Kochii. Standards and falls rich claret-purple. Early, compact and handsome. 24 inches.

Spectabilis. Violet-purple, very free flowering.

Walhalla. Standards lavender-blue; falls urne-red; immense flower. 30 inches.

IRIS, PUMILA HYBRIDA

An early flowering type growing from 10 to 12 inches high.

Blanc Pur La Fiancee. Pure white with striking yellow beard.

Butterfly. Pale yellow, spotted brown. 8 inches.

Cyanea. Rich royal purple.

Dixmude. Uniform deep blue, large flowers. 10 inches.

Floribunda. Creamy-yellow.

Florida. Very large, pale creamy-yellow. 10 inches.

Schneekuppe. Pure white.

IRIS SIBIRICA

Emperor. Rich, violet-blue. 3 feet.

Snow Queen. Pure white.

Sibirica Perry's Blue. A recent introduction, with very large, clear blue flowers on long stems.

Price, any of the above Iris, 4 for \$1.00 (by P. P., \$1.10); \$2.50 per doz.; per 100, \$15.00.

LAVENDULA (Lavender)

Vera. This is the true Sweet Lavender; grows about 18 inches high; delightfully fragrant blue flowers in July and August. 4 for \$1.00 (by P. P., \$1.10); \$2.50 per doz.; per 100, \$15.00.

LIATRIS (Blazing Star, or Gay Feather)

Grand Dubois. Tall, showy plant; red flowers on long spikes.

Pycnostachya. Showy and attractive native plants, succeeding anywhere, producing spikes of light rosy-purple flowers in July and August; 5 feet.

Scariosa (Early type). Deep purple flowers; 3 to 4 feet.

Scariosa (Late type). Similar to the above but flowers much later. September.

4 for \$1.00 (by P. P., \$1.10); \$2.50 per doz.; per 100, \$15.00.

LINUM (Flax)

Perenne. A desirable plant for the hardy border or rockery; light graceful foliage and large blue flowers all Summer. 4 for \$1.00 (by P. P., \$1.10); \$2.50 per doz.; per 100, \$15.00.

LOBELIA

Handsome border plants thriving in any good garden soil but preferring a moist loam where they will not suffer from drought.

Cardinalis (Cardinal Flower). Rich fiery cardinal flowers. 4 for \$1.00 (by P. P., \$1.10); \$2.50 per doz.; per 100, \$15.00.

LILY OF THE VALLEY

Bundles or Clumps. For outdoor planting only. Bundles contain 12 good size pips, with good root growth, all of which will flower with the proper care. They are especially imported from abroad, the best of the stock being selected for us. 50c. per bundle (by P. P., 60c.); doz. bundles, \$5.00 (by P. P., \$5.25); \$40.00 per 100 bundles.

LYTHRUM

Roseum Superbum (Rose Loose-strife). A strong growing plant, thriving in almost any position, large spikes of rose colored flowers from July to September. Grows 3 to 4 feet high. 4 for \$1.00 (by P. P., \$1.10); \$2.50 per doz.; per 100, \$15.00.



New English Lupins

NEW ENGLISH HYBRID LUPINUS

Truly a wonderful innovation of Lupinus. These New English Hybrids created the most flattering comment in England and was awarded Gold Medals at all Exhibitions. We offer these in five distinct color groups, selected from named varieties.

Group A. Bronze, apricot, yellow, orange.

Group B. Rose, pink, flesh, buff.

Group C. Purple and mahogany.

Group D. Blue and lavender.

Group E. Cream, white.

Price of any of the above, 50c. each; doz., \$5.00; \$40.00 per 100.

LUPINUS (Lupins)

These flower in May and June; are 3 to 4 feet high.

Polyphyllus Blue. Very showy.

Polyphyllus White.

Polyphyllus Pink.

3 for \$1.00 (by P. P., \$1.10); \$3.00 per doz.; per 100, \$20.00.

LYCHNIS (Campion)

All of the *Lychnis* are of the easiest culture, thriving in any soil and this, in addition to their brightness, has brought them into high favor with lovers of hardy plants.

Chalcedonica. A most desirable plant; heads of brilliant orange-scarlet flowers in June and July; grows 2 to 3 feet high.

Haageana Hybrids. Brilliant, large, orange, scarlet, pink and crimson flowers in mixture; 1 foot; July.

Viscaria Splendens. Fl. Pl. Forms a dense tuft of evergreen foliage, and in June sends up spikes of handsome deep red flowers; 1 foot.

4 for \$1.00 (by P. P., \$1.10); \$2.50 per doz.; per 100, \$15.00.

LYSIMACHIA

Clethroides (Loose-strife). A fine hardy variety about 2 feet high; dense, recurved spikes of white flowers from July to September.

Nummularia (Creeping Jenny, or Honey-wort). Valuable for planting under trees or shrubs where grass will not grow, where it quickly forms a dense carpet.

4 for \$1.00 (by P. P., \$1.10); \$2.50 per doz.; per 100, \$15.00.



Matricaria, Little Gem

MATRICARIA (Feverfew)

Little Gem. Pure white, double flowers, splendid for cutting, flowering July and August; height, 12 inches. 4 for \$1.00 (by P. P., \$1.10); \$2.50 per doz.; per 100, \$15.00.

MAZUS RUGOSUS

Loose trailing masses of blue and white flowers, speckled with gold in the throat. Splendid for flagging and carpeting. 4 for \$1.00 (by P. P., \$1.10); \$2.50 per doz.; per 100, \$15.00.

MERTENSIA (Blue Bells)

Virginica. An early Spring flowering plant growing 1 to 1½ feet high with drooping panicles of handsome light blue flowers fading to clear pink; May and June. 4 for \$1.00 (by P. P., \$1.10); \$2.50 per doz.; per 100, \$15.00.

MONARDA (Bergamot)

Didyma Cambridge Scarlet (*Oswego Tea*). Crimson scarlet.
—**Rosea** (*Bee Balm*). Flowers of a rose color, and sweetly fragrant foliage; 18 inches; July to September. 4 for \$1.00 (by P. P., \$1.10); \$2.50 per doz.; per 100, \$15.00.

MYOSOTIS (Forget-Me-Not)

These are most effective when intermingled with Pansies, English Daisies, or amongst Summer-flowering perennials.
Palustris Semperflorens (*Perpetual Flowering Forget-me-not*). Blue with yellow throat; damp places; spread rapidly. 9 inches. 4 for \$1.00 (by P. P., \$1.10); \$2.50 per doz.; per 100, \$15.00.

NEPETA

Mussini. An excellent plant for rock gardens, being a compact grower and forming tufts of small violet-blue flowers during July and August.
Souv. de Chaudron. Large, rich, lilac-blue flowers from June to September; 1 foot. 4 for \$1.00 (by P. P., \$1.10); per doz., \$2.50; \$15.00 per 100.

NIEREMBERGIA (Cup Flower)

Rivularis. A lovely dwarf creeping plant, with large cup-shaped flowers, from June until September. Excellent for the rockery. 4 for \$1.00 (by P. P., \$1.10); \$2.50 per doz.; per 100, \$15.00.

OENOTHERA (Evening Primrose)

The evening Primroses are elegant subjects for growing in a sunny position, blooming the greater part of the Summer.
Missouriensis. Large golden-yellow. 1 foot.
Youngi. Bright yellow flowers; 18 inches. 4 for \$1.00 (by P. P., \$1.10); \$2.50 per doz.; per 100, \$15.00.

PACHYSANDRA

An evergreen trailing plant, with thick, glossy foliage forming a dense mat; one of the finest ground covers.
Terminalis. Green; 6 to 8 inches high; small flower spikes of a grayish white, in May and June. Strong plants from 2¼-in. pots, 6 for \$1.00 (by P. P., \$1.10); \$1.50 per doz.; per 100, \$10.00; \$90.00 per 1000. Strong plants from 3-in. pots, 4 for \$1.00 (by P. P., \$1.10); \$2.50 per doz.; per 100, \$15.00; \$125.00 per 1000.

PARDANTHUS (Blackberry Lily)

Chinensis. Bright orange, Lily-like flowers during July and August, followed in September by seeds which resemble Blackberries; 2½ feet. 4 for \$1.00 (by P. P., \$1.10); \$2.50 per doz.; per 100, \$15.00.

PENTSTEMON (Beard Tongue)

Barbatus Torreyi. Spikes of brilliant scarlet flowers; height, 3 to 4 ft.; June to August.
Coral Gem. Large spikes of coral-pink flowers.
Digitalis. Large spikes of long purple-white flowers with purple throats, during June and July. 2 to 3 feet.
Gloxinoides, Sensation. A beautiful strain bearing spikes of large Gloxinia-like flowers in a great variety of bright colors, including rose, cherry, crimson, purple, lilac, etc. The plants grow 2 ft. high and bloom from early Summer till frost.
Praecox Hybrids. Somewhat similar to the variety *Barbatus Torreyi* but with flowers about twice the size and in a great variety of colors, ranging from pale lilac to purple and from very pale pink to almost red. A wonderful cut flower. 50c. each (by P. P., 60c.); per doz., \$5.00.
Price, except where noted, 4 for \$1.00 (by P. P., \$1.10); \$2.50 per doz.; per 100, \$15.00.

PHYSALIS (Chinese Lantern Plant)

Francheti. An ornamental variety of the Winter Cherry, forming dense bushes, about 2 feet high, producing freely its bright orange scarlet lantern-like fruits; highly interesting. 4 for \$1.00 (by P. P., \$1.10); \$2.50 per doz.; per 100, \$15.00.

PHYSOSTEGIA (False Dragon-Head)

One of the most beautiful of our Midsummer flowering perennials, forming dense bushes 4 to 6 feet high, bearing spikes of delicate tubular flowers, not unlike a gigantic heather.
Grandiflora Vivid. A new variety growing from 18 to 24 inches high, bearing a profusion of bright violet-mauve flowers.
Virginica. Bright but soft pink.
—**Alba.** Pure white; very fine. 4 for \$1.00 (by P. P., \$1.10); \$2.50 per doz.; per 100, \$15.00.

PINKS, HARDY GARDEN

(*Dianthus Plumarius*)

These old-fashioned favorites, bearing their clove-scented flowers during the Spring and early Summer, are splendid cut blooms.

Her Majesty. A splendid fringed pure white.
Homer. Rosy-red with dark center.
Juliette. White laced crimson.
Variogated Reserve. White laced with crimson, everblooming.
White Reserve. An everblooming variety, double pure white. 4 for \$1.00 (by P. P., \$1.10); \$2.50 per doz.; \$15.00 per 100.

PLATYCODON

(Balloon Flower or Japanese Bell Flower)

The Platycodons are closely allied to the Campanulas, and form neat, branched bushes of upright habit.

Mrs. Ely says of them: "Do best if planted in early Spring. They grow from 2 to 2½ feet high, and after the third season each plant will have from ten to twelve stalks covered with the lovely blue or white blossoms, during July and August."

Grandiflorum. Deep blue cupped, star-shaped flowers.
—**Album.** A white-flowered form of the above. 4 for \$1.00 (by P. P., \$1.10); \$2.50 per doz.; per 100, \$15.00.

PLUMBAGO (Lead-Wort)

Larpentae. One of the most desirable border and rock plants; it is of dwarf, spreading habit, growing 6 to 8 inches high, covered with deep blue flowers during the Summer and Fall months. 4 for \$1.00 (by P. P., \$1.10); \$2.50 per doz.; per 100, \$15.00.

Next to Roses these are the most popular June flowers, and justly so, for they lend themselves to almost any style of planting, while for the little care required they give a variety of color and wealth of bloom unequalled by any other plant. Their requirements are few; they will succeed in any good garden soil in an open sunny position. Care should be taken, however, to keep all fresh manure away from the roots—if barnyard manure is used it must be thoroughly decomposed—if you are unable to procure this, Bone Meal makes a good fertilizer. Peonies may be planted any time after September 1st until the ground freezes in the Autumn, and in the early Spring until the season is too far advanced; the best time, however, is during September and October, as they make roots during the moist cool weather of the Autumn and consequently carry through the Winter in better shape. The roots should be set so that the top or upper eyes are about two or not more than three inches below the level of the soil; do not set the roots flat, but stand them up. For the best results Peonies should be planted from three to four feet apart each way, according to the space at your disposal; the ground around them should be well cultivated at all times and in the Spring after growth starts they should have an abundance of water if the season is at all dry. When cutting the flowers always leave one or two bottom leaves; it is best to leave a few flowers on the plant also, as it is of vital importance that sufficient foliage be left to develop the eyes under the ground for next season's growth. Newly planted roots may not develop a characteristic flower the first season, in fact it is usually not until the third year that perfect flowers true to description will be produced. Peonies are seldom troubled with any disease or insect pests; ants sometimes appear on the buds, coming to gather a sweet gum which the bud exudes while developing; they will do no harm and will disappear when the flower opens.

Adolph Rousseau (*Dessert & Mechin*, 1890). Early midseason. Very tall, strong grower with erect, stiff stems and large, perfectly formed flowers, dark velvety red with garnet hues and a distinct metallic reflex. Semi-double type. 75c. each.

Albert Crousse (*Crousse*, 1892). Bomb type. Large, well-formed flowers of soft shell pink with faint salmon tints. Vigorous grower with tall, erect stems. Late. 50c. each.

Auguste Dessert (*Dessert*, 1920). Cup-shaped flower of fine form, velvetish crimson-carmine, very brilliant with silvery reflex and large silvery border. A superb variety, \$2.00 each.

Baroness Schroeder (*Kelway*). Rose type. Flesh white fading to milk white. Immense globular flowers of perfect form, of great lasting substance, ideal for cutting. Does fine in southern localities. Late midseason. 75c. each.

Candeur (*Dessert*, 1920). Large globular, delicate silvery pink, slightly tinged lilac rose, fading an iridescent white, center flecked with carmine. Vigorous grower and fine clear green foliage. \$2.00 each.

Chestine Gowdy (*Brand*, 1913). Crown type; late midseason. The broad outer petals are silvery pink; these enclose a zone of fine irregularly shaped petals of deep rich cream, which in turn surround a prominent cone of broad pink petals splashed and tipped crimson. 50c. each.

Cherry Hill (*Thurlow*, 1915). Semi-rose type. Early. Deep garnet with a very noticeable sheen; in blooms not fully developed stamens are visible. Strong grower with long erect stems. Free flowering and very desirable. \$1.00 each.

Claire Dubois (*Crousse*, 1886). Rose-type; late midseason. Rich, clear satiny pink with glossy reflex. Some describe this as a glorified Mons. Jules Elie. \$1.00 each.

Couronne d'Or (*Calot*, 1873). Semi-rose type; late. Immense, very full imbricated flat flowers. Solid and compactly built; pure white with a ring of yellow stamens around a tuft of center petals tipped carmine. 50c. each.

Dr. H. Barnsby (*Dessert*, 1913). Rose type, late. Color solferino-red tinged purplish-crimson, changing to clearer tint, with very pronounced bluish reflex. \$1.50 each.

Edulis Superba (*Lemon*, 1824). Crown type; very early. Beautiful bright, clear mauve-pink with silvery reflex. Decoration Day Peony. 50c. each.

Elwood Pleas (*Pleas*). Erect compact grower of medium height. Color uniform soft violet-rose, delicately shading to lilac-white. Unusually large, the form of flower flat and compact; rose type. \$1.00 each.

Etta (*Terry*, 1905). Rose type; late. Very large flat flower, uniform delicate hydrangea pink. Fragrant, medium tall. \$1.00 each.

Eugene Verdier (*Calot*, 1864). Crown type. Beautiful cup-shaped flowers; flesh-pink with collar shaded yellow and salmon, with outer guard petals lilac-white. Fragrant. Rather a dwarf grower, but very upright. Blooms in late midseason, but the buds always open well. 50c. each.

Felix Crousse (*Crousse*, 1881). Rose type; late midseason. Rich, dazzling ruby-red without a tinge of purple, none better. 50c. each.



Peony, Baroness Schroeder

Festiva Maxima (*Miellez*, 1851). Rose type, early. The finest white in existence. Pure white with clear carmine spot on edge of center petal. 50c. each.

Francois Rousseau (*Dessert*, 1909). Semi-rose type; early; large brilliant velvety-red flowers. Very striking. \$1.25 each.

Georgiana Shaylor (*Shaylor*, 1912). Rose type. Large globular compact flower with wide graceful petals; flesh pink. Late midseason. \$1.00 each.

Germaine Bigot (*Dessert*, 1902). Crown type. Very large compact flower, composed of broad petals. Color lilac rose, medium tall stems; very free. Midseason. 50c. each.

Grandiflora—Syn Henry Woodward (*Richardson*, 1883). Rose type. Very large flat bloom of bright sea-shell pink overlaid with salmon pink. Unusually fragrant. 75c. each.

Gretchen (*Goos & Koeneman*, 1911). Perfectly formed flower without stamens. Ivory-white tinted flesh. Strong, erect dwarf habit. \$1.50 each.

Grover Cleveland (*Terry*, 1904). Rose type. Very large and full dark crimson flowers. Especially desirable on account of being practically the only late dark crimson. 75c. each.

Homer (*Kelway*). Delightful soft rose, showing golden anther. Very attractive. \$1.00 each.



Peony, Mons. Jules Elie

- Jeannot** (*Dessert*, 1918). Cup-shaped flowers of soft-shell pink, slightly tinted lavender, salmon-pink lights at base of petals. An exquisite variety. \$2.00 each.
- Jubilee** (*Pleas*, 1910). Rose type. Extremely large flat flower, having long narrow petals arranged loosely, giving a feathery effect. Buds show delicate opal tints; as they unfold the color changes to ivory white. Midseason. \$1.00 each.
- Karl Rosenfield** (*Rosenfield*, 1908). Semi-rose type; midseason. Very large globular compact flower. Rich dark crimson in color. Very strong, tall, compact grower and free bloomer. 75c. each.
- Kelway's Glorious** (*Kelway*, 1909). Midseason. Very full, enormous flower; gleaming white with a rosy streak on the outside of guard petals. Center of flower is hollow, making it very distinctive in form. In size it has no superior. \$3.00 each.
- Kelway's Queen** (*Kelway*, 1909). Rose type; late; flowers of a beautiful flesh-pink. \$2.50 each.
- Lady Alexandra Duff** (*Kelway*, 1902). An immense cup-shaped flower of rose type with wide imbricated petals. The color of the outer petals is delicate blush pink rapidly fading to lovely French white. \$1.00 each.
- La Lorraine** (*Lemoine*, 1910). Rose type. Enormous globular flowers of creamy white, borne high above the foliage. Some golden stamens are faintly visible, giving a golden light to the open flowers. The petals are exceedingly large and of splendid lasting texture. Free bloomer; distinct and very rare. Late midseason. \$2.50 each.
- La Tendresse** (*Crousse*, 1896). Rose type. Very full, large flowers borne in clusters. Color, milk-white, sometimes splashed with carmine. Midseason. 50c. each.
- Le Cygne** (*Lemoine*, 1907). Rose type; enormous, perfectly formed, globular, pure milk-white flower with incurved petals. Has the true June rose fragrance and is remarkably free blooming. A most vigorous, erect, robust grower of medium height, with stiff stems. \$3.00 each.
- Lord Kitchener** (*Renault*, 1916). Rose type; very early. Color a brilliant cherry-red, a most dazzling hue. Free bloomer, strong grower. \$1.00 each.
- Minamota** (*Millet*). Very outstanding and unusual. Almost semi-double, of the most gorgeous rose-pink, fairly sparkling with life. A large mass of yellow stamens interspersed through the center gives a golden glow to the entire flower. Blooms very large, the laterals developing at the same time as the main flower. \$2.00 each.
- Mme. Emile Lemoine** (*Lemoine*, 1899). Semi-rose type. Large, globular, compact flower. Color on first opening glossy-white overlaid with minute lilac dots. Very beautiful and one of the finest white varieties. Midseason. 75c. each.
- Mme. Jules Dessert** (*Dessert*, 1909). Rose type. Exquisite flowers of large size; broad, delicate petals of translucent texture. Color creamy-white, overlaid with a sheen of delicate blush, with a pronounced pink center, intermixed with golden stamens. Strong, vigorous stems of perfect habit. A charming variety and should be in every collection. Midseason. \$1.00 each.
- Mlle. Jeanne Riviere** (*Riviere*, 1908). Guard petals deep flesh, gradually changing lighter. Center petals narrower and of a deep cream shade. Tall, strong stems make this a valuable variety for garden or mass effects. Midseason. \$1.00 each.
- Madelon** (*Dessert*, 1922). A superb late variety. Silvery-pink tinged carmine. A beautiful full bloom of perfect form, petals decidedly imbricated. \$2.50 each.
- Marie Crousse** (*Crousse*, 1892). Bomb type; enormous full globular blooms of very delicate shell pink, formed of rather incurved petals, interspersed with an irregular ring of yellow stamens. Midseason. \$1.00 each.
- Marie Jacquin** (*Verdier*). Large globular semi-double flowers, but coming single on young plants, the laterals blooming about the same time as the terminal flowers. Color, glossy rose-white. blooming in midseason. Sometimes called the "Water Lily Peony" on account of the pleasing cupped form. 75c. each.
- Marquis C. Lagergren** (*Dessert*, 1911). Semi-rose type; midseason. Large, bright velvety crimson with a distinct silvery border. One of the finest reds ever produced; especially good for mass planting. \$1.00 each.
- Mignon** (*Lemoine*, 1908). Rose type; globular flowers of soft light rose passing to amber cream. Broad imbricated petals form perfectly double blooms, which are delightfully fragrant and standing well above the luxuriant light green foliage. Rather dwarf; midseason. \$1.50 each.
- Milton Hill** (*Richardson*, 1891). Rose type; late. Flowers large, cupped, clear soft flesh color, turning nearly white in full sunlight before fading; one of the finest varieties. \$1.50 each.
- Miss Salway** (*Kelway*, 1889). Crown type. Very large, globular, compact flowers with high crowns. Primary petals white, center lilac-white, with collar of sulphur-yellow. Strong, tall grower, free bloomer and fragrant. One of the most delightful varieties, having an individuality that is both attractive and pleasing. Midseason. \$2.00 each.
- Mons. Jules Elie** (*Crousse*, 1888). Bomb type. Very large flower of ideal glossy shell-pink, shading to a deeper rose at the base, the entire flower overlaid with a sheen of silver; fragrant. Medium height, prolific bloomer. Early midseason. 75c. each.
- Mons. Martin Cahuzac** (*Dessert*, 1899). Semi-rose type; midseason. A perfect solid ball of deep maroon with garnet hues and brilliant black luster. Claimed by some to be the darkest Peony in existence. A very distinct and handsome variety and will appeal to everyone desiring a dark-colored Peony. \$1.50 each.
- Mr. L. Van Leeuwen** (*Nieuwenhuyzen*, 1916). A gorgeous rosy-red that blends with any color in the garden. Large, beautiful flowers of graceful formation and delightful incurved petals. A first-prize winner and also a gold-medal winner at the National Peony Show. \$2.00 each.
- Nymphae** (*ThurLOW*, 1919). Midseason; large flat flowers with wide silky petals of delicate creamy-white, yellow stamens and a reflex of golden light throughout the whole flower. \$1.25 each.
- Phillippe Rivoire** (*Riviere*, 1911). Rose type. Large, well-formed, cup-shaped flower. Color, very dark uniform crimson; tea-rose fragrance. Strong grower. Late. A very beautiful and striking variety, also very rare. \$2.50 each.
- Phyllis Kelway** (*Kelway*, 1908). Midseason. Large flowers of flushed pink, yet with the delicate coloring which gives a fresh and charming effect. Strong erect stems. Delightfully fragrant. Rose type. \$2.00 each.
- Primevere** (*Lemoine*, 1907). Bomb type. Large full blooms in clusters, with outer petals sulphur-white, center petals deep sulphur-yellow. Tall grower and free bloomer. \$1.00 each.
- Rachel** (*Lemoine*, 1904). Rose type. Lively soft pink, darker when just opening. Rather dwarf, with strong stems. Very attractive and scarce. \$1.50 each.
- Reine Hortense—Syn. Pres. Taft** (*Calot*, 1857). Midseason. Enormous, compact flowers of soft flesh color deepening to shell-pink, center showing crimson splashes, sometimes faint stripes on the face of the petals. Well formed and very striking. Deliciously fragrant. Rose type. Fine for cut flowers and usually in bloom just about Decoration Day. \$1.00 each.

Richard Carvel (*Brand*, 1913). Bomb type; early. Color very bright, uniform shade of crimson. Best of all early reds and valuable as a cut-flower variety. Tall, strong grower and free bloomer. Very fragrant. \$1.00 each.

Rosa Bonheur (*Dessert*, 1905). Rose type; midseason. Large flat flower with light rose fringed petals, guards flecked crimson. Extra fine. \$1.50 each.

Samuel Hughes (*Kelway*, 1917). A very large double flower of beautiful form; color, gorgeous deep amaranth. \$1.50 each.

Sarah Bernhardt (*Lemoine*, 1906). Semi-rose type; late mid-season. Very large flower of perfect form, full and double, with twisted, imbricated petals. Color apple-blossom pink with each petal silver tipped. \$1.00 each.

Solange (*Lemoine*, 1907). Rose type. A large, full compact flower of indescribable beauty. Color rare, deep orange salmon at the heart overlaid with a delicate tender reddish-brown, a most unique color combination. Midseason. \$1.00 each.

Souv. de Louis Bigot (*Dessert*, 1913). Rose type; midseason. Color, Bengal-rose, turning to salmon-pink, with very bright silvery reflex. Fragrant. Very fine. \$1.00 each.

Strasbourg (*Goos & Koeneman*, 1911). Large bloom, eight inches in diameter. Very compact and perfectly formed. Silvery lilac rose. \$2.00 each.

Suzette (*Dessert*, 1911). Semi-rose type; midseason. Bengal-rose lightly shaded carmine purple with silvery reflex. Strong stems. 75c. each.

Therese (*Dessert*, 1910). Rose type; very large flower of beautiful soft pink with a glossy reflex. Very fragrant, erect, strong, and amazingly free flowering. Midseason. \$1.00 each.

Tourangelle (*Dessert*, 1910). Rose type; late midseason. Pearly-white overlaid with delicate salmon and with shades of La France. Most unusual and beautiful coloring. \$1.00 each.

Venus (*Kelway*, 1888). Pale hydrangea-pink, collar lighter. Fragrance fine. Exquisite pointed buds opening into large compact flowers; very fragrant. Midseason. 50c. each.

Walter Faxon (*Richardson*, 1904). Semi-rose type. Large globular flowers of perfect form; bright rose-pink with salmon shadings. A most distinctive sort, of wonderful lasting qualities. Late. Very scarce and beautiful. \$1.50 each.



Tree Peony

TREE PEONIES

Tree Peonies are similar to other Peonies, except that blooms are more vivid in color, usually much larger and in many varieties the flowers are beautifully crinkled like crepe paper. They bloom from two to three weeks earlier than other Peonies. The plants do not resemble those of other Peonies but are finer rooted and woody branched, like shrubs, hence their name, "Tree Peonies." The branch tips die back slightly in Winter, but the plants gradually grow into bushes from 3 to 5 feet in height. Freezing of branch tips in no way injures or interferes with bloom, for new shoots sprout rapidly in the Spring, frequently from the roots and produce flowers immediately. Mature plants produce scores and even hundreds of blooms.

Culture.—Tree Peonies are scarce because it is difficult to propagate them, but once established, they are as hardy as Lilacs. During the first Winter after planting, a mulch of clean straw or hay should be placed around them, 4 to 5 inches deep, after the ground is frozen; this prevents heaving in the Spring. South and East exposures (in front of walls, foundations, hedges, etc.) are preferred locations in severe climates. An ideal location is where they are protected from direct rays of morning sun and extreme heat of afternoon sun. Any good garden soil will do, feed with bonemeal or other good fertilizer but do not use stable manure, keep well cultivated and watered. Plant one inch deeper than they were in the Nursery row. Since they bloom in early Spring the plants, when in bud, should be covered at night in case of late frosts.

Banksii. Double pink with darker shades. \$6.00 each.

Haku-Raku-Ten. Semi-double, pure white. \$8.00 each.

Iro-No-Seki. Semi-double, shell pink. \$4.00 each.

Iwato-Kagami. Double, clear pink. \$6.00 each.

Moutan (*The Wild Tree Peony of Thibet*). Single red. \$4.00 each.

Nippon Ko. Semi-double, pink. \$6.00 each.

Tsukassa-Jishi. Single, rosy lavender. \$6.00 each.

Mixed. We have a nice lot of 8- to 10-inch 2-year-old plants, grown from a famous collection, which we offer in mixed colors only, at \$4.00 each.

JAPANESE PEONIES

Ruigegno (*Japanese type*). Dark maroon. \$2.00 each.

Seiriu Somae (*Japan*). Milk-white outer petals, yellow collar. Late; strong grower. \$1.50 each.

Soshi (*Millet*). Late; dark pink. \$2.00 each.

Torpilleur (*Japan*, 1913). Guard petals lively purplish carmine; central filament of same tint but streaked and tipped with yellow. Late. \$2.50 each.

SINGLE PEONIES

L'Etincelante (*Dessert*, 1902). Very vigorous, with fine erect stems. Cup-shaped flowers with broad petals of brilliant carmine color, edged silver. \$1.50 each.

Lord Kitchener (*Kelway*). Purplish crimson; very upright, robust grower. Early flowering and of immense size. \$1.50 each.

Lucienne (*Dessert*, 1908). White tinted purple, yellow crown. \$1.50 each.

PEONIES IN COLOR

We can supply good strong roots in separate colors, or all colors mixed, at prices quoted below. These should not be compared to the cheap mixtures sometimes offered at a low price, as they are for the most part choice varieties from which the labels have been lost, or have been mixed in planting. Some very choice Peonies will be found in these mixtures.

	Each	Doz.	100
Double Pink	\$0.25	\$2.50	\$20.00
Double Red	.25	2.50	20.00
Double White	.25	2.50	20.00

MICHELL'S SUPERB HARDY PHLOXES

- Antonin Mercie.** Delicate lavender, suffused bluish lilac.
Baron von Dedem. Deep pink, suffused orange; immense trusses.
Beacon. Brilliant cherry-red flowers on straight, strong stems; an excellent variety and one of the best of its color; 36 inches.
B. Comte. Brilliant rich French purple.
Commander. Brilliant crimson-red with darker eye.
Deutschland. The brightest red Phlox ever introduced; a brilliant red with crimson eye.
Eclairer. Brilliant rose-magenta, with lighter halo.
Enchantress. Bright salmon-pink, vigorous grower.
Europa. Blush white, with a large deep pink center; the flower truss is very large, while the florets are also of gigantic size.
Firebrand. Bright vermilion scarlet with deeper center, large trusses, strong grower.
Jules Sandeau. Dwarf; very large flowering; pure pink; extra fine variety.
Mrs. Jenkins. The best pure white.
Mrs. Milly Van Hoboken. Enormous trusses of bright pink flowers; very showy and outstanding.
Painted Lady. Silver pink with salmon shadings and cherry red eye. A strong upright grower with large masses of flowers; one of the most delicately colored and pleasing of the hardy Phlox.
Rheinlander. Deep salmon pink, with a distinct bright red eye.
Rheinstrom. A splendid new Phlox with gigantic flowers of a bright pink. Quite tall; continues in bloom till frost.
Thor. Deep salmon pink, suffused with scarlet; a white halo surrounds the aniline red eye.

Price of all varieties Hardy Phloxes, extra strong roots which will flower the first season, 4 for \$1.00 (by P. P., \$1.10); \$2.50 per doz.; per 100, \$15.00.

PHLOX SUFFRUTICOSA

Miss Lingard. Pure white, with a lilac eye; very early. 4 for \$1.00 (by P. P., \$1.10); \$2.50 per doz.; per 100, \$15.00.

PHLOX SUBULATA

Alba (Moss Pink). Moss evergreen-like foliage, tucking close to the ground and covered completely with white star-like flowers in May.

Atropurpurea. A distinct form of Phlox Subulata; very free flowering; rich French purple in color, very outstanding.

Fairy. Pale blue with dark purple eye; a neat compact grower. A very desirable rock plant.

Rosea. The same as above but with pure pink flowers.

Vivid. A new introduction with bright rose-colored flowers.

Price, 4 for \$1.00 (by P. P., \$1.10); \$2.50 per doz.; per 100, \$15.00.



Oriental Poppy



Hardy Phlox, Miss Lingard

MISCELLANEOUS VARIETIES OF PHLOX

Amoena. A beautiful plant, with soft rose-colored flowers; one of the best for rockeries or borders; April-May.

Divaricata Canadensis. A patch of these makes a Spring show hard to describe. The large heads of fragrant lavender flowers appear the latter part of April and in May.

—**Laphami.** A great improvement over Canadensis, the plant is more robust, the flowers larger and of a more intense shade of lavender-blue.

Price, 4 for \$1.00 (by P. P., \$1.10); \$2.50 per doz.; per 100, \$15.00.

ORIENTAL POPPIES (*Papaver Orientale*)

These are the royal representatives of this popular genus, growing about 3 feet high and far surpassing in magnificence of bloom all the other types.

Bracteatum. Rich blood red.

Edna Perry. Unusually large flowers of a soft salmon-pink.

Mrs. Perry. A soft shade of salmon rose; a beautiful large flower. This variety should be in every garden.

Olympia. A new double variety, in color a brilliant scarlet overlaid with golden-salmon; a most beautiful combination.

Orientalis. Very large, orange-scarlet flowers.

Perry's White. Pure satiny white with a bold crimson blotch at the base of each petal.

4 for \$1.00 (by P. P., \$1.10); \$2.50 per doz.; per 100, \$15.00.

ICELAND POPPIES (*Papaver Nudicaule*)

The graceful foliage is surmounted with a mass of stems a foot high, which terminate in a beautiful cup-shaped flower.

El Monte. This new variety is a California introduction; very large flowers, strong wiry stems for cutting; mixed colors.

Orange, Yellow, White; each color separate.

4 for \$1.00 (by P. P., \$1.10); \$2.50 per doz.; per 100, \$15.00.

PAPAVER ALPINUM (*Alpine Poppy*)

Like a small and more delicate Iceland Poppy in various shades of pink, white, orange and yellow, often delicately fringed. Beautiful foliage; an ideal rock plant. 3 for \$1.00 (by P. P., \$1.10); \$3.50 per doz.; per 100, \$25.00.



Hardy Primroses

PRIMULA (Hardy Primrose)

One of the first of the early Spring flowers. They delight in a rich soil, preferably in a semi-shaded location. Some of the varieties are richly colored, and are worthy of a place in every hardy garden. As a hardy border edging, as well as for rockery planting, it can be highly recommended.

Japonica, American Beauty. An improved form of Japonica in a striking cerise color; inclined to bloom again in September. 50c. each (by P. P., 60c.); per doz., \$5.00.

Veris (English Cowslip). A mixture comprising the various shades of red and yellow; a splendid plant for the Spring blooming garden.

Vulgaris (English Primrose). Beautiful light canary yellow; long flower stems with trusses. 3 for \$1.00 (by P. P., \$1.10); \$3.00 per doz.; per 100, \$20.00.

PRUNELLA (Self-Heal)

Webbiana. A low growing plant, suitable for a shady spot on the rockery or border; bright pink flowers, produced freely from June to September. 3 for \$1.00 (by P. P., \$1.10); \$3.00 per doz.

PYRETHRUM HYBRIDUM

A good old-fashioned perennial resembling colored daisies, blooming in June. They will succeed in any good garden soil in a sunny position and do best when left undisturbed for 2 or 3 years, but they should be given an annual top dressing of well-rotted manure.

Single Flowering. Mixed colors only, ranging from pure white to dark red. 4 for \$1.00 (by P. P., \$1.10); \$2.50 per doz.; per 100, \$15.00.

PYRETHRUM (Giant Daisy)

Uliginosum. Grows 3 to 4 feet high and is covered with large white Daisy-like flowers, 3 inches in diameter, from July to September. 4 for \$1.00 (by P. P., \$1.10); \$2.50 per doz.; per 100, \$15.00.

RANUNCULUS (Crowfoot Buttercup)

Acris Fl. Pl. A double flowered form of our common buttercup; 2 feet; May and June.

Repens. Fl. Pl. (Bachelor's Buttons). A pretty double flowering golden buttercup; masses of flowers during May and June. 4 for \$1.00 (by P. P., \$1.10); \$2.50 per doz.; per 100, \$15.00.

RUDBECKIA (Cone-flower)

Indispensable plants for the hardy border; grow and thrive anywhere, giving a wealth of bloom, which are well suited for cutting.

Golden Glow. A strong, robust grower, attaining a height of 5 to 6 feet, and produces masses of double golden-yellow, Cactus Dahlia-like flowers from July to September.

Newmani. Dark orange-yellow flowers, with deep purple cone; good stiff stems; 3 feet high; July to September.

Purpurea (Giant Purple Cone-flower). Flowers about 4 inches across, of a peculiar reddish purple with a remarkably large cone-shaped center of brown; forms bushy plants 3 feet high and blooms from July to October.

4 for \$1.00 (by P. P., \$1.10); \$2.50 per doz.; per 100, \$15.00.

SALVIA (Meadow-Sage)

Perennials with strikingly beautiful, orchid-like bloom, that make them welcome in the herbaceous border. Leaves are used in medicine and for the kitchen.

Azurea Grandiflora (Rocky Mountain Sage). Sky-blue flowers in greatest profusion during August and September; 6 feet.

Pitcheri. Similar to Azurea but of more branching habit and larger flowers of rich Gentian blue; 3 to 4 feet.

Virgata Nemorosa. An interesting plant for the hardy border; flower spikes bear many-flowered whorls of dark blue blossoms. 4 for \$1.00 (by P. P., \$1.10); \$2.50 per doz.; per 100, \$15.00.

SANTOLINA (Lavender Cotton)

Chamaecyparissus Incana. A dwarf evergreen perennial with attractive, silvery-white foliage; suitable for the border or rockery. 4 for \$1.00 (by P. P., \$1.10); \$2.50 per doz.; per 100, \$15.00.

SAPONARIA (Soap Wort)

Ocymoides Splendens. A good subject for the border or rockery, producing freely masses of bright rose-pink flowers. 4 for \$1.00 (by P. P., \$1.10); \$2.50 per doz.; per 100, \$15.00.

SAXIFRAGA (Megasea)

Very useful plants, growing about 12 inches high, having broad, deep green foliage and thriving in any soil in almost any position. The pretty rose-pink flowers appear very early in the Spring, almost as soon as the frost is out of the ground.

Cordifolia. Rosy-pink flowers. Extra strong plants, 3 for \$1.00 (by P. P., \$1.10); \$3.50 per doz.; per 100, \$25.00.

ROCK GARDEN PLANTS

A complete list will be found on pages 102 and 103.

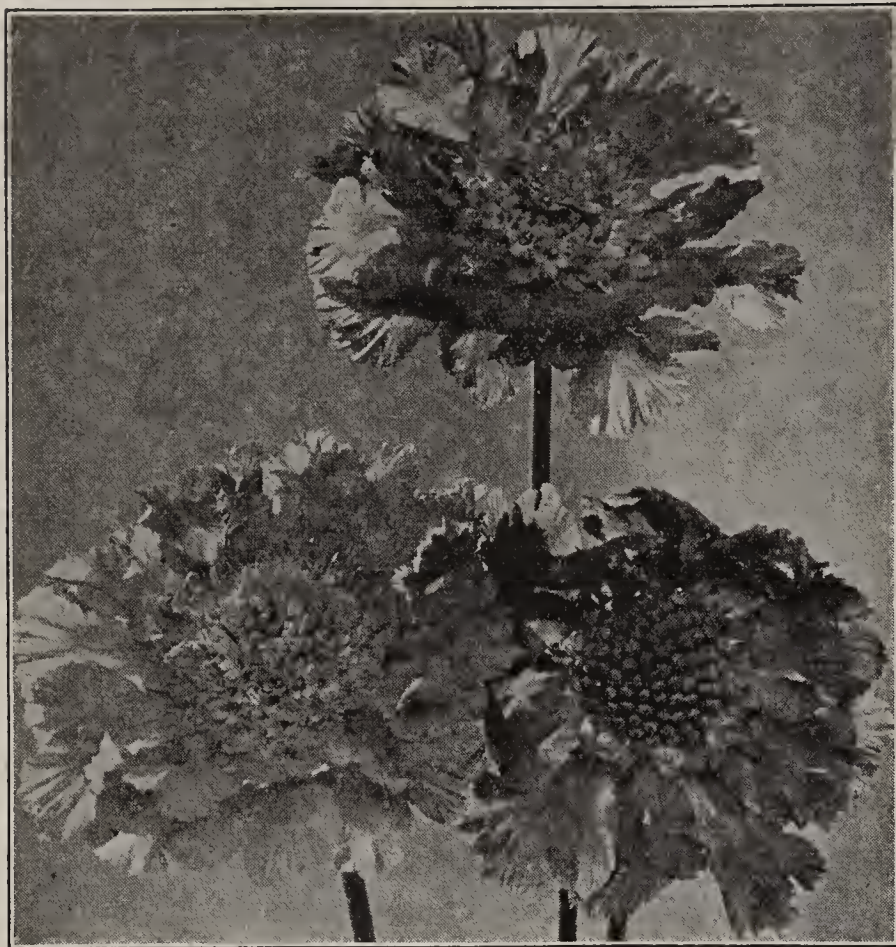

Rudbeckia Purpurea

*Scabiosa Caucasica***SCABIOSA**

The hardy variety is even more wonderful and of greater beauty than the annual sort, commonly called Mourning Bride. The flowers are gigantic, measuring frequently 3 inches and more in diameter. It delights in a sunny position, and is a cut flower few perennials can equal. It lasts a long while in water; the average height is about 2½ feet. Very free flowering.

Caucasica. A delicate shade of lavender blue, starting in flower in June and lasting well through the Summer.

Caucasica Alba. White. Like the above, except the color.

Caucasica, Giant Blue (Isaac House Strain). A splendid improvement in the Caucasica type; flowers larger and with longer stems; colors range from light lavender to dark blue; excellent for cutting.

Columbaria Anthemifolia. A low growing variety, with flowers measuring 2 to 2½ inches across; color a delightful shade of pink; splendid for cutting.

3 for \$1.00 (by P. P., \$1.10); \$3.00 per doz.; per 100, \$18.00.

SEDUM (Stonecrop)**DWARF VARIETIES**

Suitable for the rockery and covering of graves, etc.

Acre (Golden Moss). Much used for covering graves; has green foliage and bright yellow flowers.

Album. Dark green foliage with pure white flowers in June.

Anglicum. A coral rosette of gray green; delicate pink flowers.

Ibericum. Numerous deep rose flowers among dark green foliage.

Lydiu Glaucum. Glaucous green foliage, pink flowers.

Nevii. Compact rosettes of silver gray, close-set into a mosaic, pink flowers in Mid-summer.

Oppositifolium. Pinkish white flowers.

Sieboldi. Round succulent glaucous foliage with bright pink flowers during August and September.

Stahli. A compact growing variety with crimson tinted foliage in Autumn.

ERECT GROWING VARIETIES

Useful and pretty plants for the border, producing their interesting flowers during the late Summer and Fall.

Spectabile. A pretty erect growing variety with broad, light green foliage and immense heads of showy rose colored flowers during the Autumn; 18 inches.

—“**Brilliant.**” A rich colored form of the above, being a bright amaranth red.

Prices of any of the above Sedums, 4 for \$1.00 (by P. P., \$1.10); \$2.50 per doz.; per 100, \$15.00.

SEMPERVIVUM (House Leek)

Most attractive, hardy succulent plants for the rock garden and rock wall; their rosette-like thick leaves are fleshy and pointed. The small clumps spread slowly, filling pockets and crevices between the rocks.

Arachnoideum. Rosettes cobwebbed; flowers pale purple.

Fimbriatum. Medium rosettes, tipped red.

Globiferum. Flattened rosettes, two to three inches in diameter, of gray-green leaves, lightly tipped brown, pale yellow flowers.

Sobiliferum. Flat compact growth with incurving petals turning to red and brown in the Autumn.

Tectorum. Broad rosettes, the leaves having reddish-brown tips, flowers deep pink. This is the House Leek of our grandmother's garden.

4 for \$1.00 (by P. P., \$1.10); \$2.50 per doz.; per 100, \$15.00.

SENECIO (Groundsel)

Pulcher. Forms a neat tuft of foliage from which springs up, from July to October, a succession of 2-foot-high stems, with clusters of brilliant, rosy purple flowers, of good size. 3 for \$1.00 (by P. P., \$1.10); \$2.50 per doz.; per 100, \$15.00.

SIDALCEA

Mr. Lindberg (New). Flowers are a deep ruby-red; 2 feet; June and July. 3 for \$1.00 (by P. P., \$1.10); \$3.00 per doz.

Rose Queen. Bright rose-colored, mallow-like flowers during June and July. 4 for \$1.00 (by P. P., \$1.10); \$2.50 per doz.; per 100, \$15.00.

SOLIDAGO (Golden Rod)

Golden Wings. The finest of the Golden Rods; very showy; 5 feet high, with immense panicles of bright golden-yellow flowers from July to September. 4 for \$1.00 (by P. P., \$1.10); \$2.50 per doz.; per 100, \$15.00.

SPIRAEA (Goat's Beard, Meadow Sweet)

Elegant border plants with feathery plumes of flowers and neat, attractive foliage; succeed best in a half-shaded location in rich, moist soil.

Filipendula (Dropwort). Numerous corymbs of white flowers on stems 15 inches high, during June and July; pretty fern-like foliage.

Palmata (Crimson Meadow Sweet). One of the most beautiful hardy plants; the deep purple red of the stems and branches passing into the crimson purple of the broad corymbs of flowers, which are produced very freely during June and July. 3 feet.

Ulmaria Fl. Pl. (Meadow Sweet). Double white flowers during July and August; 3 feet.

3 for \$1.00 (by P. P., \$1.10); \$3.00 per doz.; per 100, \$20.00.

STACHYS (Woundwort)

Grandiflora Rosea. Large flowers of purple-rose; June and July; 15 inches. 4 for \$1.00 (by P. P., \$1.10); \$2.50 per doz.

STATICE (Sea Lavender)

Latifolia (Great Sea Lavender). Handsome plants with heads of dark blue flowers; invaluable for cutting, the flowers when dried, lasting for months. 1 to 2 feet. 4 for \$1.00 (by P. P., \$1.10); \$2.50 per doz.; per 100, \$15.00.

*Sedum Spectabile, Brilliant*

STOKESIA (Cornflower Aster)

The flower has the appearance of combining a giant cornflower and an aster. Plants are 18 inches high and are of spreading habit, blooming from June until frost. Succeeds in most any location. **Cyanea.** Very light blue. **Cyanea Alba.** Pure white. 4 for \$1.00 (by P. P., \$1.10); \$2.50 per doz.; per 100, \$15.00.

SWEET WILLIAM (Dianthus Barbatus)

This plant occupies a foremost position, producing, early in Spring, quantities of bloom which make a grand effect, for just when they are in flower it is generally too soon for other perennials. **Mitchell's Prize Mixture.** In all colors. **Pink Beauty (Sometimes called Newport Pink).** A splendid shade of salmon with immense flower trusses. 4 for \$1.00 (by P. P., \$1.10); \$2.50 per doz.; per 100, \$15.00.

TEUCRIUM (Germander)

Chamaedrys. An evergreen plant of dwarf, shrub-like habit; glossy aromatic foliage with spikes of purple flowers during July and August; 12 inches. 3 for \$1.00 (by P. P., \$1.10); \$3.00 per doz.

THALICTRUM (Meadow Rue)

Adiantifolium. A beautiful variety, with foliage like the Maiden Hair Fern and miniature white flowers in June and July; 1½ to 2 feet.

Aquilegifolium. Graceful foliage like that of a Columbine and rosy-purple flowers from May to July; 2 to 3 feet.

Dipterocarpum. Makes an ideal cut flower; the flowers are of a charming shade of violet-mauve which is brightened by a bunch of lemon-yellow stamens and anthers.

Intermedium. Pale yellow flowers in July; 2 feet. 3 for \$1.00 (by P. P., \$1.10); \$3.00 per doz.; per 100, \$18.00.

THERMOPSIS

Caroliniana. A showy tall growing plant producing long spikes of yellow flowers during June and July; 3 feet. 4 for \$1.00 (by P. P., \$1.10); \$2.50 per doz.

THYMUS (Thyme)

Citriodorus Aureus. The golden-leaved, lemon-scented Thyme. **Lanuginosus (Wolly-leaved Thyme).** Greyish foliage with rosy-lilac flowers.

Serpyllum Album (White Mountain Thyme). Forms dense mats of dark green foliage and clouds of white flowers during June and July; 3 to 4 inches.

—**Coccineum (Scarlet Thyme).** Dark green foliage with bright red flowers. 3 for \$1.00 (by P. P., \$1.10); \$3.00 per doz.; per 100, \$18.00.



Tritoma, Pfitzerii

TRADESCANTIA (Spider Wort)

Virginica. Produces a succession of blue flowers all Summer; 2 feet. 4 for \$1.00 (by P. P., \$1.10); \$2.50 per doz.; per 100, \$15.00.

TRILLIUM (Wood Lily, or Wake Robin)

Excellent plants for shady positions in the hardy border, or in a subaquatic position, flowering in early Spring; 12 to 18 inches. **Grandiflorum.** The largest white; probably the handsomest. 6 for \$1.00 (by P. P., \$1.10); \$1.50 per doz.; per 100, \$10.00.

TRITOMA

(Red-hot-Poker, Flame Flower or Torch Lily)

Multicolor Hybrids. New and distinctive colors; valuable for cutting and producing gorgeous mass effects from August to October. 3 for \$1.00 (by P. P., \$1.10); \$3.50 per doz.

Pfitzerii (The Everblooming Flame Flower). The early, free and continuous blooming qualities of this variety have made it one of the great bedding plants, and when we consider that there are few flowering plants which are suitable for massing under our severe climatic conditions, it is little wonder that such an elegant subject should become so popular. In bloom from August to October, with spikes 3 to 4 feet high, and heads of bloom of a rich orange-scarlet, producing a grand effect either planted singly in the border or in masses. 4 for \$1.00 (by P. P., \$1.10); \$2.50 per doz.; per 100, \$18.00.

Royal Standard. A distinct new variety with good sized flower heads, the flowers on the lower half of the spike are bright yellow, while those on the upper half are bright scarlet, a most effective and outstanding color combination. 2 for \$1.00 (by P. P., \$1.10); \$5.00 per doz.

Tower of Gold. New, beautiful and tall, growing from 4 to 5 feet high. Immense orange and golden yellow spikes. 50c. each (by P. P., 60c.); per doz., \$5.00.

TROLLIUS (Globe Flower)

Asiaticus Salamander. Large open flower, orange in color. 50c. each (by P. P., 60c.); per doz., \$5.00.

Earliest of All. Early and free flowering; light orange-yellow. 50c. each (by P. P., 60c.); per doz., \$5.00.

Europaes. Desirable free-flowering plants, producing their giant bright yellow, Buttercup-like blossoms on stems 1 to 2 feet high from May until August. 3 for \$1.00 (by P. P., \$1.10); \$3.50 per doz.

Gold Quelle. Large globular flowers of a rich orange-yellow. 50c. each (by P. P., 60c.); per doz., \$5.00.

Ledebouri (New). Height, 36 to 40 inches; prolongs blooming season with bright orange-yellow flowers. 50c. each (by P. P., 60c.); per doz., \$5.00.

Meteor. Very large flowers of a rich deep orange. 50c. each (by P. P., 60c.); per doz., \$5.00.

Orange Prince. Large orange flowers during May and June; wonderful for cutting. 50c. each (by P. P., 60c.); per doz., \$5.00.

TUNICA

Saxifraga. A pretty tufted plant with small pink flowers, in the greatest profusion, during the entire Summer. Ideal for the border or rockery. 4 for \$1.00 (by P. P., \$1.10); \$2.50 per doz.; per 100, \$15.00.

—**Flore Plena Rosea.** A pretty new double flowering form of the above, in which the flowers as well as being double are considerably larger than the type and of a deeper color. Perpetual flowering from June until late in the Fall. 50c. each (by P. P., 60c.); per doz., \$5.00.

VALERIANA (Valerian)

Coccinea. Showy heads of old rose flowers from June to October. **Officinalis (Hardy Garden Heliotrope).** Produces during June and July showy heads of rose-tinted white flowers, with heliotrope odor, 3 to 4 feet. 4 for \$1.00 (by P. P., \$1.10); \$2.50 per doz.; per 100, \$15.00.

VERONICA (Speedwell)

A large and much cultivated group of blue-flowered perennials, great favorites in the hardy garden. The taller forms are very pretty border plants, while the more dwarf spreading forms are well adapted to the rockery. Unexcelled for cutting purposes.

Amethystina. Amethyst-blue flowers on short spikes; one of the best; 2 feet; May to June.

Incana. Bright silvery foliage with spikes of Amethyst-blue flowers during July and August; 12 inches.

Longifolia Subsessilis (Japanese Speedwell). It is the handsomest blue-flowered plant we know of, growing to a height of two feet and completely studded with its spikes of blue flowers, which are fine for cutting. 2 feet; August to October.

Rupestris, Heavenly Blue. Dwarf and spreading; flowers very early and of an exquisite shade of blue.

—**True Blue.** Literally covers itself with blossoms of intense blue during June and July; 1 foot.

Saxatile. Mounds of evergreen foliage, about 5 inches. Flowers slate-blue in June.

Spicata. Long spikes of bright blue flowers during June and July; 18 inches. An excellent border plant.

4 for \$1.00 (by P. P., \$1.10); \$2.50 per doz.; per 100, \$15.00.

VINCA (Periwinkle or Trailing Myrtle)

It is often a perplexing problem to find the plant that will do well in a dense shade; right there is where Vincas of the hardy class should be employed, also in lawn plantings under trees, in woodlands and on spots it is desired to cover where no grass will grow. It is valuable for planting on cemetery lots by reason of its dwarf creeping habit. The foliage is green all Winter.

Minor. Green foliage, lavender flowers. Extra strong plants, 6 for \$1.00 (by P. P., \$1.10); \$1.50 per doz.; per 100, \$10.00; \$90.00 per 1000.

VIOLAS, OR TUFTED PANSIES (Viola Cornuta)

The improved forms of Viola Cornuta are one of the important bedding plants of Europe, and are rapidly growing in favor here.

Apricot Queen. Apricot yellow tinged with orange.

Blue Perfection. Deep purplish-blue.

Lutea Splendens. Rich golden yellow.

White Perfection. A fine white.

4 for \$1.00 (by P. P., \$1.10); \$2.50 per doz.; \$15.00 per 100.

VIOLA (Jersey Gem)

Without a doubt the best bedding Viola yet introduced, being most suitable to our climatic conditions, doing well in any good garden soil, but for best results should have full sunlight; under such conditions it will flower continuously from April until heavy frost. The plant is of compact growth; flowers of pure violet on stems about 6 inches long, making it valuable for cutting as well as a most attractive border plant. 4 for \$1.00 (by P. P., \$1.10); \$2.50 per doz.; per 100, \$18.00.



Yucca Filamentosa



Veronica, Longifolia Subsessilis

VIOLA, MAGGIE MOTT

Large lavender flowers, heavy with fragrance. Maggie Mott brings a tradition of English gardens with her, worthy of the greatest expectations. Continuous blooming and dependable. 50c. each (by P. P., 60c.); per doz., \$5.00.

DOUBLE RUSSIAN VIOLET

Perfectly hardy anywhere, producing double sweet scented flowers in abundance. A splendid subject for that troublesome shady place. 3 for \$1.00 (by P. P., \$1.10); \$3.50 per doz.

WALLFLOWERS

The old fragrant favorite; mixed colors, including yellow, brown, etc., 3 for \$1.00 (by P. P., \$1.10); \$2.50 per doz.; per 100, \$15.00.

YUCCA (Adam's Needle)

This plant sets off to best advantage if used as individual specimens, either on the lawn or in the shrubbery border. The foliage is of an evergreen nature, is slender and pointed. The tall flower-spikes rise 4 to 5 feet above the plant and are decked with cream-white bell-shaped drooping flowers during July and August.

Filamentosa. White, with reflexed flower bells. Extra strong plants, 3 for \$1.00 (by P. P., \$1.10); \$3.00 per doz.; per 100, \$18.00.

Variegata. A beautifully variegated form of the above, having a central stripe of green with a border of golden-yellow. 50c. each (by P. P., 60c.); per doz., \$5.00.

MICHELL'S COLLECTIONS OF HARDY PERENNIALS

We offer customers who are not acquainted with the different sorts the following collections, at greatly reduced prices.

These collections are according to our own selections at prices named.

For Sunny, Shaded or Partially Shady Perennial Border.

Collection

No.

1. 12 Hardy Perennials in a good assortment for \$2.50.
2. 25 Hardy Perennials in a good assortment for \$5.00.
3. 50 Hardy Perennials in a good assortment for \$9.00.
4. 100 Hardy Perennials in a good assortment for \$18.00.

When ordering give number and collection wanted and state if for sunny or partially shaded position.

Vines play an important part in the landscape of the home. There are so many purposes they fill that we cannot recommend too highly their general use.

AKEBIA—Quinata. Quick-growing vine; small, fine-lobed, half-evergreen leaves, and purplish brown or chocolate-colored flowers, which have a delicious odor. This plant is highly desirable where a dense shade is not desired. Extra strong plants, 50c. each (by parcel post, 60c.); \$5.00 per doz.

AMPELOPSIS—Quinquefolia (Virginia Creeper). The large handsome, dark green leaves are deeply cut into five lobes. In the Autumn the foliage turns a beautiful rich crimson; especially adapted to covering tree stumps and trunks. Extra strong plants, 50c. each (by parcel post, 60c.); 12 for \$5.00.

AMPELOPSIS—Veitchii (Boston Ivy). The popular climber for brick and stone buildings and walls. The leaves are a beautiful deep green which in the Autumn turn to a coppery red. Strong plants, 35c. each (by parcel post, 45c.); \$3.50 per doz.

ARISTOLOCHIA—Sipho (Dutchman's Pipe). Handsome light green leaves, giving a quick, dense shade. The brown flowers are shaped like the bowl of a pipe. Large plants, 75c. each (by parcel post, 85c.).

BIGNONIA—Grandiflora (Trumpet Vine). A strong-growing vine, with rich green foliage and trumpet-shaped flowers; free-flowering; dark red, throat shaded orange. Strong plants, 50c. each (by parcel post, 60c.).

CELASTRUS SCANDENS (Bittersweet or Waxwort). A vine of rapid growth. In the early Summer it produces yellow flowers, which by Autumn have turned to bright, orange-colored fruits, with red markings. Extra strong plants, 35c. each (by parcel post, 45c.).

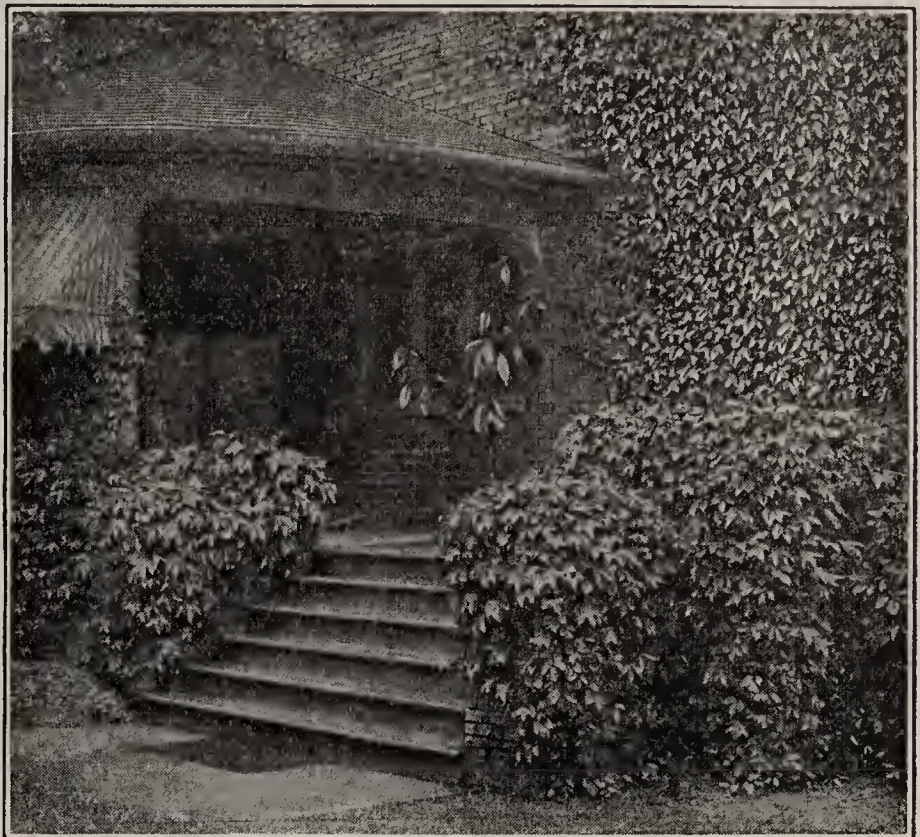

Ampelopsis Veitchii

CLEMATIS

This family of Climbing Plants are probably more popular than any other. Some of the small flowering varieties are exceedingly fragrant. The large flowering types make a glorious effect on account of their gigantic blooms and striking appearance. All Clematis delight in plenty of sunlight, rich soil and plenty of water in dry weather. Great care should be exercised in planting the large-flowering varieties. During the process of transplanting, the stem is likely to get broken below the eye shoots, which would render the plant useless. To guard against this, place a few stakes around the plant to protect it after planting. In the Winter put a covering of straw, long manure, or leaves around the roots.

CLEMATIS MONTANA RUBRA

Identical in every way with the variety Montana Undulata except in color, which is of a pleasing shade of soft rosy-red, a most desirable color. Strong plants, 50c. each (by P. P., 60c.).

CLEMATIS MONTANA UNDULATA

(Anemone Clematis)

A strong, vigorous, perfectly hardy type that succeeds under the most adverse conditions. The Anemone or Wind-flower-like white, flushed mauve flowers are from 1½ to 2 inches in diameter and frequently begin to open the last week in April, just when Wisterias are finished flowering, continuing well throughout May. The best of the early Spring flowering climbers. Strong pot plants, 50c. each (by P. P., 60c.).



Clematis, Jackmani

Coccinea. Produces pretty bell-shaped coral-red flowers from early in June until late in Fall. 50c. each (by parcel post, 60c.).

Crispa. This variety bears sweet-scented, lavender flowers. 50c. each (by parcel post, 60c.).

Henryi. Creamy white; large single flowers, borne in great profusion. Extra strong pot-grown plants, 50c. each (by parcel post, 60c.).

Jackmani. Violet-purple; intensely colored, gigantic flower. Extra strong pot-grown plants, 50c. each (by parcel post, 60c.).

Mad. Edouard Andre. Velvety red. Flowers are well formed and of great substance; the blooms are gigantic. Extra strong pot-grown plants, 50c. each (by parcel post, 60c.).

Paniculata (Japanese Virgin's Bower). A strong, luxuriant grower, with light green foliage. At the close of August innumerable star-like flowers cover the vine in a sheet of fragrant white. Strong plants, 3 for \$1.00 (by P. P., \$1.10); \$3.00 per doz.; per 100, \$18.00. Extra strong plants, 2 for \$1.00 (by P. P., \$1.10); \$5.00 per doz.; per 100, \$35.00.

NOTE—Please read carefully instructions on page 93 before ordering plants.

CINNAMON VINE. Free growing climber, with small white flowers deliciously scented; makes a quick, dense shade. Strong roots, 10c. each; per doz., \$1.00 (by P. P., \$1.10); \$7.50 per 100.

COBAEA—Scandens (Annual). A beautiful blue, cup-shaped flowering annual climber; very desirable for lattice covering, etc. Extra strong plants, 4-in. pots, 40c. each (by P. P., 50c.); 6 for \$2.25; per doz., \$4.00.

EUONYMUS—Radicans. Self-clinging vine, suitable for covering walls, stumps or rockeries, or wherever a vine of slow growing habit is desired; green foliage.

—**Variegata.** Leaves are variegated; otherwise like the above variety.

—**Vegeta.** The foliage is larger than that of the type *Radicans*, and the plant produces an orange-colored berry, which remains on the plant the most part of the Winter. *Euonymus Vegeta* should be planted more extensively than it is. Extra heavy plants.

Price of any of the above *Euonymus*, strong plants, 3 for \$1.00 (by P. P., \$1.10); \$3.00 per doz.; per 100, \$18.00.

HONEYSUCKLE. This favorite requires very little comment or description, always yielding a wealth of fragrant bloom.

—**Chinese Evergreen.** Yellow and white variegated flowers; very fragrant; blooms the entire season.

—**Halliana (Hall's Honeysuckle).** Flowers pure white, turning to yellow; hardy evergreen; flowers from June until frost.

—**Sempervirens Magnifica.** In bloom continuously from early June until late in October. Every branch bears a terminal truss of from 15 to 20 orange-scarlet, long tubular flowers. Foliage dark green with glaucous reverse. Strong plants 50c. each (by P. P., \$1.10); per doz., \$5.00.

—**Variegated (Aurea Reticulata).** Foliage beautifully mottled yellow and green; flowers white and yellow.

Price of any of the above Honeysuckles (except where noted), strong plants, 35c. each (by P. P., 45c.); \$3.50 per doz.; per 100, \$25.00.

HOP VINE (Japanese). A rapid grower, with dark green foliage, and bearing a profusion of seed-pods, suitable for many domestic purposes. Strong pot plants, 3 for \$1.00 (by P. P., \$1.10); doz., \$3.00.

IVY (English). This is an invaluable plant for covering brick and stone walls and buildings. It rarely ever dies out and needs no attention. 4-in. pot-plants, 35c. each (by P. P., 45c.); per doz., \$3.50; \$25.00 per 100.

KUDZU (Pueraria). This vine grows a foot a day and makes a dense covering; exceedingly attractive. Towards the end of Summer produces small, rosy-purple flowers. 3 for \$1.00 (by P. P., \$1.10); doz., \$3.50; \$25.00 per 100.

LATHYRUS (Hardy Pea). This is a splendid plant for training on pillars, columns and similar places; it flowers during the greater part of the Summer.

—**Latifolius.** Rich red.

—**Pink Beauty.** Beautiful rose pink.

—**White Pearl.** Pure white, giant flower trusses.

Price of *Lathyrus*, strong plants, 4 for \$1.00 (by P. P., \$1.10); \$2.50 per doz.; per 100, \$18.00.

LYCIUM (Matrimony Vine)—Barbarum. A dense growing climber, somewhat shrubby in nature. In late Summer the small purple flowers are followed by a crop of red berries, which remain until late Winter. Extra heavy plants, 50c. each (by P. P., 60c.); \$5.00 per doz.

MADEIRA OR MEXICAN VINE. The tubers if planted deep and protected during the Winter are hardy. The leaf is very deep green, and grows very dense; the flower is very small, white in color. Strong roots, 10c. each (single roots, mailed free); per doz., \$1.00 (by P. P., \$1.10); \$7.50 per 100 by express.

MOON VINE—Noctiflora (Annual). A pure white variety, blooming toward evening and in the forenoon; the flowers are frequently 6 inches in diameter. Extra strong plants, 40c. each (by P. P., 50c.); doz., \$4.00.

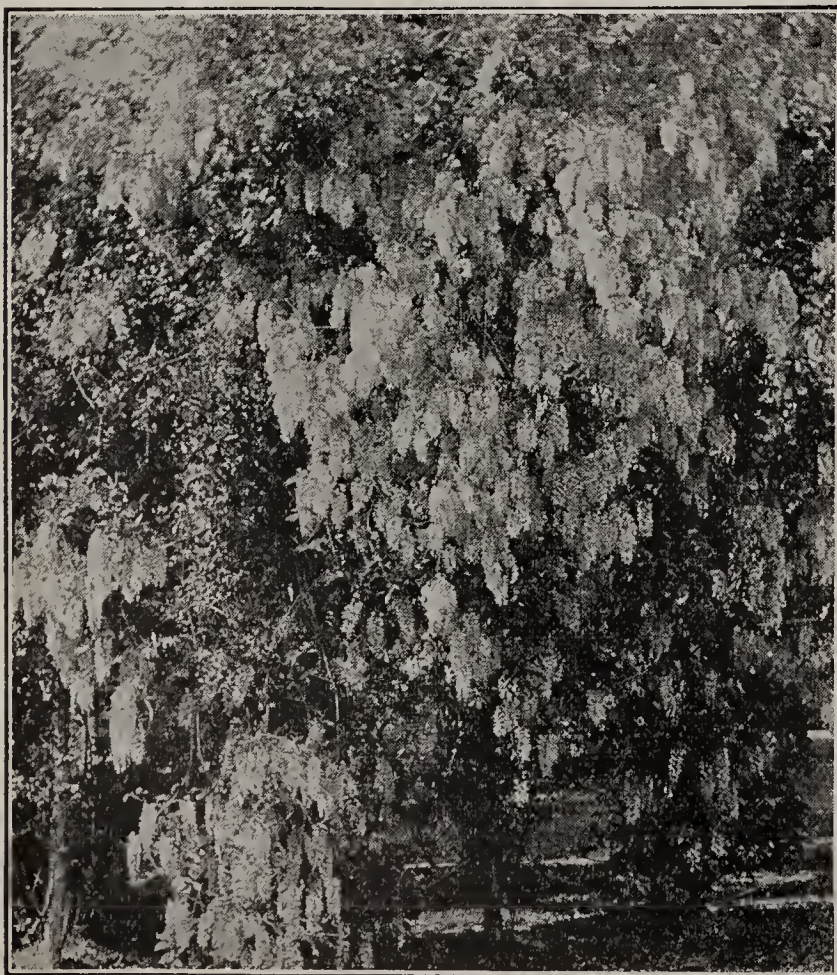

Wistaria



Polygonum Auberti

POLYGONUM

Auberti. For porches, lattice work, fences, pergolas and buildings. A useful vine which is perfectly hardy; it is quick growing, a small plant will make twenty-five to thirty feet of growth the first Summer; snowy white flowers, borne in long clusters, which turn rose color with age. It will not cling to the wall, but will ramble over anything that will support it.

Extra strong pot-grown plants, 50c. each (by P. P., 60c.); \$5.00 per doz.

WISTARIA. This flowers in the latitude of Philadelphia during May. A strong developed vine produces hundreds of flower panicles, while no foliage is visible until after the flower is faded.

Chinensis (Chinese Wistaria). Pale blue; somewhat fragrant. Extra strong plants, \$1.00 each (by P. P., \$1.10).

Chinensis Alba. A beautiful white flowering form of the above. Extra strong plants, \$1.00 each (by P. P., \$1.10).

A planting of Shrubs massed around the boundaries of a garden forms a harmonious background against which the bright-colored Peonies, Poppies, Iris, Phlox and other Hardy Perennial Plants appear to their best advantage.

Because of their easy culture, rapid growth, adaptability to most any situation and their great diversity in size, foliage and bloom, the shrubs are of first importance in creating landscape beauty. There are many suitable locations for planting shrubs about the home grounds. The house foundation and the angles and corners should be softened by shrubs of medium height. Spiraeas, Hydrangeas, Berberis, Deutzias and others of a like nature are suitable for this purpose.

Taller shrubs such as Lilacs, Philadelphus and Altheas are better planted along the sides and rear of the grounds. Here they can be used to give a frame to the property, block out undesirable views and serve as a screen for any purpose desired. Such group plantings should be made in the nature of borders, and the shrubs selected and arranged to give a continuance of bloom, pleasing foliage combinations together with a Fall and Winter coloring of bark and berries.

In planting, space the larger growing shrubs, such as Lilacs, from four to five feet apart; medium tall shrubs, such as Spiraea Prunifolia three to four feet apart, and dwarf growing sorts such as Azaleas, Berberis or Deutzia Gracilis, two to two and one-half feet apart. Dig holes of ample size, place the plant, and after filling in with two-thirds of good top soil, add water to the level of the ground and allow this to settle. After the water has passed away, complete the filling in of the soil.

In pruning, remember that all early flowering shrubs bloom on the last year's wood and should not be pruned until after they have bloomed (otherwise the blooms will be destroyed for that season), at which time the old worn-out wood and all weak growth should be cut away, allowing the vigorous young shoots to remain. The late flowering Shrubs, such as Altheas, Hydrangeas, etc., bloom on the wood made this season. These should be pruned early in the Spring, cutting them back severely to induce a vigorous new growth.

ABELIA GRANDIFLORA (*The Bush Arbutus*). A small shrub of graceful habit, flowering continuously from July until frost. The flowers are small, tubular, white shaded pink and are borne in clusters, forming a pleasing contrast with the shiny, almost evergreen foliage. Strong plants, balled and burlapped. 50c. each (by P. P., 60c.).

ALTHEA (*Rose of Sharon*). These thrive almost anywhere, producing their bloom from July till September.

—**Alba Plena**. Pure white; double.

—**Atropurpurea Plena**. Double purple.

—**Lady Stanley**. Semi-double; pale pink, splashed with carmine.

—**Wm. R. Smith**. Pure white single flowers, opening out flat, in great profusion from early July until late September; very showy and outstanding.

Plants, 2 to 3 feet high, 50c. each (by P. P., 60c.).

AMYGDALUS—Alba Flore Pleno (*Flowering Almond*). Erect, slender branches, which are covered in May with small, very double, fragrant white flowers. Strong plants, 2 to 3 feet, 50c. each (by P. P., 60c.).

—**Rosea Flore Pleno**. Identical with the above, but bearing pink flowers. Strong plants, 2 to 3 feet, 50c. each (by P. P., 60c.).

ANDROMEDA—Japonica (*Pieris*). Compact growing shrub with dark green foliage. The bell-shaped, white flowers are produced in dense panicles in early Spring. Strong plants, \$1.50 each.

AZALEAS. A family of dwarf bushy shrubs, bearing a great profusion of flowers in the Spring and succeeding best in a partially shaded position. Very useful for planting in the shady border or in groups by themselves.

—**Amoena**. An evergreen variety, literally covered with masses of rosy-crimson flowers in the late Spring. Bushy plants, \$1.50 each; \$15.00 per doz.

—**Amoena Coccinea**. A true sport of the well known variety Amoena, with brilliant red flowers. A valuable Azalea where A. Hinodegiri is not hardy. Bushy plants, 10 inches, \$1.50 each.

—**Hinamayo**. Similar to the well known variety, Hinodegiri in habit of growth; the foliage is smaller and the color is a delicate soft shade of rose-pink. Bushy plants, 10 to 12 inches, \$1.50 each.

—**Hinodegiri**. Another evergreen variety and one of the best, bearing fiery-red single flowers in great profusion. Very desirable on account of its color. Bushy plants, \$1.50 each; \$15.00 per doz.

—**Kaempferi** (*Torch Azalea*). A beautiful hardy shrub of erect habit with brick-red flowers. Strong plants, \$2.00 each.

—**Kurume, Coral Bells**. Not a very large flower, but produced very freely; a pleasing coral-pink in color, very dainty, semi-double. Strong bushy plants, \$1.50 each.

—**Flame**. Brilliant red flowers in profusion; glossy evergreen foliage. Bushy plants, \$1.50 each.



Hardy Azalea

AZALEA—Kurume, Pink Pearl. A beautiful salmon-rose, shading lighter to the center; large full trusses. Bushy plants, \$1.50 each.

—**Snow**. Large pure white flowers borne profusely in clusters, semi-double. Strong bushy plants, \$1.50 each.

—**Ledifolia Alba**. A robust growing variety with heavy mat green foliage and large pure white flowers. Bushy plants, \$1.50 each.

—**Mollis**. This is a deciduous variety, dwarf and bushy. The flowers are large and are produced in clusters on the ends of the shoots in May. We offer mixed colors only, which vary from pale yellow to the deeper orange and even scarlet. Strong plants, \$2.00 each; \$22.50 per doz.

BERBERIS—Julianae (*Wintergreen Barberry*). Evergreen variety with deep green leaves, one of the best. Thrifty young plants from 4 inch pots, 50c. each (by P. P., 60c.).

—**Tricanthophora** (*Three Spine Barberry*). One of the most graceful of the evergreen Barberries; narrow leaves and very hardy. Strong plants from 5-inch pots, 75c. each (by P. P., 85c. each).

—**Verruculosa** (*Warty Barberry*). A compact growing variety with small shiny leaves. A gem for the rock garden. Thrifty young plants from 3-inch pots, 50c. each (by P. P., 60c. each).

BERBERIS—Thunbergii (*Japanese Barberry*). See page 131.

BRIDAL WREATH. See *Spirea Prunifolia*.

NEW BUTTERFLY BUSH or SUMMER LILAC

Buddleia Ile de France

This new variety of *Buddleia*, a French introduction, will quickly replace the older varieties of this shrub which have been popular for so many years, it being superior not only in its brilliant coloring but also in its more uniform habit of growth. The plant attains a height of from 3 to 4 feet, forming a symmetrical bushy shrub, every growth terminated by a graceful spike of fragrant flowers of a brilliant rosy violet-purple, very fragrant. In bloom from the latter part of July until late September. Strong plants from 3-inch pots, 3 for \$1.00 (by P. P., \$1.10); \$3.50 per doz.; per 100, \$25.00.

CALLICARPA PURPUREA (*Beauty Fruit*). A beautiful shrub growing about 3 feet high, covered in August with tiny pink tinted flowers, followed in late September by violet purple berries borne in clusters from the axil of every leaf, remaining until the middle of Winter. Strong plants, 50c. each (by parcel post, 60c.).

CALLUNA (*Scotch Heather*). Small evergreen shrubs growing from one to two feet high with small bell-shaped flowers in great profusion from July till September. Recommended for rock gardens.

—**Vulgaris.** Midseason; grows 12 to 15 inches high; flowers rosy-pink.

—**Alba.** Early; grows 12 to 15 inches high; flowers white.

—**Alporti.** Late; grows 24 inches high; flowers rosy-purple.

—**Aurea.** Midseason; grows 12 to 15 inches high; flowers pink, foliage bright yellow-green, turning red.

—**Rubra.** Early; low spreading growth, 6 to 12 inches high; flowers rosy-carmine.

Price of *Callunas*, bushy plants, 2 years old, 50c. each (by P. P., 60c.); per doz., \$5.00.

CALYCANTHUS—Floridus (*Sweet Shrub*). Chocolate-colored double flowers, with a peculiar agreeable odor. Blooms in June. 2 to 3 feet, 50c. each (by P. P., 60c.).

CERCIS—Canadensis (*Judas Tree or Red Bud*). A tall, slender growing shrub, developing eventually into a large tree. Very early in the Spring the leafless branches are covered with delicate deep pink flowers. 2 to 3 feet plants, 60c. each.

CHIONANTHUS—Virginica (*White Fringe*). In May and June the tree is covered with long, fluffy panicles of fine white bloom. Strong plants, 75c. each (by P. P., 85c.).

CLETHRA—Alnifolia (*Sweet Pepper Bush*). Of low and dense growth; numerous spikes of small white fragrant flowers appearing in July; desirable for moist places or along water edges. 2 to 3 feet, 60c. each (by P. P., 70c.).

CORNUS (*Dogwood*). This plant is so well known that it hardly needs description. The flowers appear before the foliage in May. In Autumn it takes on a rich crimson shade.

—**Florida** (*White Flowered Dogwood*). Strong plants, 3 to 4 feet, \$1.25 each.

—**Rubra** (*Pink Flowered Dogwood*). 3 to 4 feet, \$2.50 each.

—**Elegantissima** (*Variegated Dogwood*). A beautifully variegated shrub which should be planted more freely. Strong plants, 2 to 3 feet high, 50c. each (by P. P., 60c.).

—**Lutea** (*Golden-twiggled Dogwood*). Bright yellow branches in Winter. Strong plants, 2 to 3 feet high, 50c. each (by P. P., 60c.).

—**Sibirica** (*Siberian Dogwood*). Branches, a bright, coral red which are quite ornamental for Winter effects. Strong plants, 2 to 3 feet high, 50c. each (by P. P., 60c.).

COTONEASTER—Apiculata. Low growing variety with large bright red berries.

—**Francheti** (*Rockspray, Quinceberry*). Upright, densely branched shrub with spreading branches. Fruit orange-red.

—**Horizontalis.** Low growing shrub with almost horizontal branches. Small shiny green leaves and orange-red berries produced in profusion. One of the most effective evergreen plants for the rockery.

—**Salicifolia Floccosa** (*Willow leaf Cotoneaster*). Large growing shrub of graceful habit; bright red fruits extending well along the branches.

Any of the above *Cotoneasters*, strong pot-grown plants, \$1.00 each; per doz., \$10.00.



Callicarpa Purpurea

CRAB. See *Malus*.

CYTISUS—Laburnum (*Golden Chain*). A large shrub with shining green leaves and long drooping racemes of yellow flowers, which appear in the early Summer. \$1.00 each (by P. P., \$1.10).

DAPHNE—Cneorum (*Garland Flower*). A pretty dwarf spreading shrub, growing from 6 to 8 inches high; valuable for the rockery or for the front of the border; beautiful bright pink, sweet-scented flowers early in May. Strong plants, 75c. each; \$7.50 per doz.

DEUTZIA. The *Deutzias* are among the most useful of our summer flowering shrubs. For planting either individually or in masses they are very attractive.

—**Candidissima Fl. Pl.** Abundant racemes of double, pure white flowers in June; luxuriant foliage, and fine habit. 3 ft. plants.

—**Crenata Rosea Fl. Pl.** Double; white tinged pink. 3 ft.

—**Gracilis.** Of dwarf, bushy habit; white flowers. 18 inches.

—**Lemoinei.** One of the best dwarf hardy shrubs; the flowers are large and are produced in cone-shaped heads of pure white.

—**Pride of Rochester.** The flowers, borne in large panicles, are pinkish white, with under-side of the petals rose. June. Any of the above *Deutzias*, 50c. each (by P. P., 60c.).

DOGWOOD. See *Cornus*.

ERICA—Vagans (*Cornish Heath*). A charming hardy plant, companion to the *Heathers*, bearing pale lilac flowers. Strong one-year-old plants, 50c. each (by P. P., 60c.).

EUONYMUS ALATA (*Cork-barked Euonymus*). Small delicate flowers in late Spring are followed by attractive red berries in the Fall. Curious corky bark, brilliant Autumnal foliage. Best for individual planting. 18 to 24 inches, 75c. each (by P. P., 85c.).

EXOCHORDA GRANDIFLORA (*Pearl Bush*). A medium sized shrub, producing white flowers in graceful clusters, early in the Spring; fine for cut flowers. Strong plants, 18 to 24 inches, 50c. each (by P. P., 60c.).

FLOWERING ALMOND. See *Amygdalus*.

FLOWERING CRAB. See *Malus*.

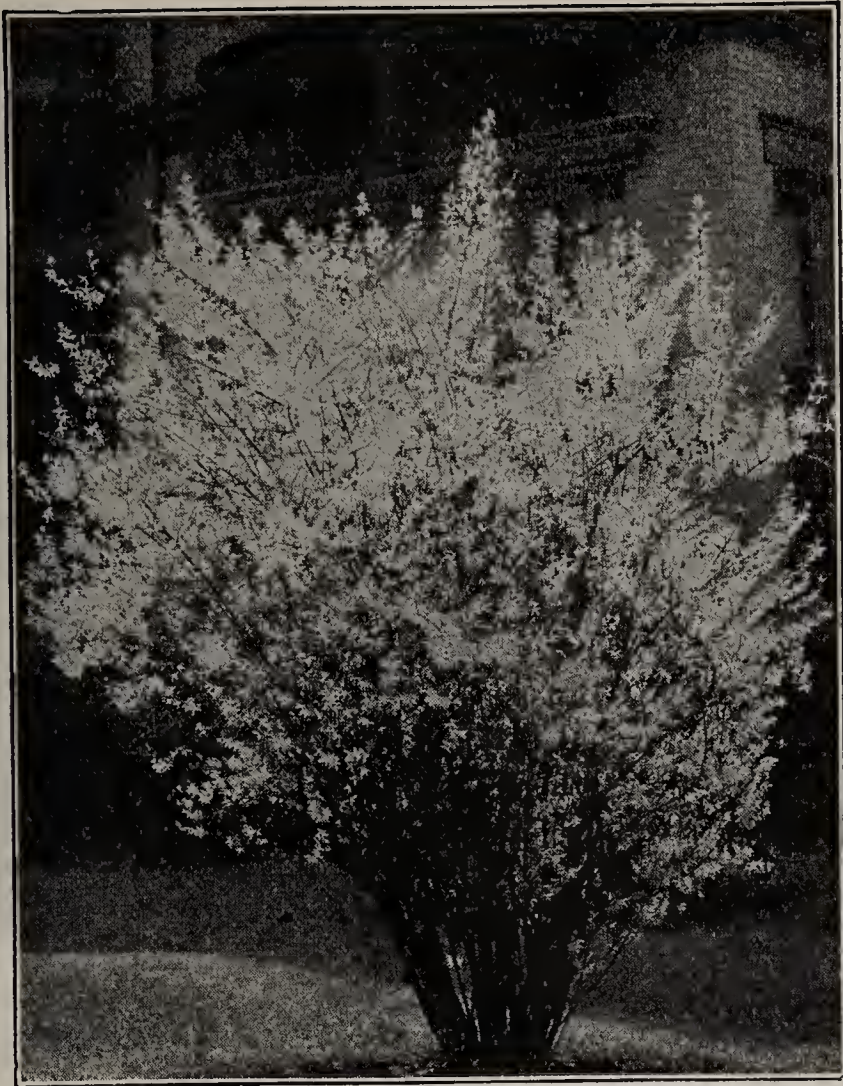

Forsythia, Spectabilis

FORSYTHIA (*Golden Bells*). Bright golden-yellow, star-shaped flowers burst into bloom just as Winter is leaving and while the bush is otherwise bare.

- Fortunei**. Erect growing with dark green foliage; strong plants, 4 feet.
- Intermedia**. April. Vigorous grower with slender, erect or arching branches. Considered by many as the best of the family.
- Spectabilis**. Strong, tall growing with very large flowers completely covering the stems, most profuse bloomer of all.
- Suspensa**. Graceful, drooping tendency. Frequently planted on banks and slopes. Beautiful as specimens or in masses. Price of Forsythias, 50c. each (by P. P., 60c.).

GOLDEN BELLS. See Forsythia.

GOLDEN CHAIN. See Cytisus.

HONEYSUCKLE. See Lonicera.

HYDRANGEA—Arborescens Grandiflora Alba (*Snowball Hydrangea*). The snow-white blooms are of the largest size, coming into flower in early June and lasting until late in August. Is more hardy than any other sort and especially suited for shaded places. 2 to 2½ ft., 50c. each (by P. P., 60c.).

—**Paniculata Grandiflora**. The large panicles of white flowers are at their best during August, later they take on a reddish cast. These plants look fine used as single specimens on the lawn or grouped in large beds. Strong bush form, 2 ft. plants, 50c. each (by P. P., 60c.). Extra strong stock, 3 ft., 75c. each (by P. P., 85c.).

—**Paniculata Grandiflora (Standard or Tree-Shaped)**. These are fine, planted as individual specimens in the lawn or in the center of beds, containing other plants. Stems 2 to 2½ feet long, with shapely heads, 75c. each.

—**Quercifolia (Oak-leaved Hydrangea)**. A handsome spreading shrub with striking foliage, turning in Autumn to a beautiful red. The flowers are produced freely in August, in flat white clusters. Strong plants, 18 to 24 inches, 75c. each (by P. P., 85c.).

ILEX AQUIFOLIUM (English Holly). Strong plants, 18 to 24 inches high, \$3.50 each.

—**Cornuta (Chinese Holly)**. A very handsome variety of Holly with large spiny, dark green leaves and large scarlet berries. Strong plants, \$1.00 each.

—**Opaca (American Holly)**. Strong plants 2 to 3 feet high, \$3.50 each.

JAPAN QUINCE. See Pyrus.

JASMINUM—Nudiflorum. A fine shrub for sheltered positions, bearing fragrant yellow flowers very early in Spring. Hardy south of Philadelphia. 50c. each (by parcel post, 60c.).

JUDAS TREE. See Cercis.

KALMIA LATIFOLIA (Mountain Laurel). Evergreen; most effective in June when the clusters of pink flowers open; nice clean foliage and likes shade. Strong plants, \$2.50 each.

KERRIA—Japonica Fl. Pl. An old-fashioned shrub, producing attractive double golden-yellow flowers from June until October. The branches, during the Winter, are a pleasing shade of green. 75c. each (by P. P., 85c.).

KOLKWITZIA AMABILIS (Beauty Bush). A handsome new ornamental shrub from China, resembling the Weigelia and Honeysuckle, to which it is allied. Growing to 6 to 8 feet high at maturity, with long arching branches covered with pale pink, bell-shaped flowers in June. One of the most outstanding shrubs. Strong plants, 18 to 24 inches high, 50c. each (by P. P., 60c.).

LILAC. See Syringa.

LONICERA—Fragrantissima (Honeysuckle). March and April. Delightfully fragrant white flowers that come with the first breath of Spring. 50c. each (by parcel post, 60c.).

—**Morrowi**. An open bush with irregular branches. The foliage is dark green with small white flowers, which appear during May. During the late Summer and early Autumn the plant is covered with bright red berries. Plants, 3 feet, 50c. each (by parcel post, 60c.).

—**Ruprechtiana**. A free flowering variety; white flowers during May and June, followed by red fruit. 50c. each (by parcel post, 60c.).

MAHONIA AQUILIFOLIUM (Oregon Holly Grape), 4 to 5 feet. Evergreen, shining green leaves which turn to rich scarlet in the Autumn; yellow flowers in May followed by blue-black fruit. Best in half shade. Strong plants, 15 to 18 inches high, \$1.50 each.

MALUS—Floribunda (Japanese Flowering Crab). One of the best of the flowering Crabs. The buds are a warm rose color opening to light pink flowers—the whole forming a shapely bush or small tree. 3 to 4 feet, 75c. (by parcel post, 85c.).

—**Ioensis Plena (Bechtel's Double Flowering Crab)**. A shapely little tree, producing quantities of very double, fragrant flowers of a soft pink, resembling a small Rose in formation. 2 to 3 feet, 50c. (by parcel post, 60c.).

—**Parkmanii (Parkman's Flowering Crab)**. Rose-colored buds open into little rosy white flowers; these are succeeded by decorative fruits. The tree is of a rather spreading, irregular habit. 3 feet, \$1.00 each (by parcel post, \$1.10).

MOCK ORANGE. See Philadelphus.

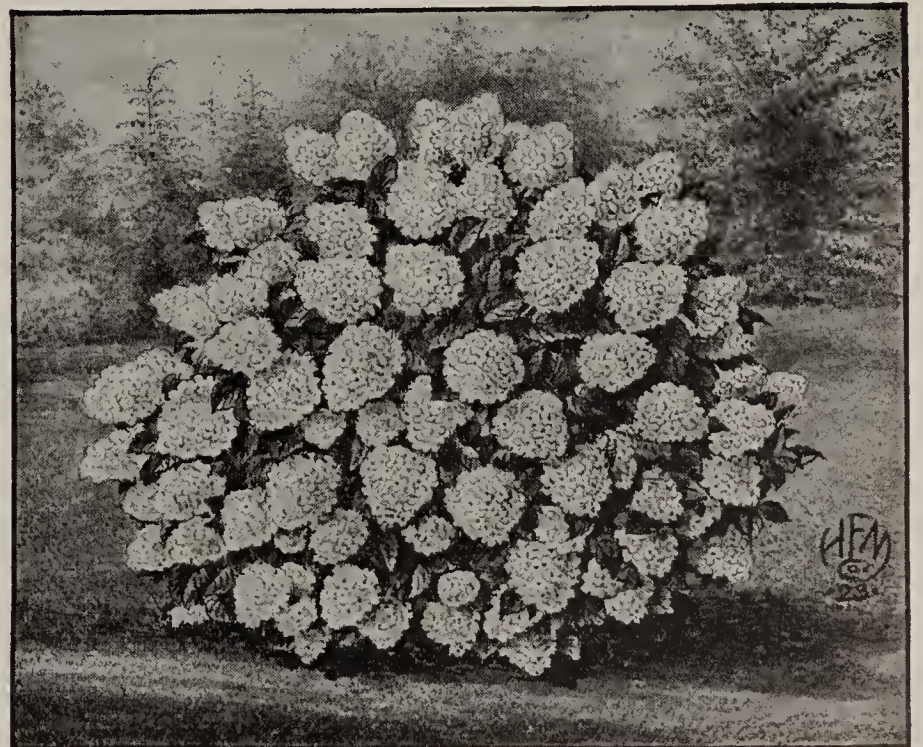

Hydrangea Paniculata

NANDINA DOMESTICA (*Chinese Bamboo*). Handsome small shrub with graceful light green foliage turning bronzy-red early in the Fall. Small white flowers in Spring followed by crimson berries. Strong plants, 18 to 24 inches high, \$1.00 each.

OSMANTHUS-AQUILIFOLIUM (*Holly Osmanthus*). Ever-green shrub with holly-like foliage and small white fragrant flowers. Strong plants, \$1.50 each.

PHILADELPHUS—Avalanche. One of the newer varieties and one of the best, growing from 6 to 8 feet in height with slender arching branches which are nearly covered with large pure white flowers. Strong plants, 18 to 24 inches high, 50c. each (by parcel post, 60c.).

—**Bouquet Blanc**. Low dense habit, blooms very freely during May and June. Strong 2 to 3 foot plants, 50c. each (by P. P., 60c.).

—**Coronarius** (*Mock Orange*). Handsome foliage and beautiful, fragrant white flowers in May and June. 2 ft. plants, 50c. each (by parcel post, 60c.).

—**Grandiflorus**. A robust growing variety, bearing large white flowers. 3 ft., 50c. each (by parcel post, 60c.).

PRUNUS—Triloba (*Double-flowering Plum*). A shapely shrub of medium height, bearing in early Spring, semi-double delicate pink flowers, about one inch in diameter. Strong plants, 2 to 3 feet, 50c. each (by P. P., 60c.).

PYRANCANTHA (CRATEGUS) COCCINEA LALANDI. (*Firethorn or Evergreen Thorn*). There is no other fruiting evergreen shrub that is so attractive throughout the year as this fiery Thorn. The large trusses of white flowers are followed in Summer by an abundance of brilliant orange-scarlet berries, which, remaining on the plants throughout the Winter, produce a gorgeous effect. Strong pot-grown plants, \$1.00 each.

PYRUS—Japonica (*Japan Quince*). This shrub is a beautiful sight when covered in the early Spring with cherry-red flowers, about the size of an apple blossom. Extra strong plants, 2 ft., 50c. each (by parcel post, 60c.).

RED BUD. See *Cercis*.

RHUS COTINUS (*Purple Mist or Smoke Tree*). An old favorite that has been out of commerce for the past few years; a new stock is now available and we are glad to be able to offer it again. A large shrub that can be planted as a single specimen or in the mixed border; about mid-summer the plant is literally covered with clusters of feathered flowers giving the appearance of a cloud of smoke or mist. Strong plants 2 to 3 feet, 50c. each (by P. P., 60c.); per doz., \$5.00.

—**Typhina Laciniata** (*Dwarf Cut-leaved Sumac*). Low growth and fern-like foliage highly colored in the Fall months. 50c. each (by P. P., 60c.).

ROSE OF SHARON. See *Althea*.

SNOWBALL. See *Viburnum*.

SPIREA—Anthony Waterer. Of dwarf, dense habit, bearing a profusion of crimson flowers. 18 inches.

—**Prunifolia** (*Bridal Wreath*). The pretty double white flowers are all along the almost leafless stem about May 1st, just as the leaves are budding. 3 feet.

—**Thunbergi**. One of the prettiest of the dwarf shrubs, with fine delicate foliage and a profusion of small white flowers in the early Spring. 18 inches.

—**Van Houttei**. The most beautiful of all white Spireas, flowering in May, when it is a complete fountain of white bloom. 3 feet.

Price of Spireas, 50c. each (by parcel post, 60c.).

SYMPHORICARPUS—Racemosus (*Snowberry*). Small red flowers are succeeded by many white berries, remaining on the plant through half the winter. Strong plants, 50c. each (by parcel post, 60c.).

—**Vulgaris** (*Red fruited or Indian Currant*). This is a well known shrub, bearing pink flowers followed by bright red fruit. 50c. each (by parcel post, 60c.).

SUMAC. See *Rhus*.

SWEET PEPPER BUSH. See *Clethra*.

SWEET SHRUB. See *Calycanthus*.



Symphoricarpus (*Snowberry*)

SYRINGA (Lilac)—Charles X. A strong growing variety, bearing large trusses of reddish purple flowers. 75c. each (by parcel post, 85c.).

—**Japonica**. A very desirable free flowering tree, bearing during June and July fragrant white flowers in large panicles. 50c. each (by parcel post, 60c.).

—**Marie Legraye**. A dwarf growing variety, producing immense trusses of beautiful creamy white flowers; one of the most popular single white sorts. 75c. each (by parcel post, 85c.).

—**Persica** (*Persian Lilac*). More slender in growth than the common lilac; purple flowers in graceful spikes. 60c. each (by parcel post, 70c.).

—**Vulgaris**. Common purple, sweet-scented lilac. 50c. each (by parcel post, 60c.).

—**Vulgaris Alba**. Pure white type of the above, but more fragrant. 50c. each (by parcel post, 60c.).

TAMARIX—Africana. Strong, slender, upright growth, with panicles of feathery pink flowers in May. 3 to 4 feet, 50c. each (by parcel post, 60c.).

—**Hispid Aestivalis**. A distinct variety, bearing delicate sprays of soft pink flowers in July and August, very light and feathery. 2 to 3 ft., 50c. each (by parcel post, 60c.).

VIBURNUM CARLESI. A rare Korean variety and one of the most desirable semi-dwarf flowering shrubs with clusters of wonderfully fragrant flowers, white shaded with pink. Strong plants, \$1.50 each.

—**Opulus** (*High Bush Cranberry*). One of the most popular shrubs, bearing clusters of white flowers in June, followed by bright scarlet berries in Autumn, which are very attractive throughout the Winter. Strong plants, 2 ft. to 3 ft., 50c. each (by parcel post, 60c.).

—**Opulus Sterilis** (*Snowball or Guelder Rose*). This is the popular white Snowball, filled with large globes of white flowers in May. Strong plants, 2 ft. to 3 ft., 50c. each (by parcel post, 60c.).

—**Plicatum** (*Japanese Snowball*). A desirable shrub. Should be in every garden or on the lawn; perfectly hardy; blooms in June. Extra fine plants, 2 to 3 feet, 50c. each (by parcel post, 60c.).

—**Tomentosum**. Distinct from all other varieties of Snowball, both in foliage and flower; the latter are more flat than those of the other varieties and followed by decorative red fruits, changing to black as they ripen. Strong plants, 2 to 3 feet. 50c. each (by parcel post, 60c.).

VITEX AGNUS CASTUS (*Chaste Tree*). A shrub or small tree, with strong aromatic odor; dense spikes of pale lilac flowers from July to September. Strong plants, 2 feet, 50c. each (by parcel post, 60c.).

—**Macrophylla**. A graceful and attractive shrub, growing 3 to 4 feet high; producing freely pretty lavender-blue flowers from July until frost. 60c. each (by parcel post, 70c.).

WEIGELIA—Candida. Flowers abundantly in June and July; additional bloom is also shown during the autumn months. The tube-shaped flowers are pure white; fine for cutting. Plants, 2 to 3 feet, 50c. each (by parcel post, 60c.).

—**Eva Rathke**. Of erect form and vigorous habit. The deep carmine-red flowers are the best of the red-flowering sorts. 2 to 3 feet, 50c. each (by parcel post, 60c.).

—**Rosea**. Remarkably showy flower; numerous spreading branches and dark green leaves. The rose-colored blooms are produced in great abundance. 50c. each (by parcel post, 60c.).

—**Rosea nana variegata**. Silvery variegated leaves and pale pink flowers. 50c. each (by parcel post, 60c.).

WHITE FRINGE. See *Chionanthus*.



Weigelia Eva Rathke

MICHELL'S CHOICE THRIFTY HEDGE PLANTS

NEW RED-LEAVED JAPANESE BARBERRY

It is similar in all respects to the green-leaved Japanese Barberry which is so popular for mixing in the shrubbery border, as single specimens, or for planting in clumps on the lawn, as well as for foundation planting and for hedges, but the foliage of this new variety is of a rich, lustrous, bronzy red, similar to the richest red-leaved Japanese Maples. As the season advances, this new Barberry becomes more brilliant and gorgeous throughout the Summer, and in the Fall its foliage changes to vivid orange, scarlet, and red shades.

All that is required to develop its brilliant coloring at all seasons is that it be planted in full exposure to the sun.

	Each	Doz.	100
Strong, 1-year-old plants, 12 to 15 inches ...	\$0.35	\$3.50	\$25.00
Strong, 2-year-old plants, 15 to 18 inches50	5.00	40.00

BERBERIS THUNBERGII (Japanese Barberry)

A good hardy plant of low dense growth. There is an air of grace and refinement to the Barberry Bush which is not embodied in any other hedge plant. It is a brilliant light green from early Spring to Winter, it should be regarded as a shrub as it can be planted individually in lawn or border. The slender branches are prickly, with small thorns, and tend to make a defensive hedge that few animals will attempt to penetrate. In autumn the foliage

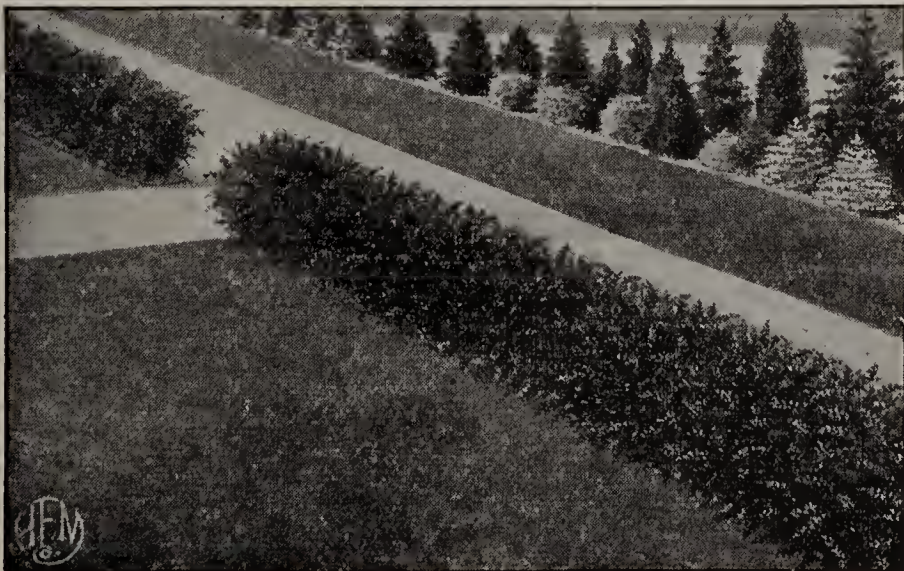

Berberis Thunbergii

is a bright crimson; when it falls a profusion of scarlet berries, which remain throughout the Winter, are revealed on the branches.

Height	Each	Doz.	100
9 to 12 inches.....	\$0.20	\$1.50	\$10.00
12 to 18 inches.....	.30	2.50	15.00
18 to 24 inches.....	.40	3.50	25.00

BOXWOOD (Dwarf, for Edging)

We have a quantity of dwarf edging, nice bushy stock for edging beds and paths. Boxwood grows into value and adds charm to the garden that no other plant can do.

Height	Doz.	100
4-6 inches.....	\$2.50	\$15.00
6-8 inches.....	3.50	25.00

BUSH SHAPED BOXWOOD

Best adapted for hedge planting. Extra bushy plants.

Height	Each	Doz.
12 to 15 in.....	\$1.00	\$10.00
15 to 18 in.....	1.50	15.00
18 to 24 in.....	2.50	25.00

GOLDEN OR VARIEGATED PRIVET

Like the California variety, but each leaf is margined and blotched golden yellow, giving it, from a distance, a striking appearance. We recommend it especially for placing among shrubbery or for planting on the lawn; the contrast between the grass and golden foliage is beautiful. **Bushy Plants, 3 for \$1.00; \$3.00 per doz.; per 100, \$20.00.**

CALIFORNIA PRIVET

The most popular of all Hedge Plants. Being absolutely hardy, it increases in beauty with each successive year. Plants should be set 12 inches apart in double rows, in zig-zag fashion, so that the plants are diagonally opposite each other; this practically places them 6 inches apart, which is desirable to get a quick, dense growth. Plant from October 15th till the ground freezes, and from March 15th to May 15th.

Height	Doz.	100	1000
1 year old, 18 to 24 inches.....	\$1.25	\$6.00	\$50.00
2 year old, 24 to 30 inches.....	1.50	8.00	70.00
2 year old, 30 to 36 inches.....	2.00	10.00	90.00

HYDRANGEA HORTENSIS

Otaksa. This is the old-fashioned favorite Japanese variety that usually flowers pink, and is the ideal variety for planting extensively at the seashore.

4-inch Pot Plants, 2 for \$1.00; \$5.00 per doz.
6-inch Pot Plants, \$1.00 each; doz., \$10.00.



This list includes the varieties mostly in demand. We can furnish all other sorts.

BIOTA—Aurea Nana (*Berckmans Golden Arborvitae*), 2½ to 3 feet. A gem for dwarf planting; compact, roundish shape; warm golden-yellow foliage. Plants 12 to 15 inches high, \$1.50 each; 15 to 18 inches high, \$2.00 each.

CHAMAECYPARIS Plumosa (*Plume Cypress*), 25 to 35 feet. Evergreen, forms a dense cone of fine texture; useful for shearing into formal shapes. Plants, 18 to 24 inches high, \$1.00 each; 2 to 2½ feet high, \$1.50 each.

—**Aurea** (*Golden Plume Cypress*), 20 to 25 feet. Similar to the above but golden-yellow in color. Plants 18 to 24 inches high, \$1.50 each; 2 to 2½ feet high, \$2.00 each.

—**Squarrosa Veitchi** (*Moss Cypress*), 25 to 30 feet. Foliage blue-gray, feathery and dense, giving a soft wooly appearance; broad pyramidal outline. Plants 18 to 24 inches high, \$1.50 each; 2 to 2½ feet high, \$2.00 each.

CRYPTOMERIA Japonica Lobbi (*Lobb Cryptomeria*), 15 to 20 feet. Forms a narrow irregular column, compact and picturesque, rich bronze Winter color. Plants 2 to 3 feet high, \$3.00 each.

JUNIPERUS Chinensis Pfitzeriana (*Pfitzer Juniper*), 5 to 6 feet. Broad bushy habit, gray-green foliage, giving a feathery appearance. A hardy adaptable Evergreen, especially for foundation planting. Plants 15 to 18 inches high, \$1.50 each; 18 to 24 inches high, \$2.00 each.

—**Hibernica** (*Irish Juniper*), 7 to 8 feet. A slender Evergreen of bluish-green color, spire-like in effect. Plants 2 to 2½ feet high, \$1.25 each; 2½ to 3 feet high, \$2.00 each.

—**Suecica** (*Swedish Juniper*), 4 to 5 feet. Quick growing, narrow upright form. Plants 2 to 2½ feet high, \$1.75 each.

—**Cracovica** (*Polish Juniper*), 4 to 5 feet. Upright, branching from ground, making a very narrow column. Plants 2 to 2½ feet high, \$1.50 each; 2½ to 3 feet high, \$2.00 each.

—**Excelsa Stricta** (*Spiny Greek Juniper*), 4 to 5 feet. Combines regularity of shape, beauty of coloring, hardiness and rather slow growth. Steel blue foliage. Plants 15 to 18 inches high, \$1.75 each; 18 to 24 inches high, \$2.25 each.

—**Sabina** (*Savin Juniper*), 6 to 7 feet. Dense dark green foliage, spreading branches, forming an irregular vase-shaped plant. Plants 15 to 18 inches high, \$1.25 each; 18 to 24 inches high, \$1.75 each.

—**Squamata Meyeri** (*Myer Juniper*), 3 to 4 feet. Beautiful deep blue foliage; particularly suitable for rockery or low foreground planting. Plants 18 to 24 inches high, \$3.00 each.

—**Virginiana** (*Red Cedar*), 25 to 30 feet. Forms a dense column of deep green foliage, purplish in the Winter. Useful in formal work or mixed plantings, where height is desired. Plants 2½ to 3 feet high, \$2.00 each; 3 to 4 feet high, \$3.50 each.

—**Glauca** (*Silver Red Cedar*), 15 to 20 feet. Similar to the above excepting in color which is a beautiful steel-blue. Plants 2½ to 3 feet high, \$4.50 each.

PICEA Excelsa (*Norway Spruce*), 80 to 100 feet. Dark green foliage; grows rapidly and makes a good windbreak. The well known Christmas tree. Plants 15 to 18 inches high, \$1.00 each; 18 to 24 inches high, \$1.50 each.

The figures following each variety, indicate in feet the approximate height of that plant when mature, it must be understood, however, that it takes a great many years to attain this height.

PICEA Pungens (*Colorado Spruce*), 60 to 80 feet. The native Spruce of Colorado; bluish-green color and very hardy. Makes a handsome lawn specimen. Plants 18 to 24 inches high, \$1.75 each; 2 to 2½ feet high, \$3.00 each.

—**Glauca** (*Colorado Blue Spruce*). 60 to 80 feet. Similar to the above but of a pleasing blue color. Selected plants, 18 to 24 inches high, \$5.00 each.

—**Kosteri** (*Koster's Blue Spruce*). 60 to 80 feet. The aristocrat of the Evergreen family; by far the most shapely of the Spruces and the truest, most persistent blue of any known tree; very scarce. Plants 2 to 2½ feet high, \$10.00 each.

PINUS—Montana Mughus (*Mugho Pine*), 2 to 3 feet. Compact dwarf Pine, forming a round-topped clump. Useful for rock planting and foundation work. Plants 12 to 15 inches high, \$1.50 each.

—**Nigra Austriaca** (*Austrian Pine*). 60 to 70 feet. A vigorous and dense grower with rich dark green foliage. Plants 18 to 24 inches high, \$1.50 each; 2 to 3 feet high, \$2.50 each.

—**Resinosa** (*Red Pine*), 60 to 70 feet. The Red Pine succeeds in poor soil and is of rapid growth, producing a nice shaped tree. Plants 18 to 24 inches high, \$1.75 each; 2 to 3 feet high, \$2.50 each.

—**Sylvestris** (*Scotch Pine*). 25 to 30 feet. One of the most rapid growing Pines, bluer than the Red Pine. Plants 2 to 3 feet high, \$1.50 each; 3 to 4 feet high, \$2.25 each.

TAXUS—Baccata Repandens (*Spreading English Yew*), 18 to 24 inches. Spreading horizontal branches, dark blue green foliage. Valuable for low planting. Plants 12 to 15 inches high, \$1.50 each.

—**Cuspidata** (*Spreading Japanese Yew*), 4 to 5 feet. This is one of the hardiest Evergreens in cultivation, with very dark green foliage and spreading bushy habit. Plants 15 to 18 inches high, \$1.50 each; 18 to 24 inches high, \$2.50 each.

—**Nana** (*Dwarf Japanese Yew*), 2 to 3 feet. One of the hardiest of the dwarf Evergreens, foliage similar to the above but slower of growth and more compact. Plants 9 to 12 inches high, \$1.50 each; 12 to 15 inches high, \$2.25 each.

THUYA—Occidentalis (*American Arborvitae*), 15 to 30 feet. Slender pyramid with broad base, bronzy Winter coloring. Good accent plant and also for hedges as it stands trimming well. Plants 2 to 2½ feet high, \$1.00 each; 2½ to 3 feet, \$1.50 each.

—**Globosa** (*Globe Arborvitae*), 2½ to 3 feet. Natural globe-shaped Evergreen, very good for formal and foundation work. Plants 12 to 15 inches high, \$1.00 each; 15 to 18 inches high, \$1.50 each.

—**Pyramidalis** (*Pyramidal Arborvitae*), 15 to 30 feet. Narrow columnar shape retaining its bright green color throughout the Winter. Splendid for accents or formal planting. Plants 2 to 2½ feet high, \$1.50 each; 2½ to 3 feet high, \$2.00 each.

TSUGA—Canadensis (*Canada Hemlock*), 75 to 90 feet. One of the most graceful and attractive native Evergreens. The spreading horizontal branches of finely cut foliage make this a most adaptable tree either for hedges or informal planting. Plants 18 to 24 inches high, \$1.75 each; 2 to 3 feet high, \$2.50 each.



This list includes the varieties mostly in demand. We can furnish all other sorts.

ACER—DASYCARPUM (*Silver Maple*), 60 to 80 feet. Quick growing, graceful shade tree, leaves silvery underneath. Trees 8 to 10 feet high, \$1.00 each.

—**PALMATUM ATROPURPUREUM** (*Purpleleaf Japanese Maple*), 6 to 8 feet. Rounded dwarf trees, with foliage of unrivaled brilliancy. Their early and mid-summer aspect is vivid blood-red, which dulls to a bronzy purple-red towards Fall. The plants we offer are grafted from the finest strain imported, being carefully selected for rich, constant color. Strong plants 12 to 15 inches high, \$2.50 each; 15 to 18 inches high, \$3.00 each.

—**PLATANOIDES** (*Norway Maple*), 50 to 75 feet. The Norway Maple makes the roundest head; is colored the deepest, coolest green and furnishes the densest shade of the entire list of good trees. Very hardy. Trees 6 to 8 feet high, \$2.00 each; 8 to 10 feet high, \$3.00 each.

—**SCHWEDLERI** (*Schwedler Maple*), 40 to 60 feet. The "Purple Norway" Maple's beautiful leaves attract attention at all seasons, but are especially fine in Spring when their gleaming red and purple contrasts brightly with the delicate green of other trees. Trees 6 to 8 feet high, \$3.00 each.

—**RUBRUM** (*Red Maple*), 50 to 75 feet. A large tree with spreading branches. The earliest Maple to bloom, its beautiful red flowers appearing in late Winter. In the Fall its leaves turn to the most beautiful shades of red and scarlet. Trees 6 to 8 feet high, \$3.00 each.

—**SACCHARUM** (*Sugar Maple*), 50 to 75 feet. This tree is chieftain of its clan; straight, spreading, symmetrical, of grand proportions and very long lived. It grows well in all except damp, soggy soils and roots deeply, allowing the grass to grow close. Very rich Autumn coloring. Trees 6 to 8 feet high, \$2.00 each; 8 to 10 feet high, \$3.00 each.

ELM. See *Ulmus*.

LINDEN. See *Tilia*.

MAGNOLIA—SOULANGEANA (*Saucer Magnolia*), 15 to 18 feet. A hardy Chinese species which, while shrub-like in its young growth, attains the size of a tree in time. Flowers are produced early in the Spring, cup-shaped, 3 to 5 inches in diameter, white inside, flushed with purple on the outside. 18 to 24 inches high, \$3.00 each; bushy plants 2 to 3 feet high, \$5.00 each.

—**STELLATA** (*Star Magnolia*), 8 to 10 feet. A pretty dwarf form that opens its snowy, star-like flowers in April; earlier than any other Magnolia; the fragrance is pronounced and delicate. Bushy plants, 15 to 18 inches high, \$3.00 each; 18 to 24 inches high, \$5.00 each.

MAPLE. See *Acer*.

MORUS—ALBA PENDULA (*Weeping Mulberry*). The most popular small "weeping" tree. Forms a most perfect round tent-shaped head, with slender leaf-studded branches drooping to the ground. Trees with 2 year heads, \$1.50 each.

MOUNTAIN ASH. See *Sorbus*.

SPECIAL NOTICE ON GUARANTEE

We spare no effort to supply trees, plants and shrubs of the best quality in first-class living condition. On account of the many causes beyond our control we regret we cannot guarantee this stock to live and establish itself, as that is usually entirely within the power of the buyer or planter. If customers desire us to guarantee plants, trees and shrubs to live we will assume such guarantee at an advance of 25 per cent, over and above our usual price, but not otherwise, and such guarantee will expire within 90 days from date of shipping.

MULBERRY. See *Morus*.

OAK. See *Quercus*.

PLATANUS—ORIENTALIS (*Oriental Plane*), 70 to 80 feet. A good tree for Park and Street planting; grows quickly and withstands smoky city conditions. Trees 8 to 10 feet high, \$1.50 each.

POPLAR. See *Populus*.

POPULUS—BOLLEANA (*Bolleana Poplar*), 50 to 60 feet. Tall spire-like character, valued for landscape work and screens. Leaves white underneath, creating an attractive flashing effect when stirred by the wind. Trees 8 to 10 feet high, \$1.00 each.

—**NIGRA ITALICA** (*Lombardy Poplar*), 60 to 80 feet. Similar to the above with foliage green on both sides. Trees 8 to 10 feet high, \$1.00 each.

PRUNUS—SUBHIRTELLA PENDULA (*Weeping Japanese Cherry*), 12 to 15 feet. A most beautiful and graceful tree, covered with single pink blossoms very early in the Spring. Strong plants, 5 to 6 foot stems, 2 year heads, \$5.00 each.

QUERCUS—COCCINEA (*Scarlet Oak*), 75 to 90 feet. Most striking Autumn colors; tall, stately grower, deeply cut leaves. Trees 6 to 8 feet high, \$5.00 each.

—**PALUSTRIS** (*Pin Oak*), 75 to 90 feet. Takes most kindly to cultivation, prefers moist soil but is very adaptable. A very good tree for street planting, highly colored in the Autumn. Trees 6 to 8 feet high, \$3.00 each.

—**RUBRA** (*Red Oak*). 75 to 90 feet. A comparatively quick grower; the young shoots and leaf stems are red with purplish crimson foliage in the Autumn. Trees 6 to 8 feet high, \$5.00 each.

SALIX BABYLONICA (*Babylon Weeping Willow*), 50 to 60 feet. Particularly appropriate for water side planting with its long pendulous branches. Trees 5 to 8 feet high, \$1.75 each.

SORBUS—AUCUPARIA (*European Mountain Ash*), 25 to 30 feet. A valuable tree on a small lawn, the scarlet berries are quite striking. Trees 6 to 8 feet high, \$1.50 each.

TILIA—AMERICANA (*American Linden*), 75 to 90 feet. A stately tree, with large shining cordate leaves. Valuable for its beautiful white wood. Fragrant yellow flowers in July. Trees 6 to 8 feet high, \$2.50 each.

—**VULGARIS** (*European Small Leaf Linden*), 70 to 90 feet. In late June the fragrant flowers are noticeable; grows symmetrical and compact. Trees 6 to 8 feet high, \$4.50 each.

ULMUS AMERICANA (*American Elm*), 80 to 100 feet. Stateliness and dignity are here exemplified. Fairly rapid in growth, this typical American tree soon assumes regal proportions and commands respect of all who look upon it. Trees 8 to 10 feet high, \$1.50 each.

WILLOW. See *Salix*.

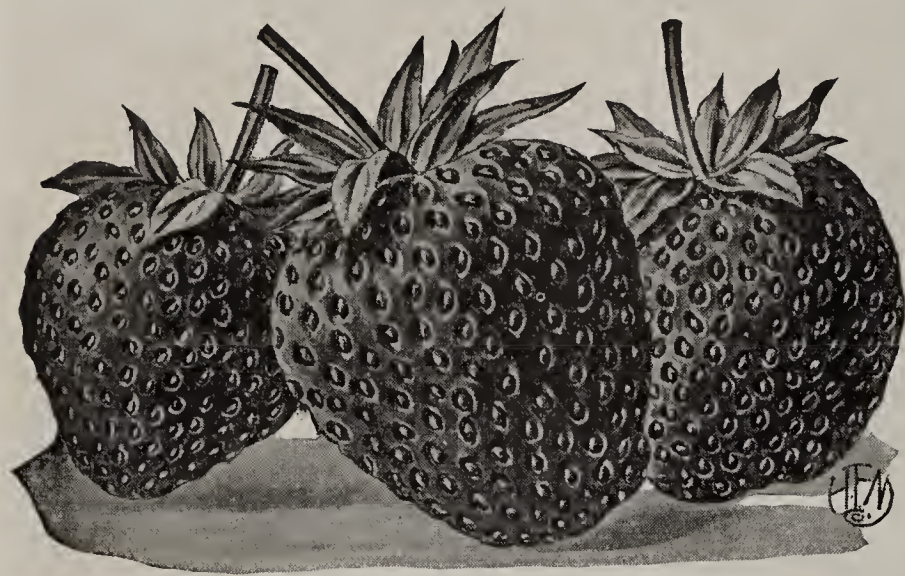

Mastodon Everbearing Wonder Strawberry

BLACKBERRIES (Extra Strong Plants)

Eldorado. A very vigorous grower; enormously productive; fruit large, excellent quality and without core.

Mersereau. Remarkably strong grower. An enormous producer of extra size berries, which are brilliant black and retain their color under all conditions; very sweet and without core.

Ward. An extra strong grower; produces an enormous crop of extra large, glossy blackberries, which are rich, sweet and tender and with no hard core.

Price of Blackberries, \$1.00 per doz. (by parcel post, \$1.10); per 100, \$6.00; \$50.00 per 1000.

RASPBERRIES (Extra Strong Plants)

Cumberland (Blackcap). The largest raspberry known; selected specimens measure an inch in diameter.

Cuthbert. Berries very large, measuring 3 inches around; conical, rich crimson; one of the old-time favorites.

Latham. The finest red raspberry to date; more productive than any other variety. The berries are very large, bright red and of wonderful flavor.

Ranere Everbearing. The fruit is of good size and of excellent flavor, in fact there is no good quality any of the regular varieties of raspberries possess that is lacking in Ranere, brilliant red.

Price, any of the above, strong plants, \$1.00 per doz. (by parcel post, \$1.10); per 100, \$6.00; \$50.00 per 1000.

GRAPE VINES

Caco. The most delicious of all Grapes and perfectly hardy; red; bunch of good size, compact and of good form. Ripens in ten days to two weeks in advance of Concord; rich in sugar, excellent in flavor. Vine a very strong, vigorous grower, healthy and prolific. 50c. each (by parcel post, 60c.); doz., \$5.00 (by parcel post, \$5.25).

Campbell's Early. A valuable and delicious grape; vine very strong, hardy and vigorous; berries large, black with light purplish bloom; flavor rich and delicious.

Catawba. Delicious flavor; medium size, red berry.

Champagne. A sterling variety of great merit. Color a coppery red. Berries very large. Immense producer. Seasons in which other varieties did not fruit, this variety stood out, bearing an immense crop. Very strong grower. 50c. each (by parcel post, 60c.); doz., \$5.00 (by parcel post, \$5.25).

Concord. The well-known standard purple variety; succeeds wherever grapes will grow.

Moore's Diamond. A strong, healthy grower; hardy and productive; color, white; berries large, flesh tender, juicy, but with little pulp; ripens before Concord.

Niagara. An unusually strong grower; bunches very large and compact; berries large, light greenish-white, semi-transparent; has very little pulp and is sweet to the center.

Price, any of the above, excepting Caco and Champagne, 2-year old vines, 25c. each (by parcel post, 35c.); doz., \$2.50 (by parcel post, \$2.75); \$20.00 per 100.

STRAWBERRY PLANTS

TWO NEW EARLY STRAWBERRIES

FAIRFAX AND DORSETT

These two new varieties were developed by scientists in the U. S. Dept. of Agriculture and were selected from thousands of seedlings as being outstanding in quality, vigor, productiveness, size and appearance. Stock of these two varieties is limited and we suggest that you place your order early for delivery at the proper time as they are sure to be sold out before the end of the season.

Dorsett. No other berry, except Fairfax, has the fine dessert quality of Dorsett. This quality is probably taken from the English variety Royal Sovereign, which is one of its parents. There are some differences of opinion as to whether Dorsett or Fairfax is of the better quality, but all are unanimous that these two varieties stand head and shoulders above all others. Dorsett berries average very large in size, are firm and rather light in color, while the flavor leaves nothing to be desired. The berries are beautiful in appearance; the light color, bright green cap, large size and attractive shape make them very desirable and should appeal to every grower of Strawberries. Once tasted this appeal becomes doubly strong.

Fairfax. No other berry, except Dorsett, can equal Fairfax in quality. It probably takes this outstanding quality from the Royal Sovereign parentage, which has been famous in England for years; it is impossible to describe it; to be appreciated it must be tasted. Fairfax berries average very large and firm and picked at the proper time are a bright red with a light green cap; as they become riper they become darker and then very dark red; they maintain their firmness and flavor even after they become very dark.

Price of the above two new varieties, 25 for \$1.00 (by P. P., \$1.10); 50 for \$1.50 (by P. P., \$1.65); 100 for \$2.50 (by P. P., \$2.70).

STANDARD EARLY VARIETIES

Premier (Perfect). Enormously productive, commencing early and bearing through a long season, the flavor is delicious.

Senator Dunlap (Perfect). This grand Strawberry will please the most critical person. One of the first to yield and continues well into the height of the season.

MID-SEASON VARIETIES

Big Joe (Perfect). The merits of this splendid variety are great vigor of plant, splendid root system, exceptional productiveness, large size of fruit, excellent flavor and length of bearing season.

LATE SEASON VARIETIES

Chesapeake (Perfect). The berries are handsome in appearance because of their large size, rich color, glossy surface, uniform shape and bright green cap.

Gandy's Prize (Perfect). One of the best late sorts, very large, solid and of a beautiful crimson color; especially good for family garden planting.

William Belt (Perfect). The plant is vigorous, though not a rampant grower; succeeds on all soils, invariably yields heavily, and continues for a long period; the berries are always of large size and highest quality; deep crimson in color and very firm.

Price of the above in layer plants, 25 for 75c. (by parcel post, 85c.); \$1.00 for 50 (by parcel post, \$1.15); 100 for \$1.50 (by parcel post, \$1.70); \$10.00 per 1000.

AUTUMN FRUITING OR EVER-BEARING STRAWBERRY PLANTS

Mastodon. This is unquestionably the most prolific of ever-bearing varieties. Bears continuously from June till frost, the late bearing fruits being as large as the early crop; berries are of excellent quality. Price, layer plants, 25 for \$1.00 (by parcel post, \$1.10); \$1.50 for 50 (by parcel post, \$1.65); per 100, \$2.50 (by parcel post, \$2.70); \$15.00 per 1000.

SPECIAL NOTICE ON GUARANTEE

We spare no effort to supply trees of the best quality in first-class living condition. On account of the many causes beyond our control we regret we cannot guarantee this stock to live and establish itself, as that is usually entirely within the power of the buyer or planter.

APPLES

Baldwin. Large round, deep red, late variety.
Delicious. A good late variety with rosy-red fruit of good size, truly delicious.
Fall Pippin. Large, yellow, rich and delicious. A good bearer when it reaches maturity. Likes a moist, well-drained soil; a good Autumn apple.
Grimes' Golden. Deep golden yellow; fine for Christmas.
Hyslop (Crab). Deep crimson with blase bloom.
Red Astrachan. An old popular variety; tart, juicy; flesh tinged with red; very early.
Stayman's Winesap. Fine variety; good keeper; deep red on a yellow ground.
 Price of Apple Trees: 6 to 8 feet high, \$1.00 each; 6 for \$5.00; \$9.00 per dozen.

APRICOTS

As fresh fruit few varieties equal in lusciousness the apricot; should be planted more generally where there is room for trees.
Alexander. Orange yellow with faint blush; firm, coarse flesh, one of the best.
 Price of Apricot Trees: \$1.00 each; 6 for \$5.00; \$9.00 doz.

CHERRIES

Black Tartarian (Sweet). Large, purplish black; immense bearer.
Early Richmond (Sour). Dark red, medium size; splendid flavor.
Large Montmorency (Sour). Light red; very productive.
Napoleon (Royal Ann). The best and most profitable yellow sweet cherry. Flesh very firm, juicy and delicious.
Schmidt's Bigarreau (Sweet). A good late variety.



Cherries

Fruit large; flesh dark red, very firm, sweet, rich and of good quality.

Price of Cherry Trees: 5 to 7 feet, \$1.00 each; 6 for \$5.00; \$9.00 per dozen.

PEARS

Bartlett. Yellow, shaded blush; very sweet and juicy; early.
Clapp's Favorite. An excellent table Pear; large, fine grained; yellow with crimson cheek. August.
Kieffer. A fine variety for late autumn and for canning.
Seckel. Small; yellowish brown; very sweet and juicy.
 Price of Pear Trees: 5 to 7 feet, \$1.00 each; 6 for \$5.00; \$9.00 per dozen.

PLUMS

Abundance. Amber, turning to a rich, bright cherry color.
Burbank. Orange yellow, overlaid red; rich and sugary.
Imperial Green Gage. Middle of August. A delicious, good-sized free-stone, sweet and juicy. Greenish in color.
 Price of Plum Trees: 5 to 6 feet, \$1.00 each; 6 for \$5.00; \$9.00 per dozen.

QUINCES

Champion. Very prolific bearer; large fruit.
 Price of Quince Trees: 4 to 5 feet, \$1.00 each; 6 for \$5.00; \$9.00 per dozen.

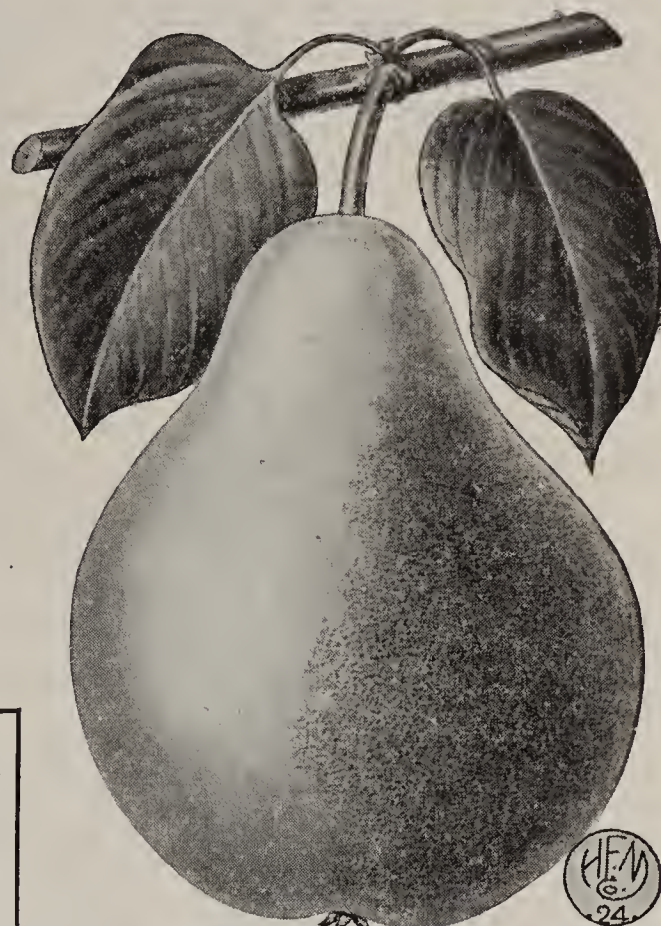

Bartlett Pear

Fruit trees are best shipped by express; they cannot be sent via parcel post as they are too large, and shipment via freight is not safe.

PEACHES

Belle of Georgia. Free-stone; rich creamy white, red cheek.
Carman. Early; pale yellow, red blush; very fine.
Champion. August. A magnificent white peach; extremely rich and juicy; very popular. Should be included in every home orchard. Free-stone.
Crawford's Late. Greenish yellow with dull red cheek.
Elberta. Mid-season; very large; yellow with red cheek.
 Price of Peach Trees: 5 to 6 feet, 75c. each; 6 for \$4.00; \$7.50 per dozen.



Peach

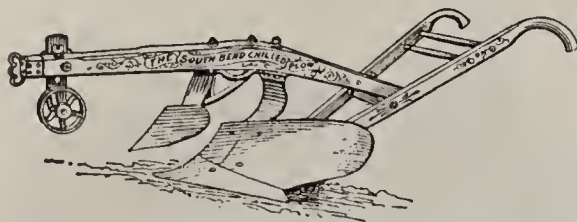

SOUTH BEND PLOWS

For garden, farm or trucker's work; made of chilled steel in various sizes.

- No. 1B. Wood beam plain; for 1 horse.....\$12.00
- No. 2F. Wood beam plain; for 1 heavy or 2 light horses.. 14.50
- No. 3F. Wood beam plain; for 2 horses..... 18.50

The prices above are for plain plows with clevis only.

The No. 3 Plow can be equipped with wheel and jointer at the following additional cost: wheel only, \$2.00; jointer only, \$3.75. The Nos. 1 and 2 are too light for wheel and jointer.

SOUTH BEND PLOW PARTS

	Shares	Mouldboards	Beams
No. 1B	\$0.50	\$2.25	\$2.55
No. 2F	.55	3.25	2.85
No. 3F	.65	4.25	3.20
No. 4F	.70	4.60	3.80

	Complete Handles	Jointer-points	Land-sides
No. 1B	\$2.05		\$0.75
No. 2F	2.25		1.00
No. 3F	2.50	\$0.30	1.25
No. 4F	2.75	.30	1.35

SINGLE AND DOUBLE TREES

No.		Price
11	Wood Single Trees, 26-inch.....	\$1.50
10	Wood Single Trees, 28-inch.....	1.60
2	Wood Double Trees, heavy, 36-inch	5.00
3	Steel Single Trees, 26-inch.....	1.75
1	Steel Double Trees, 34-inch.....	5.50

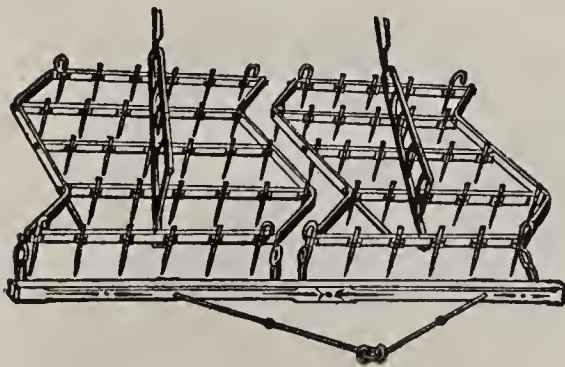

CHAMPION SPIKE TOOTH HARROW

Equipped with lever for lessening or increasing the depth of cultivation and is adjustable instantly. The teeth are equipped so as to readily pass any obstruction in the soil.

Teeth	Sections	Price
25	1	\$12.00
30	1	15.00
50	2	25.00
60	2	28.00

CRESCENT SPRING TOOTH HARROW

Teeth	Sections	Price
8	1	\$15.00
15	2	26.00
17	2	28.50

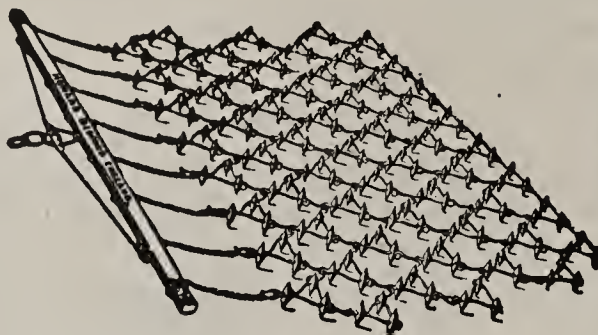

SCOTCH CHAIN HARROW

One of the best implements for pulverizing the surface soil, leveling and smoothing; also splendid for covering grass seed, etc.

No.	Size	Weight	Price
1F.	One-horse size, 5 x 6 ft..	126 lbs.	\$35.00
2F.	Medium two-horse size, 6 x 7 ³ / ₄ ft.....	236 lbs.	48.00
3F.	Full two-horse size, 9 x 11 ft.....	357 lbs.	60.00

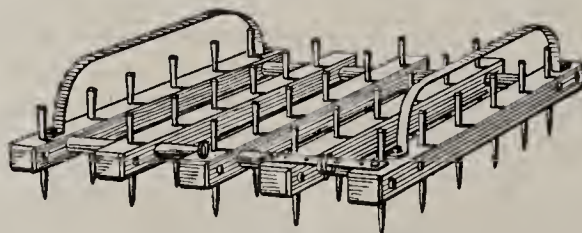

GARDENER'S SPIKE TOOTH HARROW

Though old-fashioned in appearance and construction, this harrow is still preferred by many; fitted with runners, upon which it may be turned to take it from place to place.

24 teeth.....\$12.00 | 32 teeth.....\$13.00

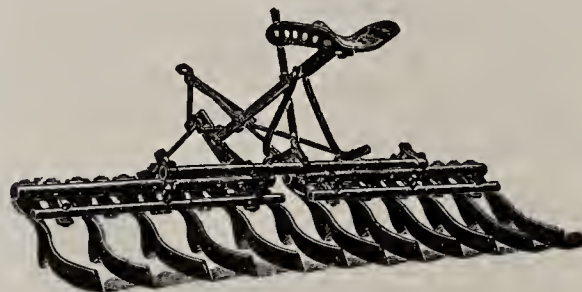

ACME PULVERIZING HARROW

This will be found by those having a large acreage an indispensable implement for pulverizing and crushing the ground.

No.	Price
12F. 6 ft. covering area, 2-horse....	\$35.00
G. 3 ft. covering area, 1-horse....	18.00

Extra blades or coulters, \$1.00 each.

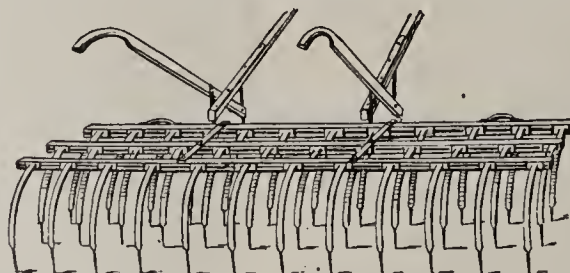

THE KEYSTONE WEEDER

This weeder can be adjusted to cover a 7¹/₂-ft. stretch. Any of the teeth can be easily removed, if it is desired not to cultivate very finely. Excellent for preparing a piece of ground prior to sowing lawn seed, etc. Equipped for one horse. Price, \$16.50. (Extra teeth, 40c. each.)

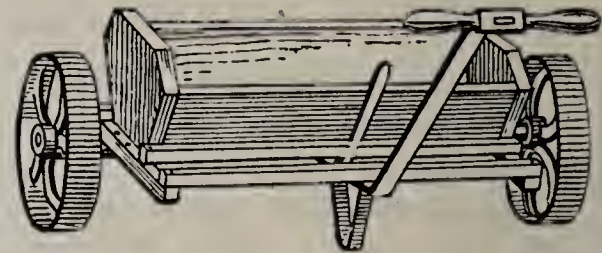

STEVENS FERTILIZER DISTRIBUTOR

For distributing bone meal, wood ashes and other commercial fertilizers on fields, lawns, golf courses, etc., also for sanding putting greens. Insures perfect and even distribution.

Hand Machine. Holds about 2 bu.; covering area 3 feet wide. Price, \$25.00.

Horse Machine. For use on large lawns, fields and golf grounds. Furnished equipped for either one or two horses as may be desired.

5 foot, 10-inch spreading area, \$70.00.

8 foot, 3-inch spreading area, 75.00.

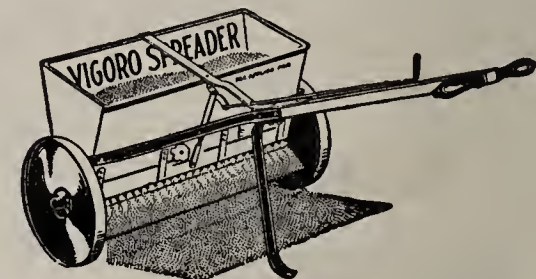

Vigoro Spreader

VIGORO SPREADER

The Vigoro Spreader was developed for the purpose of applying fertilizers in flower beds and vegetable gardens before seeds are sown or plants set out, and to sow grass seeds, top-dress lawns with sand or other dry materials and for many other purposes. Adjustments can be made so as to regulate the quantity desired to be applied.

New Model. 14-inch spreading area; capacity, 13 lbs. Price, \$2.85.

Junior. 16-inch spreading area; capacity, 30 lbs. Price, \$5.75.

Standard. 24-inch spreading area; capacity, 65 lbs. Price, \$10.85.

Special. 36-inch spreading area; capacity, 125 lbs. Price, \$17.25.

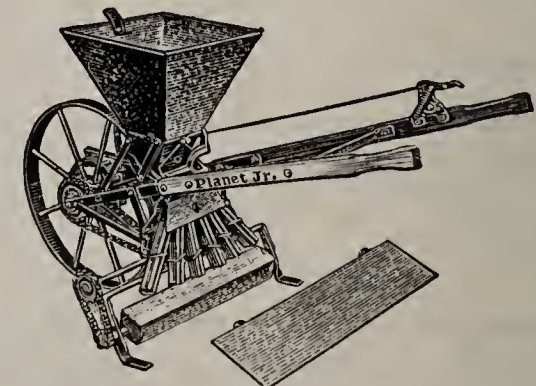

PLANET JR. FERTILIZER DISTRIBUTOR No. 235

Designed for golf courses, lawns, parks, cemeteries, etc.; distributes fertilizers in even bands up to 36 inches in width. Price, \$39.50.



No. 106, Seeder

WHEELBARROW GRASS SEEDER

A practical machine for use on the Farm and also for sowing Parks and Golf Grounds; quickly regulated to sow different quantities per acre. The distributing box is very near the ground, which is an important feature, preventing the seed from blowing away and thus coming up unevenly. No. 9 sows a width 14 feet. Price, \$17.00.

No. 106. Sows a width 10 feet; developed especially for seeding golf courses, parks and country estates. Price, \$21.00.

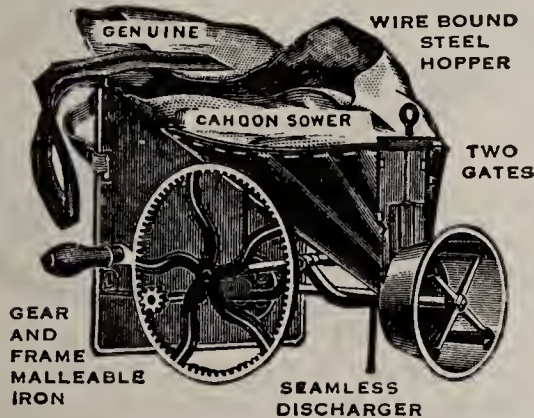

BROADCAST SEED SOWERS

For accurately sowing Timothy, Clovers, Millets and heavy seeds of grass and other farm crops. Can be regulated to sow any required quantity per acre.

- Each
- Cahoon.....\$5.00
- Cyclone..... 2.50

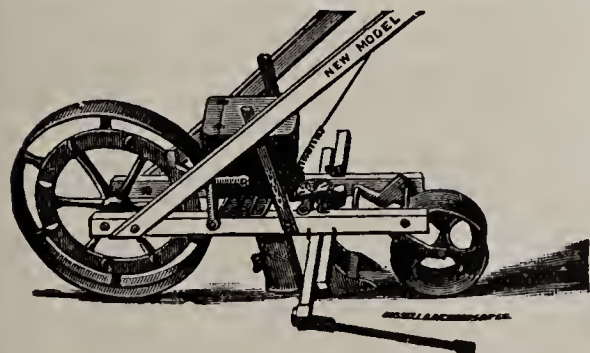

MODEL SEED DRILL

The depth of sowing can be easily regulated. A typical market gardener's drill, having a large capacity for seeds. Price, \$12.00.

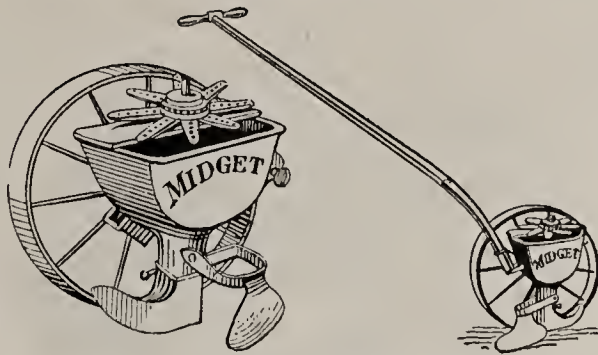

THE MIDGET SEED DRILL

The Midget Seeder will pay for itself in a short time, because it saves seed by sowing accurately. It drills almost any kind of garden seed, including peas and beans. The Midget opens the furrow, sows the seed and covers up, all in one operation. Weight, 6 pounds.

No. 1. Price, without handle, \$4.00; with handle, \$4.50.

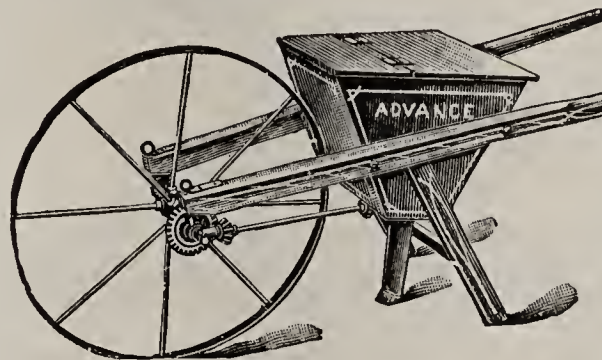

"ADVANCE" DRILL

A splendid machine for drilling in fertilizer prior to planting, or between the rows to stimulate growth after the plants are started. A shut-off, to prevent the escape of fertilizer when wheeling around end of row, is a late improvement. First-class for drilling of peas, beans, corn, etc. Price, \$18.50.

HELLIGE SOIL TESTER



This is especially intended for use by farmers, gardeners and flower growers, for the correct determination of the soil reaction and will be found very useful as a range finder in the laboratory and handy to carry in the pocket on excursions or field trips; a special solution, "Hellige Soil Indicator," is supplied with the outfit and covers the very acid to strongly alkaline range. Price, \$3.00, with Hellige Soil Handbook, \$3.75.

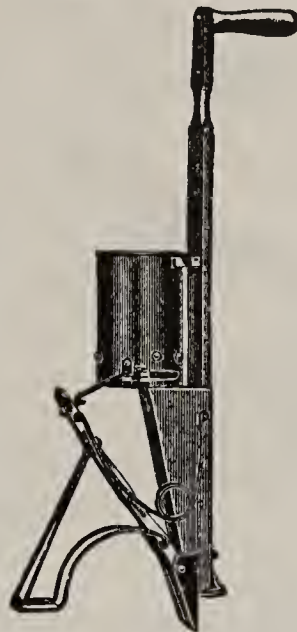

AMERICAN HAND CORN PLANTER

A great seed economizer and labor saver. Easily operated; works in all kinds and conditions of soil; accurate and reliable. Price, \$2.75.

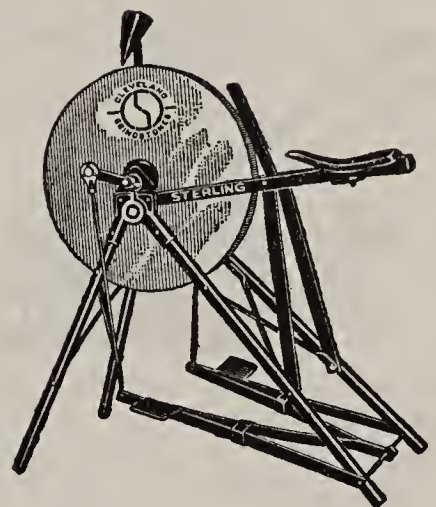

STERLING MOUNTED GRINDSTONE

Substantially made; heavy steel frame with seat and double treadles; fitted with improved ball bearings of the very best quality, encased so they will keep clean. Stone, 19 to 22 inches diameter, 1 3/4 to 2 1/4 inches thick. Weight, 100 lbs.

Shipped knocked down, crated. Price, \$12.00.

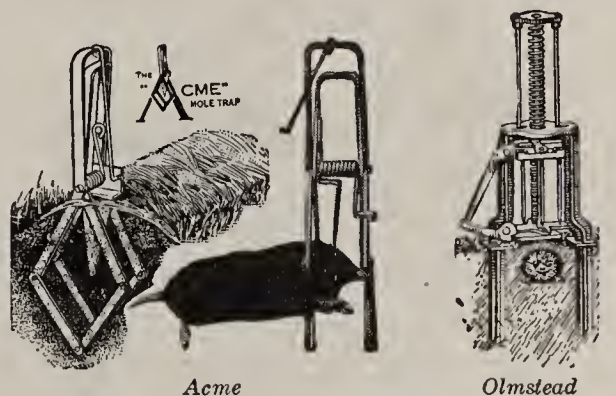

Acme

Olmstead

MOLE TRAPS

For catching moles that ruin lawns and damage the contents of hotbeds and cold frames. Moles move usually about 5 A. M. and 5 P. M., so that traps should be set for that period. See illustrations above.

Acme. Safe, sure, easily set; the most efficient mole trap on the market. Price, \$2.00 (by P. P., \$2.25).

Olmstead.....\$2.00 (by P. P., \$2.25)

Reddick..... 1.25 (by P. P., 1.50)

PLANET JR. SEEDERS, WHEEL HOES, ETC.

No. 3 PLANET JR. HILL AND DRILL SEEDER
 Price, \$16.50

Holds 3 qts. of seed. A favorite among onion growers and market gardeners.



The flow of seed is instantly started or stopped by the cut-off rod. Sows in large or small quantities in drills or in hills.

No. 4 PLANET JR. HILL AND DRILL SEEDER, WHEEL HOE, CULTIVATOR AND PLOW

Price, \$16.75



Sows practically all vegetable seeds in drills, or drops in hills 4, 6, 8, 12 or 24 inches apart. In one operation it opens the furrows, drops seeds at the right depth, covers them and marks the next row.

No. 4D SEEDER ONLY. Price, \$13.50
 As above less the cultivating attachments.

No. 25 PLANET JR. COMBINED HILL AND DRILL SEEDER, DOUBLE AND SINGLE WHEEL HOE, CULTIVATOR AND PLOW

Price, \$21.00



A splendid combination for the family garden, onion grower or large gardener.

No. 35 PLANET JR. SEEDER ATTACHMENT

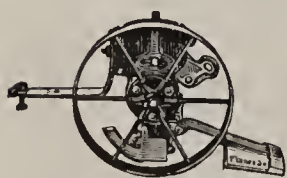

This is particularly suited for planting short rows and in small quantities. With one bolt it fastens to any Planet Jr. Wheel Hoe or Garden Plow, except the Fire-Fly and No. 19, or you can bolt a home-made handle to the bracket on the rear of the hopper and use as a seeder independently of the wheel hoe. Price, \$6.25; with handle, \$6.75.

No. 11 PLANET JR. DOUBLE AND SINGLE WHEEL HOE, CULTIVATOR, PLOW AND RAKE

Price, Complete \$13.00



Straddles crops till 20 inches high, then works between.

No. 12 PLANET JR. DOUBLE AND SINGLE WHEEL HOE, CULTIVATOR AND PLOW. Price, \$10.25



No. 13 DOUBLE WHEEL HOE
 This is like No. 12, except that it is equipped with 1 pair side hoes only. Price, \$7.60.

No. 16 PLANET JR. SINGLE WHEEL HOE, CULTIVATOR, RAKE AND PLOW. PRICE, \$8.50



No. 17 PLANET JR. SINGLE WHEEL HOE. Price, \$7.35
 This is the same as No. 16, but without the rakes.

No. 17½ SINGLE WHEEL HOE
 Same as No. 17, except there is no plow. Price, \$6.40.

No. 18 SINGLE WHEEL HOE
 This is like No. 17, except that it is equipped with 1 pair side hoes only. Price, \$5.50.



No. 300 PLANET JR. SEEDER
 An efficient plate seeder, easily adjusted to sow seed varying from turnips to bush lima beans, as there are 39 holes varying from one-tenth to three-quarters of an inch; has positive shut-off. Price, \$18.75.



No. 119 PLANET JR. GARDEN PLOW AND CULTIVATOR

Equipped with a 24 in. diameter steel wheel, one 1¼ in. cultivator tooth, one 3 prong cultivator tooth, one plow, one reversible scuffle blade. Price, \$4.25.

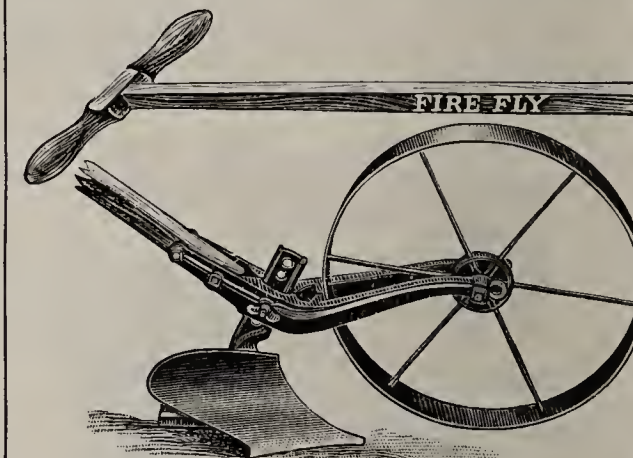

FIRE-FLY GARDEN PLOW

Useful to owners of small gardens, and to chicken raisers for plowing up scratching yards. Price, \$4.00.

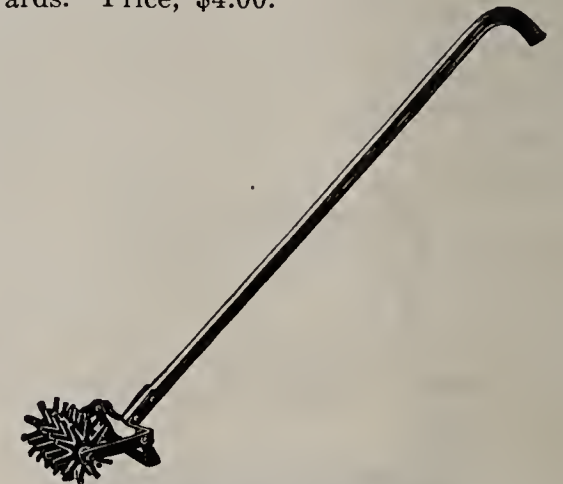

PLANET JR. STAR PULVERIZER
 Price, \$2.85

PARTS OF PLANET JR. WHEEL HOES

Disc Hoes.....	pair	\$3.50
4½ inch Hoes S100-S101.....	pair	1.20
6 inch Hoes S100-S101.....	pair	1.30
7½ inch Hoes S100-S101.....	pair	1.50
9 inch Hoes S100-S101.....	pair	1.65
Peat Land Hoes.....	pair	1.85
3 prong Cultivator Teeth.....	pair	1.50
Cultivator Teeth, Regular, No. 1395, all steel.....	each	.35
Narrow Cultivator Teeth, No. 2775, all steel.....	each	.35
Rakes, Three Tooth.....	pair	.90
Rakes, Five Tooth.....	pair	1.50
Plows for Double Wheel Hoes.....	pair	1.40
Plows for Single Wheel Hoes.....	each	1.10
Double Mouldboard Plows.....	each	1.65
Handles.....	pair	1.00



**PLANET JR.
12 TOOTH HARROW CULTIVATOR
AND PULVERIZER**

With the Twelve Tooth Harrow, you go as deep or shallow as you like and come up close to row without injuring plants. You widen and narrow as you please, between 12 and 32 inches.

- No. 90. Complete with lever, steel wheel and pulverizer, \$15.50.
- No. 90B. Without pulverizer, \$12.75.
- No. 90D. Without pulverizer and wheel, \$10.00.

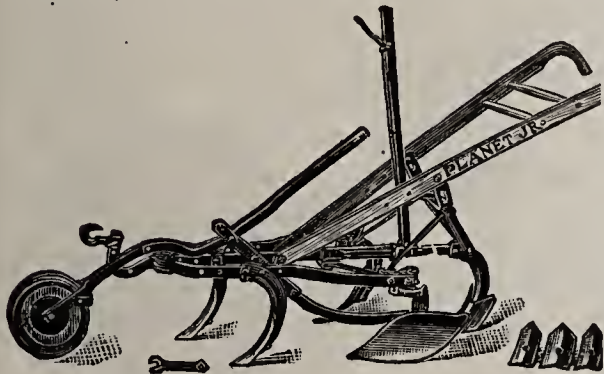

**No. 8 PLANET JR.
HORSE HOE AND CULTIVATOR**

The lever wheel and depth regulator enable the operator to increase or lessen the depth of tilling by a mere stroke of the arm. A perfect five tooth cultivator. Price, \$14.70.

**No. 83
PLANET JR.
CULTIVATOR**

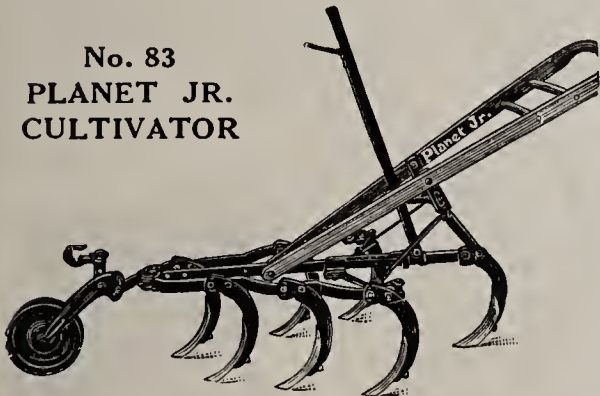

Many gardeners like the 7 tooth cultivator, because it prepares the soil better than does the five tooth machine. Price, complete with steel wheel, \$12.75.

No. 83D. Price without wheel, \$11.00.

**PLANET JR. HORSE
CULTIVATOR TEETH**

All 8 inches long.

Width	Price	Width	Price
1 1/4 inch.....	\$0.16	2 1/4 inch.....	\$0.18
1 3/4 inch.....	.17	3 inch.....	.20
4 inch.....	\$0.25		

Send for a copy of the Planet Jr. Catalog

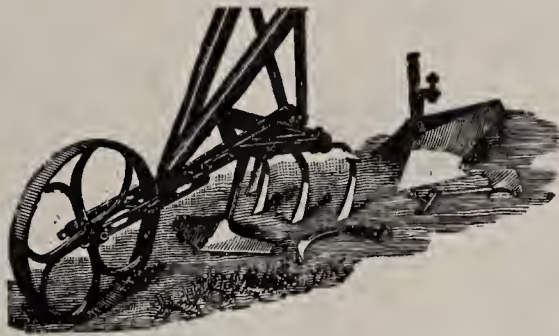

GEM SINGLE WHEEL HOE

This is suited for most any work in a garden. It weeds, hoes, hills and harrows. Price, \$7.75.



PULL EASY CULTIVATOR

The teeth are adjustable to various widths; splendid for going between rows of young, growing crops. Can be shipped by express or freight only. No. P. E. 5. Price, \$1.00.

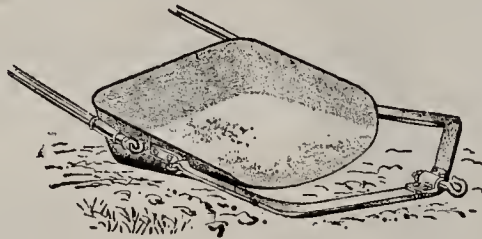

STEEL ROAD SCOOPS

For dragging soil from one place to the other, grading, filling in, etc.

No.	Capacity	Price
1.	7 cubic feet.....	\$11.00
2.	5 cubic feet.....	10.50
3.	3 cubic feet.....	10.00

HYDROSPEAR

For watering all kinds of plants, trees and shrubbery at the roots; fertilizing and applying remedies to the roots.

Screw swivel base connection on end of hose, grasp handle firmly and push point into ground to desired depth.

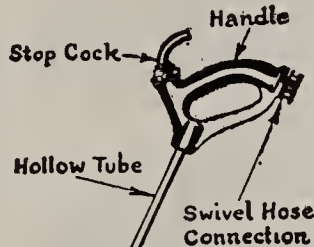

Open stop-cock and allow the amount of water desired to flow to roots. Handle, stop-cock and hose connection are brass; tube is steel, copper plated. Price, \$3.75.

Water Holes

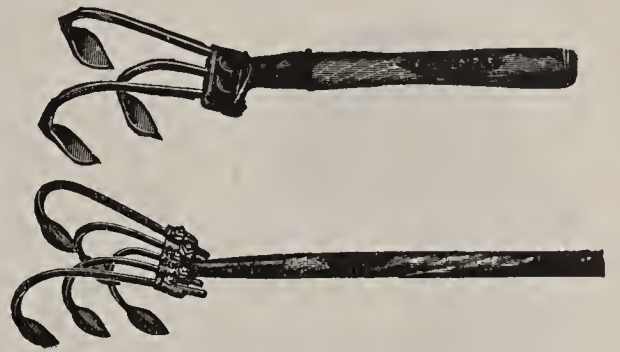

INVINCIBLE CULTIVATOR

This will be found a useful tool for weeding, loosening the soil, preparing seed beds, etc. Price, with long handle, 3 prong, 75c.; 5 prong, \$1.00.



SURE GRIP WEEDER

Designed to pull both large and small weeds without injuring the lawn; will not clog up; automatically releases the weed as soon as pulled; fitted with 38 inch handle. Price, \$1.50 each (by P. P., \$1.65).

**THE "OUT-U-KUM"
WEED PULLER**

An Entirely New Principle

A slight Push and Pull thoroughly loosens the surrounding soil and removes not only the weed, but the entire root.

When pushed into the ground, the two points guide the BRIDGE down alongside the weed, loosening the soil from that side. It then crosses under the root disengaging the latter. As the tool is withdrawn the BRIDGE slips up the opposite side of the weed, loosening the ground from that side and engages the head of the weed above the ground. The now thoroughly loosened weed is readily withdrawn in its entirety with little or no clinging soil.



Price of the Out-U-Kum Weed Puller 75c. each (by P. P., 85c.).



LEATHER HORSE BOOTS

Made of very heavy sole leather, waterproofed and finished black. The sole is reinforced with steel rivets.

- Small, per set of four \$16.00
- Medium, per set of four 16.00
- Large, per set of four 20.00

Special Size Horse Boots made to order.

TENNIS COURT MARKERS

Junior Line-o-graph. A perfect liquid lime tennis court marker especially designed for private courts; works perfectly on grass or clay. Price, F. O. B. Philadelphia, \$30.00; F. O. B. factory, \$28.50.

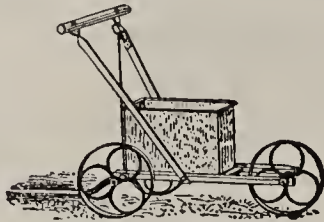

Junior Line-o-graph

No. OX. The most practical marker where dry lime is used. Price, \$3.50 (by parcel post, \$3.70).



No. OX

No. 10. For marking grass courts and grass athletic fields with liquid lime; not adapted to clay courts. Price, \$22.50.

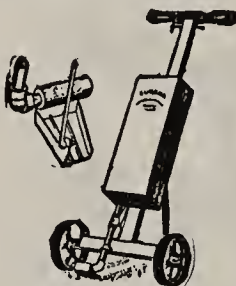

No. 10

LAWN AND PUTTING GREEN CLEANER

The flexible rake bars are of wood, with steel springs and teeth; they rotate just like a lawn mower cylinder and clean up every particle of leaves, litter or rubbish, throwing it into a receptacle or bag in the rear, which is of large capacity.

Price, 24-in. Rake, or Sweeper, \$30.00.

Please specify when ordering if wanted for lawns or putting greens.

Sweeping Brushes. Can be readily attached to the Rake for sweeping lawns, putting greens, paths, etc. Price per set of three, 24 inch, \$7.00.

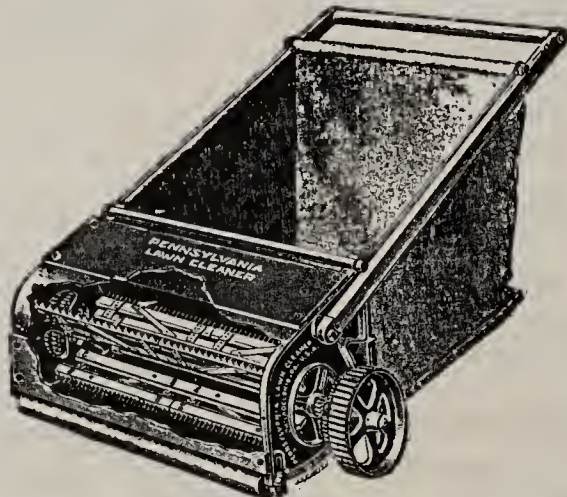

RUBBISH BASKETS

A basket for gathering up rubbish and litter will be found a great convenience, especially when it is suited for the purpose. This basket holds 3 bushels and can be carried or wheeled on a barrow. Price, with rope handles, \$4.00 each.

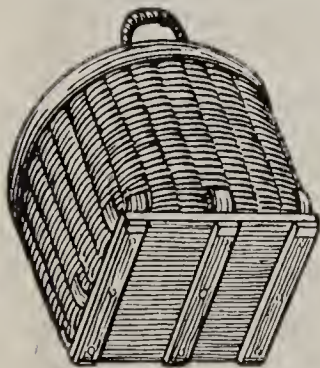

IDEAL DANDELION EXTRACTOR

This simple device is the best thing of its kind ever used for taking weeds out of the lawn. It will be seen that it is not necessary to get down on hands and knees to operate it. The cutting blade is of the best steel, equipped with a convenient handle, so that either man, woman or child can use it. 50c. each. (By P. P., 60c.)

SOD PERFORATOR

For use in loosening soil where grass is worn out, for reseeding; makes a perfect seed bed which means quick growth of grass after the seed is sown. It is used like a tamper, its own weight being sufficient to properly perforate the ground; also desirable for use on putting greens, for renovating. Price, \$5.00.



Sod Perforator



Sod Tamper

SOD TAMPER

When laying sod it is necessary to properly firm it down so that it will take new root quickly. It is also convenient for firming the soil or lawn on places where a roller cannot be used; made of iron with wood handle; 12 inches square; weight, 20 lbs. Price, \$3.50 each.

BARREL TRUCKS, Etc.

The price below includes barrel and truck. The latter is constructed so that the barrel may be detached quickly and the leaf rack attached.



- 3 1/2-inch tire truck, all iron wheels, with barrel \$27.00
- Extra Barrels, with trunnions, open head 7.00

WOOD LEAF RACKS

Excellent for gathering leaves, litter, grass, etc. They can be attached to a water barrel truck as shown above. Leaf Rack only, no truck \$10.50 Leaf Rack with 3 1/2-inch tire truck \$30.50 Truck with 3 1/2-inch tire wheels, no rack or barrel \$20.00



KEYSTONE LEAF RACKS

This device can be used on wheelbarrows with removable sides. Convenient for gathering leaves, cut grass and rubbish. Has a capacity of 10 bushels; made of galvanized wire, bolted to a wooden base. Price, not including wheelbarrow, \$8.50.



Wheelbarrows

The measurements of barrows are understood, viz.: length, meaning inside length of body; depth, inside depth at front; width, outside width at handles.

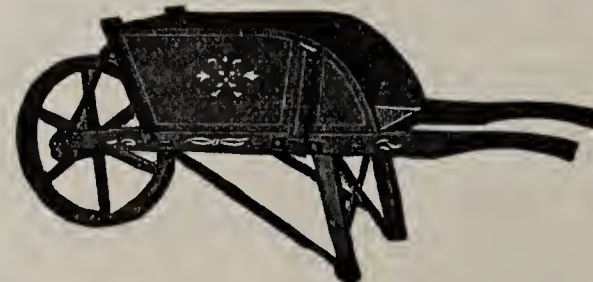

Great American Wheelbarrow

	No.	Tire	Length	Depth	Width	Price
Great American	1	2 3/4	30	12	25	\$9.00
Great American	2	2 3/4	28	12	24	8.00
Great American	3	2 3/4	26	12	22	7.50
Great American (Boys')	4	1 3/4	22	9	18	5.75
Canal. Side dump (bolted)						5.00
Special Greenhouse Style. Narrow body and handle width						10.50

MICHELL'S IMPROVED HIGH WHEEL BALL-BEARING

We have had designed by the best lawn mower makers in the United States the "Michell" High Wheel Ball-Bearing Mower. Of the best material throughout in every detail, there has been the thought to construct not only a mower that would appeal to the intending purchaser from a standpoint of looks, but to give him more for his money than we might be able to do in other makes. The "Michell Ball-Bearing High Wheel Lawn Mower" is made for us by Pennsylvania Lawn Mower Works, who are the originators and makers of the "Famous Pennsylvania Quality" machines.

It has a 5-blade cylinder of tool steel blades, each hardened and tempered in oil; equipped with internal driving gears on both sides. The cones and cups in which the balls revolve are hardened tool steel, while the balls themselves are extra large, of the best quality. The drive wheels are 10 inches high, which ensures easy running; the bottom knife's self-sharpening with raised edge, of a height of from 1/2 to 1 1/2 inches, by adjustment, while it mows with ease grass that is 6 inches high.

15 inch cut.....	\$15.00	19 inch cut.....	\$19.00
17 inch cut.....	17.00	21 inch cut.....	21.00

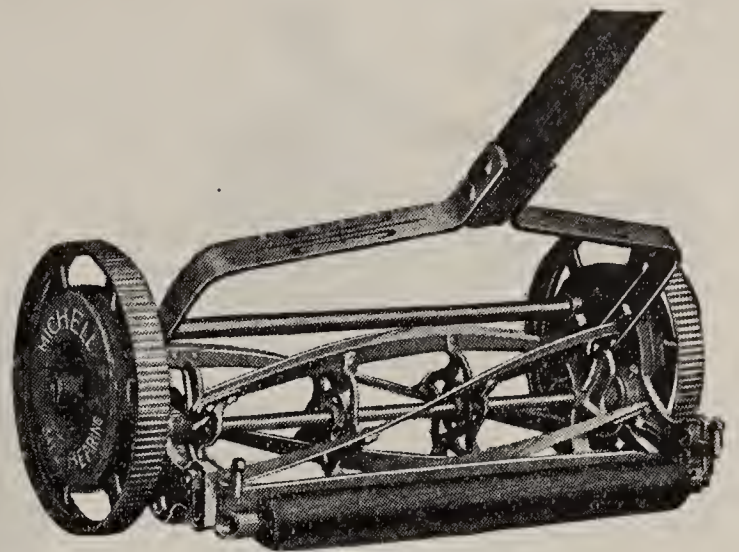

Michell BB High Wheel Lawn Mower

PENNA. JR. BALL-BEARING MOWER

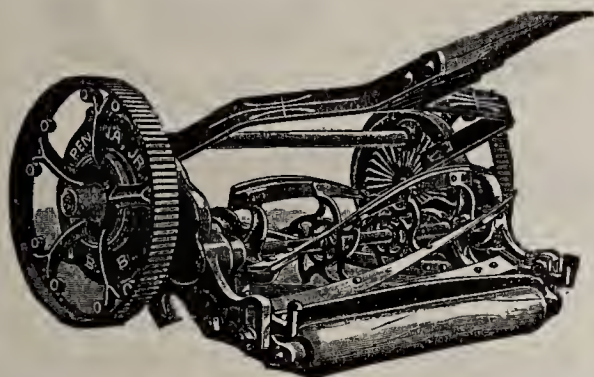

To get the best results from this machine, which does exceptionally fine work, the lawn should be mowed at regular intervals. It cuts the grass shorter than the 4-bladed machine, hence requires mowing at stated periods when the grass is growing rapidly.

8 inch or low wheel, 5 blade cylinder, 5 1/2 inch diameter.

12 inch.....	\$14.50	16 inch.....	\$18.50
14 inch.....	16.50	18 inch.....	21.50

10 inch or high wheel, 5 blade cylinder, 6 inch diameter.

15 inch.....	\$20.00	19 inch.....	\$25.00
17 inch.....	22.00	21 inch.....	28.00

We can also supply the Penna. Standard high wheel in same sizes and prices as above.

THE CONTINENTAL LAWN MOWER

The regulation style for every-day lawns. The Continental has 3 cut gears on both sides. High wheel, 10 1/2 inch diameter.

15 inch.....	\$20.00	17 inch.....	\$22.00
19 inch.....			\$25.00

SUPER GREAT AMERICAN LAWN MOWER

Ball Bearing Wheels and Cylinder

A high-class machine having all the proven qualities of the popular Great American and ball bearings in the drive wheels, steel axles and several other improved fittings. 10 inch wheels; 5 crucible steel blades, extra wide.

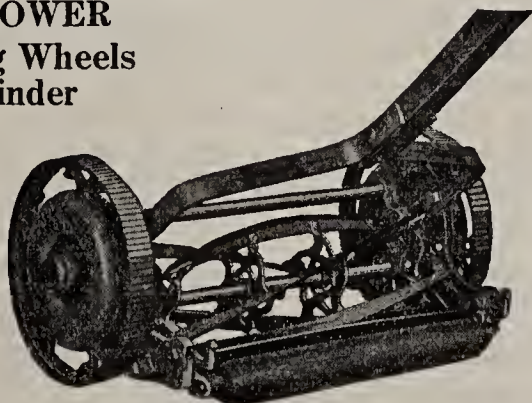

15 inch.....	\$17.00	19 inch.....	\$21.00
17 inch.....	19.00	21 inch.....	23.00

PENNSYLVANIA NEW ARISTOCRAT LAWN MOWER

A light running, smooth cutting model of the world-famous Pennsylvania Golf mower; its high gearing makes it particularly efficient in cutting creeping bent greens. It has 5 1/2-inch cylinder, with 7 crucible steel blades, oil-hardened and tempered. One size only, 19 inch. Price, \$40.00. Grass Box, \$8.00.

PENNSYLVANIA MOWER SUPER ROLLER TYPE (1934 Model)

This new mower for Golf Greens is the last word in lawn mower construction. It has eight crucible steel blades in a high-speed cylinder, aluminum driving drums and train of cut gears running in a grease-tight case. Intermediate gear and front

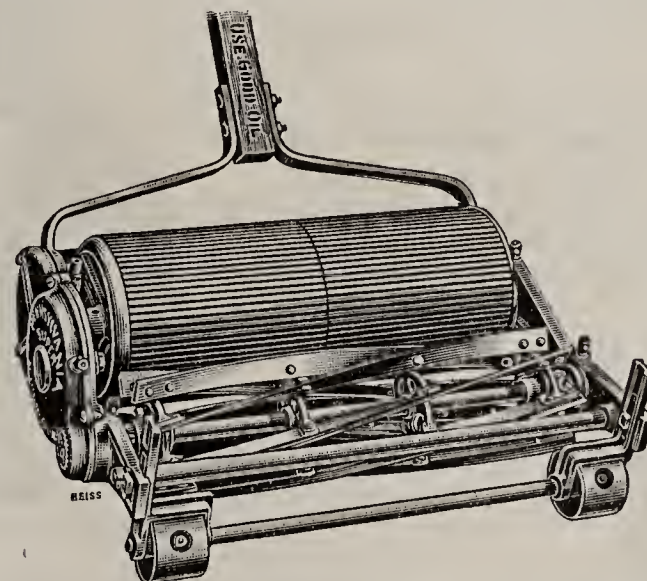

caster wheels on hardened steel bushings; drums, cylinder and front caster wheels on ball bearings. The Super Roller Mower is light running, easy to push and cuts without ridging the greens. Weight only 55 lbs. One size only, 18-inch cut. Price, \$52.00. Grass Box, \$8.00; Carriage, \$5.00.

PENNALITE ALL-STEEL BALL-BEARING MOWER

All castings are malleable iron and are positively unbreakable. It has a 10 inch closed wheel and the cylinder, 6 inches in diameter, has 5 crucible tool steel blades, driven by an internal gear in each wheel and extra wide hardened steel pawl. The bottom knife has a raised edge made of special tool steel hardened and tempered and is screwed to the casting and easily replaced when worn. Equipped with patented Staytite handle, with steel clamps adjustable for any possible shrinkage. One size only, 17 inch. Price, \$15.50.

LOGAN LAWN MOWER SHARPENER



Can be adjusted for any thickness of blade and when properly set will give a uniform bevel, the sharpener following the twist of the knife. It will also sharpen the under blade or dead knife. Price, 75c. each (by P. P., 85c.). Extra files, 30c. each (by P. P., 35c.).

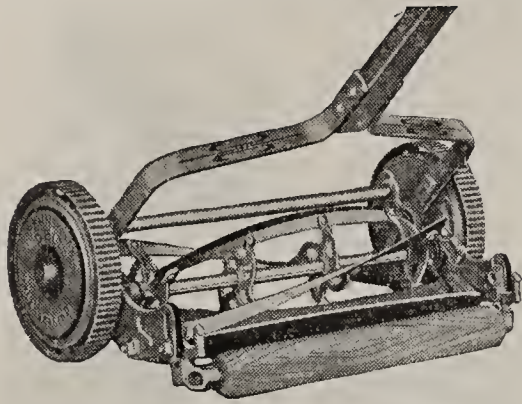

DELTA LAWN MOWER

Ball Bearing, 4-blade cylinder, 8-inch wheel; raised edge lower blade, Penna. make.
 13 inch.....\$8.00 | 15 inch.....\$8.50
 17 inch.....\$9.00

ORCHID BALL-BEARING LAWN MOWER

A splendid moderately priced, high wheel machine; internally driven, making it easy running; equipped with the best crucible steel blades; 10-inch wheels.

17 inch, 5 blade cylinder.....\$11.50
 17 inch, 7 blade cylinder..... 16.00

BEN FRANKLIN LAWN MOWER

Handsomely finished in aluminum, gold wheels, red stripes. Ball bearing, 8-inch wheels, 5-inch cylinder, 4 crucible steel blades.

12 inch.....\$5.50
 14 inch..... 6.00

INVADER LAWN MOWER

A Penna. made mower at a low price, to meet present-day conditions; 10-inch wheel, solid type; 4 hardened steel blades; ball bearing with automatic spring adjustment.
 16 inch.....\$5.00

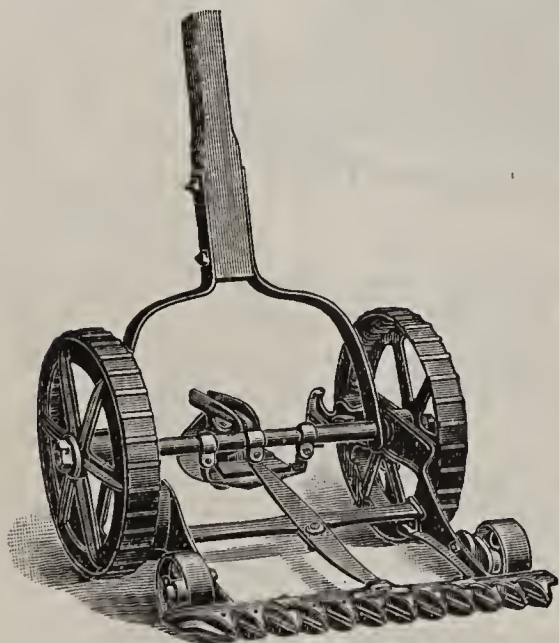

Clipper Lawn Mower

CLIPPER LAWN MOWER

The wheels travel over ground where the grass is cut, never rolling down the standing grass with the wheels, as other lawn mowers do. The small gauge wheels at the side are to gauge the height you wish to cut the grass.
 15 inch.....\$13.00 | 18 inch.....\$15.00

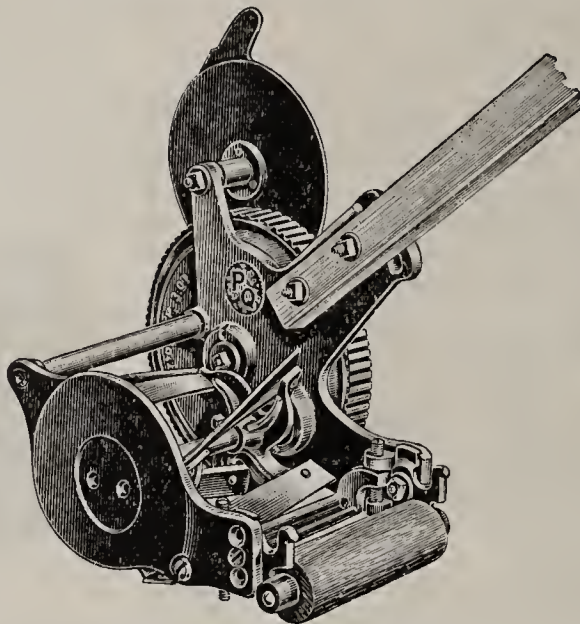

Pennsylvania Combined Trimmer

PENNA. COMBINED TRIMMER AND EDGER

This machine consisting of the Ball Bearing Trimmer, equipped with a steel disc and a small plow, will trim the overhanging grass along the edges of paths and flower beds; relieves the gardener of work with hand shears or a grass hook. Cutting width, 6 inches. Price, \$9.00.

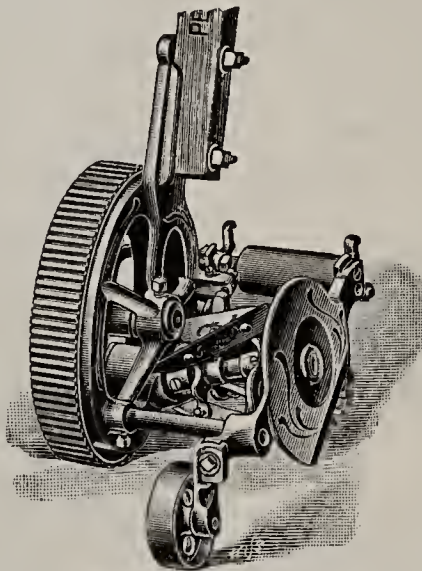

Pennsylvania Undercut Lawn Trimmer

PENNSYLVANIA UNDERCUT LAWN TRIMMER

The unique construction of the undercut trimmer permits cutting not only close to a wall, fence, tree, etc., but it will get the grass under a fence or rock, cut base of tombstones, house foundations and other places hitherto out of reach of anything but hand shears. The slanting sideplate and conical cylinder make it possible to cut all grass which the regular lawn mower will not reach. Ball bearing, with 9½ in. drive wheel; four blade cylinder. Price, \$10.50.

See pages 4 to 7 for Michell's Grass Seeds, in Mixtures and separate varieties.

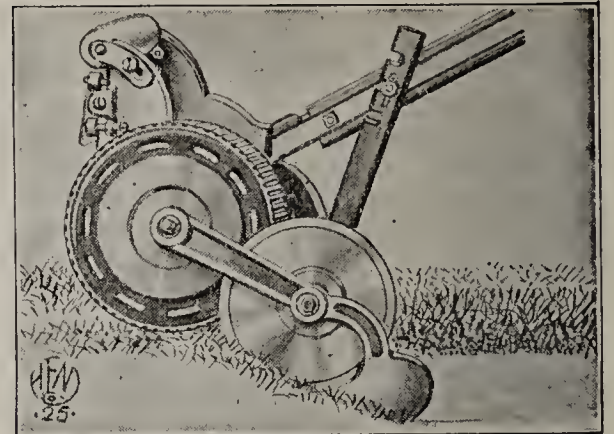

CAPITOL LAWN TRIMMER AND EDGER

The steel disc can be adjusted in a few seconds to convert it into a first-class edging device, while for trimming along borders and walks as well as against buildings, fences, etc., it will prove to be an excellent tool; cuts a swath 6 inches wide. Price, \$10.50.



No. 136, IMPERIAL LAWN EDGE TRIMMER

With this tool the rough straggling, overhanging grass along the edges of the walk can be trimmed in a few minutes. It plows a clean U-shaped trench, delivering the cutting on the sidewalk. The edges along the curbing and walk of an eighty-foot lot can be trimmed in twenty minutes, leaving the whole surroundings neat and attractive. Price, \$1.50 (by P. P., \$1.65).

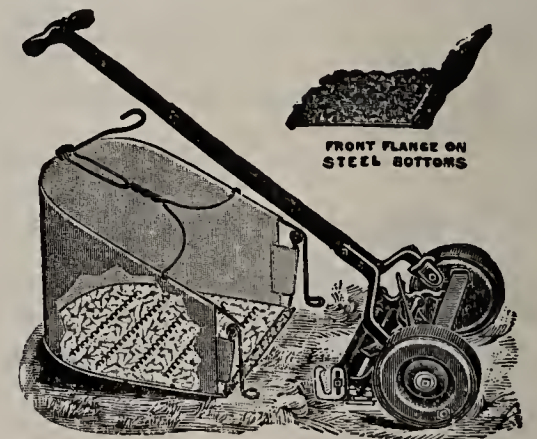

Easy Emptying Grass Catcher

GRASS CATCHERS

Despite what is said to the contrary, if you want a good-looking lawn you should not allow the cut grass to remain upon it; there are two ways of accomplishing this: one is to rake it off "costly and tedious," the other is with the use of a grass catcher "simple and practical." The weight of the catcher loaded with grass is thrown on the machine proper so that it really adds very little to the labor involved in mowing.

Easy Emptying. Short iron handle, round back, galvanized sheet steel bottom, heavy duck sides.
 No. G10, for mowers 12 to 16 inch, \$1.10 each (by P. P., \$1.30).
 No. G12, for mowers 18 to 22 inch, \$1.40 each (by P. P., \$1.60).

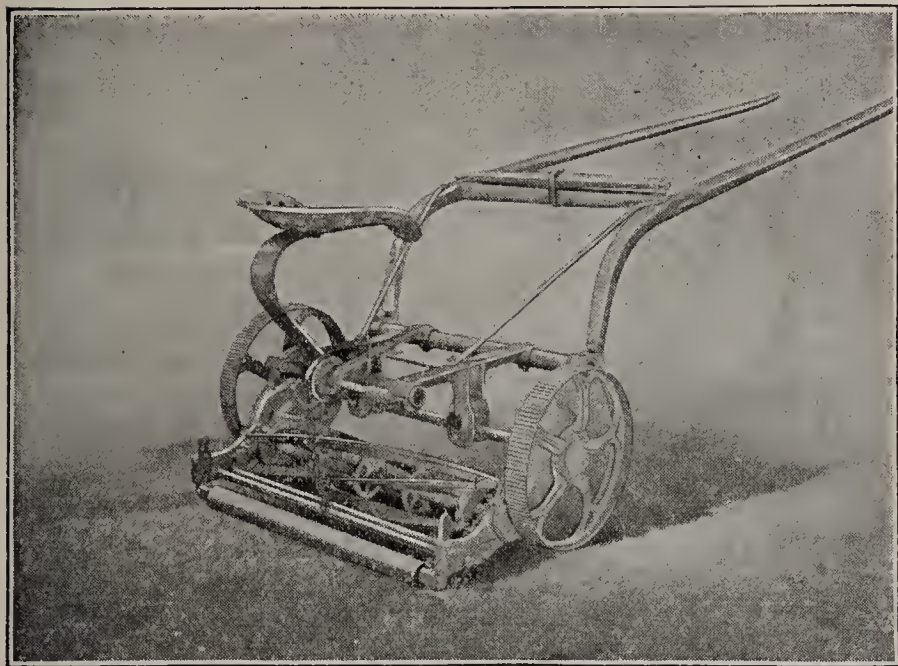

Pennsylvania Fairway Pony Mower

PENNA. FAIRWAY PONY MOWER

An improvement over the older types of horse mowers with roller construction; lighter in construction, larger wheels, quality roller and ball bearings. Wheels 17 in. by 2 1/2 in., each fitted with two sets of Timken Roller Bearings. Cylinder 6 3/4 inches in diameter. Steel blades hardened and tempered with ball bearing journals. Iron roller adjusted for different heights.

30 inch cut, 5 blade cylinder, with seat and shafts. \$150.00

COLDWELL CUB POWER LAWN MOWER



This is a light, substantially built power lawn mower with a 21 inch detachable front cutting unit and a full width drive roller. The engine has been specially designed for this mower. The cylinder is water cooled with fan and radiator so that full load can be carried continuously in hottest weather. An automobile type carburetor is used with a gasoline tank large enough for eight hours' use. Ignition is sup-

plied by a Bosch high-tension fly wheel type magneto mounted directly on the crank shaft.

Price, \$200.00. Grass Box, \$10.00.

COLDWELL MOTOR MOWERS

Twin 30. This is a combined Lawn Mower and Roller, having a capacity of from 6 to 8 acres per day; extremely flexible, making it easy to cut close up to and around trees, shrubbery, walks, etc. The drive roller is full width and is built in two sections. The two-cylinder, four-cycle, water-cooled motor provides an abundance of power for climbing steep grades.

30 inch cut, \$405.00. Grass Box, \$15.00.

L Twin. An exceptionally powerful twin-cylinder power lawn mower and roller, combining flexibility with large capacity; equally well suited for cutting small plots or trimming or mowing wide open stretches of lawn.

25 inch cut, \$355.00. Grass Box, \$12.00.

L Twin with Gang Units. 60 inch cut, \$415.00.

L Junior. A light weight, simple and dependable power mower and roller, of good capacity at a moderate price.

25 inch cut, \$280.00. Grass Box, \$12.00.

Prices quoted on all Coldwell Motor Mowers are f. o. b. Phila.

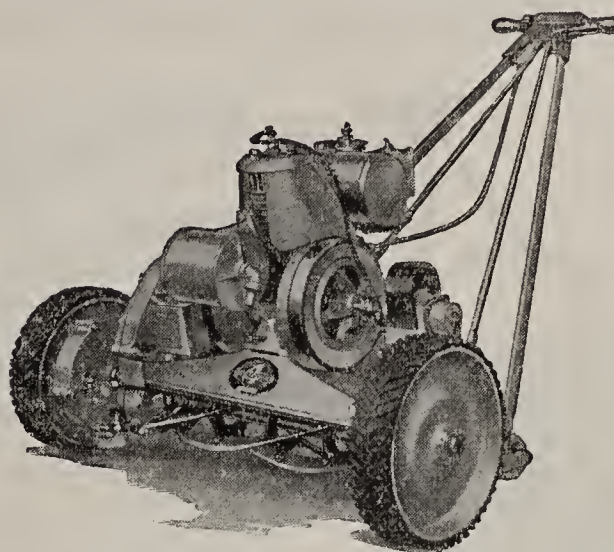

4-Acre Power Lawn Mower

JACOBSEN POWER LAWN MOWERS

The "4-Acre" Heavy Duty Mower

A Superior Mower for Parks, Cemeteries, Golf Grounds, Institutions and Private Estates.

The Heavy Duty 4-Acre is especially adapted for strenuous work where power mowers must be operated daily throughout the season with all types of operators, under all conditions. The newest model is equipped with rubber-tired wheels. Rubber tires give more quiet, smooth operation and definitely prolong the life of the mower. The traction of the mower is also increased about thirty per cent. In cutting, speed, power, durability, efficiency, and economy of upkeep, the Jacobsen 4-Acre Heavy Duty offers distinct challenge to any other walking type mower regardless of size. The 4-Acre is gear driven, gears enclosed and running in oil. Separate clutches operate from the steering handle, control the cutting unit and traction wheel. An automobile type differential makes turning and steering easy. The knives are sharpened by the mower's own power.

No. 1. Heavy Duty. Cuts 24 inches wide; net weight, 250 lbs., crated, 300 lbs. Price, f. o. b. Phila., Pa., \$290.00.

Grass Catcher, \$9.00 extra.

Junior Power Mower. Cuts 19 inches wide; net weight, 170 lbs., crated, 200 lbs. Price, f. o. b. Phila., Pa., \$210.00.

Grass Catcher, \$6.50 extra.

IDEAL MOTOR LAWN MOWER

Roller Type

The 1934 models have a number of important improvements; they are equipped with a new engine of the latest design; the complete frame assembly is more perfectly balanced. For moderately large lawns the rolling feature is very desirable. Engine has throttle control and has power to wade through tough cutting and climb moderately steep hillsides.

22 inch cut; capacity, 3 to 4 acres per day; motor, 4 cycle, air cooled, bore, 3 in., stroke, 3 in., flywheel magneto; cutting unit, bull-dog type "B" 5 blade; traction roller, 3 sections; width, 17 in., diameter, 10 in., net weight, 455 lbs.

Price, f. o. b. Philadelphia, \$275.00.

30 inch cut; capacity, 5 to 7 acres per day; motor, 4-cycle, air cooled, bore, 3 in., stroke, 3 3/4 in., flywheel magneto, throttle control; cutting unit, bull-dog type "A", 5 blade; traction roller, 4 sections, width, 24 in., diameter, 10 in., net weight, 600 lbs.

Price, f. o. b. Philadelphia, \$365.00. Riding attachment for 30 inch machine only, \$20.00 extra.

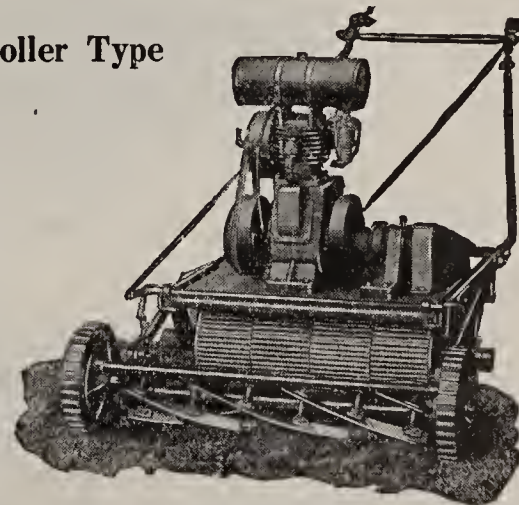

30-inch Roller Type

MICHELL'S LAWN ROLLERS, ETC.

It is very essential to roll the lawn when the frost is permanently out of the ground, and again several times during the season. A first class roller will prove a good investment, as it will last almost a lifetime, especially if it is put under cover when not in use.

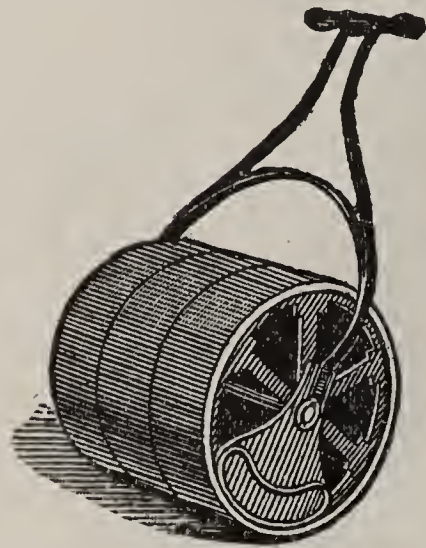

KEYSTONE HAND LAWN ROLLERS

Drums are equipped with five spokes; the face is ground smooth and carefully finished. The steel roller bearings are mechanically constructed, making the roller operate so easily a child can handle it. The handle is made of steel and hard wood; is equipped with a balance weight, so that it is always in an upright position. The drum or roller part has a bevel edge so that it cannot tear up the lawn or ground when being turned.



KEYSTONE WATER-BALLAST ROLLERS

Fill it with water, which will weight it up to any number of pounds desired, as shown below. The same roller can thus be used for soft turf, firm lawns, or for rolling the driveway and tennis court. Equipped with a device for keeping handles stationary. Ball axle bearings.

No.	Diam. Inches	Length or Width In.	No. of Sections	Lbs. Weight	Price
501.....	15	15	2	175	\$18.00
502.....	15	22	3	250	20.00
504.....	20	20	2	250	23.50
507.....	20	24	2	300	28.00
508.....	20	30	3	350	32.50
509.....	24	20	2	400	37.50
511.....	24	24	3	450	42.00
512.....	24	30	3	500	45.00
514.....	28	24	3	500	45.00

Keystone Water Ballast Roller

No.	Sections	Diam. In.	Length In.	Weight Empty	Weight filled with water	Price
601.....	1	14	24	60	250	\$14.00
602.....	1	18	24	85	330	16.00
603.....	1	24	24	100	440	18.00
604.....	1	24	32	135	590	19.00

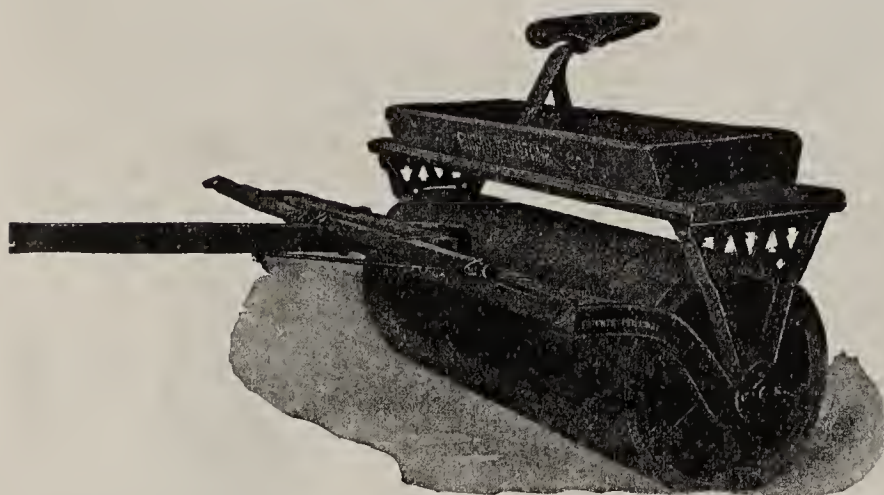

Keystone Horse Roller

KEYSTONE GOLF GROUND AND LAWN HORSE ROLLERS

Made of cast iron carefully finished with beveled edge drums; equipped with shafts for one horse or tractor hitch; all sizes are equipped with weight boxes to permit the roller being made to weigh heavier than it is when factory finished.

No.	Diam. Inches	Length Inches	Sections	Weight Lbs.	Price
341.....	24	40	4	800	\$90.00
342.....	24	50	5	950	105.00
344.....	28	40	4	1000	115.00
345.....	28	50	5	1200	135.00

Shipment of Horse Rollers is made from factory in Penna. We can also supply heavier rollers for land and golf ground use.



MICHELL'S SPIKE TOOTH ROLLER

No. 706. For aerating the sod on Golf Courses, Putting Greens, Parks and large lawns. 18 inches wide, made in two sections; diameter 9 inches; weight, 70lbs. Made of seasoned oak staves with cast iron heads. Closely covered with steel spikes. Steel top and frame so constructed that sand bags can be used for additional weight. Carrying wheels for turning or moving. Price, \$27.50.



PUTTING GREENS ROLLER

No. 700. Greens-keepers have found that a roller about 4 feet wide, weighing about 160 pounds, is right; evenly surfaced; will not leave a mark or ridge on the greens. Made of cast steel in 4 sections. Price, \$25.00.

Parcel Post charges where named are for shipment to the first and second zones; for other zones, please see parcel post table, page 1.



PLANET JR. No. 2 GRASS EDGER

A simple steel disc device, with a flange that runs on the cement path, to cut away the grass which hangs over the edge of the walk; this revolving disc operates very easily and does not cut away any of the soil which some people object to; can be used successfully on straight or curved cement paths. Price, \$1.50 (by P. P., \$1.65).



LAWN MOWER OIL

Pure oil that will not gum or get sticky is an essential for the satisfactory operation of every mower. The oil sold by us has been selected with this point in view.

Prices: Per pint, 25c.; 35c. per quart; 1/2 gal., 65c.; \$1.00 per gal.; 5 gals., \$4.25.

Lawn Mower Oil cannot be mailed

GEM OIL CANS

Finished, Brazed Steel		Price
Capacity	Spout	
No. 1706.	8 oz. 6 in. bent	\$0.50
No. 1706.	8 oz. 6 in. straight	.50
No. C14AA.	8 oz. 5 in. straight, coppered	.25
No. 1606.	1/3 pt. 6 in. bent, steel	.40
No. 1606B.	1/3 pt. 6 in. bent, brass	.65

If Oil Cans are wanted by P. P., add 10c. each.

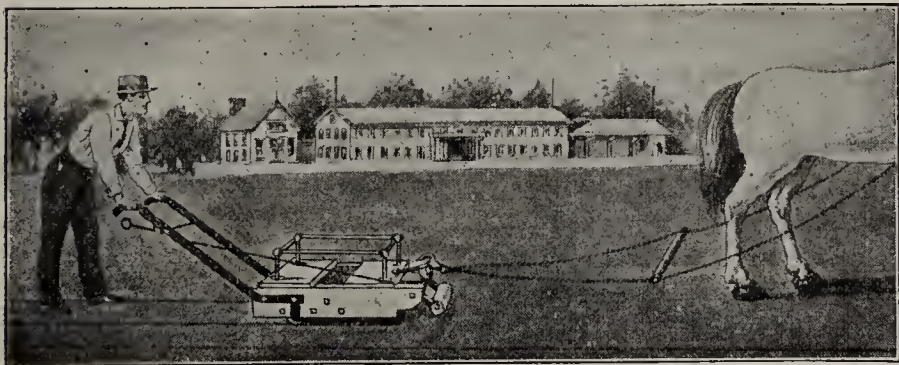
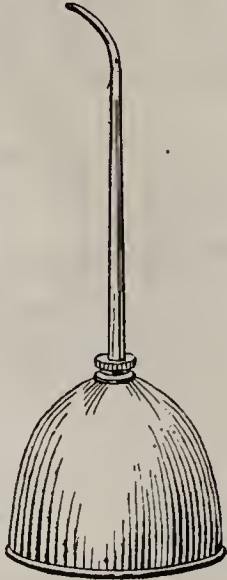

CHAMPION SOD CUTTER

The best and most satisfactory machine on the market. Used extensively where any great amount of cutting is to be done; this machine will cut in one hour as much as two men can cut in a day. The machine is so constructed that it can be adjusted to cut the sod to a uniform thickness, 1 to 2 inches; has a reversible knife. Price, \$43.50. Extra knives for above, \$10.00 (by P. P., \$10.20).



American



English

TURF OR SOD LIFTERS

At times, it is more desirable to sod a bare or worn-out spot on the lawn or grass plot than to sow it with grass seed. Our sod lifters are made of the best steel and will last a long time.

American. Steel blade, with an 18 inch steel shank and wood D handle. Price, \$1.75 each (by P. P., \$2.20).

English. No. 275. Price, \$6.00 each. (Not mailable.)

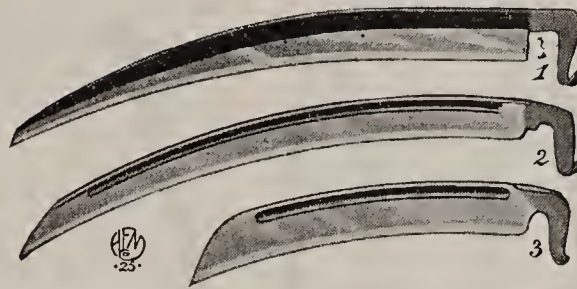

SCYTHES

Little Giant, 32 inch	\$2.00
Little Giant, 34 inch	2.00
Little Giant, 36 inch	2.00
Little Giant Brush or Briar	2.00

Key to illustration: No. 1, English; No. 2, American; No. 3, Little Giant Brush.

The Little Giant is the best American-made scythe for field and heavy grass work.

English, 32 in., rivet back	\$2.75
English, 34 in., rivet back	3.00
English, 36 in., rivet back	3.50

The English Scythes are best for fine grass or lawn work.

If scythes are wanted by parcel post, add 20c. each for postage.

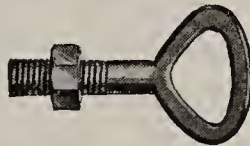

Snath Clip



SCYTHE HANDLES

No. 50. Made of hard wood, well finished.

Regular Scythe style (not mailable)	\$2.00
Snath Clips (by P. P., 30c.)	.25

SCYTHE STONES



	Each	Doz.
Sir Pike (Talacre Style)	\$0.30	\$3.50
Talacre (Imported)	.50	5.75
Darby Creek	.25	2.75
Carborundum. Very fine	.30	3.50

If Scythe Stones are wanted by parcel post, add 10c. each for postage.



CARBORUNDUM RIFLE

Price, 25c. each (by P. P., 35c.).



CARBORUNDUM FILES

No. 57. Price, 90c. each (by P. P., \$1.00).
Red Head. Price, 75c. (by P. P., 85c.).

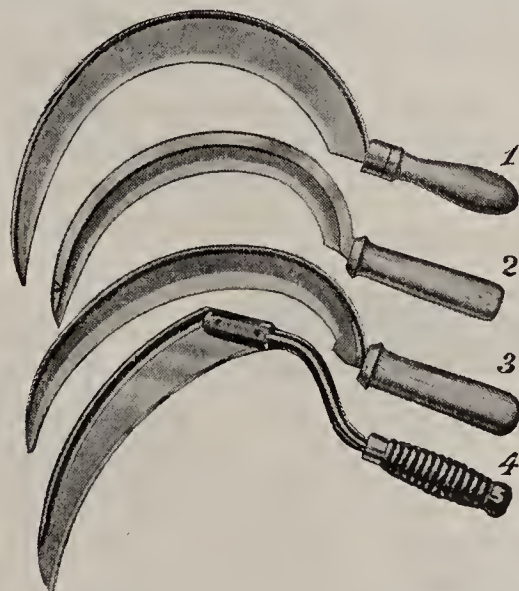

SICKLES OR GRASS HOOKS

English Rivet Back, No. 2	\$0.90
English Rivet Back, No. 3	1.00
English Solid Back, No. 2	.60
Little Giant	.70
Dutch or German, No. 2	.60

If wanted by parcel post, add 15c. each for postage.

Key to illustration: No. 1, Dutch or German; No. 2, Rivet back; No. 3, Solid back; No. 4, Little Giant.

Parcel Post charges where named are for shipment to the first and second zones; for other zones, please see parcel post table, page 1.



No. 1102 No. 1103 No. 1104

BORDER SHEARS

Made of finest American steel. They take the place of edging knives and avoid the necessity of doing much stooping. The shear without wheel works equally as well as the one equipped with wheel; this feature is an item of individual preference only.

- No. 1102. 9 inch. Without wheel.....\$3.75
- No. 1103. 9 inch. With one wheel..... 4.25

LAWN SHEARS

For trimming under shrubbery, fences and other out-of-the-way places. The two wheels permit the shears to move over the ground freely, backward and forward.

- No. 1104. 9 in. blade, long handle.....\$4.25
- Handles for Border Shears..... per pair 1.00

EDGING KNIVES

For trimming edges of paths, etc. No other implement will put a finish to a grass border, a walk or drive edged with sod like an edging knife; on straight work, it is well to use a garden line so as to make a first-class job, as nothing in the line of gardening looks so badly as edging in a crooked line.

- No. 040. American, with handle.....\$1.25
- No. 3863. English, 9 inch with handle..... 2.00

American Knives are not mailable. English knife without handle can be mailed at 10c. for P. P.



English American

FLAT FILES



- | | | |
|-----------------------------|--------|---------|
| For sharpening lawn mowers. | Each | By P.P. |
| 8 inch..... | \$0.35 | \$0.45 |
| 10 inch..... | .40 | .50 |
| 12 inch..... | .55 | .65 |

EMERY

For sharpening Lawn Mowers. Price, 20c. per lb. (by P. P., 30c.); 10 lbs., \$1.90 (by P. P., \$2.10).

GRASS SHEARS

Do not buy a cheap grass shear, they do not last long, nor do they keep a sharp edge which is an essential in trimming grass; our list comprises the best makes.

If wanted by parcel post, add 10c. each for postage.



- | | | |
|-------|---|--------|
| No. | | Each |
| 263. | 6 inch, American..... | \$0.50 |
| 012. | 6 inch, American..... | 1.25 |
| 114. | 7 inch, English, trowel shank handle..... | 2.50 |
| 113. | 7 inch, English, straight handle..... | 2.00 |
| 0267. | 6 inch, American..... | .95 |
| 0267. | 7 inch, American..... | 1.25 |

MICHELL'S GRASS SHEARS

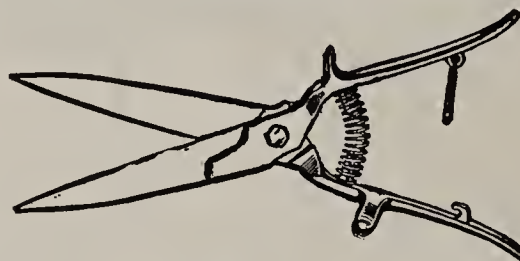

No. 90. Cuts grass easier than an ordinary shear; built like hair cutters; blades forged steel. Price, 75c. (by parcel post, 85c.).



Kut Quick Grass Shear

KUT QUICK GRASS SHEAR

No. 125. Designed especially to cut grass; works with an easy up and down motion; keeps your hands out of the dirt. Price, \$1.25.

GRASSWIPS

The New Double Edged, Long Handled Grass Cutter

The easiest way to cut grass and weeds; cuts rapidly on both the forward and backward swing.

No. 165. The gooseneck type; forged blade; double edged; 37-inch round steel shaft, with maple handle; enameled in red and green. Price, \$1.00.



See pages 4 to 7 for Michell's Reliable Grass Seeds.

THE LAWN

By L. S. Dickinson

A very comprehensive work on the subject, giving simple and practical directions on the making and care of the lawn; especially valuable to those who are interested in turf culture. Illustrated. 128 pages. Price, \$1.25.



HUDSON DANDELION or WORM CAST RAKE

When pulled across the lawn, the stems, leaves and blossoms of the dandelions are wedged between its teeth and easily pulled out. Self cleaning; also valuable for cleaning worm casts and other litter from putting greens and other fine turf playing surfaces.

16 inch...90c. each | 20 inch...\$1.00 each



Improved Metal Grip Rake

BAMBOO RAKES

Made of split bamboo, rigidly secured, with handle. Just the thing for cleaning grass clippings from walks, flower beds, borders and from the lawn.

18 inch, with bamboo handle (old style) \$0.50
 18 inch, with hardwood handle..... .75
 24 inch, with hardwood handle..... 1.00
 30 inch, with hardwood handle..... 1.50

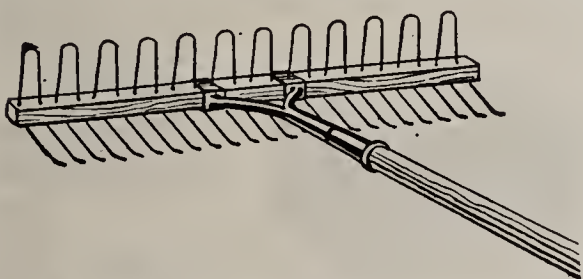

WIRE LAWN OR GRASS RAKE

Made of heavy tinned steel wire. The rake is reversible. These are excellent for lawn or walk work.

No. 124R—24-tooth.....\$0.75
 No. 36LR—36-tooth..... 1.25



STEEL BRUME RAKE

Spring steel teeth; will remove the smallest leaves and litter. Price, 85c. each.

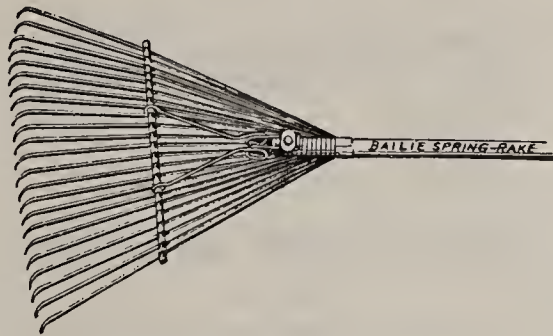

BAILIE SPRING RAKE

Fitted with extra heavy spring from handle to spacer; has 24 teeth made from spring wire, slotted and keyed throughout; ideal for lawn or driveway. Price, \$2.00.



FULLER LAWN BROOM

Well made of good material; has 28 flexible, spring steel teeth, 3/4 inch apart. Price, \$2.00.

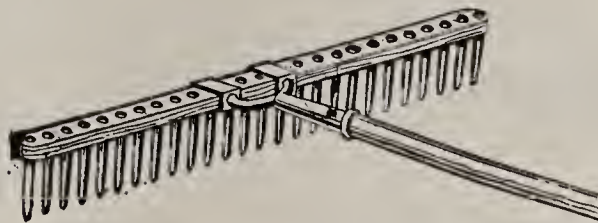

OLE OLSEN LAWN RAKE

Made of best hard wood, well braced; teeth set close together.

26-tooth, hickory wood. Price, \$1.00.

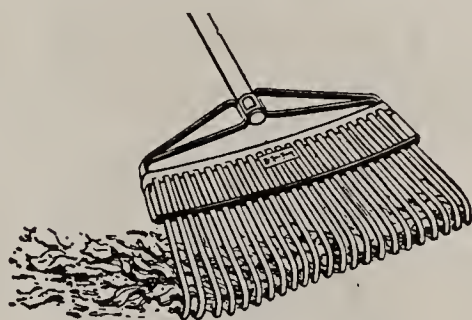

LAWNCOMB RAKE

The Lawncomb cleans your lawn without injuring tender growing grass. Frame is one-piece steel construction; electrically welded ends. 20 inch, natural finish handle, \$1.50.

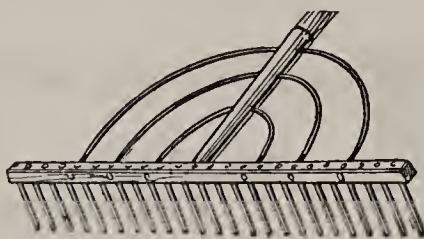

Ames, No. 37 X Rake

WOODEN RAKES

Ames, No. 37X. 28-tooth, steel bows..\$1.25
 Ames, No. 30X. 14-tooth, hardwood.. .75

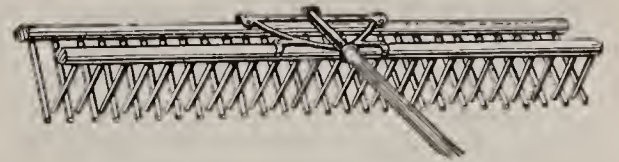

AUTOMATIC LAWN RAKE

A backward motion of the operator clears all the teeth at once.

Wood, 26-tooth.....\$1.60



STEEL GARDEN RAKES

Made of best cast steel, with long teeth.

No. 12.....12...\$0.95	No. 16.....16.....\$1.05
No. 14.....14... 1.00	No. 18.....18..... 1.10

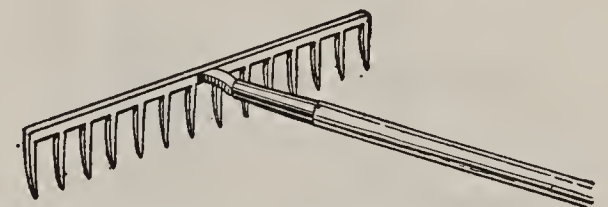

STEEL GRAVEL RAKES

These rakes are used for road making and for paths; having short teeth they do not gather up stones or gravel.

No. G14....14....\$1.15	No. G16....16....\$1.25
-------------------------	-------------------------

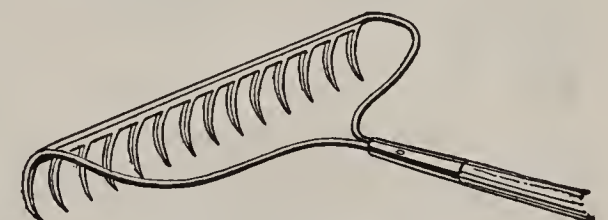

STEEL BOW RAKES

Preferred by many to the regular garden rake, the teeth being slightly bent toward the operator.

No. B12...12.....\$1.10	No. B14...14.....\$1.15
B16.....16-tooth.....\$1.25	



MICHELL'S EXCELSIOR STEEL GARDEN RAKE

Nicely balanced; 16-tooth only. Price, 75c.

**HOE AND RAKE
(Combined)**

An excellent tool for ladies, combining simplicity and utility. Made of the very best steel, which will outlast several cheaper tools of the same class.

- No. 4P. 4-prong... \$1.00
- No. 6P. 6-prong... 1.10

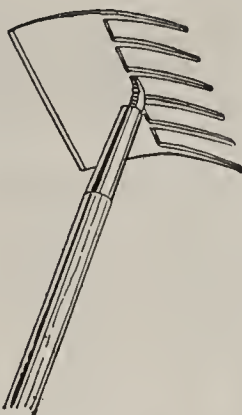

DOCK LIFTER

For field and farm use; will up-root the deepest seated weed or dock; has tremendous leverage. Made of wrought iron and oak wood; no wear out to it. Price, \$4.25.

(Not Mailable.)



Dock Lifter



Marking Rake

MARKING RAKE

Has a spread of 4 1/2 ft.; equipped with five adjustable brass teeth; no better method of row marking can be employed; suited for setting plants or sowing seed. The frame and handle are oak; no wear out to it. Price, \$6.50.

(Not Mailable.)

Extra Teeth for same. Price, 75c. (by parcel post, 85c.).



SQUARE HOES

- No. G06. 6 inch, solid shank... \$0.90
- No. G07. 7 inch, solid shank... 1.00
- No. G08. 8 inch, solid shank... 1.05
- No. 10. 10 inch, for celery... 1.50

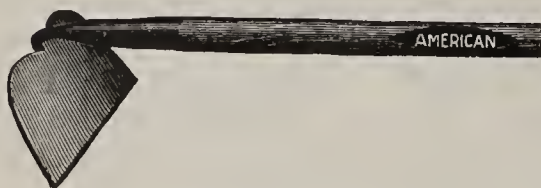

MICHELL'S SPECIAL SQUARE HOE

7 inch only; solid shank; 4 1/2 foot handle. Price, 50c.



HALF MOON HOES

Best steel, solid sockets, which will not pull out.

- No. HM4. 4 inch... \$0.95
- No. HM6. 6 inch... 1.00
- No. HM7. 7 inch... 1.05

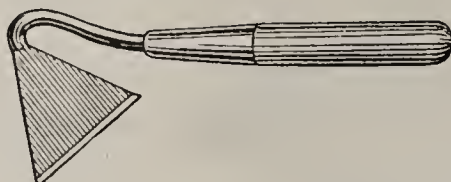

SPECIAL STEEL WEEDING HOE

No. 3W. Short Handle, 60c. (by P. P., 70c.).

TWO-PRONG ONION HOE

Will be found very valuable in weeding in narrow rows. (See cut below.)

No. 2P. Price... \$0.50

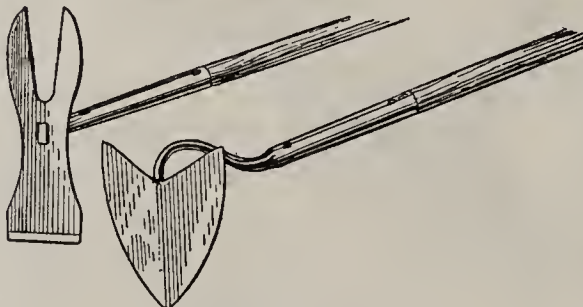

WARREN HOES

Excellent tools for making drills preparatory to sowing of seed. The backs can be used for covering. (See cut above.)

- No. W7. 7 inch... \$1.10
- No. W8. 8 inch... 1.25

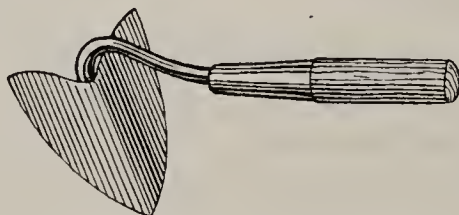

BABY WARREN HOE

No. BW4 1/2. Short Handle, 60c. (by P. P., 70c.).

SCUFFLE HOES

Made of best steel.

- 5 inch... \$0.75
- 6 inch... .80
- 7 inch... .90
- 8 inch... 1.00
- 9 inch... 1.05
- 10 inch... 1.10



Handles for Scuffle Hoes, 20c. each, extra.

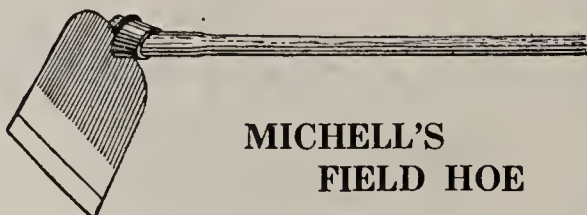

MICHELL'S FIELD HOE

For digging up stubble, small stumps, small plots of ground for planting purposes, etc.

- No. GE40. 5 1/2-inch blade, each... \$0.85
- No. IGH7. 7-inch blade, extra heavy, each... 1.75

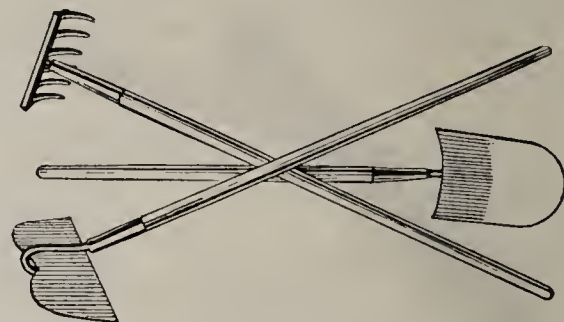

GARDEN TOOL SET

For ladies and children, in fact they are suitable for the country gentleman, consisting of 1 hoe, 1 rake and 1 spade.

No. 3PF large size, per set, \$1.75.

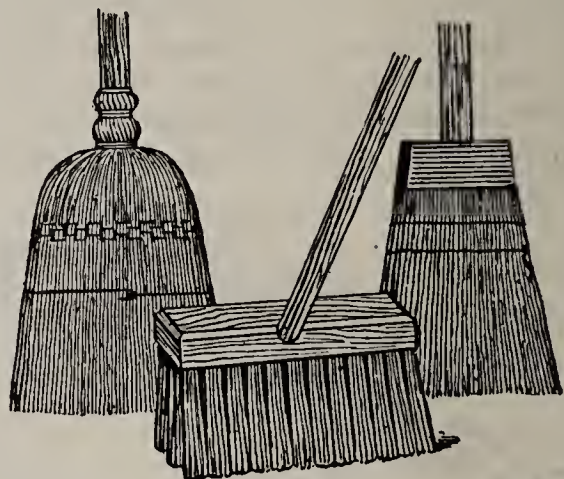

Plain Corn Rattan Push Jap. Fibre

BROOMS AND BRUSHES

For sweeping paths, gutters, roads, etc.; all with handles.

Brooms

- No. 230. Japanese Fibre... \$1.00
- No. 8. Corn and Rattan mixed... .85
- Golf Greens (Birch)... .30
- No. 7. Plain Corn, extra quality... .85

Road Brushes

- No. 1414. Bass or Cocoa Push, 14 inch... \$1.00
- No. 271. Rattan Push, 14 inch... 1.00

SIEVES

(Any Size Mesh) Made extra well.

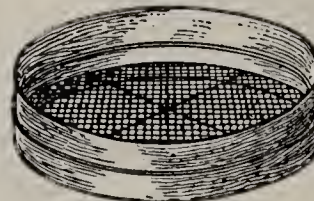

By P.P. Each Each

- 18-inch Steel (Heavy)... \$1.75 \$1.95
- 18-inch Galvanized wire... 1.75 1.95

LARGE UPRIGHT SIEVE

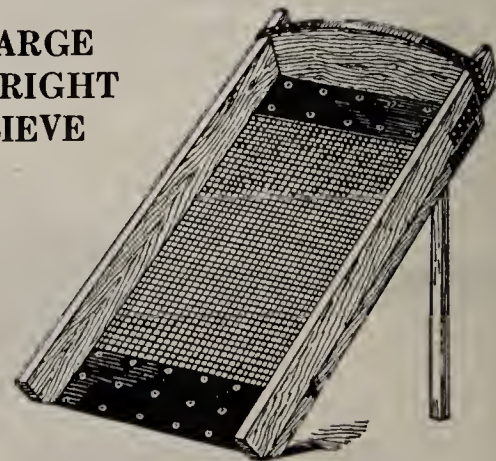

For soil, gravel, sand, etc. Made in any size mesh, of extra heavy grade foundry wire. \$17.50 each.

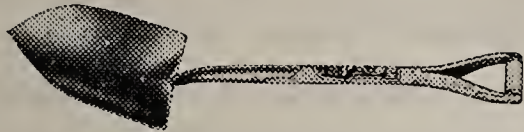

Fox Shovel

SHOVELS

Long Handle

Fox, round point.....	\$1.75
Fox, square point.....	1.75
Conneaut, round point.....	2.00
Conneaut, square point.....	2.00
Empire, round point.....	1.25
Empire, square point.....	1.25

Short Handle

Fox, round point.....	\$1.75
Fox, square point.....	1.75
Conneaut, round point.....	2.00
Conneaut, square point.....	2.00
Empire, round point.....	1.25
Empire, square point.....	1.25



STEEL SCOOP SHOVELS

Strapped shanks, wood D or short handles.

No. 1. 9 inch mouth.....	\$1.35
No. 2. 10 inch mouth.....	1.50
No. 3. 11 inch mouth.....	1.55
No. 4. 11½ inch mouth.....	1.60
No. 5. 12 inch mouth.....	1.70
No. 6. 13 inch mouth.....	1.75

WIRE SCOOP SHOVEL

For handling potatoes, turnips and root crops without bruising or cutting. Made of heavy steel wire.....\$2.75



Owosso Snow Shovel

SNOW SHOVELS

Adams. Wood, D handles.....	\$0.90
Phillips. Wood, long handle.....	.90
Owosso. Galvanized, 16 inches wide...	1.40
Owosso. 20 inches wide.....	1.75

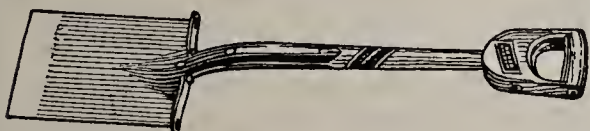

STEEL SPADES

Fox, short handle.....	\$1.75
Fox, ladies' polished.....	1.50
Conneaut, short handle.....	2.00
Nursery (Bull Dog), short handle.....	2.50
Nursery, Conneaut's Special.....	3.50
Empire, short handle.....	1.25
Boys'.....	1.25

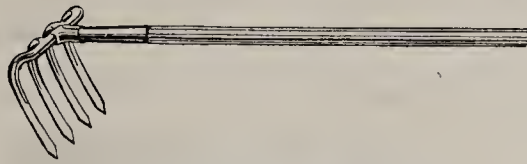

MANURE DRAGS

For spreading manure, digging potatoes, etc. Flat tines.

No. 4. 4 tine.....	\$1.25
No. 6. 6 tine.....	1.50



SPADING FORKS

Strapped shanks, short or D-wood handle. Made of best quality steel.

No. OHW. Men's 4 tine.....	\$1.75
No. O5HW. Men's 5 tine.....	2.10
No. B4D. Boys' or Ladies' 4 tine..	1.00

MICHELL'S SPECIAL SPADING FORK

No. OL42. 4 tine; nicely finished, with D bachelor handle, medium weight. Price, \$1.00.



ENGLISH DIGGING FORK

No. ED4. The prongs are solid steel, with square instead of round edges, which adapts it especially for digging in heavy soil, in which it works with ease. Every gardener should add one of these to his collection of tools. 4 tine, \$2.50 each.



STEEL HAY FORKS

O35B. 3 tine, 5 foot handle.....	\$1.50
O36B. 3 tine, 6 foot handle.....	1.75

WOOD HAY FORKS

3 tine.....	\$1.50
-------------	--------

LIGHTNING HAY KNIFE

For cutting down hay in mows, stack or bale, also for ensilage or dry corn fodder. Price, \$3.00.

IMPLEMENT HANDLES

Axe.....	Each \$0.50
Spade, plain.....	.50
Fork, Spading, plain.....	.75
Fork, Manure, plain, short.....	.60
Fork, Manure, plain, long.....	.60
Shovel and Spade, short, plain.....	.50
Hoe, plain.....	.20
Rake, plain.....	.30
Pick or Mattock.....	.50
12 foot Poles..\$2.75 14 foot Poles..	\$3.00



MANURE FORKS

Strapped Shanks.

04W—4 tine, light, short handle....	\$1.75
163 —4 tine, heavy, short handle..	2.00
05W—5 tine, medium, short handle..	2.00
06W—6 tine, medium, short handle..	2.00
044½—4 tine, long handle.....	1.50
054½—5 tine, long handle.....	1.75



MICHELL'S SPECIAL MANURE FORK

No. 04D2; 4 tine, strap ferrule, iron D handle. Price, \$1.00.

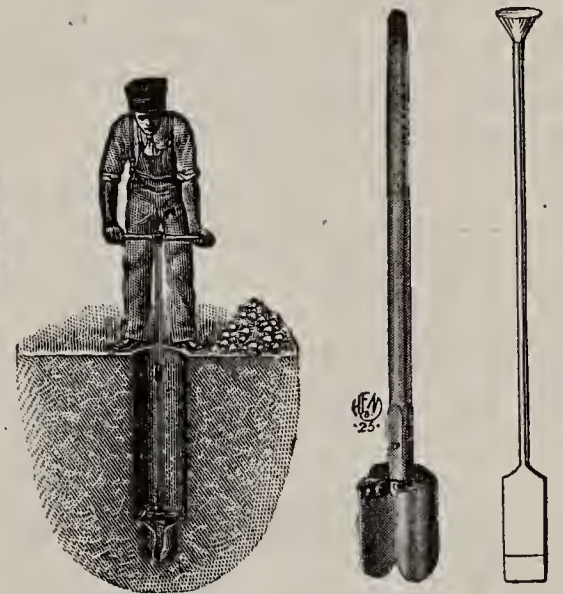

No. 8 Digger

Eureka

Spade

POSTHOLE DIGGERS

No. 8. This bores a hole 3½ ft. deep and can be adjusted in diameter from 8 to 14 inches, \$5.50.

No. 15. Eureka, \$2.50.

Post Hole Spade. All steel with tamper end, \$2.50.

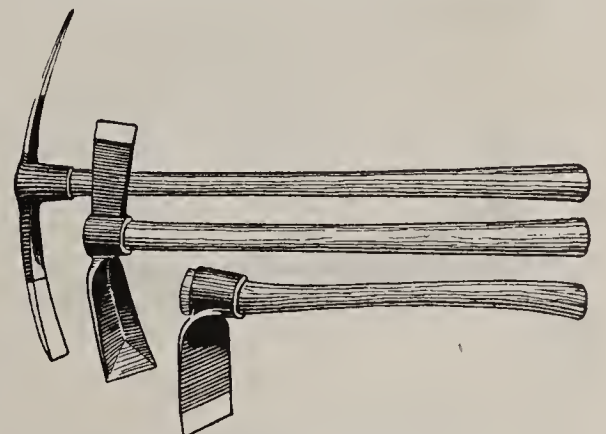

PICKS (Price includes Handle)

All steel, double point, \$1.50.

MATTOCKS (Price includes Handle)

Axe pointed.....	\$1.50
Pick pointed.....	1.25
Half Mattocks or Grub Hoes.....	1.25

Parcel Post charges where named are for shipment up to and including the second zone; for other zones, please see parcel post table, page 1.

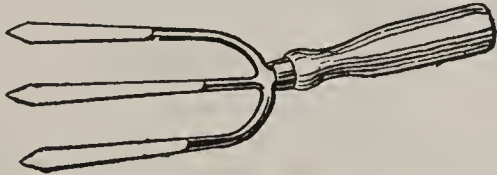

EUREKA WEEDING FORK

No. 300. Made of best flexible steel; splendid for loosening soil in the garden, in hotbeds, etc. Short handle, 45c.

No. G4. Long handle, 65c. each.

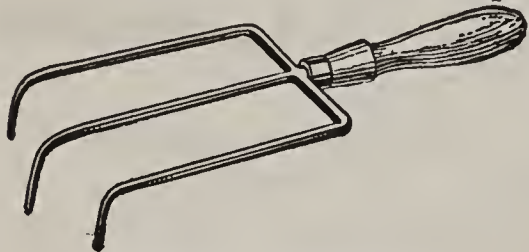

EUREKA WEEDER

No. E. Made of flexible steel; very light, an ideal tool for market gardeners, florists and amateurs. Short handle, 50c.

No. EL4. Long handle, 75c. each.



EXCELSIOR WEEDING FORK

No. 300. Made of malleable steel, finished in tin, 15c. (by parcel post, 25c.).

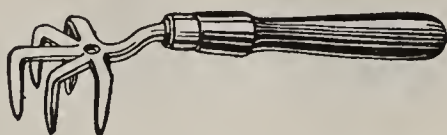

EXCELSIOR WEEDER

Made of malleable iron, finished in tin, 15c. (by parcel post, 25c.).

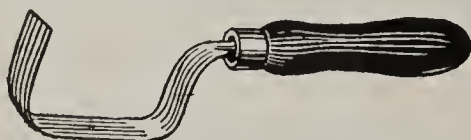

HAZELTINE WEEDER

No. BW1, 30c. (by parcel post, 40c.).

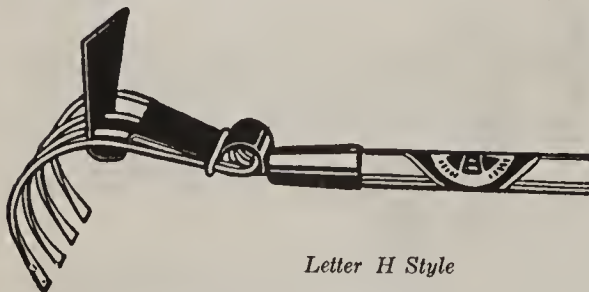

Letter H Style

MAGIC WEEDER

Made of heavy galvanized flexible wire with flattened prongs or ends.

Letter A. Short Handle, small.....\$0.20

(by parcel post, 30c.).

Letter B. Short Handle, medium..... .25

Letter F. Long Handle..... .75

Letter H. Long Handle, large..... 1.25

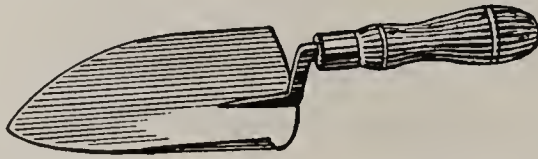

JOHNSON STEEL TROWELS, No. 211

These are made of one piece steel blade and shank, equal to the imported trowels.

5 inch.....\$0.70 | 6 inch.....\$0.75

7 inch.....\$0.80

If wanted by parcel post, add 10c. each.



D. S. T. STEEL SHANK TROWEL

These are somewhat long in blade and handle, making a very practical tool. 6 inch blade, 75c. each (by parcel post, 85c.).

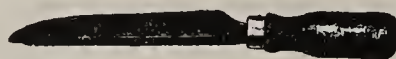

CLEVES' ANGLE TROWEL

No. 217. For getting dandelion, plantain and other weeds out of the lawn, and transplanting.

	Each	P.Post Each
5 inch.....	\$0.20	\$0.30
6 inch.....	.25	.35
7 inch.....	.30	.40

MISCELLANEOUS TROWELS

	By Each	P.Post
No. 0. Neverbreak, 6 inch, heavy steel.....	\$0.15	\$0.25
No. 215. Steel, wood handle.	.25	.35



TRANSPLANTING TROWEL

Steel shank and blade, 75c. (by parcel post, 85c.).



OLD ENGLISH BULB TROWEL

Heart-shaped blade, 4 3/4 inches wide, for planting out bulbs and plants. Price, \$1.00 (by parcel post, \$1.10).

LONG HANDLE TROWEL

Steel blade, wooden handle; 16 inches over all. 30c. each (by parcel post, 40c.).

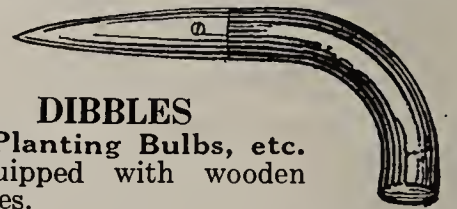

DIBBLES

For Planting Bulbs, etc. Equipped with wooden handles.

No. 2180. Brass point, \$1.00 (by parcel post, \$1.10).

No. 218. Iron point, 85c. (by parcel post, 95c.).

KNEELING PADS

Will protect the clothing and prevent dampness from affecting the knees. Price, 50c.

TREE SCRAPER

For removing loose bark from trees prior to spraying. Steel blade may be detached and sharpened.

No. 3, short handle, 65c. (by P. P., 75c.).

No. 5, 2 foot handle, extra heavy, \$1.50.



TREE OR BARK BRUSHES

For brushing down trees for removing insects, borers, etc. Made of steel.

Price, 8 1/2 inch, 40c. (by P. P., 50c.).

CLEVELAND LAWN WEEDER

Easy to operate, saves the back. The curved edge of the blade enters and loosens the soil, pressure on the lever then causes the toothed jaw to grasp the plant and a slight pull dislodges it, without disturbing the surrounding soil. Price, \$1.25.

A small amount applied at the Crown of the plant will cause the plant to shrivel up and in a few days the foliage above the ground will wither away, while the decayed root provides fertilization, so that the surrounding grass soon crowds in and covers the spot without reseeded. It will also destroy plantain, thistles and other types of vegetation. Per qt., 75c.; \$1.25 per 1/2 gal.; gal., \$2.00; \$9.50 per 5 gals.



The Killer Kane

A tube with a valve at the bottom; fill the tube with Killer-Kemical and set the Kane down over the crown of the weed to be destroyed; a slight pressure on the handle releases a small amount of Killer-Kemical. Price, \$1.00.

Killer Kit

Includes Killer Kane, 1/2 gal. Kemical; special combination. Price, \$2.10.



Parcel Post charges where named are for shipment to the first and second zones; for other zones, see parcel post table, page 1.



MONKEY WRENCHES

For machinery. Made of first quality hard steel.

8 inch, \$1.00 (by P. P., \$1.15); 10 inch, \$1.25 (by P. P., \$1.40).



STEEL PLIERS

No.	Side cutting, 6 inch.....	Each	By P.P. Each
133.		\$0.90	\$1.00
134.	Side cutting, 7 inch.....	1.00	1.10



AXES

Plumb Make, medium, man's size, made of best quality steel, \$2.50 (by P.P., \$2.70).

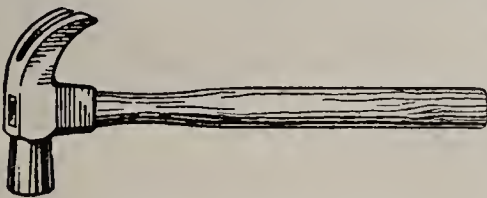

STEEL HAMMERS

No. 011 1/2 Pexto, 80c. (by P. P., 90c.).



HATCHETS

Made of the best quality tool steel, that will keep an edge.

Plumb, 90c. (by P. P., \$1.05).

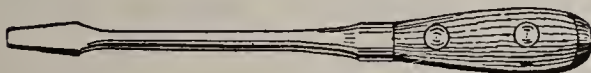

PEXTO SCREW DRIVERS

4 in. blade....	\$0.50	6 in. blade....	\$0.65
5 in. blade....	.60	7 in. blade....	.75
10 in. blade.....	\$1.00		

If wanted by Parcel Post, add 10c. each, for postage.

HUSKING PINS

No. 15. **Universal.** All metal; adjustable to any size hand, 25c. (by P. P., 30c.).

No. 16. **Combination;** leather and metal, 25c. (by P. P., 30c.).

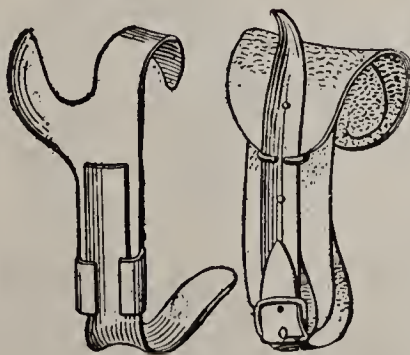

No. 15

No. 16



CORN KNIFE

No. 300. Eureka. Bent blade. Price, 60c. (by P. P., 75c.).



[Single

GARDEN REELS

Small, Single, \$1.40 (by P. P., \$1.50).

Medium, Single, \$2.00 (by P. P., \$2.15).



GARDEN LINE

Best quality white cotton braid woven closely.

	Each	By P.P. Each
100 ft. hanks.....	\$1.00	\$1.10
Plow Line, Cotton, 45 ft. hanks	.60	.70

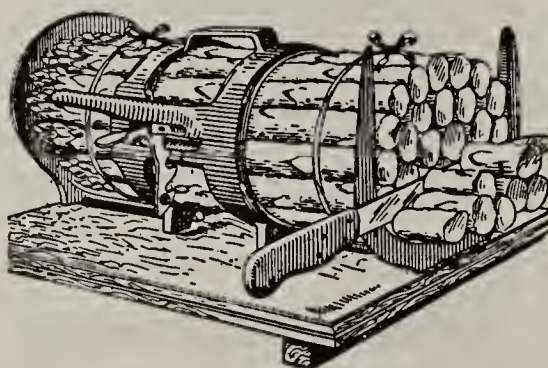

ASPARAGUS BUNCHERS

Even where one has a limited amount of asparagus to market, it pays to use a buncher. Price, with knife guard, \$4.50 (by P. P., \$4.70).

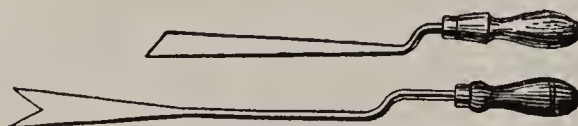

ASPARAGUS KNIVES

	Each	By P.P. Each
No. 1 (top illustration).....	\$0.50	\$0.60
No. 3 (center illustration).....	.50	.60
No. 2311 (bottom illustration)..	.40	.50

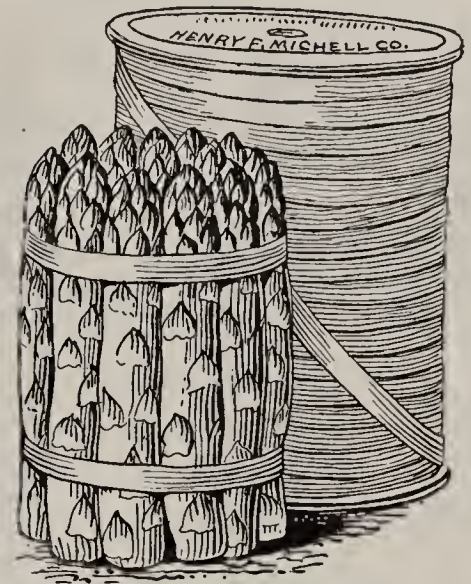

ASPARAGUS TAPE

Fast red, 1000 yd. spool, \$4.00 (by P. P., \$4.15).

Green, 1000 yd. spool, \$3.00 (by P. P., \$3.15).

SUN DIALS

These ancient time-tellers are a part of every exclusive flower or vegetable garden and indeed a very interesting one.

No. 350. 8 in. diam., bronze, plain, \$4.50 (by P. P., \$4.70).

No. 351. 9 1/2 in. diam., bronze, with motto, \$5.00 (by P.P., \$5.20).

No. 105. 10 in. diam., bronze, with motto, \$6.00 (by P.P., \$6.20).

No. 107. 11 in. diam., bronze, with motto, \$7.50 (by P.P., \$7.70).

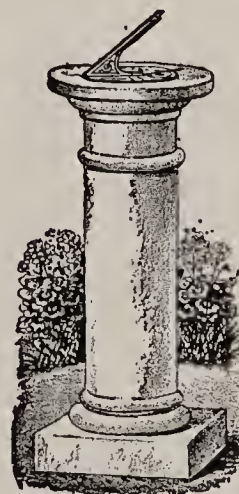

Prices do not include pedestal.

RUBBISH CONSUMERS

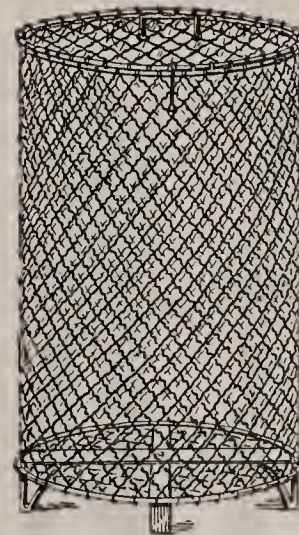

No. 5. Made of heavy crimped wire; pressed steel top and bottom; painted green. 29 inches high. Price, \$4.50 each.

Extra Heavy Construction

No. 10, 16x22 in.....\$11.50

No. 20, 20x30 in..... 16.50

No. 20 Rubbish Consumers

OUT-O-SIGHT TRAPS



The most satisfactory mouse and rat trap. Set off at the least vibration. By P.P.

	Each	Each
Mouse.....	\$0.10	\$0.15
Rat.....	.20	.25

Parcel Post charges where named are for shipment to the first and second zones; for other zones, please see parcel post table, page 1.

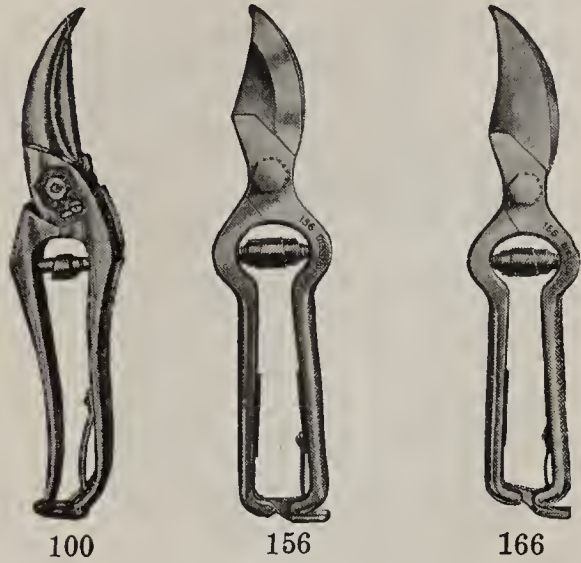

PRUNING SHEARS

Our pruning shears are procured from the most reliable makers and fully guaranteed. If wanted by Parcel Post, add 15c. each for postage and insurance.

No.	Length	Each
100 Michell.....	9 in.	\$3.75
156 Disston.....	8½ in.	3.50
166 Disston.....	9 in.	4.25
126 Disston.....	8⅓ in.	2.00
136 Disston.....	9 in.	1.65
116 Disston.....	9 in.	.90
5945 Elbersmit.....	9 in.	2.00
5720 Elbersmit, Nickeled....	5½ in.	1.50
5720 Elbersmit, Nickeled....	6½ in.	1.75
1586 French.....	7 in.	2.00
1586 French.....	8 in.	2.25
23 Levin.....		.75



No.	Length	Each
5 Pexto.....	9 in.	\$0.50
109 Wiss.....	8 in.	3.00

Spiral Springs for any of the above Pruning shears. 20c. each; per doz., \$2.00.

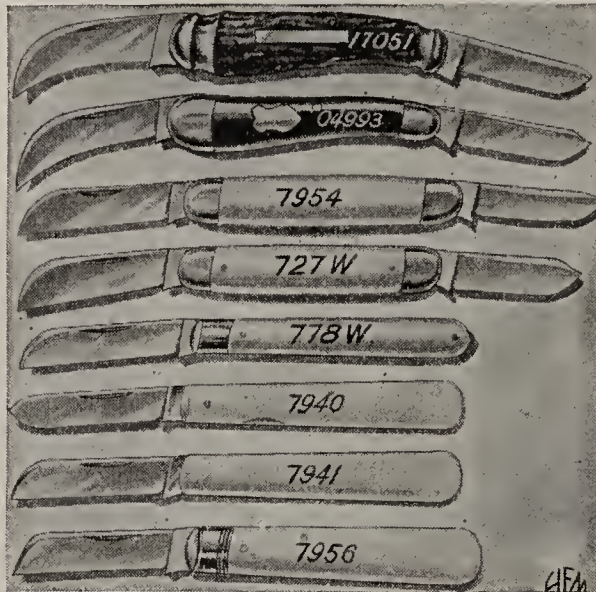

HORTICULTURAL KNIVES

Our stock consists of such styles that are practical and in demand. They are all of the best steel. Every one is guaranteed to give good satisfaction.

Wostenholm English

No.	Each
7705 Pruning, 1 blade, stag handle, extra heavy.....	\$3.00
7940 Budding, 1 blade, white handle.	2.75
7941 Budding, 1 blade, white handle.	3.00
7954 Budding, 2 blade, white handle.	3.00
7956 Budding, 2 blade, white handle.	3.50
7962 Pruning, 1 blade, stag handle..	2.25
17051 Pruning, 2 blades, white handle.	3.25

American Make

105 Pruning, 1 blade, cocoa handle.	1.10
727W Budding, 2 blades, white handle	1.10
04993 Budding and Pruning, 2 blades, stag handle.....	1.10
Florists' Favorite. 1 blade, white handle; an excellent knife for the gardener..	\$1.25



BRUSH OR BRIAR HOOK

No. 43. Long handle.....\$0.75

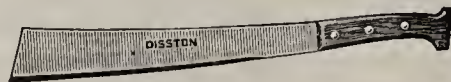

No. 1. Hedge Knife

STEEL HEDGE KNIVES

For cutting heavy brush, shrubbery, hedges, etc. Made of the finest steel. No. 1. Short handle (by P. P., \$1.00).\$0.75



ENGLISH BILL HOOKS

For trimming heavy shrubbery, trees, etc. Short Handle, \$2.25 (by P. P., \$2.40). Long Handle, \$3.50 (by P. P., \$3.65).



HEDGE SHEARS

If wanted by Parcel Post, add 20c. each for postage.

No.	Disston	English
101A 6½ inch, Ladies'....	\$1.75	
101A 8 inch.....	2.50	\$3.50
101A 9 inch.....	2.75	3.75
101A 10 inch.....	3.00	4.25
101A 12 inch.....		5.50

Bolts and Nuts for hedge shears, 30c. **Handles for Hedge Shears**, \$1.00 per pair.



WISS HEDGE SHEARS

Superior construction; blades of high carbon steel, accurately hardened and tempered. Handles of drop forged steel with comfortable wood grip handles, don't tire the arms.

If wanted by Parcel Post, add 20c. each for postage.

6½ inch.....	\$2.00
7½ inch.....	2.25
8 inch.....	2.50
9 inch.....	3.00
10 inch.....	3.25

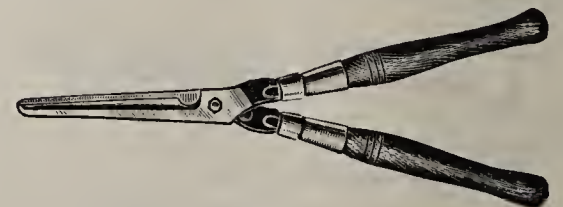

CLYDE HEDGE SHEARS

No. 5430. Drop forged solid tool steel blades, notched, full polished; handles made of ash, 12 in. long; blades 9 in. Price, \$2.00.

No. 5435. Especially for ladies' use. Drop forged solid tool steel; handles made of black walnut, 9 in. long; blades 6 in. Price, \$1.50.

LEATHER PRUNING GLOVES

If wanted by Parcel Post, add 10c. per pair for postage.

No.	Pair
No. 225. Horsehide, with gauntlets, not lined.....	\$2.50
No. 280. Horsehide, with gauntlets, lined	1.85
No. 228F. Horsehide, no gauntlets, not lined.....	2.50



Eazy Wear

EEZY WEAR GARDEN GLOVES

A soft, pliable, all-leather, dirt-proof glove for both men and women, specially adapted for general home use. 75c. per pair.

OK ELECTRIC HEDGE TRIMMER

You can trim your hedge in minutes instead of hours with an O. K.; it cleans the top as you trim; does not hook the tips and you can make the top of your hedge as smooth as a board; you can design, trim and make your hedge look best of all; you can also trim the grass edge and bushes. Weight, 2 lbs.

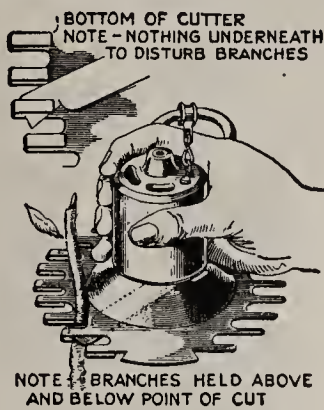

No. 2. Trimmer; for home use.....\$9.00
No. 1. Trimmer; for use on estates, cemeteries, etc.....15.00

LITTLE WONDER HEDGE TRIMMER

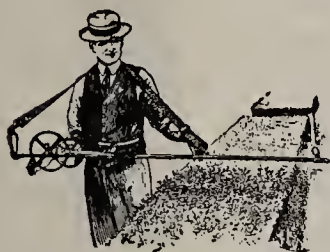

The Little Wonder Hedge Trimmer cuts every variety of hedge grown, five to six times faster than the old fashioned

hand shear method; makes hedge cutting a pleasure. Long cutting bars which make a quick and even cut; made strong and sturdy; built to last many years.

Junior. 30 in. cut, price, \$25.00.
Little Wonder. 40 in. cut, price, \$27.50.
Little Wonder. 60 in. cut, price, \$35.00.
Little Wonder, Jr. Electric. 25 in. cut, price, \$65.00.

SIMPLICITY HEDGE TRIMMER

No. 100. To be used for fresh new growth only. Works rapidly and easily. It will trim every variety of hedge grown and to any shape desired. \$3.50 (by P. P., \$3.75).

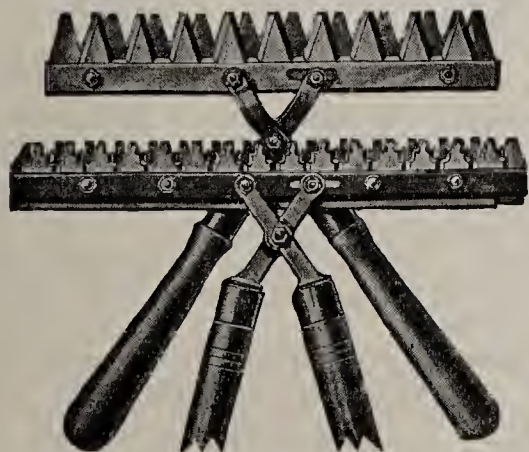

SIMPLICITY HEDGE PRUNER AND TRIMMER

No. 101. For pruning back old growth and trimming new, \$4.50 (by P. P., \$4.75).

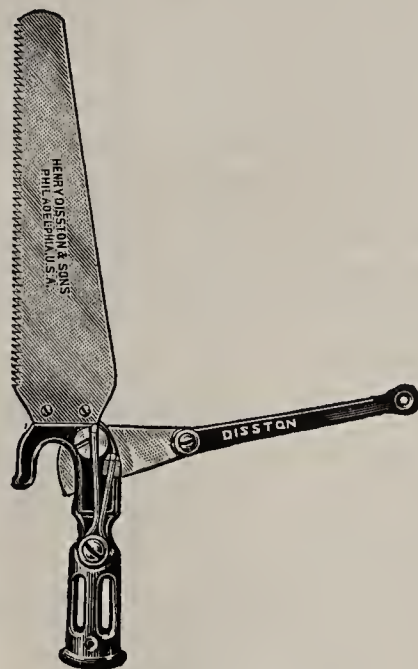

TREE PRUNERS

Disston's Little Giant. Pruner....\$2.25
Disston's Little Giant. With saw attachment..... 3.25
Prices are for Pruner without rope or pole. If wanted by Parcel Post, add 15c. each for postage.

Poles for Tree Pruners

12 feet long, 1 1/4 inch diameter.....\$2.75
14 feet long, 1 1/4 inch diameter..... 3.00



No. 111 ADJUSTABLE POLE PRUNING SAW

Adapted for sawing by hand or attached to a pole; handle made of malleable iron with socket, can be adjusted to different angles. Price, without pole, \$2.00.

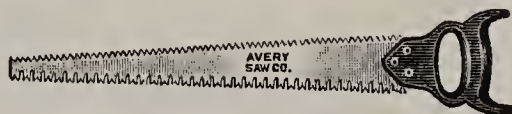

DISSTON PRUNING SAWS

If wanted by Parcel Post, add 15c. each for postage.
No. 4. 18 inch. Double edge.....\$1.65
No. 4. 20 inch. Double edge..... 1.90
No. 7. 16 inch. Single edge..... 1.50
No. 7. 18 inch. Single edge..... 1.70
No. 7. 20 inch. Single edge..... 1.80
14 inch California Pattern. Crescent shaped blade..... 1.10

PRUNING COMPOUND

Used for painting the wounds of trees after pruning.
1 quart.....\$0.50
1 gallon..... 1.50

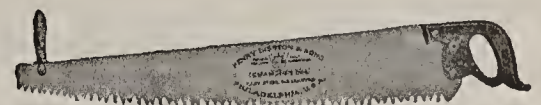

CROSS CUT LOG SAWS

Disston Make

No. 554 Champion, one-man, 3 ft. blade.\$3.50
Gt. American, two-man, 5 ft. blade.... 5.50



CARPENTER SAWS

State if rip or cross cut is wanted.
Disston No. 8D. 26 inch blade.....\$2.75

CLYDE TREE TRIMMER

No. 5407. Both blade and hook are made from the best tool steel, firmly riveted to bass-wood handles. Removable cutting blade and pole complete.

6 feet.....\$2.50
8 feet..... 2.75
10 feet..... 3.00
12 feet..... 3.25
14 feet..... 3.50

Extra blades for Clyde Pruners, 25c. each.

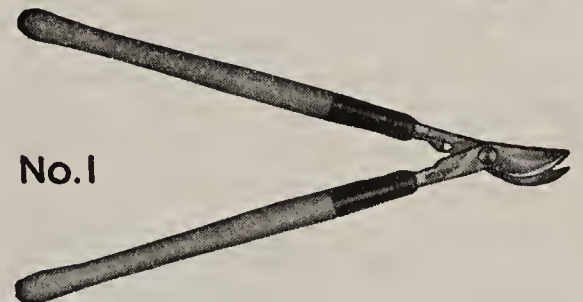
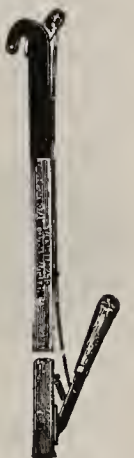

No. 1

LOPPING SHEARS

No. 1. Disston Lopping. Polished hardwood handle, 20 inches long; 27 1/2 inches over all; heavy ferrule; heavy blades for heavy work; weight, 3 1/4 lbs. Price, \$3.00 (by P. P., \$3.15).

No. 3. Disston Bull Dog Lopping. Both jaws curved and both cutting jaws; weight, 3 1/3 lbs. Price, \$2.75 (by P. P., \$2.90).



Clyde Draw Cut Lopping Shear

CLYDE DRAW CUT LOPPING SHEAR

No. 5402. Blade, hook and shank are forged from tool steel; natural finish ash handles; pressed steel strapped ferrule and cap; length of handles, 30 inch. Price, \$3.25 (by P. P., \$3.70).

Parcel Post charges where named are for shipment to the first and second zones; for other zones, see parcel post table, page 1.

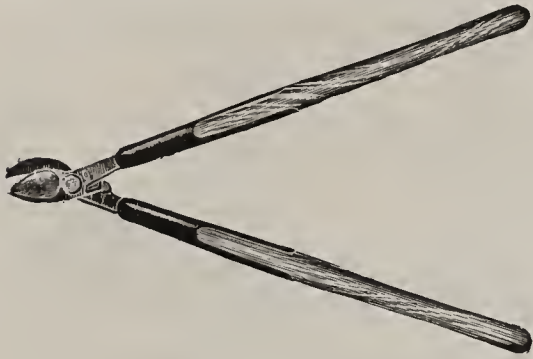

Clyde Lopping Shear

CLYDE LOPPING SHEAR

5409. Solid tool steel blade and hook; hardened steel bolt with lock nut; handles natural finish ash; polished pressed steel ferrule and cap; length of handles, 24 inch. Price, \$1.75 (by P. P., \$1.90).



RHODES LOPPING SHEAR

Makes an absolutely clean, perfect cut; the blades are concaved at the cutting edge, producing with the handles an enormous leverage. The easiest operating Lopping Shear ever made or sold. 26 inch and 30 inch handles. Price, \$3.50 (by P. P., \$3.70).

GRAFTING WAX

1/4 lb., 20c.; 30c. per 1/2 lb. (by P. P., 35c.); 1 lb., 50c. (by P. P., 60c.).

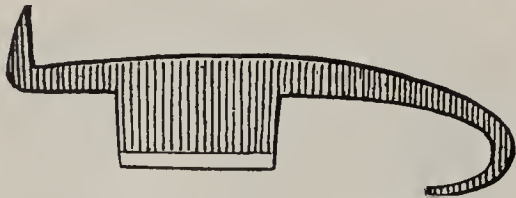

GRAFTING TOOL

Made of the best steel. For grafting trees, etc. All steel, \$1.25 (by P. P., \$1.35).

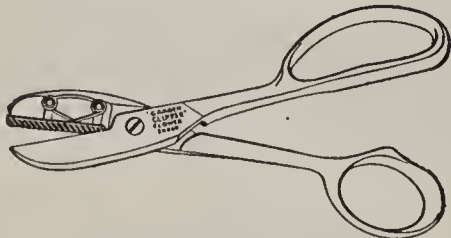

Eversharp Flower Shear

EVERSHARP FLOWER SHEAR

No. 1248. Wonderful help for cutting and gathering flowers; snips and holds in one motion; handy for picking flowers that are hard to reach. Price, 75c.

COMPOUND EXTENSION LADDERS

These are made in the best manner possible; are complete, being equipped with the necessary rope and pulleys.

20 feet.....	} 60c. per foot
22 feet.....	
24 feet.....	
28 feet.....	
30 feet.....	
32 feet.....	} 65c. per foot
34 feet.....	
36 feet.....	
40 feet.....	



SINGLE PLANK LADDERS

Made of good hard wood, free from faulty knots and with perfect rounds.

10 feet.....	\$5.00	16 feet.....	\$8.00
12 feet.....	6.00	18 feet.....	9.00
14 feet.....	7.00	20 feet.....	10.00
22 feet.....	\$11.00		

STEPLADDERS

Columbia. 4 step up to 12 step, 45c. per step.

BUCK SAW

No. 50. Each, \$1.25 (by P. P., \$1.50).

SAW-HORSE or WOODBUCK

No. 2. Each, \$1.25 (by P. P., \$1.40).

PEAT MOSS, TORF MULL

(Imported, Granulated)

A moisture retaining humus and an aid for saving soil fertility. It furnishes the needed organic matter which all soils require. For lawns, cover lightly in the fall with Peat Moss. Cover all perennial beds with 1 to 2 inches of Peat Moss; for shrubs and evergreens mulch to a

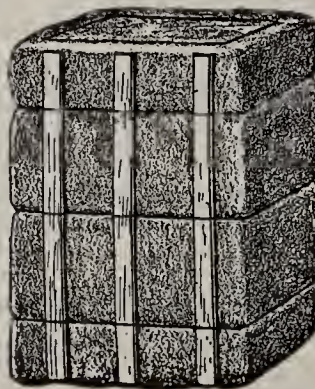

Peat Moss

depth of 3 inches or more. For roses, dig deeply and incorporate with the soil Peat Moss to the depth of 6 inches, before spading. For the flower garden, spread evenly from 3 to 6 inches deep a covering of Peat Moss, mixing well with the soil. For window or porch boxes, mix a good proportion of Peat Moss with some rich compost or soil. For the greenhouse, mix Peat Moss with the potting soil.

1/4 size bale.....	\$1.50
Large bale.....	3.50

ELLISCO BEETLE CATCHERS



Type 0. A small neat container with a standard thread on bottom to fit any Mason jar. The Beetles pass through the trays into the jar where they can easily be destroyed; made of tin, enameled green all over. Price without jar, 40c. each.



Type 4. This is the most recent type, developed for the United States Department of Agriculture in experiments to control the spread of the Beetles. Made of rust-resisting galvanized steel and enameled green and white; fitted with a standard screw cap for quart and two quart Mason jars.

Price without jar, \$1.00 each.

MULCH PAPER

Cuts down garden labor, doubles all vegetable crops

A strong fibre paper impregnated with asphalt, designed for use in fields, orchards and gardens, under all sorts of conditions and tough enough to last an entire season.

Mulch Paper is applied to the soil surface after the proper preparation. This will eliminate weeds entirely and make cultivation and weeding unnecessary. Exhaustive tests have proven earlier crops are produced and in many cases increased the production over 100%. It also retains the moisture and brings crops to maturity far in advance of normal plantings. Wherever this paper has been used, it is known as the miracle paper. Made in two widths.

PRICES ON MULCH PAPER

Type A.—For Field Culture. 300 yards.	
18 in. wide.....	\$3.00 per roll
36 in. wide.....	6.00 per roll
Type B.—For gardens, fruit trees and berries. 150 yards.	
18 in. wide.....	\$3.00 per roll
36 in. wide.....	6.00 per roll

MANUAL OF GARDENING

By L. H. Bailey

An exceedingly practical and helpful manual on the planning and planting of the garden; very attractively illustrated. 541 pages. Price, \$3.00.

Parcel Post charges where named are for shipment to the first and second zones; for other zones, please see parcel post table, page 1.

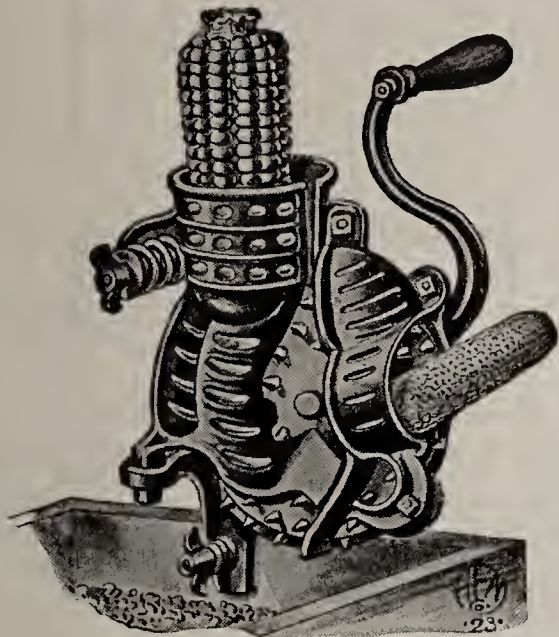

BLACK HAWK CORN SHELLER

Excellent for small poultry farms, etc. Ball bearing; suitable for fastening to a bench, box, etc., for shelling small quantities of corn. \$3.00 each (by P. P., \$3.25).

PENNA. CORN SHELLER No. 3

Useful on every farm and private estate. Separates the corn from the cob, throwing the cob to one side and allowing the corn to pass out another. \$15.00.

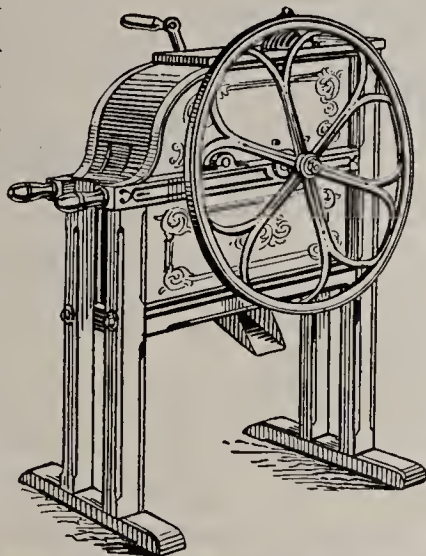

GRAPE PROTECTING BAGS

Thousands of bunches of grapes are wasted annually because they are not protected against the ravages of insects, birds, etc. Michell's Improved Grape Bags are economical, easily attached and last a season. The fruit ripens just as readily in them as it does in the open. The bags should be attached when the grapes are the size of a pea, prior to which it is suggested that they be sprayed (even though not affected) against blight or fungus; the bags should be left attached until the fruit is ready to harvest.

	P.P.		
	100	per 100	1000
2 lb. size	\$0.45	\$0.55	\$4.00
3 lb. size	.55	.65	4.75
4 lb. size	.65	.80	5.50

BANNER ROOT CUTTERS



Roots of vegetables cut up fine take the place of grass and greens during the Winter months.

No. 7. For poultry, sheep and lambs, \$7.00.

No. 35. Large size, \$40.00.

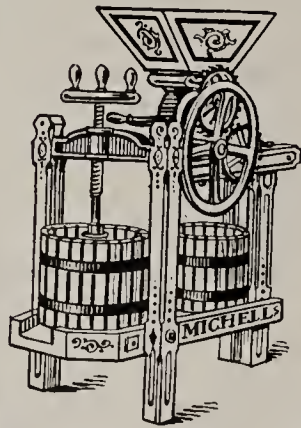

Cider Mill



Fruit Press

CIDER MILLS

	Capacity	Price
Junior	5/8 bu.	\$25.00
Medium	3/4 bu.	31.00
Senior	1 1/4 bu.	37.50

FRUIT PRESSES

Made of best quality wood, carefully bolted and finished.

No.	Capacity	Price
1	1/4 bu.	\$7.00
2	1/2 bu.	9.00
3	1 bu.	12.50

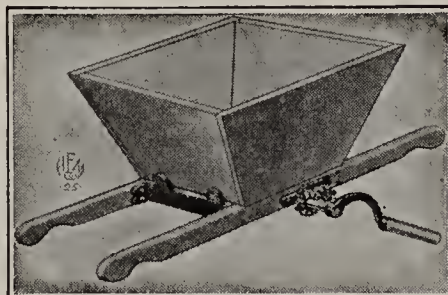

GRAPE GRINDER

Suitable for crushing berries, grapes and similar soft fruit.

No. 18	\$7.00
Handy Crusher	7.00

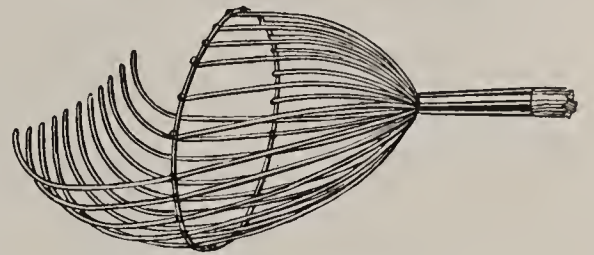

Boss Fruit Picker

BOSS FRUIT PICKER

Made substantially of galvanized wire. Can easily be attached to a pole of any length. Price, 50c. (by P. P., 60c.).

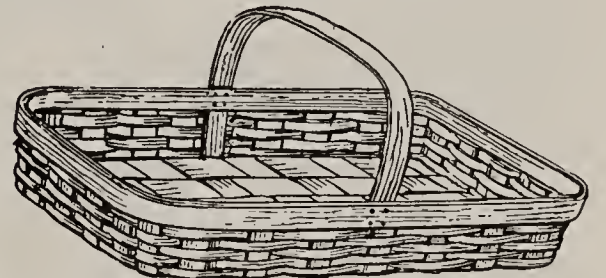

GATHERING BASKET

Very convenient for carrying berry boxes, asparagus and other vegetables. Made of oak, with substantial handles; 12 in. wide, 25 in. long, 4 in. deep. Price, \$1.00 (by P. P., \$1.20).

GARDEN BASKETS



No. 2, Stiff Handle
1/2 bu., 80c. each (by P. P., \$1.00).

No. 3, Drop Handle
1/2 bu., 80c. each (by P. P., \$1.00).

No. 4, without Handle
1/2 bu., 85c. each (by P. P., \$1.00).
1 bu., \$1.00 each (by P. P., \$1.20).



SPLINT OR CHIP BASKETS

With Single Stiff Handles

	Each	Doz.
1/8 bu.	\$0.12	\$1.25
1/4 bu.	.15	1.50
1/2 bu.	.20	1.75
3/4 bu.	.25	2.25
1 bu.	.30	2.75

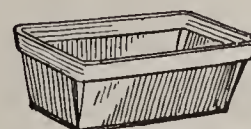

BERRY BOXES

	100	1000
1 pt.	\$1.25	\$11.00
1 qt.	1.25	11.00

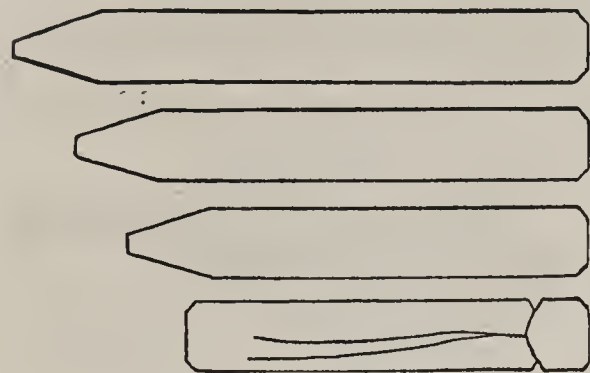

TREE LABELS

If wanted by parcel post, add 10c. per 100, 25c. per 1000 for postage.

	100	1000
Iron Wired. Plain	\$0.35	\$2.25
Iron Wired. Painted	.40	2.65
Copper Wired. Plain	.40	2.60
Copper Wired. Painted	.50	3.15
Copper Sheet, wired, 30c. doz.	1.70	
Zinc Sheet, wired, 30c. doz.	1.70	
Indelible Marking Pencils. Each	15c.	

PAINTED POT LABELS

	100	per 100	1000
4 inch.	\$0.35	\$0.40	\$2.15
4 1/2 inch.	.40	.45	2.65
5 inch.	.45	.50	2.90
6 inch.	.55	.65	3.40
8 inch.	1.50	1.70	8.50
10 inch.	1.60	1.90	10.25
12 inch.	2.00	2.45	13.00
18 inch, for field use.	4.75	5.00	43.50

The 18 inch field labels are not painted.

SIMPLEX CELLULOID POT LABELS

Made of white celluloid with specially prepared writing surface.

	Doz.	100
No. 21. 4 x 5/8 in.	\$0.25	\$2.00
No. 22. 5 x 3/4 in.	.35	3.00



Plant Label

SIMPLEX WEATHER-PROOF PLANT LABEL

The material carrying the writing is white celluloid with a specially prepared surface, protected by a transparent cover of mica. Marking done with an ordinary lead pencil is not affected by the most severe weather conditions and will last for years; water entering under the cover will not deface the writing. Simplex Weather-proof Labels are adapted for all outdoor garden records.

Prices include copper wires for attaching.

Sizes	Doz.	100
No. 1—3 x 1/2 in.	\$0.50	\$3.00
No. 2—4 x 3/4 in.	.85	5.00
No. 3—5 x 1 in.	1.10	7.00

If wanted by parcel post, add 5c. per doz.; 10c. per 100 for postage.

SIMPLEX WEATHER-PROOF GARDEN LABEL

Card holder is made of special Armco rustproof galvanized iron. The stake is 24 inches long, finished in dark green, enameled.

	Each	Doz.
No. 10—2 3/4 x 1 1/2 inches	\$0.30	\$3.00

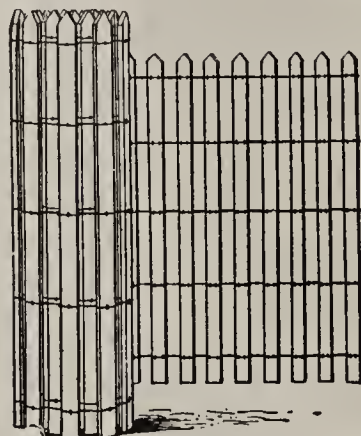

CEDAR PICKET FENCING

Will wear for years without paint. Readily put up and saves time, labor and expense of fence building. Rolls of 50 feet are carried in stock; 75 and 100 ft. rolls will be shipped from factory.

3 ft. high,	12c. per running foot.
4 ft. high,	15c. per running foot.
5 ft. high,	20c. per running foot.

WIRE NETTING

Price is constantly changing and is subject to market.

No. 19. Galvanized, two-inch mesh, 150 running feet per bale.

Width	Per bale	Width	Per bale
12 inches	\$1.50	42 inches	\$4.00
18 inches	2.25	48 inches	4.50
24 inches	2.75	60 inches	5.50
30 inches	3.25	72 inches	6.75
36 inches	3.75		

No. 20, galvanized, one-inch mesh, 150 running feet per bale.

Width	Per bale	Width	Per bale
12 inches	\$2.75	42 inches	\$7.00
18 inches	4.00	48 inches	8.25
24 inches	4.75	60 inches	10.25
30 inches	5.50	72 inches	12.00
36 inches	6.00		

STAPLES

3/4 inch, for fastening netting, 15c. per lb. (by parcel post, 25c.).

CUT WIRE NETTING

We can furnish this in both 1- and 2-inch mesh, in units of 25 ft., 50 ft., 75 ft., 100 ft. and 125 ft. lengths. 1-inch mesh at 4c. per square ft.; 2-inch mesh at 2c. per square ft.

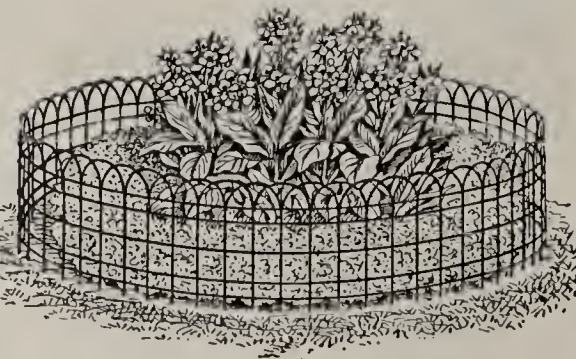

FLOWER BED FENCING

For putting around beds, lawns, etc. Any length desired up to 165 running feet.

16 in.	Less than 165 ft. roll,	10c. per ft.
16 in.	In roll lots, 165 ft.,	9c. per ft.
22 in.	Less than 165 ft. roll,	12c. per ft.
22 in.	In roll lots, 165 ft.,	10c. per ft.

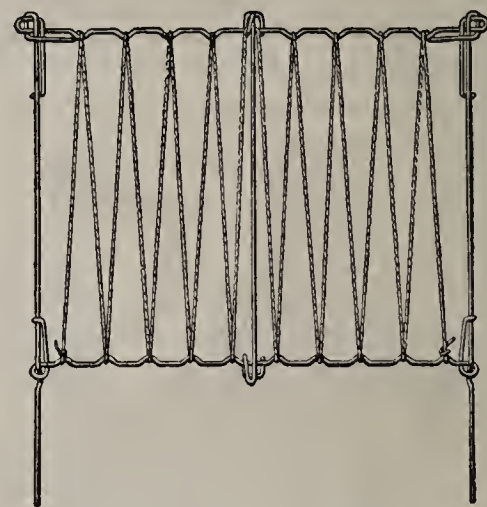

TIMESAVER TRELLIS

For Sweet Peas, Garden Peas and other vines. Dimensions, 5 x 5 feet over all; stands about 4 feet above ground when placed; frame made of 1/4 inch galvanized steel; green non-fade rope center; easily assembled and taken apart.

Price each	\$2.25
Per dozen	25.00

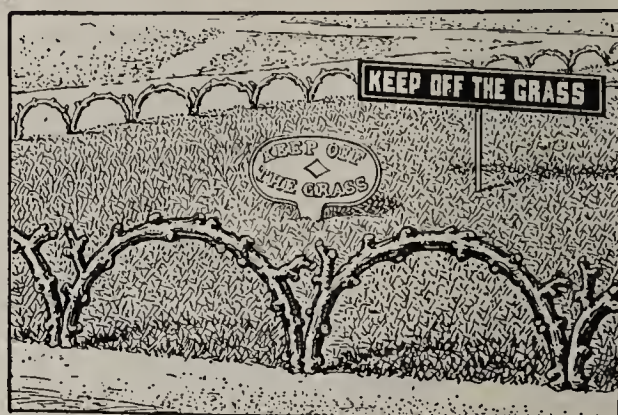

LAWN GUARDS

For path corners, flower beds, etc. Iron (see cut), nicely painted green, \$2.50 each. Not mailable.

Wire, made extra heavy and well galvanized. Price, 30c. each (by P. P., 40c.); per doz., \$3.25 (by P. P., \$3.60).

LAWN SIGNS

Excellent for putting on grass plots where thoroughfare is not desired.

Iron, painted gray, trimmed red, \$1.00 each (by P. P., \$1.15); per doz., \$10.00.

Enamelled Iron Style. (See cut above.) This pattern is best for conspicuous places. Nameplate finished with green and white enamel; 20 inches long and about 4 inches wide. Equipped with iron stake. \$2.25 each (by P. P., \$2.45); per doz., \$25.00.

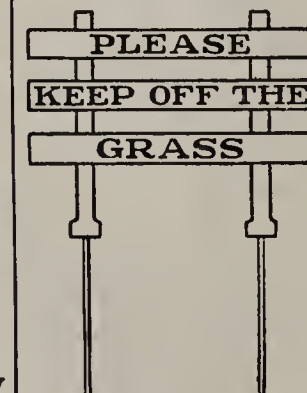

KEEP OFF THE GRASS SIGN

Iron, white enameled, green letters; equipped in back with holders for three flags. Price, \$1.00 each.

NO GUNNING SIGNS

Made of white oilcloth, with large black lettering; size, 12 by 13 inches. Price, 6 for \$2.50; \$4.50 per doz.



IRON PLANT STANDS

Enameled Green

In.	Size of Plates	Each
12	5 x 7	\$1.65
18	5 x 7	2.00
24	8 x 10 1/2	2.75
30	8 x 10 1/2	3.00
36	8 x 10 1/2	3.25
42	8 x 10 1/2	3.30
48	8 x 12	3.50
60	8 x 12	3.60
72	8 x 12	4.25

EXTRA PLATES FOR IRON STANDS

Size	Each
5 inch	\$0.75
7 inch	.85
8 inch	1.00
10 1/2 inch	1.25
12 inch	1.50

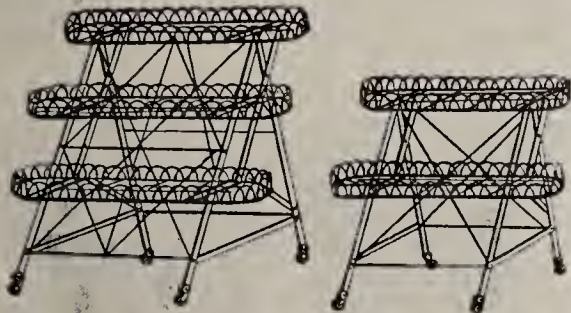

Jones Plant Stands

WIRE PLANT STANDS

Painted dark green and finished in bronze; very substantial and will carry almost any weight that can be placed on them. We recommend the Jones style, as it is collapsible and takes up very little space when not in use.

	Height	Width	Depth	Price
Jones, 1 shelf	.27 in.	25 in.	14 in.	\$2.50
Jones, 2 shelf	.28 in.	30 in.	21 in.	5.00
Jones, 3 shelf	.36 in.	30 in.	22 in.	6.00

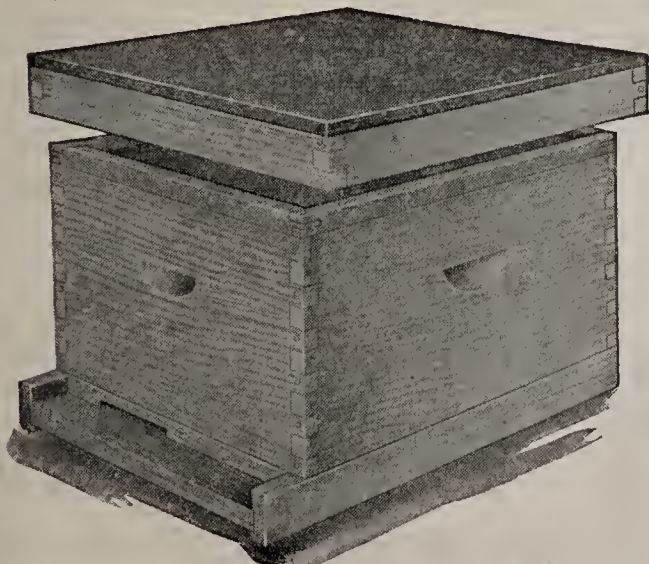

Bee Hive

ADJUSTO PLANT SUPPORT

Consists of a stake 7/8 inch square, and of different lengths as may be required and an instantly adjustable patented loop of 7-gauge strong spring-wire for supporter. It contains no nails, hooks, or screws.



A permanent equipment which can be used year after year.

Height	Each	Doz.
18 inch	\$0.10	\$1.00
24 inch	.15	1.10
3 feet	.20	2.25
4 feet	.25	2.50
5 feet	.30	2.75
6 feet	.35	3.00

MICHELL'S DOUBLE SNAPDRAGON SUPPORT

The only support of the kind on the market and indispensable to the proper growing of this popular plant; 48 inches high; 3-ring. Per doz., \$2.50; \$16.50 per 100.

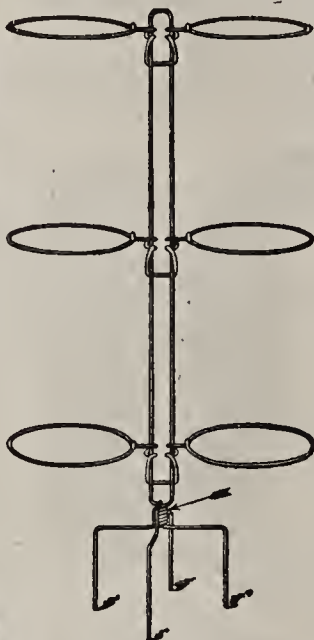

Carnation Support

MICHELL'S DOUBLE 3-RING CARNATION SUPPORTS

Made of Nos. 11 and 14 galvanized wire, which will not rust; 28 inches high; can be put together in less than a minute; will not fall apart; can be raised and lowered to suit plants.

Per doz.	\$1.75
Per 100	12.50
Per 1000	110.00

ROOT'S BEE SUPPLIES

It is a pleasure for us to sell Root quality Bee Supplies and their guarantee assures you of absolute satisfaction.

ONE STORY STANDARD HIVE

With metal cover—8 frame. Made of selected white pine; size, 16 1/4 x 20 inches, outside measurements.

No. 21205. Nailed and painted, with full size sheets 3-ply and foundation starter, \$12.00.

BEEWAY SECTION SUPER

No. 21544. With sections, 1 inch starters complete, nailed and painted, \$4.25.

HALF-DEPTH FRAMES

No. 2910. Hoffman, 9 1/8 x 17 5/8 in. Per 10, 90c.; \$3.60 for 50.

BEE SMOKERS

The latest improved model, has anti-spark tube, long flexible hinge and wire handle.

No. 427. Big Jumbo, size of fire box, 4 x 10 inches, \$1.85.

BEE VEIL

No. 251. Made of silk tulle, \$1.85.

HONEY BOXES

Size, 4 1/4 x 4 1/4 x 1 7/8 inches, \$1.85 per 100.

Timesaver Plant Support

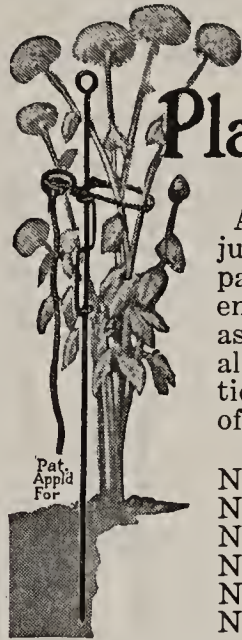

A long-lived, low-priced adjustable support, all metal parts being galvanized, java end is green; can be adjusted as to height and size of loop almost instantly and is practically hidden by the foliage of the plant it supports.

No.	Size	Doz.
No. 1	—30 in.	\$0.95
No. 2	—3 ft.	1.15
No. 3	—3 1/2 ft.	1.60
No. 3A	—4 ft.	2.20
No. 4	—5 ft.	2.75
No. 4	—6 ft.	3.05

MICHELL'S TOMATO OR PEONY SUPPORT

(See illustration below.)

Made of galvanized wire in a substantial manner; stands solid and firm. Price, 35c. each; doz., \$3.75; \$30.00 per 100.

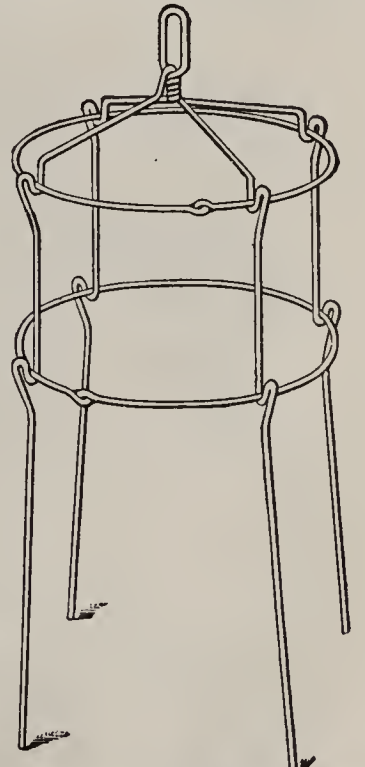

Tomato or Peony Support



Bee Smoker

BEE GLOVES

\$1.50 per pair.

THREE-PLY ARCO FOUNDATION

For brood and extracting combs; size, 8 1/4 x 16 3/4 inches.

No. 5000—10 sheet carton, \$1.85.

No. 5003A—50 sheet carton, \$8.50.

STEEL HIVE TOOL

For scraping frames and prying them loose. No. 405—10 inch, 90c.

Parcel Post charges where named are for shipment to the first and second zones; for other zones, please see parcel post table, page 1.

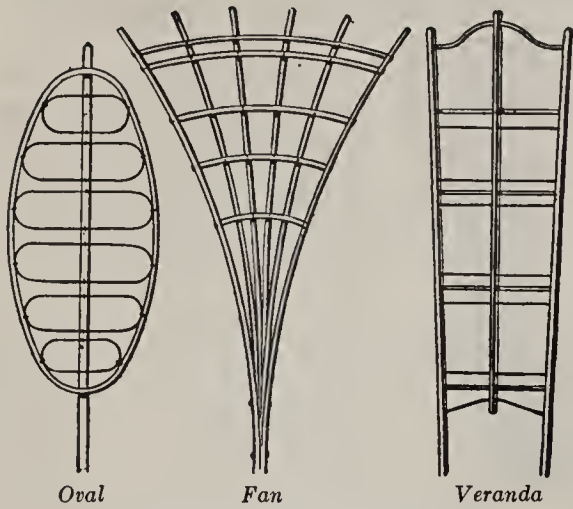

Oval Fan Veranda

VERANDA TRELLIS

Made of wood and painted green.
 2 feet.....\$0.75
 3 feet......85
 4 feet..... 1.00
 5 feet, heavy..... 1.50

FAN TRELLIS

Made of wood and painted green.
 18 inch.....\$0.30 | 36 inch.....\$1.00
 24 inch......40 | 42 inch..... 1.25
 30 inch......50 | 48 inch..... 1.50

OVAL TRELLIS

Made of wood and painted green.
 24 inch.....\$0.60

LATTICE TRELLIS

Made of wood and painted green.

	18 in. wide	24 in. wide
6 feet.....	\$2.00	\$2.50
7 feet.....	2.25	3.00
8 feet.....	2.75	3.50
9 feet.....	3.00	3.75
10 feet.....	3.50	4.00
12 feet.....	4.00	5.00

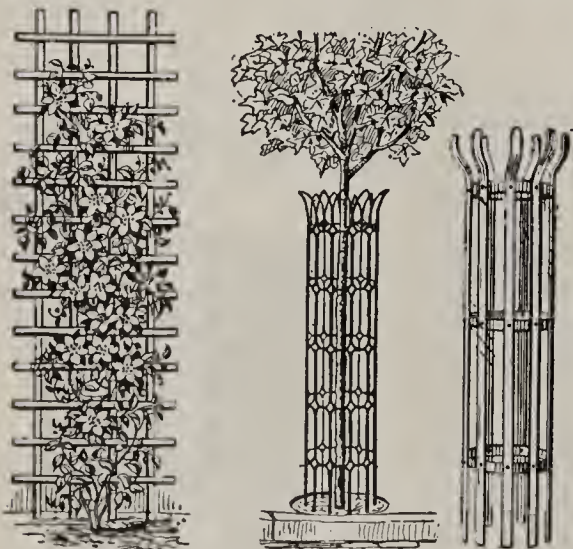

Lattice Trellis Wire Guard Iron Guard

TREE GUARDS

Galvanized Wire. Carefully made of heavy material and finished in a neat and substantial manner. 12 in. diam., \$1.75 each; 9 in. diam., \$1.50 each.
 No. 4. **Iron.** Made of flat iron, finished black; will last indefinitely with an occasional painting. \$4.50 each.
Phila. Official Tree Guard. Made of heavy round iron. \$6.50 each.

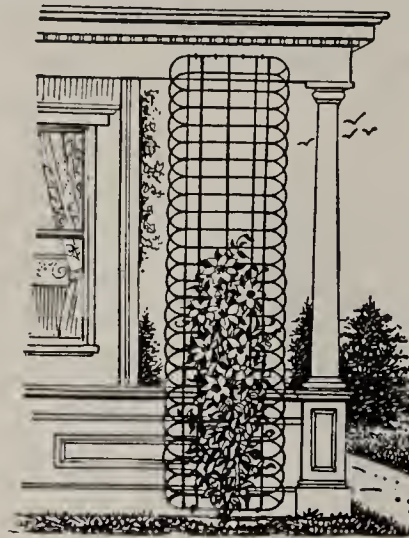

CONTINUOUS WIRE TRELLIS

Excellent for training vines of all kinds up porch verandas, pergolas, etc. Thoroughly galvanized and well made.

Any length desired up to 165 running feet.
 18 in. wide, less than 165 ft. roll, 10c. per ft.
 18 in. wide, in roll lots, 165 ft., 9c. per ft.
 24 in. wide, less than 165 ft. roll, 12c. per ft.
 24 in. wide, in roll lots, 165 ft., 10c. per ft.

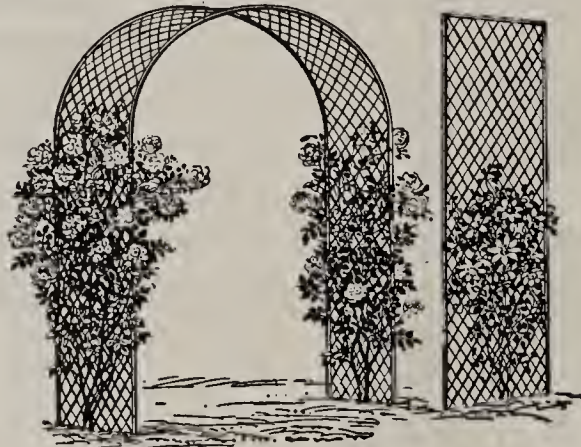

GALVANIZED WIRE WORK

This can be furnished on short notice, any height or any width, in either trellises or arches. Made of heavy diamond mesh wire with strong frames. 40c. per sq. ft. on pieces aggregating 15 sq. ft. or over; less than 15 sq. ft., 50c. per sq. ft.

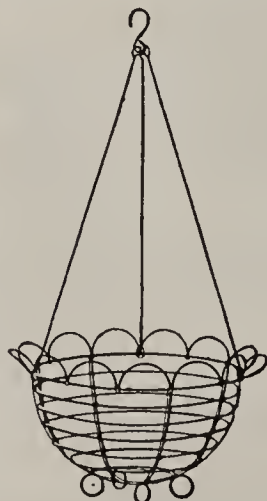

Wire Basket

HANGING BASKETS

Galvanized Wire
 For greenhouse, porch and conservatory.

Size	Each	Doz.
8 in....	\$0.25	\$2.50
10 in....	.40	4.25
12 in....	.60	5.50
14 in....	.70	7.50
16 in....	.85	9.00

 If wanted by P. P., add 10c. per basket or 40c. per doz. for postage.

BASKET HOOKS

Thoroughly galvanized so they cannot rust.
Single, 5/16 in. thick.....\$0.75
Double, 7/16 in. thick..... 1.10
 These cannot be mailed.

JONES' POT BRACKET

No. 1. Holds 5 inch pot. Each, 60c. (by P. P., 70c.).
 No. 2. Holds 6 inch pot. Each, 70c. (by P. P., 80c.).
 No. 3. Holds 7 inch pot. Each, 85c. (by P. P., 95c.).



JARDIERS

Colors, green, ivory, lavender and yellow.

	Each	Doz.
4 in. for pots.....	\$0.25	\$2.75
6 in. for pots.....	.30	3.50
No. 6. For 6 in. bulb pan....	.25	2.75
No. 7. For 7 in. bulb pan....	.30	3.25
No. 8. For 8 in. bulb pan....	.35	3.50
No. 9. For 9 in. bulb pan....	.40	4.00

VASES

For holding cut flowers on cemetery lots, etc.

	Each
Iron. Large; green.....	\$0.75
Iron. Medium; green.....	.65
Galvanized. Large.....	1.00
Galvanized. Medium.....	.85
Tin. Enameled; large, green, 15c. each; doz., \$1.50.	



WALL NAILS

For fastening climbing vines; equipped with a soft metal clasp which holds the vine against the wall.
 1 inch, 45c. per doz. (by P. P., 50c.); per 100, \$2.75 (by P. P., \$2.85).
 1 1/2 inch, 60c. per doz. (by P. P., 65c.); per 100, \$3.75 (by P. P., \$3.95).
 2 inch, 75c. per doz. (by P. P., 85c.); per 100, \$4.50 (by P. P., \$4.75).

Parcel Post charges where named are for shipment to the first and second zones; for other zones, see parcel post table, page 1.



RUBBER HOSE

Per ft.

Michell's Special.	1/2 inch.....	\$0.14
Michell's Special.	5/8 inch.....	.15
Michell's Special.	3/4 inch.....	.16
Electric. You cannot kink it.	1/2 inch	.18
Electric.	5/8 inch.....	.19
Electric.	3/4 inch.....	.20
Emerald Cord.	3/4 inch; in 25 and 50 ft. sections only.....	.22
Spray Pump Hose Electric.	3/8 inch	.16

All brands (excepting Emerald Cord) come in reels of 500 feet and sections in any length to that number of feet may be had. 25- and 50-foot sections of hose coupled free. Smaller sections coupled at the rate of 30c. per pair for couplings.

Hose Washers. 3/4 inch, 5c. per doz.; 1/4 lb., 15c.; 50c. per lb. (by P. P., 60c.). 1 inch, 6c. per doz.; 1/4 lb., 20c.; 75c. per lb. (by P. P., 85c.).



Cooper Hose Mender

HOSE MENDERS

If wanted by Parcel Post, add 10c. per doz. for postage.

		Each	Doz.
Cooper's.	3/4 inch.....	\$0.10	\$1.00
Cooper's.	5/8 inch.....	.10	1.00
Cooper's.	1/2 inch.....	.10	1.00
Jones Iron.	3/4 inch.....	.10	1.00

PERFECT HOSE MENDERS

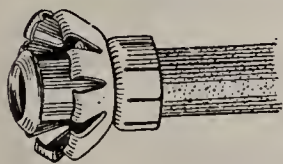

Made entirely of brass, with swivel motion — no band required. For 1/2 inch and 3/4 inch hose, 10c. each; doz., \$1.00 (by P. P., \$1.15).

HOSE COUPLINGS

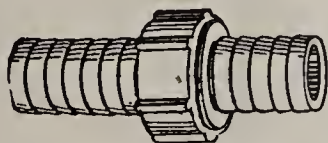

If wanted by Parcel Post, add 5c. each; 20c. per doz. for postage.

		Pair	Doz.
Plain Brass (see cut).	1/2 inch.	\$0.20	\$2.00
Plain Brass.	3/4 inch.....	.20	2.00

Perfect. Equipped with a clamp on the male and female part for securing to the hose; no band required; for 1/2 and 3/4 inch hose; mention which is wanted when ordering. 30c. per pair; doz., \$3.25.

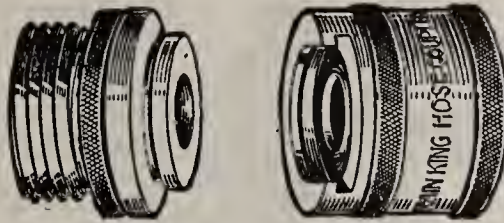

RAIN KING COUPLING

Snaps together instantly; fits nozzles, sprinklers and hose connections. 60c. each (by P. P., 65c.).



Caldwell Band as applied to Hose

HOSE BANDS

For fastening couplings and menders.

Caldwell's

If wanted by Parcel Post, add 10c. per gross for postage.

No.		Doz.	Gross
8.	For 4-ply hose.....	\$0.35	\$3.50
6.	For 3-ply hose.....	.35	3.25

Sure Grip

Can be furnished in 1/2 inch, 5/8 inch and 3/4 inch, either size, 5c. each; doz., 40c. (by P. P., 45c.).

No. 68. SIAMESE HOSE CONNECTION

This permits one lead of hose to be diverted in two directions. Additional three-way connections can be used according to the water pressure. It is specially adapted for lawn sprinkling. Price, \$1.00 each (by P. P., \$1.10).



SHUT OFF CONNECTION

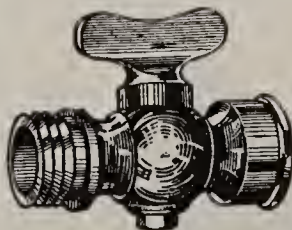

Cast brass, polished; 3/4 in. male thread on one end; 3/4 inch female thread on other end. \$1.00 each.

HOSE REDUCERS

For reducing 1 in. pipe to fit regular 3/4 in. hose. Each, 50c. (by P.P., 60c.).

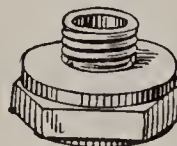

NOSCREW HOSE CLAMP

Installed instantly without annoyance by hand, no screw-driver or tools of any description required. Made of cold rolled steel, galvanized and nicked; made in 1/2 inch, 5/8 inch and 3/4 inch sizes. 10c. each; doz., \$1.00.

HOSE REELS

Wirt's Reel (All Iron)

Indestructible; light in weight.

No. 10. Holds 100 ft. of 3/4 in. hose, \$4.00.

No. 20. Holds 150 ft. of 3/4 in. hose, \$5.00.

No. 30. Holds 400 ft. of 3/4 in. hose, \$8.00.

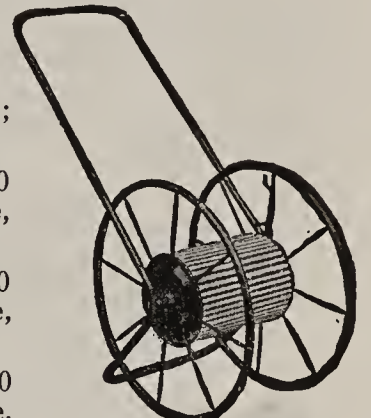

Wirt's Reel

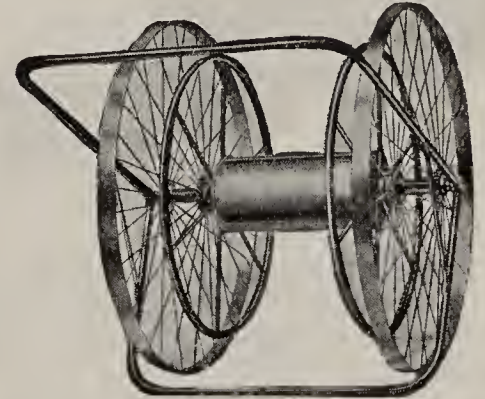

No. 31C. Reel

No. 31C. Holds 500 ft. of 3/4 in. hose, \$14.00.

Victor Reel

Constructed with channel steel frame; cast iron wheels; solid steel reel arms; heavy corrugated steel drum. Hold 100 ft. of 3/4 inch hose, \$1.50 each.

NOZZLE HOLDER

For sticking in the ground while one continues with other work. Made of galvanized heavy wire. Price, 20c. each (by P.P., 30c.).

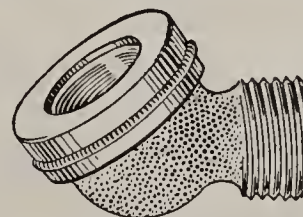

HYDRANT ATTACHMENTS

For attaching hose to smooth faucets. No. 2. For small spigot, 50c. (by P. P., 60c.).

No. 3. For large or standard spigot, 50c. (by P. P., 60c.).

FLARING ROSE SPRINKLER

Ejects a fan-like spray; especially adapted for sprinkling flowers. Price, 50c. (by P.P., 60c.).



Parcel Post charges where named are for shipment to the first and second zones; for other zones, see parcel post table, page 1.

BINKS NOZZLE

Made of aluminum, with brass face; equipped with interchangeable sprays, coarse and fine. It makes watering possible without wetting the hands. Positively the best and most indestructible nozzle made. \$2.75 each; worth twice the price (by P. P., \$2.85).

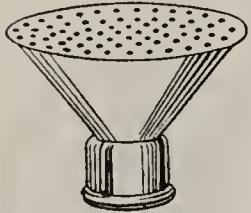
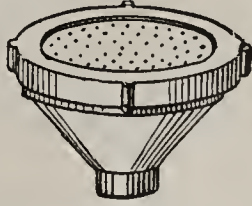

BOSTON SPRAY NOZZLE

(For 3/4 inch Hose)
Light Copper. \$1.50 (by P. P., \$1.60).
Heavy Brass. \$1.25 (by P. P., \$1.35).



AQUAMATIC HOSE NOZZLE

A high-grade water control, opening and closing automatically, by slightly pressing lever with the fingers; a positive, quick shut-off; made of heavy cast brass. Price, \$2.00 (by P. P., \$2.10).

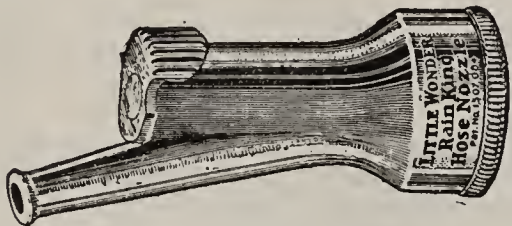

RAIN KING NOZZLE

Wear-proof, leak-proof and guaranteed; adjustable from a long, solid stream to the finest mist spray. 85c. each (by parcel post, 95c.).

CHAMPION NOZZLE

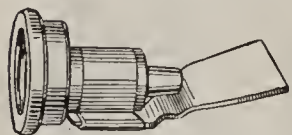

A dandy nozzle for greenhouse use; makes a spray or a solid stream; easily adjusted. 50c. each (by P. P., 60c.).

GEM PATTERN HOSE NOZZLE

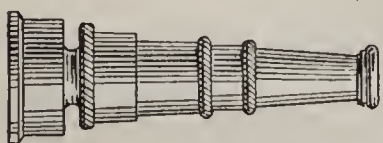

3/4 - inch hose. Can be regulated to give three different streams. Price, 45c. (by P. P., 55c.).

APRONS

For protecting the clothing while watering, etc.
Rubber.....\$2.25
Blue Denim.....1.50

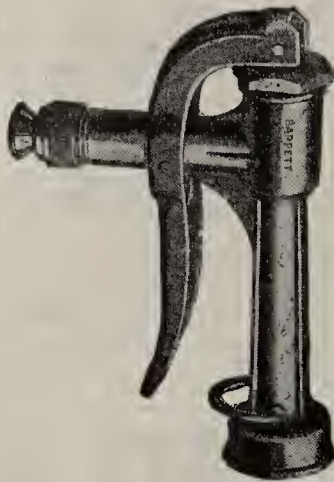

BARRETT HOSE-MASTER NOZZLE

Automatic shut-off, adjustable spray and pressure control at the nozzle. Price, \$1.50 each (by P. P., \$1.60).

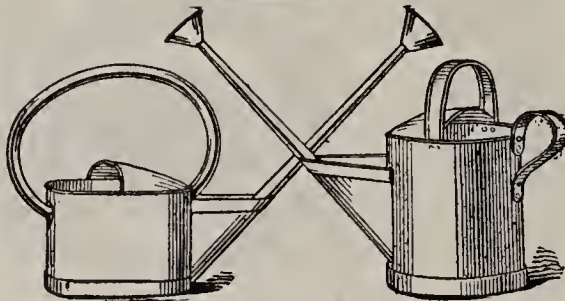

WATER CANS (Wotherspoon's)

Galvanized; extra heavy with long spout and two roses—one coarse and one fine. These cans are not mailable. Round Oval

4 quart.....	\$4.25	
6 quart.....	4.50	\$4.75
8 quart.....	4.75	5.25
10 quart.....	5.25	5.50
12 quart.....	5.75	5.75
16 quart.....	6.00	6.75
4 quart Fern or Low Watering Can.....	3.50	

Extra Roses or Sprays

For Wotherspoon Watering Can, either coarse or fine, 60c. each (by P. P., 70c.).

IRON CLAD WATER CANS

Made of light galvanized iron.

4 quart.....	\$0.85
6 quart.....	.90
8 quart.....	1.00
10 quart.....	1.10
12 quart.....	1.25
16 quart.....	1.75

If Iron Clad Water Cans are wanted by Parcel Post, add 20c. each for postage.

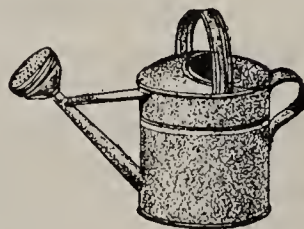

Iron Clad

PARLOR WATER CAN

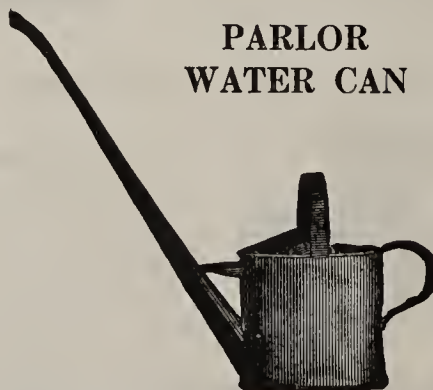

For the enclosed porch and window boxes; oval shape; enameled; assorted colors, long spout.
2 qt. size.....\$1.25

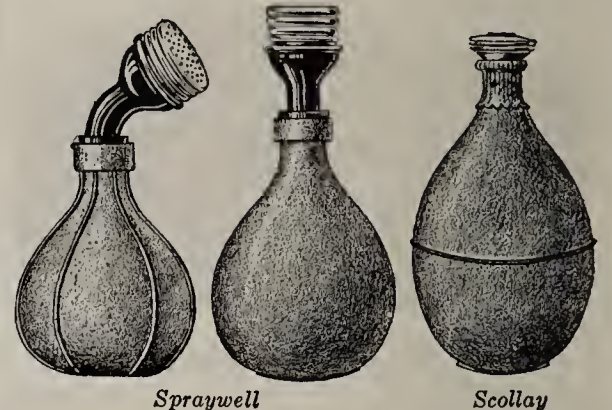

Spraywell

Scollay

RUBBER SPRINKLERS

Spraywell style in either straight or crook neck.

No.	Each
1. Spraywell Style. 6 oz. capacity..	\$0.75
2. Spraywell Style. 8 oz. capacity..	.90
3. Spraywell Style. 10 oz. capacity..	1.10
1. Scollay. 12 oz. capacity.....	1.50

If wanted by parcel post, add 10c. each for postage.



THE MISTO BOTTLE SPRAYER

An ideal sprayer for applying various insecticides to house plants. Makes a fine mist, avoiding all drip; so simple in design it will last forever; nothing to get out of order; made of metal, nicely nicked; can be used in connection with most any ordinary bottle. Guaranteed in every respect or money back. Price with bottle, \$1.50 (by parcel post, \$1.60).

ASBESTOS TORCH

For burning out worms, caterpillars and other tree pests. 50c. each (by parcel post, 60c.).



Asbestos Torch

VAPORIZING LAMP



Practical and indestructible; all metal; burns kerosene; used for dispensing fumes of Nikoteen and other preparations of this sort. 75c. each (by P. P., 85c.).

POLES FOR TORCHES, ETC.

Hardwood, 12 ft., \$2.75; Bamboo, 12 feet, 50c. Poles are not mailable.

BAMBOO POLES

	Each	Doz.	100
16 feet long.....	\$0.25	\$2.50	\$15.00
18 feet long.....	.35	3.25	22.00
20 feet long.....	.45	4.00	27.50

Parcel Post charges where named are for shipment to the first and second zones: for other zones, see parcel post table, page 1.

BELLOWS

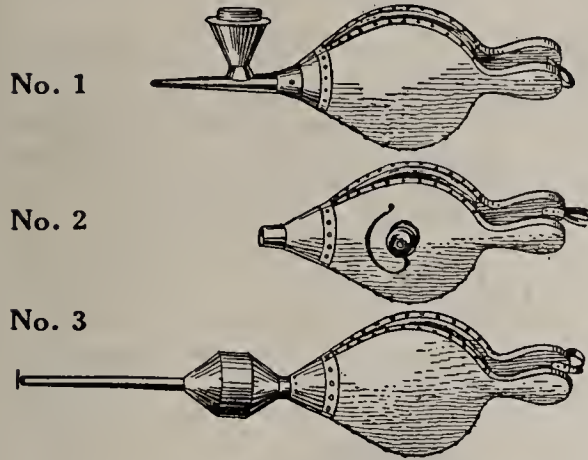

	Price By P.P.	
No. 3. Large double cone . . .	\$6.50	\$6.75
Large single cone	4.50	4.70
No. 1. Small single cone . . .	3.00	3.20
No. 2. Sulphur bellows	4.00	4.20



BROWN'S CRYSTAL DUSTER

One of the newest type Dusters, for use in dusting truck crops, in the garden, flower beds, roach powder, etc.; has the glass jar feature, which enables the operator to see the amount of dust in the container. Equipped with a long extension and adjustable nozzle; capacity, 1 quart. Price, complete, \$1.50.

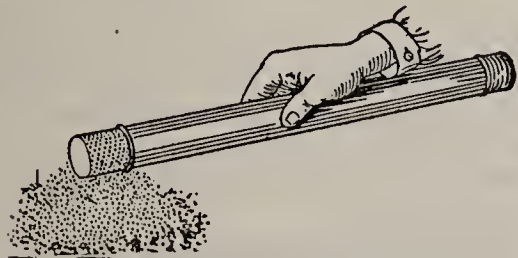

DICKEY DUSTER

Excellent for distributing Bug Death, Slug Shot, etc. Price, 50c. (by P. P., 60c.).

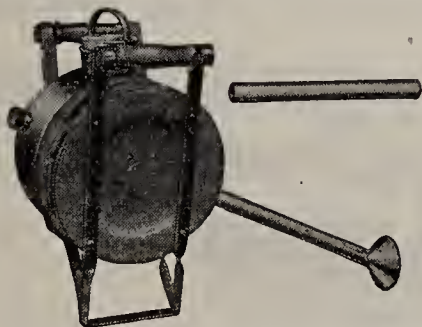

"GREEN" HAND DUSTER

Light, compact, sturdy, efficient; capacity 2 to 4 pounds; large powerful bellows; 30 inch extension with spreader; excellent for dusting either hill crops or underside of foliage. Price, \$7.00.



Double Action Duster

VERMOREL DUSTER

A knapsack machine for dusting sulphur or sulphur and arsenate mixtures, arsenate of lead, Bordeaux mixtures, lime, etc. Capacity 6 qts. dry measure.

Single Action. This being of the bellows type has no wheels, cogs, belts or other complicated mechanism that would be likely to wear. Equipped with fine and coarse screens, also strap for carrying. Price, \$14.00 (by P. P., \$14.35).

Double Action. This is a bellows type and gives a semi-continuous flow; especially adapted for work where growth is thick and for tree dusting where longer range is necessary. Price, \$18.00 (by P. P., \$18.35).

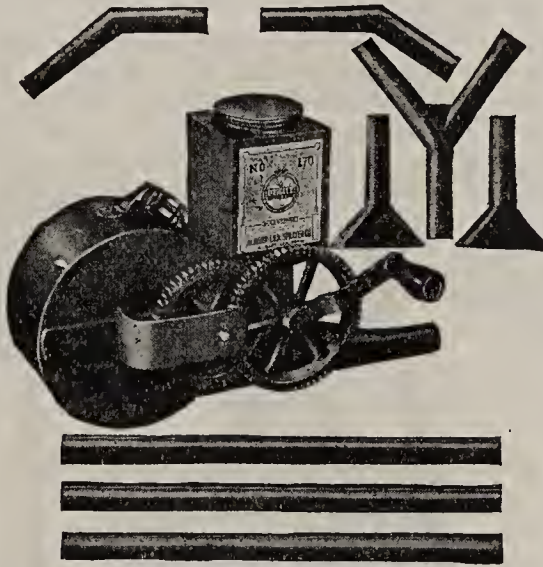

UTILITY DUSTER

Used for the application (in dry form) of Arsenate of Lead, Paris Green, etc. Made of heavy tin, enameled red; iron and brass machined gears. Provided with tubes, connections and nozzles as illustrated; also an adjustable carrying strap. Price, \$9.00 (by P. P., \$9.35).



MICHELL'S DUSTER

For applying dry insecticides, such as Bug Death, Slug Shot, Paris Green, etc.; practical and durable; easy to operate and gives quick covering to all plants and vines requiring a top application. Price, 75c. (by P. P., 85c.).

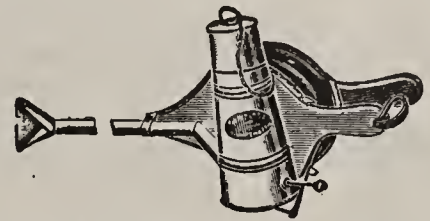

FAMOS HAND DUSTER

An ideal machine for those who need a small but efficient duster; light and compact; equipped with 24 inch extension pipe; can be adjusted to throw dust on the underside of foliage or at any angle desired. Price, \$6.00.

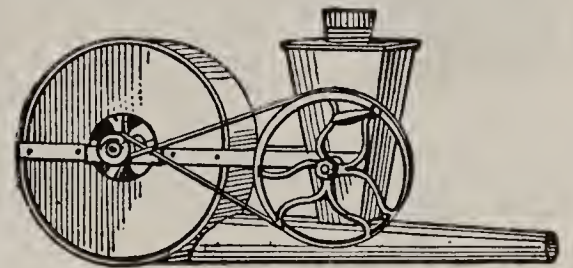

SULPHUR BLOWER

For distributing sulphur and insecticides of various kinds. Made of heavy metal, will not wear out. A man can dust a very large house in a few minutes by using one of these blowers. Price, \$10.00 (by P. P., \$10.35).

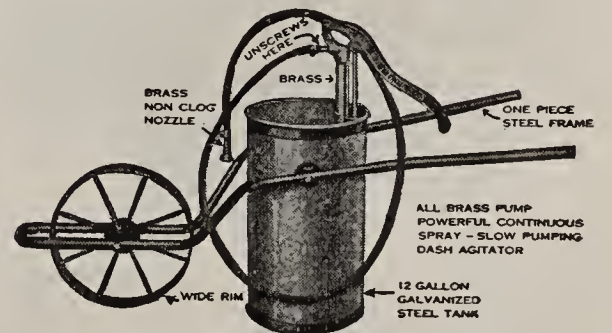

No. 50 WHEELBARROW SPRAYER

Adapted for spraying vegetable crops, flowers, vineyards, orchards, etc.; also for spraying disinfectants or whitewash in poultry houses or other buildings. Steel frame made in one piece; heavy galvanized tank; all brass pump; 8 feet of hose; all working parts brass; double action; continuous spray. Pump may be easily detached from the tank and the tank with wheel and frame used for wheeling water. Price, \$15.00. Price with brass tank, \$22.50.

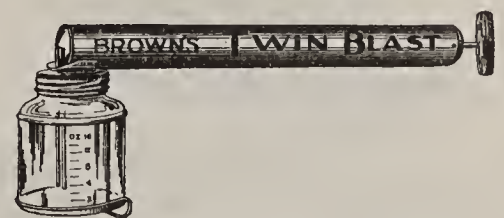

TWIN BLAST SPRAYER

Equipped with twin spray jets which diffuse a large volume of fine misty spray; glass tank enables the operator to know exactly how much liquid is in the container. Capacity, one quart. Price, 75c. (by P. P., 85c.).

Parcel Post charges where named are for shipment to the first and second zones; for other zones, please see parcel post table, page 1.

THE PARAGON SPRAYER



No. 1

These sprayers are of superior quality in material and workmanship; they will not clog, therefore it is not necessary to strain the material used. It not only handles insecticides, fungicides and disinfectants, but also whitewash, cold water paints, etc.

No. 0. Capacity, 3 1/2 gallons; equipped with 4 feet special spray hose, 3 feet spray pipe and 3 nozzles. Price, \$11.00.

No. 1. Capacity, 6 gallons; equipped with 5 feet special spray hose, 5 feet spray pipe and 3 nozzles. Price, \$15.50.



No. 3

No. 3. Capacity, 12 gallons; equipped with truck, 10 feet special spray hose, 7 1/2 feet spray pipe and 3 nozzles. Price, \$19.75. Without truck, \$16.75.

We can also supply this sprayer with single wheel at same price.



No. 4

No. 4. Capacity, 28 gallons; equipped with truck, 20 feet special spray hose, 10 feet spray pipe and 3 nozzles. Price, \$35.00.

No. 5. Capacity, 50 gallons; equipped with 25 feet special spray hose, 10 ft. extension pipe, one 3-way spray nozzle, 1 single-spray nozzle; no truck. Price, \$40.00.

Bucket Washers for Paragon Sprayers, 30c.

We can also supply the Paragon Compressed Air Power Sprayer, 40 gal. capacity for \$275.00.

Fittings for Paragon Sprayers

No.	Description	Price
E85.	2-way Spray	\$2.50
B35.	Extension Pipes	.60
E86.	Y Fitting	1.00
B 7.	Hose Coupling, complete	1.10
B18.	Strainer	1.25
B10.	Female Hose Coupling	.70
B20.	Stop-Cock	1.00
B24A.	Mist Spray Nozzle with S. and B.	.90
B22.	Brass Hose Bands	.10 Each

AUTO SPRAY

A compressed air sprayer with screw-locking cap and strongly reinforced corrugated tank.



Auto Spray

No. 9-C—Solid Copper Tank; capacity, 4 gallons; equipped with hose and Auto-Pop Attachment, \$10.00 (by P.P., \$10.25).

No. 9-A—Galvanized Tank; capacity, 4 gallons; equipped with hose and Auto-Pop, \$6.75 (by P. P., \$7.00).

No. 50—Galvanized; capacity, 2 1/2 gallons; equipped with hose and Auto-Pop, \$5.50 (by P. P., \$5.70).

Auto-Pop Nozzle Attachment; controls the flow instantly by a pressure of the hand. When Auto-Pop Attachment is purchased separately. Plain, \$1.50 each (by parcel post, \$1.60); complete with hose, \$2.00 (by parcel post, \$2.15).



VERMOREL KNAPSACK SPRAYER

A new copper knapsack sprayer which works on a compressed air principle. Compact in construction and light in weight, so that it can be easily carried around. We will sell this sprayer under the condition that if it is not satisfactory it may be returned at our expense. Price, \$18.00 (by P. P., \$18.30).

GOULD'S FRUITALL BARREL PUMP. Fig. 1188

A high-grade pump at an attractive price, within the reach of every one who has need for such a pump. Extremely simple in design and a serviceable and reliable sprayer. 2 in. diameter cylinder; bronze wearing parts. Plain pump, no hose, nozzle or barrel, \$12.00.

Outfit C.—With agitator, one 25 ft. lead of 1/2 in. spray hose and one Mistry Jr. nozzle (no barrel), \$16.50.

Outfit D.—With agitator, two 25 ft. leads of 1/2 in. spray hose and two Mistry Jr. nozzles (no barrel), \$21.00.



Gould's Pomona Spray Pump

GOULD'S POMONA BARREL PUMP. Fig. 1744

Of large capacity and powerful with long adjustable leverage. Can be used for feeding one or two leads of hose; all working parts are bronze, with lasting qualities. Plain pump, 2 1/2 in. diam. cylinder only (no barrel), \$22.00.

Outfit C.—With one 25 ft. section 1/2 in. spray hose and one Mistry Jr. nozzle (no barrel), \$26.50.

Outfit D.—With two 25 ft. sections 1/2 in. spray hose and two Mistry Jr. nozzles (no barrel), \$31.00.

Barrels for holding spray solution, 50 gal. capacity, \$7.00 each.

Truck with 3 1/2 inch tire wheels, \$20.00.



NEW ERA SPRAYER

No. 23C. An all-brass continuous atomizer especially adapted for large institutions, dairy farms and poultry houses, for spraying all disinfectants, insecticides, etc.; waxed wood handle; capacity, 3 quarts. Price, \$2.50 (by P. P., \$2.65).

Parcel Post charges where named are for shipment to the first and second zones; for other zones, please see parcel post table, page 1.

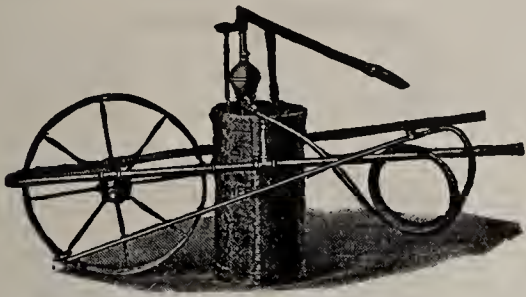

DEMING WHEELBARROW SPRAYER

A machine that is nicely balanced and easily transported. Extreme width 18 inches, narrow enough to go through the aisles of a greenhouse; 24 in. wheel with a 3 inch tread making it easily handled over soft and rough ground. Pump has 1½ in. diam. cylinder, with adjustable stroke. Equipped with 12 gal. galvanized tank, 10 ft. of hose, 4 ft. extension pole, nozzle and shut-off valve. Price, \$33.50.



MICHELL'S HAND COMPRESSED AIR SPRAYER

This is the best hand sprayer ever offered; very easily operated, especially preferred by the ladies.
Tin. Each, 90c. (by P. P., \$1.00).
Brass. Each, \$1.75 (by P. P., \$1.90).

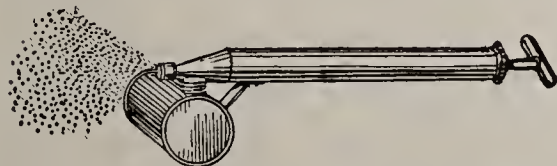

CYCLONE HAND SPRAYER

Similar to the above, except they do not have the automatic air reservoir attachment. No. 112, Tin, large, 50c. (by P. P., 60c.).



COMPRESSED AIR SPRAYER

No. 26D. Sprays on both the up and down stroke of the plunger; will handle all insecticides, disinfectants, etc.; brass pump cylinder; copper bronze container; combined straight and angle nozzle; capacity, 1 quart. Price, \$1.75.

EXTENSION PIPES, ETC.

For reaching into trees; ¾ inch threads.
Bamboo, brass lined, 8 feet \$4.50
Bamboo, brass lined, 12 feet 5.00
Brass, 2 ft. (by P. P., 70c.)60
Pet Cock, for extension pipes 1.25
Paragon Extensions, 2½ ft., 60c. each (by P. P., 70c.).

BUCKET SPRAY PUMP

These are made entirely of brass, except the foot rest and hand grip. The prices below do not include bucket, but include nozzle and 3½ feet of ¾ in. hose.

No. 689. Perfect Success (with bucket fastener), \$7.50 (by P. P., \$7.75).

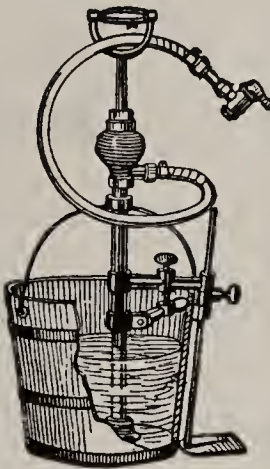

No. 327½ MYER'S BUCKET PUMP

This is a double brass chamber arrangement, and fills the want of those desiring a medium priced sprayer. Price \$3.75, including hose and nozzle (by P. P., \$3.95).

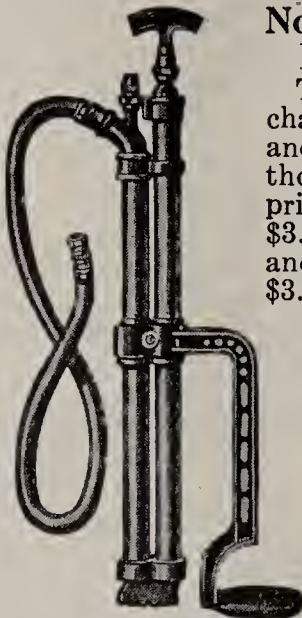

Myer's Pump



1074½



1692



1688



1691

SPRAY NOZZLES (¾ in. Thread)

If nozzles are wanted by P. P., add 10c. each for postage.

Mistry, Jr., Fig. 1688, Straight style .. \$1.00
Mistry, Jr., Fig. 1691, Elbow style ... 1.00
Fig. 1074½, Y connection for making a double spray head nozzle40
Bordeaux Nozzle, Fig. 1692, each 1.25

If nozzles are wanted for ¾ in. hose connections, add 70c. to above prices for Fig. 966 combination.

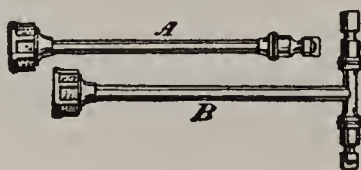

STOTT'S SPRAY NOZZLES

Splendid for spraying underneath foliage. By P.P.

A-Single \$1.65 \$1.75
B-Double 2.75 2.85



HEAVY BRASS SYRINGES

No.	Diam.	Length	Price	By P.P.
99.	1½ in.	18 in. 1 spray....	\$3.50	\$3.70
101.	1¼ in.	14 in. 2 sprays....	4.00	4.20
101A.	1½ in.	16 in. 2 sprays....	5.00	5.20
110.	1¾ in.	20 in. 2 sprays....	10.00	
120.	1¾ in.	20 in. Adjustable.	10.50	

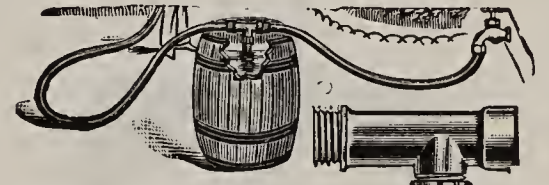

LIQUID MANURE DISTRIBUTOR

This can be attached to hose with which you are watering and connected with a barrel of liquid manure, the suction of water will draw a quantity of manure with it. \$2.75 each (by P. P., \$2.85).



SKINNER SYSTEM OF GARDEN IRRIGATION

Line covers 50 ft. wide; complete ready to use.

	Stationary	Portable
50 ft.....	\$15.75	\$17.75
100 ft.....	25.75	33.75
150 ft.....	36.75	50.75
200 ft.....	48.75	68.75

Prices on longer lines on request. Posts for above lines, 10c. per foot. Specify if lines are to be pipe or hose fed.

Automatic Oscillator for above lines, \$26.50 extra.

Hand Turn Union is included in above prices.

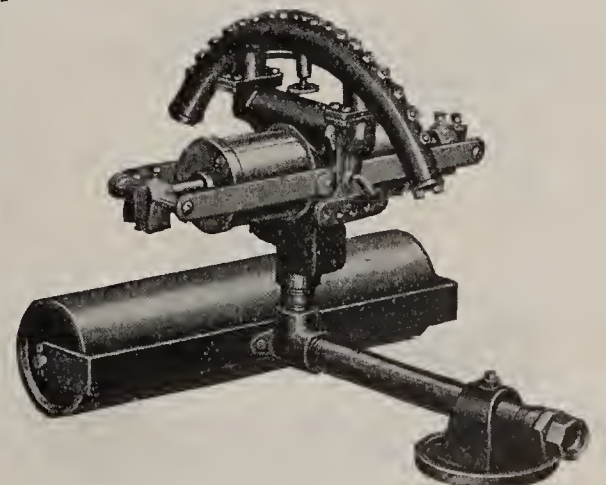

RAIN-WAVE SPRINKLER

Covers a space 50 to 60 feet square. Adjustable to one-half or one-quarter full coverage. Weight, 17 lbs. Price, \$35.00.

Parcel Post charges where named are for shipment to the first and second zones; for other zones, please see parcel post table on page 1.



Model D Rain King

MODEL D RAIN KING

Finish red and brass; height, 9 in.; sets quickly to turn fast or slow, or for stationary sprinkling. Price, \$2.00.

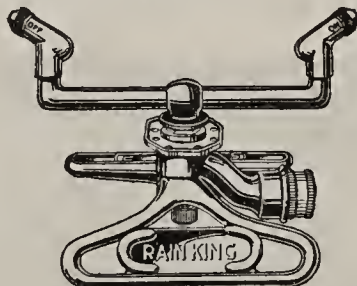

Standard Rain King

STANDARD RAIN KING

For the average lawn or garden; each nozzle a sprinkler in itself; height, 6 in. Price, \$2.25.

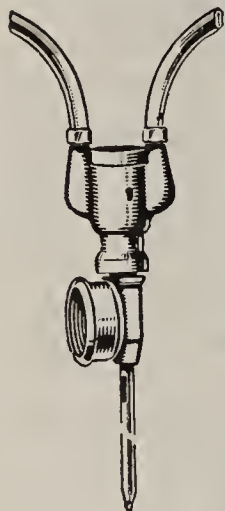

Double Whirling Shower

NEW IMPROVED DOUBLE WHIRLING SHOWER

Sprinkles exactly like rain; sprinkles a circle up to 35 feet in diameter; length over all, 12 inches; runs on any pressure from 5 lbs. up. Price, 90c.

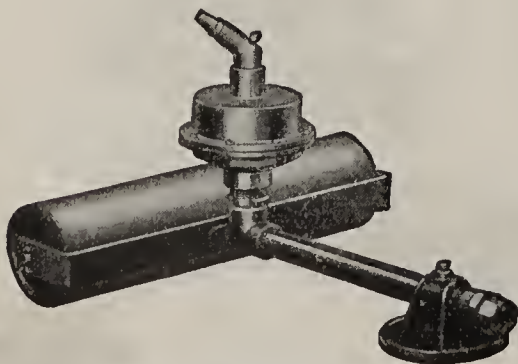

Big Circle

BIG CIRCLE

Covers an area 125 to 150 feet; pressure, 60 lbs. up; volume 22 to 40 gallons per minute. Price, \$12.75.



Giant Rain King

GIANT RAIN KING

Finished in green enamel with brass fittings; can be set for revolving or stationary sprinkling; will water a circle from 90 feet in diameter down as required; 4 feet high; 20 inch sprinkler arms. Price, \$9.50.



C. B. G.



Crescent

C. B. G.

Especially for putting greens; 4 inches high. Price, 40c. (by parcel post, 50c.).

CRESCENT

Height, 2 inches. Price, 75c. (by parcel post, 85c.).

BLAKE



Blake

A sprinkler head used where there is a pipe system on the lawn or golf course. Price, 45c. each (by parcel post, 50c.); doz., \$5.00 (by parcel post, \$5.15).

BABY RING

Height, 2 inches. Price, 60c. (by parcel post 70c.).



Baby Ring

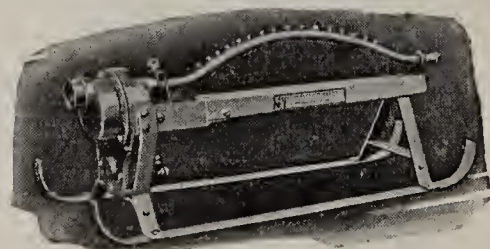

Water Fan

WATER FAN (Oscillating)

No. 7. Covers an area 40 to 45 feet; 20 inches long. Price, \$15.00.



Whirling Showers

WHIRLING SHOWERS

A complete adjustable lawn sprinkler; gives every type of spray from fine mist to heavy shower. Sprinkles strip or circle and will cover a diameter of 70 feet. Made entirely of brass excepting base, which is malleable iron. Price, \$2.00 (by parcel post, \$2.20).



Single Gear Economy Traveller

ECONOMY TRAVELLER

Especially designed for covering large areas, while at the same time distributing the same number of gallons per minute as many other machines, thus giving the water time to sink in the ground. Single gear; capacity, 10 to 20 gallons per minute; coverage, 120 to 180 feet diameter. Price, \$35.00.

ECONOMY PRESIDENT

The simplicity, durability and efficiency of this sprinkler have won for it the enthusiastic commendation of greens keepers everywhere. Especially adaptable to the hoseless system of fairway and greens watering. Capacity, 12 to 20 gallons per minute; coverage, 80 to 120 feet diameter. Price, \$15.00.

LARGE RING

Height, 2 inches. Price, 75c. (by parcel post, 85c.).

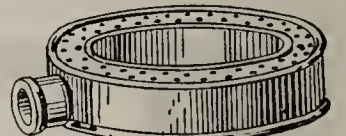

Large Ring

ADJUSTABLE NOZZLE

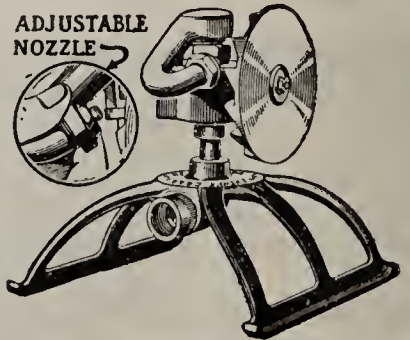

Double Rotary

DOUBLE ROTARY

A favorite with country clubs, for watering putting greens; covers a radius of 15 to 40 feet. Price, \$11.00 (by parcel post, \$11.25).

Parcel Post charges where named are for shipment to the first and second zones; for other zones, please see parcel post table, page 1.

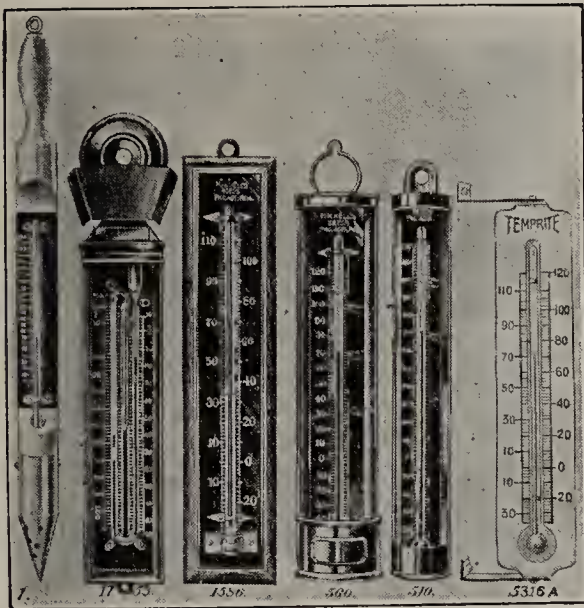

THERMOMETERS

No. 1753. Maximum and Minimum. Registers the coldest and warmest point during the previous night. 10 in., black tin case. Price, \$4.75 (by P. P., \$4.85).

Tested Thermometers

If wanted by Parcel Post, add 10c. each for postage. Each

No. 506— 8 inch, Tin Case.....	\$0.85
No. 510—10 inch, Tin Case.....	1.00
No. 556— 8 inch, Greenhouse.....	1.25
No. 560—10 inch, Greenhouse.....	1.50
No. 652— 8 inch, Genuine Copper Case	2.00
No. 656—10 inch, Genuine Copper Case	2.25
No. 1582—8 inch, Wood Back, Black Scale.....	2.00
No. 1586—10 inch, Wood Back, Black Scale.....	2.25
No. 5127—8 inch, Temprite Greenhouse; white enamel, red column..	1.25
No. 5316A—8 inch, Temprite Window or wall, white enamel, red column..	1.00

Glass Dairy Thermometer

No. 5724. For testing milk, etc., also used for soil purposes. 40c. each (by P. P., 50c.).

Mushroom or Hotbed Thermometer

No. 20450. Iron Point, oxidized finish, each, \$2.25 (by P. P., \$2.40).

Recording Thermometer

No. 200. This type of thermometer which can be equipped with either a daily or weekly chart enables one to keep an accurate record of the temperature in his greenhouse during every hour of the day and night; the thermometer is equipped with a high grade clock and ink stylus which marks very accurately. It is an ideal installation; in ordering state if weekly or daily record chart is desired. Price, \$40.00 by express.

COAL FOR WAGON HEATERS

\$1.25 per 20 brickets; per 100 bricks, \$8.50.



ELECTRIC THERMOSTAT

This device can be set to ring an alarm when the temperature goes above or drops below a desired point. All brass.

No. GH3, not waterproof style, \$11.50 (by P. P., \$11.75).

No. GH4, waterproof style, \$17.50 (by P. P., \$17.75).

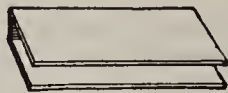

PEERLESS GLASS REPAIR CLAMP

For supporting broken lights of glass. Will not rust. Price, \$1.75 per 100 (by P. P., \$1.85).



GLASS CUTTERS

Single Wheel, steel, each.....	\$0.20
6 Wheel, steel, each.....	.40
No. 8 Small Diamond. Ebony handle	5.00
No. 8A Large Diamond. Mahogany handle.....	6.00

LIQUID GLAZING PUTTY

Superior to ordinary putty, more easily applied and lasting. Can be put on with a putty bulb or mastica machine.

Especially adapted for glazing wood and metal sash. Per gal., \$2.25.

MASTICOTE GLAZING CEMENT

Black. Apply with a mastica machine. Per gal., \$1.50.

MASTICA

For glazing greenhouses. One gallon will cover about 300 running feet. Gal., \$2.40.

GREENHOUSE PAINT

A superior white paint for sash bars, sash frames, etc. Per gal., \$3.75.

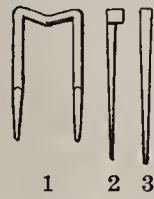

Glazing Points

No. 1. Peerless.
No. 2. Siebert's.
No. 3. Zinc Nails.

GLAZING POINTS

See illustration opposite.

Peerless. Three sizes.

No. 1, for single thick glass.

No. 2, for single thick glass.

No. 2½, for double thick glass.

Price, 60c. per 1000 (by P. P., 70c.).

Pincers. For driving Peerless Points, \$1.00 (by P. P., \$1.10).

Siebert Style (Zinc). Made with a prominent head; cannot rust; easily driven. ⅝, ¾ and ⅞ inches long. 45c. per lb. (by P. P., 55c.); 5 lbs., \$2.15 (by P. P., \$2.30). 1000 to 1200 in a lb.

Zinc Glazing Nails. 40c. per lb. (by P. P., 50c.).

PUTTY DISTRIBUTOR

For distributing putty, mastica, etc. Price, \$1.50 (by P. P., \$1.60).



Mastica Machine



Putty Distributor

MASTICA MACHINE

For distributing mastica, etc. Made of heavy zinc. Price, \$3.00 (by P. P., \$3.15).

DAYLIGHT GLASS CLEANER

For taking off whitewash shading, etc. Apply with a brush, leave on a few minutes and rinse off with cold water. One gallon will clean 400 to 600 square feet of glass. Per gal., \$2.50; \$10.00 per 5 gals.



GLAZIT GUN

For applying liquid glazing putty, mastica, etc. Price, \$4.50 (by P. P., \$4.65).



GLAZING CHISEL

Made of the best quality steel. Price, \$1.25 (by P. P., \$1.40).

Parcel Post charges where named are for shipment to the first and second zones; for other zones, please see parcel post table, page 1.

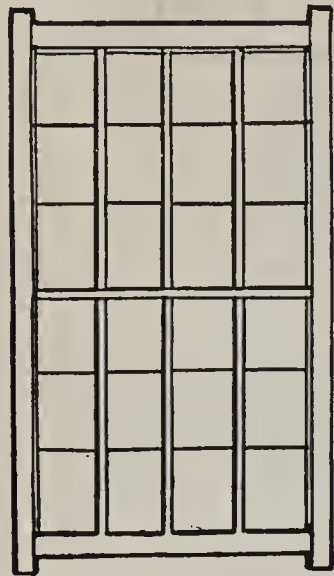

HOTBED SASH

Philadelphia Style. Made of best quality cypress. Size, 3 feet 1 1/2 inches wide, 6 feet long, 1 3/4 inches thick. Plain, not glazed or painted. Each, \$3.50. Glazed, primed and puttied, \$7.00.

FLEX-O-GLASS

A glazed cloth used in place of glass in poultry houses, hotbeds, greenhouses, etc. Transparent and readily admits light, while at the same time withholding cold, water and wind; 36 inches wide. Cut pieces.....25c. per yd. Full roll lots (100 yds.).....23c. per yd.

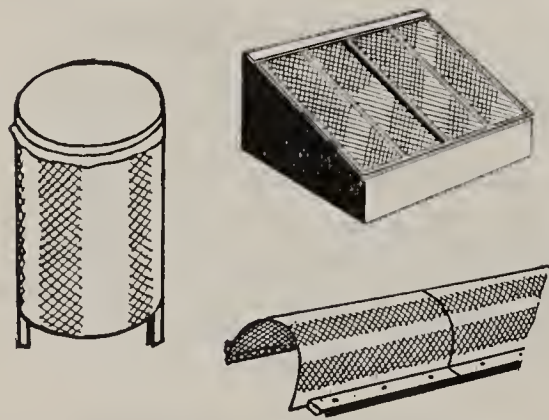

CEL-O-GLASS

Grow your own plants; get earlier flowers and vegetables with Cel-O-Glass; use the new improved style on your cold frames and hotbed sashes—for such important new uses as cylinders and cones for individual plants, forcers for row plants and newly planted seeds. Can be used where ordinary glass and cloth cannot and is much lighter. Sashes are easier to handle; not affected by hail, snow, rain or wind and cannot break like glass; flexible; easy to cut and use; highly translucent, lets in the ultra-violet rays of sunshine. The new improved Cel-O-Glass lasts twice as long; saves heavy lifting, breakage and repair expense, 36 inches wide. Per running foot, 50c. Full roll lots, per running foot, 45c.

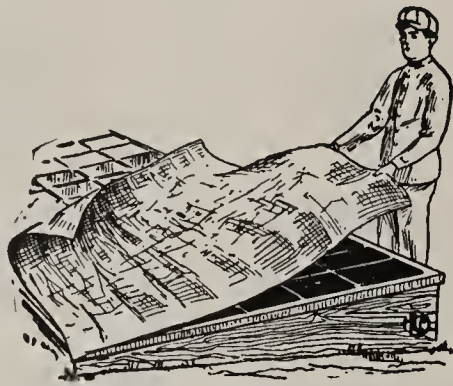

Hotbed Mats

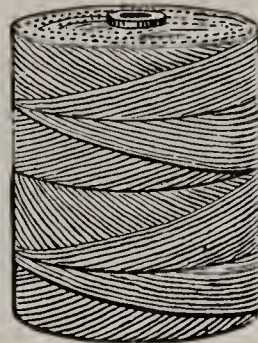

Peerless



Raffiatape



Sikaline



Green Sea Island

HOTBED MATS

Hotbed mats keep frost and severe cold out of frames. They mean earlier and bigger crops. The Burlap style are the best mats that it is possible to procure. They are padded with shoddy and are practically indestructible. **Burlap, Non-Waterproof.** 76 x 76 inches, covering two regular size sash. Each, \$3.50; \$40.00 per doz. **Burlap, Non-Waterproof.** 40 x 76 inches, for one sash. Each, \$2.00; \$22.00 per doz. **Burlap one side, Waterproof Drill one side.** 76 x 76 inches. \$4.50 each; doz., \$52.00. **Burlap one side, Waterproof Drill one side,** 40 x 76 inches. \$2.50 each; doz., \$28.50. Special sizes of the above mats made to order. Prices on application.

BURLAP

For covering shrubbery, etc. Per yd. 3 ft. wide, cut pieces.....\$0.19 Full pieces, 100 yds......18 40 in. wide, cut pieces......21 Full pieces, 100 yds......20 4 ft. wide, cut pieces......23 Full pieces, 100 yds......22

SHADING OR PROTECTING CLOTH

Largely used as a substitute for glass where protection is desired. It is admirable for Summer use, protecting plants, etc., from the sun and at the same time allowing ventilation. Made of brown cloth.

	Yards	Price Per piece	Price Per yard	Price Per piece
Light.....	60	\$0.17		\$9.60
Medium.....	50	.21		10.00
Heavy.....	40	.35		13.20

GERMACO HOTKAPS

An individual hothouse for each and every plant; protects plants from frost and other elements; matures crops earlier; keeps insects out; keeps soil soft. Made of scientifically constructed wax paper. Prices: 1000 lots, \$11.00; 5000 lots, \$10.50 per 1000; 10,000 lots, \$10.00 per 1000; 250, Trial pkg., including Garden Setter with Tamper, \$3.75; 100, Home pkg., including Garden Setter with Tamper, \$2.25 (by P. P., \$2.45). **Germaco Hotkap Steel Setters.** For setting hotkaps accurately and quickly, \$2.50 each (by P. P., \$2.65).

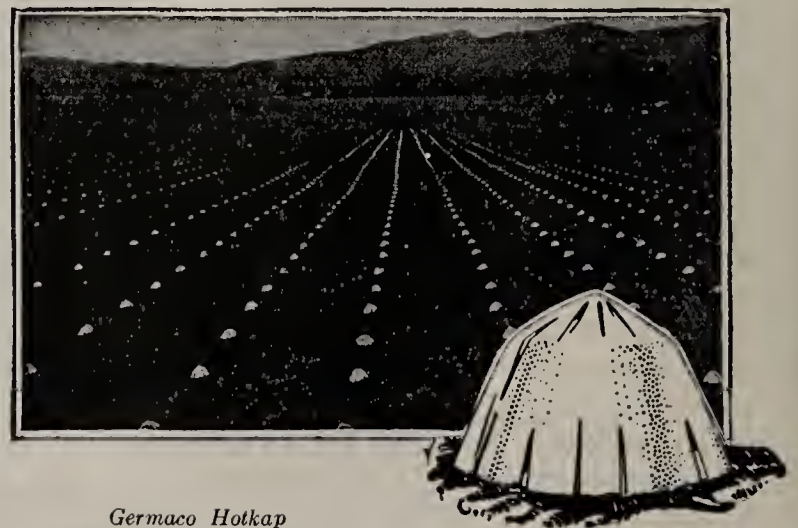

Germaco Hotkap

TWINES, ETC.

If twines are wanted by parcel post, add 10c. per lb. for postage.

No. 108. White Cayuga, Medium.....	\$0.30	Ball	Lb.	\$0.60
No. 208. White Cayuga, Heavy.....	.30			.60
Jute, 2 ply and 3 ply.....	.15			.30
Linen Bouquet.....	.15			.85
Green Sea Island.....	.10			.60
No. 4 1/2. Jap. Twine. Medium heavy.....	.25			
White Cotton, 3 ply.....	.15			.50
Peerless. Color, Nile green..				.70
Tarred. For mat making....	.30			
Tarred Sisal. For fodder....				.16
Binder.....				.20
Express. Very heavy.....	.25			

Green Silkaline. For stringing Smilax, Asparagus, etc. F, fine; FF, medium; FFF, coarse. 35c. per spool; per lb. (8 spools), \$2.60. **Everbest Thread.** Very similar to the above; fast color. Price, 25c. per spool; per lb., \$1.50.

RAFFIA

For tying, basket making and fancy work; very long and fibrous. **Natural Color,** 40c. per lb. (by P. P., 50c.); 5 lbs., \$1.90 (by P. P., \$2.05). **Green,** 75c. per lb. (by P. P., 85c.); 5 lbs., \$3.50 (by P. P., \$3.65).

RAFFIATAPE

This article is made of a composition of paper and linen and is tremendously strong; it is about 1/8 inch wide and is put up in 250 yard bolts or hanks. This is very desirable for tying bouquets, flower boxes or for any other purpose where attractive tying material is desired. Color, Nile green. Per bolt of 250 yards, 75c. (by P. P., 85c.); 6 bolts, \$4.25 (by P. P., \$4.45).

Parcel Post charges where named are for shipment to the first and second zones; for other zones, please see parcel post table, page 1.

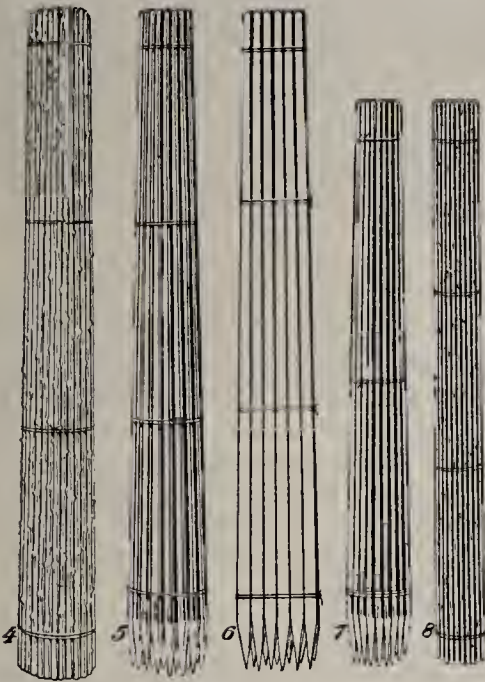

Key to above illustration: No. 4, Japanese Cane, natural; No. 5, Dahlia; No. 6, Square; No. 7, Tapering; No. 8, Japanese Cane, green.

PLANT STAKES

No. 10, Steel Wire, Galvanized

	Doz.	100	1000
2 foot	\$.25	\$1.25	\$8.75
2 1/2 "	.30	1.60	10.50
3 "	.40	2.00	12.10
3 1/2 "	.45	2.25	14.25
4 "	.50	2.50	16.50
4 1/2 "	.55	2.75	18.75
5 "	.65	3.00	21.00
6 "	.85	3.50	23.00

No. 8, Steel Wire, Galvanized

For staking American Beauty and other strong growing roses.

	Doz.	100	1000
2 foot	\$.30	\$1.60	\$12.40
2 1/2 "	.40	2.00	15.50
3 "	.50	2.25	18.25
3 1/2 "	.55	3.00	21.75
4 "	.60	3.25	24.25
4 1/2 "	.65	3.50	26.50
5 "	.70	3.75	28.60
6 "	.90	4.75	35.25

GREEN PAINTED TAPERING PLANT STAKES

	Each	Doz.	100
1 1/2 foot	\$.04	\$0.35	\$2.00
2 "	.06	.55	3.50
2 1/2 "	.07	.75	5.00
3 "	.10	1.00	6.50
3 1/2 "	.11	1.15	8.25
4 "	.13	1.40	10.00
5 "	.16	1.75	12.00

GREEN PAINTED ROSE OR DAHLIA STAKES

	Each	Doz.	100
3 foot	\$.15	\$1.40	\$10.50
4 "	.20	1.90	14.00
5 "	.25	2.40	18.00
6 "	.30	3.00	22.00

SQUARE PAINTED PLANT STAKES

	Each	Doz.	100
1 1/2 foot	\$.04	\$0.30	\$1.75
2 "	.05	.50	2.50
2 1/2 "	.07	.65	3.50
3 "	.10	1.05	6.75
4 "	.15	1.35	9.00
5 "	.20	2.00	13.00
6 "	.25	2.50	15.00

HYACINTH STAKES (Wood) Dyed Green

Used for staking hyacinths, tulips and slender plants.

	Doz.	100	1000
5 inch	\$.05	\$0.20	\$1.00
12 "	.07	.30	1.75
18 "	.10	.40	2.50

JAPANESE CANE STAKES

These are very attractive for all purposes of plant staking; thin and very strong.

Feet	Doz.	100	1000
1 1/2 Green	\$.15	\$0.65	\$3.50
2 "	.20	.90	5.50
2 1/2 "	.25	1.15	6.00
3 "	.30	1.25	7.00
3 1/2 "	.35	1.40	8.00
4 "	.40	1.75	9.00
5 "	.45	2.00	11.00
6 Natural	.45	2.00	12.00

CHINESE TONKIN BAMBOO STAKES

A heavy, substantial stake for Dahlias, Ivy, young trees, etc.

	Doz.	100
4 feet high, 3/8 inch diameter	\$.55	\$3.00
6 feet high, 5/8 to 3/4 inch diam.	1.00	6.00

LIGHTNING WIRE STAKE TIE



For fastening plants to stakes, either wire or wood; can be used many times.

Price, 35c. per 100; per 1000, \$2.50 (by P. P., \$2.60).

STAKE FASTENERS

These take the place of string entirely, lasting several seasons; used for fastening cross wires to galvanized stakes.

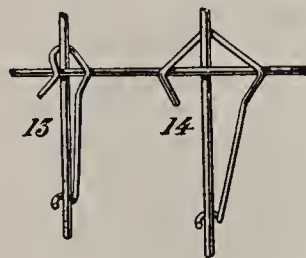

	500	1000
Everlasting Style, heavy	\$.175	\$3.00
Eureka Style, light	1.25	2.25

If wanted by Parcel Post, add 10c. per 500; 15c. per 1000 for postage.

BAMBOO POLES

Used extensively for brushing worm casts off Putting Greens, also for staking young trees.

	Each	Doz.	100
16 feet long	\$.25	\$2.50	\$15.00
18 feet long	.35	3.25	22.00
20 feet long	.45	4.00	27.50

Poles (Wood)

	Each
12 feet long, 1 1/4 inch diam.	\$2.75
14 feet long, 1 1/4 inch diam.	3.00

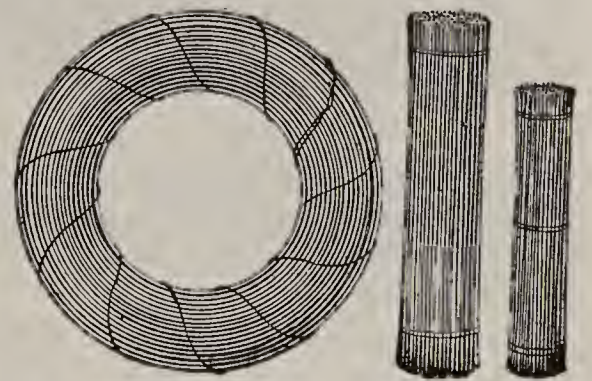

WIRE

If wanted by Parcel Post, add 10c. per lb.; 25c. per 12 lbs. for postage.

	Lb.	Stone
No. 16. Galvanized	\$.20	\$1.90
No. 18. Galvanized	.25	2.10
No. 19. Galvanized	.25	2.00
No. 20. Galvanized	.25	2.25
No. 22. Galvanized	.30	2.25
No. 16. Annealed	.18	1.50
No. 18. Annealed	.20	1.60
No. 20. Annealed	.25	1.75
No. 22. Annealed	.25	1.80
No. 24. Annealed	.30	2.00

TINNED WIRE

Used for bunching celery, etc. No. 19, in 10 lb. boxes, cut 8 1/2 inches, 30c. per lb.; per box, \$2.25.

CUT BOUQUET WIRE For Stemming Flowers

Cut, 9, 12 or 18 inches in length.

No. 20, 25c. per lb.; per box, 12 lbs.	\$2.75
No. 22, 30c. per lb.; per box, 12 lbs.	3.00
No. 24, 35c. per lb.; per box, 12 lbs.	3.50



WIRE AND TIN SHEARS

If wanted by Parcel Post, add 10c. each for postage.

No. 369. 7 1/2 inch, serrated edge, long blade	\$1.50
No. 833. 7 1/2 inch, used for cut flower wire, etc.	1.10
No. 832. 8 inch, used for cut flower wire, etc.	1.15
No. 12. 8 inch for heavy wire and tin.	1.25
No. 10. 10 inch for heavy wire and tin.	2.00

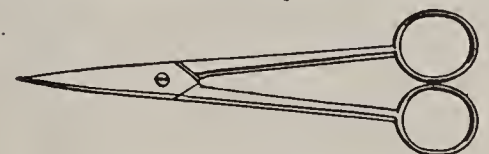

GRAPE SCISSORS

For thinning out bunches of grapes, and not disturbing the berries that are to remain for development.

No. 846. 6 inch, \$1.25 (by P. P., \$1.35).

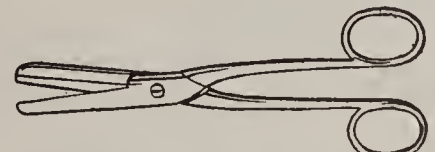

FLOWER SCISSORS

No. 575. Cuts flowers and holds the stem. Price, \$1.75 (by P. P., \$1.85).



Rustic Window Box

WINDOW BOXES

Wooden Rustic Bark Style. Attractively made and neatly finished; for indoor or outdoor use.

Length	Depth outside	Width outside	Price
24 inch.....	7½ inch	11 inch	\$1.75
30 inch.....	7½ inch	11 inch	2.25
36 inch.....	7½ inch	11 inch	2.50

Any length made to order, \$1.00 per running foot, 11 inches wide.

RUSTIC BARK (Cedar)

For covering boxes, columns or any other article.

Per square foot.....	\$0.15
25 square feet.....	2.75
50 square feet.....	5.00

BIRCH BARK

Per lb., 50c.; \$4.50 per 10 lbs.

WINDOW BOXES

Plain Wood Style (Painted Green). We recommend these for use at the temporary Summer home in the country or at the seashore, or in cases where one may not feel like spending a larger cost than these entail. They are substantially made and finished and will last many years.

Length	Depth outside	Width outside	Price
24 inch.....	6½ inch	8 inch.....	\$1.25
30 inch.....	6½ inch	8 inch	1.50
36 inch.....	6½ inch	8 inch	1.75

Any length made to order, 80c. per running foot, 8 inches wide.

PERFECTO FLOWER BOXES

Air-Circulating, Self-Irrigating

Made of coppered steel, which will neither rust nor deteriorate; finished in enameled green. The self-irrigating system provided by the inner plate, with the raised connecting troughs, equalizes the water into a perfect distribution to the roots.

Length	Depth	Width	Price
20 inch.....	6 inch	7 inch	\$1.00
26 inch.....	6 inch	7 inch	1.25
32 inch.....	6 inch	7 inch	1.50
38 inch.....	6 inch	7 inch	2.00
44 inch.....	6 inch	7 inch	2.50



WINDOW BOXES Savo Self-Watering

The Savo Flower and Plant Boxes are made of the best grade of galvanized steel, with neat round corners and a full roll rim; watering easy, drainage ample, air circulation perfect. The green enamel finish both inside and out prevents rust or leakage. Reservoir requires water about every 10 days to two weeks.

Model	Height	Width	Length	Price
Model A... 8 in.	8 in.	9½ in.	23 in.	\$3.25
Model B... 8 in.	8 in.	9½ in.	29 in.	3.75
Model C... 8 in.	8 in.	9½ in.	35 in.	4.25
Model D... 8 in.	8 in.	9½ in.	41 in.	4.75

These are outside measurements, including the ¼ inch roll rim.

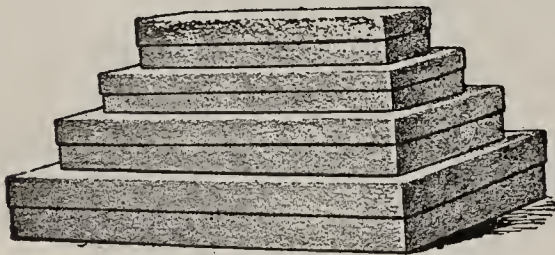

CUT FLOWER BOXES Corrugated Paper

These are desirable for shipping cut flowers from country estates to city residences; very durable.

Size	Each	Doz.
48 x 14 x 8 inch.....	\$0.60	\$5.00
42 x 14 x 8 inch.....	.50	4.00
36 x 14 x 6 inch.....	.45	3.50
30 x 12 x 6 inch.....	.40	3.00
24 x 8 x 5 inch.....	.25	2.50

Light Weight Paper

Mist green, lined white inside. The sizes offered in this finish are carried in stock; other sizes in this finish, also in manila, mist tan and oxford gray can be supplied on short notice.

L.	W.	D.	Doz.	100
18 x	5 x	3 inch.....	\$0.70	\$4.40
24 x	5 x	3½ inch.....	1.10	7.00
24 x	8 x	4 inch.....	1.30	8.80
28 x	8 x	5 inch.....	2.00	12.20
30 x	10 x	6 inch.....	2.25	16.50
30 x	12 x	7 inch.....	3.00	21.00
36 x	8 x	5 inch.....	2.25	16.50

We can also supply other sizes and styles of boxes.

PAPER FOR WRAPPING BOXES AND FLOWERS

	Lb.	½ rm.	Rm.
Manila. For wrapping.....	\$0.20	\$2.25	\$4.00
Manila. Tissue.....	.25	1.10	2.00
White Wax. 24 x 36 in.....	.35	1.75	3.00
Green Wax. 24 x 36 in.....	.40	1.75	3.25

CREPE PAPER

(Waterproof)

Colors, moss green, Nile green, red, blue, pink, yellow, purple, lavender and white. 50c. per roll (by parcel post, 55c.).

ROOFING PAPER, ETC.

	Sq. ft.	Per roll
Celery paper	500	\$2.00
Marley Rubber Roofing, 2 ply 108		3.00
Marley Rubber Roofing, 3 ply 108		3.50
Caps for paper. 1 lb., 15c. (by parcel post, 25c.); 5 lbs., 70c. (by parcel post, 85c.).		
Nails for paper. 1 lb., 15c. (by parcel post, 25c.); 5 lbs., 70c. (by parcel post, 85c.).		

SUNDRIES

- Bulb Fibre.** Qt., 15c.; 45c. per ½ pk.; pk., 75c.; \$1.25 per ½ bu.; bu., \$2.00.
- Bull Dog Clips.** For fastening packages, etc., \$1.00 per box (by P. P., \$1.10).
- Carnation Bands (Rubber).** For mending bursted calyx. 25c. per oz.; ¼ lb., 90c.
- Carnation Clips (Baus).** For mending carnations. \$1.50 per 1000. Pliers for attaching same, \$3.25.
- Carnation Staples (Wire).** 50c. per 1000.
- Celery Tape.** Fast red, in 1000 yard spools, \$4.00 (by P. P., \$4.15).
- Celery Tape.** Green, in 1000 yard spools, \$3.00 (by P. P., \$3.15).
- Charcoal (Lump).** For use in potting. Pk., 65c.; \$1.50 per bu.; bbl. sack, \$2.00.
- Charcoal (Ground).** Coarse, fine and powdered. Per lb., 10c.; 35c. per 5 lbs.; 10 lbs., 60c.; \$1.25 per 25 lbs.; 100 lbs., \$3.50.
- Moss (Green Lump).** Pk., 50c.; \$1.50 per bu.; bbl. bag, \$2.50.
- Moss (Green Sheet).** Per lb., 25c.; \$2.00 per bag.
- Moss (Sphagnum, dry).** Bbl. bags, \$1.25; \$2.50 per large bale.

SUNDRIES

(Continued)

- Moss (Sphagnum, live).** Pk., 40c.; \$1.25 per bu.; bbl., \$3.00.
- Pearl Chips.** For bulb bowls, aquariums, etc. White or colored. Per 1 lb. pkg., 15c. (by P. P., 25c.); 85c. per 6 pkgs.; 12 pkgs., \$1.60.
- In bulk, white, 5 lbs., 75c.; \$1.25 per 10 lbs. Colored, 5 lbs., 85c.; \$1.50 per 10 lbs.
- Peat or Leaf Mould.** Pk., 45c.; \$1.25 per bu.; bbl., \$3.00.
- Peat (Orchid).** Pk., 50c.; \$1.60 per bu.; bbl. bag, \$3.25.
- Pebbles.** Qt., 10c.; 75c. per pk.; bu., \$2.50; \$5.00 per bbl. sack.
- Pruning Compound or Tree Dressing (Fraims).** Per qt., 50c.; \$1.50 per gal.
- Sand.** For propagating. Per qt., 10c.; 40c. per pk.; bu., \$1.40; \$3.00 per bbl. sack.
- Shaderine.** For shading greenhouse glass. 5 lbs., \$1.50; \$2.75 per 10 lb. can.
- Soil.** For potting. Qt., 10c.; 25c. per ½ pk.; pk., 40c.; \$1.50 per bu.; bbl. bag, \$3.25.
- Tin Foil (Plain).** In 5 and 6 inch widths, 1 lb. pkgs., 20c. (by P. P., 30c.); 5 lbs. for 90c. (by P. P., \$1.05); 5 inch width in 5 lb. rolls, \$1.00 (by P. P., \$1.15). Green or violet in 1 lb. pkgs., 35c. (by P. P., 45c.).
- Toothpicks.** Wired, 50c. per 1000; 10,000, \$3.50.
- Toothpicks.** 4 inch, wired, green; per 1000, \$1.00; \$4.00 per 4500.
- Toothpicks.** 6 inch, wired, green; per 1000, \$1.20; \$3.30 per 3000.
- Weed Killer (Michell's).** Qt., 50c.; \$1.50 per gal.; 5 gals., \$6.25; \$30.00 per 30 gals.; 50 gals., \$42.50.



PHILADELPHIA STONE FOUNT

Considered one of the best Poultry Founts, especially in hot weather, as they will keep the water cool for a long time. They are easily filled and can be kept clean without much trouble. Endorsed by many successful poultrymen. One quart size, 40c.; half gallon size, 60c.; 1 gallon size, 75c. each.

MOE'S TOP-FILL CLEANABLE FOUNTAINS

Made of heavy galvanized steel with double walls; keeps the water cool in Summer and retards freezing in Winter.

No.	Capacity	Each
1	1 gallon.....	\$1.40
2	2 gallon.....	2.15



Moe's Fountain



Moe's Fountain

OAKES HANDY HOPPER

Made of galvanized steel; hinged lids over both hopper and trough. No. H-15. 36 in. long, 5 compartments, \$4.00 each.



KEEP WARM THERMO FOUNTAIN

For Chicks or Hens

Insulating jacket or outer tank is an inch thick all the way down; the top is insulated; there is also a complete layer of insulation, as well as a dead air space below and all around the water in the pan. Water heated to 110 degrees will not freeze in this fountain in very severe weather. The inner tank is soldered to the base.



No.	Capacity	Price
3	3 gallons.....	\$4.00
5	5 gallons.....	5.00

See page 184 for list of books on Poultry, Bees, Pigeons, and Birds.

MOE'S LARGE CAPACITY FEEDER

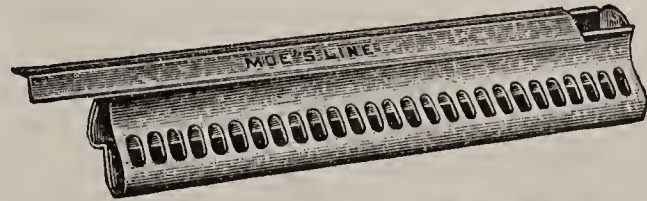

No. 140. Capacity, 10 quarts, length, 21 in.; width, 8½ in.; height, 7 in.; 16 openings on each side; galvanized

steel; sliding top cover. \$1.25 each.

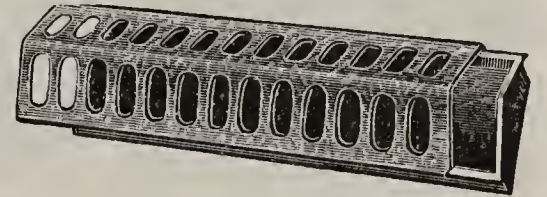

MOE'S IMPROVED DOUBLE CHICK FEEDER

Made of galvanized steel; sliding top.

No.	Length	No. of holes	Each
58	12	18	\$0.30
59	18	26	.50
60	24	36	.65



Eagle Style Egg Box

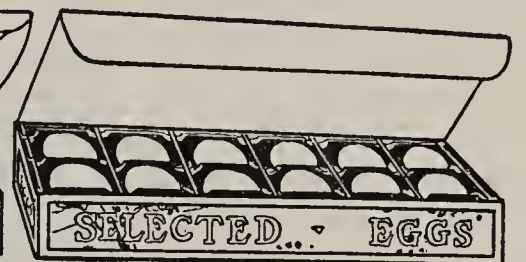

Suwanee Egg Box

PAPER EGG BOXES (1 Doz. Cap.)

Suwanee Paper Egg Cartons. For delivering table eggs; capacity one dozen each. Made of heavy cardboard; oblong shape. 30c. per doz. (by P. P., 40c.); 25 for 50c. (by P. P., 60c.); \$1.75 per 100; per 1000, \$15.50.

Eagle Style. Light weight cardboard, 20c. per doz. (by P. P., 25c.); 25 for 35c. (by P. P., 45c.); \$1.00 per 100; per 1000, \$9.00.

Printing of Egg Boxes. \$3.00 per 1000.

METAL EGG SHIPPING BOX

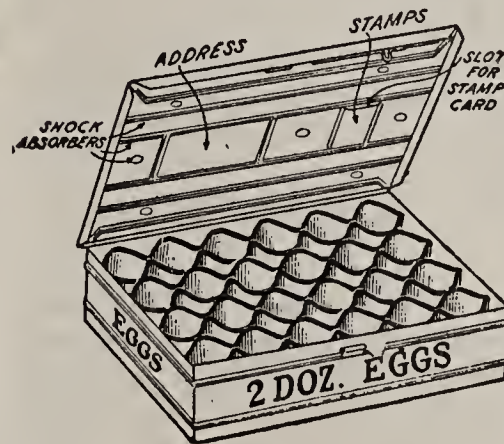

This is the ideal, indestructible box for forwarding household eggs by parcel post or express; can be used indefinitely.

Capacity	Each
2 dozen capacity....	\$1.25
3 dozen capacity....	1.50
4 dozen capacity....	1.75
6 dozen capacity....	2.00
9 dozen capacity....	2.50
12 dozen capacity....	3.00

If wanted by parcel post, add 15c. per box for mailing.

SEARCHLIGHT EGG TESTER

A portable, electric tester; speedy, accurate, easy to operate; the tester is moved over the eggs, instead of the eggs over the tester, not only saving the handling of the eggs, but the light penetrates at the top where the germ rests. Price, \$3.50.



THE HOME HATCHER HOVER



Especially designed to meet the requirements of the raiser of a small flock of poultry. Substantially built and of fireproof construction throughout. With the exception of the legs, the entire hover, including the lamp, is made of heavy galvanized iron. It is fitted with a lamp for which a separate housing is provided. An ideal hover for baby chicks. Capacity, 50 chicks. Price, \$6.00.

"MICHELL'S" SETTING AND BROOD COOPS

For a hen and her chicks or while she is setting. Gives protection from rats, skunks, hawks and other enemies. Insures larger hatches—fewer broken eggs. This coop is just the thing for colony raising and has proved its success for many years. Shipped knocked down.

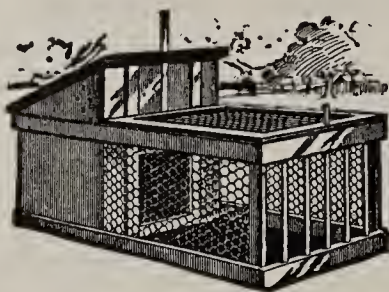

Brood Coop

	Length incl. Yard	Width	Height of Coop	Floor Space of Coop	Each
Large.....	49 in.	22 in.	23 in.	18½ x 18½ in.	\$6.50

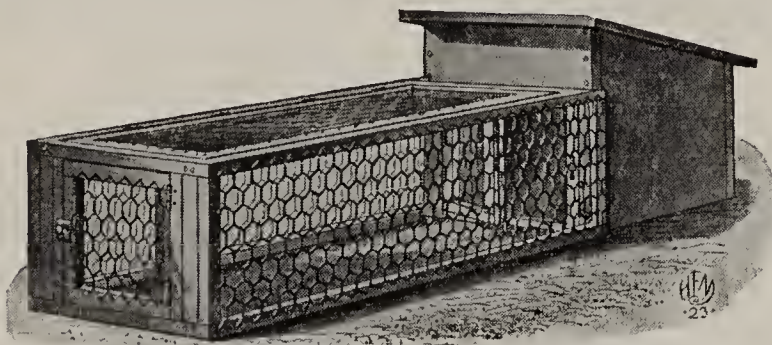

FARM BROOD COOP

A big, roomy coop that will accommodate a bunch of chicks. Well ventilated; substantially made; shipped knocked down. Made from grooved and tongued lumber, not painted. It is 21 inches wide, 22 inches from front to back, 22 inches high in front, 14 inches high in back. The roof is hinged. Then there is a wire run 38 x 21 x 16 inches. The top is hinged. Price, complete, \$6.00.

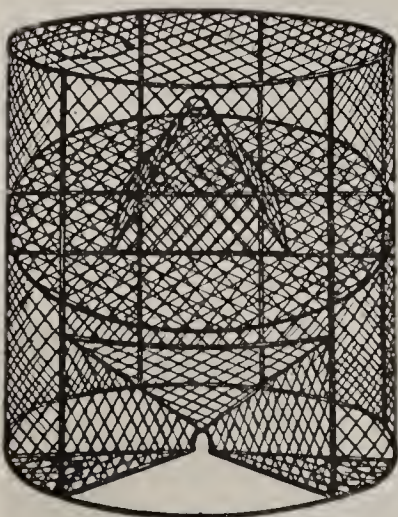

SPARROW TRAP

(Wire)

We have tried this out and found it to be the best trap made. Scatter a little cracked corn and set the trap right over it. You'll be surprised at the catch. \$6.00 each (by P. P., \$6.40).

A complete line of Poultry Foods will be found on page 172.

CHICK BOXES

Made of corrugated paper; extensively used; will carry chicks any distance with perfect safety. Are shipped knocked down and take up a small amount of space.

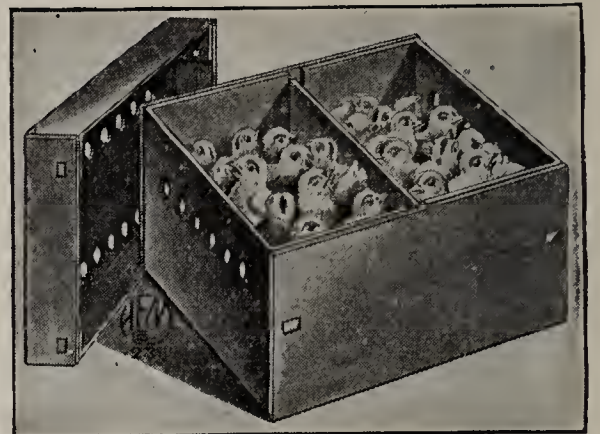

If wanted by parcel post, add 5c. each or 30c. per doz. for postage.

Capacity	Size	Each	Doz.
25 Chicks.....	12 x 6 x 5.....	\$0.25	\$2.00
50 Chicks.....	12 x 12 x 5.....	.30	2.50
100 Chicks.....	24 x 12 x 5.....	.40	3.50

GATE TRAP NEST FRONT

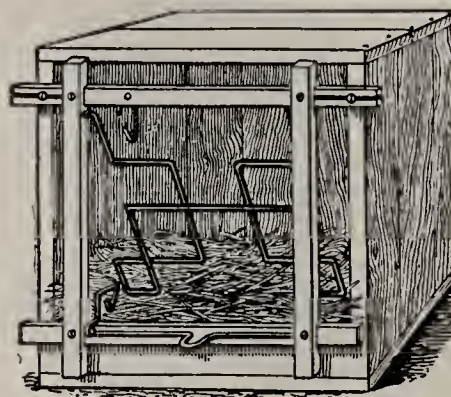

A trap worked entirely by the hen, arresting it every time it enters the nest. Of simple construction; cannot get out of order; must last a lifetime; will never frighten a hen. If you use trap nests you can tell which hens are layers and which are drones.

We furnish fronts only, attachable to a square box of suitable size. Each, 75c. (by P. P., 90c.); \$8.50 per doz. (by P. P., \$8.80).

COLLINS OAT SPROUTER

The most practical, quickest growing, perpetual, sectional and fireless Oat Sprouter. The Collins Sprouter is made in units, light individual pans, one pan for each day of the week and a drip pan at the bottom.

The production of eggs and the proper development of growing stock depend upon some form of "green stuff," something that is growing, that has life in it. The feeding of sprouted oats is no longer an experiment. Experience has proven time and again its value as a food for stimulating egg production. Oats sprouted in the right manner furnish food most nearly akin to the fresh green growth of Springtime, the prolific laying time of the year.

No. 1—8 Pan 11 x 15 inch.....	\$3.75
No. 2—5 Pan 11 x 15 inch.....	2.50
No. 3—8 Pan 11 x 32 inch.....	7.00

If wanted by parcel post, add 30c. each for postage.

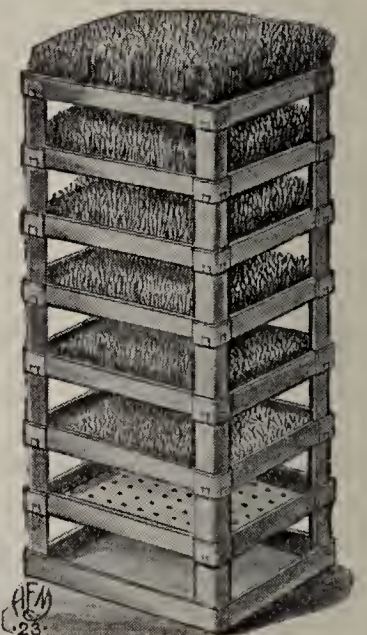

SALT BRICKS

For dairy cows, horses and other animals. Essential to general good health in stables; fastened on the wall it is accessible at all times and remains clean. Per brick, 25c. (by P. P., 35c.); \$2.75 per dozen.

Salt Brick Holders, 45c. each (by P. P., 60c.); doz., \$4.75.

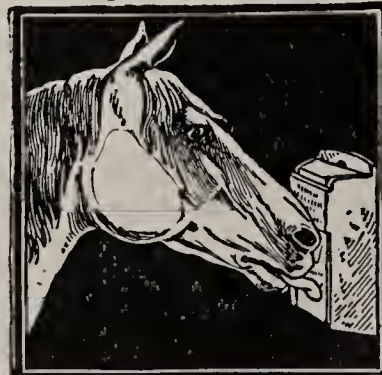

Richmond Butter Churn

First quality white cedar, carefully finished, easily cleaned. You can make butter according to the amount of milk or cream on hand.

	Each	By P.P.
No. 1. 3 gals.....	\$4.25	\$4.50
No. 2. 4 gals.....	5.00	5.50
No. 3. 7 gals.....	5.50	6.00



Butter Churn

See page 174 for complete line of Bird Houses.

THE NEW 1934 MODEL SOL-HOT BROODER

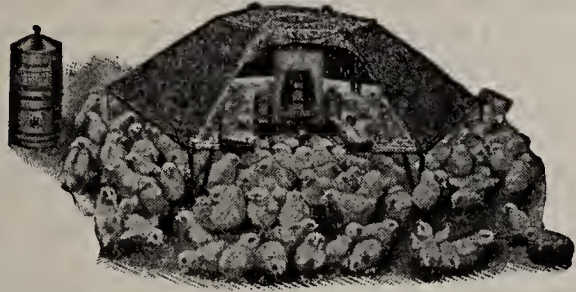

Sol-Hot is the only brooder on the market that has a different size burner for each size canopy. It costs more to build them this way, but it means economy for you.

You take no risk when you order a Sol-Hot

If you are thinking of buying a brooder this season, by all means buy a Sol-Hot—it means so much to you in the way of saving of labor and better results in the rearing of your chicks.

You may be able to buy a brooder that costs a little less money, but based on the better value you get—the more chicks you will raise—the freedom from trouble—the elimination of fire hazard—Sol-Hot is by far the cheapest brooder in the long run.

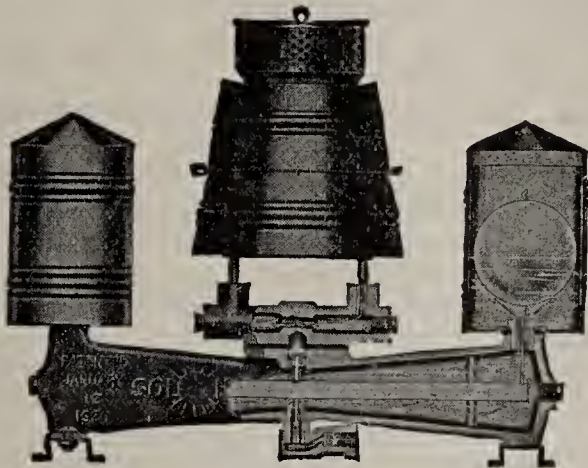

It's the Twin Float Automatic Oil Level Control

Sol-Hot, with its many years of undisputed leadership, once more steps "Way out in front" this season with the greatest invention ever made for oil-burning Brooders. The patented TWIN-FLOAT Oil Level entirely eliminates the trouble and bother of having to level up the brooder in order to get it to burn properly. Equipped with the New Twin-Float Oil Level, the Sol-Hot Brooder can be set anywhere, regardless of uneven floor conditions. Comes assembled, ready for immediate operation. No leveling of any kind needed.

100 Per Cent Safe

No danger from fire—no trouble—no worry. All you have to do is put oil in container, prime and light the burner, and turn flame control valve—like knob on gas stove—to height desired. The oil container is connected to the burner with copper tubing. It can be set anywhere, on the floor, on a shelf, high or low—it makes no difference. Burner cannot overflow—cannot go out—the Twin-Float absolutely prevents it. Operating a Sol-Hot is as simple as using a gas stove.

Prices

Baby, 24-inch Canopy, broods 100 chicks.....	\$11.50
Standard, 34-inch Canopy, broods 250 chicks.....	16.00
Standard, 44-inch Canopy, broods 500 chicks.....	18.00
Standard, 54-inch Canopy, broods 1000 chicks.....	20.00

Complete descriptive circular on Sol-Hot Brooders free on request.

PILLING CAPONIZING SETS

The operation of caponizing is very simple and is easily performed with the instruments contained in these caponizing sets. The instructions sent with each are so complete and explicit that any person, after a careful reading of same, will be able to perform the operation.

Lansdowne, No. 1.....	Each \$5.00
Farmers.....	3.50
Philadelphia.....	5.00

SOL-HOT ELECTRIC BROODER

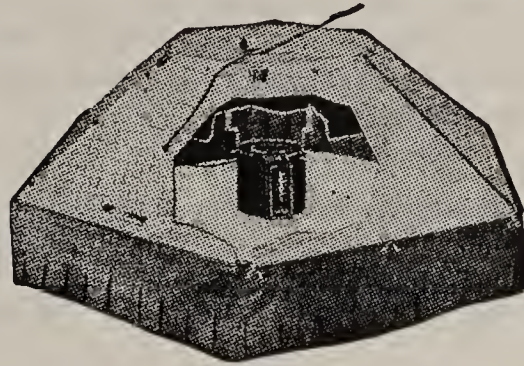

Just plug into any electric light socket, set the temperature control on the Sol-Hot Electric Brooder at the temperature desired, turn on the electricity and that's all there is to it. The Sol-Hot Electric will give you the temperature desired day in and day out—week after week and month after month without atten-

tion. No ashes to carry or sweep up, no refueling every day, and, best of all, chicks are kept warm and comfortable in an atmosphere that is pure and fresh.

Prices

SH85—34 in. Canopy; capacity, 250 to 300 chicks.....	\$16.00
SH90—44 in. Canopy; capacity, 500 chicks.....	18.00
SH95—54 in. Canopy; capacity, 1000 chicks.....	20.00

EUREKA COAL STOVE BROODER

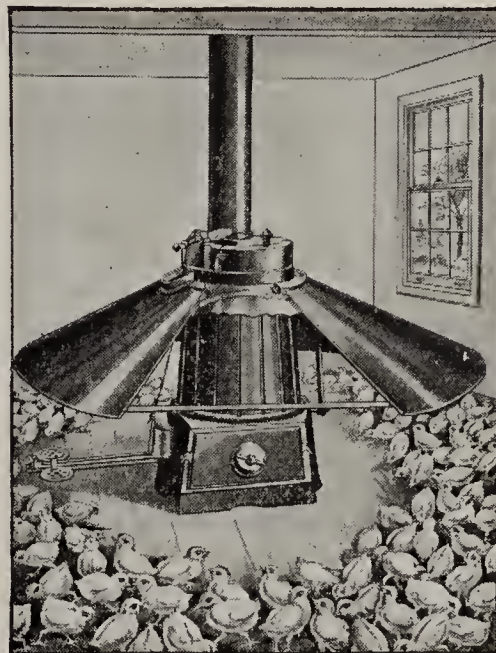

This type has a corrugated fire pot claimed to be gas proof; is self regulating and the manufacturer claims you can operate it at a cost of 5 cents per day. It requires no attention except coaling once in 24 or 48 hours according to weather. Made in two sizes:

No. 11, weight 95 lbs., for brooding 500 chicks, \$14.00.

No. 22, weight 117 lbs., for brooding 1000 chicks, \$17.50.

PUTNAM BROODER HEATER

This can be used in any home-made brooder. The heater acts like an open fireplace, carrying the foul air out and drawing the fresh air in, thus providing perfect ventilation automatically. Heat is radiated from above onto the backs of chicks, giving the natural and soothing effect of the hen, without the lice. Made of brass and galvanized iron and is practically indestructible. Price of heater, \$4.75 (by P. P., \$5.00).

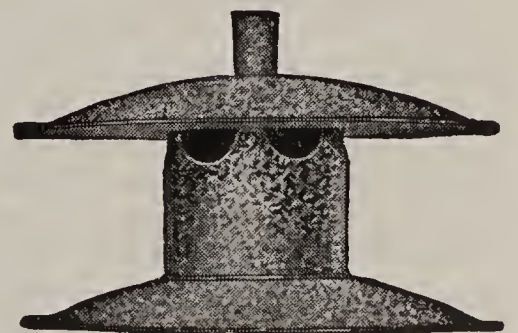

LITTLE PUTNAM STOVE

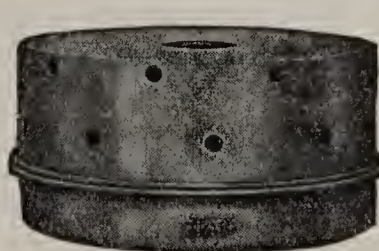

This is used under the drinking vessels of the poultry house to keep the water from freezing in the coldest Winter weather. The stove is nine inches in diameter and four inches high; made of galvanized iron and equipped with a burner. The oil tank holds three pints of oil and burns three to four weeks without refilling or any other attention; the wick never needs trimming. Price, \$2.00 (by P. P., \$2.15).

If Poultry Foods are wanted by Parcel Post, add for postage as follows: 10c. for 1 lb.; 15c. for 5 lbs.; 20c. for 10 lbs. to the first and second zones; for other zones see parcel post table page 1. Larger quantities by express or freight.

Prices of Poultry Food fluctuate constantly and are subject to change.

For Bird Seeds and Supplies see Page 173.

Alfalfa Hay. 5 lbs., 25c.; 40c. per 10 lbs.; 25 lbs., 75c.; \$2.50 per 100 lbs.

Barley. Per qt., 10c.; 25c. per 4 qts.; pk., 40c.; \$1.50 per bu.

Bone (Coarse Ground). 5 lbs., 35c.; 60c. per 10 lbs.; 25 lbs., \$1.25; \$4.00 per 100 lbs.

Bone (Fine Grade). 5 lbs., 35c.; 60c. per 10 lbs.; 25 lbs., \$1.25; \$4.00 per 100 lbs.

Bran (Wheat). 5 lbs., 20c.; 35c. per 10 lbs.; 25 lbs., 70c.; \$1.25 per 50 lbs.; 100 lbs., \$2.25.

Broken Rice. Per lb., 15c.; 50c. per 5 lbs.; 10 lbs., 85c.; \$1.50 per 25 lbs.; 50 lbs., \$2.80; \$4.50 per 100 lbs.

Buckwheat. Per qt., 15c.; 40c. per 4 qts.; pk., 65c.; \$2.00 per bu.

Canada Peas. Per qt., 20c.; 55c. per 4 qts.; pk., \$1.00; \$3.75 per bu.



Cat Food (Spratt's). Saves the necessity of especially preparing food for tabby. Small carton, 20c.; 35c. per large carton.

Catnip Balls. A plaything and tonic for pussy. 20c. each.

Charcoal. Two grades, fine and coarse. 5 lbs., 35c.; 60c. per 10 lbs.; 25 lbs., \$1.00; \$3.50 per 100 lbs.

Chicgrain (Spratt's). 5 lbs., 35c.; 65c. per 10 lbs.; 25 lbs., \$1.50; \$5.50 per 100 lbs.

Chick Food (Michell's). 5 lbs., 30c.; 50c. per 10 lbs.; 25 lbs., 90c.; \$2.75 per 100 lbs.

Chick Food (Park and Pollard). 5 lbs., 30c.; 50c. per 10 lbs.; 25 lbs., \$1.00; \$3.00 per 100 lbs.

Chick Food with Buttermilk (Pratt's). Per 2½ lbs., 25c.; 50c. per 5¾ lbs.; 10 lbs., 85c.; \$1.50 per 25 lbs.; 50 lbs., \$2.80; \$4.50 per 100 lbs.

Chick Meal (Spratt's Nos. 3, 5 and 12). 5 lbs., 65c.; \$1.25 per 10 lbs.; 25 lbs., \$3.00; \$5.75 per 50 lbs.; 100 lbs., \$11.00.

Conkey's Poultry Tonic. To induce the hen to lay more and larger eggs. 25c. per 1½ lb. pkg. (by P. P., 35c.).

Conkey's Starting Food for Baby Chicks. 5 lbs., 45c.; 80c. per 10 lbs.; 25 lbs., \$1.50; \$4.75 per 100 lbs.

Conkey's Y-O. Yeast with cod-liver oil in powder form. Insures vitamins. Per lb., 50c.; 90c. per 2 lbs.; 5 lbs., \$1.60.

Corn Meal (Special Process). 5 lbs., 25c.; 40c. per 10 lbs.; 25 lbs., 85c.; \$1.50 per 50 lbs.; 100 lbs., \$2.50.

Cracked Corn. 5 lbs., 25c.; 40c. per 10 lbs.; 25 lbs., 75c.; \$1.25 per 50 lbs.; 100 lbs., \$2.00.

Cut Clover Hay. 5 lbs., 25c.; 45c. per 10 lbs.; 25 lbs., \$1.00; \$1.75 per 50 lbs.; 100 lbs., \$3.25.

Developing Food (Michell's). 5 lbs., 30c.; 50c. per 10 lbs.; 25 lbs., 90c.; \$2.75 per 100 lbs.

Gluten Meal. 5 lbs., 25c.; 45c. per 10 lbs.; 25 lbs., 85c.; \$1.50 per 50 lbs.; 100 lbs., \$2.50.

Grit. Fine, medium and coarse. 5 lbs., 15c.; 25c. per 10 lbs.; 25 lbs., 50c.; \$1.50 per 100 lbs.

Grit (Red Cross Health). For pigeons. 5 lbs., 20c.; 35c. per 10 lbs.; 25 lbs., 65c.; \$2.25 per 100 lbs.

Ground Oats. 5 lbs., 30c.; 50c. per 10 lbs.; 25 lbs., \$1.00; \$3.00 per 100 lbs.

Growing Food (Park and Pollard). 5 lbs., 30c.; 50c. per 10 lbs.; 25 lbs., \$1.10; \$3.25 per 100 lbs.

Hemp Seed. Per lb., 15c.; 70c. per 5 lbs.; 10 lbs., \$1.25; \$2.50 per 25 lbs.

Hulled Oats. 5 lbs., 25c.; \$1.10 per 25 lbs.; 50 lbs., \$2.00; \$3.50 per 100 lbs.

Kaffir Corn. Per lb., 15c.; 40c. per 5 lbs.; 10 lbs., 65c.; \$1.25 per 25 lbs.; 50 lbs., \$2.00; \$3.50 per 100 lbs.

Linseed Meal. Lb., 20c.; 75c. per 5 lbs.; 10 lbs., \$1.00; \$2.00 per 25 lbs.; 100 lbs., \$6.00.

Mash Food (Laying Buttermilk). 5 lbs., 30c.; 45c. per 10 lbs.; 25 lbs., 90c.; \$2.90 per 100 lbs.

Mash Food (Park and Pollard). 5 lbs., 30c.; 50c. per 10 lbs.; 25 lbs., \$1.10; \$3.25 per 100 lbs.

Mash Food (Growing Buttermilk). 5 lbs., 30c.; 50c. per 10 lbs.; 25 lbs., \$1.00; \$3.00 per 100 lbs.

Meat (Prepared). 5 lbs., 35c.; 60c. per 10 lbs.; 25 lbs., \$1.25; \$2.00 per 50 lbs.; per 100 lbs., \$3.75.

Middlings. 5 lbs., 25c.; 45c. per 10 lbs.; 25 lbs., 85c.; \$1.50 per 50 lbs.; 100 lbs., \$2.75.

Millet. 5 lbs., 45c.; 75c. per 10 lbs.; 25 lbs., \$1.50; \$5.00 per 100 lbs.

Oat Meal (Pin Head). 5 lbs., 30c.; 50c. per 10 lbs.; 25 lbs., \$1.10; \$2.00 per 50 lbs.; 100 lbs., \$3.75.

Oyster Shells. Fine and coarse. 5 lbs., 15c.; 30c. per 10 lbs.; 25 lbs., 50c.; \$1.50 per 100 lbs.

Pan-a-min (Drs. Hess and Clark). 3 lbs., 50c.; \$1.00 per 7 lbs.; 15 lbs., \$2.00.

Pheasant Meal (Spratt's). No. 12 Fine; No. 5 Coarse. 5 lbs., 75c.; \$1.35 per 10 lbs.; 25 lbs., \$3.00; \$5.75 per 50 lbs.; 100 lbs., \$11.00.



Pigeon Food. 5 lbs., 30c.; 50c. per 10 lbs.; 25 lbs., \$1.10; \$3.50 per 100 lbs.

Poultry Food (Spratt's No. 3). 5 lbs., 75c.; \$1.35 per 10 lbs.; 25 lbs., \$3.00; \$11.00 per 100 lbs.

Poultry or Scratch Food (Michell's). 5 lbs., 25c.; 40c. per 10 lbs.; 25 lbs., 85c.; \$2.50 per 100 lbs.

Poultry or Scratch Food (Park and Pollard). 5 lbs., 30c.; 50c. per 10 lbs.; 25 lbs., \$1.00; \$2.75 per 100 lbs.

Pratt's Poultry Regulator. Price, 24 oz., 25c. (by P. P., 35c.); 50c. per 4 lbs. (by P. P., 65c.); 12 lb. pkg., \$1.40 (by P. P., \$1.70); 25 lbs., \$3.00; \$10.00 per 100 lbs.

Sunflower Seed. Per lb., 15c.; 40c. per 3 lbs.; 5 lbs., 65c.; \$1.25 per 10 lbs.; 25 lbs., \$3.00.

SPRATT'S DOG FOODS



Spix. A bone-sized biscuit for small breeds. 31 oz. size, 35c.; 85c. per 5 lbs.; 10 lbs., \$1.50; \$3.50 per 25 lbs.; 50 lbs., \$6.75.

Ovals. A miniature biscuit for small breeds. 26 oz. size, 35c.; 85c. per 5 lbs.; 10 lbs., \$1.60; \$3.50 per 25 lbs.; 50 lbs., \$6.75.

Fibo. A granulated food. 2 lbs., 40c.; 90c. per 5 lbs.; 10 lbs., \$1.70.



Miniature samples of the above can be supplied on request. Illustrated booklet of 56 pages on "Care and Feeding of Dogs" free.

Parcel Post charges where named are for shipment to the first and second zones; for other zones see parcel post table, page 1.



Carbola. An improvement on white-wash, combining the features of a cold water paint and disinfectant; will not rub or chip; not a lime product. 75c. per 5 lbs.; 10 lbs., \$1.25; \$3.00 per 25 lbs.; 50 lbs., \$5.00.

Carbolineum. A poultry house disinfectant, louse and mite destroyer; insures absolute riddance of the pests if applied but twice a year. Excellent for preserving wood against rot and decay; in gallon cans only. \$1.50 per gal.; 5 gals. for \$7.00.

Chemo. A liquid lice killer that will not discolor the plumage of white poultry. Per gal., \$2.00.

Conkey's Nox-i-side. A germ destroyer, which will keep the poultry house in a pure, sanitary condition, destroy all germs and drive out the lice and mites. 50c. per pt.; qt., 80c.; \$1.30 for 2 qts.; gal., \$2.00.

Conkey's Old Reliable Powder. An excellent roup remedy; can be given in the drinking water. 25c., 50c. and \$1.00 per box (by P. P., add 10c. extra).

Conkey's Poultry Worm Remedy. 25c. and 50c. per pkg. (by P. P., add 10c. extra).

Death to Lice (Lambert's). For dusting fowls and nests. The most effective chicken lice exterminator in existence. 25c. for 15 ozs. (by P. P., 35c.); 48 ozs., 50c. (by P. P., 65c.); \$1.00 per 100 oz. pkg. (by P. P., \$1.20).

Death to Lice Ointment (Lambert's). A salve or ointment used on the heads of newly-hatched chicks. It drives away lice instantly. 10c. and 25c. per box (by P. P., add 10c. extra).

Gape Worm Extractor. *Pilling*, made entirely of German silver, 25c. each.

Germozone. The standard remedy for the prevention and cure of most every ill that affects poultry, such as roup, cholera, bowel complaint, diarrhoea, sore head, gapes, etc. In tablet form, 75c. (by P. P., 85c.).

Pratt's Disinfectant. For dipping and spraying poultry and stock. Pt., 35c.; 50c. per qt.; 1/2 gal., 85c.; \$1.45 per gal.; 5 gals., \$6.50.

Pratt's Gape Compound. For external use. 50c. per pkg.

Pratt's Powdered Lice Killer. For dusting nests, fowls, chicks, etc.; quickly kills the lice. 25c. and 50c. per box (by P. P., add 10c. extra).

Pratt's R. P. Tablets. For roup, canker, catarrh and diphtheria. As a preventative it is unsurpassed. 25c. and 50c. per box (by P. P., add 10c. extra).

Pratt's Poultry Worm Powder. 50c. per pkg. (by P. P., add 10c. extra).

Pratt's Sore Head Chicken Pox Preparation. A sure, rapid cure for the dreaded disease known as sore head or chicken pox. 60c. per pkg. (by P. P., add 10c. extra).

Pratt's Chick Tablets. For baby chicks; keep the germs of the disease from becoming active by using this remedy. 25c. and 50c. (by P. P., add 10c. extra).

Pratt's N. K. Capsules (Poultry Worm Capsule). Pkg. for adult fowls, 90c.; pkg. for chicks, 50c.

Pratt's Special Compound. A preparation for cholera. 50c. per pkg.

Roup Syringe (Pillings). For administering liquid roup remedies in the nostrils or throat. Price, 60c. each.

Spratt's Dog Soap. Entirely free from poison, and at the same time most effective in the destruction of lice and fleas. 25c. per cake (by P. P., 35c.).

Sulphur Candles. 20c. each (by P. P., 25c.); doz., \$1.65.

Tobacco Dust. For dusting on roosts, nests, etc., to keep away vermin. Carton with sifter top, 25c.; 5 lbs. for 35c.; 60c. for 10 lbs.; 25 lbs., \$1.25; \$2.00 per 50 lbs.; 100 lbs., \$3.50.

Tobacco Stems. For making nests, etc. 1 lb., 10c.; 30c. for 5 lbs.; 10 lbs., 50c.; \$1.00 per 25 lbs.; large bales of about 250 lbs., at 2c. per lb.; per 1/2 ton, \$15.00; \$27.50 per ton.

Zenoleum Liquid. Dilute one part Zenoleum to one hundred parts water. It is non-poisonous and is not irritating or inflammable. Should be used freely around barns and poultry houses. Zenoleum is a concentrated solution of coal tar. It is mixed with hot or cold water, making a perfect emulsion that requires no boiling or stilling. 8 ozs., 35c.; 50c. per pt.; qt., 75c.; \$1.25 per 1/2 gal.; gal., \$2.00; \$9.50 per 5 gals.

MICHELL'S RECLEANED BIRD SEEDS, PET SUPPLIES, ETC.

If Bird Seeds, etc., are wanted by Parcel Post, add for postage as follows: 10c. for 1 lb.; 15c. for 5 lbs.; 20c. for 10 lbs.

Bird Manna. Keeps Canary birds in prime condition and prevents the loss of song. Pkg., 15c.

Canary Seed (Plain Sicily). Recleaned and of splendid quality. Per lb., 20c.; 85c. per 5 lbs.; 10 lbs., \$1.50; \$3.25 per 25 lbs.

Canary Seed (Mixed). A mixture of the finest quality and in proper proportions. Per lb., 20c.; 90c. per 5 lbs.; 10 lbs., \$1.50; \$3.25 per 25 lbs.



Catnip Balls. A plaything and tonic for pussy. 20c. each.

Cuttle Fish Bone. Good for digestion and general health. Each, 5c.; 20c. per 1/4 lb.; per lb., 60c.

Cuttle Fish Bone. With holder for fastening to cage. 10c. each.

Fish Food. Granular and wafer form. Per pkg., 10c.

Hemp Seed. Birds are very fond of this seed; it is rich and should be fed with discretion. Lb., 15c.; 5 lbs., 70c.; 10 lbs., \$1.25; \$2.50 per 25 lbs.

Lettuce Seed. A slight sprinkle of this is much relished by canaries. Oz., 10c.; 1/4 lb., 20c.; 50c. per lb.

Maw Seed. Calculated to improve the song of canaries, etc. Lb., 30c.; \$1.25 per 5 lbs.

Millet Seed. Recleaned seed; nutritious and appetizing. Lb., 15c.; 5 lbs., 60c.; 10 lbs., \$1.00.

Thistle Seed. Per 1/2 lb., 25c.; 45c. per lb.; 5 lbs., \$2.00; \$3.75 per 10 lbs.; 25 lbs., \$8.75

Parrot Food (Spratt's). Small pkg., 20c.; large pkg., 30c.

Rape Seed. Will keep the birds in excellent condition; feed with canary seed. Lb., 15c.; 5 lbs., 70c.; 10 lbs., \$1.25.

Sand. For bird cages. Red, fine. Pkg., 10c.; \$1.00 per doz. pkgs.

Sand. Silver, fine. Pkg., 10c.; \$1.00 per doz. pkgs.

Sand or Gravel. Silver, coarse; for parrots' cages. 10c. per pkg.; doz. pkgs., \$1.00.

Song Restorer. For canaries, 25c. per bottle; doz., \$2.50.

Spratt's Sing Song. A tonic and song restorer. Pkg., 25c.

Sunflower Seed. We are very large handlers of this important food for parrots. Our customers may depend upon getting a very choice article. 15c. per lb.; 3 lbs., 40c.; 65c. per 5 lbs.; 10 lbs., \$1.25; \$3.00 per 25 lbs.

Unhulled Rice. Lb., 20c.; 5 lbs., 75c.; 10 lbs., \$1.40.

Wild Bird Seed Mixture. Lb., 20c.; 80c. per 5 lbs.; 10 lbs., \$1.50; \$3.00 per 25 lbs.; 100 lbs., \$10.00.

Prices on Bird Seed in large quantities quoted on application.



MICHELL'S RUSTIC AND ORNAMENTAL BIRD HOUSES

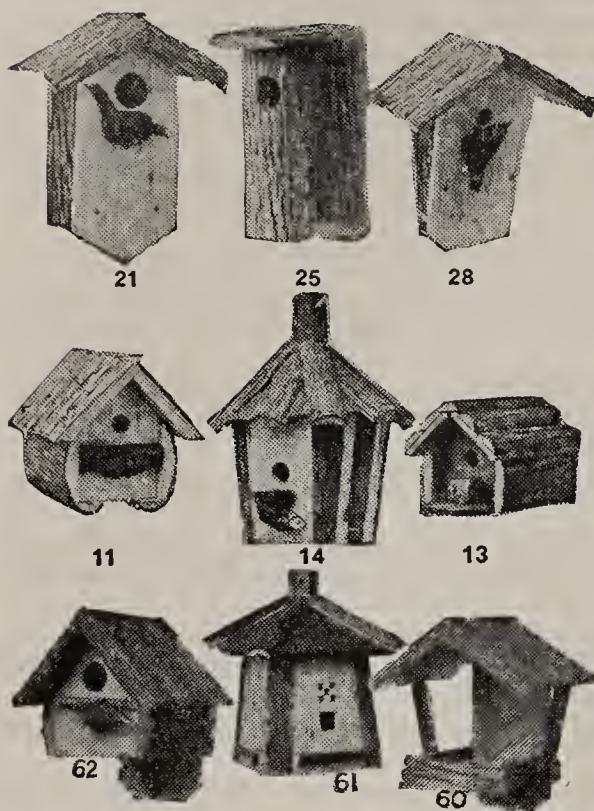

No.	Description	Price Each	P. Post Each
8.	Martin House. 14 room (not mailable)....	\$18.00	
11.	Wren House.....	1.75	\$2.00
12.	Wren House.....	1.75	2.00
13.	Wren House.....	1.75	2.00
14.	Wren or Bluebird House.....	2.00	2.25
17.	Wren House.....	1.75	2.00
21.	Bluebird House.....	1.75	2.00
23.	Wren House.....	1.75	2.00
24.	Wren House.....	1.75	2.00
25.	For Woodpeckers, Chickadees, Nut Hatches, etc.....	1.75	2.00
28.	Wren House Beautiful.....	2.00	2.25
50.	Wren House. Swinging.....	1.75	2.00
60.	Robin House.....	1.75	2.00
61.	Wren House. Swinging.....	1.75	2.00
62.	Bluebird House.....	1.75	2.00
63.	Wren and Robin House.....	2.00	2.20
65.	Maryland Wren Box.....	.50	.70
77.	Martin House. 4 room.....	5.00	5.60
81.	Squirrel House.....	5.50	5.90
104.	Rustic Seed Feeder.....	2.50	2.75
105.	Rustic Suet Feeder.....	1.50	1.70
107.	Weathervane Feeder.....	5.50	5.80
110.	Combination Shelter.....	2.25	2.50

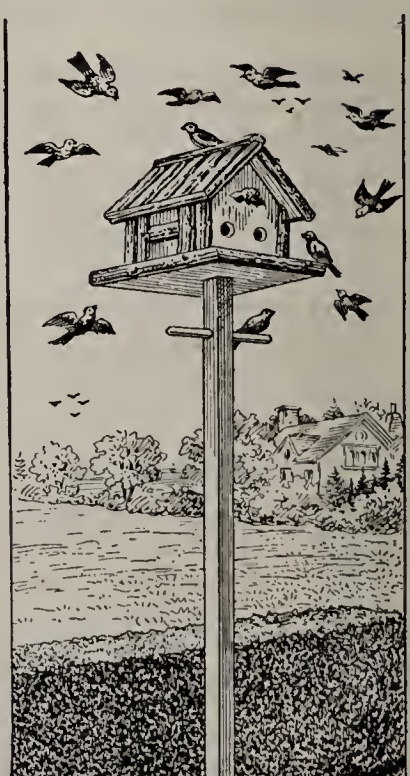
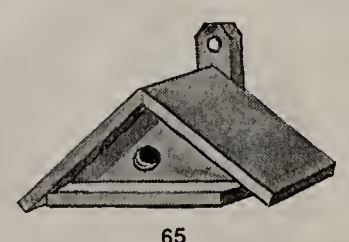
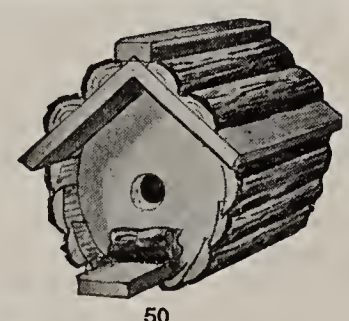
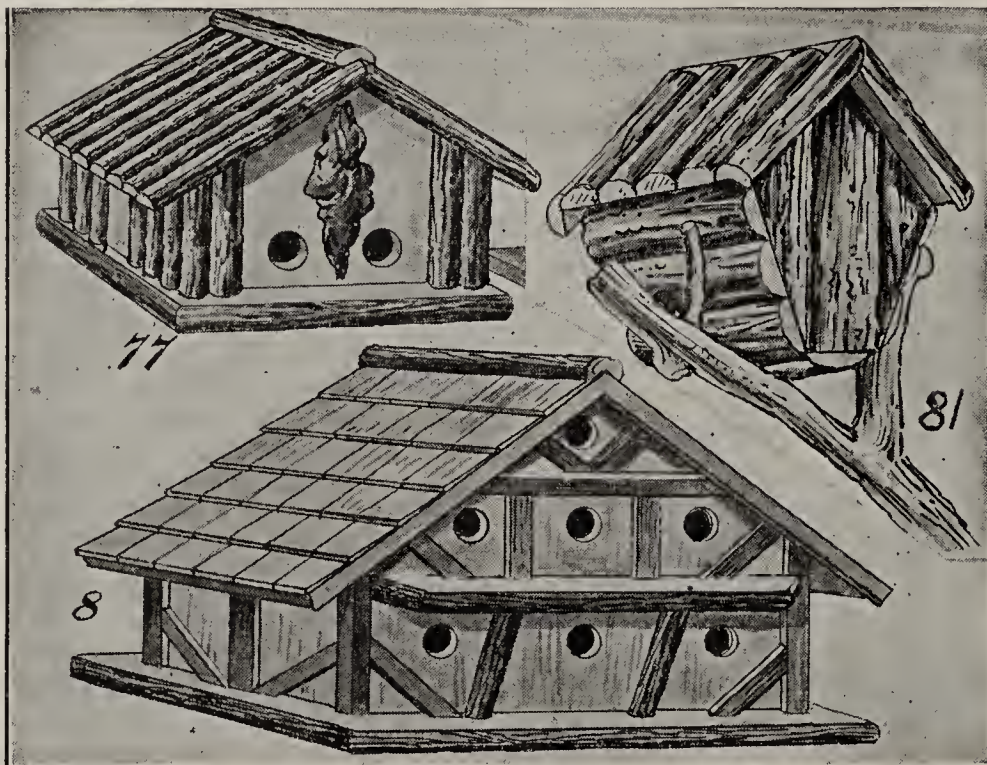
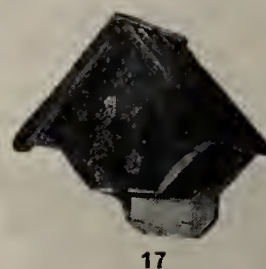

Revolving Feed Box
 This bird feeder, the most popular American type, with its glass end always faces the wind so that the large open end is protected from storms. Size, 24 by 36 inches. Furnished with an iron pole, 7 feet long. Price, \$10.00.
 Smaller size of above, with wood pole, \$6.50.

Parcel Post charges are for shipment to the first and second zones; for other zones, see parcel post table, page 1.

MICHELL'S WEED KILLER



Positively destroys every kind of weed and vegetation wherever applied. One application is usually required yearly; add 40 gallons of water to one gallon of weed killer, then sprinkle the solution upon the vegetation you wish destroyed.



One gallon will cover 150 sq. yds.; can be applied any time. It will do better work with less labor than the old way.



Just the thing for driveways, clay tennis courts, baseball diamonds, drives and walks where you want no weeds.

Weed Killer cannot be used in the garden, flower beds or on the lawn where you want to grow plants and grass.

Qt.	\$0.50	30 gals.	\$30.00
Gal.	1.50	50 gals.	42.50
5 gals.	6.25		

Weed Killer is not mailable

CLIMAX LAWN SAND

Kills Weeds in the Lawn Without Injury to the Grass

A combination of finely ground chemicals, which, when sprinkled over the grass, possess the remarkable property of destroying Moss, Chickweed, Plantains, Dandelion, and all other weeds on Lawns, Tennis Courts, Golf Greens, etc., at the same time promoting the growth of the finer grasses. It may be applied any time during the growing season of the year. The lawn must be absolutely dry. It acts as a powerful fertilizer for grasses if applied as a top dressing in the early Spring. For top dressing as a fertilizer apply 1/4 ton per acre.

Quantity Required as a Weed Destroyer

3 1/2 lbs. will dress	150 square feet	\$0.75	By P.P.	\$0.90
7 lbs. will dress	250 square feet	1.35		1.60
14 lbs. will dress	500 square feet	2.50		2.90
28 lbs. will dress	1000 square feet	4.00	} By express or freight collect.	
56 lbs. will dress	2000 square feet	6.50		
112 lbs. will dress	4000 square feet	12.50		

AMERICAN PEAT SOIL SPONGE

Michigan Absorbent Sedge Peat

A preferred domestic absorbent peat of a purely organic formation, that combines the qualities of the foreign peats and the merits of a leaf mould. For all horticultural purposes.

Prices

50 lb. bag	\$1.50	1/2 ton (10 bags)	\$22.50
100 lb. bag	2.50	1 ton (20 bags)	45.00
500 lbs. (5 bags)	12.00	5 tons (100 bags)	212.50

Special prices quoted on carload lots.

ANT KILLER (Cyanogas)

For Lawn and Garden Ants

Will effectively destroy ants on tennis courts, lawns and gardens. Get rid of these annoying pests by using Cyanogas Ant Killer. Per 4 oz. can, 30c.



RED ARROW INSECT SPRAY

Gives protection against insects affecting the Flower Garden, Vegetable Garden and Fruit crops, also Poultry House, Kennel and Dairy Farm. A simple effective method of exterminating insects, such as aphids, Japanese Beetles, rose chafer, caterpillars, thrips, white flies, etc.

Prices

1 oz. bottle	\$0.35	1 pt. tin	\$3.25
3 1/2 oz. tin	1.00	1 qt. tin	6.00
1/2 pt. tin	1.75	Gallon tin	17.50

OLEATE COATED ARSENATE OF LEAD

Kills Japanese Beetles

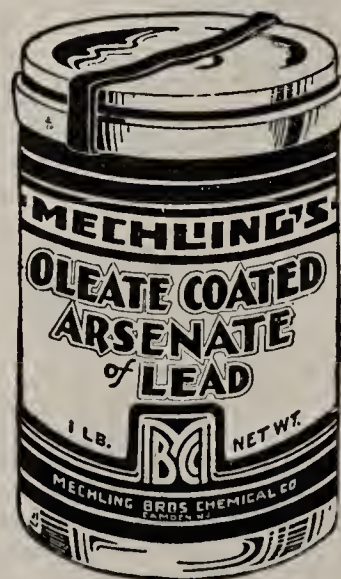

Spray early, when the first Beetles are seen. Kills Japanese Beetles and protects the foliage. The dead Beetles are not seen as they go into the soil to die, but it is estimated that 80% of those that start feeding on foliage sprayed with this material are killed. It has such great sticking qualities that one thorough spraying will be sufficient for protection during the Beetle season. Every particle is covered by an Oleate Soap, which makes it palatable to the Beetle. Foliage which has been thoroughly sprayed is never seriously injured by Beetle feeding. A one pound jar will make 10 gallons of spray.

Prices

Lb.	\$0.50	10 lbs.	\$3.00
2 1/2 lbs.	1.00	25 lbs.	6.50
100 lbs.	\$18.00			

Antrol

The National Ant Control



ANTS DESTROYED

New Method "Gets"
Them at Their Source—
Safe, Permanent, Effective



The Antrol system is adapted to any size house or garden and quickly destroys all species of sweet eating ants. It is composed of small glass containers and a special formula of syrup. The containers are partially filled with syrup and placed about the outside edges of the house or along "ant" trails in the garden if the infestation occurs there. The ants smell the syrup, eat it and then transmit its mild poison to the queen in the nest. Soon the entire ant colony is destroyed!

The complete system should cover every 15 feet around the outside of the house or "ant" trails in the garden. Once installed permanent, effective and safe protection is insured from these annoying pests.

Prices

Antrol sets, containing 4 containers and one 4 oz. bottle of syrup \$0.75
Antrol extra containers10
Antrol Syrup, 4 oz. bottle35
Per pint, 85c.; \$3.50 per gal.



READY FILLED ANTROL

Consisting of four patented glass feeders, filled with regular Antrol Syrup.

Price, 50c.

ANTROL ANT and ROACH POWDER

An improved fast killing powder for the extermination of ants; ideal for use in apartments, Summer or beach houses, camping, etc.

Per 2 oz., 25c.; 40c. per 4 ozs.; 5 lbs., \$5.00.

TRI-OGEN COMBINED SPRAY TREATMENT

Fungicide—Insecticide—Plant Stimulant

Complete protection against plant insects and diseases. Mildew and black spot easily controlled with this spray treatment.

- A. Small kit (makes 16 quarts) \$1.50
- B. Medium kit (makes 64 quarts) 4.00
- C. Large kit (makes 32 gallons) 6.00
- D. Estate kit (makes 128 gallons) 20.00



FULTON'S

Plantabbs

Odorless Plant Food Tablets

A concentrated odorless plant food in tablet form; clean and easy to use; they dissolve in water almost instantly

and make a wonderful liquid fertilizer for potted plants or in the garden.

Prices

Pkg. of 30 tablets, 25c. (by parcel post, 30c.).
Pkg. of 75 tablets, 50c. (by parcel post, 55c.).
Pkg. of 200 tablets, \$1.00 (by parcel post, \$1.10).
Pkg. of 1000 tablets, \$3.50 (by parcel post, \$3.65).

Snarol

The National Pest Control



QUICKLY KILLS GARDEN PESTS

Science Provides
New Safe Method
That Does the Work
Without Fuss



Snails, Cutworms, Slugs, Grasshoppers, Sowbugs,
Earwigs, Etc., are Exterminated

Snarol is a ready prepared meal that you simply broadcast on the ground, under the vegetation. The pests eat the meal and are quickly destroyed.

Snarol will not deteriorate from rain or sprinkling and also is non-injurious to vegetation when used according to simple directions. These features distinguish it from ordinary controls and make Snarol popular with professional gardeners and nurserymen. Prices, 35c. per 1 1/2 lbs.; 85c. per 4 lbs.; 15 lbs., \$3.00; \$8.00 per 50 lbs.

NEW EVER GREEN SPRAY

NON-POISONOUS

Effective for killing cucumber and melon bugs, cabbage worms, rose slugs, aphid, leaf hoppers, and most other plant insects, including cut worms; harmless to humans, animals and birds; it kills only insects. It will not injure tender plants. Evergreen has a pleasant odor—being liquid, it is easy to mix and stays in solution without being stirred.

One gallon makes 800 gallons of spray against plant lice.

Prices

Oz.....	\$0.35	16 oz.....	\$2.00
6 oz.....	1.00	Gal.....	12.00
5 gals.....			\$50.00

SELOCIDE

Scientific research reveals powerful new killing agent that gives positive control of Red Spiders. Also kills the eggs and does not harm tender plants when properly used. Dilute 1 part to 49 parts of water. Prices, \$1.25 per qt.; gal., \$3.25; \$15.00 per 5 gals.

VIGORO

Specially prepared plant food

Vigoro contains all the food elements plants must get from the soil to produce rich green, velvety lawns, beautiful flowers, full foliaged shrubs and trees and early delicious vegetables. Clean, odorless and economical.



Prices

12 oz. pkg.....	\$0.10	25 lbs.....	\$1.50
5 lbs.....	.50	50 lbs.....	2.50
10 lbs.....	.85	100 lbs.....	4.00

All prices subject to market changes

(wc)

ADCO ARTIFICIAL MANURE

converts garden refuse, such as leaves, stalks, cuttings, potato, bean and pea vines, etc., into artificial manure.

ADCO is a powder which, when mixed with almost any non-woody vegetable waste and kept moist, gradually converts the mass into real manure fully equal to the farmyard product in fertilizing power, but free from foul odor, flies, weed-seeds, etc. The process is perfectly simple and not at all laborious.

GARDENERS can now have plenty of manure at low cost and little trouble.

FARMERS, by utilizing straw, corn stalks, etc., can secure their manure without the expense and labor of maintaining livestock.

25 lbs. is sufficient to make one-half ton of manure; 150 lbs. is sufficient to make three tons of manure.

Prices

25 lb. bag.....	\$2.00	600 lbs.....	\$42.00
150 lb. bag.....	10.50	2100 lbs.....	145.00

PHILOGAN

A Natural Manure for All Crops



Organic material, treated and manufactured by scientific process and special machinery. Nothing added or taken away; all weed seeds have been destroyed and harmful bacteria removed. It is a perfect food, all available and will supply nourishment as soon as applied. Of great value in producing Carnations, Roses and other flowers, also excellent for the lawn; invigorates root action, strengthens

stems and adds quality to the blooms. Will not injure the most delicate blooms or foliage.

Prices

25 lbs.....	\$0.85	500 lbs.....	\$12.00
50 lbs.....	1.50	½ ton.....	23.00
100 lbs.....	2.50	Ton.....	40.00

Hyper-Humus NATURE'S OWN SOIL ENRICHER

This is rich soil humus that has been aerated, sweetened and composted, making it an ideal top dressing for lawns and flower beds; makes heavy soils light and porous, light soils heavy, just what you need to promote plant and lawn development at the seashore; gives immediate and permanent effects wherever used. No odor; no weeds.

For lawns use 200 lbs. to 1000 sq. ft.; for vegetables and flowers, spread about one inch thick. It will work wonders.

Prices

5 lbs.....	\$0.30	100 lbs.....	\$2.00
10 lbs.....	.50	500 lbs.....	9.50
25 lbs.....	.75	½ ton.....	15.00
50 lbs.....	1.25	Ton.....	25.00

If wanted by parcel post, add 15c. per 5 lbs.; 20c. per 10 lbs., for postage.

Carload lots in bulk, \$10.00 per ton f. o. b. Factory.



For Lawns
For Gardens
For Flower Beds

For a green velvety lawn, for a colorful full-flowered garden, for plump, in-advance-of-the-season vegetables, use LOMA.

Agricultural experts all agree that the quickest and surest way to lawn beauty is proper root feeding, for grass depends upon the soil for nourishment, and, unless you put the food into the ground your grass cannot thrive. Good gardeners and golf course keepers know this.

Rich in life-giving nitrogen so often lacking in the soil—in potash and phosphates, too. For lawns, apply at the rate of 16 to 20 pounds to a space 20 x 20 feet.

Prices

1 lb. can.....	\$0.15	25 lb. bag.....	\$1.50
5 lb. can.....	.50	50 lb. bag.....	2.50
10 lb. can.....	.85	100 lb. bag.....	4.00

If wanted by parcel post, add 15c. per 5 lbs.; 20c. per 10 lbs., for postage.

SOIL-PREP

A scientific soil conditioner for Lawns, Greens, Fairways, Flowers, Vegetables, Shrubs and Trees

Soil-Prep is approximately ten times as effective as the average barnyard manures; high in humus; does not have an unpleasant odor; free from weed seeds. Recommended application—2 to 8 pounds per 100 square feet.

Prices

5 lb. bag.....	\$0.30	25 lb. bag.....	\$1.00
10 lb. bag.....	.50	50 lb. bag.....	1.75
100 lb. bag.....			\$3.00

SOLVAY CALCIUM CHLORIDE

For Laying Dust in Driveways and Dressing Courts

An ideal material for not only laying the dust, but also in keeping down the cost of resurfacing gravel roads. Forms a binder and prevents the surface of the road from blowing away in the form of dust, or from being washed away by rains or excessive sprinkling.

Prices

Per 100 lb. bag, \$3.00; \$2.70 per 100 lbs. in drums of about 400 lbs.

REVIVO

Japanese Beetle Grub Controlled—Crab Grass Prevented The Lawn Fertilized

A unique scientific preparation that controls the Japanese Beetle by destroying the beetle grub in the ground. Crab Grass is prevented by the application of Revivo; chickweed, plantain and dandelion are stunted in growth and have a low rate of germination wherever Revivo is used. Rake the dead grass off the lawn, and sprinkle Revivo all over the ground at the rate of 10 lbs. to 250 square feet, 100 lbs. to 2500 square feet. Follow this by sowing lawn seed at the rate of one quart to 100 square feet.

Prices

2 lbs.....	\$0.35	25 lbs.....	\$2.50
10 lbs.....	1.25	100 lbs.....	8.00
500 lbs.....			\$37.50

SCIENTIFIC PREPARATIONS FOR ROSES ¹⁷⁹

AND OTHER PLANTS (*Rosenbluth Formulae*)



For Leaf Chewing Insects

A remarkably effective insecticide that rids your roses and other plants of leaf chewing insects, including caterpillars, slug worms, Japanese beetles and many blights. Use alternately as a companion spray with Fungtrogen; both carry their own spreader; only water is required. Makes 60 times its volume.

	Prices
4 ozs.....	\$0.60
1/2 pt.....	1.00
Pt.....	1.75
Qt.....	2.75
1/2 gal.....	4.50
Gal.....	8.00

ROSES AND **Fungtrogen**



In the several years since its discovery by the widely known horticulturist, E. M. Rosenbluth, Fungtrogen has achieved national and international recognition for its remarkable fungicidal and stimulating properties. This Invisible Spray is harmless to foliage or blooms. It has enabled amateurs to produce plants of unusual vigor, with superb foliage and blooms of true professional beauty. We unhesitatingly recommend this effective fungicide and the companion insecticide sprays—Insectrogen and Aphistrogen.

Equally beneficial for other flowering plants, such as hollyhocks, snapdragons, phlox, sweet peas, carnations, etc. Fungtrogen spray carries its own spreader. Simply mix with water. Makes 60 times its volume.

	Price		Price
1/2 pt.....	\$0.75	Qt.....	\$2.00
Pt.....	1.25	1/2 gal.....	3.50
Gal.....	\$6.00		



For Aphis—Plant Lice

This spray destroys all traces of these pests, outdoors or under glass, in two or three applications; for roses, chrysanthemums, golden glow and all others subject to plant lice. Will not discolor the foliage. Aphistrogen is complete. No soap required—simply mix with water and use. Aphistrogen is also a good plant disinfectant. Splendid for house plants.

	Prices	By P.P.
2 ozs.....	\$0.50	\$0.55
4 ozs.....	.75	.80
1/2 lb.....	1.25	1.35
2 lbs.....	3.50	3.65
12 lbs.....	15.00	By express

Important Ground Dressings for Your Rose Beds



Spring—Summer Ground Dressing and Soil Stabilizer

A remarkable Plant Food, soil stabilizer and ground dressing for your roses. Feroegen should be cultivated into your rose beds in the early Spring and Summer. It supplies vital chemical elements and stimulates to vigorous root action and strong growth. In convenient powdered form. Feroegen reinforces stable manures.

	Prices By P.P.			Prices By P.P.	
1 lb.....	\$0.75	\$0.85	5 lbs.....	\$2.75	\$2.95
2 lbs.....	1.25	1.40	10 lbs.....	4.75	5.00
	(By Express or Freight)				
25 lbs.....	\$11.00		100 lbs.....	\$40.00	



Autumn—Winter Ground Dressing and Soil Disinfectant

Terogen destroys the spores of fungi of most diseases that have fallen to the ground, as well as the larvae of most insects, including the rose pith borers, rose bugs, aphids and most beetles. Terogen also acts as a valuable fertilizer. Makes sturdy, healthy foliage and helps to prevent chlorosis. In convenient semi-powdered form.

	Prices By P.P.			Prices By P.P.	
1 lb.....	\$0.75	\$0.85	5 lbs.....	\$2.75	\$2.95
2 lbs.....	1.25	1.40	10 lbs.....	4.75	5.00
	(By Express or Freight)				
25 lbs.....	\$11.00		100 lbs.....	\$40.00	



English Hurdle Fence

ENGLISH HURDLE FENCE

Panels measure 8 ft. 3 in. in length and are 4 ft. high when in position; 640 hurdles to the mile of fence.

Space between bars	Approx. Weight	Chestnut (split rail)	Cedar (round rail)
4 Bar, 12 in.....	60 lb.	\$2.70	\$2.25
5 Bar, 9 in.....	70 lb.	2.90	2.50
6 Bar, 7 in.....	80 lb.	3.25	2.75

GATES

Supplied with strong heavy hinges.

Driveway Gates		Pathway Gates	
4 Bar, 10 ft. wide.....	\$8.00	4 Bar, 4 ft. wide.....	\$5.00
5 Bar, 10 ft. wide.....	8.25	5 Bar, 4 ft. wide.....	5.25
6 Bar, 10 ft. wide.....	8.50	6 Bar, 4 ft. wide.....	5.50

LINECRAFT WOVEN CEDAR FENCE

A beautiful rustic fence, woven by hand, from deep swamp, white cedar saplings; in 5 ft. sections, ready to erect.

	With inner bark	With bark entirely removed
4 ft. high, \$1.30 per running foot.....		\$1.40
5 ft. high, 1.50 per running foot.....		1.60
6 ft. high, 1.80 per running foot.....		1.90

This same fence may be had in chestnut, with bark entirely removed, at same prices.

GATES

For 4 ft. fence.....	\$16.50
For 5 ft. fence.....	17.50
For 6 ft. fence.....	19.50



Linecraft Woven Cedar Fence

DIRECTIONS FOR USING ANY OF THE FOLLOWING WILL BE FOUND ON EACH PACKAGE

PLEASE NOTE.—Insecticides marked * cannot be sent by parcel post.

- ***Agri Pax.** A contact insecticide which controls rose-bugs as well as soft-bodied insects; can be used on currants, asparagus, lettuce, celery, etc. Per qt., \$1.25; \$3.50 per gal.; 5 gals., \$13.00.
- ***Antrol.** The Antrol system is adapted to any size house or garden and quickly destroys all species of sweet eating insects. It is composed of small glass containers and a special formula of syrup. Antrol sets containing 4 containers and one 4-oz. bottle of syrup, 75c.; Antrol extra containers, 10c. each; Antrol syrup, 4-oz. bottle, 35c.; 85c. per pt.; gal., \$3.50. Antrol ready filled sets, consisting of 4 containers, filled with Antrol syrup, 50c.
- ***Antrol Ant and Roach Powder.** An improved fast-killing powder for the extermination of ants. Per can of 2 ozs. with shaker twist top, 25c.; 40c. per 4 oz.; 5 lbs., \$5.00.
- ***Aphine.** For destroying aphids, green fly, thrip, red spider and other greenhouse and outdoor insects. It dilutes readily in water about 1 part to 40 of the latter. Per $\frac{1}{4}$ pt., 30c.; 45c. per $\frac{1}{2}$ pt.; pt., 70c.; \$1.10 per qt.; gal., \$3.25.
- ***Aphis Punk.** A paper that has been thoroughly saturated with nicotine. Used for fumigating, giving off dense fumes of nicotine. Excellent for aphids, thrip, white and green fly, also red spider. Contains 22 $\frac{1}{2}$ % of nicotine. (For use in greenhouses only.) Per pkg. of 12 sheets, \$1.00; \$9.50 per case of 12 pkgs.
- Aphistrogen.** Makes a complete spray for aphids (plant lice) and most sucking insects; prepared especially for roses and other plants. Per 4 oz., 75c.; \$1.25 per $\frac{1}{2}$ lb.; \$3.50 per 2 lbs.; 12 lbs., \$15.00.
- ***Arsenate of Calcium.** Used in control of potato bugs, tomato and cabbage worms and many other chewing insects, which attack vegetables. Per $\frac{1}{2}$ lb., 20c.; 30c. per lb.; 5 lbs., \$1.20; \$2.25 per 10 lbs.; 25 lbs., \$4.00.
- ***Arsenate of Lead (Coated).** Especially valuable for protecting foliage against the Japanese Beetle. Per lb., 50c.; \$1.00 per 2 $\frac{1}{2}$ lbs.; 10 lbs., \$3.00; \$6.50 per 25 lbs.; \$18.00 per 100 lbs.
- ***Arsenate of Lead (Powdered).** 1 lb. to 1 $\frac{1}{2}$ lbs. dilutes to 50 gals. of water or may be used dry like Paris Green. Per $\frac{1}{2}$ lb., 25c.; 45c. per lb.; 5 lbs., \$1.50; \$2.50 per 10 lbs.; 25 lbs., \$5.00; \$16.00 per 100 lbs.
- Astogen.** A non-poisonous effective remedy for root aphids, cutworms and other soil insects affecting Asters and similar plants. Per 2 lbs., 75c.; \$1.50 per 5 lbs.; 10 lbs., \$2.75; \$5.00 per 25 lbs.; 50 lbs., \$8.50; \$15.00 per 100 lbs.
- Black Arrow Insect Dust.** Non-poisonous, will not burn; for use in greenhouses, gardens, fields, etc. Per lb., 50c.; \$2.50 per 5 lbs.; 10 lbs., \$4.75; \$10.00 per 25 lbs.; 50 lbs., \$19.00; \$35.00 per 100 lbs.
- ***Black Leaf 40.** Per 1 oz. bottle, 35c.; 5 oz., \$1.00; lb., \$2.25; \$3.25 per 2 lbs.; 5 lbs., \$5.85; \$9.85 per 10 lbs.
- ***Bordeaux Mixture (Powder).** 12 $\frac{1}{2}$ % copper mixture, for spraying purposes. Per $\frac{1}{2}$ lb., 20c.; 35c. per lb.; 5 lbs., \$1.40; \$2.50 per 10 lbs.; 25 lbs., \$5.50; \$17.00 per 100 lbs.
- Bug Death.** Largely used instead of Paris Green; powder form. Not poisonous to persons. Per 10 oz. containers, 25c.; \$1.00 per 5 lbs.; 12 $\frac{1}{2}$ lbs., \$2.25; \$12.00 per 100 lbs.
- Calcium Casenate.** Used as a spreader to mix with other insecticides which do not mix readily. Per lb., 30c.; \$1.25 per 5 lbs.; 10 lbs., \$2.40; \$4.50 per 25 lbs.
- ***Carbolineum.** A germicide and disinfectant for purifying poultry houses, stables, etc. Per gal., \$1.50; \$7.00 per 5 gals.
- ***Ceresan (DuBay).** A dust disinfectant for cotton, flax, millet, peas and narcissus. Per lb., 75c.; \$3.00 per 5 lbs.; 25 lbs., \$12.50; \$49.00 per 100 lbs.
- Ceresan (New Improved) (DuBay).** A dust disinfectant for wheat, oats and barley. Per lb., 75c.; \$3.00 per 5 lbs.
- ***Copper Solution.** Made of sulphate of copper and other materials. Excellent spray for carnation rust and diseases of the grape, pear, apple and other fruits. A good thing to use for leaf blight and mildew. It is diluted in water. Per qt., \$1.50; \$3.75 per gal.
- ***Cyanegg.** For generating Hydrocyanic Acid Gas. Claimed to be the best remedy for killing white fly. Do not use on Sweet Peas. Per lb., 60c.; \$2.50 for 5 lbs.
- ***Cyanogas.** (Calcium Cyanide) (G. Fumigant). A valuable insecticide for greenhouse fumigation, for destroying aphids, white fly, soft scale, thrips, etc. \$3.00 per 5 lbs.; 25 lbs., \$10.00; \$30.00 per 100 lbs. Descriptive circular free.
- ***Cyanogas (Calcium Cyanide).** A Dust. For killing rats, moles, woodchucks and other rodents. Per $\frac{1}{2}$ lb., 45c.; 75c. per lb.; 5 lbs., \$3.00.
- ***Derrisol.** A highly concentrated, odorless insecticide for the control of plant lice, leaf hopper, green flies, thrips, red spider, etc. Per 1 oz. bottle, 35c.; \$1.25 per $\frac{1}{2}$ lb.; lb., \$2.25; \$3.25 per 2 lbs.; 10 lbs., \$12.00.
- ***Dutox.** A non-arsenical control for beetles and leaf-eating insects; does not injure plants nor impair fertility of soil. Per lb., 30c.; \$1.35 per 6 lbs.
- Evergreen Insecticide, New.** A non-poisonous insecticide, recommended for killing a wide variety of insects. Per 1 oz., 35c.; \$1.00 per 6 ozs.; 16 ozs., \$2.00; \$12.00 per gal.; 5 gals., \$50.00.
- Fish Oil Soap.** An excellent Summer spray, when something stronger cannot be used, where San Jose Scale exists. It is nice for washing off lemon trees, oleanders and almost anything that would be infested with soft-shelled or in fact most any kind of insect. 25c. per lb.; 5 lbs., \$1.00; \$1.75 per 10 lbs.; 25 lbs., \$3.25; \$6.00 per 50 lbs.; per 100 lbs., \$10.50.
- Fish Oil Soap (Good's Caustic).** Used extensively as a tree spray and as a Summer remedy for San Jose Scale; it comes in a soft soap form and is easily dissolved, 1 lb. to 10 gals. water. Per lb., 25c.; \$1.10 per 5 lbs.; 10 lbs., \$1.85; \$3.50 per 25 lbs.; 50 lbs., \$6.00; \$10.00 per 100 lbs.
- Fish Oil Soap (Rosin).** Especially recommended for the destruction of boxwood maggot, bag worm and caterpillars. Per 5 lbs., \$1.50; \$2.75 per 10 lbs.; 25 lbs., \$4.50; \$7.50 per 50 lbs.; 100 lbs., \$13.00.
- Fly Spray (Mechling's).** For keeping the flies off cattle and horses. Per gal., \$1.50; \$7.25 per 5 gals.
- Formaldehyde Dust, Ansul.** A seed and soil treating compound, which controls seed-borne diseases. Per lb., 75c.; \$2.00 per 5 lbs.; 25 lbs., \$5.50.
- ***Fungicide (Zenke's).** For various forms of fungus diseases. Per $\frac{1}{2}$ gal., \$2.25; \$3.50 per gal.
- ***Fungtrogen.** A highly concentrated form of fungicide that will conquer mildew and control black spot on roses. It also supplies an essential fertilizer. Dilutes 1 part with 60 parts of water. 75c. per $\frac{1}{2}$ pt.; pt., \$1.25; \$2.00 per qt.; $\frac{1}{2}$ gal., \$3.50; \$6.00 per gal.
- Getz-there Soap.** For washing palms and spraying in place of Fish Oil Soap. 2 lbs., 65c.; \$1.75 for 8 lbs.; 25 lbs., \$5.00.
- Grape and Rose Dust.** A powder preparation used for mildew, aphids, black fly and other insects and fungus diseases, principally in greenhouse. Per 5 lbs., \$1.50; \$4.75 per 25 lbs.; 100 lbs., \$17.50.
- ***Hellebore.** The ideal material for destroying rose bugs, currant worms, and other soft-shelled insects that infest the garden. 30c. per $\frac{1}{2}$ lb.; lb., 50c.; \$2.25 per 5 lbs.
- ***Hydroxide (Mechling's).** A combined insecticide and fungicide spray; kills quickly; always ready for use; sticks to the leaf. Per $\frac{1}{2}$ lb., 25c.; 40c. per lb.; 5 lbs., \$1.50.
- ***Insectrogen.** A complete spray for leaf chewing insects, including caterpillars, rose slug worms and Japanese Beetles. Per $\frac{1}{2}$ pt., \$1.00; \$1.75 per pt.; qt., \$2.75; \$4.50 per $\frac{1}{2}$ gal.; gal., \$8.00.
- Kerosene Emulsion (Liquid Miscible Oil).** Diluted in water this makes an excellent spray for all mild forms of scale, and soft lice of any kind such as infest rose and fruit bushes, vegetables and trees. Dilutes 1 part to 20 parts of water. 45c. per pt.; 75c. per qt.; gal., \$1.75; \$6.00 per 5 gals.
- Lemon Oil Insecticide.** Effectually destroys mealy bug, scale, thrip and red spider. Per $\frac{1}{2}$ pt., 30c.; 50c. per pt.; qt., 85c.; \$1.50 per $\frac{1}{2}$ gal.; gal., \$2.50; \$10.00 per 5 gal. keg.
- Lethane 420.** A contact insecticide for killing mealy bug, red spider and thrips, as well as white fly and similar insects. Per qt., \$6.00; \$11.00 per $\frac{1}{2}$ gal.; gal., \$20.00.
- ***Lime Sulphur.** For scale insects on trees and shrubs, and such fungus diseases as can be treated in Winter or early Spring; also for leaf curl of peaches. Per qt., 40c.; \$1.00 per gal.; 5 gals., \$3.75; \$9.50 per $\frac{1}{2}$ bbl. (30 gals.); bbl. (50 gals.), \$13.00.
- Lime Sulphur (Dry Powder Form).** Dilute 1 lb. to 6 gals. of hot or cold water. Per lb., 35c.; \$1.40 per 5 lbs.; 10 lbs., \$2.50; \$4.25 per 25 lbs.; 50 lbs., \$8.00; \$14.00 per 100 lbs.

- *Mag-O-Tite.** Protects crops against the ravages of the root maggot and other garden pests; also eradicates earth worms. In powder form, ready for use. Per lb., 50c.; \$1.50 per 5 lbs.; 25 lbs., \$5.00; \$9.00 per 50 lbs.
- Mexican Bean Beetle Destroyer.** Dust or spray; no danger of burning. Per lb., 35c.; \$1.25 per 4 lbs.
- Mexogen.** Kills and repels Mexican Bean Beetles, including the adult, larvæ and eggs; non-poisonous to humans, animals and birds, when directions are followed. Per ½ pt., 75c.; \$2.00 per qt.; gal., \$6.00.
- *Mo Lo.** For destroying and driving away moles. Per pkg., 25c.
- Molgen.** Eliminates moles from the lawn within 2 or 3 days; non-poisonous to humans or pets. Per ½ lb. can, 50c.; \$1.25 per 1 ½ lb. can; 5 lb. can, \$4.00.
- *Mouse Seed.** For destroying mice. Per pkg., 25c.
- *Nico Fume (Liquid).** For use as a spray or vapor, for controlling green fly, aphid, etc., in greenhouses and outdoors. \$2.50 per lb.; 4 lbs., \$6.00; \$11.00 per 8 lbs.; 40 lb. drums, \$45.00.
- *Nico Fume Paper.** For fumigating greenhouses; gives off dense fumes charged with nicotine. Per box of 24 sheets, \$1.50; \$4.75 for 144 sheets; 288 sheets, \$8.50.
- *Nico Fume Fumigating Powder.** A tobacco powder highly charged with nicotine; splendid for fumigating greenhouses. Per lb. can, \$1.15; \$3.50 for 5 lbs.; 10 lbs., \$6.25.
- *Nicotine Pyrox.** Kills both chewing and sucking insects; controls blight and other diseases; just mix with water and spray. Per 10 ozs., 50c.; \$1.25 per 40 ozs.; 5 lbs., \$1.75; \$3.00 per 10 lbs.
- *Nikoteen (30%).** One of the very best forms of tobacco or nicotine preparations; usually diluted in water. Per 1 oz. bottle, 30c.; 45c. per 1 ¼ oz. bottle; ½ lb. bottle, \$1.25; \$2.00 per lb.; 4 lbs., \$6.00; \$11.50 per 8 lbs.
- *Nikoteen (40% solution).** Per 4 lbs., \$6.50; \$12.50 per 8 lbs.
- *Para Dichlorobenzine.** For peach tree borers; full directions on each package. Can be used successfully only during August and September. Do not use on very young trees. Ask for descriptive circular. Per 1 lb. can, 50c.; \$2.25 per 5 lb. can; 10 lb. can, \$4.00; \$10.00 per 25 lb. keg; 100 lb. keg, \$30.00.
- *Paris Green.** May be used in liquid form 1 pound in 50 gallons of water, or with Land Plaster at the rate of 1 pound of Paris Green to 100 pounds Land Plaster. Per ¼ lb., 20c.; 35c. per ½ lb.; lb., 55c.; \$2.50 per 5 lbs.; \$5.50 per 14 lbs.
- Pomo-Green or Massey Dust.** The leaf-green dust; protects roses and other flowering plants against insects and fungus diseases, without making the treatment conspicuous. Per 1 lb. can, 50c.; \$1.75 per 5 lb. carton.
- *Pomo-Green with Nicotine.** A leaf green all-in-one dust, or spray for leaf eating insects and many plant diseases. Per lb., 75c.; \$3.00 per 5 lbs.
- Pyrethrum Powder.** Valuable as a poison for plant lice, water bugs, roaches, etc., also the strawberry moth. Per lb., 60c.; \$2.25 per 5 lbs.; 10 lbs., \$4.00.
- Pyrote.** A non-poisonous insecticide for killing both chewing and sucking insects. Per 1 oz., 35c.; \$1.00 per 6 oz.
- *Pyrox (Bowker's).** A combined insecticide and fungicide for all leaf eating insects, blights and fungus troubles. Per lb., 50c.; \$1.75 per 5 lbs.; 10 lbs., \$3.00; \$6.25 per 25 lbs.; 50 lbs., \$8.00; \$13.00 per 100 lbs.; 300 lbs., \$35.00.
- Rat Paste (Zelio).** The most efficient poison for destroying rats, mice and other rodents. Per 2 oz. tube, 50c.
- Red Arrow Insect Spray (Pyrethrum Soap).** A non-poisonous, efficient insecticide for use against sucking and chewing insects, such as Mexican bean beetles, Japanese beetles, rose chafers, aphids (plant lice), leaf hoppers, etc. Per oz., 35c.; \$1.00 per 3 ½ oz.; ½ pt., \$1.75; \$3.25 per pt.; qt., \$6.00; \$17.50 per gal.
- *Revivo.** Destroys the grub of the Japanese beetle, also other grubs, in the soil; checks the growth of crab grass, chickweed, plantain, dandelion, etc. Per 2 lbs., 35c.; \$1.25 per 10 lbs.; 25 lbs., \$2.50; \$8.00 per 100 lbs.; 500 lbs., \$37.50.
- Rotocide.** A non-poisonous insect spray, for the control of mealy bugs, white flies, midges, aphid, etc.; not injurious to tender plants and flowers. Per qt., \$3.00; \$8.00 per gal.
- Scalecide.** Used for the destruction of the San Jose Scale. Dilute at the rate of one gallon Scalecide to 20 gallons water. Spray during the Winter or early Spring when the trees are dormant. Per qt., 60c.; \$1.50 per gal.; 5 gals., \$5.25; \$9.50 per 10 gals.; 30 gals., \$24.00; \$32.00 per 50 gals.
- *Scale Oil.** An efficient oil spray for controlling scale insects, aphid, thrip, red spider, etc. Per qt., 70c.; \$1.50 per gal.; 5 gals., \$5.50; 30 gals., \$18.00; \$25.00 per 55 gals.
- *Selocide.** A powerful new killing insecticide that controls red spiders in one application; also kills the eggs and does not harm tender plants when properly used; dilute 1 part to 49 parts of water. Per qt., \$1.25; \$3.25 per gal.; 5 gals., \$15.00.
- *Semesan (DuBay).** A mercuric disinfectant for the control of many seed, plant and soil diseases. One ounce treats 15 lbs. of seed. Per 2 ozs., 50c.; \$2.50 per lb.; 5 lbs., \$11.75; \$46.25 per 25 lbs.; 100 lbs., \$180.00.
- *Semesan Bel (New Improved DuBay).** For treating seed potatoes before planting, controlling seed-borne diseases. 1 lb. treats 16 to 20 bushels of seed. Per 4 oz., 50c.; \$1.75 per lb.; 5 lbs., \$8.00; \$31.25 per 25 lbs.; 100 lbs., \$120.00.
- *Semesan Jr. (New Improved DuBay).** For controlling seed-borne diseases of seed field and sweet corn; protects the seed from rotting in the ground. Per 4 oz., 50c.; \$1.50 per lb.; 5 lbs., \$7.00; \$28.75 per 25 lbs.; 100 lbs., \$110.00.
- Slug Shot.** The standard remedy for currant worms, rose slugs, cabbage worms, etc. Per 1 lb. carton, 25c.; \$1.00 per 5 lbs.; \$4.00 per 25 lbs.; 125 lb. keg, with a duster, \$16.50; full barrel lots (about 250 lbs.), with duster, \$32.00.
- Snarol.** For the control of cutworms, snails, slugs, etc.; non-injurious to vegetation and very economical to use. Per 1 ½ lbs., 35c.; 85c. per 4 lbs.; 15 lbs., \$3.00; \$8.00 per 50 lbs.
- Soap (C. P. O.).** For control of many insects on evergreens, flowering plants, fruits and vegetables. Per 3 oz. bottle, 25c.; 65c. per pt.; qt., \$1.00; \$2.50 per gal.
- Soap Spray (Imp.).** An all around outdoor and greenhouse insecticide. Per pt., 65c.; \$1.00 per qt.; gal., \$3.00; \$12.00 per 5 gals.; 10 gals., \$20.00; \$58.50 per ½ bbl. (about 30 gals.).
- Sulfocide.** An effective Summer spray for the control of scale and black-rot on fruit trees, also for mildew and black-rot on roses, etc. Per qt., 90c.; \$2.50 per gal.; 5 gals., \$8.50.
- *Sulphate of Copper.** For destroying fungus diseases of all kinds; also used in making Bordeaux mixture. Per lb., 15c.; 65c. per 5 lbs.; 10 lbs., \$1.20; \$2.75 per 25 lbs.; 100 lbs., \$9.00.
- Sulphur.** Used principally in greenhouses for checking mildew. It is also used as a preventive and cure for San Jose Scale, when it is used in connection with lime and salt. Per lb., 10c.; 45c. per 5 lbs.; 10 lbs., 85c.; \$2.00 per 25 lbs.; 100 lbs., \$7.50.
- Sulphur, Ansol Colloidal.** A general sulphur fungicide and contact insecticide for fruits, vegetables, flowers, shrubs and trees. Per tube, 90c.; \$2.00 per 3 lb. pkg.
- Sulphur Candles.** 20c. each; per doz., \$2.25.
- Sunoco Spray Oil.** For controlling scale insects, red spider, aphid, thrip, etc. Per gal., \$1.25; 5 gals., \$5.00; \$8.50 per 15 gals.; 30 gals., \$14.00; \$20.00 per 50 gals.
- *Thrip Juice (Hammond's No. 2).** This preparation is very effective against aphid, red spider, mealy bugs and sucking insects generally. Per pt., 80c.; \$1.25 per qt.; gal., \$4.00.
- Tobacco Dust (For Dusting).** Per 1 lb. can with sifter top, 25c.; 35c. per 5 lbs.; 10 lbs., 60c.; \$1.25 per 25 lbs.; 50 lbs., \$2.00; \$3.50 per 100 lbs.
- Tobacco Dust (For Fumigating).** A specially prepared article. Per lb., 10c.; 45c. per 5 lbs.; 10 lbs., 75c.; \$1.25 per 25 lbs.; 50 lbs., \$2.25; \$4.25 per 100 lbs.
- Tobacco Stems (Fresh).** For fumigating. Per lb., 10c.; 30c. per 5 lbs.; 10 lbs., 50c.; \$1.00 for 25 lbs.; large bales at 2c. per lb.; ½ ton, \$15.00; \$27.50 per ton.
- Tree Tanglefoot.** A paste preparation for painting around the trunks of trees, in the form of a band. Caterpillars and other crawling pests cannot get over it. Per lb., 60c.; \$2.75 per 5 lbs.; 10 lbs., \$5.25; \$11.00 per 25 lbs.
- Volck. (Garden).** A Volck-Nicotine combination spray for the garden. Controls red spider, mites, white flies, scales, mealy bugs, caterpillars, aphid, thrip, etc. Per 3 ½ ozs., 35c.; 90c. per pt.; \$5.00 per gal.
- Volck (Nursery).** A mineral oil spray for general use on growing plants in the nursery, greenhouse and garden; it is not to be confused with "Garden Volck," which contains soap and nicotine. Per ½ pt., 35c.; 55c. per pt.; qt., 80c.; \$2.75 per gal.; 5 gals., \$8.00.
- Wilson's O. K. Plant Spray.** A powerful yet harmless and efficient insecticide for aphid, red spider, mildew, scale, etc., for inside and outside spraying. Per ½ pt., 40c.; \$1.00 per qt.; gal., \$3.25; \$13.00 for 5 gals.; 10 gals., \$22.00; \$57.00 per ½ bbl. (30 gals.); bbl. (50 gals.), \$90.00.
- Worm Destroyer (For earth worms).** This is a powder and is distributed over a given surface and soaked with water, which causes the worms to come to the surface. Per 100 lb. bag, \$3.50; \$15.00 per 500 lbs.; per ½ ton, \$28.50; \$50.00 per ton.
- *X. L. All Insecticide Compound.** A preparation for spraying, for mealy bug, red spider and other insects. Per gal., \$8.00.

PLEASE NOTE—No smaller quantity of Fertilizer than here offered can be supplied.

All Prices on Fertilizers subject to market changes.

Acid or Rock Phosphate (16%). Apply 1000 lbs. per acre. Used for mixing with other fertilizers to increase the phosphoric acid analysis. 5 lbs., 35c.; 60c. per 10 lbs.; 25 lbs., \$1.00; \$3.50 per 200 lbs.; ½ ton, \$13.00; \$24.00 per ton.

Adco. A bacterial food for making artificial manure, by mixing it with leaves, grass cuttings, green weeds or, in fact, all the many wastes that accumulate during the garden year and applying water, the product is a clean manure. 25 lb. bag, sufficient to make one-half ton of manure, \$2.00; \$10.50 per 150 lb. bag, sufficient to make 3 tons of manure; 600 lbs., \$42.00; \$145.00 per 2100 lbs.

All Crop Fertilizer. A high-grade, properly balanced fertilizer for general use on all farm and garden crops. 25 lbs., \$1.00; \$1.75 per 50 lbs.; 100 lbs., \$3.00; \$5.00 per 200 lbs.; ½ ton, \$21.00; \$40.00 per ton.

Ashes, Hard Wood. Apply 1000 lbs. per acre. Indispensable for all crops requiring potash; excellent for mixing with potting soil. For top dressing lawns and grass fields it is applied to best advantage either in very early Spring or late Fall. 25 lbs., \$1.00; \$1.75 per 50 lbs.; 100 lbs., \$3.00; \$5.00 per 200-lb. bbl.; ½ ton, \$22.50; \$40.00 per ton.

Asparagus Fertilizer. A mixture that promotes the root and top growth. Apply 800 lbs. per acre. 25 lbs., \$1.00; \$1.50 per 50 lbs.; 100 lbs., \$2.50; \$4.50 per 200 lbs.; ½ ton, \$21.50; \$40.00 per ton.

Bacteria for Leguminous Crops. (See *Stimugerm.*)

Blood (Dried). For indoor culture of flowering plants, like roses, carnations, etc., its chief element being nitrogen. One of the quickest acting fertilizers. 5 lbs., 60c.; \$1.10 per 10 lbs.; 25 lbs., \$2.00; \$3.50 per 50 lbs.; 100 lbs., \$6.00; \$11.00 per 200 lbs.; 500 lbs., \$20.00.

Blood, Bone and Potash. A very high grade fertilizer for all vegetable and farm crops. 100 lbs., \$5.00; \$9.50 per 200 lbs.; ½ ton, \$37.50; \$65.00 per ton.

Blood Flour. Very finely bolted. 5 lbs., 60c.; \$1.00 per 10 lbs.; 25 lbs., \$2.00; \$3.50 per 50 lbs.; 100 lbs., \$6.00; \$11.00 per 200 lbs.

Bone (Coarse Ground). Apply 800 to 1000 lbs. per acre. Prepared from raw bone, exactly like bone meal, except that it is not so fine or quick in action; it is used for the same purpose. 100 lbs., \$4.25; \$7.50 per 200 lbs.; ½ ton, \$35.00; \$65.00 per ton.

Bone Flour. Finely pulverized and bolted. Effective immediately. For rose growing this cannot be excelled. Rich in phosphoric acid and ammonia. Apply 600 lbs. per acre. 5 lbs., 50c.; 85c. per 10 lbs.; 25 lbs., \$1.50; \$2.25 per 50 lbs.; 100 lbs., \$4.00; \$7.00 per 200 lbs.; ½ ton, \$32.00; \$60.00 per ton.

Bone Meal. (*Michell's Special Grade*). Unusually rich in nitrogen and phosphoric acid, the two principal plant foods. We recommend this especially for lawns, gardens and greenhouses, or any purpose where a high-class fertilizer counts. Apply 800 to 1000 lbs. per acre. 3 lbs., 25c.; 40c. for 5 lbs.; 10 lbs., 65c.; \$1.25 for 25 lbs.; 50 lbs., \$2.25; \$3.75 per 100 lbs.; 200 lbs., \$7.00; \$32.50 per ½ ton; ton, \$55.00.

Clay's Fertilizer. An English chemical fertilizer, for forcing greenhouse plants and vegetables. It can be used in either dry or liquid form. 28 lbs., \$3.75; \$6.25 per 56 lbs.; 112 lbs., \$12.00.

Cotton Seed Meal. Apply 800 lbs. per acre. Exceedingly rich in potash and ammonia, making it excellent for use as a grass and grain fertilizer; for putting greens it is invaluable. 5 lbs., 40c.; 75c. for 10 lbs.; 25 lbs., \$1.25; \$2.00 for 50 lbs.; 100 lbs., \$3.50; \$32.50 per ½ ton; ton, \$60.00.

Cow or Cattle Manure (Shredded). One sack of this is equal to one cartload of cow manure in regular form. Convenient to handle, making it possible for everyone to get this usually scarce article at all times. Especially suited for soil mixing, mulching and liquid manuring. Apply 1000 lbs. per acre. 5 lbs., 45c.; 70c. for 10 lbs.; 25 lbs., \$1.25; \$2.00 for 50 lbs.; \$3.25 per 100 lbs.; 500 lbs., \$16.00; \$30.00 per ½ ton; ton, \$55.00.

If small quantities of Fertilizers listed are wanted by parcel post, please add for postage as follows: 10c. for 3 lbs.; 15c. for 5 lbs.; 20c. for 10 lbs., to the first and second zones; for other zones, see parcel post table, page 1.

Cow or Cattle Manure (Pulverized). Thoroughly sterilized and weedless. Quick in action and especially desirable for pot plants, etc. \$3.25 per 100 lbs.; 500 lbs., \$16.00; \$30.00 per ½ ton; ton, \$55.00.

Driconure. This contains just two ingredients—cow manure and peat moss, so treated as to be free of weed seeds and practically odorless; a real soil conditioner for the lawn and garden. Per bag of 50 lbs., \$3.00; \$14.50 per 5 bags; 10 bags, \$28.00.

Ferogen. A Spring and Summer ground dressing; reinforces any manure fertilizers you may use. Per lb., 75c.; \$1.25 per 2 lbs.; 5 lbs., \$2.75; \$4.75 per 10 lbs.; 25 lbs., \$11.00; \$40.00 per 100 lbs.

Floranid. A highly concentrated organic nitrogen fertilizer for vegetables, flowers, shrubs, lawns, etc.; ½ lb. is sufficient to treat 100 square feet of ground. Full directions on each package. Per lb., 25c.; 90c. per 5 lbs.; 10 lbs., \$1.50; \$2.75 per 25 lbs.; 100 lb. bag, \$10.00.

Horn Shavings. Used principally for mixing in potting soil; rich in ammonia; especially valuable in chrysanthemum growing. 5 lbs., 70c.; \$1.25 for 10 lbs.; 25 lbs., \$2.00; \$3.75 for 50 lbs.; 100 lbs., \$7.00.

Hortobacco (Michell's). A fertilizer manufactured from a tobacco base; for lawns, putting greens, flower and vegetable gardens, etc.; also acts as an efficient insecticide. Per 5 lbs., 25c.; 45c. per 10 lbs.; 25 lbs., \$1.00; \$1.75 per 50 lbs.; 100 lbs., \$3.00; \$13.00 per 500 lbs.; ½ ton, \$26.00; \$50.00 per ton.

Hyper-Humus. An excellent article to incorporate with poor soil in the garden, greenhouse or in potting plants. When used in garden work, the ground should be covered with ½ to 2 inches of Humus and spaded in. Per 5 lbs., 30c.; 50c. for 10 lbs.; 25 lbs., 75c.; \$1.25 per 50 lbs.; 100 lbs., \$2.00; \$9.50 per 500 lbs.; ½ ton, \$15.00; \$25.00 per ton. Car-load lots in bulk, \$10.00 per ton f. o. b. Factory.

Kainit (Potash Salts). Apply 800 to 1000 lbs. per acre. Excellent for potatoes, corn and other grains; also for top dressing asparagus beds, etc. 5 lbs., 35c.; 60c. per 10 lbs.; 25 lbs., \$1.00; \$1.75 per 100 lbs.; 200 lbs., \$3.25; \$14.00 per ½ ton; ton, \$25.00.

Land Plaster. Used for top dressing newly-plowed land prior to harrowing and for sweetening the soil on lawns and fields; also used for mixing with Paris Green. Apply 1500 to 2000 lbs. per acre. 40c. for 10 lbs.; 25 lbs., 85c.; \$1.25 for 50 lbs.; 100 lbs., \$2.00; \$3.75 for 200 lbs.; ½ ton, \$16.00; \$30.00 per ton.

Lawn Dressing and Fertilizer. (*Michell's*). This is a complete balanced fertilizer for lawns, grass plots, fairways and putting greens. It is complete in every way and will produce wonderful results. Apply at the rate of 1000 lbs. per acre. 5 lbs., 35c.; 60c. per 10 lbs.; 25 lbs., \$1.00; \$1.75 per 50 lbs.; 100 lbs. \$3.00; \$27.50 per ½ ton; ton, \$50.00.

Lawn Sand. (*Climax*). For destroying weeds in the lawn without injury to the grass; also acts as a fertilizer. For best results follow directions on the package. 3 ½ lb. tin, 75c.; \$1.35 for 7 lbs.; 14 lbs., \$2.50; \$4.00 per 28 lbs.; 56 lbs., \$6.50; \$12.50 per 112 lbs.

Lime (Hydrated or Powdered). This is a very fine article for distributing on grass. Promotes growth, gives the grass a rich color and has a tendency to prevent the growth of weeds. Apply one ton per acre. 10 lb. box, 35c.; 85c. per 50 lbs.; 100 lbs., \$1.40; \$6.75 per 500 lbs.; ½ ton, \$13.00; \$22.50 per ton.

Limestone (Pulverized). For applying on sour or worn out soils at the rate of one ton per acre. Put up in 100-lb. bags. \$1.25 per 100 lbs.; 500 lbs., \$5.50; \$10.00 per ½ ton; ton, \$19.00.

Loma. A scientifically prepared plant food for the lawn, flower garden, vegetable garden, shrubbery, potted plants, etc.; rich in life-giving nitrogen, potash and phosphates. Lb., 15c.; 50c. per 5 lbs.; 10 lbs., 85c.; \$1.50 per 25 lbs.; 50 lbs., \$2.50; \$4.00 per 100 lbs.

PLEASE NOTE—No smaller quantity of Fertilizer than here offered can be supplied

Manure (*Fresh Horse, Stockyard and Cow*). At short notice we can usually supply first-class horse, cow and stockyard manure in carload lots only. Prices on request.

Mum Manure (*Smith's*). Give your plants a quick start by using this manure. A perfect food for Mums and other flowers, either under glass or in the garden. \$2.75 per 50 lbs.; 100 lbs., \$5.00.

Muriate of Potash. Apply 100 to 150 lbs. per acre, usually with other fertilizers. Excellent for potatoes, corn and other grains. Analysis, equal to 50 per cent. actual potash. 5 lbs., 35c.; 60c. per 10 lbs.; 25 lbs., \$1.25; \$2.25 for 50 lbs.; 100 lbs., \$4.00; \$7.50 for 200 lbs.; ½ ton, \$33.00; \$65.00 per ton.

Mushroom Soil (*Prepared*). This is the straight mushroom soil which has been screened and kiln-dried, so as to destroy weed seed and other obnoxious matter. Ideal for top dressing the lawn. 25 lbs., 75c.; \$1.25 per 50 lbs.; 100 lbs., \$2.00; \$13.00 per ½ ton; ton, \$25.00.

Nitrate of Soda. Apply 100 to 150 lbs. per acre, mixing with land plaster or other fertilizers to render application more easy. Use only after plants are above ground. If used in liquid form dilute 2 ozs. to 1 gal. of water and do not apply oftener than twice a week. 5 lbs., 50c.; 75c. per 10 lbs.; 25 lbs., \$1.25; \$2.00 per 50 lbs.; 100 lbs., \$3.50; \$6.50 per 200 lbs.; ½ ton, \$31.00; \$60.00 per ton.

Nitrophoska. A well-balanced, quick acting food for every purpose in the garden, on lawns, flowers, shrubs, vegetables, etc. Analysis: Nitrogen, 15%; Phosphoric Acid, 30%; Potash, 15%. For the garden or flowers, use 5 to 10 lbs. to 1000 square feet; for lawns, apply 6 to 10 lbs. to 1000 square feet. Per lb., 25c.; 90c. per 5 lbs.; 10 lbs., \$1.50; \$2.75 per 25 lbs.; 100 lbs., \$7.00.

Philogan. A natural manure for all crops; organic material manufactured by scientific process; no waste, all available; all weed seeds destroyed and harmful bacteria removed; invigorates root action. An ideal food for Carnations, Roses and all other greenhouse crops. 25 lbs., 85c.; \$1.50 per 50 lbs.; 100 lbs., \$2.50; \$12.00 per 500 lbs.; ½ ton, \$23.00; \$40.00 per ton.

Phosphate (*Michell's High Grade*). For all vegetable crops, grains, grass, etc. Apply 800 to 1000 lbs. per acre broadcast. 5 lbs., 40c.; 70c. per 10 lbs.; 25 lbs., \$1.25; \$2.00 per 50 lbs.; 100 lbs., \$3.50; \$6.00 per 200 lbs.; ½ ton, \$25.00; \$45.00 per ton.

Phosphate for Corn and Oats. Apply 800 lbs. per acre. 100 lbs., \$3.00; \$5.00 per 200 lbs.; per ½ ton, \$21.50; \$40.00 per ton.

Plantabbs. An odorless plant food in tablet form, for all plants in the house or garden; they dissolve in water almost instantly and make a wonderful liquid fertilizer. Per pkg. of 30 tablets, 25c.; 50c. for 75 tablets; 200 tablets, \$1.00 (by P. P., \$1.10); \$3.50 per 1000 tablets (by P. P., \$3.65).

Potato Fertilizer (*Michell's*). Apply at the rate of from 800 to 1000 lbs. per acre. 25 lbs., \$1.00; \$1.75 per 50 lbs.; 100 lbs., \$3.00; \$5.75 per 200 lbs.; ½ ton, \$27.50; \$50.00 per ton.

Salt. For asparagus beds and putting on walks and roads to kill weeds. Apply 800 lbs. per acre in early Spring. 25 lbs., 75c.; \$1.25 for 50 lbs.; \$2.00 per 100 lbs.; 200 lbs., \$3.50; \$16.00 per ½ ton; ton, \$30.00.

Sheep Manure (*Wizard Brand*). Apply 1000 lbs. per acre. One of the most extensively used of animal manures. The analysis shows it to be a perfectly balanced plant food. For garden, lawn or greenhouse use, nothing surpasses sheep manure; it is clean and easily handled, besides giving immediate results. 3 lbs., 25c.; 40c. per 5 lbs.; 10 lbs., 65c.; \$1.00 per 25 lbs.; 50 lbs., \$1.75; \$3.00 per 100 lbs.; 500 lbs., \$14.00; \$26.50 per ½ ton; per ton, \$50.00.

Soil Prep. A companion product to Loma; a scientific soil conditioner for lawns, greens, fairways, flowers, vegetables, shrubs and trees; it is high in humus; free from weed seeds; apply 2 to 8 lbs. per 100 sq. ft.; 5 lbs., 30c.; 50c. per 10 lbs.; 25 lbs., \$1.00; \$1.75 per 50 lbs.; 100 lbs., \$3.00.

Soot (*Imported Scotch*). This is used principally for bringing a good healthy color into the foliage of chrysanthemum and other greenhouse plants. Also destroys insects and grubs that work on top of and underneath the surface. 5 lbs., 60c.; \$1.00 per 10 lbs.; 25 lbs., \$1.50; \$5.00 per 100 lbs.

If small quantities of Fertilizers listed are wanted by parcel post, please add for postage as follows: 10c. for 3 lbs.; 15c. for 5 lbs.; 20c. for 10 lbs., to the first and second zones; for other zones, see parcel post table, page 1.

Stimugerm. A pure culture of nitrogen-fixing bacteria. When ordering, be sure to state what crops you wish to inoculate. Special garden size, for Garden Peas, Beans and Sweet Peas 25c. For Alfalfa and mixed Clovers, ½ bu. size, 35c.; 1 bu. size, 65c.; 2½ bu. size, \$1.40. For Cow Peas and Soy Beans, 1 bu. size, 35c.; 2 bu. size, 65c.; 5 bu. size, \$1.40. For Vetch, Peas and Beans, 1 bu. size, 35c.; 2 bu. size, 65c.; 5 bu. size, \$1.40.

Stim-U-Plant. A plant food in tablet form; contains highly concentrated, immediately available forms of plant food for use in stimulating all fruit, flower, vegetable and ornamental plants and may be used in tablet or in liquid form. Per pkg. of 30 tablets, 25c. (by P. P., 30c.); 75c. per pkg. of 100 tablets (by P. P., 85c.); 1000 tablets, \$3.50 (by P. P., \$3.65).

Sulphate of Aluminum. Especially adapted for fertilizing Rhododendrons and other plants requiring an acid soil. 5 lbs., 40c.; 70c. per 10 lbs.; 25 lbs., \$1.25; \$4.00 per 100 lbs.; 200 lbs., \$7.50.

Sulphate of Ammonia. Apply 75 to 100 lbs. per acre only with other fertilizers deficient in nitrogen. A valuable fertilizer for all plants in which a large leaf development or rapid growth is desired; will stimulate growth almost immediately. Analysis equal to 25% of ammonia. 5 lbs., 50c.; 85c. per 10 lbs.; 25 lbs., \$1.25; \$2.00 per 50 lbs.; 100 lbs., \$3.50; \$6.50 per 200 lbs.

Sulphate of Potash. Apply 100 to 125 lbs. per acre, usually with other fertilizers. On account of its great strength it must be used judiciously. Valuable for roots and grain crops. Analysis equal to 50% of actual potash. 5 lbs., 40c.; 70c. per 10 lbs.; 25 lbs., \$1.25; \$2.25 per 50 lbs.; 100 lbs., \$4.00; \$7.50 per 200 lbs.

Tankage. This is usually applied to plants such as roses, etc., under glass. It is similar to dried blood. 5 lbs., 40c.; 70c. per 10 lbs.; 25 lbs., \$1.25; \$2.00 per 50 lbs.; 100 lbs., \$3.75; \$7.00 per 200 lbs.; ½ ton, \$31.00; \$60.00 per ton.

Terogen. A new Autumn and Winter ground dressing acting both as a fertilizer and an insecticide. Per 1 lb. tin, 75c.; \$1.25 per 2 lb. tin; 5 lb. tin, \$2.75; \$4.75 per 10 lb. tin; 25 lb. tin, \$11.00; \$21.00 per 50 lbs.; 100 lbs., \$40.00.

Tobacco Stems. For fumigating, mulching and fertilizing, these are invaluable. The chief fertilizing element in them is the potash. Per lb., 10c.; 30c. per 5 lbs.; 10 lbs., 50c.; \$1.00 for 25 lbs.; large bales at 2c. per lb.; per ½ ton, \$15.00; \$27.50 per ton.

Tree Food, Evergreen (*Michell's*). A wonderful fertilizer for fruit and shade trees; contains the three necessary elements to promote vigorous growth. 25 lbs., \$1.50; \$2.50 per 50 lbs.; 100 lbs., \$4.00; \$19.00 per 500 lbs.; ½ ton, \$35.00; \$65.00 per ton.

Vigoro. A specially prepared plant food for lawns, vegetable and flower gardens, shrubbery, trees, etc. 10c. per 12 oz. pkg.; 5 lbs., 50c.; 85c. per 10 lbs.; 25 lbs., \$1.50; \$2.50 per 50 lbs.; 100 lbs., \$4.00.

Wheat Fertilizer. For grass and grain crops. Apply 800 lbs. per acre. 100 lbs., \$3.00; \$5.00 per 200 lbs.; ½ ton, \$23.50; \$45.00 per ton.

Wonder Worker Fertilizer. An extremely high grade animal base fertilizer, adapted for growing all vegetable crops; will not burn and not being a chemical product, no special instructions are necessary. Analysis: Ammonia, 7%; phosphoric acid, 6%; potash, 5%. 100 lbs., \$4.50; \$8.50 per 200 lbs.; 500 lbs., \$20.00; \$37.50 per ½ ton; ton, \$65.00.

Wood Ashes. See Ashes at top of opposite page.

BOOKS On Horticulture, Agriculture and Kindred Subjects

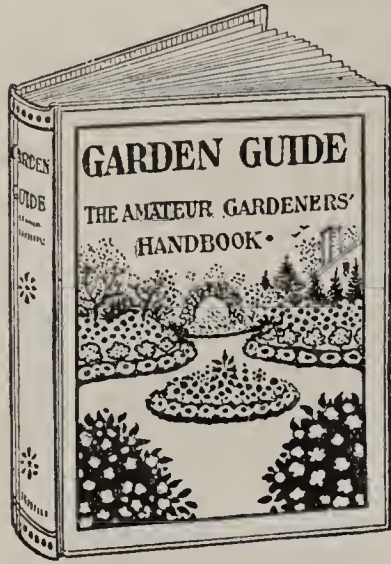

Here is a selection of books that is thoroughly up to date, practical and comprehensive. Written by authors of national reputation—outstanding men who figure prominently in the various phases of garden and farm work. These books will show you how to raise bigger and better crops—better your condition—increase your efficiency—add to your income. Read and make your reading count.

FLOWERS AND ORNAMENTAL PLANTS

Annuals, The Book of (*Hottes*). 182 pages. . . . \$1.50
Aquarium, The Modern (*Innes*). Packed with practical information. . . . 1.00

Book of Bulbs (*Rockwell*). A complete treatise on the growing of bulbs, both for Fall and Spring planting. 264 pages. . . . 2.00
Bulbs, Spring Flowering (*Thayer*). 128 pages. . . . 1.25
Cactus Culture (*Schulz*). . . . 2.00
Carnation Culture, Practical (*Weston*). 224 pages. . . . 2.00
Chrysanthemum and Its Culture, The (*White*). . . . 2.00
Climbing Plants, A Little Book of (*Hottes*). 250 pages. . . . 2.00
Commercial Floriculture (*Bahr*). 616 pages. . . . 5.50
Dahlia, The (*Peacock*). A practical treatise on this popular flower. 128 pages. . . . 1.25
Dahlias. Their culture, etc. (*Rockwell*). 80 pages. . . . 1.00
Delphiniums and How to Excel with Them (*Macself*). Paper.35
Everybody's Garden (*Waugh*). The How, the Why, and especially the Wherefore of the Home Garden, 300 pages. . . . 3.50
Garden Flowers in Color (*Stevens*). A picture cyclopedia of flowers; 400 photographs in color; 320 pages. . . . 3.75
Garden Lilies (*Preston*). Preparation of the soil, planting the bulbs and general care. 128 pages. . . . 1.25
Gladiolus, The (*Beal*). A practical treatise. 128 pages. . . . 1.25
Home Floriculture (*Rexford*). A practical guide. . . . 1.75
Iris, The (*Wister*). A treatise on its history, development and culture. 128 pages. . . . 1.25
Lilacs and Their Culture (*Wister*). Very complete. . . . 1.25
Milady's House Plants (*Palmer*). 176 pages. Cloth, \$1.25; paper. . . . 1.00
Perennial Gardens (*Ortloff*). 170 pages. . . . 1.25
Perennials, The Book of (*Hottes*). 280 pages. . . . 2.00
Pronouncing Dictionary, The Home Gardeners (*Hottes*). 96 pages.50
Rock Gardens, American (*Hamblin*). 128 pages. . . . 1.25
Rock Gardens (*Rockwell*). 86 pages. . . . 1.00
Roses and Their Culture (*Hubbard*). 128 pages. . . . 1.25
Roses, How to Grow (*Pyle-McFarland-Stevens*). 211 pages. . . . 2.00
Sweet Peas (*Unwin*). Their history, development and culture. . . . 2.00
Violet Culture, Practical (*Coon*). 128 pages. . . . 1.75
Water Gardens and Gold Fish (*Sawyer-Perkins*). 190 pages. . . . 2.00
Wild Flowers, How to Know the (*Dana*). . . . 3.00

PLANT BREEDING, PROPAGATING, PRUNING, Etc.

Greenhouses, Their Construction (*Wright*). . . . \$2.00
Handbook of Plants and General Horticulture (*Henderson*). A dictionary of plants. 562 pages. . . . 3.50
Plant Propagation, Greenhouse and Nursery Practice (*Kains*). Very complete. 342 pages. . . . 2.25
Principles and Practice of Pruning (*Kains*). 425 pages. . . . 2.50
Pruning Manual, The (*Bailey*). 400 pages. . . . 2.50
Standard Cyclopedia of Horticulture (*Bailey*). Three volumes. 3637 pages. . . . 25.00

LANDSCAPE GARDENING, Etc.

Evergreens, Hardy (*Schrepfer*). 128 pages. . . . \$1.25
Shrubs, Hardy (*Waugh*). Everything about shrubs. . . . 1.25
Landscape Gardening (*Cridland*). Shows in a simple and practical way how to beautify the home grounds. 282 pages. . . . 2.50
Landscape Gardening, Book of (*Waugh*). 236 pages. . . . 2.00
Lawn, The (*Dickinson*). Simple and practical; gives the latest directions that everyone may follow. . . . 1.25
Our Native Trees (*Keeler*). 350 illustrations. . . . 3.00
Planning and Planting the Home Garden (*Murray*). . . . 3.50

FARM AND GARDEN

Alfalfa (*Coburn*). A complete work. 164 pages. . . . \$1.10
Around the Year in the Garden (*Rockwell*). Gives a complete outline of the year's work in the garden. 350 pages. . . . 2.50
Asparagus (*Hexamer*). Very comprehensive. . . . 1.10
Cauliflower and Broccoli Culture (*Bouquet*). . . . 1.25
Clovers and How to Grow Them (*Shaw*). 337 pages. . . . 2.00
Farm and Garden Rule Book (*Bailey*). Useful information for farmers, fruit growers, truck gardeners, florists, etc. Full of useful information. 587 pages. . . . 3.00
Farmers Cyclopedia of Agriculture (*Wilcox and Smith*). A compendium of science and practice on farm, orchard and garden crops, including farm animals. . . . 4.50
Fertilizers and Crop Production (*Van Slyke*). Illustrated; 504 pages. . . . 4.00
Garden Book, The (*Davis*). . . . 1.25
Garden Guide. A complete treatise on the garden. 384 pages. Cloth, \$1.50; paper. . . . 1.00
Manual of Gardening (*Bailey*). A practical guide to the making of home grounds and the growing of flowers, fruits and vegetables. 539 pages. . . . 3.00
Mushroom Growing (*Duggar*). 260 pages. . . . 2.00
Mushrooms, How to Grow Them (*Falconer*). 170 pages. . . . 1.75
Muskmelon Production (*Lloyd*). . . . 1.25
Onion Culture (*Greiner*). 140 pages. . . . 1.10
Potato Production, Principles of (*Nixon*). 128 pages. . . . 1.25
Right Use of Lime in Soil Improvement (*Agee*). . . . 1.25
Roadside Marketing (*Watts*). . . . 1.25
Soils (*Burkett*). A complete work. 300 pages. . . . 1.75
Spraying Crops (*Weed*). 140 pages.75
Starting Early Vegetable and Flowering Plants Under Glass (*Nissley*). 350 pages. . . . 3.00
Sweet Potato Production and Handling (*Thompson*). . . . 1.25
1001 Garden Questions Answered (*Hottes*). Covers flowers, fruits and vegetables. 320 pages. . . . 2.00
Tomato Culture (*Tracy*). 150 pages. . . . 1.10
Vegetable Forcing (*Watts*). 400 pages. . . . 3.00
Vegetable Gardening (*Watts*). 511 pages. . . . 2.50
Weeds of the Farm and Garden (*Pammel*). 300 pages. . . . 2.00

FRUITS AND FRUIT CULTURE

American Fruits (*Fraser*). Their propagation, cultivation, harvesting, etc. 916 pages. . . . \$4.75
Bush Fruit Production (*Van Meter*). 128 pages. . . . 1.25
Cherry and Its Culture (*Gardner*). . . . 1.25
Grape Culturist (*Fuller*). Best work on the hardy grape. . . . 2.00
Pear and Its Culture, The (*Tukey*). . . . 1.25

POULTRY, BEES, PIGEONS AND BIRDS

A B C of Bee Culture (*Root*). 437 pages. Very complete. . . . \$2.00
Canary Birds (*Burkett*). 64 pages.80
Feeds and Feeding, Poultry (*Lamon & Lee*). . . . 1.75
How to Select the Laying Hen (*Lamon & Kinghorne*). A practical guide. 144 pages. . . . 1.25
Poultry Breeding and Management (*Dryden*). 416 pages. . . . 2.00
Poultry Production (*Lippincott*). 517 pages. . . . 3.50
Rabbits for Food and Fur (*Ashbrook*). 212 pages. . . . 2.00
Squabs for Profit (*Rice*). A complete work. . . . 1.10

Use Natural Plant Food this year!

Only Natural Plant Foods restore the humus and essential elements used up by your plants each year. Wizard Brand Manures bring out the real beauty of your lawn and garden because they supply the humus not found in chemical fertilizer and at the same time furnish all the essential plant food elements in a form easily digested by plants. Wizard Brand Sheep and Cow Manures are safe, economical and easy to use. Feed your lawn, flowers, shrubs, trees and vegetables with Wizard. You will be amazed at the new growth and beauty that Wizard brings.

Wizard Sheep Manure is a highly concentrated pure sheep manure, dried and sterilized to kill all weed seeds. It is Nature's way of building up soils and making plants grow. Wizard is safe for lawns and all plants. It is most economical because **ONE BAG EQUALS A WHOLE WAGON LOAD OF STABLE MANURE.**

LAWNS AND GARDENS. Wizard produces

thick, velvety, green lawns of lasting beauty. Make an application early in Spring and you will be surprised at the new beauty it will develop. On old lawns broadcast, like sowing seed, 6 to 10 lbs. per 100 sq. ft.; on new lawns 10 lbs. per 100 sq. ft. raked into the surface soil. Luxurious green foliage and a wealth of vivid colored flowers quickly follow the use of Wizard. Mix well with the soil under new plantings and cultivate into the surface soil around established plants. Fine for vines, shrubs and trees.

VEGETABLES AND FRUIT. Every gardener knows that nothing equals manure for growing big crops of crisp, tender vegetables. Wizard will insure profitable crops on time for the early market. It also improves the color and flavor of fruit. Use 1000 to 1500 lbs. per acre.

FLORISTS. Wizard has been used by florists for over twenty-six years. It is of highest quality, safe and dependable for all crops under glass or in the field.

Michell's Quality Seeds and Wizard Brand Sheep Manure have worked together making beautiful lawns and gardens for more than twenty-five years

WIZARD BRAND COW MANURE

Wizard Shredded and Pulverized Cow Manures are dried and sterilized manures with all weed seeds killed. They are cool, slow-acting manures and preferred to sheep manure for roses, lilies and all plants requiring a milder and cooler manure. Shredded Cow Manure is rough and coarse and is unexcelled as a mulch and plant food combined for growing roses. Pulverized Cow Manure is finely ground and resembles sheep manure in appearance. It is preferred by practical florists for preparing bench and potting soils. It is especially valuable for binding loose, sandy soils.

For Prices on Wizard Brand Manures, see Fertilizer Section of this Catalog



MANURE IMPROVES
AND BUILDS UP
WORN-OUT SOILS!

WIZARD
TRADE BRAND MARK
COW
MANURE

NATURE'S PERFECT
PLANT FOODS-PURE
AND WEEDLESS!

**MICHELL'S
SEEDS
BULBS ~ PLANTS**

1934

HENRY F. MICHELL CO.
516 and 518 MARKET ST., PHILA., PA.

NURSERIES, TRIAL GROUNDS, GREENHOUSES, ANDALUSIA, PA.