

2200

2/85
302

Fabriek van Bronswerken van **Becht en Dyserinck.**

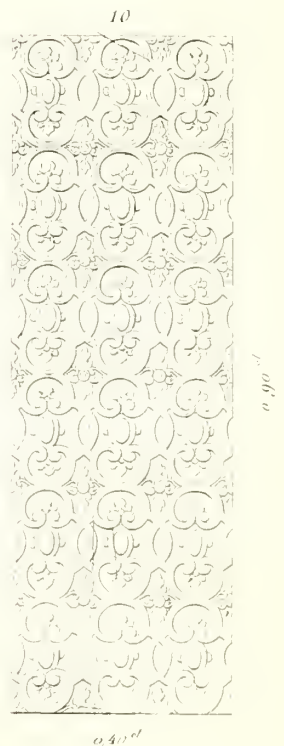
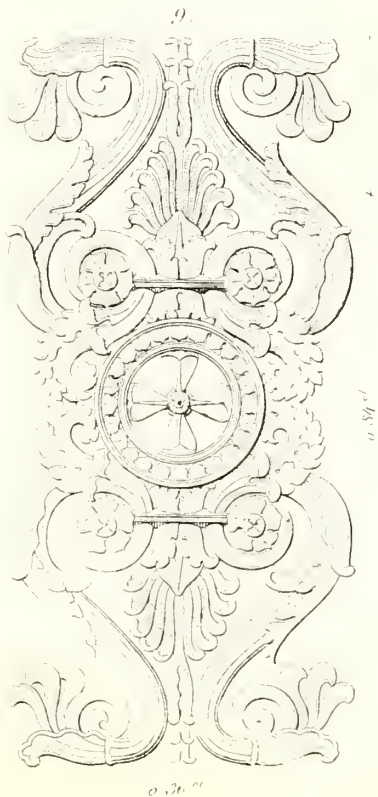
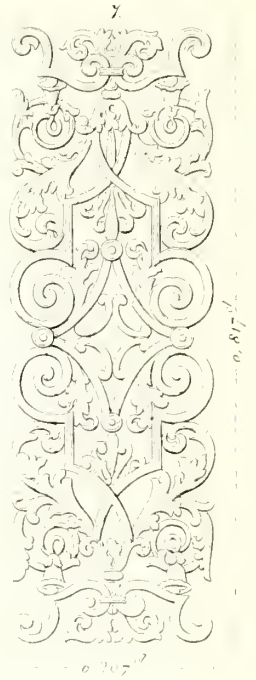
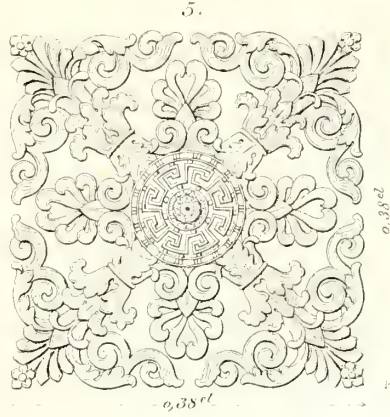
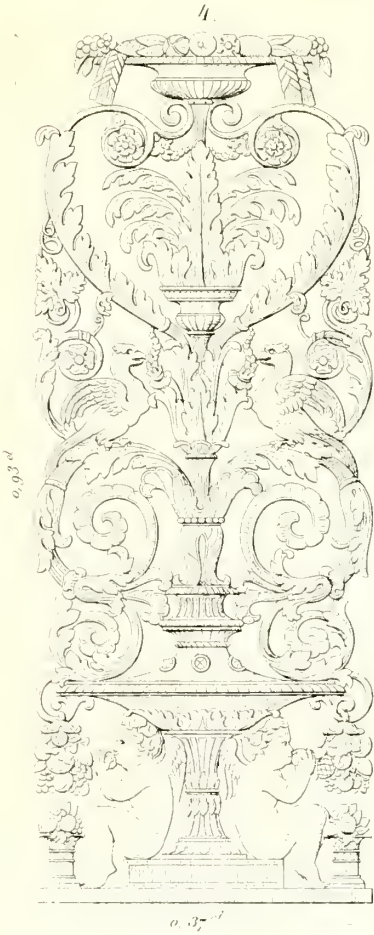
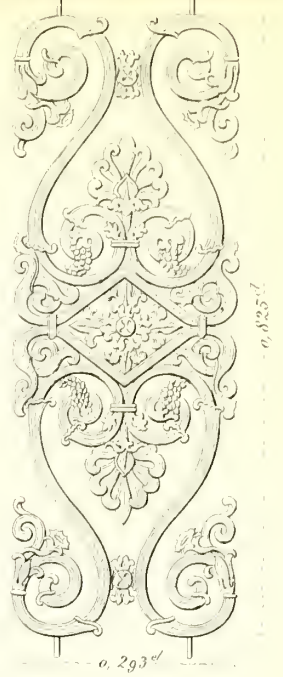
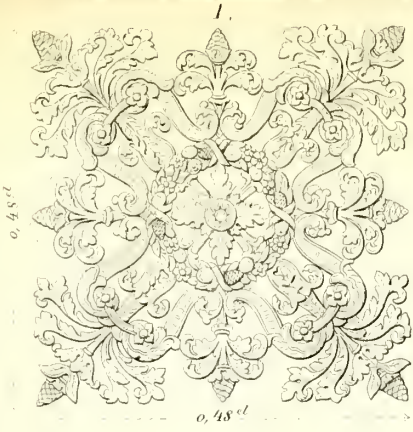

Fabriek van Bronswerken van *Becht en Dyserinck.*

11.

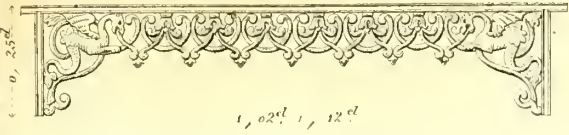

1, 02^{el} 1, 12^{el}

12.

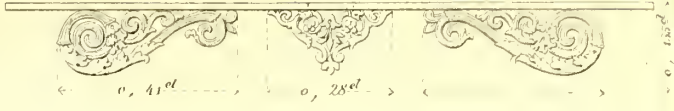

0, 41^{el} 0, 28^{el}

13.

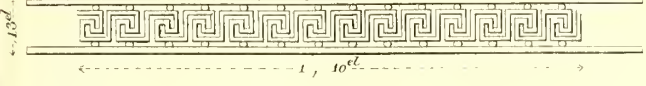

1, 10^{el}

14.

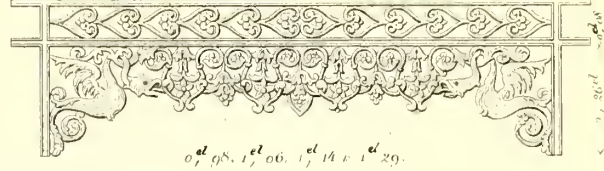

0, 98, 1, 06, 1, 14, 1, 29.

15.

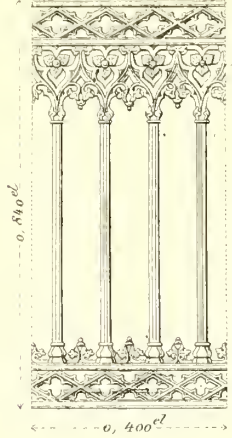

0, 840^{el}

0, 400^{el}

16.

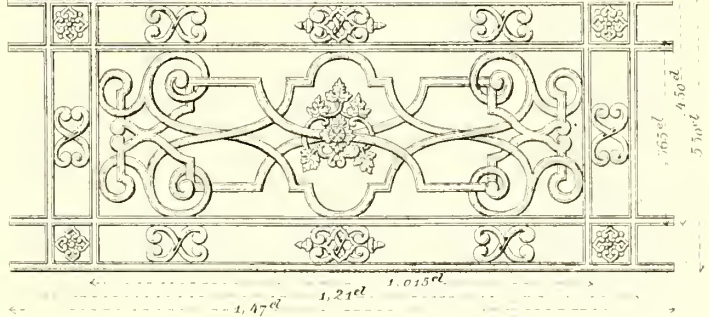

1, 47^{el} 1, 21^{el} 1, 015^{el}

1, 65^{el} 4, 50^{el} 5, 70^{el}

17.

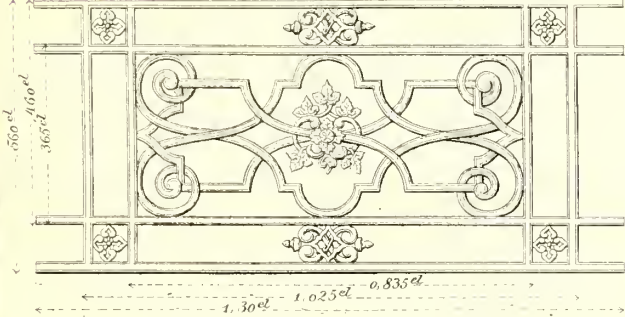

0, 560^{el} 3, 65^{el}

1, 50^{el} 1, 025^{el} 0, 835^{el}

18.

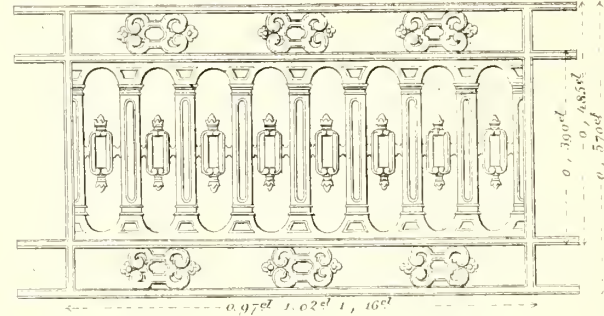

0, 300^{el} 0, 485^{el} 0, 570^{el}

0, 97^{el} 1, 02^{el} 1, 16^{el}

19.

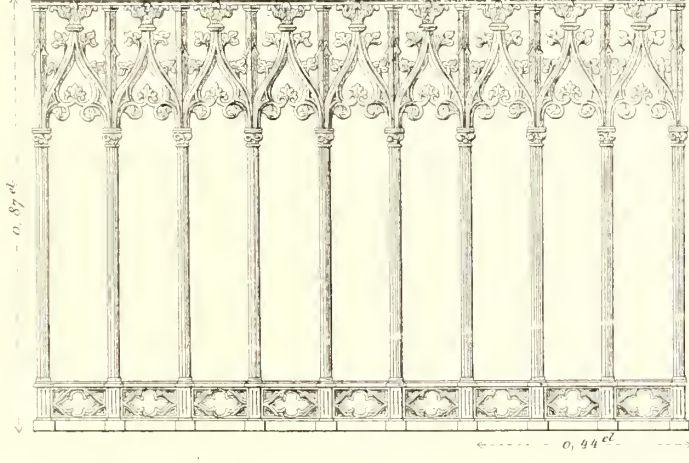

0, 87^{el}

0, 44^{el}

20.

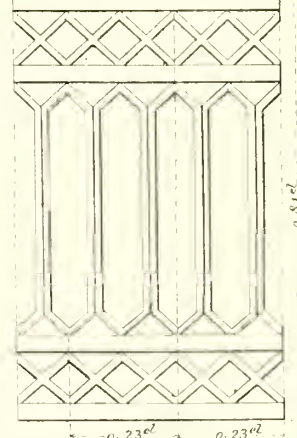

0, 81^{el} 0, 85^{el}

0, 23^{el} 0, 23^{el}

21.

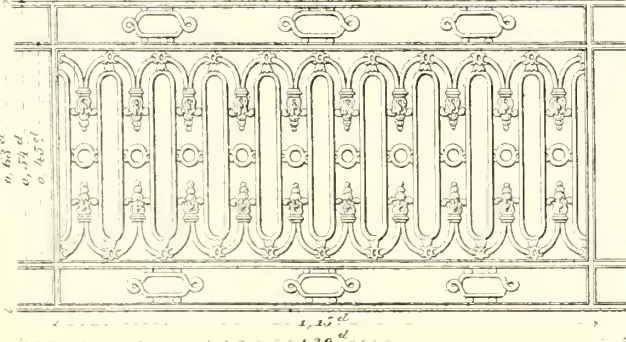

0, 63^{el} 0, 54^{el} 0, 63^{el}

1, 15^{el} 1, 29^{el}

22.

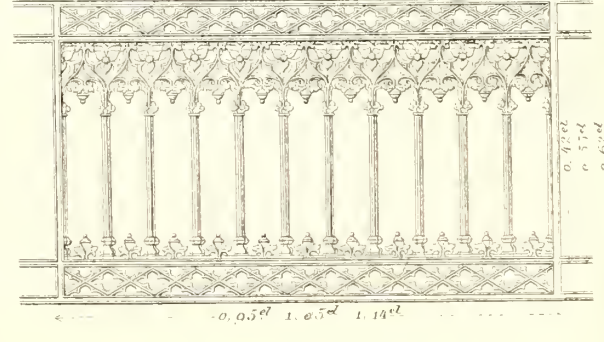

0, 42^{el} 0, 57^{el} 0, 62^{el}

0, 05^{el} 1, 05^{el} 1, 14^{el}

Fabriek van Bronswerken van *Becht en Dyserinck.*

47.

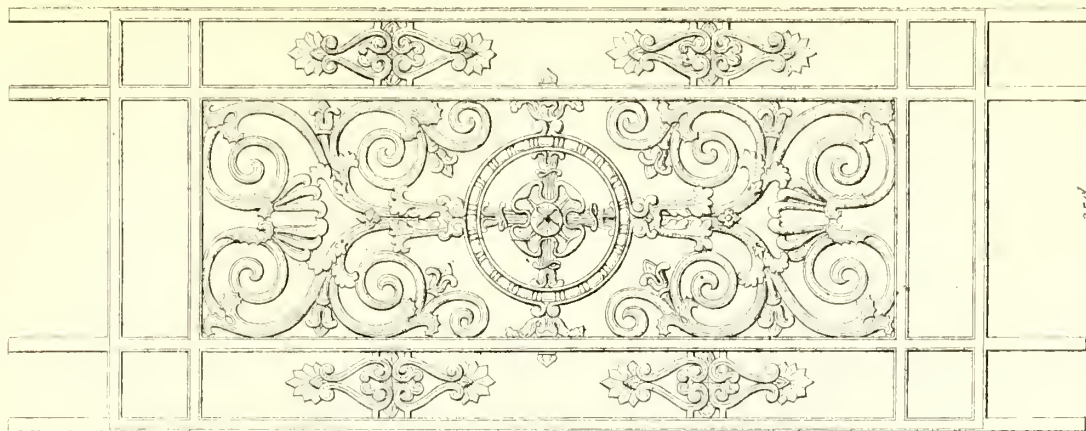

0,35^d
0,45^d
0,56^d

1d 18
0,97^{el}

48.

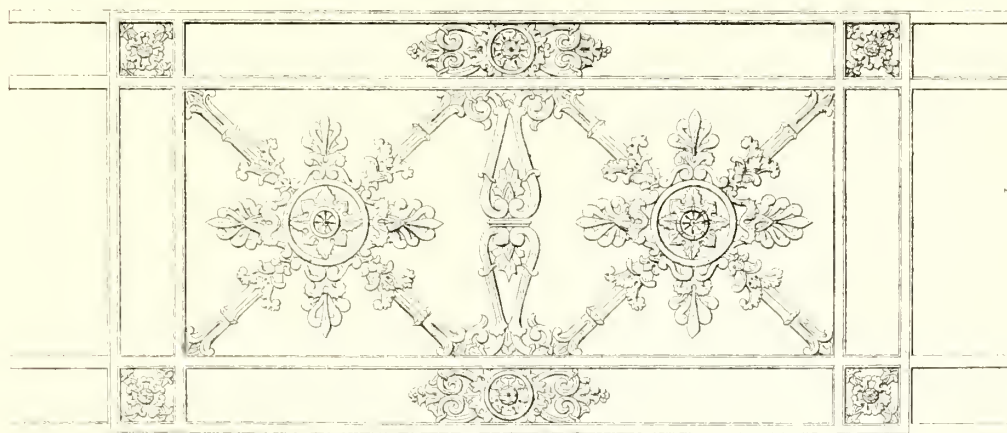

0,39^d
0,47^d
0,56^d

1d 08
0,90^{el}

49.

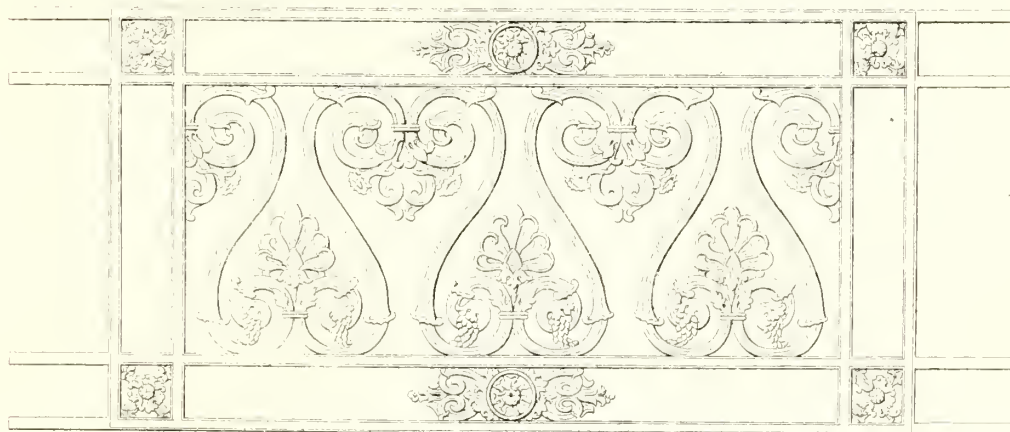

0,30^d
0,40^d
0,57^d

1d 09
0,92^{el}

50.

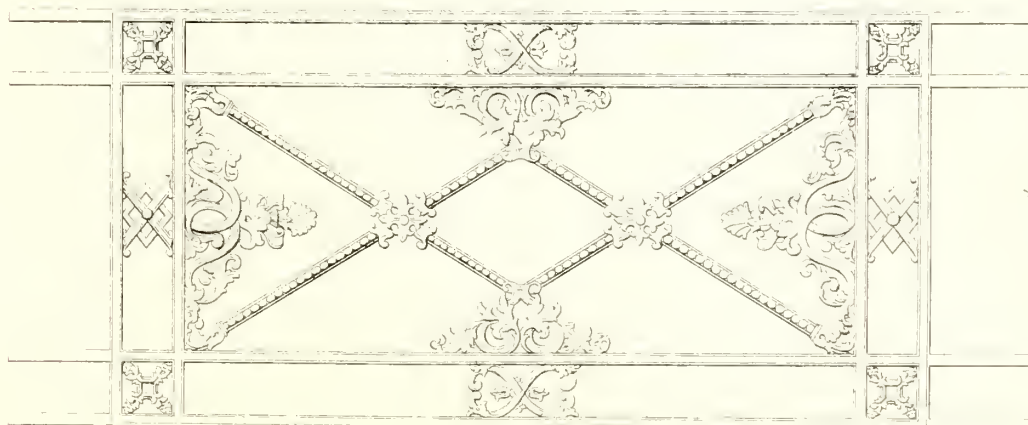

0,30^d
0,42^d
0,56^d

1d 13
0,93^{el}



Digitized by the Internet Archive
in 2015

Fabriek van Bronswerken van *Becht en Dyserinck.*

23.



1, 33^{el}

24.



25.

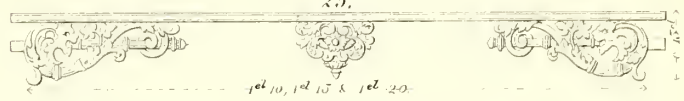

26.



27.

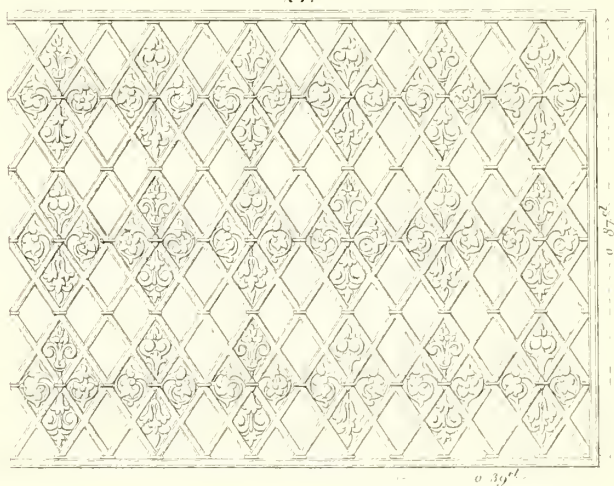

28.

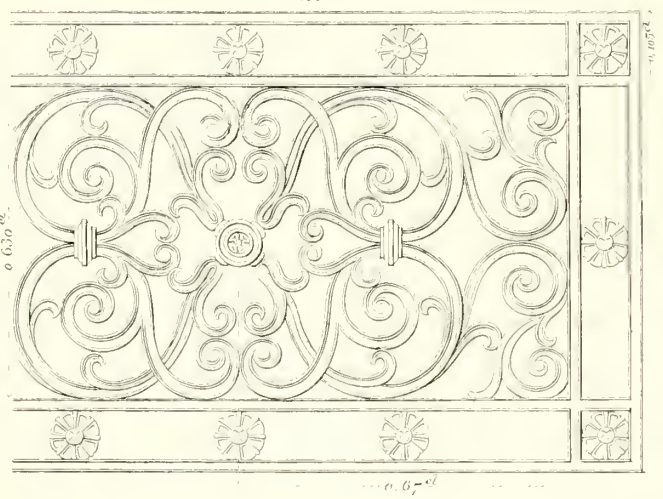

29.

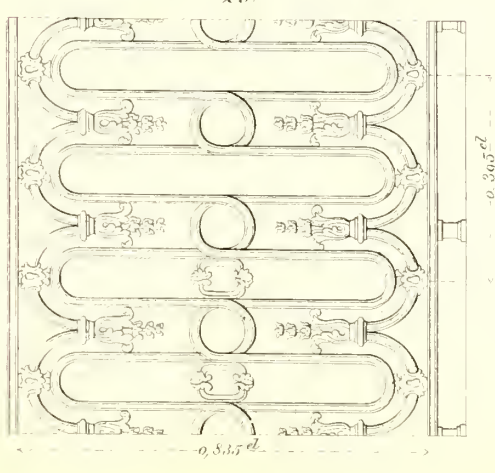

30.

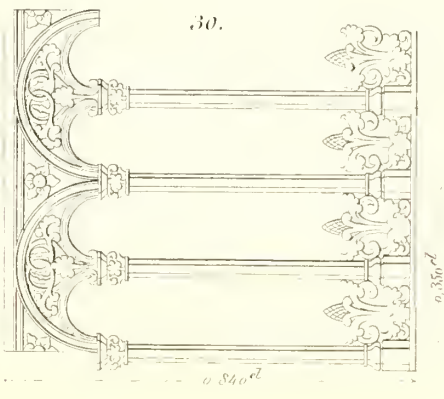

Fabriek van Bronswerken van *Becht en Dyserinck*.

51.

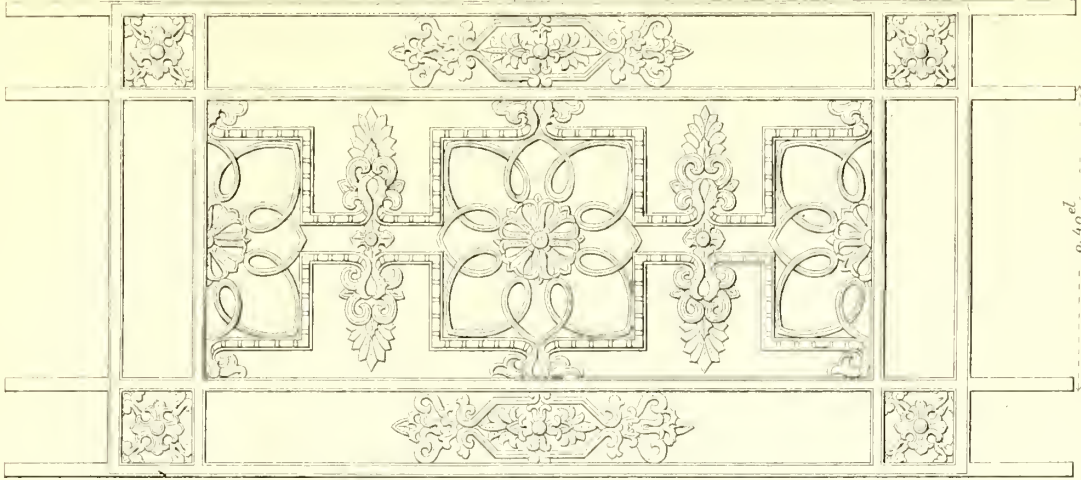

0,40^{el}
 0,52^{el}
 0,625^{el}

1 El 16
 0,94^{el}

52.

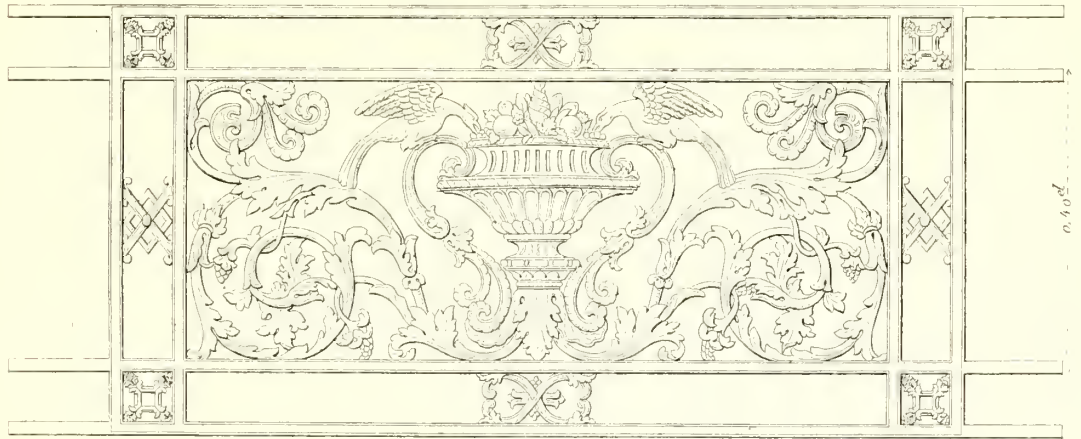

0,40^{el}
 0,49^{el}
 0,575^{el}

1 El 16
 0,99^{el}

53.

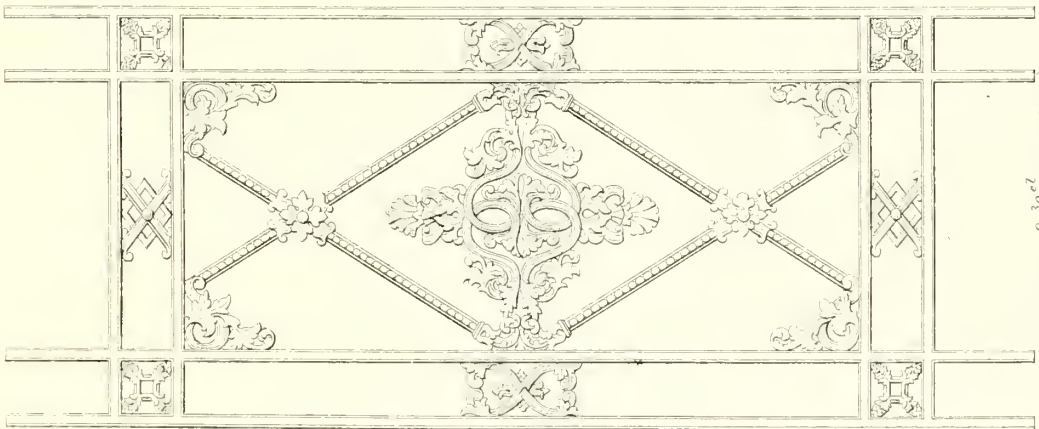

0,30^{el}
 0,47^{el}
 0,56^{el}

1 El 13
 0,95^{el}

54.

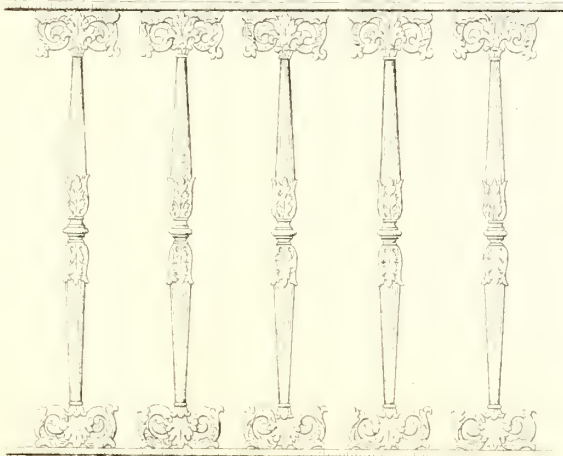

- van alle lengten -

55.

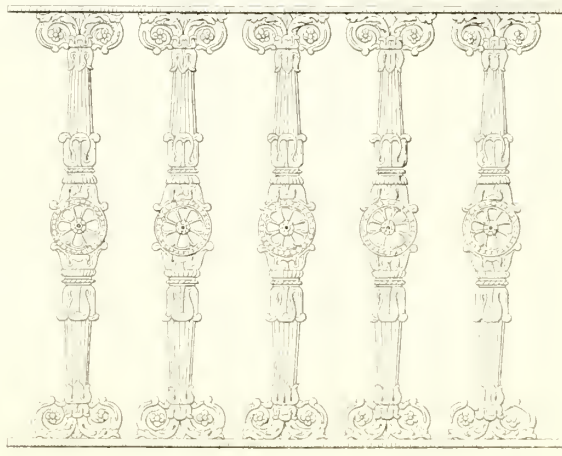

- van alle lengten -

Fabriek van Bronswerken van *Becht en Dyserinck.*

89.

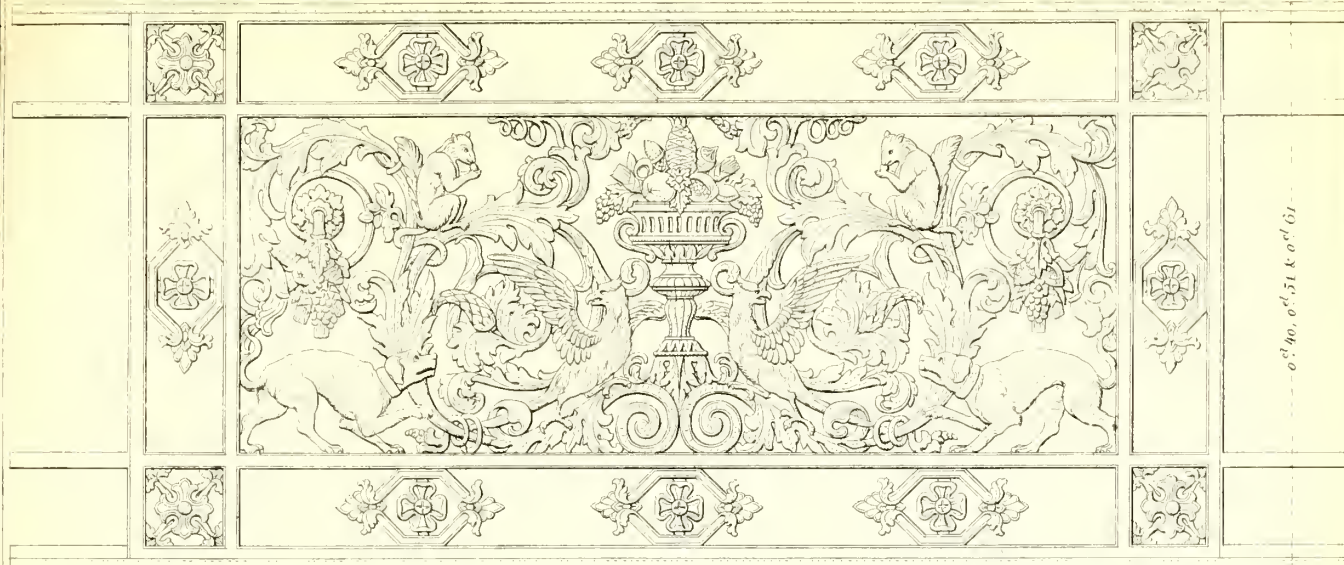

o^d 40, o^d 51 x o^d 61

1^d 01 x 1^d 21

90.

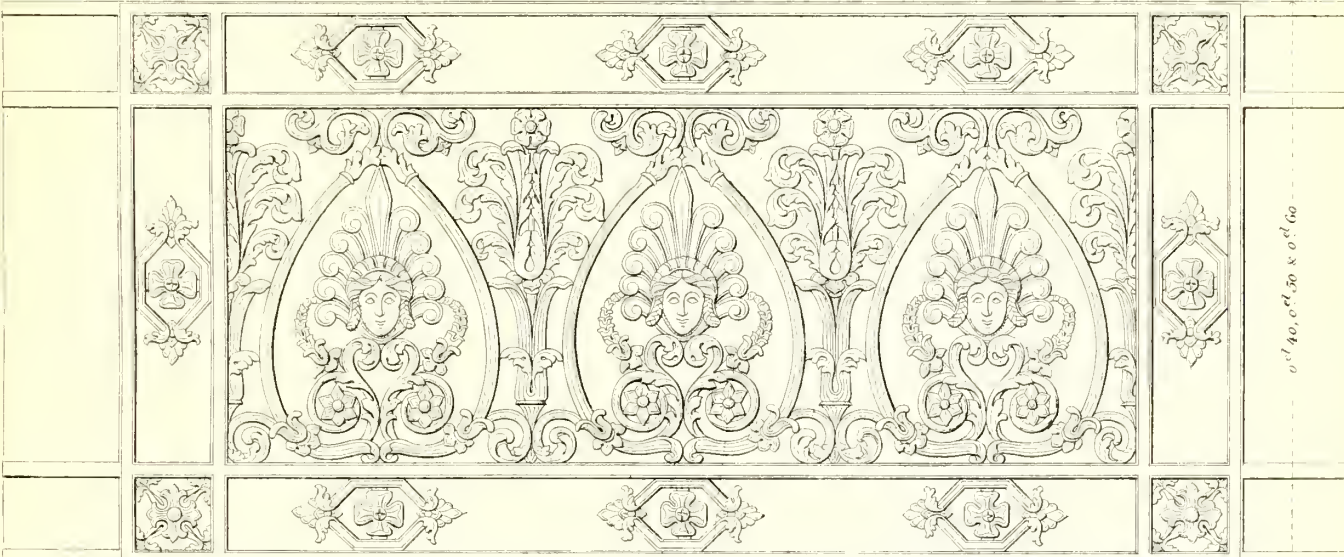

o^d 40, o^d 50 x o^d 60

o^d 98 x 1^d 20

91.

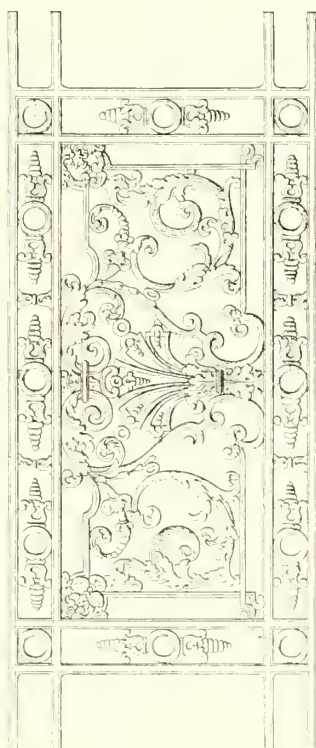

1^d 25
o^d 94

o^d 425
o^d 51
o^d 60

92.

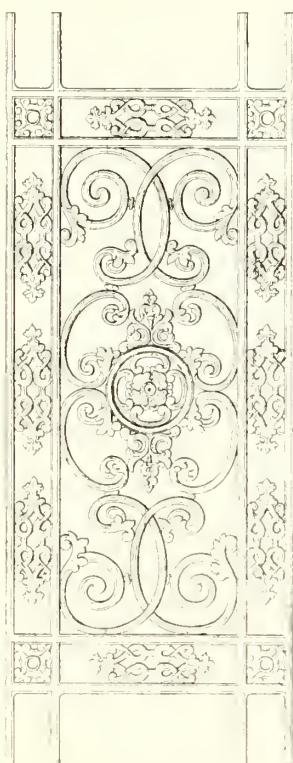

1^d 655
o^d 965

o^d 37
o^d 465
o^d 56

93.

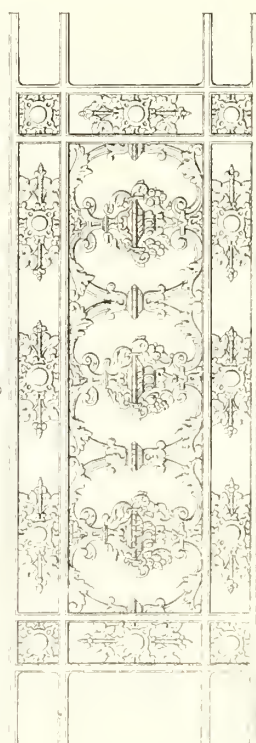

1^d 115
o^d 91

o^d 285
o^d 38
o^d 48

Fabriek van Bronswerken van *Becht en Dyserinck.*

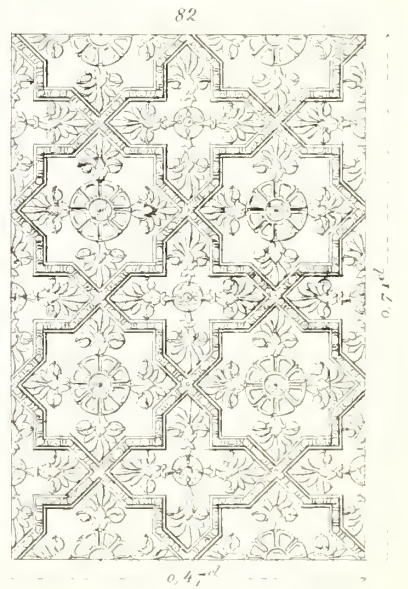
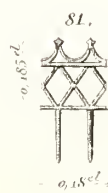
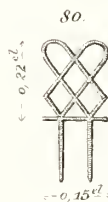
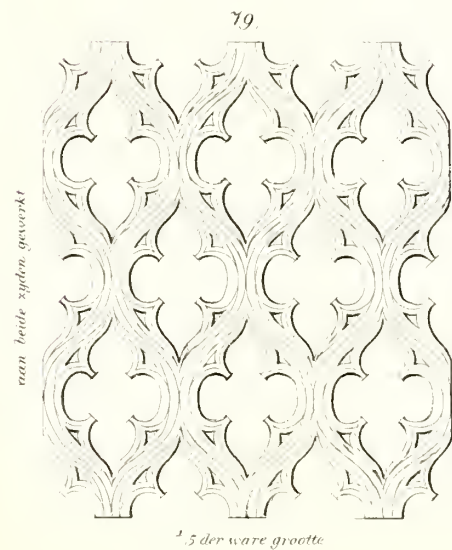
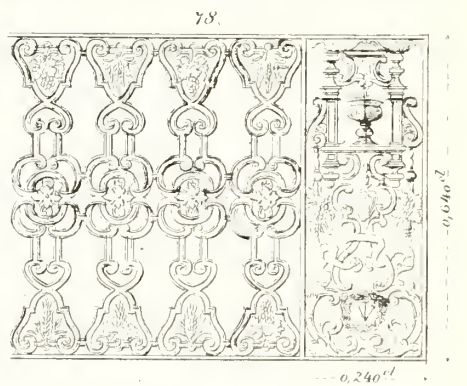
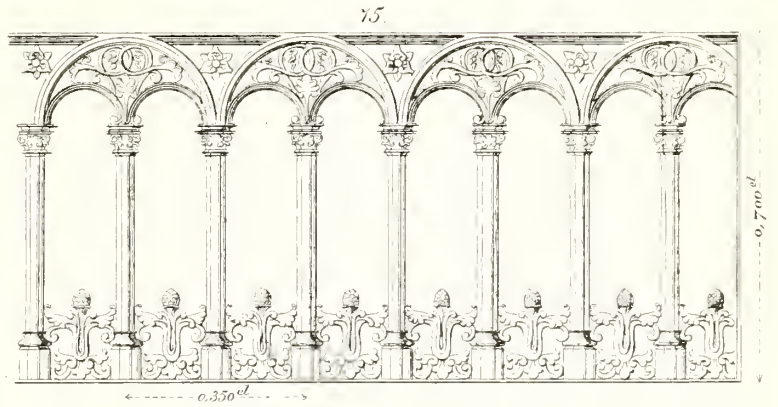
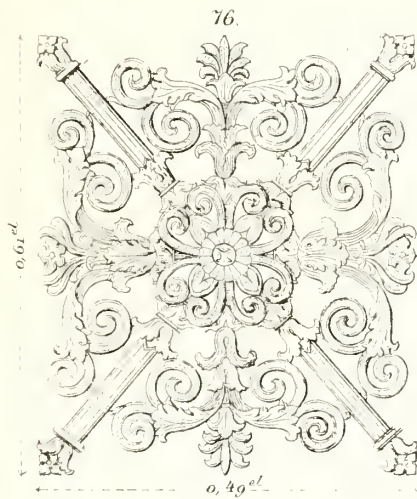
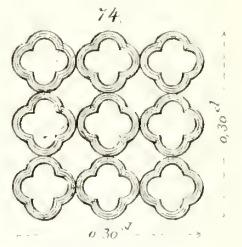
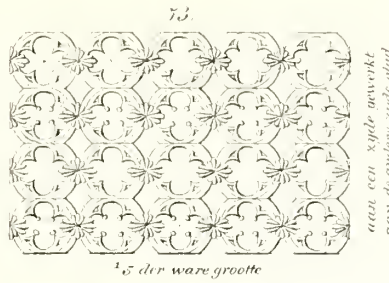
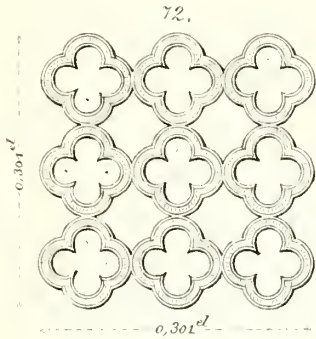
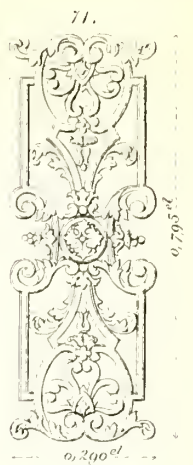
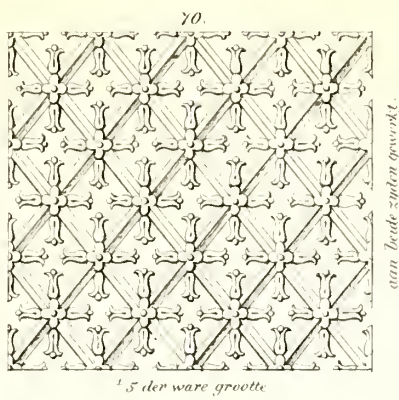
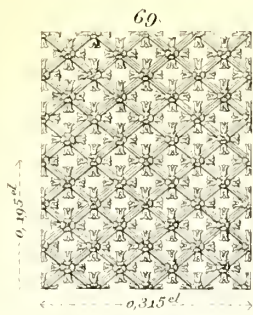



Fabriek van Bronswerken van *Becht en Dyserinck.*

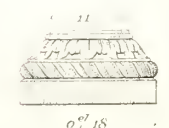
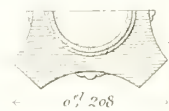
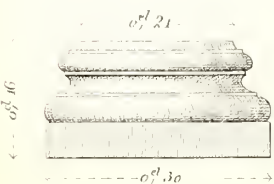
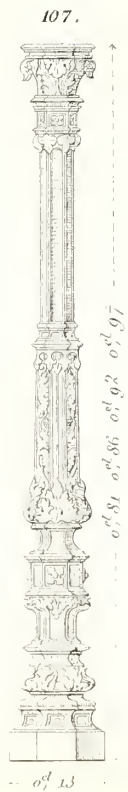
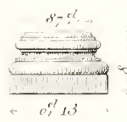
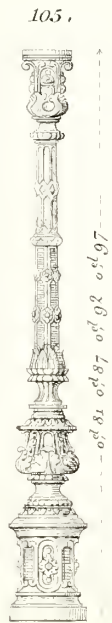
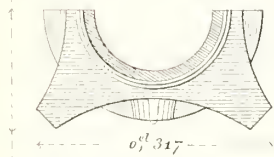
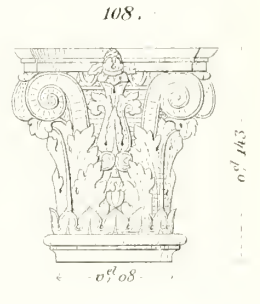
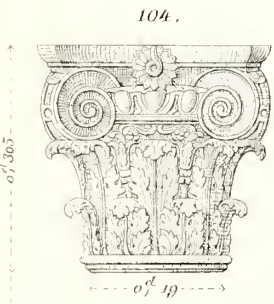
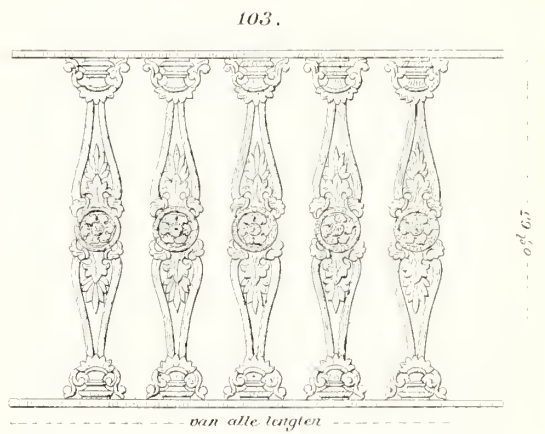
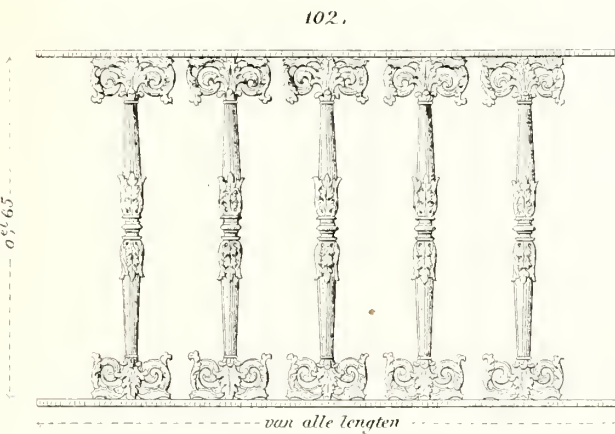
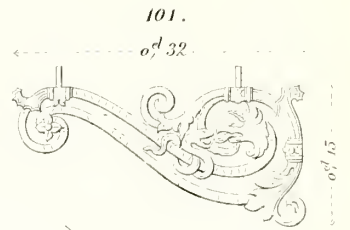
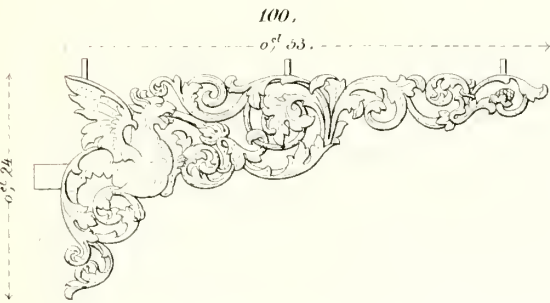
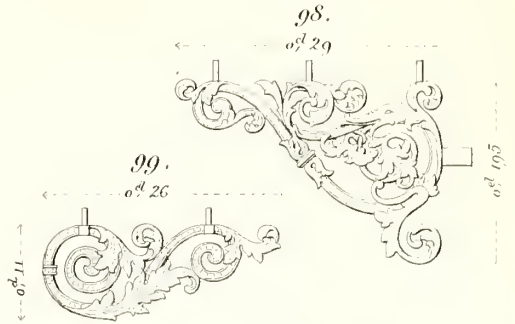
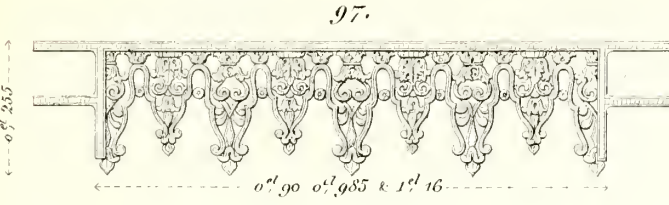
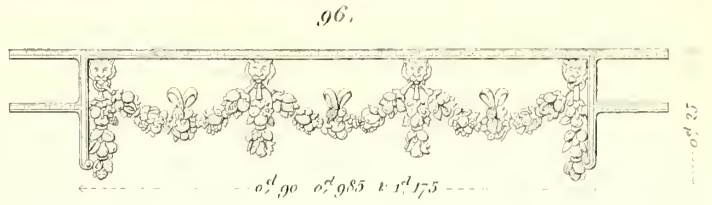
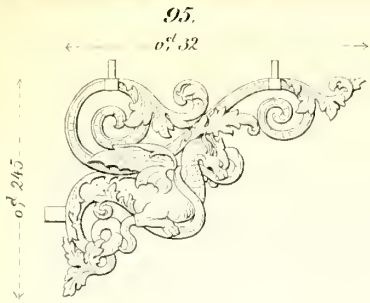

Fabriek van Bronswerken van *Becht en Dyserinck.*

83.

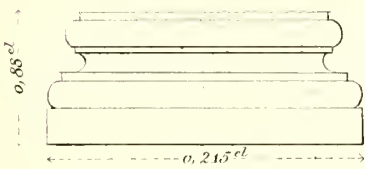
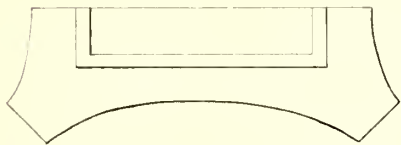
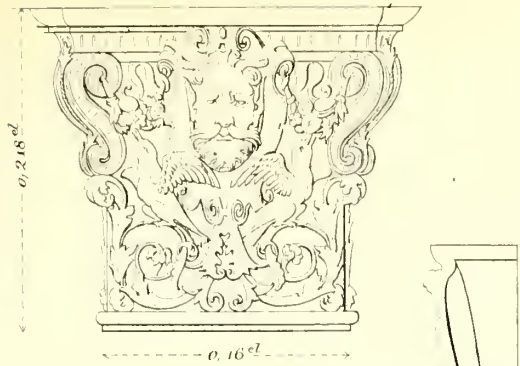

85.

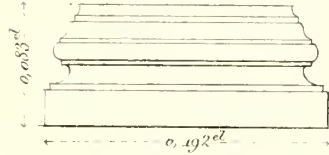
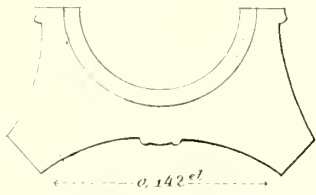
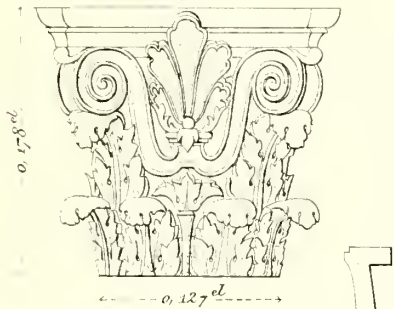

87.

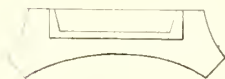
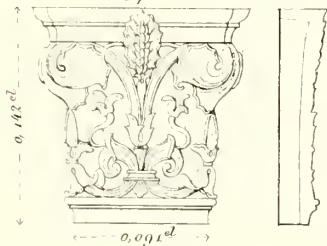

84.

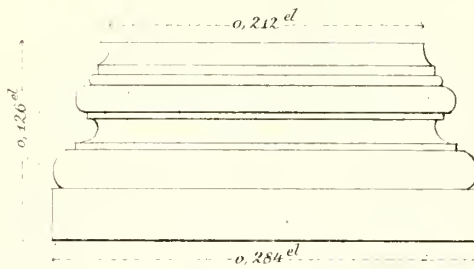
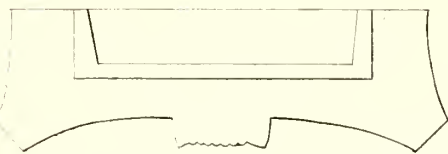
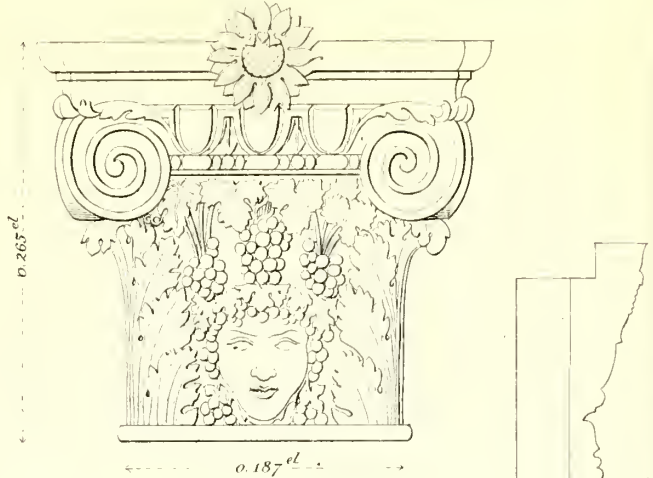

86.

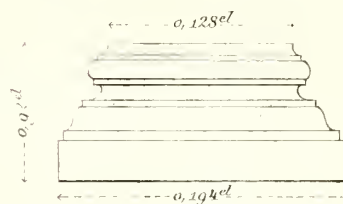
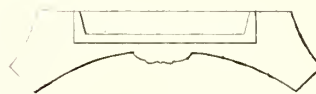
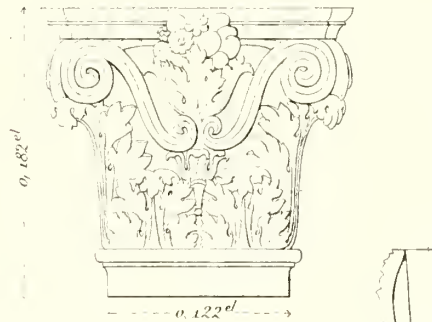

88.

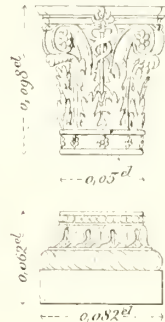

Fabriek van Bronswerken van *Becht en Dyserinck.*

110.



111.

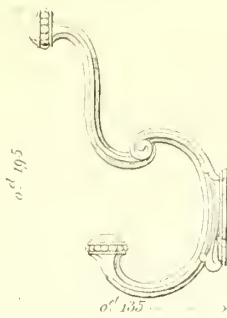

112.

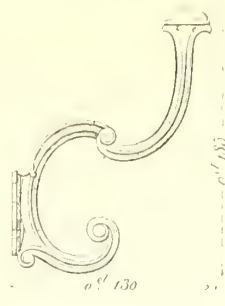

113.

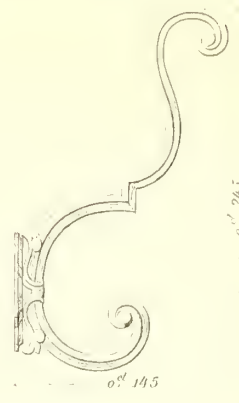

114.

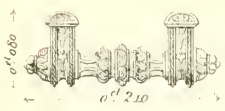

115.

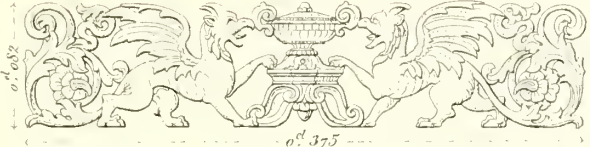

116.



117.



118.

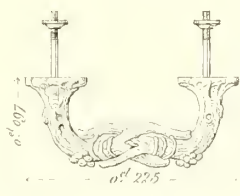

119.

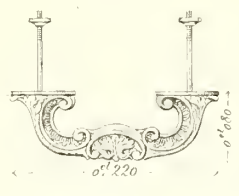

120.



121.

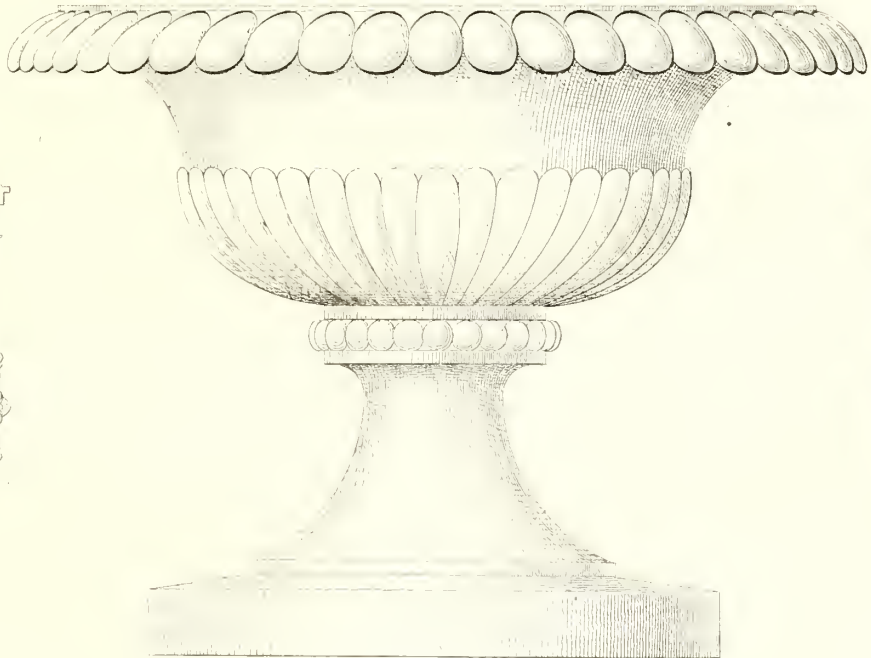

122.

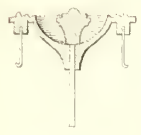

123.

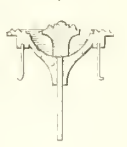

124.



126.

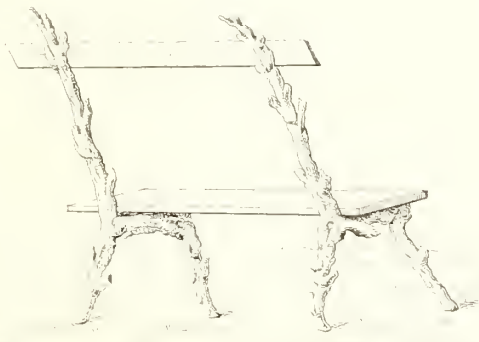

125.

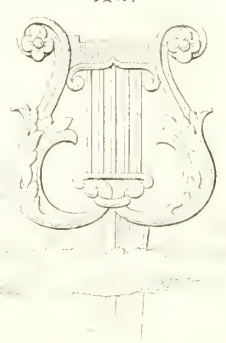

Fabriek van Bronswerken van *Becht en Dyserinck.*

43.



44.

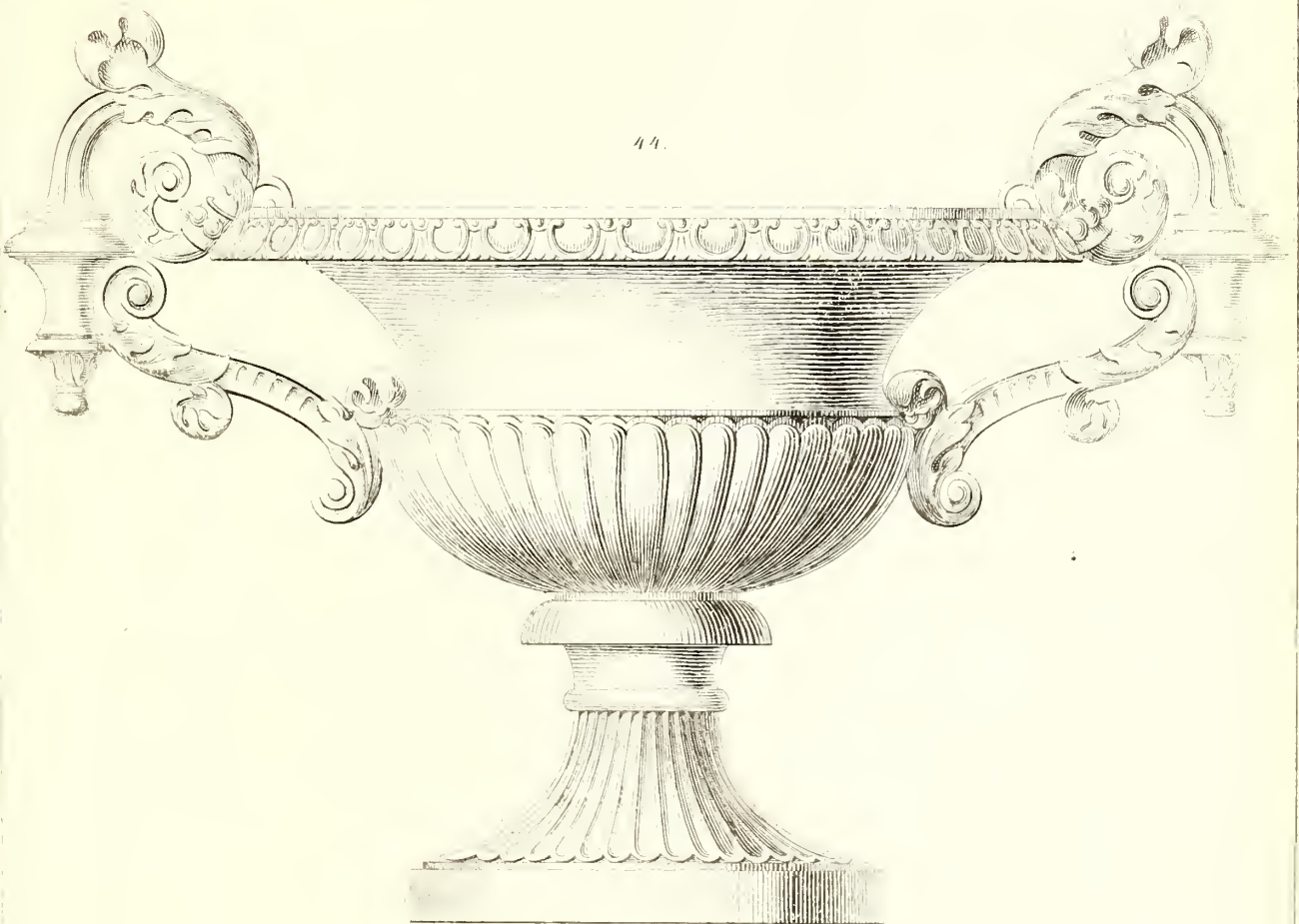

Fabriek van Bronswerken van *Becht en Dyserinck.*

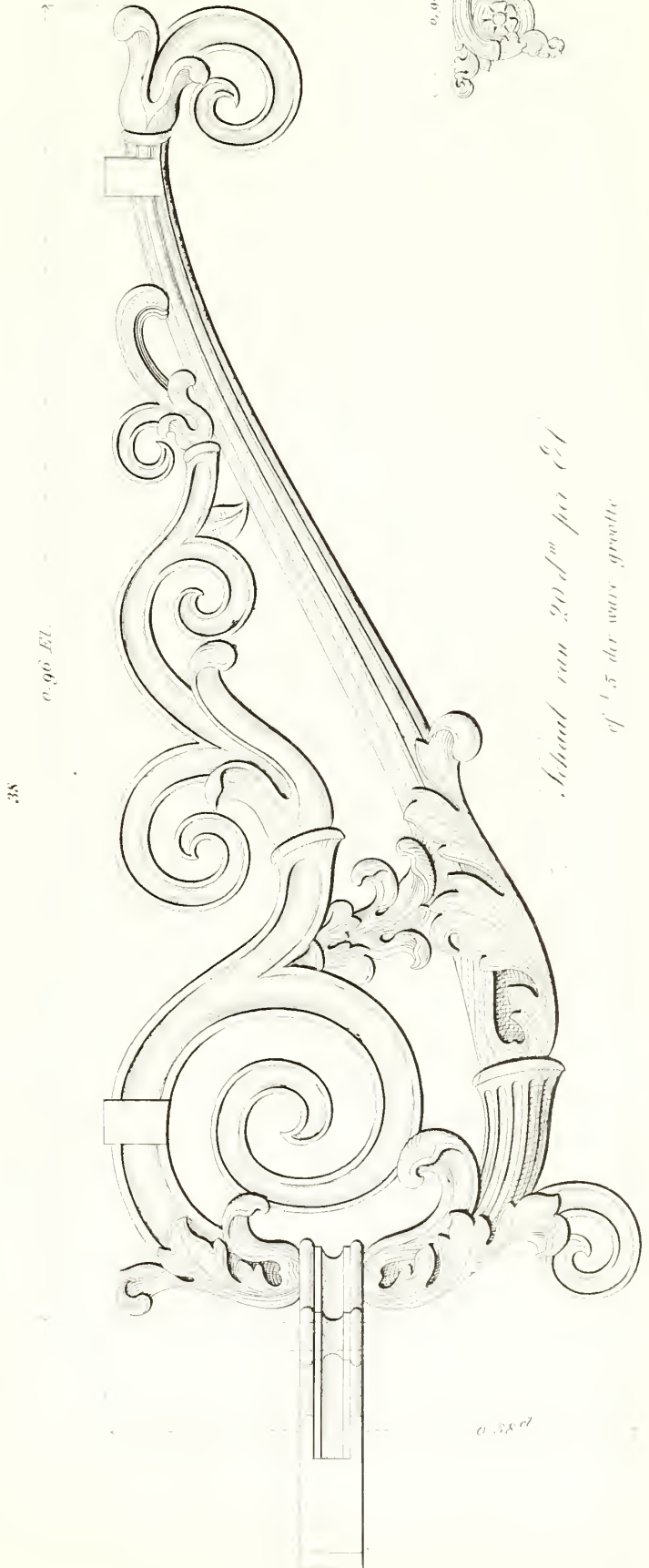
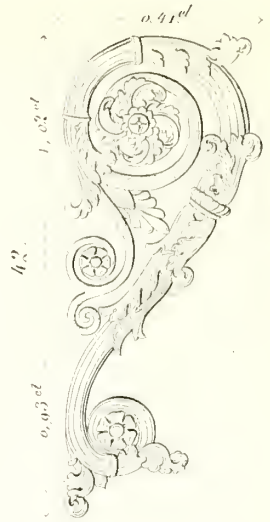
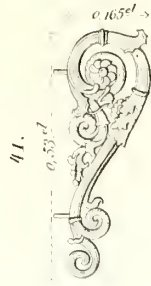
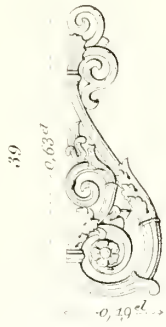
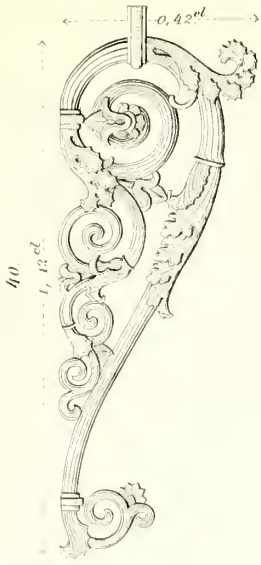
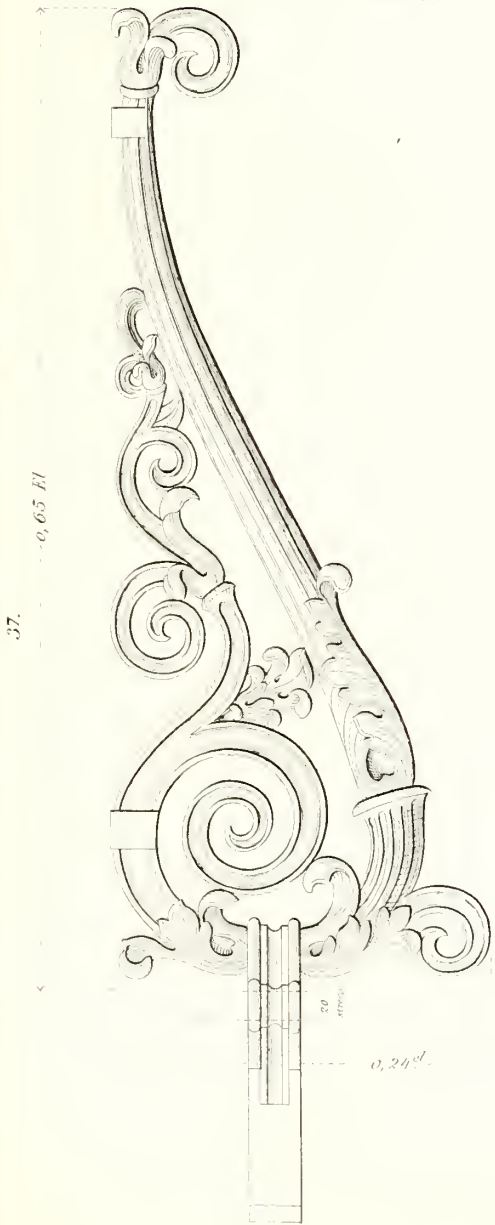

*Behoud van 20^{de} mm per El.
of 1,5 der ware grootte*

Fabriek van Bronswerken van *Becht en Dyserinck.*

132.

o^l 17
o^l 31

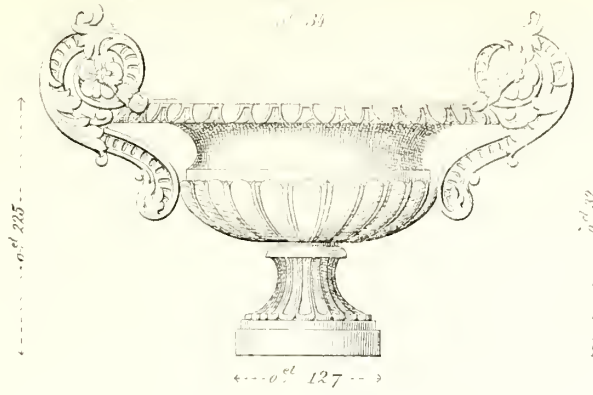

134.

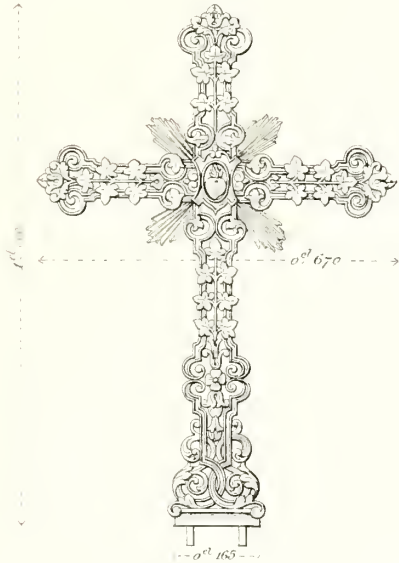

135.

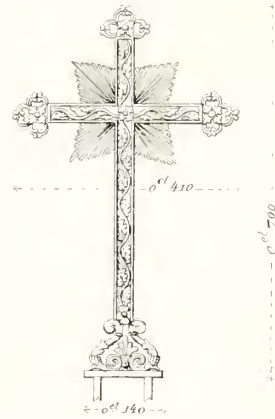

133.

o^l 70
o^l 475

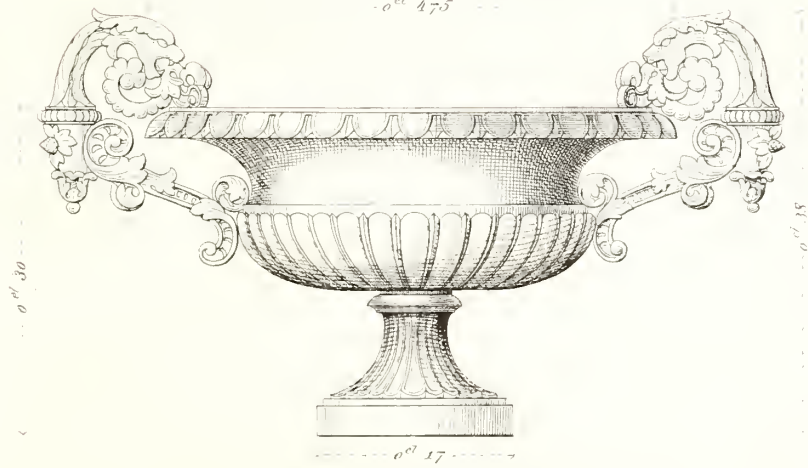

Fabriek van Bronswerken van *Becht en Dyserinck.*

94.

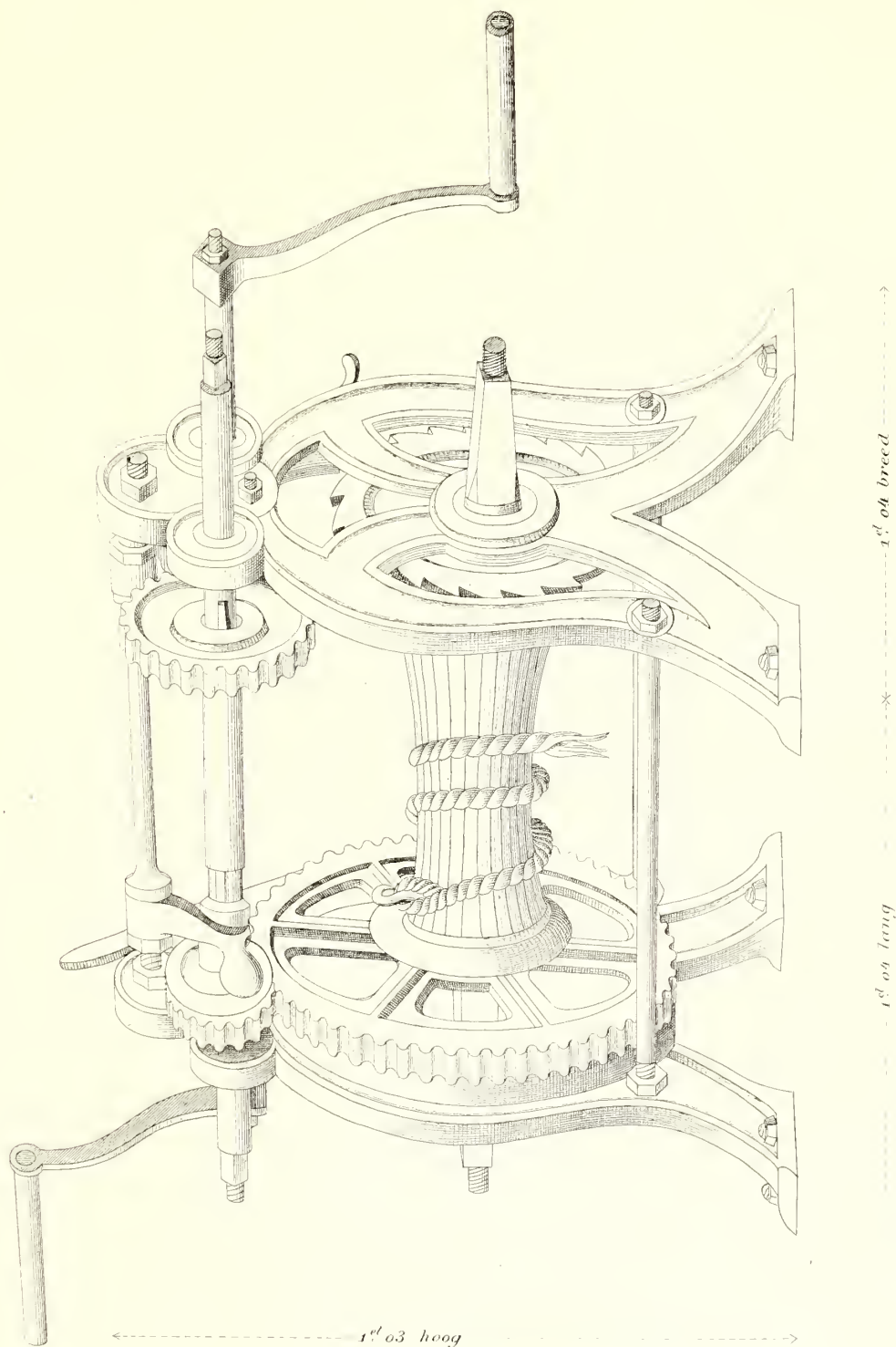

Fabriek van Bronswerken van *Becht en Dyserinck.*

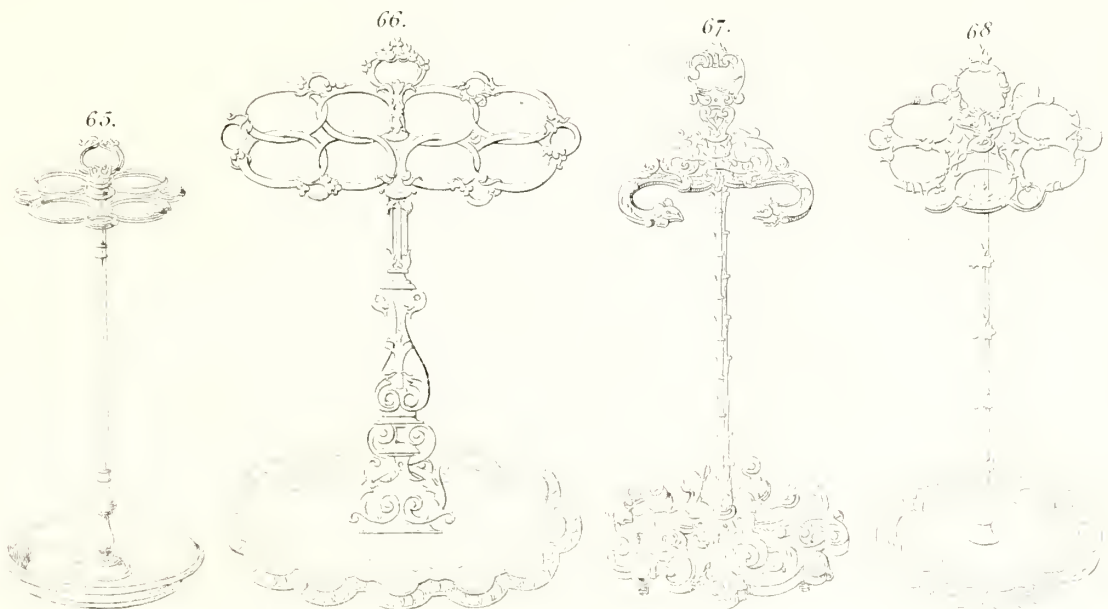
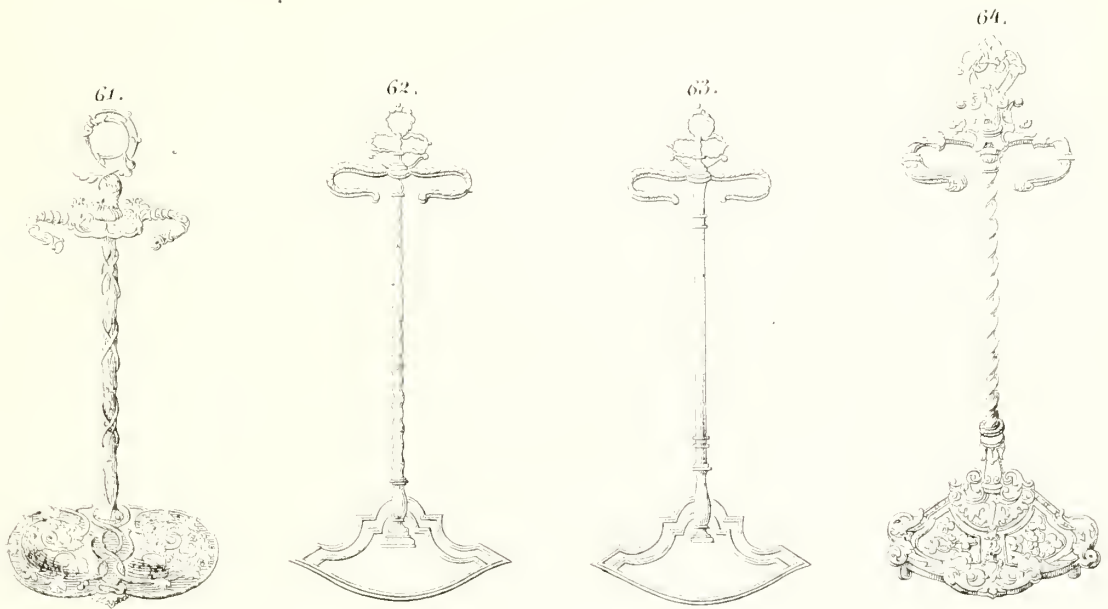

Fabriek van Bronswerken van *Becht en Dyserinck.*

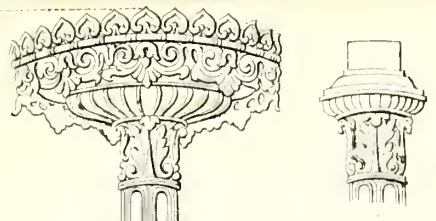

4.7.

2.32^{el}

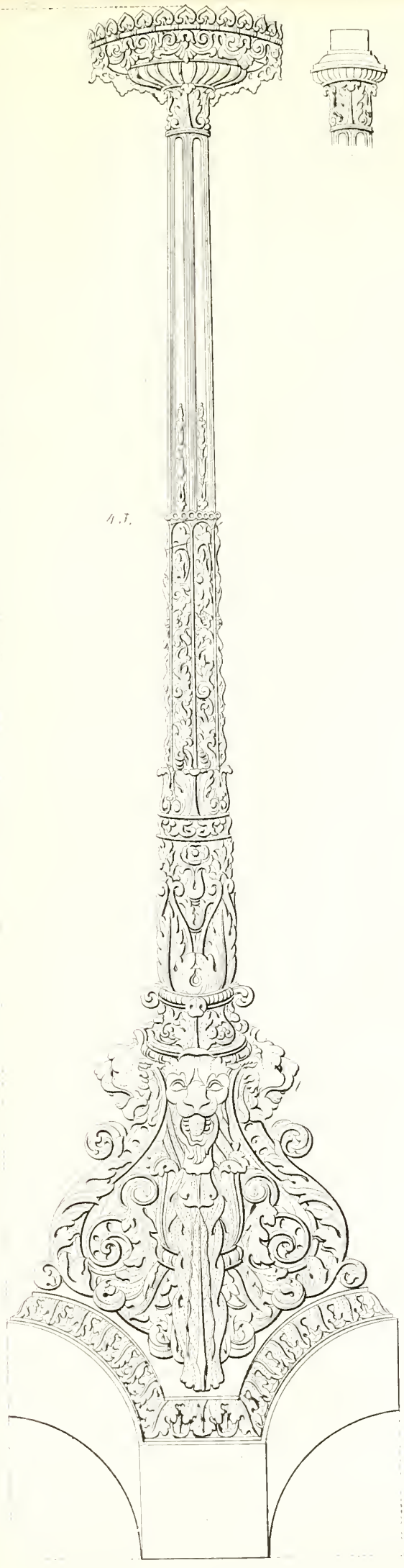

0.70^{el}

Schaal van 0.125 per El.

46.

1.55^{el}

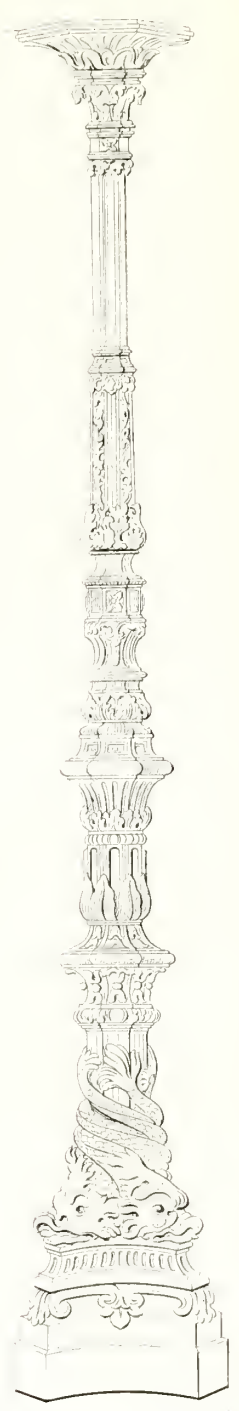

0.295^{el}

Schaal van 0.06 per El.

Fabriek van Bronswerken van *Becht en Dyserinck.*

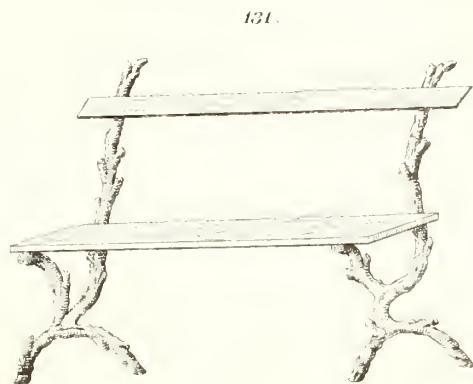
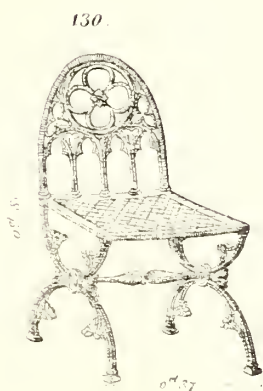
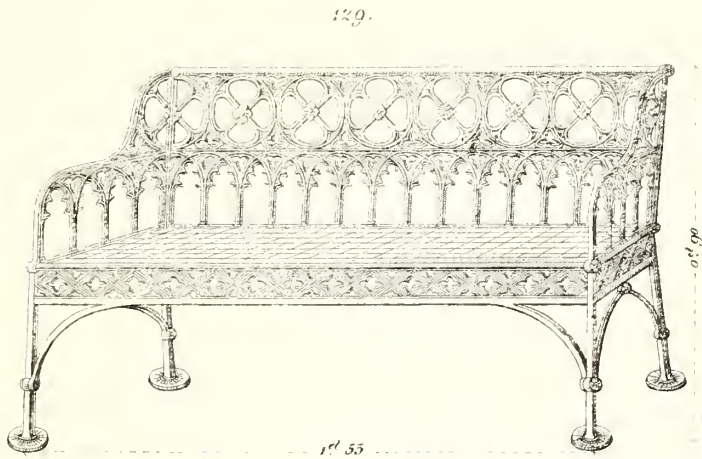
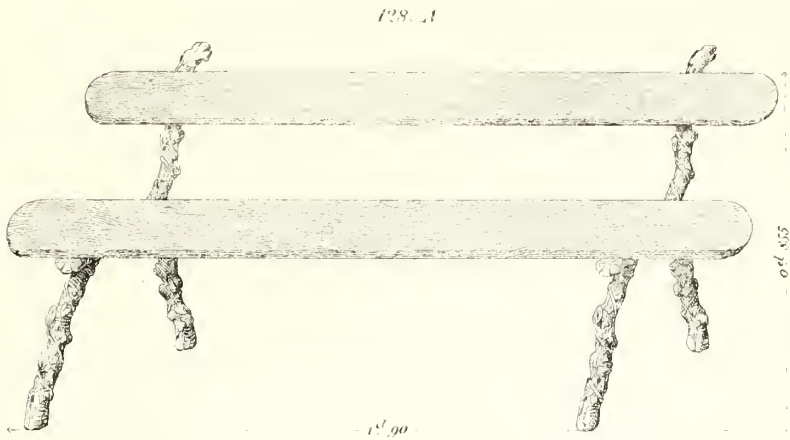
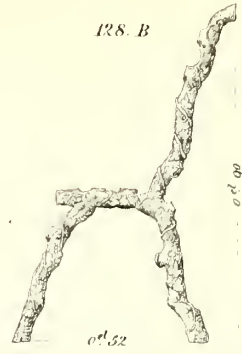
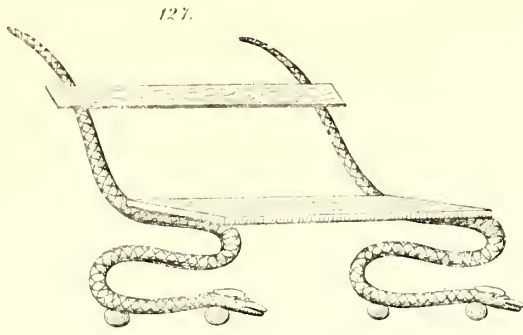

Fabriek van Bronswerken van *Becht en Dyserinck.*

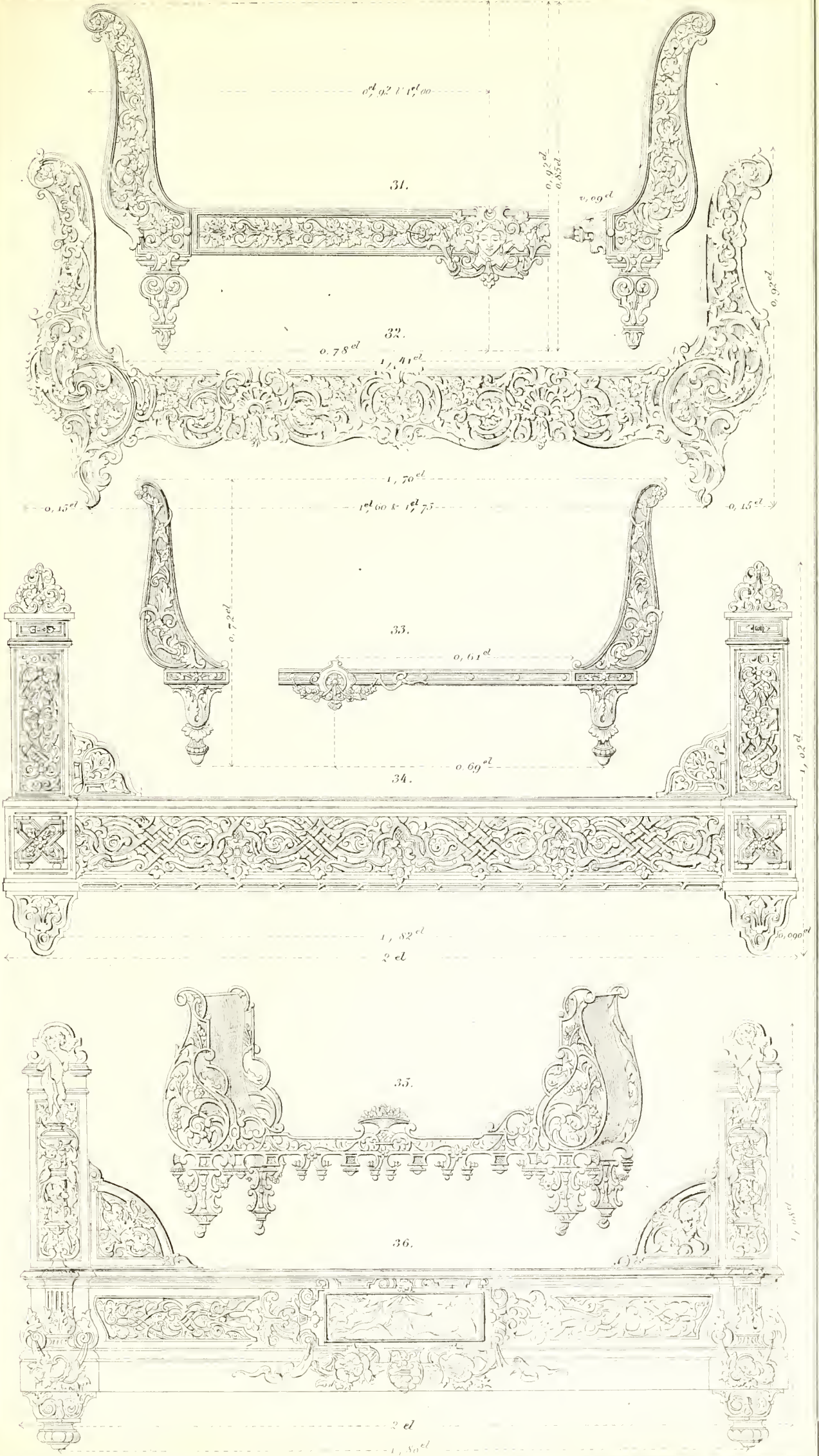

Fabriek van Bronswerken van *Becht en Duserinck.*

136.



137.

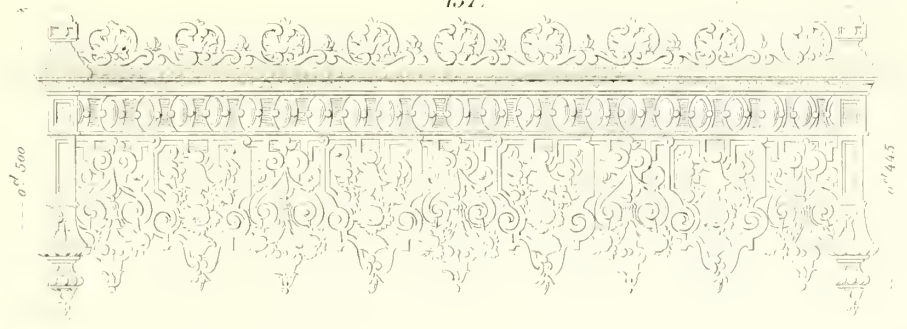

138.

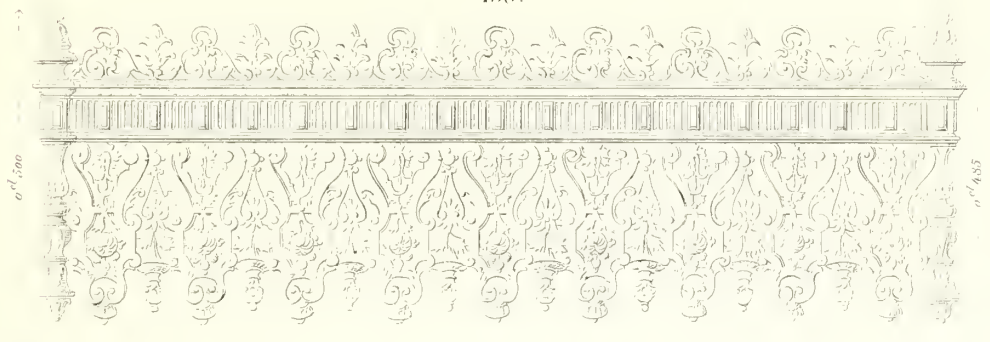

139. "

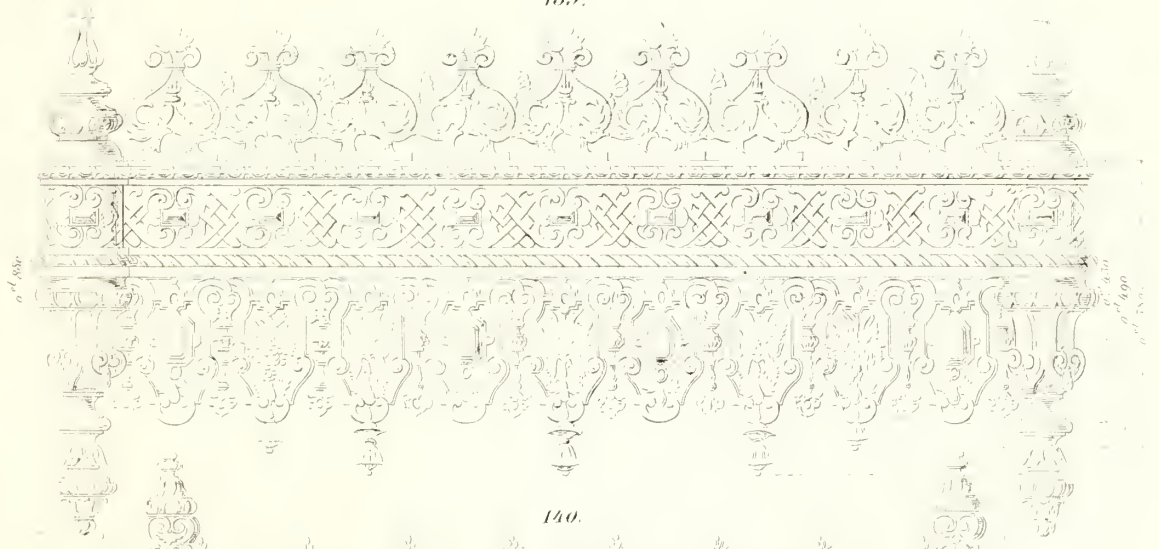

140.

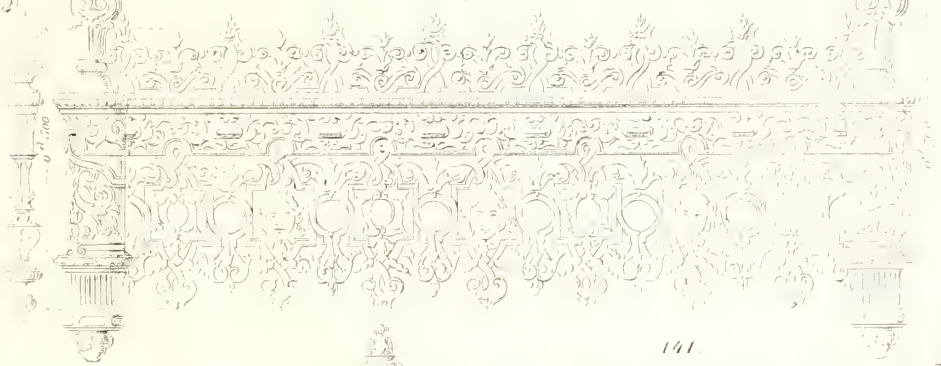

139. b



141.

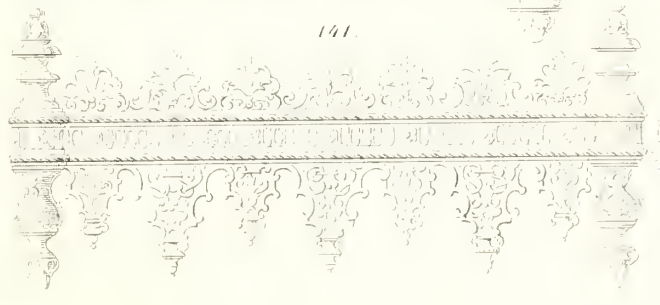

Fabriek van Bronswerken van *Becht en Dyserinck*.

Op $\frac{1}{4}$ der ware grootte.

A.

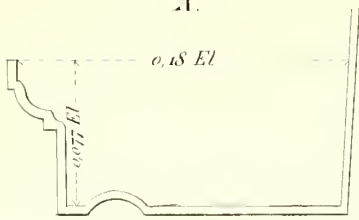

B.

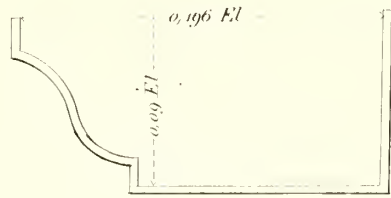

C.

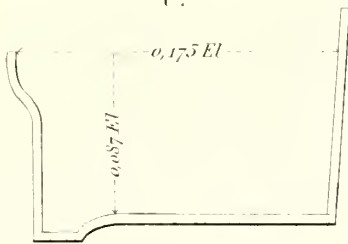

D.

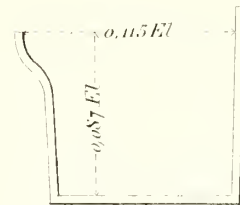

E.

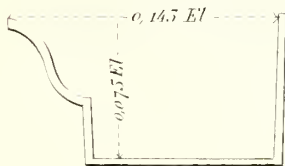

F.

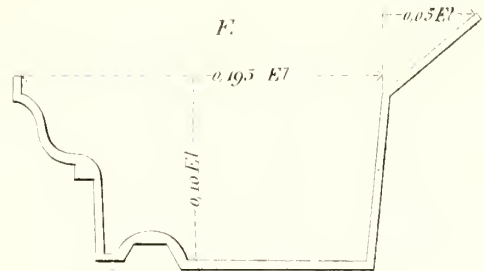

G.

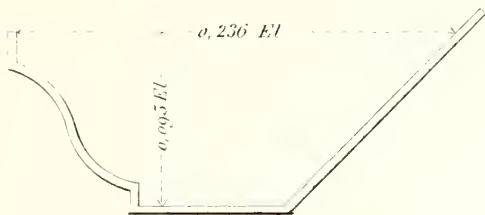

H.

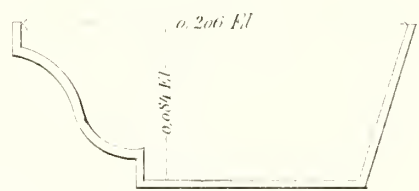

J.

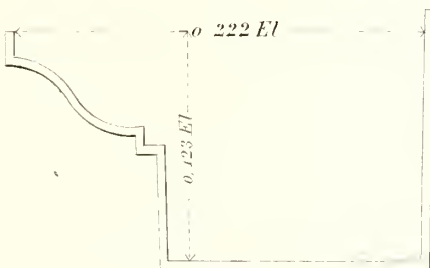

K.

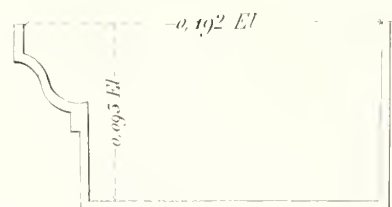

M.

L.

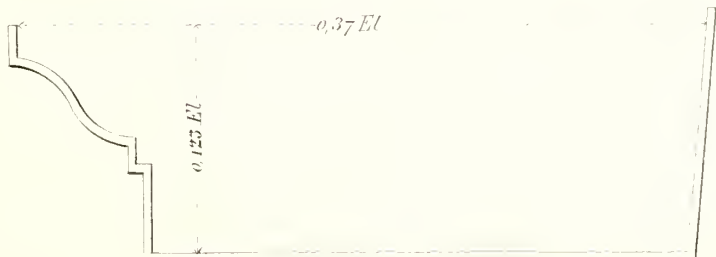
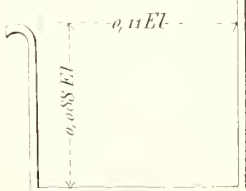

Fabriek van Bronswerken van *Becht en Dyserinck.*

Op $\frac{1}{3}$ der ware grootte

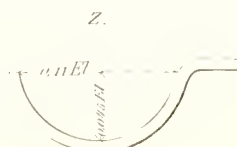
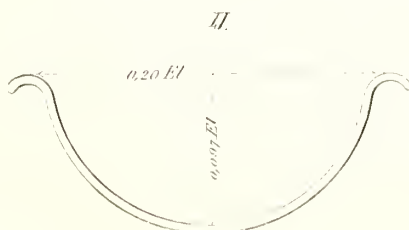
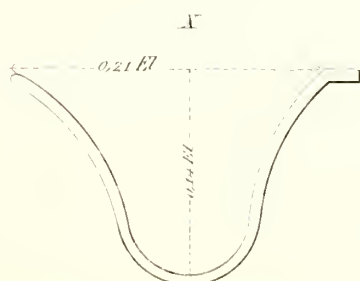
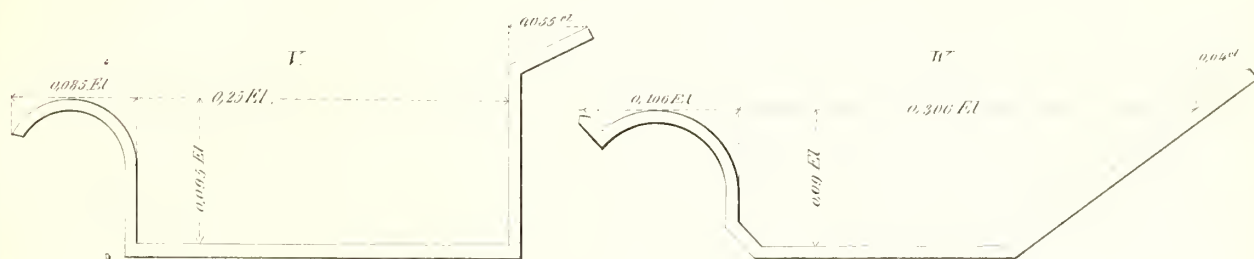
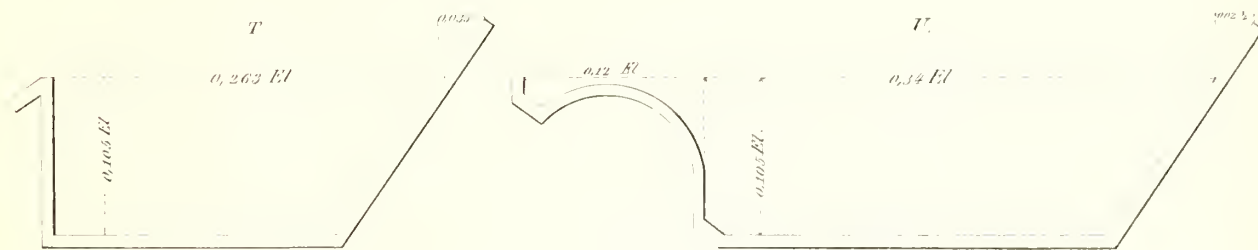
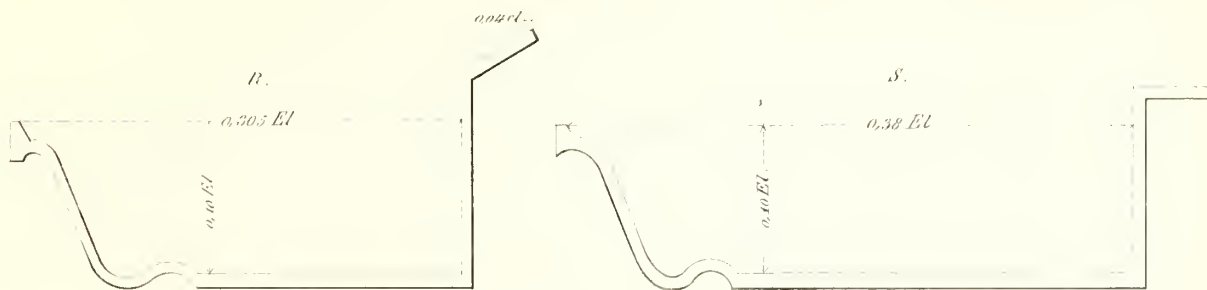
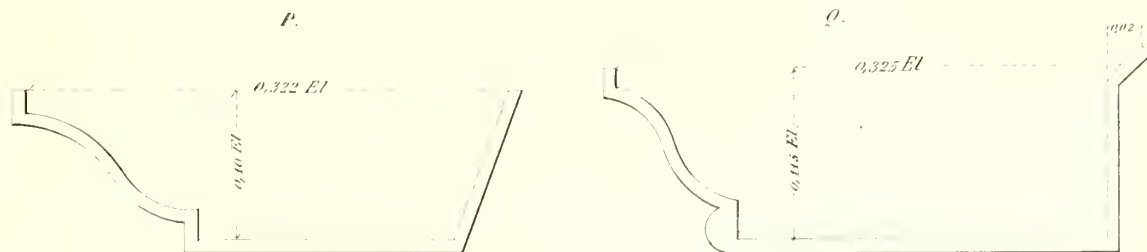
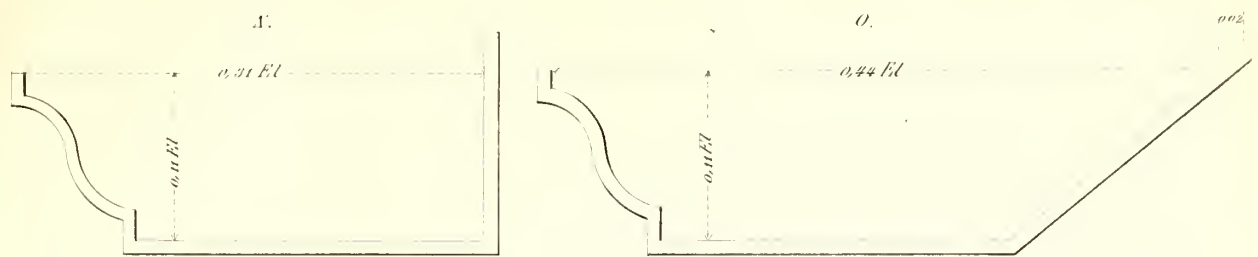

Fabriek van Bronswerken van *Becht en Dyserinck.*

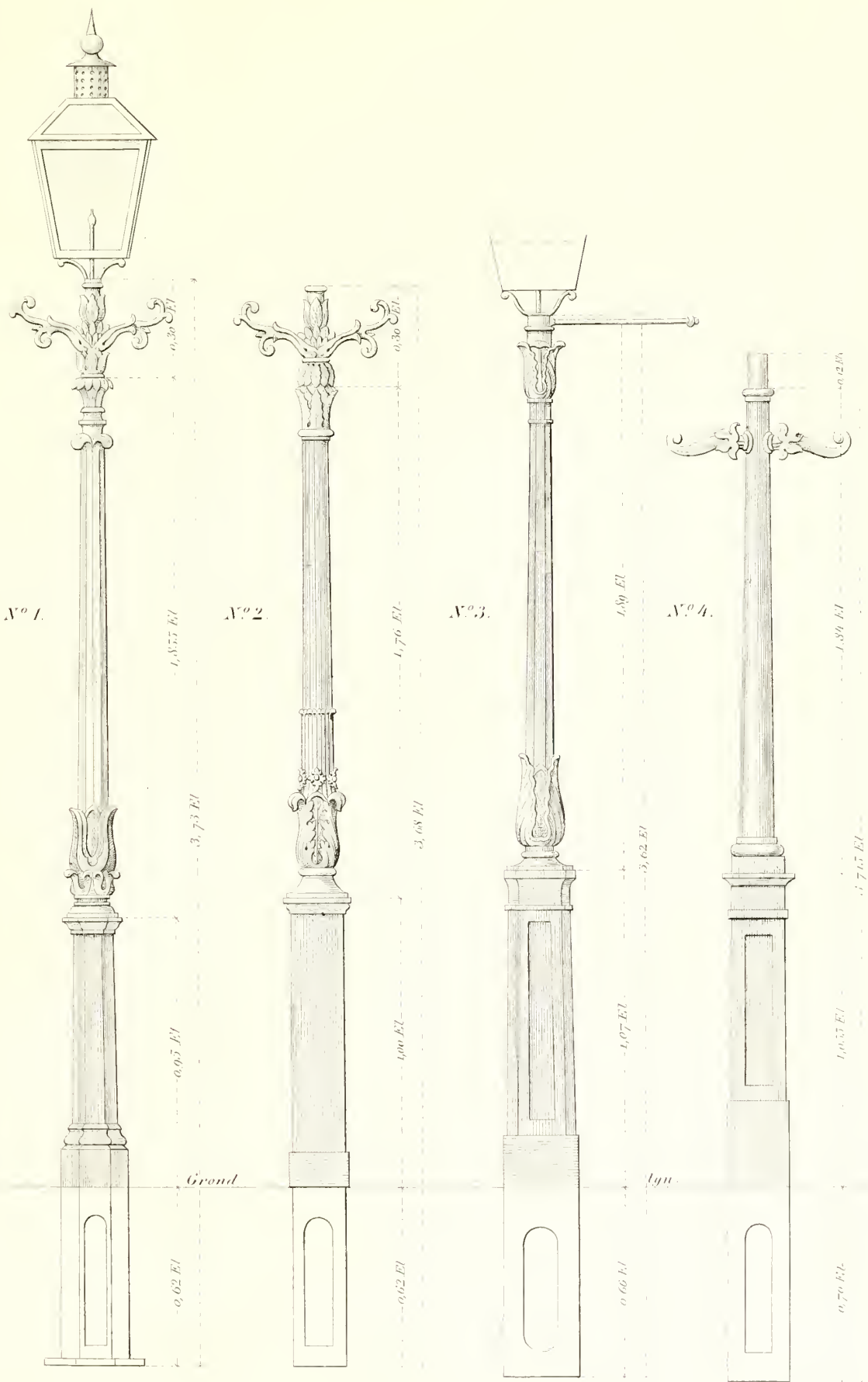

Schaal van 0,05 de El = 1,00.

Fabriek van Bronswerken van *Becht en Dyserinck*.

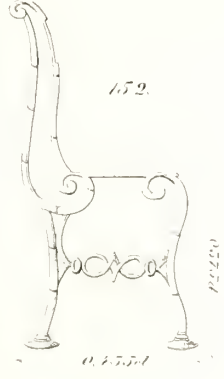
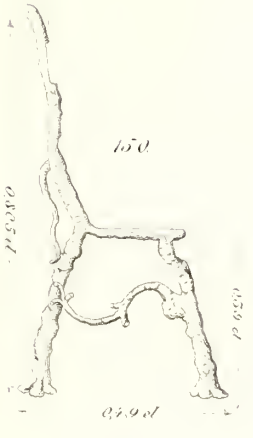
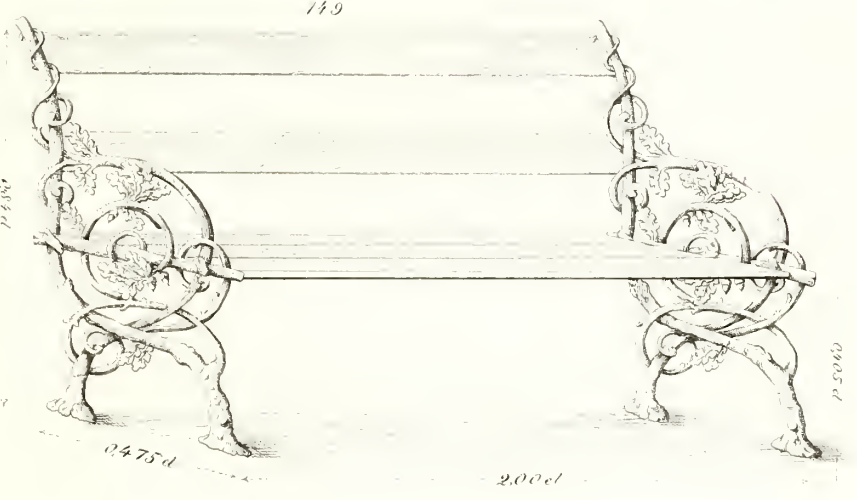
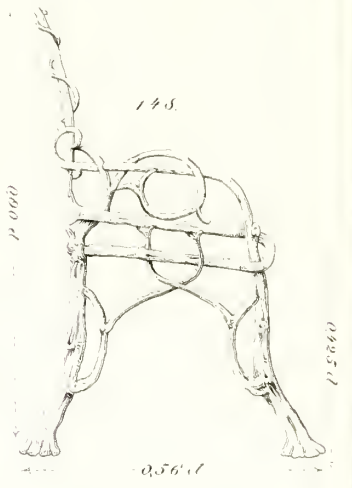
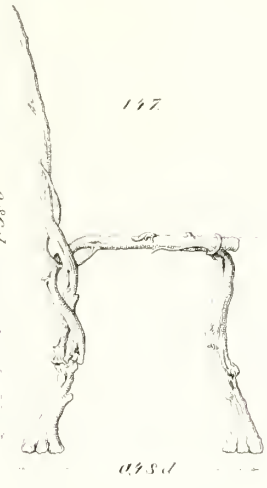
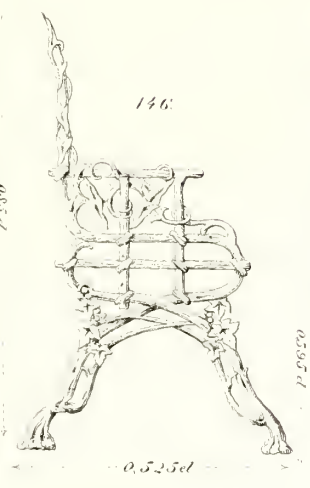
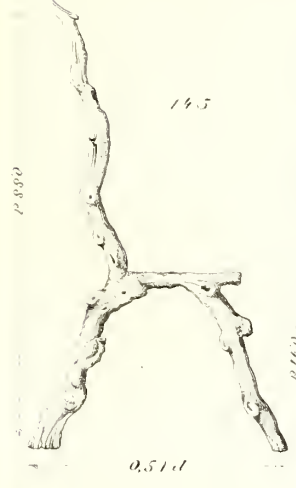
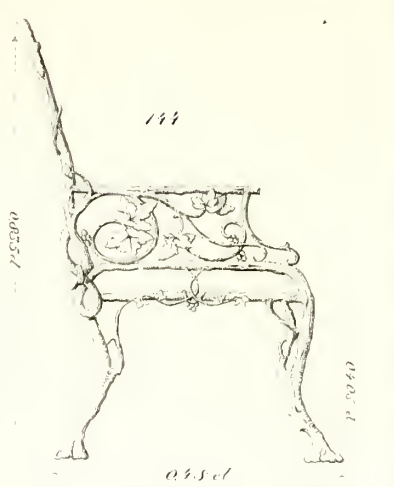
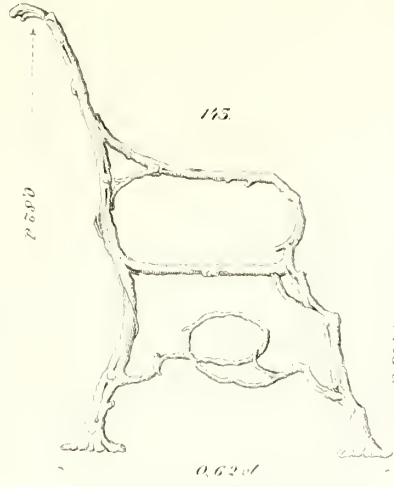
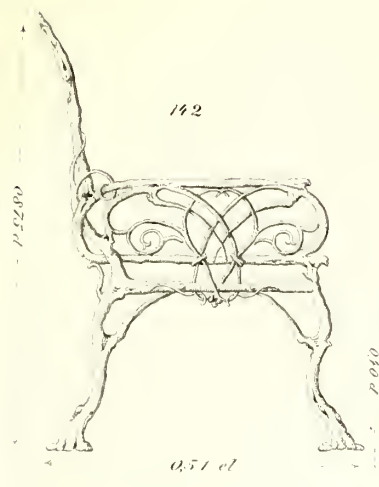

Fabriek van Bronswerken van *Becht en Dyserinck*.

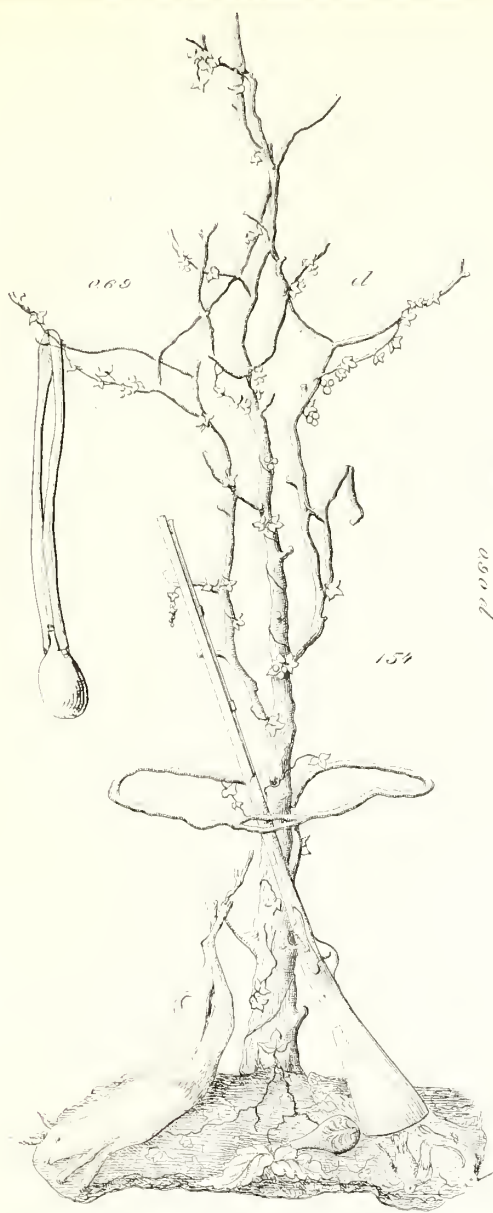

069

154

079 d

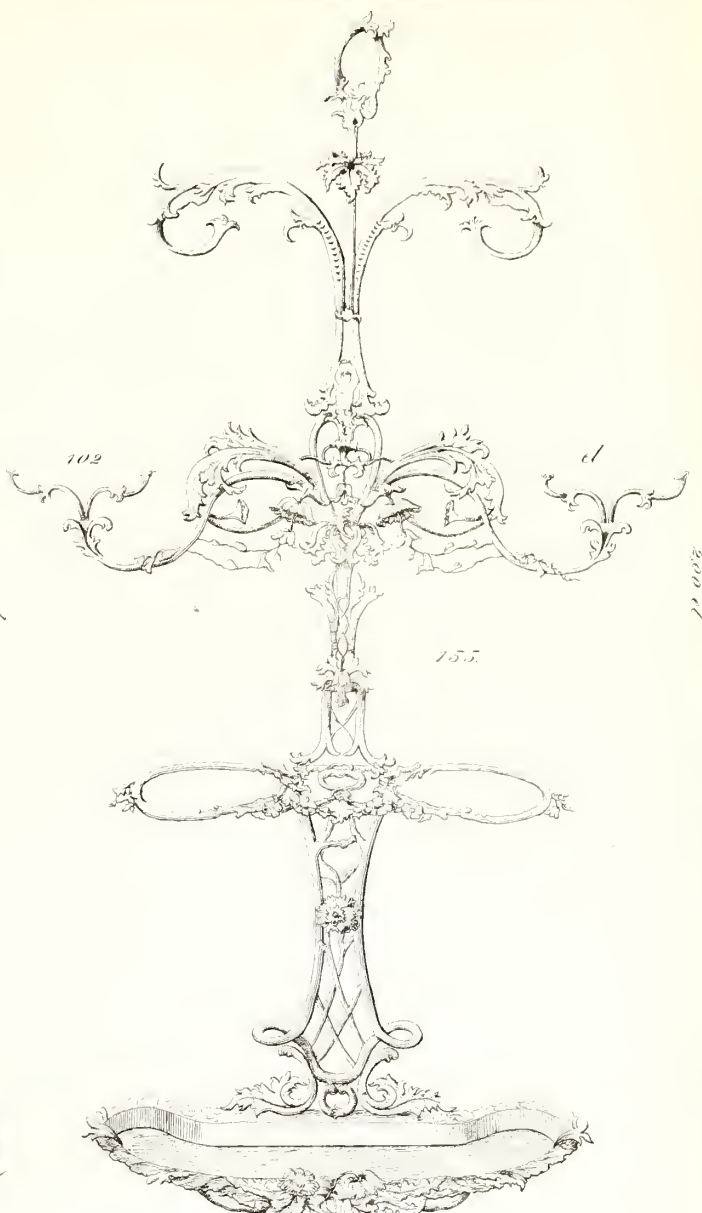

102

155

155

155

079 d

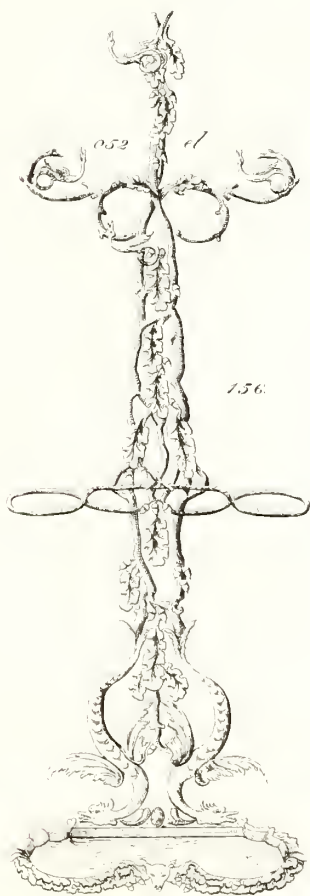

052

156

055 d

de zijkte 156 d
155 d

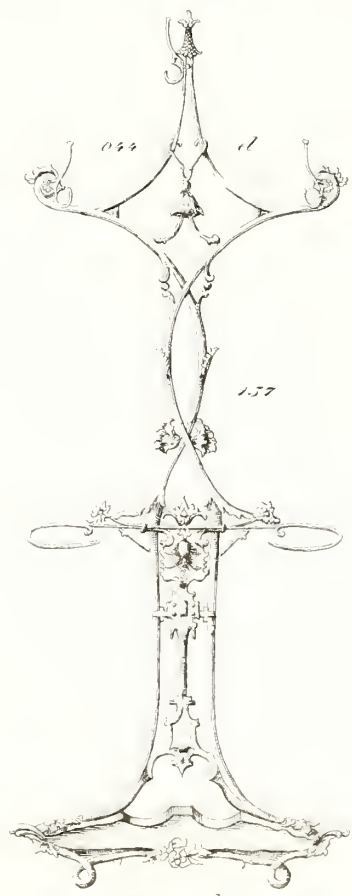

044

157

048 d

157 d

Fabriek van Bronswerken van *Becht en Dyserinck.*

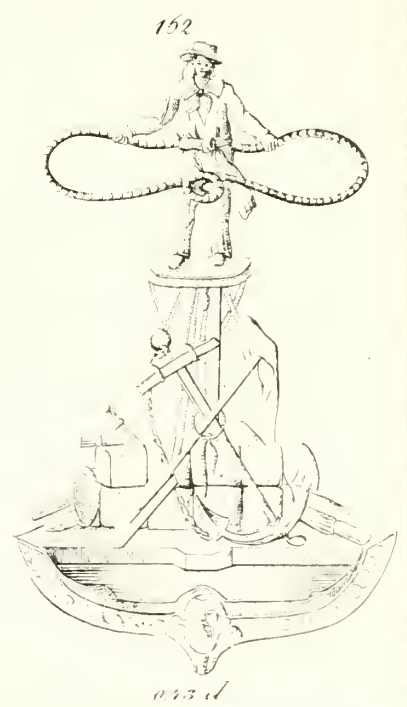
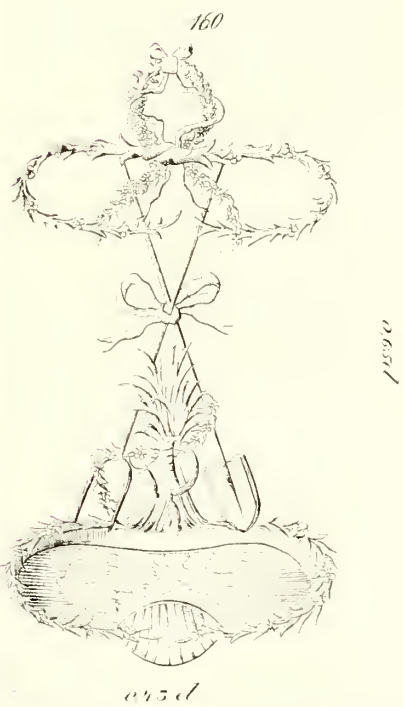
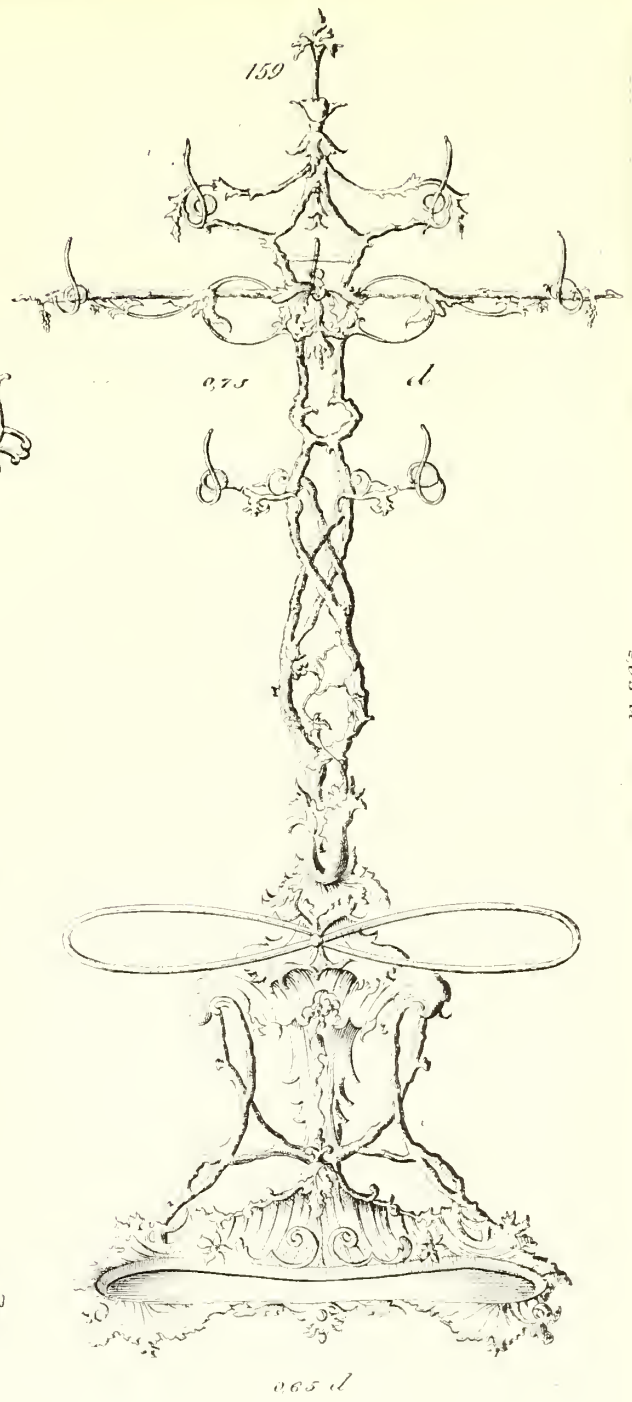
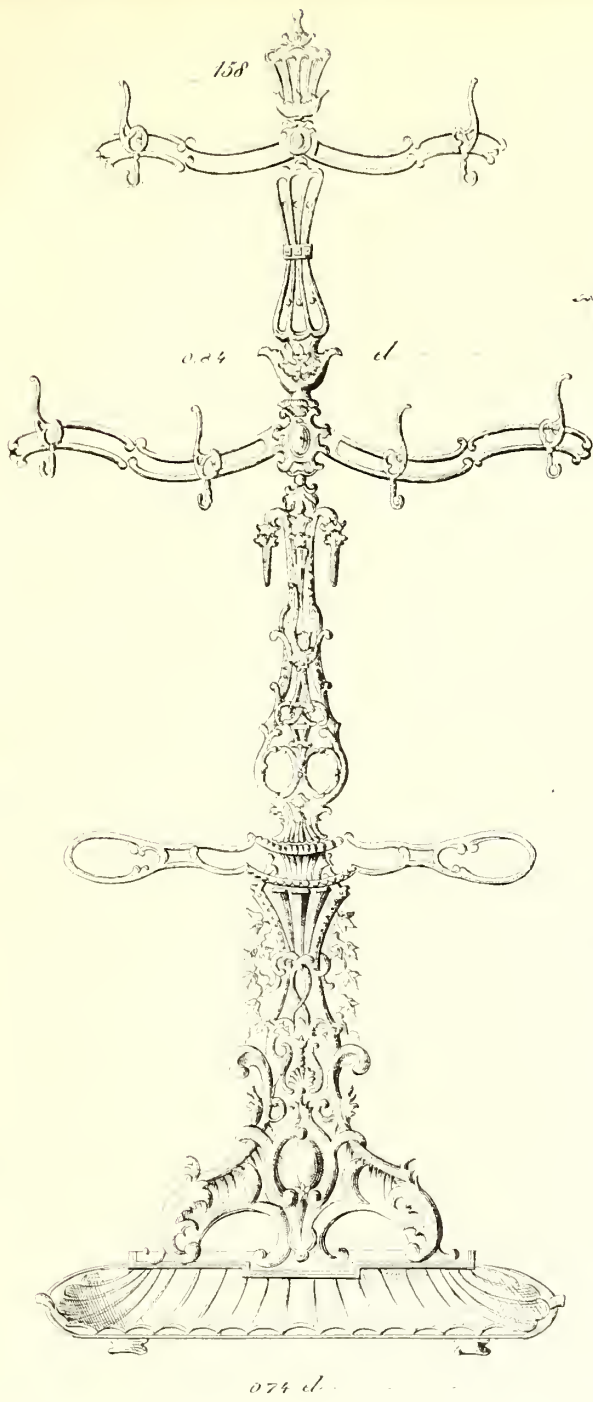

Fabriek van Bronswerken van *Becht en Duserinck.*

163.



0,89^{cl}

164.



0,83,5^{cl} en 0,83^{cl}

165.

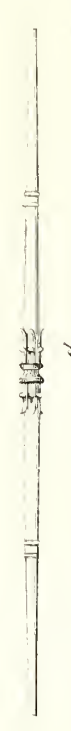

0,83^{cl}
1,100

166.

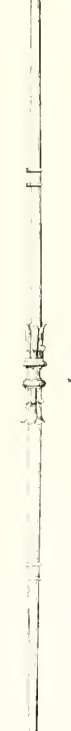

1,102

167.



0,85^{cl}

168.



0,85^{cl}

169.



0,88^{cl}

170.



0,77^{cl}

171.



0,96^{cl}

172.



0,99^{cl}

173.



1,106

174.



0,89^{cl}

175.



0,89,5^{cl}

176.



0,85^{cl} en 0,84^{cl}

177.



0,80^{cl}

178.



0,80,5^{cl}

in der ware grootte.

Fabriek van Bronswerken van *Becht en Dyserinck.*

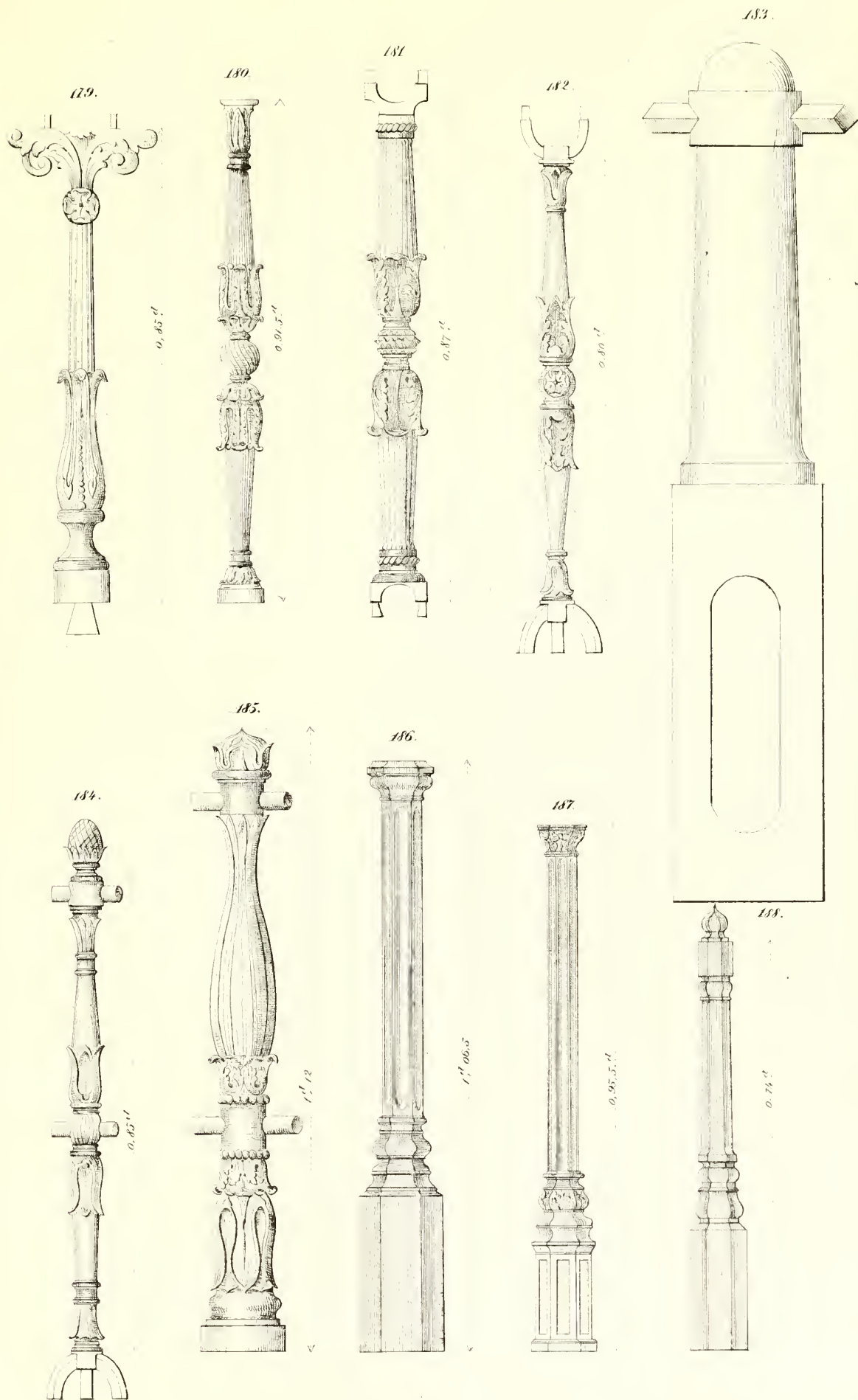

to der ware grootte.

Fabriek van Bronswerken van *Becht en Dyserinck*.

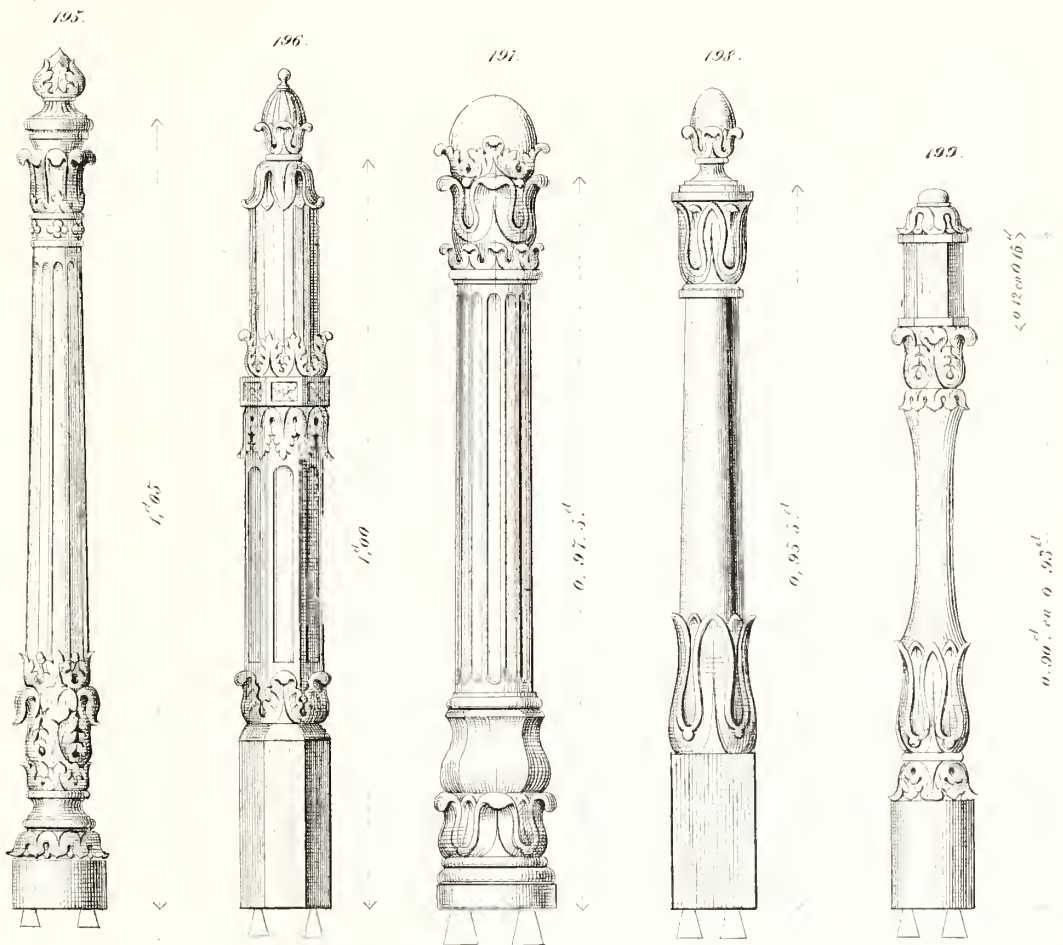
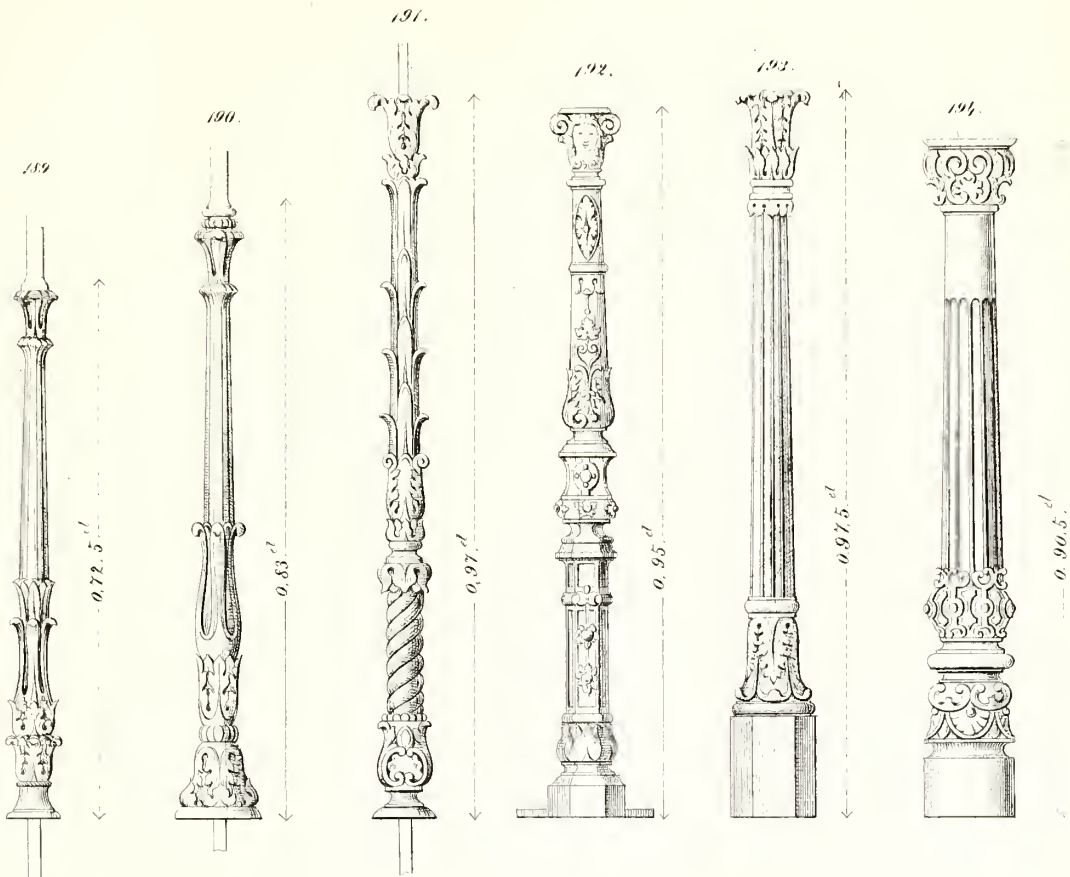

1/10 der ware grootte.

Fabriek van Bronswerken van *Becht en Dyserinck.*

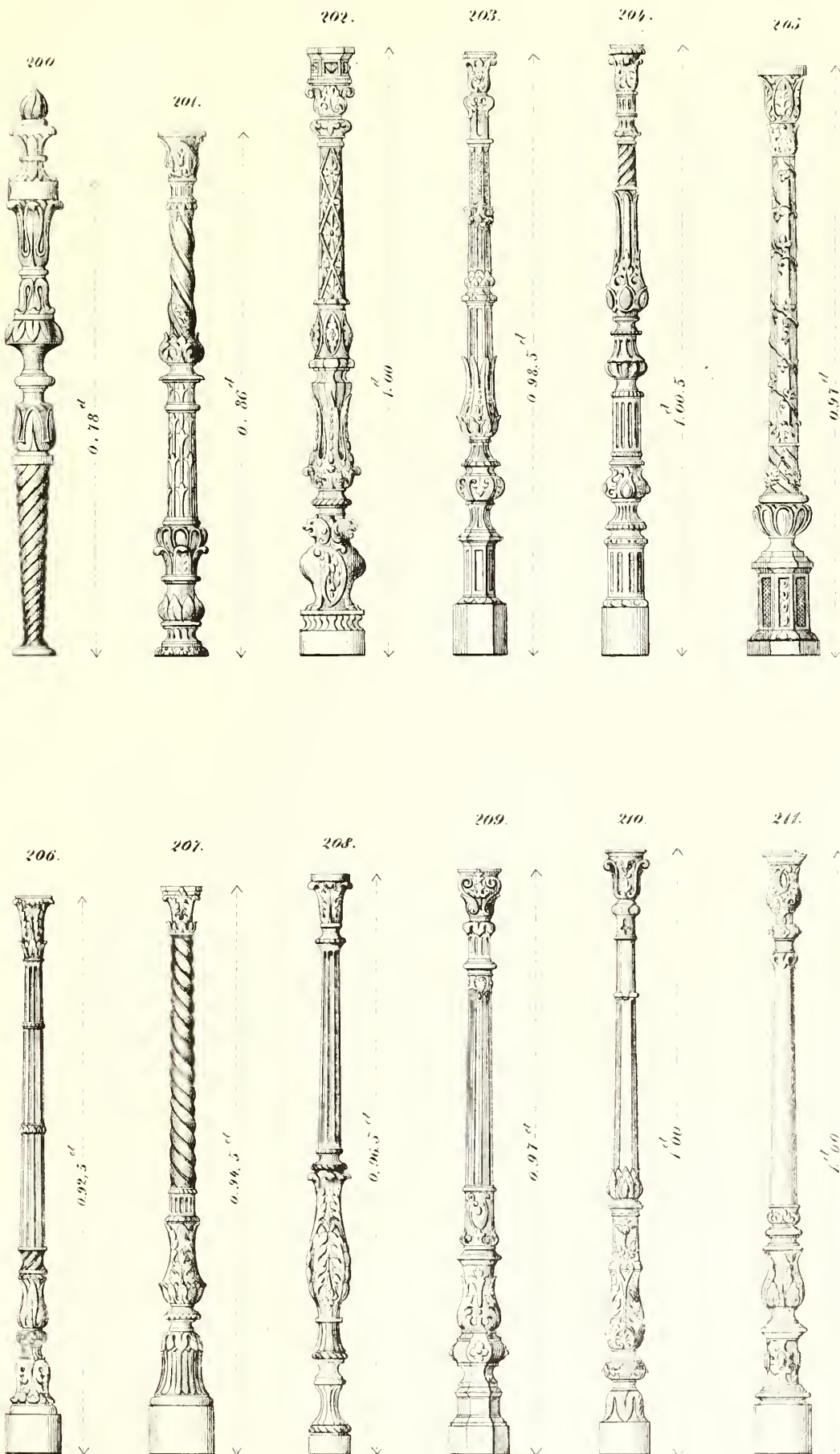

1/10 der ware grootte

Fabriek van Bronswerken van *Becht en Dyserinck*.

212.

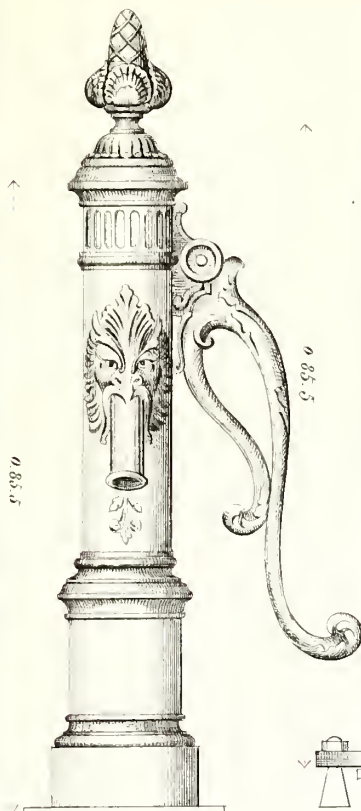

a

213.

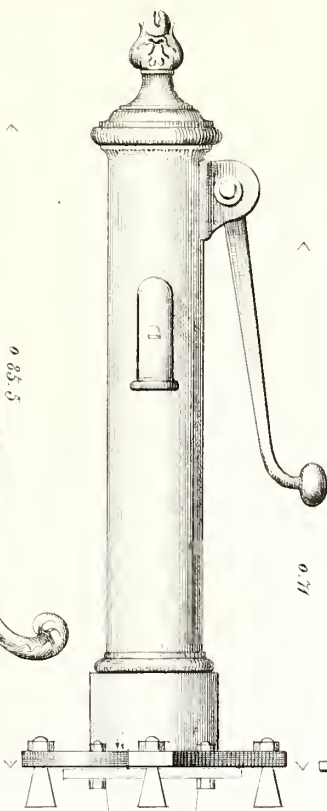

b

214.

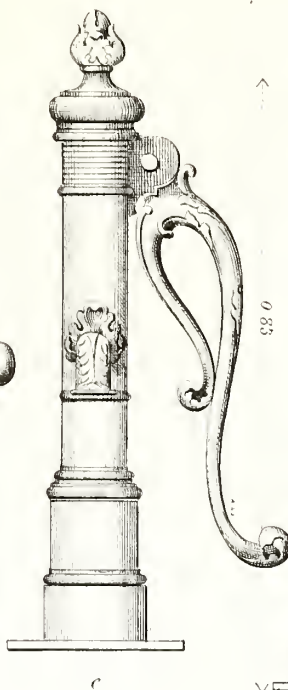

c

215.

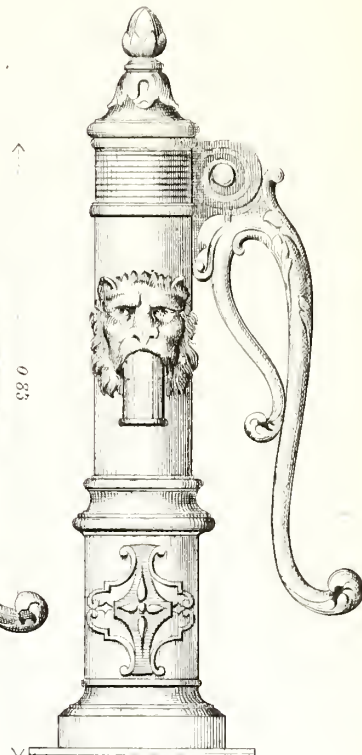

d

216.

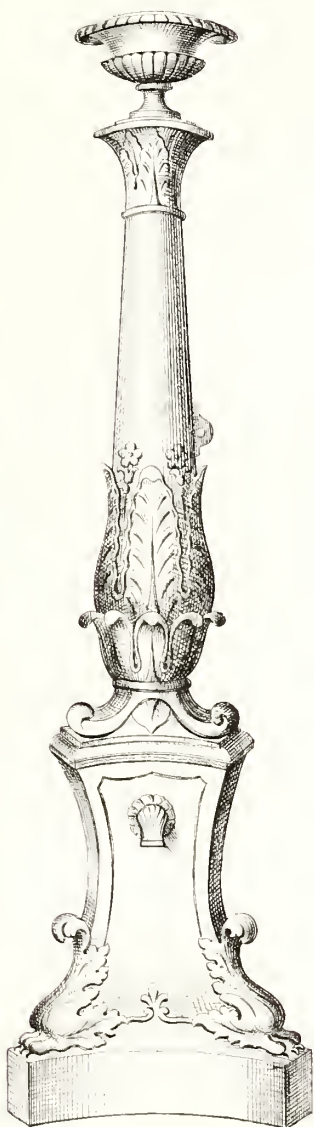

e

217.

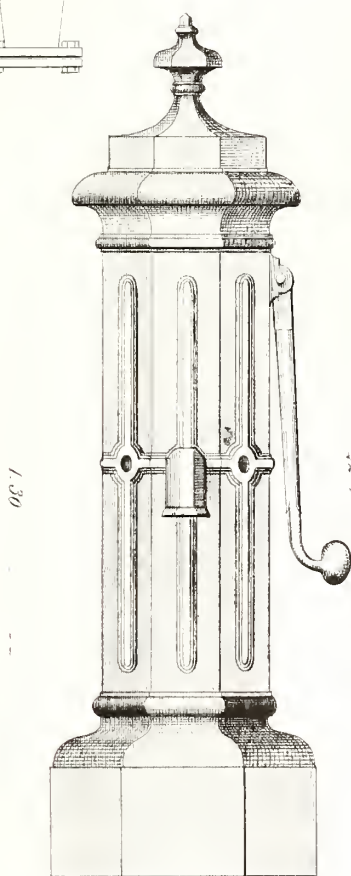

f

218.

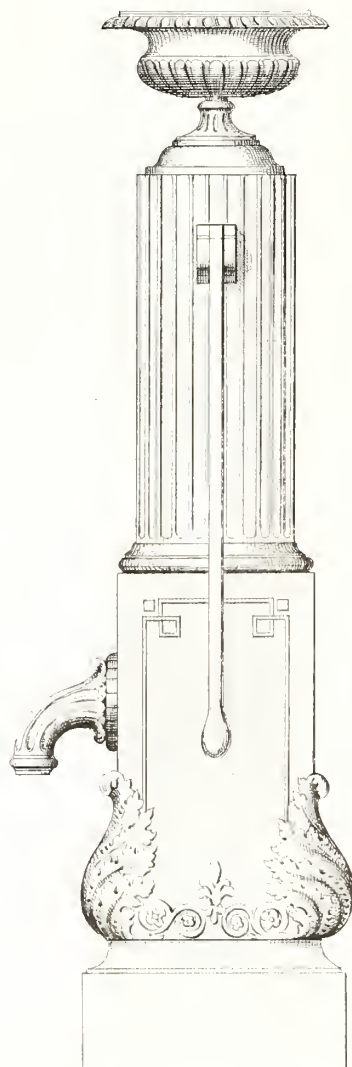

g

2.66

1.30

1.70

2.15

Fabriek van Bronswerken van *Becht en Dyserinck.*

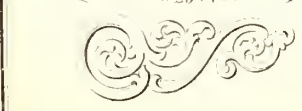
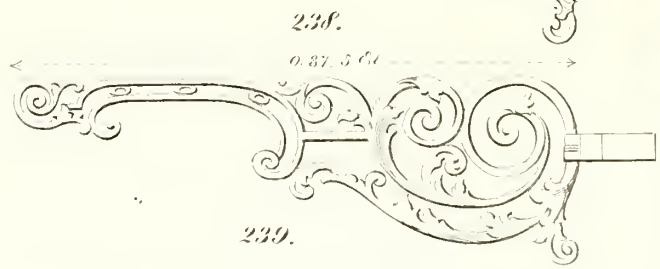
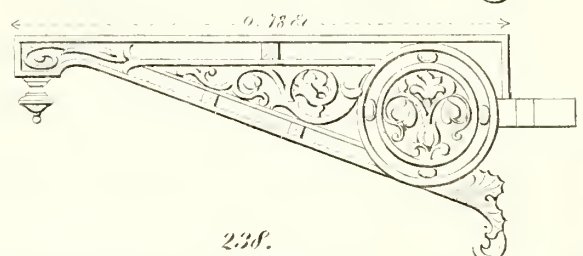
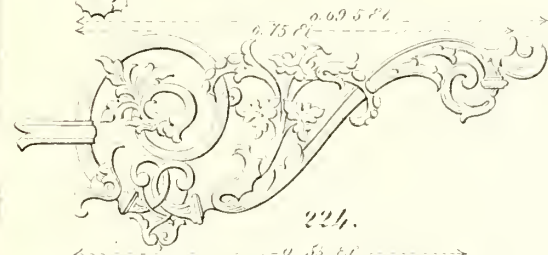
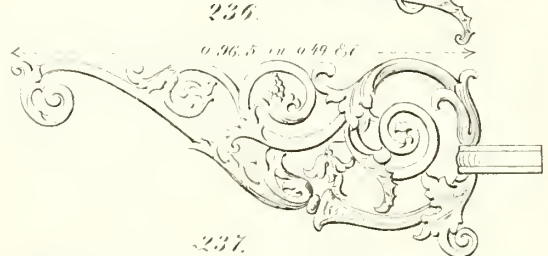
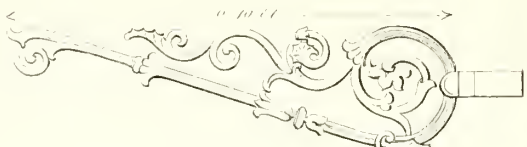
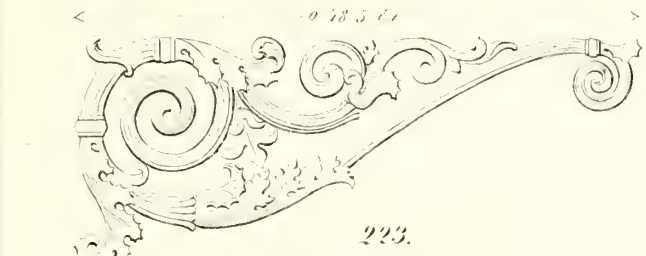
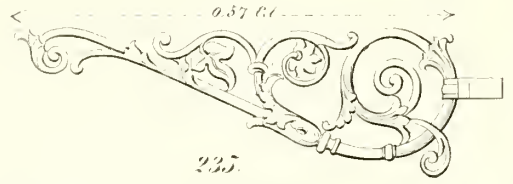
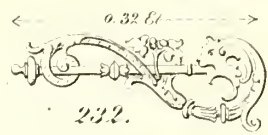
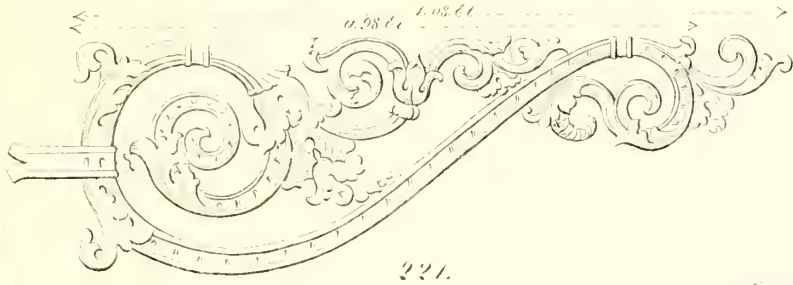
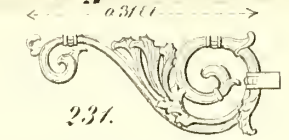

Fabriek van Bronswerken van *Becht* en *Dyserinck*.

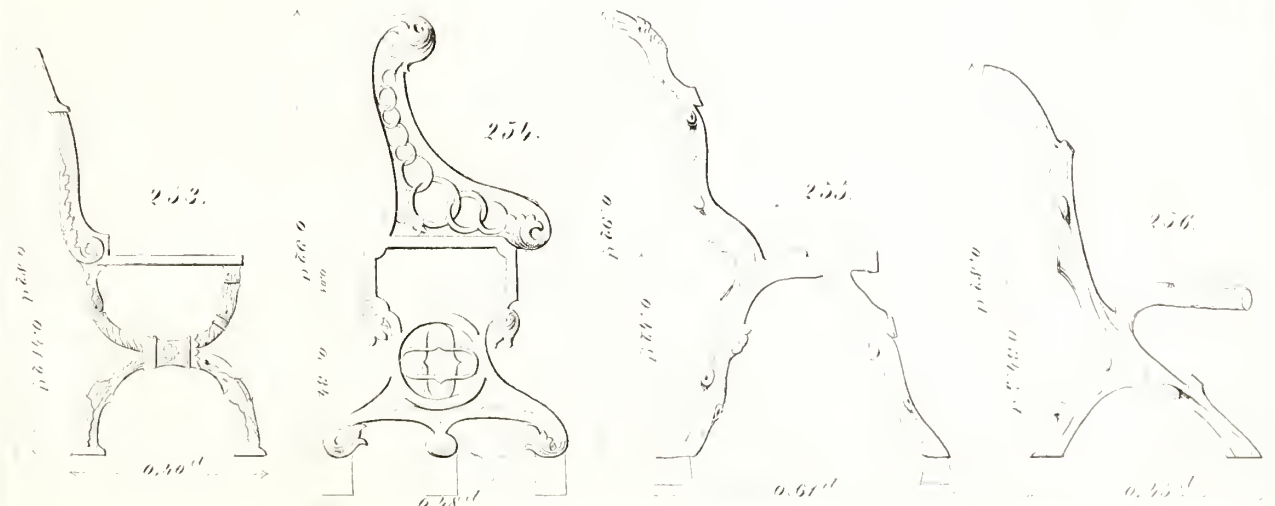
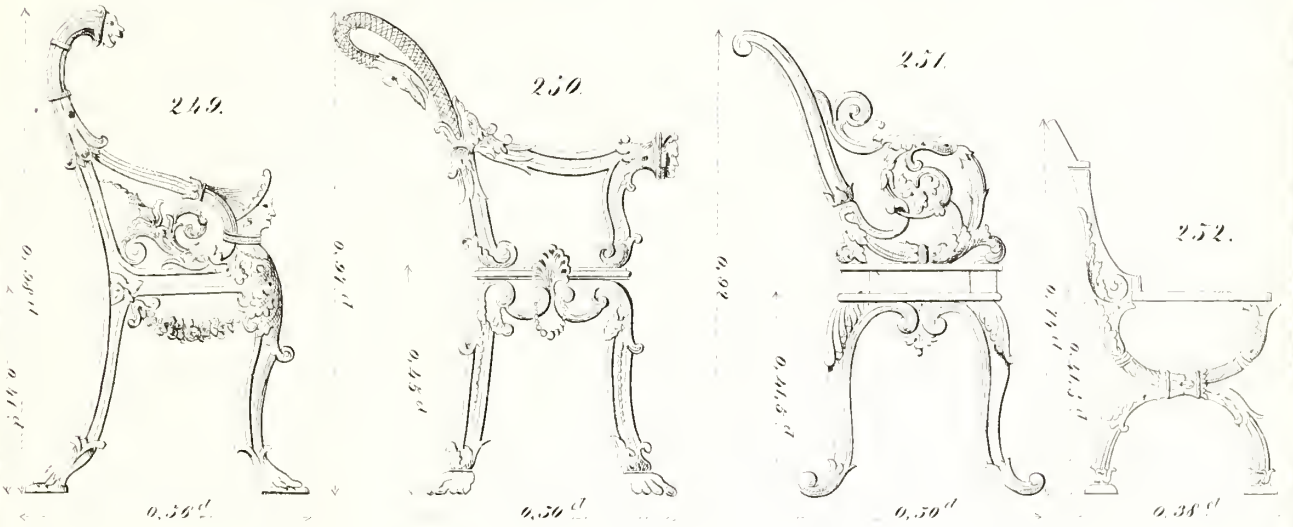
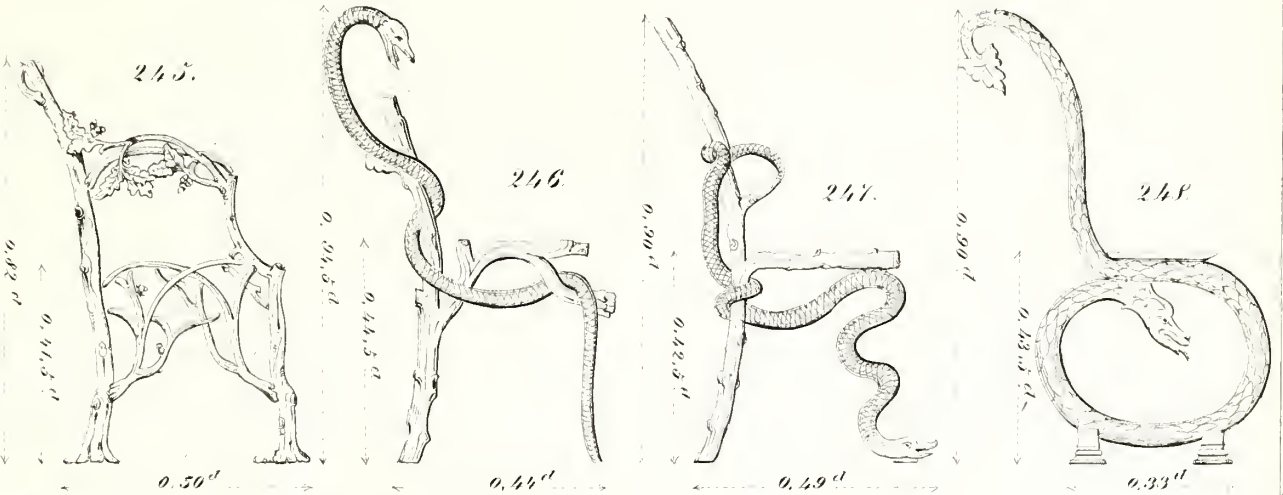
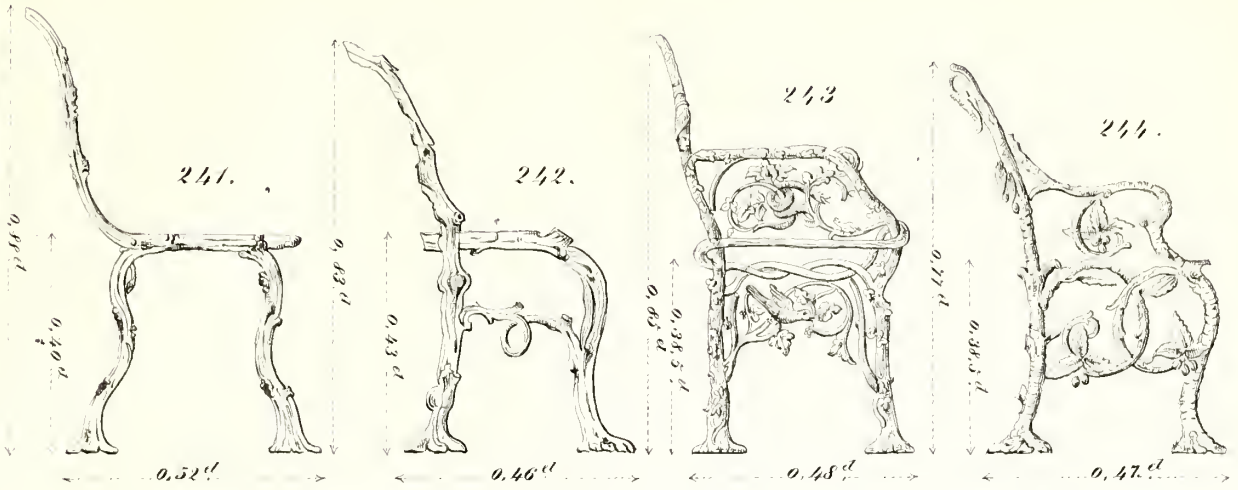

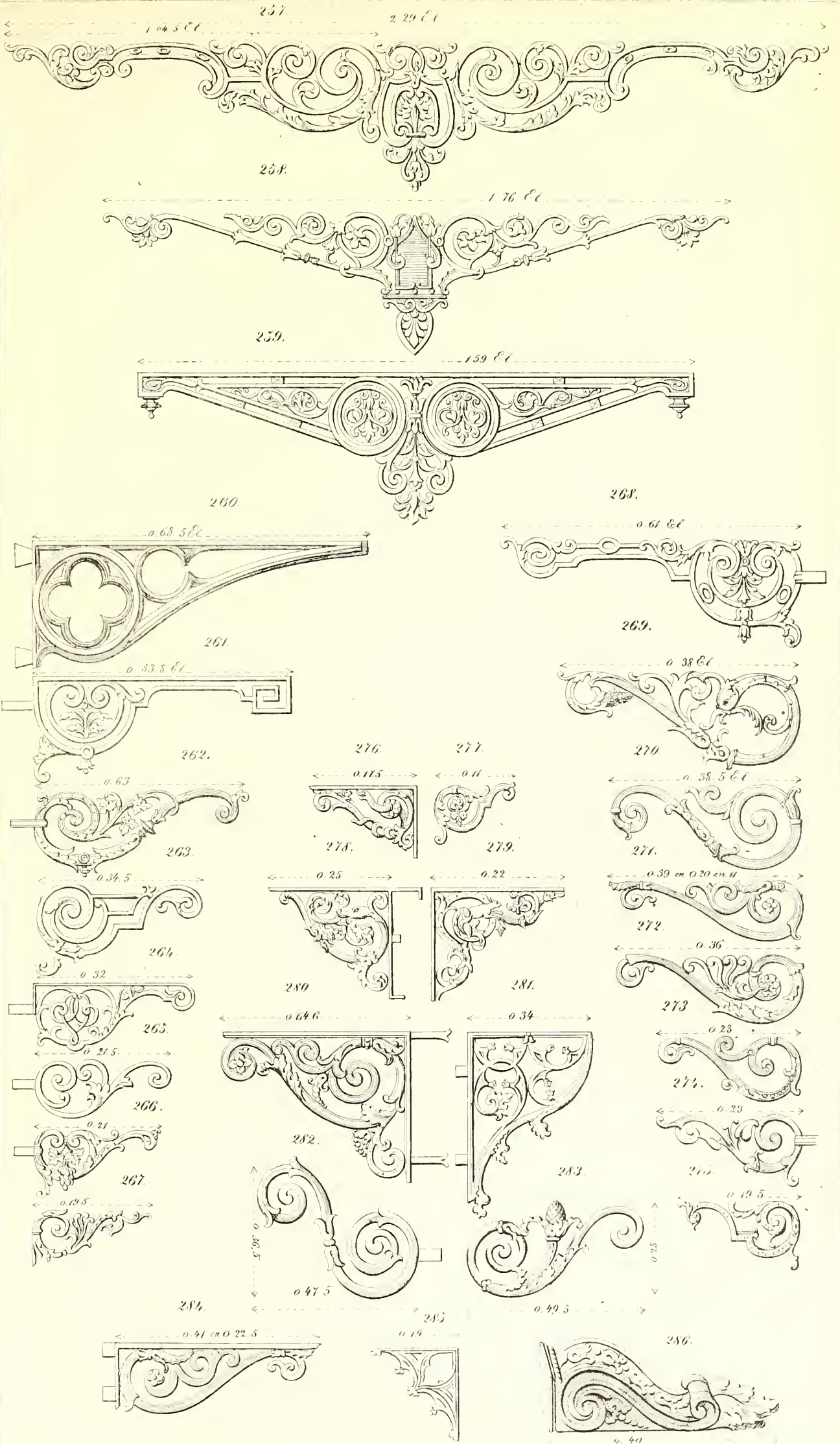

Fabriek van Bronswerken van *Becht en Dyserinck*.

287.

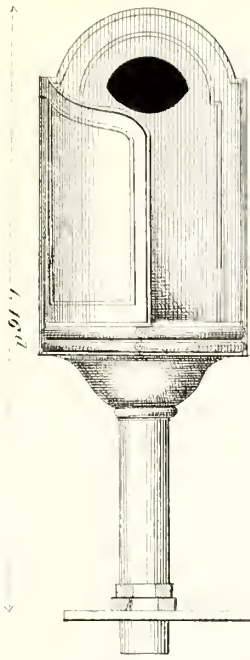

289.

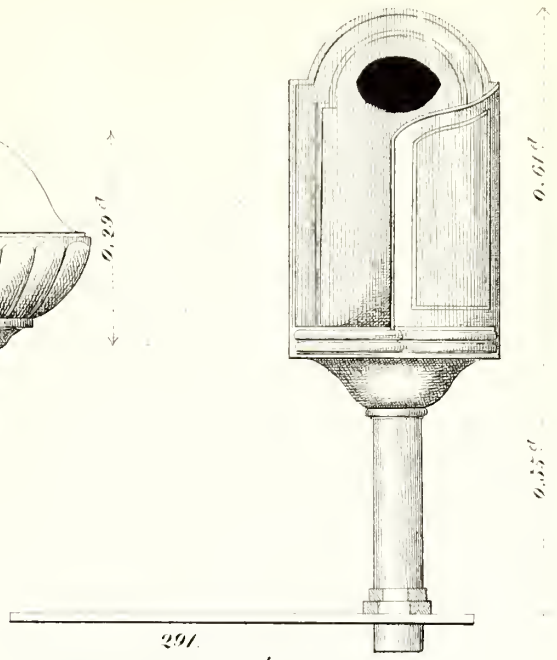

288.

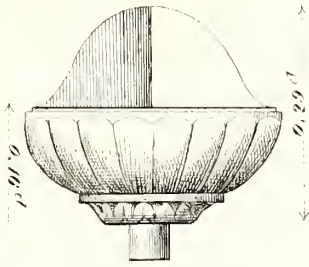

0.395^d

290.

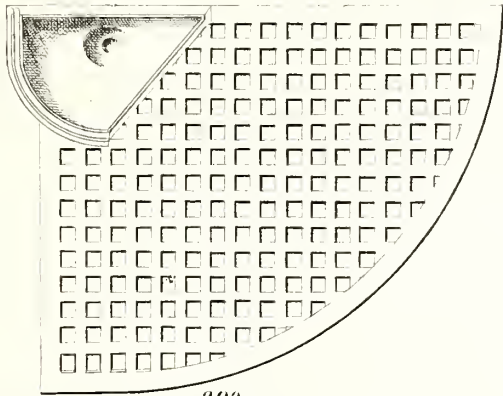

0.39^d

291.

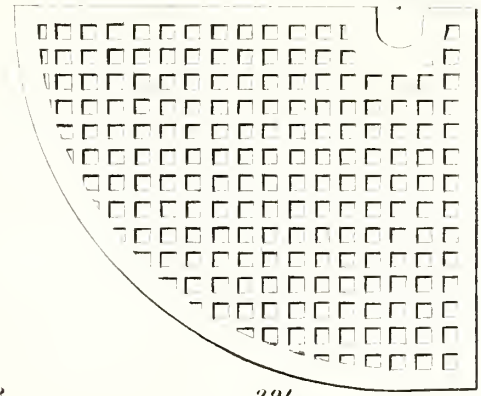

0.74^d

292.

293.

294.

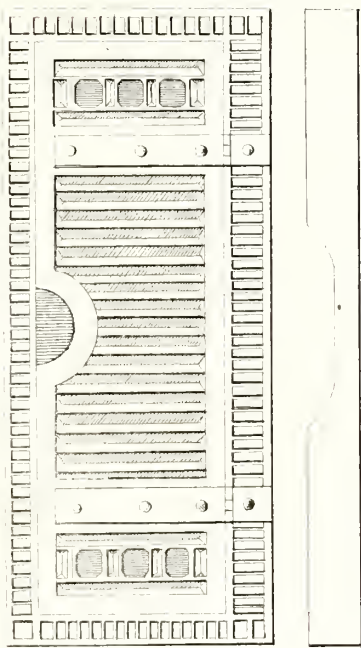

0.431^d

0.44^d

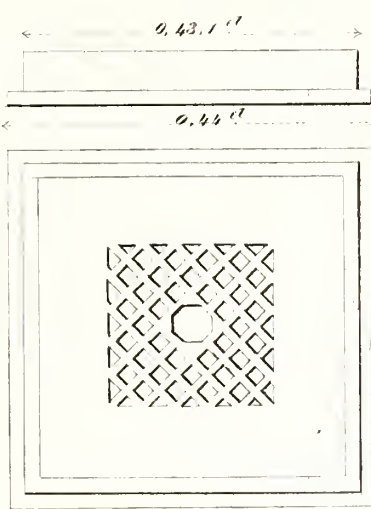

0.88^d

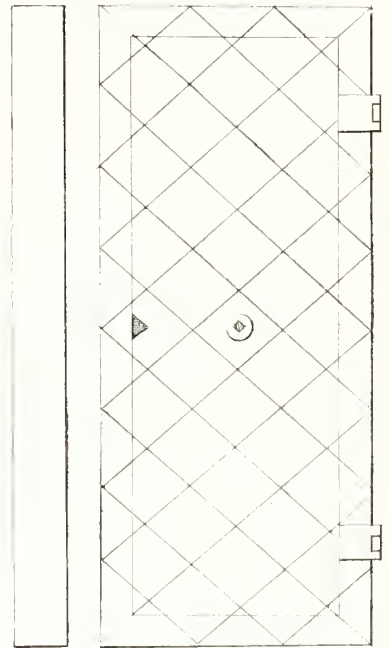

0.353^d

295.

296.

0.52^d

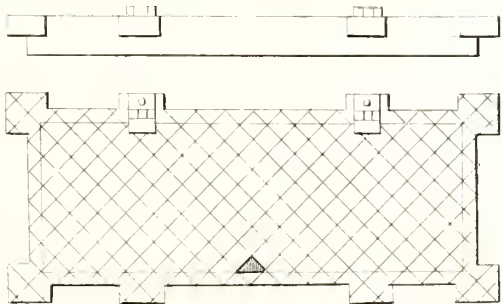

0.52^d

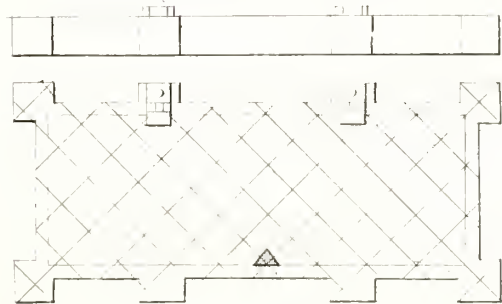

0.52^d

Fabriek van Bronswerken van *Becht* en *Dyserinck*.

297.

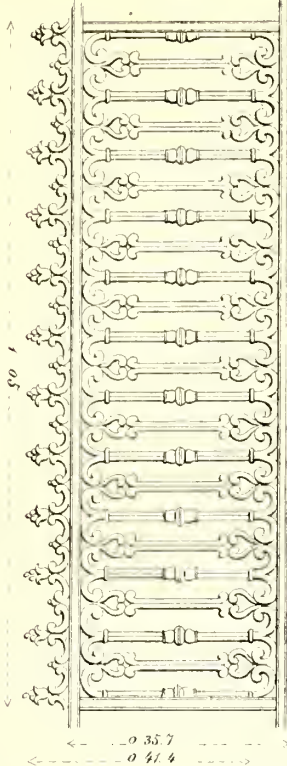

298.

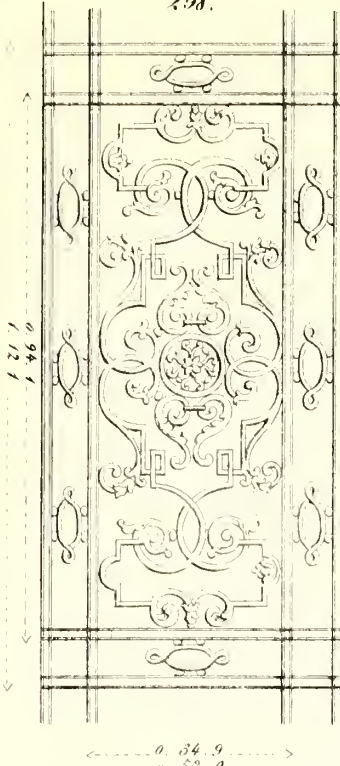

299.

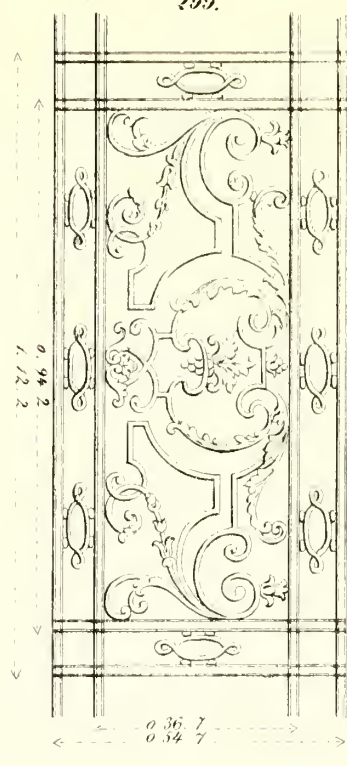

300.

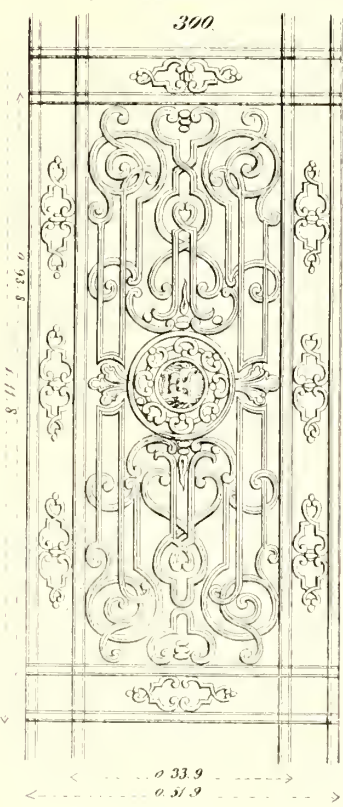

301.

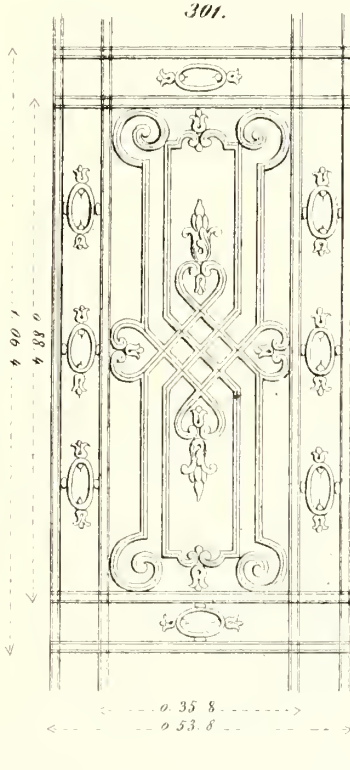

302.

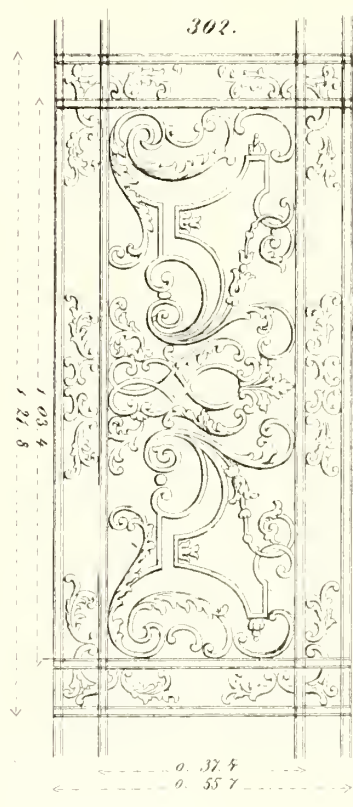

303.

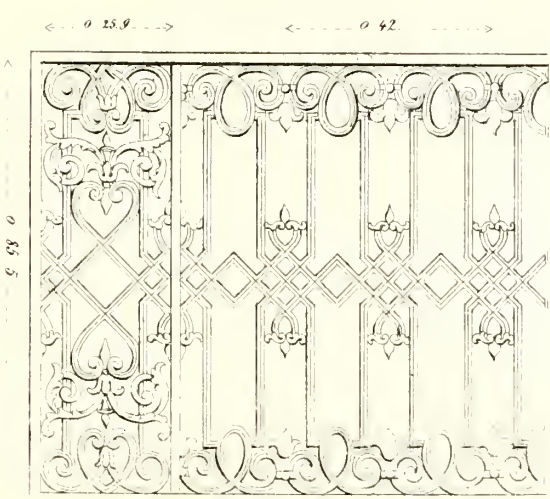

304.

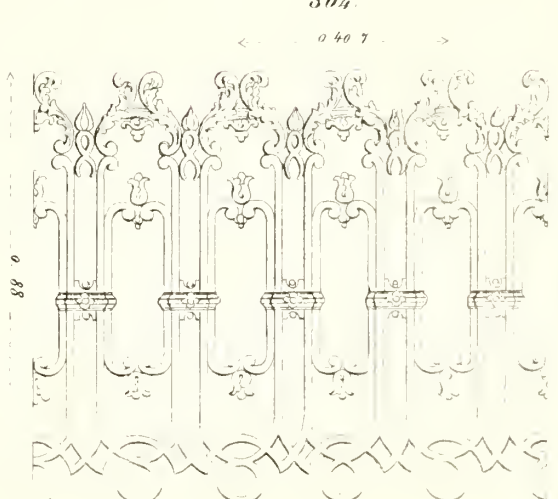

Fabriek van Bronswerken van *Becht* en *Dyserinck*.

305.

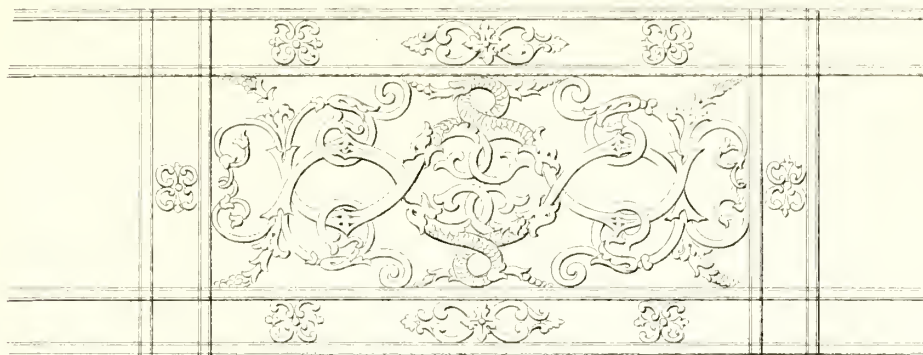

0 88 3
1 08 2

0 33 7
0 55 7

306.

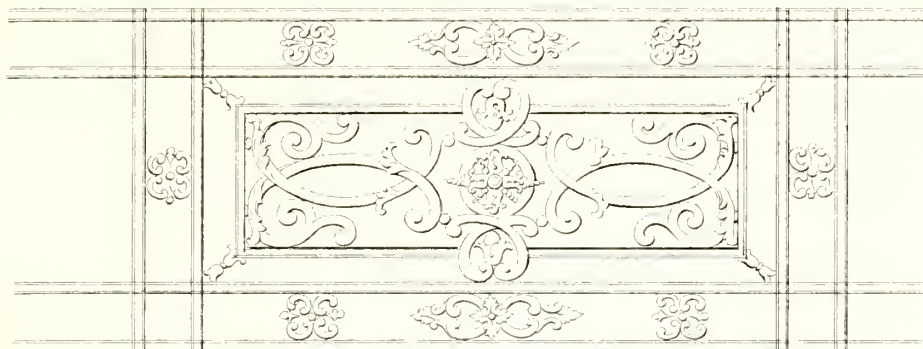

0 94 2
1 12 2

0 36 8
0 54 8

307.

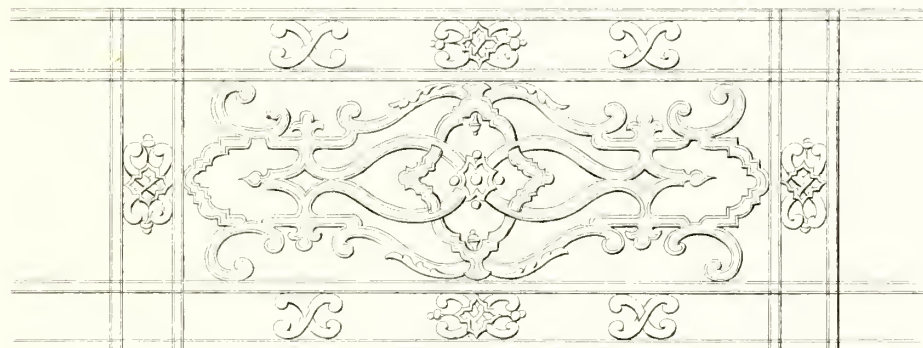

0 97 1
1 15 1

0 37
0 55

308.

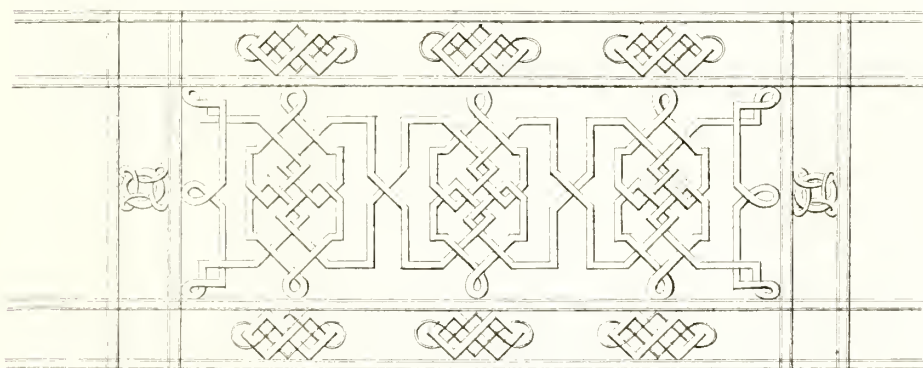

0 93 8
1 11 8

0 58 6
0 56 6

309.

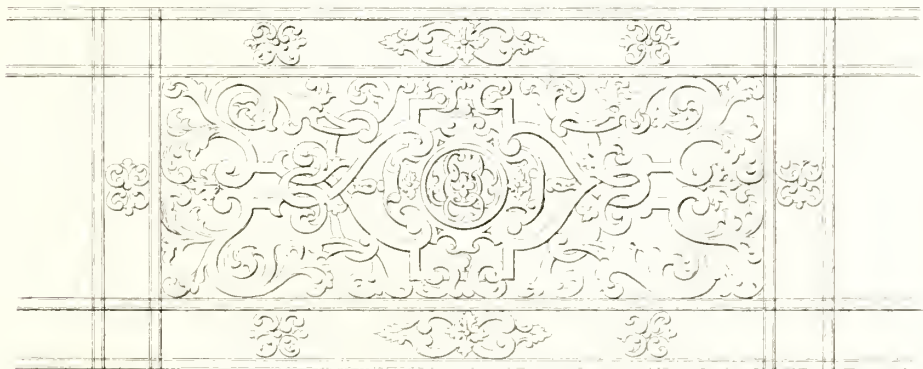

0 98 7
1 16 7

0 39 3
0 57 3

Fabriek van Bronswerken van *Becht en Dyserinck.*

310.

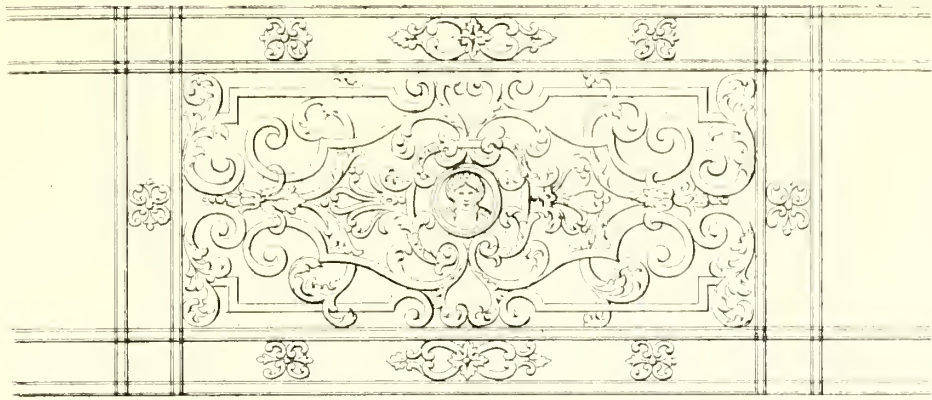

0. 44. 6
0. 62. 6

311.

0. 94
1. 12

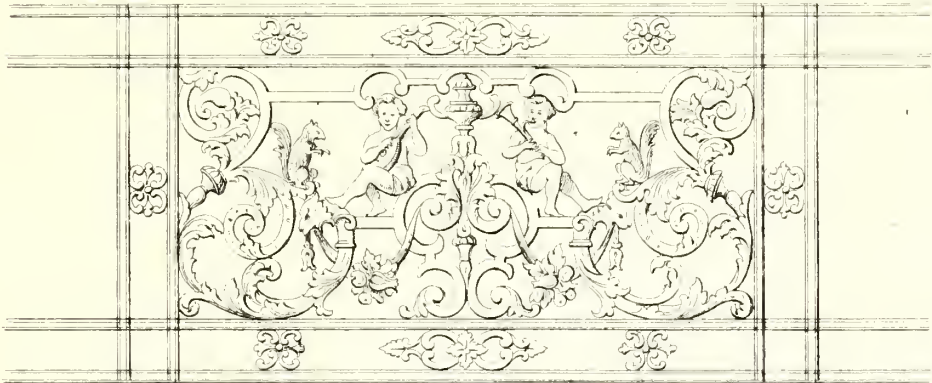

0. 44. 2
0. 62. 2

312.

0. 96
1. 14

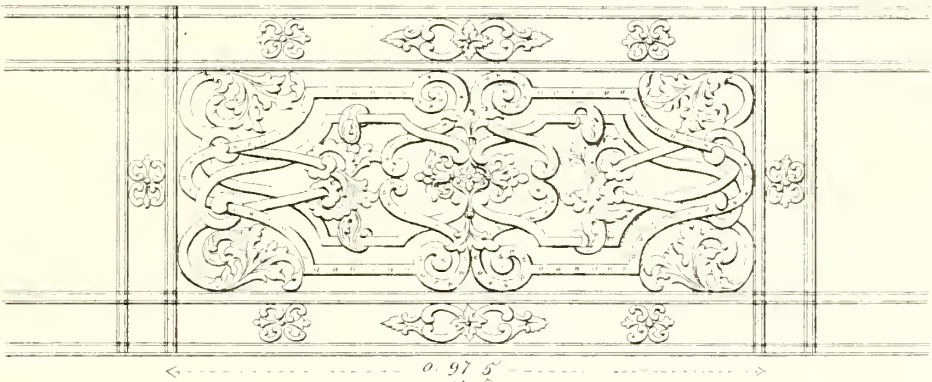

0. 40.
0. 58

313.

0. 97. 5
1. 15. 5

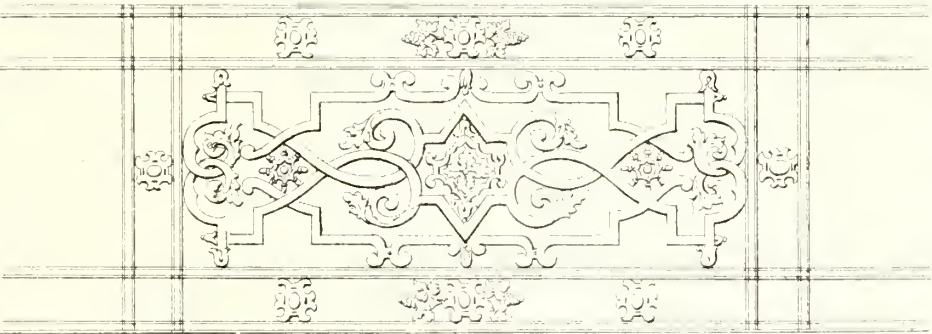

0. 34. 8
0. 72. 8

314.

0. 93. 7
1. 11. 7

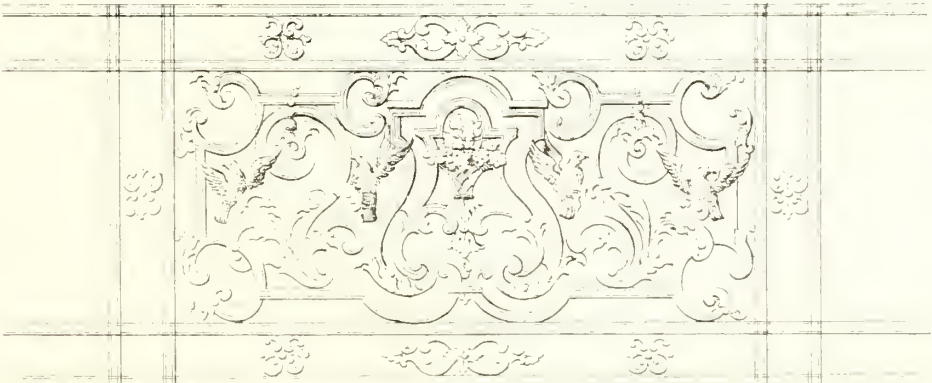

0. 44. 6
0. 62. 6

0. 96. 7
1. 14. 2

Fabriek van Bronswerken van *Becht en Dyserinck.*

315.

316.

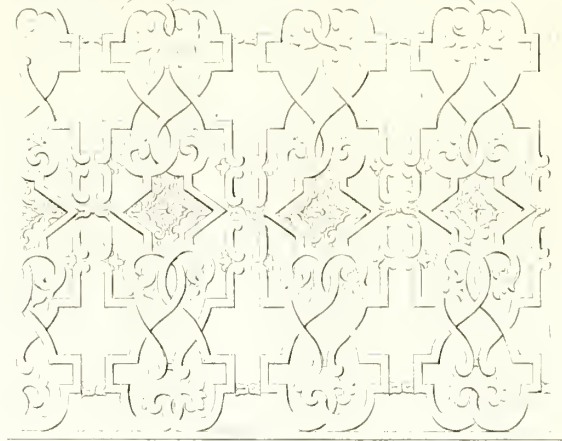
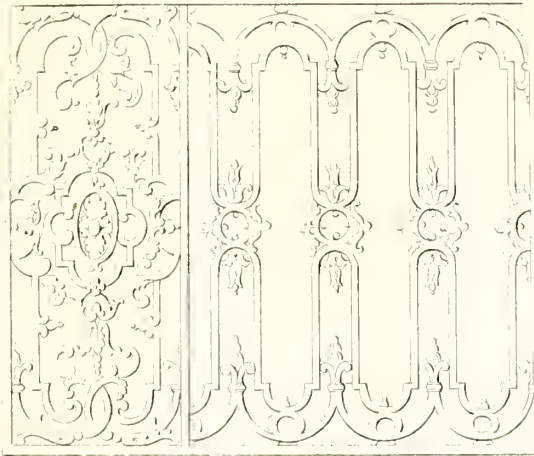

0 31.5

0 32.2

0 31.5

318.

317

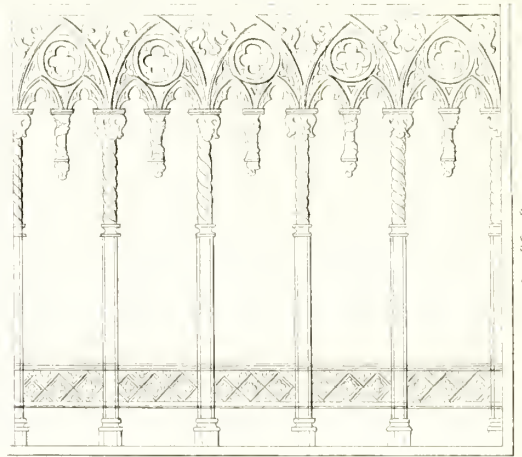
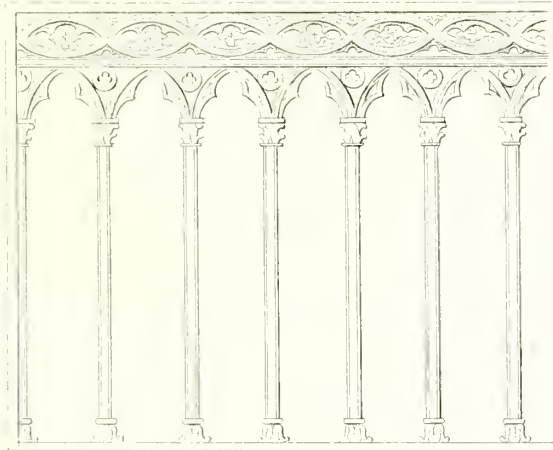

0 33.1

319

0 35.8

320

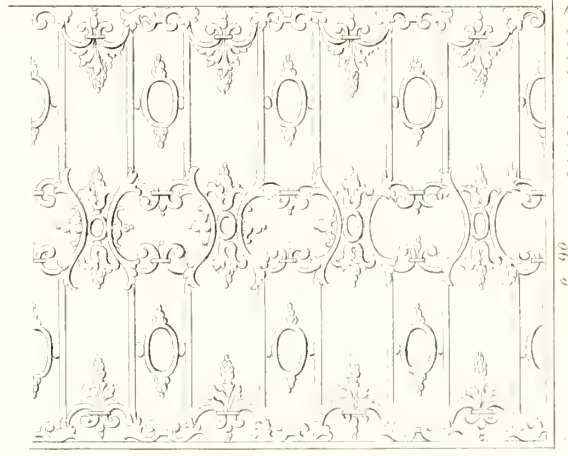
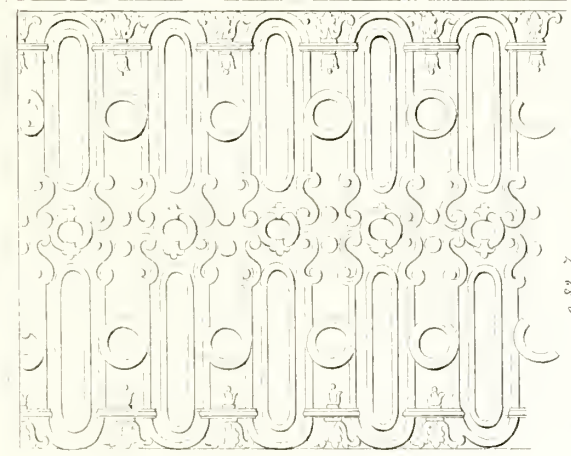

0 37.3

321

322

0 30.8

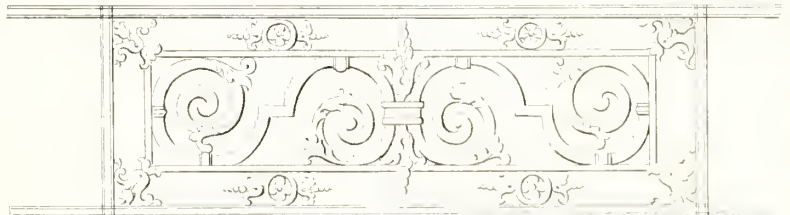
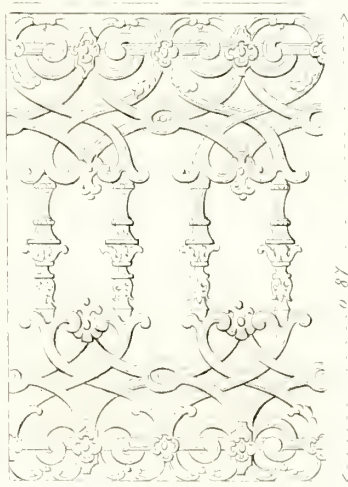

0 94.8

323

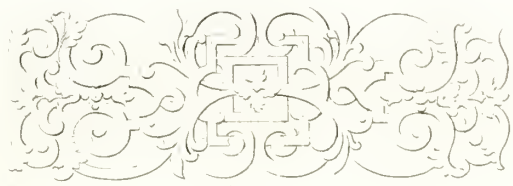

0 51
0 60.7

0 28.5

Fabriek van Bronswerken van *Becht en Dyserinck*.

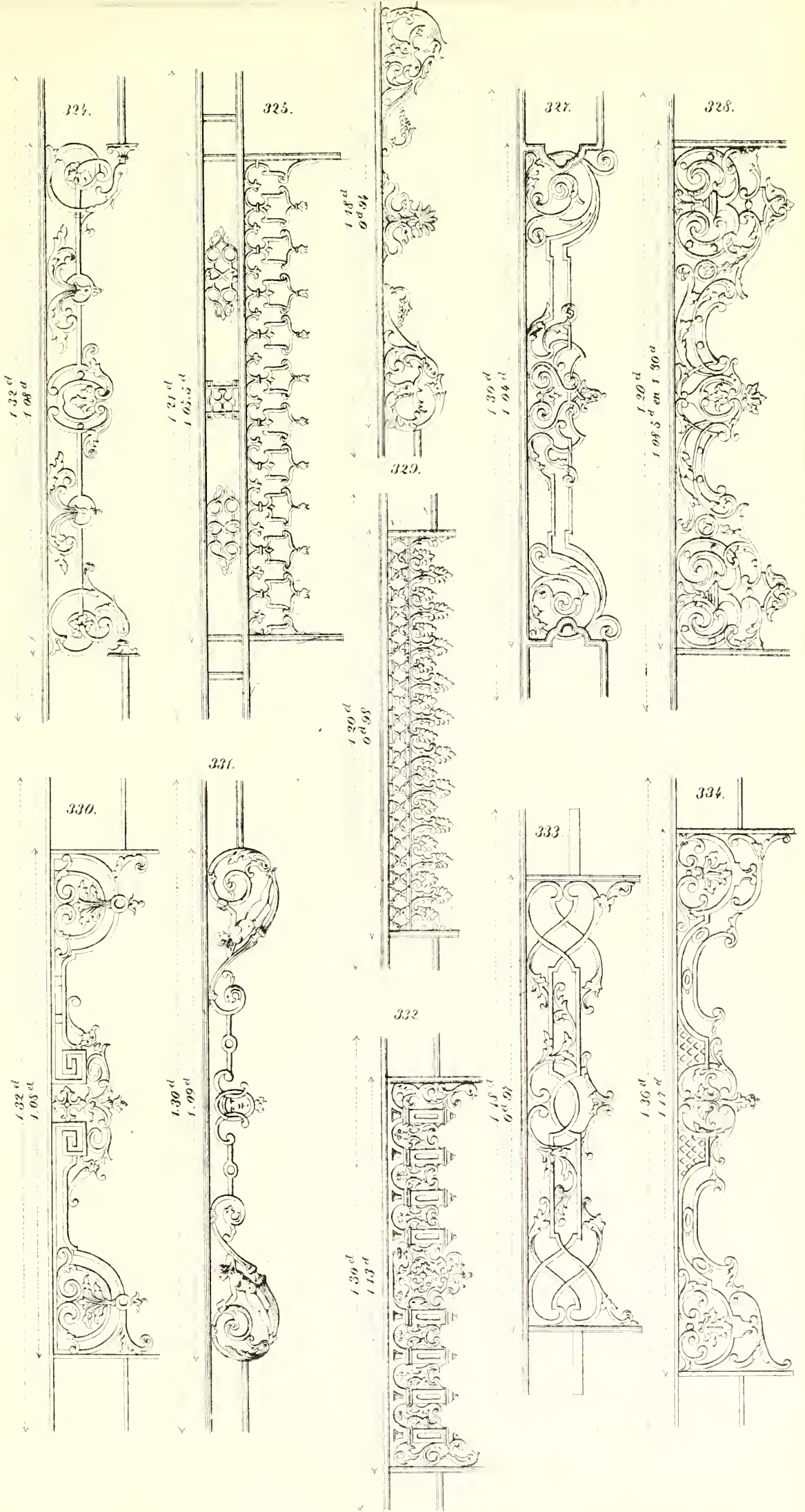

Fabriek van Bronswerken van *Becht en Dyserinck.*

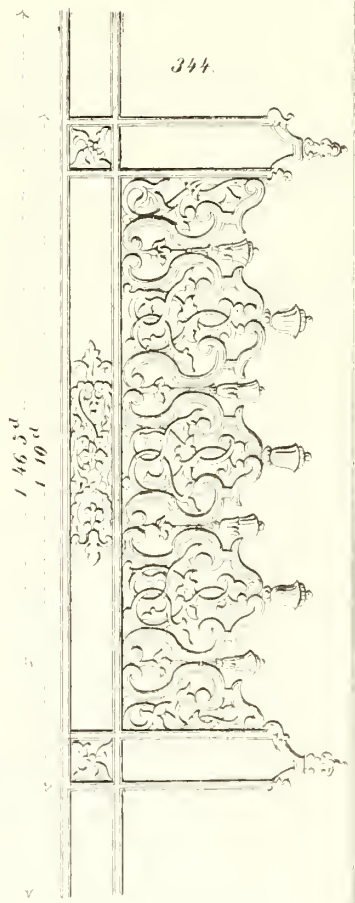
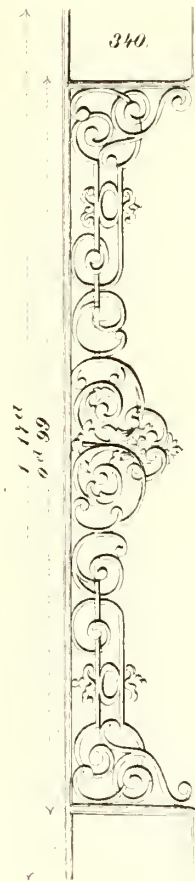
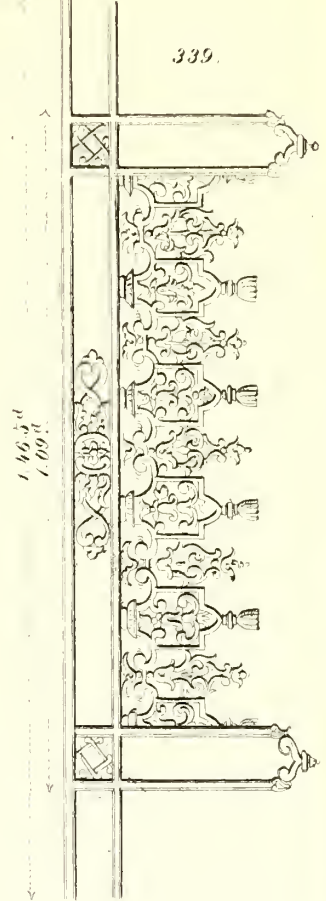
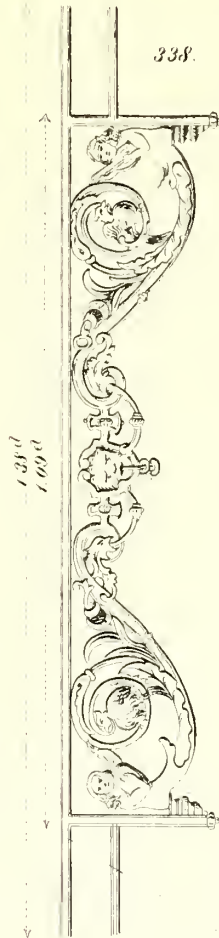
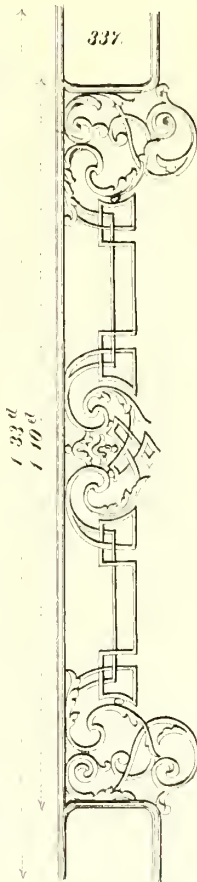
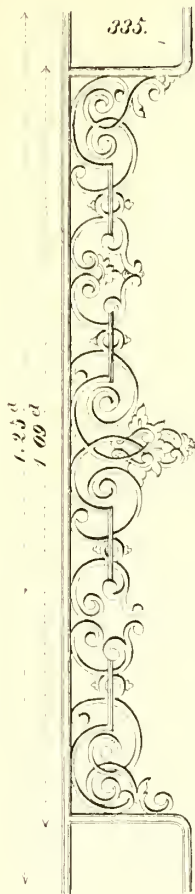

Fabriek van Bronswerken van *Becht en Dyserinck.*

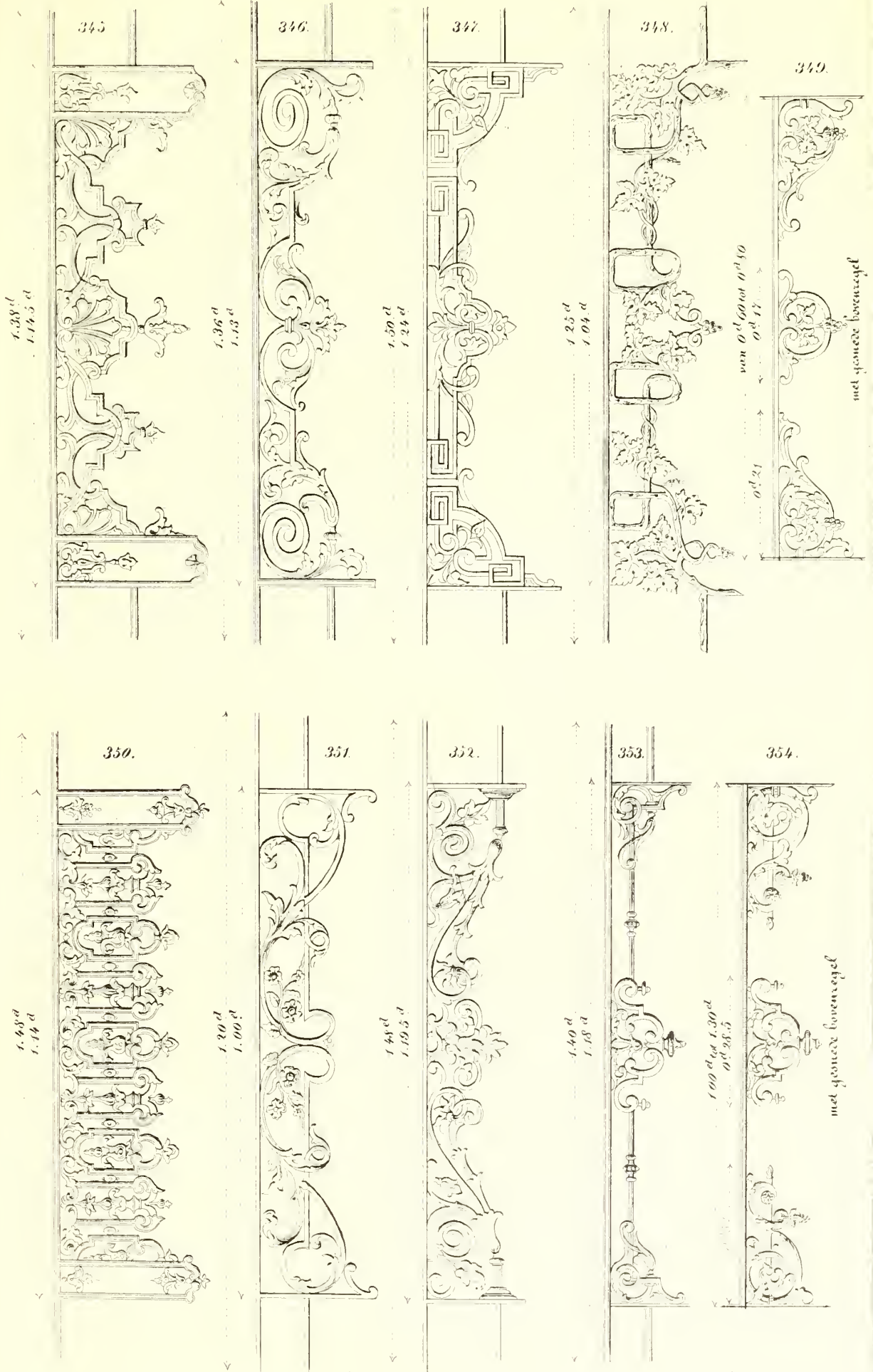

Fabriek van Bronswerken van *Becht en Dyserinck.*

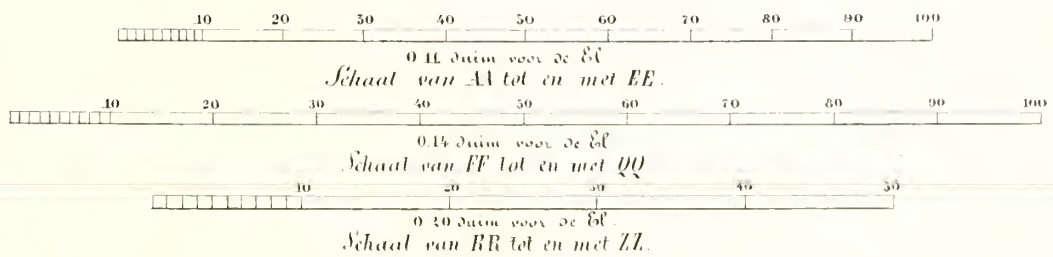
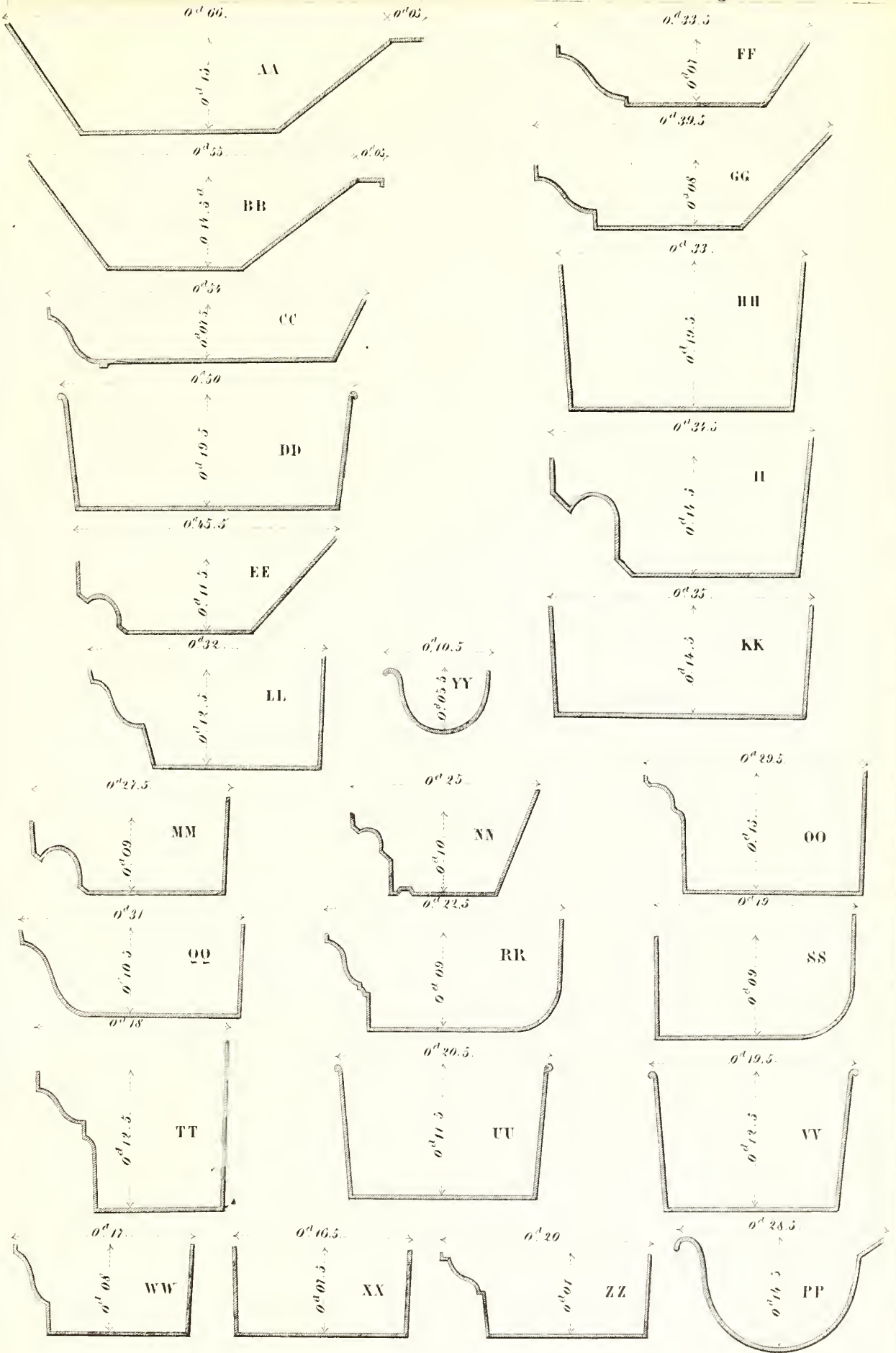



Fabriek van Bronswerken van *Becht en Dyserinck*.

356

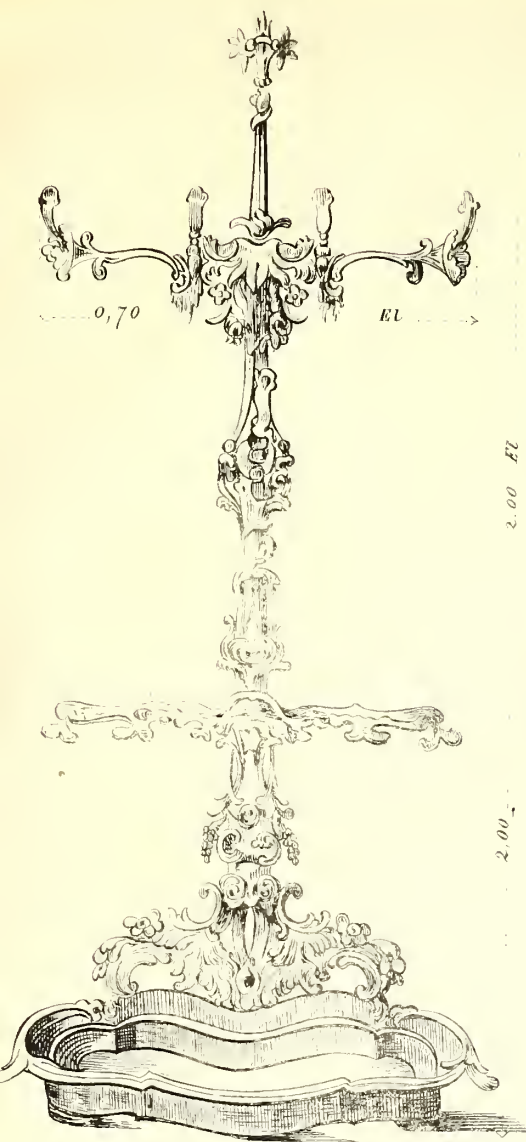

357

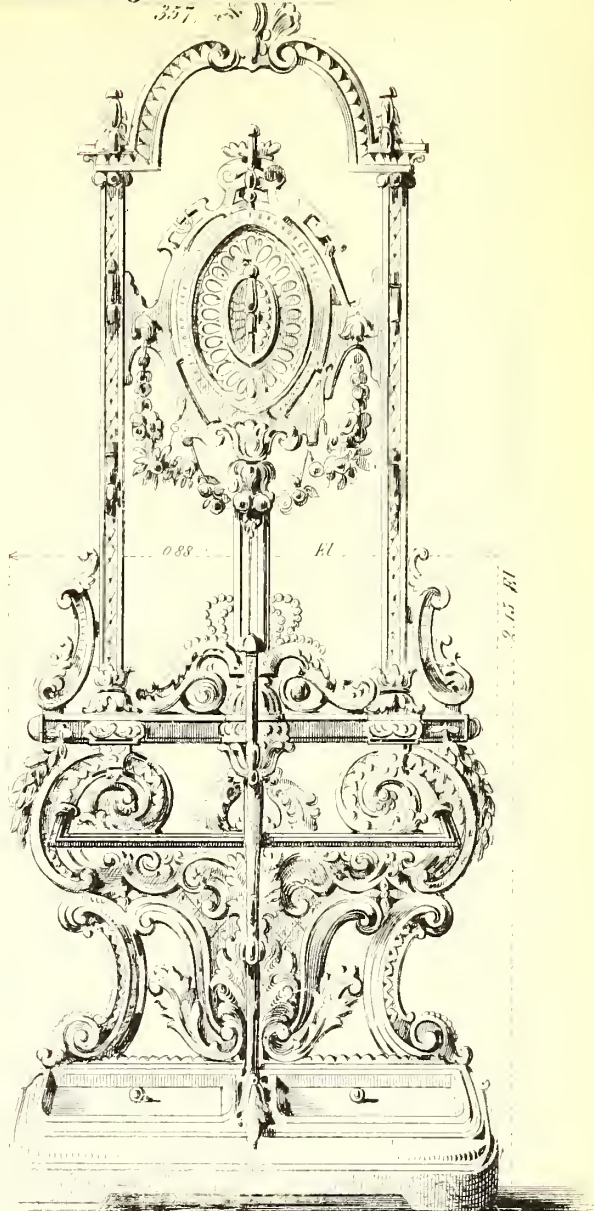

358

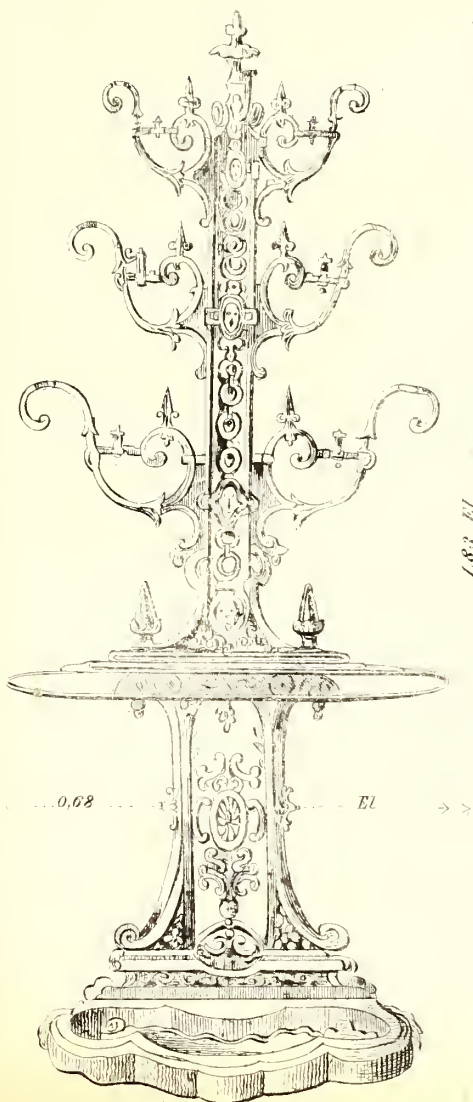

359



Fabriek van Bronswerken van *Becht en Dyserinck*.

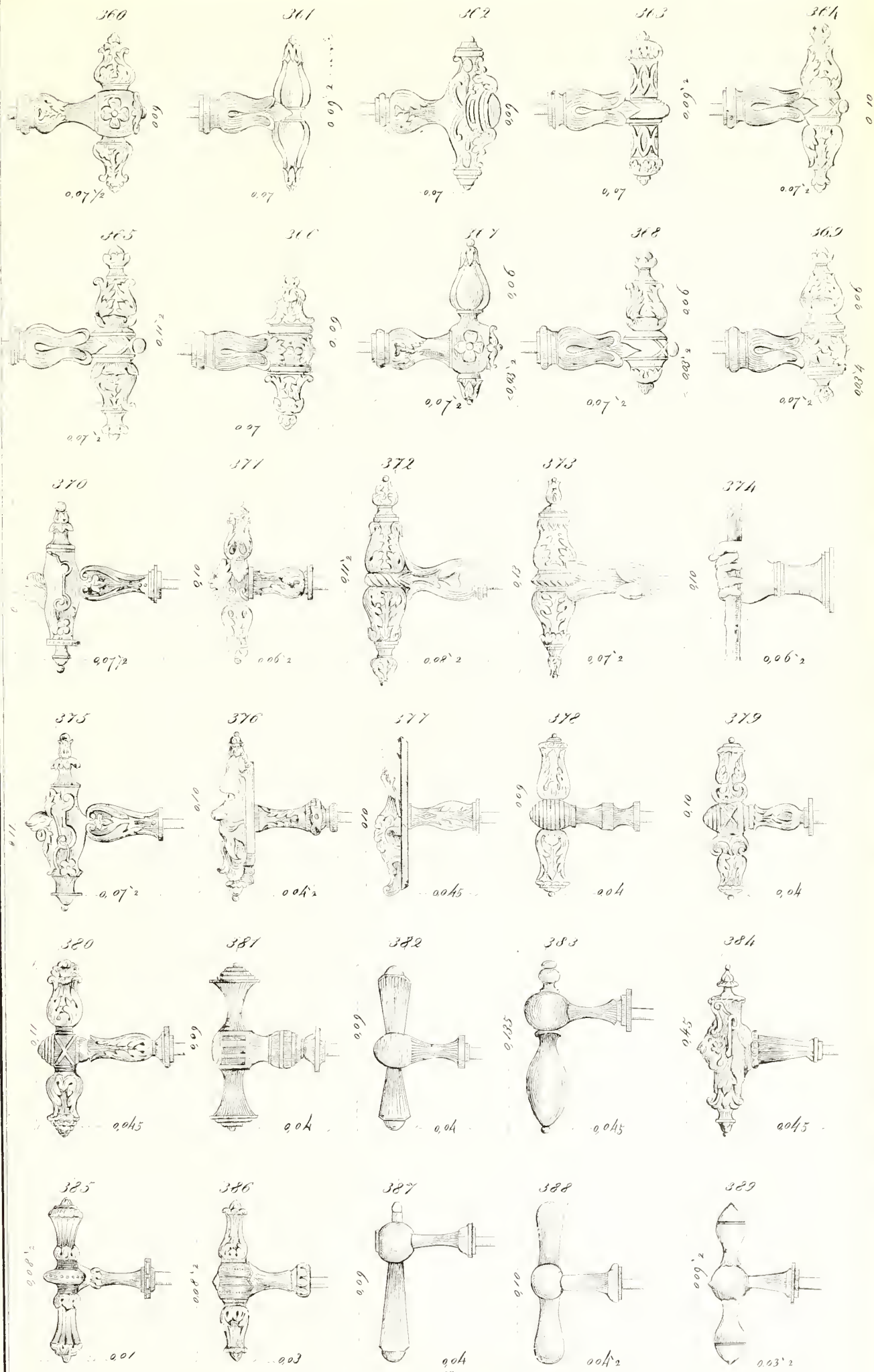

Fabriek van Bronswerken van *Becht en Dyserinck.*

391

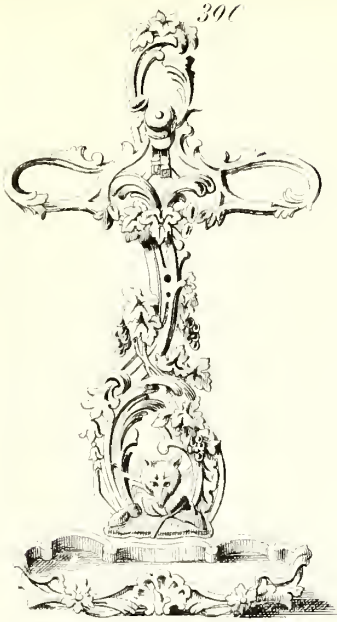

391

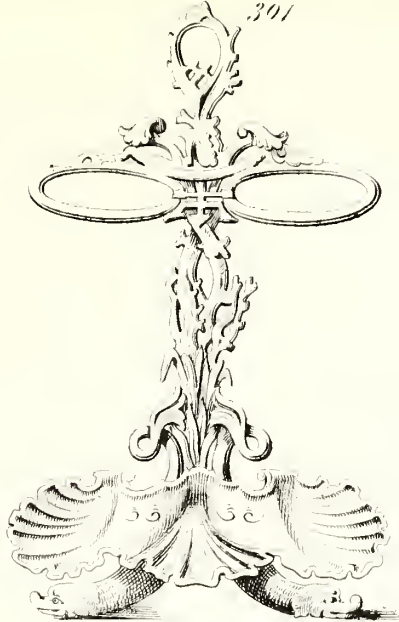

392

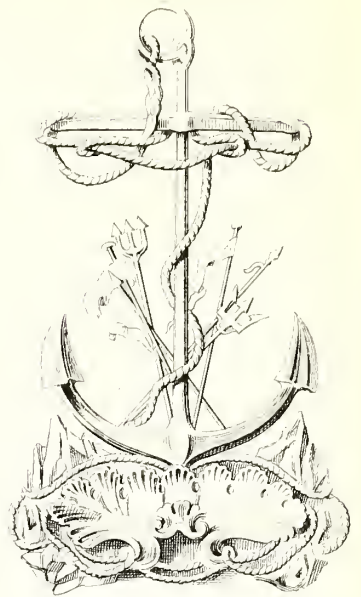

394

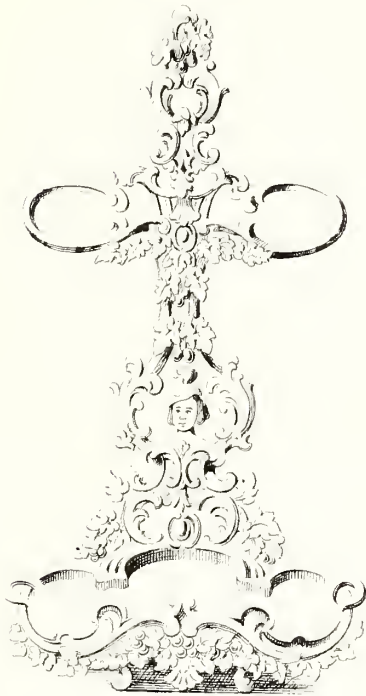

393

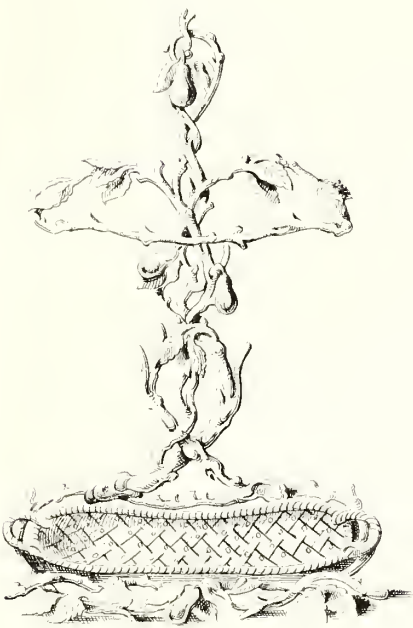

395

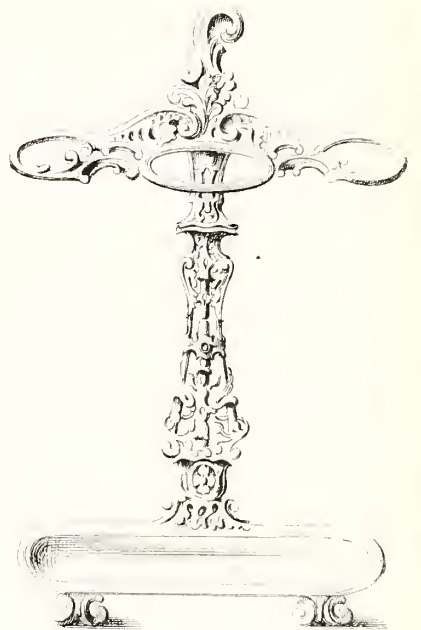

396



397

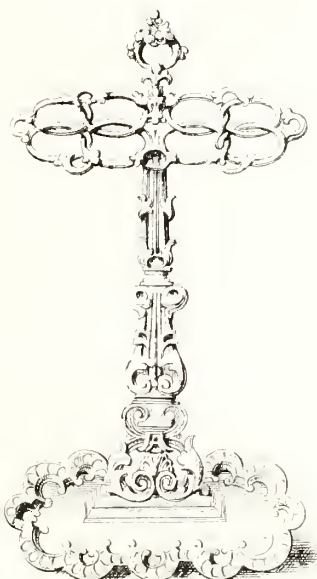

398

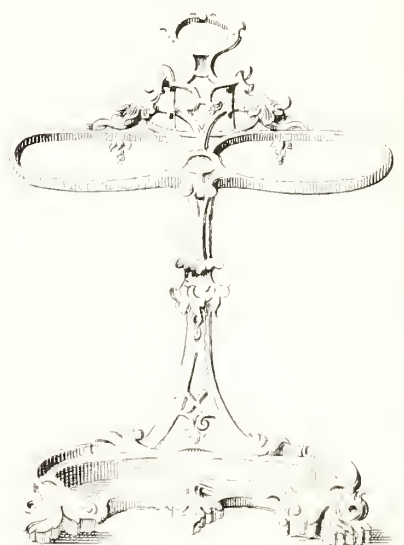

Fabriek van Bronswerken van *Becht en Dyserinck*.

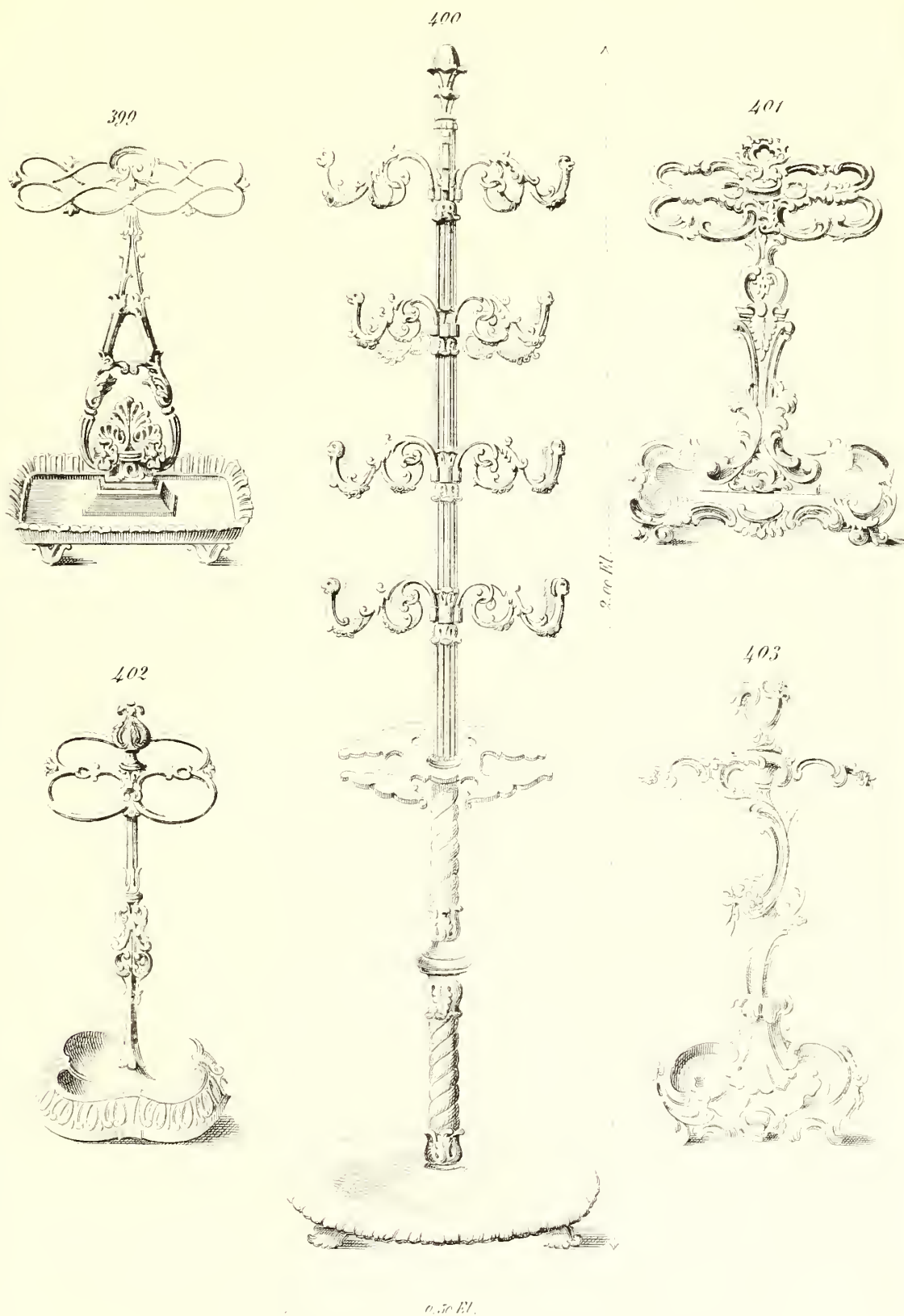

Fabriek van Bronswerken van *Becht en Dyserinck.*

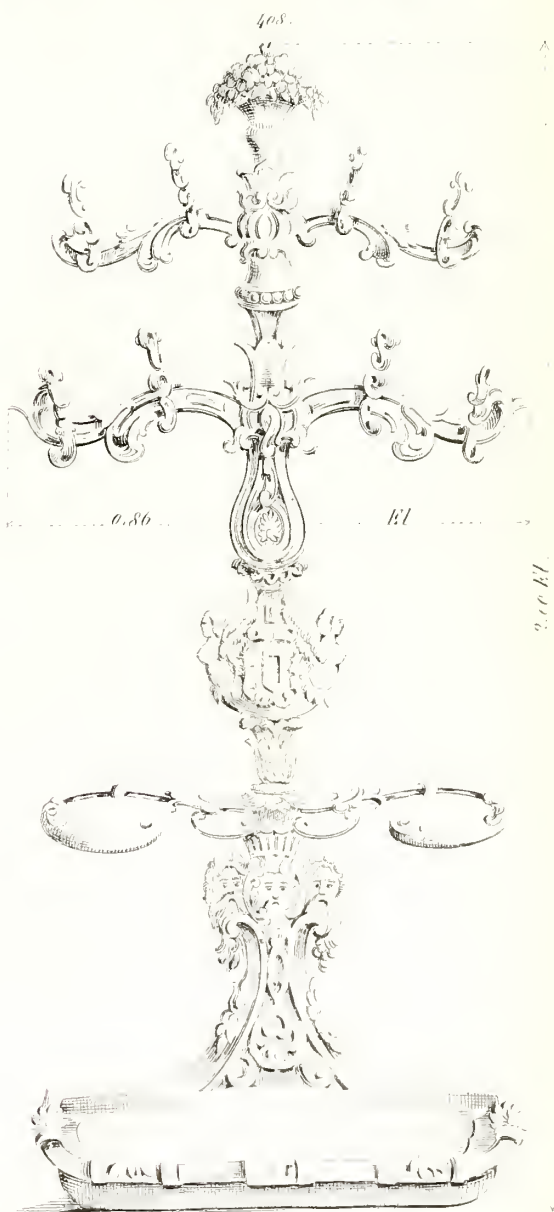
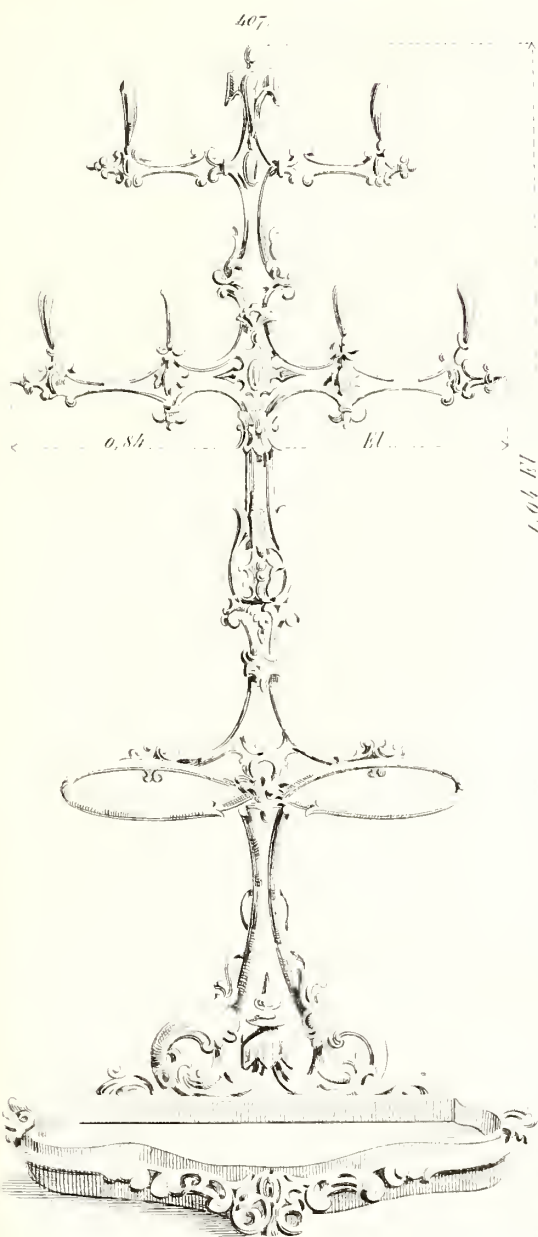
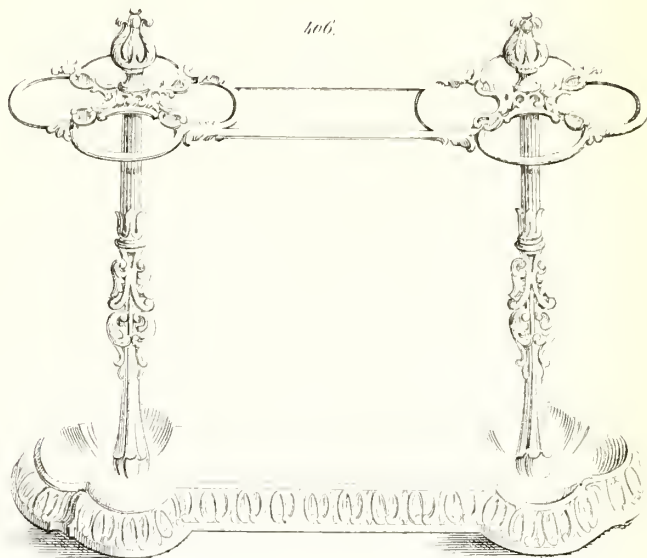
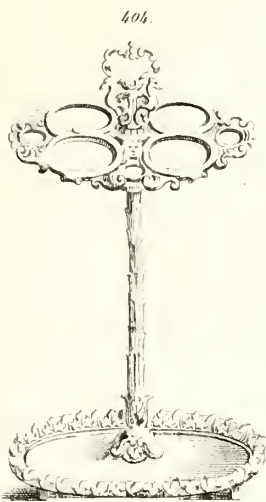

Fabriek van Bronswerken van *Becht en Dyserinck.*

Kandelabres.

410

411

409

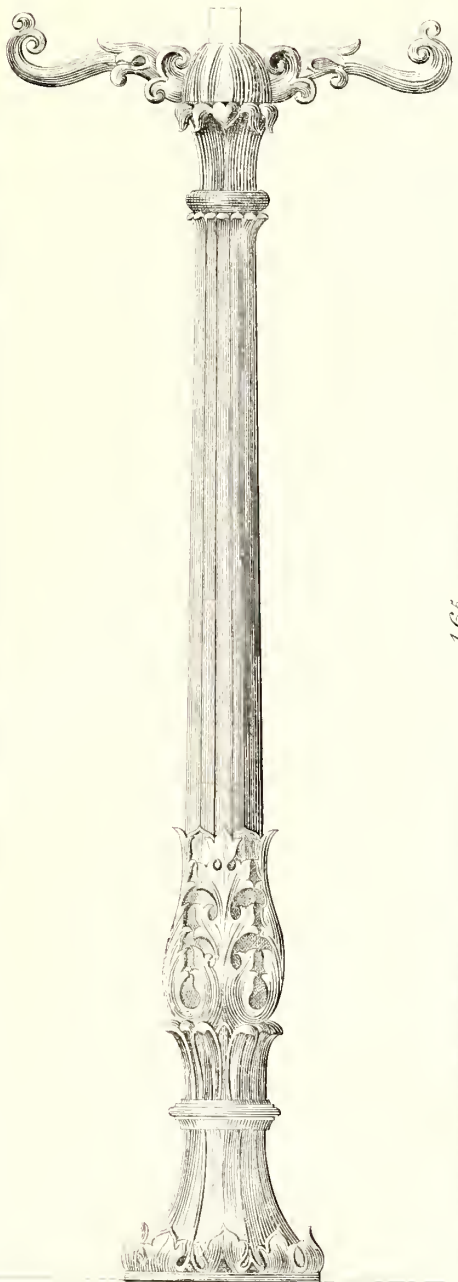

1,65

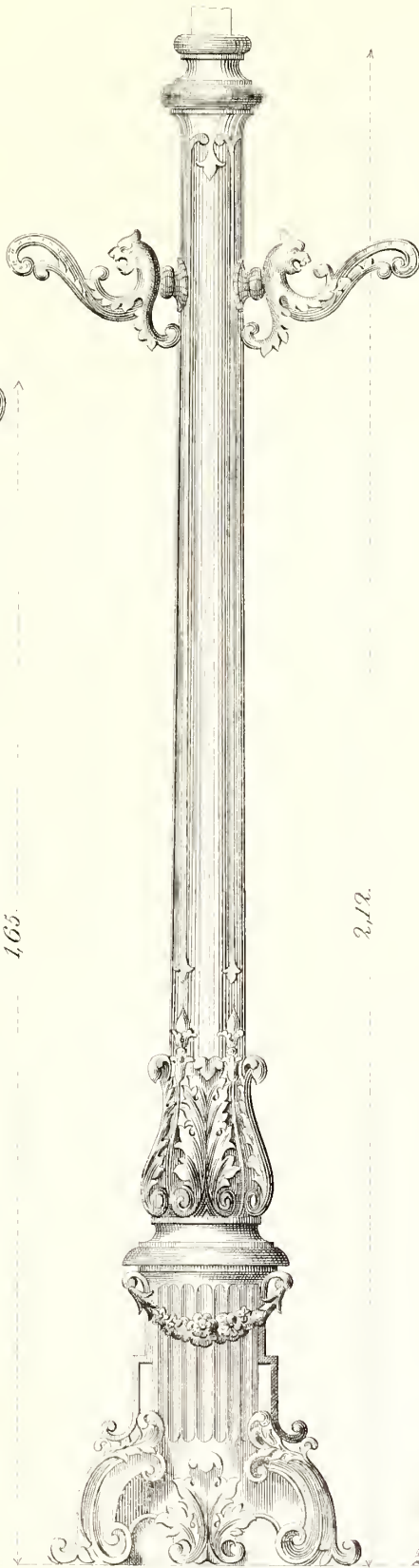

2,12

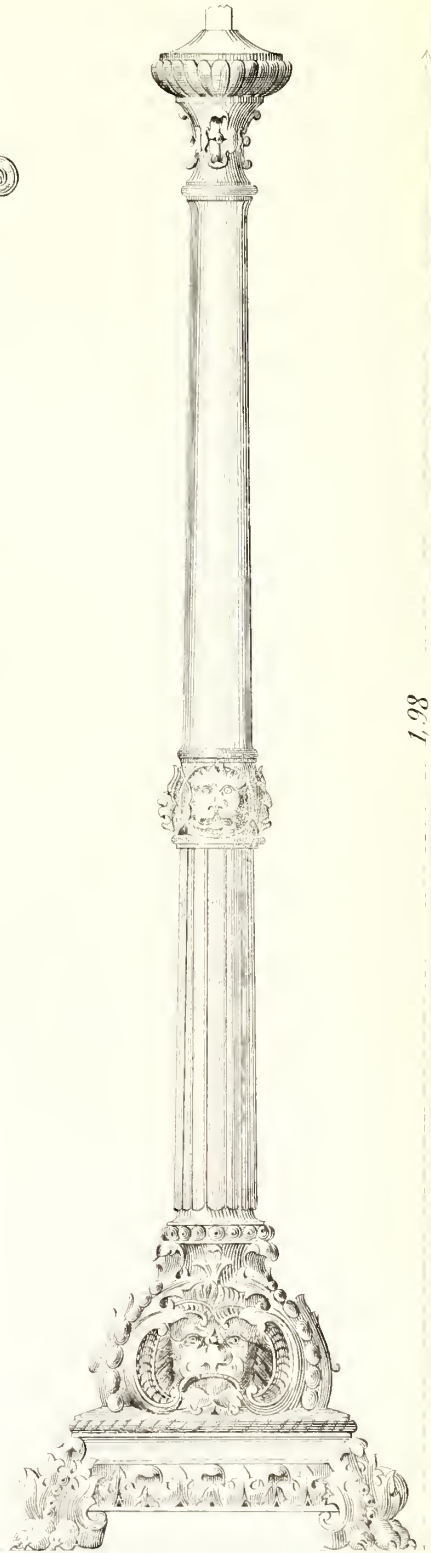

1,98

veerkant 0,48 by 0,24

410 der ware grootte.

Fabriek van Bronswerken van *Becht en Dyserinck.*

412



413

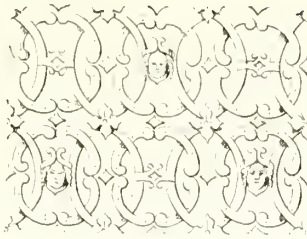

414

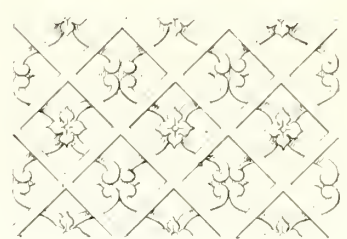

416

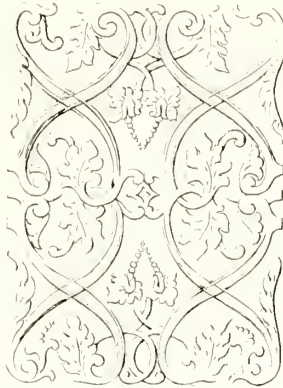

417

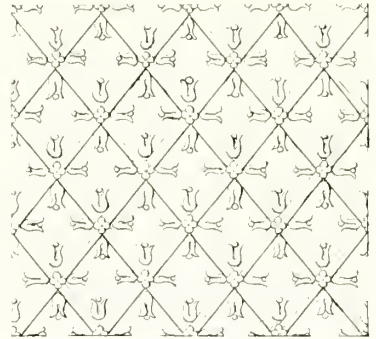

415

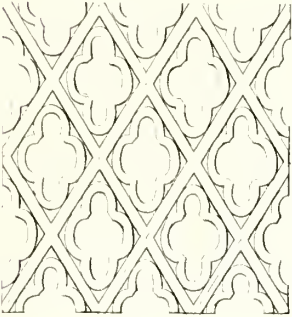

422

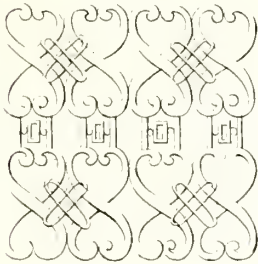

418

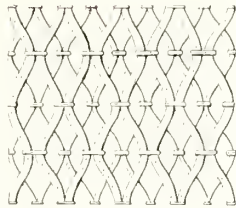

419

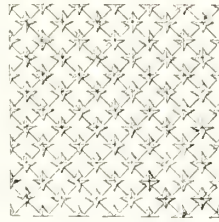

423

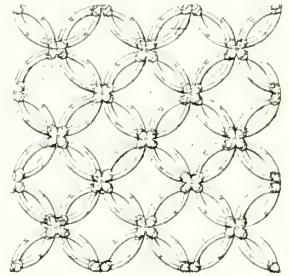

424

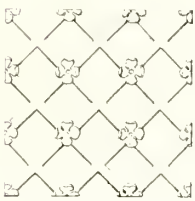

420

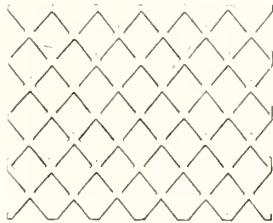

421

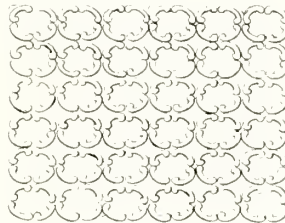

425

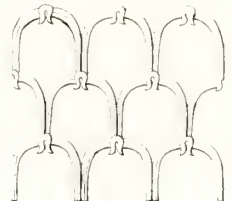

426

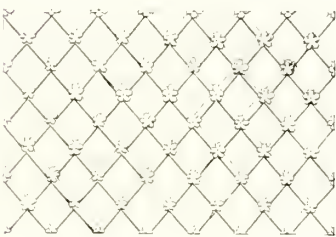

427

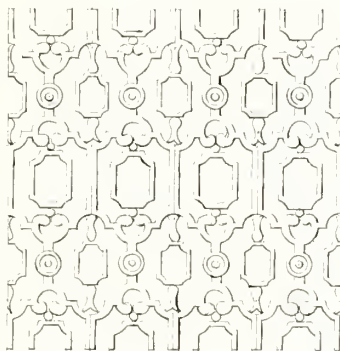

428

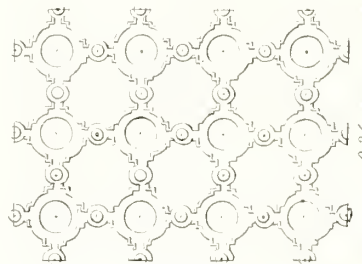

429

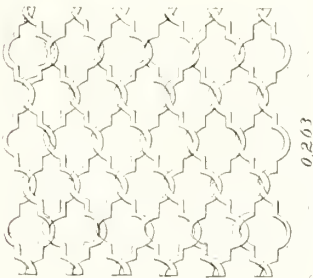

0,32

430

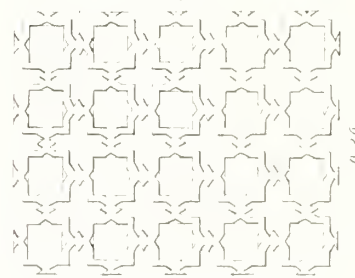

0,263

0,325

Schaal voor 412 tot en met 421

Schaal voor 422 tot en met 427

Wij 422, 423, 425, 426, 427, 429 aan beide zijden gebruikt, want aan 423, 425 en 429 aan de achter zijde ook gebruik gemaakt van beide zijden.

Fabriek van Bronswerken van *Becht en Duserinck.*

431.

N^o 432

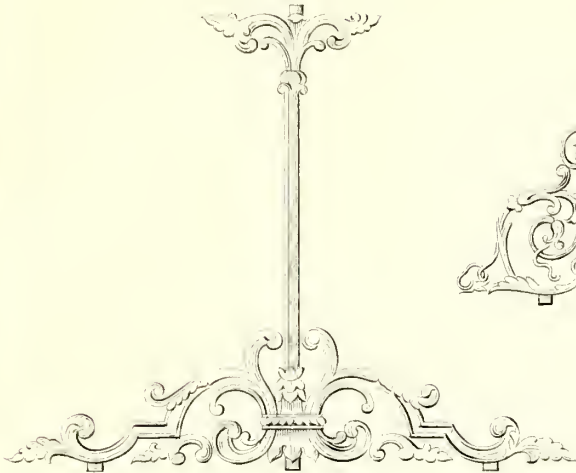

N^o 433

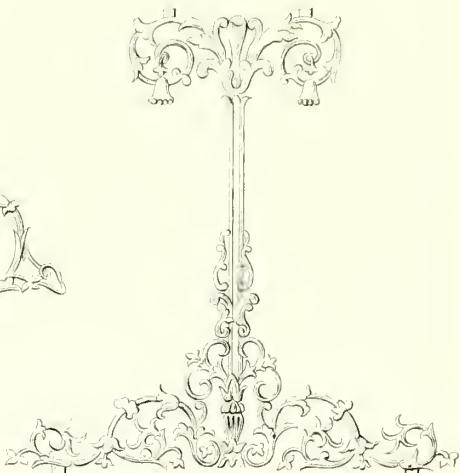

N^o 434

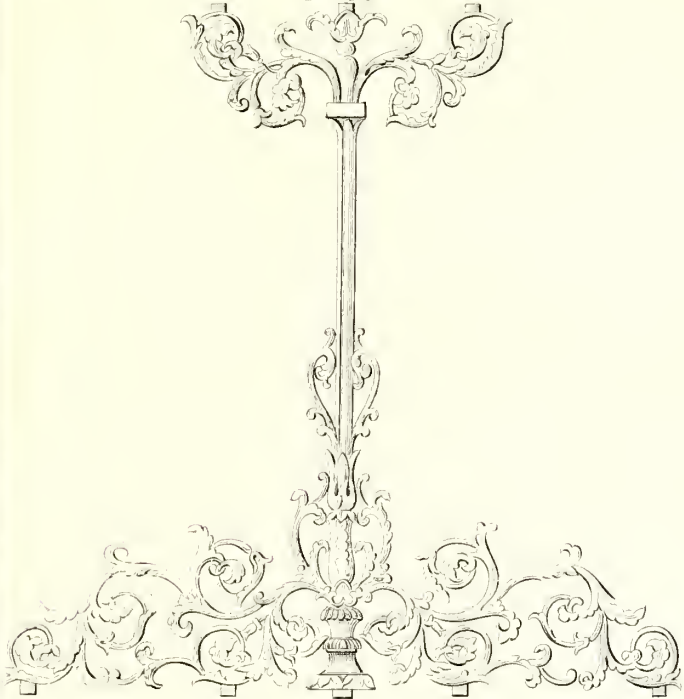

N^o 435

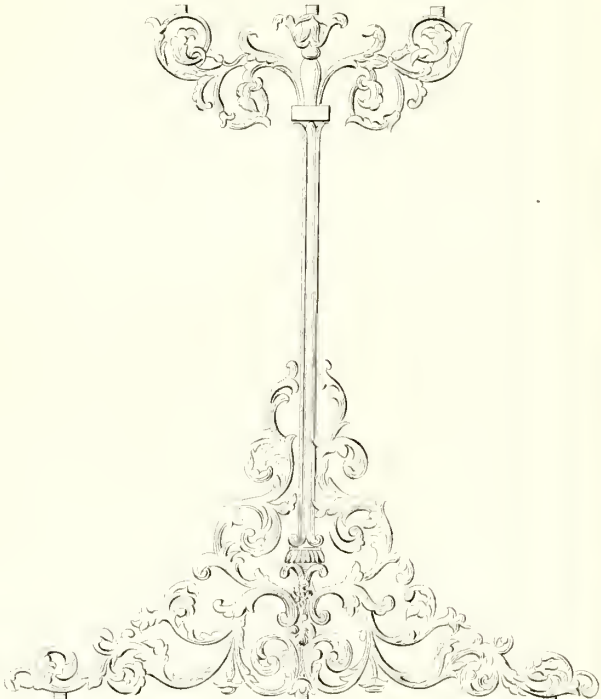

N^o 438

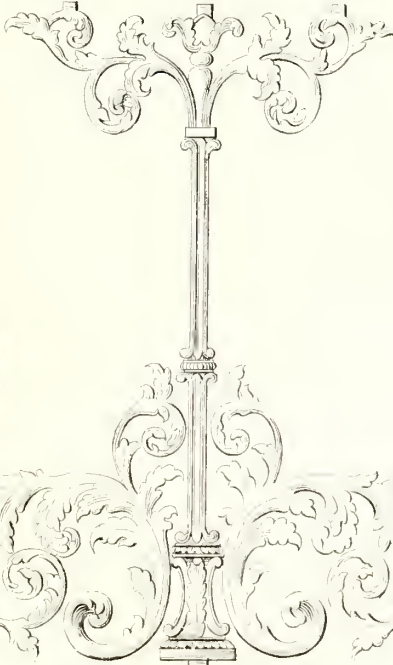

N^o 436



N^o 437

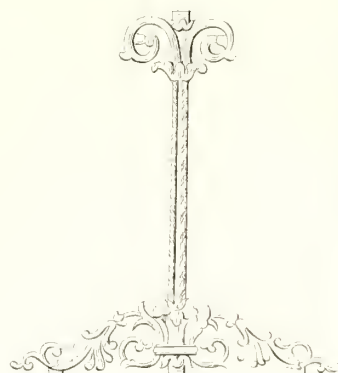

N^o 431, 432, 433 hoog met 0,05 opklimmende van 0,45 tot 0,70
 N^o 434, 435, 438 " " 0,10 " " " 0,70 " 1,00.
 N^o 437 " " 0,05 " " " 0,35 - 0,55.

Op to der ware grootte.

Fabriek van Bronswerken van *Becht en Dyserinck.*



N° 439



N° 440



N° 441



N° 442



N° 443

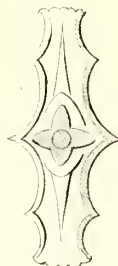

N° 444

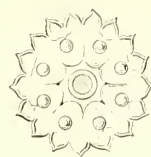

N° 445

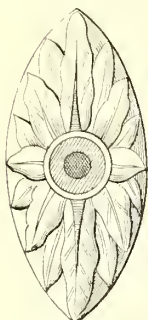

N° 446



N° 447

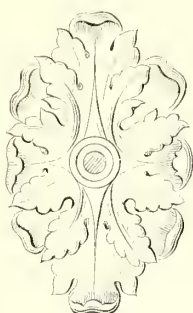

N° 448



N° 449

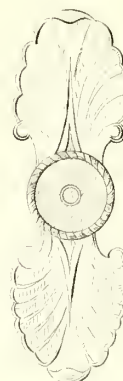

N° 450

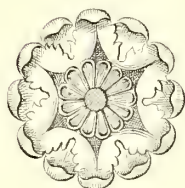

N° 451

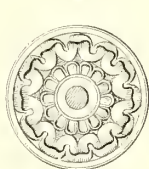

N° 452

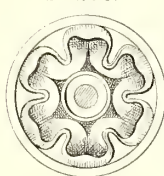

N° 453

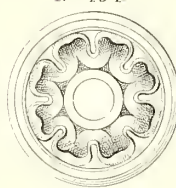

N° 454



N° 455



N° 456

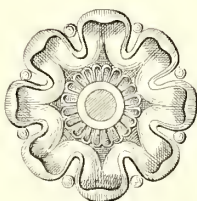

N° 457



N° 459

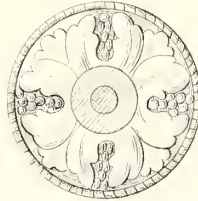

N° 460

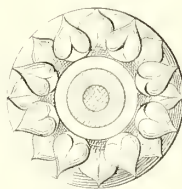

N° 461

N° 463

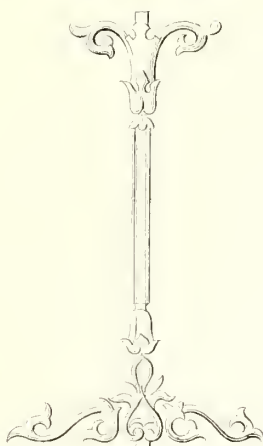

N° 462

N° 464

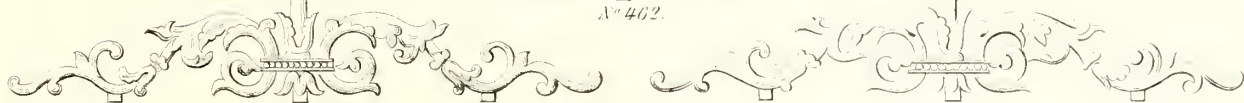

Op 1/2 der ware grootte.

Fabriek van Bronswerken van *Becht en Dyserinck.*

Op de der ware grootte.

Gegoten ijzeren hek.

N^o 465

Nota.

- a. Stylen 005 El vierkant (21^m d^m)
- b. Regels 0025 " - 005 El (1.2 " ")
- c. Grote spylen 0023 " rond (73 " ")
- d. Kleine spylen 0017 " rond (53 " ")

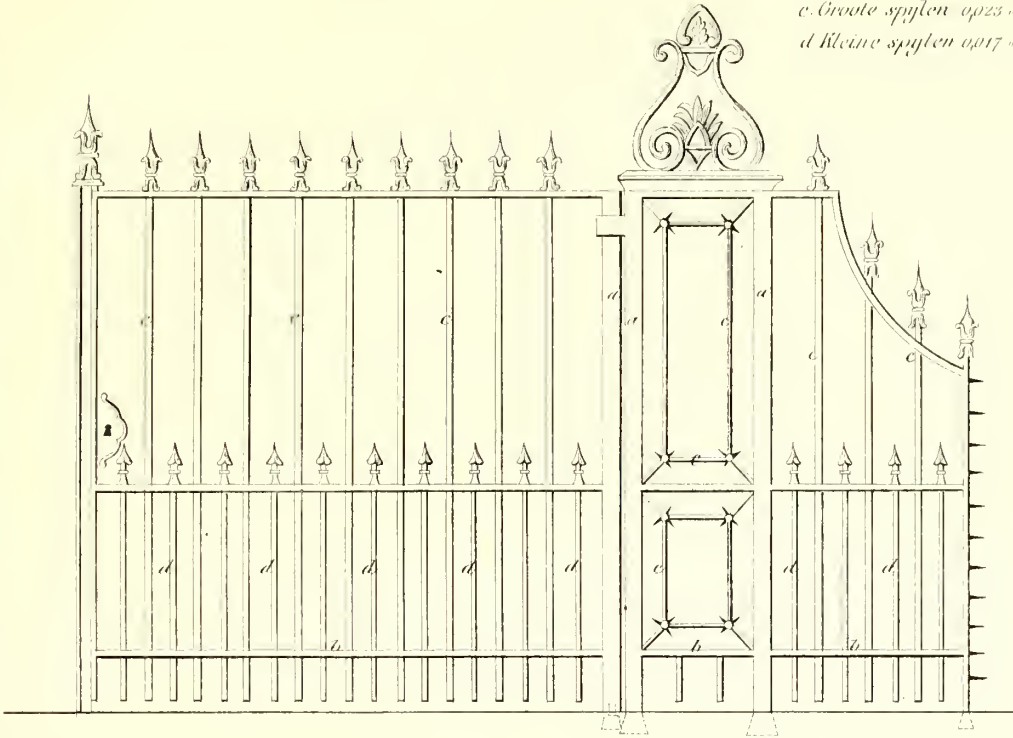

Gesmeed ijzeren hek.

N^o 466

Nota.

- a Kolonnen gegoten ijzer Diam 0 09 El (3/8 1^m d^m)
- b Stylen gesmeed dik 0,045 x 0,045 " (1 3/4 x 1 3/4 ")
- c Regels " " " 0,045 x 0,02 " (1 3/4 x 3/4 ")
- d Grote spylen " " " 0,02 El rond (3/4 ")
- e Kleine " " " 0,013 " " " (1/2 ")
- f Picken gegoten ijzer.

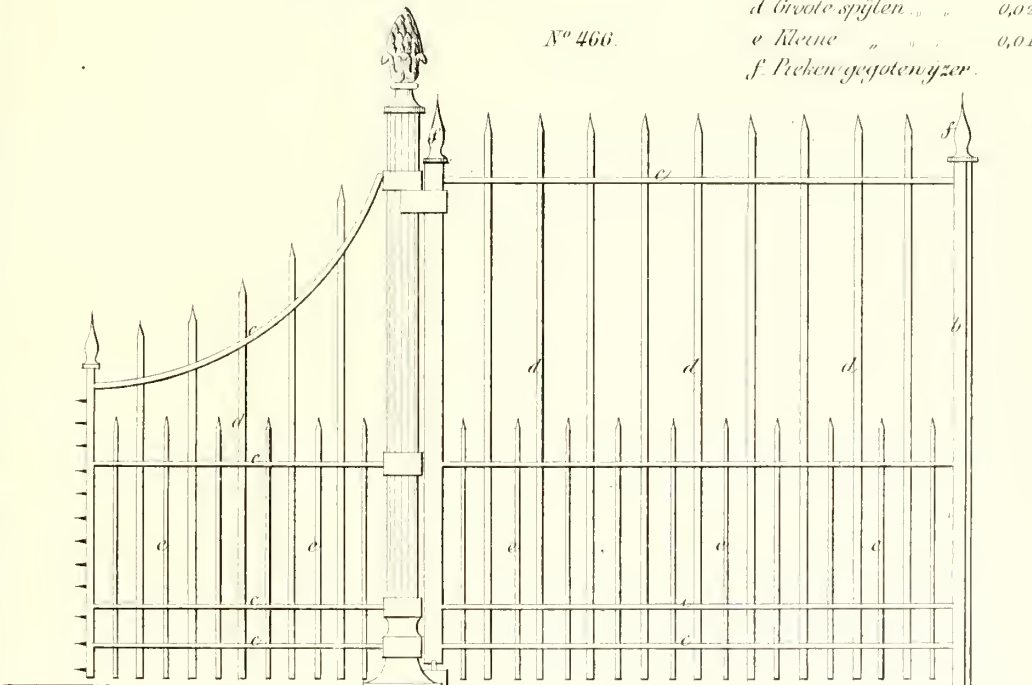

Schaal van 10 tot 20 of 2 daem op de El

Fabriek van Bronswerken van *Becht en Dyserinck.*

N^o 467.

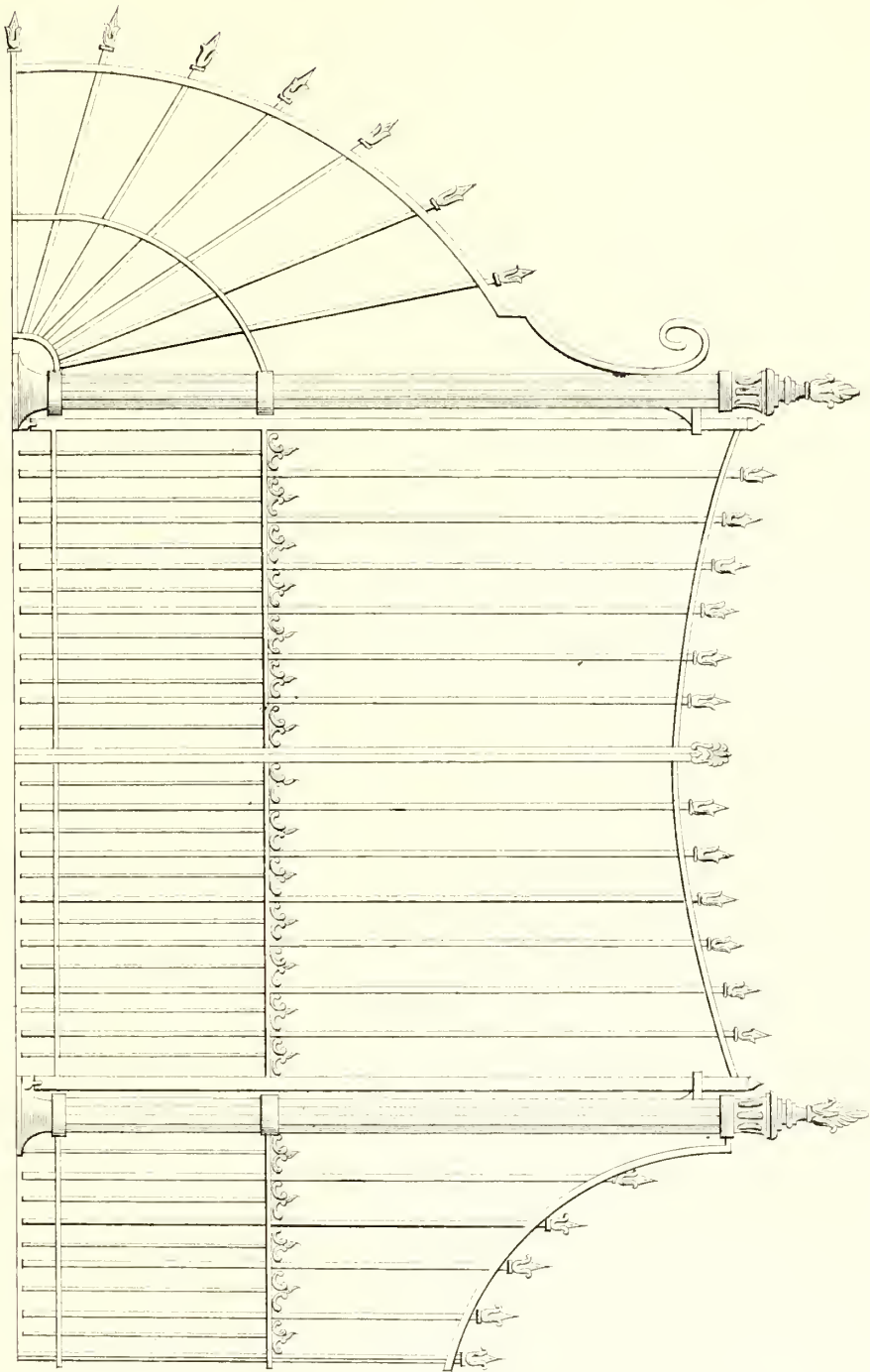

Op 26 der ware grootte

Schaal van 5 duim per P^{is}

Fabriek van Bronswerken van *Becht en Dyserinck.*

N^o 468.

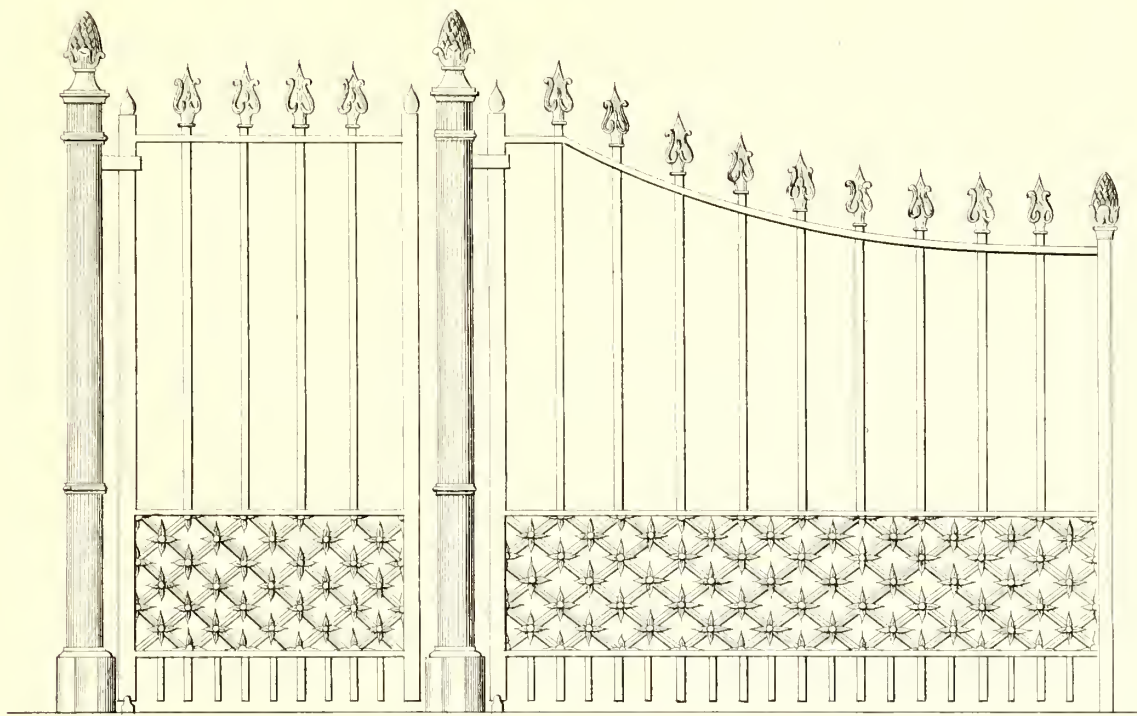

Op $\frac{1}{20}$ der ware grootte.
Schaal van 5 duim pr El.

N^o 469

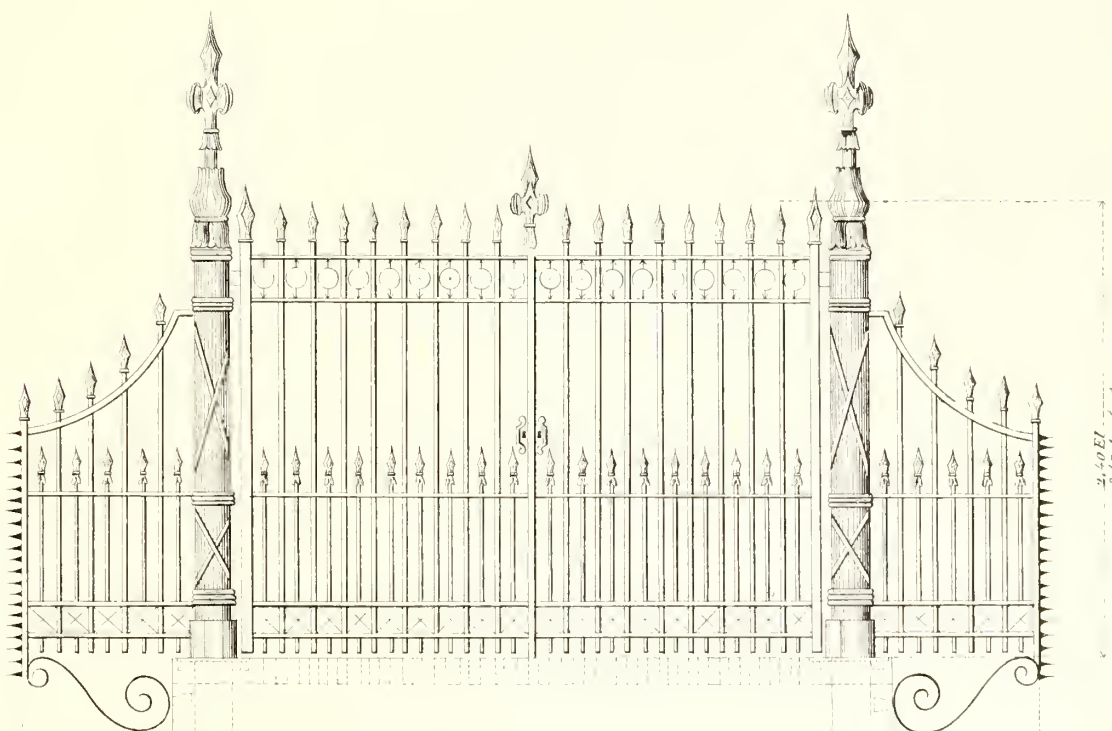

0,80
 2,82 1^m 0'

geheele lengte 3,60 El.
 12,7 1^m 8'

2,40 El.
 7 1/2 duim pr El.

Fabriek van Bronswerken van Becht en Dyserinck.

*De naam der higheste of boordery kan er
naar verkiezing op gegoten worden*

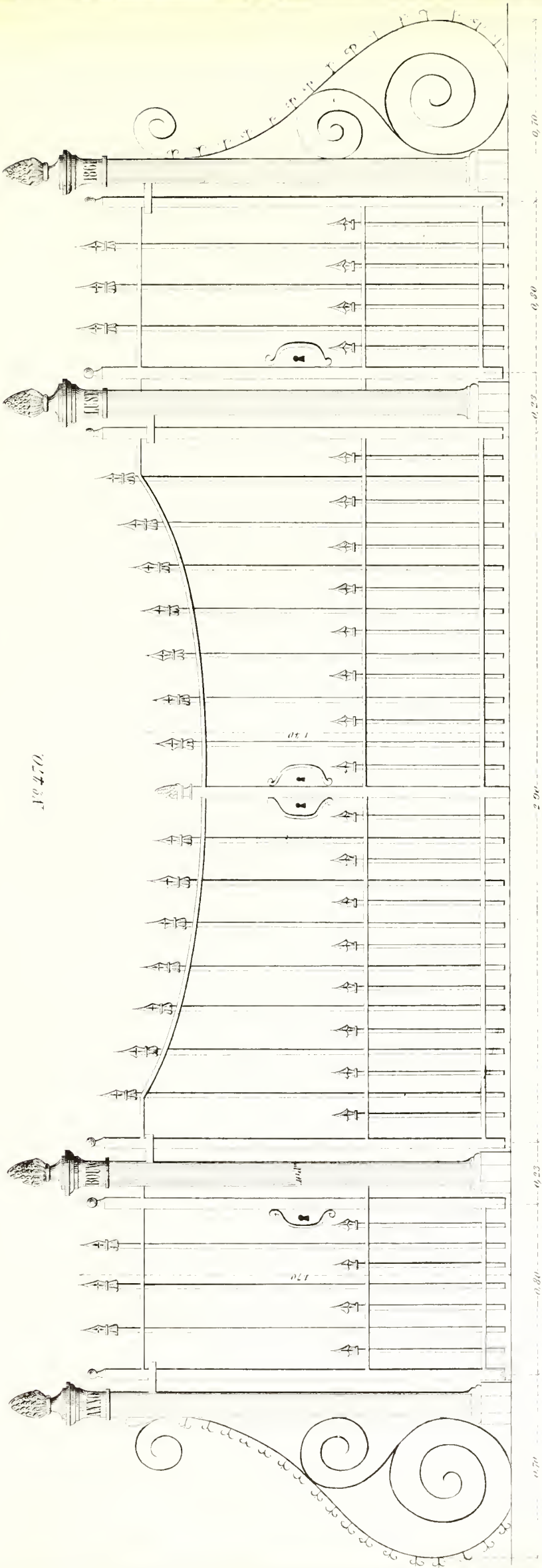

19470

Schaal 1 a 20

Op 20 der ware grootte.

Fabriek van Bronswerken van *Becht en Dyserinck.*

N^o 471.

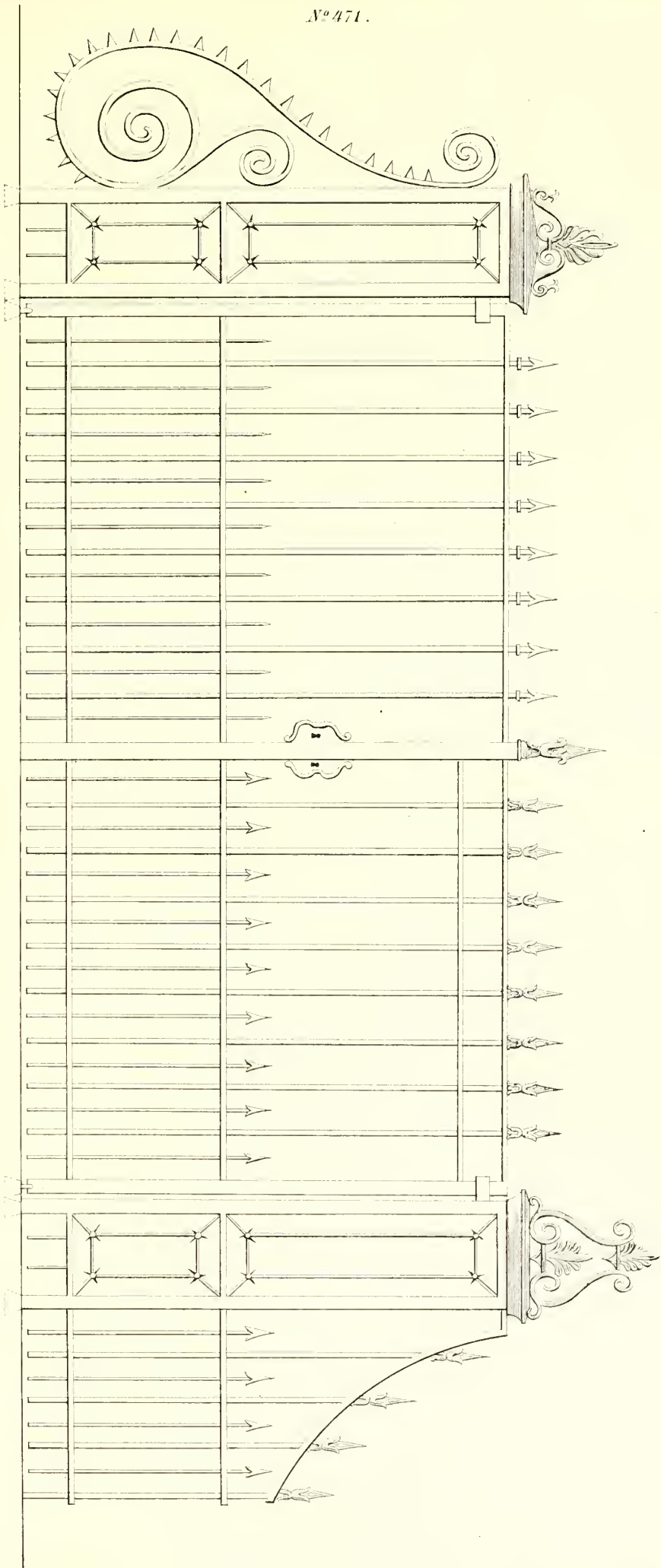

Op de ware grootte.

Schaal van 5 duim p^r P^o.

Fabriek van Bronswerken van *Becht en Dyserinck.*

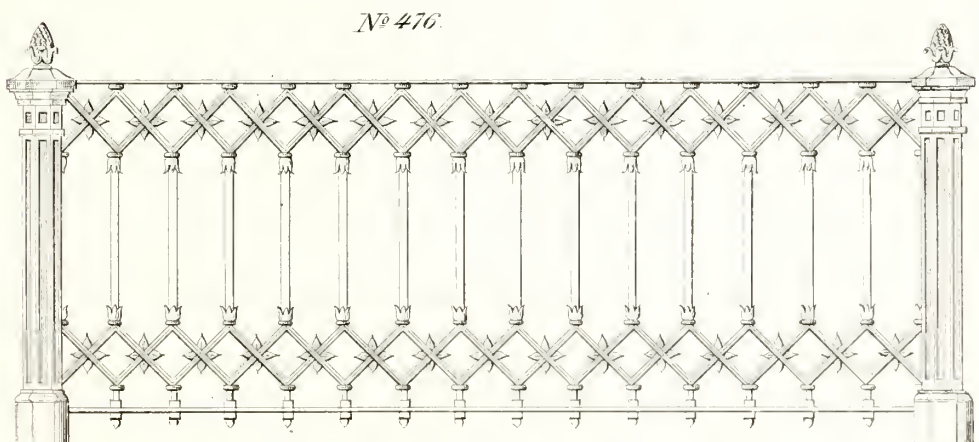
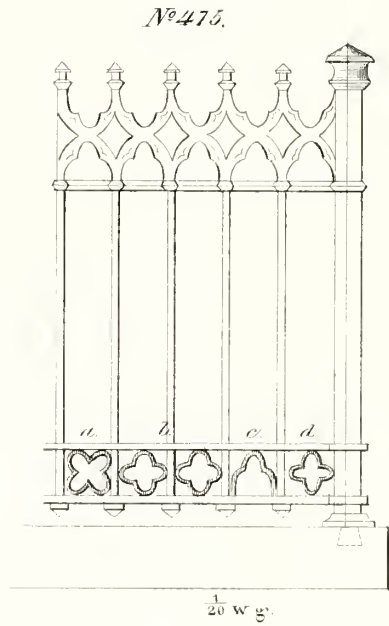
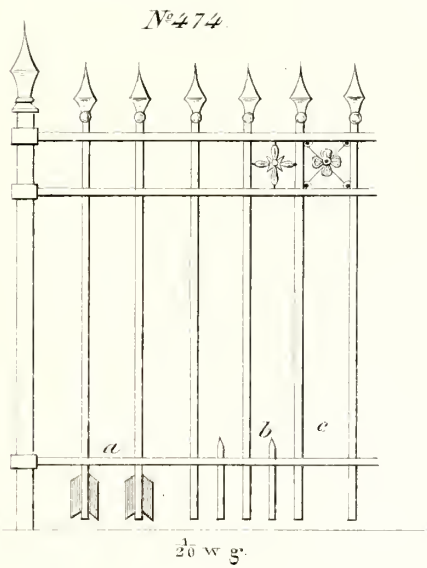
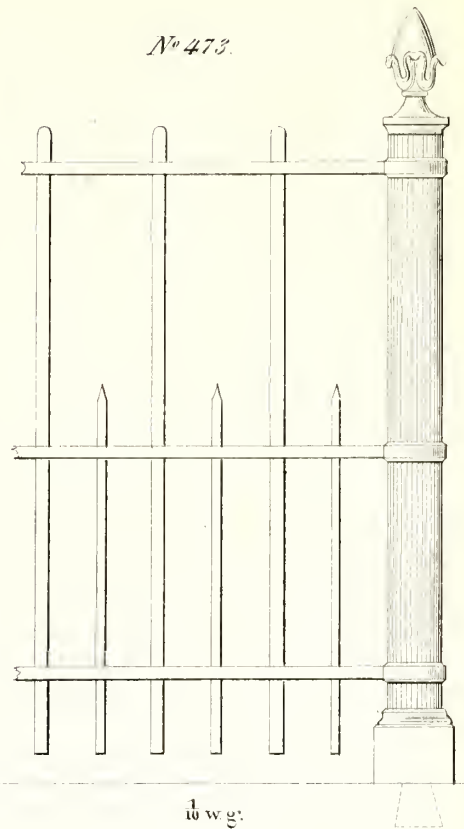
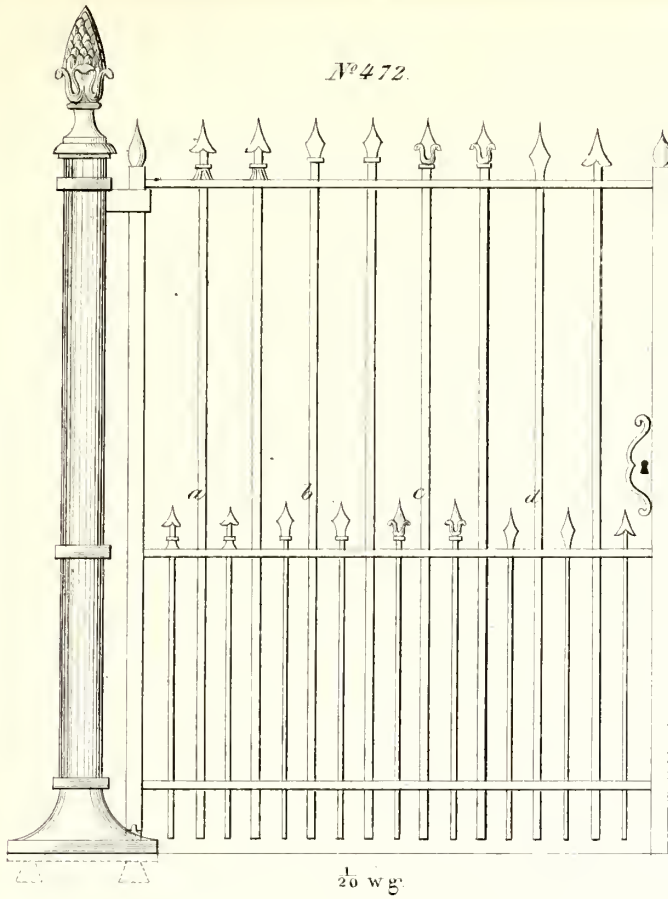

Schaal van 5 duim per El.

Fabriek van Bronswerken van *Becht en Dyserinck.*

N^o 411

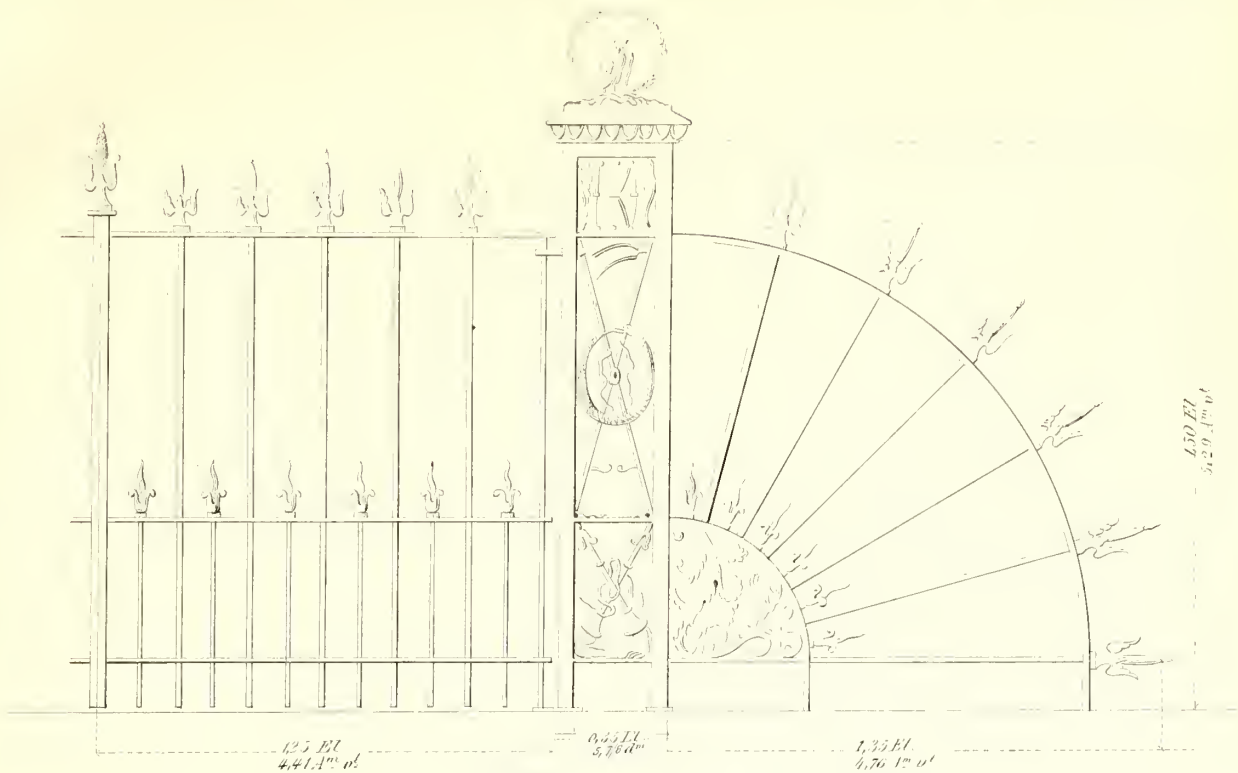

450 El
5429,1 m

Schaal van 5 duim per El.
op $\frac{1}{2}$ der ware grootte.

N^o 478.

Nota

- Kolonnnetjes, gesmeed *Diam.* 3 $\frac{1}{2}$ A^o 2^o 0,10 El.
- Hoofdstylen 0,045 x 0,045 El
- Groote spijlen *Diam.* 0,025 El 3^o
- Kleine idem 0,018 El 2^o
- Vleugel van gesmeed yzer naar maat 0,04 El
- Scharen achter de kolonnnetjes 0,03 x 0,10
- 7,1 m

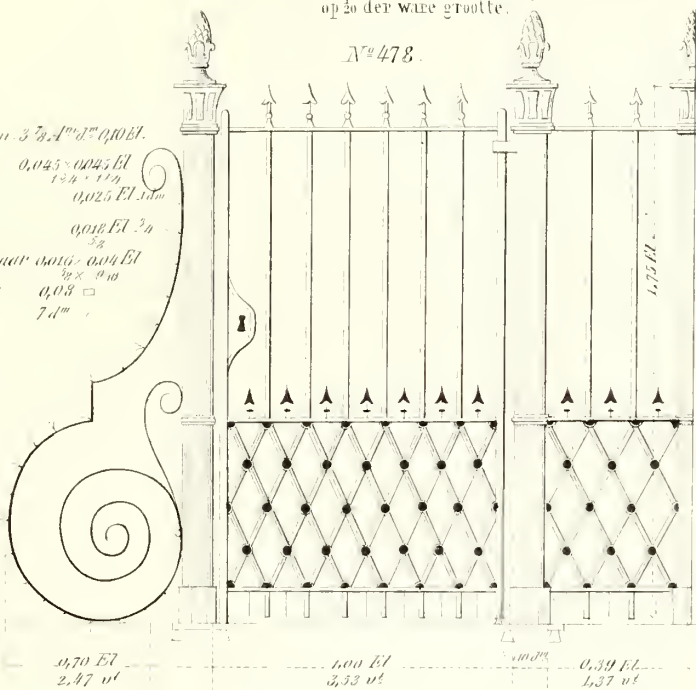

N^o 479.

Schaal van 4 duim per El. N^o 480.

op $\frac{1}{2}$ der ware grootte.

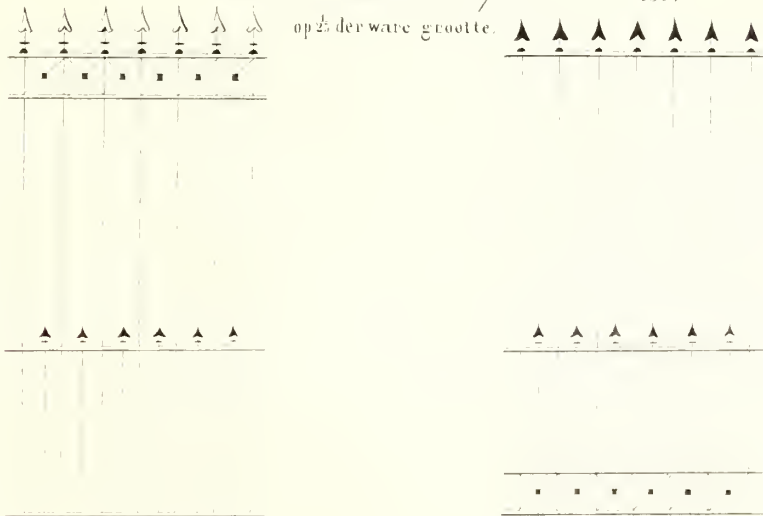

Fabriek van Bronswerken van *Becht en Dyserinck.*

N^o 481.

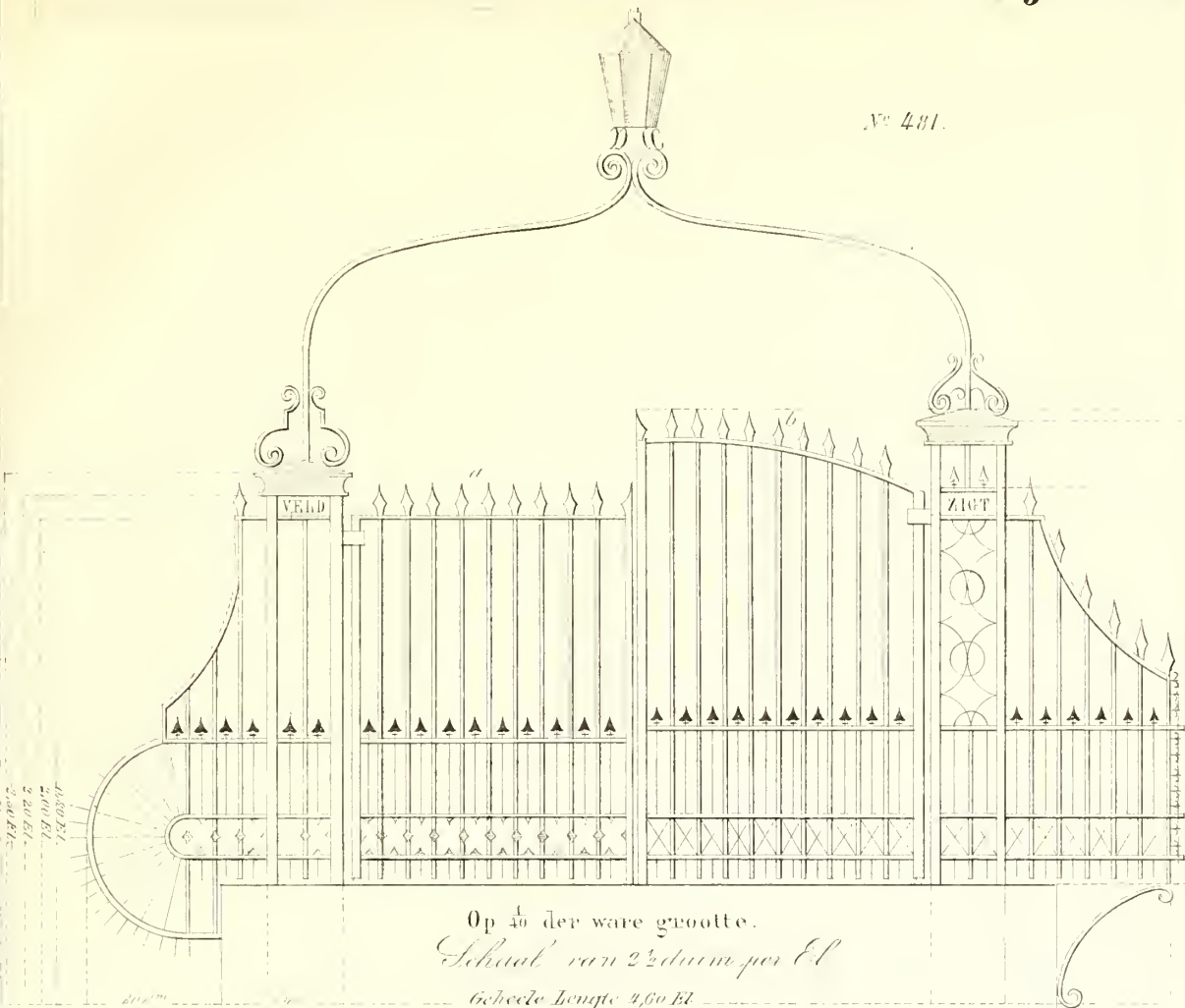

N^o 482.

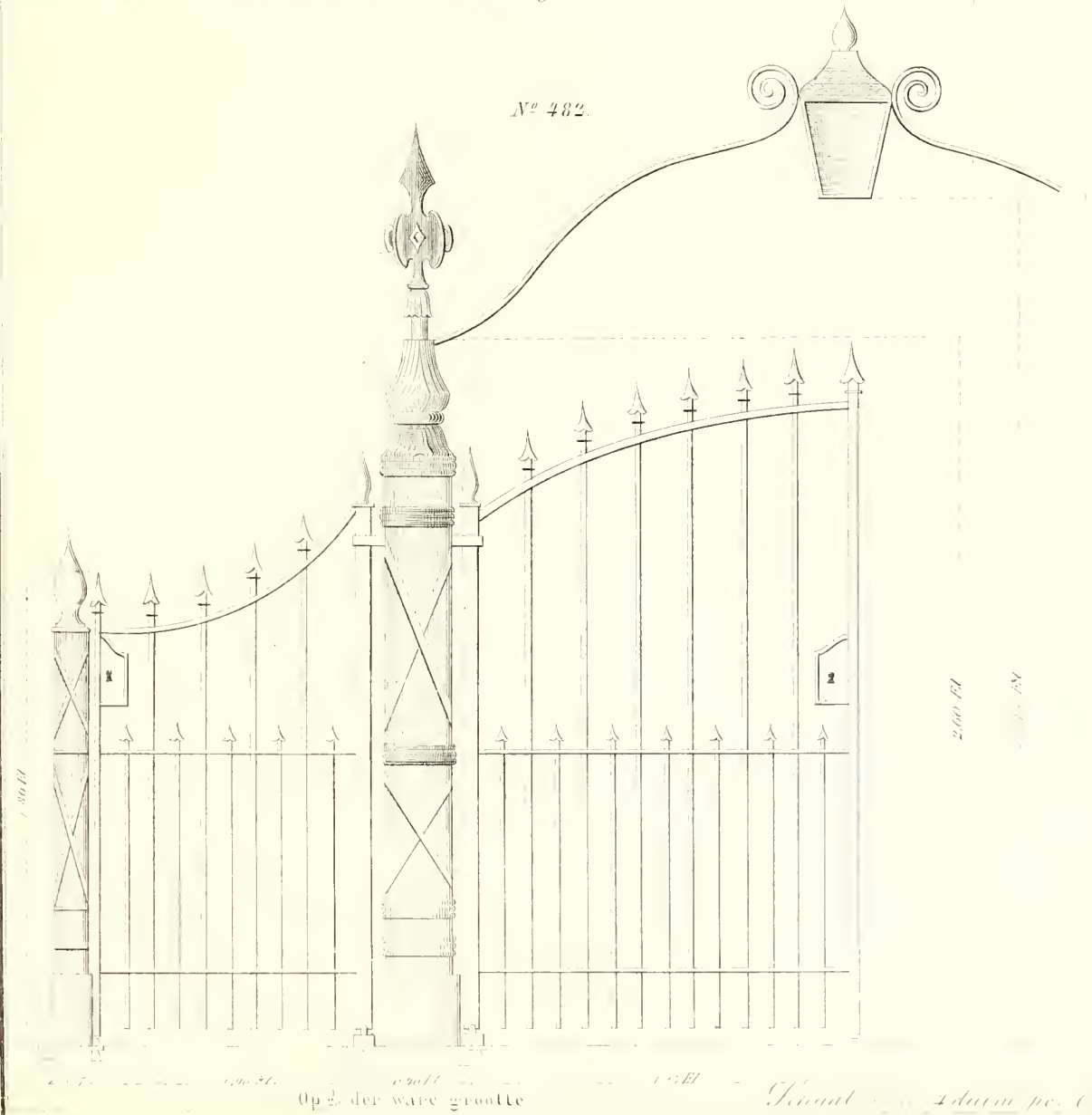

Fabriek van Bronswerken van Becht en Dyserinck.

N^o 483

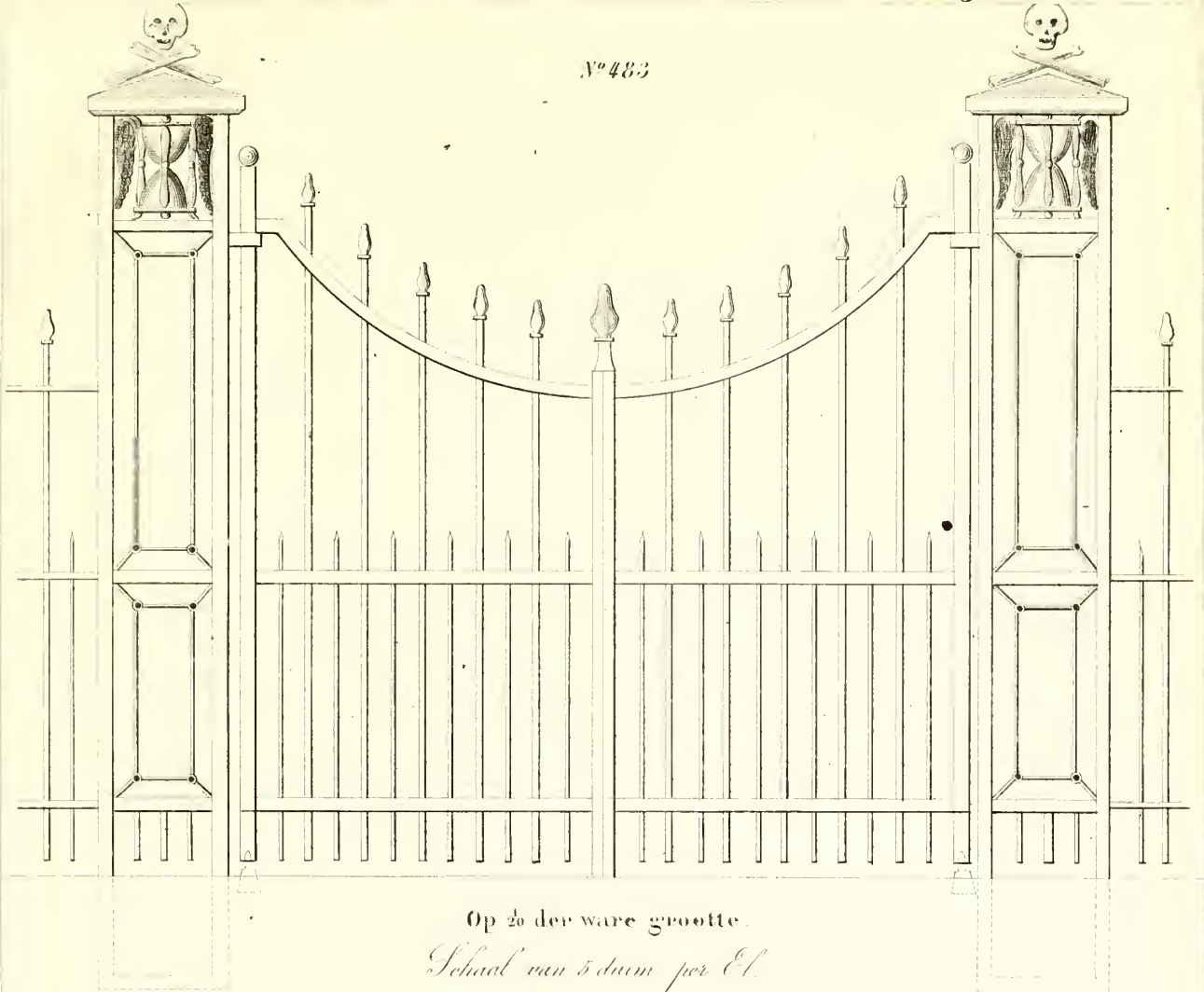

Op $\frac{1}{2}$ der ware grootte.

Schaal van 5 duim per El.

Nota.

- Kolommen (geconiceerd) Diam. 0,10 El. (3 $\frac{1}{2}$ Amst. duim)
- Groote spijlen 0,022 " (7 $\frac{1}{2}$ " ")
- Kleine " 0,016 " (5 $\frac{1}{2}$ " ")
- Regels zwaar 0,022 - 0,05 " (2 x 7 $\frac{1}{2}$ " ")
- Hoofdstijlen zwaar 0,05 - 0,05 " (2 x 2 " ")
- Schoor van gesmeed yzer 0,032 - 0,032 " (1 $\frac{1}{2}$ x 1 $\frac{1}{2}$ " ")

N^o 484

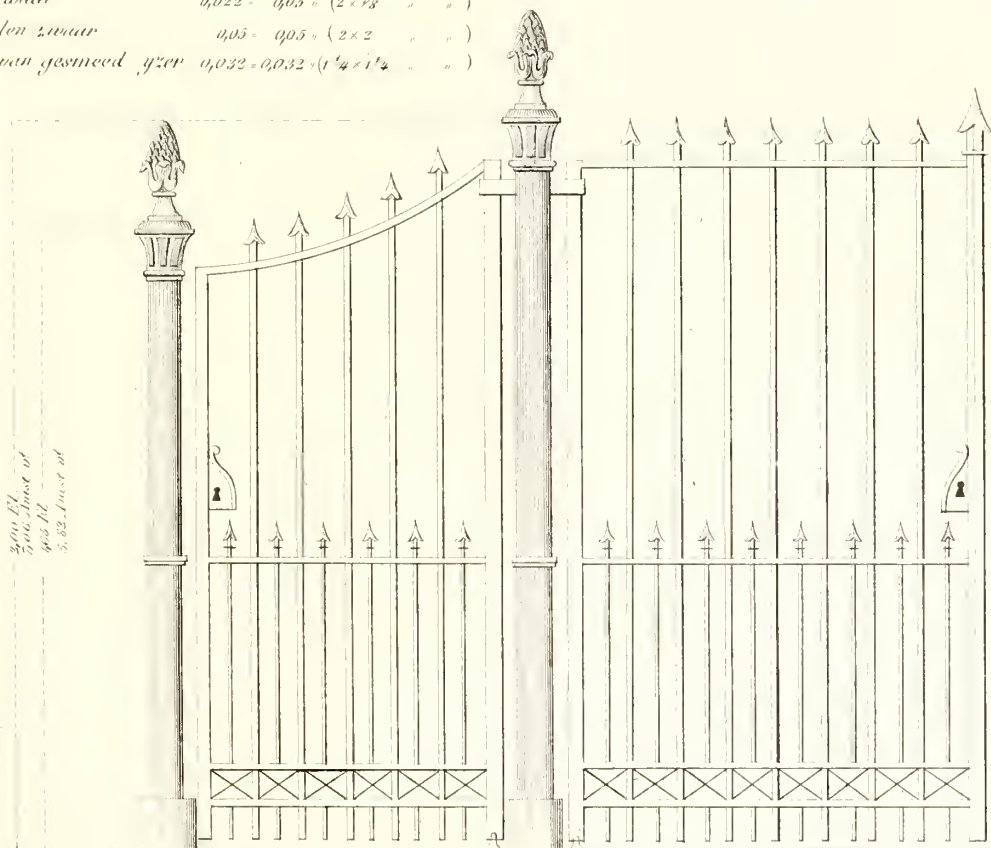

2,00 El.
 2,00 Amst. duim
 4,00 El.
 3,82 Amst. duim

4,00 El.
3,82 Amst. duim

1,25 El.
1,17 Amst. duim

Op $\frac{1}{2}$ der ware grootte.

Schaal van 5 duim per El.

Fabriek van Bronswerken van *Becht en Dyserinck.*

N^o 485

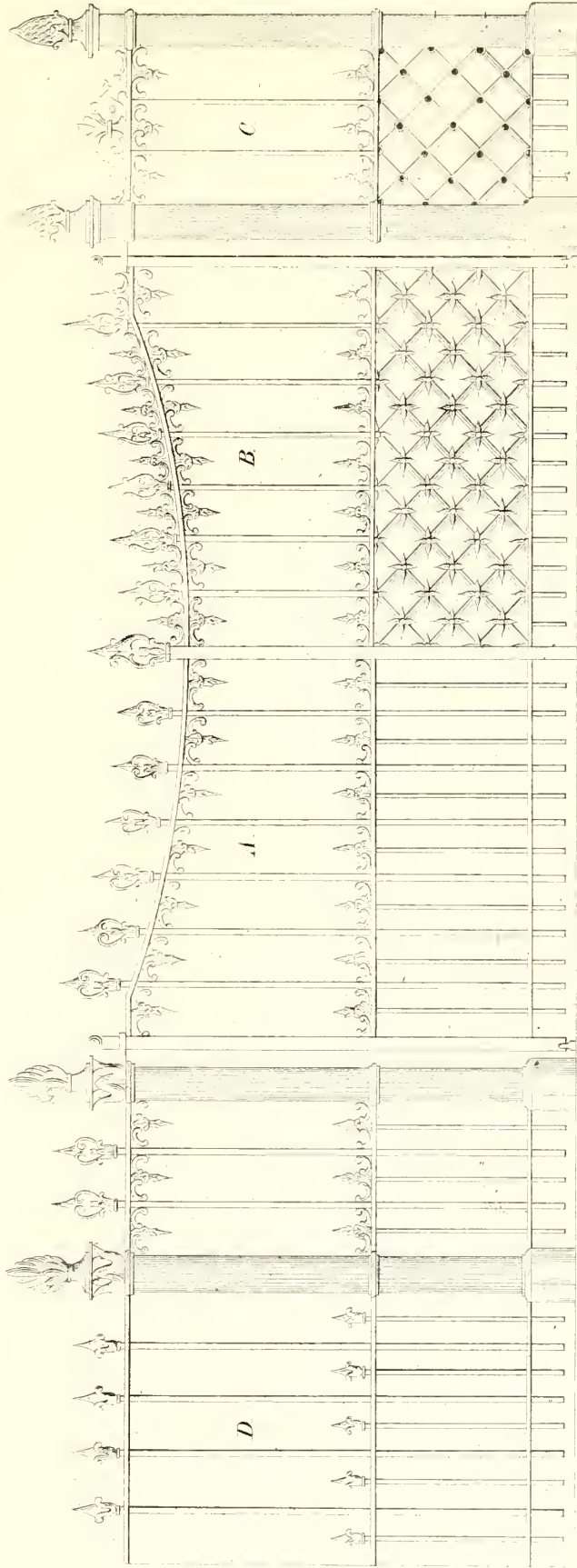

Op 26 der ware grootte

Schaal van 5 duim p^r El.

Fabriek van Bronswerken van *Becht en Dyserinck.*

N^o 486

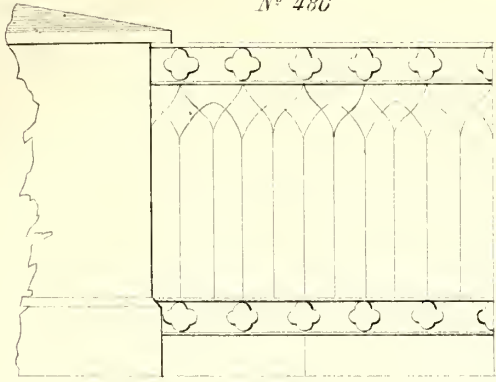

20 w g.

N^o 487

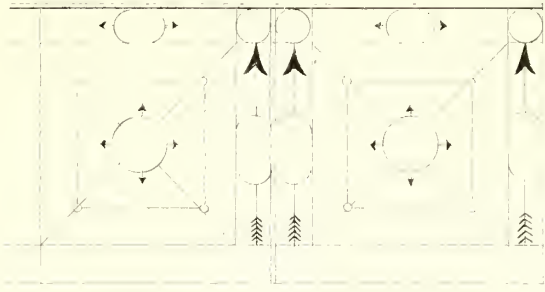

20 w g.

N^o 488

N^o 489

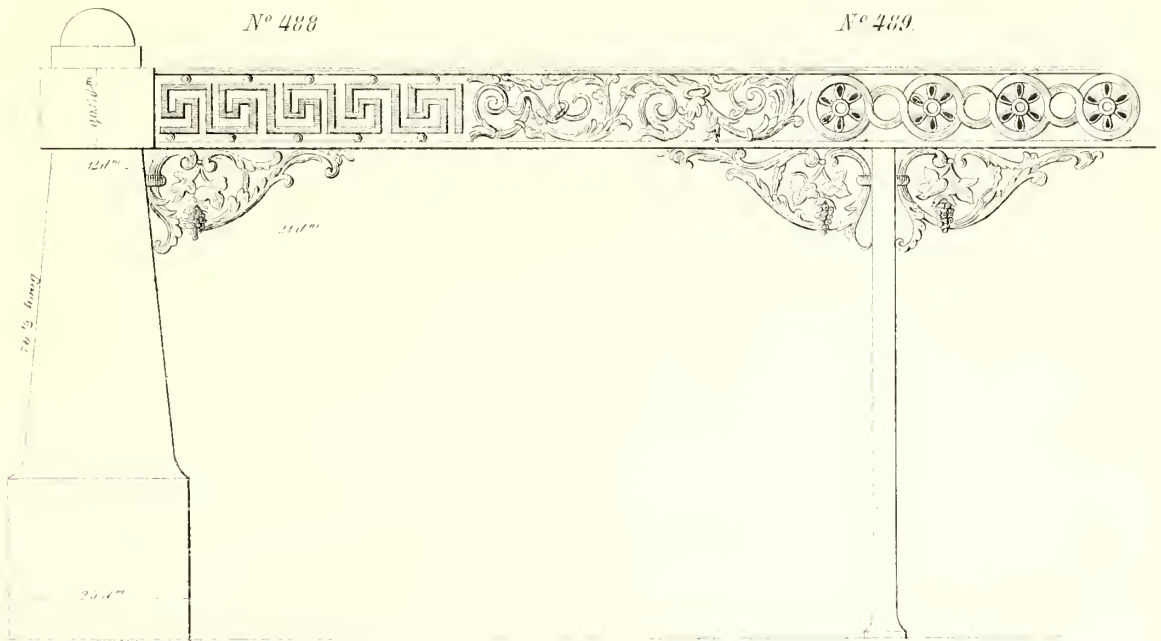

N^o 490

N^o 491

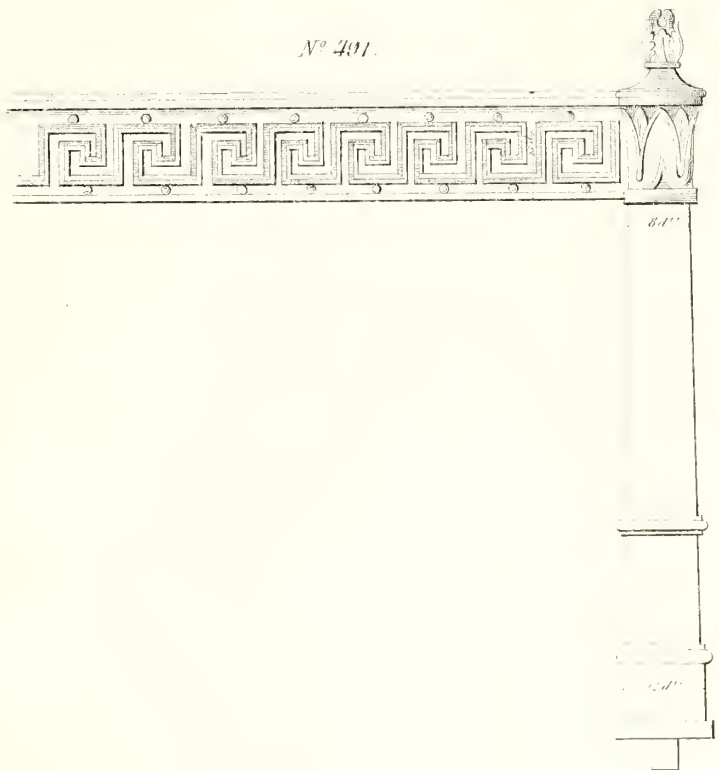
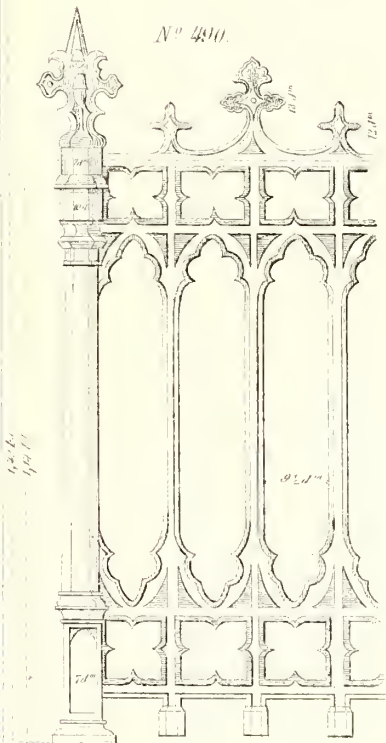

Becht en Dyserinck

Fabriek van Bronswerken van *Becht en Dyserinck*.

N^o 492.

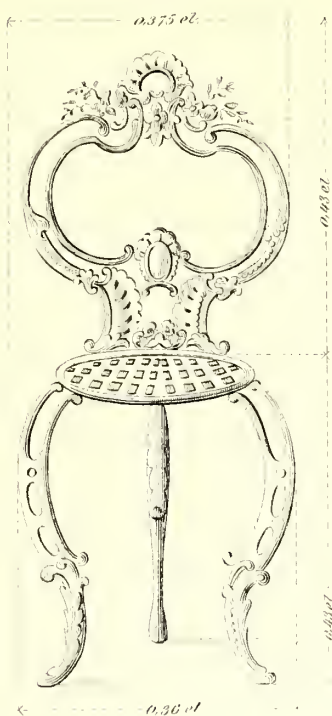

N^o 493.

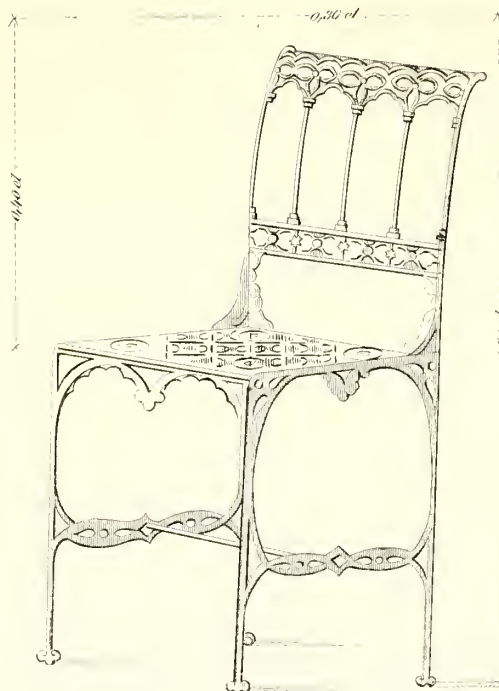

N^o 495

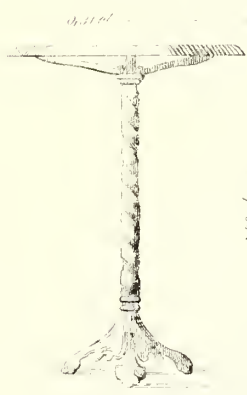

N^o 494

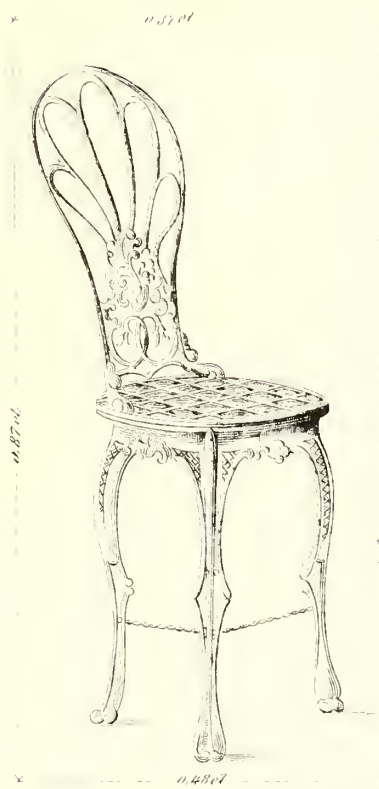

N^o 496.

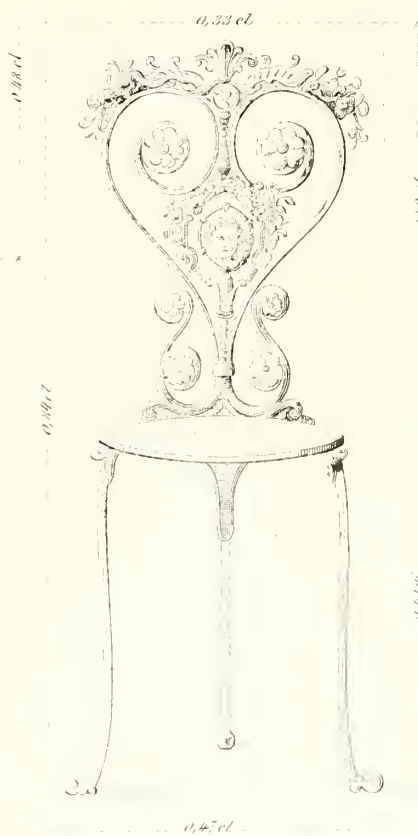

Fabriek van Bronswerken van *Becht en Dyserinck*.

Men kan deze pomp naar verkiezing met of zonder ornament overkrygen, als ook de uitwatering des verkiezende in het lozengeedele der pomp.

N^o 497

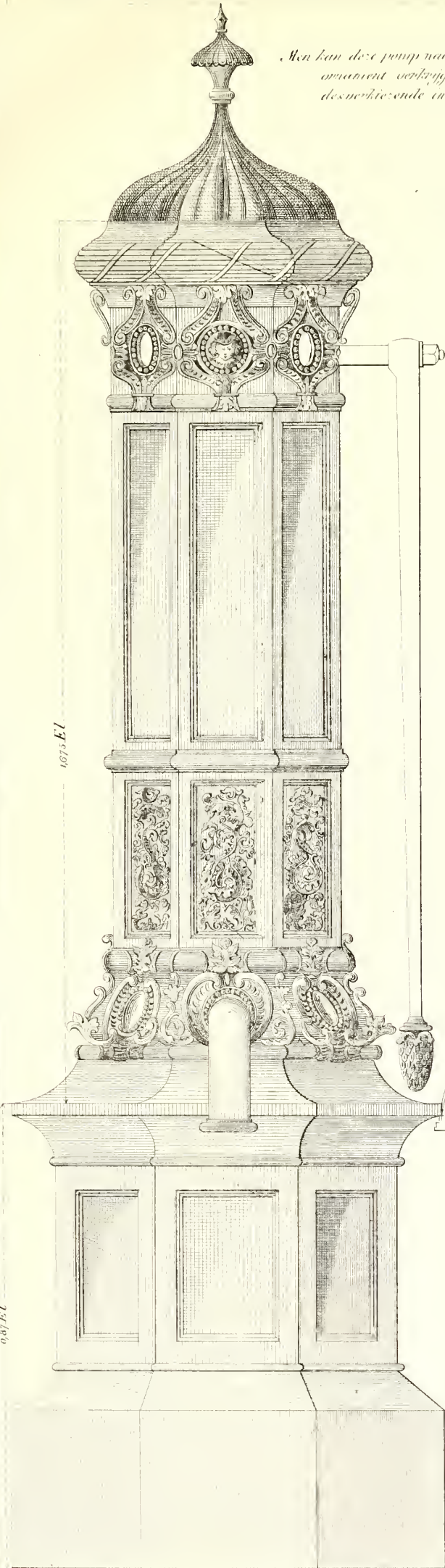

1075 EL

27/180

022 EL

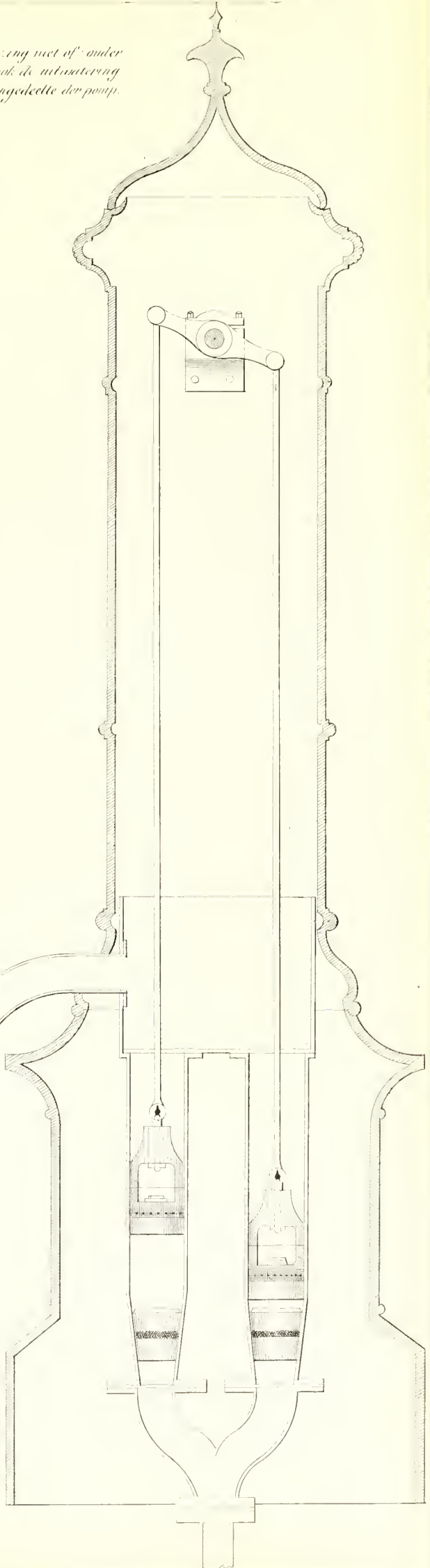

Fabriek van Bronswerken van *Becht en Dyserinck.*

N^o 498.

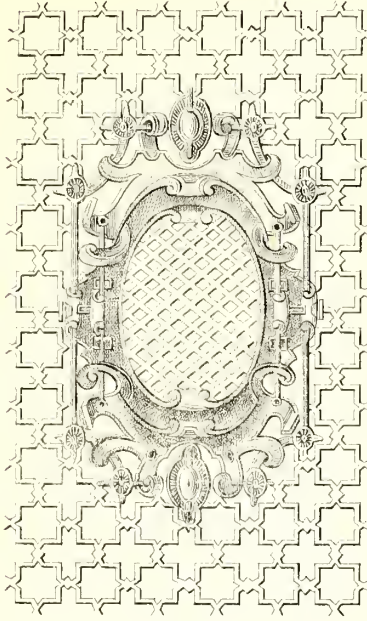

N^o 499

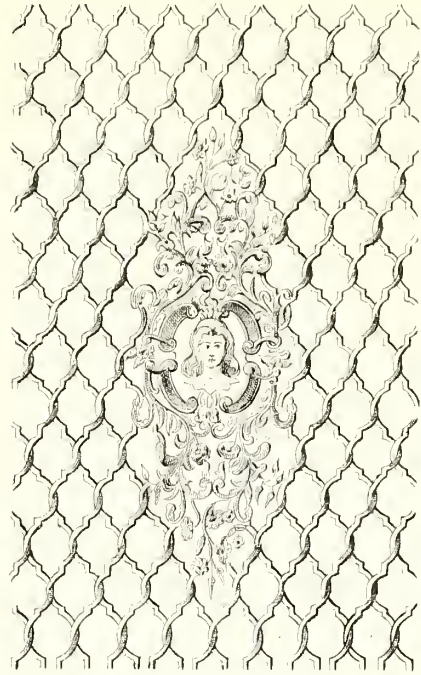
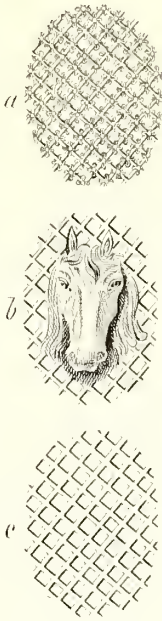

a

N^o 500.

N^o 3.

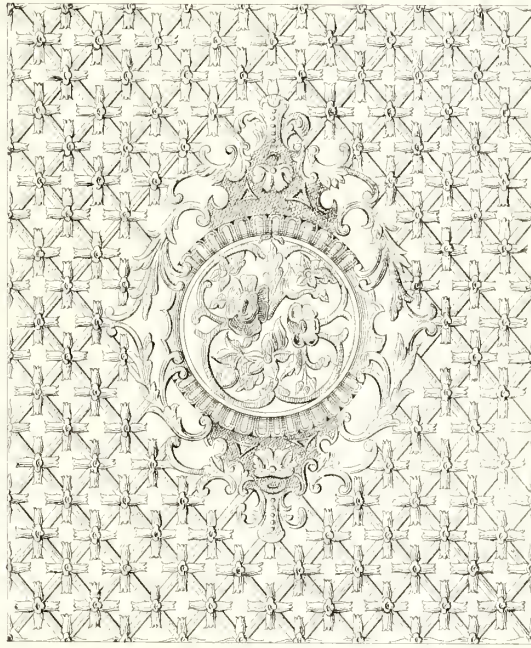

N^o 1.

N^o 4



N^o 2.

N^o 5.



N^o 502

N^o 501

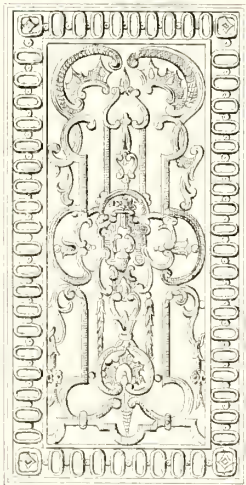

N^o 505



1,065 Fl.

0,25 Fl.

N^o 506.



1,222 Fl.

0,42 Fl.

N^o 503



0,25 Fl.

N^o 504

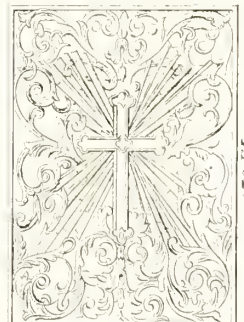

0,70 Fl.

0,20 Fl.

Fabriek van Bronswerken van *Becht en Dyserinck.*

N^o 508

0,71 El.

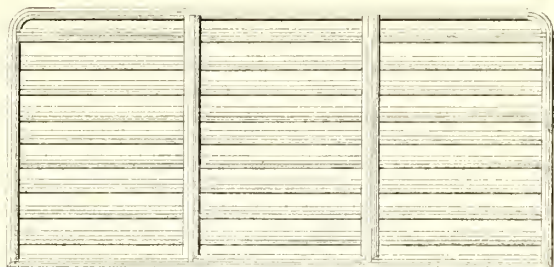

0,39 El.

N^o 507.

0,21 El.

0,39

0,31 El.

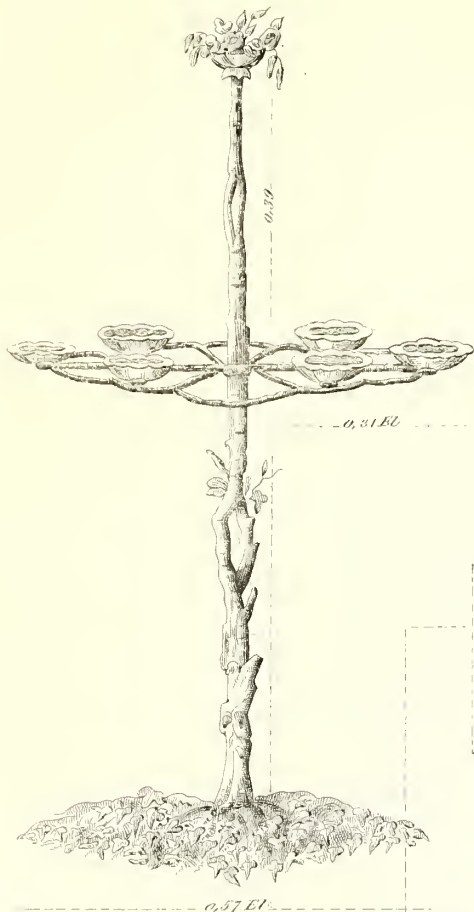

N^o 509.



0,19

0,23 El.

N^o 510.

0,42 El.

0,68 El.

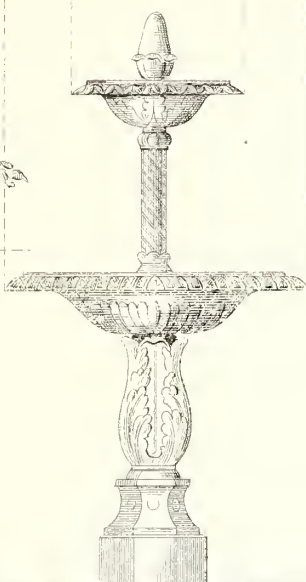

0,51

0,52

N^o 512.

0,16

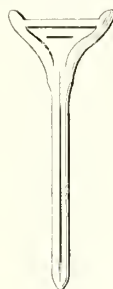

0,40 El.

N^o 511.

0,16 El.

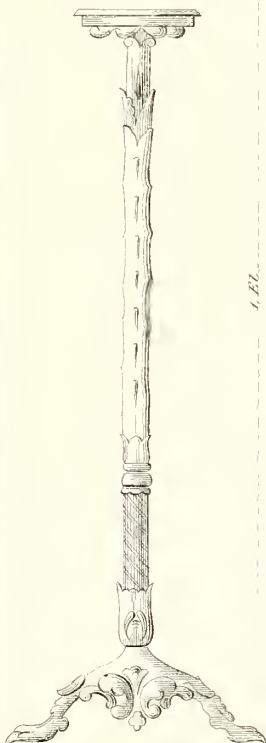

1 El.

1,06 El.

1,07 El.

N^o 513

0,21

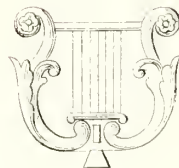

0,11 El.

N^o 514.

0,16



0,16

Fabriek van Bronswerken van *Becht en Dyserinck.*

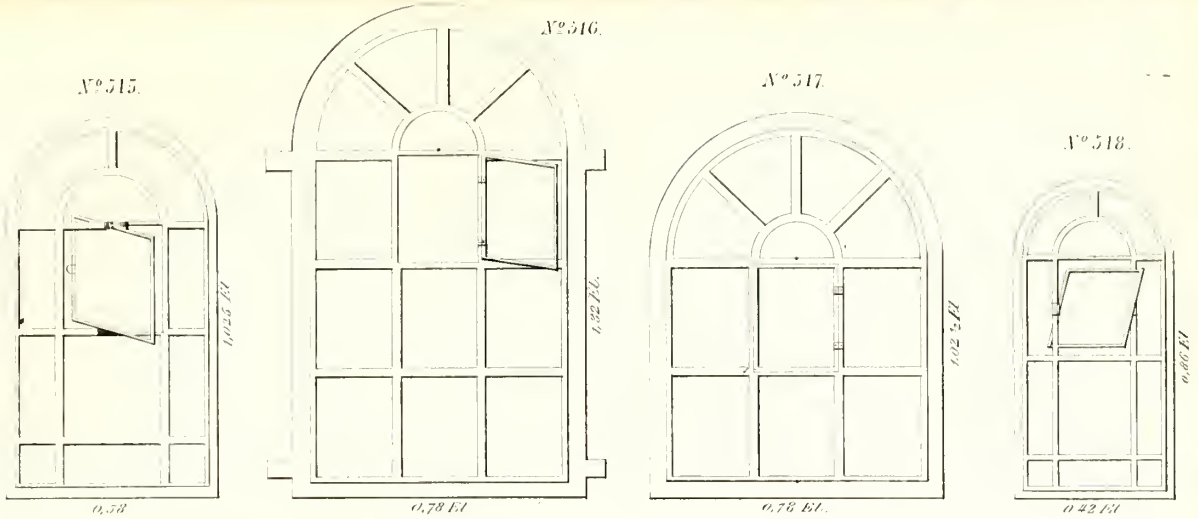

N° 519
tuimelend.

N° 521
rust

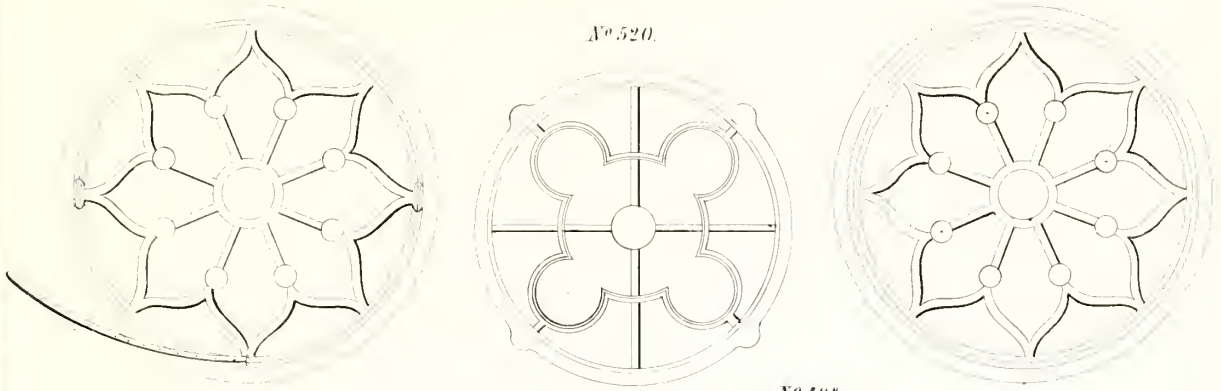

1,00 El

0,84 El

1,00 El

N° 522

N° 524

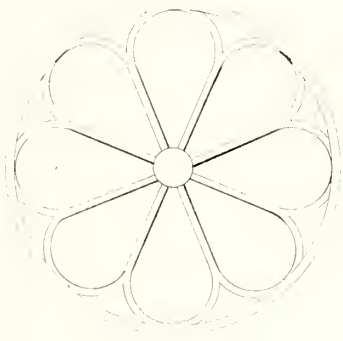

0,885 El

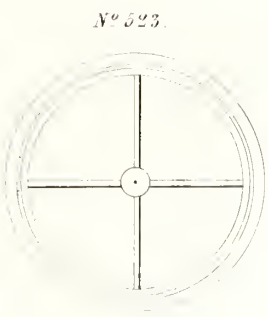

0,70 El



N° 525

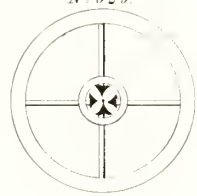

0,49 El

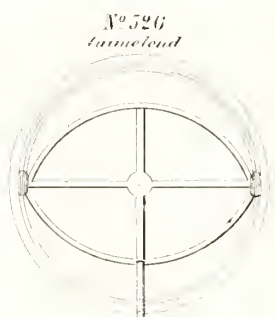

0,70 El

N° 526
tuimelend

N° 527

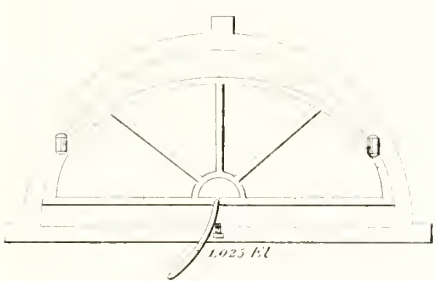

1,025 El

N° 528

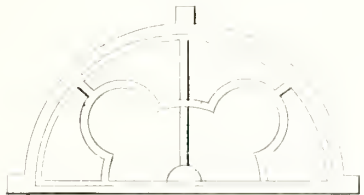

0,64 El

N° 529



0,84 El

N° 530

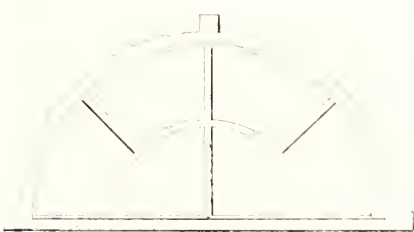

1,00 El

N° 531

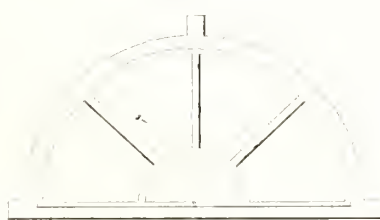

0,90 El

N° 532
tuimelend

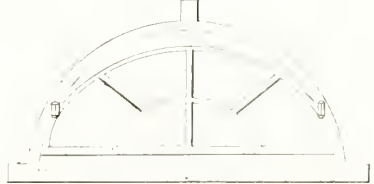

0,84 El

Fabriek van Bronswerken van *Becht en Dyserinck.*

N^o 533.

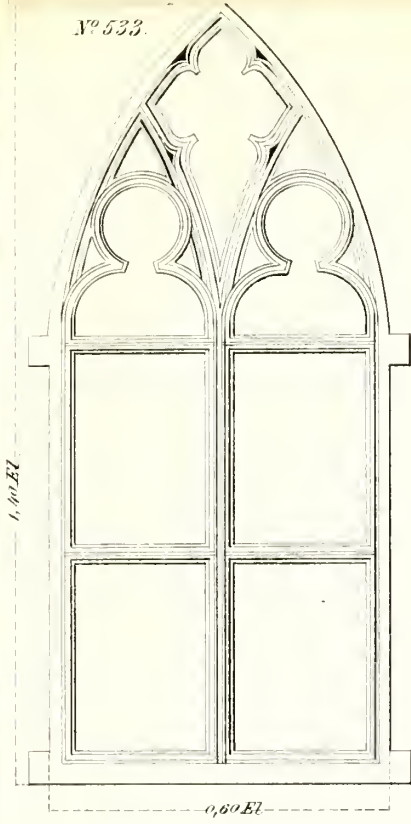

N^o 534

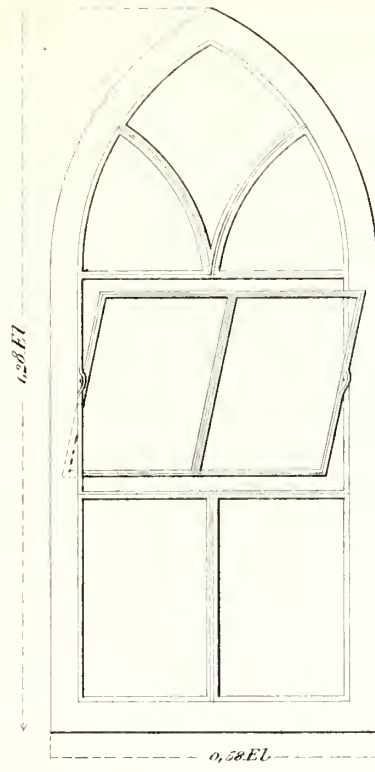

N^o 535

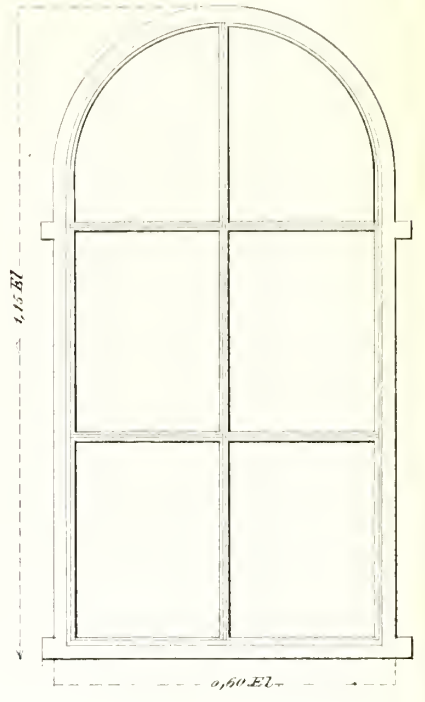

N^o 536.

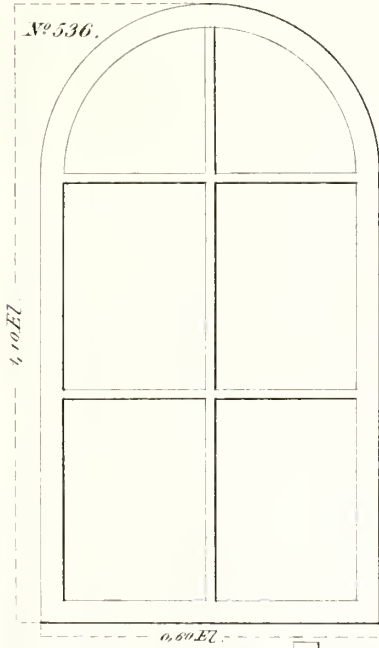

N^o 537

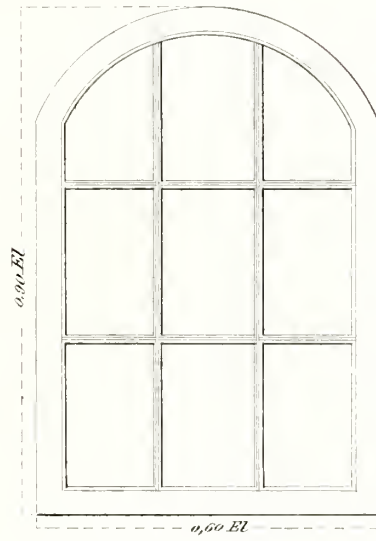

N^o 538.

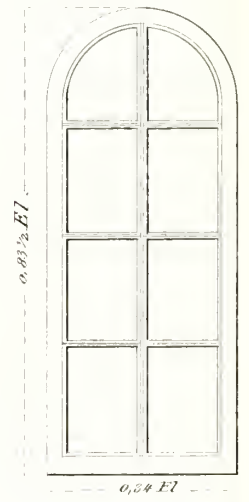

N^o 539

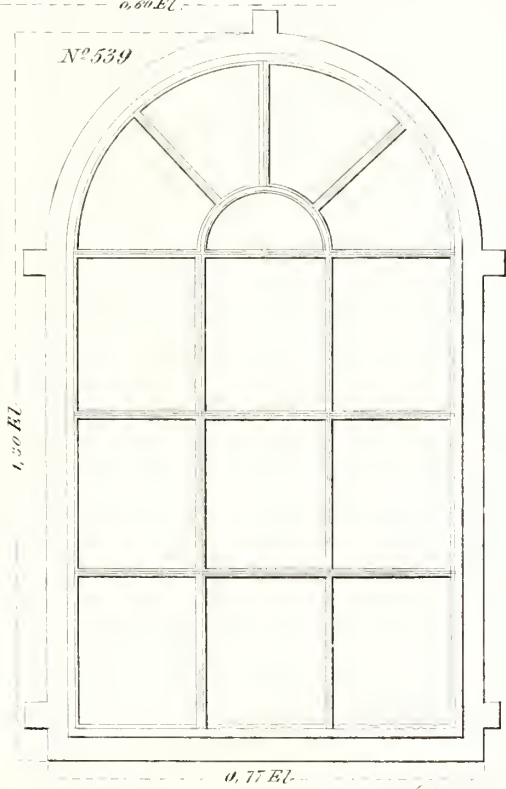

N^o 540
truncolend

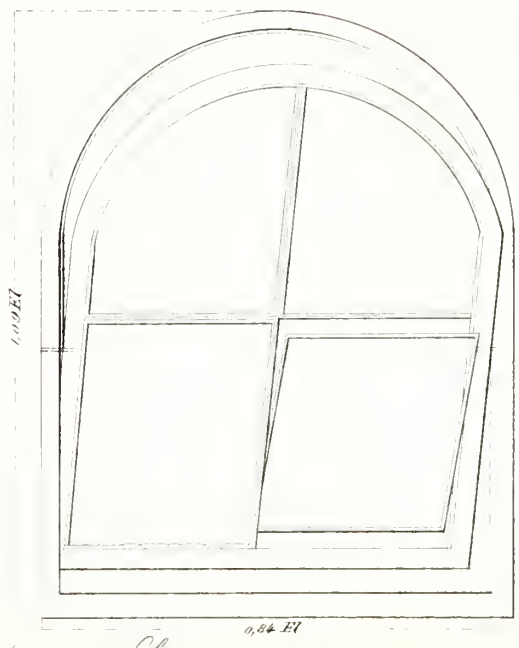

Getruud van 75 duime per EL

Fabriek van Bronswerken van *Becht en Dyserinck.*

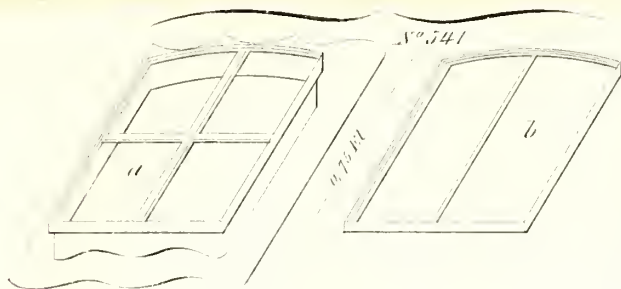

0,66 El
5 pannen

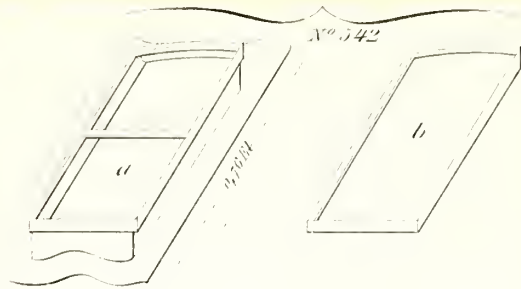

0,44 El
6 pannen

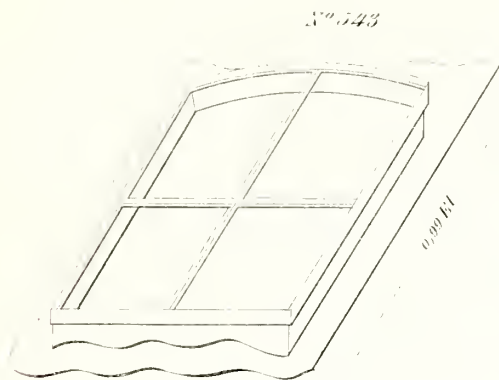

0,80 El
16 pannen

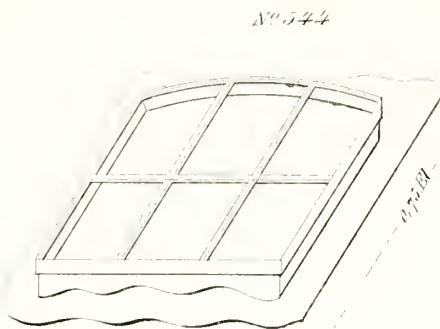

0,86 El
12 pannen

Men kan de open staande raampjes naar verbetering met laagje afgemaakte ruiten bestellen volgens tekening

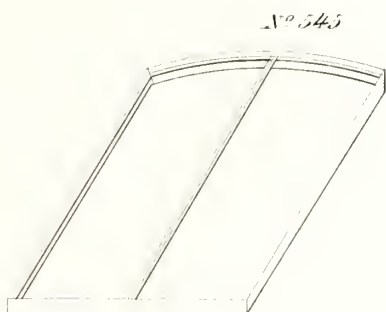

N^o 545

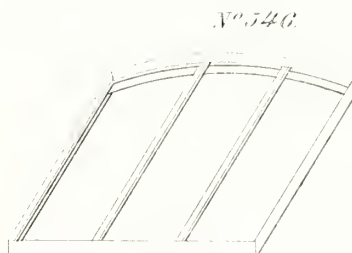

N^o 546

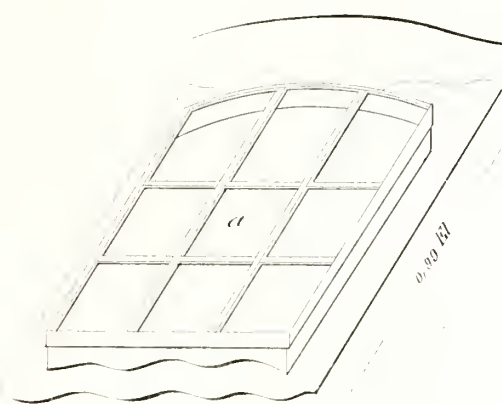

0,86 El
16 pannen

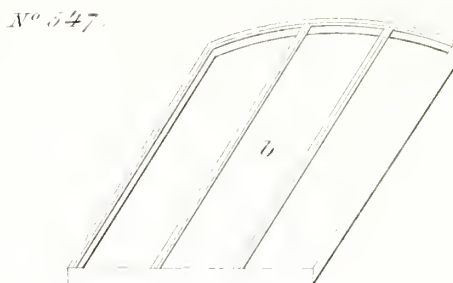

N^o 547

Dakramen gebruikelijk voor daken beled met Oostgeraatsche pannen

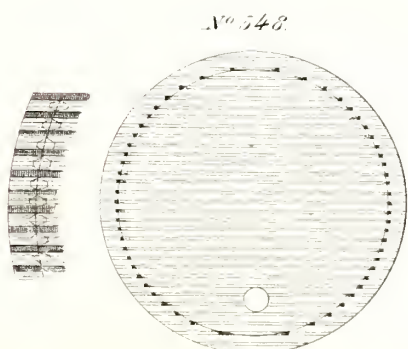

N^o 548

Rood kolk

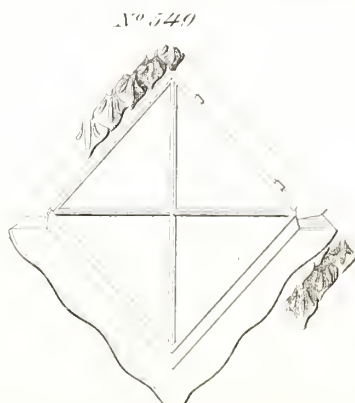

N^o 549

Gehaakt naar ontwerp per H. 10 30 6

Fabriek van Bronswerken van *Becht en Dyserinck.*

N^o 550.

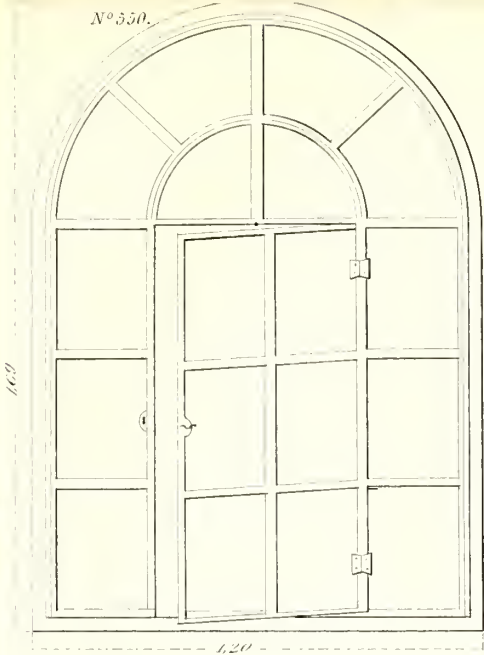

N^o 551.

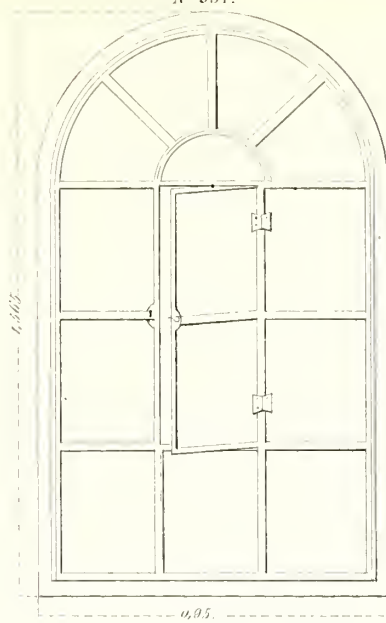

N^o 552.
tuinleud

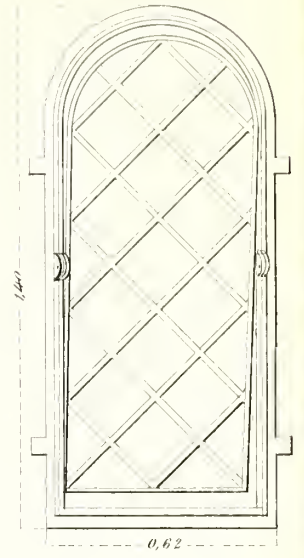

N^o 553. *tuinleud*

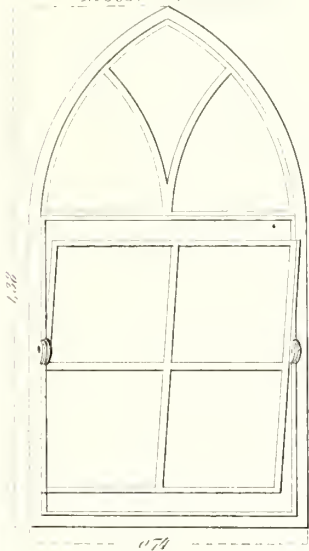

N^o 554

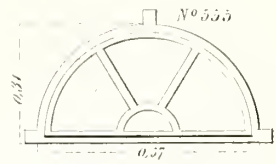
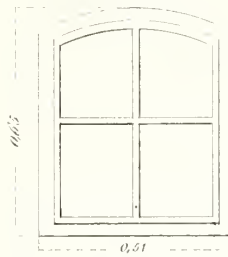

N^o 557 *tuinleud*

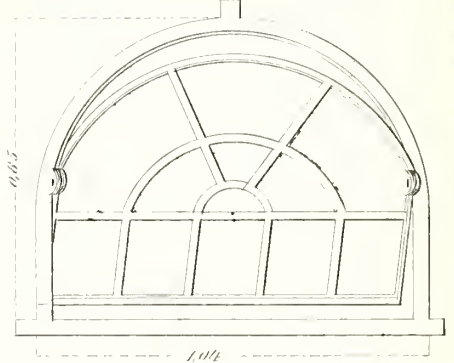

N^o 556.

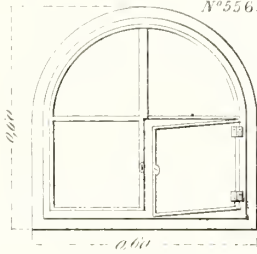

N^o 558

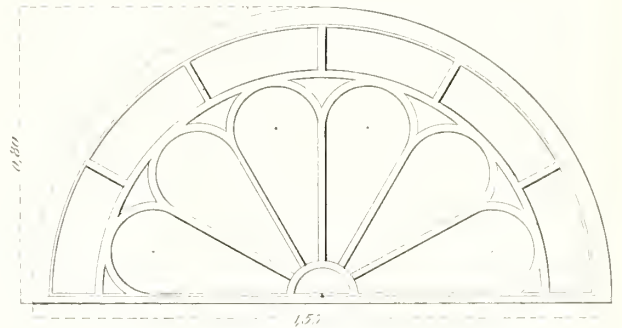
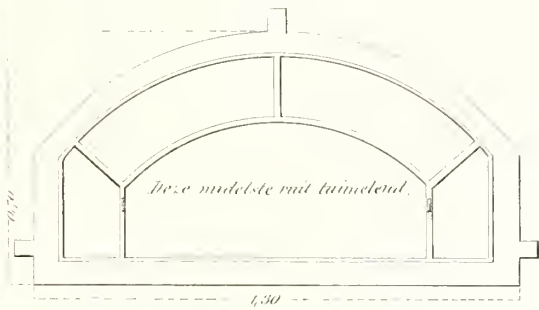

N^o 560.

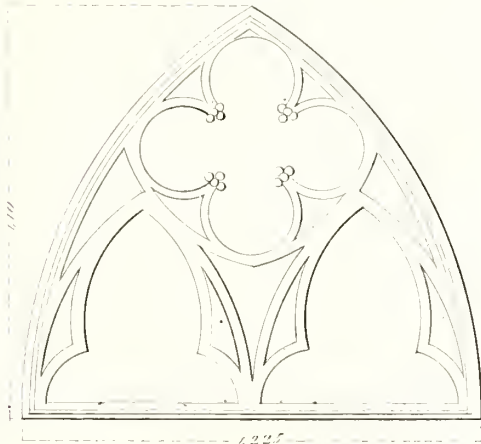

N^o 561.

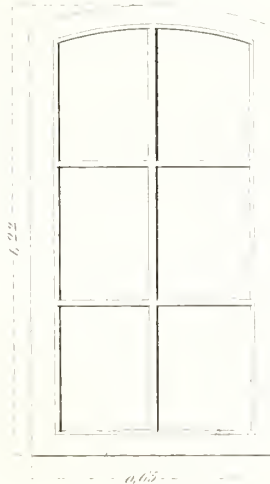

N^o 562

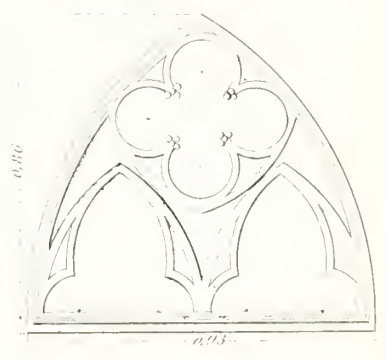

Schaal van 5 daarn per El of 120 W.G.

Fabriek van Bronswerken van *Becht en Dyserinck.*

N^o 564

N^o 565

N^o 563

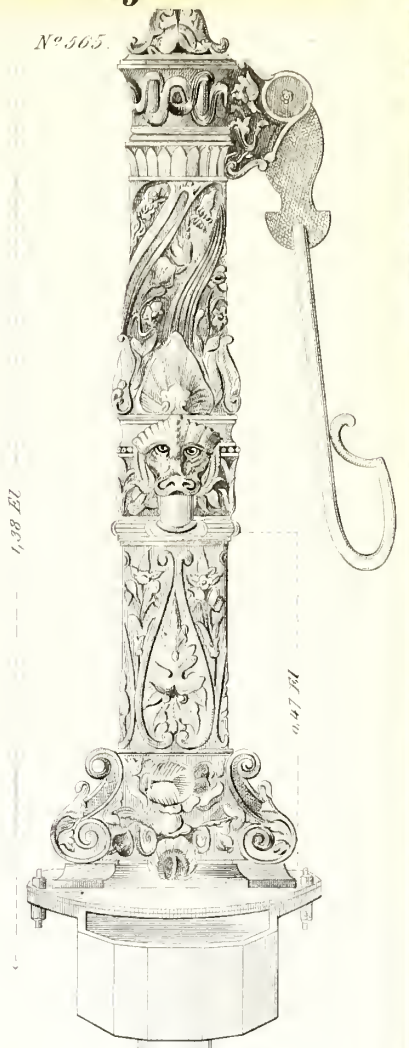
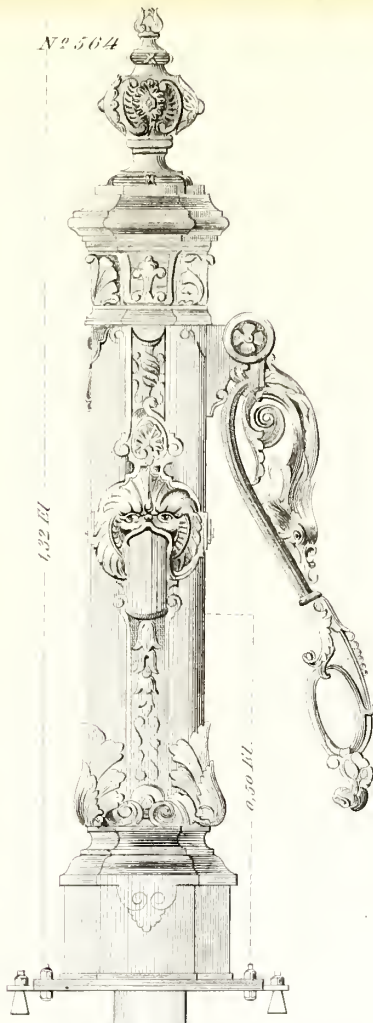
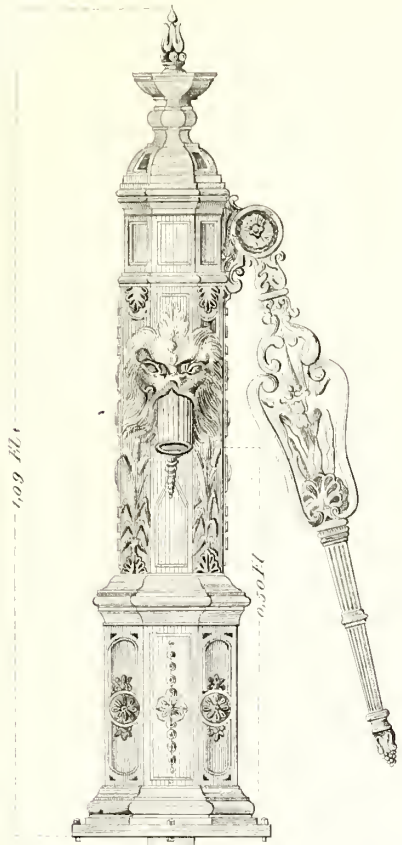

N^o 567

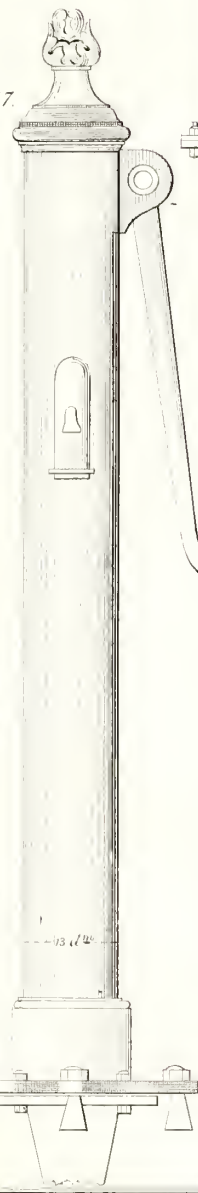

N^o 568

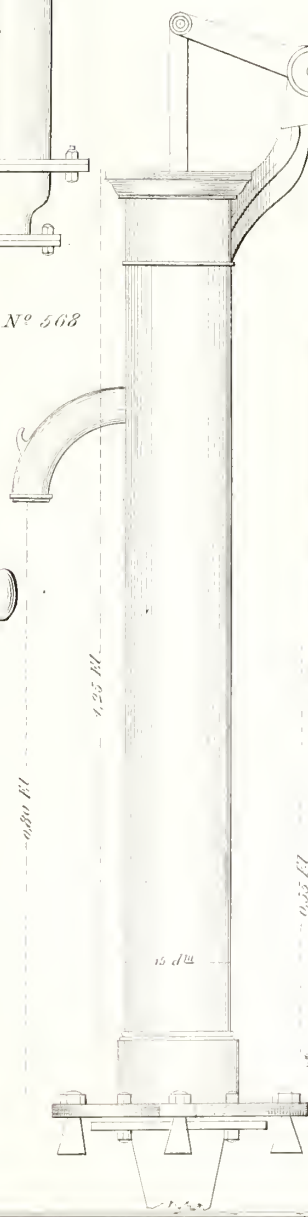

N^o 566

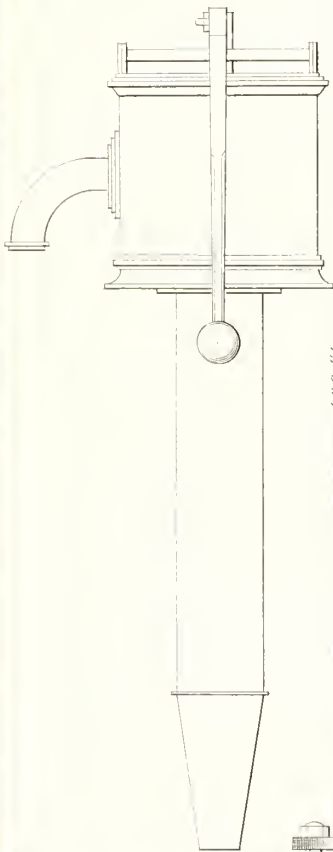

N^o 569

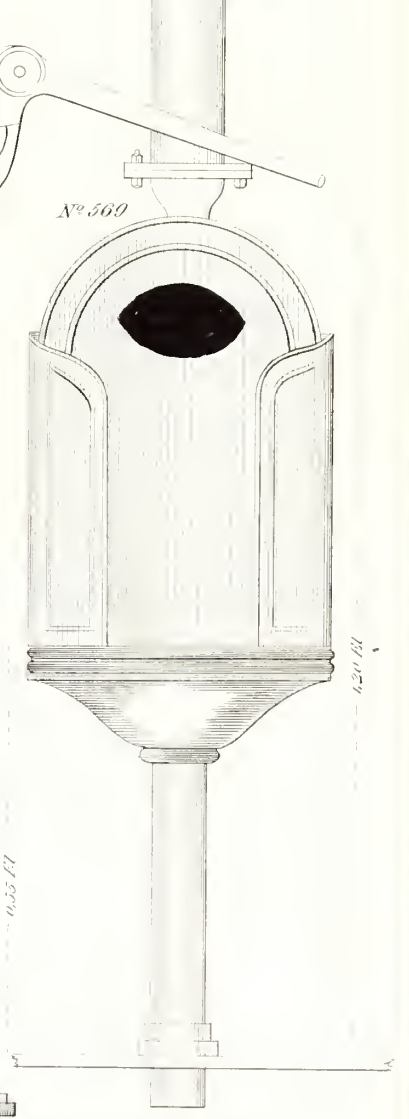

Schaal 20 mm per El.

Des werkende einde met een half ronden raaster

N^o 570

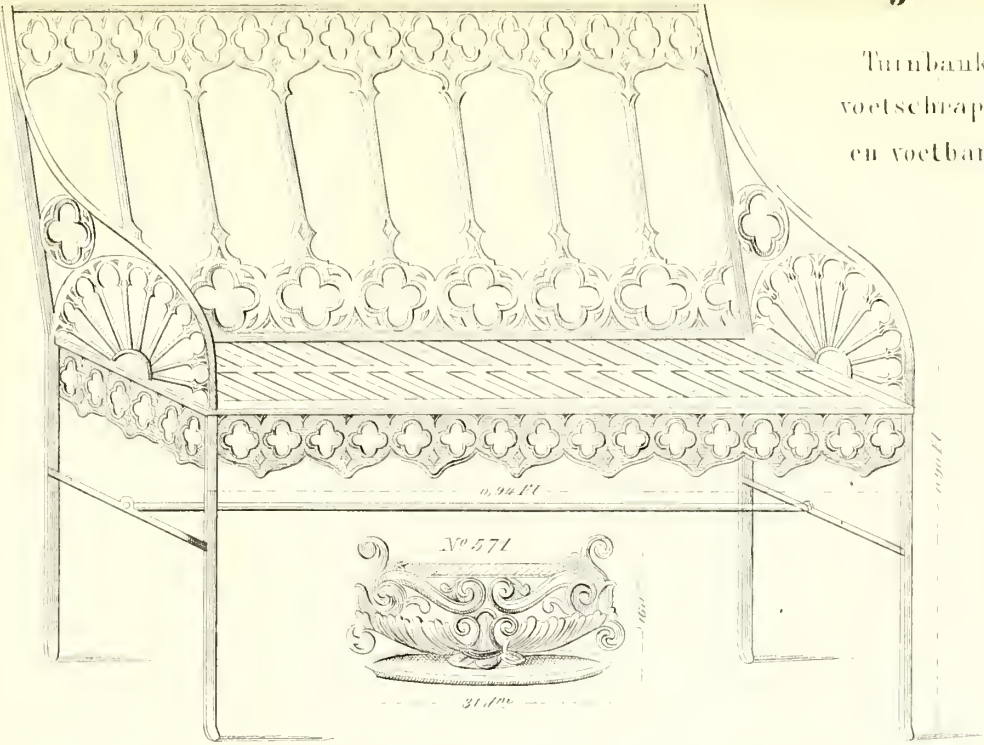

Turnbanken
voetschrappers
en voetbankje.

N^o 571

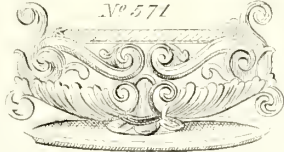

0,85 El

N^o 572

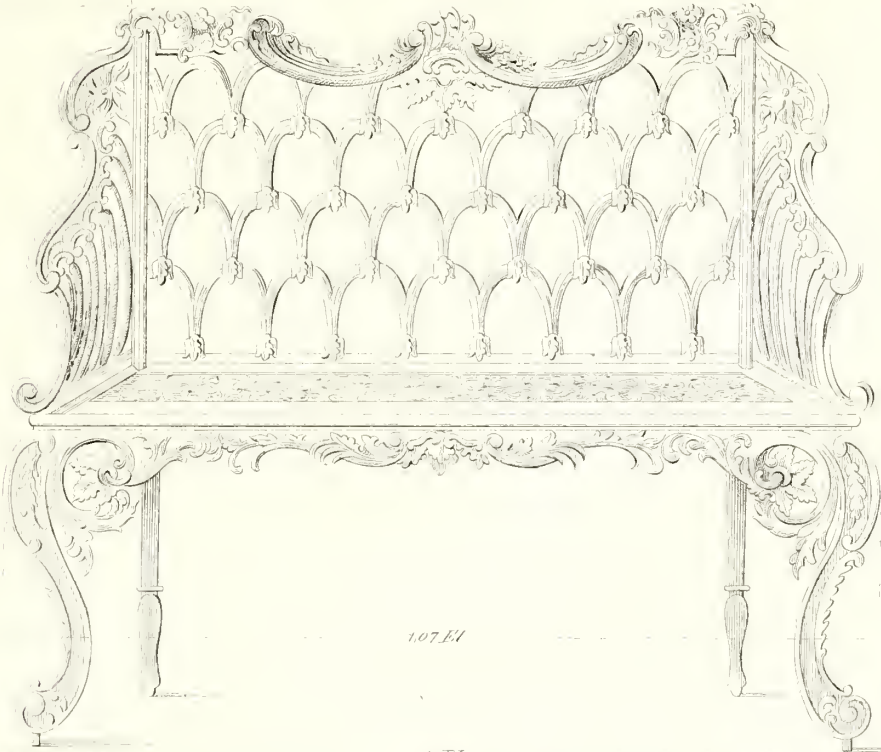

1,07 El

N^o 573

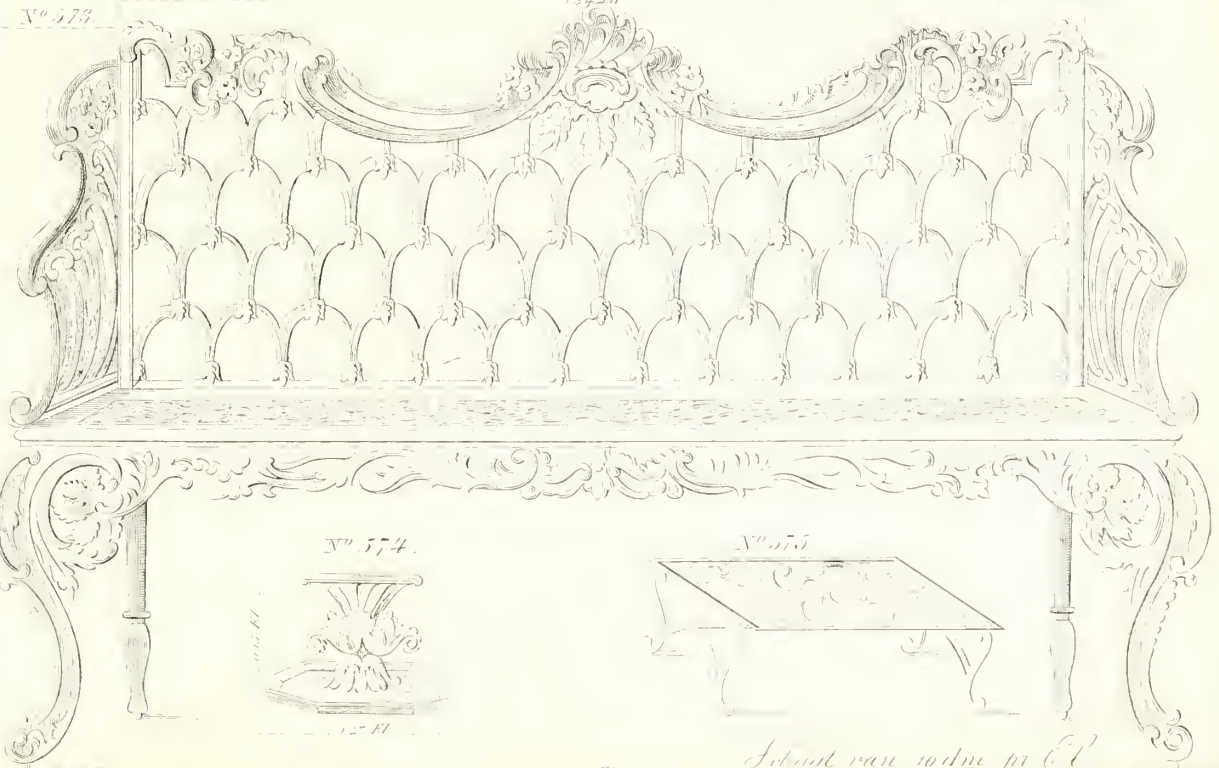

N^o 574



N^o 575



1,50 El

Schout van indne pr C^o

Fabriek van Bronswerken van *Becht en Dyserinck*.

0,90 Fl

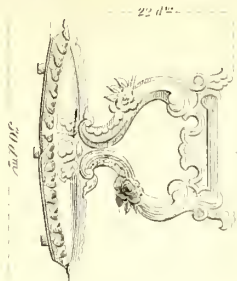

N^o 579.

22 d^m

30 d^m

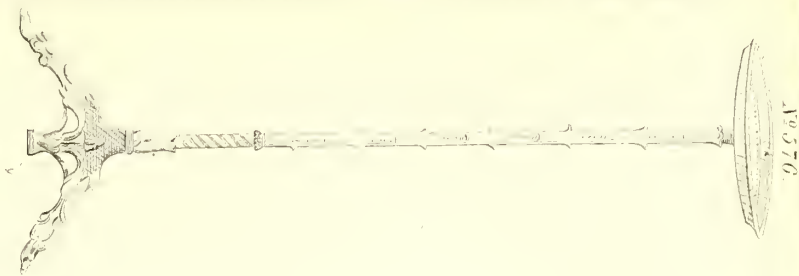

N^o 576.

0,62 Fl



N^o 580.

2 Ellen

0,53 Fl

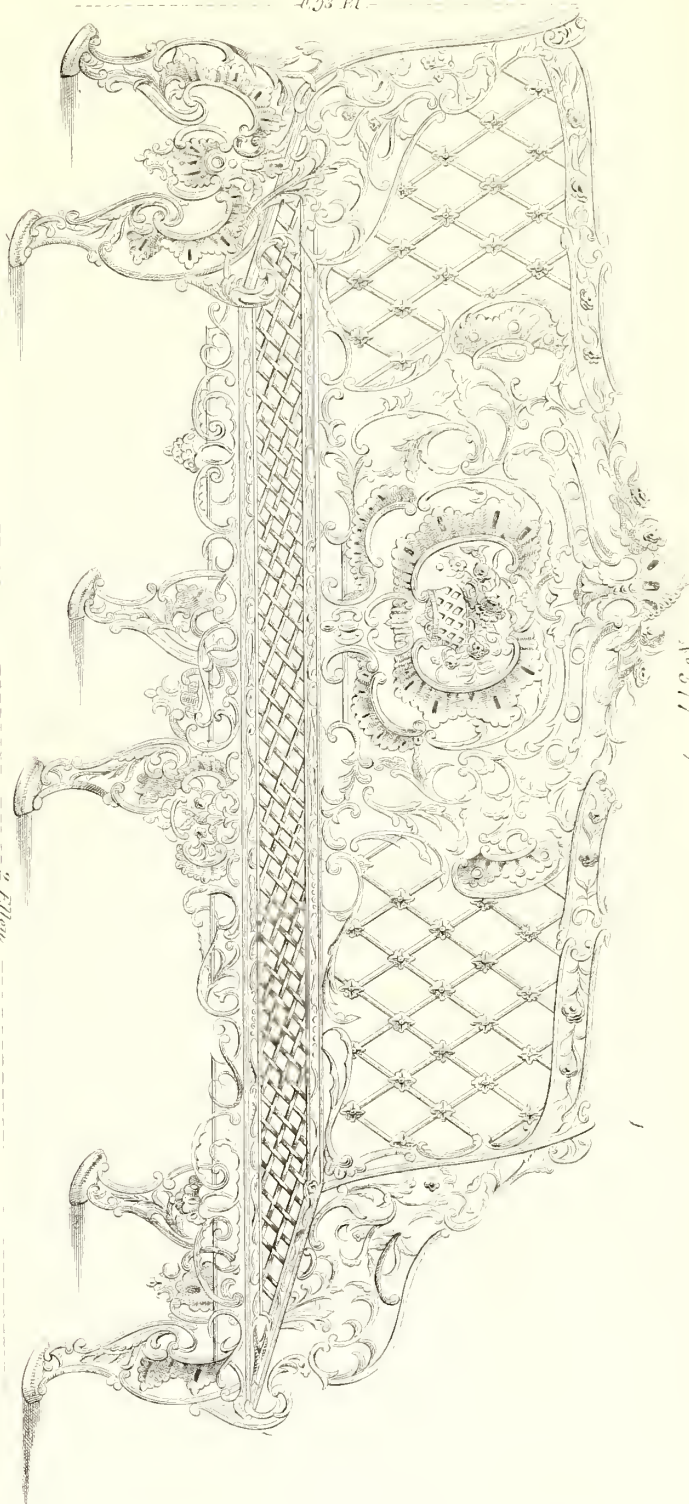

N^o 577

Deze raambanken op een schuif van 7,5 d^m per Fl en de andere raambanken op 40 of 50 d^m per Fl.

2 Ellen

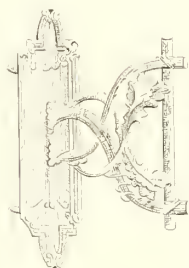

N^o 581.

22 d^m

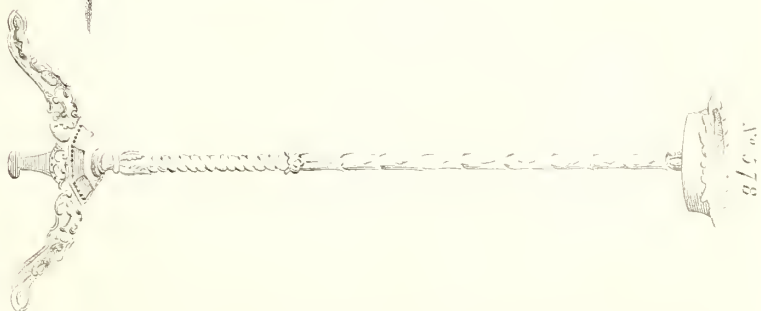

N^o 578

0,96 Fl

22 d^m

Fabriek van Bronswerken van *Becht en Dyserinck.*

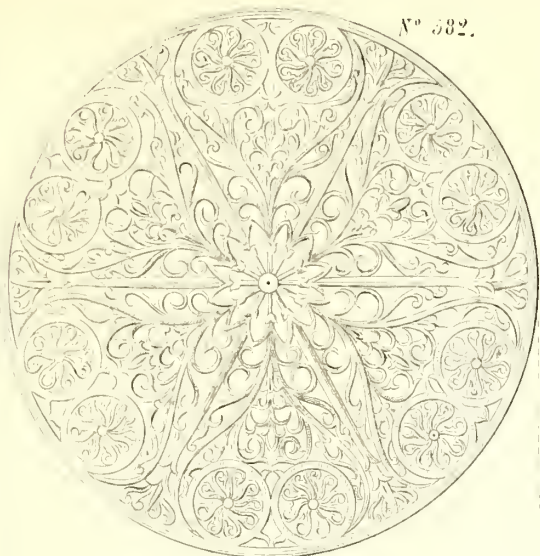

N^o 582.

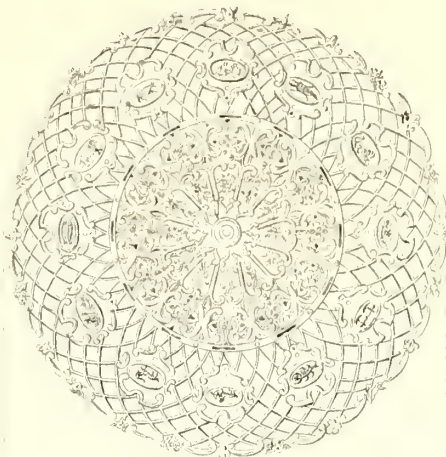

N^o 583

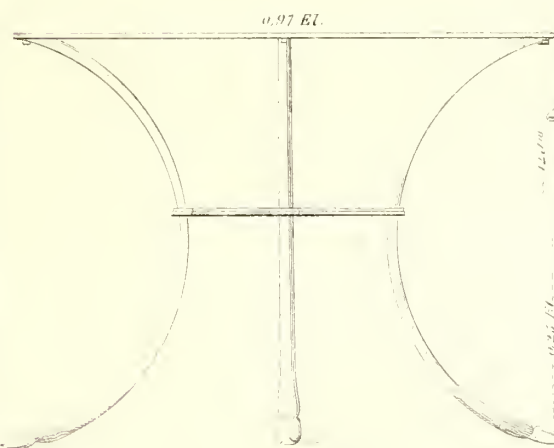

0,97 El.

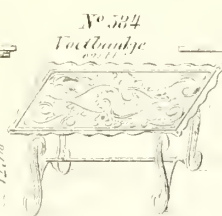

N^o 584
Voetbankje

12,50

0,25 El.



Voetocjer

N^o 585

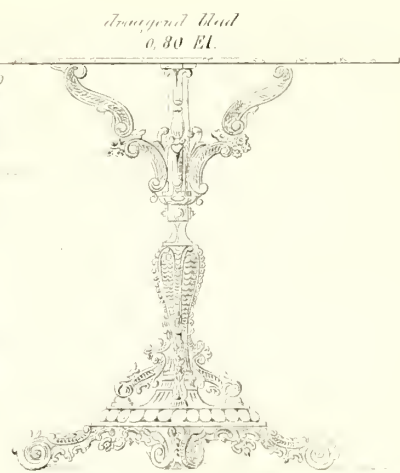

draagend blad
0,80 El.

0,75 El.

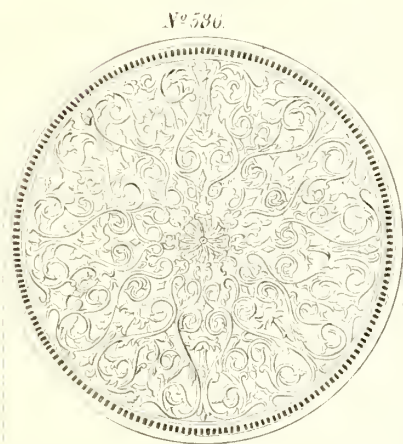

N^o 586

op-laand blad

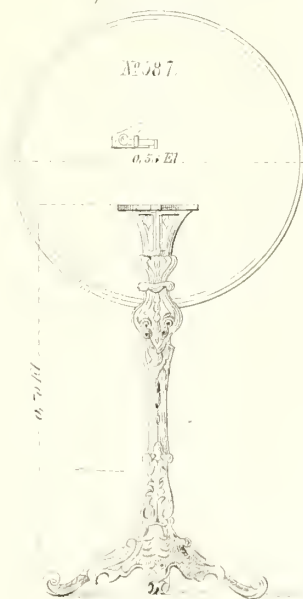

N^o 587

0,5 El.

0,70 El.



N^o 588

0,39 El.

0,33 El.

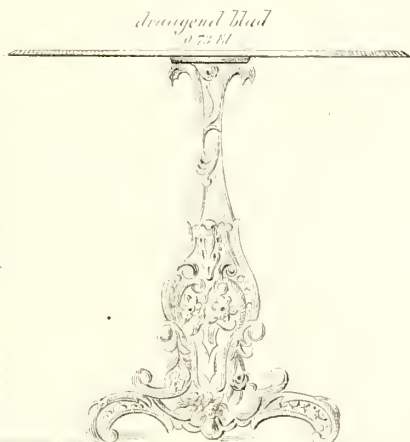

draagend blad
0,73 El.

0,50 El.

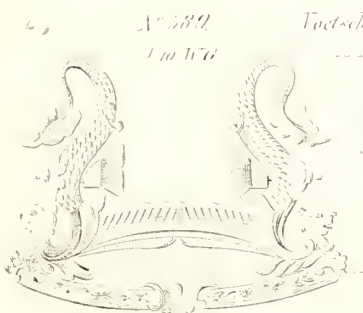

N^o 589
1,10 W 6

Voetschrappers



N^o 590
1,00 W 6

Deel van 1,50 El.

De voetschrappers op een schaal van 1,50 El.

Fabriek van Bronswerken van **Becht en Dyserinck.**

N^o 591

Tuintafels en Tabouretjes.

N^o 592

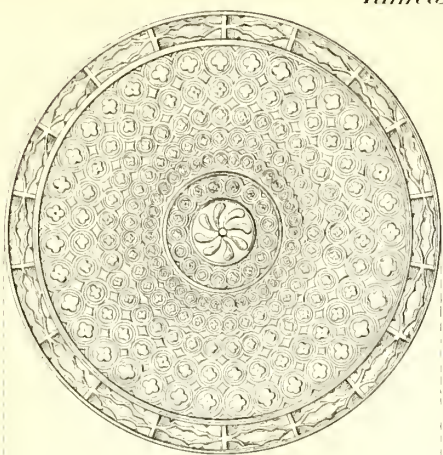

0,80 El.

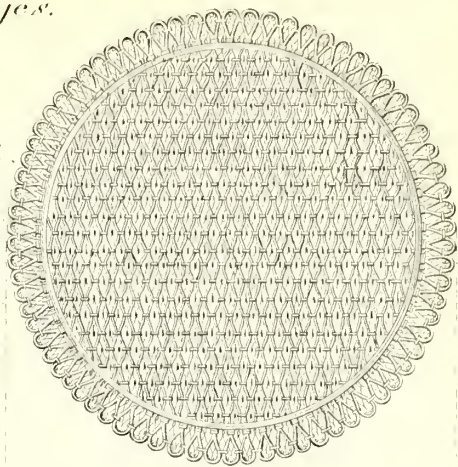

A
0,80 El.

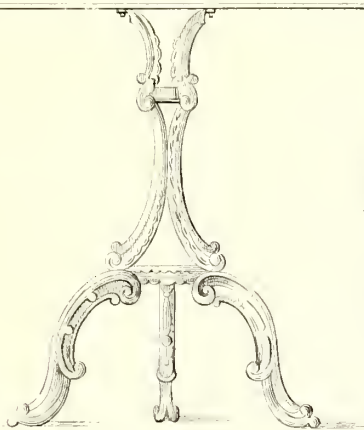

N^o 595
0,94 El.

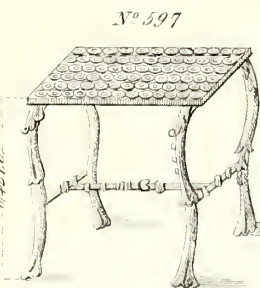

N^o 597



N^o 593
B
0,80 El.



N^o 596
0,99 El.

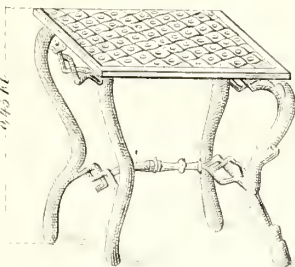

N^o 598



N^o 594
C
0,80 El.

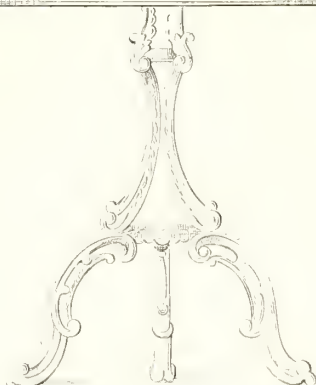
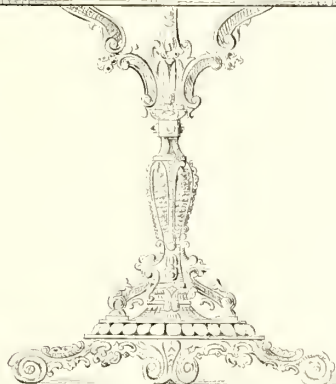

De voetstukken van N^o 595, 596 hebben het zelfde ornament van het blad als N^o 591

A, B, C. Behooren by het zelfde blad
Schaal van 7 1/2 duer El.

Fabriek van Bronswerken van *Becht en Dyserinck.*

N^o 599



0,73 El. A

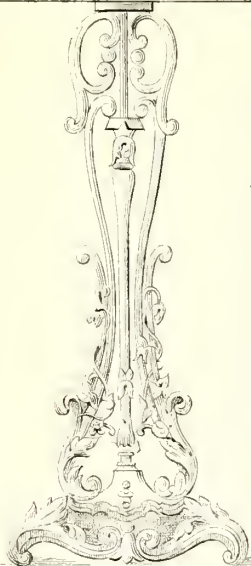

1,00 El.

A en B behooren by hetzelfde blad.

N^o 605
B

0,73 El.

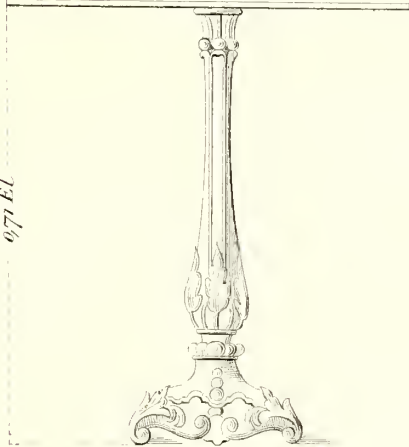

0,71 El.

N^o 606

0,44 El.

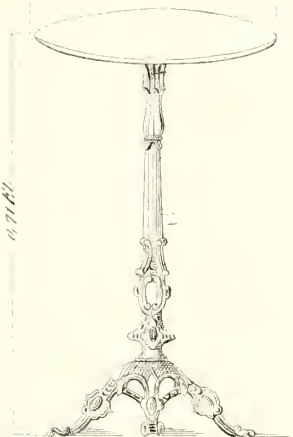

0,71 El.

Tuintafels.

N^o 600

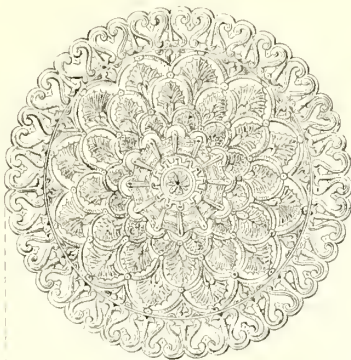

0,62 El.

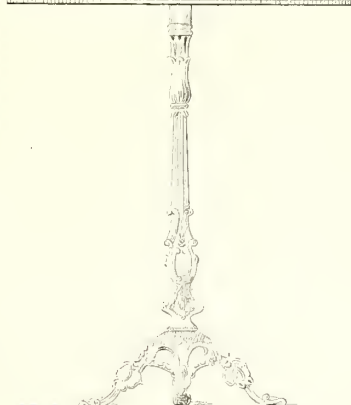

0,71 El.

N^o 601

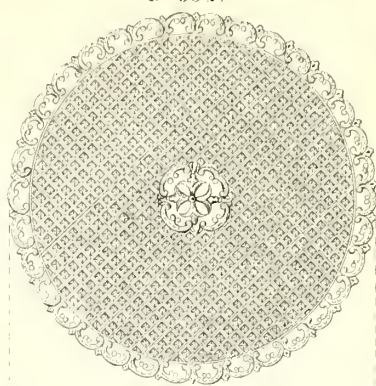

C

0,66 El.

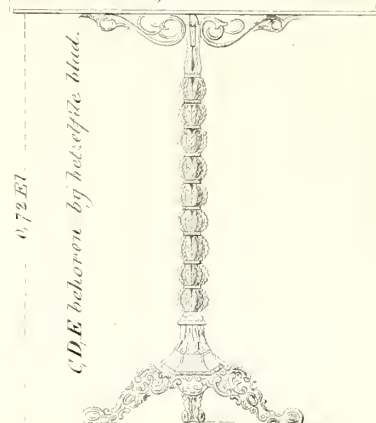

0,72 El.

C, D, E behooren by hetzelfde blad.

N^o 602
D

0,66 El.

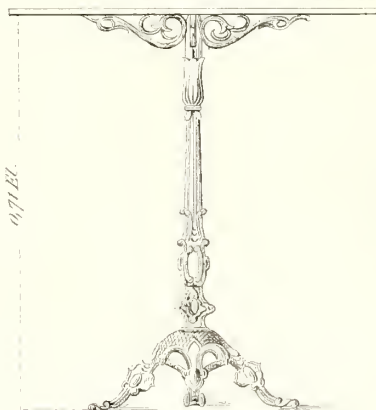

0,71 El.

N^o 604

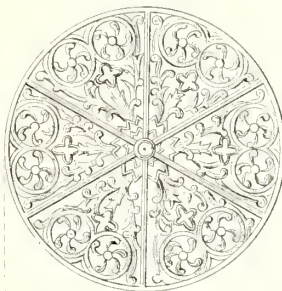

0,50 El.

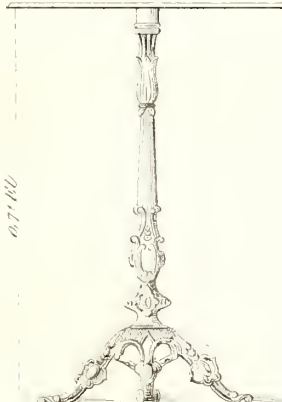

0,71 El.

N^o 603
E

0,66 El.

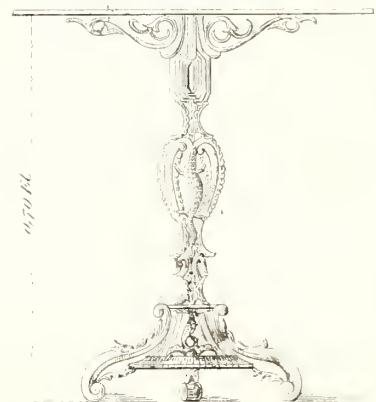

0,70 El.

Schaal 7,5 stuks per El.

Fabriek van Bronswerken van *Becht en Dyserinck*.

Paraplu en Kleerenstandaards.

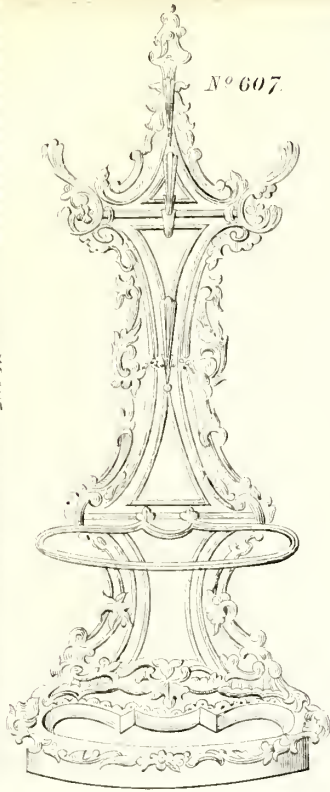

N^o 607.

2.15 Fl.

0.80 Fl.

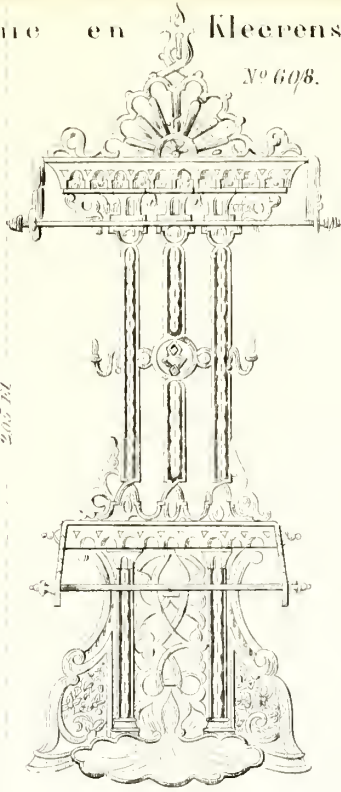

N^o 608.

2.05 Fl.

0.80 Fl.

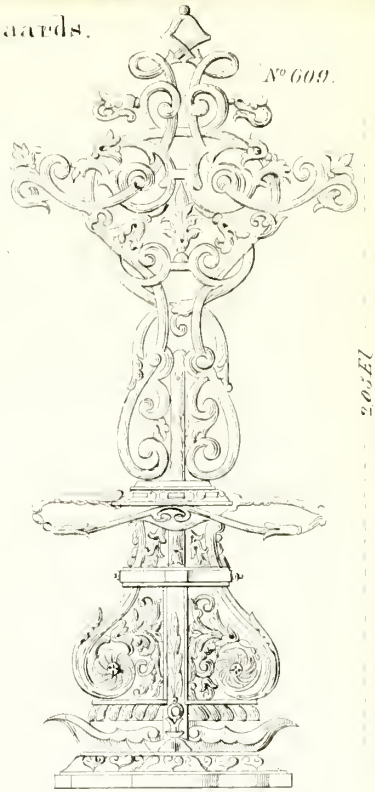

N^o 609.

2.05 Fl.

0.65 Fl.

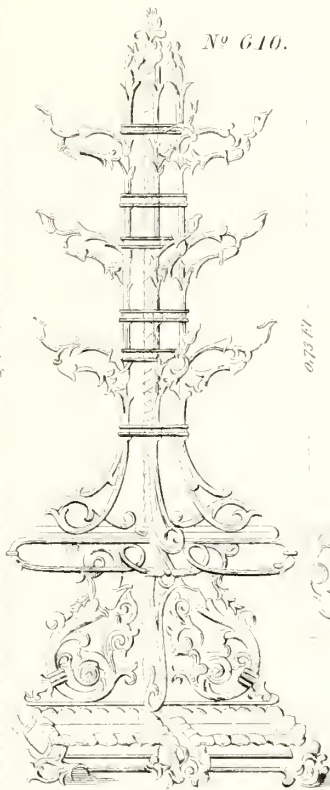

N^o 610.

2.10 Fl.

0.73 Fl.

0.77 Fl.

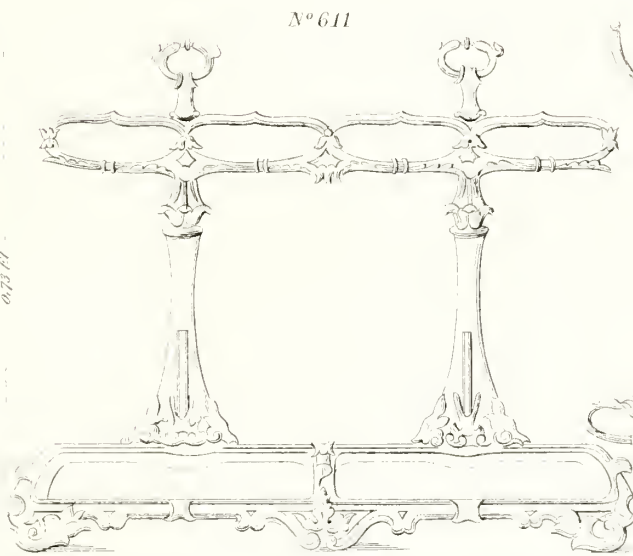

N^o 611.

0.87 Fl.

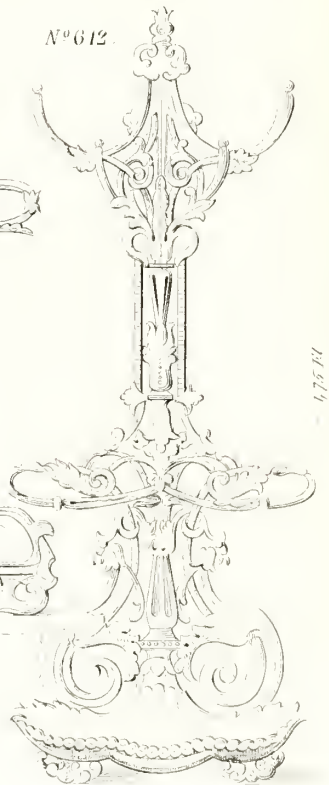

N^o 612.

1.75 Fl.

0.58 Fl.

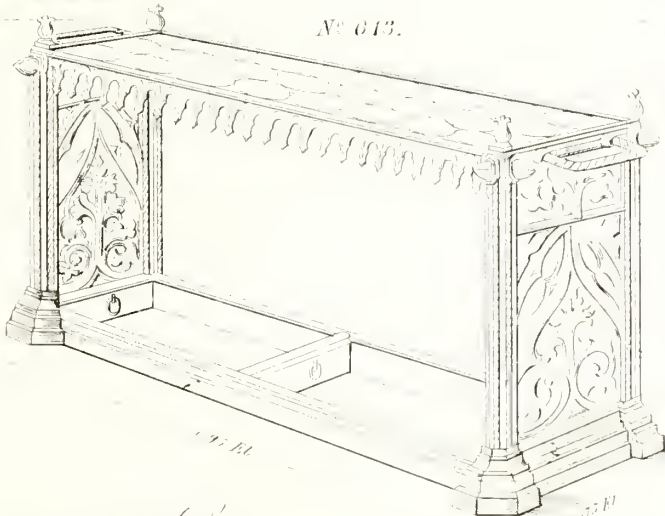

N^o 613.

1.10 Fl.

1.10 Fl.

0.75 Fl.

Gemaakt van 5 duim g. B.

Fabriek van Bronswerken van *Becht en Dyserinck.*

N^o 614

Tuintafel en bloemenstandaard.

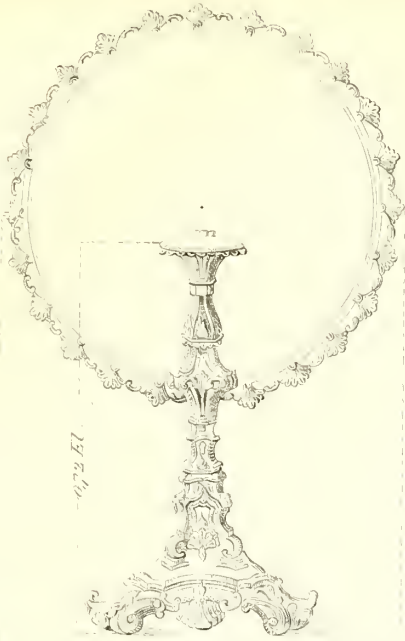

0,72 El.

0,72 El.

N^o 615

0,90 El.

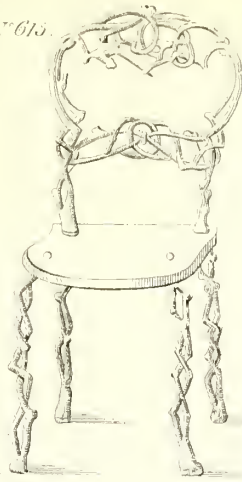

0,72 1/2 El.

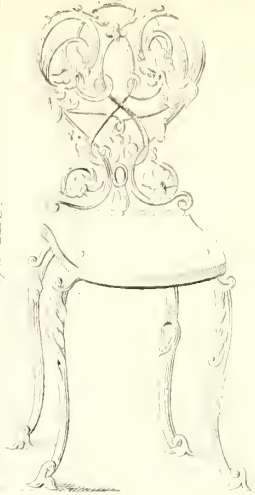

N^o 618

0,78 1/2 El.

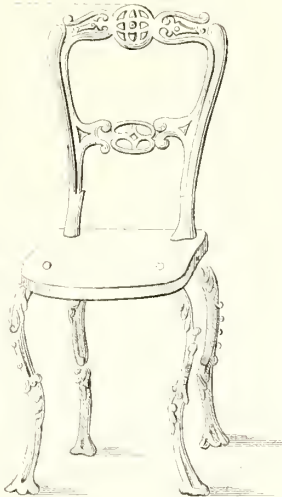

N^o 619

0,83 El.

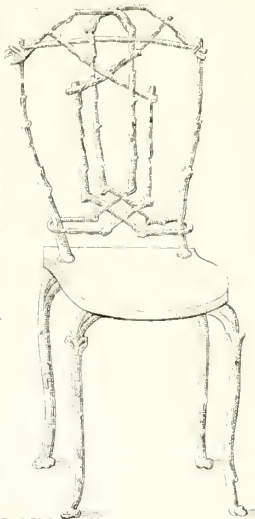

N^o 617

0,52 1/2 El.

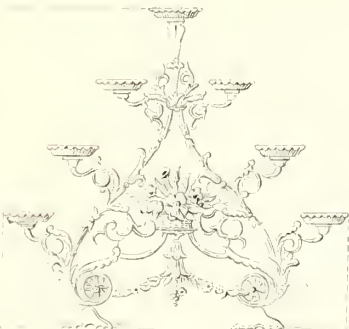

0,65 El.

N^o 620

1,30 El.



0,90 El.

N^o 621 A

0,70 El.

N^o 622 B

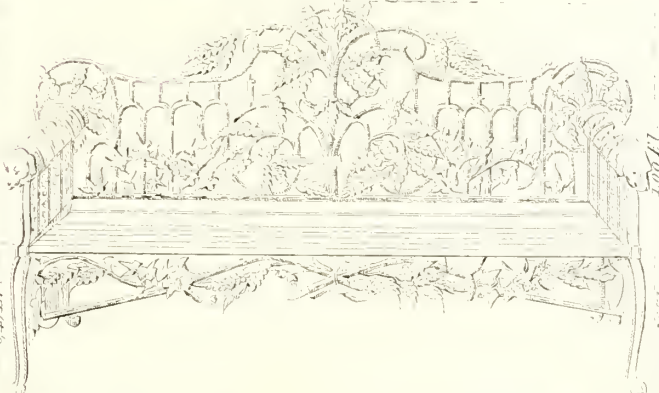

0,45 El.

1,00 El.

1,52 El.

0,50 El.

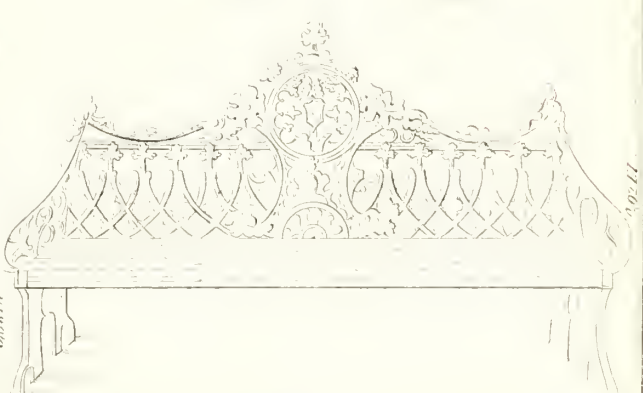

0,92 El.

1,10 El.

Journal van 720, 1844, 1845, 1846, 1847, 1848, 1849, 1850, 1851, 1852, 1853, 1854, 1855, 1856, 1857, 1858, 1859, 1860, 1861, 1862, 1863, 1864, 1865, 1866, 1867, 1868, 1869, 1870, 1871, 1872, 1873, 1874, 1875, 1876, 1877, 1878, 1879, 1880, 1881, 1882, 1883, 1884, 1885, 1886, 1887, 1888, 1889, 1890, 1891, 1892, 1893, 1894, 1895, 1896, 1897, 1898, 1899, 1900.

Fabriek van Bronswerken van *Becht en Dyserinck.*

Deurhandvat en Deurknoppen.

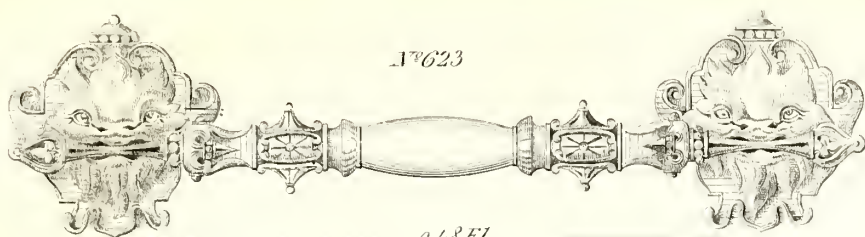

N°623

0,48 El.

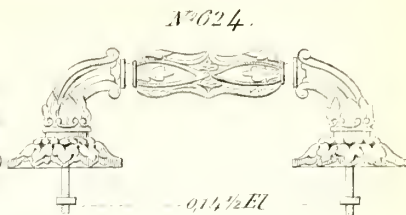

N°624.

0,14 1/2 El.

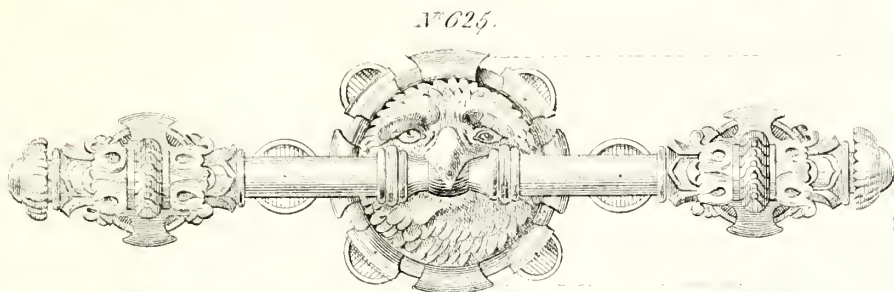

N°625.

0,47 El.

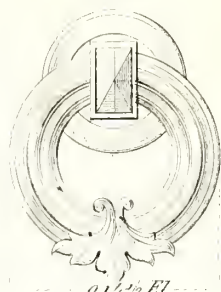

N°626.

0,14 1/2 El.

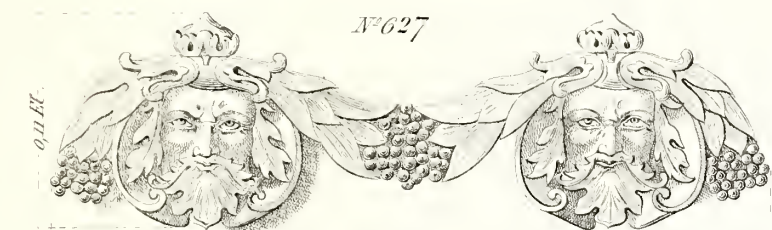

N°627

0,40 El.

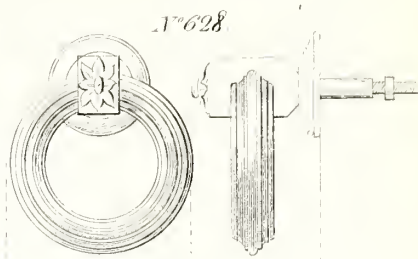

N°628

0,11 El.

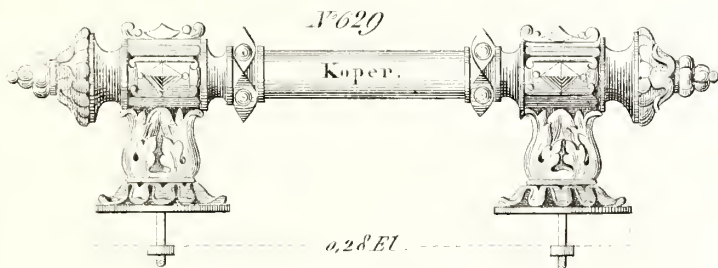

N°629

0,28 El.

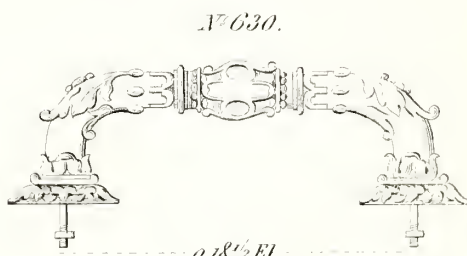

N°630.

0,18 1/2 El.

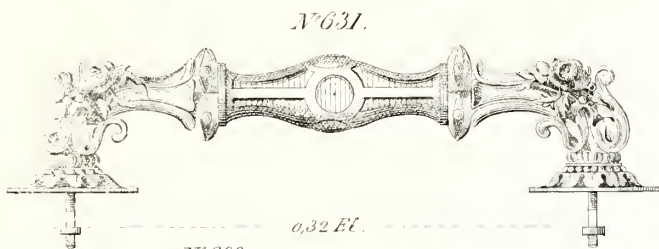

N°631.

0,32 El.

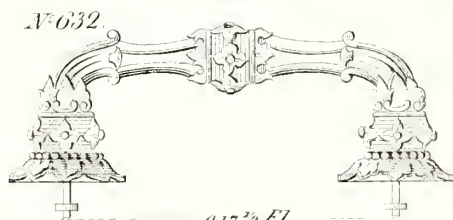

N°632.

0,17 1/2 El.

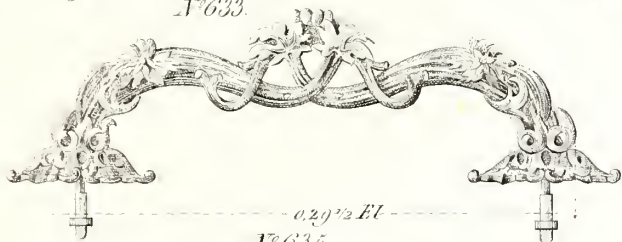

N°633.

0,29 1/2 El.

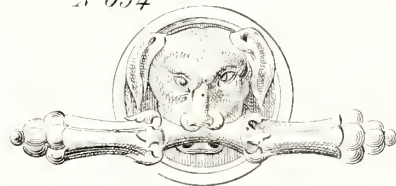

N°634

0,08 El.

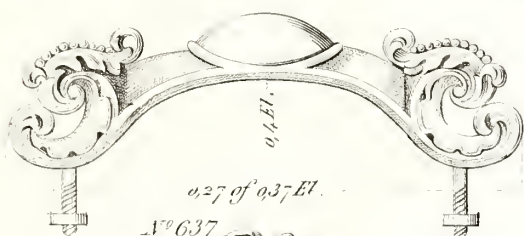

N°635.

0,27 of 0,37 El.

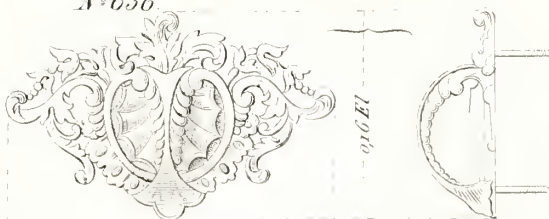

N°636

0,26 El.



N°637

0,24 1/2



N°638

0,9 El.

0,8 1/2 El.

Fabriek van Bronswerken van **Becht en Dyserinck.**

N^o 639.

N^o 640.

op 1/2 de van guelle

Beoord by N^o 639.

Beoord by N^o 640.

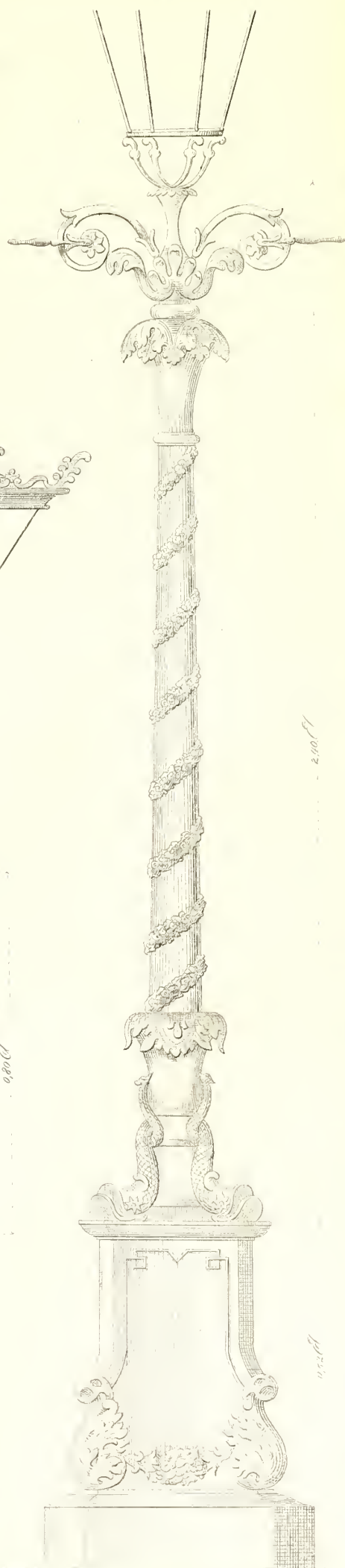
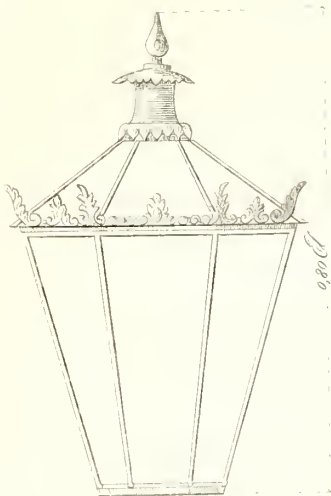
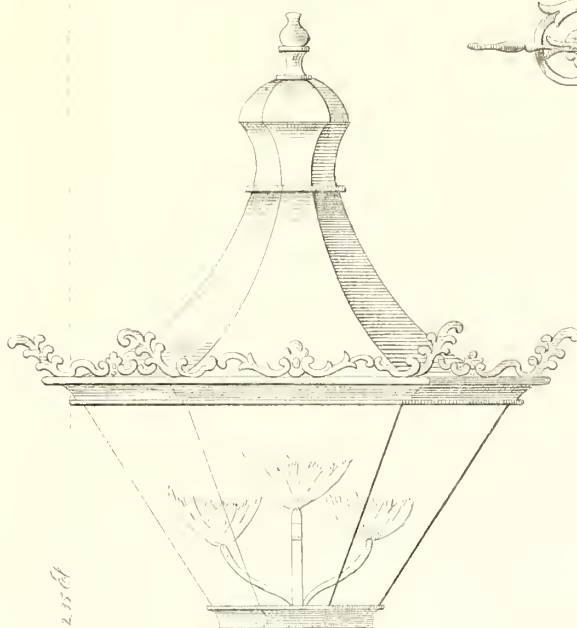
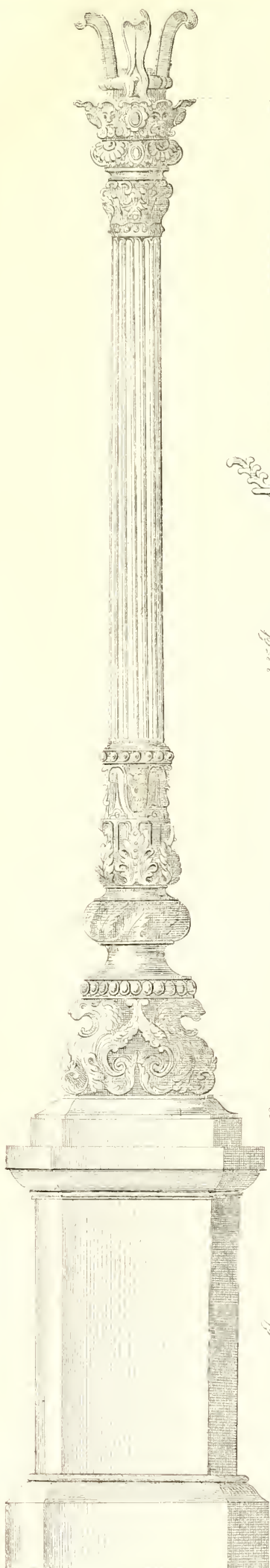

200 cl

255 cl

Fabriek van Bronswerken van *Becht en Dyserinck.*

Bloemen-stand aards, Tuinparkhekjes, Spuwbakjes en Voelenbankjes.

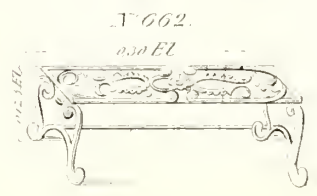
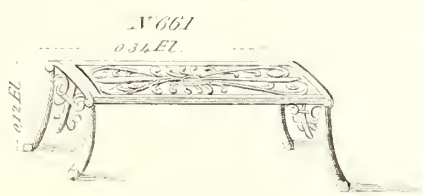
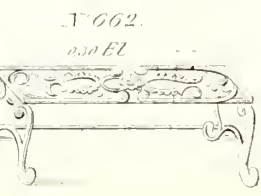
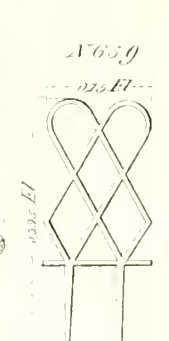
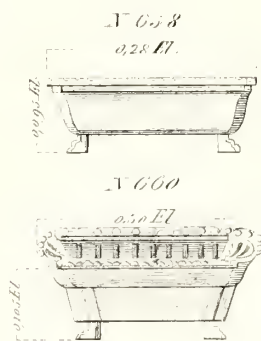
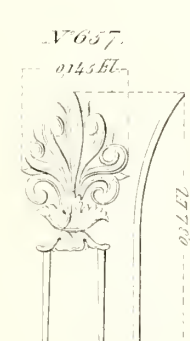
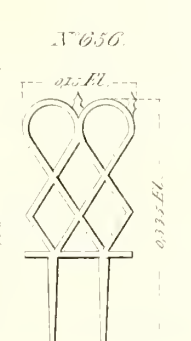
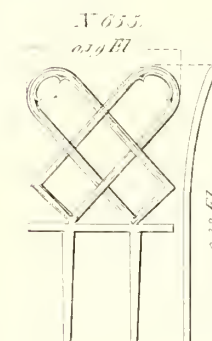
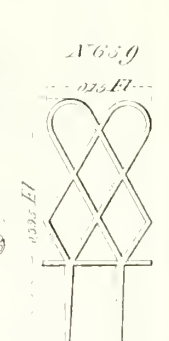
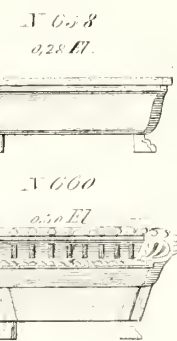
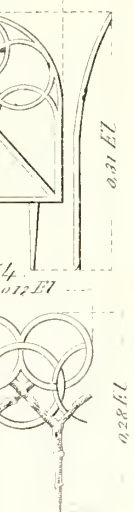
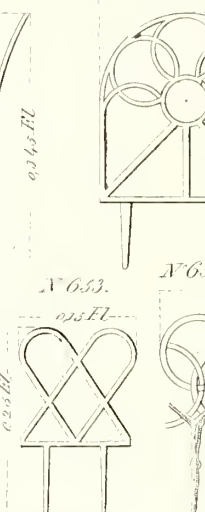
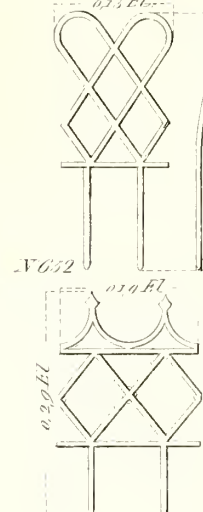
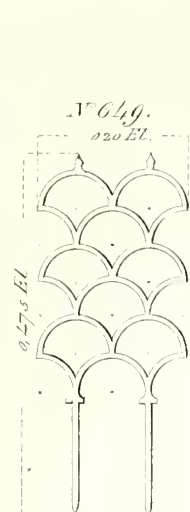
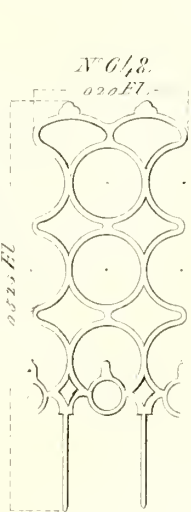
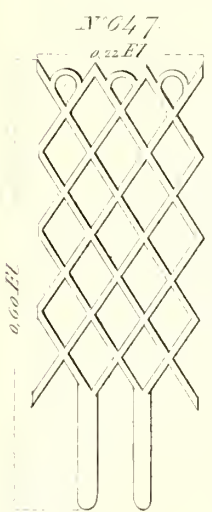
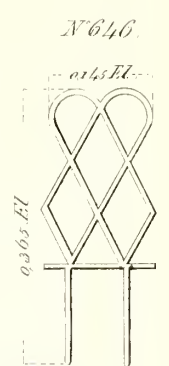
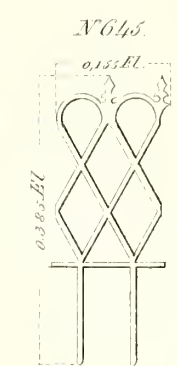
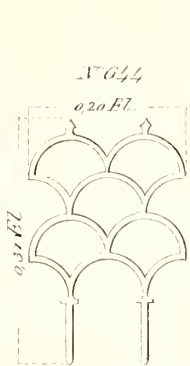
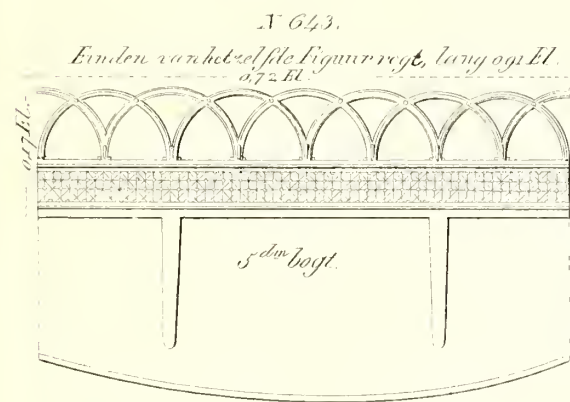
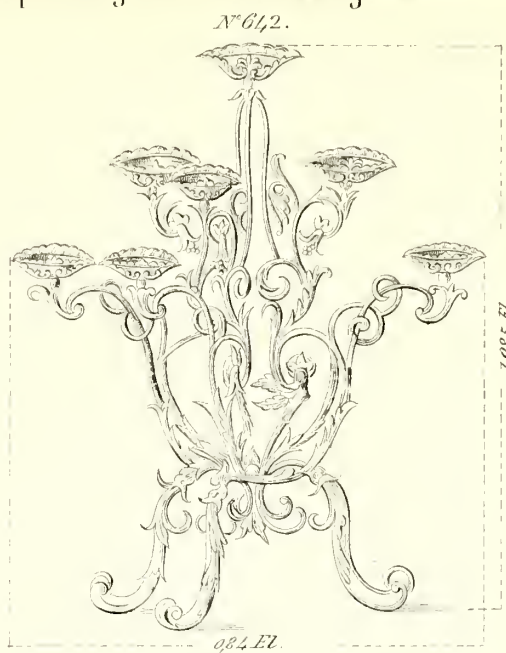
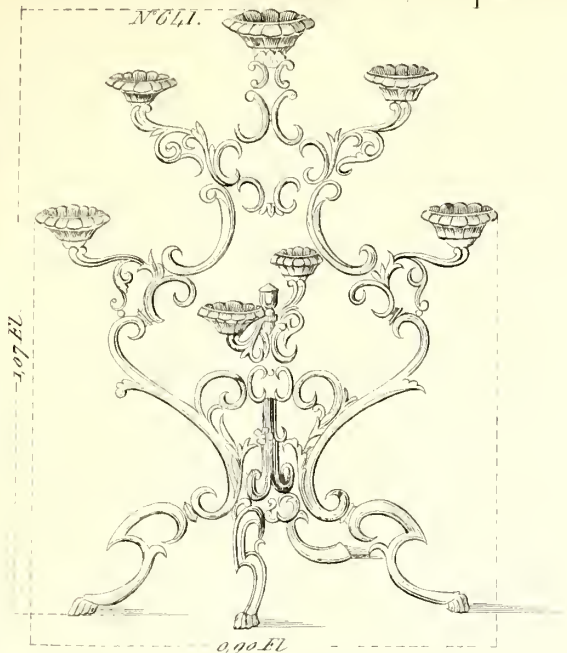

Fabriek van Bronswerken van *Becht en Dyserinck.*

N°664.
Rosetten, Deurhandvaten, Deurknoppen en Beltrekkers

N°663

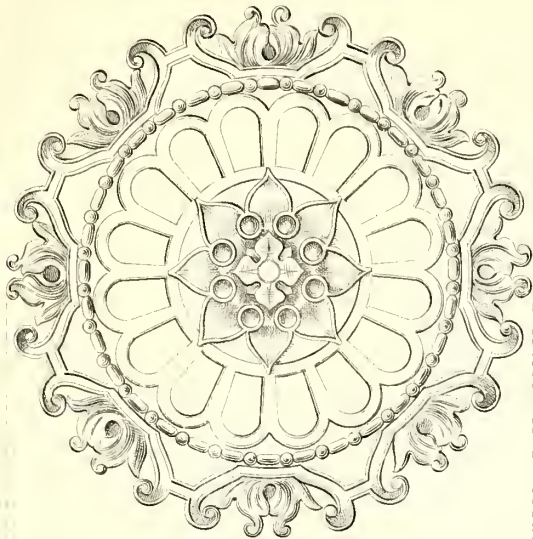

029 El.

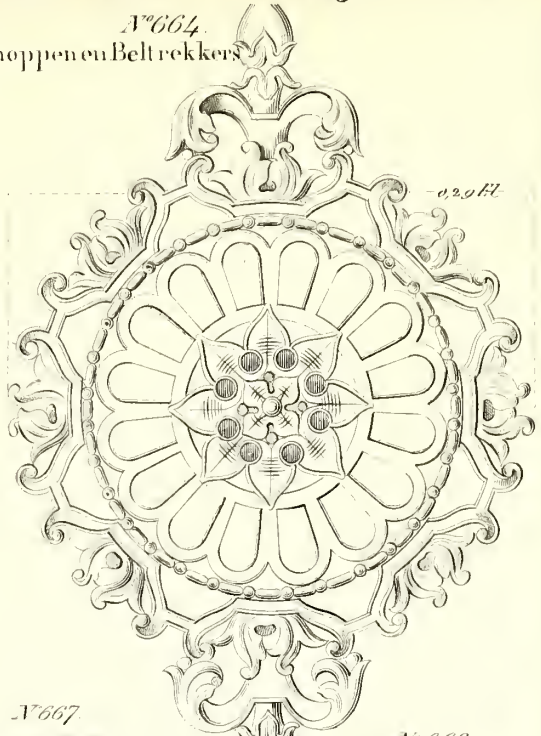

029 El.

043 El.

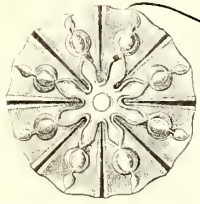

01 El.

N°666

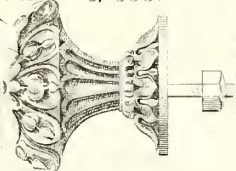

010 1/4 El.

N°667



010 El.

N°668



085 El.

N°669

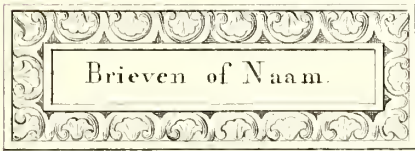

025 El.

08 El.

N°670



009 El.

N°671



N°672



005 El.

N°673



006 1/2 El.

N°674

075 El.

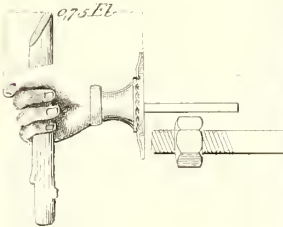

N°675



017 El.

015 1/2 El.

N°676



018 El.

009 1/2 El.

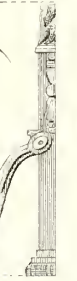

N°677

022 El.

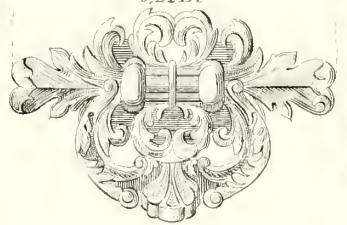

N°678

028 1/2 El.



N°680

035 El.

N°682



034 1/2 El.

N°679

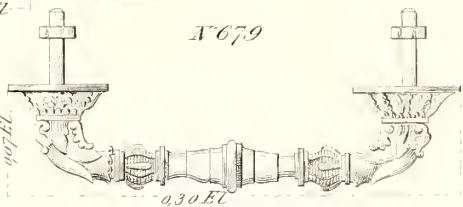

030 El.

N°681

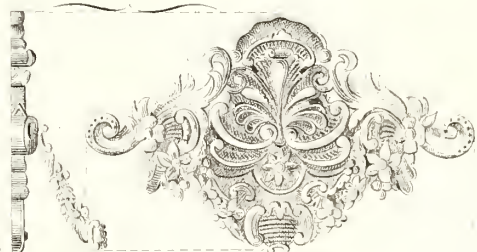

026 1/2 El.

Fabriek van Bronswerken van *Becht en Dyserinck.*

685

684

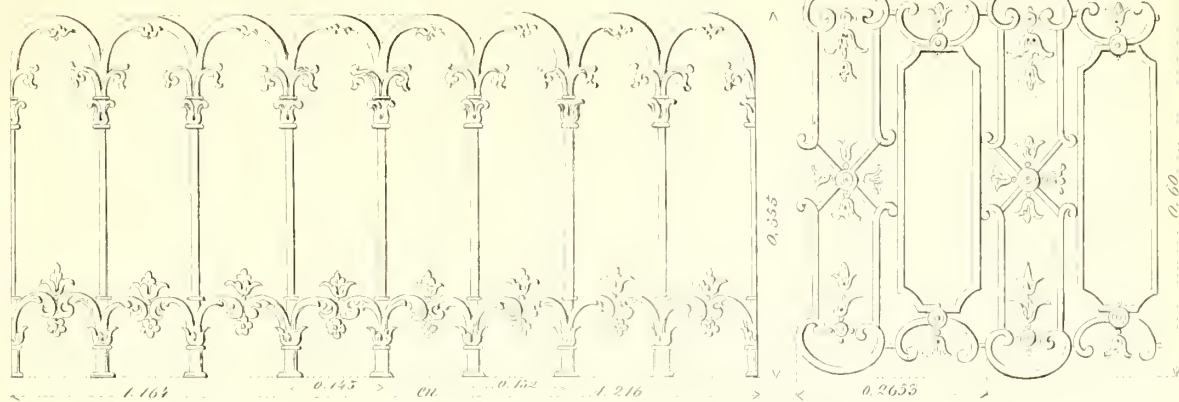

685

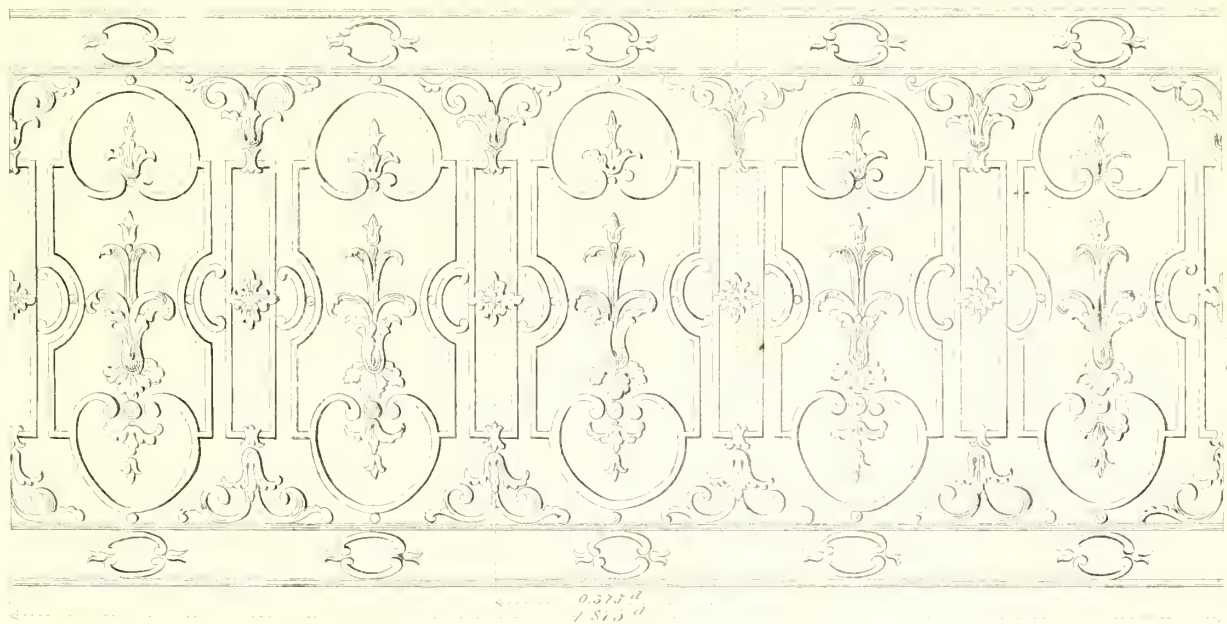

686

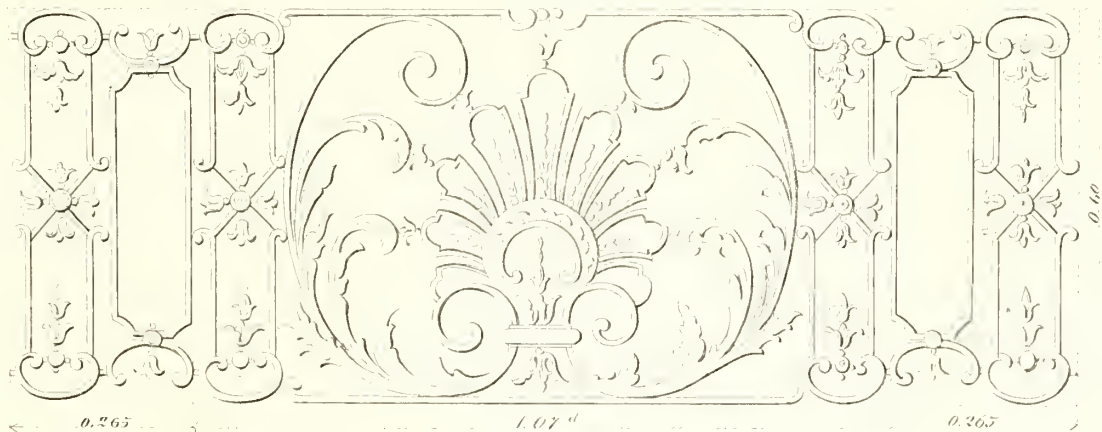

687

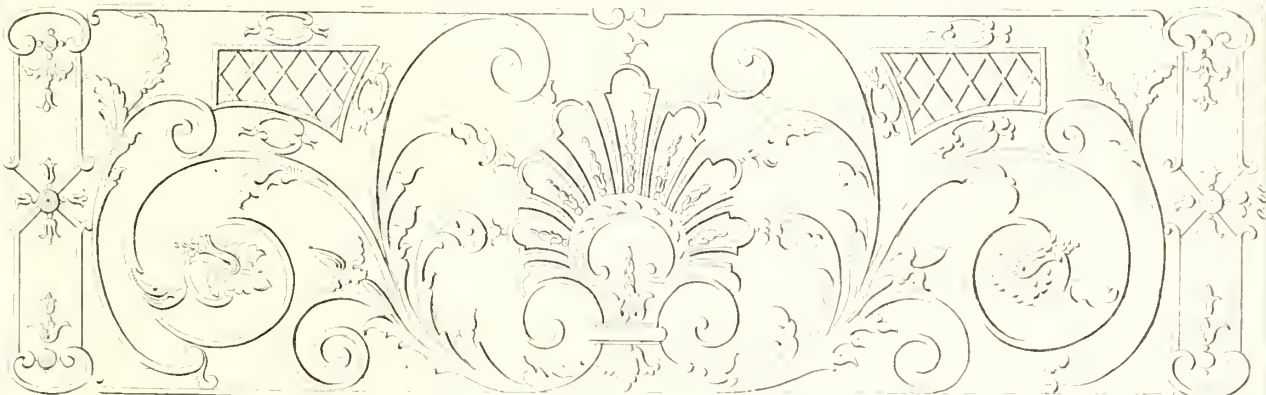

1.965

De teekeningen van deze plaat en plaat N. 84 worden met en zonder startstukken geleverd, en kunnen in rood van het metaal of verlegd worden, doch mogen, om aan een stuk gegoten te worden de lengte van 2.50" niet te boven gaan.

Fabriek van Bronswerken van *Becht en Dyserinck.*

688

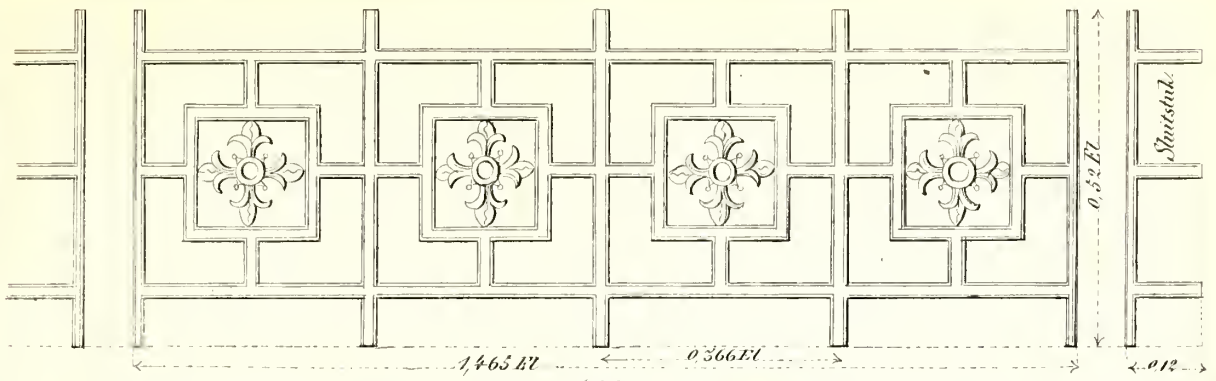

689

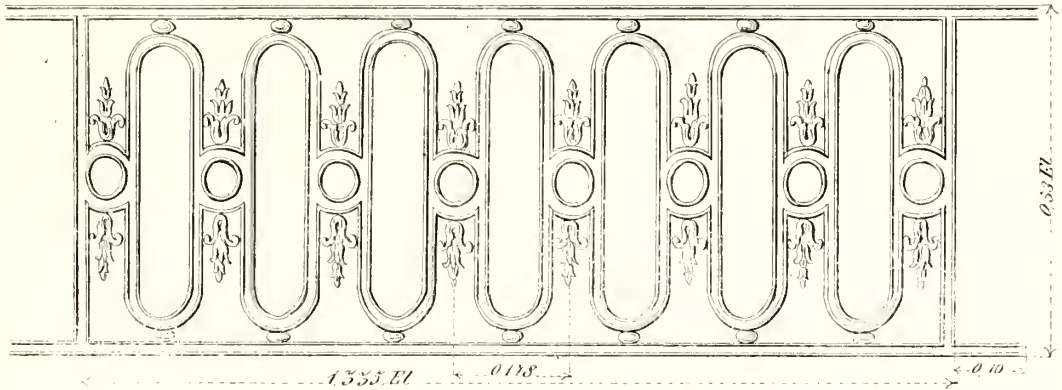

690

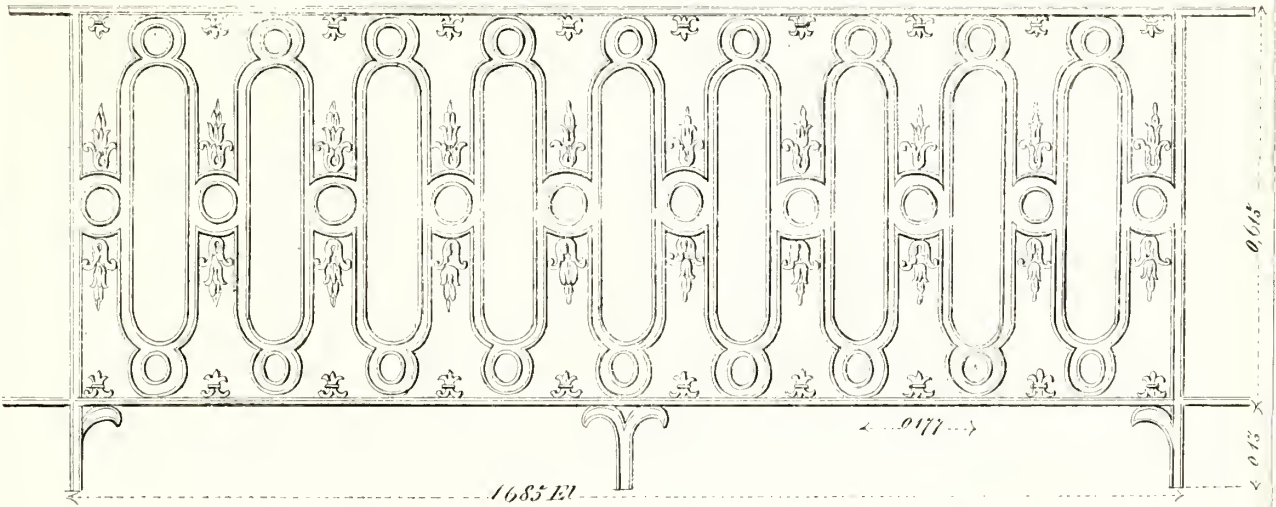

691

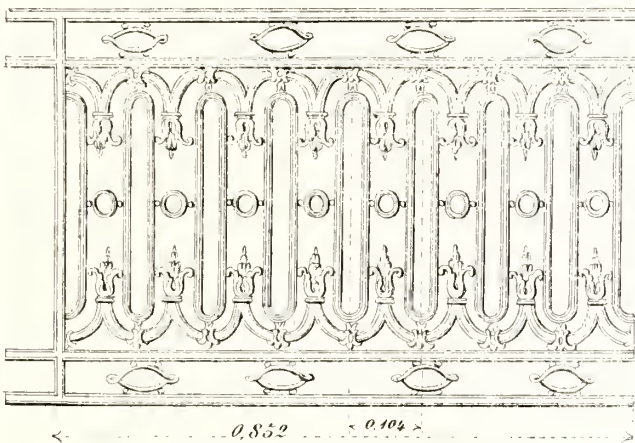

692

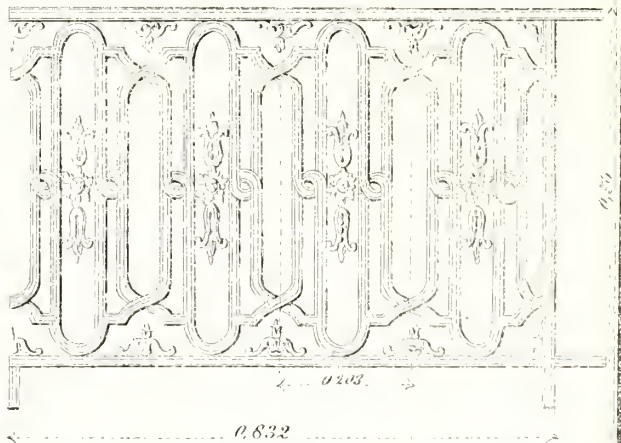

693

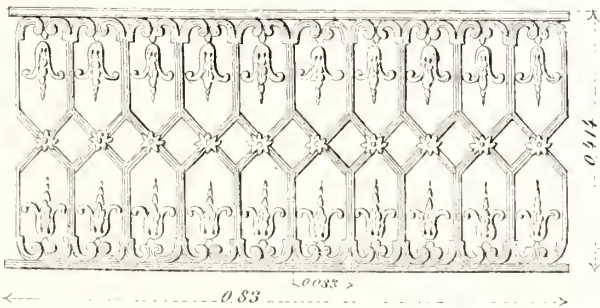

694

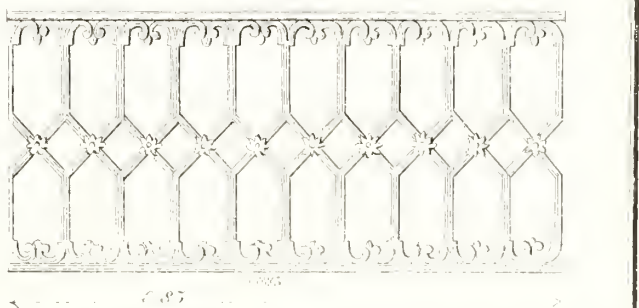

Fabriek van Bronswerken van **Becht en Dyserinck.**

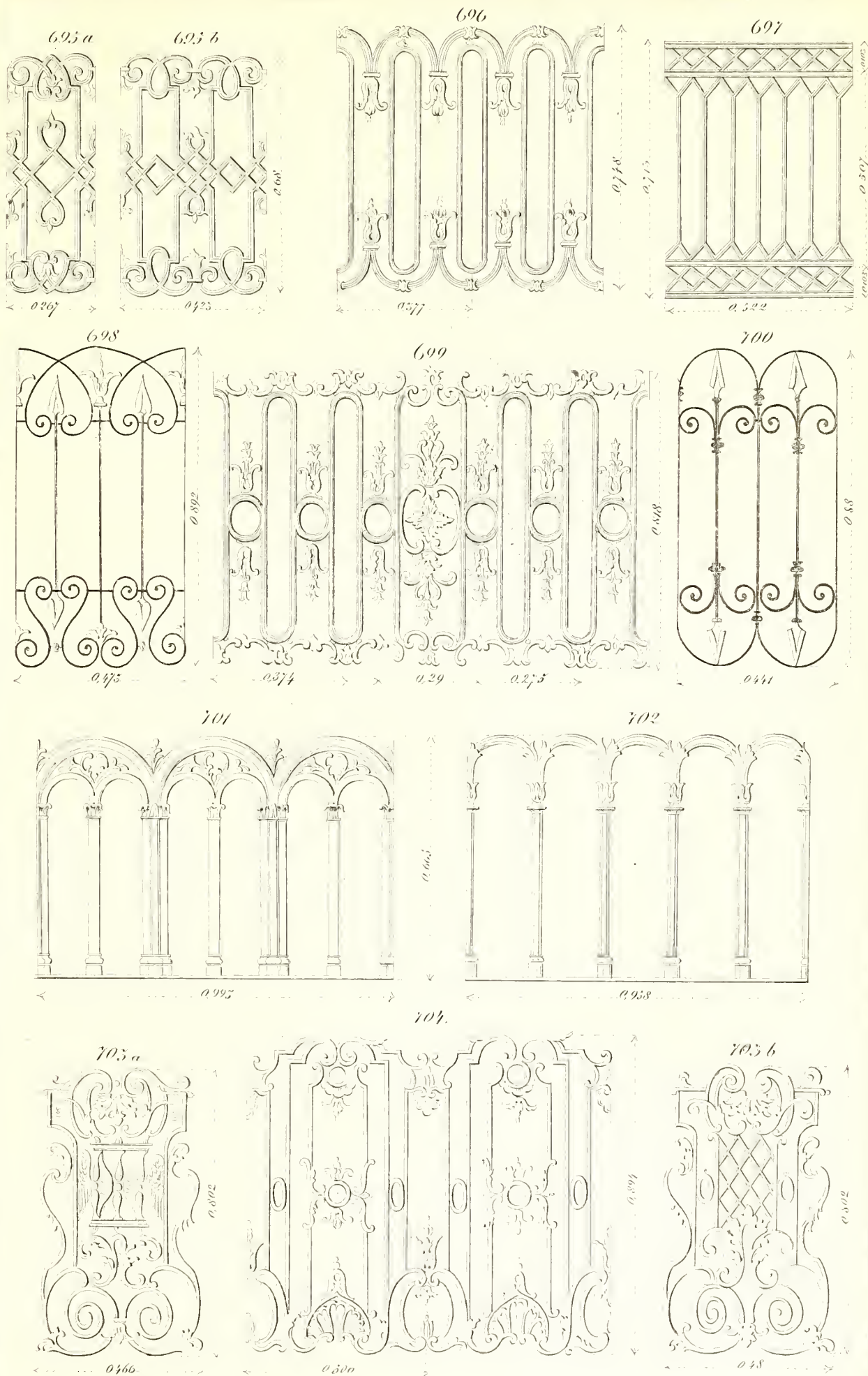

*Deze bekransingen worden zij aan zij of grotere afmetingen gegoten dan de
ingeschreeven maten, en langere bekransingen samen te stellen worden ze
door ijeren of houten lagers verbonden worden*

Fabriek van Bronswerken van *Becht en Dyserinck.*

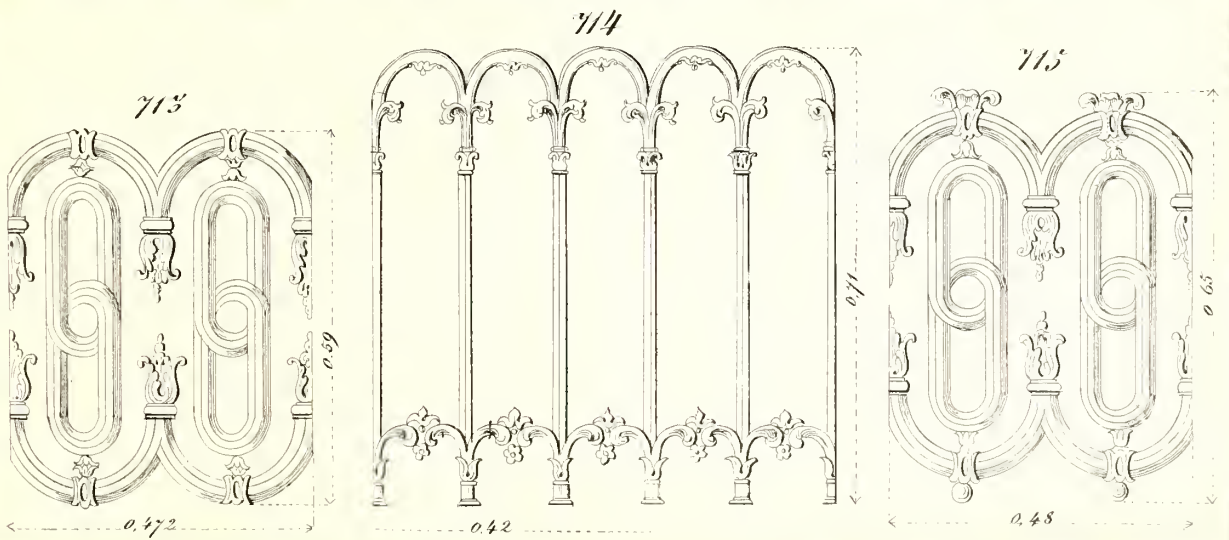
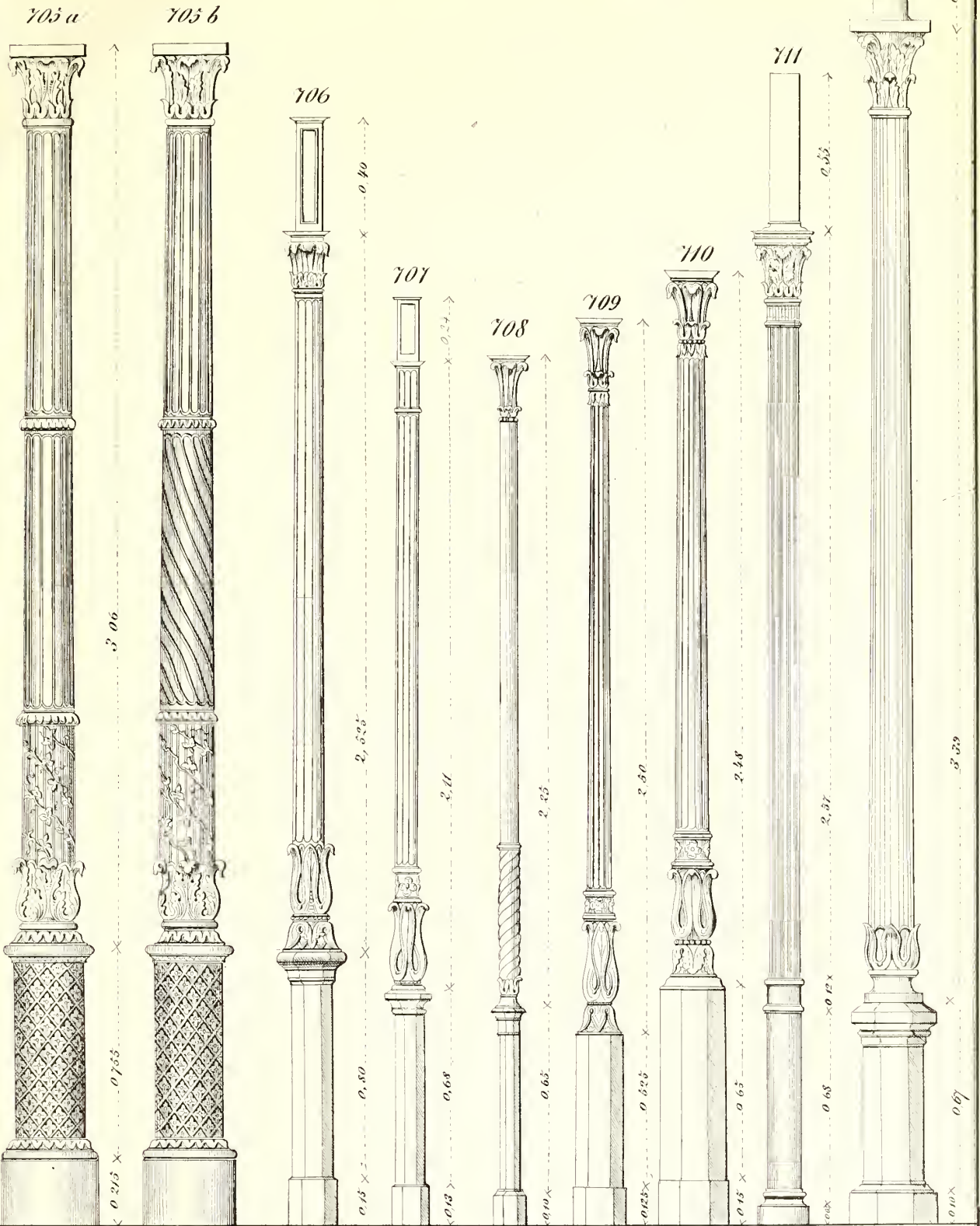

Fabriek van Bronswerken van Becht en Dyserinck.

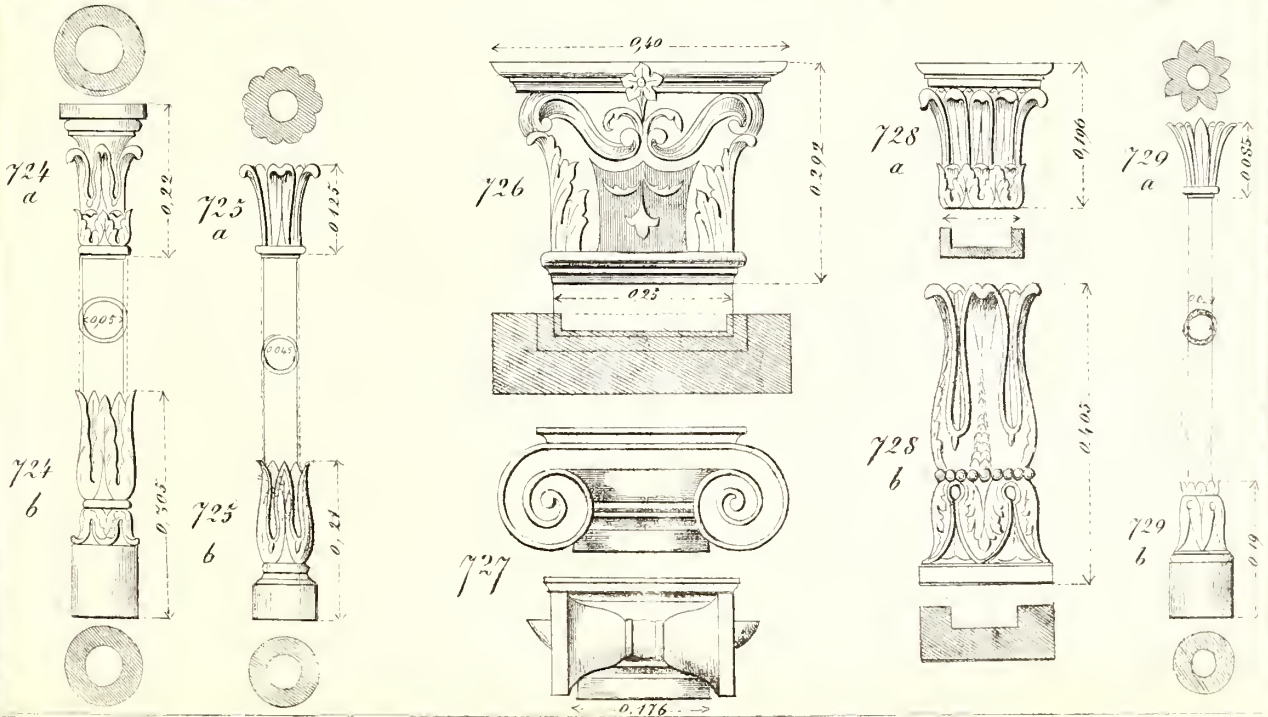
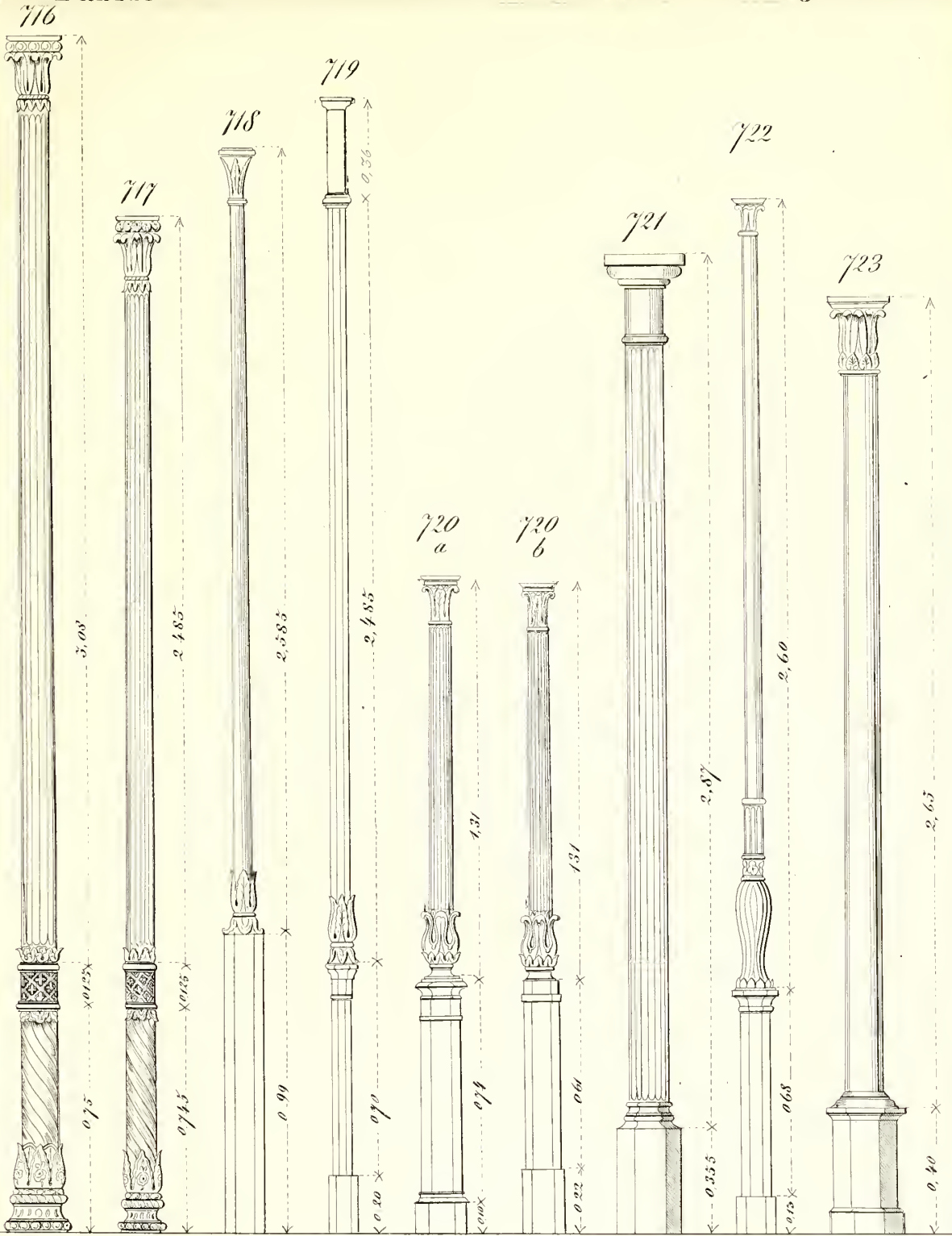

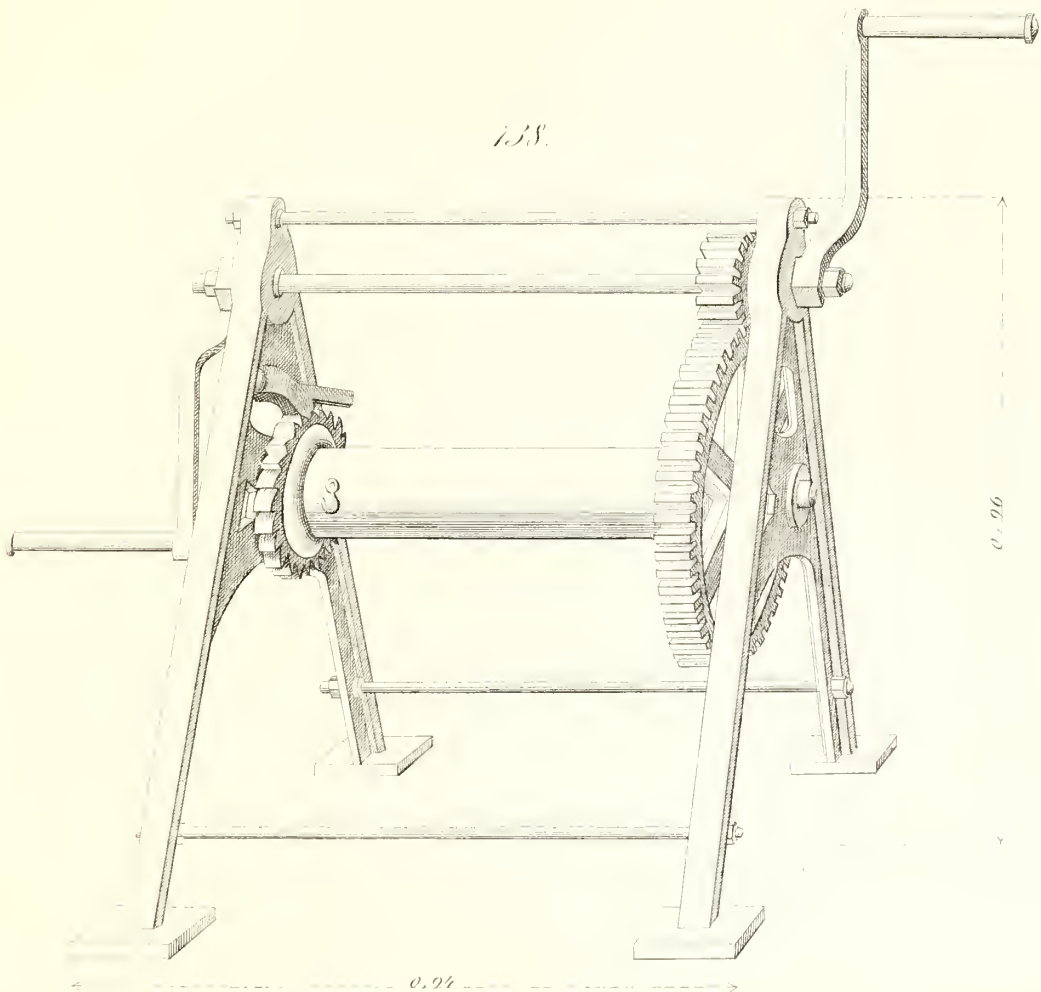
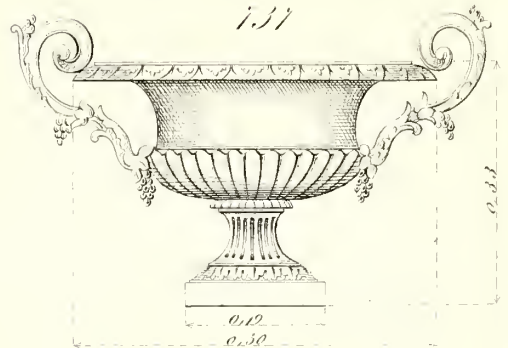
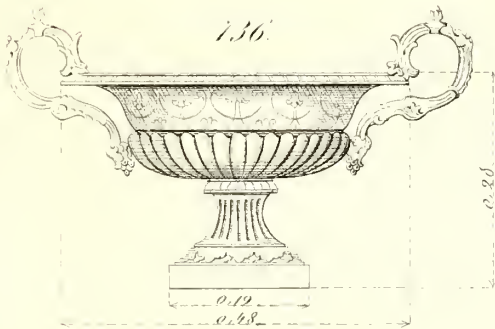
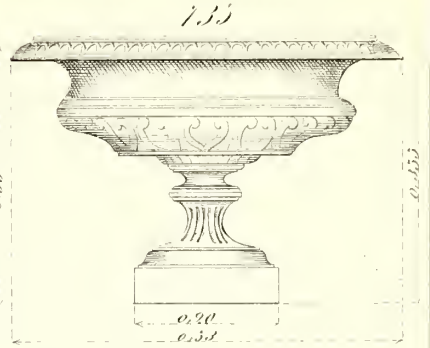
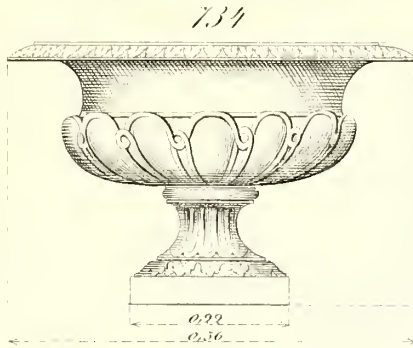
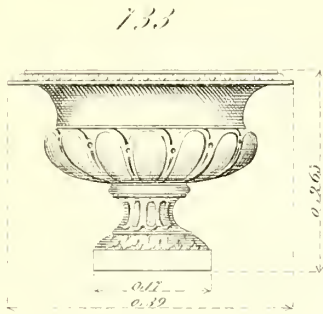
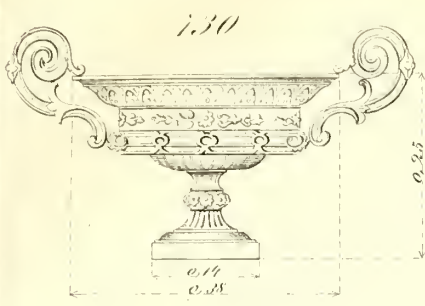

Fabriek van Bronswerken van *Becht en Dyserinck.*

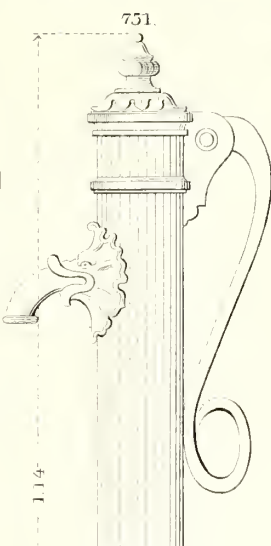
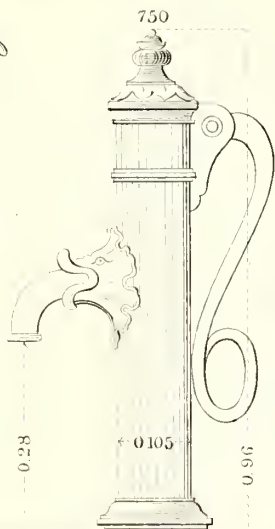
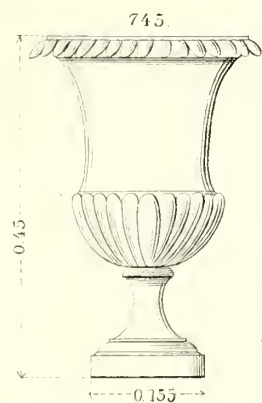
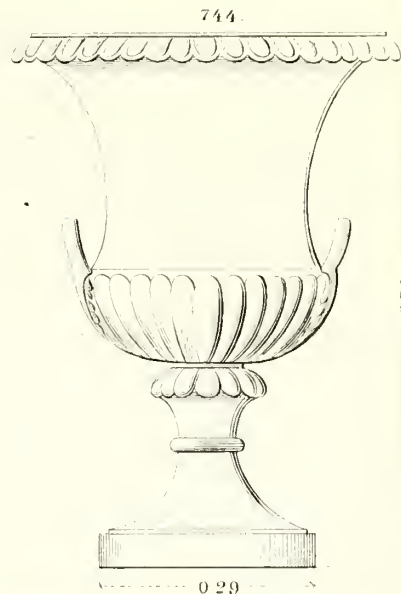
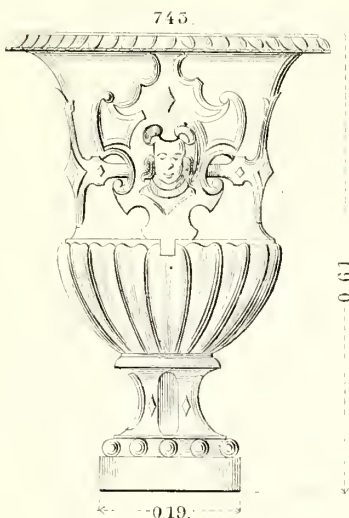
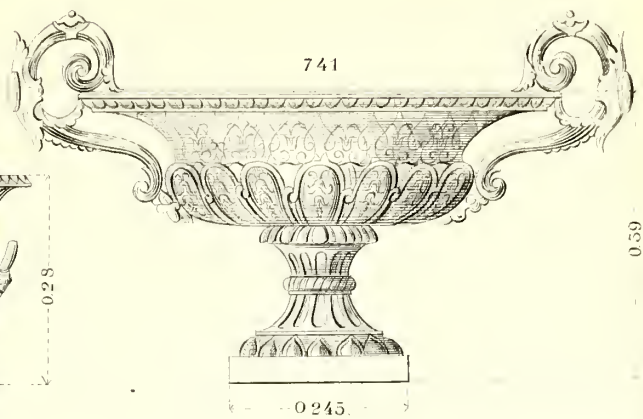
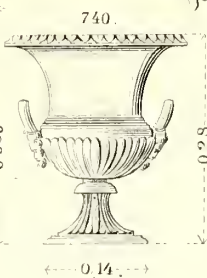

Deze Pompen worden met en zonder water-bakken geleverd

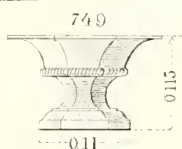
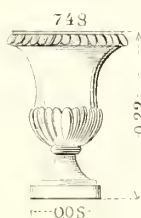
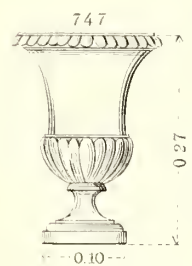

Grondvlak van N° 755 Fol. 90.
1 20

N° 746 Wordt uitsluitend in Zink geleverd. De Slingers van N° 750 en 751 worden desverkiezende verplaatst.

Fabriek van Bronswerken van *Becht en Dyserinck.*

N^o 752

N^o 753.

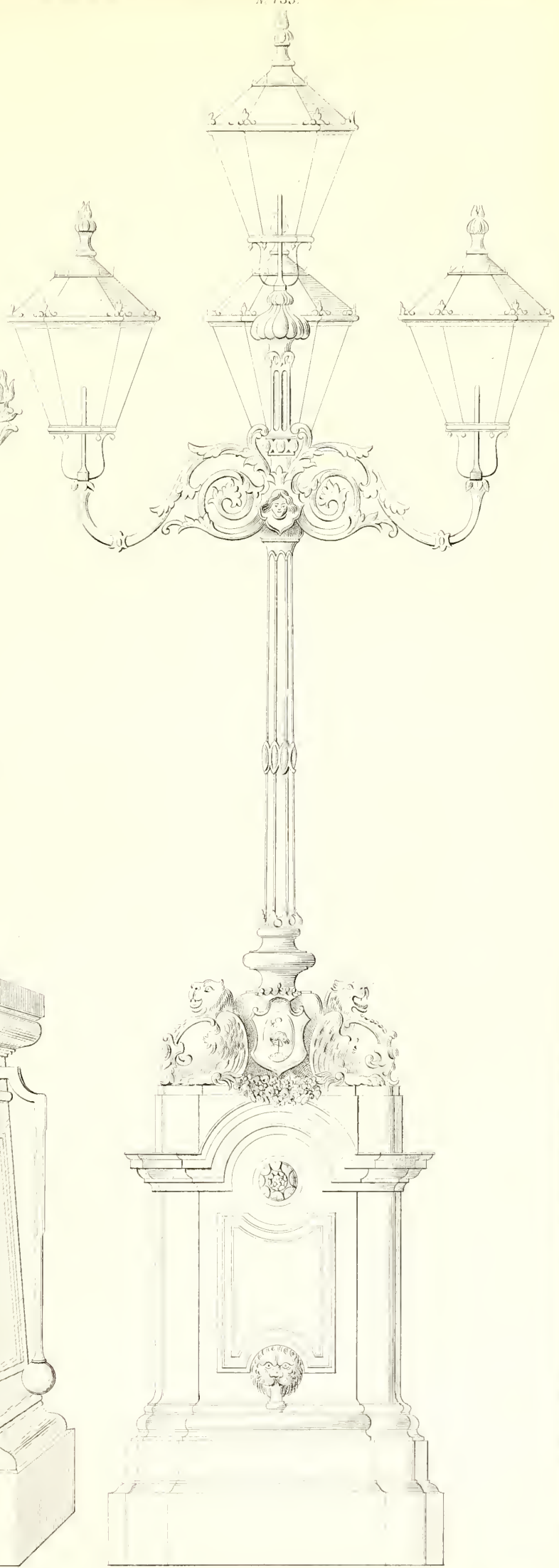
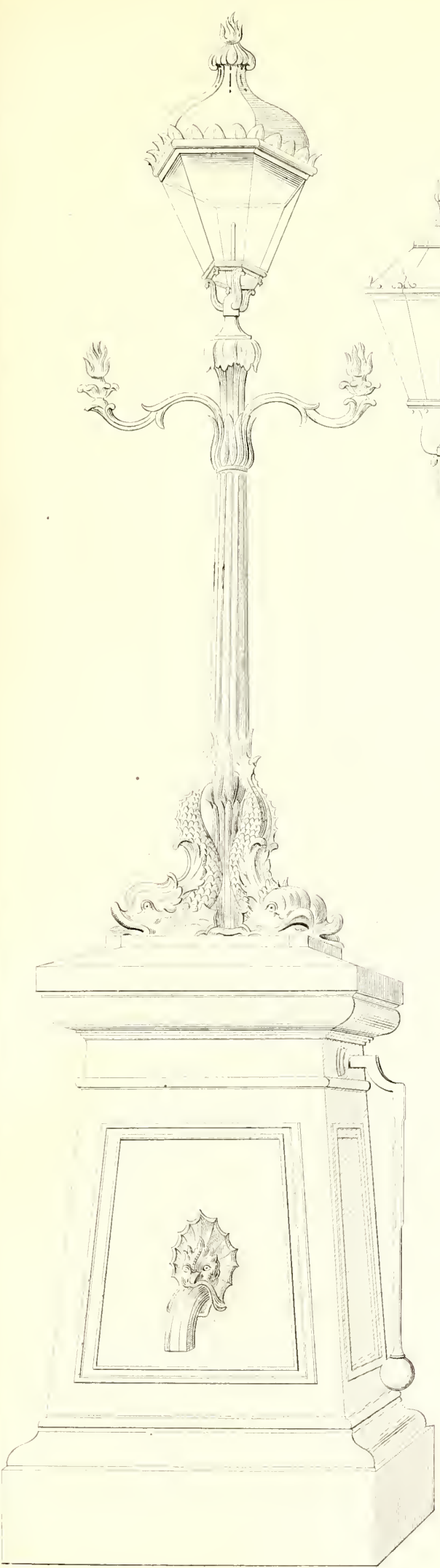

¹ 20 der ware grootte.

Fabriek van Bronswerken van *Becht en Dyserinck.*

Plafond - Rozetten.

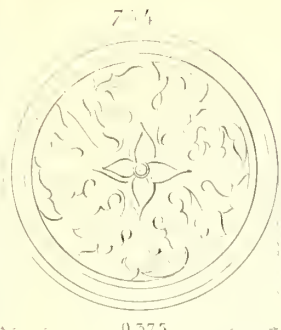

754

0.575

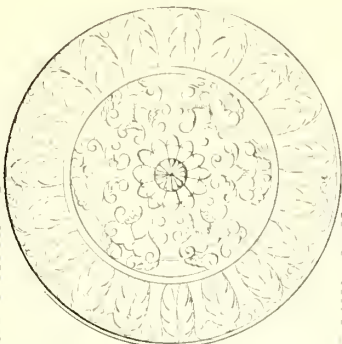

755

0.47

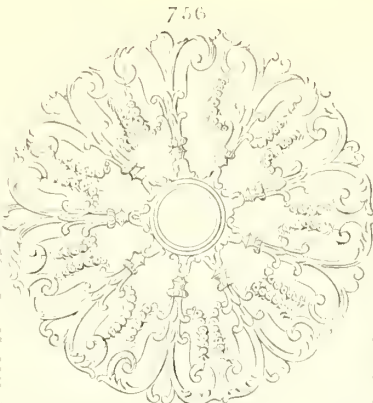

756

0.495

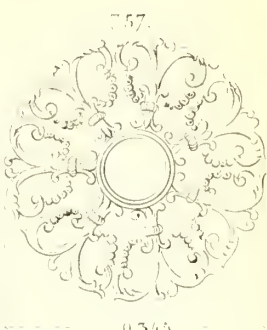

757

0.545

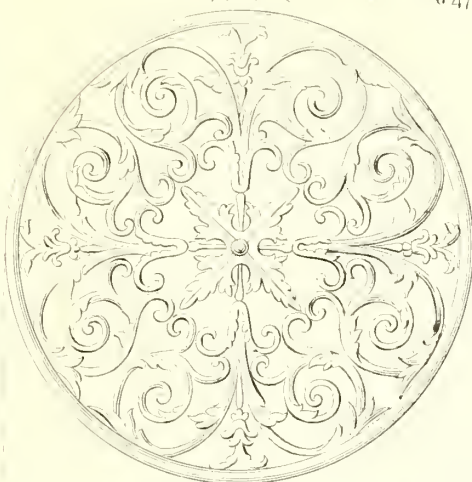

758

0.59

0.63

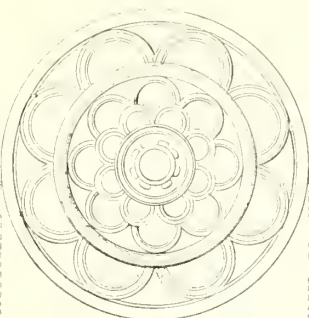

759

0.415

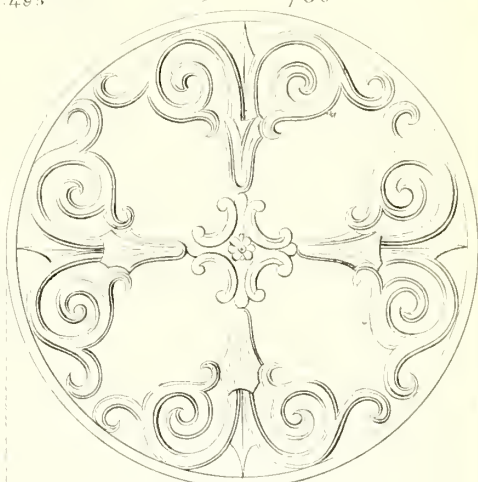

760

0.64

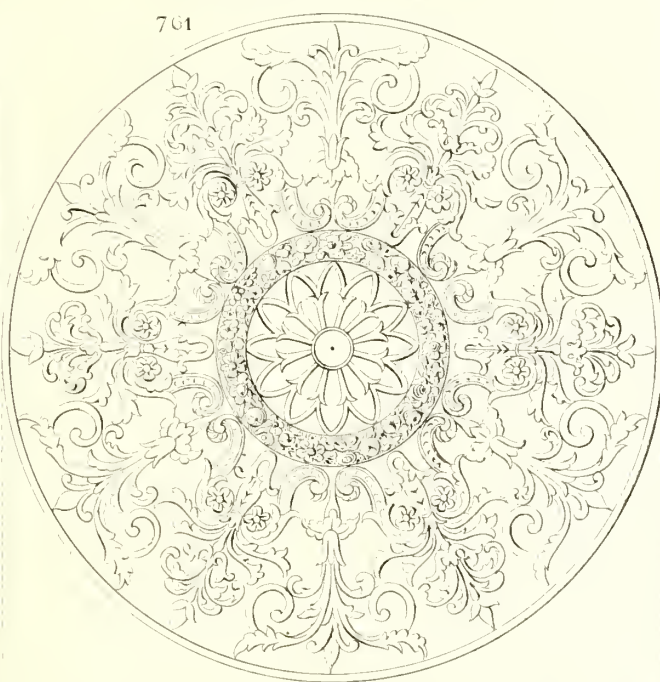

761

0.89

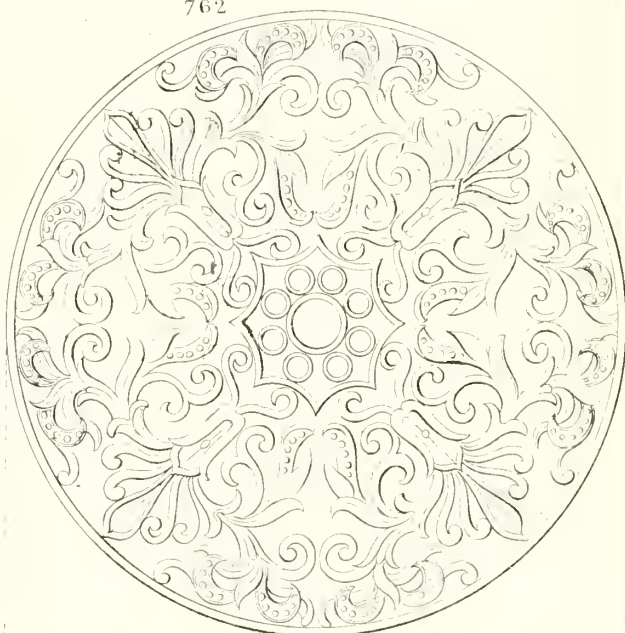

762

0.86

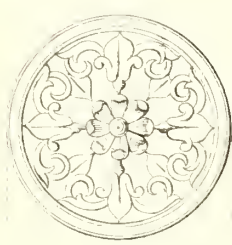

763

0.515

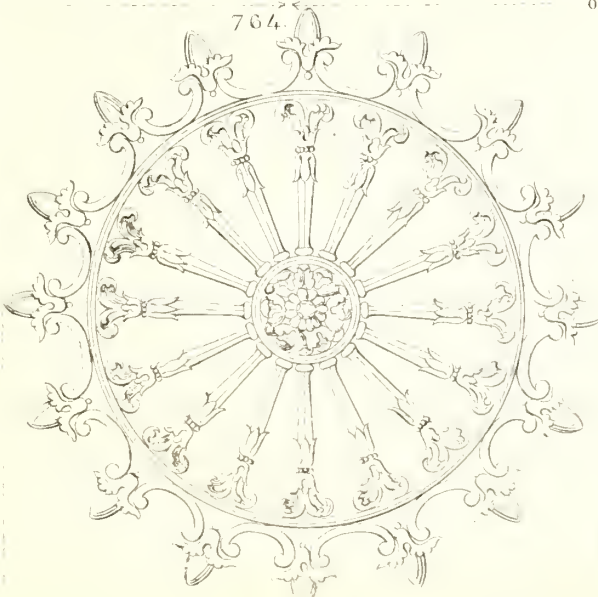

764

0.83

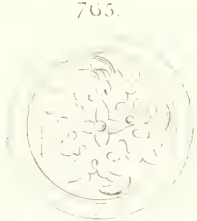

765

0.25

Fabriek van Bronswerken van *Becht en Dyserinck.*

FABRIEK-POZELLE-EN-MAAI-OPRICHTING

766.

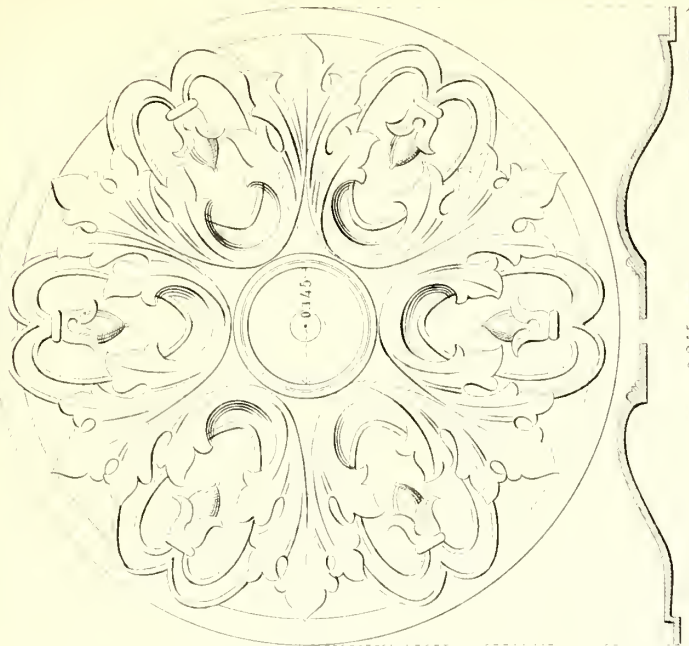

0.855

767.

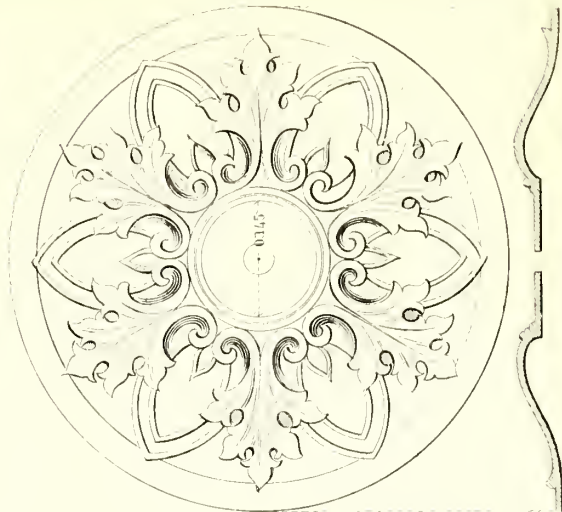

0.655

768.

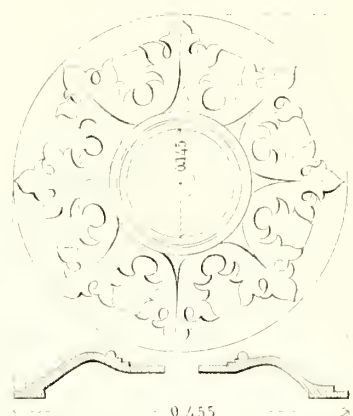

0.455

769

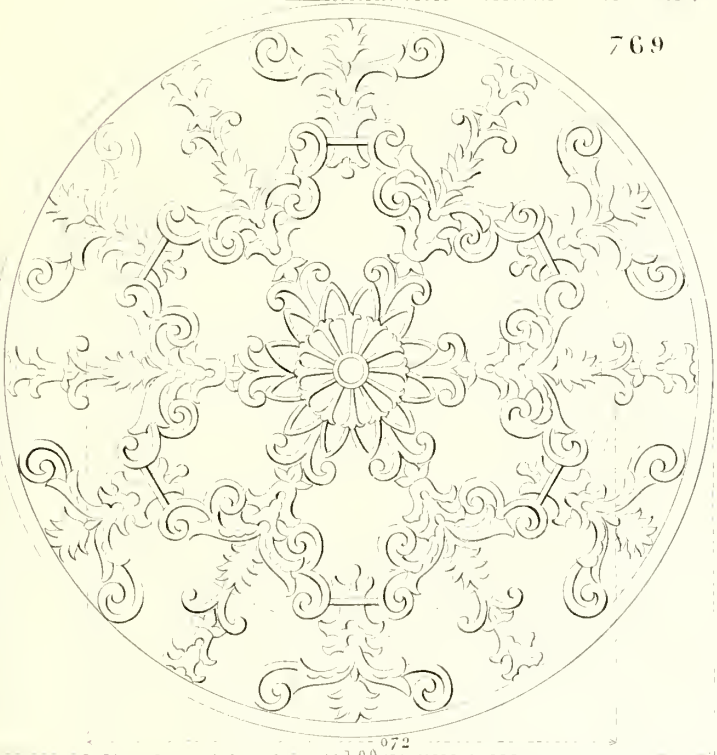

L.00 072

771

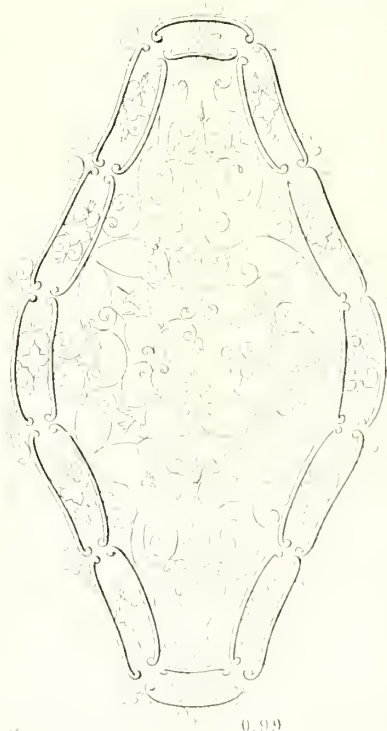

1.98

0.99

770

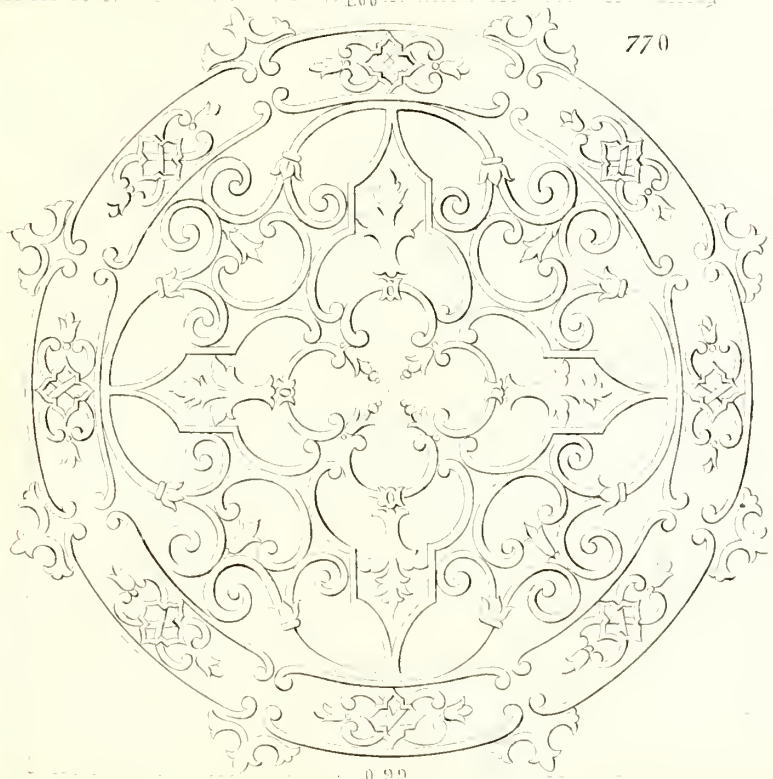

0.99
1.10

772

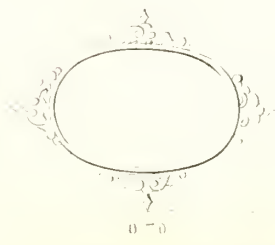

0.55

0.70

Fabriek van Bronswerken van *Becht en Dyserinck.*

Pui-en Lantaarnramen en Plafond-rozetten.

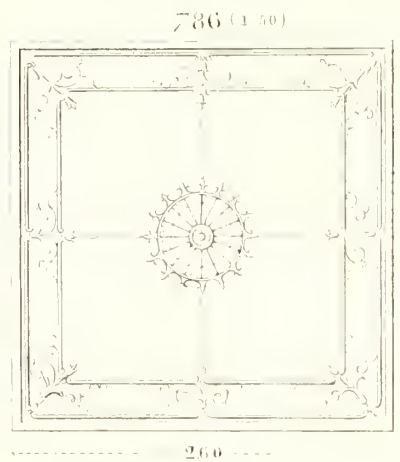
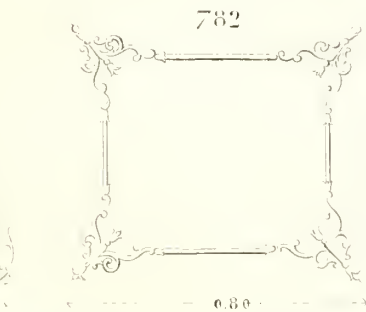
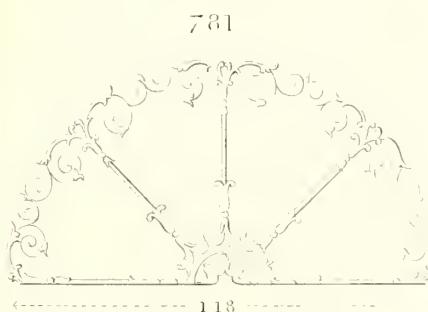
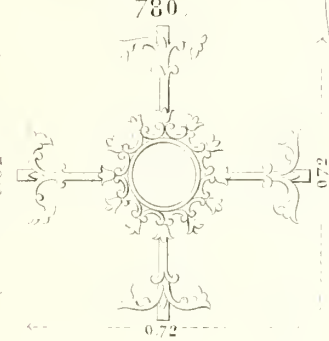
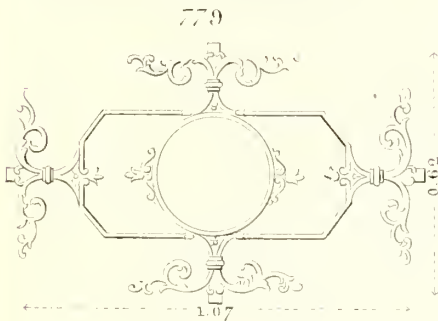
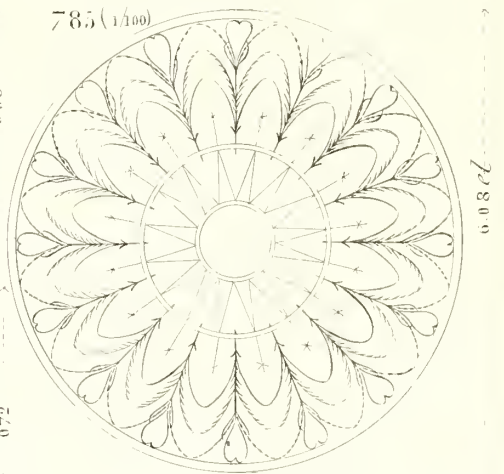
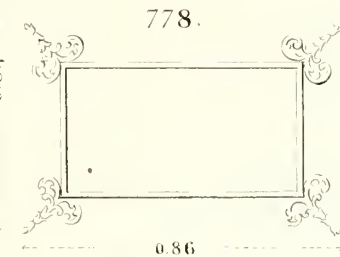
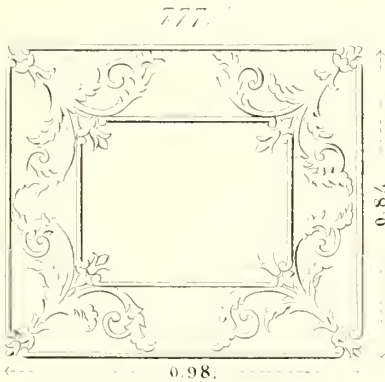
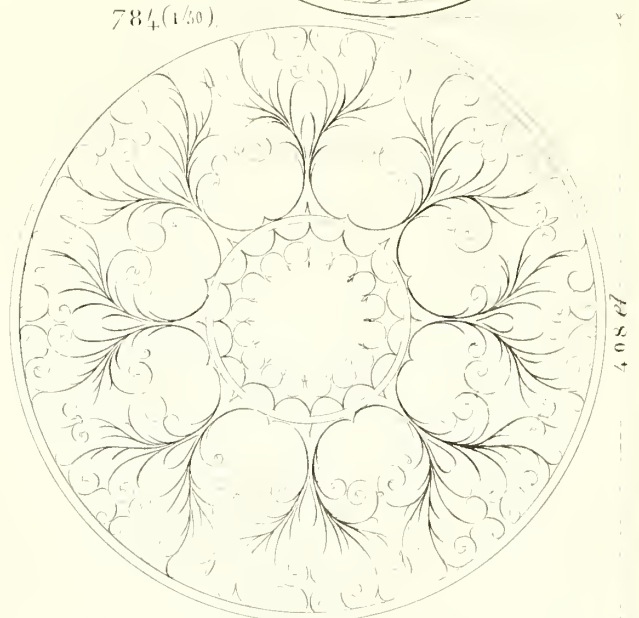
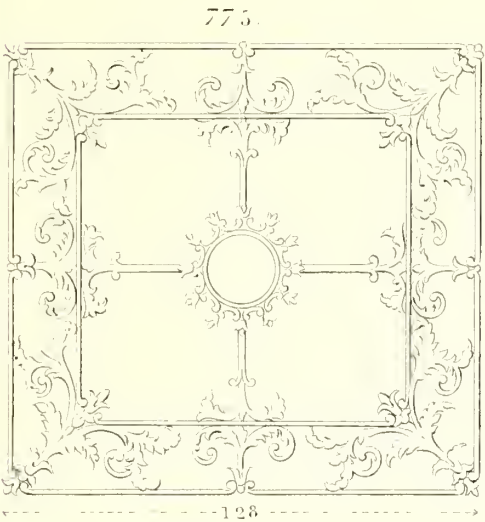
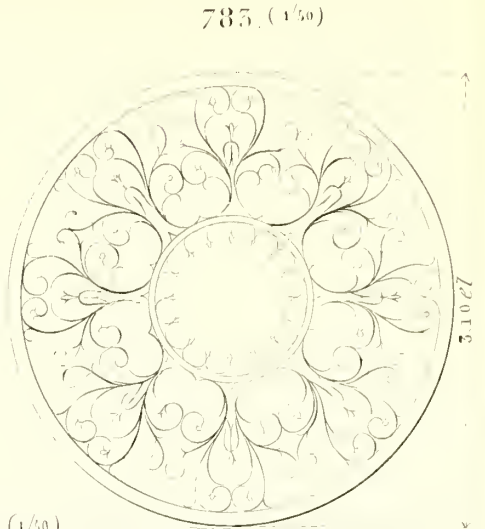
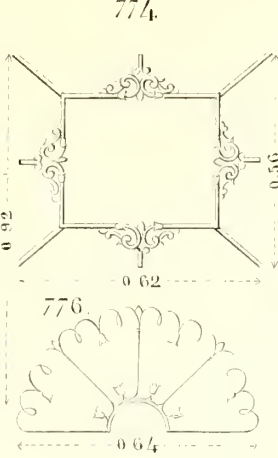
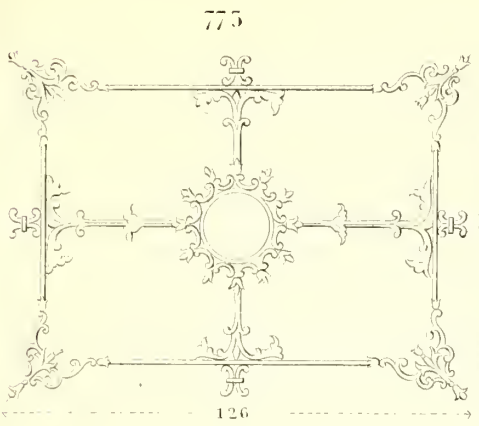

Deze pui-ramen en het lantaarnraam N^o 36 worden naar keuze op bykomende afmetingen veranderd.

Fabriek van Bronswerken van *Becht en Dyserinck.*

Stalboortigheden en $\frac{1}{20}$ der ware grootte

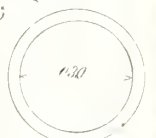
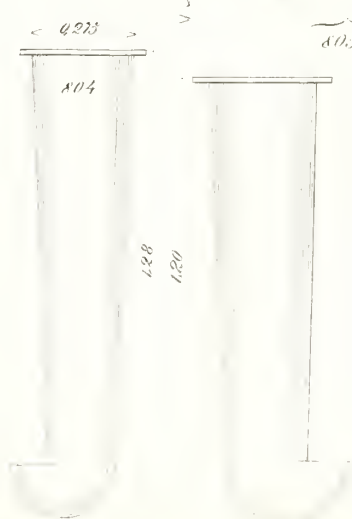
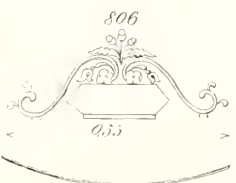
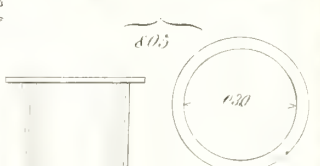
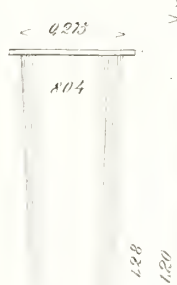
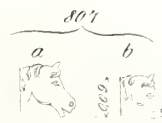
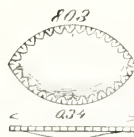
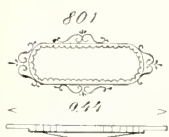
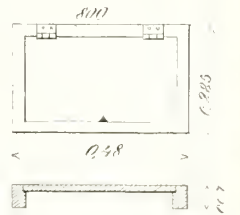
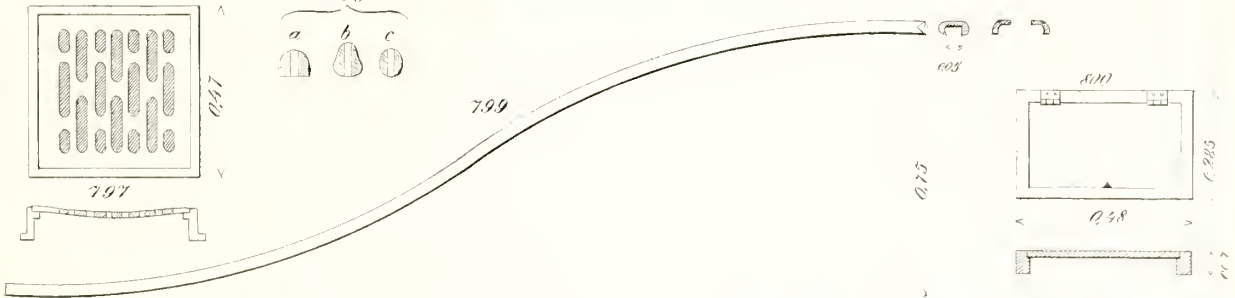
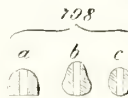
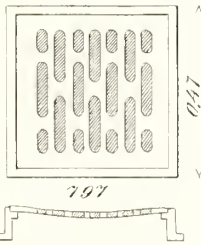
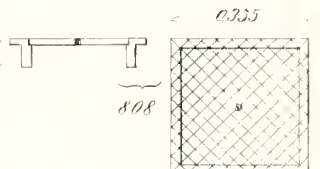
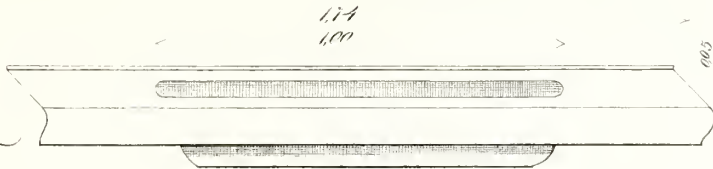
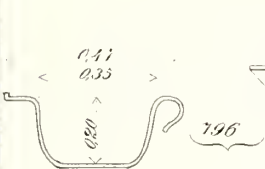
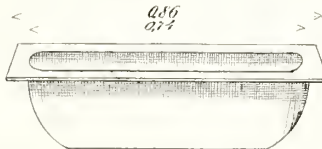
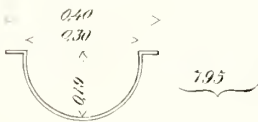
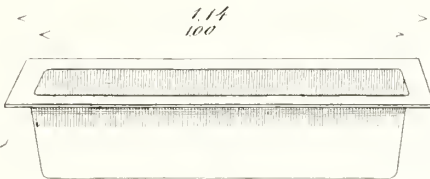
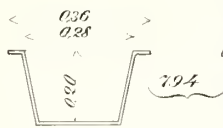
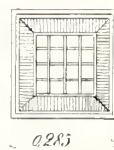
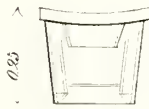
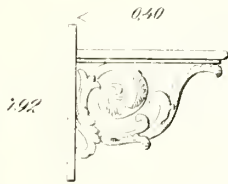
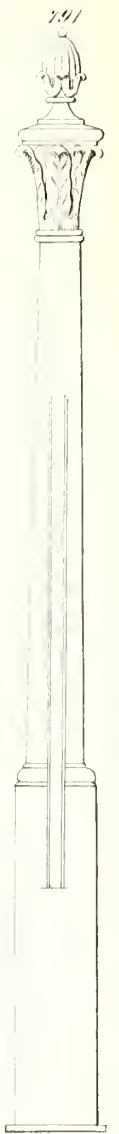
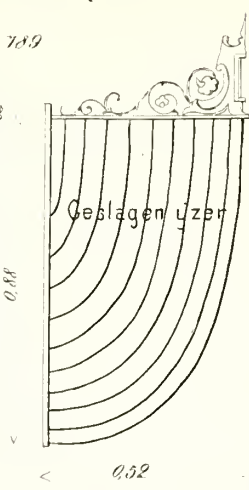
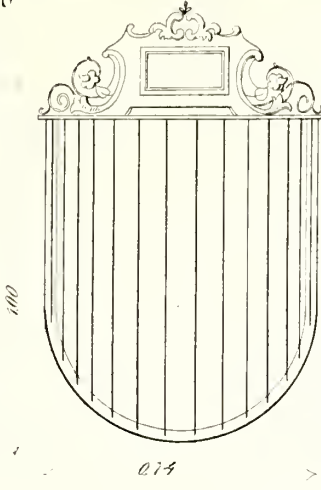
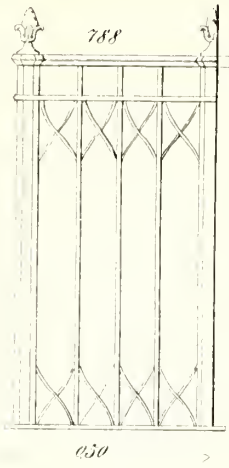

Fabriek van Bronswerken van *Becht en Dyserinck.*

Ruif, Voerbakken, Straatberrien enz. op 1/20 der ware grootte.

809.

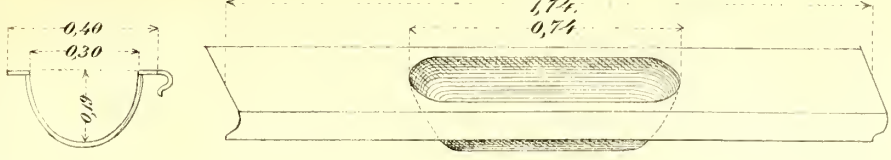

810.

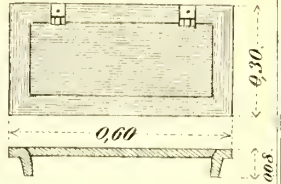

811.

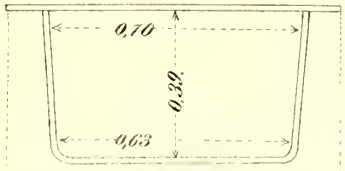
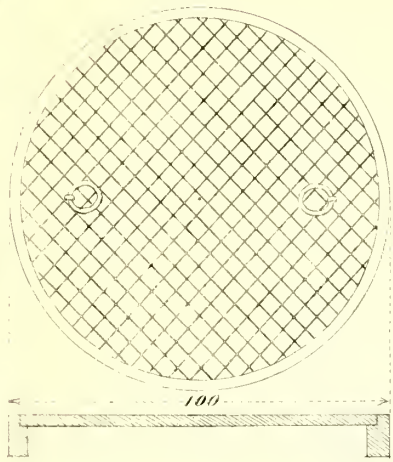

812.

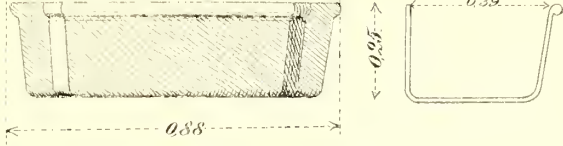

813.

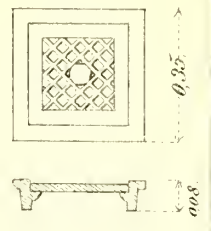

815.

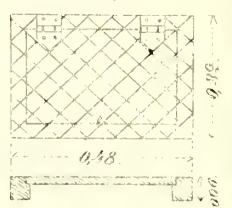

816.

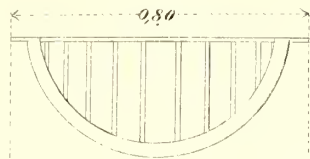
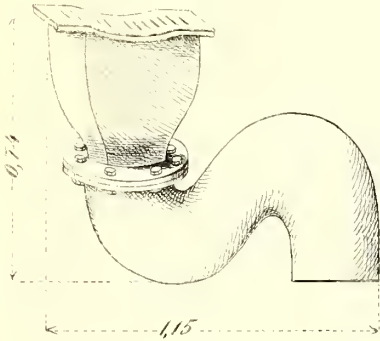

814.

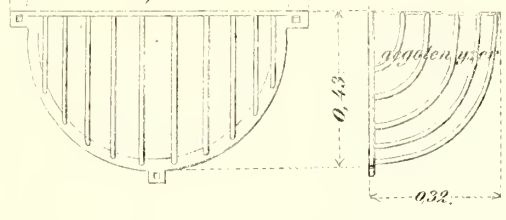

817.

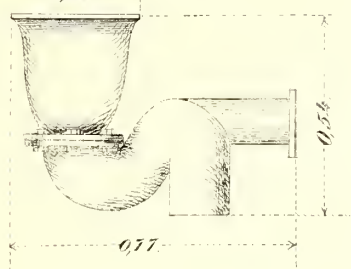

819.

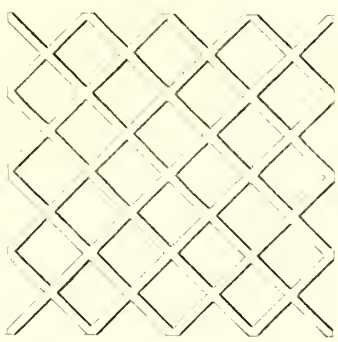

820.

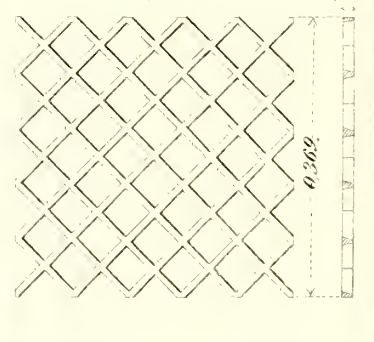

818.

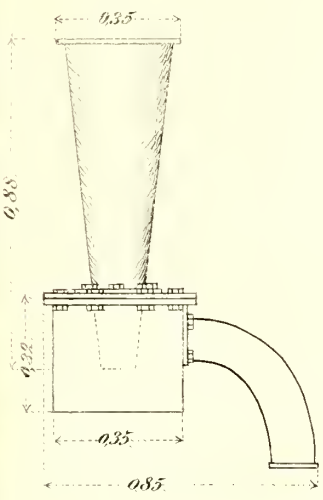

821.

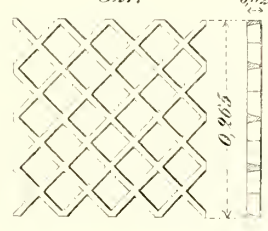

822.

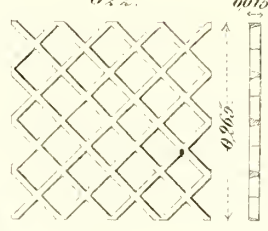

823.

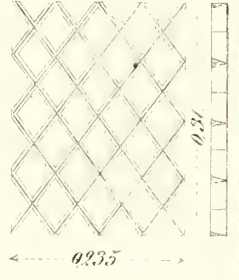

824.

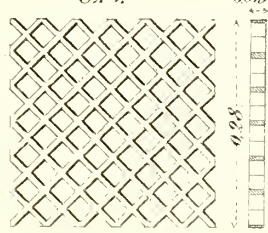

825.

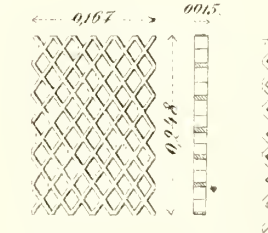

826.

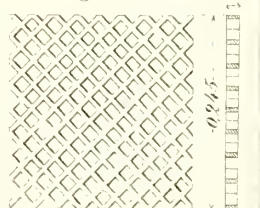

1/10 der ware grootte

Deze roosters worden op verlangte afmetingen geleverd

Fabriek van Bronswerken van *Becht en Dyserinck.*

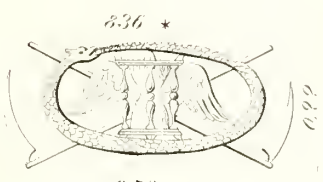
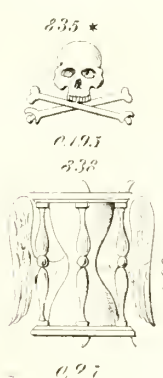
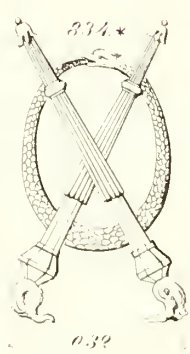
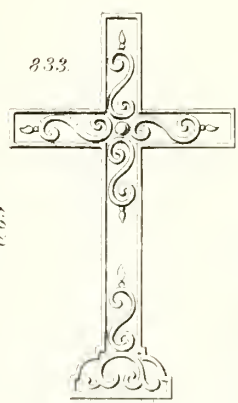
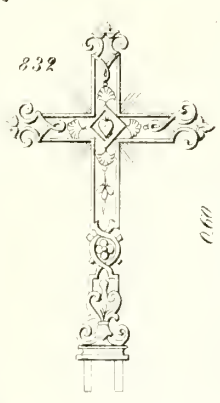
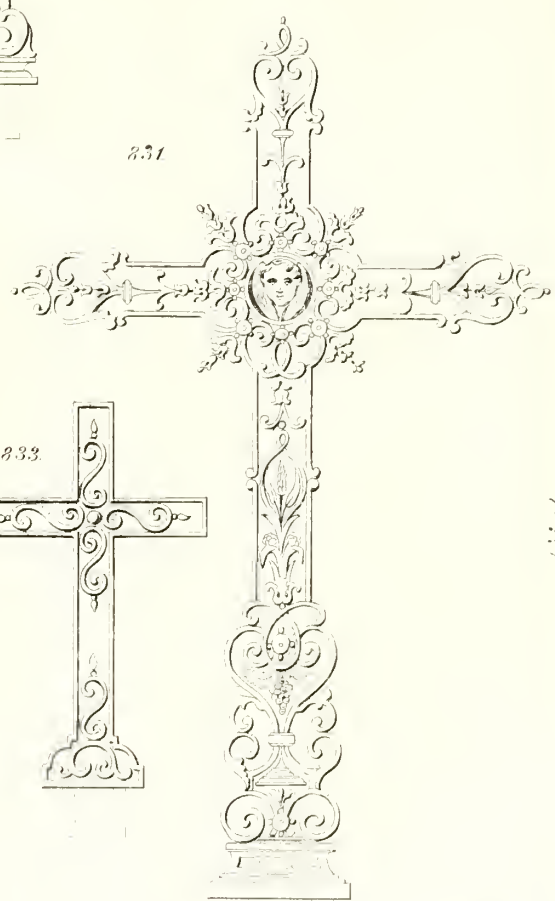
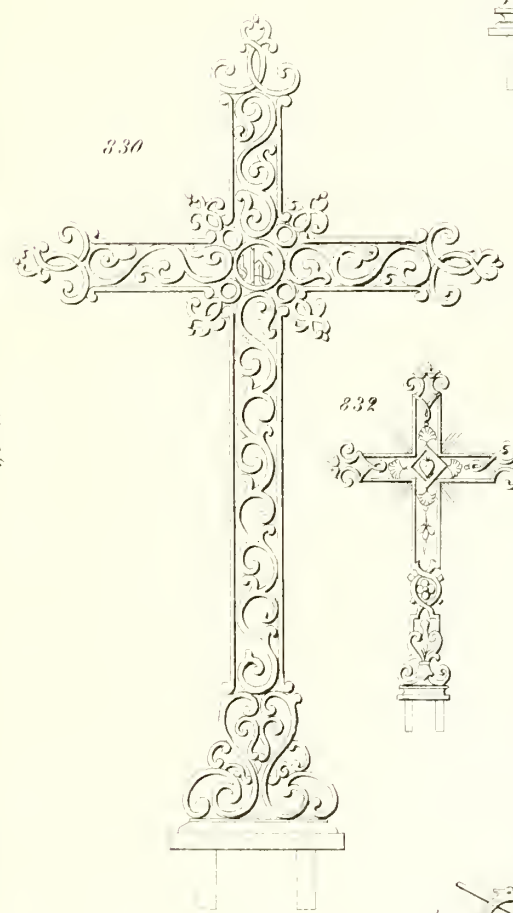
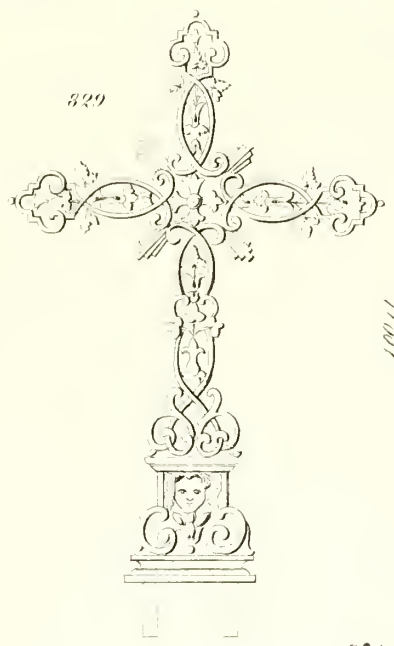
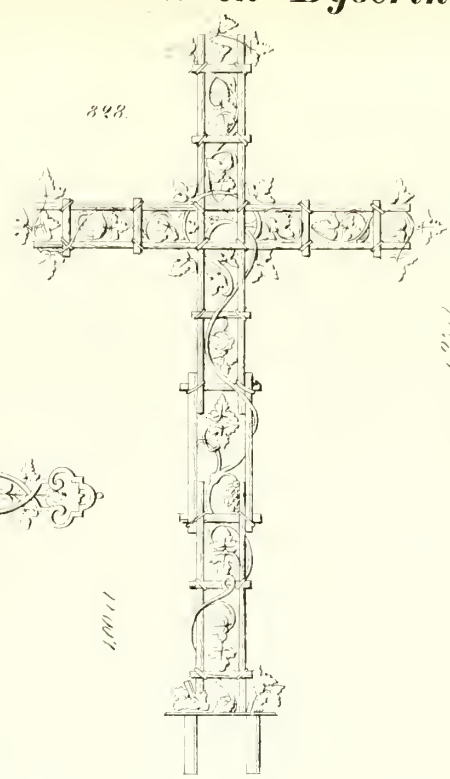
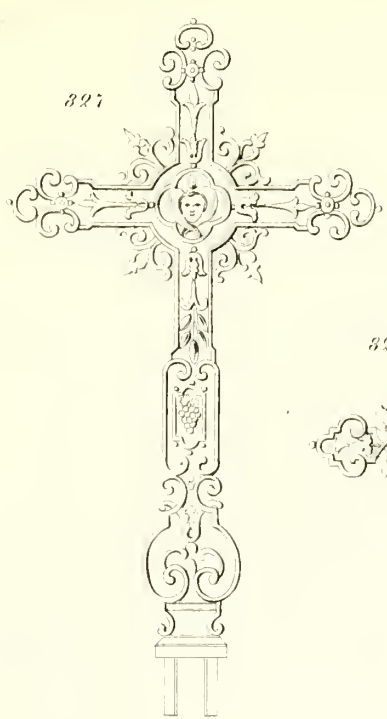

*De nummers met een * gemerkt zyn aan de uitbreyde ghest of heet*

Fabriek van Bronswerken van *Becht en Dyserinck*.

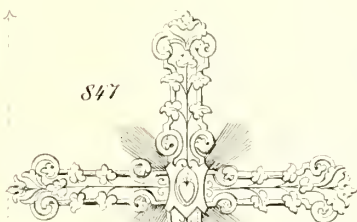
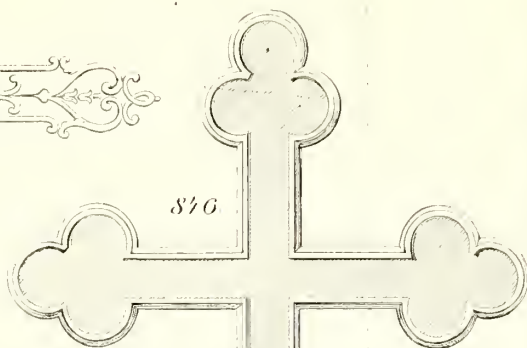
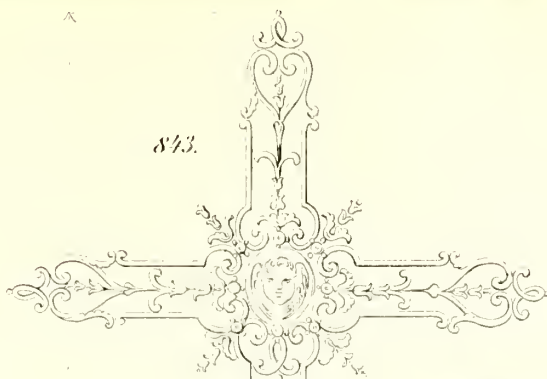
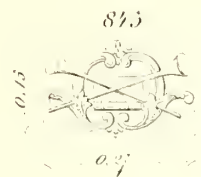
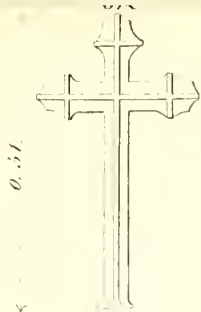

1.55

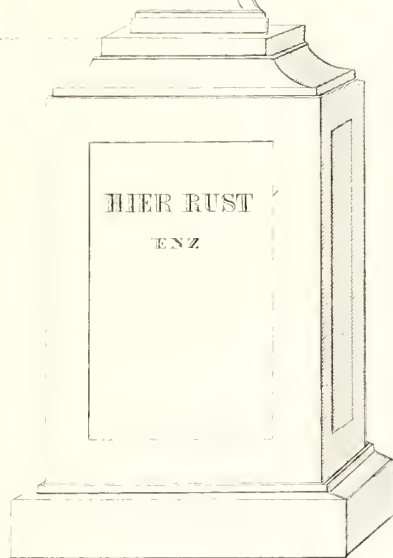

0.92

0.60

1.00

0.50

HIER RUST
ENZ

0.30

2.00 Ft

0.23

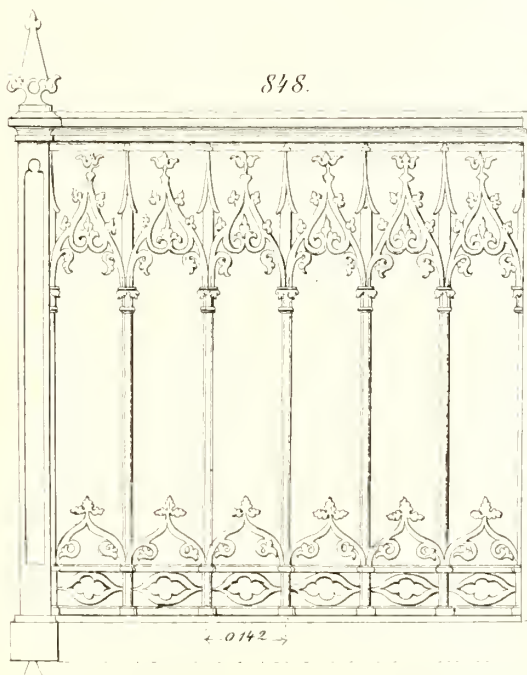

0.142

0.91

0.84

0.07

0.08

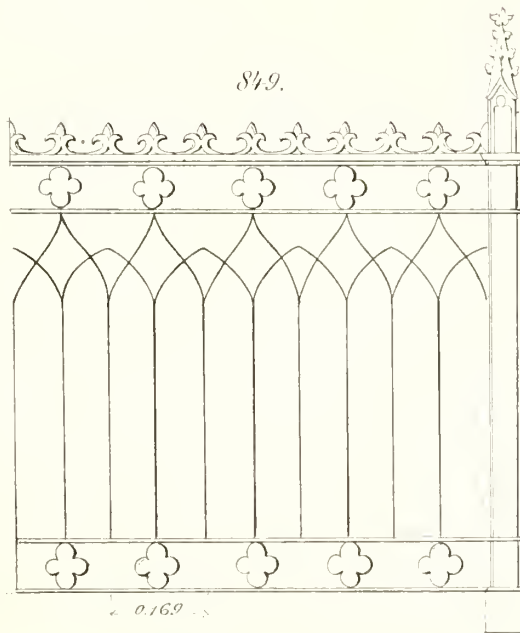

0.169

Fabriek van Bronswerken van *Becht en Dyserinck.*

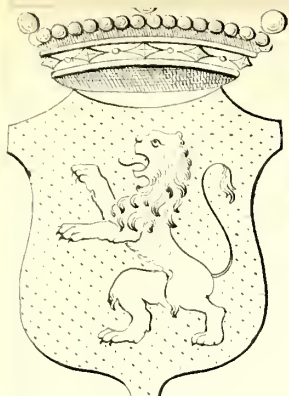

UTRECHT



850



851



852

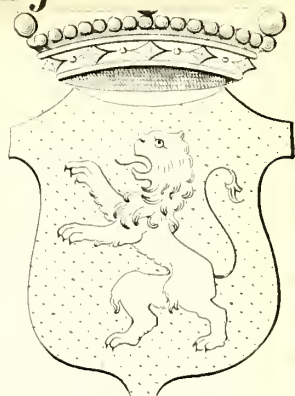

NOORDBRABANT

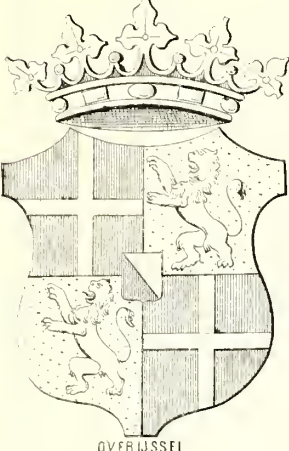

OVERIJSEL



853

855



856

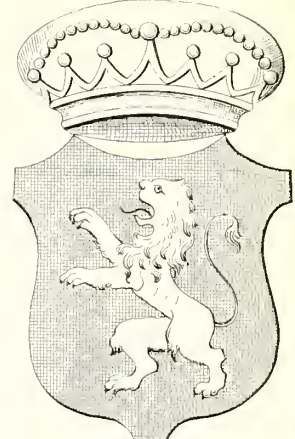

GELDERLAND

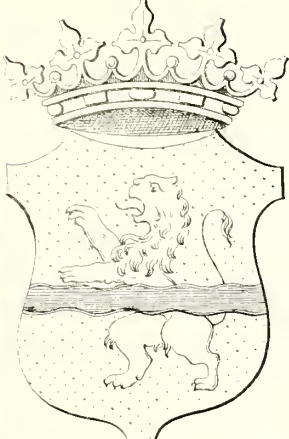

GRONINGEN

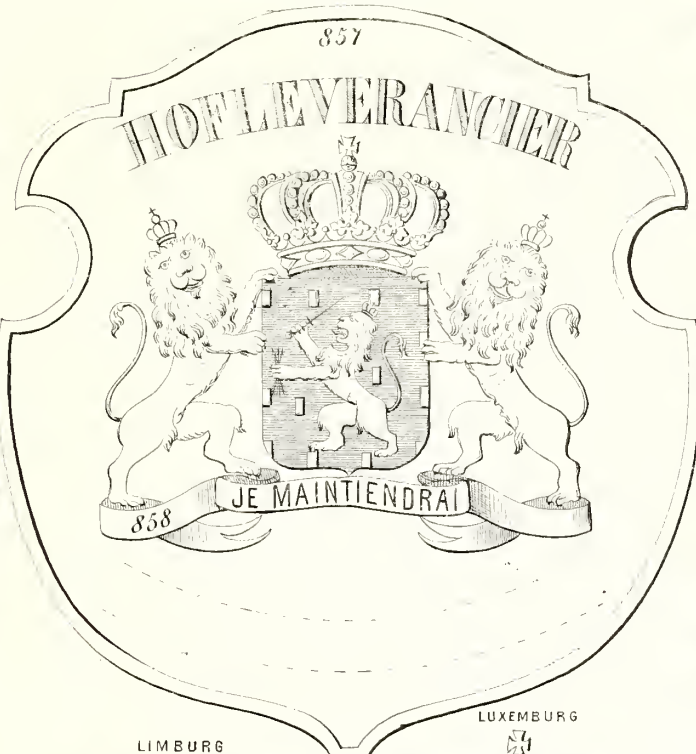

857

858

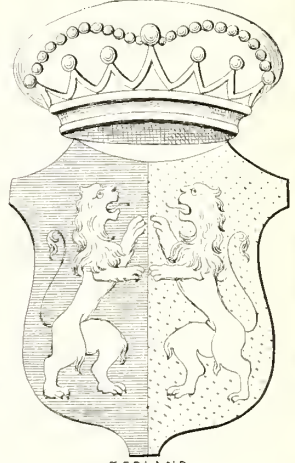

ZEELAND

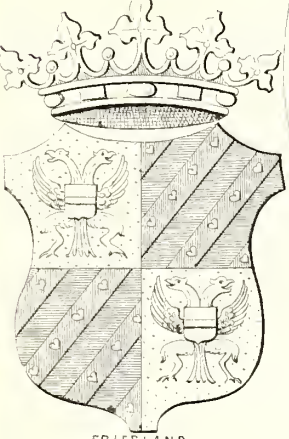

FRIESLAND

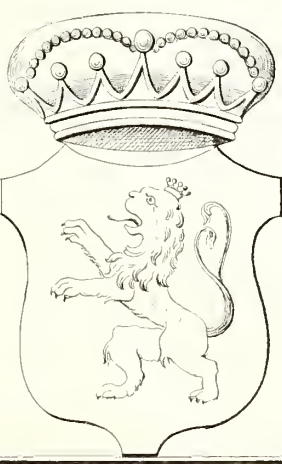

LIMBURG

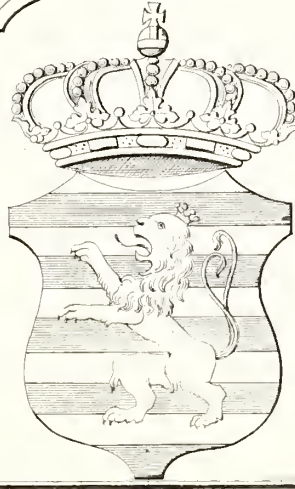

LUXEMBURG

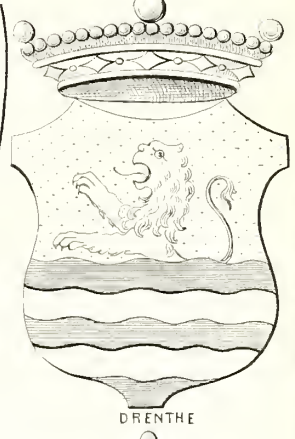

DRENTHÉ

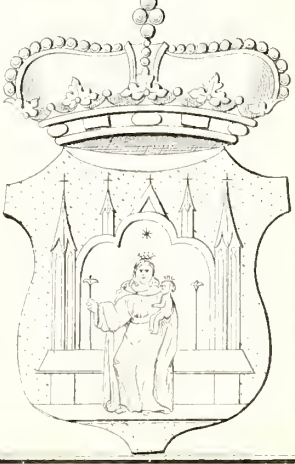
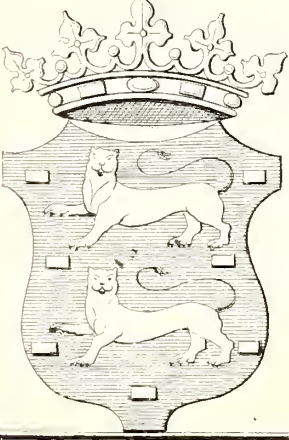

De letters van 3^o 857 kunnen desverkiezende aangepast of veranderd worden.

Fabriek van Bronswerken van *Becht en Dyserinck.*

no der ware grootte

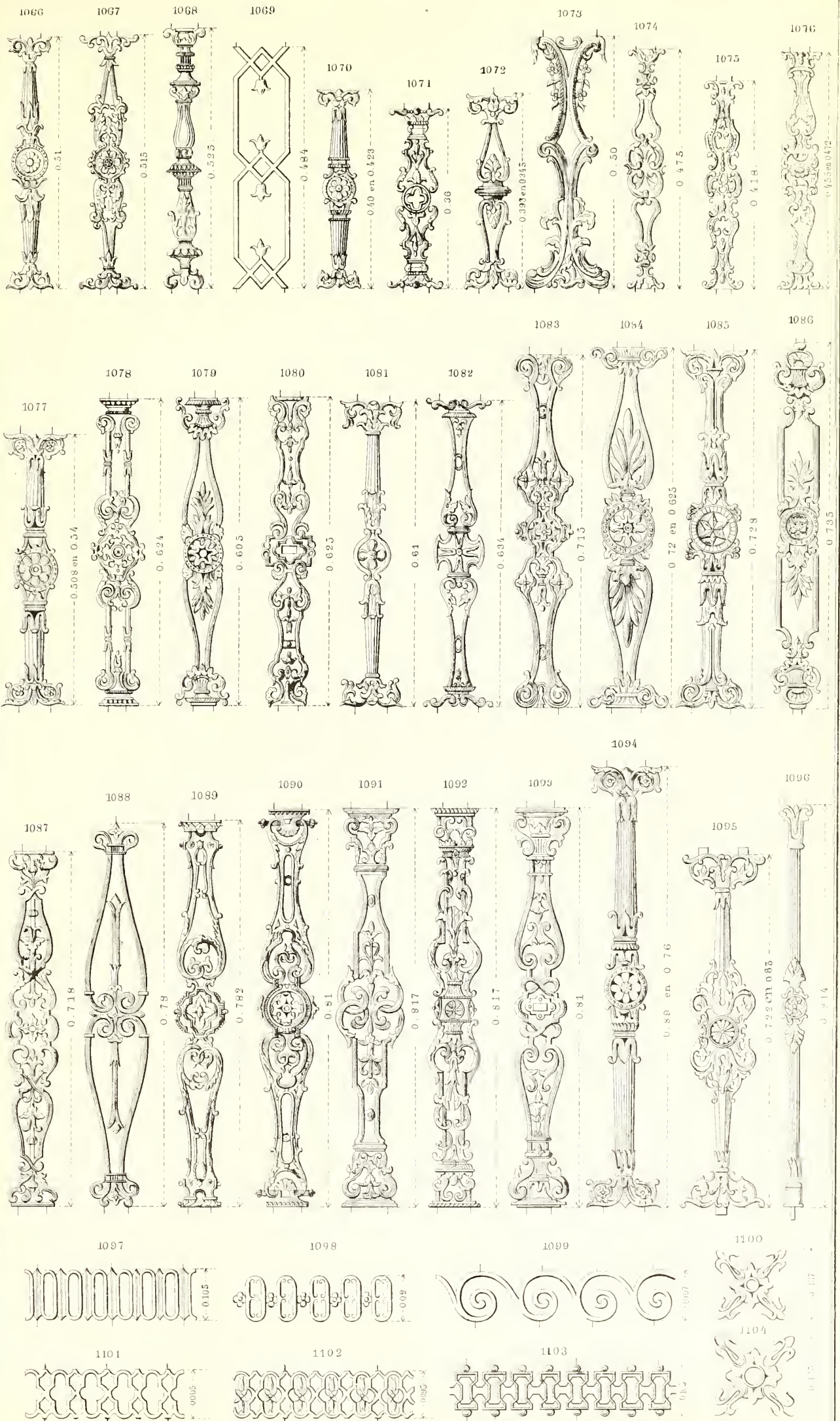



Fabriek van Bronswerken van *Becht en Dyserinck.*

20 der ware grootte.

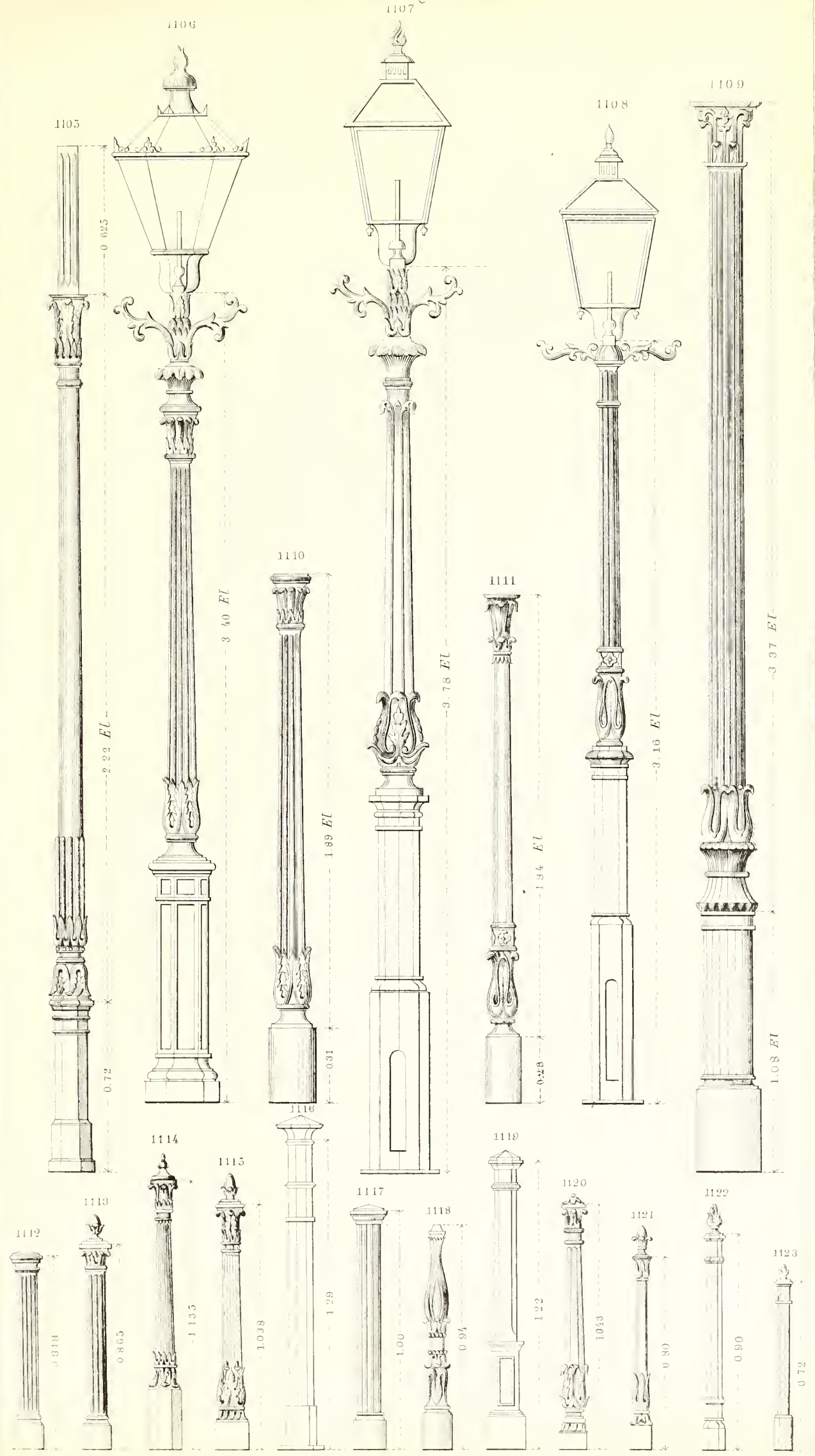

Fabriek van Bronswerken van Becht en Dyserinck.

PAALMETTEN



Fabriek van Bronswerken van *Becht en Dyserinck.*

N^o 1138

Schaal van 1:20

N^o 1139

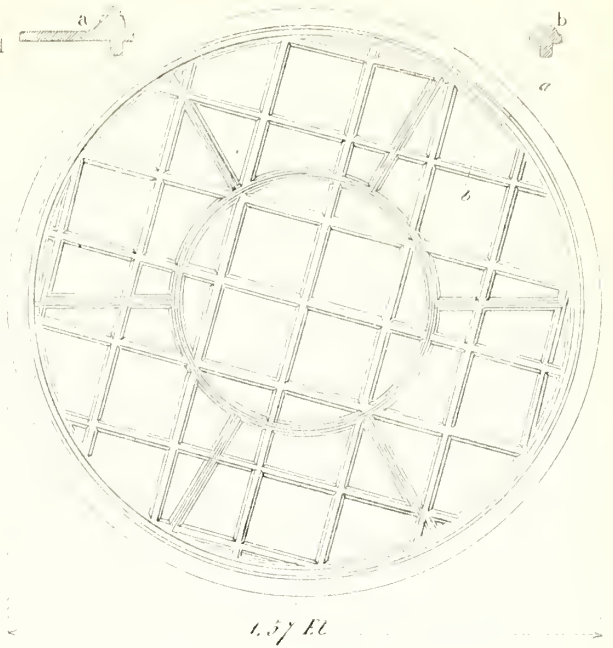
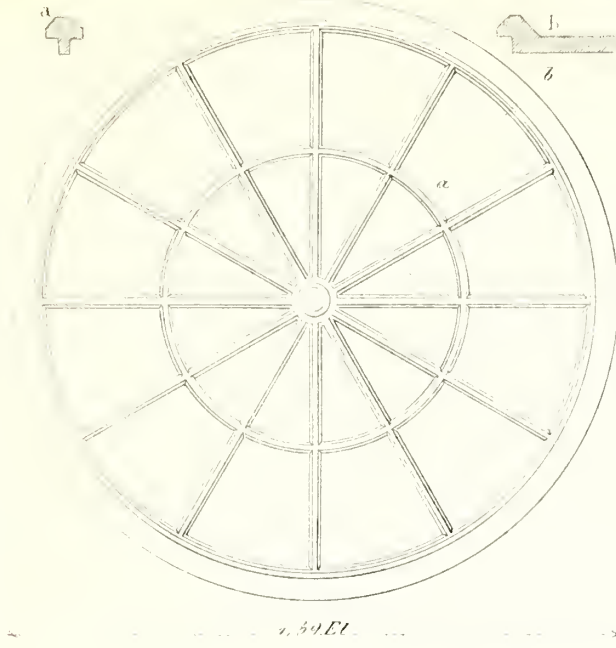

N^o 1140

N^o 1141

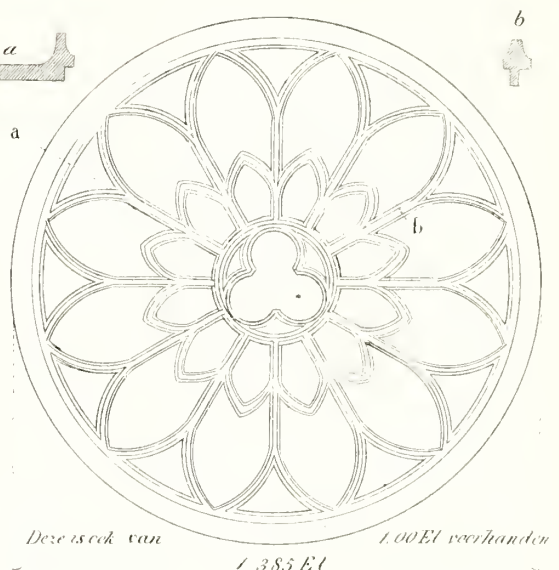
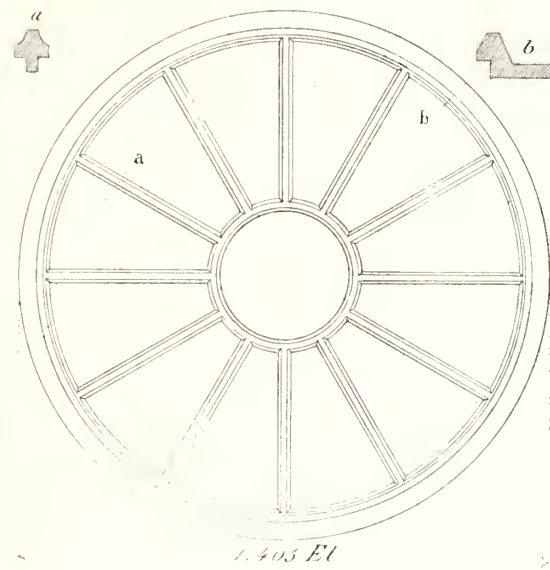

N^o 1142

N^o 1143

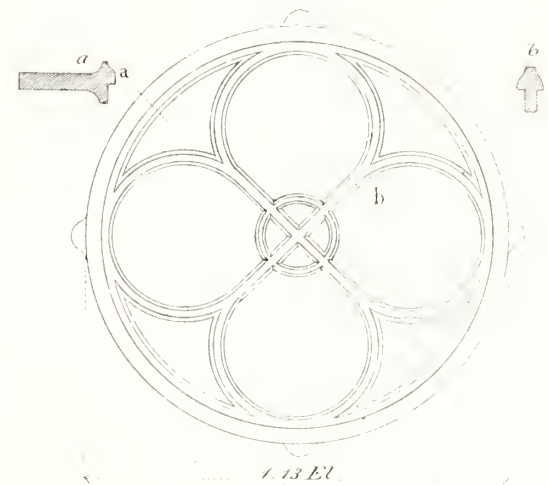
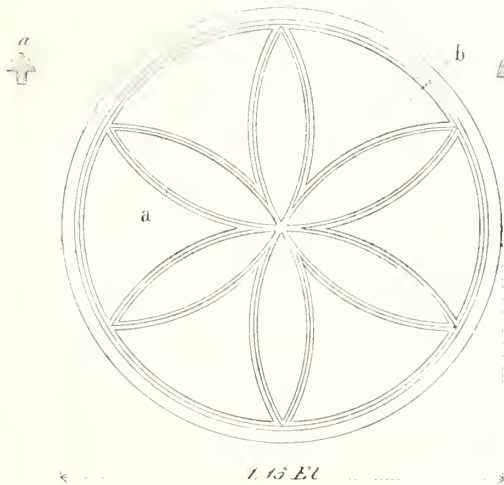

NB De doorsneden op 1/3 der ware grootte.

Fabriek van Bronswerken van *Becht en Dyserinck*.

N^o 1144

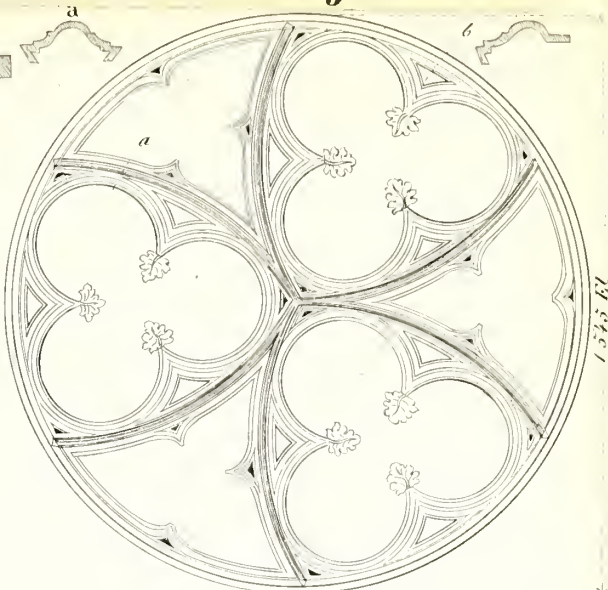
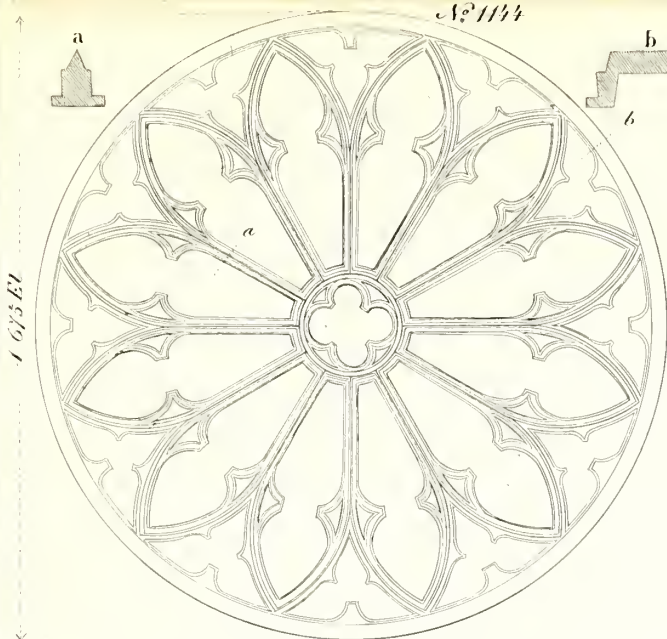

N^o 1147
1 49 El

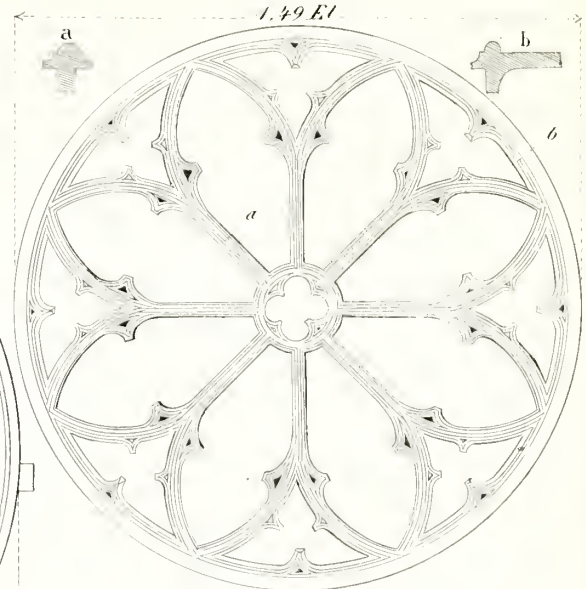

N^o 1146

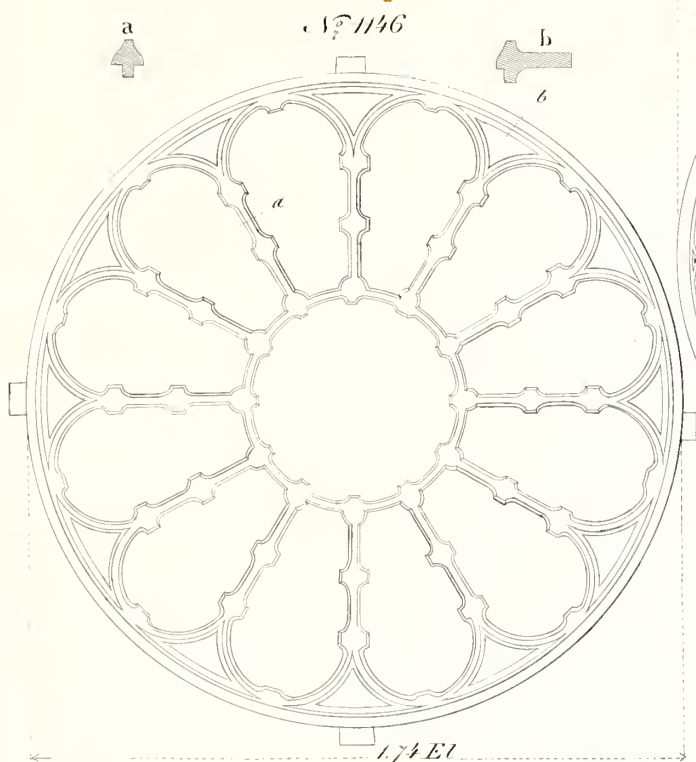

Doorsnide der drie laatste nummers
schaal 2 3



N^o 1148

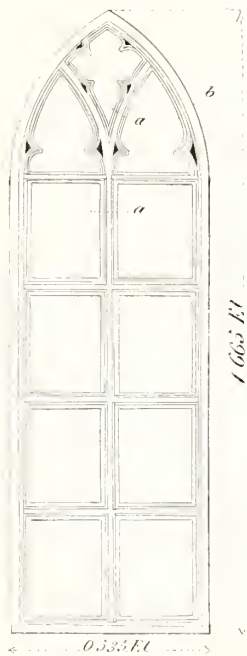

N^o 1149



N^o 1150

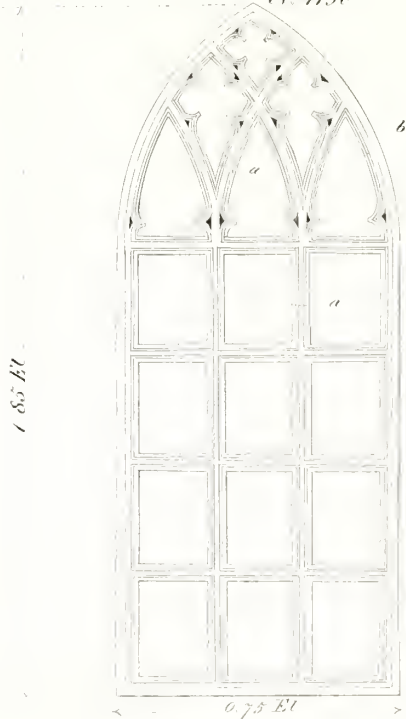

Schaal van 1 20

Doorsneden schaal van 1 5

Fabriek van Bronswerken van *Becht en Dyserinck.*

N^o 1151

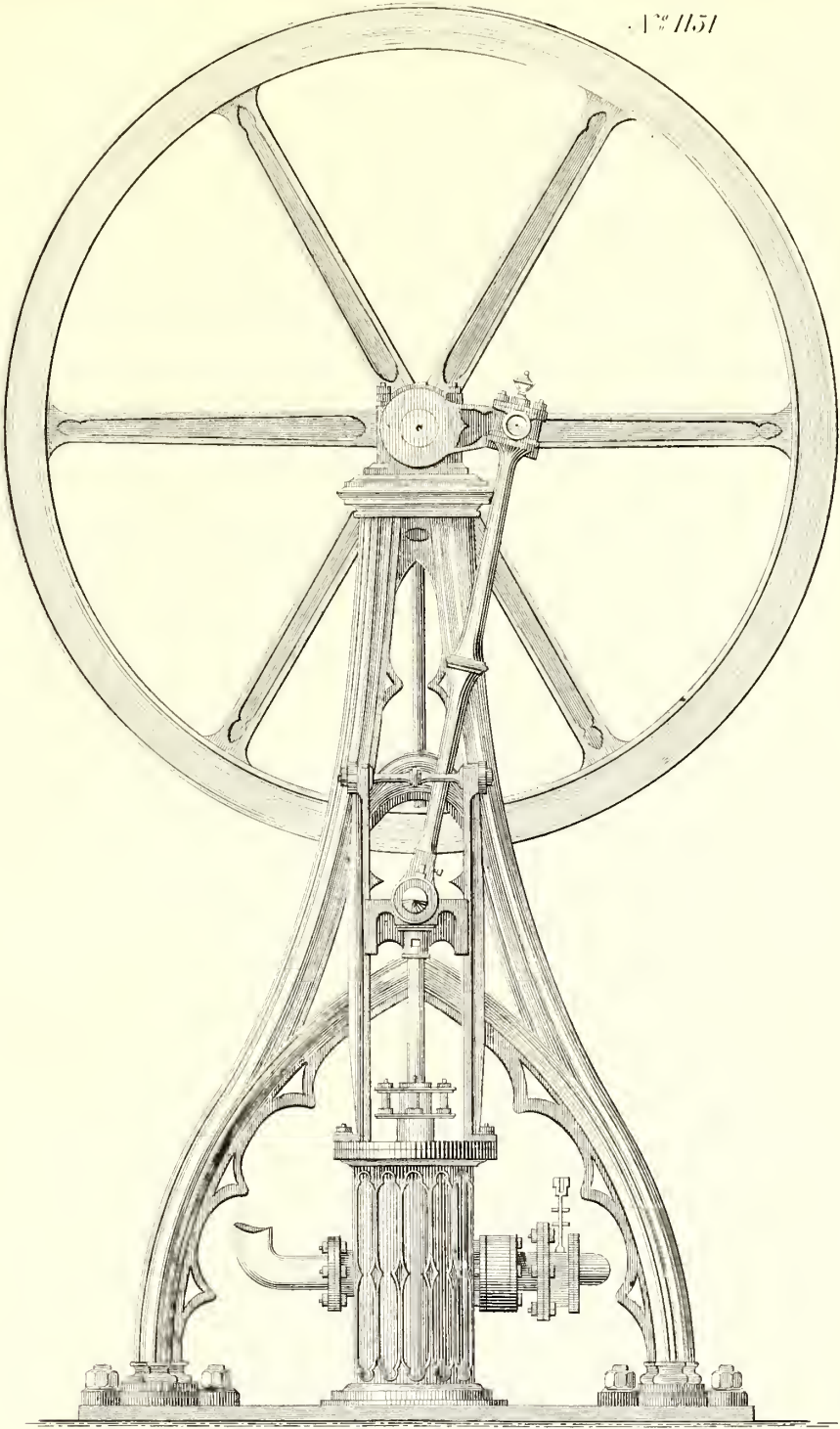

N^o 1152

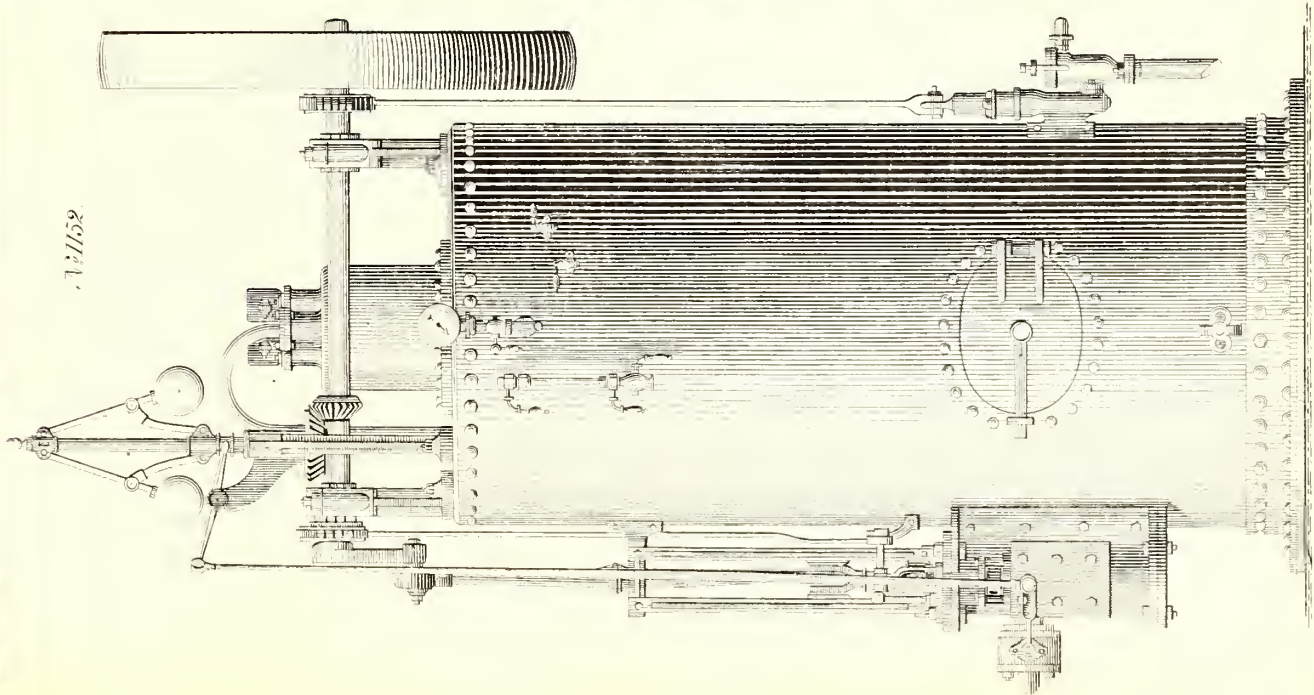

Fabriek van Bronswerken van *Becht en Dyserinck.*

1153.



0,685 El.

1154.

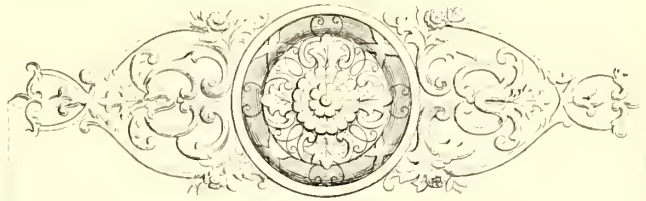

0,56 El.

1155.



0,685 El.

1156.

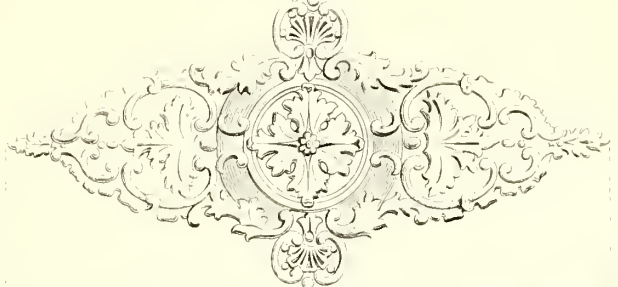

0,80 El.

1157.

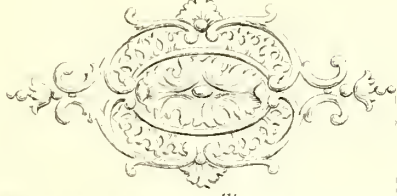

0,51 El.

1158.

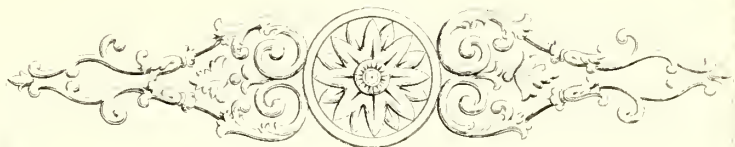

0,98 El.

1159.

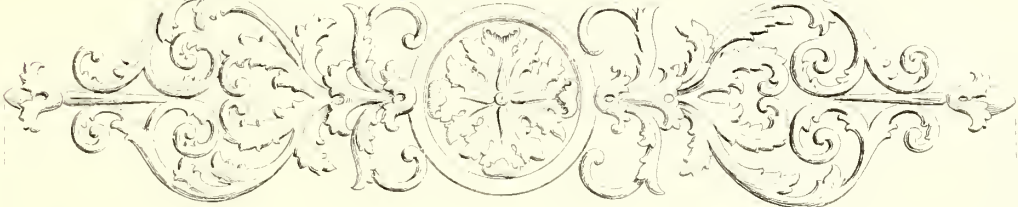

1,33 El.

1160.



0,88 El.

1161.



0,48 El.

1162.



0,59 El.

1163.



0,49 El.

1164.



0,686 El.

1165.



0,68 El.

1166.



0,505 El.

1167.

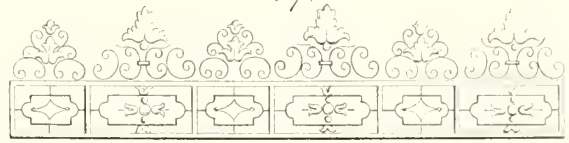

0,246 El.

1168.



0,307 El.

1169.



0,758 El.

Fabriek van Bronswerken van *Becht en Dyserinck*.

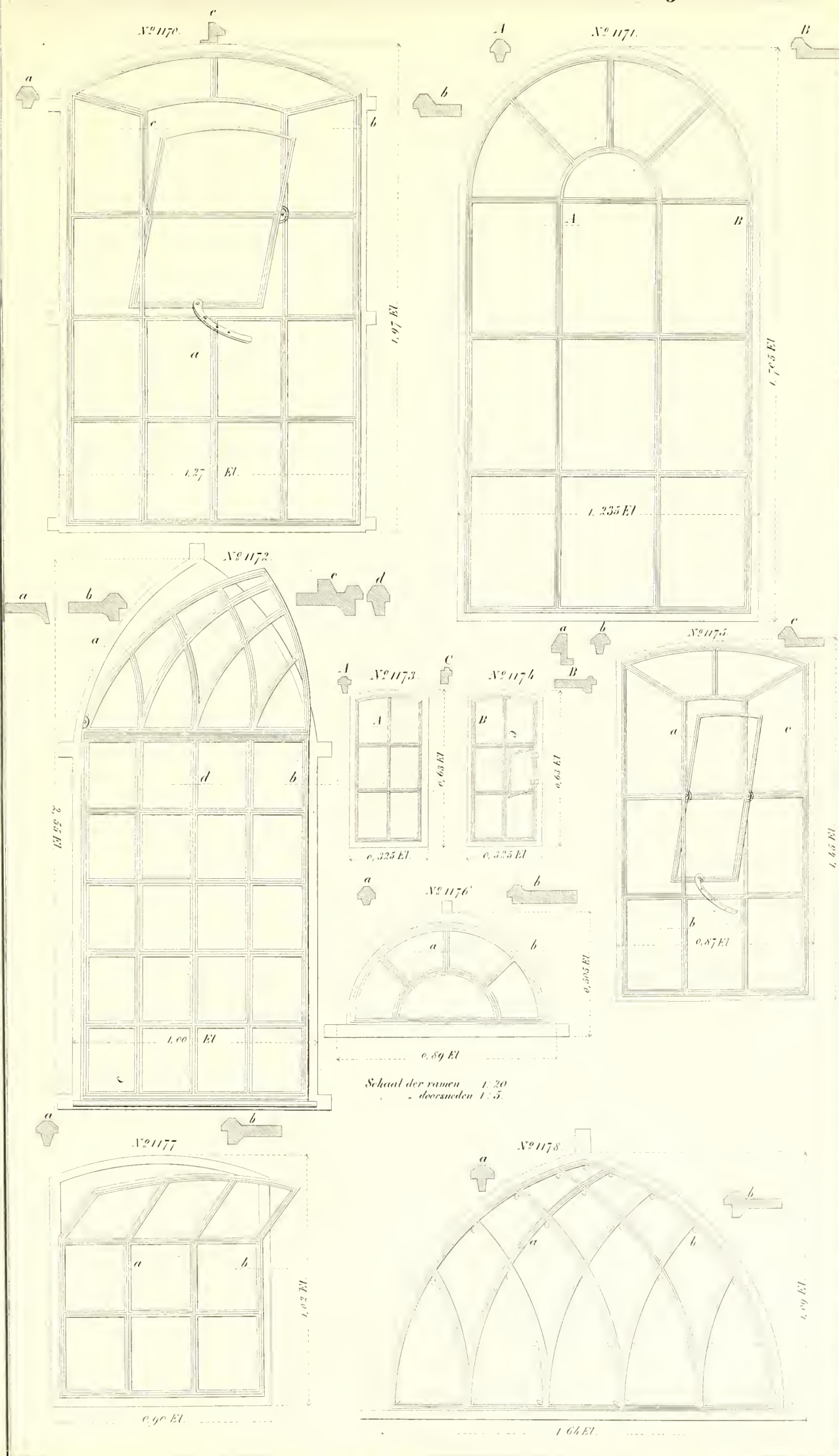

Fabriek van Bronswerken van *Becht en Dyserinck.*

N^o 1179.

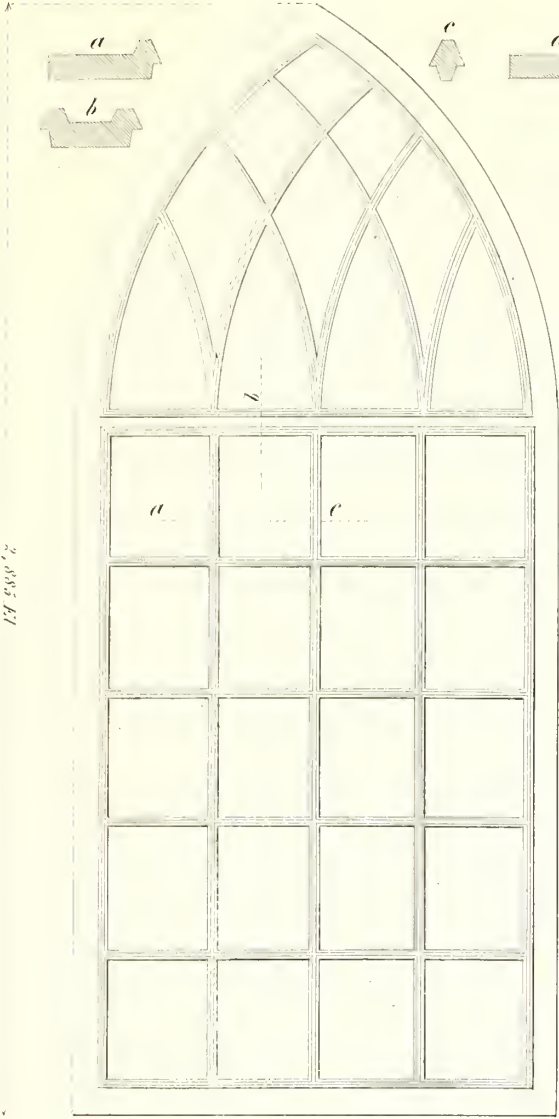

N^o 1180.

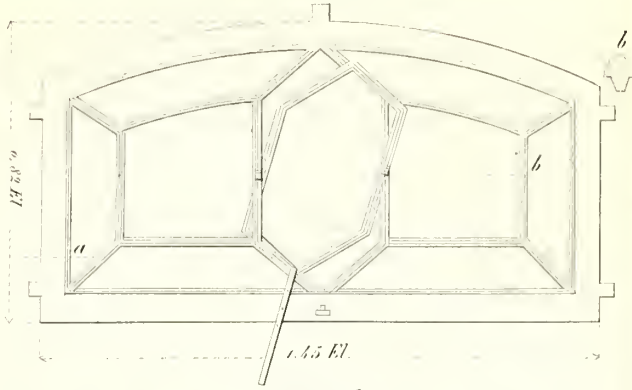

N^o 1181.

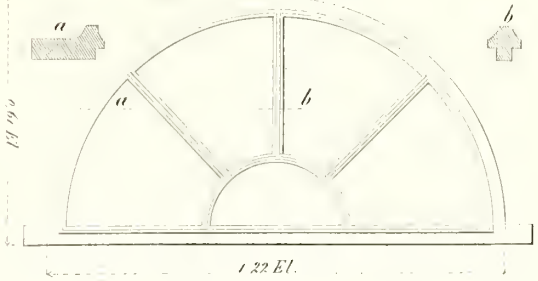

N^o 1182.

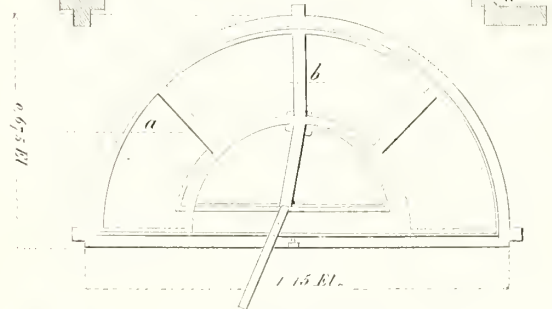

N^o 1183.

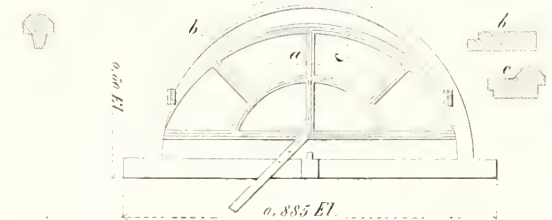

N^o 1187.

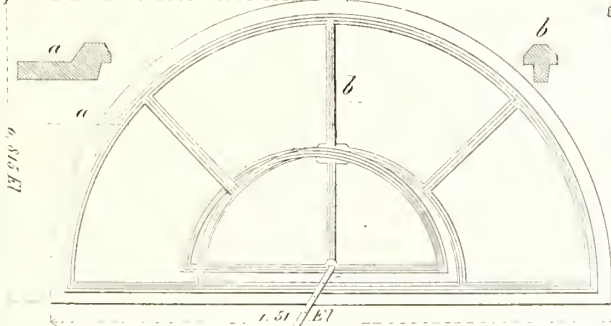

N^o 1184.

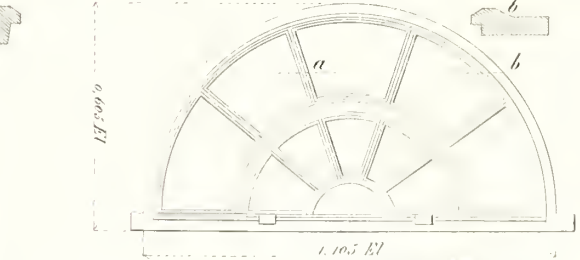

N^o 1188.

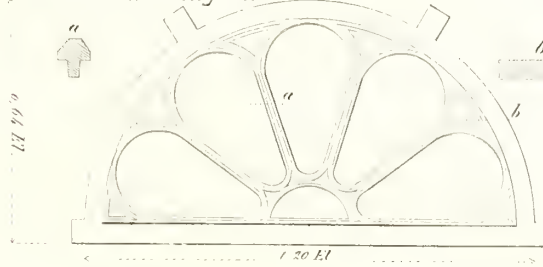

N^o 1185.

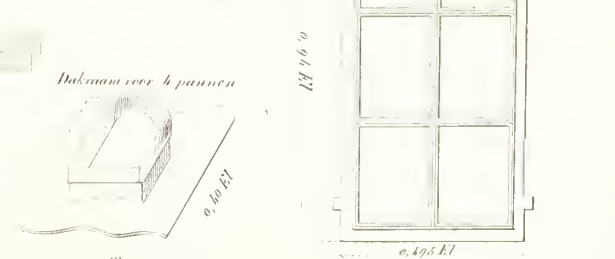

Dakruim voor 4 panen

N^o 1189.

Fabriek van Bronswerken van *Becht en Dyserinck.*

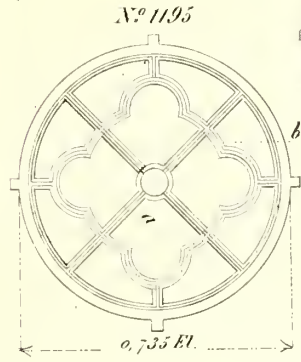
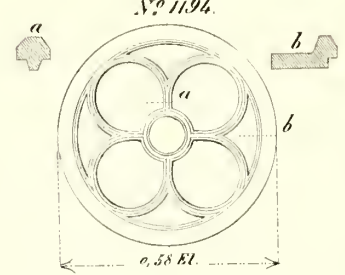
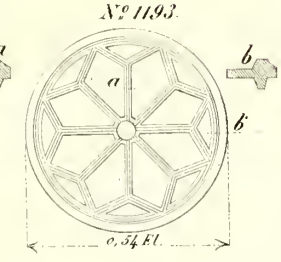
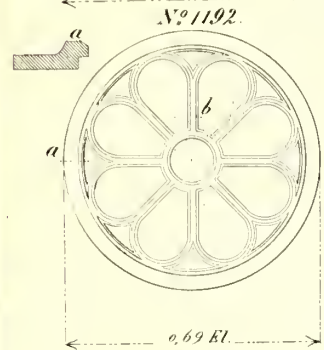
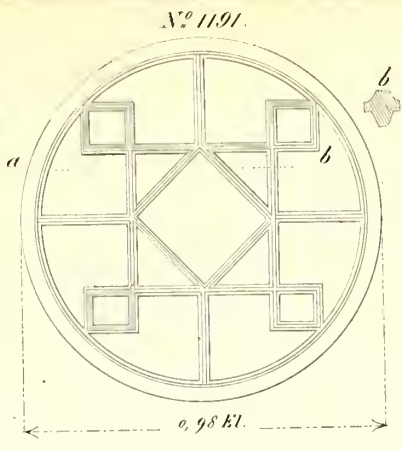
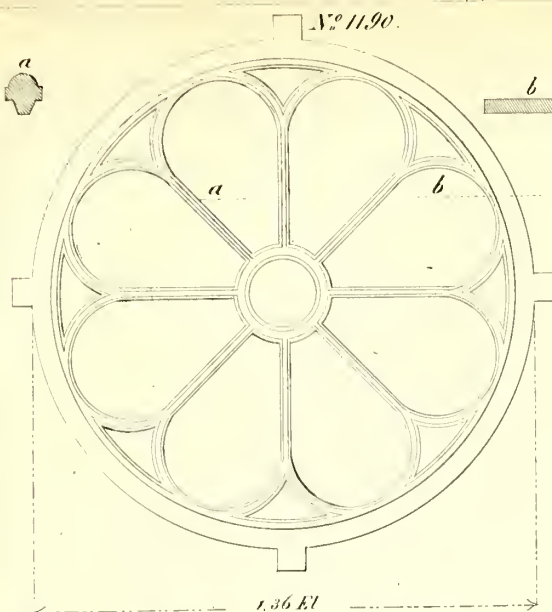

doorsneden
der
Nos
1195 en 1196.

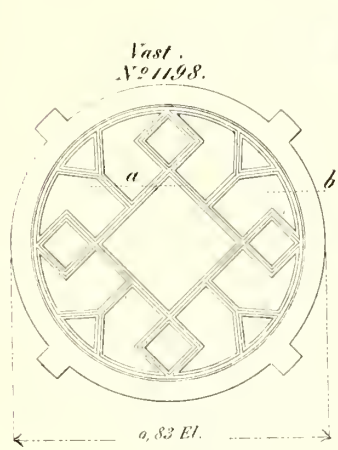
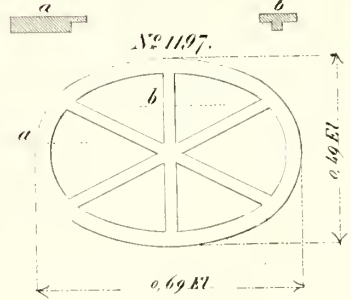
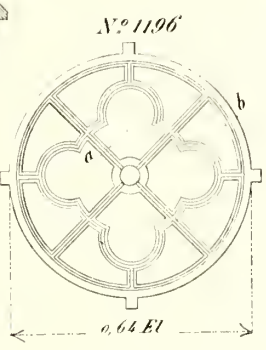

doorsneden der
N^o 1198 & 2000.

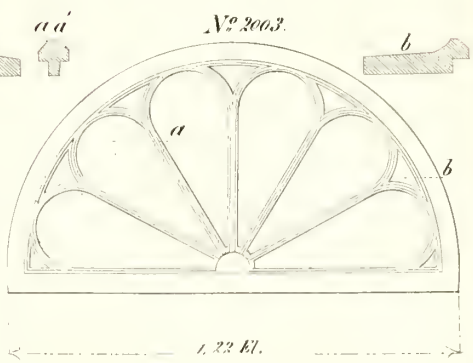
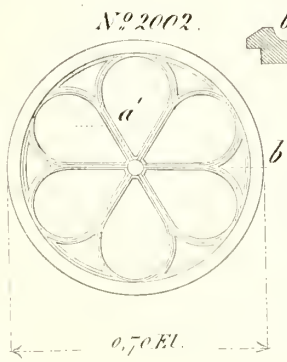
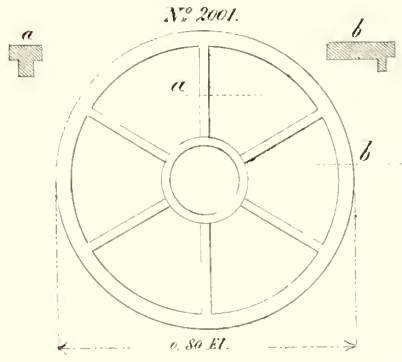
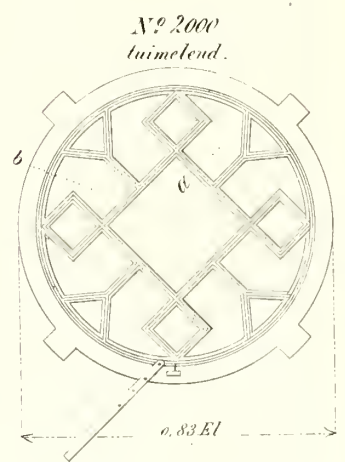
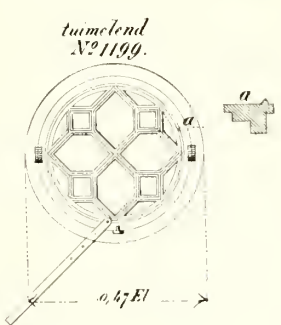

Fabriek van Bronswerken van *Becht en Dyserinck.*

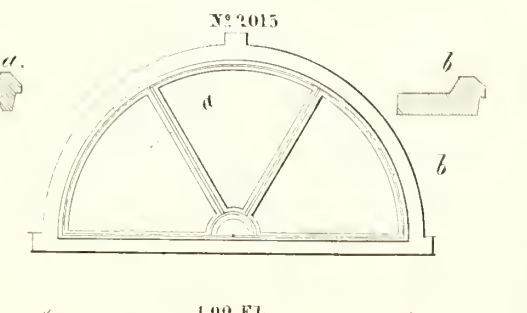
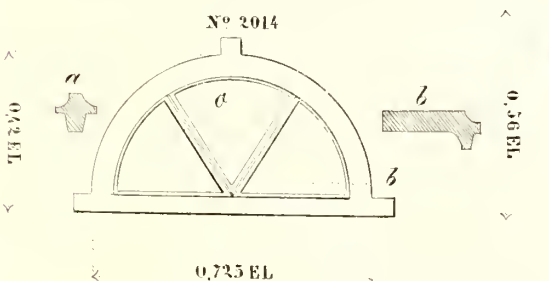
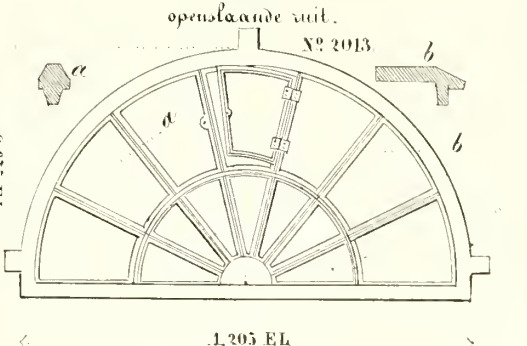
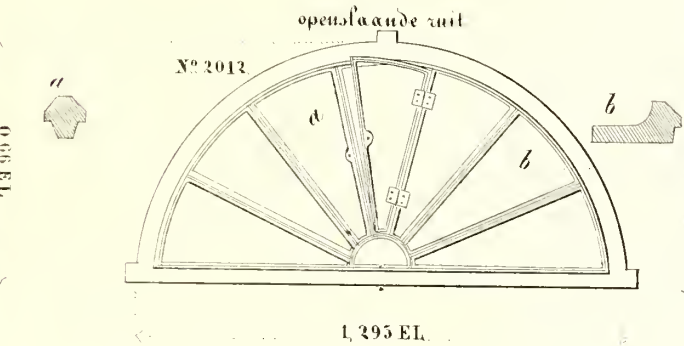
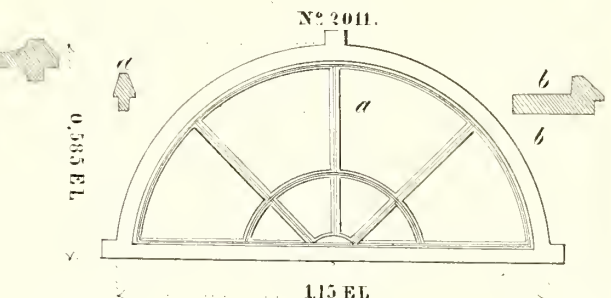
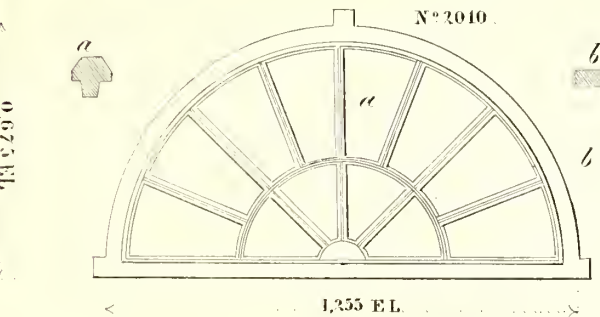
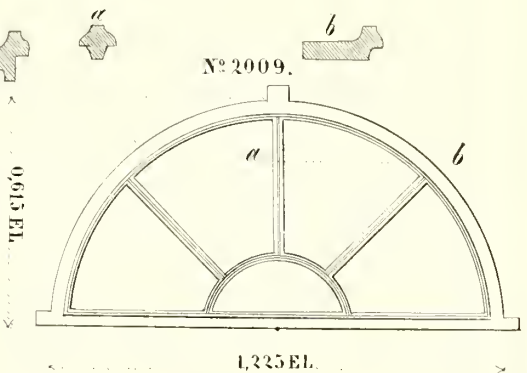
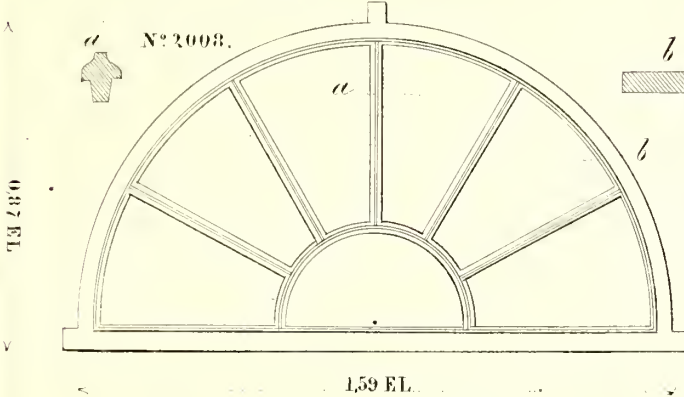
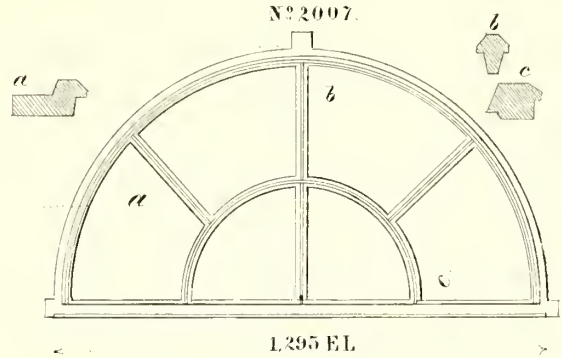
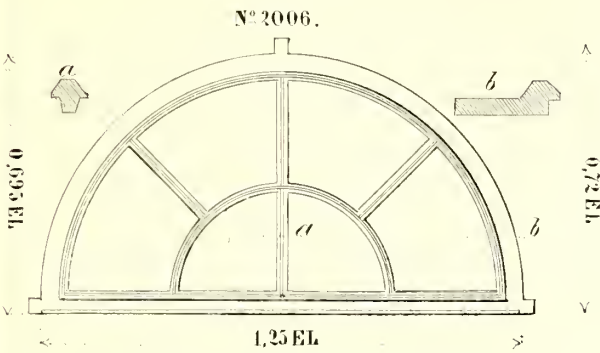
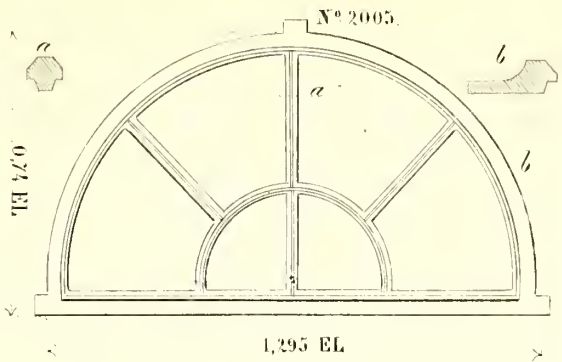
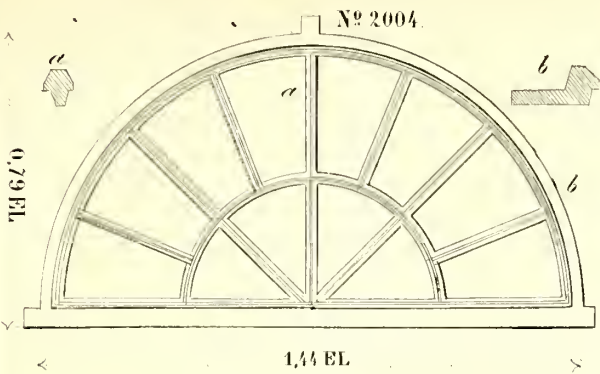

Schaal op 1:20 = 1/20

doorsnede op 1,5 = 1/3

Fabriek van Bronswerken van *Becht en Dyserinck.*

N^o 2016.

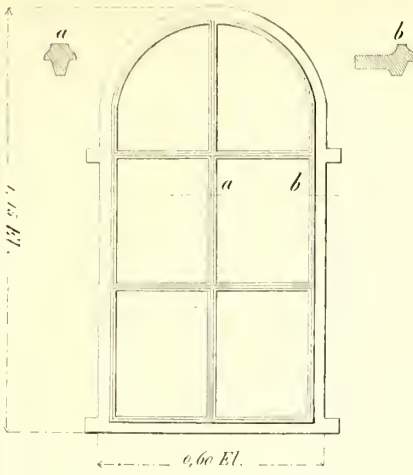

N^o 2017.

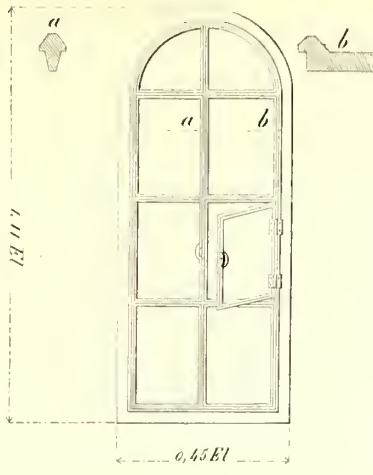

N^o 2018.

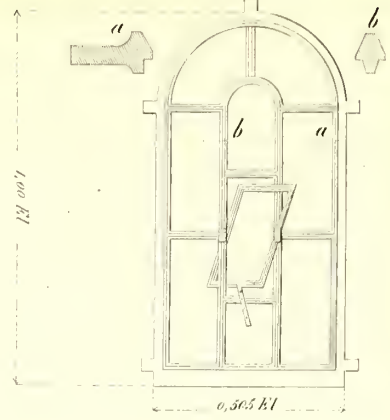

N^o 2019.

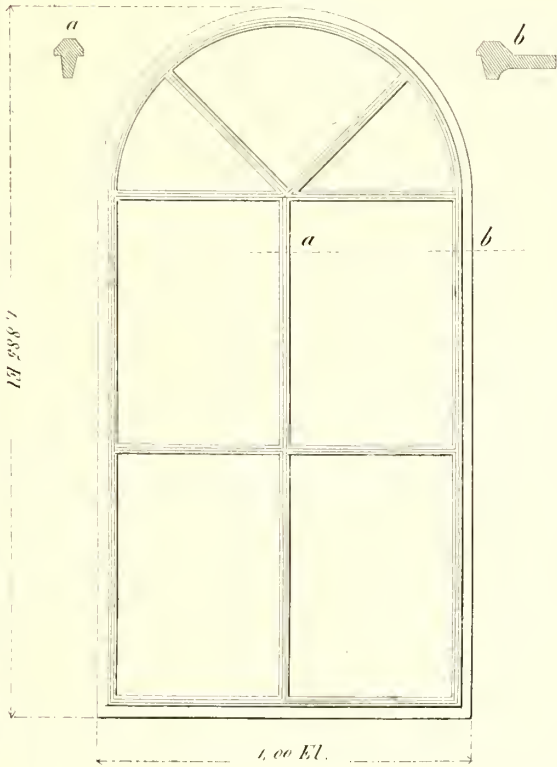

N^o 2020.

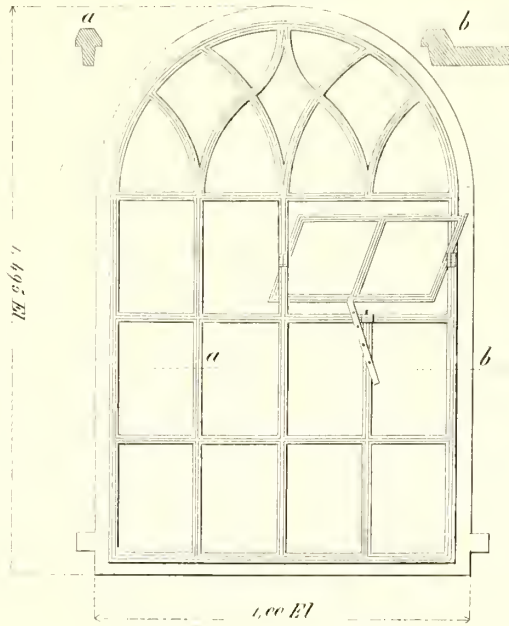

N^o 2021.

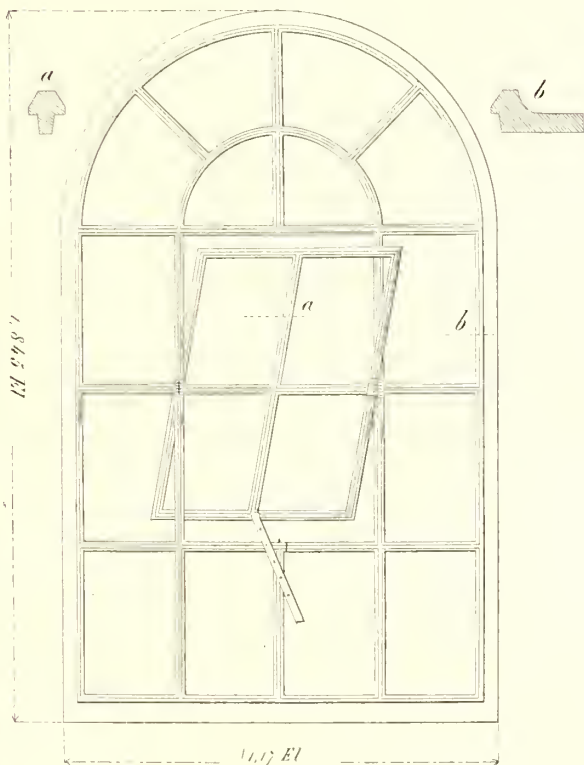

N^o 2022.

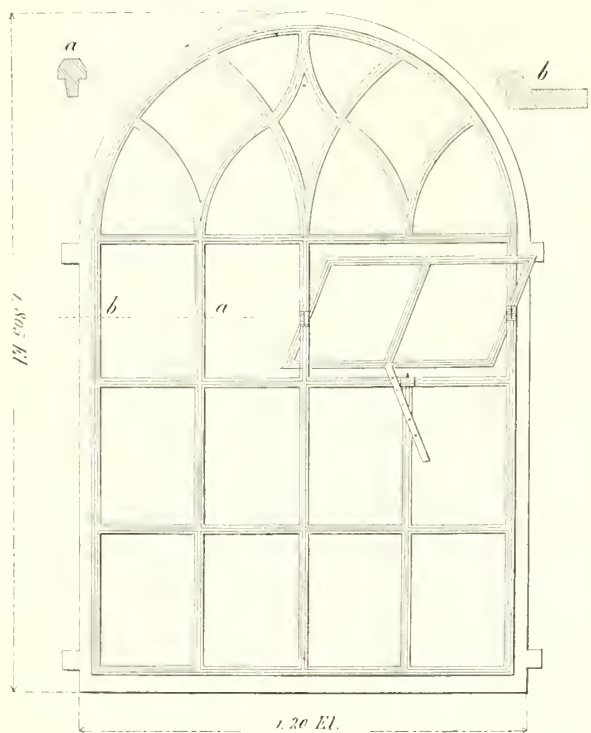

Fabriek van Bronswerken van *Becht en Dyserinck.*

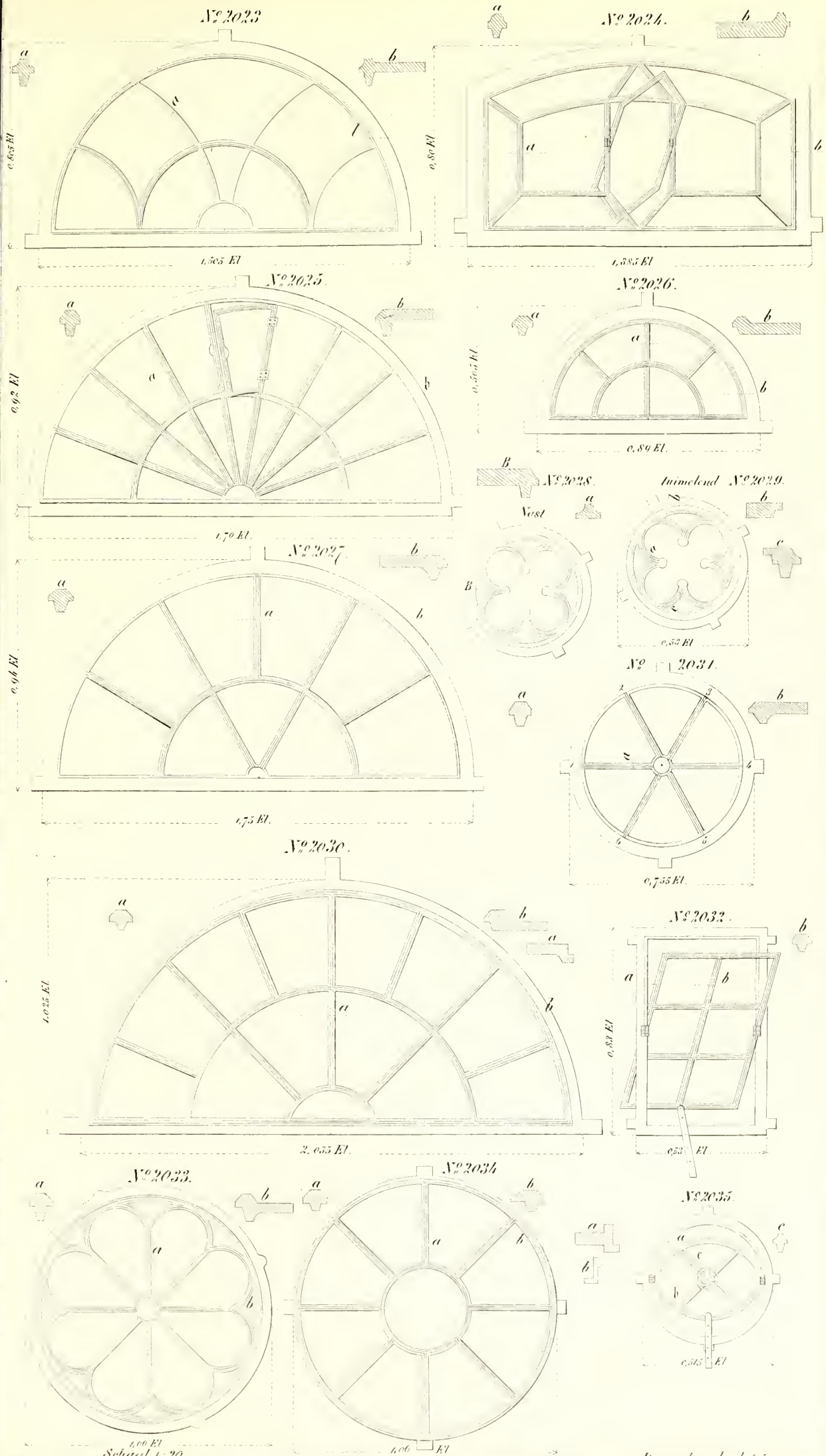

Fabriek van Bronswerken van **Becht en Dyserinck.**

N^o 2036.

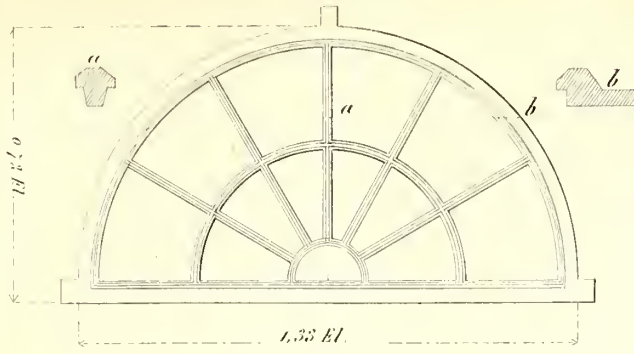

N^o 2037.

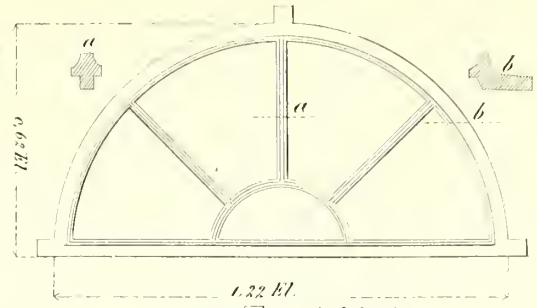

N^o 2038.

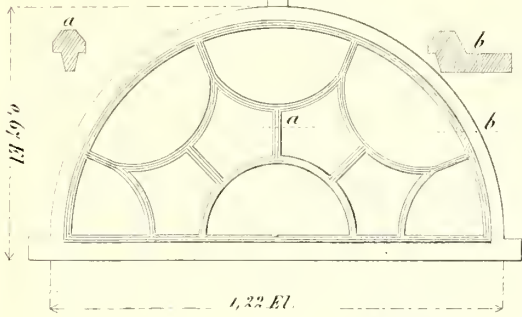

N^o 2039.

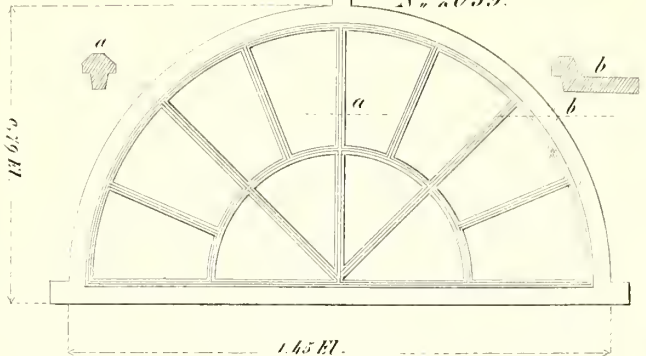

N^o 2040.

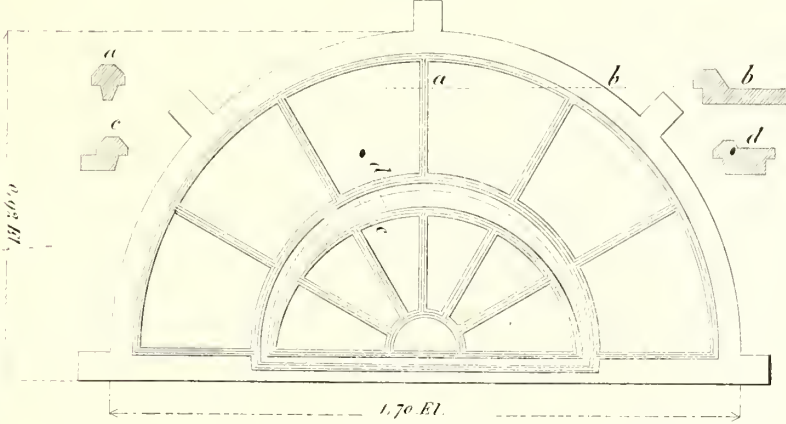

N^o 2041.

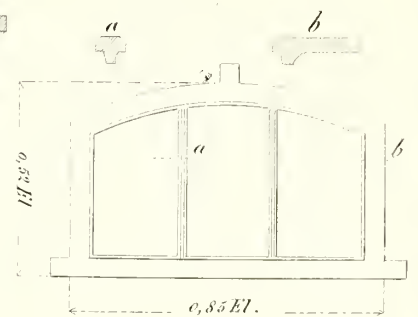

N^o 2042.

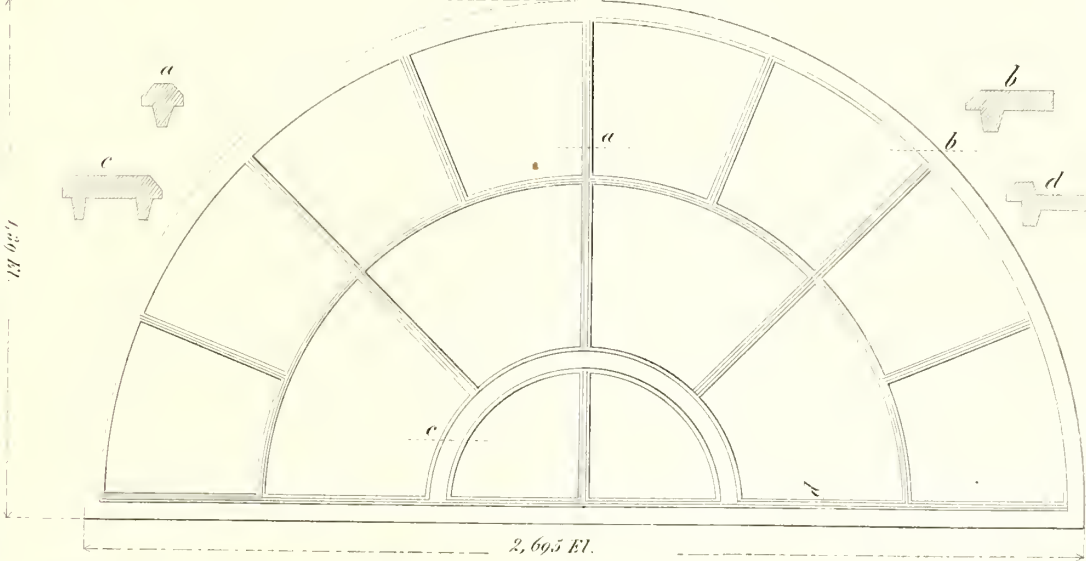

N^o 2043.

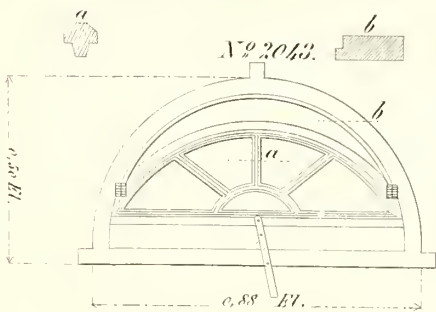

N^o 2044.

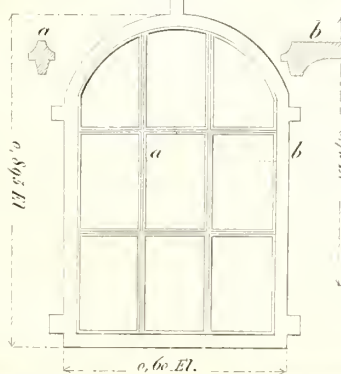

N^o 2045.

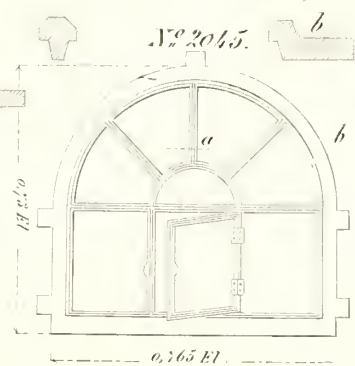

Schaal 1:20.

Doorsneden schaal 1:5.



Fabriek van Bronswerken van *Becht en Dyserinck.*

N^o 2046.

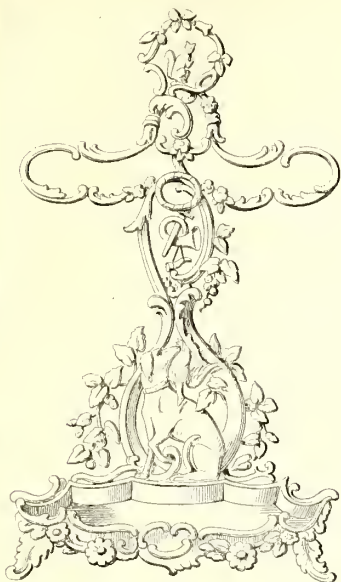

N^o 2047.

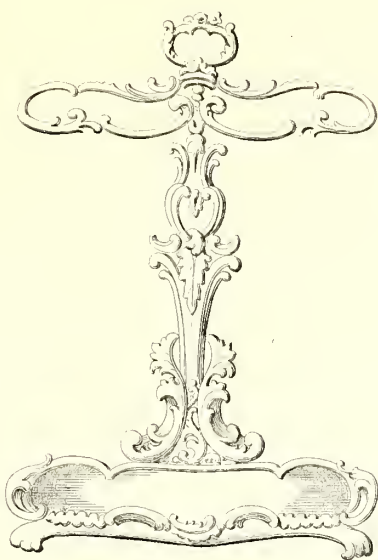

N^o 2048.

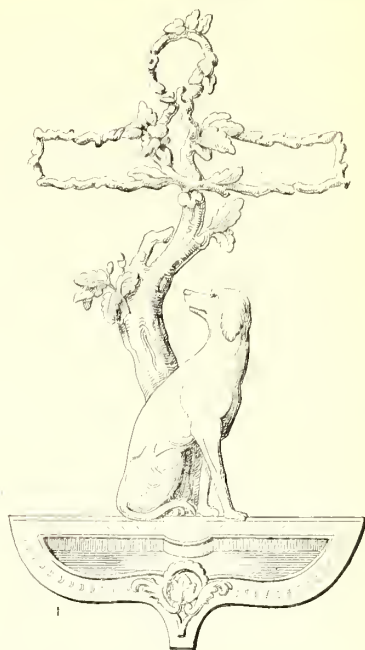

N^o 2049.



N^o 2050.

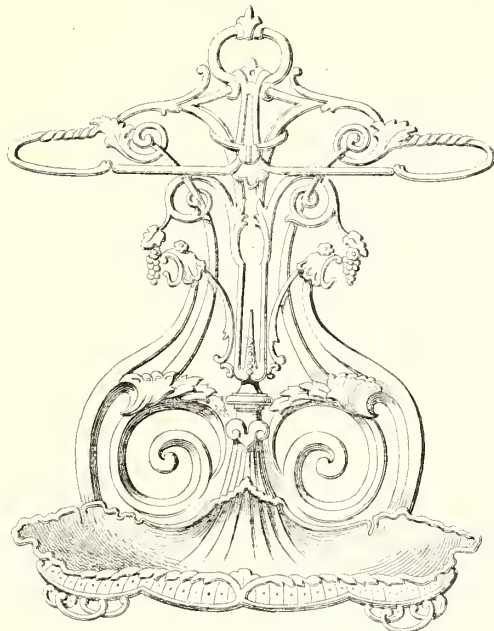

N^o 2051.



N^o 2052.

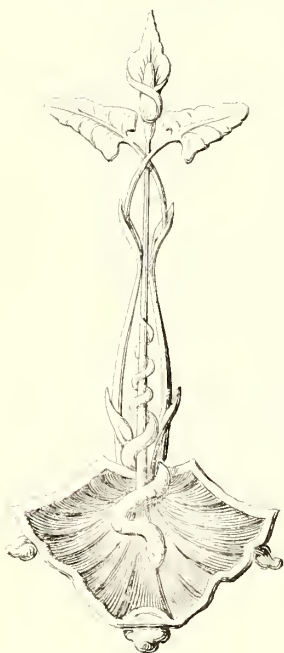

N^o 2053.

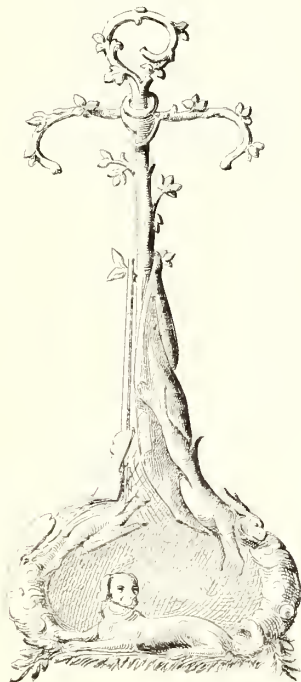

N^o 2054.

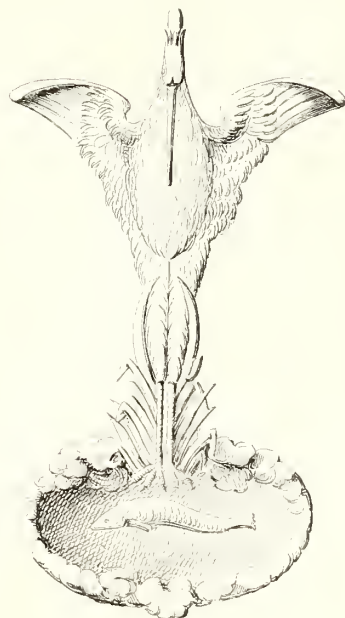

Fabriek van Bronswerken van *Becht* en *Dyserinck*.

N^o 2055.

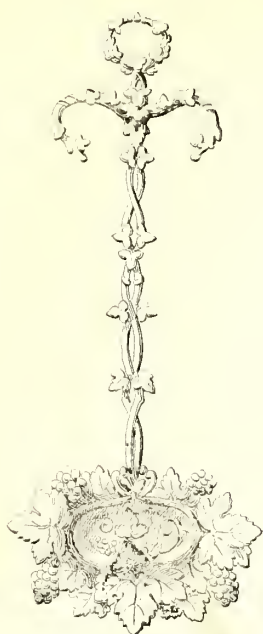

N^o 2056.

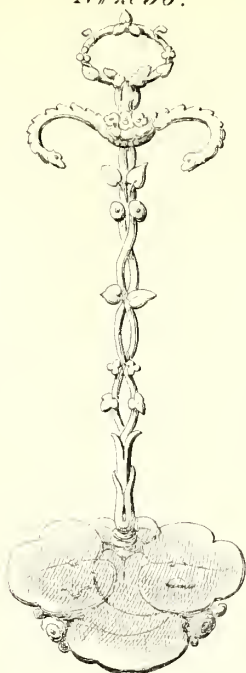

N^o 2057.

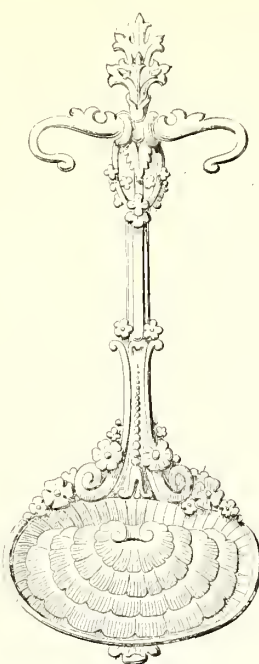

N^o 2058.

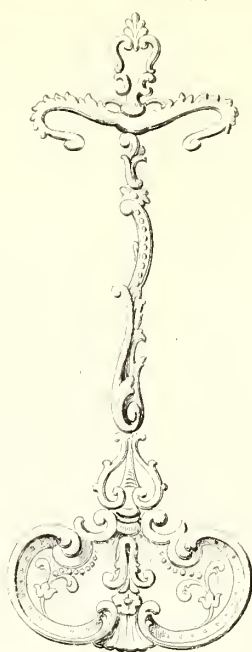

N^o 2059.

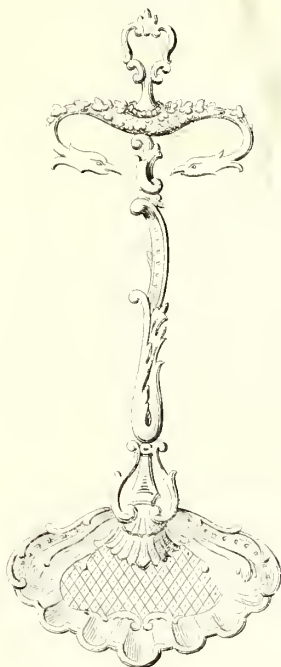

N^o 2060.

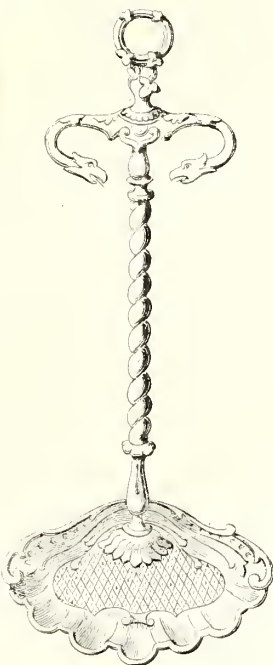

N^o 2061.

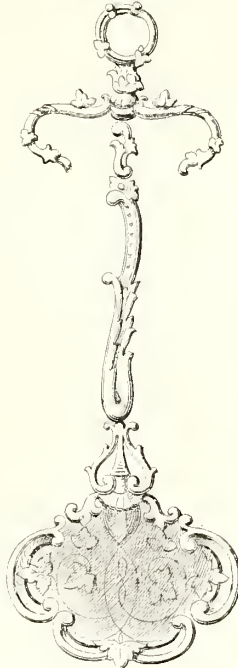

N^o 2062.

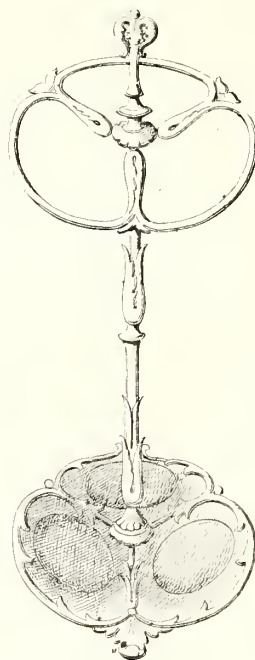

N^o 2063.

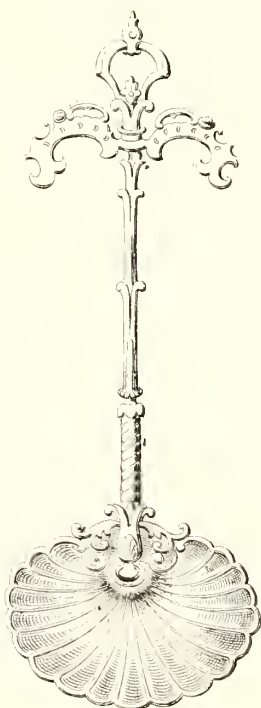

N^o 2064.

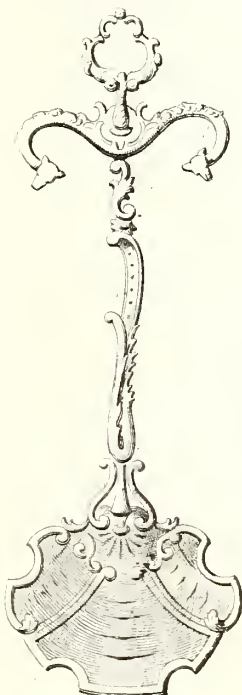

N^o 2065.

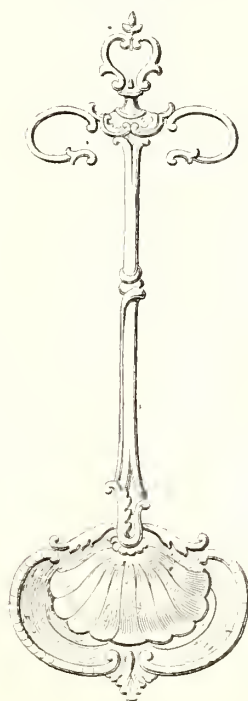

N^o 2066.

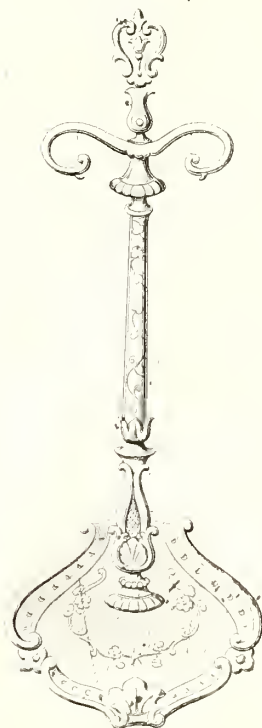

Fabriek van Bronswerken van *Becht en Dyserinck.*

Schaal van 1:20.

N^o 2067.

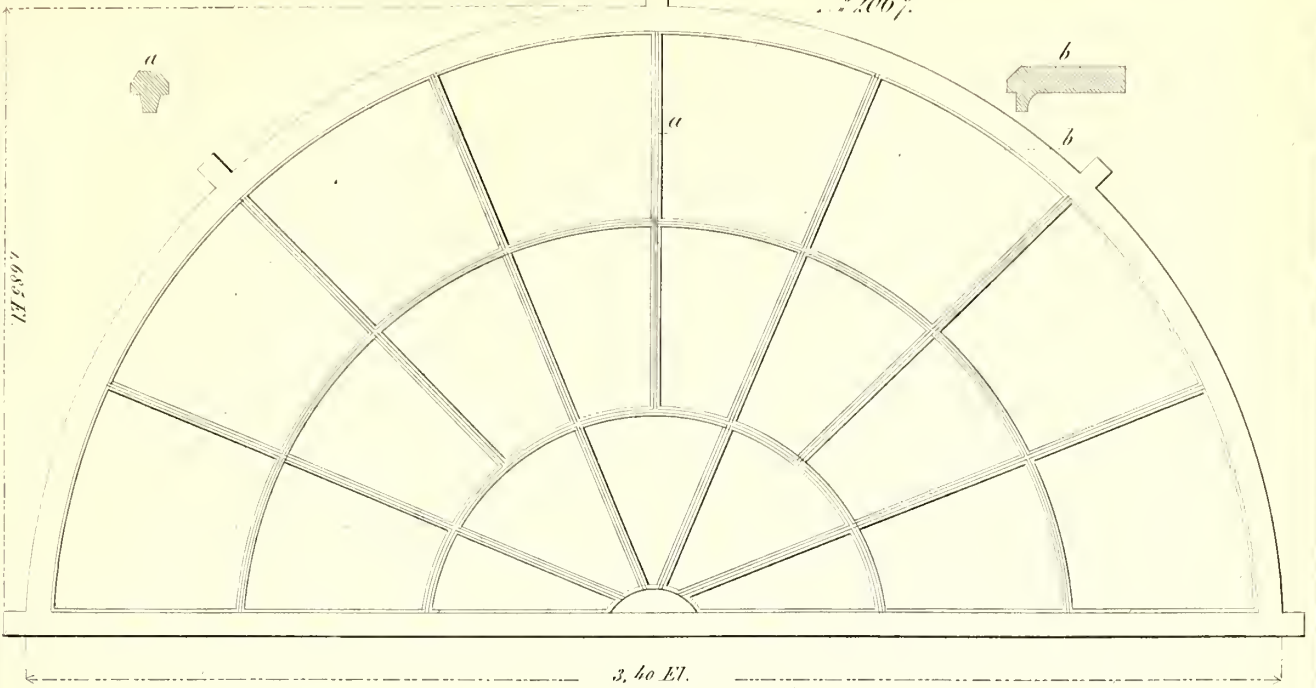

N^o 2068.

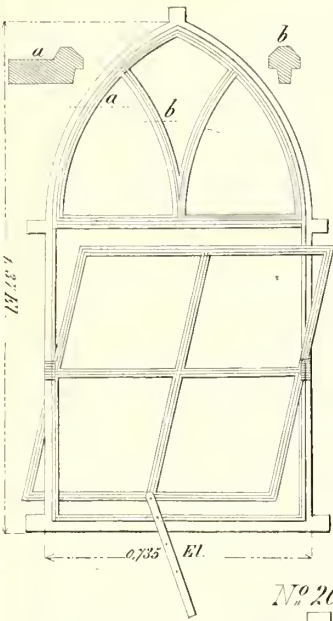

N^o 2069.

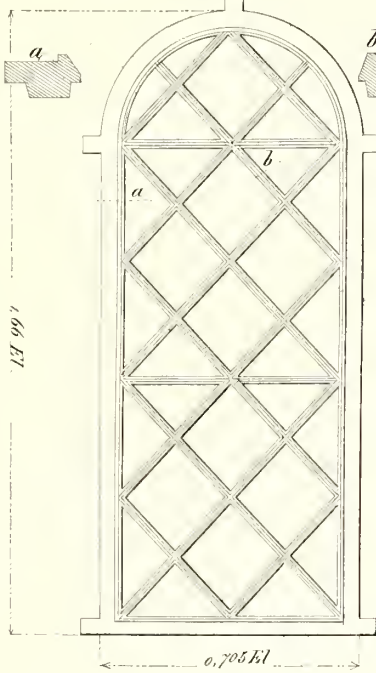

N^o 2070.

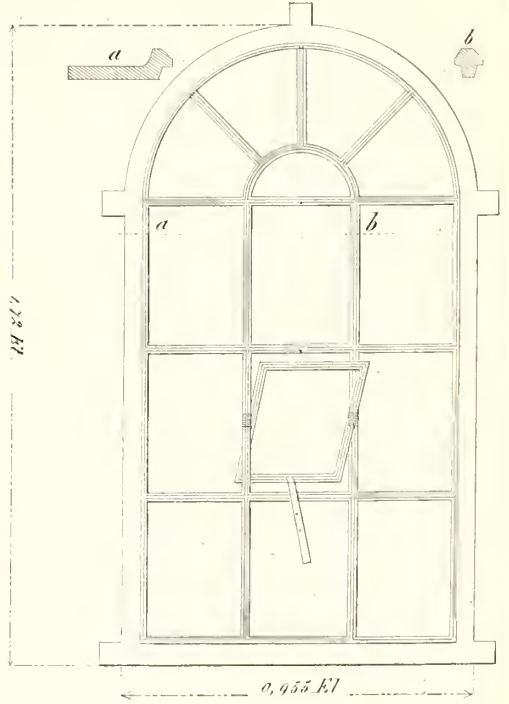

N^o 2071.

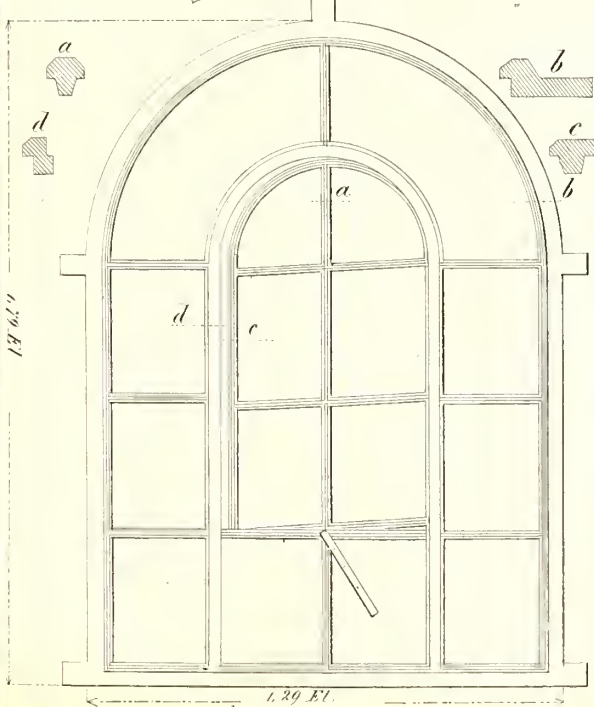

N^o 2072.

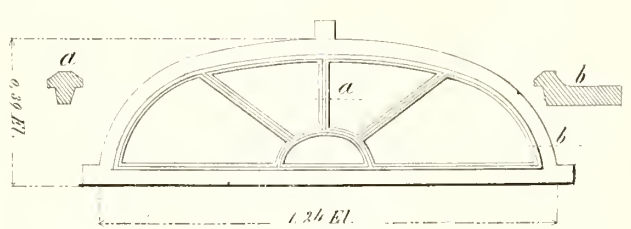

N^o 2073.

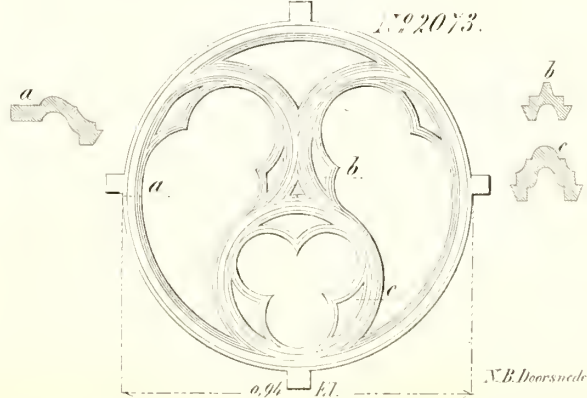

N.B. Doorsneden op '5

Fabriek van Bronswerken van *Becht en Dyserinck.*

N^o 2074.

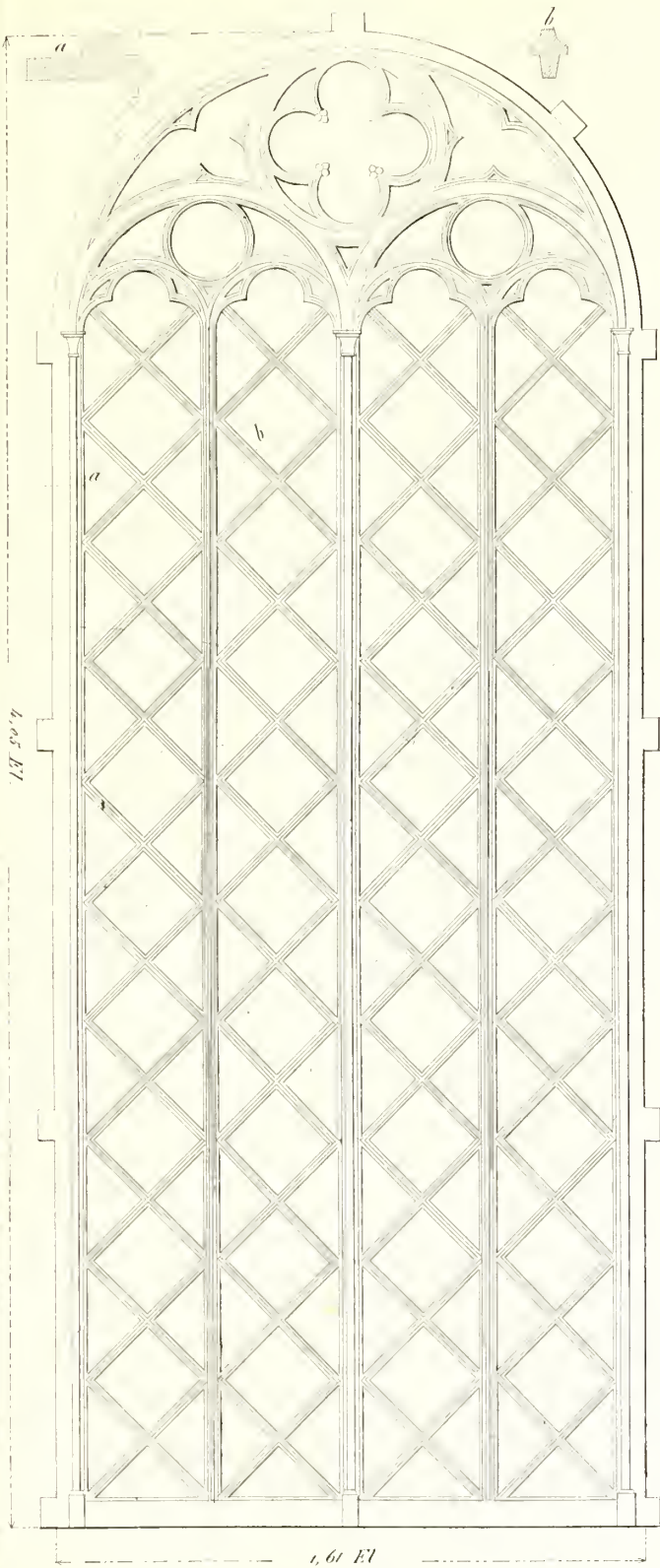

Deersnede als bovenstaande.

N^o 2077.

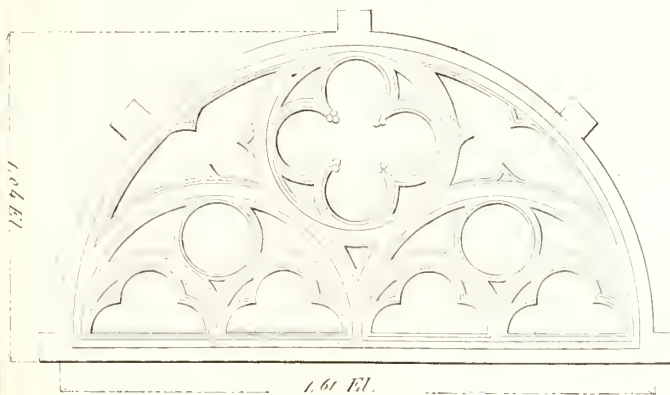

Schaal van 1 à 20.

N^o 2075.

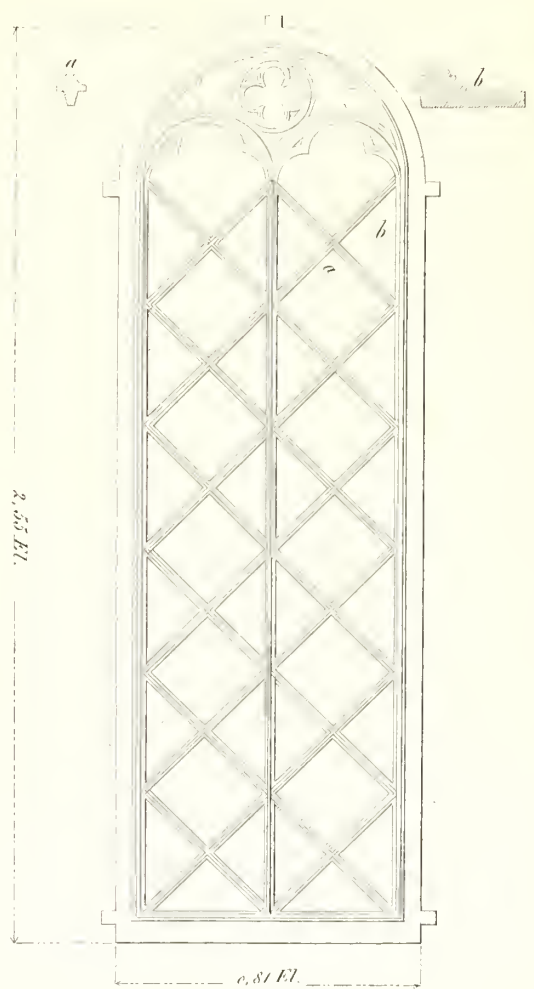

N^o 2076.

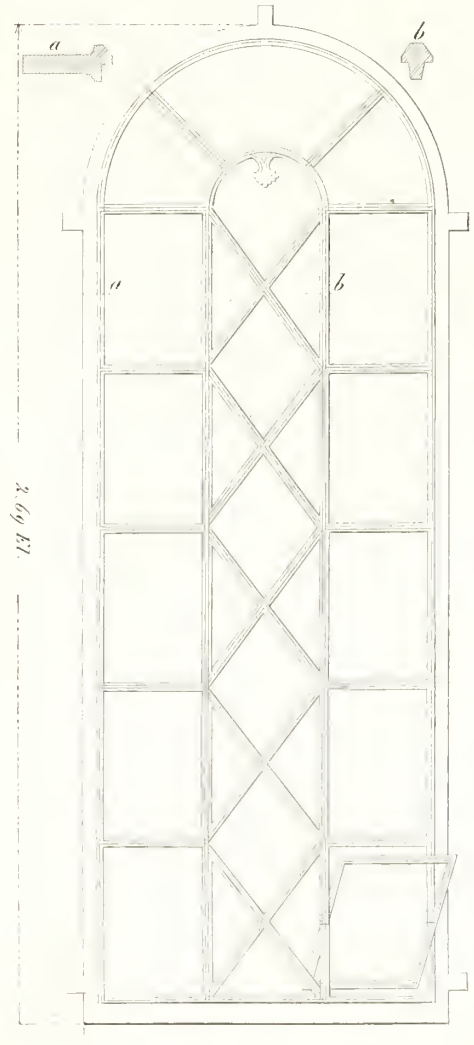

De deersnede op 1/5 der ware grootte.

Fabriek van Bronswerken van *Becht en Dyserinck.*

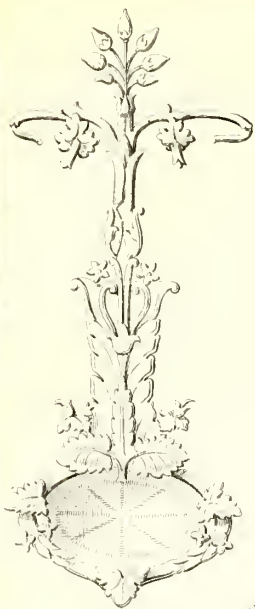

N^o 2082.

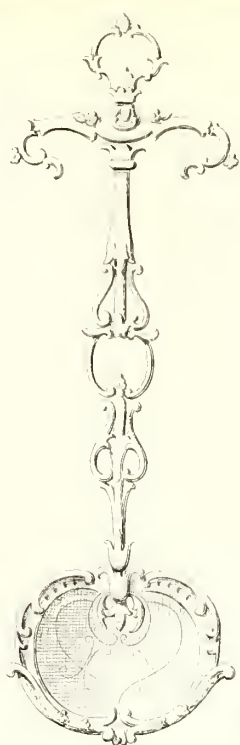

N^o 2083

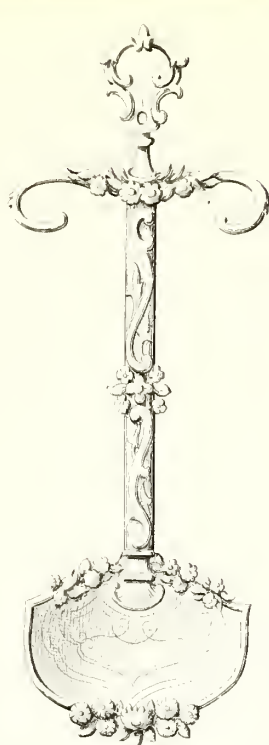

N^o 2084

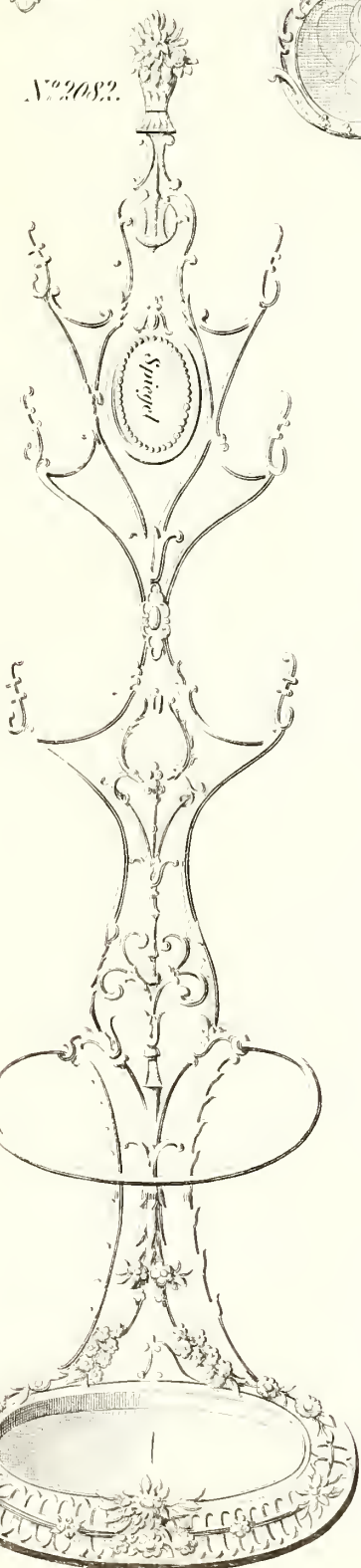
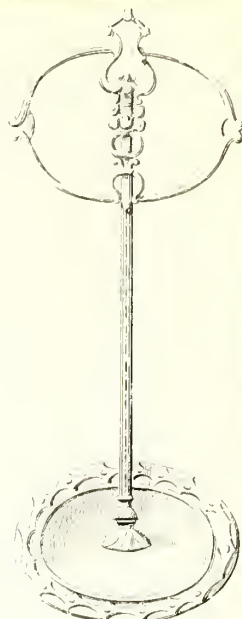

N^o 2085.

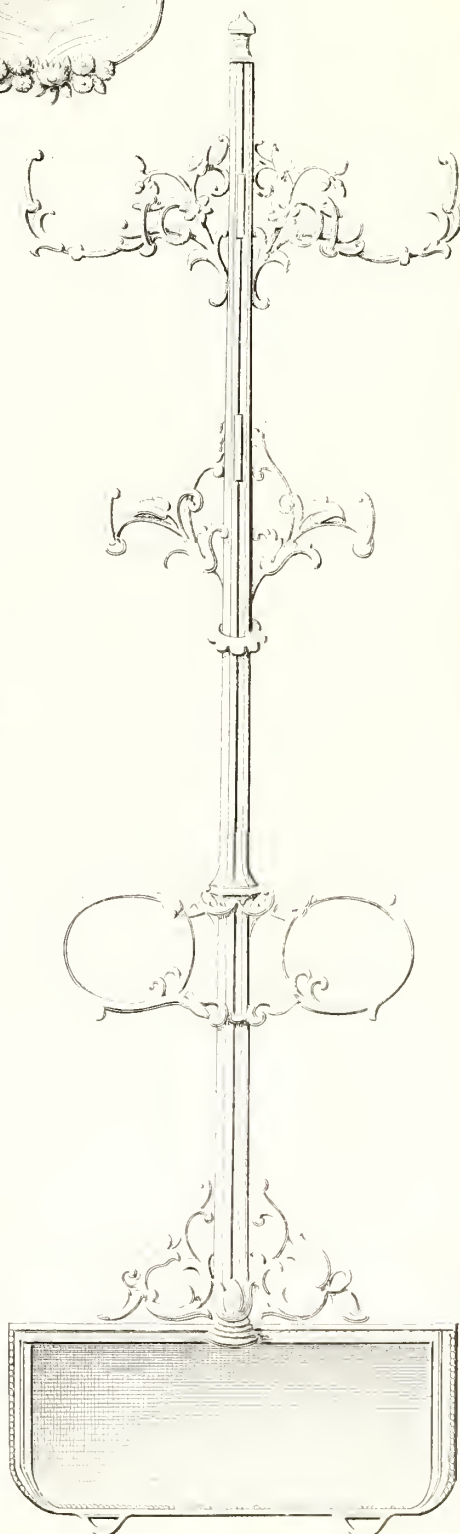

Fabriek van Bronswerken van *Becht en Dyserinck.*

N^o 2086.

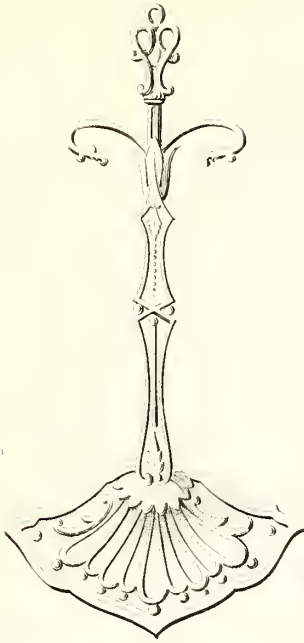

N^o 2087.

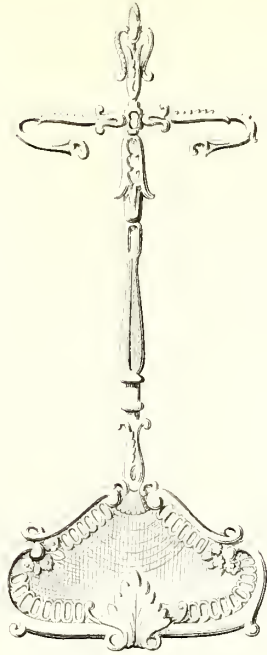

N^o 2088.

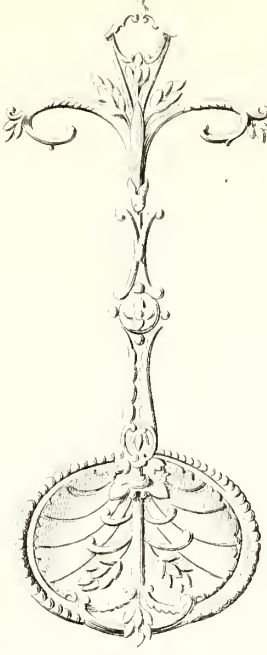

N^o 2089.

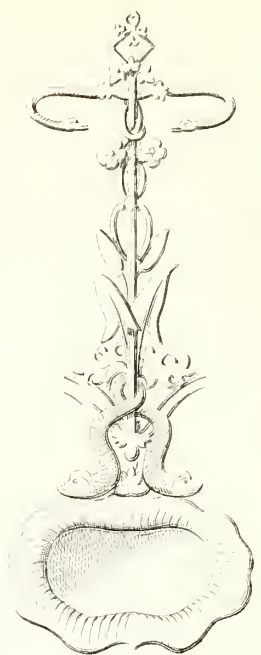

N^o 2090.

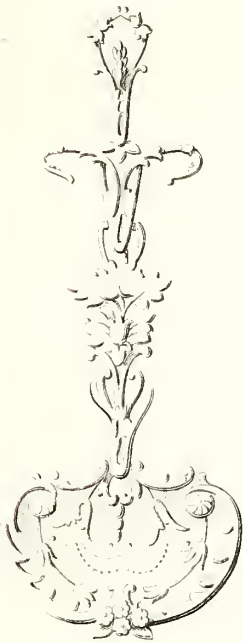

N^o 2091.

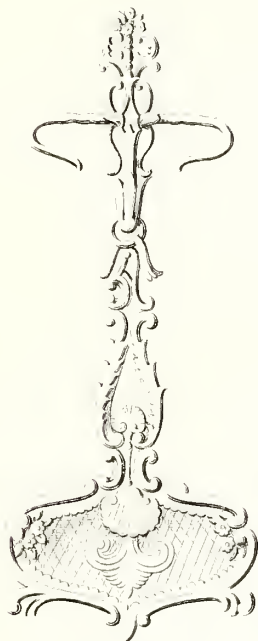

N^o 2092.

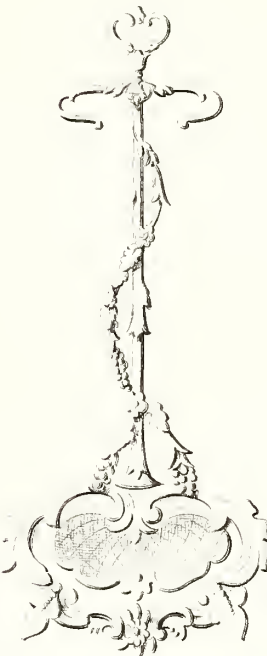

N^o 2093.



N^o 2094.

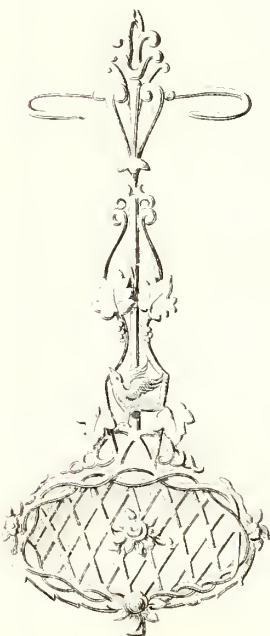

N^o 2095.

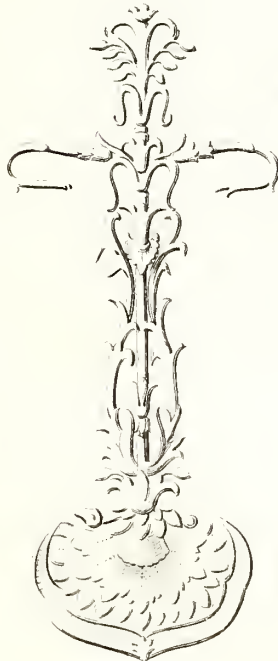

N^o 2096.

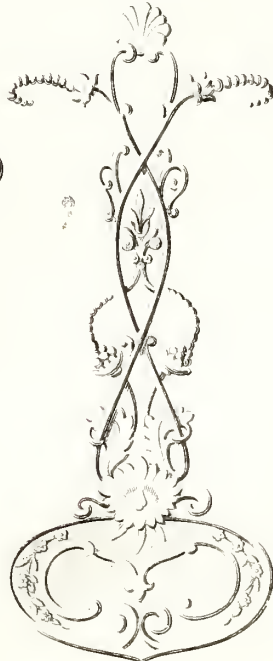

N^o 2097.



Fabriek van Bronswerken van *Becht en Dyserinck.*

N^o 2098.

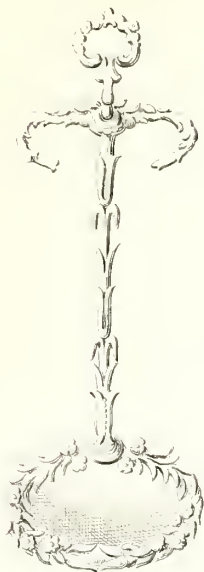

N^o 2099.

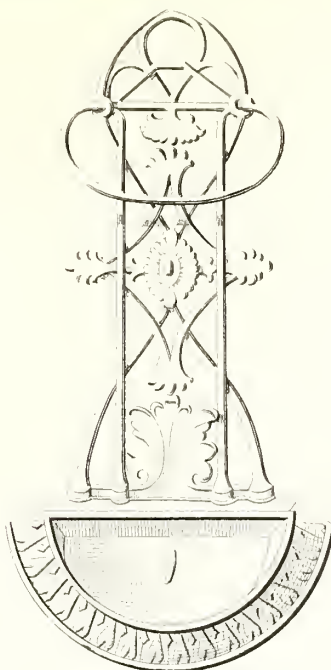

N^o 3000.

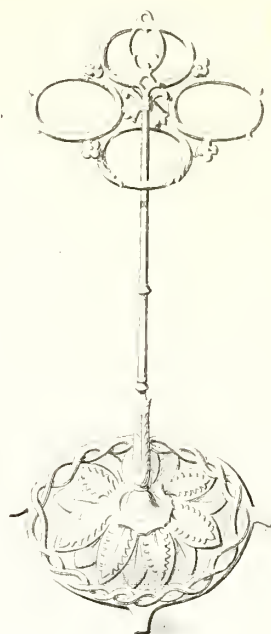

N^o 3001.

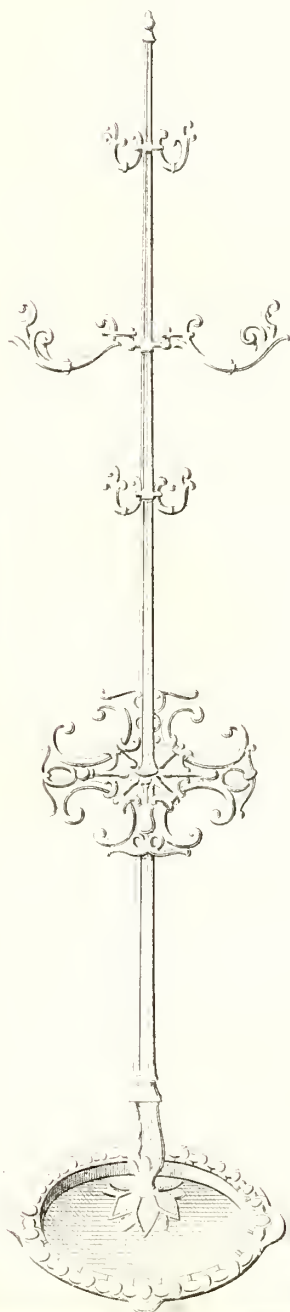

N^o 3002.

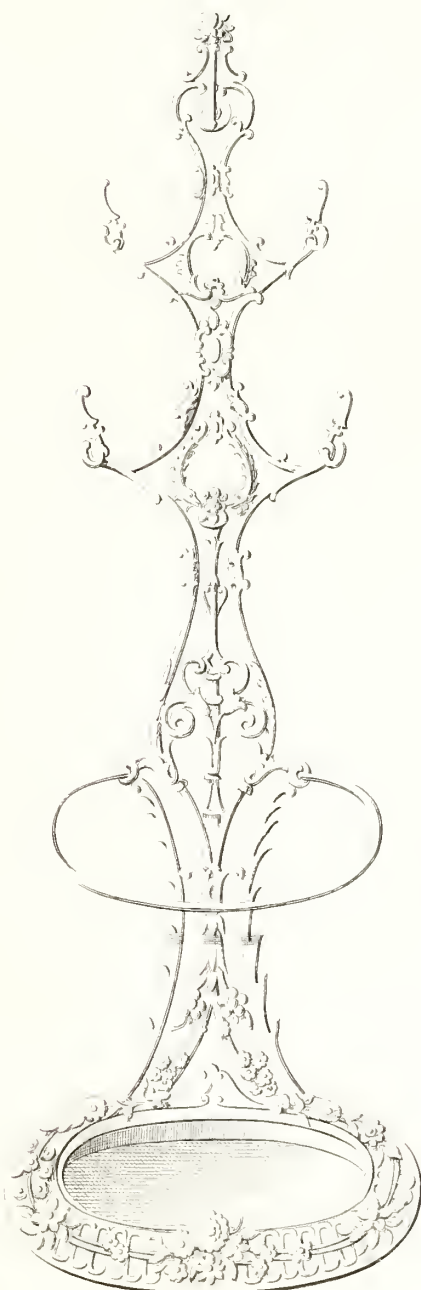

N^o 3003.

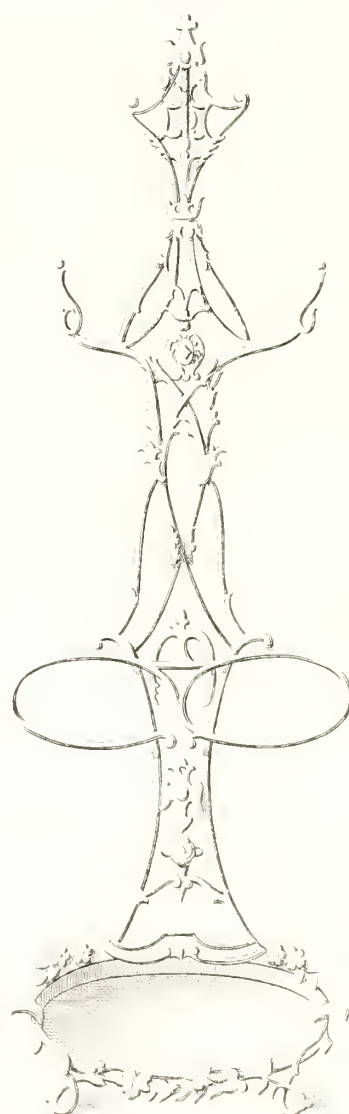

GEGOTEN HAARDEN.

N^o 3004.

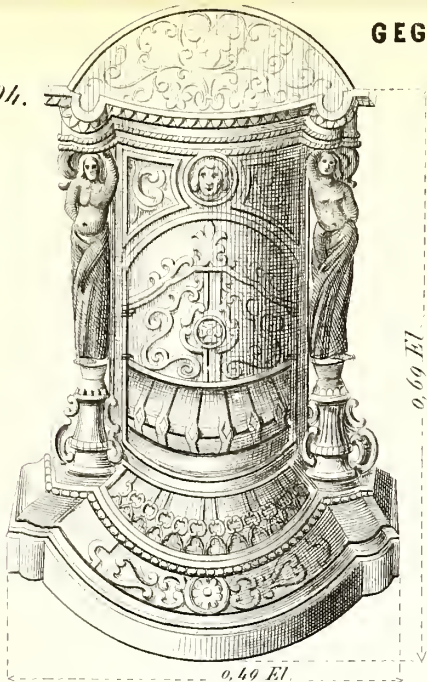

0,69 El

0,49 El

N^o 3005.

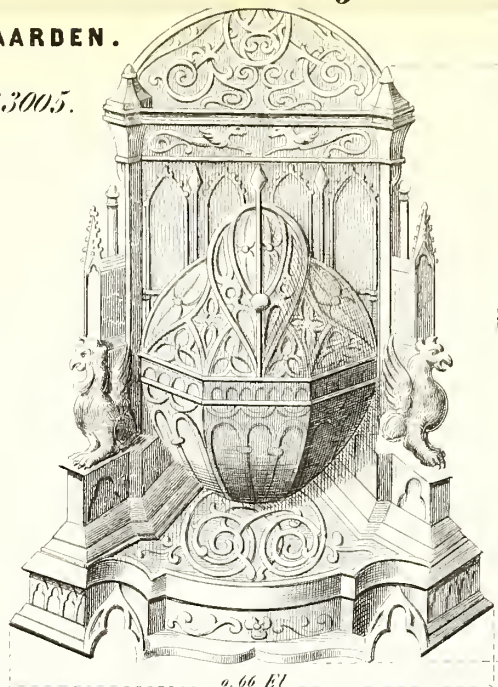

0,73 El

0,66 El

N^o 3006.

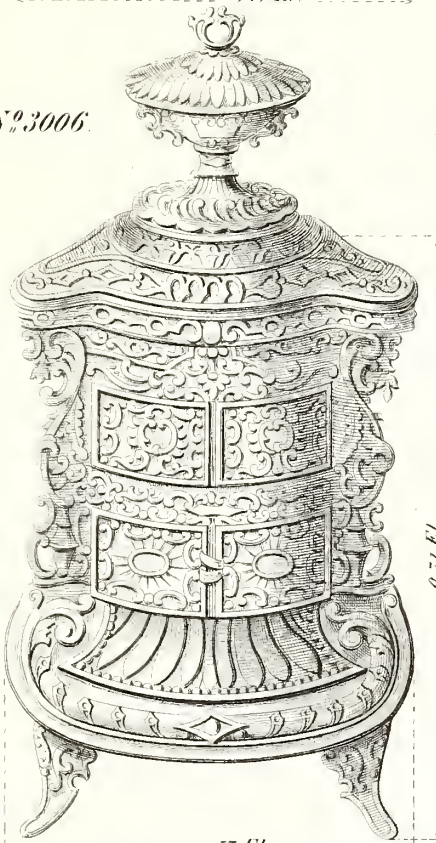

0,71 El

0,57 El

N^o 3007.

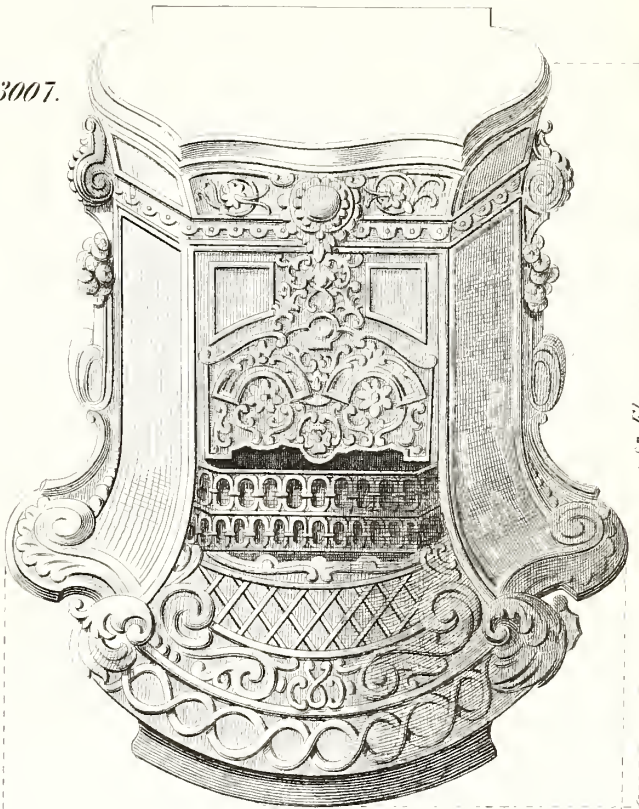

0,87 El

0,81 El

N^o 3008.

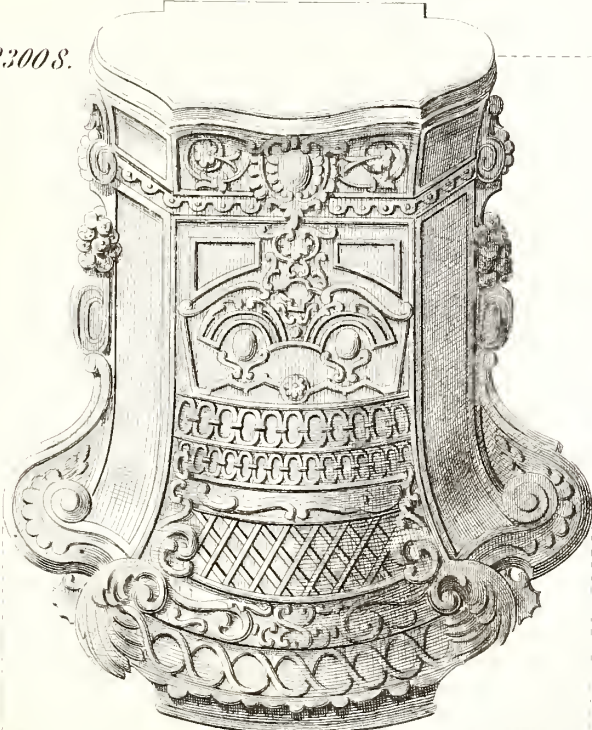

0,865 El

0,78 El

N^o 3009.

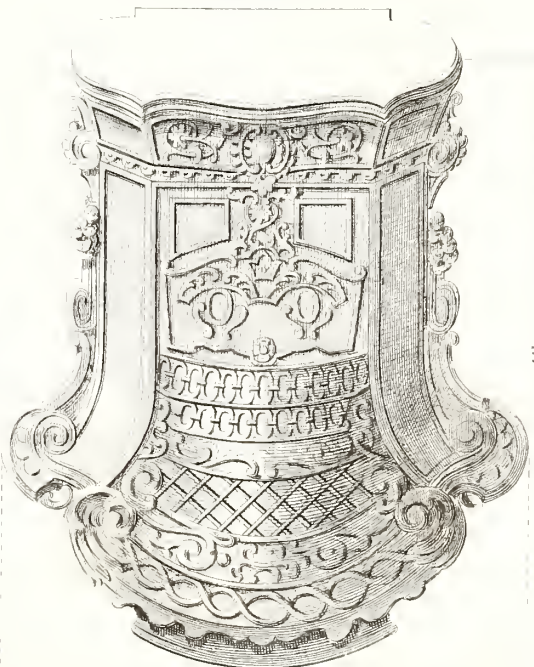

0,77 El

0,725 El

Fabriek van Bronswerken van **Becht en Dyserinck.**

Consolles voor étagères, plankleggers en balconrand.

N^o 3010.

0,505 El.

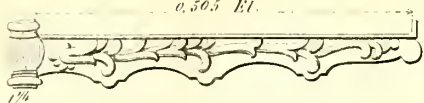

N^o 3011.

0,50 El.

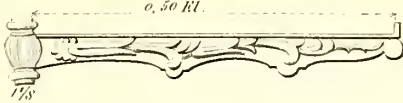

N^o 3012.

0,495 El.

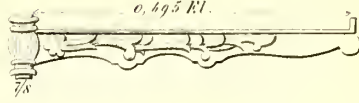

N^o 3013.

0,505 El.

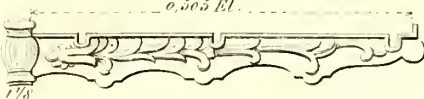

N^o 3014.

0,425 El.

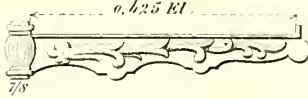

N^o 3015.

0,365 El.



N^o 3016.

0,325 El.

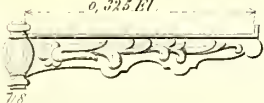

N^o 3017.

0,295 El.

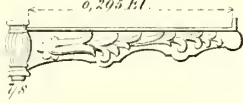

N^o 3018.

0,265 El.

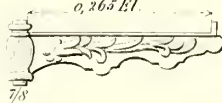

N^o 3019.

0,36 El.

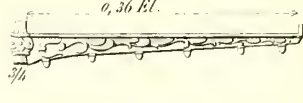

N^o 3020.

0,355 El.

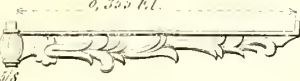

N^o 3021.

0,315 El.

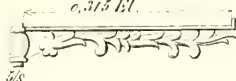

N^o 3022.

0,29 El.

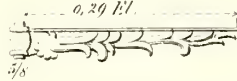

N^o 3023.

0,26 El.

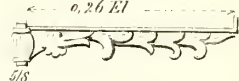

N^o 3024.

0,235 El.

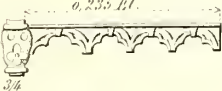

N^o 3025.

0,185 El.

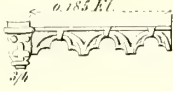

N^o 3026.

0,175 El.

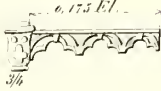

N^o 3027.

0,12 El.

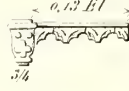

N^o 3028.

0,40 El.

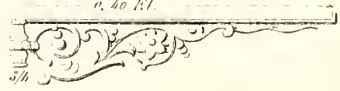

N^o 3029.

0,355 El.

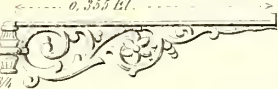

N^o 3030.

0,55 El.

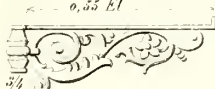

N^o 3031.

0,32 El.

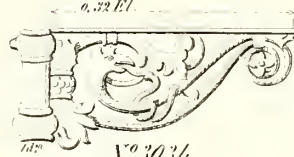

N^o 3032.

0,265 El.



N^o 3033.

0,19 El. 0,39 El.

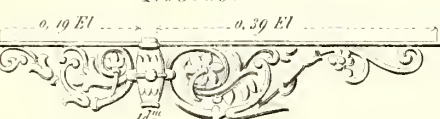

N^o 3034.

0,38 El.

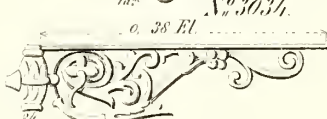

N^o 3035.

0,28 El.



N^o 3036.

0,15 El.



N^o 3037.

0,315 El.

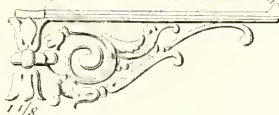

N^o 3038.

0,265 El.



N^o 3039.

0,315 El.

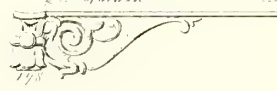

N^o 3040.

0,22 El.

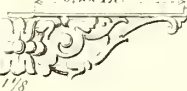

N^o 3041.

0,165 El.



N^o 3042.

0,245 El.



N^o 3043.

0,195 El.



N^o 3044.

0,15 El.



N^o 3045.

0,28 El.



N^o 3046.

0,24 El.

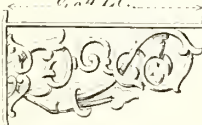

N^o 3047.

0,19 El.

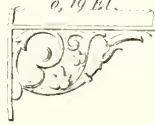

N^o 3048.

0,17 El.

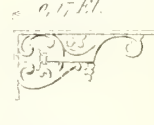

N^o 3049.

0,275 El.

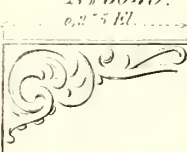

N^o 3050.

0,215 El.



N^o 3051.

0,12 El.



N^o 3052.

0,22 El.

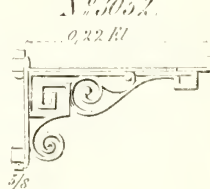

N^o 3053.

1,425 El.

1,20 El.

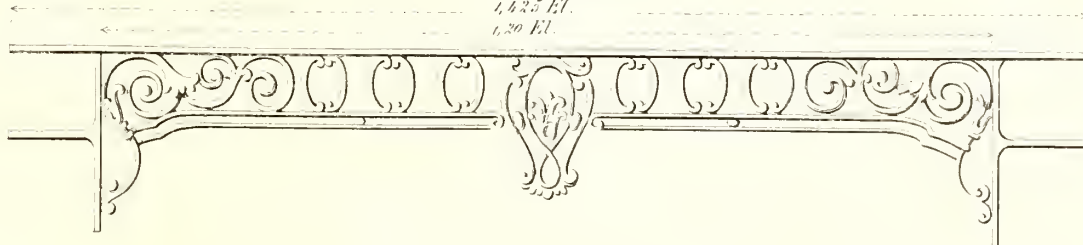

De gewone breuken geven de grootste afmetingen der gaten aan, in Eng. maat.

Fabriek van Bronswerken van *Becht en Dyserinck.*

N^o3054. Lichttramen.

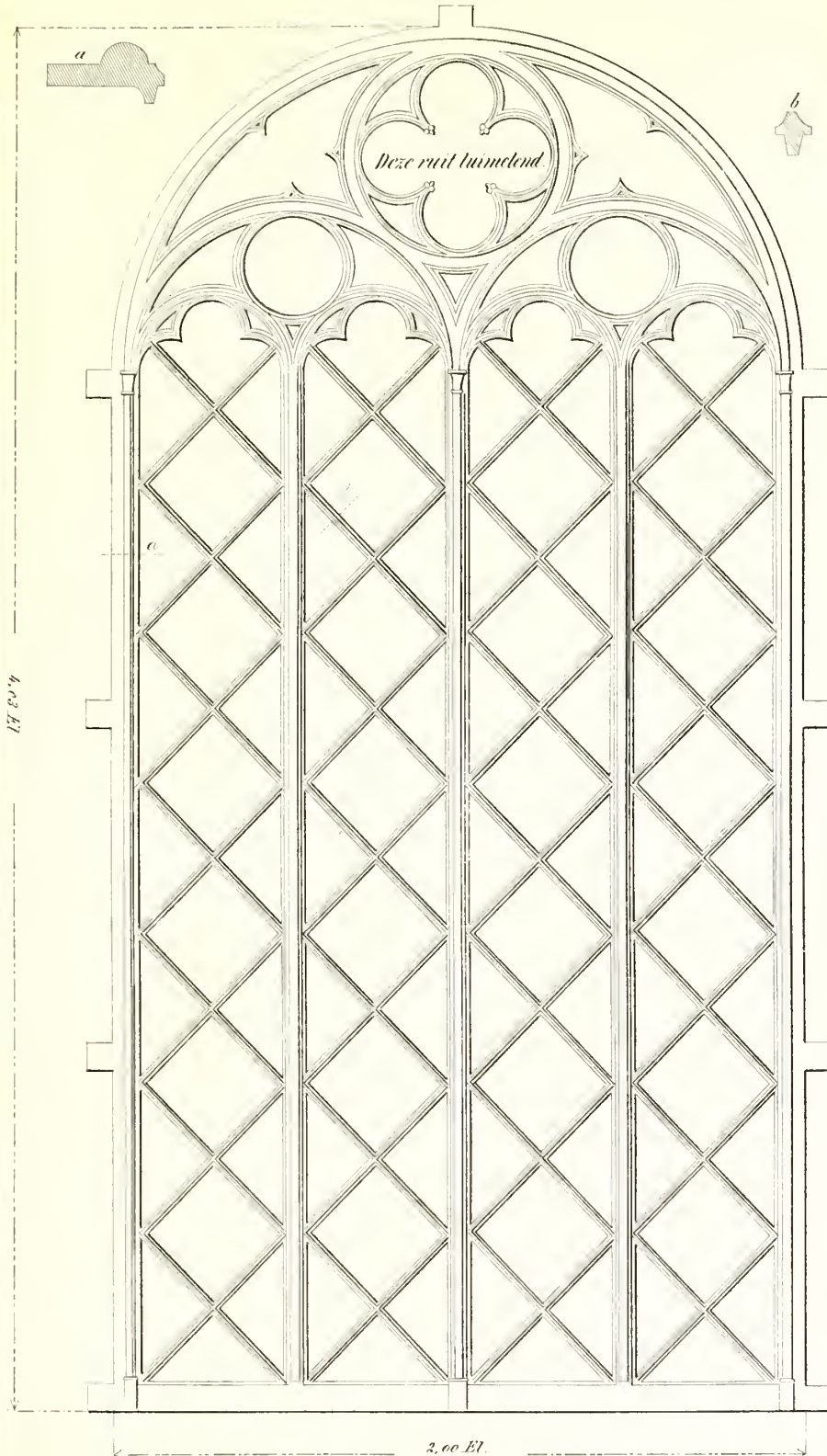

N^o3055.

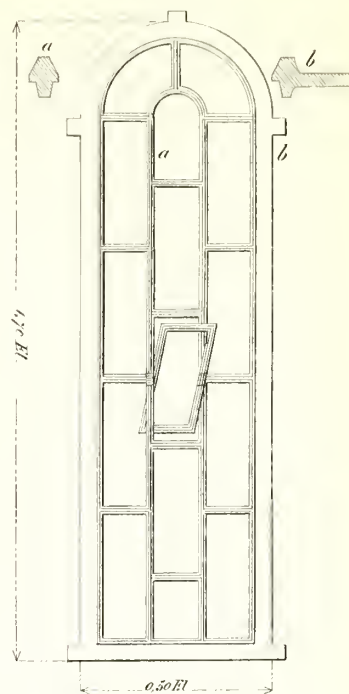

N^o3057.

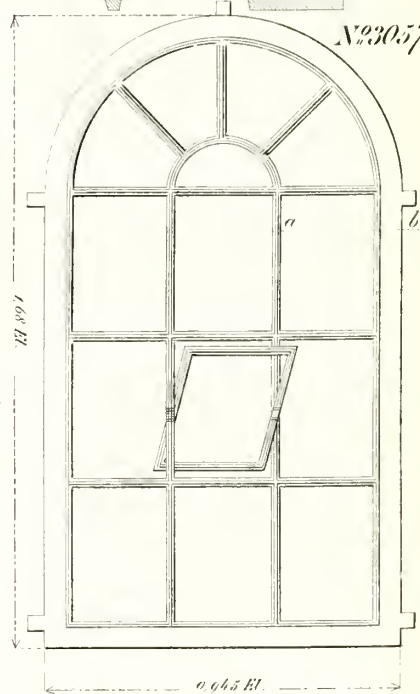

N^o3058.

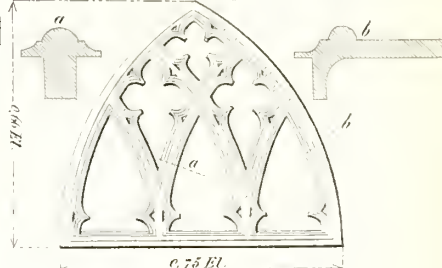

N^o3059.

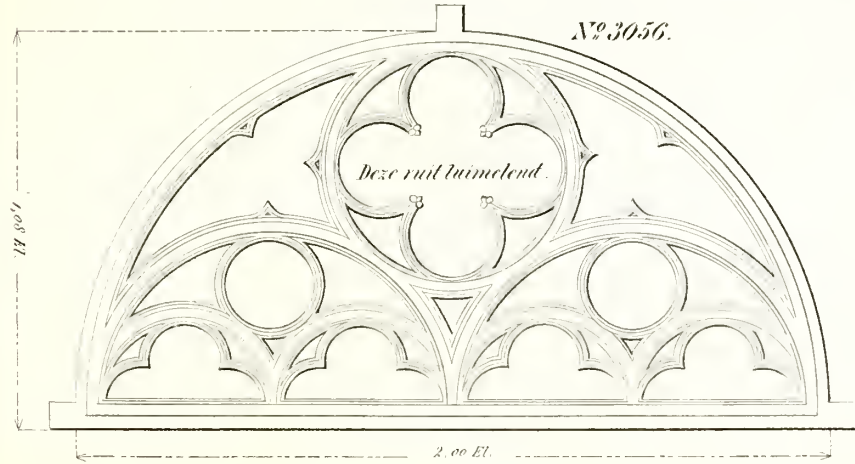
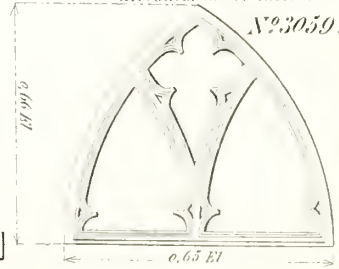

Schaal van 1:20

Deersneden schaal van 1:5

Fabriek van Bronswerken van *Becht en Dyserinck.*

Deur-panels met middaillons.

N^o 3060.

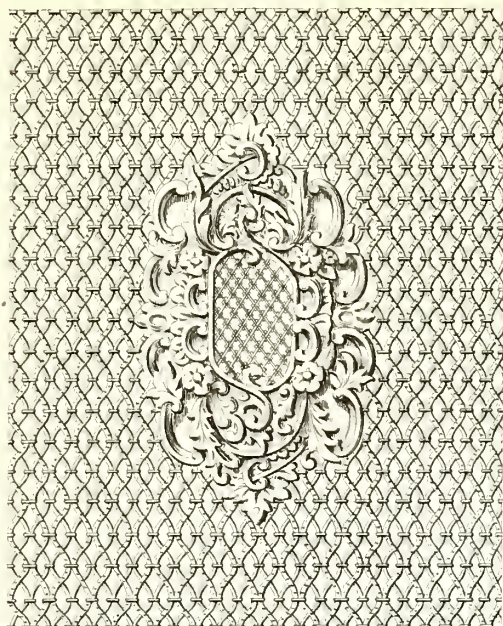

N^o 3061

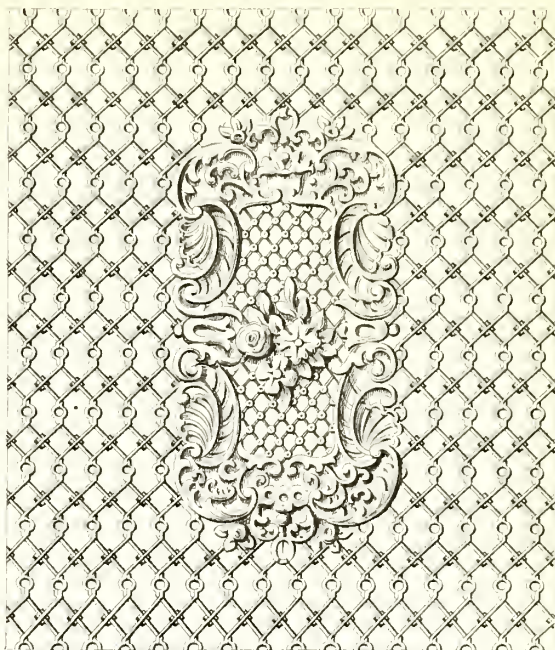

N^o 3062.

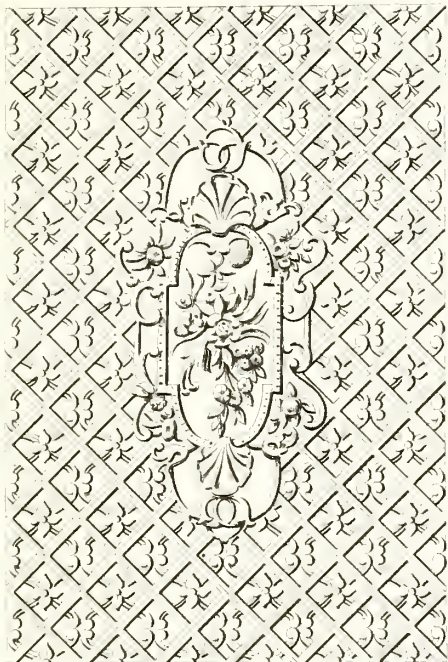

N^o 3063

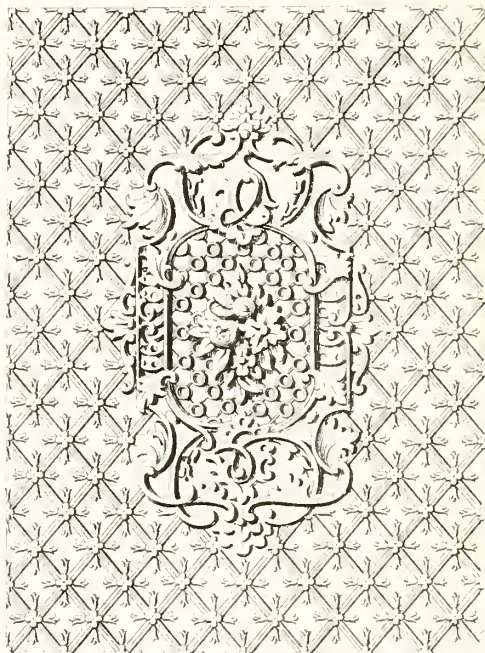

N^o 3064.

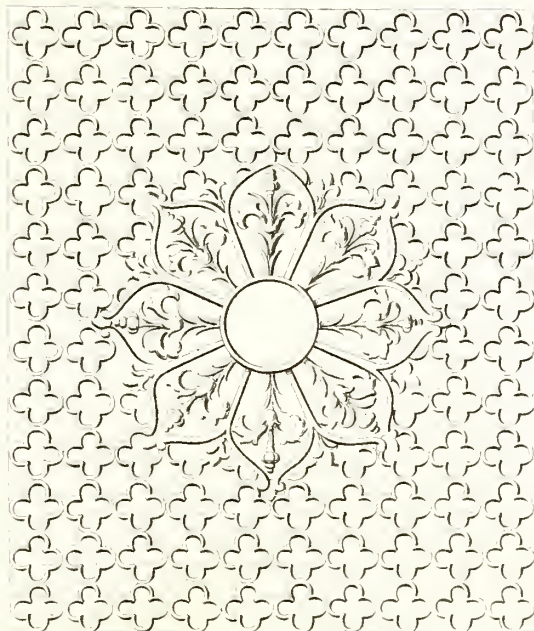

N^o 3065

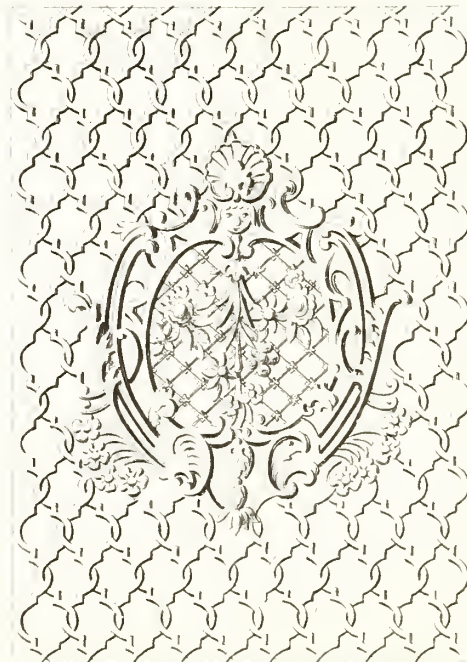

Fabriek van Bronswerken van *Becht en Dyserinck.*

Middaillons.

N^o 3066.

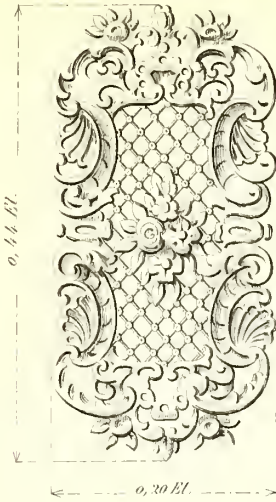

N^o 3067.

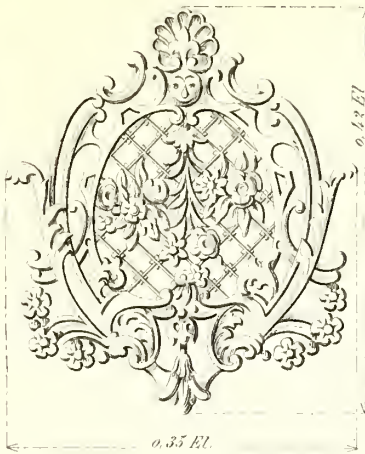

N^o 3068.

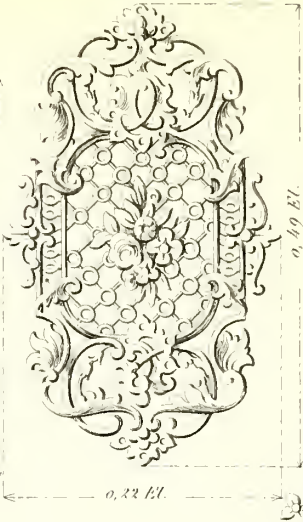

N^o 3072.

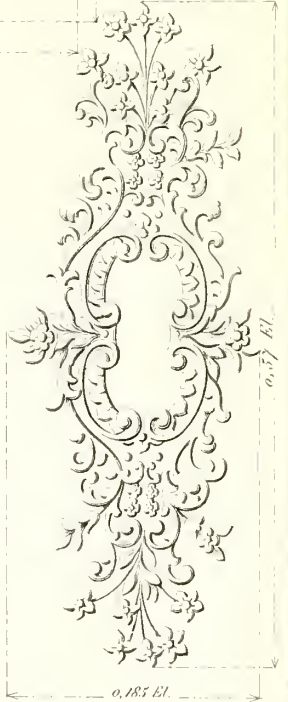

N^o 3069.

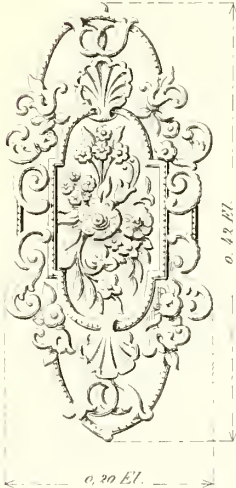

N^o 3070.

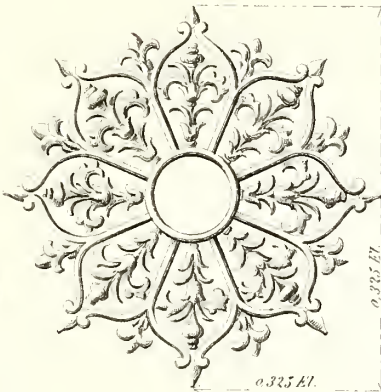

N^o 3071.

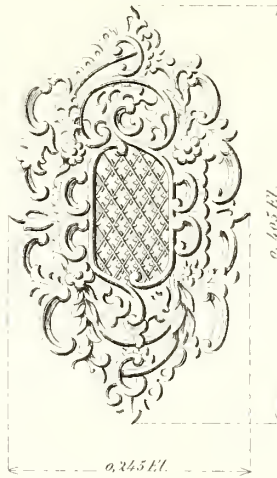

N^o 3074.

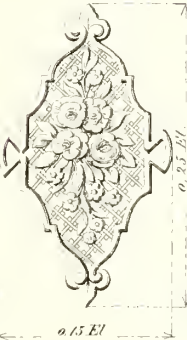

N^o 3073.



N^o 3075.

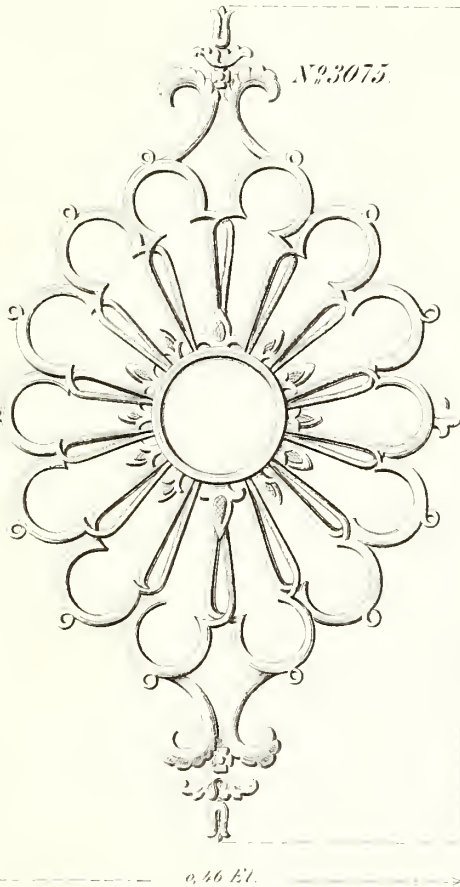

N^o 3076.

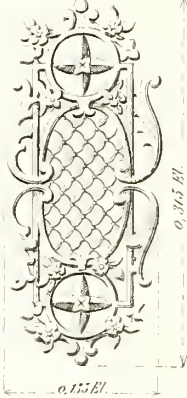

N^o 3077.



N^o 3078.



N^o 3079.

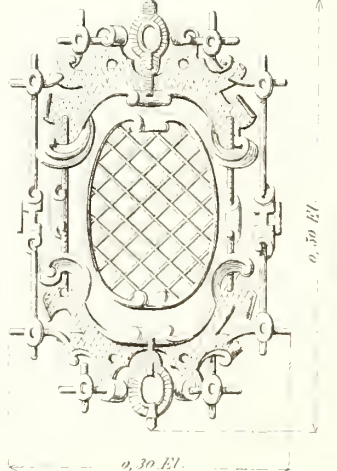

Deze middaillons kunnen in verschillende paanden naar keuze verkregen worden.

Fabriek van Bronswerken van *Becht en Dyserinck.*

Doorsnede van de ramen N^o 3081, 3082, 3083.

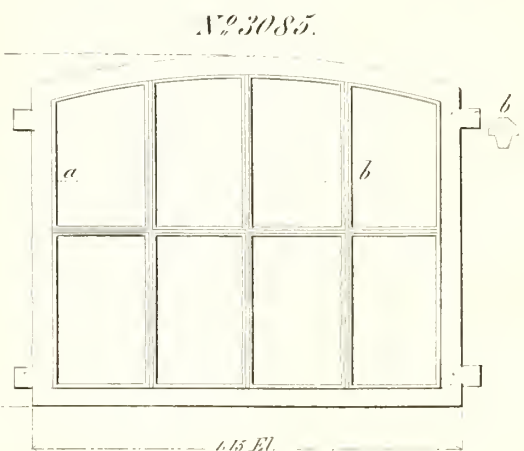
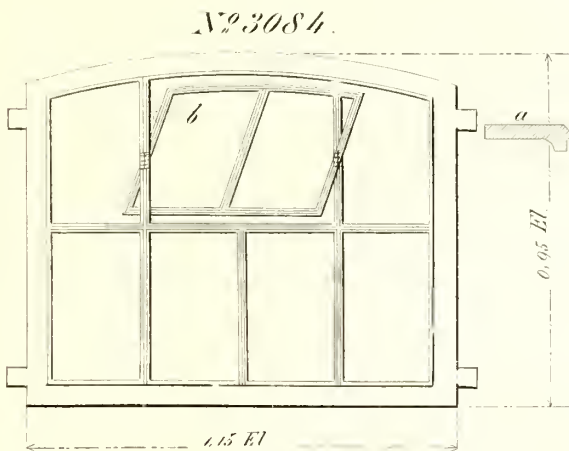
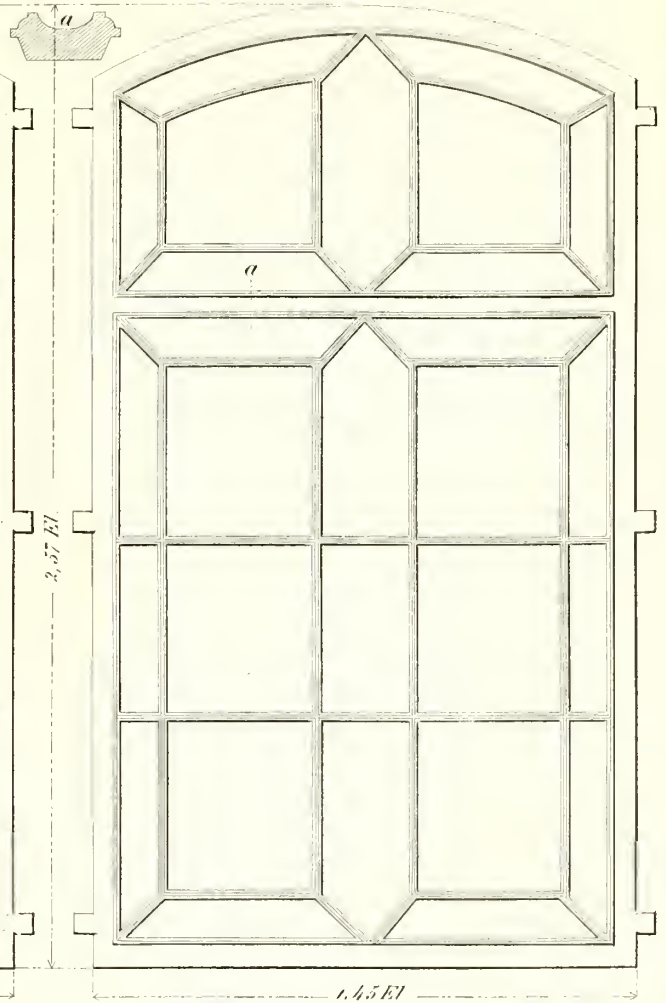
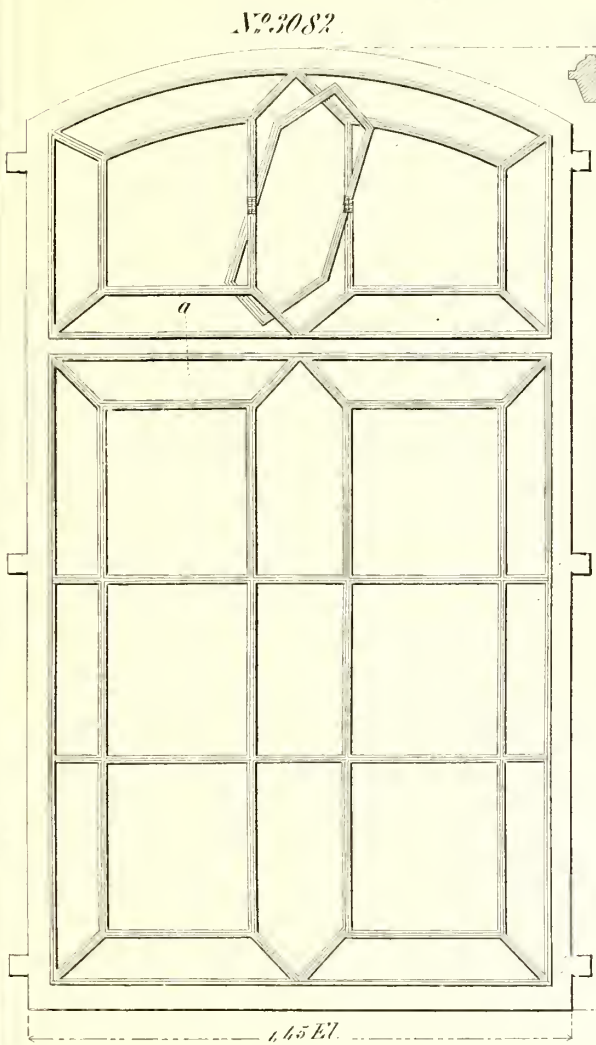
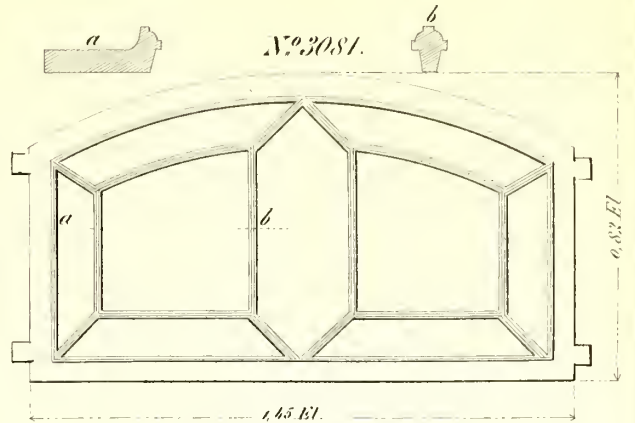
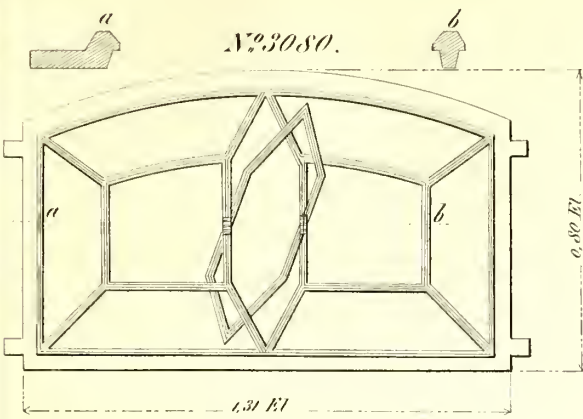

Ramen open.

Schaal 1 à 20.

Doorsnede schaal 1/5

Fabriek van Bronswerken van *Becht en Dyserinck.*

Tuinbankpooten, vierkante Tuintafels, wiegenpooten, en Penantafels.

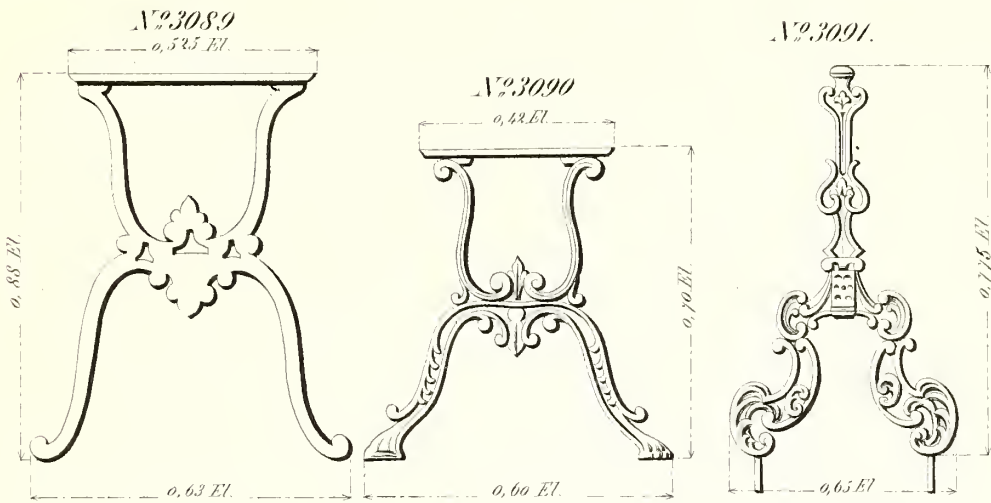
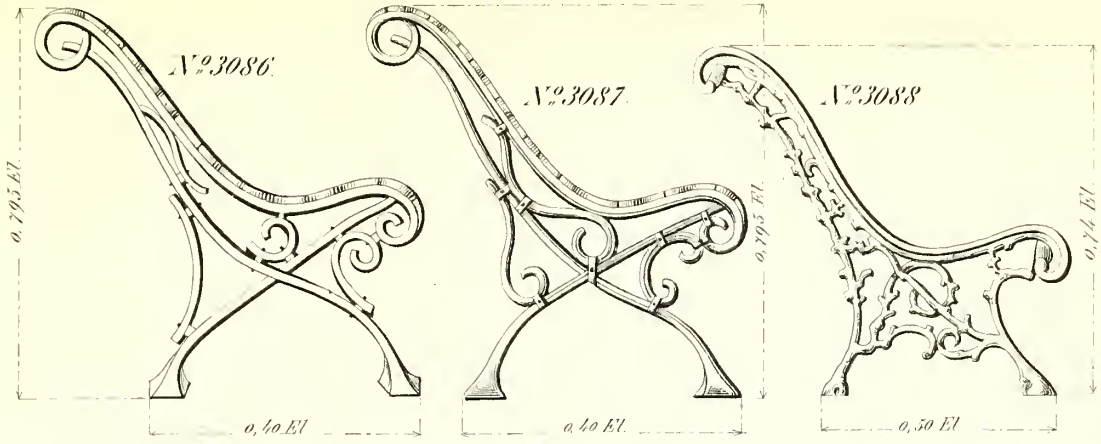

Deze tafels door marmer of geschilderd hout te dekken.

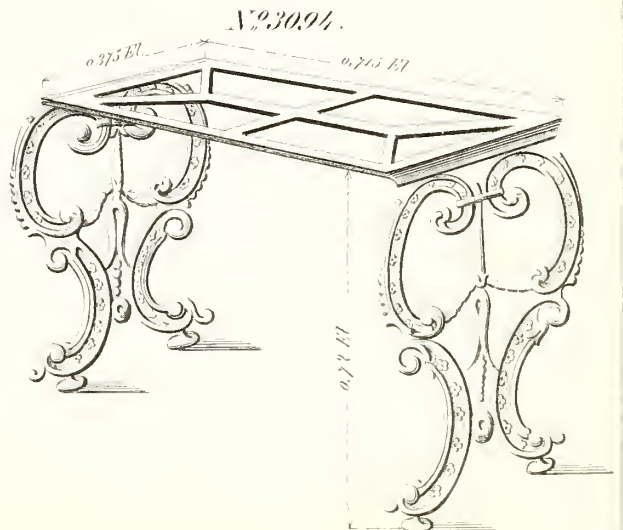
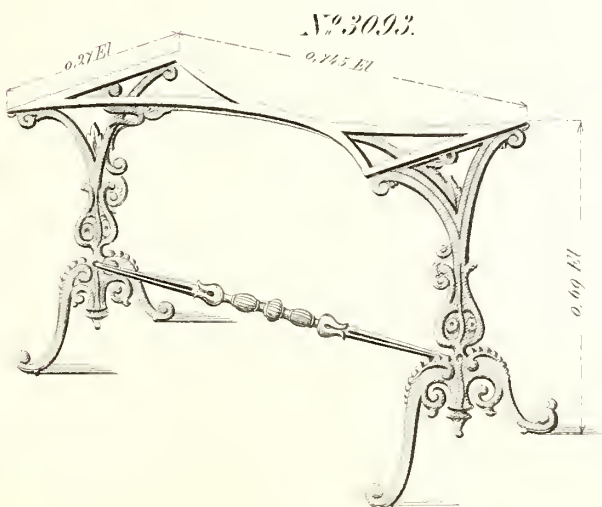
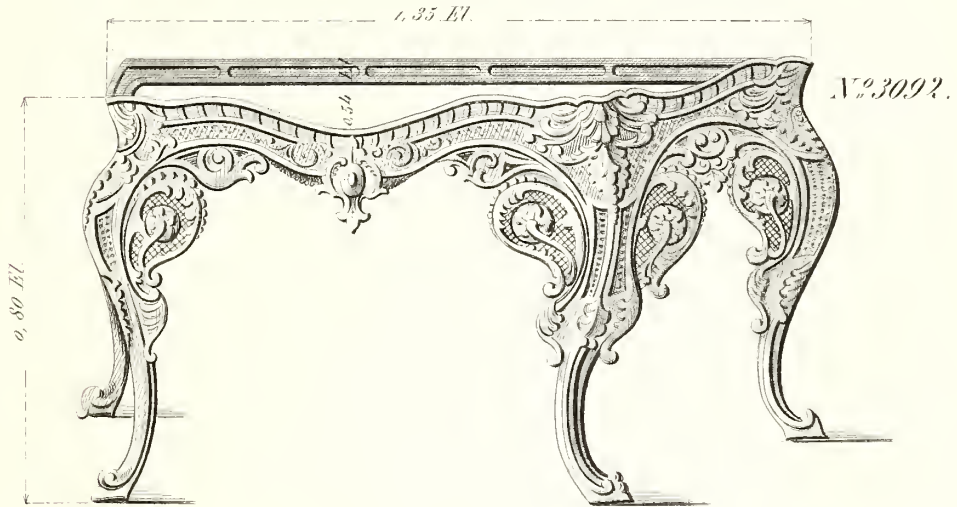

Fabriek van Bronswerken van *Becht en Dyserinck.*

N^o 3121.

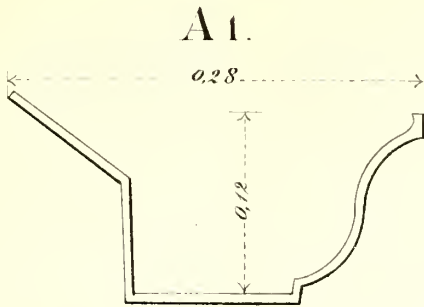

N^o 3122.

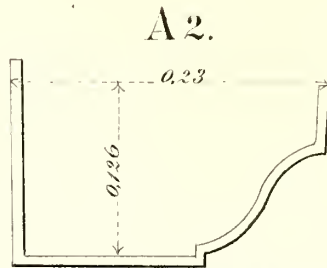

N^o 3123.

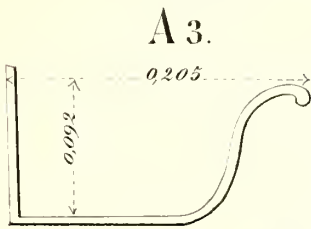

N^o 3124.

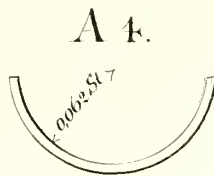

N^o 3125.

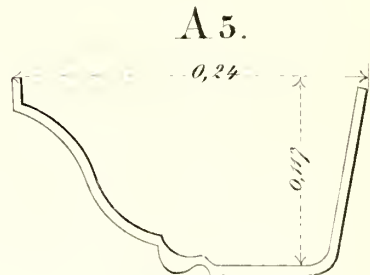

N^o 3126.

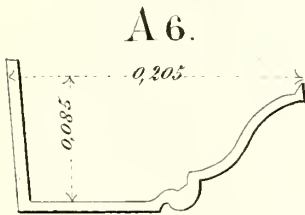

N^o 3127.

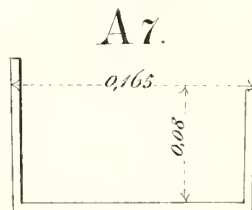

N^o 3128.

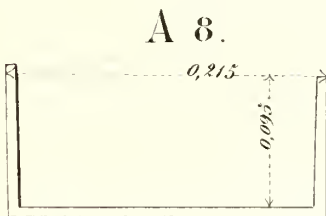

N^o 3129.

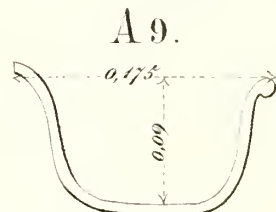

N^o 3130.

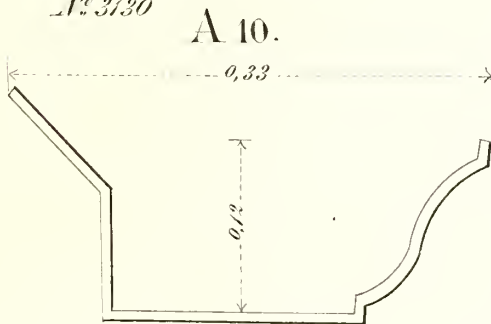

N^o 3131.

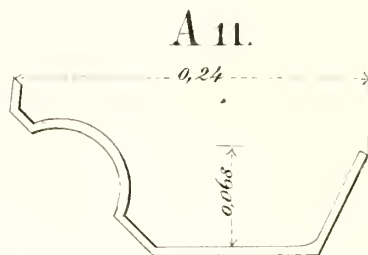

N^o 3132.

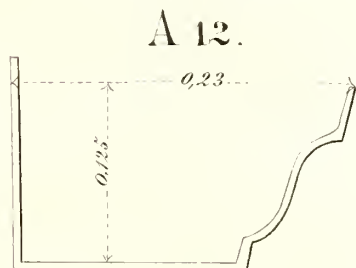

N^o 3133.

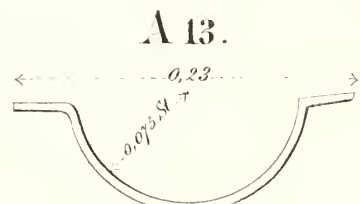

Schaal 1 à 5.

Fabriek van Bronswerken van *Becht en Dyserinck.*

N^o 3107.

A 24.

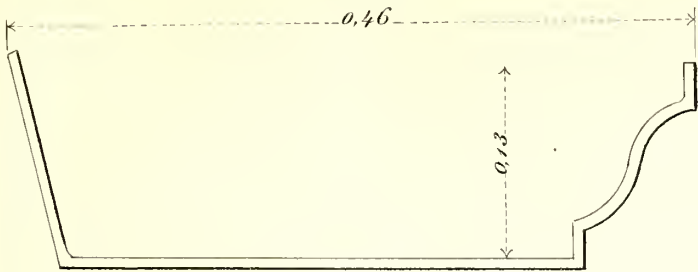

N^o 3108.

A 25

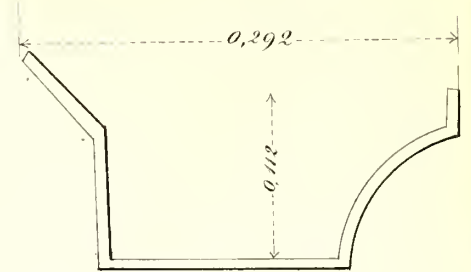

N^o 3109.

A 26.

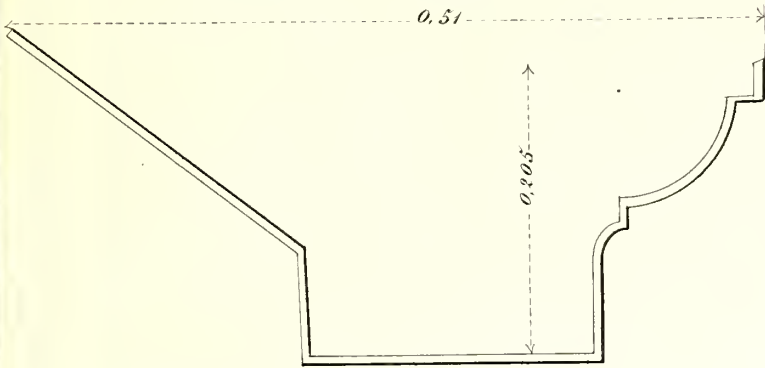

N^o 3110.

A 27.

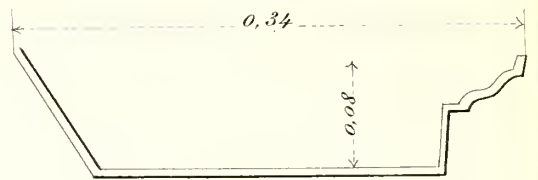

N^o 3111

A 28.

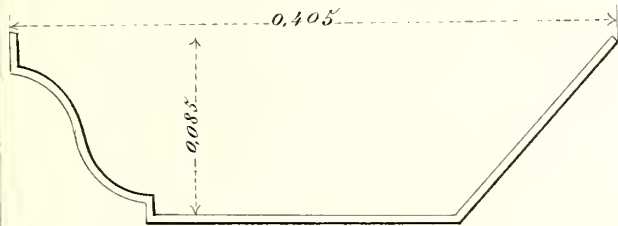

A 29.

N^o 3112.

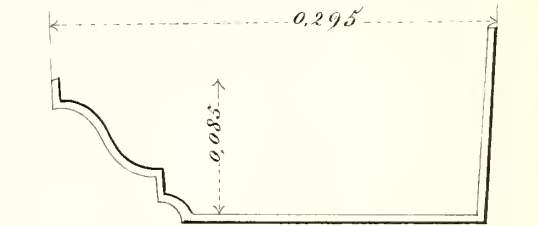

N^o 3113

A 30.

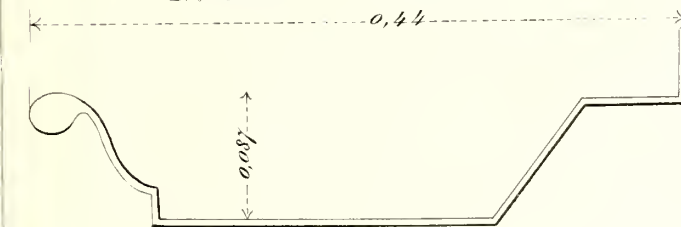

A 31.

N^o 3114.

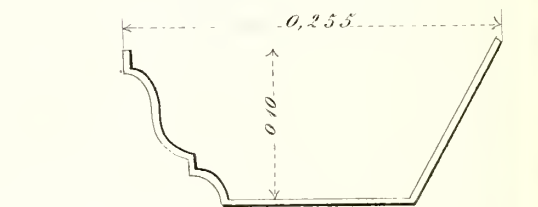

N^o 3115

A 32.

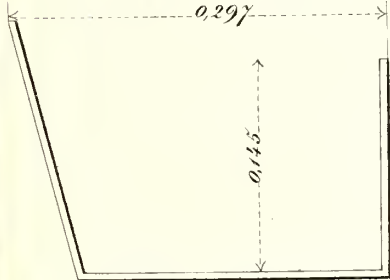

N^o 3116

A 33

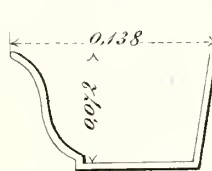

N^o 3117

A 34.

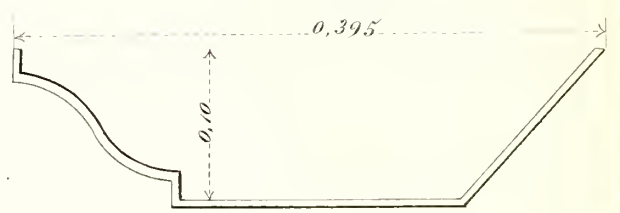

N^o 3118

A 35.

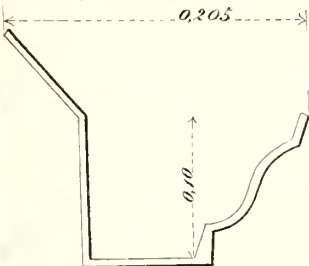

N^o 3119.

A 36.

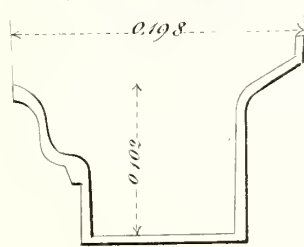

N^o 3120.

A 37.

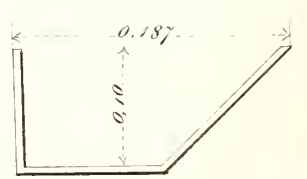

Fabriek van Bronswerken van *Becht en Dyserinck.*

N^o 3095

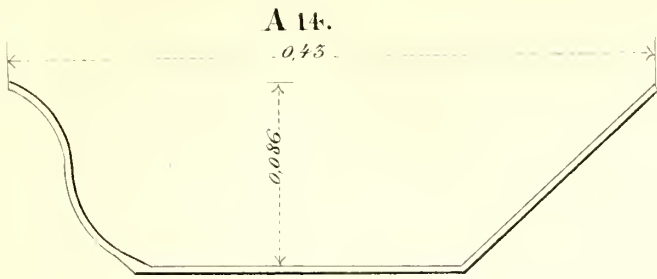

N^o 3096

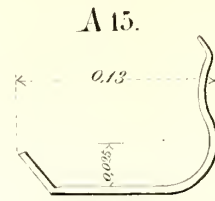

A16. N^o 3097.

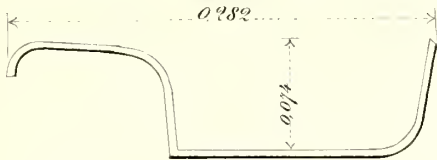

N^o 3098. A17.

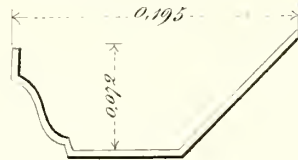

N^o 3099. A1'

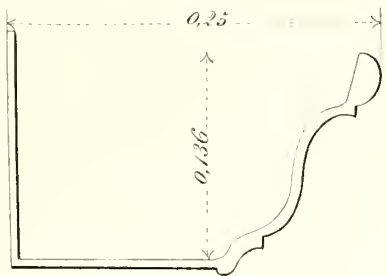

N^o 3100.

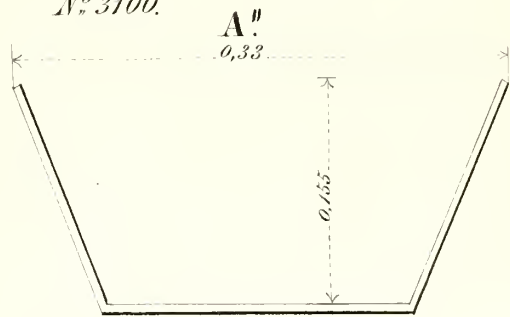

N^o 3101.

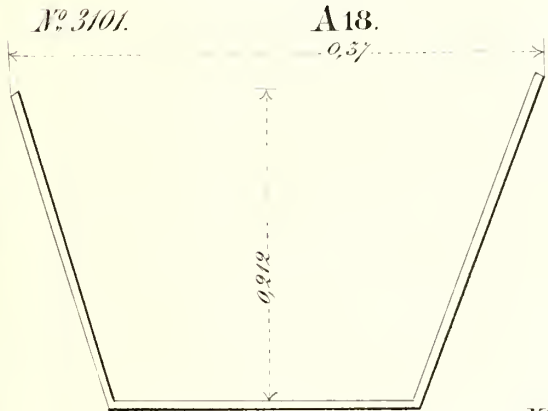

N^o 3102

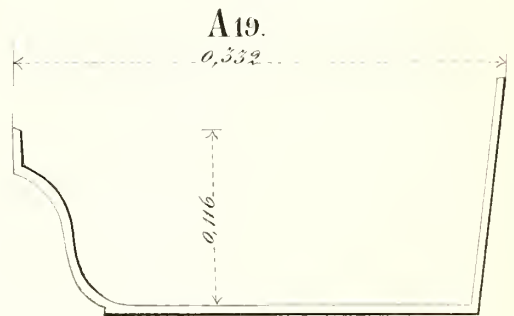

A20. N^o 3103.

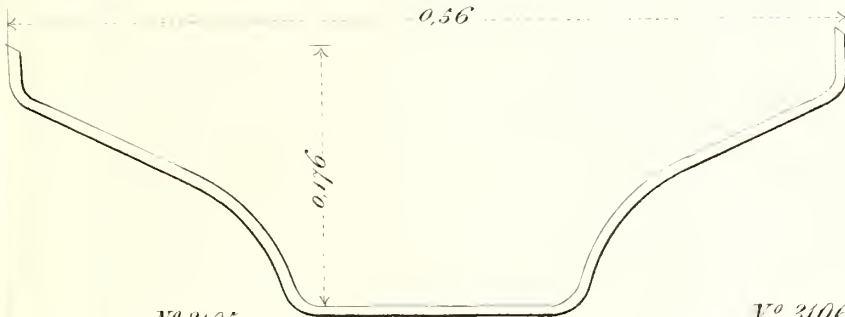

N^o 3104. A21.

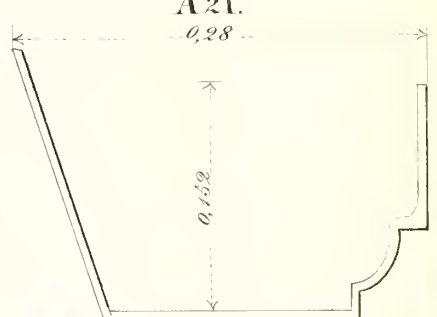

N^o 3105.

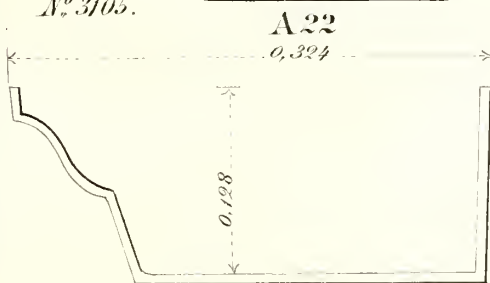

N^o 3106.

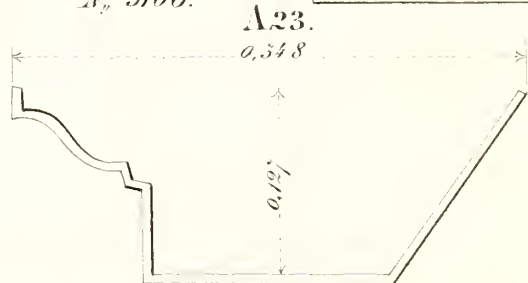

Fabriek van Bronswerken van *Becht en Dyserinck.*

Schoollafels en banken en Voetschrappers.

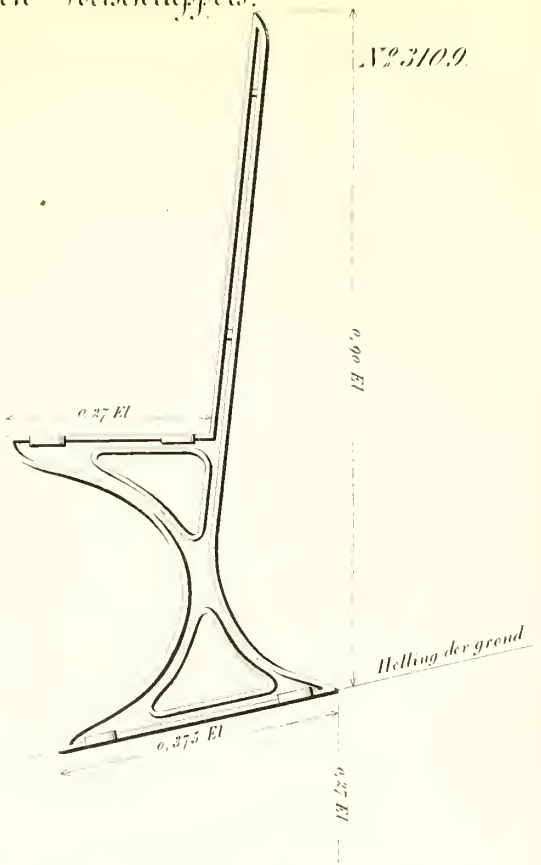
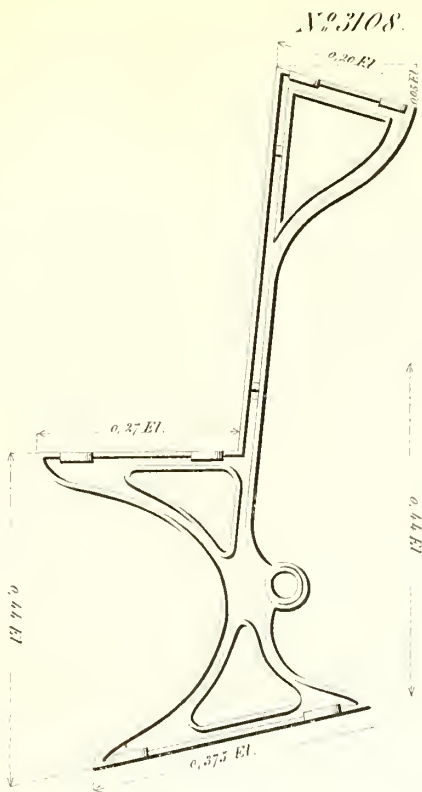
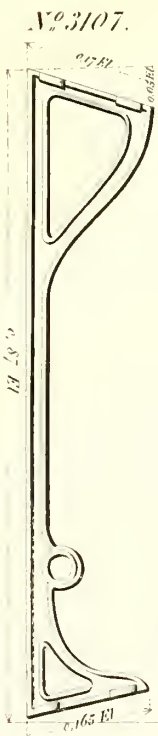

1.25 El. Waterpaslijn

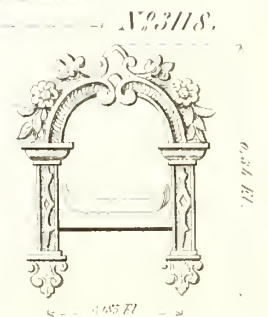
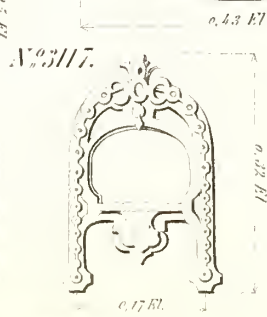
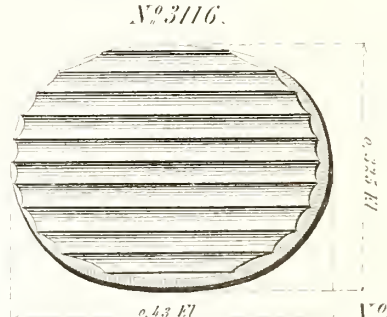
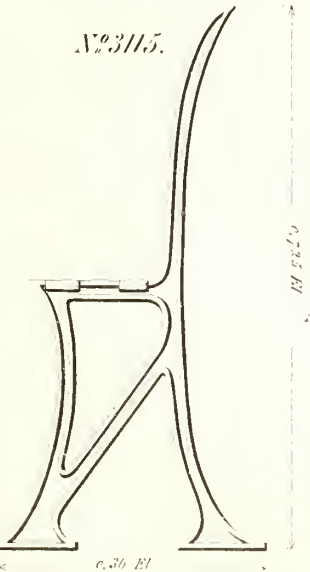
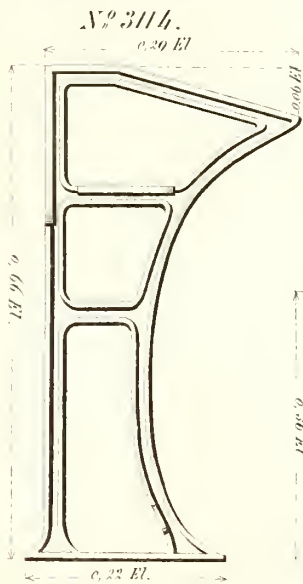
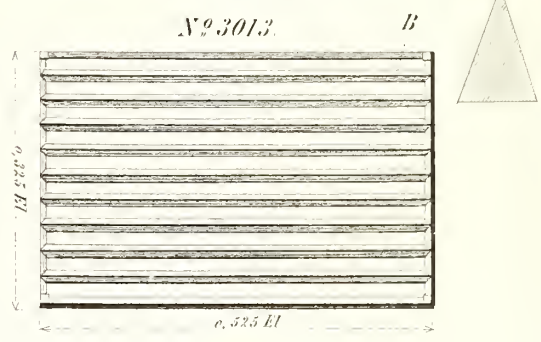
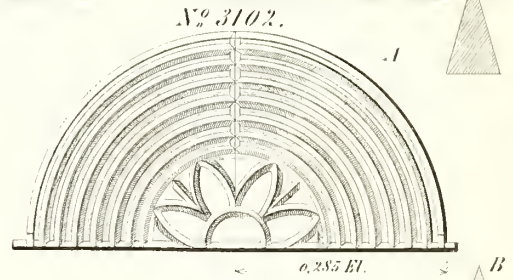
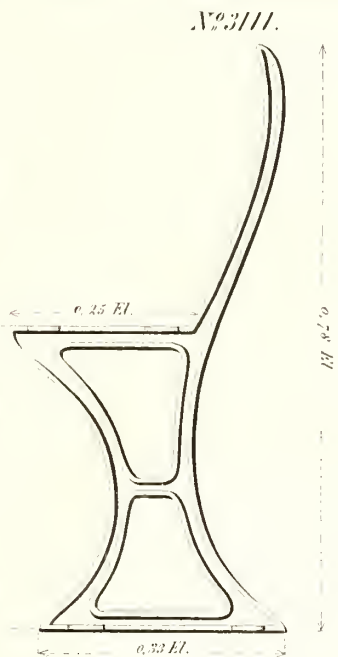
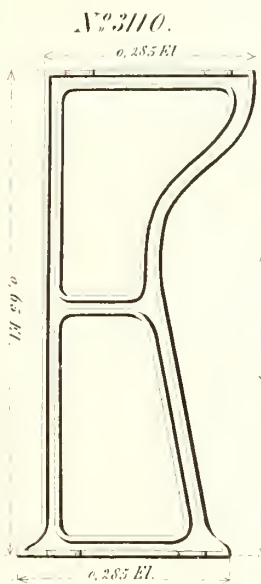

Fabriek van Bronswerken van *Becht en Dyserinck*.

N^o 3119.

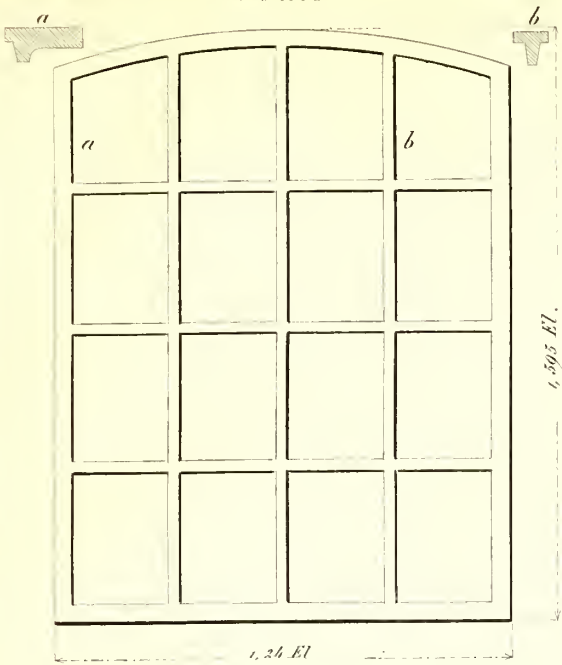

N^o 3120.

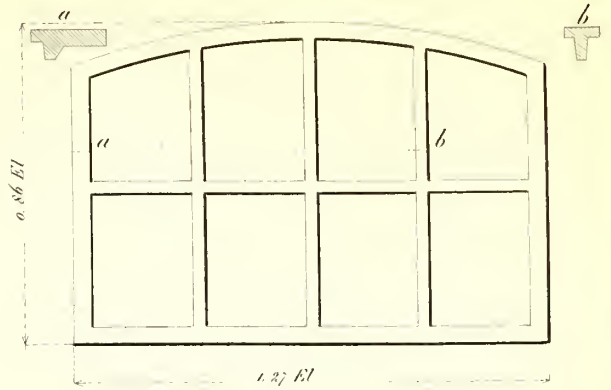

N^o 3122.

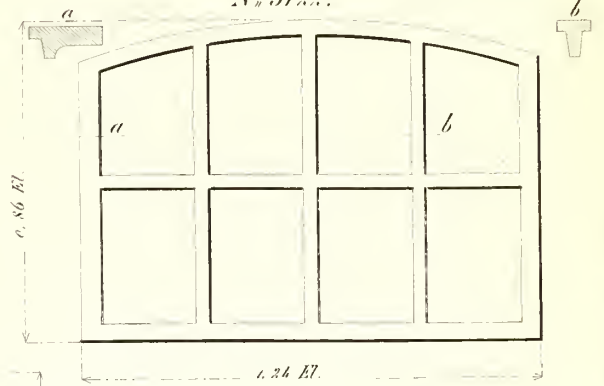

N^o 3121.
tuimelend raam.

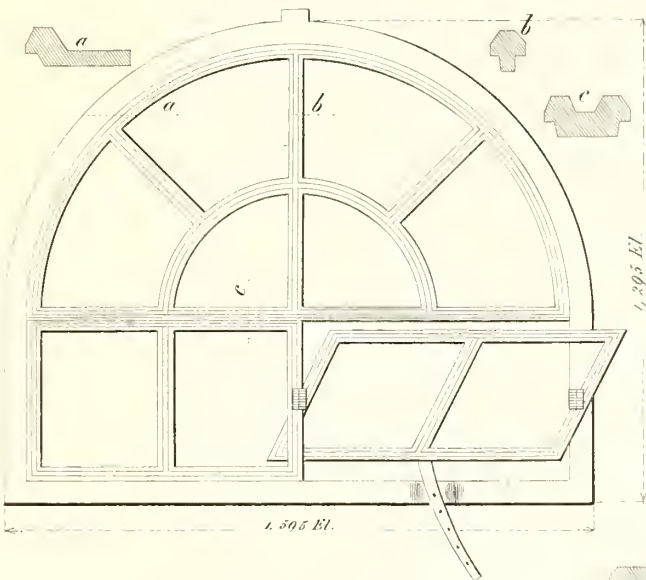

N^o 3123.

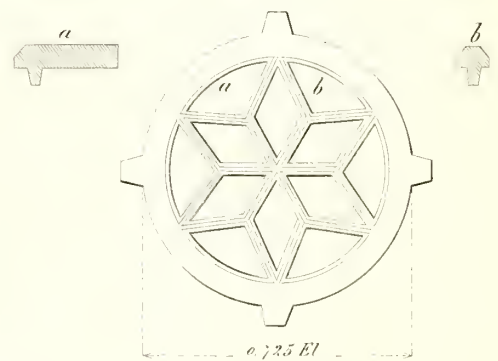

N^o 3125.

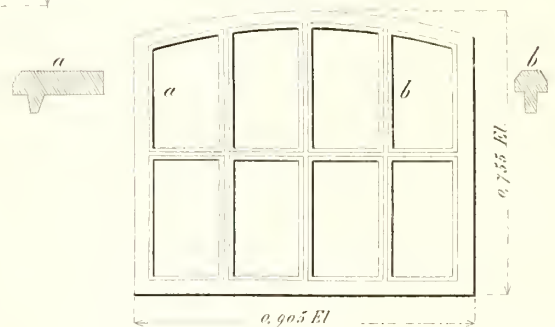

N^o 3124.

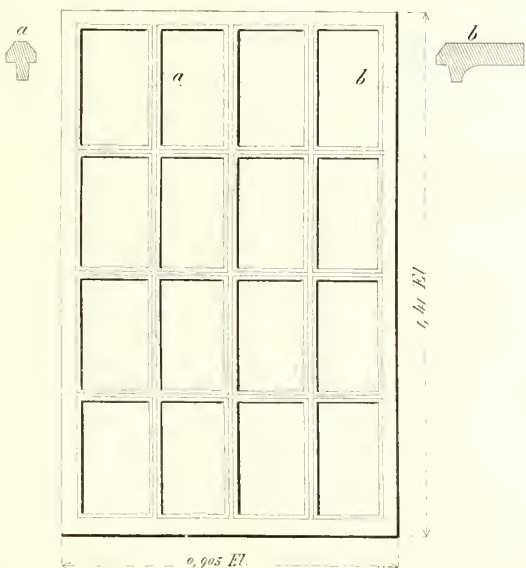

N^o 3126.

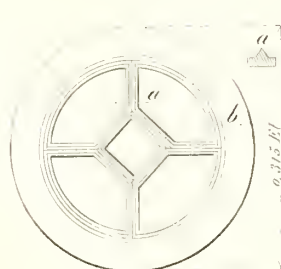

N^o 3127.
tuimelend.

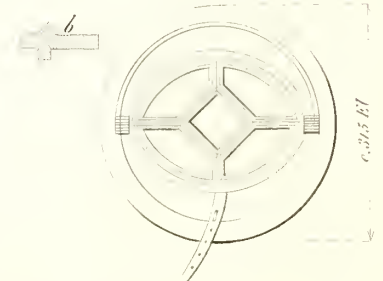

Schaal van N^o 3126 en N^o 3127 1:10.

Schaal 1 à 20.

Doorsneden Schaal 1 à 5.

Fabriek van Bronswerken van *Becht en Dyserinck*.

N^o 3128.

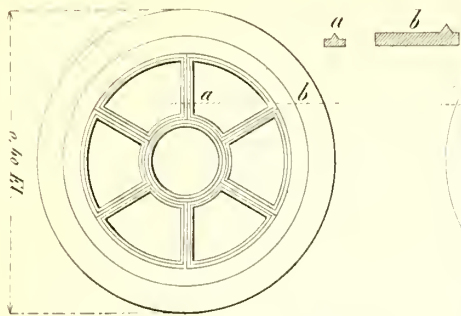

N^o 3129.
tuimelend

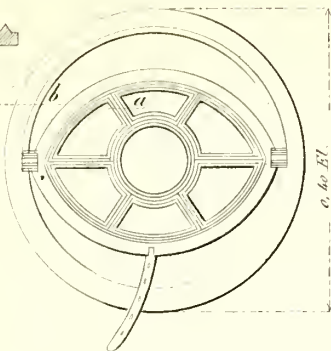

N^o 3130.

Dakraam voor platte ruypannen.

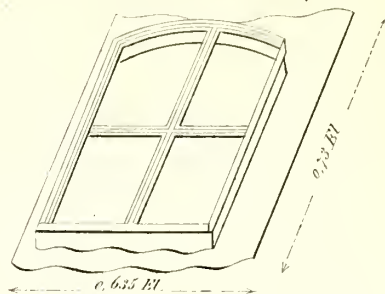

N^o 3131.

Dakraam 25 pans.

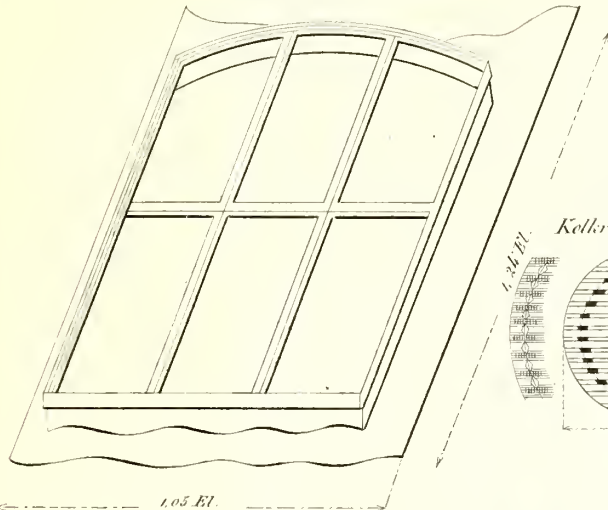

N^o 3132.

Dakraam voor zinken dakbekleding

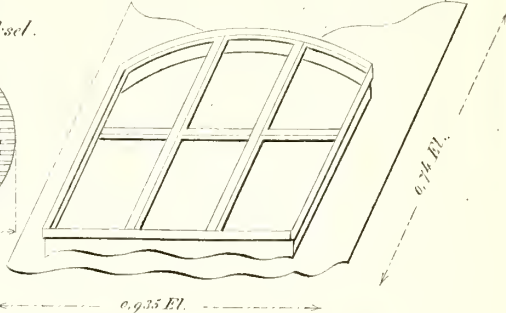

N^o 3132.

Kelkrand met deksel.

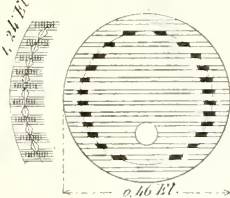

N^o 3134.

Dubbele heutenpomp.

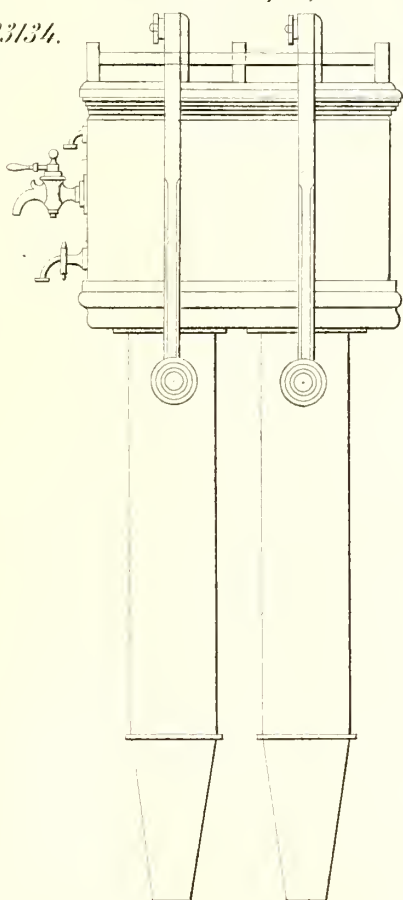

N^o 3135.

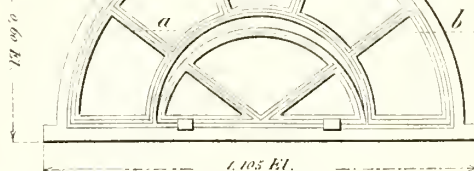

N^o 3136.

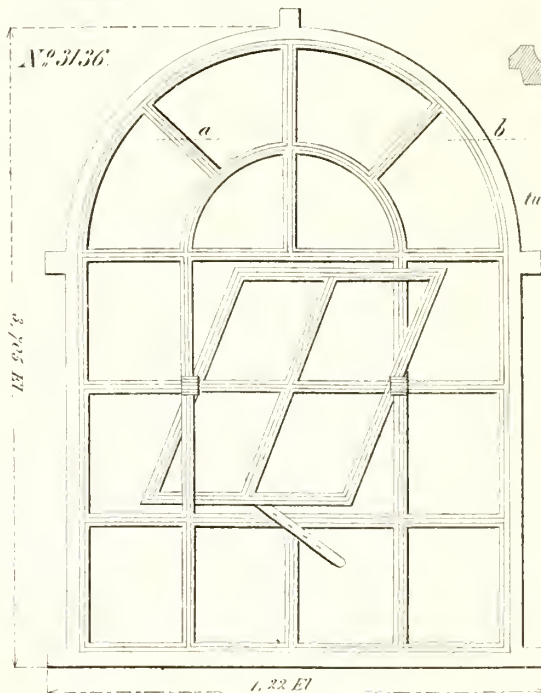

tuimelend raam





135
2000

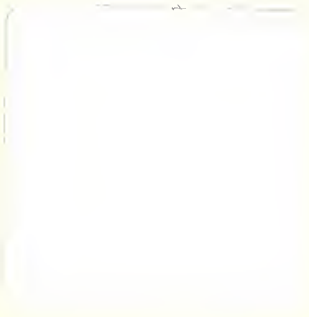

GETTY CENTER LIBRARY



3 3125 00066 1534

