

XC .U35

V.7

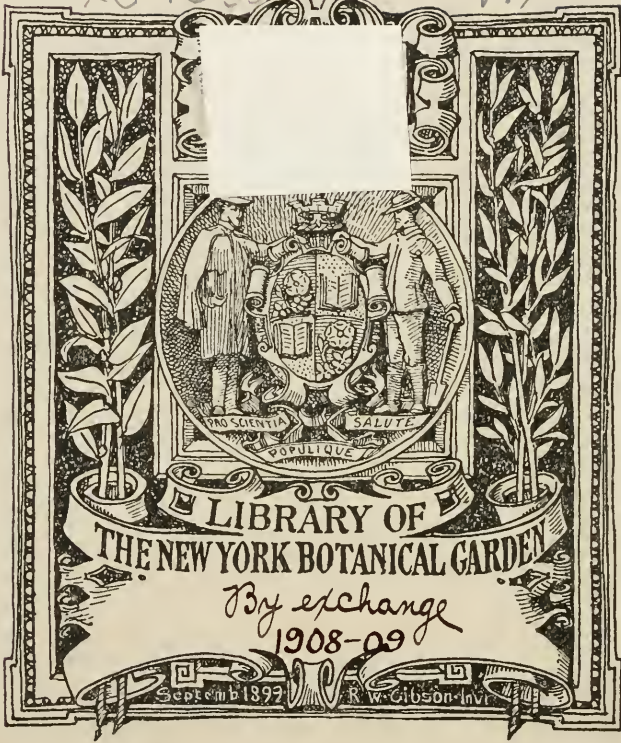

LIBRARY OF
THE NEW YORK BOTANICAL GARDEN

By exchange
1908-09

Sept 1897

R. W. Gibson - Inv.

THE CVBA REVIEW



50 Cents A Year DECEMBER 1908. 5 Cents A Copy

Published by the Munson Steamship Line 82-92 Beaver Street New York City

Ceballos "The Garden Spot of Cuba"

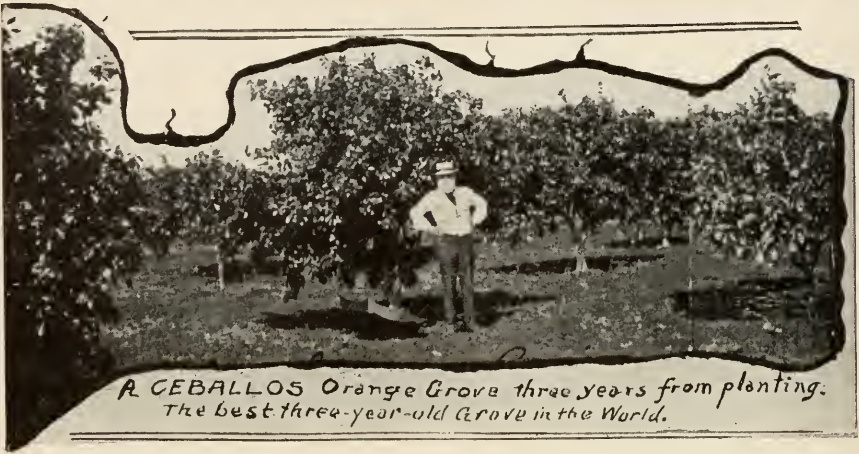

*A CEBALLOS Orange Grove three years from planting.
The best three-year-old Grove in the World.*

The **TIME** to invest in Cuba is now The **PLACE** is in the "Garden Spot," Ceballos
The **OPPORTUNITY** is offered by the Development Company of Cuba, owners of Ceballos

Write for information to

Geo. H. Gillett, Secretary, **43 Exchange Place, New York**

BITUMO

Invaluable como preservativo. Más barata que otras pinturas, dura más tiempo y está lista para aplicarse inmediatamente. Soporta ácidos y calor.

Para Hierro Estructural, Chimeneas, Carros de Hierro, Puentes, Barandillas, Techos, Calderas, Tanques, Cemento, Piedra, Pilotes.

Composición para los Fondos de Buques de Hierro y de Acero "RELIANCE."
Pinturas de Cobre para los Fondos de Buques de Madera "RELIANCE."
Pinturas Marinas y Estructurales, Esmaltes y Cementos "RELIANCE."

Pídanse Precios y Detalles de la

RELIANCE PAINT COMPANY

2 STONE STREET

NEW YORK

**FOR MOLASSES USE
STEEL TANKS**

BUILT BY

HAMMOND IRON WORKS

WARREN, PA., U. S. A.

... MATERIAL FABRICATED OR ERECTED COMPLETE ...

W. B. HAMMOND, SALES AGENT, : : : 29 BROADWAY, NEW YORK

Tivoli Beer

—*Enough said.*

Havana Brewery

Havana

CERVEZA

TOMA UNA COPA DE

BEER



Pilsner, Muenchner, Lager

NO HAY MEJOR

THE JOHN EICHLER BREWING CO.

Unico Agente para Exportacion

A. C. FABRICIUS

82-92 BEAVER STREET, NEW YORK



BUCKEYE NURSERIES

M. E. GILLET, Proprietor

TAMPA, FLORIDA, U. S. A.

ORANGE, LEMON AND GRAPE FRUIT TREES

LARGEST CITRUS NURSERY IN THE WORLD

QUALITY VARIETY DELIVERY

Price may be forgotten—Quality NEVER.

We grow nothing but standard Varieties which we can recommend to the trade as Money-Makers. Having had 29 years' experience we thoroughly understand packing trees for long distance shipments.

We guarantee our trees to be True to Name, Free from White Fly and to ARRIVE AT DESTINATION IN GOOD CONDITION.

Consider the future and protect your investment by planting reliable trees from

THE BUCKEYE NURSERIES

La Gloria has Arrived. All other American colonies in Cuba have yet to come.

La Gloria has Better soil, climate, water, schools, docks, cheaper transportation, living, more American people, push and natural advantages.

The Oldest, Largest and Best American Colony.

First Prize for citrus fruits Havana Exposition, 1908.

The La Gloria Transportation Company's fine mail and passenger steamer connects with Munson Line steamers at Nuevitas. Sailings Tuesdays, Thursdays and Saturdays.

Boulevard Completed. The Cuban Government has completed a fine macadamized boulevard from the townsite to Port Viaro, costing \$80,000.

La Gloria is All its Name Implies.

Not a promoter's dream but an assured fact. Our West Canasi tract, just opened, is the finest orange land in Cuba. We have also a few choice town lots for sale.

Send for our new booklets showing pictures of homes and plantations, and giving terms and conditions.

Cuban Land and Steamship Company

32 Broadway, New York City



Sugar Plantation—Cuba Railroad.

The Cuba Railroad

This new line completing the railroad connection between Havana and Santiago, and Antilla, on the Bay of Nipe, is of standard gauge and similar in its construction and equipment to the better class of northern lines. All of its important bridges are of steel and masonry, and the line generally is rock-ballasted. The main line passes along the center of the eastern and wider half of Cuba, and opens up a matchless and most picturesque agricultural region, and passes through the tropical forests of mahogany, cedar, lignum vitae, ebony and many other trees, hung with vines and millions of orchids. Palm trees of magnificent aspect and great variety abound everywhere. The famed Parana and Guinea grasses, covering most of the open districts and standing from six to twelve feet high and

green the year round, together with frequent running streams, make this an ideal cattle country. No food has to be put up and no shelter is required. The rich soils everywhere are adapted to sugar, tobacco, cotton, corn and an endless variety of products. The swamps which occur at places along the coasts of Cuba are absent from the interior, which is high, dry and exceptionally healthy. The trade winds blow across Cuba every day, and bring to all parts fresh sea air; the extreme heat of northern summers is consequently unknown and the humidity of other tropical countries is also unknown.

The Cuba Railroad Company's **Hotel Camaguey**, at Camaguey (formerly Puerto Principe) is by far the most popular resort in Cuba, Spanish in style, and provided with bath rooms and other modern conveniences, and is first-class in all respects.

This old city has about 40,000 inhabitants, is picturesque and is situated in a beautiful and remarkably healthy district. The hotel is especially favored by those wishing to spend some weeks or months in a matchless sub-tropical climate.



A Corridor, Hotel Camaguey.



Map of The Cuba Railroad

THE CUBA REVIEW

"ALL ABOUT CUBA"

An Illustrated Monthly Magazine, 82-92 Beaver Street, New York

MUNSON STEAMSHIP LINE, Editors and Publishers

SUBSCRIPTION

50 Cents Per Year - - - - - 5 Cents Single Copy

Advertising Rates on Application

Vol VII.

DECEMBER, 1908

No. 1

Contents of This Number

Cover page is of a picturesque old well at Nueva Gerona, Isle of Pines.

Political and Government review are on pages 7 and 8.

Page 9 contains Cuban newspaper cartoons reflecting the political situation.

Unusually interesting United States newspaper comments on the results of the election and Cuba's future prospects on pages 10 and 11.

Government activities on pages 12 and 13. Illustrations are of a new abbatoir at Cienfuegos and the new lecture hall of the National University at Havana.

Commercial matters are on pages 14 and 15, showing mahogany and cedar prices at New York, custom house collections at Havana, a visitor's interesting notes regarding American manufactures in Cuba, and statistics of United States trade with the Island during the years 1905 to 1908.

Important Cuban customs changes, some to take effect on January 1, 1909, and others already in effect, will be found on pages 16 and 17.

Interesting experiences of an American printer in Cuba will be found on page 18.

Page 19 is devoted to railroad and financial matters.

Some biographical sketches of foreign consuls accredited in Cuba, with portraits, are shown on page 20.

Horse races, automobile road races and baseball on page 21.

Religious views on Cuba by Bishops W. A. Candler and Albion W. Knight, with an illustration of the Baptist Church at Camaguey, on page 22.

Bridge building in Cuba, method and cost of construction of a wooden highway truss bridge, on page 23.

Agricultural matters, New York prices for Cuban products and other important matters on pages 24, 25 and 26, with an illustration on the latter page of an American home in La Gloria.

The monthly sugar review is prices by the well-known authorities, Willett & Gray, is on page 28, and a Spanish translation of the same important article is on page 30.

Various sugar notes, a chart of prices and the sketch and portrait of the owner of the Loteria sugar estate appear on page 32.

The number is profusely illustrated as usual.

DEC 26 1908

LIBR
NEW
BOTAN
GARD



SCENE ON THE LOS INDIOS RIVER, ISLE OF PINES.

THE CUBA REVIEW

“ALL ABOUT CUBA.”

Copyright, 1907, by the Munson Steamship Line.

Volume VII.

DECEMBER, 1908.

Number 1.

POLITICAL AND GOVERNMENT MATTERS.

**Liberals and Conservatives Harmonizing—How the House and Senate Will Stand—
President Gomez's Cabinet—The Cause of the Conservative Defeat—
President Roosevelt's Warning—The Cuban Loan.**

The election is over, and reports from various places show that Liberals and Conservatives are generally fraternizing. Gen. José Miguel Gomez and Alfredo Zayas were elected President and Vice-President of Cuba and will hold office until May 20, 1913, when, according to promise, Alfredo Zayas will be the Liberty party candidate for President.

A House of Representatives of eighty-three members, fifty-two Liberals and thirty-one Conservatives, and a Senate of twenty-four members, four from each province, were also elected. Half of the Senators will not take their seats until April, 1910, there being twelve Senators, elected for eight years in 1902, whose terms do not expire until that time. The twelve who will take office now will be selected by drawing lots.

There will be twelve negro members in the new House, just four times as many as when the Cuban Republic first opened for legislative business.

In the House the Conservatives will have a minority, as the electoral law provides for proportional representation in Congress, which makes it necessary that there shall be a minority.

In the recent Presidential election the total vote of the island was approximately 329,805, about 70 per cent. of the registration, while that cast in the provincial elections last August was about 60 per cent.

The newly-elected members of the House are divided as follows: Province of Pinar del Rio, 6 Liberals, 4 Conservatives; Province of Havana, 15 Liberals, 7 Conservatives; Province of Matanzas, 6 Liberals, 4 Conservatives; Province of Santa Clara, 10 Liberals, 8 Conservatives; Province of Camaguey, 3 Liberals, 2 Conservatives; Province of Santiago, 11 Liberals, 7 Conservatives; total, 51 Liberals, 32 Conservatives.

Regarding President Gomez's cabinet, the following, from the Cuba Review's correspondent in Havana, will prove interesting reading:

“Nothing that the newspapers have said about President Gomez's cabinet is well founded. Each daily makes a list to show itself as well informed; but all is reduced to suppositions made up by those who want secretaryships. The following memorandum is correct:

“Treasury, Marcelino Diaz de Villegas; Justice, Pelayo Garcia, a leading attorney-at-law; Government, Eusebio Hernandez; Health, Dr. Nicholas Albardez. These four secretaryships belong to President José Miguel Gomez.

“Public instruction, Dr. Ramon Mesa, professor of literature in the University of Havana; State, Justo Garcia Velez, who is now the acting secretary; Public Works, Manuel Luciano Diaz or Benito Lagueruela, formerly the Municipal Archi-

fect of Havana; Agriculture, Ortelo Foyo, an influential merchant. These secretaryships above belong to Vice-President Alfredo Zayas.

"The secretaryships of Justice and Public Works, as given above, have not yet been fully decided upon.

"War, Loynaz del Castillo; President's Secretary and Legal Adviser, Dr. Jose Lorenzo Castellanos."

Gen. Gomez will face some difficult problems after taking office, and some of these are: First, the amalgamation of the Liberals. His efforts in this direction are made easier by Vice-President Zayas's recent outspoken recommendation for fusion. Second, the distribution of offices. Besides the clamor of his own partisans, seventy-five per cent. of the Conservative officials now in office are likely to bring on trouble if discharged by him, and, third, scarcity of money in the treasury to meet future obligations, although Governor Magoon declared that Cuba will have no debts when the American intervention ends.

In his message to Congress President Roosevelt thus sums up the Cuban situation and sounds a warning note:

"In Cuba our occupancy will cease in about two months' time; the Cubans have in orderly manner elected their own governmental authorities, and the island will be turned over to them. Our occupation on this occasion has lasted a little over two years, and Cuba has thriven and prospered under it. Our earnest hope and one desire is that the people of the island shall now govern themselves with justice, so that peace and order may be secure. We will gladly help them to this end; but I would solemnly warn them to remember the great truth that the only way a people can permanently avoid being governed from without is to show that they both can and will govern themselves from within."

The Cuban newspapers disapproved of the warning paragraph on Cuba in the message. The *Diario de la Marina* said:

"As if enough had not been said already regarding this matter, President Roosevelt launches a fresh threat against the Cubans. His words are unjust. Cuba is a free and sovereign nation, whose sovereignty should not be extinguished on the pretext of its inability to govern itself."

Cuba, conservative, said: "It is evident that the President of the United States has told his successor that his obligations are limited to respecting the independence of Cuba while she conducts herself in an exemplary fashion; but at the first political convulsion Mr. Taft is explicitly authorized to blot out even the name of the republic."

La Discusion, also conservative, said that President Roosevelt's "great truth" applies only to small nations which are at the mercy of the great ones, and instances the fate of the Transvaal.

All the talk of a Cuban loan is met in the official report of United States Secretary of War Wright on Dec. 11, in which he says that:

"To insure the ability of the new Cuban government to meet obligations incurred by the provisional government for the sanitation of the island, the provisional government will probably, by decree, authorize the President of Cuba to issue bonds to the total of \$15,000,000, the estimated cost of the work.

"The original contracts for these works had been let during the former occupation of Cuba by the United States and under the administration of President Palma. The issue of bonds will be \$5,000,000 each year for three years. There is much opposition in Cuba to the proposed loan, and President Gomez authorized his organ, *El Triunfo*, to say that "With an economic and orderly administration Cuba will easily be able to meet future demands on the treasury."

The *Diario de la Marina* on the same subject said "That although the cash on hand is only \$1,756,595 and the obligations to be met for the public works voted by the Cuban Congress and decreed by the provisional government amounts to \$6,756,747, a majority of these works are still in their earliest stages and are not of urgent necessity."

Cuba's Official Census.

The official record of the last Cuban census shows that the population of the island increased in the last eight years from 1,572,797 to 2,048,980, an increase of 476,183. The population by provinces is as follows: Pinar del Rio Province, 240,372, an increase of 70,018; Havana Province, 538,010, an increase of 110,496; Matanzas Province, 239,812, an increase of 37,368; Santa Clara Province, 457,431, an increase of 100,895; Camaguey Province, an increase of 30,035, and Oriente Province, 455,036, an increase of 127,371.

The only city of any importance that has retrograded in population is Cardenas, which, in 1907, had 30 fewer inhabitants than in 1899.

CUBAN PICTORIAL COMMENT ON CUBAN ELECTION.

Las elecciones del día 14

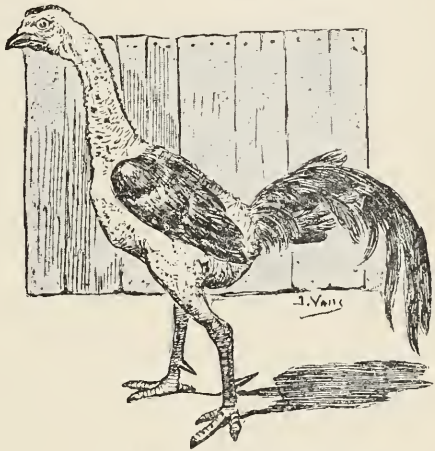

EL VERDADERO TRIUNFADOR

THE REAL CONQUEROR.

The game cock was a part of the emblem of the Miguelista party.

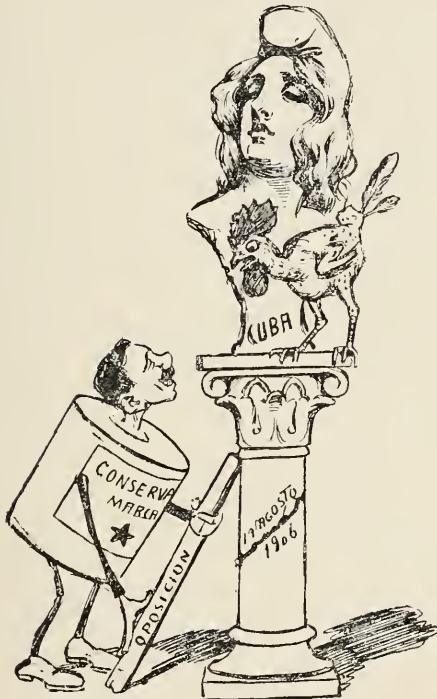

THE REPUBLIC RESTORED.

The conservative points to the August, 1906, fracture and insinuates that the glue or cement is still very fresh, and intimates that with his "opposition" the Cuban base will remain firm.

El reparto del lechon

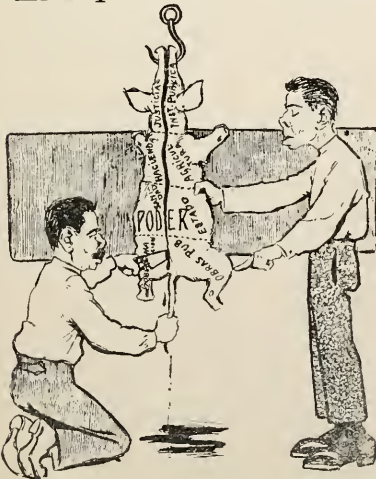

1907 MIGUEL.—No te quejes porque son dos trozos iguales. ZAYAS.—Y el rabito? —El que queda al rabito? —No me fijas al rabito?

AN EXACT DIVISION REQUIRED.

José Miguel—"You can not complain; there are two equal pieces."

Zayas—"And the little tail? . . . The little tail must also be divided."

On one side of the pig: Government, Health, Treasury Justice. On the other side: Public Works, State, Agriculture, Public Instruction.



EL PROGRAMA LIBERAL

The programme of the victorious Liberal party, "With All and For All."

EL GRANDE Y BUEN AMIGO



Roosevelt saluda y felicita al Presidente cubano

President Roosevelt salutes and congratulates the new President of Cuba.

 UNITED STATES NEWSPAPER COMMENT.

 North, East, South and West Opinions on the Elections—Ultimate Annexation, Etc.

Some of the American officers who have been quartered in the island say that it will be hardly necessary for them to remove all of the baggage, maintaining that it would be much easier to place the same in storage.—South Bend (Ind.) Tribune.

The fiery little islanders will have learned that the wisest way to settle differences in a republic is to submit them to the arbitration of the ballot-box.—Troy (N. Y.) Record.

Every house has its shady side, says President Eliot, but wise inhabitants occupy the sunny aspect. And we may hope that there is at last "room in the sunlight" for the independent republic of Cuba.—N. Y. Globe.

Now Cuba has a chance to keep that new flag flying without a fear of a stain.—Troy (N. Y.) Times.

Leaders of both parties will try earnestly to redeem themselves in the eyes of the world and prove their right to self-government.—Washington (D. C.) Post.

We have put them on their feet again, and once more they will have a chance to walk alone among the family of nations—if they can.—Chicago Examiner.

Gomez has a great opportunity. Let us hope that, with the unselfish assistance of his fellow-patriots, he will make the most of it for Cuba's sake.—Boston Journal.

The question of American annexation was not one of the issues of the campaign. All parties are opposed to that, at least nominally.—Turk Island (Ill.) Argus.

They will make the renewed experiment with the unfeigned good wishes of the great majority of the American people. But our God-speed will be tempered with some misgiving and doubt.—Philadelphia (Pa.) Record.

Gen Gomez is strongly in favor of schools and progress and there is reason for believing that Cuba will enjoy prosperity and fairly good government under his rule.—Jersey City (N. J.) Journal.

Another failure on the part of the Cubans would convince many that it is a wasted and fatuous effort.—Dallas (Tex.) News.

Good roads, schools and other public utilities are needed, in the supplying of which the insular government will have to do no more than to continue in the course already marked out and pursued by the provisional government.—N. Y. Tribune.

The permanent annexation of the island to the United States ought to have taken place long ago, and if it had not been for the Quixotic ideas of some American senators, the unfortunate experiment of Cuban independence would never have been made.—Pueblo (Colo.) Chieftain.

The tobacco growers, who, in large measure, sided with the Liberal party, are opposed to the establishment of closer relations with the United States. They fear that Cuba would be flooded with cheap American tobacco which would be re-imported in the United States as Cuban tobacco, to the detriment of the Cuban planters.—Syracuse (N. Y.) Herald.

Mr. Taft's experience in Cuba has peculiarly fitted him to deal with any crisis that may arise at any time, and the Cuban people will receive much more consideration and much more justice from Mr. Taft than from any other executive because Mr. Taft knows all about Cuba.—Albuquerque (New Mexico) Citizen.

Whenever disorder and disturbance in Cuba shall imperil the lives and property of American citizens and others for which this Government is responsible, there will be no hesitation in resuming possession and control of the island.—Tampa (Fla.) Times.

The election was to decide who will have charge of the "counter" and Cubans are proverbially hungry. — Hannibal (Mo.) Post.

Governor Magoon scrupulously and vigilantly avoided anything even remotely resembling the exercise of any influence upon the election save for the confirmation of law, order and integrity.—N. Y. Tribune.

This country desires to see the Cubans set up a decent, stable government of their own and maintain it under an American protectorate which shall shield them from outside aggression. — Philadelphia (Pa.) Bulletin.

We are treading very close to the making of a wretched mistake in the case of Cuba. Better American occupation for another ten years than independence followed almost inevitably by a speedy re-occupation.—N. Y. Commercial.

It appears that the election in Cuba has been carried by the party least in sympathy with the American protectorate.—Minneapolis (Minn.) Tribune.

The United States should be particularly careful that the next "revolution" in Cuba does not bear the stamp, "made in America." —Columbia (S. C.) State.

UNITED STATES NEWSPAPER COMMENT—(Continued).

There is no good reason why the Cubans should not overcome all difficulties relating to self-government. Many good patriots fought under Gomez and Garcia. If those people can be made to understand that they must be heroes in public service as well as in the field they may manifest the qualities so essential to good citizenship.—Troy (N. Y.) Record.

American interests in the island are such that discrimination would cause the Washington Government to take steps which might cause no end of trouble for Gomez and his supporters.—Troy (N. Y.) Record.

American statesmen have combined to instruct the people of Cuba in their duties as citizens and how to conduct affairs until it is believed that they are capable of managing for themselves. If they cannot do so the American Government will have to resume its role as protector and instructor and continue the course for an indefinite period.—Joliet (Ill.) Herald.

This country has enough problems involving outside possessions without adding another by annexing an island whose people cannot govern themselves.—Rochester (N. Y.) Chronicle.

The more intelligent Cubans who are viewing the situation from Washington consider annexation at a comparatively early date certain, not because of disorder, but from the recognition of the benefits that would accrue to Cuba through the establishment of free trade with the United States.—Fort Wayne (Ind.) Sentinel.

It is hoped that the Liberals will give their country a safe and sane administration, thereby permanently removing all pretext for further intervention and ultimate annexation.—New Orleans (La.) Picayune.

If our government is willing to wait patiently for ten years or twenty, interfering always in behalf and on the side of constituted authority in emergencies, the Cubans may learn eventually that peace and order are not only possible, but that they are compulsory.—Concord (N. C.) Tribune.

Will Cuba be glad or sorry when the United States protecting arm and flag are no longer near?—Canton (O.) Repository.

Predictions are freely made that the faction now in power is less qualified to run Cuban affairs than were Palma and those associated with him.—Augusta (Me.) Journal.

There is no apparent reason why the United States should have ever again to interfere.—McKeesport (Pa.) News.

Maybe, after all, we have established a nation which will be peaceful, strong and prosperous, an honor to itself and to us.—Richmond (Va.) Leader.

The United States has done splendid and generous work in the island. It is ready to step down and out. Are the Cubans ready to take over and carry on their governmental affairs in peace, freedom and honor?—Chicago Record-Herald.

Uncle Sam stands by as a friendly guard, but the country should run its own affairs without calling for interference every few years.—Troy (N. Y.) Times.

The United States has made too great sacrifices for Cuba to see all thrown away. Cuba must be at peace and must be industrious.—Mobile (Ala.) Register.

If this experiment fails, Cuba will without doubt be formally annexed, and given a government like that of Porto Rico. This would long ago have been the Cuban status but for the folly of the Teller "self-denying clause" in the declaration of war with Spain.—St. Paul (Minn.) Pioneer Press.

In Gen. Gomez the people of Cuba have chosen a grand old warrior who has won a sure place in the hearts of his constituents.—Lincoln (Neb.) Star.

Uncle Sam will withdraw his troops from Cuba in a short time, and then President Gomez will have the wild ones on his hands.—Knoxville (Tenn.) Tribune.

May Cuba have better luck this time.—Buffalo (N. Y.) Express.

Cuba is one of the most fertile countries on the globe, rich in minerals, in area almost equal to England, with 2,000 miles of sea coast, many fine harbors and is close to the markets of the United States.

Cuba needs only peace, industry and enterprise to speedily become one of the most prosperous and happy nations in the world.—Harrisburg (Pa.) Patriot.

It is Cuba's last chance at absolute independence. For in the final resort this must be the lash by which Gen. Gomez can whip even his most belligerent countrymen into line.—Chicago (Ill.) Post.

The United States will undoubtedly be forced into the position of having this rich and populous island thrust into its list of insular possessions.—Sioux Falls (S. D.) Argus-Leader.

Cuba, with good government and industrial expansion, should be prosperous and happy.—Hailey (Ida.) Times.

Liberalism in Cuba means the right to seize the property of others under forms more or less of law; less rather than more. Of course, property will resist. Then there will be anarchy, and the army and navy of the United States will be sent to Cuba again.

All this is absolutely certain.—Portland Oregonian.

GOVERNMENT ACTIVITIES, NEW LAWS, CONSULATES, TAXES, ETC.

Water Meters for Havana.

Water meters are to be placed at all the factories and farms within the city of Havana, according to a decree of Nov. 23 by Governor Magoon.

As the old law read, only stores were obliged to pay for the water. Under the new law water used by factories will be charged for at the rate of four cents per cubic meter, and at places where the water is drawn by pumps at five cents per cubic meter.

The city engineer will decide where meters are to be placed, the property owners paying the cost of installation.

The Provincial Councils Income.

The provincial councils of Cuba are finding themselves in serious financial difficulties on account of the reduction in revenues made by the new provincial law.

Under an older law their revenue equalled about 30 per cent. of the taxes collected by all the municipalities, and of this amount 35 per cent. was allowed them for salaries, the balance for public works. Under the new law their revenue is only equal to 10 per cent. of the municipal tax, while they are still expected to pay salaries and defray the expense of public works.

Pinar del Rio and Camaguey Provinces found even the 30 per cent. apportionment inadequate for their needs and were compelled to frequently ask for aid from the central government. Budgets will have to be cut down in all provinces, which will mean reductions in salaries and curtailment in public work. Meetings by delegates from the provincial council have been held and the government has been asked to annul the law

and permit the old apportionment to remain.

The Island Without Debt.

Gov. Magoon, while in Washington Dec. 5, said that the Cubans would take charge of the island without debt other than that from incompleting public work in course of construction. Every obligation will be met up to the time of the American withdrawal. Not only has all debt been wiped out, but out of the revenues have been paid provisional government expenses, improvements of all kinds, including new roads, schoolhouses, lighthouses, barracks for soldiers and rural guards, maintenance and repairs of public buildings, the taking of a census, the holding of two elections, sanitary work of various kinds, and settling with the Catholic Church for confiscation of and damages to church property.

U. S. Customs Inspectors in Havana.

On December 2 Governor Barry approved the proposition made to the Cuban Government by the Treasury Department in Washington to have two custom house inspectors in Havana to examine the baggage of passengers going to the United States from that port. The appointments will be made by Washington and paid for by the United States. The Cuban Government will supply adequate quarters for the examination of baggage at the Machina Building, Havana. Passengers, when this arrangement is working, will send their baggage to the wharf ahead of time, and after examination it will go to the steamer and be delivered unopened without further examination in the United States.

The Governor also said that no decision as to the issue of about \$12,000,000 bonds to pay the extensive improvements in the sewer system and street department of Havana has been reached, a work the contractors have just begun. It is probable that the payment for the contract will be left to the Cuban Government, which may be able to meet the payments out of its current revenues without the issuing of bonds.



Abattoir recently built in Cienfuegos at a cost of \$25,000. Is large enough to supply a city of 60,000 inhabitants.



New lecture hall now nearly finished for the National University in Havana.

*New Post
Offices and
Telegraph
Stations.*

A new money order office has been opened at Arriete, Santa Clara province.

A money order office has been opened in Manicaragua,

Santa Clara province.

A new post office is open at Cidra, province of Matanzas.

Other new offices are as follows:

Post Offices:—Amaro, Santa Clara Province; Providencia, Havana Province.

Money Order Offices:—Cano, Havana Province; Wajay, Havana Province.

Telegraph Office:—Chambas, Camaguey Province.

Governor Magoon has accepted the resignation of Serafin Garcia Menocal as Cuban Consul in Baltimore, and has appointed Jose Agustin Castellanos to fill the vacancy.

A credit of \$23,700 was appropriated Nov. 15 by the Provisional Governor for the building of the cart road from San Juan y Martinez to Punta Cartas, province of Pinar del Rio.

Antonio Martin Rivero, minister from

Cuba to Mexico, an appointee of the late ex-President Palma, will hand in his resignation to President-elect General Miguel Gomez on January 28.

He with all other of the Cuban diplomatic representatives tendered his resignation at the time of the renewal of the provisional government, but the resignation was not accepted.—Mexico Record.

The wireless stations at Camaguey and Santa Clara were tested with the most gratifying results, communications being exchanged between the two cities with the greatest ease.

The Signal Corps recently conducted some very interesting experiments in wireless telegraphy from Monserrate hill, sending and receiving messages from Camp Columbia and Key West.

That part of the Malecon along the sea to Vedado which heretofore had been called Gulf Avenue, will now be called Maceo Avenue, according to a resolution adopted Dec. 2, at the city council.

COMMERCIAL MATTERS.

American Manufactures in Cuba.

A visitor's interesting observations on American manufactures in Cuba, comprising in the main articles in the interior of the island, shows that the use of labor-saving devices is increasing, and this will be bound to develop a larger demand. He says:

"Five days after our arrival in Cuba, I was engaged in the erection of an American windmill, in combination with the pumps of a well-known eastern maker; these two examples of superiority in our products enjoy wide popularity in Cuba, assuring a rapidly growing demand in the future. Once properly erected, very little attention is needed to keep them in good working condition for years. The absence of frost is of great assistance in securing this excellent service, and the labor-saving features appeal to the dweller in the tropics. The growing popularity of corn meal for table use, and the prevalence of destructive insects that compel the storage of corn in the husk, on the cob, make the family corn mill and the family coffee mill two promising lines of light manufacturing. In Cuba the coffee mill is the first sound denoting the approach of morning.

Our host at Manicaragua has a small coffee mill that has been in use for many years. The burrs had become worn. I wrote the manufacturer giving the principal features and the markings, and for less than one dollar secured by mail a pair of new burrs that were substituted in a few minutes, fitted perfectly, and incidentally won for that far-seeing manufacturer an enthusiastic admirer in an influential resident. Simplicity and durability are two indispensable requisites in every line of products that would win and retain favor in the keen competition met in manufacturing for export.—Raymer T. Hanford, in the Dryden (N. Y.) Herald.

High Priced Cars in Cuba.

There is a big sale for high-priced foreign automobiles in Cuba, says the New York Times, strange as this may seem, the explanation being that a low tariff puts the foreign makes on an even selling level with cars of American manufacture, and this probably accounts for the willingness of foreign houses to enter cars in the Cuban races.

Custom House of Havana.

The Custom House collections of this port for November were \$1,446,351.89.

For the same month of 1907 the collections were \$1,739,743.11, a decrease of \$293,391.12 for 1908.

The Cuban Reciprocity Treaty.

The five years' limit prescribed in the Cuban reciprocity treaty, at the end of which the treaty might be terminated, will expire December 27. It was said at the war and state departments recently that the treaty would continue effective for an indefinite period until either the United States or Cuba serve notice of its termination. Although the treaty provides that it shall remain in effect for five years from December 27, 1903, it also provides that it shall be continued in force from year to year thereafter until one of the parties to the treaty shall notify the other that the treaty will no longer be regarded as valid and binding. This notice, it is provided, must be given a year in advance of the date on which it is desired that the treaty shall terminate. No such notice has been received or given by either Cuba or the United States as yet, and none is expected.

The Cuban treaty has been a bone of contention throughout the whole of our recent tariff difficulty and will, undoubtedly, continue to be so. Particular acuteness is given to the situation by the fact that during the month the date will be reached when by giving a year's notice we can at any time terminate the treaty. The agreement was entered upon before the Germans had begun their campaign for better trade relations with the United States and of course they could not consistently urge the violation of treaty rights during the life of the document. A different problem is presented when the end of the regime thus established is arrived at.—New York Journal of Commerce.

New York Mahogany and Cedar Prices.

Mahogany.—There were five ports represented in the month's arrivals. All of this wood came forward on order, and consequently has passed into second hands. The stock that was on hand a month ago remains unchanged. The market is not active, although shipments of wood of good size can be recommended.

Cedar.—The receipts of this grade of wood were somewhat smaller than the previous month, and have all passed into second hands, together with part of the stock that was on hand a month ago, which shows an improvement in the trade. Large wood in good condition will undoubtedly be well received.—Geo. F. Herriman, December 1, 1908.

UNITED STATES COMMERCE WITH CUBA.

Government Statistics of Imports and Exports During the Years Ending June 30, 1905—1908.

Some Exports to Cuba.

| Quantities. | | | | Values. | | | |
|---|------------|------------|------------|-------------|-------------|-------------|-------------|
| 1905. | 1906. | 1907. | 1908. | 1905. | 1906. | 1907. | 1908. |
| BOOTS AND SHOES (PAIRS). | | | | | | | |
| 1,379,933 | 1,448,002 | 1,275,687 | 1,976,901 | \$1,322,030 | \$1,769,706 | \$2,145,415 | \$2,577,956 |
| COFFEE, GREEN OR RAW (POUNDS). | | | | | | | |
| 6,253,051 | 11,739,124 | 16,317,890 | 13,074,166 | \$761,077 | \$1,376,175 | \$1,888,310 | \$1,468,347 |
| COFFEE, ROASTED OR PREPARED (POUNDS). | | | | | | | |
| 196,880 | 466,988 | 1,805,542 | No figures | \$25,574 | \$54,142 | \$214,694 | No figures |
| BUTTER (POUNDS). | | | | | | | |
| 131,278 | 232,300 | 306,798 | No figures | \$27,850 | \$50,290 | \$71,930 | No figures |
| STARCH (POUNDS). | | | | | | | |
| 2,899,717 | 1,513,320 | 636,762 | No figures | \$68,231 | \$36,444 | \$16,677 | No figures |
| POTATOES (BUSHELS). | | | | | | | |
| 464,484 | 431,872 | 999,649 | No figures | \$360,104 | \$349,443 | \$826,998 | No figures |
| BOARDS, DEALS, PLANKS, JOISTS, ETC. (M. FT.). | | | | | | | |
| 113,374 | 140,345 | 119,801 | 108,554 | \$1,518,665 | \$2,450,604 | \$2,330,865 | \$1,870,715 |
| AGRICULTURAL IMPLEMENTS, PLOWS AND CULTIVATORS AND PARTS THEREOF. | | | | | | | |
| (Values only given.) | | | | \$79,740 | \$163,036 | \$137,114 | \$68,236 |

Some Imports from Cuba.

| Quantities. | | | | Values. | | | |
|-------------------|---------|---------|------------|-------------|-----------|-------------|------------|
| 1905. | 1906. | 1907. | 1908. | 1905. | 1906. | 1907. | 1908. |
| HONEY (GALLONS). | | | | | | | |
| 131,314 | 63,026 | 76,312 | No figures | \$57,918 | \$26,239 | \$33,380 | No figures |
| BEESWAX (POUNDS). | | | | | | | |
| 79,926 | 158,523 | 331,942 | No figures | \$24,006 | \$48,120 | \$93,702 | No figures |
| BANANAS. | | | | | | | |
| | | | | \$1,437,952 | \$959,628 | \$1,273,820 | \$875,272 |
| COCOANUTS. | | | | | | | |
| | | | | \$254,374 | \$302,478 | \$262,822 | \$195,518 |
| ONIONS (BUSHELS). | | | | | | | |
| 33,895 | 7,989 | 10,670 | No figures | \$21,860 | \$6,206 | \$10,226 | No figures |
| MAHOGANY (M. FT.) | | | | | | | |
| 1,467 | 2,150 | 3,254 | 2,415 | \$88,500 | \$120,201 | \$187,011 | \$150,793 |



NEW CUBAN SCHOOLHOUSES. The one illustrated above has six rooms and will accommodate about 200 or 250 pupils.

IMPORTANT CUBAN CUSTOMS CHANGES.

To Take Effect January 1, 1909.

Summarized especially for the CUBA REVIEW by Victor H. Barranco, Attache, Consulate-General of Cuba at New York.

Extracts from Decree No. 1076, Havana, November 15th, 1908, signed by Charles E. Magoon, Provisional Governor of Cuba, amending the Consular Tariff Law of February 14th, 1903, are here presented:

Article 21.—Invoices under the value of \$50.00 need not be certified (*excepting those invoices which contain merchandise originating from those countries which benefit under the Reciprocity Treaty with Cuba). *Modification by Cable—December 21st, 1908.

Consular Fees.

Article 21.—For certifying invoices from \$50 to \$200, \$2 each invoice.

Article 21.—For certifying invoices over \$200, for each additional \$100 or fraction thereof amounting to over \$50, 10 cents each invoice. Invoices of less value than \$50 originating from the same firm or individual, forming part of the same shipment and addressed to the same consignees, will be taxed the proper fees at the Cuban Custom House at Havana, on the total amount of such invoices.

Article 22.—In case of loss of the original, or at the request of the parties interested, a second certificate will be issued at 50 cents each invoice; former cost, \$5 each invoice.

Article 23.—For deposit of merchandise or for damaged goods at the demand of the Consulate, or at the request of the parties interested, in addition to the storage and watchman's expenses, there shall be an additional charge on the value of the goods so deposited of (twenty cents per hundred dollars), 20 per cent.

Article 58.—Any American or foreigner sending merchandise to the Republic of Cuba must file with the respective consular office the corresponding invoice for proper certification, provided the same represents a value of \$50 or more.

Article 59.—With the exception made in the foregoing article, the Cuban Custom House shall require in order to take action on a declaration or clearance of merchandise, the proper invoice certified to in the respective consular office, or in exceptional cases, the necessary security for the later fulfilment of said requirements.

The Custom Houses of the Republic shall impose fines amounting to double the proper consular fees, in the event of the presentation of invoices the certifications of which bear a date subsequent to the date of the arrival of the vessel carrying said goods at the first port of entry of Cuba.

Invoices whose amounts at the time of assessment of duties should have been raised to a larger sum than the one declared therein as a basis for the application of this law, shall likewise be fined by the Customs of the Republic double the amount of fees short paid at the Consulates. For example, if an invoice amounting to \$300 is presented for certification and after the consular fees have been paid the value of said invoice is increased to a larger amount, say \$1,300, in such case, as stated in this paragraph, the customs officers at that port would double the amount of the legal fee on \$1,300. As originally presented at the Consulate for certification the fee would be \$3.10, but this would now be \$6.20.

Said fine will not be imposed when the merchandise covered by the invoice filed proceeds from a country and is shipped at a port wherein no Consular Officer exists.

No fees will be charged for certificates, declarations or explanatory notes required on invoices for the purpose of establishing the origin of merchandise, in order that it may enjoy the benefits extended by Treaties.

Article 54.—The fees established by this Tariff are understood to be in U. S. Currency or in National Gold when the same shall be adopted by the Cuban Government, but they should be received in the official currency of the country wherein the Consular Officer resides, and at such rates of exchange as may avoid any loss to the Treasury.

The following are already in effect:

Immigrants to Cuba.

All steerage passengers sailing for Cuba or the Isle of Pines must appear in person at the Cuban Consulate at the port of sailing, and receive an Inspection Card, which will be issued gratis in their names. The different Steamship Companies must not issue a passage ticket until the passenger presents this card at their office.

The object of this Inspection Card is to avoid the Immigrant being detained at Quarantine and the railroads of Cuba.

Important Modification in the Consular Declaration which must be Affixed on Invoices Covering Shipments to Cuba.

Decree No. 1016, Havana, October 30th, 1908, signed by Provisional Governor Charles E. Magoon, and reads as follows:

First.—That Paragraph 4 in Clause 11 of the Article 97 of the existing Customs Regulations be and the same is hereby amended as follows: "No Consular Invoice shall be admitted in which there are amendments or erasures, nor shall any invoice be admitted except the original one of the manufacturer, producer, seller, owner, or shipper of the merchandise, as the case may be. Invoices shall be made on firm and durable paper, in a legible manner, etc., etc., etc." (Explicit instructions as to making out Consular Invoices, etc., will be found in the July issue of the "Review.")

NOTE.—Previous to this ruling, only the "fabricante, vendedor ó productor" (manufacturer, producer or seller) of the goods shipped, was authorized to sign the Spanish declaration at the foot of the invoice.

NOTE.—Heretofore any person shipping furniture, household goods, etc., etc., was obliged to suffer delays and annoyances by being compelled to write to the manufacturer or seller of the goods for invoices, and in cases the majority of the documents were not made out properly, i. e., some lacking the weights, others signatures, number of copies, etc., and thereby making it necessary to mail them back, in order that they be made out according to the requirements; in the meantime the shipper in this city is obliged to pay storage on the goods, loss of time, etc. But with this modification it will be much easier for the shipper.

Special Duties on Cuban Imports Continue Indefinitely.

NEW YORK, Nov. 23, 1908.—Please state when the 20 per cent. reduction in duty on goods arriving from Cuba will cease to be allowed.

AGENT.

Reply.—It is a treaty or convention between the United States and Cuba, ratified in March, 1903, which provides that "all articles of merchandise being the product of the soil or industry of the Republic of Cuba * * * imported into the United States shall be admitted at a reduction of 20 per centum

of the rates of duty thereon as provided by the tariff act of the United States," etc. This is to continue "so long as the said convention shall remain in force," and the convention provides, by its own terms, that it is "to continue in force for the term of five (5) years from the date of going into effect, and from year to year thereafter until the expiration of one year from the day when either of the contracting parties shall give notice to the other of its intent to terminate the same."



New Custom House in Matanzas. Will house Custom House, Post Office, Telegraph and Department of Public Works. All these formerly occupied separate quarters, at a heavy rental. The saving is nearly eighteen per cent. The building is now finished.

AN AMERICAN PRINTER IN CUBA.

A note of warning is sounded to the American printer who contemplates a trip to Cuba without having something in sight by the Typographical Journal of Indianapolis, Ind., in the following letter from its correspondent in Havana:

After a vain search all over the island, this printer found an office in Cienfuegos that was really hard up for help. The proprietor told at some length the trouble he was in to get his work out on time, and the printer inquired about the wages to be paid, thinking that such great need would be profitable to him. He was offered the sum of \$30 a month, Spanish. Where wages were so low, he thought, living should be cheap. He accepted the place tentatively, and went out in search of board. The best he could do was \$30, American! Allowing an exchange rate of 16 to 18 cents, it is easy to see where the printer got off.

Being one of the old school of printers who are able to take a hand at several occupations, he was also a musician. He came to Havana and looked over the theatrical field. A local theater was in need of a trombone player, and after a satisfactory trial the "maestro" said he would do. Upon inquiring about the pay, he was told he would get more than any other member of the orchestra—\$8 a week, Spanish. He finally made up his mind that any place was better than Cuba, and accepted employment with a construction gang on a new railroad in South America.

The wages paid by the two American papers in Havana look large to printers in the States. They are a big inducement for them to come here, but after they find what it costs to live they do not stay very long. A respectable room anywhere near one's employment will cost from \$15 to \$20, American money, a month—more often the latter figure.

Automobile Roads of Isle of Pines.

Considerable attention has been attracted to the Isle of Pines through the new roads which have been built and which make the tour of the island in a motor car a matter of real pleasure. The newly completed road from Havana to Batabano is a favorite with those who enjoy this form of traveling, and from there a rate by steamer of \$7.50 is made on the "New Cristobal Colon" for the transportation of the machine, making it a comparatively cheap matter for the autoist to extend his trips in Cuba to the Isle of Pines.

Board, under any circumstances, will be expensive. Possibly the best bargain that has come to my knowledge is a house that gives seven dinners for \$3, American money. If one eats at the different cafes, as is often done, his living expenses will be great. If married, housekeeping is almost out of the question, unless one wants to live in an oven in the city proper.

There are no amusements here such as obtain in the States, and the printer must either make his own pastime or sit still. If he wants amusement, and must make it himself, it will make a hole in his pocketbook. If he sits tight, he will save money and soon get tired of the place and go back to the States. This has led to a new man coming every now and then, and situations change hands often. It is in this particular case that a word of advice should be given to the men who are sent for in a "rush." They should insist on a contract as to their hours and duties, and especially overtime pay.

On the basis of the New York operators' night scale of \$31 a week, the New York man will make \$38.76, counting the seventh night at the overtime rate. Taking from \$45 about 25 per cent. for the increased cost of living here—and this is a very moderate allowance—it is easy to see where \$45 is not so big as it looks.

There have been rumors for some time that an American company was about to be organized in the States for the purpose of erecting a large office to be devoted exclusively to printing. The intention was to turn out everything in the printing line, from composition to binding. It is said the success or failure of the scheme depends on the length of the American occupation.

JOHN H. CLAPHAM.

Commencing January 1, 1909, the Havana Post will publish a weekly edition for the colonists and farmers of Cuba. It will contain "All the News Once a Week," and will be known as The Havana Post-Weekly.

Blue hospital tents in Cuba have been found extremely effective in the case of patients suffering from nervous strain caused by the sun's glare. Further experiments are now in progress along the line of protection for officers and men from the sun's powerful actinic rays.

RAILROADS AND FINANCIAL.

Report of the Cuba Company—Earnings of the United Railways of Havana, the Havana Electric Co., Etc.

Cuba Railroad.

The report of the Cuba Railroad Co., for the month of October and four months ended October 31, compares as follows:

| | 1908. | 1907. |
|-----------------------|-----------|-----------|
| October gross | \$133,195 | \$134,118 |
| Expenses | 83,997 | 99,705 |
| October net | 49,198 | \$34,413 |
| Charges | 32,488 | 28,329 |
| October surplus | \$16,710 | \$6,084 |
| Four mos. gross..... | 556,052 | 577,574 |
| Expenses | 341,100 | 417,992 |
| Four mos. net..... | \$214,952 | \$159,582 |
| Charges | 129,275 | 113,317 |
| Four mos sur..... | \$85,677 | \$46,265 |

National Bank of Cuba Absorbes the Banco de la Habana.

Announcement was made Nov. 17 that the Banco Nacional de Cuba would absorb the Banco de la Habana, for which negotiations had been progressing for several months.

An agreement was finally reached after Mr. Vaughan, president of the National Bank, had consulted with financial interests in Paris and New York, and finally with Mr. De Zaldo, president of the Bank of Havana. In New York J. P. Morgan and Company and the National City Bank, usually financial rivals, reached an agreement on the subject. The National City Bank has practical control of the Bank of Havana.

The present capital of \$5,000,000 of the National Bank will not be increased. The combination will make the National Bank the most powerful financial institution in Cuba.

The Banco Nacional will conduct the liquidation of the Bank of Havana.

United Railways Earnings.

The earnings of the road, which suffered much during the summer months, are beginning to show the effects of increased winter business.

The total earnings for the week ending November 28 were £14,005, as against £13,580 during the same week in 1907, an increase of £425. The earnings of the road for the present economic year are £268,470, which show a deficit of £11,210.

Havana Electric Railway's Earnings.

The earnings for the week ending November 28 of the Havana Electric Railway show an increase of \$1,871 over the same week in 1907. The earnings for the week were \$34,636, as against \$32,765 in 1907.

There has been no decrease in the earnings of this road and instead it shows an increase of \$96,530 since January 1 over the earnings in 1907, which were \$1,612,914.

Camaguey Company's Earnings.

The following is a comparative statement of the earnings of the Camaguey Company, Limited, for the month of October, 1907-8, and for ten months ending October 31:

| | 1907 | 1908 | Increase |
|--|-----------|-----------|-----------|
| Gross ... | 6,961.76 | 11,283.69 | 4,321.93 |
| Nett .. . | 3,187.68 | 4,915.55 | 1,727.87 |
| For ten (10) months ending October 31, 1907-8: | | | |
| | 1907 | 1908 | Increase |
| Gross | 62,974.75 | 97,423.48 | 34,448.73 |
| Nett .. . | 32,345.98 | 44,542.40 | 12,196.42 |

QUOTATIONS FOR CUBAN SECURITIES.

Supplied by LAWRENCE TURNURE & CO., New York City, Dec. 4, 1908.

| | Bid. | Asked. |
|--|------|--------|
| Republic of Cuba 5 per cent. bonds | 102½ | 103½ |
| Republic of Cuba 6 per cent. bonds | 100 | 101 |
| Republic of Cuba 5 per cent. new bonds (interior loan) | 91 | 93 |
| Havana City first mortgage 6 per cent. bonds.. | 105 | 105 |
| Havana City second mortgage 6 per cent. bonds | 103 | 106 |
| Cuba Railroad first mortgage 5 per cent. bonds | 96 | 98 |
| Cuba Railroad preferred stock | 47 | 45 |
| Cuba Company 6 per cent. debentures | 78 | 85 |
| Havana Electric consolidated mortgage 5 per cent. bonds | 90 | 92 |
| Havana Electric preferred stock | 84 | 88 |
| Havana Electric common stock | 34 | 36 |
| United Railways | 90 | 95 |

Prices in Havana on Dec. 10 for Cuban securities were as follows:

| Securities. | Bid. | Asked. | Securities. | Bid. | Asked. |
|-------------------------|------|--------|--------------------------------|------|--------|
| United Rys. bonds..... | 111 | 116 | Havana Electric pfd.... | 91¼ | 92 |
| United Rys. stocks..... | 99¾ | 99¾ | Havana Electric com.... | 37¼ | 37¾ |
| Gas Co. bonds | 111 | 114 | Interior Debt | 90½ | 90¾ |
| Gas Co. stocks..... | 105 | 110 | Havana Central stock and bonds | | |
| Spanish Bank | 77½ | 78½ | nominal. | | |

FOREIGN CONSULS ACCREDITED IN CUBA.



Señor Alfredo Perez-Carrillo, Consul of Paraguay at Habana.

Alfredo Perez-Carrillo, Consul of Paraguay at Habana, was born in Cuba. He has won distinction in literary circles, being a contributor to "Diario de la Marina," "El Figaro," "Ilustracion de Cuba," "El Hogar," "La Discusion," and other periodicals. For several years he edited "La Habana Elegante."

Mr. Perez-Carrillo is an honorary member of the International Board of Commerce in Cuba a member of the "European Scientific Society in Paris," and a charter member of the Academy of Industrial Arts and Science of Bruxelles, as well as of the Scientific Museum and Observatory of Jerusalem. He is Commander of the Order of the "Star of the East" of Jerusalem.

The handsome monument to be erected to the Cuban patriot, Jose Marti, who devoted his life to the work of freeing Cuba, will soon be set up in Matanzas. The base and ornamental columns of the monument are of selected Carrera marble and the monument itself represents the finest work in bronze, and cost about \$70,000.

An application was filed Nov. 27 with the city council of Holguin, Oriente province, for a franchise to establish an electric light and power service in the city. At present the public lighting there is gas.

The first shipment of carts made in Tampa, Fla., ever put on the local market was received in Havana Nov. 28.

Venezuela conferred upon him the condecoracion called "The Bust of Bolivar," an order established in commemoration of Simon Bolivar, who freed his country from Spanish rule, and established the Spanish-American Republics.

He was appointed Consul General of Paraguay at Habana in 1892 and has held that office for over sixteen years to the satisfaction of the Republic of Paraguay.



Mr. Thorvald L. Culmell, Consul of Denmark at Havana.

The youngest member of the consular corps in Havana, Mr. Thorvald L. Culmell, is twenty-four years of age, was born in this city, and is a Danish subject. His father, Mr. Thorvald C. Culmell, was a native of Denmark and held the office of Consul of Denmark in Cuba for 17 years, with credit and distinction and to the satisfaction of his Government. Upon his death, Mr. Thorvald L. Culmell was appointed to succeed his father on October 19th, 1907.

Mr. Culmell is actively engaged in the commercial development of Cuba, and is especially interested in the leaf tobacco trade.

The new railroad station at Santiago de las Vegas, on the Western Railway of Havana, has been opened for the use of passengers. The station is of concrete.

Industrial Note.

Joseph A. MacLennan has resigned his position at the Philadelphia works of the Link-Belt Company to accept the presidency of the Wilmot Machinery Company, of New Orleans. Mr. MacLennan has been associated with the Link-Belt Companies for over twelve years. His early practical training was obtained in the erection department of the Wm. Cramp & Sons Ship and Engine Building Company, Philadelphia.

Horse Races a Novelty in Cuba.

Horse racing in Cuba is passing through an experimental period which indicates that its life will be brief. Americans who have been seeking new places to keep the game alive sought Havana as a prospective remunerative point, but with the sport yet practically a novelty the Cubans have failed to evince interest in it.

The meeting at Almendares Park, under the auspices of the Cuban Racing Association, which opened Dec. 1, attracted only 1,200 persons, and the next day's racing brought out 300, with the American contingent strongest. While the purses offered are only \$200 and \$300, the patronage thus far does not justify the belief that the sport will be established on a paying basis.

One thousand people were present at the races at Almendares Park Dec. 5.

Gov. Magoon refused a subsidy for racing. He could not encourage in Cuba a sport condemned by the party leaders in the States. A new track is talked of at Palatino Park, Havana.

The Automobile Races.

There is a possibility that Cuba may yet be the scene of an international automobile road race, much the same as the recent contest held at Savannah. While the Automobile Club of America has declined the invitation to manage the affair, which was proffered it by the auto racing enthusiasts of Cuba, who are promoting the proposed race, it seems probable that certain individ-

uals will undertake the affair and endeavor to hold a long-distance race on the island in the latter part of March or April. The proposition has aroused much enthusiasm among the adherents of auto racing in Cuba, says the New York Globe. The general opinion among prominent automobilists is that the race in Cuba would result in an event of considerable international importance, for it is thought that many foreign manufacturers would enter cars in such a race.

Races in Cuba, says the same paper, have always shown a financial loss, and those who took part in the first ventures have been enthusiastic about repeating them. But there should be no reason why, with the assistance of the City of Havana, a race meet could not be given and be a success, both from a racing and financial standpoint.

The War Department, on Dec. 11, gave out the first details regarding the withdrawal from Cuba of the American army of pacification which has been on duty there since the fall of 1906. The movements of the troops will begin on January 1 and will be completed by April 1. The officers and civilians on duty in connection with the provisional government will sail from Havana the day after the inauguration of President Gomez, and the troops remaining in the island after that date will be withdrawn as rapidly as transportation facilities will permit.



Playing baseball in Cuba.

Playing Baseball in Cuba.

The Cincinnati Baseball Club is invading Cuba and the Isle of Pines and playing the various fast teams in Havana, such as the Cuban Giants, Nacionals and others. Commenting on this

the Cincinnati (Ohio) Times-Star says: "Cuba ought to be glad she found us. First we teach her how to hold elections so as to make them more exciting than an insurrection. Then we come along with a baseball team."

RELIGIOUS WORK IN CUBA.

The Outlook—Views of Bishops W. A. Candler and Albion W. Knight.

Bishop W. A. Candler in an address before the British Wesleyan Conference at York, England, recently said that the missions in Cuba and other lands were very prosperous. Cuba is the youngest mission field where "we have had an organized mission since 1898." He said further: "I am glad to tell you that we have strong and growing churches in every provincial capital of the island and in many towns and cities of smaller size. Our Cuban members number above 3,000. In the soft accents of the Castilian tongue the sentiments of Charles Wesley's hymns are sung with the same fervor with which they are poured forth in their own island home.

The Rev. M. N. McCall in the Atlanta (Ga.) Christian Index, writes that "when the history of modern missions shall have been completed one of its brightest pages will be on Cuba."

"In our last three Baptist Conventions there the mayors of the respective cities welcomed the body in the name of the town, from the pulpit of our chapel. Two of these towns were provincial capitals, and one of them the third city in the island. We are accustomed to such things in the states, but a few years ago it would have been unthinkable in Cuba.

There are now thirteen Baptist churches, thirty preaching stations which will later be organized. The Cuban-American College, Havana, has completed its second year.

The Home Board has secured excellent lots in a number of places, and on some of them has erected chapels. The church building at Matanzas has just been completed, and is a model of beauty and convenience."

In the addresses of the Rt. Rev. Albion W. Knight, Episcopal Bishop of Cuba,

delivered in Washington recently, much interesting information regarding the work of the Episcopal Church in Cuba was given. Speaking of general sanitary conditions there, he said:

"Cuba is a health resort. The contagious diseases that once were a scourge are now but little known, and I think that Cuba is as healthy as any locality in the United States."

In discussing the missionary work of the church he said: "The Episcopal Church has built a church in Havana, the construction of which was paid for by donations from the people.

"Three years ago there were but 85 children, 200 communicants, and 2 clergymen connected with the church on the island. This year's report shows there are 700 children, 1,171 communicants, and 16 clergymen."

During the bishop's first year on the island he confirmed 23 communicants; last year 294 were received, 230 of whom were natives unable to speak the English language.

There are eight parochial schools, sustained by the parents of the pupils. The Cathedral School, in Havana, is for girls and three years old. When the school opened there were 20 pupils; the second year 130, and this year there are 260.

Another school was opened this year for the poor children of the city of



Baptist Model Church in Camaguey, near center of City.

Havana. There were 86 pupils at the opening, and each one brings a small sum of money from time to time, which goes toward the support of the school.

Among other religious institutions on the island is the Industrial School for Negroes, which was started last year. The bishop said the negro has been neglected religiously, and that this new school is the only one outside of the public school to which the negro can turn for education. Already there have been fifty negroes confirmed, and the work is meeting with great success. It costs about \$12,000 a year to carry

on the work, and most of this is paid by public subscription and by those interested in the work.

The new church in Guantanamo, says the New York Churchman, is rapidly approaching completion, and it will soon be ready for occupation. It is the gift of Mr. W. W. Frazer, of Philadelphia. Another new church is in process of erection at Ensenada de Mora, a sugar estate east of Cienfuegos, on the southern shore. It is being erected through the generosity of Mr. Alfred Harrison, of Philadelphia, and it will minister to a population of more than 1,800 men.

BRIDGE-BUILDING IN CUBA.

Method and Cost.

By Charles M. Kercher, Nuevitas, Cuba.

The bridge was a 10-meter or 32.81 ft. wooden highway truss bridge, something on the style of a King truss. The abutments are concrete and the bridge proper is built entirely of the hardwoods abounding plentifully in the district where it was built. The woods used were:

Acana; weight 81 lbs. per cu. ft., modulus of rupture 18,500 lbs., tensile strength 11,200 lbs.

Jucaro prieto; weight 67.3 lbs. per cu. ft., modulus of rupture 16,000 lbs., tensile strength 11,200 lbs.

Yaba roja; weight 75 lbs. per cu. ft., modulus of rupture 18,000 lbs., tensile strength 10,000 lbs.

The Yaba wood was used for flooring and the Acana and Jucaro prieto were used in the beams, stringers, etc.

The concrete was a 1—3—5 mixture, mixed by hand, and after being placed was well spaded and tramped. The cement used was Atlas Portland, which cost \$4.50 per bbl. at the work. The cost per cubic yard of materials was as follows:

| | |
|--|----------------|
| 1.13 bbl. of cement at \$4.50..... | \$5.08 |
| 0.80 cu. yd. crushed rock at \$2.85 per cu. yd. | 2.28 |
| 0.48 cu. yd. river sand at 20 cts. per cu. yd. | .096 |
| Total | \$7.456 |

The excavation for the abutments was made in a good firm soil and was only of a sufficient depth to secure good foothold for the masonry. No solid rock could have been found without excavating over ten times the amount excavated. The excavation consisted of 65 cu. yds. of common excavation at \$0.594 per cu. yd., a total of \$38.61.

The cost of concrete, forms, etc., was as follows:

| | Total Cost. | Cost per Cu. Yd. |
|--|-----------------|------------------|
| 92 cu. yds. concrete..... | \$685.95 | \$7.456 |
| 400 ft. B. M. lumber for forms at \$18 per M. ft. | 7.20 | 0.078 |
| Labor on forms, 2 carpenters, 2 days at \$4. | 8.00 | 0.087 |
| Mixing and placing 92 cu. yds. concrete | 94.76 | 1.03 |
| Total | \$795.91 | \$8.651 |

The framing was carried on by a master carpenter and two assistants under the continual supervision of the inspector. The cost of timber, framing, etc., was as follows:

| | |
|---|-----------------|
| 7,100 ft. B. M. hardwood timber at \$50 | \$355.00 |
| Framing timbers (1 carpenter \$2.50 per day, 2 assts. \$1.75 per day), 8 days, \$6..... | 48.00 |
| 1,000 lbs. plates, bolts, spikes, etc., at 16 cts. per lb..... | 160.00 |
| Labor erecting, bolting, nailing, 5 men 6 days at \$1.50..... | 45.00 |
| Painting 1,000 sq. meters, 2 coats red lead at 15 cts..... | 150.00 |
| Total | \$758.00 |

The painting was done by contract by a firm that has a contract the year round to paint all new structures. The summary of costs is as follows:

| | |
|-----------------------|---------|
| Excavation | \$38.61 |
| Concrete | 795.91 |
| Bridge proper | 614.00 |
| Superintendence | 137.85 |

Total cost \$1,586.37

This gives a cost per lineal meter of bridge of \$173.04 and a cost per lineal foot of bridge of \$52.76.—Engineering-Contracting, Chicago.

AGRICULTURAL MATTERS.

Prices of Cuban Fruits and Vegetables—Honey and Beeswax Exports and Prices at Havana—Cost of a Box of Oranges, Etc.

Late New York Prices for Cuban Products.

New Cuban Tomatoes.—The first arrivals of the 1908 crop Cuban tomatoes were recorded this week, and the stock, while showing somewhat pale color, moved out in a fair way at from \$2 to \$3 per carrier. There was a fair demand for the comparatively few lots on the market, though the movement is somewhat restricted. Reports from Cuba are to the effect that the coming crop is fairly large, and a freer delivery of the stock is looked for on the steamers to come forward.

Squash.—A feature of the week has been the arrival of the early Cuban squash, and sales of the white were noted in crates at from \$1.25 to \$2 per crate.

Pineapples.—In Cuban pineapples the tone was easy. The lots arriving are not heavy, but there seems to be enough to supply the demand ruling. The range on 24s was from \$1.50 to \$1.75 per crate. On the 30s the range was given as from \$1.25 to \$1.50 per crate, with \$1 to \$1.25 quoted on the 36s. The market for 42s was given as somewhat nominal in the range of 75c. to \$1 per crate. It is the opinion in some quarters here that the heavy supplies of oranges and apples have had a good deal to do with the neglected situation on the pineapples. There is expected to be some improvement in the general demand following the purchases of stock for the Christmas trade requirements.

Grape Fruit.—There has been a rather moderate arrival of stock from Cuba, and this has brought only fair prices. The trade is fair on the good stock and buyers are not taking hold except in small lots to meet their actual wants. The impression seems to be that supplies will continue heavy and that there is no need in any quarter to fill up with the fruit even on the low level of values now ruling. The trouble seems to be that the various markets outside of New York are being filled up with stock direct from the shipping points. This leaves this market with a circumscribed outlet, and the result is that we are over-supplied. Reports from Boston and other markets note a congested situation. The consumption has not fallen off materially and I do not believe that there is such a weak situation here when all conditions are taken into consideration.—Fruitman's Guide, New York, Dec. 4, 1908.

Cuban Honey and Beeswax Exports.

Consul-General James L. Rodgers, of Habana, in answer to inquiries, furnishes

the following information concerning the exportation of honey and beeswax from Cuba:

Although there are large amounts of these products exported, there has been no practical exploitation of the business, except on a few places in Oriente Province owned by Europeans.

During the calendar year 1906, the last available statistics, exports were 6,712,533 pounds, of which about 50 per cent. went to Germany, 25 per cent. to France, 15 per cent. to the United States, and the remainder to various European countries.

Wax exports from honey during the same period were 1,383,464 pounds, of which Germany took about 50 per cent., the United States 25 per cent., France 20 per cent., the remainder being distributed among other countries.

Prices in Havana.

Beeswax and Honey.—Beeswax continues plentiful. Yellow beeswax sells at from \$28.50 to \$29 per cwt. White wax brings higher prices, but is in less demand.

Honey is bringing good prices. Exporters say from 44 to 45 cents per gallon in packages ready for export delivered in this city.—December quotations in Cuba.

Potatoes.—The season for potato planting is just drawing to a close, but reports of Nov. 22 are to the effect that there has been an unusually large amount planted since September.

Seed potatoes are selling from \$4.25 to \$4.50.

Most of the potatoes on the market are from Long Island, there being hardly any native potatoes to be had. Not until the latter part of the year will the movement of potatoes begin to pick up, for in January and February the first crop of the year will be planted.

American Rice.—A delegation of Texas rice growers called on President Roosevelt, Nov. 21, to get him interested in a project which, if successful, will result in making a market in Cuba for 2,000,000 bags of Louisiana and Texas rice. They want the reciprocity treaty existing between the two countries amended so as to allow the importation of American rice into Cuba free of duty.

The duty on rice is now one-third of a cent per pound. The growers believe that if Cuba removes it the American article could go into the market in competition with rice from the Orient.

They were told that there is nothing under way now looking to a revision of the treaty.

Foot and Mouth Disease.

The foot and mouth disease is said by experts of the United States Bureau of Animal Industry to be an excessively contagious malady, peculiar to ruminating animals, such as cattle, sheep, goats and swine. The Bureau's report says:

The disease is characterized by the eruption of blisters in mouth, on heels or between the toes and on the teats or udder. The appetite is depressed, the milk flow diminished and the animal loses condition and becomes lame. After a day or two the vesicles break, peel off and leave a raw surface that may heal in a few days or, especially upon the feet and teats, may remain sore for a long time and lead to serious complications. The death rate is very low, but it attacks the whole herd and many animals are seriously damaged, so that the loss to a herd owner is heavy. Unlike most infectious diseases, it may attack animals repeatedly.

The statement is made by officials that stock owners of England, France and Germany have been injured by this disease in a single year to the extent of \$5,000,000.

Horses, dogs, cats, and even poultry have been victims of the infection, the last three classes being particularly dangerous as carriers of the contagion. Man himself is not immune, and the frequency of his infection by coming in contact with the diseased animals themselves is established by numerous observations. Children suffer as a result of drinking the unboiled milk from infected cattle. In such cases the symptoms resemble those observed in animals. There is fever and difficulty in swallowing, followed by an eruption of blisters in the mouth and very rarely by similar ones on the fingers. The disease is very seldom fatal, and chiefly restricted to children and to those adults who handle sick animals or drink large quantities of unboiled milk. The disturbance of health is usually too slight to come to the notice of the family doctor.

As regards the depredations of this dangerous disease in semi-tropical countries, the following letter conveys valuable information:

UNITED STATES DEPARTMENT OF AGRICULTURE.

Bureau of Animal Industry.
Washington, D. C.

December 2, 1908.

To the Editor of The Cuba Review:
Dear Sir.—Foot and mouth disease has been known to appear in tropical countries, having caused the loss of 10,400

cattle in the presidency of Madras in East India in 1894-95.

Semi-tropical lands have suffered severely on several occasions. Algeria, in Africa, has had trouble in the past in eradicating this disease, which not only affects cattle but camels as well.

The shores of the Caspian Sea have been visited by the infection in a very malignant form. Southern Italy has also suffered from its ravages on several occasions, especially in 1845-46, 1855-57, and later in 1883.

Its worst form seems to have occurred in temperate zones, but there is no doubt that it will appear and spread in tropical latitudes if the germ is allowed to be introduced under suitable conditions.

Very respectfully,

HENRY J. WASHBURN,

Acting Chief, Pathological Division.

Tobacco Receipts.

From the 6th to the 19th of November inclusive, there have arrived at Havana from the tobacco districts of the island, the following lots:

| | Tierces. |
|--|----------|
| Per Western Railway from Vuelta Abajo | 5,808 |
| Per Western Railway from Semi Vuelta | 2,229 |
| Per Western Railway from Partidos | 1,233 |
| Per United Railways main line from Santa Clara | 9,956 |
| Batabanó branch from Vuelta Abajo | 149 |
| Guanajay branch from Partidos | 198 |
| By steamers and schooners from Santa Clara | 7,915 |
| By steamers and schooners from Vuelta Abajo | 1,913 |
| From Matanzas | 000 |
| From Puerto Príncipe | 1,305 |
| From Santiago de Cuba | 876 |

Total during fourteen days . . .31,582
Previously since January 1 . . .459,024

Total up to November 19, 1908.490,606

Nicholas Whelan, former speaker of the Michigan house of representatives, to-day leaves for Bartle, Oriente Province, Cuba, where he will make his future home, engaging in the dairy business. Whelan, who began his career as a country school teacher, studied law, and was practicing here at the time he was elected to the legislature, says the Muskegon (Mich.) Chronicle.



AMERICAN HOMES IN CUBA. Residence of Chas. E. Hall in La Glorta. Built of native woods; palm thatched; twelve-foot porch on three sides; six rooms, kitchen and bathroom. Approximate cost between \$2,500 and \$3,000.

Cuban Beekeepers' Mistakes.

"I would advise any American who desires to settle in Cuba to locate in the eastern provinces, where there are many Americans, and the people are very decent," says Frank Reiman in *Gleanings in Bee Culture* for Dec. 1. He says further:

"The greatest mistake the Cuban beekeepers make is to let the stock go too long before introducing new queens. Stock deteriorates very rapidly here, and some new queens should be bought every year. In Cuba it is impossible to raise good stock, so we must send to the United States. Red-clover long-tongued stock I find the best. Black bees we can not use, as the moth-worms often eat a super, honey and all, even when the hive below is in good condition. I think the great improvement in the honey queens has been the cause of overstocking the market more than any thing else. With the black bees the yield used to be from 5 to 10 lbs. a hive; but now it is 50 to 100. In Cuba a good hive of Italians can make a barrel of money in a year when the natives make only from one to five gallons a year. I have since purchased and transferred 170 hives, and have now over 200 in work-

ing order, and am waiting results in my new district."

Manzanillo, Cuba.

To Make Bananas Grow.—The banana needs a great deal of water, probably as much as sugarcane, which was found in Hawaii to be from 75 to 100 gallons per pound of sugar. Bananas succeed well under irrigation.

The ideal banana soil is one containing an abundance of moisture without being subject to periodical droughts, an abundance of humus and plant food, and so situated that it is, or can be, drained. Strong winds are ruinous to the banana plantation. The large leaves of the banana plant are necessary for the making of strong plants and first-class bunches of fruit. Therefore, when cut into ribbons by the wind, vitality is lost and the growth is checked.—*Tropical Life*, London, England.

The Cuban National Horticultural Society for 1909 officially announce an exhibit of agricultural products, beginning Jan. 13 and ending Jan. 19, in the exhibition room offered by Messrs. Harris Bros., on O'Reilly street. A large number of premiums and ribbons will be offered.



Arados Mejorados para Caña de Azucar

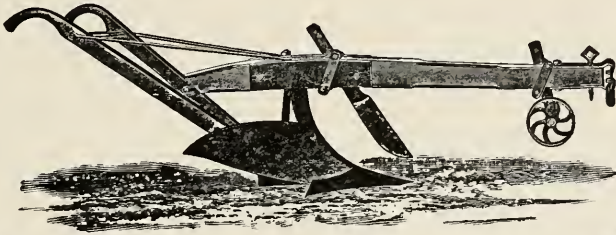

Arados Rompedores Perfeccionados
Sistema de "Hall"

TODOS CON RUEDA y CUCHILLO



HENCH, DROMGOLD & CO.

FABRICANTES

29 Broadway,

NEW YORK, U. S. A.

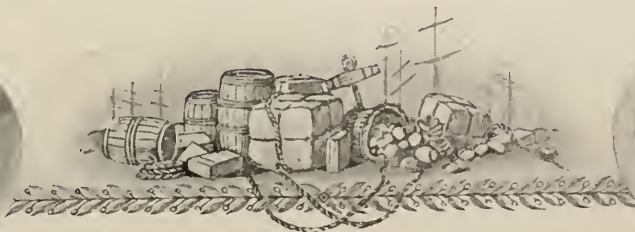

SUGAR REVIEW.

Specially written for The CUBA REVIEW by Willett & Gray, of New York.

Our last sugar review for this Magazine was dated November 16th. Cuba Centrifugals were then 3.94c. per lb. for 96 test duty paid here, and are now 3.86c. per lb., showing decline of 8c. per 100 lbs. During this period the price has been no higher nor lower than these quotations, the tone and tendency being downward, which tendency still continues, being influenced by the opening of the new Cuba crop season with sales at $2\frac{1}{2}$ c. c & f. 96 test for December and January shipments. As we write, January shipment is offered at $2\frac{7}{16}$ c. c. & f. 96 test basis, equal to 3.80c. landed, with December held at $2\frac{1}{2}$ c.

Buyers are disposed to purchase slowly and on a scale down when practicable until the upward turn is visible.

Last season the bottom was touched at $2\frac{5}{16}$ c. c. & f. on February 13, with a few sales, but larger business was practicable only at $2\frac{3}{8}$ c. c. & f. This season the Cuba crop will be larger, but with the European markets well maintained at a considerable advance over our parity, there is small reason to expect any essential difference in values. During the first half of the new year, there will be Tariff agitation for reduced duties which will have an effect on the marketing of the crop, probably delaying purchases beyond fairly immediate wants of refiners here unless a speculative sentiment should appear to buy and hold off for prospective lower duties. One or two things in Tariff changes can be taken for granted—first, a free admission of 300,000 tons per annum from the Philippine Islands; second, to offset this concession on the part of the domestic sugar interests, the duties on sugar from Cuba and other countries will remain nearly or quite unchanged. It is just possible that a small reduction may be made from the 1.685c. duty on 96 test, but only after extreme opposition. If such reduction should be made, the Cuba Reciprocity Treaty still provides for 20% differential on the highest fixed duty.

Should the highest duty be $1\frac{1}{2}$ c. per lb. for 96 test, the reciprocity duty for Cuba would be 20% less, say a concession of 30c. per 100 lbs., and in order to leave the differential at 34c. per 100 lbs., the reading of the Reciprocity Treaty would have to be changed or a new Treaty made after six months' notice by either side.

The hearings already had by the Ways and Means Committee of the House of Representatives developed a variety of requests, varying from free duty, raw and refined, to unchanged or higher full duty rates.

The question of revenue will have a strong bearing on the outcome of the sugar schedule, and as already said we look for little or no change with the exception of the addition of free sugar from the Philippines, although there is strong pressure on the Committee to do something more for the consumer's interests.

Cuba has never been able to take full advantage of the 34c. per 100 lbs. differential, except at rare intervals, for one reason and another. Would she be any better off with a differential of 30c. per 100 lbs. on a $1\frac{1}{2}$ c. duty on 96 test?

Under the $1\frac{1}{2}$ c. duty, Java might become a larger competitor than now for American trade to the disadvantage of Cuba. Any change in duties seems to bear more consequences to Cuba than appear on the surface.

European markets have continued above the parity of our markets (now 26c. per 100 lbs.) and beet sugars thus excluded from importation.

The beet crop season is virtually ended and crop reports have no influence, the latest estimate of outturn being 6,490,000 tons for all Europe. Less European beet sugars will be required in the United States than last campaign, when imports reached 139,500 tons.

Present value of 88 analysis beet sugar is 10s 0 $\frac{3}{4}$ d equal to 4.12c. per lb. landed for Centrifugals parity here.

Refined sugar shows increasing consumption and will continue to do so throughout the campaign because no stock of old crop domestic beet granulated remains in stock and very little of new crop will be carried over into the new year, as compared with last year.

The outlook is for a good and satisfactory condition of the sugar trade to all concerned in the coming campaign.

New York, December 9, 1908.

CABLE ADDRESS: Turnure.

NEW YORK,
64-66 Wall Street.

LAWRENCE TURNURE & CO.

BANKERS

Deposits and Accounts Current. Deposits of Securities, we taking charge of Collection and Remittance of Dividends and Interest. Purchase and Sale of Public and Industrial Securities. Purchase and Sale of Letters of Exchange. Collection of Drafts, Coupons, etc., for account of others. Drafts, Payments by Cable and Letters of Credit on Havana and other cities of Cuba; also on England, France, Spain, Mexico, Puerto Rico, Santo Domingo, Central and South America.

CORRESPONDENTS:

HAVANA—N. Gelats y Ca.
MEXICO—Banco Central Mexicano.

LONDON—The London Joint Stock Bank, Ltd.
PARIS—Heine et Cie.

FRANKLIN H. KALBFLEISCH CO.

Manufacturing Chemists

Aqua Ammonia
Acetic Acid
Sulphuric Acid
Muriatic Acid
Nitric Acid
Phosphoric Acid

Agua Amoniaco
Acido Acético
Acido Sulfúrico
Acido Muriático
Acido Nítrico
Acido Fosfórico

y Productos Químicos Pesados para todos propósitos.

Se mandan Listas de Precios á petición.

**BROADWAY AND SIXTEENTH STREET, NEW YORK
WORKS**

Brooklyn, N. Y.; Waterbury, Conn.; Erie, Pa.; Elizabeth, N. J.



Ribbon Screw-Conveyor for Moist Sugar

CONVEYORS FOR SUGAR MILLS

Bagasse Feeders

Detachable Link-Belt

Particulars from

LINK-BELT COMPANY

299 Broadway, New York

REVISTA AZUCARERA.

Escrito expresamente para la CUBA REVIEW por Willett & Gray, de Nueva York.

Nuestra última revista azucarera para esta publicación tenía fecha 16 de Noviembre. Los centrifugas cubanos polarización 96° se cotizaban entonces á 3.94 cents. la libra, incluidos los derechos, y ahora se cotiza á 3.86 cts. la libra, lo que acusa una baja de 8 cts. en las 100 libras. Durante dicho período, el precio no fué más alto ni más bajo que el de esas cotizaciones, siendo el tono y la tendencia del mercado hacia la baja, cuya tendencia continúa todavía debido á la influencia del comienzo de la nueva zafra en Cuba con ventas á 2½ cts., costo y flete, polarización 96°, para embarques en Diciembre y Enero. En el momento de escribir estas líneas, los embarques para Enero se ofrecen á 2 7-16 cts., costo y flete, polarización 96°, equivalente á 3.80 cts. puesta en el muelle, manteniéndose el precio para el embarque en Diciembre á 2½ cts.

Los compradores están dispuestos á comprar parsimoniosamente y siempre que puedan á precios más bajos, hasta que se bislumbre la subida de los precios.

En la zafra pasada se llegó al límite de la baja cotización, el día 13 de Febrero, en que se hicieron algunas ventas á razón de 2 5-16 cts., costo y flete, no siendo posible hacer grandes transacciones á menos que se pagase á 2¾ cts., costo y flete. La presente zafra de Cuba será mayor, pero con los precios en los mercados europeos muy sostenidos á un alza considerable sobre el equivalente de este mercado, no hay razón para esperar ningún cambio esencial en las cotizaciones. Durante el primer semestre del año entrante ocurrirá el movimiento para la revisión de los Aranceles á fin de reducir los derechos, lo cual habrá de influir en alguna manera en la venta de los azúcares de esta zafra, con la probabilidad de que se pospongan las compras, limitándolas á lo necesario para satisfacer las demandas inmediatas de los refinadores americanos, á menos que surja un espíritu especulador que induzca á comprar y almacenar en espera de la reducción de los derechos. Hay una ó dos cosas que pueden considerarse como hechos en lo relativo á la modificación del Arancel, y son, primero; la admisión libre de 300,000 toneladas de azúcar anuales de las islas Filipinas; segundo: para compensar esta concesión en cuanto se refiere á los productores de azúcar del país, los derechos sobre el azúcar de Cuba y otros países permanecerán casi sin alteración. Es muy posible que se haga una pequeña reducción en el derecho de 1.685 cts. que pagan los azúcares polarización 96°, pero esto sólo después de una oposición extremada. Si se hiciera esa reducción, el tratado de reciprocidad con Cuba establece aun un derecho diferencial de 20% en los derechos más elevados que existan.

Si el derecho más alto fuera de 1½ cts. en libra, polarización 96°, el derecho de reciprocidad para Cuba sería 20% menos, ó sea una concesión de 30 cts. en las 100 libras, y á fin de dejar el derecho diferencial á 34 cts. en las 100 libras, sería necesario modificar el texto del Tratado de Reciprocidad ó hacerse un nuevo tratado, previa la notificación con seis meses de un telación por cualquiera de las partes.

En las audiencias tenidas por la Comisión de Medios y Arbitrios de la Cámara de Representantes, aquella ha recibido gran número de peticiones, unas solicitando la excepción de derechos para los azúcares mascabados y refinados, y otras pidiendo que se impongan derechos más altos ó que se conserven los que existen.

La cuestión de los ingresos del Herario habrá de influir grandemente en lo que se resuelva con respecto á las partidas del Arancel relativas al azúcar, y como dejamos dicho, esperamos muy poca ó ninguna alteración salvo la admisión libre del azúcar de Filipinas, si bien se están poniendo en juego grandes influencias cerca de la Comisión para que se haga algo más en favor de los consumidores.

Cuba no ha podido nunca aprovecharse completamente del derecho diferencial de 34 cts. en las 100 libras, excepto en raros períodos, ya por una causa ya por otra. Tendría Cuba mayores ventajas con un derecho diferencial de 30 cts. en las 100 libras, si el derecho fuera de 1½ cts., en azúcares polarización 96°?

Con el derecho de 1½ cts., Java pudiera convertirse en un competidor de mayores proporciones que lo es ahora en el mercado americano, con perjuicio para Cuba. Cualquier modificación en los derechos de aduana, parece tener mayores consecuencias para Cuba de lo que se ve en la superficie.

Las cotizaciones en los mercados europeos continúan siendo mayores que el equivalente en nuestros mercados (ahora 26 cents por las 100 lbs.), estando excluidos de la importación, por este motivo, los azúcares de remolacha.

La cosecha de remolacha puede considerarse terminada, por lo que las noticias relativas á la misma no tienen la menor influencia; el último cálculo hecho de lo recolectado es de 6,400,000 toneladas en toda Europa. En esta zafra se necesitará menos azúcar de remolacha en los Estados Unidos que la zafra pasada, en que se

FARQUHAR ARADOS

Así como también las diferentes clases de Implementos Agrícolas y Maquinaria, son artículos tan extensa y favorablemente conocidos en toda la Isla, que es innecesario referirse á la buena clase de materiales y mano de obra empleada, por ser un hecho bién conocido, la buena calidad de los primeros y el gran cuidado con que se procede á la construcción.

Los productos de FARQUHAR ciertamente que figuran en primera línea.

A. B. FARQUHAR & CO.

Cotton Exchange Building, New York City, Manufacturers

Para pormenores dirigirse a nuestros agentes:

Pídanse catálogos. Correspondencia en todos los idiomas modernos.

AMERICAN TRADING CO., CUBA No. 76, HABANA, CUBA

CARROS PARA CAÑA

De todas
clases

Fabricados
de madera
ó ácero

Dirección
Telegrafica
RAMALIAM

RAMAPO
IRON WORKS

170 Broadway
New York, N. Y.

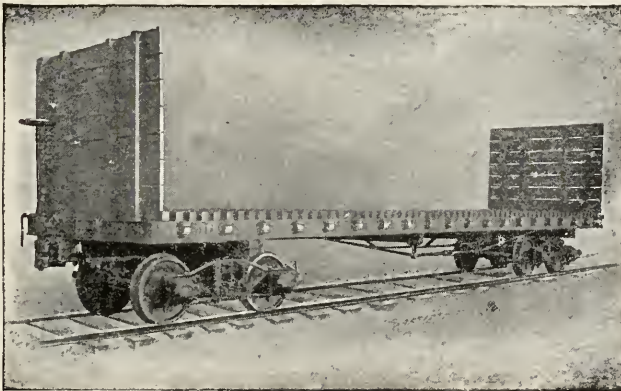

CANE CARS

OF EVERY
DESCRIPTION
OF STEEL
OR WOOD

Cable Address
RAMALIAM

RAMAPO
IRON WORKS

170 Broadway
New York, N. Y.

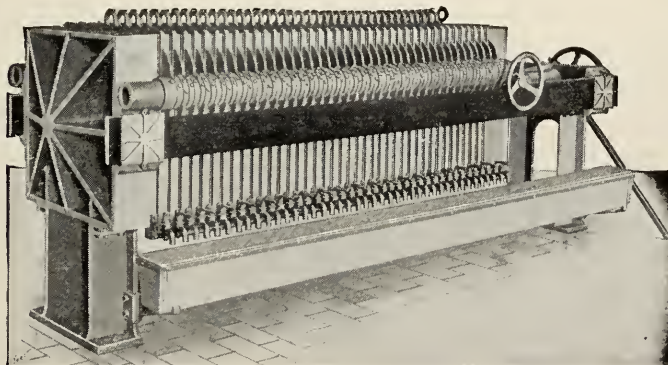

Prensas de
Filtrar
para Ingenios

SHRIVER Filter Presses

Write us for Cata-
logue, Prices and
Information.

T. SHRIVER & CO.

814 Hamilton Street
HARRISON, N. J.

TWO IMPORTANT MAPS

Blue-prints of Cuba, showing the location of the Sugar Plantations and the Rural Guard Stations of the Island. Specially prepared for The CUBA REVIEW. Each 60 cents. Either map with a year's subscription, 75 cents. Both blue-prints and magazine, one year, \$1.

The Rural Guard of Cuba

The Sugar Plantations of Cuba

importaron 139,500 toneladas. La cotización actual del azúcar de remolacha, análisis 88, es 10s. 0¾d., equivalente á 4.12 cents la libra de centrifuga puesta en el muelle aquí.

El consumo del azúcar refinado acusa un aumento y continuará siendo mayor durante toda la zafra, á causa de no haber sobrante en almacén ningún azúcar granulado de remolacha del país, y muy poco de la nueva zafra quedará para su consumo en el año que entra, en comparación con lo quedado el año pasado.

Los indicios son que la campaña que ahora comienza será pródiga en buenos y satisfactorios resultados para todos los interesados en el comercio azucarero.

Nueva York, Diciembre 9 de 1908.



BUSINESS MEN OF CUBA.
Dr. Rafael Fernández de Castro.

Dr. Rafael Fernández de Castro.

In colonial times, he was one of the autonomist leaders, when the autonomic regime was established Civil Governor of the Province of Havana, and in the sad days of the siege, when hunger was destroying the population and a multitude of "reconcentrados" walked through the streets of the city, Dr. Fernández de Castro worked heroically to alleviate the widespread suffering.

Dr. Fernández de Castro is the owner of the Lotería sugar estate, in Jaruco.

Tirso Mesa, a multi-millionaire and a member of the London Board of Directors of the United Railways of Havana, was shot and killed Nov. 29 on his estate near Aguado de Pasajeros, Matanzas Province, by Ramon F. Victorio, a local merchant.

Mesa was a prominent sugar planter, and the owner of much real estate in Havana.

According to the Havana Post of Dec. 3, no less than a dozen Hawaiian sugar planters have been in Cuba in the last few days, visiting different parts of the island in search of suitable sugar lands. They made the trip through Oriente Province, visiting the Guantanamo Valley.

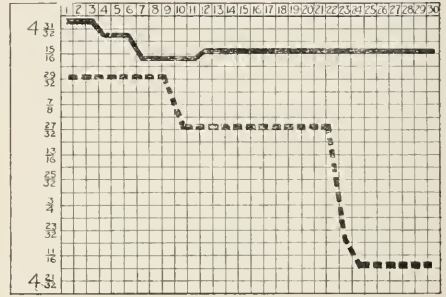

CENTRIFUGAL SUGAR 96° TEST.
Prices at New York for November.
1908. Broken line, 1907.

Sugar Company Increases Capital.

The Trinidad Sugar Company amended its certificate of incorporation, increasing its capital stock from \$600,000 to \$1,000,000. The assenting stockholders included the executors of the estate of Henry O. Havemeyer, Horace Havemeyer, Edward J. Francke, Edwin Atkin and John Mayer.

Free Sugar Feared.

Any action of the United States Congress looking to the placing of three hundred thousand tons of Filipino sugar on the free list would be regarded with grave apprehension by Cubans identified with the sugar industry. The Lucha adjures Cuban politicians to unite with the planters in their efforts to obtain concessions.

New Cuba Crop Harvesting Begun.

A special cable from Havana, Cuba, to Willett & Gray, December 3, states that "One Central is grinding, the Reglita, located in the Province of Matanzas."

Last season grinding commenced on December 13, 1907, and in 1906 on November 20.

Cuba's Sugar Production.

In five years the sugar production of the Island has increased by 440,437 tons.

The present temperature favors the young sugarcane and a good crop is expected. The next cutting will be wholly of new sugarcane, the old having all been utilized last season, contrary to custom.

CANADA LAND AND FRUIT CO.

LOS INDIOS

Owners

ISLE OF PINES

CANADA AND LOS INDIOS TRACTS

Location: Siguanea Bay. The Deep-Water Harbor of the Island.

We have at our new and progressive town of Los Indios a sawmill, planing-mill, general store, school, hotel, church, post office and nursery, all under the supervision of Americans. A strictly American town.

We also have rowboats and gasoline launch for pleasure parties. Fishing and hunting the best.

We own the finest citrus fruit, vegetable and tobacco land on the island. We offer same for sale in acres to suit purchaser, either for cash or on installments. Special inducements to actual settlers.

Write for prospectus and further information to our general office,
Marinette, Wisconsin.

WILLETT & GRAY, Brokers and Agents

FOREIGN AND
DOMESTIC

SUGARS

RAW AND
REFINED

52 WALL STREET, NEW YORK

Publishers of Daily and Weekly Statistical Sugar Trade Journal—the recognized authority of the trade.
TELEGRAPHIC MARKET ADVICES FURNISHED



SUSINI

✿ Cork Tip Cigarettes ✿

Pectoral Paper Rice Paper
—: PRICE, 10 CENTS :—

THE BEST CIGARETTE
MANUFACTURED IN CUBA

DEPOT,
Zulueta 10 and Prado 118
HAVANA, CUBA.

MAGNOLIA

THE COMING AMERICAN CENTER

With best of soil, very favorable location, cheap water transportation right through the colony, good water, perfect title, and plans perfected by experience.

At Magnolia we offer you all the delights possible in the most favored land on earth. Here you can grow the largest crops of the finest quality, and the market is at your door.

We produce a very wide range of crops, which sell at top prices.

Write the Cuba Land and Improvement Company, No. 516-517 The Murray, Grand Rapids, Michigan, for literature and full information.

HAVANA

CUBA

National Bank of Cuba

Government Depository

Capital, Surplus and Undivided Profits
\$6,000,000.00

HEAD OFFICE, HAVANA

FIFTEEN BRANCHES IN CUBA

New York Agency, 1 Wall Street

COLLECTIONS

THE TRUST COMPANY OF CUBA

Offices: CUBA 31, HAVANA

PAID UP
CAPITAL \$500,000

Transacts a General Trust
and Banking Business

REAL ESTATE DEPARTMENT

Examines Titles, Collects Rents,
Negotiates Loans on Mortgages

Correspondence Solicited from
Intending Investors

The Royal Bank of Canada

INCORPORATED 1869

Fiscal Agent of the Government of the Republic of
Cuba for the Payment of the Army of Liberation

CAPITAL AND RESERVE, \$8,200,000.00

TOTAL ASSETS, . . . \$45,500,000.00

Head Office, MONTREAL

NEW YORK AGENCY, 68 William St.

Branches in Havana: Obrapla 33, Gallano 92;
Matanzas, Cardenas, Manzanillo, Cienfuegos,
Camaguey and Santiago de Cuba.

ESTABLISHED 1844

H. UPMANN & CO. Bankers

TRANSACTION A GENERAL BANKING BUSINESS
CORRESPONDENTS AT ALL THE PRIN-
CIPAL PLACES OF THE ISLAND

Safe Deposit Vaults

Manufacturers of the Famous H. Upmann
Brand of Cigars

FACTORY: Paseo de Tacon 159-163
OFFICE: Amargura 1-3

Established 1876

N. GELATS & COMPANY

Bankers

Transact a general banking
business.

Correspondence at all the prin-
cipal places of the island.

SAFE DEPOSIT VAULTS

Office: Aguiar 108

MOLINA BROTHERS

Customs Brokers

Forwarders, Lighterage and Ship Agents

Officios 52, Havana

HAVANA

United Railways of Havana

Cuba's First and Foremost Railroad. (First Section opened to Traffic in 1837)

Takes you to All Parts of the Island East of Havana Comfortably and Quickly through Varied and Beautiful Scenery and Past Extensive Sugar Plantations

Parlor, Observation and Sleeping Cars attached to principal trains.

Full information and through tickets to all points in Cuba reached via the United Railways of Havana can be obtained of the following:

Thos. Cook & Son
Seaboard Air Line R. R.
Foster & Reynolds
Atlantic Coast Line R. R.
Illinois Central R. R.

Ward Line
Florida East Coast Railway
Washington Southern Railway
Peninsular & Occidental SS. Co.

Southern Pacific R. R.
Mobile & Ohio R. R.
Raymond & Whitcomb Co.
Louisville & Nashville R. R.
Munson Line

LA AMBROSIA

MANUFACTURERS of the well-known brand of Chocolate, "LA AMBROSIA," Biscuits, Macaroni, Bonbons, all kinds of Confectionery

GUAVA PASTE AND EXTRA FINE GUAVA JELLY

ORDERS RECEIVED FOR EXPORT

BALDOR, FERNANDEZ & CO.

Write for quotations.

Sol 21 & 23, Havana, CUBA

'PHONE No. 401

P. O. BOX 741

FERNANDO de CARDENAS

CUSTOM HOUSE BROKER

:: Import and Export Agent ::

Munson S. S. Line Building

Obispo No. 1, Havana, Cuba

JAMES S. CONNELL & SON

Sugar Brokers

Established 1836, at 105 Wall Street

Cable Address—"Tide, New York"

I know a great deal about Cuba

Free Information for the asking

Ask Mr. Foster

1 MADISON AVENUE, NEW YORK

INTERNATIONAL SEAL CO., OFICINA PRINCIPAL, 96 BROADWAY, NEW YORK, E. U. A.

SELLOS para CARROS de CARGA, CONTADORES DE GAS
y ELECTRICIDAD, BOTELLAS, BULTOS DE VALOR, etc.

Contratistas de los Gobiernos de los EE. UU., Alemania y Rusia, y de las principales compañías de ferrocarriles y de alumbrado eléctrico en los EE. UU., Canadá y Mexico.

Fabricamos sellos de la mejor calidad, como también sellos baratos. Proyectamos sistemas especiales, adaptados a todas condiciones. Nuestros intereses y los suyos son iguales, v.g., evitar toda pérdida por el robo, fraude y descuido, usando una prensa de primer orden y un sistema y un sello sin igual.

H A V A N A

THE HERRADURA LAND COMPANY

Office: No. 3 Bernaza Street, Habana, Cuba

CAPITAL, \$440,000.00

Own 22,000 acres of land in the Province of Pinar del Rio, suitable for Oranges, Vegetables, Cotton, Corn and Tobacco. The land has all been surveyed and sub-divided into 40-acre tracts and is offered for sale in acres to suit the purchasers, for Cash or on instalments.

We have a new and progressive American town with Railroad Station, Telegraph, Telephone, Stores, Hotel, American School, all within short distance from Havana City.

Titles perfect. Transportation from Havana free for buyers.
WRITE OR CALL FOR INFORMATION.

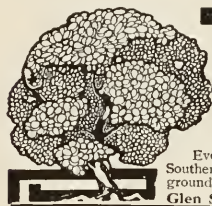

TREES

Well rooted and well grown, true to name and grown especially for planting in the South. In our "test-orchards" we see the parent tree grow, bloom and bear—true to name.

For Semi-Tropical Planting

Everything we offer has been tested and found to grow in some part of the Southern States, Mexico or West Indies. Our stock is full and complete—800 acres of grounds keep it so. Twenty-six years' successful business. Write for 1900 Catalogue. Glen Saint Mary Nurseries Company, Box 41, Glen Saint Mary, Florida



PASO ESTANCIA—Oriente Province—Cuba

The healthiest and most fertile spot on the island, in the rich valley of the Cauto River, 400 feet above sea level.

One of the prettiest spots in Cuba.

Paso Estancia is right on the main line of the Cuba Railroad, only 40 miles from its terminus at Nipe Bay, 39 miles from Santiago.

The soil is rich, dark, sandy loam; no rocks or swamps.

Two hundred acres now under cultivation demonstrate by prolific production the richness of the soil.

A comfortable hotel at **Paso Estancia** accommodates visitors.

Paso Estancia offers the best opportunities in Cuba.

Choice land on easy terms.

Visit there and confirm all we say. You will be well received.

Full particulars
from

Cuba Properties Limited

56 Bank of Ottawa Bldg.
MONTREAL

111 German Savings Bank Bldg.
NEW YORK

Paso Estancia
CUBA

Free Information about Cuba.

NO FEES, NO COMMISSIONS.

Complete, definite, valuable information.

Ask Mr. Foster, 1 Madison Avenue, New York.

HENRY E. BROWN
Pharmacist

Shipping and Export Chemist and Druggist, Ships' Medicine Chests Furnished and Replenished. Prescriptions Compounded by a Graduate in Pharmacy.

Trusses, Surgical Appliances, etc.

Office and laboratory, Room 36.

116 BROAD ST., NEW YORK

Telephone Call: 274-A Hamilton.

JOHN M. DONOVAN

13 Summit St. (Atlantic Dock) - BROOKLYN

Dealer in

Dunnage Mats

FOR BAG FLOUR, BAG AND BULK GRAIN
AND GENERAL CARGOES.

— BAGS AND BAGGING —

MOBILE, ALA.

HOME INDUSTRY IRON WORKS Engines, Boilers and Machinery

Manufacturing and Repairing of all kinds. Architectural Iron and Brass Castings. Light and Heavy Forgings. All kinds of Machinery Supplies.

Steamship Work a Specialty

A. KLING, Prop.
JAS. S. BOGUE, Supt.

MOBILE, ALA.

The Principal Hotels in Mobile, Ala.

THE CAWTHON (FIREPROOF) **THE BIENVILLE** (MODERN)

European, 175 Rooms

European, 150 Rooms

\$1.50 Up

\$1.00 Up

Both Hotels in Heart of City, Facing Bienville Square

Cable Address: Pitchpine, Mobile, Ala.

CHICAGO LUMBER & COAL CO.

MANUFACTURERS AND SHIPPERS OF

Pitch Pine—Export and Interior

Docks at MOBIL^E, ALA., and PORT ARTHUR, TEXAS.

General Offices: ST. LOUIS, MO.

Office Export Department: MOBILE, ALA.

OLLINGER & BRUCE DRY DOCK CO.

Ship Builders and Repairers

Operating seven Sectional Dry Docks, capacity 1,000 tons, and one Balance Dock, capacity 3,000 tons. Equipped with Air Plant for operating Pneumatic Tools, and Steam Pump for cleaning vessels' bottoms.

25-TON DERRICK BARGE AND STEAM PILE DRIVER.

Material of all kinds kept on hand. Shipwrights, Caulkers, Painters, Sparmakers and Riggers furnished promptly, and at reasonable rates. Correspondence solicited.

MOBILE, ALA.

Cuban Land and
Investments

Geo. T. Street

CAMAGUEY
CUBA

Land in Santa Clara, Camaguey, and Oriente Provinces. See me before buying. If you have good land with clear title in this section of Cuba, list it with me. I can sell it if anyone can. Agents in all parts of the U. S. More agents wanted.

BARTLE

Twenty-five thousand acres of the richest and best watered land in Cuba on the main line of the Cuba Railroad, with the finest station on the line, 120 miles from Nipe Bay—the best harbor on the Island; also the nearest to New York. No swamps or insect pests.

BARTLE is not in the wilderness—we offer all the comforts of civilization, GOOD STORES, HOTEL, CHURCH, SCHOOL, SAW-MILL, Etc.

TWO MAILS DAILY.

SUGAR, FRUITS, TOBACCO AND VEGETABLES produce wonderful crops at BARTLE.

When you consider Soil, Transportation, Social, Religious and Educational advantages, BARTLE offers something not to be had elsewhere in Cuba. Write for particulars.

"Ten Days in Cuba," just published by Hon. Nicholas J. Whalen, Speaker of the Michigan Legislature, may be had through newsagents at 25 cents per copy, or will be sent free to any address by the owners of the Bartle Colony. Address, Duncan O. Bull, Gen'l Mgr. Cuban Realty Company, Limited, Temple Building, Toronto, Can., or 141 Broadway, New York City.

DUNCAN O. BULL, General Manager

CUBAN REALTY CO., Ltd. Temple Bldg., Toronto, Canada
141 Broadway, New York Bartle, Cuba

PURE
DISTILLATION
OF
SUGAR CANE

BACARDI RON

Sole United States Agent

D. S. de JONGH 128 Water St.

BEST MIXER
FOR
HIGHBALLS
AND
OTHER DRINKS

"SUGAR NEWS FROM CUBA"

is the title of the interesting correspondence from the tropical island, appearing in every issue of "THE AMERICAN SUGAR INDUSTRY AND BEET SUGAR GAZETTE."

Capable correspondents, in every part of the world, write regularly, covering reliable sugar news for "THE AMERICAN SUGAR INDUSTRY AND BEET SUGAR GAZETTE."

In the United States, Cuba and Mexico, \$2 per annum. In Foreign Countries, \$2.50 per annum.

Subscribe for it if you want to keep posted. Sample copy free. Send for advertising rates.

Address: BEET SUGAR GAZETTE CO.
No. 5 Wabash Avenue, Chicago, Ill., U.S.A.

For Free Information about Cuba

Ask Mr. Foster

1 Madison Avenue, New York.

PURDY & HENDERSON, Inc.

Engineers and Contractors

New York Chicago Boston

Cuba Office, Empedrado 32, Havana

THE BIG FOUR ROUTE

3 Daily Trains Each Way 3

Parlor Cars, Sleepers, Dining Cars.

Through Train Service
BETWEEN
Cincinnati, Toledo and Detroit
(Via Michigan Central R. R.)

Ask for Tickets Via

BIG FOUR

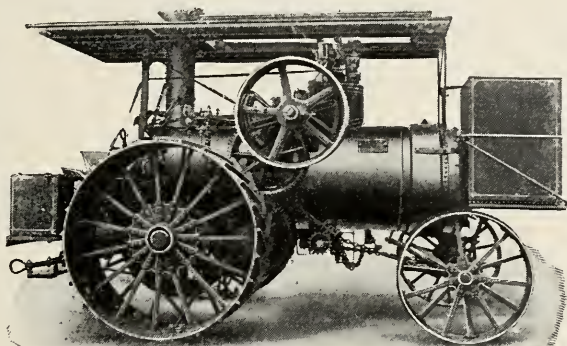

LA NEUVA Máquina de TRACCION HUBER.

Esta máquina es conocida como Para Contratistas ó Para Arar.

Esta ideada y construida para los trabajos mas difíciles sobre caminos ó sobre el campo. Arrastrando grandes pesos o arando hay una tensión tremenda sobre la transmisión y la rueda volante. Hemos puesto especial atención en la construcción de estas partes, haciéndolas del mejor material que se puede conseguir, de tal manera que hemos conseguido la fuerza mayor posible combinada con el minimum de peso.

Nuestras máquinas alcanzaran mayor fuerza que la estimada y haran mayor cantidad de trabajo y mucho mejor que lo que puede hacerse por medios de caballos, no se diga de bueyes.

Tendremos muchísimo gusto en tratar de estas máquinas detalladamente con las personas interesadas en el mejor modo de tracción tanto en carreteras, caminos reales como campo de arado.

Estas máquinas sirven tambien, mediante un aparato especial, para tirar maderas del monte ó arados por medios de cable de alambre.

Enviaremos catálogos á quienes nos los pida, en español o ingles.

Para otros informes, sirvanse dirigirse á

THE HUBER MANUFACTURING CO.,
STATION J, MARION, OHIO, U. S. A.

ó á nuestro agente para Cuba, Sr. P. D. de Pool, Obispo 7, P. O. B. 1069. Habana.

CAMAGUEY

M. J. CABANA

COMMISSION MERCHANT.

Solicits Correspondence from all the important cities
of the United States of America.
P. O. Box 3, Camaguey.

ANTILLA

YOUNG AND CO.

The Pioneer General Grocery Store.
American Canned Goods
and Liquors a Specialty.

Ask Mr. Foster

anything about Cuba. No charge, no fees, no commissions. Reliable unbiased information.

1 Madison Avenue, New York.

An Enthusiastic Exponent of Cuba.

Nos ha visitado el número correspondiente á Octubre de la notable publicación ilustrada "The Cuba Review" que tan efectiva propaganda realiza en favor de nuestro país y que se reparte profusamente en toda la Unión.

El Comercio, la Agricultura y la In-

dustria cubana, tiene en esa revista un entusiasta exponente.

Entre los numerosos y magníficos grabados de este número, figura el retrato del doctor Julio de Cárdenas, Alcalde de la Habana. También trae "The Cuba Review," una revista política muy atinada.—La Discusion Havana.

Kind Words for The Cuba Review.

"All About Cuba," expresses the aim of the editors of The Cuba Review, and the table of contents is made up exclusively of articles concerning that country and its interests. The magazine is profusely illustrated, making a publication both interesting and attractive.—California Fruit Grower, San Francisco, Cal., Aug. 29, 1908.

All Kinds of Information.

"Whoever would like to be up-to-date regard-

ing the development and progress on the Island of Cuba, so dear to true Americans, will find an opportunity by reading the monthly magazine, The CUBA REVIEW, published by the Munson Steamship Line, No. 82-92 Beaver Street. The same is enriched with many illustrations, and a synopsis is given of political and government affairs, also railroads and finance. The reader will find the latest statistical statements, and in addition all kinds of information worth knowing."—New York Staats-Zeitung.

BUSINESS FIRMS OF CAIBARIEN

ANGEL MATA
Comerciante.
Caibarién, Cuba.

Apartado 114. Cable: "Mata."

Ferretería, Mueblería y Locería
LA LLAVE

DE INCHANSTI Y HNO.
Caibarién, Cuba.

Marti 11 y 13. Apartado 24.

R. CANTERA Y CA.
(S. en C.)

Comerciantes Importadores,
Escobar 28. Caibarién.

A. ROMANACH
Almacenistas Importadores de Viveres,
(S. en C.)
Caibarién.

P. B. ANDERSON,
Ship Broker. U. S. Consular Agent,
Caibarién, Cuba.
Agent for Munson Steamship Line and Lloyds.

MARTINEZ & CO., S. en C.
Comerciantes Banqueros,
Importadores de Viveres,
Exportadores de Azucar.

Apartado 115. Telegrafo: Urquiza.

COMERCIO,
Hotel - Restaurant - Cafe
De José Urquiza.

Calle de Marti nums 16 y 18 - Caibarién

LA MARIPOSA DE EVARISTO BERGNES
Importador de Peletería y Talabartería, Fabricante
de Calzado.
Caibarién.

Apartado 104. Telegrafo: "Bergnes."

YMAZ Y CA.

Ymportadores de Ferrería en General.
Apartado de Correos Num. 15,
Caibarién, Cuba.

Calle Justa Num. 27. Cable: "Imaz."

ARIAS Y COMP

Provisiones, Loza y Muebles.
Cuba Num. 20, Esquina a Marti,
Caibarién, Cuba.

Correo Apartado Num. 15. Telegrafo: "Arias."

ZARRAGA Y CA.,

Caibarién, Cuba.

Casa Banca. Exportadores de Azucar.

BONIFACIO DIAZ,

Gran Peletería y Sombrereria.
Marti 17 - - - - Caibarién
Constantes novedades en los dos giros de esta casa.

RODRIGUEZ Y VINA, S. en C.,

Almacenistas Importadores de Viveres en General,
Comisiones y Consignaciones,
Consignatarios de Buques.

"Depositos de Carburo."

Telephone, 33 Hamilton
Night Call, 411 Hamilton

Cable Address:
"Abiworks," New York

Atlantic Basin Iron Works

Engineers and Boiler Makers

Machinists, Plumbers, Tinsmiths, Pipe Fitters, Blacksmiths, Coppersmiths,
Pattern Makers, Sheet Iron Workers. Iron and Brass Castings. Steamship
Repairs a Specialty.

Cor. Imlay and Summit Streets

Brooklyn, N. Y.

John Munro & Son

Steamship and
Engineers' Supplies

13 Conover Street, Brooklyn, N.Y.

Cable Address: Kunomale, New York

Telephone, 196 Hamilton

Telephone
215 Hamilton

Box 186
Maritime Exchange

YULE & MUNRO

SHIPWRIGHTS

Caulkers, Spar Makers

Boat Builders, Etc.

No. 9 SUMMIT STREET
Near Atlantic Dock BROOKLYN

WINTER HAVEN NURSERIES

A. M. KLEMM, Proprietor

Established 1884.

Winter Haven, Fla.

Wholesale Growers of Citrus Stock of the best commercial varieties. We guarantee our extensive Stock to be well grown, free of insects and true to name.

Silver Cluster Grape Fruit our leading Specialty.

Prices right. Grading and Packing perfect.

Write for Catalogue.

The Standard Guide to Cuba—Reliable—accurate—maps—illustrations. 50 cents.

FOSTER & REYNOLDS, 1 Madison Avenue, New York.

BUSINESS FIRMS OF SANTIAGO

E. GIRAUDY & CA.
ALMACEN DE VIVERES
Marina baja n. 33, Santiago de Cuba.
Agentes de Schlitz Beer.

JULIAN CENDOYA
Steamship Agent and Broker
COMMISSION MERCHANT
CABLE: Cendoya. Santiago de Cuba.

VALLS, RIBERA & CA.
(S. en C.)
Importadores de Ferreteria y Machinery.
Telégrafo: Valribe.
Santiago de Cuba y Manzanillo.

A. B. C. Code, 5th Edition. Telephone, 190.
P. O. Box, 95. Cable address: SILVAPA.
SILVA Y PARRENO H.
General Commission Merchants.
Custom House Brokers—Forwarding Agents.
Consignees of the Cuban steamers of the Carlos J. Trujillo, S. en C., Line, formerly Menéndez & Co.
References:—J. Cendoya and Nat'l Bank of Cuba.

CAMP HERMANOS, Santiago de Cuba.
Ron Selecto "Golondrina" y "Carta Cuba."
Medalla de Oro, St. Louis, 1904.

RON BACARDI
DE BACARDI & CO., Distillers, Proprietors.
43 San Ignacio, cor. Santa Clara, Havana,
Santiago de Cuba.

LARREA Y BESEALIE
Importers of General Groceries and Exporters of
Cocoa, Wax, Honey and Woods.
Apartado 65, Marina Baja 46. Cable: Larrea.

Importación. Exportación.
L. ABASCAL Y SOBRINOS
Agentes de las líneas Pinillos Izquierdo y Ca., de
Cadiz. Larrinaga y Ca., de Liverpool. Compañía de Seguros, Aachen & Munich, Aix-la-Chapelle.

BROOKS & CO.
Bankers and General Commission Merchants.
Santiago and Guantanamo.

The American Traders' Attitude.

Americans are too independent; that's the reason why they're losing in the commercial game in Cuba, is the opinion of William Henry Cox, who was several years in the office of American consul at Havana, Cuba.

"The French, English, and Germans are picking up the money down there," says Mr. Cox, "because they cater to the wants of the people.

"I remember a case in Havana that shows the difference. An American merchant was showing samples of silk to a dealer whom I knew. On one piece the stripes ran up and down. 'My customers want the stripes running the other way,' said the Cuban. 'That's the only kind I have,' said the American; 'take it or leave it.'

"The Cuban left it.

"A few days later a Frenchman came along with silk with the stripes running up and down. The Cuban made the same complaint that he had made to the American.

"'All right,' said the Frenchman, 'wait a month and I'll have silk made for you with stripes running whatever way you want them.' The Frenchman is now selling the Havana merchant all the silk the latter uses.

"Americans can't pack goods well, either. Stuff coming from New York will land in Havana all knocked to pieces, because it was poorly packed. Goods from Europe are always well packed and arrive never damaged in the least."—Washington (D. C.) Herald.

VINEGAR BEND LUMBER CO.

Manufacturers and Exporters

Long Leaf Yellow Pine Lumber and Timber

Cuban Business Our Specialty VINEGAR BEND, ALA., U. S. A.

Daily Capacity, 200,000 Feet

Cable Address: "TURNER"

Codes: A B C, Fourth Edition; Southards; Watkins; Western Union



SOBRINOS DE BEA & CO.

Bankers and Commission Merchants
Importación directa de todas los centros
manufactureros del mundo.

Agents for the
Munson Steamship Line, New York and
Mobile.

James E. Ward & Co., New York.
Serra Steamship Company, Liverpool.
Vapores Transatlánticos de A. Folch & Co.
de Barcelona, España Independencia
Street 17/21.

MATANZAS, CUBA.

JOHN W. McDONALD

COAL, WOOD, LUMBER
and TIMBER of Every
Description

112 WALL STREET
Near South Street NEW YORK

Yard: 58-68 Beard Street, Eric Basin
Telephones:

Office, 1905 John Yard, 316 Hamilton

There is an end to all things, even to the
patience of the United States, and the Cubans
should understand this.—N. Y. Press.

It is probable that the whole people will
pull together for a permanent republic, and
that Cuba will be well governed and will
prosper accordingly.—Mobile (Ala.) Regis-
ter.

"The Comfortable Way"

Between the East and the West is
via the Toledo, St. Louis and
Western Railroad

"Clover Leaf" Route

Rates lower than by any other
direct line. Send four cents in
stamps for copy of "Get Out or
Get in Line," a booklet by Mr.
Elbert Hubbard, Chief of the Roy-
crofters.

GEO. J. CHARLTON,
General Passenger Agent,
Chicago, Ill.

THE SNARE AND TRIST COMPANY

CONTRACTING ENGINEERS

Steel and Masonry Construction
Piers, Bridges, Railroads and Buildings

We are prepared to furnish plans and estimates
on all classes of contracting work in Cuba.

N. Y. Office
143 LIBERTY ST.

Havana Office
LA LEAL BUILDING

W. H. Bennett

F. W. Hvoslef

Bennett, Hvoslef & Co.

18 Broadway, New York

Steamship Agents and Ship Brokers

Cable: "Benwalsh"



New York-Cuba Service

PASSENGER and FREIGHT

Sailings subject to change without notice

| STEAMER | NEW YORK | NIPE | NUEVITAS | NIPE | BANES | GIBARA and VITA | PUERTO PADRE | NUEVITAS | NIPE | NEW YORK |
|---------------|----------|---------|----------|--------|--------|-----------------|--------------|----------|---------|----------|
| | Sail | Arr. | Arr. | Arr. | Arr. | Arr. | Arr. | Sail | Sail | Arr. |
| CURITYBA..... | Dec. 30 | | Jan. 4 | Jan. 6 | Jan. 8 | Jan. 9 | | Jan. 14 | Jan. 15 | Jan. 20 |
| OLINDA..... | Jan. 13 | Jan. 18 | Jan. 20 | | | Jan. 23 | Jan. 26 | Jan. 28 | Jan. 29 | Feb. 3 |
| CURITYBA..... | Jan. 27 | | Feb. 1 | Feb. 3 | Feb. 5 | Feb. 6 | | Feb. 11 | Feb. 12 | Feb. 17 |

FREIGHT ONLY

- S. S. CUBANA: Dec. 23d for Caibarien, Matanzas, Cardenas and Sagua.
- S. S. PALOMA: Jan. 6th for Matanzas, Cardenas, Sagua and Caibarien.
- S. S. CUBANA: Jan. 20th for Caibarien, Matanzas, Cardenas and Sagua.
- S. S. PALOMA: Feb. 3d for Matanzas, Cardenas, Sagua and Caibarien.
- S. S. CUBANA: Feb. 17th for Caibarien, Matanzas, Cardenas and Sagua.

MOBILE = CUBA SERVICE

FREIGHT ONLY

Regular Sailings Mobile to Havana and Mobile to Northside and Southside Cuban Ports.

BALTIMORE = COLON SERVICE

FREIGHT ONLY

Regular Sailings Baltimore to Colon

For rates, reservations or further information, address

MUNSON STEAMSHIP LINE

GENERAL OFFICES

82 BEAVER STREET, NEW YORK

AGENCIES AT ALL PORTS

Lillie Multiple Evaporators

Model of 1904-1905 (Patented)

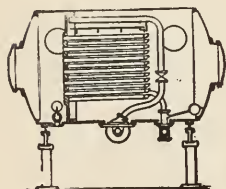

Model 1904-1905
ECONOMY its **BOAST**

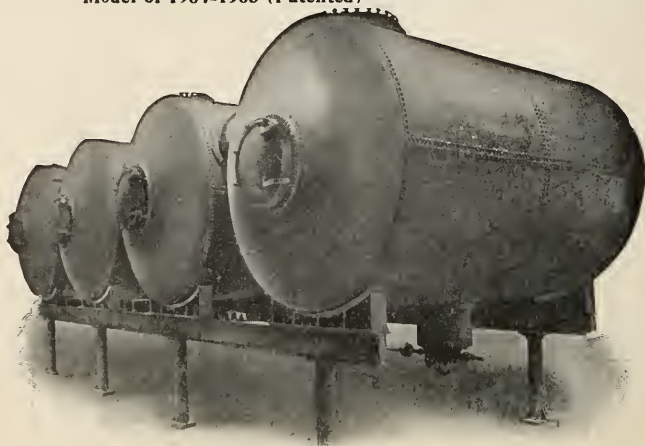

Lillie Quadruple effect for Nipe Bay Co., Cuba (Model 1904-1905. Condensers not shown.) Capacity, 600,000 gallons cane juice per 24 hours.

Apply for reading matter and information to

The Sugar Apparatus Manufacturing Co.

328 Chestnut St., Philadelphia, Pa.

MORRIS LILLIE, President

LEWIS C. LILLIE, Secretary and Treasurer.

BALDWIN LOCOMOTIVE WORKS

Broad and Narrow Gauge Simple Expansion and Compound

LOCOMOTIVES

Compressed Air Locomotives. Electric Locomotives with Westinghouse Motors



PLANTATION LOCOMOTIVES

For all Gauges of Track. To meet all conditions of service. Specifications furnished on application.

BURNHAM, WILLIAMS & CO.

Philadelphia, Pa., U. S. A.

Cable Address: "Baldwin, Philadelphia"

Agents for Cuba, Krajewski-Pesant Co., Aguiar 92, Havana, Cuba.

THE CVBA REVIEW



50 Cents A Year JANUARY 1909 5 Cents A Copy
Published by the Munson Steamship Line 82-92 Beaver Street New York City.

Ceballos "The Garden Spot of Cuba"

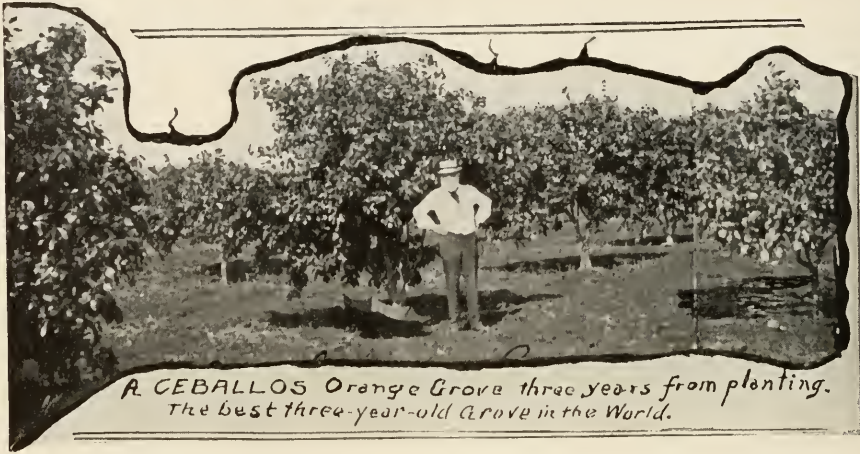

The TIME to invest in Cuba is now The PLACE is in the "Garden Spot," Ceballos
 The OPPORTUNITY is offered by the Development Company of Cuba, owners of Ceballos

Write for information to
 Geo. H. Gillett, Secretary, 43 Exchange Place, New York

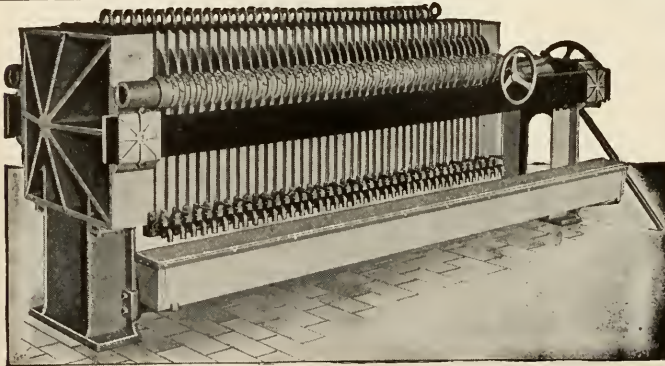

**Prensas de
 Filtrar
 para Ingenios**

SHRIVER
Filter Presses

Write us for Catalogue, Prices and Information.

T. SHRIVER & CO.
 814 Hamilton Street
 HARRISON, N. J.

**FOR MOLASSES USE
 STEEL TANKS**

BUILT BY

HAMMOND IRON WORKS
 WARREN, PA., U. S. A.

... MATERIAL FABRICATED OR ERECTED COMPLETE ...

W. B. HAMMOND, SALES AGENT, : : : 29 BROADWAY, NEW YORK
 OFFICE MEXICO CITY, CINCO DE MAYO NO. 32

Tivoli Beer

—*Enough said.*

Havana Brewery

Havana

CERVEZA

TOMA UNA COPA DE

BEER



Pilsner, Muenchner, Lager

NO HAY MEJOR

THE JOHN EICHLER BREWING CO.

Unico Agente para Exportacion

A. C. FABRICIUS

82-92 BEAVER STREET, NEW YORK



BUCKEYE NURSERIES

M. E. GILLETT, Proprietor

TAMPA, FLORIDA, U. S. A.

ORANGE, LEMON AND GRAPE FRUIT TREES

LARGEST CITRUS NURSERY IN THE WORLD

QUALITY VARIETY DELIVERY

Price may be forgotten—Quality NEVER.

We grow nothing but standard Varieties which we can recommend to the trade as Money-Makers. Having had 29 years' experience we thoroughly understand packing trees for long distance shipments.

We guarantee our trees to be True to Name, Free from White Fly and to ARRIVE AT DESTINATION IN GOOD CONDITION.

Consider the future and protect your investment by planting reliable trees from

THE BUCKEYE NURSERIES

LA GLORIA

The Colony where the Best Oranges are Raised

LA GLORIA FRUIT CARRIED OFF THE BLUE RIBBONS AT THE 1908 EXHIBITIONS OF THE CUBAN NATIONAL HORTICULTURAL SOCIETY AT HAVANA.

THERE IS NO OTHER "JUST AS GOOD."

WRITE FOR HANDSOME ILLUSTRATED BOOKLET.

CUBAN LAND AND STEAMSHIP CO.

No. 32 Broadway, New York City



Sugar Plantation—Cuba Railroad.

The Cuba Railroad

This new line completing the railroad connection between Havana and Santiago, and Antilla, or the Bay of Nipe, is of standard gauge and similar in its construction and equipment to the better class of northern lines. All of its important bridges are of steel and masonry, and the line generally is rock-ballasted. The main line passes along the center of the eastern and wider half of Cuba, and opens up a matchless and most picturesque agricultural region, and passes through the tropical forests of mahogany, cedar, lignum vitæ, ebony and many other trees, hung with vines and millions of orchids. Palm trees of magnificent aspect and great variety abound everywhere. The famed Parana and Guinea grasses, covering most of the open districts and standing from six to twelve feet high and green the year round, together with frequent running streams, make this an ideal cattle country. No food has to be put up and no shelter is required. The rich soils everywhere are adapted to sugar, tobacco, cotton, corn and an endless variety of products. The swamps which occur at places along the coasts of Cuba are absent from the interior, which is high, dry and exceptionally healthy. The trade winds blow across Cuba every day, and bring to all parts fresh sea air; the extreme heat of northern summers is consequently unknown and the humidity of other tropical countries is also unknown.



A Corridor, Hotel Camaguey.

The Cuba Railroad Company's **Hotel Camaguey**, at Camaguey (formerly Puerto Principe) is by far the most popular resort in Cuba, Spanish in style, and provided with bath rooms and other modern conveniences, and is first-class in all respects.

This old city has about 40,000 inhabitants, is picturesque and is situated in a beautiful and remarkably healthy district. The hotel is especially favored by those wishing to spend some weeks or months in a matchless sub-tropical climate.



Map of The Cuba Railroad

THE CUBA REVIEW

"ALL ABOUT CUBA"

An Illustrated Monthly Magazine, 82-92 Beaver Street, New York

MUNSON STEAMSHIP LINE, Editors and Publishers

SUBSCRIPTION

50 Cents Per Year - - - - - 5 Cents Single Copy
Advertising Rates on Application

Vol VII.

JANUARY, 1909

No. 2

Contents of This Number

The cover is of a beautiful scene on the Los Casas River on the Isle of Pines. Plans for the inauguration of the Cuban President and for the evacuation of the United States forces and a synopsis of the Cuban Congress quorum decree, will be found on pages 7 and 8.

Page 9 shows some very interesting cartoons portraying Cuban newspaper ideas of the situation.

United States newspaper comments are on page 10.

The public sanitary work which has been completed since the beginning of the provisional administration, with the cost of same, on page 11.

On page 12 will be found some very attractive illustrations of road work, showing a road as it was and as it became under American supervision.

Further Cuban statistics of road and bridge construction work copies from the official records in Havana, will be found on page 13.

Commercial matters on pages 14, 15 and 16; trade statistics showing Cuba's commerce with the world and her trade with the United States; also the growth of trade in American shoes in Cuba and the Island's lumber market requirements.

Cuban ore properties, automobile buyers in Cuba and miscellaneous items on page 17.

Valuable Cuban stamps, motoring in Cuba, and the Havana races, on page 18.

Railroad and financial matters are discussed on page 19. The earnings of the railroads are given.

Foreign consuls accredited to Cuba, with portraits, on page 20.

Isle of Pines road and bridge work, weather report, etc., on page 21.

The valuable trees of Eastern Cuba, pages 22 and 23.

Shipping household goods to Cuba, with full instructions as to packing and forwarding, on page 24. Every colonist and land company should preserve this article.

Agricultural matters have a place on pages 25 and 26. There are recent reports of New York and Chicago prices for Cuban vegetables and fruits, United States importations, cost of a box of oranges and other interesting items.

Sugar Review, by Willett & Gray, in English, on page 28. Sugar Review in Spanish on page 30.

Miscellaneous notes on sugar, with some interesting cartoons, on page 32.

The number is, as usual, profusely illustrated.

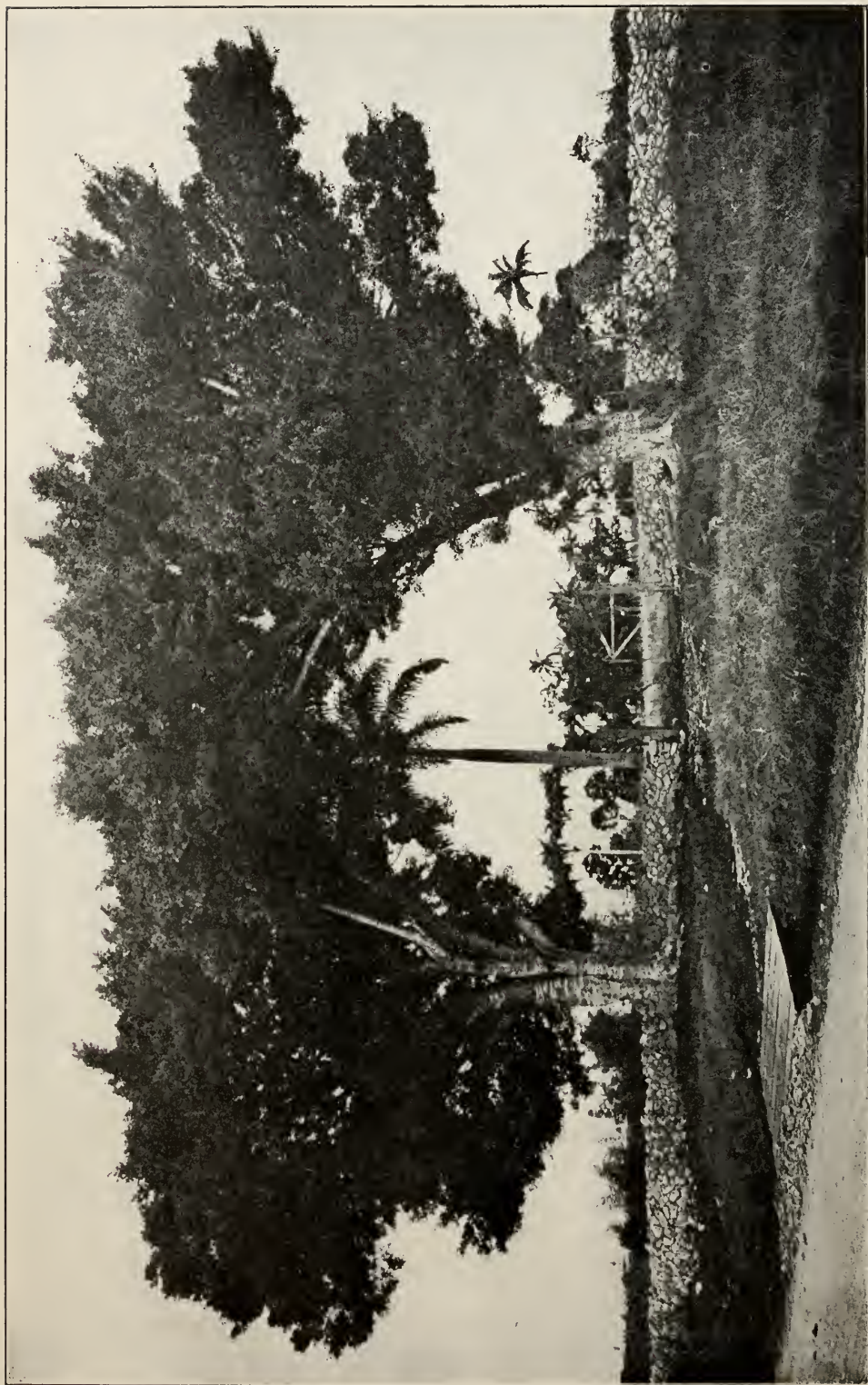

Giant Fig Trees at entrance to a Cuban Farm. The species is the Ficus Nitida, fruit not edible, and is met with throughout Cuba. It is planted

THE CUBA REVIEW

“ALL ABOUT CUBA.”

Copyright, 1907, by the Munson Steamship Line.

LIBRARY
NEW YORK
BOTANICAL
GARDEN.

Volume VII.

JANUARY, 1909.

Number 2

POLITICAL AND GOVERNMENT MATTERS.

Plans for the Inauguration—The Provisional Government Ends on January 28 at Noon—The Quorum Decree Opposed.

Plans for the ending of the provisional government and the other details coincident with President Gomez's inauguration on January 28, arrangements for which were agreed upon at a conference between President Roosevelt, Secretary Wright and Gov. Magoon, were officially set forth at Washington Dec. 26.

The War Department promptly cabled Gov. Magoon authority to call the new Cuban Congress together for organization.

The Governor accordingly issued a decree Jan. 4, convoking Congress at noon on January 13 for effecting a permanent organization and approving the election of each of its members. On January 20 Congress will meet again in joint session, pass on the election of the President and Vice-President and proclaim them. It will then take a recess until January 28, at noon, when Governor Magoon will turn over the government.

Orders have been given for the United States army and naval forces convenient to take part in the ceremonies attending the re-establishment of the Cuban republic. Rear Admiral Arnold's squadron of the Atlantic fleet, with the battleship Maine as flagship, has been ordered to Havana for the occasion.

According to present plans, Gov. Magoon and all the officials of the existing provisional government will embark on the army transport Sumner, leaving Havana Jan. 28, for Hampton Roads.

Governor Magoon's decree on Jan. 4 providing for a Congressional quorum excited much angry comment in the Cuban press. The decree in part insures a majority of each House shall be a quorum, although for special legislation a quorum shall be any regular period two-thirds of the total number of the members of each House shall be required.

Members may not absent themselves without permission nor can the House pass a resolution without the presence of a quorum. Absentees will not be paid and pay vouchers must have certificates of attendance. In the absence of a quorum, the attendance of the absentees and summon them by special messenger. The decree is at the prevention of the paralyzing delays injurious to business so familiar to the late President Palma's administration by reason of the lack of a quorum. La Lucha decree is contrary to the dignity of Congress, and with La Discusion advises it at the first session of the Cuban Congress. Others say this is impracticable. The decree was issued with the approval of the President of the United States as necessary under the Platt amendment as a measure tending to insure the stability of the Cuban Government and cannot be repealed. Aurelio Hevia, secretary of the Conservador party, asserts that the decree is a trespass on Cuba's sovereign rights, and that the Cuban Congress alone can dictate its own rules.

It is pointed out also that the enforced presence of members at the sessions of the house is provided for in the platform of Gen. Gomez, the President of Cuba, who himself advocated the same principles regarding a quorum, which is a part of the Governor's decree.

JAN 25 1909

The Senators at a meeting January 6 unanimously condemned the terms of the decree as humiliating, and agreed to revoke it at the first meeting on January 29, after the Cuban government takes possession. La Discusion says the Representatives, with few exceptions, had decided to take the same action.

Although not officially announced, it is believed President Taft, on his way to Panama with Secretary Root this month, will stop in Cuba to be present at the inauguration of President Gomez.

A resolution which seems to question the ability of the Cubans to govern themselves was introduced into the U. S. House of Representatives on Jan. 6, by Representative Lassiter of Virginia. The resolution calls upon the Secretary of War to furnish the House such information as he may possess that justifies the United States Government in assuming that the recently elected Cuban officials are capable of maintaining a stable Government.

Mr. Lassiter affirms that a state of anarchy will soon exist in the island if the United States withdraws all of its troops. He says the business interests in Cuba desire the United States withdraws all of its troops. He says the business interests in Cuba desire the protection of the United States.

New Year's Day witnessed the beginning of the evacuation of Cuba by the army of pacification, which has been in possession of the island since the beginning of the provisional Government, October, 1906.

The purpose in deferring the departure of a portion of the Seventeenth Infantry until April 1, now at Camp Columbia, it is believed was agreed upon at a conference between Gov. Magoon and President-elect Gomez, not as a measure of precaution, for which not the slightest necessity is apparent, but probably for the purpose of keeping the barracks and quarters in good order until it is possible to turn over to the Cuban authorities a model camp for occupation by the new permanent army under command of Gen. Pino Guerra, for which it is intended to form a nucleus with the present corps of Cuban artillery the transfer of a thousand members of the National Guard to the regular forces.

The Cubans generally are greatly pleased at the departure of the American forces as the complete establishment of independence, and show the kindest feelings toward the troops. On Christmas Eve the citizens of Manzanillo, the city authorities, and the citizens escorted a battalion of troops to the steamer sailing for Havana to cheer the departing troops. The Cuban officers and men are rejoicing that they will soon be homeward bound from this long and tedious occupation.

The new President of Cuba, General Gomez, is believed to be a man of strong sound sense and a strong character, and keenly alive to the great responsibility resting upon him, to the gravity of the task of proving that Cuba can maintain a creditable government of its own.

Respect for law, maintenance of order, the development of wealth and commercial interests, the fulfillment of our international obligations and justice to all are his promises, but to bring Cuba successfully through



A pen picture of General José Miguel Gomez, President of Cuba. From Cuba y America, Havana.

the four years of his administration, General Gomez and the Cuban Congress must exercise an economy which has formed no part of the policy of the Provisional Government.

He is fifty-five years of age and a native of Santa Clara Province.

At the new year's reception the Governor Magoon formally presented the diplomatic representatives and consular officers, the supervisors of the governmental departments, the judges of the Supreme and minor courts, the presidents of the commercial guilds, the representatives of the foreign and native press, the officers



Roosevelt—"Ayúdate tú, que nosotros te ayudamos."

Roosevelt—"Help yourself and we shall help you."

of the Cuban armed forces and many prominent citizens to the President-elect, General Jose Miguel Gomez, and the Vice-President-elect, Alfredo Zayas.

*Cuban
Minister
Resigns.*

The Minister Plenipotentiary of Cuba in Washington, Mr. Gonzalo de Quesado, wrote to General José Miguel Gomez, on Dec. 19, resigning his position.

General Gomez's reply was to the effect that he was not the one at that time to receive his resignation.

At Washington, on Dec. 28, it was said unofficially that Mr. Quesada would remain as Cuban Minister, although the latter stated he had received no official information to that effect.

Mr. Emilio Ferrer y Picabia, the present Cuban Minister in France, will not continue in this office, which he resigns to remain in Cuba and attend to his private business.

Among the liberals, it is said that, if Mr. Ibrahim Urquiaga is not appointed Secretary of Public Works, our representation in France will be conferred on him.—La Discusion.

*Afflicted
Immigrants
Detained.*

An order has been issued by Governor Magoon providing that immigrants or other persons arriving in the port of Havana afflicted with the trachoma or other contagious but not quarantinable diseases, may be detained in the immigrant station, where they will be treated at their own cost, and if not cured within a specified time, shall be sent back to their ports of embarkation.

An Esperanto society has been organized in Santiago de Cuba. The members are nearly all well-known people.

Acting Governor Barry has signed a decree at the recommendation of Supervisor of Police Foltz raising the monthly salaries

of the Havana Police Force about twelve per cent.

The increase will cost the city \$121,269.00 per year. Sergeants will now receive \$90.00 instead of \$83.00 per month. First-class policemen \$80.00 instead of \$70.00. Second-class men \$60.00 instead of \$55.00. Third-class men and the mounted force \$52.50 and \$55.00 respectively instead of \$44.00.



El Nuevo Gobierno: "Conocemos la cría; por eso en vez de palos, benediciones y maiz."

The New President—"We know the breed; therefore, instead of sticks we hand out blessings and feed."

Two new post offices have been established, one at Vegas de Mano, Province of Oriente, and at San Miguel, Province of Camaguey.

A money order service has been inaugurated at Macuriges, Province of Santa Clara, at Amarillas, Province of Matanzas, and at Campo Florido, Province of Havana.



APUROS DE UNA MADRE.

"Cómo pesa el hiji adoptivo!"

THE AFFLICTIONS OF A MOTHER!
Queen Havana—"My adopted son is very heavy."

Note:—Governor Magoon was recently made an adopted son of Havana by the City Council.

UNITED STATES NEWSPAPER COMMENT.

Good Wishes for Cuba—United States Cuba's Schoolmaster—Predictions of Ultimate Annexation—Cuba an Ally and a Stable Government Essential.

We have donated Cuba our services as schoolmaster in the art of self-government, and now we give our pupil his diploma and extend to him the right hand of fellowship in the widening brotherhood of republics.—Harrisburg (Pa.) Telegraph.

It is probable that many persons are now alive who will see both Panama and Cuba states of the American Union, though this association is not likely to come quite so early for Panama as it is for Cuba.—New Haven (Conn.) Palladium.

France experimented with republican government a half dozen times before it learned the right way. And little Cuba may have to try as often.—Augusta (Ga.) Herald.

The new government begins under the brightest auspices, with the liberals holding the majority in the senate and house of representatives.—New Haven (Conn.) Journal Courier.

In the present instance all the financial and commercial interests of Cuba will refuse to place any confidence in the government.—Sioux City (Iowa) Journal.

Cuba has suffered enough, first from foreign oppression and then from factional troubles. It is time that she had enduring peace under the rule of her chosen officials.—Providence (R. I.) News-Democrat.

Cubans are to be congratulated upon their forbearance, their good sense and their respect for orderly institutions.—Allentown (Pa.) News.

Those people are not fit for self government yet, yet trying to be.—Birmingham (Ala.) Ledger.

Cuba is too close to the United States and this country has too much at stake to permit of a repetition of the farce of government that has marked San Domingo and Hayti.—Beaumont (Tex.) Enterprise.

If the Cubans can get along without further help the United States would probably prefer it that way.—San Antonio (Tex.) Express.

¼ Miguel Gomez became president by an orderly and honest election, and neither by revolution, nor fraud, nor intimidation.—Hagerstown (Md.) Herald.

We haven't yet found out whether or not we shall have to add Cuba to the family.—Chicago Post.

Cuba's national election has given it not only a President, but, because of the orderliness with which it was conducted, the moral support of the Government and people of the United States.—Providence (R. I.) Bulletin.

We are always interested to watch a game of chance, and the little farce of Cuban self-government will not lack its elements of fascination.—Waterloo (Iowa) Courier.

Probably Europe is correct in assuming that Cuba and Porto Rico will become an integral part of the United States before many more years pass.—St. Louis (Mo.) Globe-Democrat.

Cuba must, in the very order of things, ever be an ally of the United States, and as an ally it will be worth nothing unless it have a sound government.—Springfield (Ill.) Journal.

The next few months will be a momentous time for the new government, from which everybody is now hoping much.—Hartford (Conn.) Post.

If trouble starts under Gomez's administration it will be through the efforts of others selfishly interested in procuring annexation to the United States.—Dubuque (Ia.) Times.

The voters of Cuba are to be congratulated upon the start they have made toward placing their republic upon a firm footing as a popular government.—St. Paul (Minn.) Pioneer Press.

This time when Havana calls out, "Help me, Washington, or I sink," Washington will go to the rescue a little quicker than before.—Hamilton (O.) News.

Cuba will again be ruled by Cubans, and possibly fairly well ruled, at least for the next few years.—Elgin (Ill.) Courier.

The next time will mean the beginning of an era of American rule which will be permanent, not provisional.—Colorado Springs (Col.) Gazette.

There are few luckier people than the Cubans. Their case dissipates the idea that opportunity knocks at the door but once.—Troy (N. Y.) Record.

So it's up to the Cubans themselves to be free or come under the protecting arm of Uncle Sam.—Hamilton (O.) Sun.

Cuba tranquil, as well as free, will be the crowning triumph of our intervention ten years ago.—Rochester (N. Y.) Chronicle.

PUBLIC SANITARY WORK.

Statement of all Works of a Sanitary Character Which Have Been Completed by the Department of Public Works Since the Beginning of the Provisional Administration of the United States.

Province of Pinar del Rio.

Aqueduct of Pinar del Rio.—Cost, \$134,432.12.

Province of Havana.

Aqueduct at Guanabacoa.—Cost, \$250,000.00.

Water supply to the village on the beach at Marianao.—Cost, \$17,987.04

Aqueduct of San Nicolas.—Cost, \$1,600.

Water supply to Camp Columbia.—Cost, \$74,574.41.

Repairs to the streets of Casa Blanca.—Cost, \$3,440.

Province of Matanzas.

Drainage of the La Furnia Lagoon at Colon. Cost, \$4,718.30.

Canalization of the Cochino Creek at Colon. Cost, \$9,254.58.

Province of Santa Clara.

Aqueduct of Trinidad. Cost, \$3,593.64.

Province of Camaguey.

Drainage work in the town of Moron. Cost, \$12,000.

Province of Oriente.

Aqueduct of Santiago de Cuba. Cost, \$425,023.88.

Aqueduct of El Morro. Cost, \$13,696.88.

Paving at Santiago de Cuba. Cost, \$37,932.18.

Works Nearing Completion.

Among the works of a sanitary character which are now nearing completion, are being constructed, or will be begun about January 1, 1909, are the following:

Province of Pinar del Rio.

Repairs to the aqueduct of Consolación del Sur. Probable cost, \$2,041.75.

Repairs to the aqueduct of Mariel. Cost, \$6,377.28.

Province of Havana.

Sewer system, paving and aqueduct betterment of the City of Havana. Cost, \$14,500,000, which will be paid in part by the City of Havana and a sum equal to 10% of the gross receipts of the Havana Custom House contributed by the State government.

Water supply for New Paz. Cost, \$2,300.

Water supply at Palos. Cost, \$2,300.

Water supply for Vegas. Cost, \$400.

Province of Matanzas.

Aqueduct at Limonar. Cost, \$8,000.

Prevention of inundations at Vieja Bermeja. Cost, \$11,250.

Repairs of streets and parks at Cardenas and construction of cess pools. Cost, \$18,896.

Province of Santa Clara.

Aqueduct and sewerage of Cienfuegos. Cost, \$2,500,000.

Prevention of inundations at Santa Clara. Cost, \$66,000. This work includes the construction of a dyke to divert the flood waters of the Sagua river and prevent the inundation of the town of Sagua.

Province of Camaguey.

Aqueduct of Camaguey. Cost, \$800,000. Work well under way.

Aqueduct of Ciego de Avila. Cost, \$30,000.

Province of Oriente.

Aqueduct of Gibara. Cost, \$100,000.

Repairs of streets in Manzanillo. Cost, \$11,000.

The following is a list of works which will be carried out as soon as funds are available, before February, 1909, and which will form a program of works urgently needed.

Drilling of wells for aqueduct of Colon, Matanzas.

Aqueduct of Santa Clara, Santa Clara.

Aqueduct of Trinidad, Santa Clara.

Aqueduct of Camajuani, Santa Clara.

Repairs to streets of Placetas, Santa Clara.

Aqueduct of Nuevitas, Camaguey.

Aqueduct of Songo, Oriente.

Aqueduct of Manzanillo, Oriente.

Aqueduct of San Luis, Oriente.

Canalization of two streams at Guantanamo.

Sewerage at Santiago de Cuba. (Continuation of old work.)

Aqueduct at Palma Soriano, Oriente.



Carretera de Guane a Luis Lazo, Oct., 1908. Tipico camino viejo, cerca del Rio Macurijes. View of a typical old road in Cuba, worn to a depth of two meters. Pinar del Rio Province.



Carretera de vuales a la Esperanza en la cùspide de los Pinares.

A typical new road in Cuba constructed by the Department of Public Works. There are already enough fine hard roads completed to make an automobile a necessity and a pleasure for the resident and tourist.

CUBAN PUBLIC WORKS.

Summary of Appropriations Made and Expended on Works Up to the 30th of June, 1908.

(Copied from the official records at Havana.)

| | Appropriation. | Expended. | Balance. |
|------------------------------------|------------------------|------------------------|-----------------------|
| Highways, roads and bridges..... | \$14,048,913.01 | \$10,919,501.95 | \$3,129,411.06 |
| Waterworks | 2,758,443.17 | 1,548,915.07 | 1,209,528.10 |
| State buildings | 3,980,342.91 | 2,174,688.14 | 1,805,654.77 |
| Sanitation | 6,265,338.73 | 3,444,901.78 | 2,820,436.95 |
| Harbor works | 1,408,269.98 | 983,950.37 | 414,319.61 |
| Lighthouse, buoys and beacons | 635,745.14 | 259,205.48 | 376,539.66 |
| Survey of new works | 146,612.80 | 138,788.10 | 7,824.70 |
| Sundry expenses | 982,262.11 | 947,125.29 | 35,126.82 |
| Railroad Commission | 50,545.54 | 47,311.08 | 3,234.46 |
| Emergencies | 40,000.00 | 28,212.86 | 11,787.14 |
| | <u>\$30,316,473.39</u> | <u>\$21,492,600.12</u> | <u>\$8,823,873.27</u> |

ROAD AND BRIDGE CONSTRUCTION WORK.

(Copied from the official records in Havana.)

Road work.—Statement of kilometers of roads existing in Cuba before Sept. 30, 1906 (beginning of U. S. intervention). Number of kilometers existing at present up to and including June 30, 1908.

| Provinces. | Previous to Sept. 30, 1906. | To June 30, 08 (American intervention) |
|-------------------|-----------------------------------|--|
| Pinar Del Rio .. | 151.338 kil. | 93.627 kil. |
| Havana. | 231,562 " | 129,119 " |
| Matanzas | 45,987 " | 61,059 " |
| Santa Clara . . . | 57,498 " | 72,245 " |
| Camaguey | 25,538 " | 9,870 " |
| Oriente | 98,519 " | 39,358 " |
| Total | 610,442 " | 405,278 " |

The following is an official statement of bridges constructed in the Republic of Cuba up to and including June 30, 1908. These bridges do not form part of any roads. Twenty-eight bridges have been constructed during American intervention, less than two years' time:

Province of Pinar del Rio.

One of concrete, 13 of steel, and 19 of wood. Total 33.

Province of Havana.

Three of steel and 2 of wood. Total 5.

Province of Matanzas.

Five of steel and 2 of concrete. Total 7.

Province of Santa Clara.

Thirteen of steel, one of concrete, and 14 of wood. Total, 28.

Province of Camaguey.

Eleven of steel, 6 of concrete and 26 of wood. Total, 43.

Province of Oriente.

Twelve of steel, 2 of concrete, and 8 of wood. Total 22.

Summary.

Bridges existing before Sept. 29, 1906. . . 105
Bridges constructed to June 30, 1908. 28

Total 140

New Road Communication. Embankments finished December 31 will permit of communication by carriage and automobile between Bahia Honda and Cabanas, in Havana province.

Work on the bridges over the San Claudio, Nazareno, Sabee and Santiago rivers is also being continued.

The bridge over the Santiago river will be of steel, 500 feet long, and the largest bridge to be constructed in Cuba.

The Cienfuegos Waterworks. The work of sewerage and waterworks of Cienfuegos began anew on Dec. 28, the City Council allowing Contractor Reilly to ditch through the streets in the daytime. Just a week previous the same City Council, under the Mayor's instructions, had stopped all work because the contractor was working during the day. The reversal of the Council's first decision followed the contractor's appeal to Governor Magoon, Mr. Reilly asserting that the work already done had been performed with the approval of Mr. Page, the engineer in charge.

COMMERCIAL MATTERS.

Five Years of Cuba's Commerce.

| | Imports. | Exports. |
|---------------|--------------|--------------|
| 1903. | \$67,077,676 | \$78,486,400 |
| 1904. | 82,835,651 | 89,978,141 |
| 1905. | 103,220,985 | 112,280,026 |
| 1906. | 99,539,661 | 108,909,667 |
| 1907. | 105,218,208 | 116,592,648 |

The commerce of 1907 is divided as follows:

| | Imports. | Exports. |
|--------------------------------------|--------------|---------------|
| United States. . . | \$51,447,053 | \$100,653,335 |
| Other countries of America | 9,277,605 | 2,504,299 |
| Germany. | 7,592,326 | 3,211,959 |
| Spain | 9,499,002 | 639,374 |
| France. | 6,643,826 | |
| Great Britain . . . | 15,322,981 | 4,506,458 |
| Other countries of Europe | 3,604,052 | 744,189 |
| All other countries | 1,831,036 | 486,817 |

Postmaster-General Meyer is negotiating parcels post conventions with Cuba and Brazil.

United States Trade With Cuba.

| | Imports. | Exports. |
|---------------|--------------|--------------|
| 1905. | \$86,304,259 | \$38,380,601 |
| 1906. | 84,979,821 | 47,763,688 |
| 1907. | 97,441,690 | 49,305,274 |
| 1908. | 83,284,692 | 47,161,306 |

Customs receipts at Havana for the fiscal year ending June 30, 1908, were \$18,811,730.80, as compared with \$18,674,975.41 in the preceding year.

For the first six months of 1908—January to June—total receipts at the port aggregated \$8,638,390.56, against \$9,831,697.88 in the corresponding period of 1907.

The Secretary of the Treasury sent a circular to the Custom House Administrators, December 14, ordering the following:

"Hydraulic and mosaic paving blocks in future and until the question of tariff is decided, shall be classified by item No. 20 of the Customs Tariff, instead of item 19."



Sanitarium for consumption at La Esperanza, near Havana. On the right are shown the docker houses for one or more patients; on the left are the dining rooms and quarters for assistants.

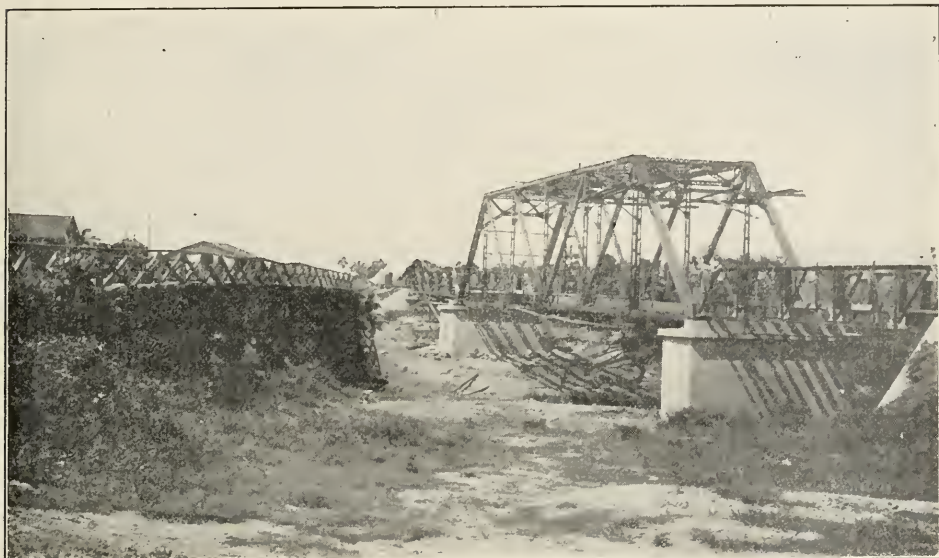

Puente nuevo y puente viejo a la salida de Pinar del Rio.
Old bridge over Guamá River at Pinar del Rio, and new bridge now almost completed.

AMERICAN SHOES IN CUBA.

Cuba has been a fine market for American shoes the past few years. In 1903 shoes valued at \$162,003 were sent from this country to Cuba, but last year the value of shoes imported from America was \$1,123,405. The total value of shoes imported by Cuba the last-mentioned year was \$1,572,493. Since 1903 Americans have had the advantage of reduced duties in Cuba, the reduction of the duty on shoes being some 30 per cent.

The shoe salesman has been far more active in Cuba than have American salesmen in most other places, and there has been more care in endeavoring to give satisfaction. United States Deputy Consul Starrett at Havana recommends that the manufacturers remember that the Cuban has a small foot with high instep, hollow on the shank and slightly curved. The ladies require especially small shoes. Another requirement of the trade is low cut tans all the year for the Cuban and other Latin-American markets. It has been almost impossible to get these from American dealers in the winter.

The superiority of the American shoe, says Consul Starrett in his report, is generally conceded as compared with the Spanish article. The Cuban trade in ladies' shoes demands especially small sizes, and stocks should carry from 1 up instead of 2½ up. All ladies' shoes should be carefully lined and the inner sole should be of oak leather in order to protect light-colored hosiery from being stained. Welt soles should be as light weight as possible.

Sizes run in halves from 1 to 7 and widths "D" and "E E" with an occasional "C."

Misses' and children's shoes should be the usual summer style. Sizes run from 8½ to 11 and misses' 11½ to 2, with "D" and "E" widths.

Men's and boys' shoes are low, lace or button, with medium and narrow toes, straight tips, medium soles, and lasts should be hollow on the shank, flat on the sole, and with the "Cuban" heel. Sizes for boys run from 1 to 5 and for men 4 to 10, widths "D" and "E," some "C."

There is a good market here for low-priced white canvas shoes in men's, women's and children's sizes. They should be made up stylish and follow closely the above specifications as to cut, sizes, width, etc.—such a shoe that would cost in the United States from 75 cents to \$1.50, manufacturer's price.

Expenses due to the intervention from Oct. 1, 1906, to June 30, 1908, under the act of Congress approved March 4, 1907, are to be reimbursed from the Cuban treasury. The total amount is \$5,311,822.02.

The amount paid from Cuban funds on account of intervention expenses is \$737,343.92.—Report of General C. R. Edwards, Chief of the U. S. Bureau of Insular Affairs, Dec. 21, 1908.

According to the official records, there are 555 drug stores in Cuba.

Lumber Markets in Cuba.

Most houses of the better class are built of stone or cement, but cottages, stables, etc., are of yellow and white pine and spruce. Annual importations of yellow pine amounts to 150 million feet, 80 per cent. of which comes from the United States.

It is believed with better business conditions now evident, building activity in Cuba during the coming year will be very great. Deputy Consul-General Henry P. Starrett of Havana gives a detailed description of specifications and lumber market conditions of interest to all American lumber exporters, as follows:

Nearly all lumber is bought in cargo lots of from 250 M to 400 M feet, quotations being c. i. f., on the three kinds imported—yellow pine, white pine, and spruce.

Specifications for cargo lots usually run as follows: Two-thirds of cargo from 12 to 30 feet in length and one-third from 30 to 36 feet in length; 30 per cent. should be 10 and 12-inch stuff, 1 to 12

Indies shippers" quality, being from \$34 to \$36 per M, c. i. f., and for "No. 7" quality from \$45 to \$50 per M, c. i. f.

Nova Scotia supplies all the 10,000,000 feet of spruce imported. Market requirements are for 1 by 6-inch to 1 by 12-inch stuff, from 10 to 25 feet in length. There is only one grade imported, the price being from \$22 to \$24 per M, c. i. f.

Terms of sale are usually sixty days' draft for 90 per cent. of the invoice against shipping documents, the remaining 10 per cent. being paid at the time of the discharge of the cargo, except in the case of white pine, when draft is usually given for sixty days for the full amount of the invoice, shipping documents attached. There is no duty on undressed, common pine lumber, but harbor dues amount to 20 cents per thousand feet and wharfage about 12 cents per thousand.

It is best to have an agent who is known in Havana, as buyers do not seem to care to purchase direct from the shipper. The current commission is 75



Perspectiva del Palacio de Justicia de la Provincia de Santiago de Cuba, Departamento de Obras Publicas Construcciones Civiles, '08.

The new Palace of Justice Building to be built in Santiago de Cuba. The illustration gives a very good idea of the scope of the work.

inches thick, and the balance from 2 by 2 inches to 8 by 8 inches. The market price in Havana for first-class (merchantable quality) yellow pine lumber is from \$21.50 to \$22, United States currency, per M, c. i. f., and for second-class quality, from \$17 to \$18 per M, c. i. f.

White Pine.—8,000,000 to 10,000,000 feet of white pine is imported, and Canada furnishes the most. Market requirements are for 1 by 8-inch to 1 by 12-inch stuff, from 12 to 16 feet in length. The market price in Havana for "West

cents per thousand feet.—U. S. Report, Dec. 17, '08.

Cuban Mahogany and Cedar.

Mahogany.—Arrivals were represented by two ports only, totaling under the yearly monthly average. Small wood was slow of sale. Large wood secured better prices.

Cedar.—Receipts fell off fifty per cent. Business depression made stock in first hands larger than in months. Improvement in trade now looked for.—From G. F. Herriman's N. Y. Report, Jan. 1, 1909.

CUBAN ORE PROPERTIES.

President E. C. Felton, of the Pennsylvania Steel Co., has just returned from a visit of inspection of the Spanish-American Iron Co.'s ore properties in Cuba.

He visited first the new properties near Mayari on the north coast of the island where development of the extensive ore deposits of the company are now being made. He found the work well advanced and the construction of the railroad and terminals very nearly completed. The opening up of the ore deposits has been begun and all the promises as to both the quantity and quality of ore are being realized. The railroad, where it penetrates the ore field, is itself built of iron ore, there being no other material in the vicinity of the line out of which the road could be constructed. It is expected that shipments of iron ore from this new property will begin about the middle of 1909.

In reference to the gold properties situated near Santiago on the south side of the island, which he also visited, Mr. Felton said:

"These mines show no falling off in the visible amount of ore, and while they have probably reached their maximum of output a large tonnage may be expected from them for many years to come. The small demand for steel products during 1908 did not allow of the consumption of the entire product of

these mines by the Pennsylvania and Maryland Steel Companies, but the mines have nevertheless been operated during the year to their full capacity and the surplus ore stock amounting to an excess of 200,000 tons piled near the mines where it is available when needed by the two steel companies."—Wall Street Journal, Dec. 31.

Productivity of Cuban Ore Fields.

Charles M. Schwab, president of the Bethlehem Steel Co., before the Ways and Means Committee at Washington, D. C., Dec. 15, said that though the Cuban fields promised a productivity greater than that of the Mesaba fields, freight rates to inland points in this country would absolutely protect the Mesaba ore from competition in its natural markets.

As it is now, he said, Cuban ore can be laid down as cheaply in Pittsburg as can the Mesaba ore, and his own Bethlehem works use the Cuban ore exclusively. However, a reduction of all duties from Cuba would only mean a decreased cost of production along the Atlantic seaboard of 50 cents a ton, while further inland the cost would not be affected at all.

"That young man, Schwab, of Bethlehem, also has a mine in Cuba and will make a great fortune."—Andrew Carnegie, Dec. 21, before the same committee.

English Teaching in Cuban Schools.

Boys and girls in Cuba began to learn English from a text book, the first ever used in Cuban schools, on Jan. 1. The Department of Education plans to place the book in use in all the schools where English is taught and to have a course in every school, as soon as possible. The enlargement of this work necessitated more teachers and examinations which were held recently yielded certificates to thirty-five out of the fifty-seven applicants. Further examinations will soon be held in four other provinces. The text book was prepared by Miss Abbie Phillips, Supervisor of English in the schools of Havana Province.

The Belen University seismograph at Havana registered the terrible earthquake in Italy.

The record shows that it was the most violent ever known, not even excepting the shock at Kingston, Jamaica.

The Havana City Council on January 5 appropriated \$10,000 for the relief of the Italian earthquake sufferers.

Mayor Cardenas approved the purchase in France of an automobile fire engine, which is to be used at the Chas. E. Magoon fire headquarters on Zulueta Street.

Automobile Buyers in Cuba.

"Cuba will purchase over \$1,500,000 worth of American automobiles next year," said William Mitchell Lewis, president of the Mitchell Motor Car Company, of Racine, Wis., who arrived here yesterday in the Ward Line steamer Havana.

"Heretofore the machines used in Cuba were mostly of foreign make; in fact, only about 19 per cent. were of American manufacture," said Mr. Lewis. "During the coming year it is safe to say that over 50 per cent. of the cars shipped to Cuba will be of American make. Our agent has placed an order with us for 100 Mitchell cars for early spring delivery, and several other American automobile companies have been favored with orders for different makes."

The city of Santa Clara will soon have an electric light installation. The plant is essentially modern.

The Americans at Camaguey made a Christmas tree of a mammoth mango, standing on the grounds, and this was illuminated with Japanese lanterns with gifts for everybody. Santa Claus had the novel experience of needing a ladder to distribute his gifts.

Earthquake shocks were felt at Santiago Dec. 8 and 16, causing great alarm, as the shocks were more severe than usually felt. There was no damage.

Some Valuable Cuban Stamps.

Increasing interest is taken by American collectors in the stamp issues of Cuba and it has had a decided influence on the stamp values, says the *Pittsburg, Pa., Post*. Many new prices of the surcharged Cuban stamps will be placed in the 1909 catalogue for the first time.

Among these are the stamps of Puerto Principe. Chief of these rarities is the orange brown stamp surcharged "three cents" on a Cuban stamp of the denomination of three milesimas. This stamp has been erroneously quoted by the foreign catalogues at from \$15 to \$30, although a specimen sold for \$87 last winter in New York city and it is now catalogued at \$100.

The new quotation on the used three milesimas orange brown stamp of the same issue with the "three cents" surcharge, but with the letters on the surcharge upside down, is \$75. The five-cent surcharge on the unused one milesima orange brown stamp is now quoted at \$75, and the used five-cent surcharge on the three milesimas orange brown stamp is also placed at \$75.

Of the Puerto Principe blue green stamps with the black surcharge very few were quoted in the 1908 catalogue, but the 1909 issue will show many new prices. Among these the used five-cent surcharge on the two milesimas blue green stamp is quoted at \$65 and the five cent on four milesimas blue green stamp at \$100. The unused three-cent surcharge on the one milesima blue green stamp is quoted at \$30; the three cent on two milesimas blue green at \$40 and the same stamp showing the misspelled surcharge "cents" for "cents," at \$60.

One great attraction to the collector of the surcharged Cuban stamp is their very recent issue. Careful watch of correspondence often enables a collector nowadays to pick up a rare specimen of these makeshift stamps for little or nothing.

Motoring in Cuba.

The center of the street is the automobilist's; other vehicles keep to the sides, where when a crowd is out, as at carnival time, the police hold them in lines moving in opposite directions. There are no rules or regulations governing automobiles once they are outside the city limits, excepting at Camp Columbia, where army authorities have fixed eight miles an hour as the speed limit while passing through the reservation. Cars should slow up on approaching hamlets and villages. This is a courtesy which should be the more readily accorded because it is not demanded but merely confidently expected as a matter of course.

As few accidents have occurred on country roads of Cuba, the automobilist is welcome everywhere. It is customary for persons meeting on the road to salute each

other. The surprising variety of smiles and grave inclinations of head and body received in recognition makes the effort well worth while.

A knowledge of Spanish is not necessary. He should, however, learn to pronounce properly the name of the place he means to reach or have the name written on a card in plain characters. Then, in case of doubt as to his way there, he need but pronounce the name or show the card to persons he meets. The tourist will find everybody willing to help him. The Cuban who directs him may not speak a word of English, but he will converse so eloquently in pantomime that the traveler, even without any knowledge of Spanish, will understand.

It is quite impossible to get really lost in the country; there is always the alternative of turning back to Havana (or Matanzas or Pinar del Rio), for in the provinces all good roads leading in the general direction of the capital city inevitably arrive there. Cuba is properly policed, in the city and in the country; but even were provincial police in blue and rural guards in khaki entirely absent from the Government highways, which they patrol in pairs, no traveler would be in any wise molested.—From Bulletin of the International Bureau of the American Republics.

Havana Races.

The track is located in a suburb of Havana called Almandares, from which it takes its name. There is a good trolley service to the course, which is about three or four miles from the city. The plant was erected by the Cubans, and is a rather crude affair. The track itself is a mile and a furlong and 100 yards in circumference. The paddock and stalls are open affairs, but so as to give the horses plenty of fresh air.

While it is doubtful if the present meeting will be a successful one financially, says *Racing Form*, still it is almost a certainty that in a few years racing will be a big thing in Havana.

Up to date the racing has been much better than expected. There are a number of good horses entered, and some fast time has been made considering the construction of the course. The Cuban Racing Association has but little idea of how a race meeting should be conducted and had to overcome the many mistakes made last season.

The Cubans are the greatest bettors in the world. They are good losers, too, and it is only a question of time before racing on the island will be a national sport. In the early days of the *Jai-Alai* in Havana this game was run at a loss. The profits now are enormous, the yearly dividends being something like 150 per cent. Baseball was a losing venture here for the first few years, yet a few weeks ago 21,000 persons witnessed a game.

RAILROADS AND FINANCIAL.

Report of the Cuba Company—Earnings of the United Railways of Havana, the Havana Electric Co., Etc.

Cuba Railroad.

The report of the Cuba Railroad Company for the month of November and five months ended November 30, 1908, compares as follows:

| | 1908 | 1907 | 1906 |
|----------------------|-----------|-----------|-----------|
| Nov. gross. . . | \$117,209 | \$142,034 | \$120,179 |
| Expenses . . . | 83,733 | 101,289 | 94,767 |
| Nov. net . . . | \$33,476 | \$40,745 | \$25,412 |
| Charges. . . . | 32,496 | 28,329 | 25,976 |
| Nov. surplus | 980 | 12,416 | *564 |
| Five mos. gross | 673,261 | 719,608 | 642,036 |
| Expenses . . . | 424,832 | 519,281 | 621,427 |
| Five mos. net | \$248,429 | \$200,327 | \$120,609 |
| Charges | 161,771 | 141,646 | 127,626 |
| Five mos. sur. . . . | \$86,658 | \$58,681 | *\$7,017 |
| * Debit. | | | |

United Railways of Havana Earnings.

The earnings of the United Railways of Havana and Regla Warehouses, Ltd., during the week ending Dec. 5th were £15,076, an increase of £2,144 as compared with the same week last year, which was £12,932.

Up to the week ending the 5th the earnings of the United Railways were £283,546, a decrease of £9,666.

The earnings of the United Railways of Havana and Regla Warehouses, Ltd., in the week ending the 19th inst. were £18,600, or £2,102 more than in the same week of last year.

To the week ending December 19th the United Railways collected £318,605, or £4,543 decrease.

Havana Electric R. R. Co. Earnings.

In the week ending Dec. 6th the earnings of the Havana Electric R. R. Co. were \$38,951.45 U. S. currency, or \$3,861.45 more than during the same week last year, which was \$35,090.

To the same date the earnings have been \$1,758,395 U. S. currency, an increase of \$100,391 U. S. currency.

In the week ending Dec. 20th, the Havana Electric R. R. Co. earnings were \$36,918.10, or \$2,062.14 U. S. currency more than in the same week last year, which was \$34,535.70 U. S. currency.

To the same date the Havana Electric R. R. Co. earned \$1,794,082 U. S. currency, an increase of \$101,797 U. S. currency over last year.

A survey is under way for a branch of the Western Railways to Bahia Honda.

Banco de La Havana.

A special meeting of the stockholders of the Banco de la Habana will be held at the head office of the Bank, 76 Cuba Street, Havana, Cuba, the fifteenth day of January, 1909, for the purpose of considering the advisability of the liquidation of the assets of the Banco de la Habana or merger with another bank.

Stockholders, having bearer shares, residing in the Island of Cuba, are notified that they must deposit the certificates at least three days prior to the meeting at the office of the bank or with its correspondents in the Island, and those holding similar shares abroad must deposit the certificates at least eight days prior to the meeting at the following agencies: In Paris, with the Banque Francaise pour le Commerce et l'Industrie; in London, with the London Bank of Mexico and South America, Ltd., and in New York with the National City Bank of New York.



Exterior view of parlor cars of the Havana Electric Railway, which have been placed in commission by the company. These cars are for the public service and may be hired out by private parties for theater parties and excursions through the city on the streets and avenues traversed by the company. The cars have been constructed at the shops of the company at Chorrera, majagua wood being employed wherever possible.

Restores Salaries.

Beginning Jan. 1, the United Railways of Havana will restore the old scale of wages which were paid prior to the 10 per cent. reduction on March 26. The improvement in the business outlook warrants the higher salaries.

On December 18 the directors of the National Bank of Cuba declared the regular semi-annual dividend of 4%, payable to stock of record December 31.

Mr. Sherwood F. Yawger, who has been in charge of the Matanzas branch of the National Bank of Cuba from its establishment in that city, has been transferred to Havana.

FOREIGN CONSULS ACCREDITED IN CUBA.



Señor Alfredo Labarrere, Consul of Greece at Habana.

The Consul of Greece at Havana, Señor Labarrere, was born in France, and came to Cuba in his boyhood with his family. He has passed the greater part of his life in Habana, and said in an interview that, like all people whose existence is happy and peaceful, he has no special history. Señor Labarrere has a wife, and their family of good looking lads is the pride of their fond parents' hearts.

Alfredo Labarrere was appointed Consul of Greece in Havana eleven years ago, during the Spanish regime. For his services to the government of Denmark during the late Spanish-American war he was condecorated with the Cross of "Daneberg" by the King of that country.

Congregationalists Will Give up Cuba.

The Congregational Home Missionary Society which assists weak churches among the ordinary American population, has of late years been doing a work not strictly of its own type among the Spanish people of Cuba, but feeling that the task was detracting from its proper obligations within the United States, the society recently voted to transfer the Cuban work to the American Missionary Association. The latter declined, however, to receive the transfer on



Señor Emiliano Mazon, Consul General of Guatemala at Habana.

The representative of the Guatemalan Government at Habana, Señor Emiliano Mazon, was born in Havana in 1876, and when only twenty-one years of age began his consular career as honorary Consul of Venezuela. In recognition of his services he was condecorated with the Order of Simon Bolivar.

When Dr. Arostegui resigned his office of Consul of Guatemala at Havana, Señor Mazon was appointed to fill his place, first as acting consul and two years later, in 1907, he was promoted to Consul General of Guatemala. Recently the governments of San Salvador and Nicaragua have named him their representative in Havana to transact all consular duties relative to these Central American Republics.

Señor Emiliano Mazon was graduated with high honors at the Habana University. For the past four years he has been an editor of the well-known journal "La Discusion," and a frequent contributor to the press.

the ground that its own finances are in too precarious a condition to endure an added drain. There being "no takers," it appears the Cuban work will necessarily be abandoned.—Tacoma (Wash.) Ledger.

Rev. Ernest L. Lloyd has assumed the duties as pastor of the American Methodist Episcopal congregation in Havana, having been recently appointed by Bishop Candler.

ISLE OF PINES MATTERS.

Road and Bridge Construction Work — Weather Report — Crate Factory Promised.

Postmaster Samuel E. Gray, of Terre Haute, Ind., returned recently from a three-weeks' visit to the Isle of Pines, off the southern coast of Cuba, where he, in company with several capitalists from St. Louis and Washington, leased 70,000 acres of timber land, which will be converted into a winter resort for wealthy Americans.—Terre Haute (Ind.) Tribune.

There has never been in the history of the island so much doing as at the present time. Land in all parts of the island is selling at prices four times as great as the same land sold for several years ago and the demand continues.—Isle of Pines Appeal.

Chas. S. Brown, of Marinette, Wisconsin, is head of the Canada Land & Fruit Company whose lands lie on the Sigüenza bay in the Canada and Los Indios tracts.

Among the enterprises of the company is a regular service by the company's launch "Canada" from Nueva Gerona to Los Indios upon the arrival of the steamer Cristobol Colon every Thursday and Sunday mornings.

New Roads and Bridges.—The Santa Fe and La Ceiba broad macadam calzada which has been in course of construction for several months past is rapidly nearing completion. This will be one of the best roads on the island. If the government continues the calzada to Los Indios, the beneficial results would be incalculable.

The 77-foot bridge over the Nuevas River is nearing completion.

The McKinley calzada, one of the best on the island, is now completed and has been provisionally accepted. This road is twelve kilometers in length and cost \$72,000. It is the second calzada on the Isle of Pines to be accepted under the appropriation of last year.

A December week's weather report at Nueva Gerona:

| | Max. | Min. | Rain. |
|----------------|------|------|-------|
| Saturday . . . | 79 | 72 | 0.0 |
| Sunday | 80 | 78 | 0.0 |
| Monday | 79 | 74 | 0.0 |
| Tuesday . . . | 74 | 72 | 0.0 |
| Wednesday . . | 80 | 70 | 0.0 |
| Thursday . . . | 76 | 70 | 0.0 |
| Friday | 75 | 75 | 0.0 |

A crate factory is needed and it is understood that a company is being organized at Santa Fe to take over the sawmill there and add a crate and a wagon factory to its other activities.

Americans Own 90 Per Cent.

The struggle of American citizens of the Isle of Pines to be free from the yoke of Cuba will be watched with renewed interest, now that the United States troops are soon to be withdrawn from the new republic, says the Scranton (Pa.) Tribune. The men who are now asking a square deal from the government of the United States own 90 per cent. of the property on the island. Under

the American flag they can prosper, but if left to the tender mercies of a Cuban administration there is every reason for apprehension on their part.

The Cuban newspapers are confident that the United States will do nothing for the residents of the Isle of Pines, and cite Hawaii as an instance to show that the Washington authorities would not annex the territory of the Pacific unless forced to do so by a war on the islands. But this very argument should work in favor of the annexation of the Isle of Pines. If the United States Government saw fit to annex Hawaii, there is no reason why there should be hesitation about annexing a territory to which Cuba never had legal claim and which is practically



Colonists' homes in the Isle of Pines. Mr. Symes' residence at Los Indios.

owned by American citizens.—Scranton (Pa.) Tribune.

The island has two weeklies. The Isle of Pines Appeal is published at Santa Fe, and is now in its fifth volume; the Isle of Pines News is published at Nueva Gerona. Both these papers are well printed, with good ink and excellent paper, and both are interesting. — Jacksonville (Fla.) Times-Union.

Peanut Oil Yields.—Reliable authorities state that the average yield of peanuts in oil, according to quality and origin, is from 38 to 50 per cent. of their weight. The first pressure gives from 16 to 18 per cent. of high-grade edible oil; the second, from 7 to 8 per cent. of second grade, after which from 7 to 10 per cent. of industrial oil is also obtained. The remaining cake is often also treated by the sulphur of carbon or tetrachlorure of carbon process, which extracts a further 7 to 10 per cent. of low-grade industrial oil.

Edible peanut oil is very highly esteemed, bringing at present \$13.51 to \$15.44 per 100 kilos, as compared with \$13.70 for choice winter edible cotton oil. The soap-making varieties are quoted at \$12.16 to \$12.26. Ruffisque peanut oil cake sells at \$3.13 per 100 kilos; Coromandel peanut cake at \$3.33. —U. S. Gov. Report.

THE TREES OF EASTERN CUBA.

Much Valuable Lumber. Prevalence of Hardwoods. Neglected Plantations. Cuba Adapted to Many Northern Forms of Arborea.

BY B. S. BOWDISH.

Special Inspector of Wild Birds imported by dealers for the U. S. Dept. of Agriculture, Chief Clerk of the National Association of the Audubon Society.

Cuba, while it has lost by axe and fire much of its primeval abundance of timber, still retains much scattered lumber of very considerable marketable value, and more or less value commercially.

Among the important trees are log-wood (*Haematoxylon campechianum*), valuable for its use in the manufacture of dyes; West Indian cedar (*Cedrela odorata*), used largely in the manufacture of cigar boxes, and mahogany (*Swietenia mahogani*). That this valuable wood was once abundant in Cuba is shown by the inferior uses to which it was put in the older structures, and it is still found to some extent; lignum vitae (*Guaicum officinale*), used in the manufacture of pulleys, blocks and other objects where extreme hardness and toughness is required, is fairly abundant and is exported to a considerable extent. Some of the trees which shade the streets of Cuban cities are Spanish laurel, West Indian almond (*Ficus indica*), beefwood (*Casuarina equisetifolia*), resembling a conifer at a distance, but possessing hard, heavy wood and introduced from Australia and the East Indies, and sandbox trees (*Hura crepitans*), deriving its name from the fact that in early times the seed pods were used as receptacles for sand for blotting purposes.

The grand ceiba or silk cotton trees (*Ceiba pentandra*) are scattered all over the island, but are not much more abundant than the valuable hard woods. The wood is soft and light. This tree is common to most tropical countries and is remarkable for its peculiar growth, great buttresses at the base with elliptic shaft and sparse branching.

Among fruit trees in Cuba are the orange, lemon, lime, mango, banana, grape fruit, bread fruit, guava and coffee. The first five are well known as to their commercial value. The fruit of the mango is perhaps more highly prized by the natives, but the taste for it, once acquired by the American, is apt to prove strong.

The Cuban pine (*Pinus heterophylla*), found also on the Gulf coast of the United States and in Central America, gives the name to the Island of Pines as well as to Pinar del Rio.

A feature which indicates the really tropical nature of the forests of the

Siena Maesha region in the eastern part of Cuba, in Santiago Province, is the prevalence of hard woods. Conifers are not well represented, though a pine occurs which has been provisionally referred to as *Pinus occidentalis*. A peculiar feature regarding this tree is that while elsewhere it is a "white" pine, with four or five needles growing from a sheath, it is here found producing two and three needles after the manner of the "yellow" pine.

One of the large growing trees is the "almacigo" or gumbo-limbo (*Bursera simarubra*), notable for the papery and



Cuban Coffee in Blossom.

flaky qualities of the red bark. Another attaining a still larger growth is the "jobo" or West Indian plum (*Spondias lutea*). A tree of the basswood family, the "Majagua de Cuba" (*Carpodiptera cubensis*), is conspicuous because of bunches of small rose-colored flowers which it bears.

Some of the hard woods occurring here are granadillo, ebony, sabicu, majagua and mastic. About the shores the black mangrove (*Avicennia nitida*), the white mangrove (*Laguncularia race-*

mosa) and the common mangrove (Rhizophora mangle).

Some thirty or more years ago Cuban insurgents established strongholds in this range and cultivated plantations. Traces of this civilization are to be found in the wild coffee trees which have straggled away from the former cafetieras, guavas, the delicious little fruit from which the celebrated guava jelly is made; cacao, avocado pears, bread fruit, cocoa, palms, bananas and some other fruits which mark the sites. Toward the top of the range a change occurs in the general character of the trees, and large specimens of the mulato, alleyota, barril and retayma, with trunks attaining a diameter of three to four feet, and a number of smaller species not found in the lower altitudes, make their appearance. The height of the trees seldom exceeds 125 feet, but the diameter in some cases is as much as six feet. Such palms as the spiny

juta and the manacá, with tree ferns preserve the tropical character of the growth at the top of the range, where the underbrush and growth of vines form an even more dense jungle than elsewhere.

Cuba seems adapted to the growth of many northern forms of arborea, as well as vegetables, and the conditions there, favoring rapid development, encourage the belief that there might well be founded a forest nursery, supplying in no small part, the requirements of a tree-improved world.

Immense tracts of native pine exist on the lines of the Western Railway in the Province of Pinar del Rio, which, though containing too high a percentage of resin to last long when used for building purposes, is especially valuable for the manufacture of charcoal, with turpentine as a by-product. In the same section were recorded some hard woods not yet acquired by foreign interests.



FRUIT TREES OF CUBA. The Sapote, bearing a fruit very much liked by Cubans, and which the visitor soon finds palatable.

FRUTAS CUBANAS. El Zapote. Es un magnífico árbol de sombra y de adorno, cuya fruta está muy apreciada por los cubanos y los extranjeros también la hallarán muy sabrosa.

SHIPPING HOUSEHOLD GOODS TO CUBA.

Packing is Important—Do not use Tags but Paint Name and Destination on Package—How Annoying Mistakes Can be Avoided.

Prospective settlers in Cuba who purpose moving household furniture, farm implements, etc., from interior cities or towns to New York and thence to Cuba are not in many instances familiar with the proper manner of shipping. Local railroad officials are not well informed on the matter and sometimes mistakes are made which cause much annoyance and what is of more consequence may even cause the goods to miss the steamer, thus extending the trouble and entailing additional worry and expense.

Yet household or other goods can be dispatched from any point to Cuba and reach destination in good season and condition, and the few hints here given will help matters materially.

Packing is important. Large farm tools can be left uncrated but furniture should be crated or boxed and all small articles (crockery, etc.), should be well packed in barrels or boxes. Do not be afraid of making your crates or other packages too strong. Your goods will be handled and rehandled many times before they get to their destination and must be well packed to prevent breakage. Transportation companies will not be responsible for broken furniture if not crated, or if not strongly crated. Neither will they assume the risk of interior breakage. Steamer charges are based on the space occupied, therefore fill every box or package well in order that you may get the benefit of the space for which you will have to pay.

Plainly mark your name, destination and port via which the goods are going on each package with paint. Tags on anything but regular baggage are not recommended, as they are liable to come off and leave the package without identification.

It is best to allow two weeks between the day you ship and the sailing day from New York, which allows time for the usual delays.

You may obtain a lower railroad freight rate by limiting the value of your goods to \$5.00 per 100 lbs. in event of loss or damage, and the chances are that they will arrive in good condition. The delivery in New York is at the freight station, as in other cities, and the goods have to be carted to the steamship pier. Do not prepay this service, as the local agent usually fails to note the advance payment on the papers, and it is almost sure to be overlooked at the

New York end. As a consequence the steamship company pays for the cartage and the passenger is confronted with a bill which naturally he refuses to pay again. Pay the charges to New York only, consign the goods in care of the steamship line, and send the receipt or bill of lading immediately to the steamship office with a letter stating by which steamer the sender will take passage. When you arrive in New York, inquiry concerning your goods should be made at once at the steamship office, and if you have followed the foregoing directions you will probably find they have already reached the dock.

Heretofore your goods have been called freight, but from now on they are classed as baggage, with very few exceptions. Thus described it is easier to get them through the Cuban custom house. As freight they would necessitate a bill of lading, consular invoice, etc., not necessary for baggage. All baggage over that allowed on your ticket is termed "excess baggage," and an additional but nominal charge is made for this.

Upon arrival in Cuba, make a declaration that the goods are your own, are not for sale, and have been used previously.

The Cuban Tariff laws provide for free entry on the following:

Used furniture of persons coming to settle in the island, provided the same has been in use for one year.

Wearing apparel, toilet objects, and articles for personal use, bed and table linen, books, portable tools and instruments, theatrical costumes, jewels, and table services, bearing evident trace of having been used, imported by travelers in their luggage in quantities proportionate to their class, profession and position.

This will cover practically everything you take with you, unless it is new.

After the customs officers pass your goods you are free to send them to your future home. As to the best method of doing this, the local agent of the steamship line can advise you.

By following these general directions and by writing for information where you do not understand, you will be able to assure yourself of a pleasant trip free of worry because of household effects left behind to follow you by another steamer.

AGRICULTURAL MATTERS.

Prices of Cuban Fruits and Vegetables—United States Importations—Cost of a Box of Oranges, Etc.—Cuban Horticultural Society Exhibit, Etc.

Cuban Products in New York.

Baracoa coconuts, Dec. 21, brought \$25.00 to \$26.00 per thousand.

Tomatoes—A few coming. When nice they sold fairly well, but most of them were green and were held for ripening. Floridas, per crate (six baskets), when nice brought \$3.75. Cubans, good, \$2.75@3.00.

Generally Cuban vegetables showed irregular quality. Some tomatoes brought \$2.50 to \$3.00 per crate.

Cuban squash sales were \$1.25 to \$2.00 per crate for the white variety.

Cuban peppers with a fair demand brought \$2.00 to \$4.50 per basket.

New York, Dec. 24th.

Latest quotations, Jan. 9:

Tomatoes—Market a shade more active for Cuban stock. Sales for fancy, \$2.50 per carrier.

Peppers—Prices \$2.00 to \$3.00 per carrier.

Okra—Sales at \$1.00 to \$2.00 per carrier.

Florida shipments brought higher prices in nearly all cases.

Pineapples—The demand was not equal to the supply and prices became weak.

The Pineapple Market.

On December 24 the market was reported a little higher, and on the large sizes practically all the offerings in the best grades were absorbed. Some lots of Cuban 24s sold at \$2 per crate, but a few sellers were willing to accept \$1.50. On the 30s, Cubans sold early in the week at from \$1.25 to \$1.75 per crate, and Florida 30s of good quality were procurable up to \$2 per crate. For the 36s there was less call, and the few lots in Cubans sold above \$1.50 and in most cases \$1 to \$1.25 per crate was quoted. Very little demand was noticed on 42s, and both Cuban and Florida stock sold at 75c. to \$1 per crate. An occasional lot brought \$1.25 per crate, but to bring this price the fruit had to be exceptionally good. The general demand can hardly be called active.

The Chicago Market.

Chicago receivers of Cuban tomatoes have been busy ripening their stock. One trouble importers complain of is that after ripening the tomatoes have to be repacked. Good stock is in demand.

The noteworthy feature of the onion market at Chicago this week was the arrival of the first important shipments of the new

crop Cuban onions. These came on a fairly active market and sold in a range of \$2.50 to \$3 per crate. The stock was of good appearance, and quality was reported as fine. It is expected that a fair shipment will continue to come forward until the free movement sets in from the principal shipping sections of the island.

United States Importations.

Lemons.—Of the 41-3 million dollars' worth of lemons imported by the United States in the fiscal year of 1908, nearly the whole supply came from Italy.

Tobacco.—Of the 32 million dollars' worth of tobacco (including in this term the manufactured as well as unmanufactured articles) brought into continental United States in 1908, 13 million dollars' worth came from Cuba in the crude state and 4 million dollars' worth in the manufactured form.

Cane Sugar.—Of the 133 million dollars' worth of cane sugar brought into continental United States in the fiscal year 1908, Cuba contributed 58 million dollars' worth.

Cuba and Brazil Leads.—Of the 600 million dollars' worth of products of tropical and sub-tropical countries, Cuba and Brazil supply a larger share than any other two countries.—Annual Report U. S. Dept. of Commerce and Labor, Dec. 31, 1908.

The Cuban Horticultural Society's Agricultural Exhibit.—More than \$600.00 worth of premiums have been offered, some in cash and others in suitable goods. Railroads will sell members half-fare tickets for themselves and families during the annual session of the society and its exhibit to be held this month, and will give free transportation for all exhibits to Havana. The Herrera steamship line and other transportation companies are expected to do likewise.

Mayor Cardenas of Havana wanted the fair to be a part of the carnival attractions, but as this is scheduled for February 5, the members of the Horticultural Society objected to a postponement of their exhibit, but offered to help to make a second show a success in February if the authorities so desired. Despite their efforts to secure larger accommodations, the offer of Harris Bros. remains the best yet considered. This firm offered a portion of their store in O'Reilly street in which to hold the exhibition.

Governor Magoon on Dec. 29th, after being approached by the Mayor, refused to grant any further appropriation for the Agricultural Exposition, which has already received \$5,000 from the State.

Cost of a Box of Oranges.—The cost of producing a box of oranges in California, as gathered from a large number of growers and packers, exclusive of interest, is \$1.05 per box. This is apportioned as follows: Cost of labor, 59c.; material used in growing and packing, 46c.; cost of transportation to eastern markets, including 10c. for ice, is 93c. a box, making the total cost of a box of oranges delivered to the eastern market for \$1.98. Fifty-eight per cent. of orange shipments are under refrigeration. The cost of producing a box of oranges in Italy is 65c.; transportation to New York, 25c.; duty, 72c., making the total cost delivered of \$1.62, or an advantage in favor of the Italian orange of 36c.—California Fruit Grower.

Alfalfa Easy to Grow.—It does not make any difference where you live, says Gleanings in Bee Culture, alfalfa can be made to grow all the way from Maine to Florida. Here are the directions boiled down, from the Ohio Farmer, written by Willis O. Wing, the great authority on the subject of alfalfa:

Please do not make a mystery of alfalfa-growing any longer. It is such a simple matter that one can write all the rules needed in small space. Here they are: Drain the water out; let the air into the soil; fill the land with lime if nature did not do it; get humus into it—stable manure or some vegetable matter to rot and promote the

life of bacteria there. Put in plenty of phosphorus. Sow good seed, with a little inoculated soil. Lime brings alfalfa. Alfalfa brings corn. Corn brings money, homes, pianos and education for farm boys.

When all the interests in Cuba become organized and a stable government is insured, growers there are going to ship strawberries and vegetables to Baltimore, Philadelphia, New York, and all the North Atlantic coast cities from three to six months in the year.—The Manufacturers' Record, Baltimore, Md.

Bermuda Potatoes and Parsley.—The first arrivals of the 1908 crop Bermuda potatoes and parsley arrived here this week; the price was around \$8 per barrel. The parsley sold out at \$1 to \$1.25 per box.—New York Report

Orange Cultivation in Cuba.

Consul R. E. Holaday, of Santiago de Cuba, reports that the orange crop of Cuba this year will be the largest in the history of the island and will reach 500,000 boxes. Until the last three years large quantities of oranges were annually imported into Cuba from Florida and California, but it is believed that in another year the industry will supply local demand. The business of orange culture in Cuba is almost entirely in the hands of Americans.—Daily U. S. Consular Trade Report, Nov. 24, 1908.



Hog Exports.

Most of the hogs exported to Cuba from the United States go to Havana, where the demand is usually active. Gulf coast shippers report that American hogs are more than holding their own in the island, and when placed in com-

petition with those of other countries they seem to command preference. The Cuban hog exporting trade is recognized as a splendid asset, and is steadily growing between the gulf ports and Cuba.—New Orleans Picayune.



Arados Mejorados para Caña de Azucar

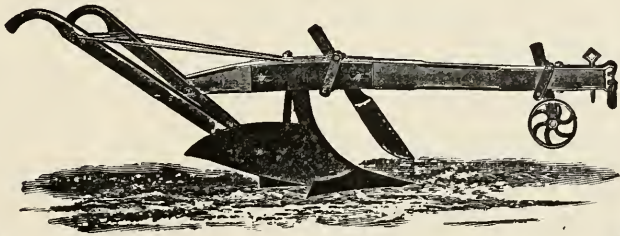

Arados Rompedores Perfeccionados
Sistema de "Hall"

TODOS CON RUEDA y CUCHILLO]



HENCH, DROMGOLD & CO.

FABRICANTES

29 Broadway,

NEW YORK, U. S. A.

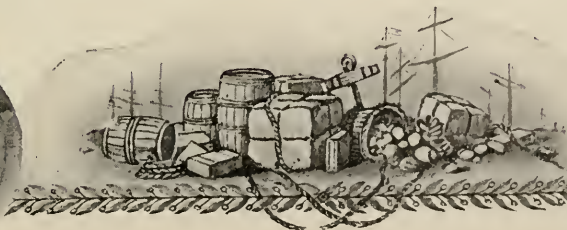

SUGAR REVIEW.

Specially written for The CUBA REVIEW by Willett & Gray, of New York.

Our last sugar review for this magazine was dated December 9th, 1908. Cuba Centrifugals were then 2 7-16c. c & f equal to 3.80c. landed for January shipment. The spot quotation was then 3.86c. per lb. for 96 test and is now 3.73c., having been 3.67c. at lowest point during the time covered.

January shipments are now 2 3/8c. c & f 96 test, having been 2 5-16c. at the lowest.

The upward turn last year came February 13th from the same low point of 2 5-16c c & f, and has started this year January 7th from same low level, which is 47c. per 100 lbs. below the parity of Hamburg.

Last season the low level was 40c. per 100 lbs. below Hamburg parity. At this writing 81 Centrals are working in Cuba, against 70 last year at corresponding time, and the crop as estimated by Messrs. Guma-Mejer is 1,397,500 tons, against crop of 961,958 tons last year.

The continued steadiness of the European markets is much in favor of present value, proving the lowest of the season.

Our refiners start the new year with smaller stock than last new year and must of necessity draw most of their supplies for months to come from Cuba.

It is always somewhat of a mystery why, with the U. S. market entirely at their disposal, the Cuban planters should continue to sell so far below the European parity of values and still have the courage to ask the United States for further concessions of duties in their favor. Sooner or later some better method of selling the Cuba crop should give the planters the full benefit of present reciprocity. They are not very likely to have any larger concessions under the new Tariff than the present 20 per cent. gives. No change in the reciprocity treaty is likely to be made, so long as Cuba voluntarily abandons the benefit. The entire 34c. per 100 lbs. is lost and an 1/8c. more without having any competition for the United States market within 1/2c. per lb. of Cuba present selling basis.

These are facts no doubt considered by the Ways and Means Committee in dealing with Cuba sugar duties.

The consumption of the United States should show large increase over last year, easily absorbing all surplus crop of Cuba at full prices if asked. This is plain, in view of the large quantity of full duty sugars still required to meet the wants of this country.

Herewith we give our annual statement of the sugar trade of the U. S. for the calendar year 1908, a study of which will confirm our persistent views that Cuba ought to get more money for her crop this year, even without any improvement in values in the European markets.

The figures show the consumption of sugar 3,185,789 tons, an increase of 191,810 tons from 1907, or 6.406 per cent. increase, against an increase of 129,966 tons or 4.538 per cent. increase for the preceding year, against 4.551 per cent. average yearly increase for 27 years.

The total consumption of sugar upon which full duty was paid was 684,625 tons, and of sugar on which a concession of duty was allowed was 1,600,166 tons. Consumption of domestic production 900,998 tons.

Cuba contributed 916,742 tons; Hawaiian Islands, 453,250 tons; Porto Rico, 185,085 tons; Philippine Islands, 45,089 tons; domestic cane, 390,888 tons; domestic beet, 493,200 tons; maple sugar, 11,000 tons; and molasses sugar, 5,910 tons.

The total consumption of refined sugar in 1908 was 3,022,153 tons, of which the American Sugar Refining Company manufactured 1,364,286 tons, or 45.14 per cent., against 49.27 per cent. in 1907, and 51.03 in 1906.

The independent refiners manufactured 1,147,712 tons, or 37.98 per cent., against 37.44 per cent. in 1907, and 37.38 per cent. in 1906.

Domestic beet sugar factories contributed 492,969 tons, or 16.31 per cent., against 13.19 in 1907, and 10.87 in 1906.

The Hawaiian cane factories contributed 15,442 tons, or .51 per cent., against .06 per cent. in 1907, and .61 per cent. in 1906.

Foreign refined supplied 1,744 tons, or .06 per cent., against .04 per cent. in 1907, and .11 per cent. in 1906.

The average difference between raw and refined in 1908 was .884c. per pound, against .893c. per pound in 1907, and .829c. per pound in 1906.

New York, January 8, 1909.

CABLE ADDRESS: Turnure.

NEW YORK,
64-66 Wall Street.

LAWRENCE TURNURE & CO.

BANKERS

Deposits and Accounts Current. Deposits of Securities, we taking charge of Collection and Remittance of Dividends and Interest. Purchase and Sale of Public and Industrial Securities. Purchase and Sale of Letters of Exchange. Collection of Drafts, Coupons, etc., for account of others. Drafts, Payments by Cable and Letters of Credit on Havana and other cities of Cuba; also on England, France, Spain, Mexico, Puerto Rico, Santo Domingo, Central and South America.

CORRESPONDENTS:

HAVANA—N. Gelats y Ca.
MEXICO—Banco Central Mexicano.

LONDON—The London Joint Stock Bank, Ltd.
PARIS—Heine et Cie.

FRANKLIN H. KALBFLEISCH CO.

Manufacturing Chemists

Aqua Ammonia
Acetic Acid
Sulphuric Acid
Muriatic Acid
Nitric Acid
Phosphoric Acid

Agua Amoniaco
Acido Acético
Acido Sulfúrico
Acido Muriático
Acido Nítrico
Acido Fosfórico

y Productos Químicos Pesados para todos propósitos.

Se mandan Listas de Precios á petición.

**BROADWAY AND SIXTEENTH STREET, NEW YORK
WORKS**

Brooklyn, N. Y.; Waterbury, Conn.; Erie, Pa.; Elizabeth, N. J.

LINK-BELT COMPANY

299 Broadway, New York City



Elevator for barrels, casks, etc.
Capacity, 600 per hour.

**ELEVATORS
and
CONVEYORS**

for barrel, bag, pack-
age, box—at depot,
wharf, factory, store
or warehouse.

Write for details.

REVISTA AZUCARERA.

Escrito expresamente para la CUBA REVIEW por Willett & Gray, de Nueva York.

Nuestra última revista azucarera para esta publicación tenía fecha 9 de Diciembre de 1908. Entonces se cotizaban los centrífugas cubanos á 2 7-16 cents., costo y flete, equivalente á 3.80 cents. puestos en el muelle para su embarque en Enero. La cotización para entrega inmediata era en dicha fecha 3.86 cents. la libra, polarización 96° y es ahora 3.73 cents., habiendo sido el precio más bajo durante dicho período el de 3.67 cents.

Los azúcares para embarque durante Enero se cotizan ahora á 2 3/8 cents. costo y flete, polarización 96°, habiendo bajado hasta 2 15-16 cents.

El alza en los precios comenzó el año anterior el 13 de Febrero, en cuyo día el precio era el mismo de 2 5-16 cents. costo y flete, y este año se ha iniciado el alza el día 7 de Enero partiendo desde ese mismo bajo precio que es 47 cents. en las 100 libras menos que el equivalente en Hamburgo. En la última zafra el precio más bajo fué 40 cents. en la 100 libras menos que el equivalente en Hamburgo.

Al presente hay 81 centrales moliendo en Cuba contra 70 que había en la misma época el año pasado, y los Sres. Gumá-Mejer calculan que la zafra será de 1,397,500 toneladas contra 961,958 toneladas en la zafra del año último.

La continuada firmeza de los mercados europeos hace esperar que los precios actuales sean los más bajos de la zafra.

Los refinadores americanos comenzaron el nuevo año con menores existencias en almacén que las que tenían al principiar el año 1908, y habrán necesariamente de abastecerse durante muchos meses de los azúcares de Cuba.

Parece siempre un tanto misterioso el que contando completamente con el mercado de los Estados Unidos, los hacendados cubanos continúen vendiendo á precios tan por debajo de la equivalencia con los precios europeos, y aun tiene el valor de pedir á los Estados Unidos que les conceda mayores rebajas en los derechos de aduana. No pasará mucho tiempo antes de que se adopte algún método mejor para la venta de los azúcares cubanos que proporcione á los hacendados la manera de disfrutar de todas las ventajas que les ofrece el actual tratado de reciprocidad. No es probable que los hacendados cubanos obtengan concesiones en el nuevo arancel mayores de lo que para ellos representa el 20% que se les concede en el present arancel. No existen indicios de que se hagan alteraciones en el tratado de reciprocidad mientras los cubanos abandonen voluntariamente las ventajas que el mismo les reporta en la actualidad. Los 34 cents. en las 100 libras se pierden completamente y 1/8 de centavo más y esto sin que á la cotización presente tengan los cubanos ninguna competencia en el mercado de los Estados Unidos en un margen de 1/2 centavo en libra.

Hechos son esos que sin duda habrá tenido en consideración la Comisión de Medios y Arbitrios al ocuparse de los derechos que pagan los azúcares cubanos.

El consumo en los Estados Unidos deberá acusar un gran aumento en comparación con el año pasado, por lo que pudiera consumirse todo el azúcar cubano sobrante de la zafra anterior, pagándose al precio de plaza si se pide. Esto es evidente en vista de la gran cantidad de azúcares que pagan derechos completos que aun se necesitan para satisfacer las demandas de este país.



Liborio—"Hemos hecho zafra de votos en la campaña electoral. Ahora: á romper la molienda!"
 Laborer—"We have secured a great harvest of votes. Now for a great sugar harvest."

Present Equipment of the Cuba Co. Railroad.

The Cuba Company in the construction of its railway system, opened to settlement and productive cultivation an area of twelve to fifteen million acres, or nearly one-half of the entire island, which had previously been of little or no value.

There are now 440½ miles in operation, not including sidings and spurs, of which 356 miles constitutes the main line from Santa Clara to Santiago. There are seven branches, varying in length from four to thirty-one miles. The company, at the end of their fiscal year, June 30, 1908, had 47 locomotives, 56 passenger train cars, 1,201 freight cars,

15 conductors' cars, 26 auxiliary cars, and three steam shovels. In addition to these are four steam tugs and seven lighters. The gross earnings in 1904 were \$524,041.60, and the operating expenses \$566,199.24, showing a deficit of \$42,077.64, or a little over 8 per cent. In 1905, the earnings were \$1,029,256.53 and the operating expenses \$733,635.16, leaving the net earnings \$295,623.37. There has been an annual increase in the gross earnings, and for the year ending June 30, 1908, they were \$2,039,467.95, and the operating expenses were \$1,318,180.36, or 64.63 per cent. of the gross earnings, leaving the net earnings \$721,287.59, and, after deducting \$365,863.34 for interest on the funded debt and loans, a net income of \$355,424.25.

FARQUHAR ARADOS

Así como también las diferentes clases de Implementos Agrícolas y Maquinaria, son artículos tan extensa y favorablemente conocidos en toda la Isla, que es innecesario referirse á la buena clase de materiales y mano de obra empleada, por ser un hecho bien conocido, la buena calidad de los primeros y el gran cuidado con que se procede á la construcción.

Los productos de FARQUHAR ciertamente que figuran en primera linea.

A. B. FARQUHAR & CO.

Cotton Exchange Building, New York City, Manufactureres

Para pormenores dirigirse a nuestros agentes:

Pídanse catálogos. Correspondencia en todos los idiomas modernos.

AMERICAN TRADING CO., CUBA No. 76, HABANA, CUBA

CARROS PARA CAÑA

De todas
clases
Fabricados
de madera
ó ábero

Dirección
Telegráfica
RAMALIAM

RAMAPO
IRON WORKS
170 Broadway
New York, N. Y.

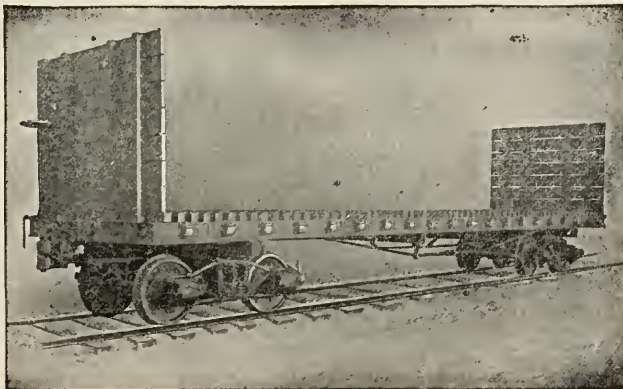

CANE CARS

OF EVERY
DESCRIPTION
OF STEEL
OR WOOD

Cable Address
RAMALIAM

RAMAPO
IRON WORKS

170 Broadway
New York, N. Y.

TWO IMPORTANT MAPS

Blue-prints of Cuba, showing the location of the Sugar Plantations and the Rural Guard Stations of the island. Specially prepared for The CUBA REVIEW. Each 60 cents. Either map with a year's subscription, 75 cents. Both blue-prints and magazine, one year, \$1.

The Rural Guard of Cuba

The Sugar Plantations of Cuba

SUGAR MISCELLANY.

Sugar Consumption in the United States.

Sugar statistics of the Department of Commerce and Labor show a total consumption in the United States of from 6,000,000,000 to 7,000,000,000 pounds a year, the total for the latest year, 1907, being 7,089,667,975 pounds. Calculating this enormous total at the average retail price of $5\frac{1}{4}$ cents per pound, we get a total of \$372,000,000 as its cost to the consumer, or more than \$1,000,000 for each of the 365 days of the year. Dividing this total of 7,089,667,975 pounds by the 1907 figures of population, we get an average consumption for 1907 of $82\frac{3}{5}$ pounds per capita, which is more than one-half of the average per capita weight of the people of the country, including men, women and children in this calculation.

3,236,000,000 pounds came from Cuba, against 2,820,000,000 pounds in the former high record year 1904.

Need not Fear Philippine Sugar.

Cuban sugar interests are somewhat alarmed by the proposal to allow 300,000 tons of Philippine sugar to enter the United States annually free of duty, and are actively organizing a campaign to get concessions from the American Congress. They want a renewal of the reciprocity treaty and also a reduction in the duty on Cuban sugar of fifty cents per hundredweight.

The tobacco interests are also interested in the proposal that a certain quantity of Philippine tobacco shall be admitted duty free into the United States, and they will work with the sugar interests in an attempt to get tariff concessions.

If Cuba could grow just a little optimistic, her sugar and tobacco handlers would see that there is a market, and a profitable one, for her products just the same in the American markets as before the change was made, or will be made, regarding the Philippine material. The consumption of both products is very large in this country, and our exports are correspondingly great, so that Cuba, with its cheap transportation service and close contiguity to the American markets, can readily dispose of its output, even if the United States doesn't step in and help things out with a necessary reduction in the Cuban duties, to make competition more even.—Brooklyn (N. Y.) Times.

Industrial Notes.

Hammond Iron Works, Warren, Pa., U. S. A., have opened an office in Mexico City, Mexico, located at Cinco de Mayo No. 32, Room 222, Francis E. Pratt, in charge.

C. M. Warner in the Cuba. Co.

President C. M. Warner of the Warner Sugar Refining Company has been elected a director and a member of the executive committee of the Cuba Company. The fact that the latter concern, which has an authorized capital stock of \$8,000,000, is a large grower of sugar on the Island of Cuba led to reports in lower Wall Street circles, says the New York Journal of Commerce, that the Warner Sugar Refining Company have made arrangements with the Cuba Company for its supply of new sugar. This was denied by Mr. Warner.



LA DISCUSSION.

Cuba—"Anjá? Y no padré yo lograr lo que logró una China?"

Cuba—"Well! And can I not get what they give to China?"

Will Furnish Workmen.

The Secretary of Agriculture, Industry and Commerce of Cuba has issued a circular to the sugar-mill owners and planters and the colonos, requesting that they communicate to him the location of their places, the scale of wages paid by them, and the number of workmen required, and the department will, without charge, furnish the necessary workmen.

K. Saiki, of Japan, is in Cuba by direction of his government to study the cultivation of cane in Cuba, and brings letter to the Cuban officials from the U. S. government at Washington.

The year 1908 started with centrifugal sugar, 96 test, quoted at 3.85, and closed at 3.67 cents. The highest price for the year was 4.49 cents on April 29, and lowest on Feb. 20 at 3.67 cents.

CANADA LAND AND FRUIT CO.

LOS INDIOS

Owners

ISLE OF PINES

CANADA AND LOS INDIOS TRACTS

Location: Sigüanea Bay. The Deep-Water Harbor of the Island.

We have at our new and progressive town of Los Indios a sawmill, planing-mill, general store, school, hotel, church, post office and nursery, all under the supervision of Americans. A strictly American town.

We also have rowboats and gasoline launch for pleasure parties. Fishing and hunting the best.

We own the finest citrus fruit, vegetable and tobacco land on the island. We offer same for sale in acres to suit purchaser, either for cash or on installments. **Special inducements to actual settlers.**

Write for prospectus and further information to our general office,
Marinette, Wisconsin.

WILLETT & GRAY, Brokers and Agents

FOREIGN AND
DOMESTIC

SUGARS

RAW AND
REFINED

52 WALL STREET, NEW YORK

Publishers of Daily and Weekly Statistical Sugar Trade Journal—the recognized authority of the trade.
TELEGRAPHIC MARKET ADVICES FURNISHED

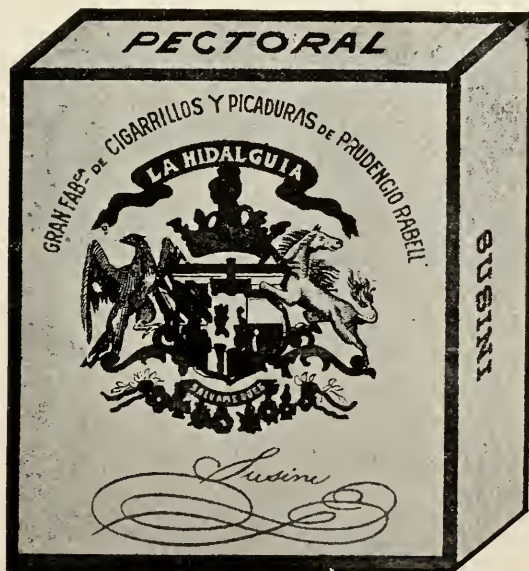

SUSINI

✻ Cork Tip Cigarettes ✻

Pectoral Paper Rice Paper
—: PRICE, 10 CENTS :—

THE BEST CIGARETTE
MANUFACTURED IN CUBA

DEPOT,
Zulueta 10 and Prado 118
HAVANA, CUBA.

MAGNOLIA

THE COMING AMERICAN CENTER

With best of soil, very favorable location, cheap water transportation right through the colony, good water, perfect title, and plans perfected by experience.

At Magnolia we offer you all the delights possible in the most favored land on earth. Here you can grow the largest crops of the finest quality, and the market is at your door.

We produce a very wide range of crops, which sell at top prices.

Write the Cuba Land and Improvement Company, No. 516-517 The Murray, Grand Rapids, Michigan, for literature and full information.

H A V A N A

CUBA

National Bank of Cuba

Government Depository

Capital, Surplus and Undivided Profits
\$6,000,000.00

HEAD OFFICE, HAVANA

FIFTEEN BRANCHES IN CUBA

New York Agency, 1 Wall Street

COLLECTIONS

THE TRUST COMPANY OF CUBA

Offices: CUBA 31, HAVANA

PAID UP CAPITAL \$500,000

Transacts a General Trust
and Banking Business

REAL ESTATE DEPARTMENT

Examines Titles, Collects Rents,
Negotiates Loans on Mortgages

Correspondence Solicited from
Intending Investors

The Royal Bank of Canada

INCORPORATED 1869

Fiscal Agent of the Government of the Republic of
Cuba for the Payment of the Army of Liberation

CAPITAL AND RESERVE, \$8,200,000.00

TOTAL ASSETS, . . . \$45,500,000.00

Head Office, MONTREAL

NEW YORK AGENCY, 68 William St.

Branches in Havana: Obrapla 33, Gallano 92;
Matanzas, Cardenas, Manzanillo, Cienfuegos,
Camaguey and Santiago de Cuba.

ESTABLISHED 1844

H. UPMANN & CO. Bankers

TRANSACTION A GENERAL BANKING BUSINESS
CORRESPONDENTS AT ALL THE PRIN-
CIPAL PLACES OF THE ISLAND

Safe Deposit Vaults

Manufacturers of the Famous H. Upmann
Brand of Cigars

FACTORY: Paseo de Tacon 159-163
OFFICE: Amargura 1-3

Established 1876

N. GELATS & COMPANY

Bankers

Transact a general banking
business.

Correspondence at all the prin-
cipal places of the island.

SAFE DEPOSIT VAULTS

Office: Aguiar 108

MOLINA BROTHERS

Customs Brokers

Forwarders, Lighterage and Ship Agents

Officinas 52, Havana

HAVANA

United Railways of Havana

Cuba's First and Foremost Railroad. (First Section opened to Traffic in 1837)

Takes you to All Parts of the Island East of Havana Comfortably and Quickly through Varied and Beautiful Scenery and Past Extensive Sugar Plantations

Parlor, Observation and Sleeping Cars attached to principal trains.

Full information and through tickets to all points in Cuba reached via the United Railways of Havana can be obtained of the following:

Thos. Cook & Son
Seaboard Air Line R. R.
Foster & Reynolds
Atlantic Coast Line R. R.
Illinois Central R. R.

Ward Line
Florida East Coast Railway
Washington Southern Railway
Peninsular & Occidental SS. Co.

Southern Pacific R. R.
Mobile & Ohio R. R.
Raymond & Whitcomb Co.
Louisville & Nashville R. R.
Munson Line

LA AMBROSIA

MANUFACTURERS of the well-known brand of Chocolate, "LA AMBROSIA," Biscuits, Macaroni, Bonbons, all kinds of Confectionery

GUAVA PASTE AND EXTRA FINE GUAVA JELLY

ORDERS RECEIVED FOR EXPORT

BALDOR, FERNANDEZ & CO.

Write for quotations.

Sol 21 & 23, Havana, CUBA

'PHONE No. 401

P. O. BOX 741

FERNANDO de CARDENAS

CUSTOM HOUSE BROKER

:: Import and Export Agent ::

Munson S. S. Line Building

Obispo No. 1, Havana, Cuba

JAMES S. CONNELL & SON

Sugar Brokers

Established 1836, at 105 Wall Street

Cable Address—"Tide, New York"

I know a great deal about Cuba

Free Information for the asking

Ask Mr. Foster

1 MADISON AVENUE, NEW YORK

ACEITES LUBRICANTES Y GRASAS

ACEITE CENTRIFUGA
ACEITE PARA CILINDROS
ACEITE PARA MAQUINARIA
ACEITE PARA MAQUINAS
ACEITE PARA DINAMOS
ACEITE PARA CARROS

MARCAS
HERCULES

GRASA CLARA PARA EJES
GRASA OSCURA PARA EJES
GRASA PARA MOLINOS DE VIENTO
SEBO
GRASA PARA ENGRANAJES
GRASA PARA COPAS

ACEITES "AUTOLENE" PARA AUTOMÓVILES

CLASES ESPECIALES PARA PAÍSES TRÓPICOS

PÍDANSE LISTAS DE PRECIOS Y MUESTRAS

F. C. ARNOLD CO., 12 Peck Slip, New York

HAVANA

THE HERRADURA LAND COMPANY

Office: No. 3 Bernaza Street, Habana, Cuba

CAPITAL, \$440,000

Own 22,000 acres of land in the Province of Pinar del Rio, suitable for Oranges, Vegetables, Cotton, Corn and Tobacco. The land has all been surveyed and sub-divided into 40-acre tracts and is offered for sale in acres to suit the purchasers, for Cash or on instalments.

We have a new and progressive American town with Railroad Station, Telegraph, Telephone, Stores, Hotel, American School, all within short distance from Havana City.

Titles perfect. Transportation from Havana free for buyers.

WRITE OR CALL FOR INFORMATION.

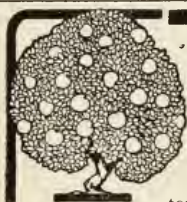

TREES IN FULL BEARING

por toda la Costa del Golfo fueron suministrados al tiempo de plantarse por los planteles Glen Saint Mary. Estos árboles crecen bien, son resistentes y vigorosos, producen buenas cosechas y se han probado iguales a sus nombres. Entre nosotros las

NECESIDADES DE LA COSTA DEL GOLFO,

tanto en árboles frutales como en árboles ornamentales, han sido un estudio de la vida. Los árboles maduros y en plena producción demuestran la calidad de nuestras existencias. No se corre riesgo con hacernos pedidos. Se manda gratis un Catálogo Nuevo y Completo.

GLEN SAINT MARY NURSERIES COMPANY, Box 41, Glen Saint Mary, Florida.

PASO ESTANCIA—Oriente Province—Cuba

The healthiest and most fertile spot on the island, in the rich valley of the Cauto River, 400 feet above sea level.

One of the prettiest spots in Cuba.

Paso Estancia is right on the main line of the Cuba Railroad, only 40 miles from its terminus at Nipe Bay, 39 miles from Santiago.

The soil is rich, dark, sandy loam; no rocks or swamps.

Two hundred acres now under cultivation demonstrate by prolific production the richness of the soil.

A comfortable hotel at **Paso Estancia** accommodates visitors.

Paso Estancia offers the best opportunities in Cuba.

Choice land on easy terms.

Visit there and confirm all we say. You will be well received.

Full particulars
from

Cuba Properties Limited

56 Bank of Ottawa Bldg.
MONTREAL

111 German Savings Bank Bldg.
NEW YORK

Paso Estancia
CUBA

Free Information about Cuba.

NO FEES, NO COMMISSIONS.

Complete, definite, valuable information.

Ask Mr. Foster, 1 Madison Avenue, New York.

HENRY E. BROWN
Pharmacist

Shipping and Export Chemist and Druggist, Ships' Medicine Chests Furnished and Replenished. Prescriptions Compounded by a Graduate in Pharmacy.

Trusses, Surgical Appliances, etc.

Office and laboratory, Room 36.

116 BROAD ST., NEW YORK

Telephone Call: 274-A Hamilton.

JOHN M. DONOVAN

13 Summit St. (Atlantic Dock) - BROOKLYN

Dealer in

Dunnage Mats

FOR BAG FLOUR, BAG AND BULK GRAIN
AND GENERAL CARGOES.

— BAGS AND BAGGING —

MOBILE, ALA.

HOME INDUSTRY IRON WORKS Engines, Boilers and Machinery

Manufacturing and Repairing of all kinds. Architectural Iron and Brass Castings. Light and Heavy Forgings. All kinds of Machinery Supplies.

Steamship Work a Specialty

A. KLING, Prop.
JAS. S. BOGUE, Supt.

MOBILE, ALA.

The Principal Hotels in Mobile, Ala.

THE CAWTHON

(FIREPROOF)

European, 175 Rooms

\$1.50 Up

THE BIENVILLE

(MODERN)

European, 150 Rooms

\$1.00 Up

Both Hotels in Heart of City, Facing Bienville Square

Cable Address: Pitchpine, Mobile, Ala.

CHICAGO LUMBER & COAL CO.

MANUFACTURERS AND SHIPPERS OF

Pitch Pine—Export and Interior

Docks at MOBILE, ALA., and PORT ARTHUR, TEXAS.

General Offices: ST. LOUIS, MO.

Office Export Department: MOBILE, ALA.

OLLINGER & BRUCE DRY DOCK CO.

Ship Builders and Repairers

Operating seven Sectional Dry Docks, capacity 1,000 tons, and one Balance Dock, capacity 3,000 tons. Equipped with Air Plant for operating Pneumatic Tools, and Steam Pump for cleaning vessel's bottoms.

25-TON DERRICK BARGE AND STEAM PILE DRIVER.

Material of all kinds kept on hand. Shipwrights, Caulkers, Painters, Sparmakers and Riggers furnished promptly, and at reasonable rates. Correspondence solicited.

MOBILE, ALA.

I can sell your land in Santa Clara, Camaguey, or Oriente Provinces, if anyone can. Have calls for town lots to 100,000 acre tracts. Titles must be perfect. Agents everywhere, more wanted.

IF YOU WANT TO BUY LAND OR PLANTATION STOCK, CALL ON ME, OR WRITE,

GEO. T. STREET,

CUBAN LAND AND INVESTMENTS

Camaguey, Cuba

BARTLE

Twenty-five thousand acres of the richest and best watered land in Cuba on the main line of the Cuba Railroad, with the finest station on the line, 120 miles from Nipe Bay—the best harbor on the Island; also the nearest to New York. No swamps or insect pests.

BARTLE is not in the wilderness—we offer all the comforts of civilization, GOOD STORES, HOTEL, CHURCH, SCHOOL, SAW-MILL, Etc.

TWO MAILS DAILY.

SUGAR, FRUITS, TOBACCO AND VEGETABLES produce wonderful crops at BARTLE.

When you consider Soil, Transportation, Social, Religious and Educational advantages, BARTLE offers something not to be had elsewhere in Cuba. Write for particulars.

"Ten Days in Cuba," just published by Hon. Nicholas J. Whalen, Speaker of the Michigan Legislature, may be had through newsagents at 25 cents per copy, or will be sent free to any address by the owners of the Bartle Colony. Address, Duncan O. Bull, Gen'l Mgr. Cuban Realty Company, Limited, Temple Building, Toronto, Can., or 141 Broadway, New York City.

DUNCAN O. BULL, General Manager

CUBAN REALTY CO., Ltd. Temple Bldg., Toronto, Canada
141 Broadway, New York **Bartle, Cuba**

PURE
DISTILLATION
OF
SUGAR CANE

BACARDI RON

Sole United States Agent

D. S. de JONGH 128 Water St.

BEST MIXER
FOR
HIGHBALLS
AND
OTHER DRINKS

"SUGAR NEWS FROM CUBA"

is the title of the interesting correspondence from the tropical island, appearing in every issue of "THE AMERICAN SUGAR INDUSTRY AND BEET SUGAR GAZETTE."

Capable correspondents, in every part of the world, write regularly, covering reliable sugar news for "THE AMERICAN SUGAR INDUSTRY AND BEET SUGAR GAZETTE."

In the United States, Cuba and Mexico, \$2 per annum. In Foreign Countries, \$2.50 per annum.

Subscribe for it if you want to keep posted. Sample copy free. Send for advertising rates.

Address: BEET SUGAR GAZETTE CO.

No. 5 Wabash Avenue,

Chicago, Ill., U.S.A.

For Free Information about Cuba

Ask Mr. Foster

1 Madison Avenue, New York.

PURDY & HENDERSON, Inc.

Engineers and Contractors

New York Chicago Boston
 Cuba Office, Empedrado 32, Havana

THE BIG FOUR ROUTE

3 Daily Trains Each Way 3

Parlor Cars, Sleepers, Dining Cars.

Through Train Service
BETWEEN

Cincinnati, Toledo and Detroit

(Via Michigan Central R. R.)

Ask for Tickets Via

BIG FOUR

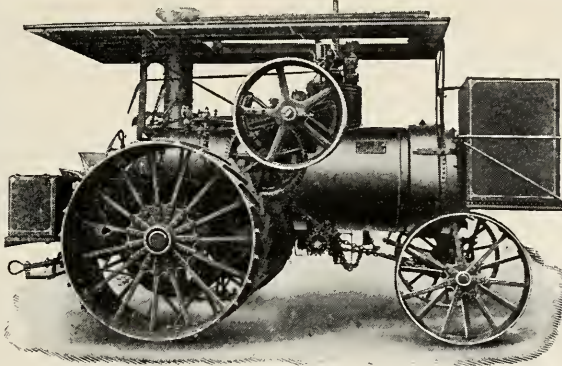

LA NUEVA Máquina de TRACCION HUBER.

Esta máquina es conocida como la mejor para Contratistas ó para Arar.

Está ideada y construida para los trabajos más difíciles sobre caminos ó sobre el campo. Arrastrando grandes pesos ó arando hay una tensión tremenda sobre la transmisión y la rueda volante. Hemos puesto especial atención en la construcción de estas partes, haciéndolas del mejor material que se puede conseguir, de tal manera que hemos conseguido la fuerza mayor posible combinada con el minimum de peso.

Nuestras máquinas alcanzarán mayor fuerza que la estimada y harán mayor cantidad de trabajo y mucho mejor que lo que puede hacerse por medio de caballos, no se diga de buyes.

Tendremos muchísimo gusto en tratar de estas máquinas detalladamente con las personas interesadas en el mejor modo de tracción tanto en carretas, caminos reales, como campo de arado.

Esta máquinas sirven también, mediante un aparato especial, para tirar maderas del monte ó arados por medio de cable de alambre.

Enviaremos catálogos á quienes nos los pidan en español ó inglés.

Para otros informes, sirvanse dirigirse á

THE HUBER MANUFACTURING CO.,
STATION J, MARION, OHIO, U. S. A.

ó á nuestro agente para Cuba, Sr. P. D. de Pool, Obispo 7, P. O. B. 1069. Habana.

CAMAGUEY

M. J. CABANA
COMMISSION MERCHANT.

Solelts Correspondence from all the important cities
of the United States of America.

P. O. Box 3, Camaguey.

Some of the newspapers consider the election in Cuba and the proposed withdrawal of the American troops a mere farce, a kind of polite way for this government to notify the world that it has done all it can before taking the island of Cuba permanently.—Davenport (Ind.) Times.

Ask Mr. Foster

anything about Cuba. No charge, no fees, no commissions. Reliable unbiased information.

1 Madison Avenue, New York.

An Enthusiastic Exponent of Cuba.

Nos ha visitado el número correspondiente á Octubre de la notable publicación ilustrada "The Cuba Review" que tan efectiva propaganda realiza en favor de nuestro país y que se reparte profusamente en toda la Unión.

El Comercio, la Agricultura y la In-

dustria cubana, tiene en esa revista un entusiasta exponente.

Entre los numerosos y magníficos grabados de este número, figura el retrato del doctor Julio de Cárdenas, Alcalde de la Habana. También trae "The Cuba Review," una revista política muy atinada.—La Discusion Havana.

Kind Words for The Cuba Review.

"All About Cuba," expresses the aim of the editors of The Cuba Review, and the table of contents is made up exclusively of articles concerning that country and its interests. The magazine is profusely illustrated, making a publication both interesting and attractive.—California Fruit Grower, San Francisco, Cal., Aug. 29, 1908.

All Kinds of Information.

"Whoever would like to be up-to-date regard-

ing the development and progress on the Island of Cuba, so dear to true Americans, will find an opportunity by reading the monthly magazine, The CUBA REVIEW, published by the Munson Steamship Line, No. 82-92 Beaver Street. The same is enriched with many illustrations, and a synopsis is given of political and government affairs, also railroads and finance. The reader will find the latest statistical statements, and in addition all kinds of information worth knowing."—New York Staats-Zeitung.

BUSINESS FIRMS OF CAIBARIEN

ANGEL MATA
Comerciante.
Caibarién, Cuba.

Apartado 114. Cable: Mata."

Ferretería, Mueblería y Locería
LA LLAVE
DE INCHANSTI Y HNO.
Caibarién, Cuba.

Marti 11 y 13. Apartado 24.

R. CANTERA Y CA.
(S. en C.)

Comerciantes Importadores,
Escobar 28. Caibarién.

A. ROMANACH
Almacenistas Importadores de Viveres,
(S. en C.)
Caibarién.

P. B. ANDERSON,
Ship Broker. U. S. Consular Agent,
Caibarién, Cuba.
Agent for Munson Steamship Line and Lloyds.

MARTINEZ & CO., S. en C.
Comerciantes Banqueros,
Importadores de Viveres,
Exportadores de Azucar.

Apartado 115. Telegrafo: Urquiza.
COMERCIO,
Hotel - Restaurant - Cafe
De José Urquiza.
Calle de Marti nums 16 y 18 - Caibarién

LA MARIPOSA DE EVARISTO BERGNES
Importador de Peletería y Talabartería, Fabricante
de Calzado.
Caibarién.

Apartado 104. Telegrafo: "Bergnes."

YMAZ Y CA.
Ymportadores de Ferrería en General.
Apartado de Correos Num. 15,
Caibarién, Cuba. Cable: "Imaz."

ARIAS Y COMP
Provisiones, Loza y Muebles.
Cuba Num. 20, Esquina a Marti,
Caibarién, Cuba.
Correo Apartado Num. 15. Telegrafo: "Arias."

ZARRAGA Y CA.,
Caibarién, Cuba.
Casa Banca. Exportadores de Azucar.

BONIFACIO DIAZ,
Gran Peletería y Sombrerería.
Marti 17. Caibarién
Constantes novedades en los dos giros de esta casa.

RODRIQUEZ Y VINA, S. en C.,
Almacenistas Importadores de Viveres en General,
Comisiones y Consignaciones,
Consignatarios de Buques.
"Depositos de Carbuero."

Telephone, 33 Hamilton
Night Call, 411 Hamilton

Cable Address:
"Abiworks," New York

Atlantic Basin Iron Works

Engineers and Boiler Makers

Machinists, Plumbers, Tinsmiths, Pipe Fitters, Blacksmiths, Coppersmiths,
Pattern Makers, Sheet Iron Workers, Iron and Brass Castings. Steamship
Repairs a Specialty.

Cor. Imlay and Summit Streets

Brooklyn, N. Y.

John Munro & Son

Steamship and
Engineers' Supplies

13 Conover Street, Brooklyn, N.Y.

Cable Address: Kunomale, New York

Telephone, 196 Hamilton

Telephone
215 Hamilton

Box 186
Maritime Exchange

YULE & MUNRO

SHIPWRIGHTS

Caulkers, Spar Makers

Boat Builders, Etc.

No. 9 SUMMIT STREET
Near Atlantic Dock BROOKLYN

WINTER HAVEN NURSERIES

A. M. KLEMM, Proprietor

Established 1884.

Winter Haven, Fla.

Wholesale Growers of Citrus Stock of the best commercial varieties. We guarantee our extensive Stock to be well grown, free of insects and true to name.

Sil er Cluster Grape Fruit our leading Specialty.

Prices right. Grading and Packing perfect.

Write for Catalogue.

The Standard Guide to Cuba—

Reliable—accurate—maps—illustrations.

50 cents.

FOSTER & REYNOLDS, 1 Madison Avenue, New York.

BUSINESS FIRMS OF SANTIAGO

E. GIRAUDY & CA.

ALMACEN DE VIVERES

Marina baja n. 33, Santiago de Cuba.

Agentes de Schlitz Beer.

JULIAN CENDOYA

Steamship Agent and Broker

COMMISSION MERCHANT

CABLE: Cendoya. Santiago de Cuba.

VALLS, RIBERA & CA.

(S. en C.)

Importadores de Ferreteria y Machinery.

Telégrafo: Valribe.

Santiago de Cuba y Manzanillo.

A. B. C. Code, 5th Edition. Telephone, 190.
P. O. Box, 95. Cable address: SILVAPA.

SILVA Y PARRENO H.

General Commission Merchants.

Custom House Brokers—Forwarding Agents.

Consignees of the Cuban steamers of the Carlos J. Trujillo, S. en C., Line, formerly Menéndez & Co. References:—J. Cendoya and Nat'l Bank of Cuba.

CAMP HERMANOS, Santiago de Cuba.

Ron Selecto "Golondrina" y "Carta Cuba."

Medalla de Oro, St. Louis, 1904.

RON BACARDI

DE BACARDI & CO., Distillers, Proprietors.

43 San Ignacio, cor. Santa Clara, Havana, Santiago de Cuba.

LARREA Y BESEALIE

Importers of General Groceries and Exporters of Cocoa, Wax, Honey and Woods.

Apartado 65, Marina Baja 46. Cable: Larrea.

Importación.

Exportación.

L. ABASCAL Y SOBRINOS

Agentes de las lineas Pinillos Izquierdo y Ca., de Cadiz. Larrinacio, cor. Santa Clara, de Liverpool. Compañia de Seguros, Aachen & Munich, Aix-la-Chapelle.

BROOKS & CO.

Bankers and General Commission Merchants. Santiago and Guantanamo.

How to Play Jai Alai.

Representative Tawney, chairman of Appropriations Committee of the United States House of Representatives, came back from a trip to Cuba a short time ago, and was telling Representative Landis, of Indiana, about what he had seen, says a Baton Rouge, La., paper.

"I went around to see a game of jai alai," said Tawney. "It is a most exciting and interesting game."

"How do they play it?" asked Landis.

"Why," said Tawney, "they have long, narrow baskets that are strapped to their arms and they catch the ball in those baskets and hurl it against the wall. It requires much skill to catch the ball in the basket."

"Well," said Landis, "if we played that

game out in Indiana, we would use wash-tubs and take no chances."

The Cuban's Viewpoint.

Even the Cuban, with some ideas of patriotism, looks at things from a different standpoint than an American. All his life he was subject to absolute authority, and when that was removed he found it hard to make an adjustment between that and constituted authority upheld by the will of the people. It has never yet occurred to him that to pull down constituted authority for personal reasons, provided he could do it, was treason to the state, and still further is he from knowing that a government built upon no stronger principle than personal popularity cannot stand—that union under such conditions is impossible.—Atlanta, Ga., Constitution.

VINEGAR BEND LUMBER CO.

Manufacturers and Exporters

Long Leaf Yellow Pine Lumber and Timber

Cuban Business Our Specialty VINEGAR BEND, ALA., U. S. A.

Daily Capacity, 200,000 Feet

Cable Address: "TURNER"

Codes: A B C, Fourth Edition; Southards; Watkins; Western Union



SOBRINOS DE BEA & CO.

Bankers and Commission Merchants
Importación directa de todas los centros
manufactureros del mundo.

Agents for the
Munson Steamship Line, New York and
Mobile.

James E. Ward & Co., New York.
Serra Steamship Company, Liverpool.
Vapores Transatlánticos de A. Folch & Co.
de Barcelona, España Independencia
Street 17/21.

MATANZAS. CUBA.

JOHN W. McDONALD

COAL, WOOD, LUMBER
and TIMBER of Every
Description

112 WALL STREET

Near South Street NEW YORK

Yard: 58-68 Beard Street, Erie Basin
Telephones:

Office, 1905 John Yard, 316 Hamilton

There are blessed spots on the troubled surface of the earth where hay fever is not known. One of them, we have been told, is Cuba. The only fatal thing in Cuba is man; nothing else kills you. The native prefers the word "danoso," dangerous, to "venoso," poisonous.—Columbia (S. C.) State.

"The Comfortable Way"

Between the East and the West is
via the Toledo, St. Louis and
Western Railroad

"Clover Leaf" Route

Rates lower than by any other
direct line. Send four cents in
stamps for copy of "Get Out or
Get in Line," a booklet by Mr.
Elbert Hubbard, Chief of the Roy-
crofters.

GEO. J. CHARLTON,
General Passenger Agent,
Chicago, Ill.

THE SNARE AND TRIEST COMPANY

CONTRACTING ENGINEERS

Steel and Masonry Construction
Piers, Bridges, Railroads and Buildings

We are prepared to furnish plans and estimates
on all classes of contracting work in Cuba.

N. Y. Office
143 LIBERTY ST.

Havana Office
LA LEAL BUILDING

W. H. Bennett

F. W. Hvoslef

Bennett, Hvoslef & Co.

18 Broadway, New York

Steamship Agents and Ship Brokers

Cable: "Benwalsh"



NEW YORK = CUBA SERVICE

PASSENGER and FREIGHT

Sailings subject to change without notice

| STEAMER | NEW YORK | NIPE | NUEVITAS | NIPE | BANES | GIBARA and VITA | PUERTO PADRE | NUEVITAS | NIPE | NEW YORK |
|---------------|------------|------------|------------|-----------|-----------|--------------------|-----------------|------------|------------|------------|
| | Sail | Arr. | Arr. | Arr. | Arr. | Arr. | Arr. | Sail | Sail | Arr. |
| OLINDA..... | Feb. 10 | Feb. 15 | Feb. 17 | | | Feb. 20 | Feb. 23 | Feb. 25 | Feb. 26 | Mch. 3 |
| CURITYBA..... | Feb. 24 | | Mch. 1 | Mch. 3 | Mch. 5 | Mch. 6 | | Mch. 11 | Mch. 12 | Mch. 17 |
| OLINDA..... | Mch. 10 | Mch. 15 | Mch. 17 | | | Mch. 20 | Mch. 23 | Mch. 25 | Mch. 26 | Mch. 31 |

FREIGHT ONLY

- S. S. PALOMA: Feb. 3 for Matanzas, Cardenas, Sagua and Caibarien.
- S. S. CUBANA: Feb. 17 for Caibarien, Matanzas, Cardenas and Sagua.
- S. S. PALOMA: Mch. 3 for Matanzas, Cardenas, Sagua and Caibarien.
- S. S. CUBANA: Mch. 17 for Caibarien, Matanzas, Cardenas and Sagua.
- S. S. PALOMA: Mch. 31 for Matanzas, Cardenas, Sagua and Caibarien.

MOBILE - CUBA SERVICE

FREIGHT ONLY

Regular Sailings Mobile to Havana and Mobile to Northside and Southside Cuban Ports.

BALTIMORE - COLON SERVICE

FREIGHT ONLY

Regular Sailings Baltimore to Colon

For rates, reservations or further information, address

MUNSON STEAMSHIP LINE

GENERAL OFFICES

82 BEAVER STREET, NEW YORK

AGENCIES AT ALL PORTS

Lillie Multiple Evaporators

Model of 1904-1905 (Patented)

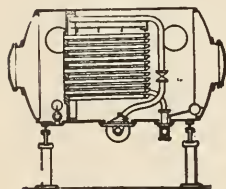

Model 1904-1905
ECONOMY its **BOAST**

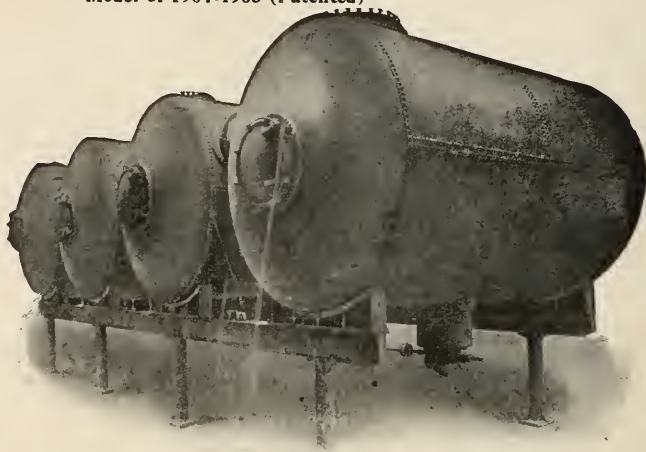

Lillie Quadruple effect for Nipe Bay Co., Cuba (Model 1904-1905. Condensers not shown.) Capacity, 600,000 gallons cane juice per 24 hours.

Apply for reading matter and information to

The Sugar Apparatus Manufacturing Co.

328 Chestnut St., Philadelphia, Pa.

S. MORRIS LILLIE, President

LEWIS C. LILLIE, Secretary and Treasurer.

BALDWIN LOCOMOTIVE WORKS

Broad and Narrow Gauge Simple Expansion and Compound

LOCOMOTIVES

Compressed Air Locomotives. Electric Locomotives with Westinghouse Motors



PLANTATION LOCOMOTIVES

For all Gauges of Track. To meet all conditions of service. Specifications furnished on application.

BURNHAM, WILLIAMS & CO.

Philadelphia, Pa., U. S. A.

Cable Address: "Baldwin, Philadelphia"

Agents for Cuba, Krajewski-Pesant Co., Aguiar 92, Havana, Cuba.

THE CVBA REVIEW



50 Cents A Year FEBRUARY 1909 5 Cents A Copy
Published by the Messager Strauch, Inc. 82,02 Broadway, New York, N. Y. U.S.A.

Ceballos "The Garden Spot of Cuba"

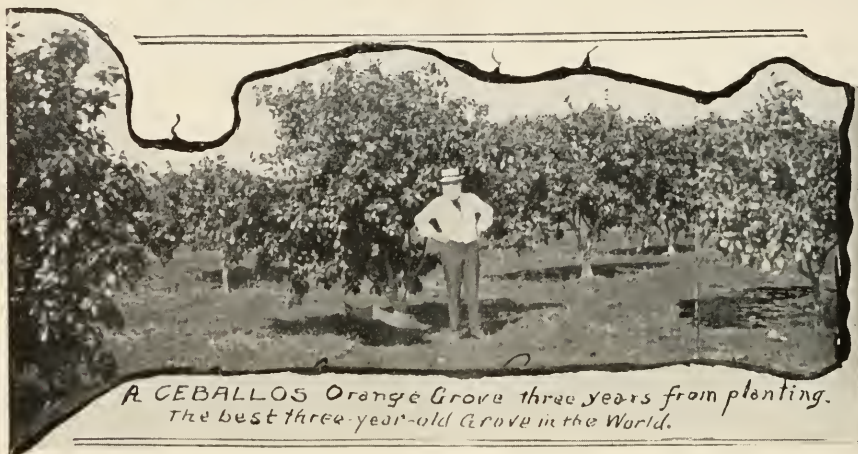

*A CEBALLOS Orange Grove three years from planting.
The best three-year-old Grove in the World.*

The TIME to invest in Cuba is now The PLACE is in the "Garden Spot," Ceballos
The OPPORTUNITY is offered by the Development Company of Cuba, owners of Ceballos

Write for information to

Geo. H. Gillett, Secretary,

43 Exchange Place, New York

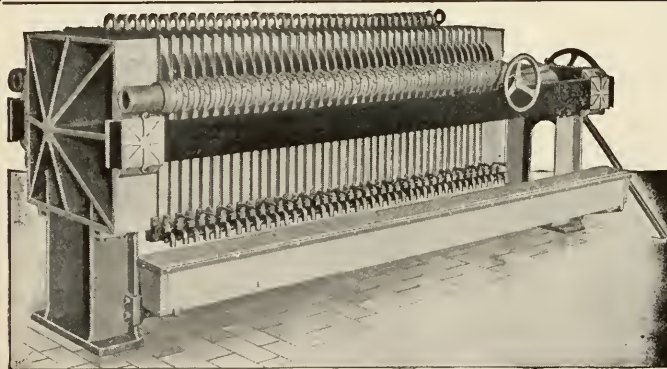

**Prensas de
Filtrar
para Ingenios
SHRIVER
Filter Presses**

Write us for Catalogue, Prices and Information.

T. SHRIVER & CO.
814 Hamilton Street
HARRISON, N. J.

Sole Agents for Porto Rico
McMurtrie-Guiler Co.
SAN JUAN, P.R. and BEAVER BLDG.,
BEAVER STREET, NEW YORK

FOR MOLASSES USE STEEL TANKS

BUILT BY

HAMMOND IRON WORKS

WARREN, PA., U. S. A.

... MATERIAL FABRICATED OR ERECTED COMPLETE ...

W. B. HAMMOND, SALES AGENT, : : : 29 BROADWAY, NEW YORK
OFFICE MEXICO CITY, CINCO DE MAYO NO. 32

Tivoli Beer

—*Enough said.*

Havana Brewery

Havana

CERVEZA

TOMA UNA COPA DE

BEER



Pilsner, Muenchner, Lager
NO HAY MEJOR

THE JOHN EICHLER BREWING CO.

Unico Agente para Exportacion

A. C. FABRICIUS

82-92 BEAVER STREET, NEW YORK



BUCKEYE NURSERIES

M. E. GILLET, Proprietor

TAMPA, FLORIDA, U. S. A.

ORANGE, LEMON AND GRAPE FRUIT TREES

LARGEST CITRUS NURSERY IN THE WORLD

QUALITY VARIETY DELIVERY

Price may be forgotten—Quality NEVER.

We grow nothing but standard Varieties which we can recommend to the trade as Money-Makers. Having had 29 years' experience we thoroughly understand packing trees for long distance shipments.

We guarantee our trees to be True to Name, Free from White Fly and to ARRIVE AT DESTINATION IN GOOD CONDITION.

Consider the future and protect your investment by planting reliable trees from

THE BUCKEYE NURSERIES

La Gloria has Arrived. All other American colonies in Cuba have yet to come.

La Gloria has Better soil, climate, water, schools, docks, cheaper transportation living, more American people, push and natural advantages.

The Oldest, Largest and Best American Colony.

First Prize for citrus fruits Havana Exposition, 1908.

The La Gloria Transportation Company's fine mail and passenger steamer connects with Munson Line steamers at Nuevitas. Sailings Tuesdays, Thursdays and Saturdays.

Boulevard Completed. The Cuban Government has completed a fine macadamized boulevard from the townsite to Port Viaro, costing \$80,000.

La Gloria is All its Name Implies.

Not a promoter's dream but an assured fact. Our West Canasi tract, just opened, is the finest orange land in Cuba. We have also a few choice town lots for sale.

Send for our new booklets showing pictures of homes and plantations, and giving terms and conditions.

Cuban Land and Steamship Company
32 Broadway, New York City



Sugar Plantation—Cuba Railroad.

The Cuba Railroad

This new line completing the railroad connection between Havana and Santiago, and Antilla, on the Bay of Nipe, is of standard gauge and similar in its construction and equipment to the better class of northern lines. All of its important bridges are of steel and masonry, and the line generally is rock-ballasted. The main line passes along the center of the eastern and wider half of Cuba, and opens up a matchless and most picturesque agricultural region, and passes through the tropical forests of mahogany, cedar, *lignum vitæ*, ebony and many other trees, hung with vines and millions of orchids. Palm trees of magnificent aspect and great variety abound everywhere. The famed Parana and Guinea grasses, covering most of the open districts and standing from six to twelve feet high and green the year round, together with frequent running streams, make this an ideal cattle country. No food has to be put up and no shelter is required. The rich soils everywhere are adapted to sugar, tobacco, cotton, corn and an endless variety of products. The swamps which occur at places along the coasts of Cuba are absent from the interior, which is high, dry and exceptionally healthy. The trade winds blow across Cuba every day, and bring to all parts fresh sea air; the extreme heat of northern summers is consequently unknown and the humidity of other tropical countries is also unknown.



A Corridor, Hotel Camaguey.

The Cuba Railroad Company's **Hotel Camaguey**, at Camaguey (formerly Puerto Principe) is by far the most popular resort in Cuba, Spanish in style, and provided with bath rooms and other modern conveniences, and is first-class in all respects.

This old city has about 40,000 inhabitants, is picturesque and is situated in a beautiful and remarkably healthy district. The hotel is especially favored by those wishing to spend some weeks or months in a matchless sub-tropical climate.

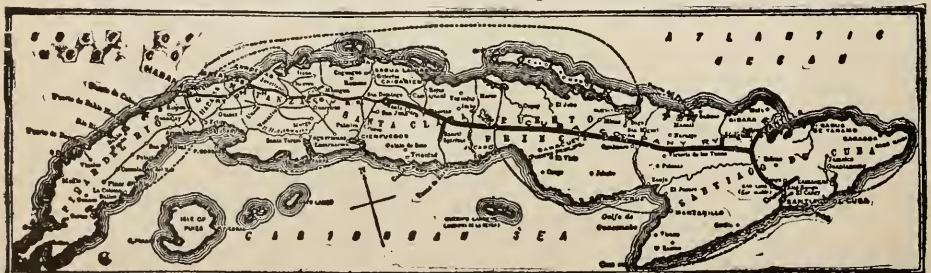

Map of The Cuba Railroad

THE CUBA REVIEW

"ALL ABOUT CUBA"

An Illustrated Monthly Magazine, 82-92 Beaver Street, New York

MUNSON STEAMSHIP LINE, Editors and Publishers

SUBSCRIPTION

50 Cents Per Year - - - - - 5 Cents Single Copy

Advertising Rates on Application

Vol VII.

FEBRUARY, 1909

No. 3

Contents of This Number

The cover page is a characteristic Cuban scene, and represents a seller of water, a service very necessary during the drouth which prevails at times on the island.

The frontispiece shows the Reception Room in the Palace at Havana where President Gomez will receive his visitors.

Cuba's inauguration ceremonies are described on pages 7 and 8.

News items regarding the division of officers and condition of the Cuban Treasury are on page 8.

On page 9 is an interesting photograph of the wife of the President and family.

Further items of Government activity, showing Sagua's improvements; Havana Art and Trade Schools on page 10.

The President's Cabinet as officially announced, and some striking photographs of new and old roads in Cuba, on page 11.

Some United States newspaper cartoons are given on pages 12 and 13. They indicate prevailing sentiment on the present and future of Cuba.

Commercial matters begin on page 14. Items regarding matches and the introduction of California wines into Cuba are on that page.

Cuba as a soap market and the Customs Collections, on page 15.

Sponge fishing at Batabano (illustrated) is on page 16.

More commercial information, giving Cuba's trade in 1907, its exports of food products to the United States and the falling off of its trade with New Orleans on page 17.

Bishop Warren A. Candler reviews conditions in Cuba, and a picture of Cuba's Statue of Liberty are on page 18.

Havana's tenements and their occupants are described and illustrated on page 19, together with information regarding Cuban mahogany and cedar arrivals at New York.

Cuban railway construction, organization and earnings are on page 20.

Some interesting comment on Cuban character is on page 21.

The portraits of the United States Consul-General and Vice-Consul-General of Cuba will be found on page 21, with short biographical sketches.

Valuable information of the cost of tobacco growing, together with statistics of exports, on page 23.

Page 24 is devoted to the Isle of Pines.

Cuban Fruits and Vegetables in New York, with arrivals, demand and prices, especially prepared for the REVIEW by The Uerner-Barry Company, will be found on page 25.

United States Consul-General Rogers' reports on Cuba's opportunities for the American colonist on page 26.

Decay in Oranges. The result of experiments by the United States Bureau of Plant Industry is condensed on page 27.

Sugar Review by Willett & Gray on page 28. A Spanish translation of same article on page 30.

The number is handsomely illustrated.

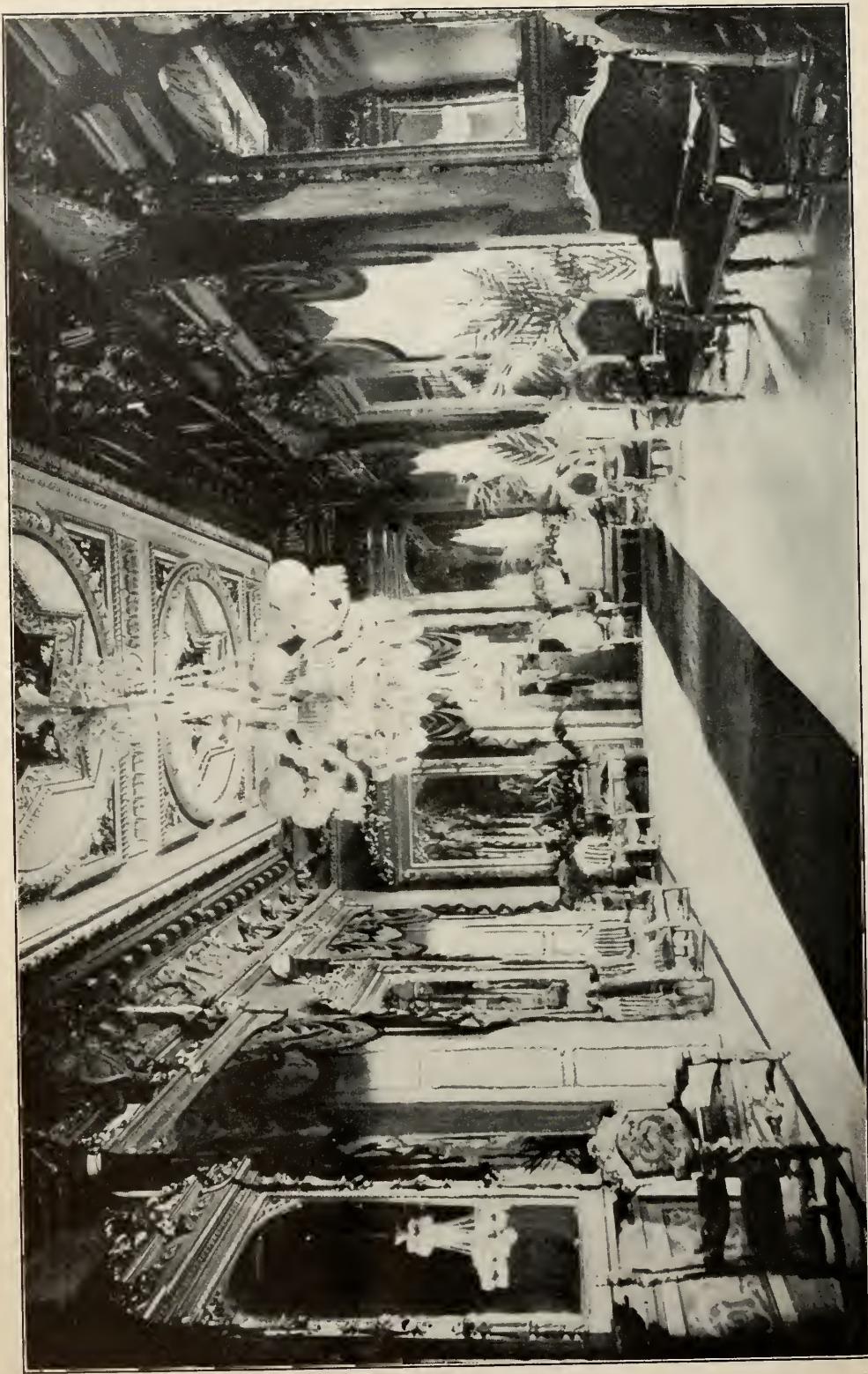

Courtesy of the New York Tribune.

THE RECEPTION ROOM IN THE PALACE AT HAVANA.
In this room the new President will hold official, social and diplomatic functions.

THE CUBA REVIEW

LIBRARY
NEW YORK
BOTANICAL
GARDEN.

"ALL ABOUT CUBA."

Copyright, 1908, by the Munson Steamship Line.

Volume VII.

FEBRUARY, 1909.

NUMBER 3.

CUBA'S NEW PRESIDENT INAUGURATED.

Simple Ceremonies—Dissatisfaction Over Appointments, and Friction Developed Between President and Vice-President—Labor Troubles Predicted.

The Cubans on January 28 came into their own for the second time at the hands of the American government.

The ceremonies of inauguration of the new President of Cuba at the palace in Havana were very brief. At noon President Gomez stepped out upon the balcony overlooking the Plaza de Armes and took the oath to enforce the laws of the republic and defend the constitution. The oath was administered by the chief justice of the Supreme Court.

Returning inside to the reception room of the palace, President Gomez received from the hands of Mr. Magoon the final decree turning over all the affairs of the island, together with an order from Washington terminating Mr. Magoon's commission as provisional governor.

Vice-President Zayas was sworn in at a special session of the Senate earlier in the day.

An important feature of the withdrawal was that part of Governor Magoon's address in which he set forth clearly the terms under which the administration was turned over:

"I am directed by the President to declare that the United States considers that the second article of the appendix of the constitution of Cuba forbids Cuba to assume or contract any public debt in excess of or in addition to the debt already contracted or authorized by now existing laws and now existing decrees of the provisional government, and that the United States will not recognize or concede to be a valid obligation of Cuba any bond or evidence of debt which may be issued in violation of this understanding. I am further directed by the President to declare that it is the final and conclusive determination and decision of the provisional government that all claims of the soldiers of the war of liberation have been fully satisfied and discharged by the execution of existing laws, and Cuba remains under no further obligation or indebtedness in respect thereof; and that the declaration hereinbefore contained in respect of the increase of the Cuban debt specifically and especially applies to any attempt to create an indebtedness for the discharge of such alleged or pretended obligation."

The new Cuban President, José Miguel Gomez, showed that he understood the terms and said:

"Once again we are masters of our fate, and there is not a Cuban heart but swears to maintain for all time the newly acquired integrity of the nation and who does not at the same time feel the profoundest gratitude toward those who, after governing them, have faithfully performed their agreement and now leave us in the full enjoyment of our sovereignty."

Within one hour after the inauguration Mr. Magoon and his staff had left Cuba for the north, the former on the battleship *Maine* and the latter on the transport *McClellan*. Three thousand troops of American army remain under command of Major-General Thomas L. Barry. These will be returned to the United States as fast as the transport service will permit.

FEB 25 1909

President Roosevelt cabled this message to Cuba's new head: "Our fondest hope is that you may enjoy the blessings of peace, prosperity, justice and orderly liberty, and that the friendship which has existed between the Republic of the United States and the Republic of Cuba may continue for all time to come."

Twenty-four hours after the inauguration Vice-President Zayas had threatened to resign because of the appointment by President Gomez of Ricardo Arnauto as Chief of the Secret Police. The appointment was later withdrawn and Zayas pacified. Arnauto was then made Chief of the Public Order Service, by many considered a much more important post. A second clash between the leaders occurred on Feb. 7, when Zayas was refused an office for one of his followers. In spite of his protests the President refused to sanction the appointment.

*Presidents
of the
House
and
Senate.*

On Jan. 18 the House of Representatives elected Orestes Ferrara president. Ferrara was secretary to the Cuban delegation at the last Hague Conference, but resigned his position because of the disclosures that he had been indicted in Italy, of which country he is a native, on anarchistic charges.

The Senate elected Martin Morua Delgado, a negro politician, as its president. He managed President-elect Gomez's campaign, and was formerly a prominent leader in the Senate. His influence is extraordinary among his own race.

The Senate is made up entirely of Liberals, and the House has fifty-one Liberals and thirty-two Conservatives.

*Dividing
the
Offices.*

All applications for office must be passed upon by a committee of the two Liberal factions. President Gomez means that allotment shall be made on the percentage basis, and hopes in this way to obtain exemptions from the solicitations of office seekers. Yet on Feb. 4 the newspapers esteemed that thousands of applicants were thronging the palace.

The following is the division decided upon: Liberals, 70 per cent., apportioned equally among the followers of Gomez and Zayas, and 30 per cent. to the Conservatives. The three parties will also each give 10 per cent. to negro members. Old government employees are being rapidly discharged.

*Cuba Pays
Spain.*

A convention was signed at Madrid Jan. 29 settling the questions of the ownership of the war materials left in Cuba by Spain upon the evacuation of the island by the Spanish. Under the agreement Spain will turn over this material to Cuba in consideration of the payment of \$300,000, payable in installments as follows: Fifty thousand dollars July 1 of the present year, \$100,000 on July 1, 1910, and the remainder on July 1, 1911.

*The
Cuban
Treasury.*

A Cuban Treasury statement issued Jan. 27 is as follows: Cash in treasury vaults, \$776,043; cash in bank, subject to check of treasurer, \$133,333; cash in bank, subject to daily call, \$795,853; cash in transit, \$124,250; cash in hands of disbursing officers in excess of their outstanding checks, \$1,051,189; total cash immediately available for purposes of new government, \$2,860,668.

In addition there is in the treasury \$1,000,000 in Cuban bonds purchased by the Palma government, and carried on the books in the treasury statement as cash.



MEN TALKED ABOUT IN CUBA.

Orestes Ferrara, who was elected President of the Cuban House of Representatives and now presides over that body.



SENORA AMERICA ARIAS GOMEZ,
Wife of the President-elect of Cuba, and their children.

SENORITA PETRONILA GOMEZ
and
SENORITA MANUELA GOMEZ,
Daughters of General Gomez.

MIGUEL MARIANO GOMEZ,
Only son of the President-elect.
NARCISA AND MARIANA,
Younger daughters of General Gomez.

—Courtesy of the New York Tribune.



Carretera Guane a Luiz Lazo. Caminos viejo y nuevo junto al Hiacos.

BRIDGE BUILDING IN CUBA.—Two 90-foot spans over the Hiacos River on the road from Guane to Luiz Lazo, showing concrete piers and new and old roads.

*Arts and
Trade
Schools.*

By a decree issued January 26 by Governor Magoon, a foundry, a school for the teaching of moulding, decorative painting and improvements in the system of teaching the English language will be inaugurated at the School of Arts and Trade of Havana, one of the most valuable educational institutions in Cuba.

Governor Magoon also granted an appropriation of \$3,000 for an industrial museum which is to be located at the school, and \$6,000 for the purchase of machinery and other necessary implements for the foundry. Hundreds of Havana children are attending this school.

*Tranship-
ment of
Merchandise.*

A decree permitting the transfer and transhipment of merchandise arriving on foreign ships to coastwise steamers was signed January 25 by Governor Magoon, and takes effect within ten days.

The present law requires that duty be paid at the port of arrival before a transhipment can be made. Under the new decree merchandise arriving in Havana destined to some port where the foreign ships do not touch can be forwarded to other ports and the duty there collected.

One hundred thousand dollars was appropriated by *Sagua's Im-* the Provisional Government for dredging the Maravilla channel leading into the harbor of Sagua, where 30 feet depth is needed. The total cost is estimated at \$2,000,000 and will require several years to complete, including improvements up the Sagua River to the city. The entire Sagua district is annually overflowed with consequent immense damage. The river itself will be straightened and deepened and thus carry an increased volume of water without spreading all over the country. The bids will be opened this month. It is said eleven firms are bidding for the contract.

*The New
Map of
Cuba.*

There have been announcements from time to time in the newspapers of the United States and Cuba that the new map of Cuba, long in preparation, had been completed and was ready for distribution. Inquiries as late as Jan. 30, 1908, at the United States War Department at Washington elicited the official information "that there is no possibility of these maps being finished for some time yet. The department believes that every time some one branch or detail of the map is finished the press takes it for granted that it is the whole map that is completed."

Labor Troubles. It is probable that President Gomez will soon be confronted with serious labor difficulties. Strikes have taken place at Cienfuegos and Cardenas and among the stevedores in Havana.

The striking stevedores at Cienfuegos and the workmen of the San Manuel estate went on strike on January 11 for an eight-hour day. It was settled in favor of the men when President Gomez telegraphed his earnest wish to have the struggle terminate.

A general strike is now expected to obtain an equalization of working hours.

The Harbor Mail Boat. One of the first vessels to be built for the use of the government of Cuba is a harbor mail boat, known as the *Correos*, built at Croton, N. Y. In Havana the vessels do not tie up at wharves, but are loaded from lighters and the policy of the government requires the use of a mail boat visiting the ships at intervals, collecting and distributing mail. The *Correos*, which resembles a towboat and also a small river boat, is admirably fitted for this purpose. She is seventy-two feet in length, with a beam of 15 feet and gross tonnage of thirty-three tons.



Carretera de Pinar del Rio caminos viejo y nuevo.

ROAD MAKING IN CUBA. The new road in the background; the old road in the foreground.

The Cabinet Secretaries President-elect Gomez's Cabinet is as follows. This is his own official announcement:

Secretary of Government, Nicholas Alberdi.

Secretary of State, Justo Garcia Velez.

Secretary of Finance, Emarcellino Diaz de Villega.

Secretary of Justice, Luis Octavia Divino.

Secretary of Sanitation, Dr. Mathias Duque.

Secretary of Public Works, Benito Lagrueula.

Secretary of Education, Dr. Ramon Meza.

Secretary of Agriculture, Ortolio Foyo.

General Eusebio Hernandez was originally selected by President-elect Gomez as Secretary of Government, but declined to accept the place on account of differences concerning a sub-secretary.

The following assistant secretaries were likewise officially named on January 23:

Government, Licentiate Francisco Arango y Mantilla; State, Dr. Jose Francisco Ramirez de Estenoz; Finance, General Francisco Lopez Leiva; Justice, Dr. Juan de Dios Kohly; Education, Major Pedro Mendoza Guerra; Agriculture, Colonel Luis Perez. The departments of Sanitation and Public Works have no assistant secretaries.

Legislative Program. The legislative program includes the following:

Codification of Cuban laws, tariff reformation, government customs and warehouses, building of schools, creation of a normal school, creation of national boards of agriculture and education, arbitration of differences arising between employers and employees, an independent statistical department, the creation of a national library and the removal of the ban against cock fighting.

On Feb. 4 a bill was introduced revoking Governor Magoon's decree providing for a quorum. The Senate sent the bill to the Committee on Government.

VIEWS OF THE UNITED STATES CARTOONISTS.

Good Wishes and Good Advice for Cuba—Must Now Manage its Own Affairs—
Fears for the Future.



W. A. Rogers in the New York Herald.



C. R. Macaulay in the New York World.

If Cuba stumbles the people of the United States are going to lend her a helping hand. Should she insist upon lying down and rolling in the dust, then Uncle Sam may conclude that she cannot get along without a guardian.--Troy (N. Y.) Record.

It is the general impression that if the American flag is ever run up again it will be for good and all, likewise for the good of all.—South Bend (Ind.) Tribune.



UNCLE SAM SEES HOW CUBA CAN GO IT ALONE WITHOUT THE CRUTCH.

Williamsport, Pa., Weekly Grit.



Uncle Sam—"Careful, now, Sonny! Here's where I let you go alone."

Duluth, Minn., News.



EVACUATED.
Butte (Mont.) Intermountain.

It was Elihu Root who took hold of the difficult problem of creating a nation out of Cuba, establishing a government there and training men to run it and to prepare it for standing alone. He made Cuba, and he wrote what is known in history as "the Platt Amendment," upon which to this day are based the relations of Cuba to the United States.—Walter Wellman, in the Review of Reviews.

The Cuban must become Americanized, but he will not do it without a fight.—Frederic J. Haskin.



WEANING THE BABY.
From the Hutchison (Kans.) News.

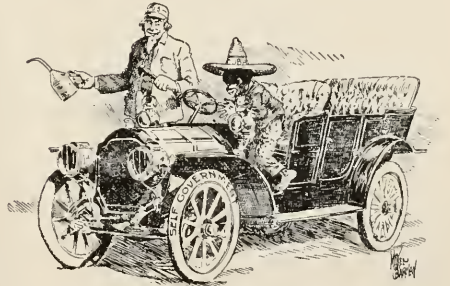

Uncle Sam—"Well, she's had a good overhaulin' an' she's as fit as a flea! Git in an' don't do any more scorchin'!"—Baltimore (Md.) Sun.



Wall Street Journal.



Washington (D. C.) Herald.

COMMERCIAL MATTERS.

Foreign Trade of Cuba—California Wines Seeking the Island's Trade—Returning of Crates—Cuba as a Soap Market—Customs Collections, etc.

Matches.—The production of matches in Cuba amounts approximately to forty thousand gross of boxes (480,000) per month. As to the importation of foreign matches, it is distributed in the first half of the year 1906 in this way:

| | | |
|-------------------------|--------|-------|
| United States | 174 | Gross |
| Spain | 1,250 | " |
| Italy | 6,780 | " |
| France | 16,600 | " |

The importation of matches into Cuba is estimated at one million gross of boxes annually, because in the last two years it has increased considerably.

It is unnecessary to say that the United States could compete successfully in this line of exports for Cuba, provided they send wax matches and not wooden matches, which are not acceptable in the Cuban market.

The American manufacturers are advised to take as their model the Italian, Spanish or French match, in artistic, well decorated boxes, making the price three cents per box of fifty matches to the retail dealer, and if they could manufacture smaller boxes with thirty matches at one cent each, it would bankrupt the Cuban match industry.

The American manufacturer can do all this, because the Cuban match manufacturer must import all his raw materials.

California Wines in Cuba.

A writer discusses in the San Francisco, Cal., Chronicle, the condition of the wine

trade of Cuba from the standpoint of the consumer habitually purchasing wine from retail grocers in case lots or less. He says that a well-known moderate priced California wine sells in Cuba for 10 cents per bottle more than a European wine of similar character, the dealers claiming the former cannot be sold cheaper, and the latter therefore getting the trade. Assuming that the California producer made the most favorable prices possible, it follows, he thinks, that the Cuban market is closed to California wines and can only obtain a footing by receiving a proper concession in the duty to the new reciprocity treaty.

The Cuban market for light wines is important, as they are, just as in all Latin-American countries, in universal family use and are a staple commodity.

"In the present Cuban reciprocity," comments the Chronicle, "American products receiving advantages in Cuba are in three schedules, receiving reductions of 20, 25 and 30%, respectively, from the regular Cuban tariff. American beer, cider and mineral water are all in the 30% schedule, but no advantage whatever is given to California wines. A market for our wines in Cuba would be worth something to us. We believe that the omission to provide for American wines in the present treaty with Cuba was due to the fact that our negotiators were not sufficiently impressed with the importance of our wine industry, and that with the proper representations which will now be made to the State Department our wines will receive due consideration in the new Cuban treaty."



PERSPECTIVA DE LA ADVANA DE SANTIAGO DE CVBA
-D- DEPARTAMENTO DE OBRAS PUVLICAS CONSVRUCIONES CIVILES. -81-

Perspective of the new Custom House for Santiago de Cuba.

Articles Returned as Growth of Country.

The protests of C. I. & M. Dingfelder, of New York, against the assessment of duty on wooden crates or coverings exported from Cuba and returned as articles the growth, produce and manufacture of the United States have been overruled by Appraiser Somerville, of the Board of United States General Appraisers.

The collector of customs in each case added the value of the crates to that of the contents, as returned by the local appraiser, under the provisions of section 19 of the customs administrative act of 1890.

Many importers testified, and the evidence went to show that many of these crates, or at least those of similar manufacture were exported in quantities varying more or less from about 3,000 crates from the states of Georgia and Florida and perhaps other localities in the South. It is admitted that no effort was made by the importers in any instance to file with the collector the papers and documents required by the regulations of the Secretary of the Treasury and designed to prove the identity of such articles when exported from and returned to this country, nor has the collector waived the production of export certificates of such merchandise which are required by such regulations, nor was any bond given for the production of these documents, nor has the local appraiser returned these articles as being of the kind covered by paragraph 483 covering this matter.—American Industries, Jan., 1909.

Cuba as a Soap Market.

Consul-General James L. Rodgers, of Habana, in response to the request of a Kansas City company for information as to the importation of soap into Cuba, says that very nearly all soap used is imported; some local manufacture is devoted to the highly perfumed varieties and does not compete with the imported article. The statistics available at this time show total importations of ordinary soap in bars for laundry and common purposes of 8,827,131 pounds in one year. The United States furnished about 12½ per cent., Spain 80 per cent., and the remainder from France. In the same period the importation of toilet soaps amounted to 76,188 kilos (kilo equals 2.2 pounds), the United States furnishing about 50 per cent. and France 45 per cent. Of all other varieties the importation amounted to 165,881 kilos, of which the United States furnished about 75 per cent. and France about 20 per cent.

The Duty.

Common soap in bars is \$3.90 per 100 kilos.

Toilet soap in cakes or tablets, \$13 per 100 kilos.

Extra fine toilet soap, whether fancy, perfumed or not, and including all medicinal and medicated soaps, \$26 per 100 kilos.

Discounts.

Upon the first two classifications importations from the United States receive 30 per cent. discount, and upon the last 40 per cent. discount.—U. S. Report, Jan. 14.

Havana Customs Collections.

| | |
|--------------------------|----------------|
| Collections during month | |
| of December, 1908..... | \$1,409,794.36 |
| Collections during month | |
| of December, 1907..... | 1,658,207.03 |
| Decrease | \$248,412.67 |

The January collections still show a marked decrease. The figures for 1909 are \$1,335,552.66 as compared with \$1,639,442.41 and \$1,677,950.49.

During the calendar year of 1908 there has been a falling off of more than three millions in the Havana customs collections, as compared with the preceding year.

The following table shows this:

| Month— | 1907. | 1908. |
|--------------|-----------------|-----------------|
| Jan. | \$1,677,950.59 | \$1,639,442.41 |
| Feb. | 1,415,208.39 | 1,327,083.09 |
| March | 1,828,364.87 | 1,445,400.15 |
| April | 1,830,054.95 | 1,420,777.11 |
| May | 1,507,063.86 | 1,370,889.04 |
| June | 1,573,055.22 | 1,434,798.76 |
| July | 7,088,017.90 | 1,313,839.41 |
| August | 1,095,600.55 | 1,267,154.99 |
| Sept. | 1,722,547.08 | 1,276,186.61 |
| October | 1,669,234.57 | 1,469,084.43 |
| Nov. | 1,739,743.11 | 1,446,351.89 |
| Dec. | 1,658,207.03 | 1,409,794.36 |
| | \$20,005,048.12 | \$16,820,802.25 |

Decrease in 1908, \$3,184,245.87, or 15.91 per cent.

The Bureau of Manufactures at Washington is in receipt of a communication from a Cuban business man who would like to enter into correspondence with parties in the United States requiring large quantities of hardwood charcoal and firewood. The name and address may be secured at the bureau by referring to 2989, the number of the inquiry.

SPONGE FISHING AT BATABANÓ.

In Cuba, at Batabano, sponge fishing is pursued with all the primitiveness and leisure associated with sponge fishing since classic times.

Cuban fishermen still employ the old sky-glass and rake methods, which were in vogue in Florida also before the latest commercializing methods revolutionized the industry. The Cuban goes out in a small chalupa, a cross between a river boat and a canoe, carrying his professional instruments. These latter drop a pole 20 to 50 feet long, fitted at the end, with a three-pronged rake, and a large bucket from which the bottom has been knocked out and substituted by a piece of ordinary window glass. By means of this glass the sponges can be distinctly seen on the bottom of the sea.

With no small skill the rake is brought into play, the sponge harpooned and the catch brought to the surface. The whole process of sponge fishing a la Cubano is

tedious and trying and it requires a patience beyond belief. To maintain one's self in a shallow skiff without upsetting and at the same time to spy out sponges through the glass bottom of an inverted bucket, and further to acquire those sponges on the end of a fifty-foot pole is a complication of arts.

The sponge being an animal, it is necessary to kill it. This is done by exposing it for several hours on the broad decks of the boats. In summer they soon die, but in winter it takes a long time, owing to the weaker force of the sun. After death they are brought ashore and put in the cradles. These are inclosures made on the seashore by setting stakes a little apart from each other. The ebb and flow of the tide wash the animal matter from the sponge and the work is completed by manual labor. They are then taken to the packing-house, graded, strung, baled and dispatched to their destination.—Florida Times Union.



Fishing for sponges off Batabanó. Skiffs and crews from the fishing fleet at work. Searching the bottom through glass-bottom buckets, by means of which the sponges can be distinctly seen.

Cuba's Trade in 1907.

The annual report of the department of hacienda for the fiscal year of 1906-7, just issued, contains some interesting data.

Of Cuba's imports the United States supplied only 49 per cent. The United Kingdom, 14 per cent, other American countries, 9 per cent; Spain, 8 per cent.; Germany and France each 6 per cent, and the balance scattering.

Exports: United States, 88 per cent.; United Kingdom, 4 per cent.; other countries, 8 per cent.

Other countries are doing business with Cuba which the United States should have. Reliable merchants, consuls and others have often said that it is not so much a matter of price and quality, but rather the indifference and obstinacy of the American manufacturer which hinders the expansion of the United States trade in the island.

Importations of Food Products.

Value of some importations of farm and forest products during 1905, 1906, 1907, by the United States from Cuba are as follows:

| | 1905 | 1906 | 1907 |
|---|----------------|---------------|----------------|
| Beeswax | \$24,006 | \$48,120 | \$93,702 |
| Honey | 57,918 | 26,239 | 33,380 |
| Cattle hides.. | 44,046 | 152,191 | 346,615 |
| Packing house products .. | 123,465 | 232,019 | 438,567 |
| Cocoa shells. | 259,720 | 160,258 | 445,178 |
| Chocolate and cocoa | 260,965 | 162,541 | 448,545 |
| Bananas | 1,437,952 | 959,628 | 1,273,826 |
| P r e p a r e d or preserved fruits | 19,687 | 280,764 | 27,466 |
| Cocoanuts .. | 254,374 | 302,478 | 262,822 |
| Onions | 21,860 | 6,206 | 10,226 |
| Total vegetables.... | 112,854 | 93,654 | 149,565 |
| Mahogany .. | 88,500 | 120,201 | 187,011 |
| Other cabinet woods. | 368,058 | 452,060 | 986,679 |
| L u m b e r, boards, etc. | 158,091 | 194,959 | 331,878 |
| Other wood. | 615,349 | 767,237 | 1,507,484 |

Figures from report of the U. S. Dept. of Agriculture, Jan. 12, 1909.

Telephone girls in Havana, says La Lucha, receive \$30 silver per month working every day, Sundays included. To permit of the maintenance of an active sublist no girl is allowed to work more than 22 days, with a corresponding decrease in wages.

Cuba Trade With New Orleans.

Exports to Cuba through New Orleans during 1908 were about half the volume of exports during 1907; and imports from Cuba through New Orleans during 1908 were about one-third of the volume of 1907. The end of commercial relations between New Orleans and Cuba will soon be reached unless something is done to increase the facilities for handling commerce between New Orleans and Havana, said the Cuban Consul at New Orleans, recently, to a Pecayune representative.

Last year New Orleans shipped only \$2,146,103, as against \$3,596,740 in 1907, and \$3,273,600 in 1906. In articles imported from Cuba in 1906 there were \$5,993,534 worth; in 1907, \$6,976,855, and in 1908 only \$1,962,161.

Cargoes from New Orleans to Havana in 1906 amounted to 69,1/1 tons; in 1907, 75,813, and in 1908, 54,946. Cargo from Havana, in 1906, 9,883 tons; in 1907, 14,928, and in 1908, 8,055.

Methodist Church Changes.

The Methodist Church in Cuba, according to Bishop Warren A. Candler, has more than 3,000 members. The changes in pastorates made at the annual meeting in Matanzas Jan. 20 are as follows:

Rev. E. E. Clements from Havana to Cardenas.

Rev. S. A. Neblett from Matanzas to Havana.

Rev. H. B. Bardwell succeeds the former in Havana.

Rev. H. W. Baker from Havana to Santiago.

Rev. W. G. Fletcher from Santiago to Matanzas.

Rev. J. T. Redman will continue in charge of the work on the Isle of Pines, and Rev. J. R. Lancaster will remain at Camaguey.

The steamship Oteri, running between Santiago de Cuba and Jamaica, was withdrawn January 11, and the Aviles, formerly of the Herrera line, substituted.

Demetrio Castillo, a Cuban, will be admitted to the West Point Military Academy by virtue of a joint resolution of Congress January 14, suspending the provisions of the Revised Statutes making foreigners ineligible.

Mrs. Tomas Estrada Palma, widow of the late President of Cuba, has decided to return to Central Valley, Orange County, to spend her remaining days. Mrs. Palma said the happiest days of her life were spent in that village.

Conditions in Cuba.

Bishop Warren A. Candler in a signed article in the Atlanta (Ga.) Journal, reviews conditions in Cuba. He writes from Havana just before the inauguration. Among other comment, the following is important.

The sanitary conditions of Cuba have improved. Havana is to-day a cleaner and healthier city than Atlanta;—its health record is better than a number of our American cities. Yet I remember that when I first saw the place its sanitation was so bad that a stranger who came within its gates took his life in his hands.

Decreased poverty and good crops, he says further, will promote contentment and quiet among the Cuban people. This year the seasons have been good and the yield of cane and tobacco promises to be extraordinary. The new government starts off, therefore, with this great advantage and gives ground for hope that the government may be stable and enjoy a good measure of success.

On the other hand, there are facts which give rise to misgivings as to the outcome.

The new government is a coalition government—and in all lands and times coalitions are notoriously unreliable. The factions contend with each other in the Congress, and of course the representatives of the defeated party of the Conservatives sit by to take advantage of the strife existing between them. These conditions furnish a fine chance for a row over the distribution of the offices.

Cuba has no Bolivar, says the Bishop, no Juarez, no Porfirio Diaz! Cuban leaders are not statesmen, but politicians. When a country has no great leader, or leaders, the times become the fecund mother of politicians who grasp at power without the wisdom to wield it for the welfare of the people, and at such times since the politicians are numerous and all of a size they are liable to make a mess of public interests in their struggles for place and pelf.

About twenty-five prominent men of Havana assembled recently for the purpose of organizing a council of the Knights of Columbus. A regular lodge will be instituted and an active canvass made throughout the community with a view of making that one of the strongest orders in Cuba.

The German Emperor has conferred a decoration on Dr. D. T. Lainé of Havana for his skill in treating the Prince von Reuss, son of the Duchess of Mecklenburg, recently at the American hospital in Vedado. The Prince von Reuss was an officer of a German training ship, and was taken ill while in this city, and Dr. Lainé performed the necessary operation.



Courtesy New York Herald.

Cuba's Statue of Liberty.

Cuba is to have a Statue of Liberty at Matanzas. Salvatore Buemi, of Rome, an Italian sculptor, executed the figure, which will stand in a public park in the city and dedicated Feb. 24 next.

Signor Buemi has been at work on the statue for more than two years and will take an important part in the dedication ceremonies.

In addition to the bronze figure representing liberty, which will rest on a granite pedestal, the bronze image of José Martí will form a part of the same monument, which is being erected by a popular subscription. The liberty statue will stand twelve feet high, and will be at the foot of the Martí monument, which will rest on a higher pedestal.

The expensive wireless tower erected last year near Morro Castle will probably have to be taken down and re-erected at some other point, says the Havana Lucha.

The apparatus has failed to work satisfactorily, some days not at all, because the foundations are on the solid rock, when it should have been built on plenty of earth, to make the ground circuit complete.

Mr. R. T. Tanner has again entered the newspaper field and has taken the post of commercial editor of the Havana Telegraph, a daily newspaper which he founded.



Children of Cuban Tenements.

Children of Havana Tenements.

The common sort of dwellings for the poor classes are like the illustration. Rooms open on narrow courts, where women work at the wash tub, while their children play around them—clad or rather unclad in nature's garb. In one tenement a little urchin was seen shouldering a broomstick for a musket, a paper hat on his head, and no other covering, while his little squad, likewise unclad, went through childish military evolutions.

Cubans are fond of flowers and decorate their homes with potted plants freely.

The reading of Zola's novel, "Labor," at an Havana cigar factory inspired the formation of "La Crecherie," a society of 100 members for the improvement of homes for the laboring classes. The first fruits of their work was the opening of twenty-five new houses—clean, comfortable and hygienic in every way. These houses, which are in the Vedado, outside of Havana, in a most salubrious location, were built and sold on the instalment plan, and others are now being constructed.

The mayor of Havana, Señor Julio Cardenas, and many prominent men attended the inauguration of these dwellings.

Each member of "La Crecherie" pays eight dollars American currency monthly to the building fund. Although only organized in 1903, the society has already

expended \$26,500, and the enterprise is proving profitable.

Cuban Mahogany and Cedar.

Arrivals and market at New York for January, 1909, were as follows:

Mahogany: There were a great many more ports represented in the January receipts than usual, contributing a very large number of logs. Some of the receipts have passed into second hands, but the stock that was on hand a month ago has been materially increased.

Cedar: There was an unusually large number of logs received during the month of January and a very small proportion sold, thus increasing the stock in first hands to a very large extent. As a matter of fact, the present holdings are larger than they have been for a long time, with a very limited demand.—Geo. F. Herriman, Feb. 1, 1909.

Among close friends of the administration it is believed certain that Gonzalo Quesada will be within a few days transferred to Paris as the Cuban Minister, and General Carlos Garcia Velez will take his place at Washington.

At the indication of the French Legation, through its Minister, M. LeFaivre, the National Bank of Cuba has elected Mr. Ernest Gaye, General Agent of the French Transatlantic Steamship Company, as one of its directors.

RAILROADS AND FINANCIAL.

Report of the Cuba Company—Dividend of the Havana Electric Co., Etc.

Cuba Railroad's December Earnings.

Surplus, 41,702, against \$14,529 in 1907; six months \$128,361, against \$73,211 in 1907.

The report of the Cuba Railroad for the month of December and six months ended December 31, compares as follows:

| | 1908 | 1907 | 1906 |
|--------------------|-----------|-----------|-----------|
| December gross.... | \$174,348 | \$149,723 | \$152,577 |
| Expenses | 100,144 | 104,034 | 98,849 |
| December net .. | \$74,204 | \$45,689 | \$58,728 |
| Charges | 32,502 | 31,160 | 28,329 |
| December surplus.. | \$41,702 | \$14,529 | \$25,399 |
| Six months gross.. | \$47,610 | 869,332 | 794,613 |
| Expenses | 524,976 | 623,316 | 620,276 |
| Six months net.. | \$322,634 | \$246,016 | \$174,337 |
| Charges | 194,273 | 172,805 | 155,955 |
| Six months surplus | \$128,361 | \$73,211 | \$18,382 |

It is understood that the Cuba Company will soon start a large number of improvements, Sir William Horne having expressed himself in very optimistic terms of business conditions in general. Among the improvements planned is the construction of model stations at Holguin and at Camaguey; the construction of a line uniting the former with Nipe Bay, touching at Alcala, and a branch line uniting Puerto Padre with the trunk line.

Cuban Railroads Reorganize.

A plan of reorganization of the Cuba Eastern Railroad Company and its subsidiaries, financed by the Knickerbocker Trust Company, has been proposed by the Bondholders' Committee. They are in favor of the formation of a new corporation, which will issue \$600,000 first mortgage bonds, \$2,750,000 first preferred mortgage bonds, \$2,750,000 second preferred, and \$2,500,000 common stock. The reorganization proposed will be with the approval of the trust company.

The bonds are to bear 6 per cent. interest and mature in twenty years, being redeemable at par and interest on any interest date. The first preferred stock is to be 7 per cent. and the second preferred 5 per cent., both non-cumulative. After the payment of the preferred dividends and 5 per cent. on the common stock in any one year, dividends are to be declared equally on all classes of securities. It is also provided that equipment trust certificates may be ordered to cover new equipment.

The new bonds are to be offered for subscription at 85, and will carry a bonus of \$250 in first preferred and the same amount in common stock. The first mortgage bondholders of the Cuba Eastern Railroad, the Northeastern Cuba

Railroad, the Cuba Eastern Terminals Company, and the Eastern Railroad of Cuba, the four companies concerned in the reorganization, are to receive under the plan \$500 in new first preferred stock and \$500 in common stock for each of their bonds. The debenture bonds of the Cuba Eastern and the Northeastern Cuba Railroads will receive \$500 in the new second preferred stock for their bonds. There will remain in the treasury \$136,500 of the new first preferred stock, \$139,500 of the new second preferred stock, and \$136,500 of the new common.

Progress of Cuban "Loop."

Work on the "loop line" of the Cuba Railroad from San Luis, as an eastern terminus, to Marti, with Bayamo as chief city included en route, is progressing satisfactorily.

"Twelve miles of the extension, from San Luis west to Palma, Soriano, have been completed, and six miles have been completed at the western end, from Marti to Guaimaro," said Sir William, Jan. 13. "In all the loop is to be 140 miles long, and it will penetrate many old settlements and sugar plantations, to which lateral lines and spurs of greater or less length will be extended as circumstances warrant. Bayamo, about sixty miles out of San Luis, is the chief old town reached, and a road about thirty miles long is to be built from Bayamo down to Manzanillo at the coast.

"The Cuba Railroad covers about seventy per cent. of the area of the island, and at Santa Clara, its western terminus, connects with the United Railway of Havana. From Santa Clara to Santiago, the main line is 356 miles, and there are 83½ miles of branches completed.

"Work on the new branches of the railroad continues with large forces of men, except during the sugar season, when men are allowed to go to work on the plantations to help harvest the crop and prepare it for shipment, much the same as on western harvest fields."—Interview with Sir Wm. Van Horne, N. Y. Herald, Jan. 14.

The directors of the Havana Electric Railway Company on Jan. 15 declared an initial dividend of 1 per cent. on the common stock and the regular quarterly dividend of 1½ per cent. on the preferred stock, both payable February 15 to stock of record January 23. The annual meeting will be held February 23 at Jersey City.

The Cuban Viewpoint.

A Cuban officer in the Treasury Department stole \$190,000 of the public funds. It was during the recent presidential campaign, and the defaulter was a supporter of Gomez, who was elected. The unfeeling American at the head of the Treasury Department found out about the theft and called the embezzler before him. The man admitted that he took the money, and declared that he used it all himself, although there is a well-defined opinion in Havana that much of it found its way into the Liberal campaign fund. The man went to jail, and there he is to-day.

But he cannot understand why the American treasury official refused to pay him his salary. He is an officer of the Government and needs it. He has written several letters from jail demanding his pay. When the new Government comes in he hopes he will be included in the general amnesty pardon decree, which President Gomez is to sign with a gold pen bought for that express purpose by the Historical Liberal Association of Havana. A Cuban newspaper argued that the money was collected from the people, that it belonged to the people, and that the defaulter was one of the people, so that judgment upon him must not be too harsh.

Provisional Government representatives visited several towns to see what was needed most. In one town where the plumbing in the hospital was out of repair so that there had been no running water for two years, the authorities could think of nothing they needed except money to build a museum to house a collection of pretty sea shells. Another town did not boast of a single street which was not eighteen inches deep in mud. It most needed a municipal band to play in the plaza.

In one town the hospital was found to be in a horrible condition. There was no running water and the filth was dreadful. In the same town, strange to say, the abattoir was found to be in an ideal state of cleanliness. The hospital manager was asked for an explanation. He said the hospital would be fixed up next week. Then he asked the Americans if they had noticed the terrible condition of the abattoir. The Americans said that the abattoir was in a surprisingly good condition. Whereupon the Cuban threw up his hands in horror and exclaimed: "But the front of it! It hasn't been painted for three years!"—Frederic J. Haskin.

Cuba in 1909.

The "Journal of Commerce" publishes a letter from Havana by Raymer Hanford which bids us dismiss from our minds at once the notion that Cuba is becoming Americanized. For every American on the island there are two Chinamen, he says,

and twenty Spaniards. The retail stores, shops and restaurants are in the hands of Spanish owners. The clerks in these establishments are industrious, ambitious young fellows from poor homes in Spain. They have crossed the sea to seek their fortune. Their employers lodge them, feed them, eat with them, take paternal care of them, and after five or six years assist them to buy a partnership, or set up in business for themselves independently. About the first thing done by the merchant for the homesick lad from Spain is to get him into one of the Spanish co-operative associations or clubs. Of these Mr. Hanford says:

They are found in every town. In Havana there are half a dozen, with a total membership of 100,000. Each has besides its large clubhouse with reading rooms, library, game-room, gymnasium and night school, features of still greater value to the young man away from home, such as medical advice, hospital, drug store, lawyers' services in business matters, notaries, banking facilities, and all free of charge to members, whose dues are \$1.25 per month. There is no initiation fee, and the second month you continue as a member entitles you to all the benefits. In numbers and financial strength these institutions have had a marvelously rapid growth; the funds are being used to extend the sphere of Spanish domination in Cuba. This condition must be recognized by the American export movement, for it seems probable that the merchant from Spain will come to control the retail trade in all the Spanish-speaking Americans, and that the wholesale importing houses will also be secured by means of the important advantages to be gained.

The Bank of Havana's Future.

Two members of the New York committee of the directors of this bank are in Havana to formulate plans either for the bank's liquidation or its continuance with reduced capital, says the New York Times.

Important French and English banking groups are interested in the bank in addition to the New York banking interests who hold stock. If a reduction in capital is decided on the plan is to reduce it from \$2,500,000 to \$1,000,000. In the past the bank's business consisted largely of lending money on securities traded in in the Havana market, but these are limited in number, and it is the desire of the American and other foreign interests to have the bank give its attention to a general commercial business. Its accounts are in such liquid shape that if liquidation is decided on there will be little else to do than to distribute the cash to the stockholders.

FOREIGN CONSULS ACCREDITED IN CUBA.



Mr. James Linn Rodgers, American Consul-General at Havana.

James Linn Rodgers was born in Columbus, Ohio, and was educated at the Ohio State University. In his early manhood he was for nine years editor of the Columbus Dispatch. Mr. Rodgers traveled through Europe and made an exhaustive study of labor and trade questions in London and other capitals of Europe. Upon his return the results of his labors was a series of able and masterly articles which he contributed to the press.

Governor Bushnell appointed him his private secretary, and he held that office during President McKinley's administration. Soon after the expiration of this period he was appointed Consul at Shanghai, and in 1907 was transferred to Havana. Mr. Rodgers is married, and his wife was Miss Fay, of Columbus, Ohio. They have a son and a daughter at school in the United States. Mr. Rodgers is very genial, and has many friends in Havana, as well as his charming wife. They have a fine residence on the Malecon.

Mr. Joseph Alden Springer, American Vice-Consul-General at Havana.

Joseph Alden Springer is a native of the old Pine Tree State, was born in Longfellow's "City by the Sea," and is a descendant of John Alden of Pilgrim Rock fame. He was educated at a military school in New York, and when

a mere lad was appointed Consular Clerk at Havana by Gen. Grant in 1870. He was promoted to Vice-Consul-General in 1883, and held that office until the outbreak of the Spanish-American War, when American consuls were recalled. When peace was declared he was commissioned by the State Department to wind up consular matters in Cuba, and shortly after sent in his resignation. During ensuing years Mr. Springer was co-agent of the Royal Bank of Canada, then known as the Merchants Bank of Halifax, and aided in putting the branch in Havana on a prosperous basis. When the Republic of Cuba was inaugurated, desiring to have an able officer at Havana, the State Department reappointed Mr. Springer to the post of Vice-Consul-General at Havana, an office he now holds.

American Consul Max Baehr, long stationed at Cienfuegos, was offered the Consul-General's post at Buenos Aires, but declined the offer, preferring to remain in Cuba.



JOSEPH ALDEN SPRINGER,
American Vice-Consul-General at Havana.

CUBAN TOBACCO RAISING.

The cost of labor and equipment in relation to final returns has been investigated by United States Consul Max J. Baehr of Cienfuegos. He found exact information difficult to procure, but his deductions, he states, come near to showing the average cost of labor and other requirements. His figures, which follow, are based on Spanish silver. A dollar, or peso, is worth 86 cents United States currency at this time. His basis is one acre of land in Santa Clara Province capable of producing 900 pounds of tobacco, and he finds as follows:

For the preparation of sufficient ground to produce enough young plants for 1 acre of land..... \$13

For their cultivation, weeding and watering..... 10

For preparing the soil of 1 acre of land for the reception of the young plants.. 14

For the planting of the young plants..... 5

This figure is based on the fact that 1 man can plant 2,400 plants per day, that 1 acre takes 12,000 plants, thus necessitating employment of 5 men in order to plant this quantity in one day, at the rate of \$1 per day.

After the planting, the weeding and cultivation of 1 acre up to the cutting time comes to..... 50

For cutting the tobacco crop of 1 acre..... 30

Explained as follows: An acre of land is supposed to yield under ordinary conditions 300 cujes, or poles from which the tobacco leaf is hung, and to fill each pole costs 10 cents labor.

Now the tobacco is ready for the drying house, and after being cured awaits the final work of selecting, heading, bundling and baling.

These 300 cujes should yield under ordinary conditions 6 bales of 150 pounds each; they are headed, selected, bundled and baled at the rate of \$10 per bale or 60

Total cost of labor.....\$182

Then there are the poles to consider; 300 will be required which cost \$4 per hundred, also a drying house costing \$50. A yoke of oxen and implements are figured at \$100 and \$20 respectively, or an additional \$182. But at these last at least four years, one-fourth alone is calculated, making an additional expense of \$48.50, including \$3 for seed.

These figures represent the total cost of production of tobacco on 1 acre of land; the yield is 900 pounds of tobacco—6 bales of 150 pounds each—and the cost \$230.50 Spanish silver, or 25.61 cents per pound.

Time occupied in the production of tobacco from seed to bale, six months.

The present price for good light tobacco is \$70 Spanish gold, and if it is of heavy material, or what is called "tobaco de partido," \$50 per bale, so that for the sake of calculation the medium price of \$60 per bale should be taken, all of which points to satisfactory profit per acre.

Cuban Tobacco in 1907 and 1908.

According to the statistics published by *El Tabaco*, of Havana, the year 1908 shows a gain only of 1¼ per cent. in exports of cigars from the port of Havana, as compared with 1907. The United States, which country was ahead of Great Britain the previous year, fell back into second place again last year.

The principal eleven countries, which received above one million cigars within the twelve months showing the following differences:

| | 1908. | 1907. |
|-------------------|------------|------------|
| Great Britain ... | 70,677,528 | 56,699,274 |
| United States ... | 47,669,742 | 61,869,131 |
| Germany | 24,183,131 | 23,205,411 |
| France | 11,418,782 | 10,638,875 |
| Canada | 7,084,020 | 10,271,013 |
| Australia | 6,906,042 | 4,261,173 |
| Spain | 5,548,745 | 3,119,836 |
| Argentine Rep... | 3,893,745 | 3,166,168 |

| | | |
|---------------|-----------|-----------|
| Chile | 2,636,963 | 3,524,752 |
| Austria | 1,151,815 | 1,784,051 |
| Belgium | 1,124,183 | 1,097,762 |

The tremendous falling off in exports from Havana to the United States is undoubtedly owing to the financial effects of the late panic. The exports of leaf tobacco to the United States increased heavily. The total excess of exports of leaf tobacco in bales in 1908 is 65 per cent. greater than in 1907, or 131,655 bales. The six chief countries taking Havana leaf compares as follows:

| | 1908. | 1907. |
|----------------------|---------|---------|
| United States | 236,849 | 180,274 |
| Germany | 51,590 | 6,945 |
| Spain | 18,720 | 2,950 |
| Austria | 6,901 | 2,930 |
| Argentine Republic . | 6,555 | 1,671 |
| Canada | 3,563 | 3,361 |



ISLE OF PINES SCENERY—LAMA PARK, BIBIJAJUA.

Isle of Pines Status Not Settled.

By and by the war with Spain came along. The Isle of Pines became American territory—so Mr. McKinley and John Hay thought. Then Mr. Roosevelt and Elihu Root changed the executive American mind, and said the Isle of Pines was Cuban territory. The Platt amendment had declared that the question of the title was to be kept open for future adjustment. That adjustment was attempted by the negotiaion of a treaty giving Cuba a quit-claim deed to the island in consideration of sundry sites for naval stations, and such on the island of Cuba. For several years the Senate of the United States has refused to confirm that treaty, and it likewise has neglected to reject it. There was an American revolution on the Isle of Pines, and great excitement, but the status was not changed nor the issue settled.—Frederic J. Haskin.

T. J. Keenan, of Pittsburg, president of the American Association of the Isle of Pines, who has just returned from Cuba, said to the Philadelphia Press on Feb. 5, that he had an interview with President Gomez, who assured him that the administration would do all in its power to protect property throughout the island and would take all measures to

encourage foreign capital.

He also said that Gomez was a more able man than Palma. Mr. Keenan has extensive interests in the Isle of Pines, and was one of the prime movers in organizing the opposition to the treaty which would turn over the island to the Cuban government. He says he is still of the opinion that the United States should own the Isle of Pines, although he admits that the Cubans have given it good government. They have built roads costing \$30,000, he said, and erected a court of justice. The Isle of Pines, Keenan said, was the only purely Anglo-Saxon colony in the tropics. At the present time it has between five thousand and six thousand Americans owning property.

The Fruit Exhibits.

The Isle of Pines display of fruits at the exhibition of the Cuban Horticultural Society in Havana, Jan. 20, attracted great attention, says La Lucha.

Exhibitors sent beautiful specimens of oranges, grape-fruit, tangerines, lemons, all kinds of vegetables and canned fruits, preserves and jellies.

A mammoth king-orange attracted much attention, and some very large smooth Cayenne pineapples were likewise admired.

CUBAN FRUITS AND VEGETABLES IN NEW YORK.

Supplies of Vegetables Light, with Tomatoes Plentiful, but Low in Price—Improvement in Packing Necessary—Cuban Oranges and Grapefruit.

Especially written for The CUBA REVIEW by the Urner-Barry Company, of New York.

About April increasing supplies of tomatoes, lettuce, cucumbers, beans, peas, etc., etc., are sent to New York from Florida and later from other parts of the South. By the time New Jersey vegetables are in the market, stock is also coming from all other nearby States. After the second and even third southern crops are marketed, about November, there is a shortage for a few months. In this period lies Cuba's opportunity for placing vegetables upon the New York market to best advantage.

Receipts from Cuba are usually light during November and December, but increase materially during January and February. Tomatoes seem to have been the most profitable vegetables shipped in past seasons, and receipts have been more liberal during the past few weeks than all other Cuban vegetables. Just at this season there are few tomatoes received from Florida, and practically none from California, the season closing there around the first of the year, consequently the supply is so short that high prices could be realized for really fancy stock, and scattering sales of such from Florida have been making of late from \$2 to \$2.50 per carrier, even higher in instances, though many of the Florida are too poor in quality and range much lower. The liberal arrivals of Cuban tomatoes during the past few weeks have sold low, probably too low to net shippers a reasonable profit. A few of the very best have found buyers at \$1.75 to \$2 per carrier, but the great bulk of the arrivals have not been attractive enough to exceed \$1.25 to \$1.50, and many have been too poor to command those figures.

Grading and Packing.

While there has been much improvement in grading and packing tomatoes, there is still room for improvement, and many shippers realize more for their product better packed. This season Cuban tomatoes seem to be running smaller in size than usual, and it is much more important to grade carefully when the stock is less attractive. One of the largest receivers of Cuban tomatoes told the writer that the Cuban shippers had improved so much in their sorting and packing that the stock was received in shape equal to Florida shipments, but other prominent receivers held out different opinions, and upon personal examination of many different marks the writer gained the impression that most shippers were packing too few tomatoes in a basket. The stock is shipped in six-till carriers—carrier crates holding six small baskets and most shippers seem to be packing twenty-four tomatoes to a basket—two layers of twelve. Many of these baskets contain tomatoes of irregular size and of so small an average that it would have been far better to pack thirty or more tomatoes to the basket, which would have made the stock fit more snugly and doubtless carry in better condition during the trip. It would seem that these baskets should be well filled regardless of the number of tomatoes required.

Peppers are in moderate supply from Cuba and recent sales have been in range of \$2 to \$3 per carrier, comparatively few showing size to command the outside figure, and some very small have had to sell still lower.

Cuban okra is arriving sparingly and sales have ranged from \$3 to \$5 per carrier, with tone stronger than last week and some business reported up to \$6, but this week's steamer brought increased quantities and market fell to \$2 to \$4, comparatively few ranging higher.

Eggplants in light supply and worth \$2 to \$3 per box for average quality, though fancy large have a possible higher value, had to range lower. Such vegetables as eggplants if not received in strictly sound condition have to be repacked by the commission house before they can be sold to advantage and this causes considerable shrinkage, three or four boxes making only two strictly sound, but more can be realized in this manner than if the vegetables were sold without rehandling as received.

Cuban onions are commencing to arrive in large supplies, this week's steamer "Saratoga" bringing 375 crates. These onions have met rather a moderate sale owing to the free offerings of domestic stock, and most sales have been at about \$2.50 per crate. There will be no Bermuda onions to speak of for some weeks and outlook seems favorable for Cuban.

A few Cuban potatoes have appeared, but hardly in quantity to establish reliable quotations. Late crop Bermuda have been selling of late mainly in range of \$4 to \$5 per barrel, and new Cuban should command a substantial premium over the price realized for Bermuda if well graded and of desirable size and appearance.

Oranges and Grapefruit.

The market is liberally supplied with Florida, California and Porto Rican oranges, but the receipts from Cuba are small. The California oranges have been selling mainly in range of \$2 to \$3.50 of late, and the Florida fruit \$1.50 to \$3. Porto Rico have not shown quality to exceed \$1.25 to \$2, few above \$1.75 to \$1.80, and the Cuban have brought little if any more than Porto Rico. Cuban grapefruit has been in light supply and has sold fairly; Florida is worth from \$1.50 to \$3.50 and Cuban would command as much if of equal quality, though the recent arrivals have seldom been attractive enough to equal Florida in price. At auction February 3 there were 65 crates of Cuban grapefruit offered, which sold at \$1.45 to \$1.50 for 36s, 46s and 54s.

Pineapples are in light receipt from Florida and Porto Rico and the Cuban receipts have met a good outlet though prices comparatively low; 140 crates Cuban sold at auction February 3 at \$1.50 per crate for 24s and 30s, though from store as high as \$1.75 is being realized and in some cases \$2 for fancy, well packed. Some of the Cuban pines are not packed tightly enough and arrive showing more or less waste because they have had sufficient room to shake and bruise in transit.

New York, February 5, 1909.

CUBA'S OPPORTUNITIES.

U. S. Consul-General Rodgers on Cuba Products for Cuba's Market—These Can Be Sold at Big Prices.

Opportunities for the American colonist in Cuba are great along the line of providing the home market with products easily raised, but which the native imports, says our consul in Cuba, James L. Rodgers. Among imported foodstuffs are rice, coffee, potatoes, onions, beans and eggs.

The consul's comments on the opportunities in these products are as follows:

Rice comes through English and German exportation, some from Spain and a very little from the United States, but its profitable culture in Cuba at present cannot be considered. The industry requires cheap labor, and that is not available.

Potatoes.—The United States supplies 60 per cent. of the demand and 35 per cent. coming from Canada. Cuba's climate is not favorable to growth and storage half of the year, but cold storage would help greatly.

Coffee comes from the United States, Venezuela and Porto Rico, the latter supplying 50 per cent.

The cost of labor is also a factor in this industry, but because of better machinery some plantations in Santa Clara and Oriente provinces are doing well financially. Should labor prices advance, however, and the government lower the duty, which is \$18.72 per 100 kilos to the United States and \$23.40 for all other countries, the industry would become unprofitable.

Onions are supplied by the United States to the amount of 13 per cent. only, Spain and the Canary Islands 70 per cent. The consul reports that onions are said to deteriorate in Cuba like potatoes, and cold storage facilities are likewise necessary.

Beans.—Forty per cent. come from the United States, 35 per cent. from Mexico and 13 per cent. from Germany. All kinds grow well in Cuba, but are subject to the ravages of worms, hence protective storage is advisable.

Eggs.—Practically all importations come from the United States. Chickens thrive and natural foods is easily obtained. The climate is not too hot, and there are no animal enemies. The 1907 importations were valued at over \$1,000,000. Given protection in all ways, the chicken and egg business in Cuba should attract capital.

Hog raising is another profitable industry. Nature provides plenty of food, and the animal thrives. Cubans bought 15,000,000 pounds of salted pork from the United States in 1906.

These products the American farmer can sell at big prices in Cuba, and he need not fear competition from the Cubans.

The consul in conclusion says: Cuba's laws, conditions, manners and customs are different from the United States; its labor is not cheap, and that these things should all be carefully considered.



Steamer La Gloria leaving Port Viaro.

DECAY IN ORANGES.

Florida Loses \$500,000 Annually Through Decay—Interesting Experiments to Discover Causes.

The loss through decay in transit or on the market, in the Florida orange industry, is something like \$500,000 annually. Some interesting experiments to discover the causes of the decay have been made by the U. S. Bureau of Plant Industry, and Circular No. 19 contains information of value to Cuban orange growers.

A minute fungi does the damage, but it appears an orange with an uninjured skin is immune. Bruised or broken skin is the first requisite of decay.

Punctures by clippers in severing the fruit is the injury most common. Then follows injuries by pulling the oranges, by splinters in the crates, and cuts made by the finger nails of the pickers or packers. Then about seven per cent. of the fruit had stems sufficiently long to injure other fruit.

Injuries by clippers represented 6.1 per cent. and long stems 16.8 per cent.

In every experiment it was found, sound, carefully handled fruit, graded and sized by hand, showed the least decay.

Experiments to determine the loss by decay were made with (1) sound oranges graded by hand; (2) sound oranges graded by machinery; (3) oranges dropped 18 or 20 inches into the basket or field crate; (4) mechanically injured oranges, showing some kind of puncture or abrasion. After being held two weeks in the packing house these results were obtained:

| | | | |
|--------|------|-----------|-----------|
| No. 1. | 2.1 | per cent. | of decay. |
| " 2. | 20.3 | " | " |
| " 3. | 10.0 | " | " |
| " 4. | 35.4 | " | " |

With shipments to Washington examinations were made upon arrival, after one week and after two weeks, with the following results:

| No. | Decay | | After 2 weeks. |
|---------------|-----------|---------------|----------------|
| | Per-cent. | After 1 week. | |
| No. 1 | 0.4 | 1.9 | 4.5 |
| 2 | 1.1 | 5.4 | 12.4 |
| 3 | 2.3 | 6.0 | 10.9 |
| 4 | 20.2 | 38.0 | 52.4 |

As careless handling certainly prepares the way for decay, there was instituted a campaign of education among the pickers, each being shown the damage that was being done and its injury to the fruit's keeping qualities.

Within three weeks, the damage from clipper cutting was reduced one-seventh and the total injury by reason of long stems one-fourth. It was also found that the use of a hopper was a source of much injury, and the department believes that the hopper can be eliminated and the fruit delivered to the sizing machine on carrying belts.

The experimental work indicates that what has been accomplished may be duplicated in Cuba. The decay of oranges is closely connected with rough methods of handling the fruit. Careful methods result in good keeping quality. Rough and careless work should be expected to cause decay, and the experiments show that this is true.

Advantages of Goat's Milk.

Both as a milk producer and as meat, the goat, it seems, has been much neglected, says the Duchess of Hamilton, president of the British Goat Society. She says that goat's milk and goat's flesh should be more used, and she practices what she preaches.

Her four children, the eldest of whom is not yet six years old, have all been fed on goat's milk, and wherever they go a goat accompanies them, so that there is always a supply of goat's milk at hand.

In addition, the Duchess advocates the eating of goat's flesh, which, she says, resembles Welsh mutton in flavor.

There is little or no danger of phthisis being contracted from use of goats' flesh. Goats rarely, if ever, suffer from the disease, and their milk cannot contain its germs.

"Again, goat's milk is very rich in nutriment, and is of great value in the feeding of children. It contains a high proportion of cream, and has no unpleasant taste.

"They are hardy animals, and find nutriment where a cow would starve.

"A friend of mine bought a milch goat, and fed it a pound of oats a day.

"He got a quart of milk in the morning and a pint in the afternoon, and he said he preferred it to that from the dairy."

A Sweetmeat from Bananas.—A delicious sweetmeat is prepared in Santo Domingo by both natives and foreigners, says U. S. Consul Ralph J. Totten, of Puerto Plata. Large, thoroughly ripe bananas are used. The skins are removed and the fruit cut into thin quarter-inch thick slices, sprinkled with fine or powdered sugar and placed in the sun, on boards. As the fruit dries out it is turned over several times and each time is dusted with the sugar. In a few days it becomes sufficiently dry and the result is a crystallized conserve most delightful to the taste, and superior in flavor to any of the costly crystallized fruits.

Lands in Texas thought almost worthless and fit only for goat grazing are now bringing their owners an annual net income of between \$300 to \$500 per acre from onion crops. What can be done in Texas and Bermuda may be done in Cuba.

SUGAR REVIEW.

Specialy written for The CUBA REVIEW by Willett & Gray, of New York.

Our last sugar review for this magazine was dated January 8.

Cuba Centrifugals were then $2\frac{3}{4}$ c. c. & f. 96 test, equal to 3.73c. duty paid, and are now $2\frac{9}{32}$ c. c. & f., the former low level of $2\frac{5}{16}$ c. c. & f. in January having been passed by $\frac{1}{32}$ c. per lb. $2\frac{9}{32}$ c. c. & f. is equal to 3.64c. duty paid for 96 test. The spot quotation was then 3.73c. per lb. and is now 3.64c. per lb., showing a decline of .09c. per lb.

Present quotation for Cuba Centrifugals is $\frac{1}{32}$ c. per lb. less than the low point of the last season and the tone and tendency is now in the direction of a slight further easiness, with possibility of $2\frac{1}{4}$ c. c. & f. being quoted in the near future. The present basis is 47c. per 100 lbs. below the parity of Hamburg beet sugars. The quotation for beet sugars in Europe is now 10s. per cwt., against 10s. $1\frac{1}{2}$ d. January 8.

The Cuba crop is now in full grinding, 168 Centrals working, leaving but one more to begin in a few days. Receipts at shipping ports naturally begin to show large increase and, at such times, the lowest quotation of the season are usually made so that from about the present low level of the month of February a steady improvement may be expected until finally the difference in parity between Hamburg beets and Cuba Centrifugals will be closed. This difference is now 47c. per 100 lbs.

The present method of selling refined sugars giving only 7 days for delivery regulates the trade to an even steady demand, whereas formerly on the 60 and 90 days basis, the market was subject to many periods of abnormal activity and abnormal dullness. This steadiness tends to keep the values of refined steady, also, in the absence of any particular movement in raw sugars, but may, also, at the same time have a deterrent effect upon the business in raw sugars, as refiners are not now obliged to provide raw supplies for abnormal sales for future delivery. This fact, together with the uncertainty relating to the tariff changes tend to decrease the activity in raw sugars. The tariff agitation will commence in Congress early in March and whatever changes may be in contemplation by the Ways and Means Committee are entirely unknown outside of committee. Unless a duty should be placed upon coffee and tea, of which there is some talk, the change in the sugar schedule will be little or nothing, with the exception that 300,000 tons Philippine sugars will certainly come in free of duty to the United States. Some persons think that several years may be required to increase the Philippine crop from its present size of 150,000 tons to 300,000 tons, but our own opinion is that two years' time will be amply sufficient to produce such increase, after which the question will arise as to what will become of further crop increase. At that time, it will be necessary for our government to develop a method of apportioning the 300,000 tons free of duty to the different producers of sugar in the Philippine Islands on some plan such as is now in operation in Russia pertaining to the export of its surplus production by each refinery. It may be that the Ways and Means Committee may cover this necessity in their bill, but the subject has not been broached up to the present time. It seems easy now to look forward into the probable consumption of sugar in the United States during the current campaign and to note several circumstances which tend to indicate a very considerable increase of our consumption. One such item is the absence of any considerable amount of domestic beet sugars in the country, showing that whatever the consumption may be it must depend almost entirely upon the refining of raw cane sugars.

The tone and tendency at the close is to $2\frac{1}{4}$ c. c. & f. for 96 test Centrifugals as being at or very close to the bottom level.

New York, Feb. 6, 1909.

Sugar Notes.

The will of Tirso Mesa y Hernandez, a native of Cuba, but a citizen of the United States, who was shot and killed on November 29 last on his sugar estate in Matanzas Province, was filed in the Surrogate's office January 3, New York City, and disposes of an estate valued at \$1,500,000. The estate is bequeathed to Eustaquio Cardoso.

Of the \$133,000,000 worth of cane sugar

imported into continental United States in the fiscal year 1908, Cuba contributed \$58,000,000 worth, Porto Rico \$19,000,000 worth, the Hawaiian Islands \$40,000,000 worth, and the Dutch East Indies \$11,000,000 worth.

Jacinto Alsina Roca, one of the wealthiest sugar planters of this province and owner of the Santa Rita sugar mill, died, January 23, at Mauzanillo, after a severe illness.

CABLE ADDRESS: Turnure.

NEW YORK,
64-66 Wall Street.

LAWRENCE TURNURE & CO.

BANKERS

Deposits and Accounts Current. Deposits of Securities, we taking charge of Collection and Remittance of Dividends and Interest. Purchase and Sale of Public and Industrial Securities. Purchase and Sale of Letters of Exchange. Collection of Drafts, Coupons, etc., for account of others. Drafts, Payments by Cable and Letters of Credit on Havana and other cities of Cuba; also on England, France, Spain, Mexico, Puerto Rico, Santo Domingo, Central and South America.

CORRESPONDENTS:

HAVANA—N. Gelats y Ca.
MEXICO—Banco Central Mexicano.

LONDON—The London Joint Stock Bank, Ltd.
PARIS—Heine et Cie.

FRANKLIN H. KALBFLEISCH CO.

Manufacturing Chemists

Aqua Ammonia
Acetic Acid
Sulphuric Acid
Muriatic Acid
Nitric Acid
Phosphoric Acid

Agua Amoniaco
Acido Acético
Acido Sulfúrico
Acido Muriático
Acido Nítrico
Acido Fosfórico

y Productos Químicos Pesados para todos propósitos.

Se mandan Listas de Precios á petición.

**BROADWAY AND SIXTEENTH STREET, NEW YORK
WORKS**

Brooklyn, N. Y.; Waterbury, Conn.; Erie, Pa.; Elizabeth, N. J.

LINK-BELT COMPANY

299 BROADWAY, NEW YORK CITY

CONVEYORS

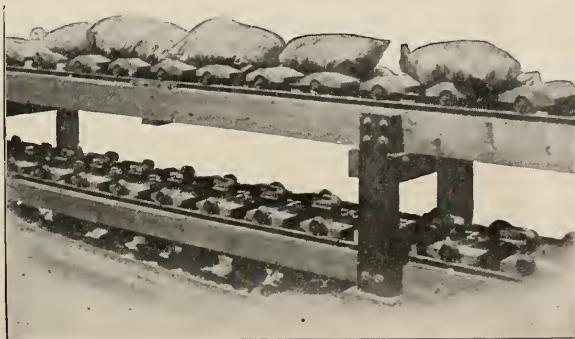

The one illustrated can be used to carry barrels as well as bags —an indication of the adaptability of Link-Belt Apparatus.

SEND FOR CATALOG

REVISTA AZUCARERA.

Escrito expresamente para la CUBA REVIEW por Willett & Gray, de Nueva York.

Nuestra última revista azucarera para esta publicación estaba fachada el 8 de Enero. Entonces se cotizaban los centrífugas cubanos á $2\frac{3}{8}$ cents., c. y. f., polarización 96 grados, equivalente á 3.73 cents, derechos pagados, y se cotizan ahora á $2\frac{9}{32}$ cents., c. y. f., habiéndose excedido la cotización más baja que hubo en Enero ó sea $2\frac{5}{16}$ cents., c. y. f., en $\frac{1}{32}$ de centavo en libra. El precio de $2\frac{9}{32}$ cents., c. y. f., equivale á 3.64 cents. derechos pagados por la de polarización 96 grados.

La cotización para entrega inmediata era entonces 3.73 cents. la libra, y ahora es 3.64 cents. la libra, lo que acusa una baja de .09 de centavo en libra.

La cotización actual de los centrífugas cubanos es $\frac{1}{32}$ de centavo en libra menos que el precio más bajo alcanzado la zafra anterior, y el tono y tendencia es ahora hacia una pequeña alza, siendo posible que dentro de muy poco se coticen dichos azúcares á $2\frac{1}{4}$ cents. La presente base es 47 cents. los 100 libras menos del equivalente del precio de los azúcares de remolacha de Hamburgo.

La cotización del os azúcares de remolacha en Europa es ahora 10s. el quintal, contra 10s. $1\frac{1}{2}$ en Enero 8.

La molienda en Cuba está ya en todo su apogeo, pues hay 168 centrales moliendo y queda sólo uno que empezará dentro de pocos días. Los arribos á los puertos de embarque comienzan, naturalmente, á ser mayores, y entonces es cuando se hacen por lo general las más bajas cotizaciones de la zafra, de modo que partiendo del poco más ó menos presente precio más bajo del mes de Febrero, puede esperarse una constante subida hasta que al fin la diferencia en el equivalente del precio de los azúcares de remolacha de Haburgo y los centrífugas de Cuba desaparezca. Esta diferencia es ahora de 47 cents. en las 100 libras.

El presente método de vender los azúcares refinados dando solamente 7 días para su entrega, regula el comercio á una demanda constante y uniforme, mientras que anteriormente, vendiéndose sobre la base de 60 y 90 días, el mercado estaba sujeto á muchos períodos de actividad anormal y de calma también anormal. Esa uniformidad en la demanda, tiende á mantener firmes los precios de los azúcares refinados en caso de no haber ninguna especial actividad en las transacciones de los azúcares mascabados, pero puede al mismo tiempo tener un efecto disuasivo en las transacciones con azúcares mascabados, pues los refinadores no están ahora obligados á almacenar la materia prima para ventas anormales para entrega futura. Este hecho, junto con la incertidumbre relative á los cambios en el Arancel, tiende á que disminuya la actividad en la demanda de azúcares mascabados. La agitación con motivo del Arancel comenzará en el Congreso á principios de Marzo, y los cambios que se propone introducir la Comisión de Medios y Arbitrios se desconocen por completo fuera de la Comisión misma. A no ser que se imponga un derecho sobre el café y el té, de los que se ha hablado algo, el cambio en la tarifa del azúcar será poco ó nada, con la excepción de que 300,000 toneladas de azúcar de las islas Filipinas entrarán seguramente libres de derechos en los Estados Unidos. Algunas personas creen que se necesitarán varios años para aumentar la producción azucarera de la Filipinas de las 150,000 toneladas á que asciende al presente á las dichas 300,000 toneladas, pero nuestra opinión es que bastarán ámpliamente dos años para que se realice ese aumento, después de lo cual surgirá la cuestión de qué se hará con lo que exceda de las 300,000 toneladas cuando la producción en dichas islas pase de esa cifra. Para ese tiempo será necesario que nuestro Gobierno adopte un método de prorratear las 300,000 toneladas de entrada libre entre los distintos hacendados de las Filipinas basado en algún plan semejante al implantado ahora en Rusia con respecto á la exportación del excedente de producción de cada refinería. Es posible que la Comisión de Medios y Arbitrios atienda á esta necesidad en su proyecto, pero el asunto no ha sido abordado hasta estos momentos. Parece fácil ahora juzgar con respecto alla probable consumo de azúcar en los Estados Unidos durante la presente zafra, y notar varias circunstancias que tienden á indicar un muy considerable aumento en el consumo. Una de ellas es la ausencia de grandes cantidades de azúcares de remolacha del país en ninguna parte de los Estados Unidos, dejando ver que cualquiera que sea el consumo, habrá de depender casi por completo del refinado de azúcares mascabados de caña.

Al cerrar estas líneas, el tono y tendencia es hacia el alza á $2\frac{1}{4}$ cents, c. y. f., por las centrífugas de polarización 96 grados, como el precio más bajo ó muy cerca de serlo.

Nueva York, Febrero 6 de 1909.

LA DESFIBRADORA "NATIONAL"

Resarce su Costo muy pronto
Estudiense sus Ventajas

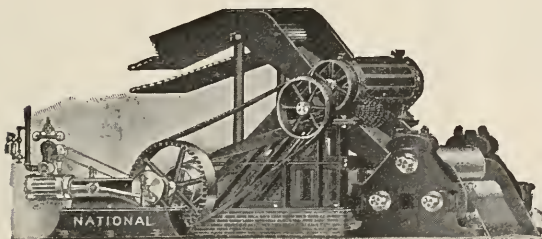

Construimos Desfibradoras de todos tamaños desde cinco toneladas por hora, hasta de 75 toneladas por hora, y además vendemos toda clase de enseres para ingenios de azúcar, y daremos con gusto los informes que se nos pidan.

Nuestras Desfibradoras de Caña "National" tienen patente en todos los países del mundo, y se usan con resultados excelentes en Cuba, Puerto Rico, Santo Domingo, Java, Hawái, México, Yucatán, Guatemala, Argentina, Brasil, Perú, Australia, Trinidad, Madeira, Martinique, Luisiana, etc. Las tienen algunos de los más grandes ingenios de Cuba.

DESFIBRADORA "NATIONAL" PARA CANA, TRABAJANDO CON UN TRAPICHE.
NEWELL MANUFACTURING CO., 149 Broadway, New York

FARQUHAR ARADOS

Así como también las diferentes clases de Implementos Agrícolas y Maquinaria, son artículos tan extensa y favorablemente conocidos en toda la Isla, que es innecesario referirse á la buena clase de materiales y mano de obra empleada, por ser un hecho bien conocido, la buena calidad de los primeros y el gran cuidado con que se procede á la construcción.

Los productos de FARQUHAR ciertamente que figuran en primera línea.

A. B. FARQUHAR & CO.

Cotton Exchange Building, New York City, Manufactureros

Para pormenores dirigirse a nuestros agentes:

Pídanse catálogos. Correspondencia en todos los idiomas modernos.

AMERICAN TRADING CO., CUBA No. 76, HABANA, CUBA

CARROS PARA CAÑA

De todas
clases
Fabricados
de madera
ó ábero

Dirección
Telegráfica
RAMALIAM

RAMAPO
IRON WORKS
170 Broadway
New York, N. Y.

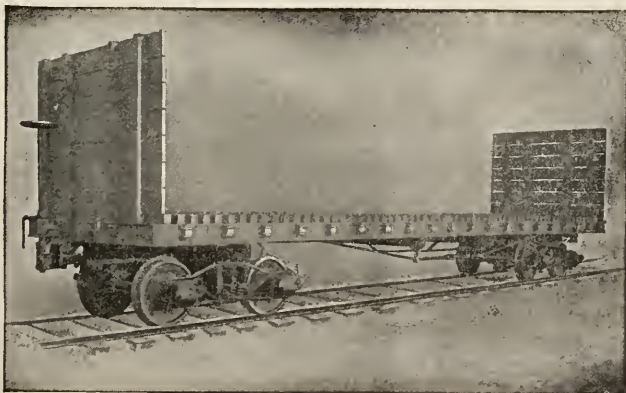

CANE CARS

OF EVERY
DESCRIPTION
OF STEEL
OR WOOD

Cable Address
RAMALIAM

RAMAPO
IRON WORKS

170 Broadway
New York, N. Y.

TWO IMPORTANT MAPS

Blue-prints of Cuba, showing the location of the Sugar Plantations and the Rural Guard Stations of the Island. Specially prepared for THE CUBA REVIEW. Each 60 cents. Either map with a year's subscription, 75 cents. Both blue-prints and magazine, one year, \$1.

The Rural Guard of Cuba

The Sugar Plantations of Cuba



Arados Mejorados para Caña de Azucar

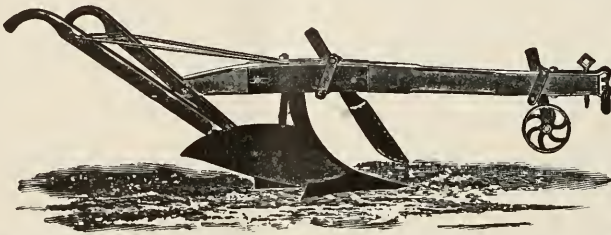

Arados Rompedores Perfeccionados
Sistema de "Hall"

TODOS CON RUEDA y CUCHILLO



HENCH, DROMGOLD & CO.

FABRICANTES

29 Broadway,

NEW YORK, U. S. A.



CANADA LAND AND FRUIT CO.

LOS INDIOS

Owners

ISLE OF PINES

CANADA AND LOS INDIOS TRACTS

Location: Sigüanea Bay. The Deep-Water Harbor of the Island.

We have at our new and progressive town of Los Indios a sawmill, planing-mill, general store, school, hotel, church, post office and nursery, all under the supervision of Americans. A strictly American town.

We also have rowboats and gasoline launch for pleasure parties. Fishing and hunting the best.

We own the finest citrus fruit, vegetable and tobacco land on the island. We offer same for sale in acres to suit purchaser, either for cash or on installments. **Special inducements to actual settlers.**

Write for prospectus and further information to our general office,
Marinette, Wisconsin.

WILLETT & GRAY, Brokers and Agents

FOREIGN AND
DOMESTIC

SUGARS

RAW AND
REFINED
52 WALL STREET, NEW YORK

Publishers of Daily and Weekly Statistical Sugar Trade Journal—the recognized authority of the trade.
TELEGRAPHIC MARKET ADVICES FURNISHED

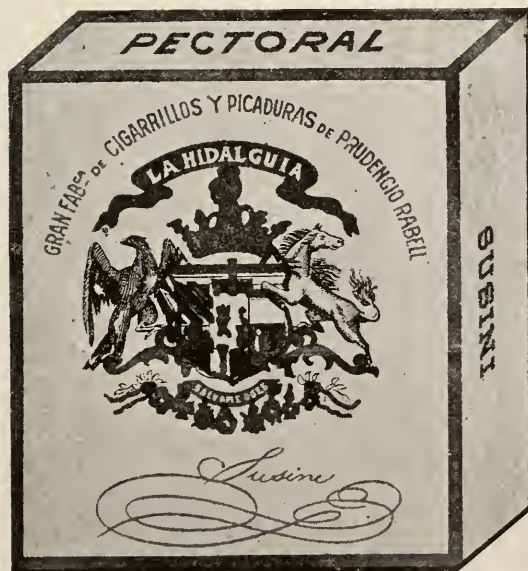

SUSINI

✿ Cork Tip Cigarettes ✿

Pectoral Paper Rice Paper
—: PRICE, 10 CENTS :—

THE BEST CIGARETTE
MANUFACTURED IN CUBA

DEPOT,
Zulueta 10 and Prado 118
HAVANA, CUBA.

MAGNOLIA

THE COMING AMERICAN CENTER

With best of soil, very favorable location, cheap water transportation right through the colony, good water, perfect title, and plans perfected by experience.

At Magnolia we offer you all the delights possible in the most favored land on earth. Here you can grow the largest crops of the finest quality, and the market is at your door.

We produce a very wide range of crops, which sell at top prices.

Write the Cuba Land and Improvement Company, No. 516-517 The Murray, Grand Rapids, Michigan, for literature and full information.

HAVANA

CUBA

National Bank of Cuba

Government Depository

Capital, Surplus and Undivided Profits
\$6,000,000.00

HEAD OFFICE, HAVANA

FIFTEEN BRANCHES IN CUBA

New York Agency, 1 Wall Street

COLLECTIONS

THE TRUST COMPANY OF CUBA HAVANA.

Capital and Surplus \$540,000

Transacts a General Trust and Banking Business

REAL ESTATE DEPARTMENT

Examines Titles, Collects Rents, Negotiates Loans on Mortgages

Correspondence Solicited from Intending Investors

OFFICERS

J. A. Gonzales, President
Norman H. Davis, Vice-President
F. J. Sherman, 2nd Vice-President
O. A. Hornsby, Secretary and Treasurer
J. M. Hopgood, Asst. Treasurer

Offices: CUBA 31, HAVANA

The Royal Bank of Canada

INCORPORATED 1869

Fiscal Agent of the Government of the Republic of Cuba for the Payment of the Army of Liberation

CAPITAL AND RESERVE, \$8,200,000.00
TOTAL ASSETS, . . . \$45,500,000.00

Head Office, MONTREAL

NEW YORK AGENCY, 68 William St.

Branches in Havana: Obrapla 33, Gallano 92; Matanzas, Cardenas, Manzanillo, Cienfuegos, Camaguey and Santiago de Cuba.

ESTABLISHED 1844

H. UPMANN & CO. Bankers

TRANSACTION A GENERAL BANKING BUSINESS
CORRESPONDENTS AT ALL THE PRINCIPAL PLACES OF THE ISLAND

Safe Deposit Vaults

Manufacturers of the Famous H. Upmann Brand of Cigars

FACTORY: Paseo de Tacon 159-163
OFFICE: Amargura 1-3

Established 1876

N. GELATS & COMPANY

Bankers

Transact a general banking business.

Correspondence at all the principal places of the island.

SAFE DEPOSIT VAULTS

Office: Aguiar 108

MOLINA BROTHERS

Customs Brokers

Forwarders, Lighterage and Ship Agents

Officios 52, Havana

H A V A N A

United Railways of Havana

Cuba's First and Foremost Railroad. (First Section opened to Traffic in 1837)

Takes you to All Parts of the Island East of Havana Comfortably and Quickly through Varied and Beautiful Scenery and Past Extensive Sugar Plantations

Parlor, Observation and Sleeping Cars attached to principal trains.

Full information and through tickets to all points in Cuba reached via the United Railways of Havana can be obtained of the following:

Thos. Cook & Son
Seaboard Air Line R. R.
Foster & Reynolds
Atlantic Coast Line R. R.
Illinois Central R. R.

Ward Line
Florida East Coast Railway
Washington Southern Railway
Peninsular & Occidental SS. Co.

Southern Pacific R. R.
Mobile & Ohio R. R.
Raymond & Whitcomb Co.
Louisville & Nashville R. R.
Munson Line

LA AMBROSIA

MANUFACTURERS of the well-known brand of Chocolate, "LA AMBROSIA," Biscuits, Macaroni, Bonbons, all kinds of Confectionery

GUAVA PASTE AND EXTRA FINE GUAVA JELLY

ORDERS RECEIVED FOR EXPORT

BALDOR, FERNANDEZ & CO.

Sol 21 & 23, Havana, CUBA

Write for quotations.

'PHONE No. 401

P. O. BOX 741

FERNANDO de CARDENAS

CUSTOM HOUSE BROKER

:: Import and Export Agent ::

Munson S. S. Line Building

Obispo No. 1, Havana, Cuba

JAMES S. CONNELL & SON

Sugar Brokers

Established 1836, at 105 Wall Street

Cable Address—"Tide, New York"

I know a great deal about Cuba

Free Information for the asking

Ask Mr. Foster

1 MADISON AVENUE, NEW YORK

Telephone 825 Broad

THE MARINE WORKS

Ship Plumbers and Sheet Metal Workers. Manufacturers, Suppliers and Repairers of Steamship Galley and Cabin Utensils; Tanks, Lights and Ventilators. Tinning of every description.

31 Coenties Slip

New York

H A V A N A

THE HERRADURA LAND COMPANY

Office: No. 3 Bernaza Street, Habana, Cuba
 CAPITAL, \$440,000.00

Own 22,000 acres of land in the Province of Pinar del Rio, suitable for Oranges, Vegetables, Cotton, Corn and Tobacco. The land has all been surveyed and sub-divided into 40-acre tracts and is offered for sale in acres to suit the purchasers, for Cash or on instalments.

We have a new and progressive American town with Railroad Station, Telegraph, Telephone, Stores, Hotel, American School, all within short distance from Havana City.
 Titles perfect. Transportation from Havana free for buyers.

WRITE OR CALL FOR INFORMATION.



FRUITS, NUTS AND FLOWERS

May be had in abundance by planting of trees and plants grown for the section where they are to be matured. Glen Saint Mary Nurseries were established to supply nursery stock for Southern planting.

TABER'S TREES THRIVE

Our ideal climate and soil enable us to grow to perfection Southern Trees and Plants, as Citrus, Grapefruit, Peaches, Pecans, Persimmons, Roses, Shade Trees and Vines. *Catalogue free.*
 GLEN SAINT MARY NURSERIES COMPANY, Box 41, Glen Saint Mary, Florida

PASO ESTANCIA—Oriente Province—Cuba

The healthiest and most fertile spot on the island, in the rich valley of the Cauto River 400 feet above sea level.

One of the prettiest spots in Cuba.

Paso Estancia is right on the main line of the Cuba Railroad, only 40 miles from its terminus at Nipe Bay, 39 miles from Santiago.

The soil is rich, dark, sandy loam; no rocks or swamps.

Two hundred acres now under cultivation demonstrate by prolific production the richness of the soil.

A comfortable hotel at **Paso Estancia** accommodates visitors.

Paso Estancia offers the best opportunities in Cuba.

Choice land on easy terms.

Visit there and confirm all we say. You will be well received.

Full particulars
 from - - -

Cuba Properties Limited

56 Bank of Ottawa Bldg.
 MONTREAL

111 German Savings Bank Bldg.
 NEW YORK

Paso Estancia
 CUBA

Free Information about Cuba.

NO FEES, NO COMMISSIONS.

Complete, definite, valuable information.

Ask Mr. Foster, 1 Madison Avenue, New York.

HENRY E. BROWN
 Pharmacist

Shipping and Export Chemist and Drug-
 gist, Ships' Medicine Chests Furnished and
 Replenished. Prescriptions Compounded
 by a Graduate in Pharmacy.

Trusses, Surgical Appliances, etc.

Office and laboratory, Room 36.

116 BROAD ST., NEW YORK

Telephone Call: 274-A Hamilton.

JOHN M. DONOVAN

13 Summit St. (Atlantic Dock) - BROOKLYN

Dealer in

Dunnage Mats

FOR BAG FLOUR, BAG AND BULK GRAIN
 AND GENERAL CARGOES.

— BAGS AND BAGGING —

MOBILE, ALA.

HOME INDUSTRY IRON WORKS Engines, Boilers and Machinery

Manufacturing and Repairing of all kinds. Architectural Iron and Brass Castings. Light and Heavy Forgings. All kinds of Machinery Supplies.

Steamship Work a Specialty

A. KLING, Prop.
JAS. S. BOGUE, Supt.

MOBILE, ALA.

The Principal Hotels in Mobile, Ala.

THE CAWTHON
(FIREPROOF)

THE BIENVILLE
(MODERN)

European, 175 Rooms

European, 150 Rooms

\$1.50 Up

\$1.00 Up

Both Hotels in Heart of City, Facing Bienville Square

Cable Address: Pitchpine, Mobile, Ala.

CHICAGO LUMBER & COAL CO.

MANUFACTURERS AND SHIPPERS OF

Pitch Pine—Export and Interior

Docks at MOBILLE, ALA., and PORT ARTHUR, TEXAS.

General Offices: ST. LOUIS, MO.

Office Export Department: MOBILE, ALA.

OLLINGER & BRUCE DRY DOCK CO. Ship Builders and Repairers

Operating seven Sectional Dry Docks, capacity 1,000 tons, and one Balance Dock, capacity 3,000 tons. Equipped with Air Plant for operating Pneumatic Tools, and Steam Pump for cleaning vessel's bottoms.

25-TON DERRICK BARGE AND STEAM PILE DRIVER.

Material of all kinds kept on hand. Shipwrights, Caulkers, Painters, Sparmakers and Riggers furnished promptly, and at reasonable rates. Correspondence solicited.

MOBILE, ALA.

I can sell your land in Santa Clara, Camaguey, or Oriente Provinces, if anyone can. Have calls for town lots to 100,000 acre tracts. Titles must be perfect. Agents everywhere, more wanted.

IF YOU WANT TO BUY LAND OR PLANTATION STOCK, CALL ON ME, OR WRITE,

GEO. T. STREET,

CUBAN LAND AND INVESTMENTS

Camaguey, Cuba

BARTLE

Twenty-five thousand acres of the richest and best watered land in Cuba on the main line of the Cuba Railroad, with the finest station on the line, 120 miles from Nipe Bay—the best harbor on the Island; also the nearest to New York. No swamps or insect pests.

BARTLE is not in the wilderness—we offer all the comforts of civilization, GOOD STORES, HOTEL, CHURCH, SCHOOL, SAW-MILL, Etc.

TWO MAILS DAILY.

SUGAR, FRUITS, TOBACCO AND VEGETABLES produce wonderful crops at BARTLE.

When you consider Soil, Transportation, Social, Religious and Educational advantages, BARTLE offers something not to be had elsewhere in Cuba. Write for particulars.

"Ten Days in Cuba," just published by Hon. Nicholas J. Whalen, Speaker of the Michigan Legislature, may be had through newsagents at 25 cents per copy, or will be sent free to any address by the owners of the Bartle Colony. Address, Duncan O. Bull, Gen'l Mgr. Cuban Realty Company, Limited, Temple Building, Toronto, Can., or 141 Broadway, New York City.

DUNCAN O. BULL, General Manager

CUBAN REALTY CO., Ltd. Temple Bldg., Toronto, Canada
141 Broadway, New York **Bartle, Cuba**

PURE
DISTILLATION
OF
SUGAR CANE

BACARDI RON

Sole United States Agent

D. S. de JONGH 128 Water St.

BEST MIXER
FOR
HIGHBALLS
AND
OTHER DRINKS

"SUGAR NEWS FROM CUBA"

is the title of the interesting correspondence from the tropical island, appearing in every issue of "THE AMERICAN SUGAR INDUSTRY AND BEET SUGAR GAZETTE."

Capable correspondents, in every part of the world, write regularly, covering reliable sugar news for "THE AMERICAN SUGAR INDUSTRY AND BEET SUGAR GAZETTE."

In the United States, Cuba and Mexico, \$2 per annum. In Foreign Countries, \$2.50 per annum.

Subscribe for it if you want to keep posted. Sample copy free. Send for advertising rates.

Address: BEET SUGAR GAZETTE CO.

No. 5 Wabash Avenue,

Chicago, Ill., U.S.A.

For Free Information about Cuba

Ask Mr. Foster

1 Madison Avenue, New York.

PURDY & HENDERSON, Inc.

Engineers and Contractors

New York Chicago Boston

Cuba Office, Empedrado 32, Havana

THE BIG FOUR ROUTE

3 Daily Trains Each Way 3

Parlor Cars, Sleepers, Dining Cars.

Through Train Service
BETWEEN

Cincinnati, Toledo and Detroit

(Via Michigan Central R. R.)

Ask for Tickets Via

BIG FOUR

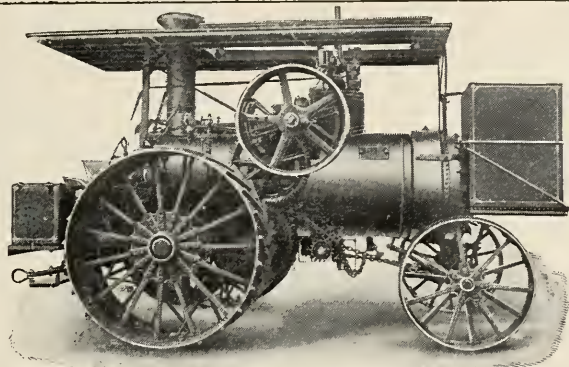

LA NUEVA Máquina de TRACCION HUBER.

Esta máquina es conocida como la mejor para Contratistas ó para Arar.

Está ideada y construida para los trabajos más difíciles sobre caminos ó sobre el campo. Arrastrando grandes pesos ó arando hay una tensión tremenda sobre la transmisión y la rueda volante. Hemos puesto especial atención en la construcción de estas partes, haciéndolas del mejor material que se puede conseguir, de tal manera que hemos conseguido la fuerza mayor posible combinada con el minimum de peso.

Nuestras máquinas alcanzarán mayor fuerza que la estimada y harán mayor cantidad de trabajo y mucho mejor que lo que puede hacerse por medio de caballos, no se diga de buyes.

Tendremos muchísimo gusto en tratar de estas máquinas detalladamente con las personas interesadas en el mejor modo de tracción tanto en carretras, caminos reales, como campo de arado.

Esta máquinas sirven también, mediante un aparato especial, para tirar maderas del monte ó arados por medio de cable de alambre.

Enviaremos catálogos á quienes nos los pidan en español ó inglés.

Para otros informes, sirvanse dirigirse á

THE HUBER MANUFACTURING CO.,
STATION J, MARION, OHIO, U. S. A.

ó á nuestro agente para Cuba, Sr. P. D de Pool, Obispo 7, P. O. B. 1069, Habana.

Ask Mr. Foster

anything about Cuba. No charge, no fees, no commissions. Reliable unbiased information.

1 Madison Avenue, New York.

CAMAGUEY

M. J. CABANA
COMMISSION MERCHANT.

Solicits Correspondence from all the important cities of the United States of America.
P. O. Box 3, Camaguey.

Years ago P. R. Williams and John Kerr, Americans, were in the banking business in Santiago de Cuba. In the troublous times which then existed they hid a vast amount of money belonging to their clients. They were accused of looting their bank and fled. Williams was captured and shot. Kerr, with his wife, escaped to Buenos Ayres. Five years later Kerr sent his wife to Oakland, Cal., entrusting her with the secret of the hidden wealth. Subsequently he died.

Mrs. Kerr, on her deathbed, intrusted the secret to Mrs. Smith, her nurse. Through A. J. Inger, her nephew, the interest of Adolph Ottinger and John H. Young was enlisted. Ottinger agreed to finance the

party. They are all residents of San Francisco.

The four departed for Santiago last May. They found the building designated. After some difficulty they rented the ground floor. In the basement they pried up the floor and began to dig. They came upon a small underground chamber. They found two iron chests and a wooden chest, but empty. Scattered near them, however, they found \$1,243 in Spanish gold and a valuable ring.

The searchers found a small tunnel hewn through the solid rock and leading from the treasure chamber to a little bungalow five hundred yards from the building. Inquiry revealed the fact that a few years ago a mysterious priest, coming from Buenos Ayres, had rented the bungalow. After a stay of about a year, during which time he had fenced in the place and lived the life of a recluse, he had departed. The inference is that Kerr, despairing of his wife's ability to recover the treasure, had imparted the secret to the priest. The latter alone had come to Cuba, had hewn his way through the rock and reached the treasure. —Herald, (N. Y.), July, 20, 1908.

BUSINESS FIRMS OF CAIBARIEN

ANGEL MATA

Comerciante.
Caibarién, Cuba.

Apartado 114. Cable: *Mata.*"

Ferretería, Mueblería y Locería
LA LLAVE

DE INCHANSTI Y HNO.
Caibarién, Cuba.

Marti 11 y 13. Apartado 24.

R. CANTERA Y CA.

(S. en C.)

Comerciantes Importadores,
Escobar 28. Caibarién.

A. ROMANACH

Almacenistas Importadores de Viveres,
(S. en C.
Caibarién.

P. B. ANDERSON,

Ship Broker. U. S. Consular Agent,
Caibarién, Cuba.
Agent for Munson Steamship Line and Lloyds.

MARTINEZ & CO., S. en C.

Comerciantes Banqueros,
Importadores de Viveres,
Exportadores de Azucar.

Apartado 115. Telegrafo: Urquiza.

COMERCIO,

Hotel - - Restaurant - - Cafe
De José Urquiza.

Calle de Marti nums 16 y 18 - - Caibarién

LA MARIPOSA DE EVARISTO BERGNES

Importador de Peletería y Talabartería, Fabricante
de Calzado.
Caibarién.

Apartado 104. Telegrafo: "Bergnes."

YMAZ Y CA.

Ymportadores de Ferretería en General.
Apartado de Correos Num. 15,
Caibarién, Cuba.

Calle Justa Num. 27. Cable: "Imaz."

ARIAS Y COMP

Provisiones, Loza y Muebles.
Cuba Num. 20, Esquina a Marti,
Caibarién, Cuba.
Correo Apartado Num. 15. Telegrafo: "Arias."

ZARRAGA Y CA.,

Caibarién, Cuba.

Casa Banca. Exportadores de Azucar.

BONIFACIO DIAZ,

Gran Peletería y Sombrería.
Marti 17 - - Caibarién
Constantes novedades en los dos giros de esta casa.

RODRIGUEZ Y VINA, S. en C.,

Almacenistas Importadores de Viveres en General,
Comisiones y Consignaciones,
Consignatarios de Buques.

"Depositos de Carburo."

Telephone, 33 Hamilton
Night Call, 411 Hamilton

Cable Address:
"Abiworks," New York

Atlantic Basin Iron Works

Engineers and Boiler Makers

Machinists, Plumbers, Tinsmiths, Pipe Fitters, Blacksmiths, Coppersmiths,
Pattern Makers, Sheet Iron Workers. Iron and Brass Castings. Steamship
Repairs a Specialty.

Cor. Imlay and Summit Streets

Brooklyn, N. Y.

John Munro & Son

Steamship and
Engineers' Supplies

13 Conover Street, Brooklyn, N. Y.

Cable Address: Kunomale, New York

Telephone, 196 Hamilton

Telephone
215 Hamilton

Box 186
Maritime Exchange

YULE & MUNRO SHIPWRIGHTS

Caulkers, Spar Makers

Boat Builders, Etc.

No. 9 SUMMIT STREET

Near Atlantic Dock BROOKLYN

WINTER HAVEN NURSERIES

A. M. KLEMM, Proprietor

Established 1884.

Winter Haven, Fla.

Wholesale Growers of Citrus Stock of the best commercial varieties. We guarantee our extensive Stock to be well grown, free of insects and true to name.

Silver Cluster Grape Fruit our leading Specialty.

Prices right. Grading and Packing perfect.

Write for Catalogue.

The Standard Guide to Cuba—

Reliable—accurate—maps—illustrations.

50 cents.

FOSTER & REYNOLDS, 1 Madison Avenue, New York.

BUSINESS FIRMS OF SANTIAGO

E. GIRAUDY & CA.
ALMACEN DE VIVERES
 Marina baja n. 33, Santiago de Cuba.
 Agentes de Schlitz Beer.

JULIAN CENDOYA
 Steamship Agent and Broker
COMMISSION MERCHANT
 CABLE: Cendoya. Santiago de Cuba.

VALLS, RIBERA & CA.
 (S. en C.)
 Importadores de Ferreteria y Machinery.
 Telégrafo: Valribe.
 Santiago de Cuba y Manzanillo.

A. B. C. Code, 5th Edition. Telephone, 190.
 P. O. Box, 95. Cable address: SILVAPA.

SILVA Y PARRENO H.
 General Commission Merchants.
 Custom House Brokers—Forwarding Agents.
 Consignees of the Cuban steamers of the Carlos J. Trujillo, S. en C., Line, formerly Menéndez & Co.
 References:—J. Cendoya and Nat'l Bank of Cuba.

CAMP HERMANOS, Santiago de Cuba.
 Ron Selecto "Golondrina" y "Carta Cuba."
 Medalla de Oro, St. Louis, 1904.

RON BACARDI
DE BACARDI & CO., Distillers, Proprietors.
 43 San Ignacio, cor. Santa Clara, Havana,
 Santiago de Cuba.

LARREA Y BESEALIE
 Importers of General Groceries and Exporters of
 Cocoa, Wax, Honey and Woods.
 Apartado 65, Marina Baja 46. Cable: Larrea.

Importación. Exportación.
L. ABASCAL Y SOBRINOS
 Agentes de las líneas Pinillos Izquierdo y Ca., de
 Cadiz. Larrinaga y Ca., de Liverpool. Compañía de Seguros, Aachen & Munich, Aix-la-Chapelle.

BROOKS & CO.
 Bankers and General Commission Merchants.
 Santiago and Guantánamo.

A Knowledge of Spanish Indispensable.

American youths who wish to add Spanish to their linguistic equipment should copy the example of the studious young Germans. A German clerk on his way out to the Americas will work away on his Spanish grammar on shipboard, and directly he lands he will make use of whatever he has acquired in the way of useful phrases; he makes of his native interlocutors so many teachers of pronunciation. The fine points in grammar and pronunciation—and they are many—he does not trouble himself greatly about at first, leaving to a later time the perfecting of himself in the details of the language. But from the very beginning he does not neglect the grammar, that basis of all accurate knowledge.

Notwithstanding the depression in all lines, young men well qualified are in demand, and in fact are difficult to secure even at high salaries; but there are few places for the man of one language, or for the man who has but a smattering of two or three. Nor are there many opportunities for the man who wants to come to Spanish-America and be taught his business and the language. The country wants prepared men who can do a definite task and who have the linguistic preparation to deal with the people in their own tongue.—U. S. Gov. Report.

While the finest Cuban tobacco has less than 2 per cent. of nicotine, the rank-est Kentucky tobacco contains nearly 8 per cent.—Mobile (Ala.) Herald.

VINEGAR BEND LUMBER CO.

Manufacturers and Exporters

Long Leaf Yellow Pine Lumber and Timber

Cuban Business Our Specialty VINEGAR BEND, ALA., U. S. A.

Daily Capacity, 200,000 Feet

Cable Address: "TURNER"

Codes: A B C, Fourth Edition; Southards; Watkins; Western Union



SOBRINOS DE BEA & CO.

Bankers and Commission Merchants
Importación directa de todas las centros
manufactureros del mundo.

Agents for the
Munson Steamship Line, New York and
Mobile.

James E. Ward & Co., New York.
Serra Steamship Company, Liverpool.
Vapores Transatlánticos de A. Folch & Co.
de Barcelona, España Independencia
Street 17/21.
MATANZAS, CUBA.

JOHN W. McDONALD

COAL, WOOD, LUMBER
and TIMBER of Every
Description

112 WALL STREET

Near South Street NEW YORK

Yard: 58-68 Beard Street, Erie Basin
Telephones:

Office, 1905 John Yard, 316 Hamilton

Gen. Gomez is said to be a strong man, adequate to his tasks. If Menocal means all that he says when he declares that the Conservatives will not start a revolution, but "will aid the Liberals to carry on the government," Gomez's heavy task will be perceptibly lightened.—N. Y. Mail and Express.

"The Comfortable Way"

Between the East and the West is
via the Toledo, St. Louis and
Western Railroad

"Clover Leaf" Route

Rates lower than by any other
direct line. Send four cents in
stamps for copy of "Get Out or
Get in Line," a booklet by Mr.
Elbert Hubbard, Chief of the Roy-
crofters.

GEO. J. CHARLTON,
General Passenger Agent,
Chicago, Ill.

THE SNARE AND TRIST COMPANY

CONTRACTING ENGINEERS

Steel and Masonry Construction
Piers, Bridges, Railroads and Buildings

We are prepared to furnish plans and estimates
on all classes of contracting work in Cuba.

N. Y. Office
143 LIBERTY ST.

Havana Office
LA LEAL BUILDING

W. H. Bennett

F. W. Hvoslef

Bennett, Hvoslef & Co.

18 Broadway, New York

Steamship Agents and Ship Brokers

Cable: "Benwalsh"

MUNSON STEAMSHIP LINE

NEW YORK-CUBA SERVICE

PASSENGER AND FREIGHT

SAILINGS SUBJECT TO CHANGE WITHOUT NOTICE

| Steamer | New York | Nipe | Nuevitas | Nipe | Banes | Gibara and Vita | Pto. Padre | Nuevitas | Nipe | New York |
|-----------------|----------|---------|----------|--------|--------|-----------------|------------|----------|---------|----------|
| | Sail | Arr. | Arr. | Arr. | Arr. | Arr. | Arr. | Sail | Sail | Arr. |
| Curityba | Feb. 24 | | Mch. 1 | Mch. 3 | Mch. 5 | Mch. 6 | | Mch. 11 | Mch. 12 | Mch. 17 |
| Olinda | Mch. 10 | Mch. 15 | Mch. 17 | | | Mch. 20 | Mch. 23 | Mch. 25 | Mch. 26 | Mch. 31 |

Steamers sail from PIER 9, EAST RIVER, foot of Old Slip, New York

FREIGHT ONLY

NEW YORK TO CAIBARIEN, MATANZAS, CARDENAS AND SAGUA

MOBILE-CUBA SERVICE

FREIGHT ONLY

REGULAR SAILINGS MOBILE TO HAVANA AND MOBILE TO NORTHSIDE AND SOUTHSIDE CUBAN PORTS

BALTIMORE-COLON SERVICE

FREIGHT ONLY

REGULAR SAILINGS BALTIMORE TO COLON

FOR RATES, RESERVATIONS OR OTHER INFORMATION, ADDRESS

MUNSON STEAMSHIP LINE

GENERAL OFFICES

82 BEAVER ST. NEW YORK

Lillie Multiple Evaporators

Model of 1904-1905 (Patented)

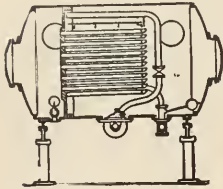

Model 1904-1905
ECONOMY its **BOAST**

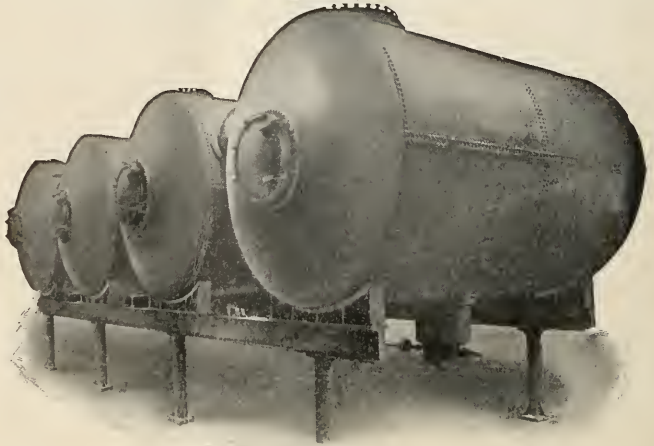

Lillie Quadruple effect for Nipe Bay Co., Cuba (Model 1904-1905. Condensers not shown.) Capacity, 600,000 gallons cane juice per 24 hours.

Apply for reading matter and information to

The Sugar Apparatus Manufacturing Co.

328 Chestnut St., Philadelphia, Pa.

M. MORRIS LILLIE, President

LEWIS C. LILLIE, Secretary and Treasurer.

BALDWIN LOCOMOTIVE WORKS

Broad and Narrow Gauge Simple Expansion and Compound

LOCOMOTIVES

Compressed Air Locomotives. Electric Locomotives with Westinghouse Motors



PLANTATION LOCOMOTIVES

For all Gauges of Track. To meet all conditions of service. Specifications furnished on application.

BURNHAM, WILLIAMS & CO.

Philadelphia, Pa., U. S. A.

Cable Address: "Baldwin, Philadelphia"

Agents for Cuba, Krajewski-Pesant Co., Aguiar 92, Havana, Cuba.

THE CVBA REVIEW



50 Cents A Year MARCH 1909 5 Cents A Copy
Published by the Munson Steamship Line-82-92 Beaver Street, New York City.

Ceballos "The Garden Spot of Cuba"

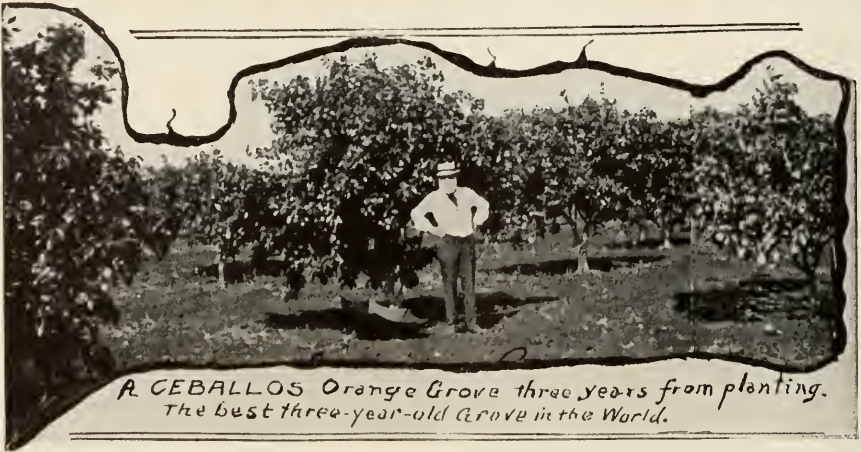

*A CEBALLOS Orange Grove three years from planting.
The best three-year-old Grove in the World.*

The **TIME** to invest in Cuba is now The **PLACE** is in the "Garden Spot," Ceballos
The **OPPORTUNITY** is offered by the Development Company of Cuba, owners of Ceballos

Write for information to

Geo. H. Gillett, Secretary, **43 Exchange Place, New York**

"PRATT IMPERIAL"

**Sugar Cane Machinery and Evaporating Apparatus.
Complete Plants Erected and Delivered to Owner Under
Guaranteed Capacity of Mills and Quantity.
Sugar House Pumps.**

We also solicit your business for our newly developed line of
Pratt **COTTON OIL MACHINERY** ;
Pratt **STEAM PUMPS** ; **SPECIAL PARTS** of
MACHINES, any size or kind ; and
HEAVY CASTINGS famous for quality.

We maintain Export Sales Offices at 80 Wall St., New York, in charge of
Mr. N. A. Helmer, an eminent Sugar Mill Engineer of wide experience. We
solicit your business with the assurance of every courtesy and perfect satisfaction.

Pratt Engineering & Machine Co. **ATLANTA, GA.**
U. S. A.

Successors to FULTON FOUNDRY & MACHINE WORKS, Atlanta, Ga.

**NIVELADOR PARA CAMINOS, MÁQUINA PARA HACER SEMILLEROS,
MÁQUINA DE ABRIR ZANJAS DE IRRIGACION, APLANADOR, Y
APARATO PARA TODO MOVIMIENTO DE TIERRAS EN GENERAL.**

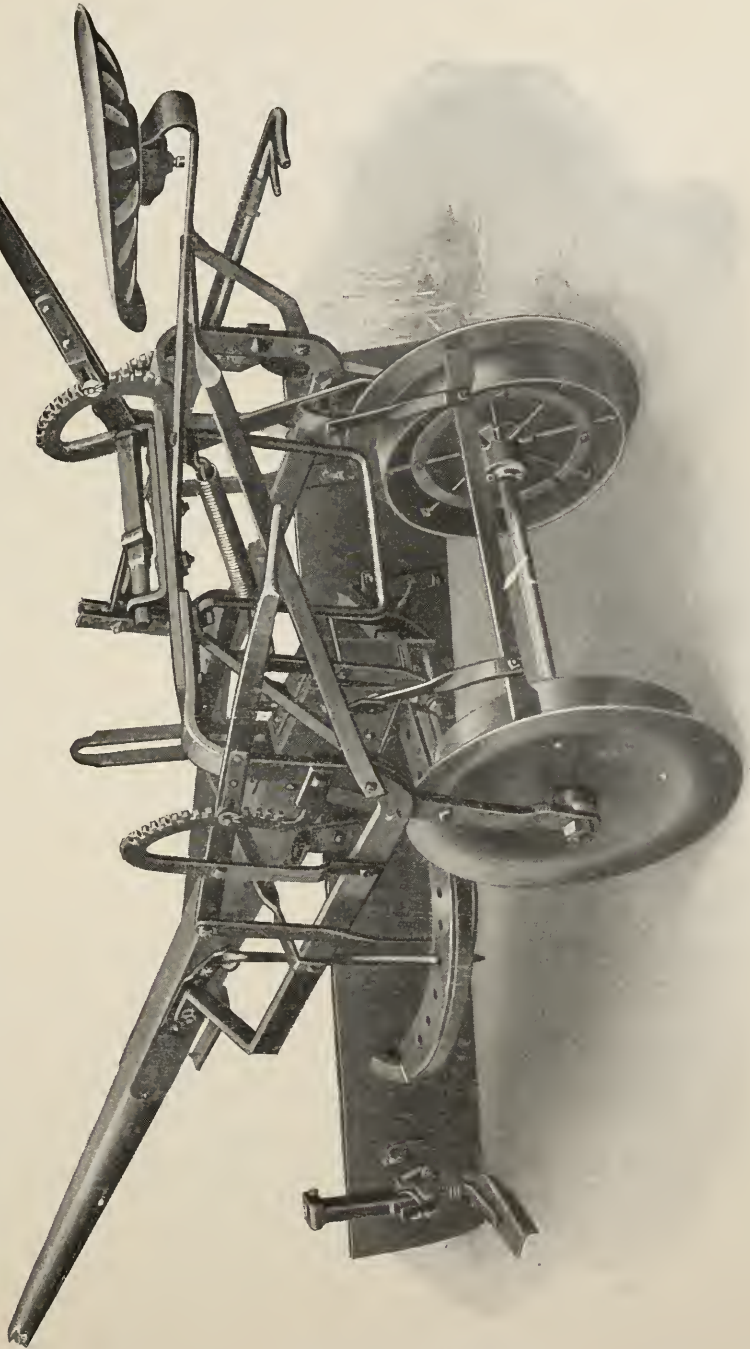

**THE
20th
CENTURY
GRADER**

=====
Pídase el libro
ilustrado, que
explica como
se hacen todos
los trabajos de
esta clase. Á
petición, se
mandan gratis
el libro y un
catálogo es-
pañol.

J. S. BARRON

=====
Barron
Building
NEW YORK
U. S. A.

ARTHUR **KOPPEL** COMPANY

**Consulting Engineers and Manufacturers of
Industrial and Portable Railways**

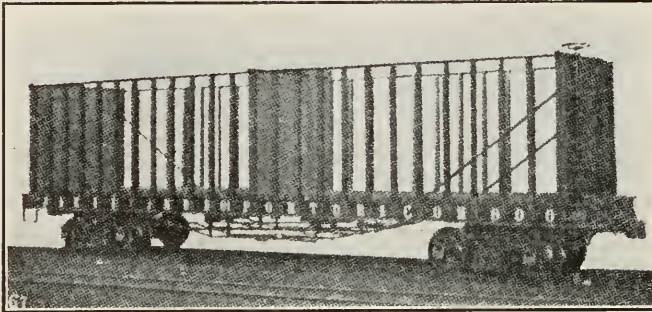

COMPLETE OUTFITS

FOR

PLANTATION RAILWAYS

STEEL AND WOODEN CANE CARS

2-30 TONS CAPACITY

TRUCKS AND ACCESSORIES FOR CANE CARS

LOCOMOTIVES

RAILS OF ANY WEIGHT

PORTABLE TRACK, SWITCHES, TURNTABLES, ACCESSORIES

Write for Catalogue No. 60

ARTHUR KOPPEL COMPANY

NEW YORK PITTSBURGH CHICAGO SAN FRANCISCO BOSTON
BALTIMORE SAN JUAN SAN PEDRO DE MACORIS

GENERAL AGENTS FOR CUBA: **SCHWAB & TILLMAN,** HABANA.
SAN IGNACIO 76

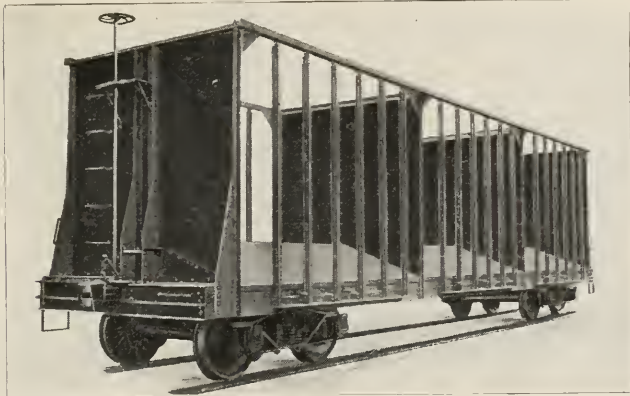

We Build All Classes of

CANE CARS

Large or Small

The Kilbourne &
Jacobs Mfg. Co.

COLUMBUS, OHIO

New York Offices:

25 Broad St. U. S. A.

Tivoli Beer

—*Enough said.*

Havana Brewery

Havana

BUCKEYE NURSERIES

M. E. GILLET, Proprietor

TAMPA, FLORIDA, U. S. A.

ORANGE, LEMON AND GRAPE FRUIT TREES

LARGEST CITRUS NURSERY IN THE WORLD

QUALITY VARIETY DELIVERY

Price may be forgotten—Quality NEVER.

We grow nothing but standard Varieties which we can recommend to the trade as Money-Makers. Having had 29 years' experience we thoroughly understand packing trees for long distance shipments.

We guarantee our trees to be True to Name, Free from White Fly and to ARRIVE AT DESTINATION IN GOOD CONDITION.

Consider the future and protect your investment by planting reliable trees from

THE BUCKEYE NURSERIES

LA GLORIA

The Colony where the Best Oranges are Raised

LA GLORIA FRUIT CARRIED OFF THE BLUE RIBBONS AT THE 1908 EXHIBITIONS OF THE CUBAN NATIONAL HORTICULTURAL SOCIETY AT HAVANA. THERE IS NO OTHER "JUST AS GOOD."

WRITE FOR HANDSOME ILLUSTRATED BOOKLET.

CUBAN LAND AND STEAMSHIP CO.

No. 32 Broadway, New York City



Sugar Plantation—Cuba Railroad.

The Cuba Railroad

This new line completing the railroad connection between Havana and Santiago, and Antilla, on the Bay of Nipe, is of standard gauge and similar in its construction and equipment to the better class of northern lines. All of its important bridges are of steel and masonry, and the line generally is rock-ballasted. The main line passes along the center of the eastern and wider half of Cuba, and opens up a matchless and most picturesque agricultural region, and passes through the tropical forests of mahogany, cedar, lignum vitæ, ebony and many other trees, hung with vines and millions of orchids. Palm trees of magnificent aspect and great variety abound everywhere. The famed Parana and Guinea grasses, covering most of the open districts and standing from six to twelve feet high and green the year round, together with frequent running streams, make this an ideal cattle country. No food has to be put up and no shelter is required. The rich soils everywhere are adapted to sugar, tobacco, cotton, corn and an endless variety of products. The swamps which occur at places along the coasts of Cuba are absent from the interior, which is high, dry and exceptionally healthy. The trade winds blow across Cuba every day, and bring to all parts fresh sea air; the extreme heat of northern summers is consequently unknown and the humidity of other tropical countries is also unknown.



A Corridor, Hotel Camaguey.

The Cuba Railroad Company's **Hotel Camaguey**, at Camaguey (formerly Puerto Principe) is by far the most popular resort in Cuba, Spanish in style, and provided with bath rooms and other modern conveniences, and is first-class in all respects.

This old city has about 40,000 inhabitants, is picturesque and is situated in a beautiful and remarkably healthy district. The hotel is especially favored by those wishing to spend some weeks or months in a matchless sub-tropical climate.



Map of The Cuba Railroad

THE CUBA REVIEW

"ALL ABOUT CUBA"

An Illustrated Monthly Magazine, 82-92 Beaver Street, New York

MUNSON STEAMSHIP LINE, Editors and Publishers

SUBSCRIPTION

50 Cents Per Year - - - - - 5 Cents Single Copy
Advertising Rates on Application

Vol VII.

MARCH, 1909

No. 4

Contents of This Number

The cover page depicts the entrance to one of the great sugar plantations of the Island.

Frontispiece is of the first meeting of President Gomez and his Cabinet.

Pages 9 and 10 are devoted to very interesting activities of the Government and the Cuban Congress.

On page 11 are given a few cartoons of the Cuban situation taken from United States newspapers.

The tobacco crop of Cuba for the last four years will be found on page 12. These very important statistics are compiled especially for THE CUBA REVIEW.

General Notes are on pages 13 and 14. There are Isles of Pines news, labor notes, an illustration of the extension contemplated for the National University of Havana, and other items.

Pages 15 and 16 give valuable information regarding Cuba's financial institutions and railways, together with an illustration on page 16 of the new branch of the National Bank of Cuba at Santiago.

Page 17 is devoted to commercial items and the illustration of the new Court House at Matanzas.

Agricultural matters are on page 18, and a review, with prices of Cuban fruits and vegetables, especially prepared for this publication by Urner-Barry Co., appears on page 19.

The instructive chart on page 20 gives prices of centrifugal sugar at New York for the years 1907-1908.

The annual compilation of the active sugar plantations of the entire Island of Cuba occupies pages 21 to 26.

Spanish Sugar Article by Willett & Gray appears on page 28.

Sugar Review in English on pages 30 and 32.



FIRST MEETING OF PRESIDENT GOMEZ AND HIS CABINET.

At the head of the table is President Gomez, on his left are Dr. José Lorenzo Castellanos, his private secretary and legal adviser; Sr. Justo Garcia Velez, Secretary of State; Sr. Ortello Foyo, Secretary of Agriculture; Dr. Ramon Meza, Secretary of Public Instruction, and Sr. Marcellus de Villergas, Secretary of the Treasury, in the order named. On the President's right are Dr. Octavio Diviño, Secretary of Justice; Dr. Nicolas Alberdi, Secretary of the Interior; Dr. Matias Duque, Secretary of Sanitation, and Benito Lagueruela, Secretary of Public Works.

THE CUBA REVIEW

"ALL ABOUT CUBA."

Copyright, 1908, by the Munson Steamship Line.

Volume VII.

MARCH, 1909.

NUMBER 4.

WORK OF THE CUBAN GOVERNMENT.

Confidence in President Gomez Increasing—Real Fusion Between the Wings of the Liberal Party—Measures Before the House and Senate—Government Appointments and Messages—The Reciprocity Treaty.

Confidence in President Gomez as a safe ruler of the Republic of Cuba appears to be strengthening, and there is a growing feeling that it is now safe to begin work on various important enterprises which have been awaiting assurances of government stability. His grasp of trying situations, many of which threatened to be hurtful if unchecked, is very noticeable. His control over the legislators brought about the defeat on March 8th of the bill prohibiting foreigners from acquiring real estate in Cuba, a bill which might have worked great havoc to the young republic.

Friction developed early in the month between the Miguelistas and the Zayistas, as the two branches of the Liberal party are called, over the division of the offices, and dissension and rupture were predicted, but at several conferences the leaders discussed all complaints amicably, and on March 9th real fusion seems to have been accomplished, both factions agreeing to unite.

Government Appointments, Measures, Etc.

On February 16th President Gomez signed a bill depriving mayors of their appointing and veto powers and giving the power of appointment to the aldermen.

On February 18th the Cuban cabinet resolved to punish all persons publishing unfounded stories calculated to cause alarm, injure the country's credit and impair its business development. Criminal proceedings will be instituted against alarmists. All cable news would also be closely scrutinized.

On February 18th Mr. Grant Duff presented President Gomez with his credentials as British Minister, in spite of the fact that he had previously presented his credentials to Governor Magoon March 4th, 1907. According to *La Lucha*, this means that Great Britain has decided the interesting point whether diplomats accredited to the provisional government should renew their credentials with President Gomez.

On February 24th President Gomez signed the appointment of Carlos Garcia Velez as Minister to the United States. The government at Washington will leave the Taft administration to answer any inquiries that may be made by the Cuban government as to his acceptability. General Velez is the elder son of General Calixto Garcia, who commanded the Cuban army at Santiago. He is a personal friend of Major-General Leonard Wood and Governor Magoon.

On February 26th President Gomez sent a message to Congress asking for the passage of a measure providing for the immediate reorganization of the new regular army which Mr. Magoon authorized when he was Provisional Governor. Such an army, he said, was the best guarantee of peace. He also wants new uniforms, guns and horses. The total cost is estimated at \$1,000,000. This was reported upon favorably by a Senate committee on March 5th.

On March 2d Francisco Carrera Justiz was appointed Cuban Minister to Spain. The post has been vacant since 1906. The new appointee is one of the most prominent attorneys in Havana. This nomination was bitterly opposed March 3d by the anti-Spanish element in the Senate.

Measures Before the House and Senate.

Of the numerous measures introduced into the Cuban House and Senate during the month the following are the more important:
In the House:—

Appropriating \$800,000 for a new post office for Havana.

Increasing the pay of representatives and senators from \$300 to \$400 per month. This was lost by a vote of 50 to 16, and when a member said that healthy, economical measures were necessary and not the increasing of officials' salaries, he was loudly applauded.

Prohibiting the circulation of brass checks and paper vouchers as currency in all the large shops, plantations, etc.

Establishing the lottery in Cuba. The revenue to be used for the construction of bridges and roads in the island. The expenses to be paid from the general revenues of the Treasury Department.

Providing for an eight-hour law for workmen employed by the state, province or municipality, and to include those employed by the contractors doing government work.

To avoid a repetition of cases like the anti-alien bill, which was repealed on March 8th. A parliamentary committee has been organized which will consider all bills prior to their introduction to the House.

Repealing General Wood's order prohibiting bull fights. It was strongly supported, and it is predicted that it will become a law.

Annulling the law regarding cock fighting. On March 10th a bill was introduced confining the sport to Sundays and holidays, and prohibiting it in provincial capitals. All proceeds go to charitable works. The bill is in the hands of a committee. In the Senate:—

Limiting to the President of the Republic the authorization or incorporation of local trust companies or mortgage banks.

Changing the present system of fees paid to registrars of property, reducing the charge by 50 per cent. and making it a salaried office at \$2,000 per year. At present registrars receive a percentage only. Under the percentage arrangement the registrar for the eastern district of Havana alone received, according to the Post, about \$20,000 per year.

An important bill authorizing the creation of mortgage banks which will facilitate loans to planters and others.

Senator Bustamante introduced a bill requiring all steamers entering or leaving the ports either in the foreign or coastwise traffic to be equipped with wireless telegraph apparatus. If passed it will come into effect January 1, 1910.

The Senate confirmed March 1st the nomination of Carlos Garcia Velez to be Cuban Minister at Washington.

The Senate Committee on March 10th resolved to request the President to send with all diplomatic and consular nominations documents proving the nominees' citizenship and freedom from penal antecedents.

An amended amnesty bill was passed on March 5th. It applies to all veterans of the War of Independence convicted of crimes whose sentences do not exceed fourteen years, and to all others except those convicted of unnatural crimes. Eight hundred prisoners were released March 8th, among them being Maso Parra.

The term of Morna Delgado, the negro president of the Senate, ended March 15th. He expects to manage the national lottery.

The Reciprocity Treaty.

March 14th President Gomez and Vice-President Zayas conferred on a new Reciprocity Treaty and agreed with upon preliminary steps, which the latter will take up unofficially with the authorities at Washington. He left Havana for this purpose on March 15th. Concessions on sugar and tobacco are the main objects sought. Cuba's business men are becoming active in the matter, and it is believed that a bill will shortly pass appropriating \$25,000 for the expenses of a commission to Washington for the same purpose. The bill says that if the present treaty is repudiated the harm done to Cuba will be immense and that "since we have special political relations with the United States, we have the right to demand special commercial relations also."

The Cuban Congress adjourned March 15th, and will reassemble April 5th.

President Taft, having received a message of congratulation from President Gomez, replied on March 8th as follows:

"It is my earnest desire that the Cuban people may enjoy uninterrupted peace, prosperity and domestic tranquility, and I offer to them and to you my heartiest good wishes."

VIEWS OF THE UNITED STATES CARTOONISTS.



KEEPING A FATHERLY EYE ON HIM.
—Philadelphia (Pa.) Inquirer.



UNCLE SAM—"NOW, PADDLE YOUR OWN CANOE."
—Jacksonville (Fla.) Metropolis.

A third occupation by American troops would mean the eventual annexation of the country to the United States. This part of the world must have assurance that a populous island at its very gates shall not be a constant threat to health and order.—Troy (N. Y.) Record.

The possession of Cuba would be an undesirable burden to the United States, and one which will not be assumed except upon the compulsion of events which every one hopes will not follow the elections.—N. Y. Press.

Tackling the Cruel, Cruel World Again



READY FOR THE RIDE.
—Fort Worth (Texas) Record.

—Denver (Colo.) News.

**THE TOBACCO CROP
OF THE ISLAND OF CUBA FOR THE YEARS 1905, 1906, 1907 AND 1908.**

Compiled for the CUBA REVIEW by Mendelsohn, Bornemann & Co., New York.

| | Bales | | | |
|-----------------------|----------------|----------------|----------------|----------------|
| | 1905. | 1906. | 1907. | 1908. |
| Vuelta Abajo | 269,661 | 139,346 | 234,012 | 261,095 |
| Semi-Vuelta | 25,704 | 11,886 | 21,885 | 25,024 |
| Partidos | 52,727 | 37,711 | 75,344 | 64,360 |
| Matanzas | 363 | 614 | 904 | 445 |
| Remedios | 119,998 | 87,851 | 93,950 | 194,029 |
| Puerto Principe | 67 | 1,028 | 1,009 | 5,228 |
| Santiago de Cuba..... | 5,097 | 7,852 | 13,641 | 12,878 |
| Total | 473,617 | 286,288 | 440,745 | 563,059 |

Leaf Tobacco.

Export of leaf tobacco from the Island of Cuba for the years 1905, 1906, 1907 and 1908:

| | Bales | | | |
|---------------------------|----------------|----------------|----------------|----------------|
| | 1905. | 1906. | 1907. | 1908. |
| To the United States..... | 245,915 | 257,800 | 180,274 | 236,849 |
| All other countries | 71,172 | 19,626 | 20,398 | 95,478 |
| Total export | 317,087 | 277,426 | 200,672 | 332,327 |

Cigars and cigarettes manufactured on the Island of Cuba during 1905, 1906, 1907 and 1908, and how disposed of:

| | Cigars. | | | |
|---|--------------------|--------------------|--------------------|--------------------|
| | 1905. | 1906. | 1907. | 1908. |
| Exported to the United States of America | 64,680,975 | 79,483,125 | 61,869,131 | 47,669,742 |
| All other countries..... | 162,347,546 | 177,254,904 | 124,559,476 | 141,177,042 |
| Total | 227,028,521 | 256,738,029 | 186,428,607 | 188,846,784 |
| Consumed on the Island.... | 214,515,975 | 196,127,500 | 177,972,390 | 148,165,400 |
| Grand total | 441,544,496 | 452,865,529 | 364,400,997 | 337,012,184 |

Cigarettes.

(Packages of 16 cigarettes)

| | 1905. | 1906. | 1907. | 1908. |
|-----------------------------|--------------------|--------------------|--------------------|--------------------|
| | Exported | 11,829,076 | 15,643,275 | 16,505,104 |
| Consumed on the Island.... | 200,908,743 | 217,960,616 | 210,794,390 | 202,607,018 |
| Total packages | 212,737,819 | 233,603,891 | 227,299,494 | 212,809,914 |

Value of entire tobacco industry of the Island of Cuba approximated for three years, 1906, 1907 and 1908:

| | 1906. | 1907. | 1908. |
|--|------------------------|------------------------|------------------------|
| Export of leaf tobacco valued at..... | \$19,419,820.00 | \$14,960,933.00 | \$18,354,420.21 |
| Export of cigars valued at..... | 16,688,571.88 | 13,112,226.00 | 12,275,040.96 |
| Export of cigarettes valued at..... | 391,081.87 | 449,928.00 | 295,883.98 |
| Export of cut leaf (picadura) valued at. | 203,112.00 | 122,821.60 | 131,576.38 |
| Totals | \$36,702,585.75 | \$28,645,908.60 | \$31,056,921.53 |

Consumed on the Island.

| | 1906. | 1907. | 1908. |
|------------------------------------|------------------------|------------------------|------------------------|
| Value of cigars | \$7,845,100.00 | \$8,898,619.50 | \$6,667,443.00 |
| Value of cigarettes | 4,359,212.32 | 4,637,486.04 | 4,457,354.39 |
| Value of cut leaf (picadura) | 129,842.40 | 161,534.50 | 139,588.00 |
| Totals | \$12,334,154.72 | \$13,697,640.04 | \$11,264,385.39 |
| Grand totals | \$49,036,740.47 | \$42,343,548.64 | \$42,321,306.92 |

GENERAL NOTES.

Interesting News Items From All Parts of the Island.

Isle of Pines News.

Following are the thermometer readings as taken by T. B. Anderson for the seven days ending Friday, Feb. 12:

| | High. | Low. |
|-----------------|-------|------|
| Saturday | 84 | 72 |
| Sunday | 78 | 72 |
| Monday | 75 | 70 |
| Tuesday | 78 | 74 |
| Wednesday | 74 | 70 |
| Thursday | 76 | 70 |
| Friday | 74 | 72 |

Bids for supplies, etc., to reconstruct the bridge across the Casas River at Nueva Gerona. The proposed improvement will, if carried out, constitute the last effort necessary to put the Nueva Gerona-Santa Fe calzada in perfect order.—Isle of Pines News.

The Santa Fe-La Ceiba calzada has been accepted by the government inspectors and found to be in every way according to the specifications of the government engineers.—Isle of Pines Appeal.

Under the new schedule the steamship Veguero sails every Wednesday evening from Batabano on the arrival there of the train leaving Havana at 5.50 P. M. Returning the Veguero leaves Nueva Gerona Friday mornings, arriving at Batabano during the afternoon in time to connect with the train for Havana.

The Cristobal Colon sails from Nueva Gerona, Isle of Pines, Sundays, Tuesdays and Fridays, at 4 P. M., and Jucaro at 6 P. M.

For the island the Colon leaves Batabano Mondays, Wednesdays and Saturdays on the arrival of the train leaving Havana, Villanueva Station, at 5.50 P. M.

Rev. Fathers Casimer and Florencis, Cuban Carmelite priests, are now in Maryland studying the English language. They state that American Catholics have located in Cuba to such an extent that it is imperative that some of the priests come to the United States to learn the language in order that they can hear confessions. The Cuban Carmelites speak words of praise for America and Americans, and think that when all the Cubans have quieted down they will thank God that the Americans have given them their help.—Catholic Messenger, Davenport, Iowa.

Labor Notes.

The longshoremens, workmen and boatmen of the harbor of Cienfuegos want eight hours to constitute a day's work. A committee interviewed the President Feb. 14. He assured them that they could count on his favoring the movement, and that he would have their petition brought to the attention of the legislature.

Feb. 15, President Gomez promised a group of stevedores from Cienfuegos that he would send a message to Congress urging the passage of a bill limiting work to eight hours per day.

Feb. 14 the *Diario de la Marine* said that threatened strikes in Havana were probably inspired at the instance of labor unions, incited by annexationists. It recalls that Samuel Gompers came to Cuba towards the end of 1906, shortly after the provisional government started, and while in the city did not conceal his advocacy of making American control of Cuba permanent.

On March 4 the Captain of the Port, Col. Charles Aguirre, informed President Gomez that a general strike of stevedores was announced for March 8. He also said that the Stevedores' Union want the steamship lines to pay for labor according to tariff order No. 17.

The Negro Problem.

A traveler from Mexico in Cuba found much difference in the population, Cubans being smaller and notably slenderer than Mexicans. Another difference he found was in the presence of the negro and the absence of the Indian. The negro is always a "problem"; the Indian in Mexico is not. The negroes in Cuba do not mix freely with the whites. The race line is, to be sure, not drawn so sharply as in our own country. Yet the substantial white population of Cuba, the indigenous Cuban people, in so far as there is such an element—the old residents—hold themselves firmly aloof from the blacks and the colored people. It is long since the stock was replenished from Africa; and protracted residence, race amalgamation, climatic conditions, and perhaps original traits, have made the prognathous, thick-lipped, kinky-headed, burly type exceedingly rare. The mulattoes of various grades are very numerous, and have had much to do with the public affairs of the island.—Nashville (Tenn.) Christian Advocate.

More and Better Santiago Hotels.

On January 1 a three-story modern hotel building, containing 35 comfortable and well-furnished rooms, was opened to the public. This hotel is situated in the wholesale commercial district, convenient to the railway station and wharves. A few months ago another well-equipped hotel was opened in the central part of the city, and by reason of the competition thus created one of the old-established hotels made some needed improvements, installing new sanitary fixtures and improving the service in many respects. The cuisine is very good in all these hotels.—U. S. Consular report.

On March 1 a postal money order branch was added to the post office at Media Luna, in the Province of Oriente.

University of Havana.

Havana has an excellent university with an attendance of probably four or five hundred pupils. The government is intending to develop this institution, believing that it could furnish an opportunity for Americans to learn the Spanish language. The Secretary of State, Garcia Velez, is an up-to-date statesman and understands English and French thoroughly, and realizes that a knowledge of the Spanish language is becoming important in all branches of the American business. He expects to develop Havana university in a direction which will afford the best opportunities for American students to learn the Spanish language, and, indeed, one could not have a better opportunity in this direction.

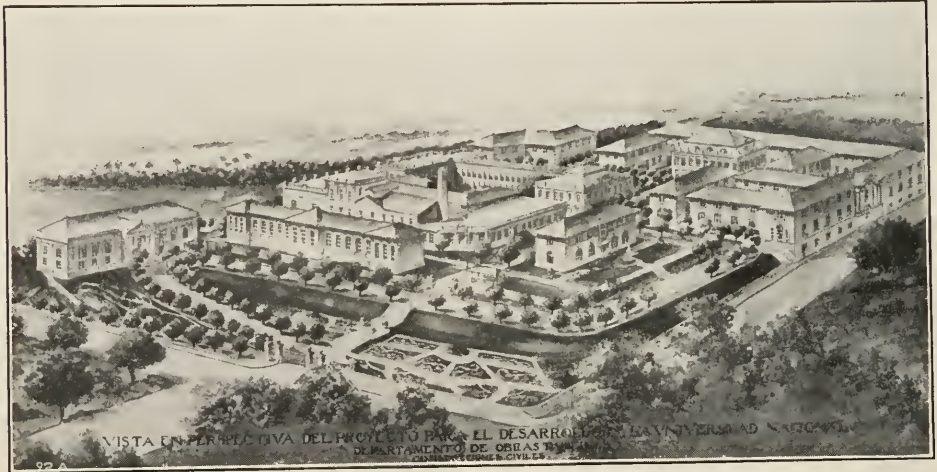

View in Perspective of the Plan for the Enlargement of the National University, Department of Public Works, Civil Buildings, 1908.

President Gomez has granted authorization to establish an electric light and power plant at the town of Sancti Spiritus and furnish light and power to Caibagan and Guayo.

President Roosevelt has ordered that those men who served in the army of pacification in Cuba shall have small bronze medals, struck in commemoration of their good service.

Hail, which is rarely seen in Cuba and practically is a phenomenon in these latitudes, fell Feb. 20 during a heavy wind and rain storm which struck Havana.

The Gas & Electric Light Company of Havana announced recently a 4 per cent. dividend.

Exports of cigars to all parts of the world during the month of December, 1908 and 1907, show the depression which has prevailed in Havana.

1907, 27,409,670 cigars, value, \$1,948,574; 1908, 18,546,756 cigars, value \$1,194,593.

According to official figures, every man, woman and child in Cuba smokes an average of nine boxes of cigarettes per month, and consumes three boxes of matches in lighting them.

The Rev. Robert Routledge, pastor of the First Baptist church, Huntington, Ind., has been called to the presidency of the associated colleges of Cuba, under the direction of the Northern Baptist association. Because of his missionary work in the Spanish countries he is considered especially qualified for the place.

FINANCIAL AND RAILROADS.

National Bank Election.

At the annual meeting of shareholders of the National Bank of Cuba, held at the offices of the bank Feb. 18, the following officers and directors were elected:

Officers.—Edmund G. Vaughan, president; Pedro Gomez Mena, Samuel M. Jarvis, W. A. Merchant, vice-presidents; H. Olavarría, cashier; W. A. M. Vaughan, Ernesto Font y Sterling, A. A. Brown, assistant cashiers; W. H. Morales, secretary; Henry M. Earle, New York secretary; F. Sonderhof, manager foreign exchange department; Alfredo Beale, assistant manager foreign exchange department; Oscar Font y Sterling, counsel; R. E. Ulbricht, comptroller; Haskins & Sells, New York, certified public accountants, auditors.

Directors.—José M. Bérriz, wholesale groceries, vice-president Chamber of Commerce, Havana; Jules S. Bache, of J. S. Bache & Co., bankers and brokers, New York; Ernest Gaye, general agent French Transatlantic Steamship lines, Havana; John G. Carlisle, former Secretary of the Treasury of the United States, New York; Pedro Gomez Mena, wholesale drygoods, Havana, Cuba, and Manchester, England; William I. Buchanan, capitalist, former United States Minister to the Argentine Republic, Buffalo; Oscar Font y Sterling, attorney at law, Havana; Samuel M. Jarvis, capitalist, New York; José Lopez Rodríguez, publisher and wholesale stationer, Havana; W. A. Merchant, vice-president; Ignacio Nazabel, wholesale sugar, president Sugars Company, Havana; Andrew W. Preston, president United Fruit Company, Boston; Edmund G. Vaughan, president.

Havana Bank's Capital Cut.

It was stated Feb. 18 that the proposed reduction in the capital of the Bank of Havana from \$2,500,000 to \$1,000,000 has been definitely decided upon by the committee of directors, which recently went to Havana to decide the bank's future policy. With its reduced capital, the larger capital having been found to be excessively large, it is expected the bank will be able to make a very satisfactory showing.

The New York directors are John E. Gardin, vice-president of the National City Bank, and Alvin W. Krech, president of the Equitable Trust Company. Among the steps taken in connection with the rearrangement of the bank's capital will be a change in the Havana managers of the bank, and new interests may also come into the bank. The purpose of the management of the bank is to conduct a general commercial banking business.

Havana Electric Ry. Bonds.

Notice is given by the Havana Electric Railway Company that, pursuant to the provisions of Article Fourteenth of the mortgage and deed of trust executed by the company to the Morton Trust Company of New York, as trustee, dated November 13, 1900, to secure its second mortgage 6 per cent. gold bonds, it will pay off at par and interest on the first day of April, 1909, the whole of the bonds numbered as follows:

| | | | | | | | | | | | |
|----|----|-----|-----|-----|-----|-----|-----|-----|-----|-----|-----|
| 11 | 86 | 92 | 655 | 661 | 823 | 930 | 936 | 942 | 948 | 954 | 960 |
| 12 | 87 | 286 | 656 | 662 | 824 | 931 | 937 | 943 | 949 | 955 | 961 |
| 21 | 88 | 287 | 657 | 617 | 926 | 932 | 938 | 944 | 950 | 956 | 962 |
| 83 | 89 | 288 | 658 | 818 | 927 | 933 | 939 | 945 | 951 | 957 | 963 |
| 84 | 90 | 289 | 659 | 821 | 928 | 934 | 940 | 946 | 952 | 958 | 964 |
| 85 | 91 | 290 | 660 | 822 | 929 | 935 | 941 | 947 | 953 | 959 | 965 |

Payment will be made at the office of the Central Trust Company, in New York. All bonds presented for payment must be presented with all coupons maturing on and after April 1, 1909. Interest on all bonds then ceases.

Tiburcio Castaneda, a promoter known in Havana, in London and in the United States, visited President Gomez, Feb. 16, and proposed in the name of certain European bankers to make a loan of \$15,000,000 for sewers in Havana and Cienfuegos, which loan Provisional Governor Magoon approved. Señor Castaneda said his bankers were ready to give a better price than Speyer & Co., of New York, gave for the first loan of \$35,000,000 to President Palma, which was 90.

The Cuban government has not decided to make the loan, deciding to try with ordinary funds to pay for indispensable public works, according to the obligation with the United States.

Sir William Van Horne, on Feb. 23, just returned from Havana, said:

"Everybody in Cuba is happy; business is good now, and it will improve steadily. I have every confidence in the future for the island, and am certain that business will have an enormous growth in the immediate future."

QUOTATIONS FOR CUBAN SECURITIES.

Supplied by LAWRENCE TURNURE & CO., New York City, March 6, 1909.

| | | Bid. | Asked. |
|---|-----------|------|--------|
| *Republic of Cuba 5 per cent. bonds | | 102½ | 103½ |
| Republic of Cuba 6 per cent. bonds | | 100 | 101 |
| Republic of Cuba 5 per cent. new bonds (interior loan) | | 91 | 92 |
| Havana City first mortgage 6 per cent. bonds | | 105 | 106 |
| Havana City second mortgage 6 per cent. bonds | | 104 | 106 |
| Cuba Railroad first mortgage 5 per cent. bonds | | 96 | 98 |
| Cuba Railroad preferred stock | No | 60 | 65 |
| Cuba Company 6 per cent. debentures | market | 78 | 85 |
| Havana Electric consolidated mortgage 5 per cent. bonds | in | 87½ | 88½ |
| Havana Electric preferred stock | | 83 | 85 |
| Havana Electric common stock | New York. | 39 | 41 |
| Matanzas City Market Place 8% bonds cfs. | | 103 | 104 |

* All prices quoted on an "and interest basis."

The Camaguey Company, Limited.

Comparative statement of earnings for January, 1908-1909. The Camaguey Company shows a substantial increase in earnings for January, compared with the corresponding month last year, the figures being as follows:

| | Jan., 1908. | Jan., 1909. | Increase. |
|-------------|-------------|-------------|------------|
| Gross . . . | \$7,555.89 | \$11,337.00 | \$3,781.11 |
| Net . . . | 3,924.72 | 5,349.78 | 1,425.06 |

Cuba Eastern R. R. Matters.

Notice is given that the time for deposits of the first mortgage bonds and debentures of the Cuba Eastern Railroad Company, Northeastern Cuba Railroad Company, Cuba Eastern Terminal Company, and the Eastern Railroad of Cuba with the committee under the bondholders' agreement, dated Jan. 24, 1908, has been extended to April 1.

The United Railways.

In the week that ended the 9th instant the United Railways of Havana, including the proceeds from the Mariano Railway, collected £36,619, against £32,961 in the corresponding week of 1908.

The total revenue during the 31 weeks and 4 days of the present fiscal year amounts to £520,646, against £493,766 in the same period of the previous year.

The earnings of the United Railway Company exceed those of last year, the sugar crop is developing under magnificent conditions, and its income will not diminish; the rolling stock, tracks, etc., are in perfect condition and do not demand any extraordinary expense, and there seems little possibility of a strike among the thousands of employees of all classes that render their services to the company.—La Discusion, Havana.



The new building of the National Bank of Cuba, a superb structure in the Greek style of architecture, was opened with much ceremony at Santiago, Feb. 25. Addresses were made by prominent citizens. Among the speakers was Edmund G. Vaughan, president of the institution.

COMMERCIAL MATTERS.

Credit Accommodations—President Gomez on Commercial Union, Etc.

Credit Accommodations.

In an article in the American Exporter on granting credit to foreign customers, the writer gives the following advice regarding the business men of Cuba:

"The principal Cuban houses are noted for their integrity. A country dependent on crops (tobacco and sugar) of course requires credit favors from foreign manufacturers. These may be safely granted to good houses. Cuba merchants are generally disposed to give confidential advice regarding the financial conditions of their fellow merchants. Credit accommodations in out-of-the-way towns in Cuba should be restricted to old-established good houses. Europeans grant a credit of six months to their Cuban customers."

Cuba's purchases in 1908 show a reduction of \$10,000,000. Cuban purchases of structural steel increased from \$422,000 to \$682,000.

President Gomez and Commercial Union.

Where the new Cuban Government stands on the question of closer commercial relations with the United States, so eloquently advocated by the Cuban Minister, Senor Ganzales de Quesada at a banquet of the National Board of Trade at Washington, recently, is emphatically stated in the following dispatch from President Gomez, and which was read at the banquet:

"I earnestly beg you to declare in my name that the future Government of Cuba will devote all its attention to the development of the most cordial relations with the great and generous American people. You will tell them that special consideration will be given by me and my Government to the commercial relations between both countries, which should be as close as if they were those existing between one and the same people. In order to obtain this result Cuba is ready to make all efforts and is disposed to all sacrifices in the confidence that the American chambers of commerce will use their prestige and influence so that their aims shall be reciprocal."

What is this, says the New York Sun, if not an official declaration in favor of commercial union?



Perspectiva de la Audiencia de Matanzas, Departamento de Obras Públicas, Construcciones Civiles, 1908.

Perspective of the Court House of Matanzas, Department of Public Works, Civil Buildings, 1908.

In the calendar years 1906, 1907, 1908, the United States exported locomotives to Cuba as follows:

| | 1906. | 1907. | 1908. |
|--------------|-----------|-----------|-----------|
| Value | \$647,498 | \$716,666 | \$198,916 |
| Number | 69 | 76 | 26 |

The exports of cotton goods to Cuba in 1907 and 1908 from the United States compare as follows:

| | Sq. Yds. |
|------------|------------|
| 1907 | 17,851,224 |
| 1908 | 14,501,039 |

AGRICULTURAL MATTERS.

Keeping Liquid Honey—Packing Limes—Tobacco in the Santa Clara District, etc.

Keeping Extracted Liquid Honey in Florida.

Right near the honey-house door, on the south side of the building, is a shallow box covered with a glass sash, the box and sash being tipped so as to incline toward the sun. In this box are glass jars of honey, I think about all the year round, and this honey stays there in the hot Florida sun until it is used to fill orders. I have just been handling the jars; and although it is between 8 and 9 P. M. the jars are still almost hot. He says that, in the afternoon, they are often too hot to handle, but not so hot as to impair the flavor of the honey. This high temperature, with, perhaps, some other influence from the strong glaring sunlight, is almost a sure preventive against candying, even when these jars of honey stand for days and weeks on the shelves of the retailer; and the longer the honey stays in this "sterilizer" the better it becomes, because it is *thoroughly ripened*. I do not know how common this idea is for ripening extracted honey, but it seems to me every bee-keeper should use this "hot-bed" feature. The same apparatus can, of course, be used for a solar wax-extractor. The sash should be hinged so as to turn back against the wall of the building; and to save lifting, a cord and pulley should be attached so the sash can easily be swung up with one hand.—Mr. Root in Gleanings in Bee Culture.

Packing Limes.

At the Colonial Fruit Show, held in London a few months ago, the following reference to limes in the official report is interesting. The secretary said: "With regard to limes, there is no question that the cases measuring 1 cubic foot, and containing from 200 to 220 fruits, are the most marketable, while, as I have so often pointed out, those limes wrapped in stout brown paper last far longer than those protected by thin tissue paper only."

Keeping Ants From Bee Hives.

I have my colonies on stands or benches. My idea in placing them on stands is to keep the ants away. I put ashes under the stands to prevent the grass from growing. Under each leg of the stands I place small lids, filled with pine tar, which need replenishing about twice during the summer. This is the best remedy I have ever tried.—Gleanings in Bee Culture.

Curing and Packing of Oranges.

Investigations, carried out by officers of the U. S. Department of Agriculture, as to the most suitable methods of transport of oranges from California to the Eastern States of America have been in progress for a considerable time, and the recently issued Bulletin 123 of the Bureau of Plant Industry gives a full account of all the work done.

It is mentioned that in California, as in many other orange-exporting countries, it was the common practice to allow the oranges to stand for a time before packing, with the object of curing or wilting the skin. It was believed that if the fruit were packed in a fresh condition, wilting would occur in the box, and the contents would arrive at the journey's end in a loose and possibly damaged condition. Comparative tests made to ascertain the effect of the preliminary curing showed, however, that except in the early part of the season, the fruit can be packed quite as successfully when the curing is omitted. The skin of the immature fruit is hard, and wilting undoubtedly facilitates the packing process. Later in the season when the fruit is ripe, curing had little influence, since at that stage the skin is naturally pliable.

Cuba's Fertile Lands.

The resources of the island, however, seem as yet to be scarcely touched. Great stretches of inexhaustibly fertile land in the immediate vicinity of Habana lie uncultivated. One sees almost no orange or banana plantations, and only here and there is sugar cane grown in a systematic and wholesale way. Small fruits and vegetables offer all kinds of flattering possibilities. If the government can only remain stable, the country is bound to see within the immediate future an immense increase in the output of its natural products and a consequent vast inflow of the wealth which they will bring.—Editorial correspondence, The Christian Advocate, Nashville, Tenn.

Prizes for La Gloria Fruits.

Three firsts, one second and three third premiums, out of a total of sixteen, is the La Gloria record for exhibits at the recent exhibition in Havana of the Cuban National Horticultural Society.

During January, 1909, Henry M. Burnside, of La Gloria, picked sixteen boxes of good, marketable grapefruit from one eight-year-old tree on his grove.—La Gloria Cuban-American.

CUBAN FRUITS AND VEGETABLES IN NEW YORK.

Tomatoes Arriving Freely and Selling Well. Eggplants, Peppers and Okra Lower in Sympathy with the Decline in Florida. Potatoes Lack Quality.

Especially written for The CUBA REVIEW by the Urner-Barry Company, of New York.

To Date of March 9, 1909.

The receipts of Cuban vegetables in New York have been somewhat larger of late, and with supplies increasing from Florida prices have generally ruled lower. Receipts during the month of February, when nine steamers arrived, reaching here three or four days apart, were as follows: Potatoes, 416 crates; onions, 455 crates; tomatoes, 16,038 crates; other vegetables, 14,589 packages; pineapples, 13,379 crates; oranges, 425 boxes; grape-fruit, 2,534 boxes; other fruit, 514 packages.

The standard package for new POTATOES on this market is the barrel, and any other package is at a disadvantage. This probably was the main reason that the Cuban POTATOES received only brought \$1.65@1.75 per crate, with quality only fair. These crates are so small that it would take four or four and one-half to fill a barrel. As the market is entirely bare of new potatoes at present, those coming from Bermuda and the South being second-crop potatoes, there is no question but what fine Bermuda stock would meet with ready sale and at comparatively high prices, probably \$1 or more above figures obtained for Bermuda second crop. At present latter are selling from \$5.50@7 per barrel. To command attention from best trade, however, potatoes must be carefully graded, of good variety and in strictly sound condition. The few ONIONS received have been held at \$2.75@3 per crate for some weeks past and have sold at those figures to a moderate extent in absence of other new onions.

The market for TOMATOES held steady during the month of February at \$2@2.50 for fancy and \$1.50@1.75 for choice, with unattractive stock lower. Just at the close, however, supply is larger from Florida and market shows some weakness, with sales averaging 25c. lower. EGGPLANTS sold early in the month at \$2.50@4.50 per box, a few fancy going even higher, but market closing lower, late sales not exceeding \$2@3 owing to the larger supplies of, and lower prices ruling for, Florida. OKRA also declined very materially; small "finger" sold during February at \$4@5 per carrier when fancy, with large or coarse down to \$2@2.50 or lower, and the short, chunky variety \$1,50@3, seldom higher, but last week or ten days ago prices have fallen rapidly, and late sales are not exceeding \$1.25@2.25 per carrier as to variety. Early in February PEPPERS sold from \$1.50@2.25, but market has gradually declined and late sales not exceeding \$1@2 per carrier. WHITE SQUASH has been in moderate supply and selling readily at \$1.50@2 per box. Small lots of other vegetables have been received, but hardly in quantity to attract much attention and values not well defined.

STANDARD CARRIERS.—Some Cuban shippers are using a different style carrier, especially for their tomatoes. This carrier is commonly called the "square" carrier and is not strong enough for shipment to this market. Such is the impression of the writer, who has noticed many of the carriers broken and damaged on arrival at the stores of the commission merchants. There is no advantage in using a different style package, and even if it costs a little less the difference is apt to be more than made up by shipping in the standard carrier, which is less flimsy and seems to carry better in transit. Buyers' whims must be catered to, and there is no question but what the usual buyer will show a money preference for a standard package rather than an unknown one which he may think contains a smaller quantity.

PINEAPPLES have arrived rather freely during the past month and have met an active demand at much better prices; in fact, values have steadily advanced, and the situation is so strong at the close that some sales are making even above the figures generally quoted. Late sales of Cuban have been mainly within the following range: 16s, \$1.85@2.25; 18s, \$2@2.35; 24s, \$2.25@2.50; 30s, \$2@2.50; 36s, \$2@2.45; 42s, \$1.50@1.85. These figures are comparatively low considering the rates being obtained for both Porto Rico and Florida pines, which are in fair supply. The Cuban have been wasty in some cases, and this is doubtless the cause of the preference buyers are giving stocks from other sections. With such the case, particular attention to packing is of great importance. The fruit should be graded carefully as to size and packed straight, never putting in one or two larger or smaller than the size being packed as such practice invariably results in dissatisfaction or loss. Buyers rarely fail to notice the odd-sized pines and use the fact as a lever for lower prices, and often the entire sale is lost.

ORANGES and GRAPE-FRUIT arrive in such small quantities that they are not much of a factor on the market. In fact, bulk of the stock coming is from one or two shippers. The fruit, while small, is sweet and attractive to buyers.

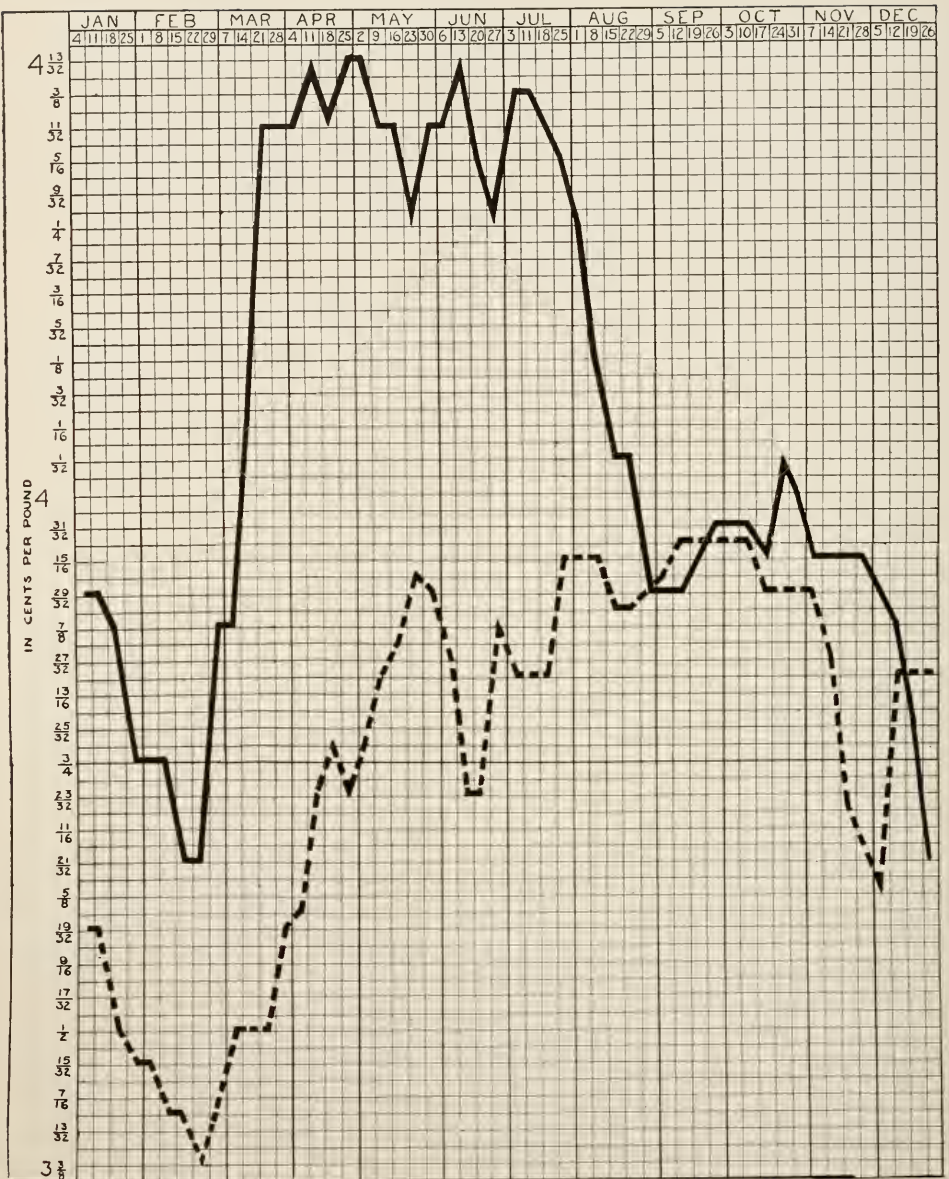

Centrifugal Sugar 96° Test. Fluctuation of Prices for the Years 1907 and 1908 at New York. Solid line, 1908. Broken line, 1907.

Sentence of fourteen years eight months and one day of imprisonment and the payment of 25,000 pesetas as indemnity to the heirs was passed upon Ramon Fernandez Victorio by the criminal branch of the audiencia in Santa Clara, Feb. 16, for the murder of Don Tirso Mesa at Aguada de Pasajero several months ago.

The sugar cane-producing districts feel the commercial need of improved roads less than the other sections of Cuba. The cane is cut and hauled in the dry season, and the large sugar plantations are provided with private railroad systems which connect with port cities or with the public railroad lines of the island.—Frederick J. Haskin, in Kansas City (Mo.) Journal.

TABLE OF ACTIVE PLANTATIONS IN THE PROVINCE OF PINAR DEL RIO

| Name of Plantation. | Location. | Owners. | Owners' Address. | Nationality of Owners. | Administrador. | Output in Bags Crop | Output in Bags 1907 Crop | Output in Bags 1908 Crop | Est. Output 1909 Crop |
|---------------------|---------------|------------------------------------|------------------------------------|------------------------|-----------------------------|---------------------|--------------------------|--------------------------|-----------------------|
| America..... | Cabañas..... | Fco. Ducasi..... | Malecón 29, Havana..... | Spanish..... | Fco. Ducasi..... | 42,276 | 30,300 | 3,880 | 6,010 |
| Anunciación..... | Cabañas..... | Juan Pedro Baró..... | Compostela 131, Havana..... | Cuban..... | D. López..... | 30,461 | 51,121 | 32,912 | 40,000 |
| Bramales..... | Cabañas..... | Alfredo Labarrere..... | Banco Nacional, Altos, Havana..... | Cuban..... | T. Rodríguez..... | 15,200 | 15,977 | 10,584 | 16,000 |
| El Pilar..... | Artemisa..... | P. de Goicoechea..... | Artemisa..... | Cuban..... | E. A. de Goicoechea..... | 52,652 | 64,079 | 38,108 | 50,000 |
| Mercedita..... | Cabañas..... | Mercedita Sugar Co..... | 107 Front St., N. Y. City..... | American..... | E. A. Longa..... | 27,513 | 25,084 | 30,269 | 45,000 |
| Orocco..... | Cabañas..... | Cia. Azucarera Central Orocco..... | Ingenio Orocco, Cabañas..... | Cuban..... | Upricio G. Canza, Pres..... | 23,200 | 15,854 | 27,010 | 35,000 |
| San Ramón..... | Martel..... | A. Balsinde..... | Martí 37, Havana..... | Cuban..... | A. Balsinde..... | 13,443 | 13,187 | 17,390 | 30,000 |
| Totals..... | | | | | | 156,192 | 226,248 | 163,923 | 222,000 |

TABLE OF ACTIVE SUGAR PLANTATIONS IN THE PROVINCE OF HAVANA

| Name of Plantation. | Location. | Owners. | Owners' Address. | Nationality of Owners. | Administrador. | Output in Bags Crop | Output in Bags 1905 Crop | Output in Bags 1906 Crop | Output in Bags 1907 Crop | Output in Bags 1908 Crop | Est. Output 1909 Crop |
|---------------------|------------------------|--------------------------------------|-----------------------------|------------------------|-----------------------------|---------------------|--------------------------|--------------------------|--------------------------|--------------------------|-----------------------|
| Amistad..... | Guines..... | A. Gómez Mena..... | Guines..... | Spanish..... | A. Gómez Mena..... | 14,000 | 14,000 | 65,083 | 52,563 | 52,563 | 120,000 |
| Fajardo..... | Guines..... | Benito Arxel..... | Gabriel..... | Spanish..... | Benito Arxel..... | 27,800 | 30,421 | 49,853 | 19,769 | 19,769 | 22,000 |
| Gomez Mena..... | San Nicolás..... | A. Gómez Mena..... | San Nicolás..... | Spanish..... | Andrés Gómez..... | 110,000 | 110,000 | 120,335 | 60,016 | 60,016 | 80,000 |
| Jobo..... | San Nicolás..... | Marañón & Bro..... | San Nicolás..... | Spanish..... | Pedro Laborde..... | 69,000 | 90,763 | 98,000 | 43,010 | 43,010 | 50,000 |
| Josefita..... | Los Palos..... | Santiago Bannatyne, Lessee..... | Los Palos..... | Cuban..... | S. Bannatyne..... | 60,000 | 60,000 | 31,697 | 40,385 | 40,385 | 50,000 |
| La Julia..... | Duran..... | Cia. Azucarera Central La Julia..... | Duran, Cuba..... | French..... | Gerónimo Martinto..... | 50,000 | 47,000 | 52,000 | 75,000 | 75,000 | 75,000 |
| Lotería..... | Iarucu..... | Rafael Fernández de Castro..... | Cerro 440, Havana..... | Cuban..... | F. de Castro..... | 28,000 | 33,237 | 37,127 | 20,755 | 20,755 | 30,000 |
| Lucía..... | Hoyo Colorado..... | Luchá Lacoeste..... | widow of Lacoeste..... | American..... | R. Donphan..... | 31,000 | 31,000 | 20,546 | 35,000 | 35,000 | 40,000 |
| Mercedita..... | Melena del Sur..... | Enrique Pascual..... | Aguilar 81, Havana..... | Spanish..... | Lemas Pascual..... | 100,000 | 112,492 | 140,000 | 92,011 | 92,011 | 135,000 |
| Nuestra Señora..... | Guines..... | Antonio Jané..... | Spain..... | Spanish..... | M. Baurell..... | 38,621 | 25,000 | 12,632 | | | |
| Nueva Paz..... | Jarucu..... | Pedro Fernández de Castro..... | Egido 8, Havana..... | Cuban..... | A. Fernández de Castro..... | 12,000 | 21,492 | 21,373 | 11,800 | 11,800 | 6,000 |
| Portugalete..... | Los Palos..... | Sociedad Anónima Cienfuegos..... | Tejadillo 44 Havana..... | Cuban..... | R. D. Cuervo..... | 65,000 | 49,919 | 68,796 | 36,095 | 36,095 | 65,000 |
| Providencia..... | Lajas..... | Guines Sugar Co..... | Ingenio Portugalete..... | Spanish..... | Fulgio Bergaza..... | 16,000 | 17,030 | 25,033 | 16,500 | 16,500 | 25,000 |
| Quijano..... | Playa de Marianao..... | Mannuel Tobias..... | Guines..... | Spanish..... | F. Izquierdo..... | 98,172 | 103,551 | 100,280 | 101,535 | 101,535 | 115,000 |
| Rosario..... | Aguacate..... | Rosario Tobias..... | Playa de Marianao..... | Cuban..... | F. Tobias..... | 1,833 | 2,123 | 3,000 | 3,000 | 3,000 | 3,000 |
| San Agustín..... | Quivicán..... | Central San Agustín Sug. Co..... | Havana Apartado 85..... | American..... | Ramon Pelayo..... | 100,000 | 109,375 | 180,000 | 92,648 | 92,648 | 120,000 |
| San José..... | Melena..... | Cia Azucarera, Cent. San José..... | San Ignacio 43, Havana..... | Spanish..... | Mannuel González..... | | | | | | 40,000 |
| San Antonio..... | Madrugá..... | Central San Antonio Sugar Co..... | Madrugá..... | Cuban..... | F. Leibmann..... | | | | | | 50,000 |
| Santa Rita..... | Sabana Robles..... | Co. E. Balenzategui, Pres..... | Madrugá..... | Spanish..... | E. Balenzategui..... | 62,000 | 49,785 | 79,504 | 45,870 | 45,870 | 60,000 |
| (Galindez)..... | Marianao..... | Antonio Galindez & Aldamo..... | Gelabert 45, Matanzas..... | Spanish..... | A. Galindez & Co..... | 28,000 | 37,412 | 44,517 | | | |
| Toledo..... | Marianao..... | F. M. Duranón..... | Mariagón..... | Cuban..... | P. Martínez..... | 55,000 | 95,000 | 45,800 | | | |
| Totals..... | | | | | | 1,024,446 | 996,861 | 1,346,880 | 794,796 | 794,796 | 1,155,000 |

* Not grinding.

TABLE OF ACTIVE SUGAR PLANTATIONS IN THE PROVINCE OF MATANZAS

| Name of Plantation | Location | Owners | Owners' Address | Nationality of Owners | Administrator | Output in 1905 | | Output in 1906 | | Output in 1907 | | Est. Output Crop |
|------------------------|----------------------------|---|--|-----------------------|-----------------------------|----------------|---------|----------------|---------|----------------|---------|------------------|
| | | | | | | In bags | Crop | In bags | Crop | In bags | Crop | |
| Aguedita..... | Macagua..... | Cla Azucarrera, Carl. Aguedita, S. A., P. de José María Herrera | Apartado 486, Havana | American. | José M. Herrera..... | 38,724 | 6,066 | 38,724 | 6,066 | 45,824 | 193,000 | |
| Alava..... | Banaguales..... | Zúñiga y Gámez Brothers..... | Cuba 20, Havana | Cuban. | Alfredo Alderregui..... | 122,305 | 124,681 | 122,305 | 124,681 | 197,339 | 200,000 | |
| Alcorta..... | Recreo..... | J. M. Montalván..... | Cuba 76, Havana | Spanish. | R. Orrantia..... | 26,812 | 36,225 | 26,812 | 36,225 | 34,752 | 40,000 | |
| Angelita..... | Villaba Martí..... | Itamón & Francisco Delgado..... | Apartado 172, Cárdenas | Spanish. | Leopoldo Bustro..... | 5,062 | 24,214 | 5,062 | 24,214 | 36,225 | 40,000 | |
| Araujo..... | Maunguito..... | Juana V. de Rísech y Feliciano Rísech..... | Maunguito | Cuban. | Feliciano Rísech..... | 18,900 | 25,119 | 18,900 | 25,119 | 25,119 | 23,000 | |
| Armonía..... | Bolondrón..... | Arcebayaleta & Cuadra..... | Bolondrón..... | Spanish. | Francisco Cuadra..... | 52,000 | 47,987 | 52,000 | 47,987 | 24,000 | 60,000 | |
| *Australia..... | Jaguay..... | Antonio Alvarez..... | Apartado 253, Havana | Spanish. | J. F. García..... | 22,062 | 24,000 | 22,062 | 24,000 | 24,000 | 70,000 | |
| Carmen (Alex.)..... | Navajas..... | Arenal y Lamadrid..... | Navajas..... | Spanish. | Manuel Lamadrid..... | 65,482 | 74,298 | 65,482 | 74,298 | 63,655 | 70,000 | |
| Carolina..... | Coliseo..... | Manuel Flores..... | Havana | Cuban. | Owner..... | 183,191 | 153,297 | 183,191 | 153,297 | 139,331 | 150,000 | |
| Cocheita..... | Azuarcres..... | Juan Pedro Baró..... | Havana | Cuban. | L. Alzugaray..... | 183,191 | 153,297 | 183,191 | 153,297 | 139,331 | 150,000 | |
| Dolores..... | Jovellanos..... | Melchor Gastón..... | Vedado 7a 76, Havana | Cuban. | Aurelio Martínez..... | 49,000 | 58,000 | 49,000 | 58,000 | 32,000 | 50,000 | |
| Dos Rosas..... | Cárdenas..... | Santiago Estévez..... | Cárdenas..... | Cuban. | Enrique García..... | 24,315 | 10,640 | 24,315 | 10,640 | 5,300 | 25,000 | |
| El Ciego..... | Cárdenas..... | Diego Zorrilla..... | Macagua | Cuban. | Enrique García..... | 17,000 | 17,000 | 17,000 | 17,000 | 17,000 | 20,000 | |
| Elcano..... | Cárdenas..... | Manuel y Sabina..... | Macagua | Spanish. | Enrique García..... | 9,222 | 17,000 | 9,222 | 17,000 | 21,633 | 20,000 | |
| España..... | Alfamales..... | Zabala y Sabán Hermanos..... | Macagua | Spanish. | Crispino Sotolum..... | 62,000 | 68,000 | 62,000 | 68,000 | 87,091 | 105,000 | |
| Esperanza..... | Callimete..... | Manuel Carrolo..... | Cuba 119, Havana | Spanish. | Miguel Traba..... | 62,000 | 57,427 | 62,000 | 57,427 | 17,000 | 40,000 | |
| Felz..... | Bolondrón..... | S. A.—S. Guedes..... | Unión de Reyes..... | Spanish. | Salvador Guedes..... | 38,133 | 39,000 | 38,133 | 39,000 | 44,911 | 50,000 | |
| Flora..... | Bolondrón..... | Flora Sugar Co..... | Matanzas | Spanish. | Horselo H. Rulens..... | 42,125 | 42,150 | 42,125 | 42,150 | 45,461 | 70,000 | |
| Guipuzcooa..... | Hato Nuevo..... | Manuel Arocena..... | Hato Nuevo..... | Spanish. | Manuel Arocena..... | 40,460 | 45,337 | 40,460 | 45,337 | 57,337 | 40,000 | |
| Indio..... | Aguada..... | Saralegui y Otriszoli..... | Matanzas | Cuban. | José M. Jorge..... | 18,000 | 25,000 | 18,000 | 25,000 | 22,000 | 20,000 | |
| Jesús María..... | Santa Ana..... | Segundo Botet..... | Matanzas | Cuban. | Segundo Botet..... | 18,728 | 26,709 | 18,728 | 26,709 | 10,299 | 15,000 | |
| Jicarta..... | Bolondrón..... | M. Díaz..... | Bolondrón..... | Spanish. | M. Díaz..... | 36,778 | 34,116 | 36,778 | 34,116 | 34,116 | 50,000 | |
| Limonas..... | Limonar..... | Emilio Terry..... | Cienfuegos..... | Cuban. | Pedro Horta..... | 11,699 | 15,864 | 11,699 | 15,864 | 26,590 | 10,299 | |
| Luisa (Condessa)..... | Limonar..... | Central Luisa Sugar Co..... | Havana Apartado 83, Havana | American. | Ricardo Diaz..... | 15,061 | 15,060 | 15,061 | 15,060 | None | 18,000 | |
| Majagua..... | Unfón..... | A. Lezama..... | Havana | Cuban. | Alcald Lezama..... | 52,000 | 71,513 | 52,000 | 71,513 | 65,225 | 85,000 | |
| Mercedes..... | Sabanilla de Guaremas..... | Central Mercedes Co..... | Sabanilla de Guaremas..... | Cuban. | Miguel Arango..... | 11,023 | 92,914 | 11,023 | 92,914 | 62,150 | 100,000 | |
| Nueva Luisa..... | Jovellanos..... | Diego San Rafael Kenning Co..... | 107 Front St., N. Y. City | American. | P. R. Leonard..... | 26,913 | 27,858 | 26,913 | 27,858 | 31,637 | 100,000 | |
| Octaidia..... | Macagua..... | Central Macagua Co..... | 101 Wall St., N. Y. City | American. | William Hiney..... | 39,000 | 42,000 | 39,000 | 42,000 | 52,556 | 50,000 | |
| Olimpo..... | Carlos Rojas..... | Sociedad Olimpo..... | Cuba 119, Havana | Spanish. | José Sosa..... | 23,050 | 17,100 | 23,050 | 17,100 | 23,000 | 20,000 | |
| Por Fuerza..... | Callimete..... | Vda de Pedemonte..... | Cárdenas..... | Spanish. | Francisco Comas..... | 39,000 | 42,000 | 39,000 | 42,000 | 52,556 | 50,000 | |
| Porveult..... | Cidra..... | Cla. Azucarrera Ingenio Porveult, S. A..... | Matanzas and Cidra..... | Cuban-Span. | E. de Cubas & A. Canal..... | 5,000 | 18,736 | 5,000 | 18,736 | 34,000 | 20,000 | |
| Pretoso..... | Cárdenas..... | Smith, Castro & Co..... | Cárdenas | Cuban. | Juan Tejera..... | 26,109 | 34,000 | 26,109 | 34,000 | 10,674 | 34,000 | |
| Progreso..... | Contreras..... | Bango & García..... | Cárdenas | Spanish. | José Gaxoso..... | 27,606 | 35,611 | 27,606 | 35,611 | 42,239 | 25,000 | |
| Puerto Canasf..... | Canasf..... | José Avendado..... | Acosta 6, Havana | Spanish. | L. F. Castañá..... | 10,000 | 16,000 | 10,000 | 16,000 | 20,472 | 12,000 | |
| Regilla..... | Perico..... | A. & S. Sardinia..... | Cárdenas | Cuban. | Anastasio Sardinia..... | 62,589 | 63,259 | 62,589 | 63,259 | 34,349 | 62,000 | |
| San Cayetano..... | Cidra..... | A. Galíndez & Co..... | Matanzas | Cuban-Span. | Pompingo Madrigo..... | 26,109 | 27,031 | 26,109 | 27,031 | 27,031 | 35,000 | |
| San Ignacio..... | Cuevitas..... | Est. of Urbitzondo..... | Agramonte | Spanish. | B. Urbitzondo..... | 57,000 | 53,000 | 57,000 | 53,000 | 32,400 | 35,000 | |
| San Juan Bautista..... | Canasf..... | San Juan Bautista Sugar Co..... | San Juan Bautista..... | Cuban. | Teodoro Ulmo..... | 20,000 | 12,000 | 20,000 | 12,000 | 17,400 | 20,000 | |
| San Juan Bautista..... | Bolondrón..... | José Imo, President..... | Havana..... | Cuban. | Ramón Rodríguez..... | 44,000 | 21,000 | 44,000 | 21,000 | 57,306 | 20,000 | |
| San Vicente..... | Jovellanos..... | Central San Rafael Sugar & Industrial Co..... | Havana..... | Spanish. | Placido Alonso..... | 21,740 | 26,890 | 21,740 | 26,890 | 18,000 | 50,000 | |
| Santa Amalia..... | Coliseo..... | Bango y García..... | Jovellanos & 112 Wall St. N. Y. Coliseo..... | Spanish. | Enzo y García..... | 57,441 | 41,687 | 57,441 | 41,687 | 53,925 | 45,000 | |
| Santa Catalina..... | Corral Falso..... | Santa Catalina Sugar Co..... | Habana 57, Havana | Cuban. | J. M. de Cárdenas..... | 30,546 | 3,200 | 30,546 | 3,200 | 3,200 | 45,000 | |
| Santa Catalina..... | Recreo..... | Cla Mercantill de Cuba, care Zaldo & Co..... | Cuba 76, Havana..... | American. | José Martiartu..... | 58,000 | 58,000 | 58,000 | 58,000 | | | |

(See totals next page)

* Not grinding.

PROVINCE OF MATANZAS—CONTINUED

| | | | | | | | | | |
|------------------------|-------------------|--|---------------------------|-----------------|--------------------------|-----------|-----------|-----------|-----------|
| Santa Filomena..... | Pedro Betancourt. | Cia Anónima Central | Havana..... | Span-Am-Cuban | W. H. Grin..... | 83,894 | 68,569 | 18,123 | |
| Santa Gertrudis..... | Ganaguises..... | Ciudad Anónima | Matanzas..... | French..... | I. G. DeLuque..... | 15,000 | 25,000 | 8,154 | 125,000 |
| Santa Rita (Baró)..... | Unión..... | Central Sta Gertrudis | Apartado 164, Havana | Spanish..... | Pedro Arenal..... | 128,000 | 129,000 | 93,000* | 125,000 |
| Santo Domingo..... | Unión..... | L. Soler & J. Guma | Havana..... | Cuban-Span..... | Miguel G. Mendoza..... | 58,670 | 47,426 | 2,401 | 80,000 |
| Saratoga..... | Limonar..... | José García Blanco | Oficios 6, Havana | Spanish..... | Gerardo Gutiérrez..... | 54,166 | 72,924 | 58,963 | 80,000 |
| Socorro..... | Pedroso..... | Central Saratoga Cia. Azu- carrera, E. Palliet, Pres. | Matanzas..... | French..... | I. G. DeLuque..... | 14,850 | 15,000 | 8,154 | 150,000 |
| Soledad..... | Jovelanos..... | Pedro Arenal..... | Cárdenas..... | Spanish..... | Pedro Arenal..... | 128,000 | 128,000 | 114,000 | 150,000 |
| Tingüaro..... | Perico..... | Rafael Fernández..... | Caracas..... | Spanish..... | Alfredo P. Marlbona..... | 57,500 | 57,500 | 34,000 | 60,000 |
| Triunfante..... | Guanacaro..... | E. Sotelo..... | 107 Front St., N. Y. City | American..... | W. S. Radford..... | 110,843 | 65,164 | 49,182 | 115,000 |
| Trinidad..... | Cidra..... | José A. M. de Alfonso..... | Limonar..... | Spanish..... | Fernando Calvo..... | 7,328 | 7,500 | 8,100 | 32,000 |
| Unión..... | Agramonte..... | Sons of Lezama..... | Apartado 16, Havana | Spanish..... | Y. Audino..... | 50,000 | 50,568 | 23,444 | 50,000 |
| Valiente..... | Alcarranes..... | C. Hechuranes..... | Havana..... | German..... | Luis A. Lezama..... | 72,994 | 79,255 | Nothing | 50,000 |
| Victoria..... | Jovelanos..... | Victoria Sugar Co. | Havana..... | Spanish..... | Simón Gortí..... | 13,075 | 7,461 | None | 50,000 |
| | | | | | | 2,400,389 | 2,393,208 | 1,515,318 | 2,330,000 |

TABLE OF ACTIVE SUGAR PLANTATIONS IN THE PROVINCE OF SANTA CLARA

| Name of Plantation | Location | Owners | Owners' Address | Nationality of Owners | Administrador | Output in bags 1905 | Output in bags 1906 | Output in bags 1907 | Output in bags 1908 | Est. 1909 | Est. Crop |
|----------------------------|--------------------------------------|------------------------------------|----------------------------|-----------------------|----------------------------------|---------------------|---------------------|---------------------|---------------------|-----------|-----------|
| Adela..... | Remedios..... | Zárraga y Rodríguez S. eu C. | Cabarrén..... | Cuban..... | Itamón Vigil..... | 55,000 | 65,340 | 74,680 | 68,188 | 70,000 | 70,000 |
| Aguada..... | Aguada de Pasajeros..... | Carol & Co..... | Aguada de Pasajeros | Cuban..... | Carlos Capuñajón..... | 34,000 | 40,000 | 22,000 | 22,000 | 40,000 | 40,000 |
| Altamira..... | Camajuhari..... | Vda de Ortiz e Hijos..... | Cabarrén..... | Cuban..... | A. Montaner..... | 22,680 | 36,151 | 40,003 | 28,600 | 35,000 | 35,000 |
| Andrelta..... | Med Tiempo..... | Central Andrelta Cia Azucarrera | Cienfuegos..... | Cuban-Span..... | José Merino..... | 115,000 | 130,000 | 145,000 | 105,500 | 140,000 | 140,000 |
| Caracas..... | Cruces..... | Emilio Terry & Brother..... | Cruces..... | Cuban-Amer..... | Manuel F. Arenas..... | 192,000 | 193,000 | 172,283 | 92,352 | 125,000 | 125,000 |
| Caridad..... | Santa Leocadia de Ranello Veloz..... | Est. of Juana Pascual Pérez | Apartment 126, Havana | Cuban-Span..... | Constantino Mandado..... | 23,632 | 22,937 | 21,549 | 22,887 | 26,000 | 26,000 |
| Carmalta..... | Vega Alta..... | Suers. of Vicente Pérez Llamada | 10 Carmen, Sta. Clara | Cuban-Span..... | Angel Férrez, López Silvero..... | 14,714 | 7,500 | 12,000 | 18,000 | 18,000 | 18,000 |
| Carolina..... | Arango..... | Esteban Cacho..... | Cienfuegos..... | Spanish..... | Isidoro Cacho..... | 11,000 | 7,000 | 7,000 | 7,200 | 10,000 | 10,000 |
| Cienegueta..... | Abrens..... | Nicolas Castaño..... | Cienfuegos..... | Spanish..... | José Quiras..... | 58,000 | 71,000 | 62,892 | 45,000 | 60,000 | 60,000 |
| Constancia..... | Constancia..... | Colonial Sugar Co. | 107 Front St., N. Y. City | American..... | R. B. Childs..... | 50,000 | 85,000 | 79,000 | 45,000 | 100,000 | 100,000 |
| Corazón de Jesús..... | Encrucijada..... | Fowler Bros..... | Encrucijada | Cuban-Amer..... | Julián Escobar..... | 64,031 | 62,493 | 63,606 | 63,606 | 74,000 | 74,000 |
| Covadonga..... | Carreño..... | Sociedad Anónima Central Covadonga | Carmen Ribalta 103, Sagua | Spanish..... | Prudencio Amezaga..... | 16,920 | 12,851 | 16,087 | 10,784 | 12,500 | 12,500 |
| Dos Hermanas (Powier)..... | Cruces..... | Dos Hermanas Sugar Co. | Cuba 119, Havana | Spanish..... | Alejo Carreño..... | 45,000 | 50,000 | 60,320 | 44,000 | 100,000 | 100,000 |
| Dos Hermanos (Acea)..... | Arango..... | Mrs. F. T. Acea..... | Cruces..... | British..... | A. E. Martí..... | 90,000 | 79,570 | 82,195 | 33,584 | 80,000 | 80,000 |
| El Salvador..... | Quimada de Guina..... | Hels of Céspedes owners | Cienfuegos..... | Cuban..... | Mrs. F. T. Acea..... | 49,500 | 48,000 | 34,000 | 28,000 | 40,000 | 40,000 |
| Esperanza (Francis)..... | Piedrillo..... | Suers de Francha..... | Sitichito..... | Cuban..... | Domingo Llorente..... | 24,200 | 29,715 | 38,601 | 10,500 | 30,000 | 30,000 |
| Esperanza (Ites)..... | Camajuhari..... | Manuel Marciano..... | Alfonso, Cuba..... | American..... | Rafael Tellez..... | 16,013 | 22,000 | 17,500 | 8,887 | 25,000 | 25,000 |
| Fidencio..... | Manacas..... | J. M. Espinosa..... | Piedrillo..... | Spanish..... | Manuel Marciano..... | 8,153 | 7,925 | 5,887 | 38,100 | 60,000 | 60,000 |
| Gratitud..... | Manacas..... | Viuda de Vega e Hijos..... | Calle 2, 4, Vedado, Habana | Cuban..... | Antonio Cass..... | 51,910 | 39,491 | 52,900 | 33,450 | 55,000 | 55,000 |
| Hormiguero..... | Paradero Hormiguero..... | Hormiguero Central Co..... | 69 Wall St., N. Y. City | Spanish..... | Domingo León..... | 36,824 | 40,399 | 52,900 | 33,450 | 55,000 | 55,000 |
| | | | | | | 14,455 | 23,742 | 7,185 | | | |
| | | | | | | 107,500 | 105,000 | 115,000 | 95,000 | 105,000 | 105,000 |
| (See totals next page.) | | | | | | | | | | | |

* Not grinding.

PROVINCE OF SANTA CLARA—CONTINUED

| | | | | | | | |
|-------------------------|------------------------------------|--|--|----------------------------------|-----------------------|----------------------|-----------------------|
| Jatibonco..... | Cuba Co..... | 80 Broadway, N. Y. City..... | American..... | W. Skaife..... | 97,000..... | 102,200..... | 120,000..... |
| Juraguá..... | Est. of Antonio Terry..... | Car. of O. Agramonte, Cienfuegos..... | American Cuban-Spanish..... | O. Agramonte José Guicer..... | 63,827 10,355..... | 46,829 6,171..... | 50,000 10,000..... |
| La Julia..... | Est. of Pestre Sisters..... | Taguayabón..... | American Cuban-Spanish Austrian..... | Domingo Nazabal..... | 90,000..... | 45,000..... | 80,000..... |
| Lequeitio..... | Sucrs. of F. Cabello..... | Cienfuegos..... | Spanish..... | C. Cabello..... | 12,782..... | 7,000..... | 7,000..... |
| Luitgardita..... | Cia Azucarera de Carabatas..... | Sierra Morena..... | Cuban..... | Fernando Rodríguez..... | 32,000..... | 19,500..... | 25,000..... |
| Macagua..... | Est. of Domingo Becharo..... | Alfonso, Sagua..... | Cuban-Span..... | Domingo Rodríguez..... | 12,689..... | 20,862..... | 18,000..... |
| Manuelita..... | Falla y Monasterio..... | Mata..... | French..... | Cesar Rodríguez..... | 60,000..... | 54,356..... | 60,000..... |
| Maria Antonia..... | Santo Domingo..... | Cienfuegos..... | Spanish..... | Mannel Arche..... | 18,558..... | 18,389..... | 25,000..... |
| Narcisca..... | North American Sugar Co..... | Santo Domingo y National Bank Bldg., Rooms 400- 401, Havana..... | Cuban..... | | 14,700..... | 17,000..... | 25,000..... |
| Natividad..... | Francisco I. del Valle..... | Obrapia, by Altos, Havana..... | American..... | R. Berrayarza..... | 98,183..... | 94,738..... | 100,000..... |
| Pastora Alto..... | Barraguir & Co..... | Santa Clara..... | American..... | P. Gómez..... | 13,100..... | 36,369..... | 18,000..... |
| Patriolo..... | Enruejadá..... | Cienfuegos..... | British..... | M. Fowler..... | 38,000..... | 28,12..... | 30,000..... |
| Perseverancia..... | Real Campaña..... | Cienfuegos..... | Spanish..... | K. M. Rodríguez..... | 33,467..... | 33,467..... | 40,000..... |
| Portugalete..... | Palмира..... | Cienfuegos..... | Spanish..... | Alfonso..... | 2,500..... | 3,844..... | 60,000..... |
| Purlo..... | Calabazar..... | Cienfuegos..... | Spanish..... | Miguel Díaz..... | 99,500..... | 92,000..... | 105,000..... |
| Ramona..... | Rancho Veloz..... | Est. of Escarza..... | Spanish-Cuban..... | Alfonso..... | 125,174..... | 92,000..... | 105,000..... |
| Reforma..... | Calbarlén..... | Est. of Tomás de Oña..... | Cuban..... | Sofero E. Escarza..... | 58,900..... | 47,288..... | 60,000..... |
| Regla..... | Cienfuegos..... | Angel y Francisco, Arecha- valeta..... | Cuban..... | R. Tomasino..... | 41,509..... | 25,017..... | 35,000..... |
| Resolución..... | Felipe Silva..... | Martinez Carrillo & Co..... | Spanish..... | | 26,374..... | 13,189..... | 20,000..... |
| Resquia..... | Carabatas..... | Carabatas, Box 210..... | Cuban..... | José I. Martíuza..... | 48,425..... | 39,700..... | 70,000..... |
| Rosalia..... | Juan de Dios Oña..... | Carabatas..... | Cuban..... | G. Alfonso..... | 9,109..... | 6,509..... | 12,000..... |
| San Agustín..... | Llanza Brothers & Urgell..... | Sagua..... | Cuban..... | José Rodda..... | 23,145..... | 8,148..... | 15,000..... |
| San Andrés..... | San Agustín Central Co., S. A..... | Taguayabón..... | Cuban..... | Isidro Lorenzo..... | 51,003..... | 26,176..... | 49,000..... |
| San Antonio..... | Nicolás Castano..... | Calbarlén..... | Spanish..... | J. M. Gutiérrez..... | 28,000..... | 24,500..... | 35,000..... |
| San Cristóbal..... | V. de G. Abreu..... | San Agustín..... | Spanish..... | Bladio Cabrera..... | 75,039..... | 61,170..... | 70,000..... |
| San Francisco..... | E. Cardoso..... | Santa Clara..... | Cuban..... | Vicente G. Abreu..... | 86,358..... | 50,000..... | 70,000..... |
| (Abreu) Asís..... | Marta Abreu..... | Central Sun Cristobal..... | Cuban..... | E. Cardoso..... | 14,151..... | 30,000..... | 45,000..... |
| San Andrés Asís..... | Cesarío Ruiz..... | Cruces..... | Cuban..... | Rafael Guardado..... | 56,000..... | 44,000..... | 55,000..... |
| San Isidro..... | Luz Ajuria de Louga..... | Alfonso..... | Spanish..... | Antonio Gutiérrez..... | 28,234..... | 11,948..... | 15,000..... |
| San José..... | Sucrs de Agustín Glocechea..... | Quemado de Guines..... | Cuban..... | Marcos A. Long..... | 11,955..... | 16,937..... | 15,000..... |
| San José..... | J. R. Ross..... | Havana..... | Cuban..... | Zárraga & Co..... | 33,200..... | 33,200..... | 45,000..... |
| San Lino..... | Medidas..... | Cárdenas and Havana..... | Cuban..... | Jasón Rabel..... | 68,299..... | 43,757..... | 70,000..... |
| San Pablo..... | Remedios..... | Rodas..... | British..... | J. L. Vandewater..... | 42,000..... | 40,000..... | 40,000..... |
| San Pedro..... | Sierra Morena..... | Edmundo Kurz..... | German..... | Edmundo Kurz..... | 60,124..... | 26,271..... | 70,000..... |
| San Pedro..... | Est. of Antonio Fernández..... | Sierra Morena..... | Spanish..... | Antonio Fernández..... | 21,425..... | 14,641..... | 20,000..... |
| Santa Catalina..... | E. Abreu..... | Cruces..... | Cuban..... | F. Fernández..... | 19,105..... | 17,563..... | 20,000..... |
| Santa Catalina..... | F. Gamba & Co..... | Sierra Morena..... | Spanish..... | Arturo Yurraide..... | 32,329..... | 9,500..... | 25,000..... |
| Santa Lucgarda..... | José M. López..... | Mata..... | American..... | José M. López..... | 45,428..... | 22,131..... | 40,000..... |
| Santa María..... | García & Co., in liquidation..... | Cienfuegos..... | Spanish..... | E. Cardelo..... | 56,000..... | 44,000..... | 45,000..... |
| Santa Rosa..... | Sitio Viejo..... | Ranchuelo..... | Cuban..... | José Rueda..... | 75,457..... | 39,300..... | 70,000..... |
| Santa Teresa..... | Sitiecito..... | Sitiecito..... | Cuban..... | Victor Aboltiz..... | 103,576..... | 82,323..... | 100,000..... |
| Santísima Trinidad..... | Ajuria Hermanos..... | Havana..... | Cuban..... | M. Escudero..... | 61,000..... | 43,000..... | 50,000..... |
| Soledad..... | Soledad Sugar Co..... | E. F. Atkins, Pres., 10 Broad St., Boston, Mass..... | American..... | L. F. Hughes..... | 81,417..... | 74,060..... | 76,000..... |
| Trinidad..... | Trinidad Sugar Co..... | E. F. Atkins, Pres., 10 Broad St., Boston, Mass..... | American..... | W. G. Puhum..... | 57,807..... | 37,593..... | 72,000..... |
| Yaguajay..... | The Yaguajay Sugar Co..... | 112 Front St., N. Y. City..... | American..... | Rosé B. Rhonda..... | 67,210..... | 71,917..... | 90,000..... |
| Yaguajay..... | Unidad Sugar Co..... | 107 Front St., N. Y. City..... | American..... | Robert McCulloch..... | 65,478..... | 50,080..... | 45,000..... |
| Yaguajay..... | Unidad Sugar Co..... | Havana..... | Spanish..... | Cruz Ibarra..... | 91,000..... | 83,076..... | 92,000..... |
| Yaguajay..... | Yaguajay..... | Cuba 20, Havana..... | Spanish..... | Marcos Larraide..... | 100,489..... | 63,979..... | 85,000..... |
| Zaza..... | Placetas..... | Placetas..... | Spanish..... | | | | |

Grand totals for Santa Clara (2 pages)..... 3,330,893; 3,678,046; 2,490,794 3,675,500

TABLE OF ACTIVE SUGAR PLANTATIONS IN THE PROVINCE OF CAMAGUEY

| Name of Plantation. | Location. | Owners. | Owners' Address. | Nationality of Owners. | Administrator. | Output in Bags 1906 | Output in Bags 1907 | Output in Bags 1908 | Est. in Bags 1909 |
|---------------------|-------------------------|-------------------------------------|--|------------------------|-----------------------|---------------------|---------------------|---------------------|-------------------|
| El Logareño..... | Nuevitas | Sociedad Anónima, Central Logareño | El Logareño | Spanish-Cuban. | | 48,499 | 91,092 | 60,716 | 85,000 |
| El Senado..... | Las Minas | The Senado Sugar Co..... | Central Senado | Cuban-Amer..... | José Mercadé..... | 93,952 | 105,000 | 59,757 | 125,000 |
| Francisco Sugar | Francisco | Francisco Sugar Co..... | 143 St. Front St., Philadelphia, Pa..... | American..... | John S. Durbam..... | 71,231 | 73,995 | 87,774 | 90,000 |
| Jagueyal..... | Morón..... | Jucuro & Morón Sugar & Land Co..... | Jerry J. Warren, Pres., 127 Obispo St., Havana | American..... | Jerry J. Warren..... | | | | 100,000 |
| Stewart..... | Stewart(new P. O.)..... | Stewart Sugar Co..... | 27 William St., New York | Amer.-British..... | Octavio E. Davis..... | | | 70,000 | 160,000 |
| Totals..... | | | | | | 212,782 | 270,087 | 278,247 | 590,000 |

TABLE OF ACTIVE SUGAR PLANTATIONS IN THE PROVINCE OF ORIENTE

| Name of Plantation. | Location. | Owners. | Owners' Address. | Nationality of Owners. | Administrator. | Output in Bags 1906 | Output in Bags 1907 | Output in Bags 1908 | Est. in Bags 1909 |
|---------------------|------------------------|--|--|------------------------|------------------------------|---------------------|---------------------|---------------------|-------------------|
| Boston | Banes | United Fruit Co..... | 131 State St., Boston, Mass. | American..... | Harold Harty..... | 174,640 | 252,289 | 212,151 | 300,000 |
| Chaparra | Puerto Padre..... | Chaparra Sugar Co..... | 107 Front St., N. Y. City. | American..... | M. G. Menocal..... | 231,647 | 337,000 | 251,555 | 400,000 |
| Cape Cruz..... | Eusemada de Mora | Cape Cruz Co..... | 138 Front St., N. Y. City. | American..... | George M. Boote..... | 64,389 | 79,755 | 61,832 | 80,000 |
| Confluente | Guantánamo | J. Sánchez de Yoca..... | Madrid, Spain..... | Spanish..... | Carlos Tiquichel..... | 10,000 | 18,796 | 12,000 | 25,000 |
| Dos Amigos..... | Campechuela | N. Castañero..... | Cienfuegos..... | Spanish..... | Antonio Muecas..... | 27,320 | 24,000 | 18,512 | 20,000 |
| Esperanza | Guantánamo | Cia. Azucarera del Guiso | Santiago..... | Cuban..... | | 43,000 | 40,000 | 49,187 | 70,000 |
| Hatillo | Medina Luna..... | Beattif & Co. (Lessee)..... | Santiago..... | Cuban..... | E. Latoralde..... | 7,500 | 8,000 | 5,000 | 10,000 |
| Isabel | Guantánamo | Guantánamo Sugar Co..... | 107 Front St., N. Y. City. | American..... | H. Beattie..... | 66,000 | 57,809 | 57,000 | 100,000 |
| Los Cafios | Guantánamo | Guantánamo Sugar Co..... | 107 Front St., N. Y. City. | American..... | H. Haget..... | 46,236 | 61,913 | 46,968 | 50,000 |
| Niquero | Niquero | New Niquero Sugar Co..... | 107 Front St., N. Y. City. | American..... | D. Batista..... | 27,265 | 28,392 | 33,985 | 40,000 |
| Preston | Preston | Nipe Bay Co. and heirs of Brooks & Co..... | 131 State St., Boston, Mass. | American..... | Ricardo Narganes..... | 31,000 | 23,000 | 41,750 | 70,000 |
| Romelle | Guantánamo | J. F. McKinlay..... | Santiago..... | British-Spanish | O. G. Sage..... | | | 98,034 | 300,000 |
| Salvador | Calicito..... | F. Condis..... | Manzanillo..... | Cuban..... | Alfonso Taupier..... | 41,207 | 41,508 | 20,700 | 45,000 |
| San Antonio..... | Barrio Rio Seco..... | Sucrs. Luis Redor..... | St. Etienne de Montlug, France..... | French..... | F. Condis..... | 19,307 | 15,537 | 19,170 | 20,000 |
| San Manuel..... | Puerto Padre..... | Francisco Piá..... | Prado 92, Havana..... | Cuban..... | Antonio Pérez M. de Oca..... | 43,495 | 45,903 | 57,035 | 50,000 |
| San Miguel..... | San Ramón..... | S. A. Central San Ramón..... | Santiago..... | Spanish..... | Francisco Piá..... | 64,653 | 48,769 | 60,000 | 70,000 |
| San Ramon..... | San Ramón..... | S. A. Central San Ramón..... | Manzanillo..... | Spanish..... | J. Reguera..... | 14,784 | 20,000 | 22,900 | 25,000 |
| Santa Ana..... | Anza..... | Est. of Anza & Escorialza..... | Anza..... | Span.-Cuban | Genaro Fernández..... | 36,500 | 39,218 | 39,587 | 69,000 |
| Santa Cecilia..... | Guantánamo | Santa Cecilia Sugar Co..... | 20 Broad St., N. Y. City. | Cuban..... | F. P. Auza..... | 27,617 | 33,000 | 30,800 | 35,000 |
| Santa Lucía..... | Guantánamo | Santa Lucía Co..... | Santa Lucía, Ghara..... | American..... | Edgar Garnett..... | 27,256 | 29,381 | 53,000 | 60,000 |
| Santa María..... | Guantánamo | Santa María Sugar Co..... | Manzanillo..... | Cuban..... | Federico J. Sánchez..... | 100,080 | 63,572 | 12,040 | 50,000 |
| Sofía..... | Guantánamo | Credit Alstir Co..... | Manzanillo St., N. Y. City..... | American..... | F. Pons..... | 12,000 | 11,000 | 12,000 | 15,000 |
| Soledad | Guantánamo | Guantánamo Sugar Co..... | 107 Front St., N. Y. City. | American..... | | | | | |
| Teresa | Ceiba Hueca..... | The Central Teresa Sugar Co..... | Hugh Kelly & Co., 81 Wall St., N. Y. City..... | American..... | E. A. Brooks, Jr..... | 50,625 | 48,294 | 104,349 | 76,045 |
| Tranquilidad | Valerino | Jaime Roca V..... | Manzanillo..... | American..... | José Tarlo..... | 38,500 | 40,000 | 60,000 | 80,000 |
| Unlon | San Luis..... | Cia. Azucarera de Santiago..... | Manzanillo..... | Spanish..... | Jaime Roca V..... | 15,000 | 20,413 | 17,347 | 25,000 |
| Totals..... | | | | | | 2,586,861 | 1,275,525 | 1,767,426 | 2,240,000 |

Summary of Active Plantations by Provinces—Output Figured in Bags.

| Province. | English, French, Spanish, etc., Ownership. | | American Ownership. | | Cuban Ownership. | | Total | |
|--------------------|--|------------|------------------------|------------|---------------------|------------|-----------|------------|
| | 1908. | Est. 1909. | 1908. | Est. 1909. | 1908. | Est. 1909. | 1908. | Est. 1909. |
| Havana | 540,260 | 742,000 | 116,648 | 170,000 | 137,888 | 243,000 | 794,796 | 1,155,000 |
| Pinar del Rio | 3,660 | 6,000 | 30,269 | 45,000 | 129,094 | 171,000 | 163,923 | 222,000 |
| Matanzas | 634,105 | 1,088,000 | 146,330 | 266,000 | 734,883 | 976,000 | 1,515,318 | 2,330,000 |
| Santa Clara | 847,513 | 1,237,500 | 757,105 | 1,046,000 | 886,176 | 1,292,000 | 2,490,794 | 3,575,500 |
| Camaguey | 60,716 | 85,000 | 157,774 | 350,000 | 59,757 | 125,000 | 278,247 | 560,000 |
| Oriente | 258,027 | 360,000 | 982,910 | 1,500,000 | 307,466 | 380,000 | 1,548,403 | 2,240,000 |
| Totals | 2,344,281 | 3,518,500 | 2,191,936 | 3,377,000 | 2,256,164 | 3,187,000 | 6,791,481 | 10,042,500 |
| Percentage | 35 | 34 | 32 | 34 | 33 | 32 | 100 | 100 |

Summary of Sugar Plantations by Provinces—Showing Nationality of Owners.

| Province. | English, French, Spanish, etc., Ownership. | | Cuban Ownership. | American Ownership. | Total. |
|---------------------|--|------|---------------------|------------------------|--------|
| | 1909 | 1908 | | | |
| Havana | 12 | 7 | 7 | 2 | 21 |
| Pinar del Rio | 1 | 5 | 5 | 1 | 7 |
| Matanzas | 27 | 22 | 22 | 7 | 56 |
| Santa Clara | 27 | 29 | 29 | 14 | 70 |
| Camaguey | 1 | 1 | 1 | 3 | 5 |
| Oriente | 8 | 8 | 8 | 11 | 27 |
| Total, 1909..... | 76 | 72 | 72 | 38 | 186 |
| Total, 1908..... | 76 | 74 | 74 | 36 | 186 |

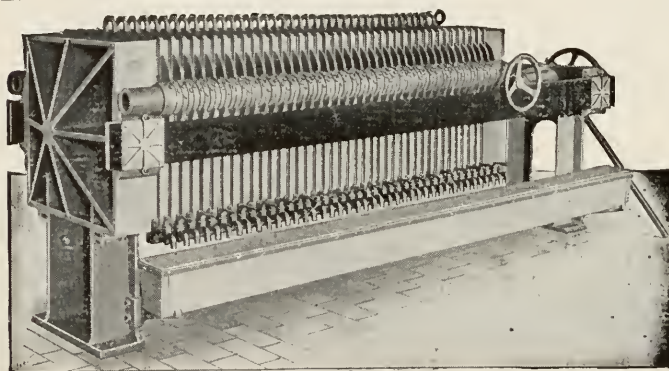

**Prensas de
Filtrar
para Ingenios
SHRIVER
Filter Presses**

Write us for Cata-
logue, Prices and
Information.

T. SHRIVER & CO.
814 Hamilton Street
HARRISON, N. J.

Sole Agents for Porto Rico
McMurtrie-Guiler Co.
SAN JUAN, P.R., and BEAVER BLDG.,
BEAVER STREET, NEW YORK

FOR MOLASSES USE
STEEL TANKS

BUILT BY

HAMMOND IRON WORKS
WARREN, PA., U. S. A.

... MATERIAL FABRICATED OR ERECTED COMPLETE ...

W. B. HAMMOND, SALES AGENT : : : 29 BROADWAY, NEW YORK
OFFICE MEXICO CITY, CINCO DE MAYO No. 32

Ask Mr. Foster

anything about Cuba. No charge, no fees, no commissions. Reliable unbiased information.

1 Madison Avenue, New York.

Your Money Earns Money

When properly invested

IN CUBA

The Cuba Land, Loan and Title Guarantee Company

Incorporated for \$1,000,000

has, in addition to its other valuable assets, taken over the immense real estate business and complete organization that has been built up during the past six years by D. E. Kerr. Mr. Kerr retains the active management of the company. There is not a better or more favorably known real estate man in the island of Cuba than D. E. Kerr.

The Company owns thousands of acres of Cuba's best lands. We have built the most wide-awake and prosperous American Colony in Cuba, at Omaja, Oriente Province. We are doing the largest real estate business, and have the most active and progressive organization in the island. We buy land in large tracts, at the lowest prices, sell in large and small tracts, develop our lands for the benefit of the company and develop land for others. We build orange groves to the bearing period on the very best land.

We will establish other colonies and erect sawmills, ice plants, starch mills, canneries, and various manufacturing enterprises in our colonies. We have many other sources of profit about which we will gladly go into detail with you.

To provide more working capital, we are selling some of our stock at par, \$25 per share. Your money is fully secured by our holdings. **Every dollar of proceeds received from the sale of stock will be invested in more lands, and in the development of the holdings of the Company.** We will, as soon as practicable, plant 1,000 acres to citrus fruits, for the benefit of the stockholders of the company. At four years, this alone should pay 10% on the outstanding stock, and will increase annually thereafter. With the various sources of profit which we have, our stock will unquestionably, within five years, pay more than 50%. Every effort, and every dollar of profit of Mr. Kerr's most capable organization, consisting of twelve men, each an expert in his line, goes toward the payment of dividends on the stock of our company.

Remember, you will have an interest in an established business, the largest of its kind in Cuba. We have greater opportunities for large profits than any company in Cuba. Join us.

CUBA LAND, LOAN AND TITLE GUARANTEE CO.

CAMAGUEY, CUBA

REVISTA AZUCARERA.

Eserita expresamente para THE CUBA REVIEW por Willett & Gray, de Nueva York.

Nuestra última revista azucarera para esta publicación estaba fechada el día 6 de Febrero. Entonces, los centrífugas cubanos polarización 96° se cotizaban á 2 9/32 cents. c. y f., y á 3.73 cents. la libra para entrega inmediata, y ahora se cotizan á 2½ cents. c. y f. y 3.82 cents. la libra para entrega inmediata, acusando la acostumbra subida desde el punto más bajo de 2¼ cents., c. y f., y de 3.61 cents. derechos pagados, que suele ocurrir en el mes de Febrero de cada año una vez que los hacendados han vendido ya suficiente azúcar para poder esperar cómodamente los resultados del resto de la zafra.

Los precios en los mercados europeos han mejorado en dicho período de tiempo, subiendo de 10s para embarque inmediato y 10s 2¼d para entrega en Mayo, á 10s 3¾d los primeros y á 10s 5¼d los segundos, equivalente á 4.18 cents. por centrífugas polarización 96° ó sean .36 de centavo más que la cotización en esta plaza.

La diferencia ha disminuido ya considerablemente, pues llegó á ser de 50 cents. en las 100 libras en esta zafra. La diferencia mayor en la zafra última fué de 40 cents. en las 100 libras.

Volviendo la vista á la zafra anterior en cuanto se refiere á Cuba, notamos que la producción cubana fué de 961,958 toneladas, muchísimo menos de lo requerido para el consumo en los Estados Unidos (3,185,789 toneladas), siendo necesario importar 684,625 toneladas de azúcar que pagó derechos completos para cubrir la demanda para el consumo. Observamos que Java fué el país que nos envió la mayor cantidad, ó sean 429,770 toneladas, y es evidente que podría competir con el resto de los países productores de azúcar en abastecer la demanda aquí, á causa de producir á un costo mucho menor. Con este motivo, también, Cuba tendrá que competir con Java que tendrá más de 400,000 toneladas en exceso con destino á los mercados del Oeste para suplir la disminuida demanda de azúcares que paguen derechos completos esta zafra, disminución causada por la grande zafra de Cuba y otros puntos y por la importación más tarde en el año de azúcares de Filipinas como consecuencia de admitirse 300,000 toneladas de azúcar de esta última procedencia libres de derechos.

Afortunadamente, todos los indicios son de que el consumo habrá de aumentar mucho tanto aquí como en el extranjero, por lo que Europa podrá absorber su producción de azúcar de remolacha sin que haya que exportar nada para este lado del Océano. En un número anterior, hemos dado detalles completos relativos al comercio azucarero en 1908, que se completarán con la estadística de precios hecha después, detalles aquellos que eran en extremo satisfactorios, pero preveemos para muy pronto mayor prosperidad tanto para Cuba como para los demás países productores de azúcar en la zafra de 1909.

El día 15 de Marzo se publicará el nuevo proyecto de ley modificando el Arancel de Aduanas. Hasta ahora no se ha podido averiguar nada relativo á los cambios que se proponen en los derechos del azúcar, si es que se intentan algunos. Sean cuales fueren las modificaciones contenidas en ese proyecto de ley, es seguro que habrá de ser objeto de mucha discusión, lo que retardará en gran manera su promulgación.

Los azúcares refinados han tenido y tienen buena demanda para el consumo diario, y son tan escasas las existencias con que se cuenta en el país, que esa demanda de mano á boca continuará por algún tiempo. La mayor parte del azúcar refinado se vende al presente para su entrega á los siete días, lo que impide toda acumulación de dicho dulce en el país.

Los indicios, al cerrar estas líneas, son que continuará la subida de los precios tanto aquí como en Europa, y que la diferencia entre las cotizaciones de los azúcares de remolacha y de caña irá desapareciendo gradualmente.

Felicitamos á los hacendados cubanos por las buenas perspectivas que tienen ante sí para el resto de esta zafra, redúzcanse ó no los derechos arancelarios sobre el azúcar.

Nueva York, Marzo 8 de 1909.

CABLE ADDRESS: Turnure.

NEW YORK,
64-66 Wall Street.**LAWRENCE TURNURE & CO.**

Deposits and Accounts Current. Deposits of Securities, we taking charge of Collection and Remittance of Dividends and Interest. Purchase and Sale of Public and Industrial Securities. Purchase and Sale of Letters of Exchange. Collection of Drafts, Coupons, etc., for account of others. Drafts, Payments by Cable and Letters of Credit on Havana and other cities of Cuba; also on England, France, Spain, Mexico, Puerto Rico, Santo Domingo, Central and South America.

CORRESPONDENTS:

HAVANA—N. Gelats y Ca.

LONDON—The London Joint Stock Bank, Ltd.

MEXICO—Banco Central Mexicano.

PARIS—Heine et Cie.

FRANKLIN H. KALBFLEISCH CO.**Manufacturing Chemists**

Aqua Ammonia
Acetic Acid
Sulphuric Acid
Muriatic Acid
Nitric Acid
Phosphoric Acid

Agua Amoniac
Acido Acético
Acido Sulfúrico
Acido Muriático
Acido Nítrico
Acido Fosfórico

y Productos Químicos Pesados para todos propósitos.

Se mandan Listas de Precios á petición.

**BROADWAY AND SIXTEENTH STREET, NEW YORK
WORKS**

Brooklyn, N. Y.; Waterbury, Conn.; Erie, Pa.; Elizabeth, N. J.

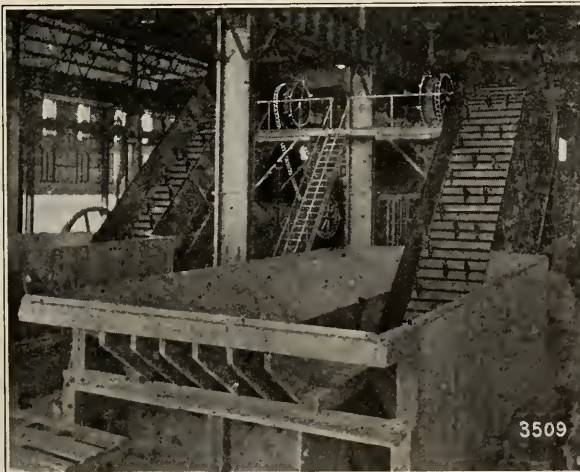
LINK-BELT COMPANY**299 Broadway, New York City****Cane-
Handling
Machinery**

Sugar Minglers,
Screw Conveyors,
Bagasse Feeders,
etc.

>Flint-Rim< Sprocket
Wheels and Original
"EWART" Detachable
Link-Belt. Catalogue.

SUGAR REVIEW.

Especially written for The CUBA REVIEW by Willett & Gray, of New York.

Our last sugar review for your magazine was dated Feb. 6.

At that time Cuba Centrifugals 96 test were 29/32c. c. & f. and 3.37c. per lb. spot, and are now 2½c. c. & f. and 3.82c. per lb. spot, showing the usual advance from the lowest point of 2¼c. c. & f., 3.61c. duty paid, which comes in the month of February each year after the planters have disposed of sufficient production to feel comfortable in the remainder.

European markets have improved during the same time from 10s. for prompt and 10s. 2¼d. for May to 10s. 3¾d. for prompt and 10s. 5¼d. for May Beet, the parity of 4.18c. for 96 test Centrifugals or .36c. above our market.

The difference has already closed up considerably from 50c. per 100 lbs. at the greatest for this crop. The largest difference on last season's crop was 40c. per 100 lbs.

Looking back over the past season, in its interests for Cuba, we note the Cuba crop was 961,958 tons, so far below the requirements for consumption in the United States (3,185,789 tons) that 684,625 tons full duty sugar was required to complete consumption. We note that Java was the country to send us the largest amount, say, 429,770 tons, and she could evidently compete with the rest of the sugar world for the open business here by reason of her low cost of production. On this account, also, Cuba will have to compete with Java, which will have over 400,000 tons surplus crop for western markets for the supply of the reduced requirements of full duty-paying sugar this season caused by the large Cuba and other crops and by the imports late in the year following the granting of free duty to 300,000 tons of Philippine sugar.

Fortunately all signs point to a large increased consumption, both at home and abroad, so that Europe can absorb its beet crops without our help. We have already, in a previous number, given full particulars of the sugar trade of 1908, which your charts of prices will complete, which was unusually satisfactory all over, but we look for soon an increase of prosperity for Cuba and all sugar-producing countries in 1909 campaign.

On the 15th of March the new tariff bill will be made public. In meantime



A cultivator carriage rigged up with a single tool, which is used to follow the fertilizer machine and mix the soil and fertilizer before the seed cane is laid in the rows.

Un carro cultivador armado con un solo utensilio, que se usa para seguir al esparcidor de abono y para mezclar el suelo y el abono antes de poner la caña de semilla en las hileras.



LOCOMOTIVES AND CARS

FITZ-HUGH, LUTHER CO.

140 Cedar Street, NEW YORK

Cable Address : "FITZLUTH"

CHICAGO

LA DESFIBRADORA "NATIONAL"

Resarce su Costo muy pronto

Estudiense sus Ventajas

Construimos Desfibradoras de todos tamaños desde cinco toneladas por hora, hasta de 75 toneladas por hora, y además vendemos toda clase de enseres para Ingenios de azúcar, y daremos con gusto los informes que se nos pidan.

Nuestras Desfibradoras de Caña "National" tienen patente en todos los países del mundo, y se usan con resultados excelentes en Cuba, Puerto Rico, Santo Domingo, Java, Hawaii, México, Yucatán, Guatemala, Argentina, Brasil, Perú, Australia, Trinidad, Madeira, Martinique, Luisiana, etc.

Las tienen algunos de los más grandes ingenios de Cuba.

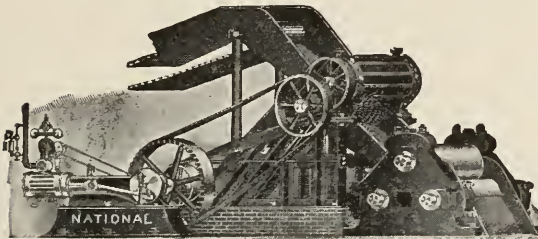

DESFIBRADORA "NATIONAL" PARA CANA, TRABAJANDO CON UN TRAPICHE.

NEWELL MANUFACTURING CO., 149 Broadway, New York

**CARROS
PARA
CAÑA**

De todas
clases

Fabricados
de madera
ó acero

Direccion
Telegrafica
RAMALIAM

**RAMAPO
IRON WORKS**

30 Church St.
New York, N. Y.

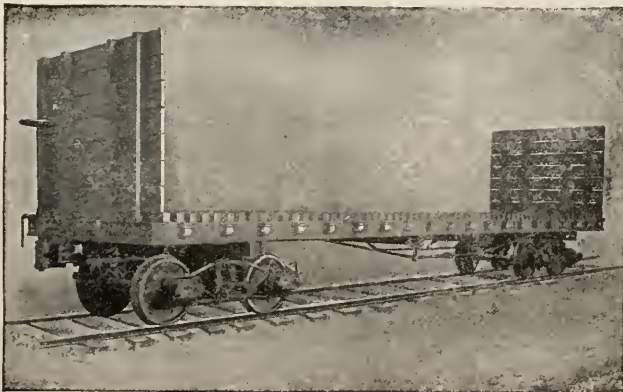

**CANE
CARS**

OF EVERY
DESCRIPTION
OF STEEL
OR WOOD

Cable Address
RAMALIAM

**RAMAPO
IRON WORKS**

30 Church St.
New York, N. Y.

TWO IMPORTANT MAPS

Blue-prints of Cuba, showing the location of the Sugar Plantations and the Rural Guard Stations of the Island. Specially prepared for The CUBA REVIEW. Each 60 cents. Either map with a year's subscription, 75 cents. Both blue-prints and magazine, one year, \$1.

The Rural Guard of Cuba

The Sugar Plantations of Cuba

nothing is known outside of committee as to duty changes, if any. Whatever the bill may say, there is sure to be very much argument and delay over its various schedules before it becomes a law.

Refined has been and is in good demand for actual daily requirements and the country is at the present time so poorly supplied with stock that this hand-to-mouth demand must continue right along. Most of the refined is now sold on a seven-day delivery basis which prevents accumulation of stock at any time in the country.

The outlook at the close is for continued advancing markets here and in Europe and a gradual closing up of the difference between beets and cane sugars values.

We congratulate your planters on the good prospects ahead of them the remainder of this campaign—whether duties are reduced or not reduced.

New York, March 8, 1909.

Cuban Mahogany and Cedar.

Arrivals at New York for February, 1909, were as follows:

Mahogany: Cuban.—Only twenty-three logs were received during the entire month, and they are still in first hands. The stock that was on hand a month ago remains unchanged, showing the very quiet conditions which exist.

Cedar: Cuban.—There was a marked falling off in the arrivals in February as compared with those of January, the receipts in February totalling about two thousand logs as against twelve thousand received in the previous month. All of the wood received has passed into second hands, together with quite a considerable amount of the wood that was on hand

February 1. Our present holdings are small, and large wood in good condition should be well received.—George F. Herriman, Mar. 1, 1909.

More American Troops Leave.

The transport Meade sailed Feb. 25 from Havana with one battalion of the Fifth Infantry and the Eleventh Cavalry, and the transport McClellan sailed with the other battalion of the Fifth Infantry.

The only troops remaining in Cuba on Feb. 25 were two battalions of the Twenty-seventh Infantry, two companies of engineers and a few hospital men, all stationed at Camp Columbia. They will leave April 1.

STAR WINDMILLS

are practical and dependable because they represent over a third of a century of experience and study of the windmill requirements, aided by the most improved machinery, the most capable mechanics, and the best materials the markets afford. On account of their great efficiency and capacity they are used with great success on plantations where a large quantity of water is needed. Thoroughly galvanized, easy running and durable.

Careful attention given to the packing and marking of export shipments.

Our new descriptive catalogue, fully illustrated, printed in English or Spanish, will be sent you upon request.

Your inquiries are earnestly solicited.

FLINT & WALLING MFG. Co.

596 OAK STREET

KENDALLVILLE, IND., U. S. A.

NEW YORK OFFICE: 96 WALL STREET

Agents in Cuba:

KNIGHT & WALL, Teniente Rey 33, Havana

HOFF & PRADA, Cienfuegos

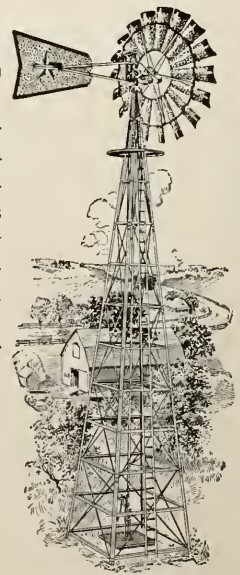

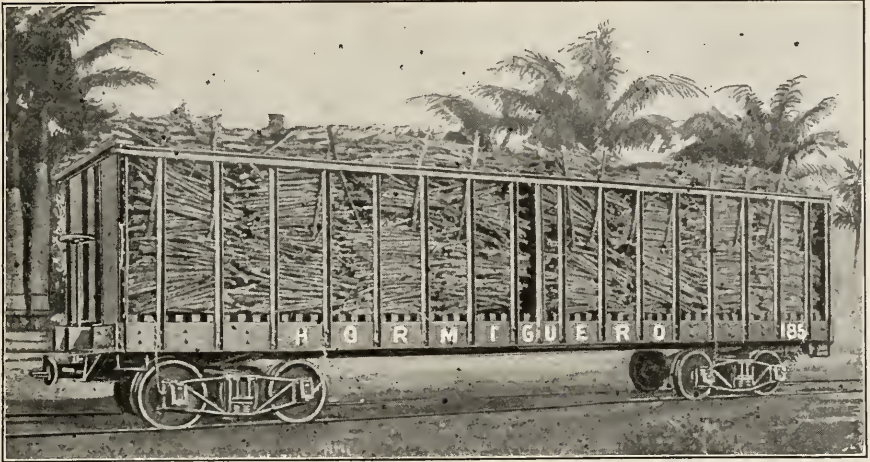

“GREGG” ALL STEEL CANE CAR.

We also make Cars with Wooden Frame or Supply Trucks, as shown above, and Irons for Frame if customer desires to supply wooden parts.



“GREGG Patent” Portable Track—“The Best.”



Frogs—All Sizes.



Split Switches.



Portable Climbing Switch.

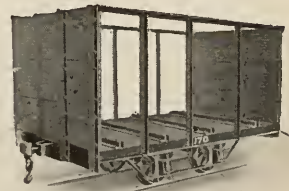
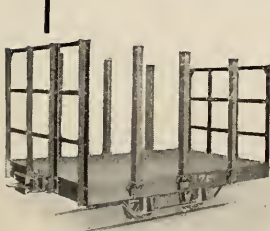

“GREGG” Four-Wheel Cars.

They are light and strong. 1 to 5 tons capacity.

THE GREGG COMPANY, Ltd.

Main Office and Works
NEWBURGH, NEW YORK

HAVANA OFFICE
Calle Cuba, 58

New York City Office
No. 80 WALL STREET

Cable Address “Cargregg,” Newburgh and all branch offices.

Write for Catalogue S 47, Printed in English and Spanish.

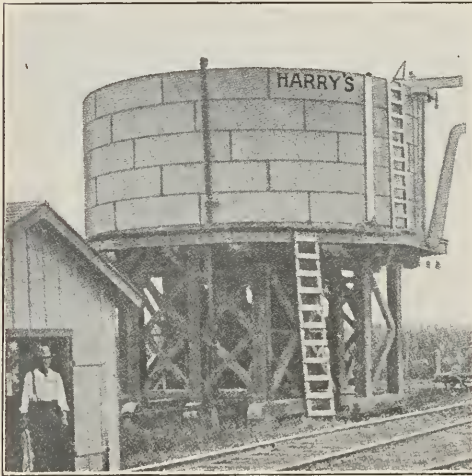
HARRY'S PATENT KNOCK-DOWN STEEL TANKS

Are easily and quickly erected by any unskilled labor.

Can be taken down and re-erected without trouble.

Are shipped completely knocked down, taking low freight rate.

Are absolutely water tight.

Cannot collapse, as outside flanges give them more than double the strength of rivetted tanks.

HARRY'S NEW PATENT CORRUGATED, GALVANIZED STEEL CULVERTS, for Railroads, Wagon Roads and General Farm Use, are shipped knocked down in half circle sections. Are quickly bolted together. Will last a life-time and are cheaper and better than any other kind of Culvert.

HARRY BROS. & CO., OF LA.

New Orleans, La.

TANQUES PATENTES DESARMADOS DE ACERO DE HARRY

Los inhábiles pueden armarlos fácil y prontamente.

Se desarman y se arman sin trabajo.

Se embarcan completamente desarmados á tipos de flete bajos.

Son absolutamente impermeables.

No pueden derrumbarse, porque los rebordes exteriores les dan más que doble la fuerza de los tanques remachados.

For Catalog and Prices apply to

THORNTON N. MOTLEY & COMPANY

EXPORT SALES AGENTS

50 CHURCH ST., NEW YORK CITY



Carros de plataforma, según el diseño arriba, de 27' 7", 30' 6", 36' y 37' 2".

LOCOMOTORAS de todas clases, pesos y vías. Carros para Ferrocarriles Eléctricos y de Vapor. Carros de Pasajeros, Combinación de Pasajeros y de Equipaje, de Pasajeros, de Equipaje y de Correo, de Equipaje, de Expreso.

Carros de Carga de todas clases, de Plataforma, Góndolas de Plataforma, Góndolas de Fondo de Tolva, de Cajón, de Refrigeración, de Ganado, de Tanque, de Clases Especiales.

Equipo para Ferrocarriles y para Contratistas Generales, Puentes, Excavadores de Vapor, Rodillos de Allancar Caminos, etc.

THE MALES COMPANY, 26 Cortlandt St., New York

THORNTON N. MOTLEY & COMPANY

No. 50 Church Street, New York

Export Sales Agents for

DETROIT SEAMLESS STEEL TUBES CO.—Open-Hearth, Cold-Drawn Steel Locomotive Flues.

The best made.

DAMASCUS BRONZE COMPANY.—Babbitt Metals, highest quality; Bronze and Brass Bearings.

Strict guarantees furnished.

MONARCH STEEL CASTINGS CO.—Monarch Automatic Car Couplers, Monarch Draft Rigging.

THE SPEAR & MILLER CO.—Car and Locomotive Brake Shoes. Will outlast two ordinary brake shoes, do not cost as much, and are much easier on tread of the wheels.

RITTER FOLDING DOOR CO.—Wharf, Warehouse and Factory Doors. Far superior to the Rolling Shutter. Write for Catalog.

HARRY BROS. TANK CO.—Knock-Down Tanks and Culverts. Easy to erect; low freight rates.

(See special advertisement on another page.)

Sales Agents for Machinery and Railway Supplies and Equipment.



Making two "V"-shaped ditches, each 30 inches wide and twenty inches deep. The adjustable seat allows an upright position while the machine is on an angle.

The 20th Century Grading Machine at Work.

This machine, illustrated above, can be used for road grading, ditch digging, for irrigation work, also for ditch digging for drainage work, for filling, leveling, railroad grading, lawn leveling, seed-bed making, and for building and repairing roads. There is practically no machine in the market which has so many different uses.

It is largely used in Mexico, New Mexico and Canada in the irrigation fields among the large farms and plantations. It will do more and neater work than thirty to forty men with shovels, and requires but one man—and he need not be a skilled mechanic—and a team to operate it. As they are built of wrought iron and steel, they last from ten to twelve years.

Coaling Barges at Havana.

The type of coaling barge shown by the illustrations has been adopted by the Havana Coal Company in the work of outside coaling required for the large steamers making port at Havana, Cuba. The improved facility brought about by the introduction of these barges is due to the elasticity of arrangement which permits coaling at the water level, or at deck height, and in the easy access to vessels surrounded by small lighters which may be receiving or delivering freight.

The conveying apparatus, made by the Link-Belt Company, Philadelphia, consists of V-shaped buckets, 20 x 20 inches, attached at intervals of 36 inches to two strands of steel roller chain, running noiselessly in a trough 130 feet long, built alongside the keelson of the barge and below the level of a false deck. The conveyor travels at a speed of 120 feet per minute. The loading of 1,200 tons in eight hours has been attained.

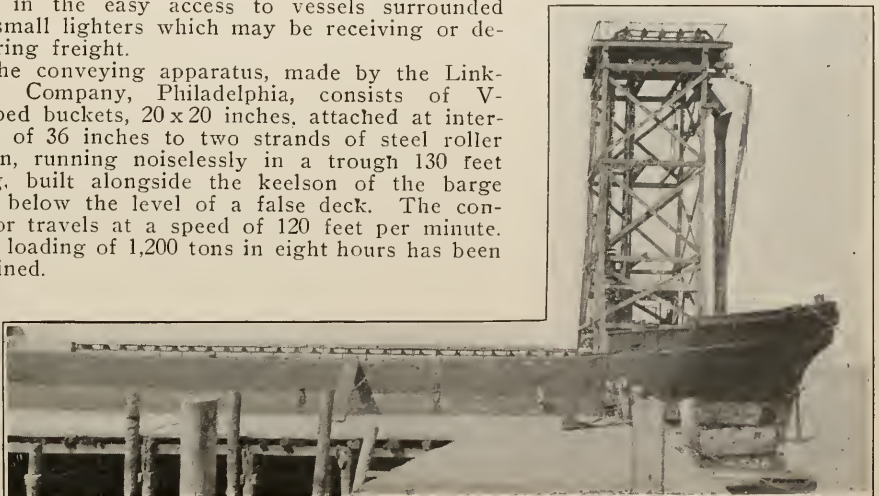

Sugar Notes.

E. F. Rigney, formerly manager of the Preston Mill, and now representing an English syndicate, is arranging for the purchase of twenty thousand "caballerias" of land at Junico, near Santa Cruz del Sur, for a new sugar mill to be constructed in that district.

Mr. Rigney says that the mill will be one of the largest in the world, and expects to sign the papers with the owners of the lands by the end of the month.—Havana Post.

An American syndicate has acquired 800 caballerias, or about twenty-seven thousand acres, at Punta Alegre Moron, Camaguey Province, with the intention of establishing there the biggest sugar plantation and mill known in Cuba and the world. In the grounds of the new plantation a town will be raised. Work will begin within two months. All this indicates an investment of large American capital.—El Triunfo, Havana.

A project involving the expenditure of more than \$1,000,000 in establishing a sugar plantation in Cuba has been undertaken by a number of Hawaiian capitalists. A tract of twenty-five thousand acres of land already has been purchased for the prospective plantation.

No Pongase a Adivinar

Asegurese

That your Engine and Pump is packed with PACKING that will increase power and save money.

"EUREKA" PACKING

WITH THIS LABEL ON PACKING ON EVERY BOX



is made in four different styles

EUREKA GUM CORE
EUREKA HIGH PRESSURE
EUREKA SPIRAL
EUREKA RED SHEET

Either one of which will give better service and cost much less than any other. **Be sure** and call for Genuine "Eureka."

Send for Catalog.

FULL STOCK CARRIED BY

EUREKA PACKING CO.

CUBA 85, HAVANA

Cuban Land and
Investments

Geo. T. Street

CAMAGUEY
CUBA

Land in Santa Clara, Camaguey and Oriente Provinces.
All titles perfect and prices right.

Agents Everywhere

More Agents Wanted

THE CUBA MILL & FURNITURE COMPANY

has recently been incorporated for the manufacture of building material, wagons, bull-carts, crate and cigar box material, axe and pick handles, and a very high-grade line of furniture, for which we will utilize the many varieties of valuable cabinet woods native to the island.

A limited amount of stock is offered to investors. The plan of organization is absolutely new, and the investor protected.

For particulars, address,

Box 191, Camaguey, Cuba

GEO. T. STREET, Secretary-Treasurer

CLARIPHOS

CLARIFICADOR DE AZUCAR Y
LAVADO CENTRIFUGO
PASTA O LIQUIDO

GARANTIZADO PURO

Usado con buen éxito por quince años en todas las grandes fábricas de azúcar en los Estados Unidos. Usado también en todos los países en el mundo que producen azúcar.

Da mayor rendimiento. Mejora la calidad.

ENSAYENSE

HYDROPURA

Para Quitar Incrustacion de Calderas y Efectos Sin Igual por su Eficacia y Economia Pídanse nuestro "HAND BOOK FOR SUGAR MAKERS," dando informes detallados y referencias. Libre de gasto. Unicos Fabricantes.

MANUFACTURED BY

PROVIDENT CHEMICAL WORKS

St. Louis, Mo., U. S. A.

Agent: **CARLOS THEYE, HAVANA, CUBA**

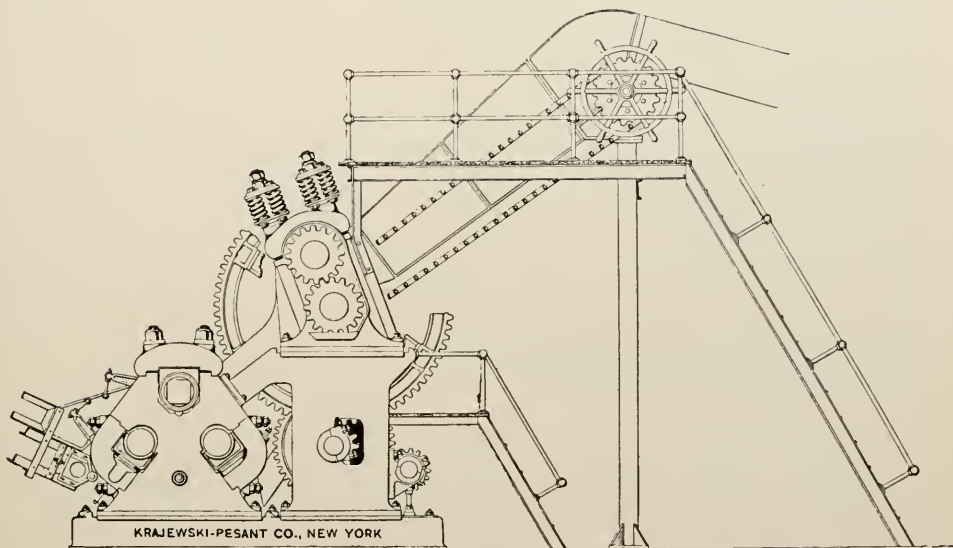

Krajewski Crusher with latest design Cane Mill

KRAJEWSKI-PESANT COMPANY
Improved Sugar Machinery

CANE CRUSHERS

CANE MILLS

VACUUM PANS

MULTIPLE EFFECTS

FILTER PRESSES, ETC.

NEW YORK CITY

CANADA LAND AND FRUIT CO.

LOS INDIOS

Owners

ISLE OF PINES

CANADA AND LOS INDIOS TRACTS

Location: Siguanea Bay. The Deep-Water Harbor of the Island.

We have at our new and progressive town of Los Indios a sawmill, planing-mill, general store, school, hotel, church, post office and nursery, all under the supervision of Americans. A strictly American town.

We also have rowboats and gasoline launch for pleasure parties. Fishing and hunting the best.

We own the finest citrus fruit, vegetable and tobacco land on the island. We offer same for sale in acres to suit purchaser, either for cash or on installments. Special inducements to actual settlers.

Write for prospectus and further information to our general office,
Marinette, Wisconsin.

WILLETT & GRAY, Brokers and Agents

FOREIGN AND
DOMESTIC

SUGARS

RAW AND
REFINED

82 WALL STREET, NEW YORK

Publishers of Daily and Weekly Statistical Sugar Trade Journal—the recognized authority of the trade.
TELEGRAPHIC MARKET ADVICES FURNISHED



SUSINI

✿ Cork Tip Cigarettes ✿

Pectoral Paper Rice Paper
—: PRICE, 10 CENTS :—

THE BEST CIGARETTE
MANUFACTURED IN CUBA

DEPOT,
Zulueta 10 and Prado 118
HAVANA, CUBA.

MAGNOLIA

THE COMING AMERICAN CENTER

With best of soil, very favorable location, cheap water transportation right through the colony, good water, perfect title, and plans perfected by experience.

At Magnolia we offer you all the delights possible in the most favored land on earth. Here you can grow the largest crops of the finest quality, and the market is at your door.

We produce a very wide range of crops, which sell at top prices.

Write the Cuba Land and Improvement Company, No. 516-517 The Murray, Grand Rapids, Michigan, for literature and full information.

HAVANA

CUBA

National Bank of Cuba

Government Depository

Capital, Surplus and Undivided Profits
\$6,000,000.00

HEAD OFFICE, HAVANA

FIFTEEN BRANCHES IN CUBA

New York Agency, 1 Wall Street

COLLECTIONS

THE TRUST COMPANY OF CUBA HAVANA.

Capital and Surplus \$540,000

Transacts a General Trust
and Banking Business

REAL ESTATE DEPARTMENT

Examines Titles, Collects Rents,
Negotiates Loans on Mortgages

Correspondence Solicited from
Intending Investors

OFFICERS

J. A. Gonzales, President
Norman H. Davis, Vice-President
F. J. Sherman, 2nd Vice-President
O. A. Hornsby, Secretary and Treasurer
J. M. Hopgood, Asst. Treasurer

Offices: CUBA 31, HAVANA

The Royal Bank of Canada

INCORPORATED 1869

Fiscal Agent of the Government of the Republic of
Cuba for the Payment of the Army of Liberation

CAPITAL AND RESERVE, \$8,200,000.00
TOTAL ASSETS, . . . \$45,500,000.00

Head Office, MONTREAL

NEW YORK AGENCY, 68 William St.

Branches in Havana: Obrapla 33, Gallano 92;
Matanzas, Cardenas, Manzanillo, Clenfuegos,
Camaguey and Santiago de Cuba.

ESTABLISHED 1844

H. UPMANN & CO. Bankers

TRANSACTION A GENERAL BANKING BUSINESS
CORRESPONDENTS AT ALL THE PRIN-
CIPAL PLACES OF THE ISLAND

Safe Deposit Vaults

Manufacturers of the Famous H. Upmann
Brand of Cigars

FACTORY: Paseo de Tacon 159-163
OFFICE: Amargura 1-3

Established 1876

N. GELATS & COMPANY

Bankers

Transact a general banking
business.

Correspondence at all the prin-
cipal places of the island.

SAFE DEPOSIT VAULTS

Office: Aguiar 108

MOLINA BROTHERS

Customs Brokers

Forwarders, Lighterage and Ship Agents

Officios 52, Havana

HAVANA

United Railways of Havana

Cuba's First and Foremost Railroad. (First Section opened to Traffic in 1837)

Takes you to All Parts of the Island East of Havana Comfortably and Quickly through Varied and Beautiful Scenery and Past Extensive Sugar Plantations

Parlor, Observation and Sleeping Cars attached to principal trains.

Full information and through tickets to all points in Cuba reached via the United Railways of Havana can be obtained of the following:

Thos. Cook & Son
Seaboard Air Line R. R.
Foster & Reynolds
Atlantic Coast Line R. R.
Illinois Central R. R.

Ward Line
Florida East Coast Railway
Washington Southern Railway
Peninsular & Occidental SS. Co.

Southern Pacific R. R.
Mobile & Ohio R. R.
Raymond & Whitecomb Co.
Louisville & Nashville R. R.
Munson Line

LA AMBROSIA

MANUFACTURERS of the well-known brand of Chocolate, "LA AMBROSIA," Biscuits, Macaroni, Bonbons, all kinds of Confectionery

GUAVA PASTE AND EXTRA FINE GUAVA JELLY

ORDERS RECEIVED FOR EXPORT

BALDOR, FERNANDEZ & CO.

Write for quotations.

Sol 21 & 23, Havana, CUBA

'PHONE No. 401

P. O. BOX 741

FERNANDO de CARDENAS

CUSTOM HOUSE BROKER

:: Import and Export Agent ::

Munson S. S. Line Building

Obispo No. 1, Havana, Cuba

JAMES S. CONNELL & SON

Sugar Brokers

Established 1836, at 105 Wall Street

Cable Address—"Tide, New York"

I know a great deal about Cuba

Free Information for the asking

Ask Mr. Foster

1 MADISON AVENUE, NEW YORK

Telephone 825 Broad

THE MARINE WORKS

Ship Plumbers and Sheet Metal Workers. Manufacturers, Suppliers and Repairers of Steamship Galley and Cabin Utensils; Tanks, Lights and Ventilators. Tinning of every description.

31 Coenties Slip

New York

H A V A N A

THE HERRADURA LAND COMPANY

Office: No. 3 Bernaza Street, Habana, Cuba
 CAPITAL, \$440,000.00

Own 22,000 acres of land in the Province of Pinar del Rio, suitable for Oranges, Vegetables, Cotton, Corn and Tobacco. The land has all been surveyed and sub-divided into 40-acre tracts and is offered for sale in acres to suit the purchasers, for Cash or on instalments.

We have a new and progressive American town with Railroad Station, Telegraph, Telephone, Stores, Hotel, American School, all within short distance from Havana City.
 Titles perfect. Transportation from Havana free for buyers.

WRITE OR CALL FOR INFORMATION.



TREES FOR THE SOUTHLAND
 Glen Saint Mary Nurseries stock is the standard of perfection for Southern planting—well-rooted, thrifty trees and plants, grown under ideal conditions by men who know how.

TABER'S TREES THRIVE
 Peaches, Pears, Plums, Grapefruit Lemons, Oranges, Pecans, Persimmons, Hardy Roses, Hedge Plants, Shrubs, Shade Trees are leading specialties. *Catalogue free.*
 Glen Saint Mary Nurseries Company, Box 41, Glen Saint Mary, Florida.

PASO ESTANCIA—Oriente Province—Cuba

The healthiest and most fertile spot on the island, in the rich valley of the Cauto River' 400 feet above sea level.

One of the prettiest spots in Cuba.

Paso Estancia is right on the main line of the Cuba Railroad, only 40 miles from its terminus at Nipe Bay, 39 miles from Santiago.

The soil is rich, dark, sandy loam; no rocks or swamps.

Two hundred acres now under cultivation demonstrate by prolific production the richness of the soil.

A comfortable hotel at **Paso Estancia** accommodates visitors.

Paso Estancia offers the best opportunities in Cuba.

Choice land on easy terms.

Visit there and confirm all we say. You will be well received.

Full particulars
 from

Cuba Properties Limited

56 Bank of Ottawa Bldg.
 MONTREAL

111 German Savings Bank Bldg.
 NEW YORK

Paso Estancia
 CUBA

Free Information about Cuba.

NO FEES, NO COMMISSIONS.

Complete, definite, valuable information.

Ask Mr. Foster, 1 Madison Avenue, New York.

HENRY E. BROWN
 Pharmacist

Shipping and Export Chemist and Drug-
 gist, Ships' Medicine Chests Furnished and
 Replenished. Prescriptions Compounded
 by a Graduate in Pharmacy.

Trusses, Surgical Appliances, etc.

Office and laboratory, Room 36.

116 BROAD ST., NEW YORK

Telephone Call: 274-A Hamilton.

JOHN M. DONOVAN

13 Summit St. (Atlantic Dock) - BROOKLYN

Dealer in

Dunnage Mats

FOR BAG FLOUR, BAG AND BULK GRAIN
 AND GENERAL CARGOES.

— BAGS AND BAGGING —

FUNDADA EN 1851

SUGAR TESTING APPARATUS

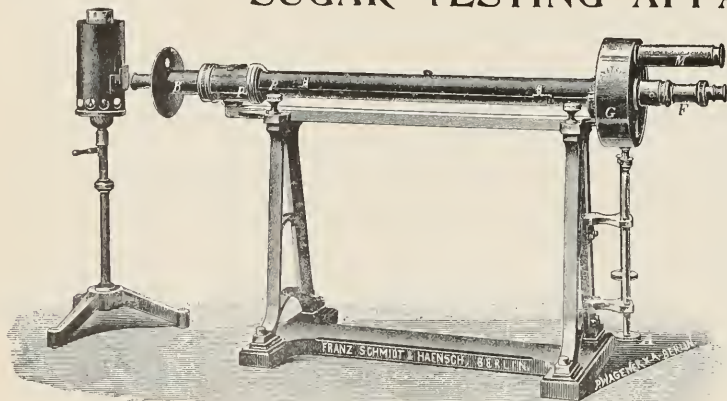

Hace una especialidad de surtir
TODOS LOS INSTRUMENTOS PARA LA PRUEBA DE AZUCAR Y HABILITACION ED LABORATORIO.

Unicos Agentes en los Estados Unidos y Canada para los

STANDARD POLARISCOPIOS

Su triple ó doble campo de vision ha sido adoptado por el Gobierno de los Estados Unidos como norma.

Toda la maquinaria experimental y los aparatos descritos en "Agricultural Analysis," del Prof. H. W. Wiley. Se suministran con gusto todos los informes pedidos. Pidanse Listas de Precios Ilustradas.

POLARISCOPIO SOBRE "BOCKSTATIV" LA FORMA MAS MODERNA
 Con caja á prueba de polvo, parte de prisma, y engranaje prolongado.

EIMER & AMEND, 205-211 Third Avenue, New York

MOBILE, ALA.

HOME INDUSTRY IRON WORKS
Engines, Boilers and Machinery

Manufacturing and Repairing of all kinds. Architectural Iron and Brass Castings. Light and Heavy Forgings. All kinds of Machinery Supplies.

Steamship Work a Specialty

A. KLING, Prop.
JAS. S. ROGUE, Supt.

MOBILE, ALA.

The Principal Hotels in Mobile, Ala.

THE CAWTHON
 (FIREPROOF)

THE BIENVILLE
 (MODERN)

European, 175 Rooms

European, 150 Rooms

\$1.50 Up

\$1.00 Up

Both Hotels in Heart of City, Facing Bienville Square

OLLINGER & BRUCE DRY DOCK CO.
Ship Builders and Repairers

Operating seven Sectional Dry Docks, capacity 1,000 tons, and one Balance Dock, capacity 3,000 tons. Equipped with Air Plant for operating Pneumatic Tools, and Steam Pump for cleaning vessel's bottoms.

25-TON DERRICK BARGE AND STEAM PILE DRIVER.

Material of all kinds kept on hand. Shlpwrights, Caulkers, Painters, Sparmakers and Riggers furnished promptly, and at reasonable rates. Correspondence solicited.

MOBILE, ALA.

BARTLE

Twenty-five thousand acres of the richest and best watered land in Cuba on the main line of the Cuba Railroad, with the finest station on the line, 120 miles from Nipe Bay—the best harbor on the Island; also the nearest to New York. No swamps or insect pests.

BARTLE is not in the wilderness—we offer all the comforts of civilization, GOOD STORES, HOTEL, CHURCH, SCHOOL, SAW-MILL, Etc.

TWO MAILS DAILY.

SUGAR, FRUITS, TOBACCO AND VEGETABLES produce wonderful crops at BARTLE.

When you consider Soil, Transportation, Social, Religious and Educational advantages, BARTLE offers something not to be had elsewhere in Cuba. Write for particulars.

"Ten Days in Cuba," just published by Hon. Nicholas J. Whalen, Speaker of the Michigan Legislature, may be had through newsagents at 25 cents per copy, or will be sent free to any address by the owners of the Bartle Colony. Address, Duncan O. Bull, Gen'l Mgr. Cuban Realty Company, Limited, Temple Building, Toronto, Can., or 141 Broadway, New York City.

DUNCAN O. BULL, General Manager

CUBAN REALTY CO., Ltd. Temple Bldg., Toronto, Canada
141 Broadway, New York Bartle, Cuba

PURE
DISTILLATION
OF
SUGAR CANE

BACARDI RON

Sole United States Agent

D. S. de JONGH 128 Water St.

BEST MIXER
FOR
HIGHBALLS
AND
OTHER DRINKS

"SUGAR NEWS FROM CUBA"

is the title of the interesting correspondence from the tropical island, appearing in every issue of "THE AMERICAN SUGAR INDUSTRY AND BEET SUGAR GAZETTE."

Capable correspondents, in every part of the world, write regularly, covering reliable sugar news for "THE AMERICAN SUGAR INDUSTRY AND BEET SUGAR GAZETTE."

In the United States, Cuba and Mexico, \$2 per annum. In Foreign Countries, \$2.50 per annum.

Subscribe for it if you want to keep posted. Sample copy free. Send for advertising rates.

Address: BEET SUGAR GAZETTE CO.

No. 5 Wabash Avenue,

Chicago, Ill., U.S.A.

For Free Information about Cuba

Ask Mr. Foster

1 Madison Avenue, New York.

PURDY & HENDERSON, Inc.

Engineers and Contractors

New York Chicago Boston

Cuba Office, Empedrado 32, Havana

THE BIG FOUR ROUTE

3 Daily Trains Each Way 3

Parlor Cars, Sleepers, Dining Cars.

Through Train Service
BETWEEN

Cincinnati, Toledo and Detroit

(Via Michigan Central R. R.)

Ask for Tickets Via

BIG FOUR

BUSINESS FIRMS OF CAIBARIEN

ANGEL MATA

Comerciante,
Caibarién, Cuba.

Apartado 114. Cable: Mata."

Ferretería, Mueblería y Locería
LA LLAVE

DE INCHANSTI Y HNO.
Caibarién, Cuba.

Martí 11 y 13. Apartado 24.

R. CANTERA Y CA.

(S. en C.)

Comerciantes Importadores,
Escobar 28. Caibarién.

A. ROMANACH

Almacenistas Importadores de Viveres,
(S. en C.)
Caibarién.

P. B. ANDERSON,

Ship Broker. U. S. Consular Agent,
Caibarién, Cuba.
Agent for Munson Steamship Line and Lloyds.

MARTINEZ & CO., S. en C.

Comerciantes Banqueros,
Importadores de Viveres,
Exportadores de Azúcar.

Apartado 115. Telegrafo: Urquiza.

COMERCIO,
Hotel - Restaurant - - Cafe
De José Urquiza.

Calle de Martí nums 16 y 18 - - Caibarién

LA MARIPOSA DE EVARISTO BERGNES

Importador de Peletería y Talabartería, Fabricante
de Calzado.
Caibarién.

Apartado 104. Telégrafo: "Bergnes."

YMAZ Y CA.

Ymportadores de Ferrería en General.

Apartado de Correos Num. 15,
Caibarién, Cuba.

Calle Justa Num. 27. Cable: "Imaz."

ARIAS Y COMP

Provisiones, Loza y Muebles.
Cuba Num. 20, Esquina a Martí,
Caibarién, Cuba.

Correo Apartado Num. 15. Telégrafo: "Arias."

ZARRAGA Y CA.,

Caibarién, Cuba.

Casa Banca. Exportadores de Azúcar.

BONIFACIO DIAZ,

Gran Peletería y Sombrería.

Martí 17 - - - - - Caibarién

Constantes novedades en los dos giros de esta casa.

RODRIGUEZ Y VINA, S. en C.,

Almacenistas Importadores de Viveres en General,
Comisiones y Consignaciones,
Consignatarios de Buques.

"Depositos de Carburo."

Telephone, 33 Hamilton
Night Call, 411 Hamilton

Cable Address:
"Abiworks," New York

Atlantic Basin Iron Works

Engineers and Boiler Makers

Machinists, Plumbers, Tinsmiths, Pipe Fitters, Blacksmiths, Coppersmiths,
Pattern Makers, Sheet Iron Workers. Iron and Brass Castings. Steamship
Repairs a Specialty.

Cor. Imlay and Summit Streets

Brooklyn, N. Y.

John Munro & Son

Steamship and
Engineers' Supplies

13 Conover Street, Brooklyn, N. Y.

Cable Address: Kunomale, New York

Telephone, 196 Hamilton

Telephone
215 Hamilton

Box 186
Maritime Exchange

YULE & MUNRO SHIPWRIGHTS

Caulkers, Spar Makers

Boat Builders, Etc.

No. 9 SUMMIT STREET
Near Atlantic Dock BROOKLYN

WINTER HAVEN NURSERIES

A. M. KLEMM, Proprietor

Established 1884.

Winter Haven, Fla.

Wholesale Growers of Citrus Stock of the best commercial varieties. We guarantee our extensive Stock to be well grown, free of insects and true to name.

Silver Cluster Grape Fruit our leading Specialty.

Prices right. Grading and Packing perfect.

Write for Catalogue.

The Standard Guide to Cuba—

Reliable—accurate—maps—illustrations.

50 cents.

FOSTER & REYNOLDS, 1 Madison Avenue, New York.

BUSINESS FIRMS OF SANTIAGO

E. GIRAUDY & CA.
ALMACEN DE VIVERES
Marina baja n. 33, Santiago de Cuba.
Agentes de Schlitz Beer.

JULIAN CENDOYA
Steamship Agent and Broker
COMMISSION MERCHANT
CABLE: Cendoya. Santiago de Cuba.

VALLS, RIBERA & CA.
(S. en C.)
Importadores de Ferreteria y Machinery.
Telégrafo: Valribe.
Santiago de Cuba y Manzanillo.

A. B. C. Code, 5th Edition. Telephone, 190.
P. O. Box, 95. Cable address: SILVAPA.

SILVA Y PARRENO H.
General Commission Merchants.
Custom House Brokers—Forwarding Agents.
Consignees of the Cuban steamers of the Carlos J. Trujillo, S. en C., Line, formerly Menéndez & Co.
References:—J. Cendoya and Nat'l Bank of Cuba.

CAMP HERMANOS, Santiago de Cuba.
Ron Selecto "Golondrina" y "Carta Cuba."
Medalla de Oro, St. Louis, 1904.

RON BACARDI
DE BACARDI & CO., Distillers, Proprietors.
43 San Ignacio, cor. Santa Clara, Havana,
Santiago de Cuba.

LARREA Y BESEALIE
Importers of General Groceries and Exporters of
Cocoa, Wax, Honey and Woods.
Apartado 65, Marina Baja 46. Cable: Larrea.

Importación. Exportación.
L. ABASCAL Y SOBRINOS
Agentes de las líneas Pinillos Izquierdo y Ca., de
Cadiz. Larrinaga y Ca., de Liverpool. Com-
pañía de Seguros, Aachen & Munich, Aix-la-
Chapelle.

BROOKS & CO.
Bankers and General Commission Merchants.
Santiago and Guantánamo.

*Home-
Grown
Tea.* The cultivation of the tea plant can safely be risked where the temperature seldom falls below 24° F. and never goes below zero, and where the annual rainfall exceeds 50 inches, 30 inches or more of this precipitation occurring during the cropping season.*

A well-drained friable and easily penetrable clay loam or sandy loam containing a large amount of organic matter is best. Very tenacious undrained soils or very sandy soils that lack water-retaining properties are not good; neither will the plants tolerate stagnant water in the subsoil.

Seed should be planted in the autumn or winter just before a rain. Plants may be set out twelve to eighteen months from the time of sowing the seed, 2 feet apart in hedge rows along fences or walks, where

they can serve for ornamental purposes, or 2 to 5 feet apart in 5-foot rows.

*Kind of Soil
and
Cultivation
Required.* The soil should be thoroughly pulverized by spading or plowing as deep as possible; then it should be leveled and holes 9 to 12 inches deep made. The plants should be placed in the holes with the tap-root straight down. If too long it should be cut.

In the autumn this plant is covered with handsome, fragrant, whitish flowers, having a golden yellow center. The crop of an average tea bush is about three ounces of cured tea, so that 100 plants will yield about 18 pounds a year. A pound makes from 350 to 400 cups of tea.—U. S. Dept. of Agriculture Bulletin No. 301.

VINEGAR BEND LUMBER CO.

Manufacturers and Exporters

Long Leaf Yellow Pine Lumber and Timber

Cuban Business Our Specialty VINEGAR BEND, ALA., U. S. A.

Daily Capacity, 200,000 Feet

Cable Address: "TURNER"

Codes: A B C, Fourth Edition; Southards; Watkins; Western Union



SOBRINOS DE BEA & CO.

Bankers and Commission Merchants
Importación directa de todas las centros
manufactureros del mundo.

Agents for the
Munson Steamship Line, New York and
Mobile.

James E. Ward & Co., New York.
Serra Steamship Company, Liverpool.
Vapores Transatlánticos de A. Folch & Co.
de Barcelona, España Independencia
Street 17/21.

MATANZAS, CUBA.

JOHN W. McDONALD

COAL, WOOD, LUMBER
and TIMBER of Every
Description

112 WALL STREET

Near South Street NEW YORK

Yard: 58-68 Beard Street, Erie Basin
Telephones:

Office, 1905 John Yard, 316 Hamilton

Gomez and his associates may mean as well as they assert. Yet it is not certain that they will be strong enough to resist the pressure to which they will inevitably be subjected and it is not certain if they do that there will be a peaceful acquiescence in their course.—Philadelphia (Pa.) Inquirer.

"The Comfortable Way"

Between the East and the West is
via the Toledo, St. Louis and
Western Railroad

"Clover Leaf" Route

Rates lower than by any other
direct line. Send four cents in
stamps for copy of "Get Out or
Get in Line," a booklet by Mr.
Elbert Hubbard, Chief of the Roy-
crofters.

GEO. J. CHARLTON,
General Passenger Agent,
Chicago, Ill.

THE SNARE AND TRIST COMPANY

CONTRACTING ENGINEERS

Steel and Masonry Construction
Piers, Bridges, Railroads and Buildings

We are prepared to furnish plans and estimates
on all classes of contracting work in Cuba.

N. Y. Office
143 LIBERTY ST.

Havana Office
LA LEAL BUILDING

W. H. Bennett

F. W. Hvoslef

Bennett, Hvoslef & Co.

18 Broadway, New York

Steamship Agents and Ship Brokers

Cable: "Benwalsh"



NEW YORK-CUBA SERVICE

PASSENGER AND FREIGHT

SAILINGS SUBJECT TO CHANGE WITHOUT NOTICE.

| Steamer | New York | Nipe | Nuevitas | Nipe | Banes | Gibara and Vita | Pto. Padre | Nuevitas | Nipe | New York |
|-----------------|----------|---------|----------|------|---------|--------------------|---------------|----------|---------|----------|
| | Sail | Arr. | Arr. | Arr. | Arr. | Arr. | Arr. | Sail | Sail | Arr. |
| Curityba | Mch. 24 | | Mch. 29 | | Mch. 31 | Apr. 2 | Apr. 3 | Apr. 8 | Apr. 9 | Apr. 14 |
| Ollinda | Apr. 7 | Apr. 12 | Apr. 14 | | | | Apr. 17 | Apr. 20 | Apr. 22 | Apr. 23 |

Steamers sail from PIER 9, EAST RIVER, foot of Old Slip, New York

FREIGHT ONLY

NEW YORK TO CAIBARIEN, MATANZAS, CARDENAS AND SAGUA

MOBILE-CUBA SERVICE

FREIGHT ONLY

REGULAR SAILINGS—MOBILE TO HAVANA—MOBILE TO N. S.—
S. S. CUBAN PORTS.

BALTIMORE-COLON SERVICE

FREIGHT ONLY

REGULAR SAILINGS—BALTIMORE TO COLON

MUNSON STEAMSHIP LINE

GENERAL OFFICES

82 BEAVER ST., NEW YORK

Lillie Multiple Evaporators

Model of 1904-1905 (Patented)

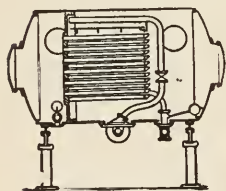

Model 1904-1905
ECONOMY its **BOAST**

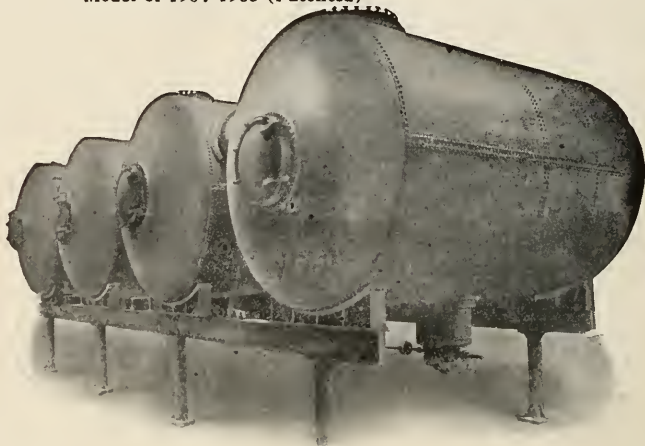

Lillie Quadruple effect for Nipe Bay Co., Cuba (Model 1904-1905. Condensers not shown.) Capacity, 600,000 gallons cane juice per 24 hours.

Apply for reading matter and information to

The Sugar Apparatus Manufacturing Co.

328 Chestnut St., Philadelphia, Pa.

S. MORRIS LILLIE, President.

LEWIS C. LILLIE, Secretary and Treasurer

BALDWIN LOCOMOTIVE WORKS

Broad and Narrow Gauge

Single Expansion and Compound

LOCOMOTIVES

Compressed Air Locomotives. Electric Locomotives with Westinghouse Motors



PLANTATION LOCOMOTIVES

For all Gauges of Track. To meet all conditions of service. Specifications furnished on application.

BURNHAM, WILLIAMS & CO.

Philadelphia, Pa., U. S. A.

Cable Address: "Baldwin, Philadelphia"

Agents for Cuba, Krajewski-Pesant Co., Aguiar 92, Havana, Cuba.

THE CVBA REVIEW



50 Cents A Year APRIL 1909 5 Cents A Copy

Published by the Munson Steamship Line-82-92 Beaver Street, New York City.

Ceballos "The Garden Spot of Cuba"



*A CEBALLOS Orange Grove three years from planting.
The best three-year-old Grove in the World.*

The TIME to invest in Cuba is now The PLACE is in the "Garden Spot," Ceballos
The OPPORTUNITY is offered by the Development Company of Cuba, owners of Ceballos

Write for information to

Geo. H. Gillett, Secretary, 43 Exchange Place, New York

"PRATT IMPERIAL"

Sugar Cane Machinery and Evaporating Apparatus.
Complete Plants Erected and Delivered to Owner Under
Guaranteed Capacity of Mills and Quantity.
Sugar House Pumps.

We also solicit your business for our newly developed line of
Pratt COTTON OIL MACHINERY;
Pratt STEAM PUMPS; SPECIAL PARTS of
MACHINES, any size or kind; and
HEAVY CASTINGS famous for quality.

We maintain Export Sales Offices at 80 Wall St., New York, in charge of
Mr. N. A. Helmer, an eminent Sugar Mill Engineer of wide experience. We
solicit your business with the assurance of every courtesy and perfect satisfaction.

Pratt Engineering & Machine Co. ATLANTA, GA.
U. S. A.

Successors to FULTON FOUNDRY & MACHINE WORKS, Atlanta, Ga.

Tivoli Beer

—*Enough said.*

Havana Brewery

Havana

BUCKEYE NURSERIES

M. E. GILLETT, Proprietor

TAMPA, FLORIDA, U. S. A.

ORANGE, LEMON AND GRAPE FRUIT TREES

LARGEST CITRUS NURSERY IN THE WORLD

QUALITY VARIETY DELIVERY

Price may be forgotten—Quality NEVER.

We grow nothing but standard Varieties which we can recommend to the trade as Money-Makers. Having had 29 years' experience we thoroughly understand packing trees for long distance shipments.

We guarantee our trees to be True to Name, Free from White Fly and to ARRIVE AT DESTINATION IN GOOD CONDITION.

Consider the future and protect your investment by planting reliable trees from

THE BUCKEYE NURSERIES

La Gloria has Arrived. All other American colonies in Cuba have yet to come.

La Gloria has Better soil, climate, water, schools, docks, cheaper transportation—living, more American people, push and natural advantages.

The Oldest, Largest and Best American Colony.

First Prize for citrus fruits Havana Exposition, 1908.

The La Gloria Transportation Company's fine mail and passenger steamer connects with Munson Line steamers at Nuevitas. Sailings Tuesdays, Thursdays and Saturdays.

Boulevard Completed. The Cuban Government has completed a fine macadamized boulevard from the townsite to Port Viaro, costing \$80,000.

La Gloria is All its Name Implies.

Not a promoter's dream but an assured fact. Our West Canasi tract, just opened, is the finest orange land in Cuba. We have also a few choice town lots for sale.

Send for our new booklets showing pictures of homes and plantations, and giving terms and conditions.

Cuban Land and Steamship Company

32 Broadway, New York City

TWO IMPORTANT MAPS

Blue-prints of Cuba, showing the location of the Sugar Plantations and the Rural Guard Stations of the island. Specially prepared for THE CUBA REVIEW. Each 60 cents. Either map with a year's subscription, 75 cents. Both blue-prints and magazine, one year, \$1.

The Rural Guard of Cuba

The Sugar Plantations of Cuba



Sugar Plantation—Cuba Railroad.

The Cuba Railroad

This new line completing the railroad connection between Havana and Santiago, and Antilla, on the Bay of Nipe, is of standard gauge and similar in its construction and equipment to the better class of northern lines. All of its important bridges are of steel and masonry, and the line generally is rock-ballasted. The main line passes along the center of the eastern and wider half of Cuba, and opens up a matchless and most picturesque agricultural region, and passes through the tropical forests of mahogany, cedar, lignum vite, ebony and many other trees, hung with vines and millions of orchids. Palm trees of magnificent aspect and great variety abound everywhere. The famed Parana and Guinea grasses, covering most of the open districts and standing from six to twelve feet high and

green the year round, together with frequent running streams, make this an ideal cattle country. No food has to be put up and no shelter is required. The rich soils everywhere are adapted to sugar, tobacco, cotton, corn and an endless variety of products. The swamps which occur at places along the coasts of Cuba are absent from the interior, which is high, dry and exceptionally healthy. The trade winds blow across Cuba every day, and bring to all parts fresh sea air; the extreme heat of northern summers is consequently unknown and the humidity of other tropical countries is also unknown.

The Cuba Railroad Company's **Hotel Camaguey**, at Camaguey (formerly Puerto Principe) is by far the most popular resort in Cuba, Spanish in style, and provided with bath rooms and other modern conveniences, and is first-class in all respects.

This old city has about 40,000 inhabitants, is picturesque and is situated in a beautiful and remarkably healthy district. The hotel is especially favored by those wishing to spend some weeks or months in a matchless sub-tropical climate.

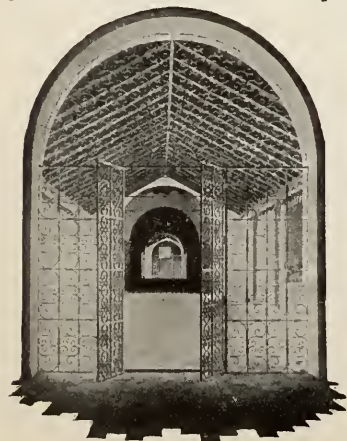

A Corridor, Hotel Camaguey.



Map of The Cuba Railroad

THE CUBA REVIEW

"ALL ABOUT CUBA"

An Illustrated Monthly Magazine, 82-92 Beaver Street, New York

MUNSON STEAMSHIP LINE. Editors and Publishers

SUBSCRIPTION

50 Cents Per Year - - - - - 5 Cents Single Copy

Advertising Rates on Application

Vol VII.

APRIL, 1909

No. 5

Contents of This Number

The cover-page pictures one of the quaint buildings found in most all Cuban cities, for the sale of drinks, sandwiches, etc. The building illustrated is just outside the railway station at Matanzas.

Government matters, with pictures of four members of Pres. Gomez's cabinet, will be found on pages 7 to 11.

Some opinions of Vice-President Zayas, of Carlos Garcia Velez, the new Cuban Minister to the United States, and of President Gomez, in his message, will be found very interesting.

United States comment with cartoons on page 12.

General notes, comprising interesting items regarding the activities throughout Cuba, will be found on pages 13 to 15.

Commercial notes comprising various important statistics of Cuba's trade, Customs House collections, importations and exportations, on pages 16, 17 and 18.

Rubber substitutes from cacti are described on page 19.

Financial and railroad news, on pages 20 and 21, comprising reports of earnings of the various railroads of the Island, and quotations of Cuban securities.

Pages 22 and 23 are devoted to Isle of Pines matters.

Tobacco in the Santa Clara section, and tobacco irrigation, on pages 24 and 25.

The cultivation of coffee in Cuba, from the Cuban viewpoint, on page 26.

Notes from Omaja Colony, with an illustration of the Citrus Fruit Nursery in the town, will be found on page 27.

Prices of Cuban fruits and vegetables in New York, especially written for The CUBA REVIEW by the Urner-Barry Company, on page 28.

A review of sugar, in Spanish and English, written for the REVIEW by Messrs. Willett & Gray, the well-known sugar authorities, on pages 29 and 30.

MANY BEAUTIFUL ILLUSTRATIONS.

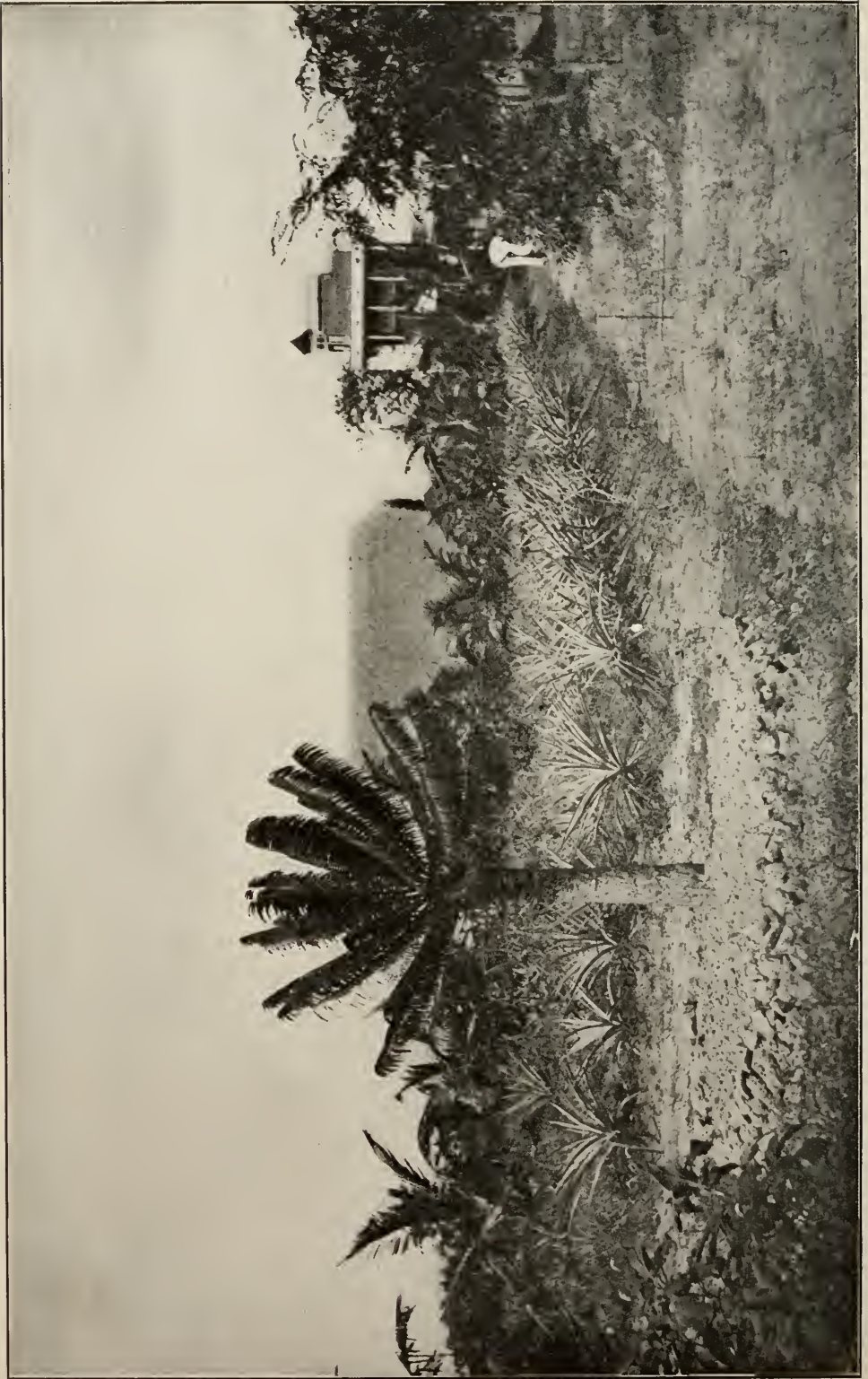

AN AMERICAN HOME AND PLANTATION NEAR PINAR DEL RIO.

THE CUBA REVIEW

"ALL ABOUT CUBA."

Copyright, 1908, by the Munson Steamship Line.

LIBRARY
NEW YORK
BOTANICAL
GARDEN.

Volume VII.

APRIL, 1909.

NUMBER 5.

GOVERNMENT MATTERS.

The Cuban Congress. The Lottery. Vice-President Zayas on the Reciprocity Treaty. Carlos Garcia Velez on Annexation. Cuban Comment.

Congress adjourned March 16 and convened April 5. It lasted 43 days, in which 21 sessions were held. It was considered more fruitful in a legislative way than any yet held. Representatives attended strictly to business and the minority accepted adverse decisions good-naturedly. In this short legislative term Congress passed the law amending the municipal law, which is now being appealed to the supreme court; the amnesty law, the judiciary law and finally the sundry army and rural guard appropriations, which covers a complete reorganization of these two forces and which permits the president to increase the army in compliance with a decree of the provisional law. The law restoring bull-fighting, the public instructions bill and a score of others are in the hands of committees. Cuban newspapers are not in favor of the restoration of the lottery and bull-fighting.

The statement of the treasurer of the new Cuban Government shows that in February, 1909, receipts exceeded expenditures by \$225,196, while in February, 1908, expenditures exceeded receipts by \$506,908. The Cuban administration effected an increase of receipts of \$132,000 and a decrease in expenditures of \$599,000.

A further statement showed that outstanding roadwork contracts provided for by special laws of Congress or by decrees of the provisional government, which amounted to \$7,500,000, could be carried out without having recourse to making a foreign loan, as authorized in Governor Magoon's decree.

The codes committee reported favorably on the lottery bill before adjourning on March 15, but the report will be discussed when Congress convenes again on April 5. At present preparations are being made at the Treasury department for the implantation of the lottery. The two large globes where the numbers are placed have been



Senor Ortelio Foyo, the new Secretary of Agriculture, Industry and Labor, Republic of Cuba.

APR 29 1909

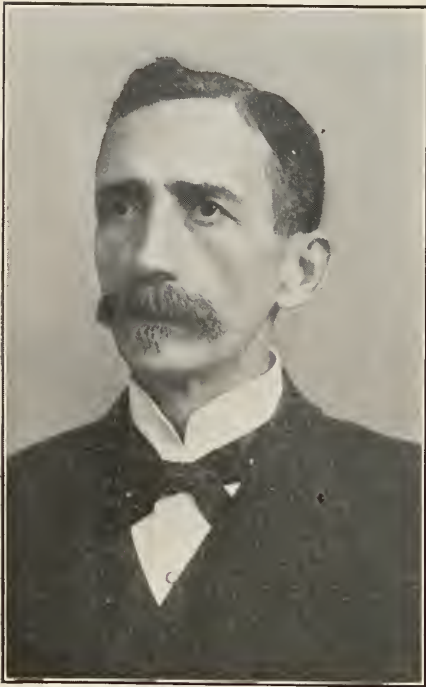

Senor Marcelino Diaz de Villergas, Secretary of the Treasury, Republic of Cuba.

taken out from the storeroom and cleaned. These globes were the ones that were used during colonial times when Cuba had her lottery working independent of that of Madrid.

Speaking in Boston, on March 25, at a banquet of the Commercial Club of that city, Vice-President Zayas spoke on the economic relations between Cuba and the United States, he said in part:

Vice-President Zayas on the Treaty. "Permanent peace exists and the present is very propitious for Cuba's attainment of a great increase in industrial and agricultural life. Our natural markets are in the United States. The reciprocity treaty is favorable to the Cuban sugar industry, and less so to cigars and vegetables, yet United States exports to Cuba have increased under it. We do not believe a new treaty will be unfavorable to the United States, and Cuba desires a little more protection for those two articles that are her principal product.

"Good conditions exist for the investment of money in Cuba, where there is offered a wide field for business. In the interior, also, there are many metals awaiting the coming of capital."

"Americans that have helped Cuba to her independence should take equal pride in seeing her rich and happy," he concluded.

J. Monzon Aguirre, Consul of Cuba at Boston, also spoke in favor of a revised tariff on fruits and other Cuban products, and predicted that there would be raised this season on the Island 1,800,000 cases of pineapples.



Dr. Nicolas Alberdi, Secretary of the Interior, Republic of Cuba.



Dr. Ramon Mesa, Secretary of Public Instruction.

Aurelio Sivera, second-class Cuban consul at Bayonne, France; *Consular Ap-pointments* Manuel Tejador, consul-general in China; Benjamin Giberga, consul-general in Montevideo, Uruguay; José Curbelo Ayala, consul in Las Palmas, Canary Islands; Arturo Carricarte, vice-consul at Montevideo; Crescencio Sacerio, vice-consul at Barcelona, Spain; Miguel Angel Diaz Piedra, consul at Santa Cruz de Tenerife, Canary Islands; José Robledo, consul at Vera Cruz, Mexico; Antonio M. Alcover, vice-consul at Jacksonville, U. S. A.; Oscar Ramos, vice-consul at Seville, Spain; Enrique Garcia, vice-consul at Trieste, Austria; Luis Rodriguez Embil, vice-consul at Antwerp; Guillermo Blanck, vice-consul at Zurich, Switzerland; Calixto Garcia, vice-consul at Hamburg, Germany; Ramon L. Bonachea, vice-consul attached to the Cuban legation in Mexico; Maximo Gomez Toro, consul at Santo Domingo; Alejo Bonachea, vice-consul at San Juan de Puerto Rico, and Mario Morello, vice-consul at Miami, U. S. A.

Carlos Garcia Velez, the new Cuban minister from Cuba, arrived in Washington on March *Annexation*. 30, and in reply to the question of the Post of that city, "Is Cuba coming into the United States?" replied:

"Eventually; yes, but with a different language and a different people; it will take some time to bring that about, although it is the commercial and political salvation of my country," he said further. "I feel most kindly toward the United States because I owe my education and my point of view to it."

The new minister, who succeeds Señor Gonzalo de Queda, is an American in everything except birth. He speaks English perfectly and has advanced American ideas.

Cuba's provincial governors *Provincial Taxes.* have come to an agreement regarding provincial taxes, and suggest that provincial taxes be apportioned as follows: Province of Havana, 50 per cent. of the internal revenue collected; Provinces of Matanzas, Santa Clara and Oriente each 40 per cent., and the total collections to the Provinces of Pinar del Rio and Camaguey. President Gomez will send a message to Congress on the subject.

A committee of the Agrarian League, led by Don Luis Marx, has requested President Gomez to make representations at Washington through General Garcia Velez, the new Cuban minister, toward tariff revision on Cuban tobacco.

New Cuban postage stamps will be in circulation about July 1. A new issue is planned on which the faces of Cuba's heroes will appear.

Some people seem to think that Congress can get up a new tariff law, a new revenue and taxation law and a revised criminal code over night and pass it the next day while waiting their turn at the barber shops.—La Lucha.

If you hear a Cuban predicting that the Americans will soon come back to Cuba and take charge you can put all your money down on good odds that he has just lost his government job.—La Lucha.

"Cubans do not dislike the Americans," says El Triunfo, the organ of President Gomez. "We respect and esteem them. To hate them we have, up to this time, no reason. The Cuban people are essentially affectionate and grateful, and it will not hate the United States if the United States do not oblige us to hate them."

Replying to Mr. Watterson's statement that Cuba, if it were to be governed from abroad, would prefer Spain to any other power, it says, the Cuban people will never accept a foreign domination, neither by Spain nor any other power. Cubans fought during thirty years for the right to be free, and not for anything nor anybody will they renounce this right.

"When Cuba raised its arms against Spain, it was not because of hate towards the discovering nation, but for love of its own independence, and today, as yesterday, it loves that independence and will not support any yoke whatsoever."

New Postal Money Order and Telegraph Offices.

Money order offices have been established at Media, Luna, Oriente Province and Caimito, Havana Province.

New telegraph offices have been opened in San Diego de los Baños, Pinar del Rio Province, and in Dimas, same province.

Cocoanut Bill Passed.

The Lores bill, granting an appropriation of \$7,000 to cover the expenses of preliminary work in extinguishing the bud rot in the cocoanut groves and to cover up to July 1 the expenses of a commission to attend to this work, as recommended in a recent presidential message, was passed.

The liberal leaders have announced that instead of allowing the conservatives 30 per cent. of the public offices, they will give them but 20 per cent. The conservatives reply that they want 330 per cent. or nothing.

No Quarantine at Present. The United States was asked by the Cuban authorities not to order its usual quarantine against Cuba. Secretary of Sanitation, Dr. Matias Duque, in his report, stated that there was no good reason for it, as the sanitary condition of the island was excellent. There were no yellow fever cases anywhere last October, none in November, two in December and none in January or February, 1909. For the same months in 1907-08 there were 83 cases. For the present there will be no quarantine, as indicated in the following bureau circular letter signed by Surgeon-General Walter Wyman, Washington, D. C., March 22, 1909, and addressed to medical officers and acting assistant surgeons, P. H. and M. H. S., in charge of United States quarantine stations, collectors of customs, masters and owners of vessels, and others concerned:

"In view of the sanitary conditions now obtaining in Cuba you are informed that there will be no quarantine imposed against the ports of that island until notice thereof is given by the bureau. A careful inspection of all vessels arriving from Cuban ports should, however, be made."

Americans Lose Their Positions. The Department of Agriculture, Industry and commerce has removed the following American scientists who have devoted nearly six years to service at the government agricultural station at Santiago de Las Vegas: Dr. Nelson A. Mayo, chief of the animal sections and his assistant, H. Montgomery; Dr. F. S. Austin, chief of the bureau of horticulture, and his assistant, C. F. Kinman; Mr. W. Horne, chief of the bureau of vegetal pathology, and his assistant, J. S. Houser, and also Director Crawley, the head of the station, will remain in their positions.



SISTER FLAGS.

The Cuban—"A viva for the flag that is coming down!"
 The Yankee—"A hurrah for the one that is going up!"—La Discusion, Havana.

Congressmen Educate Cubans. Six Cuban young men have been sent to the United States to take a course of studies by Congressman Antonio San Miguel, editor of La Lucha. They form part of a group of twelve whose studies, costing \$3,600 per annum, will be paid from the salary which Congressman San Miguel receives from the government.



AN APPEAL FOR THE RESTORATION OF THE LOTTERY AND COCKFIGHTING.
 Liborio—"Doctor, look at Mexico; each country has its traditions."—La Lucha, Havana.

*Cuban
Finances
Satisfactory.*

Congress reconvened April 5, the sessions of both Houses being devoted to the reading of the President's message of 15,000 words long. President Gomez's message was hopeful and encouraging.

The message says that the condition of the National Treasury is fairly satisfactory. There was a balance on March 27 of \$2,515,363, as against \$2,809,479 on January 27, at the end of American intervention, but the comparison actually is more favorable owing to the discharge of heavy obligations and the inclusion in the latter amount of certain balances not actually available. The present obligations of the Treasury amount to \$12,856,000, including credits granted under President Palma and credits authorized by the Provisional Government, the latter to the amount of \$5,674,000.

He believes it inadvisable to subject the country to the heavy burden of a bond issue of \$16,500,000 authorized by Governor Magoon to pay the contracts for sewers and paving of Havana and the water works at Cienfuegos. He expresses full confidence that the customs receipts will prove sufficient to cover these obligations.

The President makes an urgent plea for a new commercial treaty with the United States, favoring a reduction in

duties on imports consisting of the necessaries of life, for the purpose of lowering the present high cost of living. He also favors a reduction in the tariff on machinery, especially agricultural implements.

*Appeal
Against
Governor
Asbert*

Three weeks ago the Havana Provincial Council suspended its chairman, Pedro Bustileo, and Governor Nor Asbert replaced Bustileo in his office, causing intense friction. On April 14 the Council passed resolutions to appeal to the Supreme Court to decide whether the Governor has the right to veto or suspend the decisions of the Council and to annul vetoes previously made by himself.

The Council agreed also to accuse the Governor before the Senate of having repeatedly violated the constitution, and will ask President Gomez immediately to suspend the Governor for this same reason.

The national convention of Zayistas and Miguelistas meet April 4 to complete plans for permanent fusion of the Liberal party on April 11. The Miguelistas placed themselves on record as favoring complete fusion. It is believed the Zayistas will take the same action.



Francisco Cortes and his son Vicente, members of the Rural Guard of Cuba, under sentence of death for participation in the recent uprising. A popular appeal against the carrying out of the sentence, by the press and people, was made to the Supreme Court, which is now considering the case, and will receive a report from the Attorney-General about April 15.

UNITED STATES NEWSPAPER COMMENT



"The old man stopped our fun. But he ain't looking now."—Cairo (Ill.) Bulletin.

The Cuban people cannot be too strongly impressed with the idea that they must prove their capacity by maintaining a government of their own and preserving order. Perpetual turmoil, an irresponsible government and failure to respect the rights and property of foreigners, would doubtless force American intervention for the protection of Cuba against other nations whose subjects had been outraged.—New Orleans (La.) Times-Democrat.

The Cubans are pitifully hard to teach. They may not even yet have learned that Uncle Sam, who is responsible for their national existence, is not fooling when he says "be good." It is surely a case of exist in decency or cease to exist. America is prepared for either alternative.—Cleveland (O.) Plain Dealer.

We wish Cuba a hearty "bon voyage!" We shall rejoice in her autonomy. We have no hankering to accumulate her territory, her financial obligations, or her problems of local government.

But we wish to assure our little sister, also, that if she makes a failure of her housekeeping this time we shall arrange to stay with her between house-cleaning periods. Our reputation is at stake. She must curb the tendency of the children to throw things and call names, or we will do it for her.—St. Louis (Mo.) Republic.



Uncle Sam—"Good-Bye, Cuba. Take care of yourself."—New York Press.

GENERAL NOTES.

Interesting Items from Various Sources Regarding the Island's Activities.

More Automobile Roads.

The road which is to connect Havana with the city of Pinar del Rio will be completed by June 1, when automobiles will be able to make the trip to the capital of Pinar del Rio Province, and by continuing on the new roads could visit Luis Lazo, Guane and even go as far as the town of Mantua. Or from Pinar del Rio the trip can be made across the mountain range to the coast town of San Cayetano.

Within a short time all of the bridges on the road between San Cristobal and Pinar del Rio will be finished.

San Diego de los Baños, Cuba's famous watering place, can now be reached by auto, and here as well as in Pinar good hotels are to be found where the travelers can put up with comfort.

Baltimoreans Praise Cuba.

Gen. John Gill, president of the Mercantile Trust & Deposit Company, and Mr. William H. Blackford, president of the Maryland Life Insurance Company, both of Baltimore, Md., have just returned from a trip to important points in Cuba. Gen. Gill said:

"We arrived in Havana Monday morning and were agreeably surprised to find the temperature and weather much cooler than at any point in Florida.

"What a wonderful country to be able to produce four crops each year of all kinds of vegetation. Cuba should be left alone, under the moral influence of the United States, to work out its own problems, and it will surely do it."

Fire in La Maya.

Despatches announcing that the town of La Maya, in Oriente Province, twenty miles north of Santiago, was almost totally destroyed by fire, were received April 1. Sixty-five important stores and merchants' houses were reduced to ashes, and the loss aggregates between \$600,000 and \$1,000,000.

La Maya was a historic town in the Cuban wars, and after the construction of the Cuban railroad its importance and wealth have grown considerably, as it was a changing station for travelers from Havana going to Guantanamo on the Santiago train.

A printers' union has been formed in Havana with 110 members. Others will be organized in Santiago, Camaguey, Cienfuegos and in all Cuban cities where there is a sufficient number of printers. These unions are directly affiliated with the International Typographical Union.

Ex-Governor Magoon on Annexation.

At a meeting in Philadelphia, March 27, of the American Academy of Political and Social Science an address of former Governor Magoon was read. It contained the following important utterance on the subject of the annexation of Cuba:

"The United States will not and can not annex Cuba except with the full consent of the Cubans, and the number of Cubans now favoring annexation is probably less than one per cent. From the standpoint of the United States, annexation is undesirable.

"From what source would the United States recoup itself for the loss of enormous revenues now derived from sugar, tobacco and other productions of Cuba? Another matter to be considered is the need of public improvements, the cost of which would not be less than \$100,000,000."

Disastrous Fire in Havana Harbor.

Fourteen lives were lost, the handsome piers at the terminal of the Havana Central Railroad, together with an enormous quantity of shipping and merchandise were totally destroyed and over sixty people injured in a big fire, the largest ever known in Havana, in the upper part of the harbor on March 29. The Hamburg-American liner Altenburg, just in with a cargo of rice, was damaged to the extent of \$80,000. It is believed the entire loss will amount to over \$1,000,000. The dead are two officers of the Altenburg and twelve of her crew. Interment was in Colon Cemetery.

Camaguey's New Buildings.

Among the improvements for Camaguey are a new market, a new city hall, a municipal slaughter house, sixteen houses for workmen and other small improvements in the boroughs of Guaimaro, Coscorro, Altigracia and San Jeronimo.

Plans for all these improvements are now being made. An election will shortly be held to get the sense of the public on a proposed municipal loan of \$600,000 to carry out these improvements.

Vice-Admiral Passual Cervera, who commanded the Spanish fleet in the battle of Santiago, died at Puerto Real, Spain, April 3, of heart disease. He was born February 18, 1839.

The latest strike of the workmen on the Habanilla water-works and sewer contract at Cienfuegos was settled on March 20. A partial recompense for wages lost during the strike was given.

GENERAL NOTES.

Final Evacuation of Cuba.

The last emblem of American domination over Cuba disappeared at noon when the American flag which had flown over Camp Columbia, the headquarters of the Army of Pacification in Cuba, since October, 1906, fluttered down the pole and was replaced a moment later by the lone-starred banner of the Cuban republic. This eventful day was Mar. 31.

The ceremonies took place in the presence of the American garrison, consisting of two battalions of the Twenty-seventh Infantry and three companies of engineers and one battalion of Cuban infantry.

As the colors were hauled down the troops presented arms and the Cuban and American bands played the "Star Spangled Banner." A Cuban lieutenant raised the Cuban colors.

The Cuban troops lined the roadside and presented arms, while the Americans, numbering about 800, in heavy marching order, swung past.

They later embarked on the transports McClellan and Sumner. There was not a ripple of public interest, and the only recognition in the harbor came from the German cruiser Bremen, which dipped her ensign, and from the American steamers.

Gen. Thomas H. Barry, before leaving Cuba wrote to Governor Magoon:

"The evacuation is completed and is as clean as our service. There was not a single case of misconduct. We tried faithfully to carry out our superiors' wishes and believe that Cuba appreciates the success and beneficence of your government, of which our work was a small part. We are happy that our efforts aided your administration.

Hotel transfer and express agents doing business around Machina wharf, Havana, according to an order which has been issued by Collector of the Port Mencias, must wear the name of their business on their caps so as not to be confused with Customs House inspectors.

Burnham, Williams & Co., of Philadelphia, Pa., announce the death, on March 23, 1909, of Mr. William P. Henszey, a partner in the firm and connected with the Baldwin Locomotive Works since March 7, 1859.

A strike among the cigar makers in Santiago City is threatened. The dissatisfaction is over the wages paid.

The Cardenas Ice Co. has filed an application for the establishment of an ice plant at Guanabacoa. The town is at present supplied from Regla and Havana.



Graduated Cuban nurses appointed chiefs of the Schools for Nurses at Havana, Cienfuegos and Santiago.

In the past nine years 157 nurses have been graduated and appointed to service in the different hospitals in Havana and in the island. At present there are 143 young women taking the course at the different hospitals.

The six new appointees, to be heads of the schools for nurses in different parts of the island, are graduates of the Cuban hospitals and their promotion to executive positions have met with general approval.



Graduated Cuban nurses to take charge of the schools at different hospitals in Havana.

Moving Pictures of Cane Planting.

The Edison Moving Picture Company has a crew of men in Cuba getting up a series of views of moving pictures of the various interests of the island, especially the growing and the manufacture of tobacco and sugar cane.

Pictures are also being made of the work in the cigar and cigarette factories.

The pictures include all phases of sugar production, from the plowing of the ground, planting the cane, to the loading of the manufactured sugar on the trains. The cane was followed in the heavily laden bull carts to the mill and all the process in that great institution was put on record on the films, and some views were also taken of typical Cuban sports only seen in Cuba.

Dr. Antenor Firmin, a brother of President Firmin of Haiti, has been appointed Haitian Minister to Cuba.



Mr. George M. Bradt, Publisher of the Havana Post.

Old Things and New in Cuba.

"The oxen still tug at the wooden plow in the fields, but the latest patent in agricultural motors puffs past in the next

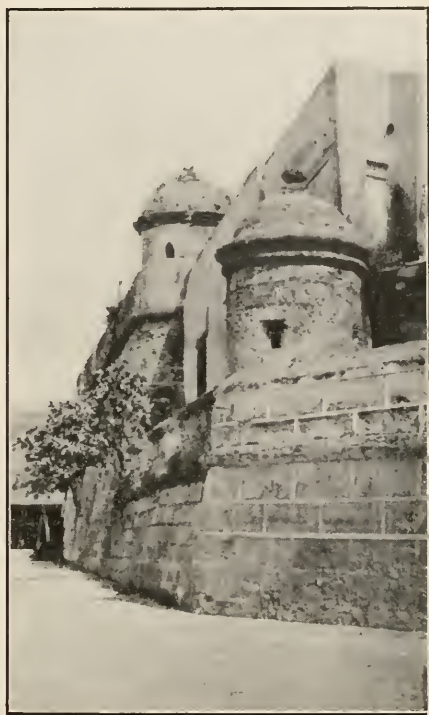

Part of Havana's Old Wall Near the Arsenal.



Colonists' Homes in Cuba.—Mrs. Graves Garden at Omaja, Cuba, showing windmill, grape arbor and water tank. The well is 21 feet deep and the water is good and plentiful.

enclosure," says the Havana Post. The volanta has fled to the mountains before the advance of the touring car on the wide white highway. The country girl still owns a mantilla, but she wears a hat on Sundays because the foreign ladies she sees smiling at her from the sleeping car windows—do they not wear marvellous hats? In the country town the old people prefer the sweet tingle of the bandurria, but the mayor's son, who attends school at Baton Rouge—he plays the mandolin. The "guajiros" who lounge in the corner café will sing you a Cuban ditty on request, but the phonograph in the back room has a disk of "Waltz Me Around Again, Willie."

A Convert to Cuba.

U. S. Congressman George A. Bartlett of Nevada, recently visited Cuba and has this to say:

"I have a word to tell about our stay in Cuba on the return trip. Before seeing that country I was bitterly opposed to annexing it, but now I am a convert. I believe that the beautiful and fertile island of Cuba should be part of the United States territory. Havana is a dream—bewitching, captivating beyond language to describe.

COMMERCIAL AND GENERAL NOTES.

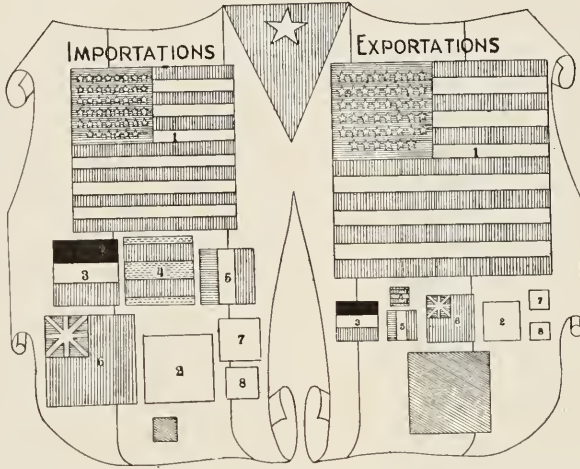

Chart showing the trade of Cuba for the year 1907. The countries interested and the volume of business are given below.

Cuba's Commerce Shown in Chart.

Trade statistics issued by the Cuban Secretary of the Treasury showing importations and exportations of Cuba during the year 1907:

| Countries. | Importations. | Exportations. |
|-------------------------------------|---------------|---------------|
| 1. United States | \$51,309,808 | \$90,874,095 |
| 2. Other countries of America | 9,277,085 | 2,502,384 |
| 3. Germany | 7,592,326 | 3,211,959 |
| 4. Spain | 9,478,615 | 481,492 |
| 5. France | 6,044,705 | 1,365,573 |
| 6. Great Britain | 15,322,981 | 4,506,458 |
| 7. Other countries of Europe | 3,604,052 | 744,189 |
| 8. All others | 1,831,363 | 486,817 |
| Total | \$104,460,935 | \$104,172,967 |

Cuban Iron Ore.

Charles M. Schwab made the statement recently that he can ship ore from Cuba to Bethlehem at a lower cost than the Steel Corporation can ship its ore to Pittsburgh. Therefore the removal of the duty on Cuban ores would give the Bethlehem and Pennsylvania Steel companies an advantage over ore companies in the United States and will influence lower prices.—Wall Street Journal.

The Philadelphia Ledger anticipates great changes for Cuban ores. It says: "The ore could be landed at Philadelphia at a cost of \$1.50 per ton below the cost of Mesaba ores delivered at Pittsburgh." It says further: "The ore fields of Cuba are believed to be wide and deep."

Condensed Milk Exportations to Cuba.

Cuba is a substantial purchaser of condensed milk, which is a comparatively new and rapidly growing export from the United States. To Cuba the growth has been rapid, the value of the product exported to that island in 1907 being \$70,485; in 1900, \$442,610; in 1906, \$665,277, and in 1908, \$905,068. In the last-mentioned year Cuba was the largest purchaser.—Report of the U. S. Department of Commerce and Labor.

Cuba's Gain From Tourists.

Consul General James L. Rodgers reports that the detail of United States customs inspectors at Havana to examine the baggage of passengers proceeding to Florida ports has given the first satisfactory basis for estimate of the volume of the winter tourist invasion of Cuba.

The reports show that there have been over 7,000 examinations of baggage since January 1, and of that number it is safe to assume that at least 6,000 dealt with the effects of transient Americans. Adding to the tourists coming and departing by the way of Florida, the number of 500 weekly from New York and New Orleans, and it can be estimated that Cuba derived benefit from 10,000 visitors during the past winter season to March 1.

Current opinion is to the effect that the average tourist spends about \$15 per diem, and that the average sojourn is about four days. If such is anywhere near the fact, then it can be seen that the 10,000 tourists have left \$600,000 in Cuba.

COMMERCIAL MATTERS.

Cotton Goods for Cuba.

Cotton goods is a leading item in the import trade of Cuba, and aggregates over £1,000,000 sterling, say the London, England, Textile Mercury. The classes selling best are madapolams and shirtings, fine and medium for underwear and bed linen, batistes, zephyrs, oxfords and Vichy and Irish cloths of the very thinnest, as well as ordinary and printed calico, with the bulk of the trade in British and Spanish hands, but a quantity comes also from France and Germany. As regards designs, the small patterns in clear colors usually enjoy the preference, the tints being pale blue, rose, red, mauve, lilac, etc., on a white background. There is also a certain trade in black printed goods. The black female population, which represents about a third of the total, usually wear orange, yellow, or maroon-colored cotton goods. The best qualities of these, with designs of flowers, come from Great Britain, France, or Germany, and are often good imitations of printed muslins. Oxfords, zephyrs and Vichy cloths are employed for men's underwear, and the cheapest qualities have the readiest sale, the poorness of the native restricting the demand for the best goods.

There is a good trade in drills such as are worn by Europeans in the Congo, but a great deal of this demand is served by Barcelona firms, owing to the strong Spanish element in the island and to the conservatism of the Cubans. Prices are very finely cut, and competition in these lines is keen. The Havana merchants insist on having very light goods owing to high import duties. This trade is done at six months' credit, with 2½ per cent. discount.

Welsh Coal for Cuba.

The anthracite mine owners in Wales have discovered a new market in Cuba, and are sending their product there.

In a recent U. S. Consular report mention is made of a shipment of anthracite washed "beans" from Swansea to Cuba. These beans are three-fourths to 1 inch in size, and well screened and washed. Recently there was another shipment of anthracite washed "nuts," 1½ to 2½ inches, for Cuba. The consignment was one of 2,000 tons, the f. o. b. price was \$6.20 per ton, and the rate of freight to Cardenas \$2.68 per ton. Like a former shipment, this one was made through a German house.—U. S. Government Report, Mar. 29, 1909.

Sugar Making Machinery in Demand.

The most encouraging outlook for the machinery trade at present is in the demand for sugar-making equipment from Cuba, which is especially heavy just now. At this time of the year estimates can be made on the outlook for the annual crop, and those in touch with the situation say that never before in the history of that industry on the island has the prospect for a record-breaking crop been so bright. This will mean that the sugar plantation and the sugar factory people in Cuba will have plenty of money to spend, and already the trade is hearing from them. The buying that has been done so far this spring exceeds that of the entire season of 1908, and a number of prominent machinery men are now in Cuba looking for business or arranging details for delivering orders.—Iron Age, Mar. 25.

A New Industry for Cuba.

There has just been incorporated "The Cuba Mill and Furniture Company" under the laws of the territory of Arizona, with a capitalization of \$500,000, of which \$100,000 is 8% cumulative preferred stock and \$400,000 is common stock. The preferred stock must be retired at par and accumulated interest before any dividends can be paid on the common stock. Par value of each share, \$10. The preferred stock sells at par, and each share carries some of the common stock as a bonus. E. B. Curtis is president and Geo. T. Street is secretary-treasurer. Main office of the company is located at Camaguey. The company has valuable timber contracts, and will manufacture building material, including shingles and doors, and will also manufacture crate and cigar-box material, ax and pick handles, wagons, bull carts and a very high grade of furniture, utilizing the many varieties of valuable hardwoods to be found in Cuba.

February Havana Customs Collections.

| | |
|------------|----------------|
| 1907 | \$1,415,208.39 |
| 1908 | 1,327,083.09 |
| 1909 | 1,237,130.93 |

The collections for March, 1909 and 1908, were as follows:

| | |
|-------------------|----------------|
| March 1909 | \$1,562,486.23 |
| March, 1908 | 1,445,400.15 |

Increase over 1908 \$117,086.08

Application has been made to the City Council of Cienfuegos for a franchise for the establishment of a trolley line in that city.

COMMERCIAL MATTERS.

Cuban Cacao Exportations.

| 1906 | | |
|--------------------------|-----------------|-----------|
| Principal countries: | Pounds. | Value. |
| United States | 3,363,173 | \$363,765 |
| Germany | 729,094 | 69,904 |
| Spain | 1,195,147 | 150,348 |
| France | 1,130,701 | 114,137 |
| United Kingdom | No exportations | |

Total exportations. . 7,214,691 779,156

| 1907 | | |
|--------------------------|-----------|-----------|
| Principal countries: | Pounds. | Value. |
| United States | 1,789,181 | \$234,081 |
| Germany | 286,705 | 46,139 |
| Spain | 291,204 | 54,168 |
| France | 1,288,337 | 231,482 |
| United Kingdom | 1,288,337 | 231,482 |

Total exportations. . 3,725,718 573,455

The following summary gives the cacao production by provinces—crop of 1906-07:

| | Plantations. | Trees. |
|-------------------------|--------------|-----------|
| Pinar del Rio | None | None |
| Havana | " | " |
| Matanzas | " | " |
| Santa Clara | 1 | 3,940 |
| Camaguey | 30 | 27,000 |
| Oriente | 714 | 1,829,366 |

Total 745 1,860,306

Official figures of the Cuban Secretary of Agriculture.

Santiago Textiles Imports.

According to statistics obtained from the local custom house there was imported into Santiago during 1907 over \$1,600,000 worth of textiles alone, of which only about 7 per cent. came from the United States. It would seem that more of this valuable trade should have been secured by American manufacturers.

The eastern section of Cuba is keeping pace with the rest of the island in commercial growth and American exporters will do well not to neglect the trade here.—U. S. Government Advertiser.

Cuba's Commerce.

Imports.—During the twelve months ending June 30, 1908, Cuba's imports amounted to \$97,000,000, as against \$96,700,000 in 1907.

Exports.—Cuba's exports for 1908 amounted to only \$97,400,000, as against \$110,800,000 for the previous year. While the average monthly importations for the

two years were about the same, the average monthly exports dropped from \$9,200,000 in 1907 to \$8,100,000 in 1908.—Official figures of the Department of Commerce and Labor.

Cuban Mahogany and Cedar.

Arrivals at New York for March, 1909, were as follows:

Mahogany: Cuban.—There were four ports represented in the month's arrivals, totaling somewhat more than the general monthly average. Some of this wood has been sold and also part of the stock that was on hand a month ago, slightly reducing the holdings in first hands.

Cedar: Cuban.—The receipts for the month were larger than those of the preceding month, but were still below the average. A large part of the receipts have passed into second hands, together with some of the stock that was on hand a month ago, which indicates a slight improvement in the trade. Fresh stock, in good condition, should be well received.—George F. Herriman.

A Big Order for Pipe.

The United States Cast Iron Pipe & Foundry Company on March 26 sent forward to Mobile four trains loaded with pipe for Cuban ports, making within the past ten days eight solid trains of iron pipe shipped from Bessemer to fill the big order booked for Cienfuegos, Cuba. Eight trains mean more than 200 cars loaded with the product.—Chattanooga (Tenn.) Tradesman.

The production of beer in Cuba during the month of February, according to the treasury statement, was 1,009,100 litres, which paid in internal tax to the government the sum of \$5,606.11.

The total value of the cedar imported into Tampa, Fla., from Cuba for the manufacture of tobacco boxes during the year 1907 was as follows:

| | |
|------------------|----------|
| Boards | \$37,359 |
| Logs | 115,592 |

Total \$152,951

United States exports of sewing machines to Cuba have steadily declined during the last few years. The official figures are as follows:

| | 1906. | 1907. | 1908. |
|--|-----------|-----------|-----------|
| | \$318,063 | \$294,721 | \$210,809 |

U. S. Govt. Report, Mar. 29, 1909.



The Euphorbia in Cuba—a cactus which grows freely in all parts of the island. The sap from this plant, it has been found, forms a good substitute for rubber. (See article below.)

Rubber Substitutes From Cacti.

A report from U. S. Consul-General William H. Michael, at Calcutta, India, states that an Indian officer was shown a ball of raw substance by a forest officer of one of the native states of India which resembled in appearance gutta-percha or rubber in its raw state. The forest officer said it was from the common cactus, which grows wild in India, known as the Euphorbia.* Acting upon suggestions, about two pounds of the sap from the cactus was procured. It had to be softened in hot water and was then churned. The effect was the same as with milk. The latex was brought to the consistency of putty, which was tough and nonsoluble in water. The putty mass was then kneaded together with sulphur—six parts of the latex to one of chloride of sulphur—and the kneaded mass was allowed to stand 24 hours. The mass was then subjected to heat at 350° F. under pressure in a vulcanizer containing hydrated lime for 1½ hours.

The experiment demonstrated that as a rubber compound, both in appearance and adhesiveness, it was equal to rubber compounds on the market which are sold at 65 cents per small tin, while

*The cactus or plant from which this sap was taken for the experiments is very common in India and is equally common in Cuba. See illustration of plant used as a hedge, for which it is particularly well adapted.

the cactus compound could be sold for 8 annas, or 16 cents. The officer says that owing to the cheapness of the composition it would be most effective as a primary coating for any woodwork exposed to dampness.

The experiments also demonstrated the fact that coagulation may be secured by mixing the latex with ordinary lime juice. This would be a cheap and easy way of experimenting with the juice of cactus found everywhere in Cuba. Should the sap of the Euphorbia prove available for the purpose described it ought to open up a new and valuable industry.

Pineapples and Cuban Fruits in the Payne Bill.

The last part of article 270, referring to preserved pineapples, says:

"Pineapples, preserved in their own juice, not having sugar, spirits, or molasses added thereto, 25 per cent. ad valorem."

Of pineapples in bulk, or in their natural state, the law reads:

"Pineapples in barrels and other packages, eight dollars per thousand."

Of citrus fruits, the law reads:

"Lemons, one and one-fourth cents per pound; oranges, limes, grape-fruit, shad-docks, or nomelos, one cent per pound."

FINANCIAL AND RAILROADS.

Cuba Railroad.

The report of the Cuba Railroad Co. for the month of January and seven months ended Jan. 31 compares as follows:

| | 1909 | 1908 |
|--|-----------|-----------|
| Jan. gross | \$218,258 | \$183,793 |
| Expenses | 114,884 | 116,757 |
| January net | \$103,373 | \$67,036 |
| Charges | 33,086 | 31,954 |
| January surplus ... | \$70,287 | \$35,082 |
| Seven months' gross.. | 1,065,868 | 1,053,125 |
| Expenses | 639,861 | 740,073 |
| Seven months' net.. | \$426,007 | \$313,052 |
| Charges | 227,359 | 205,926 |
| Seven months' surplus | \$198,648 | \$107,126 |
| The report of the Cuba Railroad for the month of February and eight months ended Feb. 28, compares as follows: | | |
| | 1909. | 1908. |
| February gross | \$223,089 | \$222,086 |
| Expenses | 108,134 | 119,828 |
| February net' | \$114,955 | \$102,258 |
| Charges | 33,760 | 31,954 |
| February surplus .. | \$81,195 | \$70,304 |
| Eight months' gross.. | 1,288,957 | 1,275,212 |
| Expenses | 747,995 | 859,901 |
| Eight months net.. | \$540,962 | \$415,311 |
| Charges | 261,119 | 237,880 |
| Eight months surplus. | \$279,843 | \$177,430 |

Plans of Sir William Van Horne.

The president of the Cuba Company, Sir William Van Horne, at a luncheon tendered him at Camaguey on March 24 by Mayor Fernandez and Congressman Vilardel, announced his purpose of nationalizing his company and of changing its present foreign officials for Cubans, says the Havana Post. After highly complimenting the honesty and ability of Cubans he announced his intention of building a home in Camaguey, where he expects to spend his leisure time. Sir William has been made an adopted son of the City of Camaguey.

Spanish Bank Officers.

At the annual meeting of the Spanish Bank, held recently at its offices in Havana, the following officers and directors were elected: President, Mr. José Marimon y Juliach; counsellors, Mr. Florentino Menéndez y Menéndez, Mr. José Gómez y Gómez, Mr. Francisco

Palacio Ordóñez, Mr. José Roig y Roig, Mr. Antero Prieto y González; substitutes, Mr. José García Morán, Mr. Higinio Leal Farrá.

National Bank of Cuba.

General balance sheet, December 31, 1908, in United States currency:

| ASSETS. | | |
|---|----------------|-----------------|
| Cash in vaults..... | \$4,934,054.74 | |
| Due from banks and bankers | 1,010,449.75 | \$5,944,504.49 |
| Bonds and Stocks: | | |
| Government bonds.. | \$3,133,788.54 | |
| City of Havana bonds | 930,972.73 | |
| Other bonds and stocks | 411,701.53 | 4,476,462.80 |
| Loans, discounts, time bills, etc. | | 10,862,632.90 |
| Furniture and fixtures | | 94,306.55 |
| Bank buildings and real estate | | 660,790.27 |
| Sundry accounts ... | | 20,822.08 |
| Total | | \$22,059,519.09 |
| LIABILITIES. | | |
| Capital | \$5,000,000.00 | |
| Surplus | 800,000.00 | |
| * Undivided profits.. | 282,789.99 | \$6,082,789.99 |
| Due to banks and bankers | | 1,660,000.06 |
| Deposits | | \$14,316,729.04 |
| Total | | \$22,059,519.09 |

* Deduct \$200,000—4 per cent. semi-annual dividend, payable Jan. 2, 1909.

Earnings of the United Railways.

The United Railways of Havana gross earnings in the week ending March 14 were £38,647, as against £34,351 in the corresponding week in 1908, an increase of £4,296.

In the week ending March 21 the earnings were £36,719, against £33,036 in the corresponding week of 1908, an increase of £3,683.

The total revenue during the 37 weeks and four days of the present economic year amounts to £743,734, against £698,425 during the same period of 1908, an increase of £45,309. Receipts quoted include those from the Marianao Railway, but not those from the Regla Warehouses.

Earnings of Cuban Railways.

| Cuban Central: | 1909. | 1908. |
|-----------------------------|---------|---------|
| Week ending Mar. 20. | £16,590 | £14,074 |
| Week ending Mar. 27. | 17,303 | 13,800 |
| Total receipts thus far | | |
| this year to Mar. 27. | 301,762 | 261,619 |
| Western Railways of Havana: | 1909. | 1908. |
| Week ending Mar. 20. | £4,628 | £5,708 |
| Week ending Mar. 27. | 4,810 | 5,190 |
| Total receipts this year | | |
| to Mar. 27 | 212,894 | 200,937 |

FINANCIAL AND RAILROADS.

Havana Electric Annual Report.

The Havana Electric Co. has issued its report for the year ended Dec. 31, 1908. The income account compares as follows:

| | 1908. | 1907. | 1906. |
|---------------------|-------------|-------------|-------------|
| Gross (Ry.)..... | \$1,937,797 | \$1,810,888 | \$1,621,209 |
| Expenses, etc. | 971,725 | 964,732 | 1,031,373 |
| Net (Ry.) | \$966,072 | \$846,156 | \$589,836 |
| Other inc. (stages) | 64,311 | 78,790 | 40,863 |
| Total income .. | \$1,030,383 | \$924,952 | \$630,699 |
| Charges and taxes. | 454,781 | 558,877 | 498,313 |
| Surplus | \$575,602 | \$366,075 | \$132,386 |
| Dividends | *374,634 | 275,000 | 200,000 |
| Surplus | \$200,968 | \$91,075 | \$67,614 |

*In 1908 includes 6% on the preferred and 1% on the common stock. The balance, \$200,968, is equal to an additional 2.6% on the \$7,463,000 common stock outstanding.

| | 1908. | 1907. | 1906. |
|---------------------------------------|----------|----------|----------|
| Operating mileage..... | 50 | 50 | 50 |
| Gross earnings per mile of road | \$38,448 | \$36,217 | \$31,406 |
| Net earn. per mile of road | 19,168 | 16,923 | 12,251 |

Manager Steinhart's report states the total trackage at present to be 57.35 miles.

The construction of necessary new lines are contemplated and plans have been drawn for the company's new office building, which will soon be erected. One hundred and forty-nine stages or guaguas are in daily active service in the city and suburbs.

Havana Electric Railway Earnings.

The Havana Electric Railway's gross earnings during the week ending March 14 were \$39,596.20, as against \$38,742.60 for the corresponding week in 1908.

During the week ending March 21 the earnings were \$38,323.85, as against \$39,707.55 in the corresponding week of 1908.

Cuba Railroad Extension.

On March 25 President Gomez signed the document obligating the government to subsidize the Cuba Railroad to the extent of \$6,000 per kilometer for the new extension to be built from Marti, southeast to Bayamo, thence east to Jiguani, Baire and Palma Soriano, 200

kilometers. From Bayamo another extension will be built to Manzanillo, about 45 kilometers.

The concession represents a subsidy of about \$1,500,000, which may be reduced a quarter of a million if the government takes advantage of its right to make the concession \$5,000 instead of \$6,000 per kilometer.

The new road will develop one of the richest sections in Cuba.

The contract provides for a reduction in the subsidy to \$5,000 per kilometer if deemed advisable, and grants the government a special train and special rate for each soldier of one cent per each kilometer for all troops transported when needed.

Cuban Securities Attractive.

The permanent treaty between the United States and Cuba, known as the "Platt Amendment," has been the principal cause for the investment in Cuban government and other securities by conservative investors. The force of this treaty, especially as regards the debt-making power of Cuba, was not thoroughly appreciated until the United States government, on transferring the control of the island of Cuba to the Cuban people on January 28 last, made it plain, through Governor Magoon, that the United States understood that this treaty forbade the government of Cuba from assuming or contracting any public debt in excess or in addition to the debt already contracted or authorized by now existing laws, and that no further indebtedness would be recognized by this government as valid. It is believed that the control which must continue to be exercised by the United States over Cuban affairs, as well as the fact that the revenues of Cuba are more than ample to provide for the service of its debt will make Cuban government issues attractive to investors.

QUOTATIONS FOR CUBAN SECURITIES.

Supplied by LAWRENCE TURNURE & CO., New York City, April 14, 1909.

| | Bid. | Asked. |
|--|------|--------|
| *Republic of Cuba 5 per cent. bonds..... | 103 | 103½ |
| Republic of Cuba 6 per cent. bonds..... | 100 | 101 |
| Republic of Cuba 5 per cent. new bonds (interior loan)..... | 93½ | 94½ |
| Havana City first mortgage 6 per cent. bonds..... | 105 | 106 |
| Havana City second mortgage 6 per cent. bonds..... | 104 | 106 |
| Cuba Railroad first mortgage 5 per cent. bonds..... | 98 | 100 |
| Cuba Railroad preferred stock..... | 62 | 66 |
| Cuba Company 6 per cent. debentures..... | 80 | 90 |
| Havana Electric consolidated mortgage 5 per cent. bonds..... | 80 | 90½ |
| Havana Electric preferred stock..... | 86 | 88 |
| Havana Electric common stock..... | 49 | 50 |
| Matanzas City Market Place 8 per cent. bonds etfs. | 103 | 104 |

* All prices of bonds quoted on an "and interest basis."

ISLE OF PINES NOTES.

In the Isle of Pines are waters whose value medicinally is great. The Spanish government many years ago recognized their curative properties and sent its officers and soldiers to the island when in need of restoration to health. The waters received the first prize at the Cuban National Horticultural Exposition in Havana in March.

Nothing would pay more handsomely for a small investment than a dairy on the Isle of Pines.

A few more calzadas would make communication between the several parts of the island easy and would increase the value of the land holdings much.

There is an immense acreage along the arroyas or creeks which is splendidly adapted to the growing of bananas and should be utilized.

A church edifice is now a sure thing for McKinley. Bishop Albion W. Knight assisted with \$500 cash.

A 35-pound watermelon grown by O. T. Anderson was an Isle of Pines exhibit at the recent Horticultural exhibition. On being cut it was found perfectly ripe, sweet and of fine flavor.

The handsome launch Canada, owned by the Canada Company, has now a schedule whereby it leaves Nueva Gerona on Thursdays and Sundays for Los Indios and leaves Los Indios for Nueva

Gerona on Wednesdays and Saturdays.

The same company, of which Charles S. Brown is president, sold during the month of February more than four hundred acres of land to men from Michigan, Kansas, Nebraska and Idaho. All of the purchasers bought with the intention of improving their holdings immediately. Mr. Brown says Los Indios is fast becoming one of the island's attractive centers and within twelve months great improvements are contemplated.

It is safe to predict that the farmers of this island will pay more attention to the growing of tobacco and the raising of poultry in the future than they have done in the past. They took first prize for tobacco at the exposition in Havana.

Sr. Cecelio Soto, formerly secretary of the board of education of the Isle, has been appointed collector of the port of Nueva Gerona (and the entire Isle) vice Capt. Arredondo.

First Lieutenant L. Alvarez has been appointed to the command of the Rural Guards on the Isle of Pines.

A cabbage weighing $27\frac{1}{2}$ pounds is to the credit of C. D. Abbey, Nueva Gerona.

A bunch of ten grapefruit, 15 pounds in all, picked from J. J. Symes' $2\frac{1}{2}$ -year-old grove, is the latest report from Los Indios.—Isle of Pines News.



S. S. Veguera at Jucaro Landing, Isle of Pines.

Work has begun on the new park at Santa Fe.

Mr. Walter McIntosh, Santa Anna, Isle of Pines, reports his success with varieties of grapes from Southern California, Southern Europe, and elsewhere, set out in April, 1908. In the following December, after a vigorous growth, the vines shed their leaves and became dor-

mant. Half of the vines were pruned back 4 to 6 feet, the others were untouched. In March, 1909, all seemed healthy, the Black Hamburg having fruited and still blooming.

The mail service between the Isle of Pines and the United States is very bad, says the Appeal.

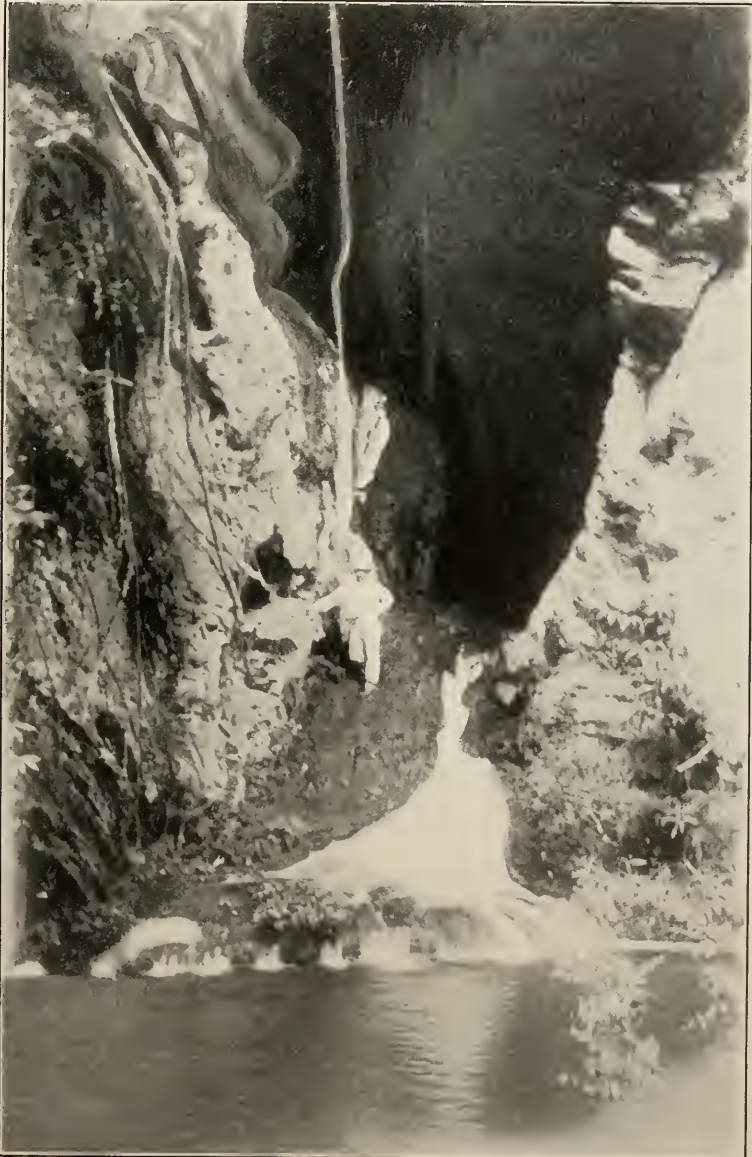

Hanabanilla Falls on the Hanabanilla River, near Cienfuegos. The source of the new water supply for the city.

AGRICULTURAL MATTERS.—TOBACCO.

Tobacco in the Santa Clara District.

Supplementing his previous report on Cuban tobacco raising,* Consul Max J. Baehr, of Cienfuegos, transmits the following information, furnished by Mr. John S. Stanley, of Manicaragua, on the cultivation of tobacco in the Santa Clara district:

"Cultivation of tobacco, it seems, is almost wholly done on the share system, the workingmen giving to the owner of the plantation one-third of the crop. The owner supplies land, living and tobacco-curing houses, poles, oxen, plows, etc., and all tools necessary, and all monies or groceries advanced are charged up against them. Two or more men work together, and each man cultivates about four acres of tobacco, or about 30,000 plants, which in an ordinary year should yield 3,000 pounds of tobacco. Work commences about Oct. 1 and continues to May 1. With 3,000 pounds, and 12½ cents a pound as an average price, the value of the crop would be \$375. Deducting the one-third for the owner of the plantation, would leave for the workman \$250 for seven months' work, or nearly \$36 per month for each. A thrifty man can almost feed his family from the extra land he is allowed to cultivate, salt, sugar, coffee and clothing being about all that he will require from the store. During the other five months he may work in the baling house sorting the tobacco, where he may earn \$1.25 to \$1.50 a day. A living house made of grass and yagua costs \$75; a tobacco house for curing the tobacco raised by two men, costs \$300; a yoke of oxen which will prepare land for two men will come to \$125; poles for drying the tobacco for two men, \$75; plows and

other necessary tools, about \$15; land necessary for two men, at current rate, is worth about \$150.

"It will be seen, therefore, that the owner has expended \$740 and receives \$250, or about 34 per cent. on his investment. The depreciation in value may be estimated at 20 per cent. per year, thus leaving about 15 per cent. as the net interest on the invested capital.

"These figures are correct under normal conditions, but should the year be very dry or too wet, the above-shown profit might be reversed to a like amount of loss."

Irrigation for Tobacco.

To judge this year's Vuelta Abajo crop is yet rather premature, and as the hilly districts have been favored by plenty of rain showers, there will be a large quantity, which may offset the shortage in the tierra llana sections. As a rule the lowland tobacco is the finest and most aromatic of the two kinds, but there might be an exception this year.

The question of irrigation upon a scientific plan, like it has been done in the States of California and Colorado, is being brought forward by influential and thinking men, and doubtless this subject will be ventilated in our Congress, in order to help the poorer farmers thus to promote the welfare and prosperity of our island. Tobacco requires more rains than nature of late has seen fit to bestow and irrigation is essential.

Results achieved by the rich planters, who could afford to buy enough iron pipes, erect pumping stations and spend money for coal, has been marvelous this year. The raising of sufficient healthy and uniform plants for seeding purposes is one of the objects which our

*See Cuba Review for February, 1909.



Drying Tobacco. La Flora Plantation, Pinar del Rio.

agricultural stations are now undertaking and which undoubtedly will bear golden fruit and help to improve the quality of Vuelta Abajo leaf.

The cheese-cloth invention of raising tobacco under cover, principally for wrapper purposes, is also bound to stay, but owing to its excessive cost cannot be undertaken by the small farmers. To help the latter some experiments have been made by substituting for the cheese-cloth palm leaves, which are placed upon posts, wires or slats. This procedure is considerably cheaper and has the advantage that the palm leaves can be taken off or put on at the pleasure of the vaquero, when he wants the growing plants to have more sunlight or more shade.

Thinking men have come to the conclusion that the old routinary ways of raising tobacco have to be abandoned and that progressive methods are in order, so as to get the most out of the soil by sufficient moisture, good fertilizers only which the soil needs most, the best kind of seeds to produce only healthy, uniform seedlings (no hybrids) and finally the careful watching of the plants during the process of its growth. The cutting of the single leaves when ripe is also a great improvement over the old system of cutting off the whole plant, as the latter always had some unripe leaves mixed with the ripe ones. The sweating process in the piles and later on in the bales might also be improved upon more generally by the farmers.

A society of large planters, packers and leaf dealers has been formed for mutual protection and for the advancement of trade. Don Louis Marx is the president; Don Angel del Valle, of Jorge & P. Castañeda, is secretary; and the directors are: General Emilio Nuñez, of Loeb Nuñez Havana Co.; General Albert Nodarse, a successful planter; Senator Manuel Lazo; Pablo Perez, of Perez & Obeso; Severo Jorge, of Jorge & P. Castañeda. Antero Prieto, of Sob. de A. Gonzales; Casimiro Heres; Antonio M. Suarez; Manuel Garcia Pulido; Jacinto Argudin, of the Tobacco Trust; Tomas Mederos; Nicolas de Cardenas, of Cardenas & Co.; Avelino Pazos, of A. Pazos & Co., and Jesus R. Bautista, of Rodriguez, Bautista & Co. This society forms part of the Agricultural League of the whole island and has the active support of the President. With peace, government support and the active help of such intelligent people as the above list contains, a failure of the Vuelta Abajo crop, or for that matter of any tobacco-growing section, ought to be almost a thing of the past, and the quality of our tobacco

ought to be greatly enhanced in the future.—From Tobacco.

The Mango in Cuba.

(Condensed from an article by Adolph von Hermann.)

The history of the mangoes in Cuba is rather obscure, and it is uncertain whether the seed was brought from some of the other islands close by, from Europe or direct from India. Such names as Manga, Indio, Filipino, Manila Ingles, France, still applied by the native Cubans, might indicate the place from which the seed was introduced, or the name by which the type was originally known.

Many thousands of seedling mangoes are found in the cultivated districts of the island marking the place of former habitations, water courses, etc.

Taken as a whole, these seedlings are as good as similar fruits found anywhere on the American continent, but when compared with the mulgoba and other of the aristocratic mangoes of the East Indies, we must call most of them poor.

There are many varieties and endless variations. Each tree of a known variety may differ from its neighbors in the color, size, shape, flavor, fiber and general consistency of the fruit. There are, however, some good varieties of mangoes in Cuba worthy of our attention. A little observation during the fruiting season will be necessary to locate the trees from which the desirable fruits find their way to the local markets and fruit stands.

Cuba, with favorable soil and climate, will not be found wanting in such an important industry as the growing of the choicest mangoes the world can furnish. Already we have at least twelve varieties, all of which have been imported within the last three years.

Among them are the Mulgoba, Soonder-sha, Alfonse of Goa, Alfonse of Douglas Bennett, Fernandez of Goa, Perrine, Gordon, Totafari, Sharhati, Fagri long, Lath-rope and Fiberless No. 11 from Jamaica.

The Best Crop for Poor Farmers.

Mr. James F. Johnson, of La Moya, writes as follows:

"Tobacco is the best paying crop for the poor farmer with a large family, for all the women and children over six years of age can help to advantage with the crop; for outside the actual planting and cultivating, the work is light, consisting of keeping the worms and birds off the plants while they are growing, and one man with the help of two boys between 11 and 14 years will harvest double the tobacco that he could if working alone."

The growing of fancy mangoes will always be more or less restricted on account of the difficulties attending the process of propagating the trees by buds or grafts, making the cost of trees seem rather high for general planting.

The writer has paid from two to five dollars each for budded and grafted trees bought of Florida nurserymen, and the price will always remain high until we find an easier method of propagating trees of certain varieties.

The mango is a gross feeder and needs plenty of fertilizer.

It is fairly free from pests or diseases, except a kind of fungus or rust present during damp or rainy weather, which causes the flowers and young fruit to die.

Mr. Roland R. Conklin at Santiago de las Vegas is the first to attempt to grow fancy mangoes on a commercial scale in Cuba.

CULTIVATION OF COFFEE IN CUBA.

A Cuban Viewpoint of This Industry.

(Translation from La Gaceta Económica, Havana.)

There are some important coffee plantations at the eastern end of Cuba and smaller ones in the central portion, but they are not a factor of public wealth, for what Cuba produces does not even suffice for home consumption.

Travelers through Cuba have seen on stock-farms large driers, indicating the cultivation of coffee in past times. Cuban coffee is of excellent quality and it can be cultivated on soils considered useless for other crops; gravelly soils are very suitable. Hillsides, especially those covered with forests, are the most suitable places for the development of coffee plantations, making regions utilizable that cannot be used for other crops. There is no necessity for destroying the woods, because it is sufficient to clear them or open them up in order to plant them with coffee.

Coffee plantations need only one cleaning up a year, in shady places, and the gathering of the berries can be done by women and children. In one "caballería" (33½ acres) there is room for 20,000 coffee plants, with the proper separation, which reduce from the third year. From five years onward the yield is about three pounds per shrub, which is perennial. When production begins to diminish it is only necessary to cut back to a quarter of the height, losing the crop for one year in order that they may regain their full vigor.

When the coffee is gathered very ripe and dried in the shell, by the old process,

Cuban coffee is as fine as that of Brazil. Wages for cleaning in July, and more for harvesting in September and October, are all that a coffee plantation requires. The matter is of the greatest importance, and we think that the Agricultural Department, to foster the cultivation of this crop, should concede exemption from taxes for five years to newly planted coffee plantations.—La Gaceta Económica, Havana.

Improved Methods of Fruit-Handling.

Under the scientific investigation by Mr. G. Harold Powell, of the U. S. Department of Agriculture, and his staff of assistants, it has been demonstrated that decay in oranges is due almost entirely to careless, ignorant and unskillful handling.* Uninjured fruit, under fairly favorable conditions, is practically immune to decay. Once the tender skin of the orange is punctured or abraded, decay sets in.

Pineapple Duties.

The Chamber of Commerce, Industry and Navigation at Havana officially took up the question of the pineapplesituation on March 24, and its president, Narciso Gelats, in a letter to President Gomez, explained the damage to the growers in Cuba which would be done by the proposed advance in the United States tariff. The letter stated that in normal years the crop amounted to about 1,000,000 crates, 50 per cent. of which contain 30, 36 to 42 pineapples, on which the duty is 14 cents per crate, less 20 per cent., under the terms of the reciprocity treaty. The proposed increase in the duty to \$8 per thousand pines would preclude the possibility of shipping any but the largest pineapples to the United States, with disastrous results to pineapple growers in Cuba, and the possible abandonment of the cultivation of pineapples in Cuba altogether, since the present duty is almost prohibitive towards the end of the season.

At the Cuban cabinet meeting, on the 24th of March, it was determined to instruct General Garcia Velez, recently Cuban Minister at Washington, to exert his official influence in behalf of more favorable tariff legislation.

Among the changes made in the Payne tariff bill on April 12 by the Senate Finance Committee was the following on pineapples:

In packages the duty on pineapples is reduced from eight to seven cents per cubic foot and in bulk from \$8 to \$7 a thousand.

* See some interesting data in the February Cuba Review.



A Citrus Fruit Nursery at Omaja.

OMAJA COLONY NOTES.

It is three years the 22d of January since the first settlers arrived in Omaja. Now there are many Americans here; all busy planting their plantations and building comfortable homes.

Among the many new houses built within the last few months are Mr. Pheuffer's, Noring's, Aho's, Johnson's, Anderson's, Lytle's, Mahan's, J. Williams', and Gilpin's.

The Brethern have erected a new church, 24x36.

In the business part of the town we have several new buildings. Mr. Rosario, our Cuban storekeeper, has erected a new building and residence, as have also our American grocers, Messrs. Kreider and Nye, Mr. Nye occupying the residence portion. Mr. Gilpin, our other genial grocer, has just moved into his new and commodious building.

The Piersons, Cranstons, Wildes and Arters, Sr., have all built additions to their residences. Messrs. N. Williams and Evans wil soon commence building.

One hundred and sixty acres have been planted to oranges, and one hundred and seventy acres more is being planted this spring.

Mr. and Mrs. Holt, of Somerville, Mass., are also new arrivals.

The Seventh Day Adventists hold service every Saturday, the Brethern every Sunday and a union service is held once a month.

The sawmill is busy every day sawing lumber for the many houses that are being erected.

The young men of the colony have organized a baseball team and have been playing the Cuban team from St. Augustine every Saturday.

The Omaja Orange Co. have planted twenty acres to oranges and expect to plant eight more this spring.

A company has been organized to put in a starch factory at Omaja, to be in running order by the fall.

A government school has been granted with a Cuban and an American teacher, Miss Alverace, of Holguin, teaching Spanish, and Mrs. Anderson teaching English. Instruction in Spanish is given the American children one hour daily.

Omaja is on the Cuba Railroad, in the Province of Oriente, about 89 miles from Nipe Bay.

CUBAN FRUITS AND VEGETABLES IN NEW YORK.

The Season for Most Cuban Vegetables Nearing a Close Owing to Increased Supplies from Nearer by—Pineapples Arriving Freely and Selling Well.

Specially written for The Cuba Review by Uerner-Barry Co. of New York.

The supply of Cuban vegetables in the New York market during the month of March was larger than any previous month this season, arrivals footing up to about 41,000 packages of vegetables, of which about 10,000 packages were tomatoes, nearly 6,000 packages onions, and about 500 potatoes. The season is now so far advanced, however, that New York is liberally supplied with vegetables from Florida and nearby-sections, and with buyers giving the latter the preference Cuban vegetables have fallen in price to a low and in some cases unprofitable point, and shipments have fallen off materially last week or two, with outlook unfavorable for any improvement on most kinds until next season. This applies to tomatoes, peppers, okra and similar kinds. The steamer in April 12, however, brought over 1,000 packages vegetables, mostly tomatoes, which are selling largely in range of \$1 @ \$1.25 per carrier. These tomatoes were mostly overripe and weak, and only suitable for cheap trade. If of better grade more money could have been realized, as Florida sold from \$1 @ \$2, with an occasional fancy mark exceeding the latter figure. Most of the other vegetables received of late have lacked keeping properties, and while often not actually overripe, the stock has shown a tendency to decay, rather than color and mature properly, so that the best class of trade has not been able to handle it, and it has seldom been suitable for shipment to distant markets from here. It would seem that if shipments are continued from now on, very close selection must be made and only finest stock forwarded in order to realize a profit.

Prices current throughout the season for Cuban vegetables have not been especially high.

Potatoes have commenced to arrive very freely from Florida and it is probable that further lots from Cuba will receive little attention. Cuban onions sold fairly well during March, but with this month more liberal supplies have appeared from Bermuda and Texas, and prices have ruled lower for all new onions. It is expected that the receipts from Texas alone this week will foot up 70 or 80 car-loads and they have fallen to \$1.75 @ \$1.90 per crate. Bermuda sold last week at \$2.25 per crate, but it is likely that \$2 will not be exceeded for next receipts, and \$1.75 @ \$1.90 is considered a full quotation at the present time for Cuban with the future course of the market depending upon the extent of shipments received from Texas.

Pineapples have arrived much more freely from Cuba of late. The second or late crop is probably exhausted and present receipts are of new pines. Few are arriving from Florida, and with other receipts moderate the Cuban fruit has been wanted and has sold promptly at quite satisfactory prices. During the month of March there were about 20,000 crates received, and so far during April receipts have been nearly as much. Recent sales have been made from \$2.75 @ \$3 for choice 24 size, down to \$1.75 @ \$2, and even lower for very small. Just at the close these figures are rather full, as offerings are quite liberal, the steamer in April 8 bringing over 10,000 crates, and sales at auction April 12 were mainly as follows: 24s., \$2.65 @ \$2.80; 30s., \$2.45 @ \$2.65; 36s., \$2.15 @ \$2.30; 42s., \$1.60 @ \$1.85; 48s., \$1.55. At this sale \$2.45 was bid for 18 size, but the receiver refused to accept that figure and withdrew the stock, expecting to realize more from store.

So few oranges, grape fruit or melons arriving that no settled prices prevail, though it is probable that good melons would sell well at fancy prices in absence of supplies from other sections.

New York, April 12, 1909.

SUGAR REVIEW.

Specially written for The Cuba Review by Willett & Gray of New York.

Our last sugar review for your magazine was dated March 8.

At that time Cuba Centrifugals of 96 test were quoted at $2\frac{1}{2}$ c. per lb. cost and freight, and 3.82c. per lb. for spot sugar.

The quotations now are $2\frac{3}{8}$ c. c. & f. for May shipment and $2\frac{19}{32}$ c. c. & f. for prompt shipment, or spots 3.95c.

During the intermediate time the market reached 4.05c. per lb., but under large offerings has reacted to present basis, a temporary reaction in an advancing market.

European beet sugar advanced during the same time from 10s. $3\frac{3}{4}$ d. to 10s. 6d., closing at 10s. $4\frac{1}{2}$ d., after several small fluctuations up and down.

Centrifugals are now 24c. per 100 lbs. below the beet parity, and 16c. per 100 lbs. below the new crop Java parity. As new crop Javas for June-July and later shipments are now coming on the market, Cuba prices will have to be considered in this new competition for the U. S. market, as restricting the further advance which might be looked for with the beet sugar only in competition.

The Tariff bill has passed the House of Representatives and gone to the Senate. The Finance Committee of the Senate has reported its bill to the Senate, leaving the sugar schedule unchanged from the Dingley bill, with the exception of a reduction of 5c. per 100 lbs. duty on refined sugar, and 300,000 tons of Philippine sugar free of all duty. The Cuban reciprocity treaty remains unchanged. The Senate is not likely to make any further concessions to Cuba.

The demand for cane refined sugar in the United States from the seaboard refiners has been unusually large since the opening of the year, by reason that the domestic beet granulated has been withheld from the market largely, but now the beet sugar factories are again pressing their surplus for sale and thereby reducing to some extent the former active demand for cane refined. After several advances in quotations the first reduction of 10c. per 100 lbs. has been made in deliveries from New Orleans and by two independent refineries at New York, indicating that the rise in the refined product is checked for the present at least.

The course of the raw sugar market will now follow the quotations for Javas and beets, and on present parity there is room for further improvement in Cubas before interference from foreign full duty paying sugar.

There is now prospect of a steady, firm market for raws, with some further possible improvement if supplies are not urged upon buyers faster than their wants require.

New York, April 12, 1909.

REVISTA AZUCARERA.

Escrita expresamente para The Cuba Review por Willett & Gray, de Nueva York.

Nuestra última revista para esta publicación estaba fechada Marzo 8. En dicha fecha los centrífugas cubanos se cotizaban á $2\frac{1}{2}$ cents. la libra, costo y flete, y á 3.82 cents. la libra por azúcar para entrega inmediata.

Las cotizaciones al presente son: $2\frac{3}{8}$ cents. costo y flete para embarque en Mayo; $2\frac{19}{32}$ cents. costo y flete para pronto embarque, y 3.95 cents. para entrega inmediata.

Durante el tiempo intermedio, el precio subió á 4.05 cents. la libra, pero las grandes ofertas hicieron que bajara á la cotización actual, que es una reacción pasajera en un mercado que tiende al alza.

El azúcar de remolacha europeo subió durante dicho período de 10s. $3\frac{3}{4}$ d. á 10s. 6d., cerrando á 10s. $4\frac{1}{2}$ d., después de algunas peyueñas fluctuaciones hacia el alza y hacia la baja.

Los centrífugas se cotizan ahora 24 cents. menos en las 100 libras que el precio equivalente del azúcar de remolacha, y 16 cents. menos en las 100 libras que la cotización del azúcar de Java de la nueva cosecha. Como quiera que ya se está vendiendo en esta plaza azúcar de la nueva zafra de Java para su embarque en Junio, Julio y meses siguientes, los precios de los azúcares de Cuba tendrán que considerarse en esta nueva competencia en el mercado de los Estados Unidos como una restricción á una nueva subida en las cotizaciones, que podría esperarse si la competencia se limitase al azúcar de remolacha solamente.

La ley modificando los aranceles de aduana ha sido aprobada en la Cámara de Representantes del Congreso y ha pasado al Senado. La Comisión de Hacienda del Senado ha presentado su informe sobre dicha ley al Senado, dejando las partidas referentes al azúcar lo mismo que estaban en la ley Dingley, con la excepción de una disminución de 5 cents en las 100 libras en los derechos del azúcar refinado y la admisión de 300,000 toneladas de azúcar de las Filipinas libres de derechos. El Tratado de Reciprocidad con Cuba queda sin alteración. No es probable que el Senado haga mayores concesiones á Cuba.

La demanda de azúcar de caña refinada por parte de los refinadores del litoral en los Estados Unidos ha sido extraordinariamente grande desde los comienzos del año, á causa de que el azúcar de remolacha granulado del país ha estado ausente del mercado por algún tiempo, pero ahora las fábricas de azúcar están otra vez forzando la venta de sus sobrantes, haciendo por lo tanto que disminuya la demanda que había de azúcar de caña refinado. Después de varias subidas en los precios, la primera baja de 10 cents en las 100 libras ocurrió en ventas hechas desde Nueva Orleans y por dos refinerías independientes en Nueva York, indicando ésto que el alza en el azúcar refinado se ha detenido por el presente á lo menos.

Las cotizaciones del azúcar mascabado seguirán ahora el curso de los precios cotizados por los azúcares de Java y los de remolacha, y en la equivalencia actual de precios, todavía hay lugar para un avance en los precios de los azúcares cubanos antes de que recurra á la importación de azúcar extranjero que pague los derechos completos.

Al presente, los indicios son de que los precios del azúcar de remolacha se mantendrán firmes con tendencia al alza, si la oferta no se hace en mayores proporciones que las que tenga la demanda, es decir, dejando que la demanda se anticipe á la oferta.

Nueva York, 12 de Abril de 1909.

SUGAR NOTES.

Cuban Sugar Refineries.

Consul-General James L. Rodgers, of Habana, reports that the refining of sugar, in a commercial way, is confined to Cardenas, where there are three refineries, the Cuban Sugar Refining Company (owned by the Cuban-American Sugar Company), José Arechabala & Co. and Echevarria & Co., the latter operating this year for the first time. The first named plant refined last year 13,500,000 pounds of crude sugar, supplied from its mills in the vicinity, and the Arechabala factory 11,375,000 pounds, the average price for crude sugar being a little over 2¼ cents American money per pound. No figures are obtainable as to the selling price. He states that under the present Cuban tariff these refineries are making a satisfactory profit. There are many small plants in Cuba where a rough refining of sugar for purely local and restricted consumption is effected. These so-called "turbinas," however, do not enter much into the modern refining question, and their aggregate output, so far as can be ascertained, is entirely unknown.

Of the sugar output for the 1909 grinding season he says:

"All that can be said with certainty

up to the present is that the early expectations as to a large crop have been sustained."

R. B. Hawley, president of the Cuban-American Sugar Company, having lately returned from Cuba, stated on April 4, that with favorable grinding conditions for the remainder of the season the probable output will reach 1,300,000 tons.

The Reciprocity Treaty in the Payne Bill.

"Sec. 6.—That nothing in this act contained shall be so construed as to abrogate or in any manner impair or affect the provisions of the treaty of commercial reciprocity concluded between the United States and the Republic of Cuba on the twenty-third day of December, nineteen hundred and three, or the provisions of the act of Congress heretofore passed for the execution of the same."

WHERE IT IS ALWAYS SUMMER.—130 acres, cattle ranch, truck or fruit farm; near Sancti Spiritus, Cuba. \$1,500. THOS. CARROLL, Tremont House, Providence, R. I.

M. J. CABANA

COMMISSION MERCHANT

Solicits Correspondence from all the important cities of the United States of America.
P. O. Box 3, Camaguey.

Ask Mr. Foster

anything about Cuba. No charge, no fees, no commissions. Reliable unbiased information.

1 Madison Avenue, New York.

CABLE ADDRESS: Turnure.

NEW YORK,
64-66 Wall Street.**LAWRENCE TURNURE & CO.****BANKERS**

Deposits and Accounts Current. Deposits of Securities, we taking charge of Collection and Remittance of Dividends and Interest. Purchase and Sale of Public and Industrial Securities. Purchase and Sale of Letters of Exchange. Collection of Drafts, Coupons, etc., for account of others. Drafts, Payments by Cable and Letters of Credit on Havana and other cities of Cuba; also on England, France, Spain, Mexico, Puerto Rico, Santo Domingo, Central and South America.

CORRESPONDENTS:

HAVANA—N. Gelats y Ca.

LONDON—The London Joint Stock Bank, Ltd.

MEXICO—Banco Central Mexicano.

PARIS—Heine et Cie.

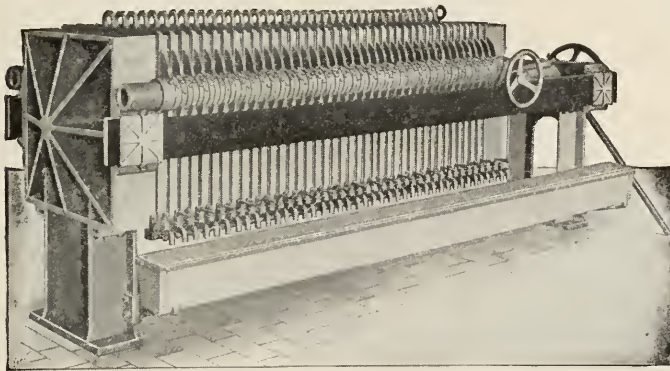

**Prensas de
Filtrar
para Ingenios
SHRIVER
Filter Presses**

Write us for Catalogue. Prices and Information.

T. SHRIVER & CO.
814 Hamilton Street
HARRISON, N. J.

Sole Agents for Porto Rico

McMurtrie-Guiler Co.

SAN JUAN, P.R., and BEAVER BLDG.,
BEAVER STREET, NEW YORK

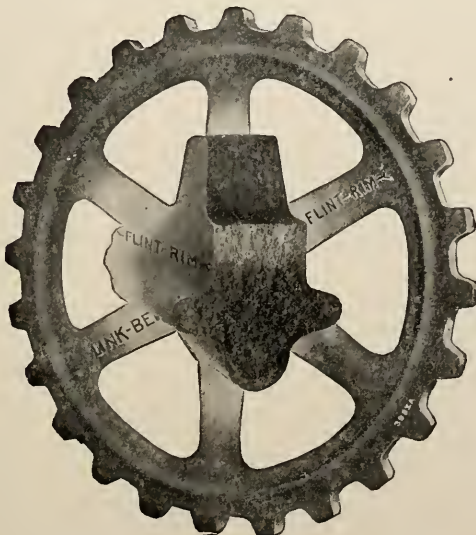
LINK-BELT COMPANY**299 Broadway, New York City****>FLINT-RIM<**

Sprocket Wheels for
DURABILITY

Made to fit the
"Ewart" and other
chains of our manu-
facture.

Cost but little more
than ordinary wheels.
Prompt shipment fol-
lows every order.

ASK FOR PAMPHLET

**CARROS
PARA
CAÑA**

De todas
clases
Fabricados
de madera
ó áceró

Dirección
Telegráfica
RAMALIAM

**RAMAPO
IRON WORKS**

30 Church St.
New York, N. Y.

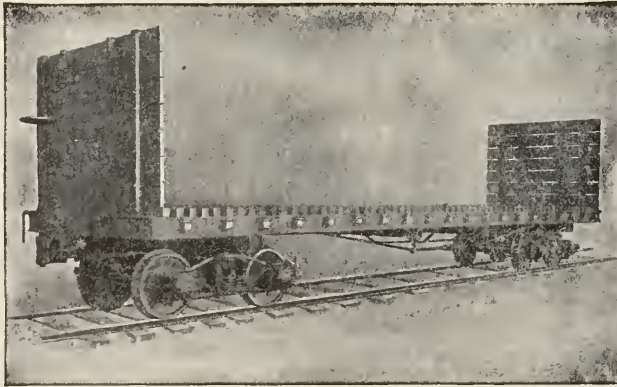

**CANE
CARS**

OF EVERY
DESCRIPTION
OF STEEL
OR WOOD

Cable Address
RAMALIAM

**RAMAPO
IRON WORKS**

30 Church St.
New York, N.

LA DESFIBRADORA "NATIONAL"

Resarce su Costo muy pronto
Estudiense sus Ventajas

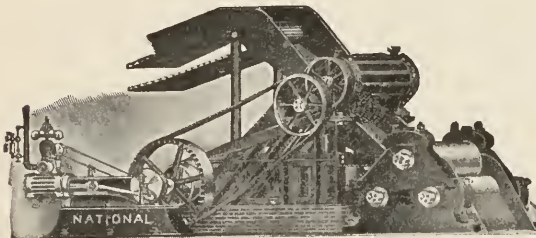

Construimos Desfibradoras de todos tamaños desde cinco toneladas por hora, hasta de 75 toneladas por hora, y además vendemos toda clase de enseres para Ingenios de azúcar, y daremos con gusto los informes que se nos pidan.

Nuestras Desfibradoras de Caña "National" tienen patente en todos los países del mundo, y se usan con resultados excelentes en Cuba, Puerto Rico, Santo Domingo, Java, Hawaii, México, Yucatán, Guatemala, Argentina, Brasil, Perú, Australia, Trinidad, Madelra, Martinique, Luisiana, etc.

Las tienen algunos de los más grandes ingenios de Cuba.

DESFIBRADORA "NATIONAL" PARA CANA, TRABAJANDO CON UN TRAPICHE.

NEWELL MANUFACTURING CO., 149 Broadway, New York



"ALL
ABOUT
CUBA"

**IT COVERS THE ISLAND'S
INDUSTRIES and ACTIVITIES**

FIFTY CENTS PER YEAR. POSTPAID

LA ATALAYA

**AMERICAN
COLONY...**

THE BEST LOCATION ON THE ISLAND OF CUBA

About three miles of frontage on the beautiful Bay of Nuevitas. The finest bathing beach in Cuba. The townsite, five miles south of the City of Nuevitas, is about 100 feet above sea level, overlooking the bay and city, has illuminating gas plant and waterworks, and is connected with Nuevitas by telephone. Fresh and salt water fishing. An ideal winter home.

The land is well watered, and the soil exceptionally fertile, adapted to sugar cane, citrus fruits, pineapples, and all garden truck. Fourteen crops of corn have been raised on the same land in the past seven years without using any fertilizer.

Absolutely the best transportation facilities of any colony on the island. Oranges placed in the hold of the Munson Line Steamers for 3c. a box from the dock in the colony. Other colonies pay from 15c. to 40c. per box. La Atalaya lands oranges in New York for 33c. a box; other colonies from 45c. to 70c. The difference will make fortunes for large planters in the colony. Furthermore, one handling, from the colony to the steamer, instead of from four to eight, as from other colonies, means fruit in much better condition landed in New York, and consequently considerably higher prices.

About 300 acres have been sold by Mr. Saucier, the owner, at \$50 an acre, on which over 6,000 grapefruit and orange trees are planted, more than 50% of which are already bearing.

We offer this land at the following astonishingly low prices:

| | | | |
|-----------|-----------------|------|-----------|
| 200 acres | will be sold at | \$20 | per acre. |
| 200 | " " " " " | \$25 | " " |
| 200 | " " " " " | \$30 | " " |
| 300 | " " " " " | \$35 | " " |
| 400 | " " " " " | \$40 | " " |

The balance at \$50 or more per acre.

Other colonies, not nearly as well located, and with no better soil, are selling land at \$50 to \$100 per acre. Here is your opportunity to get land in the best located colony in Cuba at a fraction of the prices asked by others.

THE TITLE IS PERFECT

The purchasers who first have the money deposited in the Camaguey Branch of the Royal Bank of Canada get the first allotments.

For further information, address

STREET & STRICKLAND

Cuban Land and Investments

CAMAGUEY, CUBA

We also have other small farms, timber tracts, cattle ranches, tracts for colonization, etc. All title absolutely perfect.

CANADA LAND AND FRUIT CO.

LOS INDIOS

Owners

ISLE OF PINES

CANADA AND LOS INDIOS TRACTS

Location: Siguanca Bay. The Deep-Water Harbor of the Island.

We have at our new and progressive town of Los Indios a sawmill, planing-mill, general store, school, hotel, church, post office and nursery, all under the supervision of Americans. A strictly American town.

We also have rowboats and gasoline launch for pleasure parties. Fishing and hunting the best.

We own the finest citrus fruit, vegetable and tobacco land on the island. We offer same for sale in acres to suit purchaser, either for cash or on installments. Special inducements to actual settlers.

Write for prospectus and further information to our general office,
Marinette, Wisconsin.

WILLETT & GRAY, Brokers and Agents

FOREIGN AND
DOMESTIC

SUGARS

RAW AND
REFINED

82 WALL STREET, NEW YORK

Publishers of Daily and Weekly Statistical Sugar Trade Journal—the recognized authority of the trade.
TELEGRAPHIC MARKET ADVICES FURNISHED



SUSINI

✿ Cork Tip Cigarettes ✿

Pectoral Paper Rice Paper
—: PRICE, 10 CENTS :—

THE BEST CIGARETTE
MANUFACTURED IN CUBA

DEPOT,
Zulueta 10 and Prado 118
HAVANA, CUBA.

MAGNOLIA

THE COMING AMERICAN CENTER

With best of soil, very favorable location, cheap water transportation right through the colony, good water, perfect title, and plans perfected by experience.

At Magnolia we offer you all the delights possible in the most favored land on earth. Here you can grow the largest crops of the finest quality, and the market is at your door.

We produce a very wide range of crops, which sell at top prices.

Write the Cuba Land and Improvement Company, No. 516-517 The Murray, Grand Rapids, Michigan, for literature and full information.

HAVANA

CUBA

National Bank of Cuba

Government Depository

Capital, Surplus and Undivided Profits
\$6,000,000.00

HEAD OFFICE, HAVANA

FIFTEEN BRANCHES IN CUBA

New York Agency, 1 Wall Street

COLLECTIONS

THE TRUST COMPANY of CUBA HAVANA.

Capital and Surplus \$540,000

Transacts a General Trust
and Banking Business

REAL ESTATE DEPARTMENT

Examines Titles, Collects Rents,
Negotiates Loans on Mortgages

Correspondence Solicited from
Intending Investors

OFFICERS

J. A. Gonzales Lanuza, President
Norman H. Davis, Vice-President
F. J. Sherman, 2nd Vice-President
O. A. Hornsby, Secretary and Treasurer
J. M. Hopgood, Asst. Treasurer

Offices: CUBA 31, HAVANA

The Royal Bank of Canada

INCORPORATED 1869

Fiscal Agent of the Government of the Republic of
Cuba for the Payment of the Army of Liberation

CAPITAL AND RESERVE, \$8,200,000.00

TOTAL ASSETS, . . . \$45,500,000.00

Head Office, MONTREAL

NEW YORK AGENCY, 68 William St.

Branches in Havana: Obrapla 33, Gallano 92;
Matanzas, Cardenas, Manzanillo, Cienfuegos,
Camaguey and Santiago de Cuba.

ESTABLISHED 1844

H. UPMANN & CO.

Bankers

TRANSACTION A GENERAL BANKING BUSINESS
CORRESPONDENTS AT ALL THE PRIN-
CIPAL PLACES OF THE ISLAND

Safe Deposit Vaults

Manufacturers of the Famous H. Upmann
Brand of Cigars

FACTORY: Paseo de Tacon 159-163
OFFICE: Amargura 1-3

Established 1876

N. GELATS & COMPANY

Bankers

Transact a general banking
business.

Correspondence at all the prin-
cipal places of the island.

SAFE DEPOSIT VAULTS

Office: Aguiar 108

MOLINA BROTHERS

Customs Brokers

Forwarders, Lighterage and Ship Agents

Officios 52, Havana

HAVANA

United Railways of Havana

Cuba's First and Foremost Railroad. (First Section opened to Traffic in 1837)

Takes you to All Parts of the Island East of Havana Comfortably and Quickly through Varied and Beautiful Scenery and Past Extensive Sugar Plantations

Parlor, Observation and Sleeping Cars attached to principal trains.

Full Information and through tickets to all points in Cuba reached via the United Railways of Havana can be obtained of the following:

Thos. Cook & Son
Seaboard Air Line R. R.
Foster & Reynolds
Atlantic Coast Line R. R.
Illinois Central R. R.

Ward Line
Florida East Coast Railway
Washington Southern Railway
Peninsular & Occidental S. S. Co.

Southern Pacific R. R.
Mobile & Ohio R. R.
Raymond & Whitcomb Co.
Louisville & Nashville E. R.
Munson Line

LA AMBROSIA

MANUFACTURERS of the well-known brand of Chocolate, "LA AMBROSIA," Biscuits, Macaroni, Bonbons, all kinds of Confectionery

GUAVA PASTE AND EXTRA FINE GUAVA JELLY

ORDERS RECEIVED FOR EXPORT

BALDOR, FERNANDEZ & CO.

Write for quotations.

Sol 21 & 23, Havana, CUBA

'PHONE No. 401

P. O. BOX 741

FERNANDO de CARDENAS

CUSTOM HOUSE BROKER

:: Import and Export Agent ::

Munson S. S. Line Building

Obispo No. 1, Havana, Cuba

JAMES S. CONNELL & SON

Sugar Brokers

Established 1836, at 105 Wall Street

Cable Address—"Tide, New York"

I know a great deal about Cuba

Free Information for the asking

Ask Mr. Foster

1 MADISON AVENUE, NEW YORK

THE HERRADURA LAND COMPANY

Office: No. 3 Bernaza Street, Habana, Cuba

CAPITAL, \$440,000.00

Own 22,000 acres of land in the Province of Pinar del Rio, suitable for Oranges, Vegetables, Cotton, Corn and Tobacco. The land has all been surveyed and sub-divided into 40-acre tracts and is offered for sale in acres to suit the purchasers, for Cash or on instalments.

We have a new and progressive American town with Railroad Station, Telegraph, Telephone, Stores, Hotel, American School, all within short distance from Havana City.

Titles perfect. Transportation from Havana free for buyers.

WRITE OR CALL FOR INFORMATION.

Telephone 825 Broad

THE MARINE WORKS

Ship Plumbers and Sheet Metal Workers. Manufacturers, Suppliers and Repairers of Steamship Galley and Cabin Utensils; Tanks, Lights and Ventilators. Tinning of every description.

31 Coenties Slip

New York

Journal d'Agriculture Tropicale

Founded by J. VILBOUCHEVITCH
164 Rue Jeanne d'Arc Prolongée.

Subscription, One Year - - - - 20 Francs

Deals with the leading questions of the hour, agricultural and commercial, of interest to tropical countries. International in character. Illustrated. Monthly. Descriptions of machines for tropical crops a speciality. Complete review of new agricultural publications. Commercial part intelligible for every one and always interesting. 150 contributors in West and East Africa, East and West Indies, Java, Mauritius, Central and South America, and throughout the tropical world.

Perhaps, says the Troy (N. Y.) Times, the Cubans can take a hint from the fact that, at the recent exhibition of

Cuban products in Havana, the best showings were made from farms owned or worked by Americans. This means simply that the Americans adopted the most advanced methods of dealing with the soil and had corresponding results. Cuba has soil and climate adapted to the very finest and most profitable agriculture. There is vast wealth for the island if these resources are properly utilized.

The Mergenthaler Linotype Company of Brooklyn, N. Y., will in a short time establish a branch supply station in Havana, and will keep on hand a full supply of linotypes, from the smallest model to the largest, and will also keep a full stock of parts and supplies of these machines.

PASO ESTANCIA—Oriente Province—Cuba

The healthiest and most fertile spot on the island, in the rich valley of the Cauto River 400 feet above sea level.

One of the prettiest spots in Cuba.

Paso Estancia is right on the main line of the Cuba Railroad, only 40 miles from its terminus at Nipe Bay, 39 miles from Santiago.

The soil is rich, dark, sandy loam; no rocks or swamps.

Two hundred acres now under cultivation demonstrate by prolific production the richness of the soil.

A comfortable hotel at **Paso Estancia** accommodates visitors.

Paso Estancia offers the best opportunities in Cuba.

Choice land on easy terms.

Visit there and confirm all we say. You will be well received.

Full particulars
from - -

Cuba Properties Limited

56 Bank of Ottawa Bldg.
MONTREAL

111 German Savings Bank Bldg.
NEW YORK

Paso Estancia
CUBA

Free Information about Cuba.

NO FEES, NO COMMISSIONS.

Complete, definite, valuable information.

Ask Mr. Foster, 1 Madison Avenue, New York.

HENRY E. BROWN
Pharmacist

Shipping and Export Chemist and Druggist, Ships' Medicine Chests Furnished and Replenished. Prescriptions Compounded by a Graduate in Pharmacy.

Trusses, Surgical Appliances, etc.

Office and laboratory, Room 36.

116 BROAD ST., NEW YORK

Telephone Call: 274-A Hamilton.

JOHN M. DONOVAN

13 Summit St. (Atlantic Dock) - BROOKLYN

Dealer in

Dunnage Mats

FOR BAG FLOUR, BAG AND BULK GRAIN
AND GENERAL CARGOES.

-- BAGS AND BAGGING --

FUNDADA EN 1851

SUGAR TESTING APPARATUS

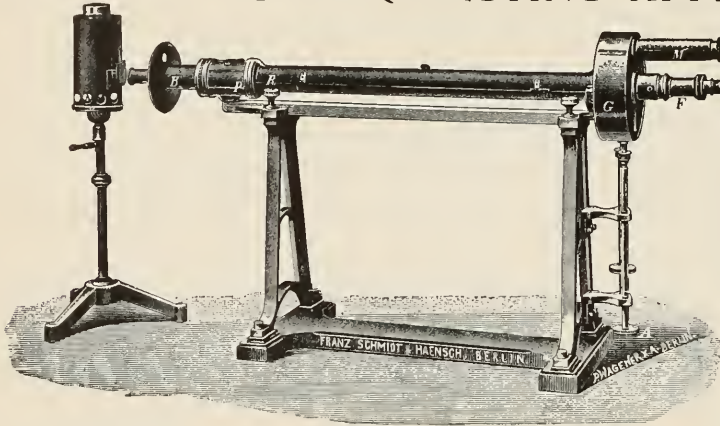

POLARISCOPIO SOBRE "BOCKSTATIV" LA FORMA MAS MODERNA
Con caja á prueba de polvo, parte de prisma, y engranaje prolongado.

EIMER & AMEND, 205-211 Third Avenue, New York

Hace una especialidad de surtir TODOS LOS INSTRUMENTOS PARA LA PRUEBA DE AZUCAR Y HABILITACION ED LABORATORIO. Unicos Agentes en los Estados Unidos y Canada para los

STANDARD POLARISCOPIOS

Su triple ó doble campo de vision ha sido adoptado por el Gobierno de los Estados Unidos como norma. Toda la maquinaria experimental y los aparatos descritos en "Agricultural Analysis," del Prof. H. W. Wiley. Se suministran con gusto todos los informes pedidos. Pidanse Listas de Precios Ilustradas.

MOBILE, ALA.

HOME INDUSTRY IRON WORKS

Engines, Boilers and Machinery

Manufacturing and Repairing of all kinds. Architectural Iron and Brass Castings. Light and Heavy Forgings. All kinds of Machinery Supplies.

Steamship Work a Specialty

A. KLING, Prop.
JAS. S. BOGUE, Supt.

MOBILE, ALA.

The Principal Hotels in Mobile, Ala.

THE CAWTHON
(FIREPROOF)

THE BIENVILLE
(MODERN)

European, 175 Rooms

European, 150 Rooms

\$1.50 Up

\$1.00 Up

Both Hotels in Heart of City, Facing Bienville Square

OLLINGER & BRUCE DRY DOCK CO.

Ship Builders and Repairers

Operating seven Sectional Dry Docks, capacity 1,000 tons, and one Balance Dock, capacity 3,000 tons. Equipped with Air Plant for operating Pneumatic Tools, and Steam Pump for cleaning vessels bottoms.

25-TON DERRICK BARGE AND STEAM PILE DRIVER.

Material of all kinds kept on hand. Shipwrights, Caulkers, Painters, Sparmakers and Riggers furnished promptly, and at reasonable rates. Correspondence solicited.

MOBILE, ALA.

BARTLE

Twenty-five thousand acres of the richest and best watered land in Cuba on the main line of the Cuba Railroad, with the finest station on the line, 120 miles from Nipe Bay—the best harbor on the Island; also the nearest to New York.

No swamps or insect pests.

BARTLE is not in the wilderness—we offer all the comforts of civilization, GOOD STORES, HOTEL, CHURCH, SCHOOL, SAW-MILL, Etc.

TWO MAILS DAILY.

SUGAR, FRUITS, TOBACCO AND VEGETABLES produce wonderful crops at BARTLE.

When you consider Soil, Transportation, Social, Religious and Educational advantages, BARTLE offers something not to be had elsewhere in Cuba. Write for particulars.

"Ten Days in Cuba," just published by Hon. Nicholas J. Whalen, Speaker of the Michigan Legislature, may be had through newsagents at 25 cents per copy, or will be sent free to any address by the owners of the Bartle Colony. Address, Duncan O. Bull, Gen'l Mgr. Cuban Realty Company, Limited, Temple Building, Toronto, Can., or 141 Broadway, New York City.

DUNCAN O. BULL, General Manager

CUBAN REALTY CO., Ltd. Temple Bldg., Toronto, Canada
141 Broadway, New York Bartle, Cuba

PURE
DISTILLATION
OF
SUGAR CANE

BACARDI RON

Sole United States Agent

D. S. de JONGH 128 Water St.

BEST MIXER
FOR
HIGHBALLS
AND
OTHER DRINKS

"SUGAR NEWS FROM CUBA"

is the title of the interesting correspondence from the tropical island, appearing in every issue of "THE AMERICAN SUGAR INDUSTRY AND BEET SUGAR GAZETTE."

Capable correspondents, in every part of the world, write regularly, covering reliable sugar news for "THE AMERICAN SUGAR INDUSTRY AND BEET SUGAR GAZETTE."

In the United States, Cuba and Mexico, \$2 per annum. In Foreign Countries, \$2.50 per annum.

Subscribe for it if you want to keep posted. Sample copy free. Send for advertising rates.

Address: BEET SUGAR GAZETTE CO.

No. 5 Wabash Avenue,

Chicago, Ill., U.S.A.

For Free Information about Cuba

Ask Mr. Foster

1 Madison Avenue, New York.

PURLY & HENDERSON, Inc.

Engineers and Contractors

New York Chicago Boston

Cuba Office, Empedrado 32, Havana

THE BIG FOUR ROUTE Through Train Service
BETWEEN
Cincinnati, Toledo and Detroit
(Via Michigan Central R. R.)
3 Daily Trains Each Way 3
Parlor Cars, Sleepers, Dining Cars.
Ask for Tickets Via
BIG FOUR

BUSINESS FIRMS OF CAIBARIEN

ANGEL MATA

Comerciante.
Caibarién, Cuba.

Apartado 114. Cable: Mata."

Ferretería, Mueblería y Locería
LA LLAVE

DE INCHANSTI Y HNO.
Caibarién, Cuba.

Martí 11 y 13. Apartado 24.

R. CANTERA Y CA.

(S. en C.)

Comerciantes Importadores,
Escobar 28. Caibarién.

A. ROMANACH

Almacenistas Importadores de Viveres,
(S. en C.)
Caibarién.

P. B. ANDERSON,

Ship Broker. U. S. Consular Agent,
Caibarién, Cuba.
Agent for Munson Steamship Line and Lloyds.

MARTINEZ & CO., S. en C.

Comerciantes Banqueros,
Importadores de Viveres,
Exportadores de Azúcar.

Apartado 115. Telegrafo: Urquiza.

COMERCIO,
Hotel - Restaurant - Cafe
De José Urquiza.

Calle de Martí nums 16 y 18 - Caibarién

LA MARIPOSA DE EVARISTO BERNES

Importador de Peletería y Talabartería, Fabricante
de Calzado.
Caibarién.

Apartado 104. Telegrafo: "Bernes."

YMAZ Y CA.

Ymportadores de Ferrería en General.
Apartado de Correos Num. 15,
Caibarién, Cuba.

Calle Justa Num. 27. Cable: "Imaz."

ARIAS Y COMP

Provisiones, Loza y Muebles.
Cuba Num. 20, Esquina a Martí,
Caibarién, Cuba.
Correo Apartado Num. 15. Telegrafo: "Arias."

ZARRAGA Y CA.,

Caibarién, Cuba.
Casa Banca. Exportadores de Azúcar.

BONIFACIO DIAZ,

Gran Peletería y Sombrerería.
Martí 17. Caibarién
Constantes novedades en los dos giros de esta casa.

RODRIGUEZ Y VINA, S. en C.,

Almacenistas Importadores de Viveres en General,
Comisiones y Consignaciones,
Consignatarios de Buques.
"Depositos de Carburo."

Telephone, 33 Hamilton
Night Call, 411 Hamilton

Cable Address:
"Abiworks," New York

Atlantic Basin Iron Works

Engineers and Boiler Makers

Machinists, Plumbers, Tinsmiths, Pipe Fitters, Blacksmiths, Coppersmiths,
Pattern Makers, Sheet Iron Workers. Iron and Brass Castings. Steamship
Repairs a Specialty.

Cor. Imlay and Summit Streets

Brooklyn, N. Y.

John Munro & Son

Steamship and
Engineers' Supplies

13 Conover Street, Brooklyn, N. Y.

Cable Address: Kunomale, New York

Telephone, 196 Hamilton

Telephone
215 Hamilton

Box 186
Maritime Exchange

YULE & MUNRO SHIPWRIGHTS

Caulkers, Spar Makers
Boat Builders, Etc.

No. 9 SUMMIT STREET
Near Atlantic Dock BROOKLYN

WINTER HAVEN NURSERIES

A. M. KLEMM, Proprietor

Established 1884.

Winter Haven, Fla.

Wholesale Growers of Citrus Stock of the best commercial varieties. We guarantee our extensive Stock to be well grown, free of insects and true to name.

Silver Cluster Grape Fruit our leading Specialty.

Prices right. Grading and Packing perfect.

Write for Catalogue.

The Standard Guide to Cuba—

Reliable—accurate—maps—illustrations.

50 cents.

FOSTER & REYNOLDS, 1 Madison Avenue, New York.

BUSINESS FIRMS OF SANTIAGO

E. GIRAUDY & CA.

ALMACEN DE VIVERES

Marina baja n. 33, Santiago de Cuba.

Agentes de Schlitz Beer.

JULIAN CENDOYA

Steamship Agent and Broker

COMMISSION MERCHANT

CABLE: Cendoya. Santiago de Cuba.

VALLS, RIBERA & CA.

(S. en C.)

Importadores de Ferreteria y Machinery.

Teléfono: Valribe.

Santiago de Cuba y Manzanillo.

A. B. C. Code, 5th Edition. Telephone, 190.
P. O. Box, 95. Cable address: SILVAPA.

SILVA Y PARRENO H.

General Commission Merchants.

Custom House Brokers—Forwarding Agents.

Consignees of the Cuban steamers of the Carlos J.

Trujillo, S. en C., Line, formerly Menéndez & Co.

References:—J. Cendoya and Nat'l Bank of Cuba.

CAMP HERMANOS, Santiago de Cuba.

Ron Selecto "Golondrina" y "Carta Cuba."

Medalla de Oro, St. Louis, 1904.

RON BACARDI

DE BACARDI & CO., Distillers, Proprietors.

43 San Ignacio, cor. Santa Clara, Havana.

Santiago de Cuba.

LARREA Y BESEALIE

Importers of General Groceries and Exporters of

Cocoa, Wax, Honey and Woods.

Apartado 65, Marina Baja 46. Cable: Larrea.

Importación.

Exportación.

L. ABASCAL Y SOBRINOS

Agentes de las líneas Pinillos Izquierdo y Ca., de

Cadiz. Larrinaga y Ca., de Liverpool. Com-

pañía de Seguros, Aachen & Munich, Aix-la-

Chapelle.

BROOKS & CO.

Bankers and General Commission Merchants.

Santiago and Guantamo.

The Maine Forgotten.

"Forget the Maine" was the slogan of a speech delivered in the House Feb. 26 by Representative Douglas, of Ohio, in opposition to a provision in the sundry civil appropriation bill providing the preliminary steps toward raising the wreck of the battleship sunk in Havana Harbor in 1898. To open up the wreck for its ghastly contents, he said, would only serve to open up sore hearts which had long since ceased to suffer, and revive the contentions as to whether or not the vessel was blown up from the inside or the outside.

"If there are commercial reasons for the wreck's removal," he continued, "let Cuba do it. If there are reasons of justice, let Spain do it."

The provision for this work was ac-

cordingly struck out. Some press comments follow:

"It can never be forgotten so long as what is left of it remains exposed to view, as it is at present, and there is hardly room for a serious argument that if the wreck is to be removed at all it should be removed by the United States and by no one else."—Phila. (Pa.) Inquirer.

"The present Congress should not dissolve without determining that this sorry example of a republic's disregard for the defenders of its flag shall be blotted out."—Phila. (Pa.) Telegraph.

Another bill was introduced in the United States Congress, March 22, providing for raising the Maine. It was referred to a committee.

VINEGAR BEND LUMBER CO.

Manufacturers and Exporters

Long Leaf Yellow Pine Lumber and Timber

Cuban Business Our Specialty VINEGAR BEND, ALA., U. S. A.

Daily Capacity, 200,000 Feet

Cable Address: "TURNER"

Codes: A B C, Fourth Edition; Southards; Watkins; Western Union



SOBRINOS DE BEA & CO.

Bankers and Commission Merchants
Importación directa de todas los centros
manufactureros del mundo.

Agents for the
Munson Steamship Line, New York and
Mobile.

James E. Ward & Co., New York.
Serra Steamship Company, Liverpool.
Vapores Transatlánticos de A. Folch & Co.
de Barcelona, España Independencia
Street 17/21.

MATANZAS, CUBA.

JOHN W. McDONALD

COAL, WOOD, LUMBER
and TIMBER of Every
Description

112 WALL STREET

Near South Street NEW YORK

Yard: 58-68 Beard Street, Erie Basin

Telephones:

Office, 1905 John Yard, 316 Hamilton

The Only Solution.

It is to be sincerely hoped that Cuba can stand alone, and be as Mexico is, a friendly republic, but if she cannot, annexation seems to be the only way to solve the problem of her peaceful and prosperous political existence.—Jacksonville (Tenn.) Sun.

"The Comfortable Way"

Between the East and the West is
via the Toledo, St. Louis and
Western Railroad

"Clover Leaf" Route

Rates lower than by any other
direct line. Send four cents in
stamps for copy of "Get Out or
Get in Line," a booklet by Mr.
Elbert Hubbard, Chief of the Roy-
crofters.

GEO. J. CHARLTON,
General Passenger Agent,
Chicago, Ill.

THE SNARE AND TRIST COMPANY

CONTRACTING ENGINEERS

Steel and Masonry Construction
Piers, Bridges, Railroads and Buildings

We are prepared to furnish plans and estimates
on all classes of contracting work in Cuba.

N. Y. Office

Havana Office

143 LIBERTY ST.

LA LEAL BUILDING

W. H. Bennett

F. W. Hvoslef

Bennett, Hvoslef & Co.

18 Broadway, New York

Steamship Agents and Ship Brokers

Cable: "Benwalsh"

Munson Steamship Line

GENERAL OFFICES

82 BEAVER STREET, NEW YORK

NEW YORK-CUBA SERVICE PASSENGER AND FREIGHT

| Steamer | New York | Nipe | Nuevitas | Nipe | Banes | Gibara and Vita | Pto. Padre | Nuevitas | Nipe | New York |
|-----------------|----------|--------|----------|---------|---------|-----------------|------------|----------|--------|----------|
| | Sail | Arr. | Arr. | Arr. | Arr. | Arr. | Arr. | Sail | Sail | Arr. |
| Curityba | Apr. 21 | | Apr. 26 | Apr. 28 | Apr. 30 | May 1 | | May 6 | May 7 | May 12 |
| Ollinda | May 5 | May 10 | May 12 | | | May 15 | May 18 | May 20 | May 21 | May 26 |

Steamers sail from PIER 9, EAST RIVER, foot of Old Slip, New York

SAILINGS SUBJECT TO CHANGE WITHOUT NOTICE

FREIGHT ONLY

NEW YORK TO CAIBARIEN, MATANZAS, CARDENAS AND SAGUA

MOBILE-CUBA SERVICE

FREIGHT ONLY

REGULAR SAILINGS—MOBILE TO HAVANA—MOBILE TO N. S.—S. S. CUBAN PORTS.

BALTIMORE-COLON SERVICE

FREIGHT ONLY

REGULAR SAILINGS—BALTIMORE TO COLON

AGENTS IN CUBA

ASMUS LEONHARD

Cuban Freight and Passenger Agent

76 Cuba Street, Havana

| | |
|-------------------------|-----------------------------|
| BERNABÉ SANCHEZ É HIJOS | Nuevitas |
| FRANCISCO PLA | Puerto Padre |
| BEOLA & CO. | Gibara |
| M. J. CABANA | Camaguey |
| J. L. DAUTERIVE | Antilla (Nipe Bay), Oriente |

For Southbound reservations address the General Offices, New York
For Northbound reservations address the agent at the port of embarkation

Lillie Multiple Evaporators

Model of 1904-1905 (Patented)

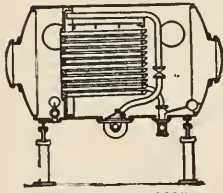

Model 1904-1905
ECONOMY its BOAST

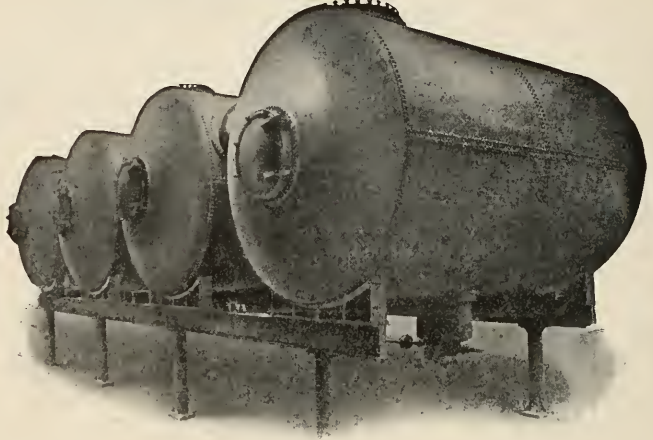

Lillie Quadruple effect for Nipe Bay Co., Cuba (Model 1904-1905. Condensers not shown.) Capacity, 600,000 gallons cane juice per 24 hours.

Apply for reading matter and information to

The Sugar Apparatus Manufacturing Co.

328 Chestnut St., Philadelphia, Pa.

S. MORRIS LILLIE, President.

LEWIS C. LILLIE, Secretary and Treasurer

BALDWIN LOCOMOTIVE WORKS

Broad and Narrow Gauge

Single Expansion and Compound

LOCOMOTIVES

Compressed Air Locomotives. Electric Locomotives with Westinghouse Motors



PLANTATION LOCOMOTIVES

For all Gauges of Track. To meet all conditions of service. Specifications furnished on application.

BURNHAM, WILLIAMS & CO.

Philadelphia, Pa., U. S. A.

Cable Address: "Baldwin, Philadelphia"

Agents for Cuba, Krajewski-Pesant Co., Aguiar 92, Havana, Cuba.

THE CVBA REVIEW



50 Cents A Year MAY 1909 5 Cents A Copy
Published by the Munson Steamship Line-82-92 Beaver Street, New York City.

Ceballos "The Garden Spot of Cuba"



*A CEBALLOS Orange Grove three years from planting.
The best three-year-old Grove in the World.*

The TIME to invest in Cuba is now The PLACE is in the "Garden Spot," Ceballos
The OPPORTUNITY is offered by the Development Company of Cuba, owners of Ceballos

Write for information to

Geo. H. Gillett, Secretary,

43 Exchange Place, New York

"PRATT IMPERIAL"

Sugar Cane Machinery and Evaporating Apparatus.
Complete Plants Erected and Delivered to Owner Under
Guaranteed Capacity of Mills and Quantity.
Sugar House Pumps.

We also solicit your business for our newly developed line of
Pratt COTTON OIL MACHINERY;
Pratt STEAM PUMPS; SPECIAL PARTS OF
MACHINES, any size or kind; and
HEAVY CASTINGS famous for quality.

We maintain Export Sales Offices at 80 Wall St., New York, in charge of
Mr. N. A. Helmer, an eminent Sugar Mill Engineer of wide experience. We
solicit your business with the assurance of every courtesy and perfect satisfaction.

Pratt Engineering & Machine Co. ATLANTA, GA.
U. S. A.

Successors to FULTON FOUNDRY & MACHINE WORKS, Atlanta, Ga.

Tivoli Beer

—*Enough said.*

Havana Brewery

Havana

BUCKEYE NURSERIES

M. E. GILLET, Proprietor

TAMPA, FLORIDA, U. S. A.

ORANGE, LEMON AND GRAPE FRUIT TREES

LARGEST CITRUS NURSERY IN THE WORLD

QUALITY VARIETY DELIVERY

Price may be forgotten—Quality NEVER.

We grow nothing but standard Varieties which we can recommend to the trade as Money-Makers. Having had 29 years' experience we thoroughly understand packing trees for long distance shipments.

We guarantee our trees to be True to Name, Free from White Fly and to ARRIVE AT DESTINATION IN GOOD CONDITION.

Consider the future and protect your investment by planting reliable trees from

THE BUCKEYE NURSERIES

LA GLORIA

The Colony where the Best Oranges are Raised

LA GLORIA FRUIT CARRIED OFF THE BLUE RIBBONS AT THE 1908 EXHIBITIONS OF THE CUBAN NATIONAL HORTICULTURAL SOCIETY AT HAVANA.

THERE IS NO OTHER "JUST AS GOOD."

WRITE FOR HANDSOME ILLUSTRATED BOOKLET.

CUBAN LAND AND STEAMSHIP CO.

No. 32 Broadway, New York City

TWO IMPORTANT MAPS

Blue-prints of Cuba, showing the location of the Sugar Plantations and the Rural Guard Stations of the Island. Specially prepared for The CUBA REVIEW. Each 60 cents. Either map with a year's subscription, 75 cents. Both blue-prints and magazine, one year, \$1.

The Rural Guard of Cuba

The Sugar Plantations of Cuba



Sugar Plantation—Cuba Railroad.

The Cuba Railroad

This new line completing the railroad connection between Havana and Santiago, and Antilla, on the Bay of Nipe, is of standard gauge and similar in its construction and equipment to the better class of northern lines. All of its important bridges are of steel and masonry, and the line generally is rock-ballasted. The main line passes along the center of the eastern and wider half of Cuba, and opens up a matchless and most picturesque agricultural region, and passes through the tropical forests of mahogany, cedar, *lignum vitae*, ebony and many other trees, hung with vines and millions of orchids. Palm trees of magnificent aspect and great variety abound everywhere. The famed Parana and Guinea grasses, covering most of the open districts and standing from six to twelve feet high and

green the year round, together with frequent running streams, make this an ideal cattle country. No food has to be put up and no shelter is required. The rich soils everywhere are adapted to sugar, tobacco, cotton, corn and an endless variety of products. The swamps which occur at places along the coasts of Cuba are absent from the interior, which is high, dry and exceptionally healthy. The trade winds blow across Cuba every day, and bring to all parts fresh sea air; the extreme heat of northern summers is consequently unknown and the humidity of other tropical countries is also unknown.

The Cuba Railroad Company's **Hotel Camaguey**, at Camaguey (formerly Puerto Principe) is by far the most popular resort in Cuba, Spanish in style, and provided with bath rooms and other modern conveniences, and is first-class in all respects.

This old city has about 40,000 inhabitants, is picturesque and is situated in a beautiful and remarkably healthy district. The hotel is especially favored by those wishing to spend some weeks or months in a matchless sub-tropical climate.



A Corridor, Hotel Camaguey.



Map of The Cuba Railroad

THE CUBA REVIEW

"ALL ABOUT CUBA"

An Illustrated Monthly Magazine, 82-92 Beaver Street, New York

MUNSON STEAMSHIP LINE, Editors and Publishers

SUBSCRIPTION

50 Cents Per Year - - - - - 5 Cents Single Copy

Advertising Rates on Application

Vol VII.

MAY, 1909

No. 6

Contents of This Number

The cover-page is a beautiful scene of one of the many magnificent roads leading out from Havana westward.

Government matters are particularly interesting this month. President Gomez is establishing himself more and more firmly in the estimation of those who are looking for a stable government in Cuba. Matters appertaining to the activities of the Cuban Congress, and other important information, will be found on pages 7 to 10, inclusive.

Comments of the press of the United States on the situation in the Island will be found on pages 11 and 12.

Government notes, comprising interesting items from all sources, are on pages 13 to 15, inclusive.

Financial and Railways: Earnings and reports, quotations of Cuban securities, etc., on pages 16 and 17.

Commercial matters are on pages 18, 19 and 20. Havana cable rates and interior telegraph rates will be found on page 18. Various other items and an illustration of the new building of the Commercial Exchange, in Havana, on the succeeding pages.

The cost of wooden highway bridges in Cuba, together with an interesting item regarding the future of Guantanamo, on page 21.

An attractive illustration is that crossing pages 22 and 23, which was taken at Camp Columbia, March 31, when the Second American Intervention ended.

Road building in Cuba, with some striking illustrations, on page 24.

Isle of Pines matters on page 25.

Unusually interesting agricultural notes on pages 26 to 30; and attention is specially directed to the condensation of the United States Government Bulletin on onion culture, which is especially important to Americans in Cuba.

The Sugar Review, by Willett & Grey, is on page 31. The same article in Spanish is on page 32.



City of Baracoa and a glimpse of the harbor. It was in this bay that the ships of Columbus dropped their anchors on November 27, 1492. Baracoa has the distinction of being the first town in Cuba. It was founded in 1511.

THE CUBA REVIEW

LIBRARY
NEW YORK
BOTANICAL
GARDEN.

"ALL ABOUT CUBA."

Copyright, 1908, by the Munson Steamship Line.

Volume VII.

MAY, 1909.

NUMBER 6.

GOVERNMENT MATTERS.

The Cuban Permanent Army. Santiago Improvements. Modern Telephone System.

The Cuban Permanent Army.

The permanent army of Cuba, as distinguished from the Rural Guard, when fully recruited will number 5,000 artillery and infantry. Up to the present the Rural Guard has constituted the only armed force of the Republic.

The organization of the Permanent Army was authorized by a decree of Governor Magoon, issued in April of last year, and General Faustino Guerra was then appointed its commander-in-chief.

New German Mausers, model of 1909, will be furnished the infantry, and Schneider-Canet guns, made in France, the artillery.

It is intended, in course of time, to establish a school for cadets on the model of West Point.

The pay of the army is liberal, and rather more than that paid in the United States. The Commander-in-Chief receives \$6,000; Brigadier-General, \$5,000; Colonels, \$3,600; Lieutenant Colonels, \$3,300; Captains, \$1,800; First Lieutenants, \$1,500, and Second Lieutenants, \$1,200. Sergeants get from \$50 to \$30; Corporals, \$25, and Privates, \$21 a month, with equipment on enlistment to the value of \$160.

Three young officers of the United States Army have been assigned by the Secretary of War the task of creating an effective, well-drilled, and well-disciplined Cuban Army. They arrived in Havana April 26.

Capt. Golderman will oversee the creation of a coast artillery corps, Captain Parker, that of a cavalry detachment, and Captain Gatley, that of the mobile artillery, paying special attention to field and mountain gun practice.

While on duty Capts. Parker, Gatley, and Golderman will rank as Lieutenant Colonels

and will draw the salary paid officers of that rank by the United States. The Cuban Government will foot the bill. They will be away probably a year.

Santiago Improvements. Public improvements costing \$650,000 are contemplated for Santiago de Cuba. Paving of the streets, better parks and the widening of the mouth of the harbor is being urged on the city council by many business men. The city now has a complete street arc light system and trolley cars. The improvement of the water works are now going on and the sewerage system is in the hands of the government engineers. The Alameda is to be macadamized and city bonds issued to provide the necessary funds. The widening of Santiago bay is also contemplated by the removal of a portion of Punta Diamante.

Modern Telephone System. The Havana Telephone Company, whose contract with the government expires in 1910, recently surrendered its rights and by presidential decree of April 27 has secured in exchange an 18-year franchise from the government, paying the latter \$24,000 per year for the first two years and \$15,000 per year thereafter. The present inadequate plant will be replaced with the latest modern automatic system. The installation will cost \$1,500,000.

Local telegraph offices have been opened to public and limited official service at La Coloma, Province of Pinar del Rio, and at Columbia, Havana Province.

MAY 18 1909

President Gomez plans trading the arsenal lands in Havana for the Villanueva station lining the Prado and building thereon new government buildings costing in the neighborhood of \$6,500,000. The most important work in the plan is the building of five piers, three off Paula and two off Tallapiedra. There is a depth of water at Paula of between forty and forty-five feet, and the three piers would permit of docking the largest steamers entering Havana Harbor. Altogether the expenditure approximates \$8,250,000 in new government buildings, which will include the presidential palace, costing \$1,300,000; buildings for the departments of state, justice, interior, public instruction, public works and sanitation at \$400,000 each; palace of justice, \$600,000; congressional building, \$1,400,000; provincial institute and school, \$300,000; jail, \$300,000; conversion of present public instruction department into post-office, \$200,000, and the extension of the Malecon; total, \$6,500,000. Building the five docks by the United Railways for the government and the city crematory, \$1,500,000; building of new railway stations by United Railways, estimated, \$250,000.

The expenses to be borne by the government will aggregate \$6,500,000, but the present government buildings can possibly be sold for \$3,500,000, leaving \$3,000,000 to be paid out of the treasury.

On April 22 the plans were approved by Congress, the leaders agreeing that the project deserved their support and prompt action.

President Gomez expects the palaces will be erected before the time estimated in the projected contract and that the Presidential and Congressional palaces at least will be ready for occupancy in the fall of 1911. The other palaces, he believes, will be completed by the end of 1911 or early in 1912. The Havana press warmly endorses the plans, and real estate owners are enthusiastic.

Decision of the committee of codes favorable to the bill establishing the lottery. Approval (without debate) of the bill relative to Congress receiving monthly, through the paymasters of the Senate and of the Chamber, the sums originated in the fixed budget.

A bill to annul Paragraph 3, of Article 10, of the existing penal military law (insurrection and rebellion) was referred.

A bill authorizing the executive to engage six foreign instructors for the police was passed for report to the committee of codes.

The following bills were presented:

Modifying the law of July 5, 1906, for the

free contracting of the state with the railway companies.

For constructing a bridge over the San Juan River in Matanzas.

The law about the appointment of judicial functionaries by the president of the republic was approved.

Bill introduced relative to the imposition of discriminating duties against nations having such laws in effect against Cuba. Referred to the tariff committee.

April 29 a bill was introduced providing for an appropriation of \$25,000 for automobile races next winter. It was referred.

April 26 the House decided to debate the bill for the establishment of a national lottery, and its passage is assured. A resolution was also adopted requesting the Senate not to delay consideration of the House bill restoring cock-fighting.

The demand for its restoration came from the country people. Everybody wants the lottery, but no one seems to want to restore bull-fighting. A majority of the members of the House voted against even its consideration when first introduced. If they vote against the bill when it is brought back from the committee, that will be the end of it.

The bill conceding an appropriation of \$25,000 for private expenses of the executive was approved.

Another appropriation of \$2,385 for X-ray apparatus for the Mercedes Hospital was also approved.

The bill equalizing the professors of the "Instituto de Segunda Enseñanza" with those of the university as to their capacity to exercise certain functions, in accordance with the law of the executive power, was approved.

Likewise the bill suspending the collection of export duties on sugar, tobacco and liquors was approved. Signed by the president April 22.

The bill modifying the mortgage law in Articles 128 and 241 was transmitted to the committee for report; likewise the bill of loans to agriculturists.

A message from the president was read, requesting authority from Congress to exchange with the United Railways Co. the Villanueva lands for those of the arsenal.

A motion was approved asking the executive for data about the concession made by the government of Spain to the Villanueva Railroad in the time of General Salamanca.

The bill ordering the erection of a statue to Carlos Manuel Céspedes in Bayamo was presented.

Three more agricultural stations were proposed in a bill introduced. One in Pinar del Rio province, one in Santa Clara province and one in Oriente. It was referred to the agricultural committee.

On April 19 the Cuban Senate approved the House bill suspending the collection of an export duty on sugar, tobacco and liquors. On April 22 the president signed this law. The export duties thus suspended are on sugar, five cents on each bag of weight up to 350 pounds; on cigars, \$1 on each 1,000 cigars, weighing up to three pounds; on cigarettes, ten cents on each 1,000 cigarettes, weighing up to three pounds, and on liquors, twenty cents on each bottle.

A bill was introduced April 30 in the Senate providing for an annual appropriation of \$4,800 to be devoted to the education of Cuban children and children of Cuban parents residing in Key West, West Tampa and Ibor City.

The Perez bill providing for the creation of a legation in Rome and for other amplifications of the diplomatic and consular service, at an estimated cost of \$48,000, was approved April 29.

The following laws have been approved in the House of Representatives since the opening of the Legislature on the 5th of April:

Reform of the municipal law given by the intervention in the sense of reducing the powers of the mayors respecting the appointment of municipal employes and granting them to the municipal governments.

Law authorizing cock-fights and abolishing all the prohibitions in force.

Granting an appropriation of \$25,000 to the executive for private expenses.

Law organizing a permanent army and appropriating \$500,000 for this object.

Law of interior budgets of the House and the Senate.

Appropriations for the widows of the patriots Bonachea and Bosa.

The laws authorizing bull-fights and the lottery are in the committees.

In the Senate the following laws have been approved since April 5:

By majority and as urgent the bill granting an appropriation of \$500,000 for the organization of the permanent army.

Ditto an appropriation of \$25,000 for private expenses of the executive.

Granting an appropriation of \$150,000 to prevent the periodical inundations of the Roque.

Ditto for studying the cocoon palm disease.

Ditto for the committee of economic corporations that will meet in Washington.

Other bills have passed to the study of the committees.

Vice-President Zayas announced May 5 his party's desire for the fusion of both liberal factions, this being also President Gomez's greatest wish. Both believe such a fusion would be highly beneficial for the country and the present government, avoiding future political discomfort and uneasiness of the public.

A bill has been prepared and *Crude Oil* will probably be taken up by *for Fuel.* the House, which provides for the free entry of crude oil to be used for fuel purposes, this product now only being allowed to enter free when imported for gas-making purposes. "Once introduced free crude petroleum would hold a commanding position over the native product of alcohol," says the Havana Post, "because of the installment of furnaces specially devised for the consumption of petroleum, at considerable cost, making the consumers reluctant to discard them for those suitable for alcohol. Importers of coal would also see in crude oil a dangerous competitor."

"Perhaps at no time before has *Havana's* the condition of public order in *Dangers.* the city of Havana been so deranged as it is at the present time," says La Lucha. "So notorious has the inactivity of the police become that criminals walk the principal streets robbing pedestrians at all hours of the day and night, without fear of detention by the bluecoats, who appear to be utterly indifferent to what is daily transpiring about them."

Ricardo Arnauto, a confidential employe at the president's palace, Havana, was indicted April 16 on a charge of rifling the trunk of José Cisneros, a prisoner, charged with shooting at General Emilio Nunez. It was over the proposed appointment of Arnauto as chief of the secret police that President Gomez and Vice-President Zayas had a serious disagreement.

Lincoln De Zayas, a member of the Cuban Cabinet under the Palma and Magoon administrations, is under indictment, charged with padding the pay-rolls in the Department of Public Instruction. He was released April 12 under \$2,000 bail.

A tuberculosis hospital in Santiago is asked for by the provincial council. A bill authorizing the expenditure of \$20,000 for such purpose was introduced April 30.

The Cuban government has raised the rank of its office in St. Louis to a full consulate, and has appointed Ernesto Casaus for the place.

Work has commenced in the port of Sagua la Grande to dredge the channel.

Havana, May 9.—The Executive Committee of the Miguelistas resolved not to accept the modifications of the terms proposed for the fusion of the two branches of the liberal party.

These modifications had been made by the Zayistas, and after deliberate discussion were deemed unacceptable by the Miguelistas.



SOURCE OF HAVANA'S WATER SUPPLY.

The Cuban philanthropist, Marta Abreu, who died in Paris recently, left \$50,000 for an asylum for the aged in Santa Clara City. The lawyer in Cuba has been instructed to turn over the property of the Santa Clara Theatre to the municipality, in obedience to his mother's wishes.

Congressman Eduardo Dolz, associate editor of *La Discusion* will also devote his salary to educate young men in the United States.

Miguel de la Torre, found guilty of stealing \$189,000, while treasurer of the Havana fiscal zone, was sentenced April 27 to 14 years' imprisonment at hard labor, and to repay the amount of money stolen.

The vice-consulates recently created by President Gomez in the United States are those of Jacksonville and Miami, State of Florida, which heretofore were honorary consulates. The appointees are Antonio Alcover and Colonel Rafael Cerviño, formerly in the custom department at Miami.

Drs. Dillon and Jones, the Louisiana health commissioners visited Caibarien May 3, and after investigating the reports of yellow fever there announced that the reports were entirely false.

Instructions have been given by the Secretary of the Treasury that all vessels docking at extension piers at Havana must do so with bows towards the harbor, so that in case of fire it will be possible to leave the pier quickly. Vessels in docking must also drop starboard anchor if docking on right side of pier and the port anchor if on the other side, in order again in case of fire to permit the steamer to swing free from the wharf.

The threatened strike of the stevedores at Havana has been temporarily averted, the president on April 30 suggesting arbitration as a means of settling differences. The secretaries of the treasury and of agriculture, three men chosen by the chamber of commerce and three others chosen by the Longshoreman's Union will form the arbitration committee. The rate of wages is the cause of the strike, the stevedores claiming payment according to General Wood's tariff.

Agitation in Cuba for a reciprocity treaty with the United States continues. La Lucha of Havana suggests that all the business elements join in a concerted action with the government and send representatives to Washington.

THE PRESS OF THE UNITED STATES.

The Annexation of Cuba.

The ultimate annexation of Cuba is embodied in a resolution introduced in the House of Representatives April 20 by Representative Helm of Kentucky. It provides that whenever a majority of the voters of the island shall vote in favor of annexation to the United States the island shall be annexed on such terms and conditions as the proper authorities of both countries may agree upon.

Mr. Helm, in explanation of the resolution, said:

"It is almost certain that the American flag, if it ever goes up in Cuba again to insure the stability of government guaranteed by treaty, will be there to stay. This resolution anticipates that event and indicates the best, easiest and most democratic way of preserving continued amicable relations."

"Of course, nothing will come of his resolution at present," says the Hartford Courant. "For the present Cuba (with the Platt amendment attached) will be left to the enjoyment of such independence as she has and such self-government as she's equal to."

The Washington Star says: "There is no impatience in this country to take over Cuba. The hope rather is to see Cuba succeed with her present experiment. It would be better for us. But should she fail, our duty will be clear. There must be order in the island. Annexation figures only as a last resort."

The Providence (R. I.) Tribune thinks that the United States voters should have a say in the matter. "The Cuban voice is not the only voice to be consulted before annexation is effected. There is a reasonable understanding that the vote of the people of the United States would be against any such bargain. It is safe to say that the majority of the citizens of this country do not desire the annexation of Cuba."

The Mobile Register inclines to the opinion that before long the Americans will be back "for keeps." It says: "The long period of Spanish government has left its mark on the Cubans; and there is the further stumbling block to satisfactory establishment of a permanent government that the fusion of whites and blacks has gone on for many years, making impossible the drawing of a color line. The strong hand must accompany any form of government in Cuba."

The more we hear from Mr. Gomez the more are we convinced that he is the one man needed in the crucial period in the life of that little republic.—Rochester (N. Y.) Herald.

Cuba's Coast Defences.

The Providence (R. I.) Tribune asks regarding Cuba's proposed coast defenses: "What possible use can there be for a chain of forts along the coasts? It is impossible to conceive any combination of circumstances hereafter that would lead anybody to desire to attack Cuba from the outside. All her troubles and perils are within, and she had better turn her whole attention in that direction."

The Albany Journal thinks the coast defence plans should not be taken seriously. It says further: "Cuba has neither the money for the construction of a string of forts, and for equipping and garrisoning them, nor the need of such protection. The United States will have to see to it that she doesn't, through her own fault, get into serious trouble with other nations."

Former Governor Magoon's high estimate of the Cuban is not in accord with that generally held in this country by that large class which has no practical knowledge of conditions, says the Louisville Times. With his contention that the United States cannot, in good faith, again intervene, except in answer to an appeal from Cuba, there can be no quarrel. When he points out the tremendous losses in revenue from tobacco, sugar and other imports that would follow the taking over of Cuba, his appeal for fair play takes on a practical phase that can be readily understood.

A correspondent of the Dayton (O.) News wants to know what it cost the United States to intervene in Cuba and who is to pay the expenses, to which the editor replies:

"It is as difficult to state what it cost as it is to say who will pay the bill. It cost about six million dollars up to the time the United States withdrew from the island, but of course there will continue to be expenses incident to the occupation of the island for many years to come. Cuba is supposed to pay the bill, but if anybody knows whether Cuba will pay it or not, he is wise."

The editor thinks it will be many years before Cuba will have any money to spare for the United States, but consoles himself with the thought that the debt will be a useful thing to this country in the event a considerable annexation sentiment grows up in this country. He says further:

"Any time a majority of our people decide to annex Cuba, they go down there and take the island for the debt incurred when we intervened and put the country in position to be worth annexing."

THE PRESS OF THE UNITED STATES.

Let it be said that in 1899 the Cubans were in favor of annexation—all except the politicians; the people of the United States also were in favor of annexation—all except the politicians. How much better all around had it been accomplished in spite of the politicians. We annexed the Hawaiian group and accepted the Philippines. We dickered But at Cuba, the one bit of insular territory, which from its position would have been easy to defend, and from its productions would have been really valuable to us, we balked. Politics aside and talking only sense, can anybody tell why?—Washington Post.

The budget of 1906-07, as framed by the Cuban Congress, was \$21,728,396. The budget for 1907-08 was \$23,309,539; that for 1908-09 was \$24,285,203. If Cuba is in danger of a deficit of \$12,000,000 for the next fiscal year, supposing the receipts to be about the same as those for 1908-09, this means that the expenditure side of her budget is to be increased by more than half. We are loath to believe that this is true, and trust that the inference is not justified. Still, if it should be true, conclusions must not be drawn too hastily. Cuba is entering upon a new order, and the initial expense may not unreasonably be something out of the ordinary. There is at least the possibility that the increased expenditure comes as a demonstration that the upbuilding work of our provisional occupation was much more fruitful and beneficial than we have yet realized.—New York Globe.

It is seemingly inevitable that there will be a deficit of \$12,000,000 in the Cuban budget consequent upon the recruiting for the army and the huge increase in the public service, some of the departments more than doubling their expenses.—Brooklyn Times.

Without speaking disparagingly of Cuba, we take it that the debates in its parliamentary body over the bills to establish a national lottery and to restore the noble sport of cock-fighting, may be accepted as a notification that it is not bent on annexation to this highly moral country just yet.—Brooklyn Citizen.

After the re-establishment of bull-fighting, a national lottery and kindred pastimes, Cuba may, says the Springfield (Mass.) Union, find time to consider plans relative to the development of the island's rich agricultural and commercial resources.

It is said that the existence of the Cuban republic depends upon the spoils

of office; that in order to carry the election for the present administration of the island, three or four times as many promises to give offices and employment were made than the needs of the service justified; and the consequence is that the public positions are crowded far beyond their needs; that there are three or four men employed where one is necessary.—Columbus (O.) State Journal.

Inefficient Administration in Cuba.

The New Orleans Picayune seems to think that predictions made when the Gomez administration was inaugurated that inefficient and objectionable men would be placed in office, and the efficient incumbents of the offices turned out to make room for the new men are fast being realized. It says the Havana police force has been disorganized by the dismissal of old and tried officials and the substituting of new and utterly untried men as rewards for political services. It says that the amnesty law "turned loose many notorious criminals and bad characters from the jails. These people, with a new and inexperienced police to deal with have inaugurated an epidemic of crime in the Cuban capital which is fast bringing that heretofore well-policed city into unenviable repute."

One of the acts of the new administration which is to be commended is the organization of what is to be known as the standing army, as distinct from the rural guard. Good progress has been made in recruiting this force, but the mistake is being made of appointing officers for political reasons and in payment of political debts, and not because of special fitness. As no military force can be efficient without good officers, the mistake of making purely political appointments in Cuba is certain to result in the so-called standing army proving a broken reed to lean upon in the event of an emergency requiring its services.

In case of embarrassment Cuba will look to us. She could not without our assistance sustain herself against a foreign power. She would receive our assistance promptly, because we could not permit a foreigner to possess the country. She would look to us even as against the uncontrollable disorder of her own people. She understands this, and has agreed to it. The Cuban republic means this reliance upon the United States in time of trouble and this deference to the United States in all matters specified. We are more than Cuba's ally. By her own consent, we are her protector. She is safe as against invasion.—Washington (D. C.) Star.

GENERAL NOTES.

Interesting Items from Various Sources Regarding the Island's Activities.

Cuba Is Contented.

W. A. Merchant, vice-president of the National Bank of Cuba in Havana, who is in New York, gave out April 30 an interview about the criticisms of the Cuban government expenditures. He said:

"The articles recently published regarding the alleged discontent and criticism of government expenditures in Cuba have no foundation in fact. The people of Cuba are satisfied with their independent government, and, with the exception of a few discontented office-seekers, who have not received government positions, are contented and disposed to support the government against all odds. The few malcontents are fully aware of the energetic measures taken by the president to preserve public order and to maintain a stable and orderly government.

"Well-informed people in the United States are aware of the condition in which the American government of occupation left the Cuban Treasury. For the fiscal year ended June 30, 1908, treasury receipts from all sources amounted to \$27,427,601.56, against disbursements of \$39,763,426.75. Their large deficit was due to extensive road-building and other important public works performed by the government of intervention. At a recent cabinet meeting in Havana it was definitely decided that the government expenditures for the next fiscal year should be reduced to a parity with estimated revenue."—*Journal of Commerce*.

May Leave Cuba.

As a result of Cuba's discrimination against the United States in the matter of armament orders, Charles M. Schwab, it is understood, will devote more time to the development of iron ore bodies in this country, at the expense of curtailed operations in Cuba. This action is due to the fact that Cuba has sent representatives to Europe for the purpose of contracting for supplies of guns and other classes of ordnance, without giving steel companies in this country an opportunity to bid for the work.

Mr. Schwab has invested heavily in iron ore properties in Cuba, and is spending at the rate of \$3,000,000 a year on the island, and he believes that the United States should receive a percentage of the steel business contracted for by Cuba, but so far the island has been favoring Europe.

A representative of the Bethlehem Steel Corporation, when asked whether or not it was true that the corporation would curtail its operations in Cuba, said:

"Cuba has been favoring other countries at the expense of the steel companies in this country. The people do not seem to realize that we are contributing millions of dollars

each year toward the island's development. We believe we ought to get some of Cuba's steel business, and if we do not it would only be natural for us to look to other fields for our iron ore supplies. I can say that we control some valuable iron ore deposits in this country, and have already planned development work on a large scale. In other words, the more ore we mine from our local deposits, the less ore we will ship from Cuba."—*Wall Street Journal*, April 29, 1909.

Cuban Studying United States Prisons.

Antonio Duzue, special representative of the Cuban government, is in the cities of the United States studying the system of prisons, reformatories and juvenile courts, and is favorably impressed. He spent a month in New York and other Eastern cities and will also go West.

A White Cuba.

Sir Harry Johnston, the eminent English traveler and authority on Africa, is confident that Cuba is to be a white man's country. And this is due not to immigration coming from this country since Spain's ejection, but from Spain herself. Galicia, Asturia and the Basque provinces and the Canary Islands have been sending thither sober, thrifty, moral, peasant workers since 1898, who have prospered, multiplied and prevented Cuba from degenerating into a Haiti or San Domingo.—*Boston Herald*.

The Carreta in Cuba.

The "carreta" is a clumsy, high, two-wheeled cart. The two wheels are six or seven feet in diameter, have narrow rims and tires, and are so set on the axle that the outer rim has a play of six or eight inches out of the perpendicular. This wheel skew is the active principle of the carreta. When the wheels get stuck in the mud, constant pulling will work the wheel first to one side, then to the other, until the rut is wide enough to permit the cart to proceed. What such a system does to a soft dirt road may be imagined. From two to ten oxen are used on these carts to pull a load that should be readily handled by two mules, and days are taken to make trips that should be accomplished in hours.

It is these narrow-tired, heavy carts which make road building so expensive in Cuba. A road built of ordinary macadam, such as would be called a good highway in the United States, was utterly destroyed in one year by the carretas. Efforts are being made

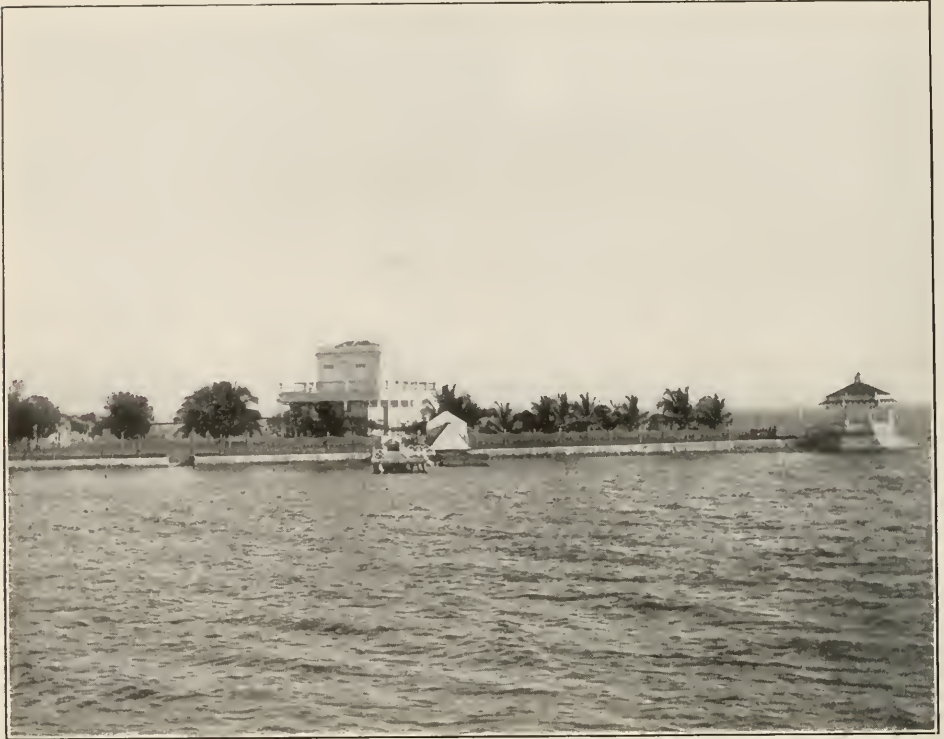

PUNTA GORDA, BAY OF CIENFUEGOS.

to discourage their use by fixing a maximum limit upon the weight to be carried in one vehicle, and the gospel of wide tires is being preached from one end of the island to the other.

Churches on Plantations.

Several of the great sugar estates have made overtures to the effect that if a resident clergyman can be found for each estate the companies will not only pay his salary, but also build a church at each place, says the Milwaukee Living Church. Chaparra is the name of the largest of these. It is regularly supplied with services, either by the clergy or lay-readers and seminary students. The ratio of the increase of communicants in this district is now said to be greater than in any diocese or missionary district in the United States.

Home for Young Women.

A good friend of the church in Cuba gave to Bishop Knight last summer funds for the purpose of establishing in Havana a boarding house, which might afford young women who were earning their living in the city the conveniences of a good home, with proper associations, and at the lowest possible cost. Apartments have been rented

near the cathedral, with accommodation for about twenty-six people. At present it is being run at a loss, owing to the fact that not all of the rooms are occupied, and consequently the manager has been receiving from time to time some tourists, in order to relieve the financial situation.

A New City.

La Independencia of Colón, Cuba, in a recent issue says that a resident and large landowner named Heraclio Ochoa has sold to a Mr. W. Shaw, representing an American syndicate, 800 caballerías, situated some fourteen leagues from Moron in the barrio of Punta Alegre. On eight to ten caballerías the purchasers design the beginnings of a city and to build a sugar mill of the proportions of Chaparra or Preston.

Charles E. Magoon, formerly Provisional Governor of Cuba, will leave New York May 22 for Antwerp and will spend about six months in Europe.

Havana Customs Collection.

| | |
|-------------------|----------------|
| April, 1909 | \$1,359,536.50 |
| " 1908 | 1,420,777.11 |
| " 1907 | 1,830,054.95 |



Projected Sixteen-Room Public School for Cuba.

What the Census Shows.

The Cuban census on education, child labor, early marriages, wage-earners and their work yields the following interesting information:

"There has been excellent progress made in public education.

"The public school system, organized under the first intervention in Cuba, is producing excellent results. Of the population 10 years of age and over, 56.6 per cent. could read, showing a decided gain in that respect since 1899. Of the native whites, 58.6 per cent. could read, and of the colored 45 per cent. were similarly educated. The proportion of literates was naturally much greater in the cities than in the country, and highest of all in Havana.

"Of the whole population 37.7 per cent. were wage-earners—a proportion but slightly less than in the United States, where it was 39 per cent. Of all males 65 per cent. were wage-earners, and of females only 7.5 per cent. Child labor was prevalent; of boys between 10 and 14 years of age, 27.8 per cent. were wage-earners, and of those between 15 and 19 years not less than 87.1 per cent., or about seven-eighths."

By distributing wage-earners among certain great groups of avocations one gets an idea of the relative importance of the industries which they represent. Thus farming, fishing and mining, collectively, employed 48.5 per cent., or nearly one-half of the wage-earners; domestic and personal service claimed 16 per cent.; manufacturing and the mechanical arts, 16.3 per cent.; trade and transportation, 17.6 per cent., or about one-sixth each, and the professions claimed 1.6 per cent. It appears that trade and transportation, manufacturing and domestic and personal service employed about

equal numbers, and collectively they claimed about the same number as farming, fishing and mining.

It is popularly supposed that Cubans, like all Latin races, marry young, but as far as the figures show they marry but little, if any, younger than the people of the United States.—From a paper by Henry Gannett, read before the American Society of Geographers.

Cuba Can Stand Alone.

General Carlos Garcia Velez, the Cuban Minister to the United States, has written to U. S. Representative Harvey Helm, of Kentucky, in reply to the latter's resolution in the House relative to the annexation of Cuba and giving reasons why the island should not be annexed. In his letter, General Garcia says:

"The Cuban people do not wish for the annexation of the island to the United States or to any other country. We feel that a half century of almost constant struggle for independence and sovereignty entitles us to enjoy the blessings of our government or even the mistakes that inexperience may bring during the infant period of our nationality. We are desirous of developing closer commercial relations with the American people; we hope that these relations will never interfere with the political status of both countries, and we will look forward, in all times, to a better understanding of the character, conditions and aims of both peoples.

"There are many other reasons less important to us than those of sentiment (which are unmistakably the principal ones for us), viz., competition of products, difference of language, race, etc., that would be sufficient to make impossible the annexation of Cuba to the United States."

FINANCIAL AND RAILROADS.



Alto Cedro Junction, on the Antilla Branch of the Cuba R. R.

Courtesy of the Publicity League of Cuba.

Cuban Railway Earnings.

Week ending April 4 the earnings of the United Railways of Havana were £37,341, against £27,512 in the corresponding week of 1908, an increase this year of £9,829.

The total earnings of the road during the 39 weeks and 4 days of the present economic year are £818,391, against £756,019 in the same period of 1908, an increase of £62,372. The earnings include those of the Marianao Railway, but not those of the Regla Warehouses.

Havana Electric Earnings.

The Havana Electric Railway earnings during the week ending April 5 were \$37,-951.05, against \$38,429.55 in the corresponding week of 1908, a decrease for this year of \$476.50.

For the week ending April 11 the earnings were \$38,420.20, against \$37,465.85 in the corresponding week of 1908, an increase this year of \$954.35.

Week ending April 11, 1909, \$38,420.20; week ending April 11, 1908, \$37,465.85, an increase in 1909 of \$954.35. To the same date the earnings for the year were \$6,105.15 in 1909 and \$6,034.50 in 1908.

Directors of the Havana Electric Railway Co. have declared the regular quarterly divi-

dend of 1½ per cent. on the preferred stock, and also declared the regular quarterly dividend of 1 per cent. on the common stock.

Both dividends are payable May 15 to stock of record April 24. Books closed April 24 and reopen May 17.

New Line Planned.

It was officially given out on April 24 that the construction of the railway between Trinidad and Placetas will begin in June. The former city and its port at Casilda, once prosperous, lost most of its importance with the growth of Cienfuegos, but railway connection with Havana will help to restore much of its former prosperity.

The Hormiguero Central Co. of Cuba gives notice that the coupon No. 37, due May 1, on the first mortgage 8 per cent. gold bonds of the company will be paid on presentation at their office. Signed by Lorenzo M. Gillet, treasurer.

President Gomez signed April 27 a contract with the National Bank postponing for four years the bank's privilege as a depository for state funds. The bank has agreed to take charge of remittances to Cuba's diplomatic representatives abroad.

FINANCIAL AND RAILROADS.

United Railways Earnings.

Week ending April 11, 1909, earnings were £31,087, as against £23,309 in 1908. Total earnings to date were £849,478 in 1909, as against £779,328 in 1908, an increase of £70,150 in favor of this year.

Week ending April 24, 1909, the earnings were £28,538, as against £15,966 in 1908, an increase of £12,572 in favor of this year. Total earnings to date were £903,369 in 1909, as against £812,713 in 1908, an increase of £90,656 in favor of this year.

For the week ending April 25 the earnings were \$39,208.25, as against \$35,913.00 in the corresponding week of 1908, an increase of \$3,295.25 in favor of this year.

Western Railways of Havana Earnings.

| | 1909. | 1908. |
|-------------------------|--------|--------|
| Week ending April 10... | £4,362 | £5,139 |
| " " 17... | 4,799 | 4,400 |

| Total receipts: | | |
|------------------|----------|----------|
| To April 10..... | £221,907 | £211,046 |
| " " 17..... | 226,706 | 215,446 |

Northeastern Cuba R. R. Trustee Resigns.

A notice has been issued by the Knickerbocker Trust Company, of New York, announcing to the Northeastern Cuba Railroad Company and to holders of its bonds issued under its mortgage dated March 1,

1905, to the Knickerbocker Trust Company, as trustee, that the said trust company has resigned as such trustee.

Cuban Central Earnings.

| | 1909. | 1908. |
|-----------------------|---------|---------|
| Week ending April 10. | £13,454 | £11,358 |
| " " 17. | 11,422 | 10,027 |

| Total receipts: | | |
|------------------|----------|----------|
| To April 10..... | £331,220 | £285,528 |
| " " 17..... | 342,642 | 295,555 |

Cuba Railroad.

The report of the Cuba Railroad Co. for the month of March and nine months ended March 31, compares as follows:

| | 1909 | 1908 |
|-------------------|-----------|-----------|
| March gross | \$251,305 | \$235,415 |
| Expenses | 127,575 | 129,542 |
| March net | \$123,730 | \$105,873 |
| Charges | 34,239 | 31,845 |

| | | |
|-----------------------|-----------|-----------|
| March surplus | \$89,491 | \$74,028 |
| Nine mos. gross | 1,540,263 | 1,510,627 |
| Expenses | 875,570 | 989,442 |

| | | |
|--------------------|-----------|-----------|
| Nine mos. net..... | \$664,693 | \$521,185 |
| Charges | 295,358 | 269,726 |

| | | |
|-----------------------|-----------|-----------|
| Nine mos. surplus ... | \$369,335 | \$251,459 |
|-----------------------|-----------|-----------|

QUOTATIONS FOR CUBAN SECURITIES.

Supplied by LAWRENCE TURNURE & CO., New York City, April 14, 1909.

| | Bid. | Asked. |
|--|------|--------|
| * Republic of Cuba 5 per cent bonds..... | 103½ | 104½ |
| Republic of Cuba 6 per cent. bonds | 100 | 101 |
| Republic of Cuba 5 per cent. new bonds (interior loan)..... | 93½ | 94½ |
| Havana City first mortgage 6 per cent. bonds | 105 | 106 |
| Havana City second mortgage 6 per cent. bonds | 104 | 106 |
| Cuba Railroad first mortgage 5 per cent. bonds..... | 98 | 100 |
| Cuba Railroad preferred stock | 62 | none |
| Cuba Company 6 per cent. debentures..... | 85 | 95 |
| Havana Electric consolidated mortgage 5 per cent. bonds..... | 80½ | 90½ |
| Havana Electric preferred stock..... | 82 | 93 |
| Havana Electric common stock | 50 | 52 |
| Matanzas City Market Place 8 per cent. bonds cts..... | 103 | 104 |

* All prices of bonds quoted on an "and interest basis."



A beautiful home, constructed in the Vedado, by the Royal Bank of Canada for its employees.

COMMERCIAL MATTERS.



Crushed Hennequen Fibre Drying on Frames at Nuevitas.

Havana Cable Tolls.

Cable rates from Havana to the United States are as follows. The rates are per word and are payable in American money:

| State. | Cents. |
|---|--------|
| Alabama | 15 |
| Arizona | 20 |
| Arkansas | 20 |
| California | 20 |
| Colorado | 20 |
| Connecticut | 15 |
| Delaware | 15 |
| District of Columbia | 15 |
| Florida—Key West | 15 |
| All other stations | 15 |
| Georgia | 15 |
| Idaho | 20 |
| Illinois | 15 |
| Indiana | 15 |
| Indian Territory | 20 |
| Iowa | 20 |
| Kansas | 20 |
| New Hampshire | 15 |
| New Jersey | 15 |
| New Mexico | 20 |
| New York | 15 |
| North Carolina | 15 |
| North Dakota | 20 |
| Ohio | 15 |
| Oklahoma | 20 |
| Oregon | 20 |
| Pennsylvania | 15 |
| Rhode Island | 15 |
| Kentucky | 15 |
| Louisiana—New Orleans | 15 |
| All other stations | 20 |
| Maine | 15 |
| Manitoba | 20 |
| Maryland | 15 |
| Massachusetts | 15 |
| Michigan | 15 |
| Minnesota—Minneapolis and St. Paul. | 15 |

| | |
|------------------------------|----|
| All other stations | 20 |
| Mississippi | 15 |
| Missouri—St. Louis | 15 |
| All other stations | 20 |
| Montana | 20 |
| Nebraska | 20 |
| Nevada | 20 |
| South Carolina | 15 |
| South Dakota | 20 |
| Tennessee | 15 |
| Texas | 20 |
| Utah | 20 |
| Vermont | 15 |
| Virginia | 15 |
| Washington | 15 |
| West Virginia | 20 |
| Wisconsin | 15 |
| Wyoming | 15 |

Interior Telegraph Rates.

Telegraph rates from Havana to provincial points are as follows:
 Within the limits of three provinces.—
 First 10 words 20 cents, and 2 cents each additional word.
 In four provinces.—Thirty cents for the first 10 words, and 3 cents for each additional word.
 In five provinces.—First 10 words 40 cents, and 4 cents for each additional words.
 In the six provinces.—First 10 words 50 cents, and 5 cents for each additional word.

The merchants of Holguin and Camaguey have petitioned President Gomez requesting that the Nipe Customs House be transferred from Preston to Antilla. They believe the new location will better serve the commercial interests of the towns along the line of the Cuba Railroad. This matter has been agitated for several years.

Henequen and Rope Making.

Although there are some 2,100 acres planted to henequen in Cuba (hemp) from which ropes are manufactured, there is not enough produced to supply the market, and in a single year over 1,000 tons were imported. To supply the market and keep the rope factories running, Cuba should produce 3,000,000 or 4,000,000 pounds. There are several henequen mills in Cuba and a rope manufactory at Havana capable of using all the henequen raised; the establishment has all kinds of machinery and manufactures from the finest thread to the heaviest and strongest cables for ships. There is also made in Cuba a bark rope which is sold very cheap.—Clinton (Mass.) Courant.

Sponge Fishing.

Sponges are classified, male and female. The minimum size of sponges allowed by law is 46 centimeters, excepting specimens for scientific studies. The production one year amounted in value to \$501,575.42, and the United States took about 35 per cent. of the output.

The yield of sponges in Cuba for eighteen months from July 1, 1906, to September 30, 1907, inclusive, was as follows. The table gives the quantity secured at the places named and their value.

| | Dozen. | Value.* |
|--------------------|----------------|---------------------|
| Cardenas | 7,082 | \$3,094.30 |
| Caibarien | 231,728 | 50,234.88 |
| Nuevitas | 71,089 | 9,528.34 |
| Batabanó | 421,659 | 338,269.41 |
| Total | 731,558 | \$401,126.93 |

From the report of the Secretary of the Cuban Department of Agriculture, Industry and Commerce.

*United States currency.

Cannery and Starch Mill Proposed.

The committee of the Herradura Vegetable Growers' Association, Herradura, Province of Pinar del Rio, have returned a favorable report on the proposition of establishing a cannery and starch mill in that town.

E. W. Halstead, the secretary, would like to enter into correspondence with manufacturers of the necessary machinery which will be required. Arrangements, it is said, are now under way for planting a large acreage of yucca for starch.

English Cottons in Cuba.

In the three months ended March 31 England exported cotton goods to Cuba as follows:

| | | |
|-------------------------------|------------|------------|
| Cotton Goods—Bleached. | 1909. | 1908. |
| Yards | 8,169,300 | 8,105,600 |
| Value | £84,512 | £69,081 |
| Cotton Piece Goods—Printed. | 1909. | 1908. |
| Yards | 5,289,300 | 3,467,500 |
| Value | £50,719 | £28,175 |
| Cotton Piece Goods—All Kinds. | 1909. | 1908. |
| Yards | 19,787,800 | 17,192,000 |
| Value | £200,568 | £150,871 |

Blind to Cuba's Possibilities.

"America seems to be absolutely blind to Cuba's possibilities," said Sir William C. Van Horne to a Herald representative in London on May 5. "Cuba," he continued, "offers one of the finest fields for American investment that could be had, and the tobacco and sugar growing interests have vast possibilities, little dreamed of by American business men. But the best opportunities," he insisted, "lay in the raising of citrous fruits and cattle. Recently a good deal of American capital has been invested in these two industries, but nothing like as much as the conditions would warrant."

Sir William also pointed out that Cuba is in itself a rich country. Its people are law abiding and industrious, and the government is perfectly safe. Personally he believes there are great possibilities, and he has proved his faith by investments amounting to several millions of dollars. The mileage of his railways in Cuba is now being increased by about two hundred, tapping some of the rich sugar and tobacco districts in the west of the island.

Cuban Imports of Watches.

Consul R. E. Holaday, in reply to an inquiry from a New York watch agency, furnishes the following statement showing the number and value of watches imported into Santiago de Cuba in 1907 and 1908:

| Whence imported. | —1907— | | —1908— | |
|-----------------------|--------------|----------------|--------------|----------------|
| | Number. | Value. | Number. | Value. |
| United States | 962 | \$338 | 596 | \$433 |
| Switzerland | 786 | 1,064 | 1,911 | 1,971 |
| Germany | 382 | 1,323 | 132 | 144 |
| France | 180 | 418 | 104 | 95 |
| Other countries | ... | ... | 2 | 8 |
| Total | 2,310 | \$3,143 | 2,745 | \$2,651 |



New Building of the Commercial Exchange of Havana.

The Havana Commercial Exchange.

The inauguration of the beautiful and stately edifice of the Lonja de Comercio on San Francisco Square, on March 28, was an impressive ceremony. President Gomez, high government officials and a distinguished crowd of invited guests, numbering hundreds, attended. The foundations under the steel columns were all made down to solid rock, which in some cases was found at a depth of 9 meters below the street level and eight meters below the level of the bay. In places it was necessary to have five large steam pumps running to keep the water down so that the excavation could go on and the concrete be put in. The whole of the building is, as far as modern engineering can make it, proof against fire, earthquakes or hurricanes, and equipped with every modern plumbing fixture. The floors are of reinforced concrete, as are the outside walls of the building. The stone was made in Havana with native workmen.

All of the woodwork in the building is of Cuban cedar and mahogany.

Over 190,000 imported Spanish mosaic tiles were used in the floors. 25,000 base tiles around the walls were used.

The five-story building covers 8,000 square feet, or 2,400 square meters, and is said to be one of the largest of its kind in the world, except as to height, and in this respect Havana has not yet tried to imitate New York, five stories being the limit of Havana's ambition so far. The dome is of a rich carmine tint with a golden figure of Mercury on its apex. The building is one in which the city may justly take pride. Purdy & Henderson were the contractors.

The Hotel Inglaterra in Havana will soon have two additional stories. The interior will be practically rebuilt, and all modern improvements added. The Sevilla is likewise undergoing important alterations, and a new five-story steel frame fireproof hotel is being built in San Lazaro street.

WOODEN HIGHWAY BRIDGES IN CUBA.

Methods and Costs of Construction (With Concrete Abutments) in Cuba.

By Charles McKercher.

These bridges were 5 meters or 16.4 ft. long, and were constructed of Acana, a Cuban hardwood. They were built under the supervision of the writer in the winter and spring of 1907-08. The cost of the materials per cu. yd. of concrete was as follows:

| | |
|--|---------|
| 1.13 bbls. of Atlas Portland cement at \$4.50 per bbl..... | \$5.08 |
| 0.80 cu. yds. of crushed rock at \$2.85 per cu. yd. | 2.28 |
| 0.48 cu. yds. of river sand at \$0.20 per cu yd. | .096 |
| Total | \$7.456 |

The lumber for the forms (250 ft. B. M., at \$18 per M.) cost \$4.50. The small amount of excavation does not indicate solid rock near the surface, but as the foundation soil was firm only a sufficient amount was excavated to secure a foothold for the abutments.

The master carpenter was paid \$2.50 and his assistants \$1.75 per day. The charge for superintendence includes inspection, laying out of work and the foreman's time of the concrete and excavation.

The costs of bridge No. 1, which follow, were greater than either of the other two, owing principally to greater excavation, and a larger quantity of materials and more labor were required.

Bridge No. 1:

22 cu. yds. common excavation for abutments at \$0.612 = \$13.47.

| | Total Cost | Per |
|--|------------|---------|
| Concrete and Forms. | Cost. | Cu. Yd. |
| 31.5 cu. yds., 1-3-5 concrete..... | \$234.86 | \$7.456 |
| Lumber for forms..... | 1.50 | .047 |
| Labor on forms, 1 carpenter | | |
| 2.4 days at \$2.50..... | 6.00 | .190 |
| Mixing and placing 31.5 cu. yds. of concrete | 34.46 | 1.094 |
| Total | \$276.82 | \$8.787 |

| Bridge Proper. | Total. |
|--|----------|
| 3,100 ft. B. M. Acana at \$50 per M..... | \$155.00 |
| Labor, framing and erecting, 6.8 days at \$4.25..... | 28.90 |
| 130 lbs. bolts, spikes, plates, etc., at \$0.16 per lb. | 20.80 |
| Painting | 75.00 |
| Total | \$297.70 |

Summary:

| | |
|-----------------------|----------|
| Excavation | \$13.47 |
| Concrete | 276.82 |
| Bridge | 279.70 |
| Superintendence | 51.55 |
| Total | \$621.54 |

| | |
|----------------------------|----------|
| Cost per lineal meter..... | \$124.31 |
| Cost per lineal foot..... | 37.90 |

The total cost of the second bridge was \$559.29, and of the third bridge \$575.90, which makes an average cost for each of \$585.57.—Engineering and Contracting.

The Future of Guantanamo.

"Congress at the last two or three sessions failed to make any provision for continuing the important work, originally outlined by the naval experts in defence, for a war base and dockyard at Guantanamo, Cuba. The work which was started at that place has practically been abandoned, and much of the material which was installed, with a prospect of its value there, has been recalled for use at the home navy yards," says the Washington (D.C.) Herald.

It will be interesting to know what action the navy department takes on the recommendations which are understood to have been made for resuming the work of installation at Guantanamo. There appears to be a difference of opinion, even within the naval service itself, concerning the advantage of Guantanamo as a naval station beyond continental limits. The anticipation of the completion of the Panama Canal requires that

some prudent measure of naval defense and ship recuperation be established in the neighborhood of the isthmus. But even this obvious requirement does not contribute to that unanimity of expert opinion which it may be too much to expect under the conditions which have lately stimulated naval controversy. There is no question that something should be done toward having a base which will be of use to naval vessels engaged in the defence of the canal, and the decision of a location should not be long deferred, considering the time required in building and equipping shops and constructing a drydock which, according to the most authoritative view, is required at such a place in order to restore damaged ships to fighting efficiency with the least possible delay.

Guantanamo has been for several years without the funds needed for its installation as a war base, and appears to be still far removed from Congressional provision in that respect.

An Historical Scene. End of the Second American Intervention. The American Fla



Cuban Artillery Band

Cuban Artillery

Cuban Permanent Army

Band, U. S. A.

PRESIDENT JOSÉ MIGUEL GOMEZ.

[Condensed from an article in Current Literature.]

His is the extraordinary magnetism of a commanding personality. It is to this personality that he owes the supreme position now his. So much, on the authority of Cuban newspapers least friendly to him, may be premised with assurance.

Like all his countrymen native to the great cane-growing province of Santa Clara, José Miguel Gomez has a very Latin temperament. He was born and brought up among a people who retain as much of the customs and manners and morals of Andalusia as our own Kentucky mountaineers conserve of the ways and speech of Shakespeare's England. Santa Clara is a species of survival of the Spain of Ferdinand and Isabella, its natives revelling in attributes exploited by writers of picturesque romances long ago. José Miguel Gomez has the old Castilian manner, an inheritance from a grandmother famed for her beauty. His father was a wealthy plantation owner and cattle-breeder. There was no reason why José should not have spent his four years at the university in Ha-

vana with a post-graduate course at Salamanca or Toledo, were it not that an innate propensity for revolution impelled him at sixteen to imprison his parents in their provincial mansion and administer the paternal acres as if they were already his by inheritance. Thus did he play before he was of age that revolutionary part which, enacted time and again before provincial audiences, was to crown him at fifty-three with supremacy.

Viewed merely as a man, there is no doubt in the Cuban journalistic mind that he possesses the requisites of greatness—the boundless fertility of resource, the fine courtesy, the spontaneous tact, the complete self-control, the tenacity of will and the intellectual power. Had he been called to the bar, he must to-day have been on the Supreme bench. Had he entered holy orders he would to-day be an archbishop. Gomez is without the distinction of height, but there is a fire in the swarthy countenance, surmounted by a mass of grizzling hair and set off with a fiercely trimmed mustache, suggestive, his admirers think, of Bolivar. His face retains still—he is fifty-three—the poetical beauty it revealed when he won his spurs in his native province by taking up

Has Just Been Hauled Down and the Cuban Flag Raised, Noon of March 31, 1909.



Gen. O. Barry

| | | | | |
|---------------------------------|----------------------------------|----------------------|----------------------------|-------------------|
| Corps of Engineers, U. S. A. | Cuban Officers, Three at Left | American Officers | 27th Infantry, U. S. A. | Cuban Rural Guard |
|---------------------------------|----------------------------------|----------------------|----------------------------|-------------------|

arms against Spain and winning the title of major when he was no more than a youth.

Over that most exquisite instrument of imaginative emprise, the Latin temperament in Cuba, Gomez exerts a control quite incomprehensible to Americans who have seen it displayed. He imbues or seems to imbue the patriotic conceptions of his followers with the overwhelming charm and the irresistible appeal of his own personality. His physique and his voice alike have limitations, yet he looks great and he talks eloquently. His influence over his followers, even in the now remote days when he camped with them in the Cuban hills, ragged, hungry and hunted, has always been a thing of the emotions, a triumph of the heart over the head, a victory of feeling over intellect. Time and again, when the Cubans in arms seemed about to disperse from despair, to disintegrate in desperation, when the ten-years' war was one long starvation, when the last revolt of all had brought Weyler to Havana, Gomez rallied his followers anew, receiving the allegiance of men still inflamed with the patriotic ardors it was his privilege alone to inspire. At critical junctures in more than one revolution his passage from one part of a province to another was signalized as far

away as Havana by the restored vigor of the campaign.

He derived his theory of strategy and his mastery of tactics from his native soil. He seems to have had little experience with artillery, and he has never commanded a respectable force of cavalry; but with the sort of infantry available in his native isle he has accomplished what European military men have pronounced magnificent results.

When the revolution comes again to Cuba, the histrionic Latinity of the genius of President Gomez will suffice for the emergency in the opinion of the Havana press.

Meanwhile, the presidential palace in Havana has become the center of every social influence calculated to charm those exclusive coteries which give its special tone to the Cuban capital.

To Visit the United States.

New Orleans, May 7.—Returning to-day from Havana, where he went to investigate health conditions, President Harvey Dillon, of the Louisiana State Board of Health, said that President Gomez of Cuba will soon make an extensive tour of the United States, although no definite date has been set.

ROAD BUILDING IN CUBA.



Road-Making on the South Line of Los Pinos, McIrvin Finca, Guanabacoa, Havana Province, Calzada, Santa Maria del Rosario.
Courtesy of the Publicity League of Cuba.

Road Building in Cuba.

One of the greatest accomplishments of the régime of the provisional governor, Charles E. Magoon, representing the United States, was the opening up of the island from end to end, and laterally with excellent macadamized roads built on the most approved modern principles. Some of these roads follow the course of old ones that had been graded in a desultory way by preceding Spanish and Cuban administrations; but

for the most part they replace cart-cut tracks through the thickets that were barely passable in dry weather and entirely useless during the long rainy season. They bring easy communication to the fertile acres of the entire country, much of which has been hitherto completely isolated. They open up the arteries of trade to sections that for hundreds of years have stagnated for a lack of ability to get their produce to market.

The roads were graded in such a way that nowhere was the incline more than 6



Road Building in Pinar del Rio—View of New Road from Los Mogotes.

per cent. The site was first plowed and leveled with an easy crown to the center. On top of this surface was placed six inches of rock in pieces as big as a man's two fists. Above this came four inches of broken stone the size of an egg, and then a final covering of fine surfacing stone, which filled all the voids. The road was then compacted by a heavy steam roller.

The cream and blue limestone of the country furnished the material for the roads.

The roads are of a universal width of 34 feet, of which the pavement covers 16 feet. All the culverts are made of concrete. The bridges are modern steel structures such as the island never saw before. The right of way was ditched to prevent inundation, and swamps were drained where they interfered with the work. At intervals of fifteen miles there is a road house, at which is stationed a caretaker and the employes who maintain the road.—Scientific American.

THE ISLE OF PINES FIVE YEARS AGO AND TO-DAY.

The Isle of Pines Appeal celebrated its fifth anniversary April 15 by publishing a twenty-page edition full of illustrations and descriptive matter concerning the Isle of Pines.

Its history of the great progress of the development of the island makes interesting reading. It says in part:

"Five years ago the Isle of Pines was looked upon as more or less of a joke by those who had heard of it, and even those who had heard of it were few. Now those who say they have not heard of the Isle of Pines argue themselves unknown. It has been heralded to the four quarters of the earth in clarion tones and few there are who have had good and sufficient cause to say ill of it. There were of course times when the Isle of Pines was less inviting than many of the frontier settlements, partially because of the fact that there were so few persons living on it who could speak the tongue which Americans were accustomed to hearing and further because of the fact that five years ago it seemed very far away from home.

"This is all changed now, and one may live and die in the Isle of Pines without being compelled to utter a syllable in any other than the English language; and many talk to people from their own State and in many parts of the island from their own city or town.

There is intercourse between the natives and the Americans of the most friendly nature, but English is now the predominating language in the Isle of Pines as are the Americans the predominating people.

"Then, the natives or Cubans or Spaniards owned nearly all of the land of the island; now the Americans own all except a possible four per cent. of the land, and even this is destined to pass to American ownership in the very near future. These figures are given to 'The Appeal' by no lesser person than Mayor Benito Ortiz whose truthfulness has never been questioned and who is himself one of those who at one time had great land holdings in the island.

"During the past five years the island has had constructed upon it a net-work of the best public roadways. We may now drive by automobile to almost any part of the island. Where there were formerly fords there are now substantial bridges and in many cases splendid steel structures. The harbors have been deepened. Churches have been built in many of the towns of the island, schools with American teachers have been established with a college in prospect, social and literary societies have been organized and the Americans on the island brought in closer communion."



Picturesque and thoroughly comfortable home of an American colonist.

AGRICULTURAL MATTERS.

Experiments With Mangoes—Poultry Feeding—Lemons and Grapefruit—Another Horticultural Exposition in 1910.

Keeping Powers of Ripe Mangoes.

Some experiments were lately carried out in British Guiana under the auspices of the Department of Science and Agriculture to test the effect of immersion for a short time in a three per cent. solution of formalin (a treatment which is known to have a preservative influence in the case of many soft-skinned fruits) upon the keeping power of 260 mangos belonging to twenty-three different varieties. The fruits were gathered two at a time, one immersed for ten minutes in the formalin solution, and the other, which was not treated with formalin, being kept under precisely similar conditions for control purposes. The mangos were handled with every care and examined daily.

It was found in practically all cases that the use of formalin tended to lessen the number of days which elapsed before the mangos became unfit for eating purposes. Incidentally, the experiment has shown that, with careful handling, mangos will, on the average, keep for ten or twelve days in British Guiana, and it is expected that in cold storage their keeping powers would be much increased.—Barbadoes Agricultural News.

Economical and Proper Feeding of Poultry.

In the West Indies the birds are fed almost entirely on maize, which is cheap and abundant, and provided the hens get plenty of liberty, and are not fed too heavily, the substance is fairly satisfactory. Like most West Indian grown poultry foods, like rice, Guinea corn, yams, sweet potatoes, etc., maize possesses an excess of starch, and is deficient in flesh-forming constituents. A common result of feeding too much maize or other starchy food is that the birds become over-fat and numbers die from apoplexy or other diseases brought on by this condition. But the addition of a certain proportion of pigeon or other peas, cocoanut or meat scraps to the maize, makes a well balanced food. Soft food, such as a mixture of various meals, should be given to fowls in the morning, and hard food, as a mixture of corn and pigeon peas, the latter roughly ground or broken, be fed in the evening. The proportion of corn to peas should be two parts of the former to one of the latter.—From Notes on Poultry in the West Indies, No. 23. Imperial Department of Agriculture, prepared by Mr. John Barclay, of Jamaica.

The Avocado Most Wholesome and Nourishing.

The Avocado.—The avocado or alligator pear is one of the best, if not the best, of all tropical fruits. It is the most easily digested, the most wholesome and the most nourishing. According to government statistics, it contains over 10 per cent. of fat, and in a form that the most delicate persons can partake of it with a relish, when they cannot partake of fat from an animal source. It is an upbuilder of the system, nerve, as well as muscle, and requires but little coaxing of the palate for one to become extremely fond of it.

It is a fruit that all physicians should look carefully into, on account of its nourishing and digestible qualities.

The avocado, says the Tampa Times, also makes the basis of a score of the finest salads that ever tickled the palate of an epicure and it has the great merit that it cannot be spoiled.

Care in Handling Lemons.

The handling of the lemon in the packing house is done with more care than is bestowed on any other orchard fruit crop, says the California Fruit Grower. The shippers have found from costly experience that the dropping of the fruit or the rough handling of it in any other way is followed by heavy losses from decay. The injunction to "handle the fruit like eggs" is kept constantly before the laborers, and this care in handling is consistently practiced in the well-managed packing houses.

Grape-Fruit.—Twelve or fifteen years ago, says the same paper, peddlers sold the first grape-fruit, calling them "big oranges," and the following day the housewives of New York were out looking for them with broomsticks and hatchets. Now grape-fruit, in season, is an indispensable adjunct to millions of breakfast tables.

Orange Grove Returns.

A California horticulturist figures the return from an orange grove as follows:

| | | | | | |
|--------------|-------|-----|-------|-----|------|
| Third year | | 10 | boxes | per | acre |
| Fourth year | | 50 | " | " | " |
| Fifth year | | 100 | " | " | " |
| Sixth year | | 175 | " | " | " |
| Seventh year | | 225 | " | " | " |
| Eighth year | | 275 | " | " | " |
| Ninth year | | 300 | " | " | " |
| Tenth year | | 325 | " | " | " |

—California Fruit Grower.



King Orange—Four-Year-Old Tree.

The "King" Orange.

An orange of superior quality, known as the "King" variety, the first plants of which were imported directly from Cochin, China, some twenty-eight years ago.

The year book of the United States Department of Agriculture has this to say about this promising fruit:

This orange is also known as the "King of Siam." It was first classed with the mandarins and tangerines, but it is so very distinct from these in many respects as to appear worthy of being classed in a distinct horticultural group. It is described as being medium to large in size, dark reddish-orange in color, the rind moderately thick, rather soft, and possessing a distinctive and agreeable aroma and flavor, flesh loose and soft in texture, juice abundant, and with a peculiarly rich, sweet flavor. The general quality of the fruit ranks it with the very finest kinds, for it is more sensitive to climatic changes than most varieties of oranges.

Great Auction of Cuban Pines.

The largest quantity of Havana pines ever disposed of at auction in one week in April was handled in the New York market in the week of April 30. A total of about 70,000 crates was disposed of.

Large sizes were hard to move and in most cases the trade gave a preference to the medium sizes. The proportion of small sizes was light, and sizes 42 and 48 would, as a rule, bring relatively higher figures than the larger sizes. The proportion of large sizes, 16 to 24, was figured as about 80 per cent. of the total in the Cuban stock.

The prices in consequence of the cool weather, and in spite of the fact that the Cuban pines were of very fine quality, although green, were the lowest in the history of the trade for sound fruit.

With better weather the cheap prices should be a thing of the past, both on account of the increased improvement in the ripeness of the pines and lessened receipts.

PROFITS IN ONION CULTURE.

Cuba's Importations and United States Consumption.

Condensed from Farmers' Bulletin 354, U. S. Dept. of Agriculture.

There is \$1,000,000 in onions alone for the colonists in Cuba in the trade of one country, viz., the United States. This country produces annually 14,000,000 bushels, valued at \$10,000,000, and this for home consumption only. In addition we import annually 1,400,000 bushels from various countries, Spain, Egypt, Bermuda, etc. The onion is well adapted for growing commercially on a small scale nearly everywhere and very little capital is required for a beginning. The growing of Spanish and Bermuda onions in the Gulf Coast States has become a great industry, for a great quantity of this type of onion can be grown upon a small

drainage and freedom from weeds. Clayey soils bake after hard rains and are therefore very injurious to the small plants, but if this kind of soil is mixed with sand it is ideal for onion culture. Sandy soils require heavy applications of fertilizer and should be underdrained. Cowpeas turned under and the occasional applications of about 1,200 pounds of lime to the acre will supply ample humus.

Once the weeds get a start the cost of production is increased or the crop may be lost altogether. New land is not generally adapted to onion growing until it has been worked one or two years with crops of



Irrigation of Bermuda Onions in Texas.

area, a few thousand acres producing all the average market can handle at a profit to the owner. There are few places where onions will not grow.

Perfect crops are secured in Egypt in alluvial as well as volcanic soils, in the South Sea Islands, in sandy plains, in irrigated portions of deserts, in reclaimed swamp soils, and in fact everywhere. In the early stages of their growth they require an abundance of moisture, but should be ripened under comparatively dry conditions.

In Texas the growing season extends from the middle of September to the following March or April.

A suitable soil includes a high state of fertility, easily workable conditions, sufficient

corn, beans or potatoes; then it should be manured heavily, giving sufficient time to be thoroughly incorporated. Do not plant the same piece of land year after year, but rotate with truck crops, choosing that which will not be exhaustive. Continuous planting will infest the land with disease and insect enemies, which will sooner or later work much damage.

If you can get the ingredients the following fertilizer formula is good:

| | Pounds. |
|-------------------------------|---------|
| Salphate of ammonia, 25%..... | 200 |
| Dried blood..... | 300 |
| Cotton-seed meal..... | 300 |
| Acid phosphate..... | 800 |
| Muriate of potash, 50%..... | 400 |



Method of Curing Onions in Sacks Standing in Field.

If you can't get cotton-seed meal, try this:

| | Pounds. |
|--------------------------------------|---------|
| Nitrate of soda, 14% to 16% nitrogen | 300 |
| Dried blood | 500 |
| Acid phosphate | 800 |
| Muriate of potash, 50% | 400 |

Quantity of seed required is $4\frac{1}{2}$ pounds per acre where rows are 14 inches apart. If 3 feet apart $1\frac{1}{2}$ pounds will do. For small pickling onions about 25 pounds per acre is necessary. Good seed is of course very essential. It is advisable to plant so that little thinning will be necessary. Eight or ten plants to the foot is enough. The average yield of Bermuda onions is about 12,000 pounds to the acre. On heavily manured land the yield averages 16,000 pounds. Estimates of costs of production in the United States are as follows:

Preparation of land and fertilizer, \$70; seed, \$9; transplanting, \$20; irrigation, \$15; cultivation and hand weeding, \$16; harvesting, \$20; interest, \$20, a total of \$170 per acre.

The best Bermuda onion farms are valued at \$300 to \$500 an acre. The normal profit is \$250 per acre.—Condensed from Farmers' Bulletin 354, U. S. Department of Agriculture.

Cuba's importations of onions for 1906 and 1907 are as follows: 1906, 9,236,164 kilos.; value, \$308,862; 1907, 10,542,821 kilos.; value, \$378,980.

The following countries supplied Cuba's market during the years quoted:

| | 1906 | 1907 |
|------------------------|-----------|------------|
| United States ..Kilos. | 1,273,257 | 908,582 |
| Spain | 5,433,192 | 7,114,713 |
| United Kingdom... | 329,852 | 48,209 |
| Egypt | 109,196 | 19,607 |
| Canary Islands | 1,435,942 | 1,598,289 |
| Argentina | 10,234 | 19,509 |
| Brazil | 7,708 | |
| Canada | 86,755 | 8,400 |
| Mexico | 7,491 | 4,140 |
| Puerto Rico | 24,426 | |
| Uruguay | 518,621 | 726,608 |
| Germany | 190 | |
| Austria | | 91,500 |
| Belgium | | 3,264 |
| Total | 9,236,164 | 10,542,821 |
| Value | \$398,862 | \$378,980 |

Healthy Foliage Essential.

The leaves of a tree are just as essential to the health and development of a tree as the roots are. Keep the leaves off a tree and it will surely die. The leaves are where the food for the growth and development of the tree is worked over into the proper condition, and without this working over, commonly called elaboration, the tree will starve to death. A tree in order to grow must have sugar, starch and other allied substances. But none of these things ever

enters the tree from the ground through the roots or from the air through the leaves. Then whence come they? They are manufactured in the leaves. Many cases produce leaf disease. Fungi showing in the form of mildew, mould, etc., and the tiny aphids work great damage. These must be killed by spraying with some fungicide and insect washes. The best fungicide is sulphate of copper, commonly called bluestone or blue vitriol. The lime sulphur wash used in killing scale and other insects is also a fungicide and helps to keep the foliage healthy.—California Fruit Grower.

Best Poultry for Cuba.

The number of breeds is legion, and as the greater number come from temperate zones it follows that discrimination is necessary in selection. For table purposes the Indian Game, the Dorking, and the English Game stand pre-eminent among breeds, being large and fleshy, and with meat of excellent quality. In Jamaica the Indian Game is a favorite bird among pen-keepers, and is more suitable to the climate than any other breed of table bird. The Dorking is suitable for dry localities in the West Indies, where there is plenty of shade and a good run, but the birds have not been so successful in Jamaica as the game breeds. The hens of the three breeds mentioned are all poor layers but good sitters.

As laying breeds the Leghorns and Minorcas are undoubtedly the best, and the former is probably the most profitable variety of hen that can be kept in the West Indies. The Leghorn appears to thrive equally well both in wet and exposed localities, and also in hot as in dry districts, in confinement and at large. Minorcas are also excellent layers of large eggs. They thrive in warm sheltered places and give very profitable returns, but will not stand exposure so well as the Leghorns. — Agricultural News, Barbados.

Poultry in Porto Rico.

In Porto Rico the Leghorn varieties, especially the white and buff kinds, appear to be most suitable to prevailing conditions. The Black Minorca fowl also does very well and lays large, white eggs, is a non-sitter, and being somewhat heavier than the Leghorn, is more valuable for table purposes. The several varieties of Plymouth Rocks, Wyandottes, Rhode Island Reds, etc., are reported to be too heavily feathered, and too addicted to sitting, to be profitable under the circumstances. The Indian Game and Buff Orpington breeds are popular in Jamaica.

Cuban Tobacco.

Gen. Garcia Velez, the Cuban minister to the United States, has this to say about Cuban tobacco:

"There is no question about Cuban tobacco being the peer of all tobaccos, no matter where raised or grown," said Gen. Garcia. "There is only one fault to find with our tobacco, and that is that it gets brittle too soon."—Washington (D. C.) Herald.



Enormous Lemons, Which Grow Freely in Cuba.

SUGAR REVIEW.

Especially written for The CUBA REVIEW by Willett & Gray, of New York.

Our last sugar review for this magazine was dated April 12.

At that time Cuba Centrifugals of 96 test were quoted at $2\frac{5}{8}$ c. c. & f. for May shipment and 3.95c. per lb. for spots and prompt shipment. The quotations now are 3.86c. per lb. for spot and prompt shipment and $2\frac{9}{16}$ c. c. & f. for June shipment (3.92c.).

Beet sugar in Europe fluctuated for the month from 10s. $4\frac{1}{2}$ d. to 10s. 6d. to 10s. 3d. to 10s. $4\frac{1}{2}$ d. at the close, an advance of $1\frac{1}{2}$ d. coming the last three days on an improved demand.

We said in closing our last review that the prospect was for "a firm market, with further possible improvement if supplies were not urged upon buyers faster than their wants require."

Unfortunately for the improvement, supplies have been pressed for sale all the month so fast as to preclude advances and at times to bring about small declines to $2\frac{1}{2}$ c. c. & f. The last day's offerings were withheld better, and with Centrifugals 30c. per 100 lbs. below beet parity there is hope of an advance in Centrifugals during the coming month, notwithstanding that statistics thus far received from the Cuba crop indicate a very full outturn.

All Cuba sugars will be needed in the United States before the close of the campaign and at whatever prices below the parity of Javas and Beets that the Cuba planter chooses to ask and wait for.

Java sugars are now held at 10c. per 100 lbs. below Beet parity and 16c. per 100 lbs. above Cubas for summer delivery.

The tariff bill is still under discussion in the Senate, and an active discussion of the sugar schedule is probable about the 20th inst.

The Canadian sugar tariff has been changed in favor of sugar from San Domingo, Brazil and Java in competition with the British West Indies.

The figures for consumption of sugar in the United States -continue to show a good increase, which will continue by reason of increase in population, and prices will follow the course of the raw market. Granulated refined is now quoted at 4.95c. per lb., less 1%.

The outlook is for a steady market with eventual improvement in both raws and refined after some possible shading of prices in instances in the latter.

New York, May 7, 1909.

CARROS PARA CAÑA

De todas
clases

Fabricados
de madera
ó ábero

Dirección
Telegráfica
RAMALIAM

RAMAPO
IRON WORKS

30 Church St.
New York, N. Y

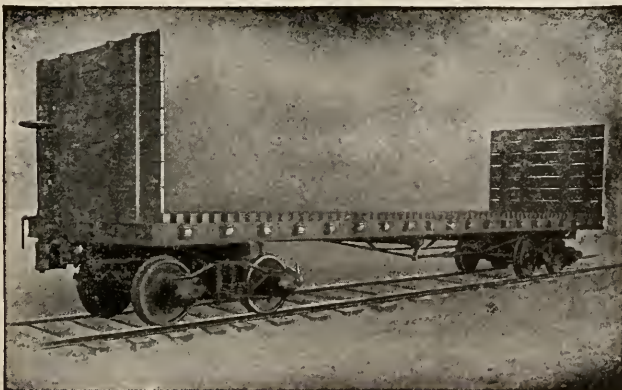

CANE CARS

OF EVERY
DESCRIPTION
OF STEEL
OR WOOD

Cable Address
RAMALIAM

RAMAPO
IRON WORKS

30 Church St.
New York, N. Y.

REVISTA AZUCARERA.

Escrita expresamente para la CUBA REVIEW por Willett & Gray, de Nueva York.

Nuestra última revista para esta publicación estaba fechada el 12 de Abril, en cuya fecha los centrifugas cubanos polarización 96° se cotizaban á 25½ cents, costo y flete, para su embarque en Mayo, á 3.95 cents. la libra para entrega inmediata y embarque pronto. Las cotizaciones ahora son: 3.86 cents. la libra para entrega inmediata y embarque pronto y 2 9/16 cents., costo y flete, para su embarque en Junio (3.92 cents.).

El azúcar de remolacha fluctuó en Europa durante el mes, de 10s 4½d. á 10s. 6d., á 10s. 3d., á 10s. 4½d., á que cerró, ó sea una subida de 1½d. que ocurrió en los últimos tres días á causa de ser mayor la demanda.

Al cerrar nuestra anterior revista dijimos que los indicios eran "de que los precios se mantendrán firmes con tendencia al alza, si la oferta no se hace en mayores proporciones que la que tenga la demanda, es decir, dejando que la demanda se anticipe á la oferta."

Desafortunadamente para el alza, durante todo el mes se han estado forzando las ventas con tal insistencia y rapidez que hicieron imposible el alza, pues por el contrario, á veces provocaron pequeñas bajas que llegaron á 2½ cents, costo y flete. En estos últimos días, las ventas fueron más ventajosas, y con los centrifugas cotizándose 30 cents. menos en las 100 libras que el equivalente de los azúcares de remolacha, hay esperanza de que ocurra un alza en el precio de los centrifugas durante el mes entrante, no obstante acusar los datos ya recibidos de Cuba una producción muy abundante.

En los Estados Unidos se necesitará todo el azúcar de Cuba antes del fin de la zafra, y ésto á los precios que los hacendados quieran pedir y se esperen hasta obtenerlos siempre que sean menores que los equivalentes de los azúcares de Java y de remolacha.

Los azúcares de Java se cotizan ahora 10 cents. menos en las 100 libras que el equivalente de los de remolacha, y 16 cents. más en las 100 libras que los de Cuba para entrega en el verano.

El proyecto de ley reformando el Arancel continúa discutiéndose en el Senado, siendo probable que para el día 20 de este mes se entable una empeñada discusión sobre los derechos que deban pagar los azúcares.

En el Canadá se ha modificado el Arancel para favorecer el azúcar de Santo Domingo Brasil y Java, en competencia al de las antillas británicas.

El consumo de azúcar en los Estados Unidos continúa acusando un buen aumento, el cual seguirá sintiéndose á causa del aumento de población, y los precios seguirán el curso de las cotizaciones de los azúcares mascabados. El refinado granulado se cotiza ahora á 4.95 cents. la libra menos el 1%.

Los indicios son que los precios se mantendrán firmes con alzas eventuales tanto en los precios del mascabado como en los del refinado, después de algunas fluctuaciones pequeñas en los precios de este último en algunas transacciones.

Nueva York, Mayo 7 de 1909.



Copyrighted, 1909.

IT COVERS THE ISLAND'S
INDUSTRIES AND ACTIVITIES

FIFTY CENTS PER YEAR POSTPAID

CABLE ADDRESS: Turnure.

NEW YORK,
64-66 Wall Street.**LAWRENCE TURNURE & CO.****BANKERS**

Deposits and Accounts Current. Deposits of Securities, we taking charge of Collection and Remittance of Dividends and Interest. Purchase and Sale of Public and Industrial Securities. Purchase and Sale of Letters of Exchange. Collection of Drafts, Coupons, etc., for account of others. Drafts, Payments by Cable and Letters of Credit on Havana and other cities of Cuba; also on England, France, Spain, Mexico, Puerto Rico, Santo Domingo, Central and South America.

CORRESPONDENTS:

HAVANA—N. Gelats y Ca.

LONDON—The London Joint Stock Bank, Ltd.

MEXICO—Banco Central Mexicano.

PARIS—Heine et Cie.

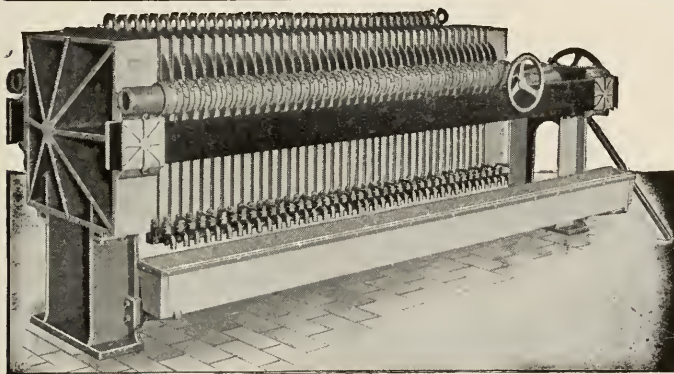

**Prensas de
Filtrar
para Ingenios
SHRIVER
Filter Presses**

Write us for Cata-
logue. Prices and
Information.

T. SHRIVER & CO.
814 Hamilton Street
HARRISON, N. J.

Sole Agents for Porto Rico
McMurtrie-Guiler Co.
SAN JUAN, P.R. and BEAVER BLDG.,
BEAVER STREET, NEW YORK

GENUINE "EWART" LINK-BELT

**and our other approved Chains,
Attachments, etc., described and
illustrated in latest Chain Catalog
No. 75.**

LINK-BELT COMPANY

299 Broadway, New York City

LA ATALAYA

(THE WATCH TOWER) AMERICAN COLONY

The Finest English-Speaking Settlement in Cuba. Located at the South End of the Beautiful Bay of Nuevitas

For the fruit grower or gardener there is nothing on the island to equal it. The soil is a chocolate loam, well watered and well drained. Good well water at 15 to 20 feet. The many wild orange trees demonstrate the adaptability of the soil to citrus fruits. The transportation facilities are without exception far superior to any other Colony in Cuba. We transfer oranges from the dock in the Colony to the Munson Line Steamers for 1½c. to 3c. a box, while other Colonies pay from 15c. to 40c. to get the fruit aboard the boat. The difference means fortunes for large growers at La Atalaya.

The town site is 100 feet above sea level, overlooking the bay. It makes an ideal winter home. The bay furnishes deep sea fishing, the river in the Colony is full of tarpon, the fresh water lake in the Colony swarms with fish, the duck shooting and deer hunting is good, and we have the finest bathing beach in Cuba.

Mr. Saucier, the owner, has sold several hundred acres at \$50 an acre. We are now in charge of the sale of this land, and are selling it at \$25 an acre. As soon as the present allotment at that figure is sold, we will sell as follows: 200 acres at \$30 an acre, 300 acres at \$35 an acre, 400 acres at \$40 an acre, and then the price will be advanced to \$50, \$75 and \$100 an acre. Other Colonies are now selling land at from \$50 to \$100 an acre, and they are not nearly as well located. Here is your opportunity to get land in the best of all locations at a fraction of the price charged by others, and a fraction of what you will pay if you wait and purchase a few months hence.

THE TITLE IS PERFECT, and you get deeds at once.

Special prices to purchasers of 100 acres or more.

1,500 acres in the Colony, good land, and well located, at attractive price.

For further information inquire of Street & Strickland.

We also have other bargains, the following being samples:

No. 390.—4,860-acre CATTLE RANCH. Fenced, and divided into pastures. Large tract of pajilla grass (excellent breeding pasture), and also much guinea grass (finest pasture for fattening). 1,000 head of cattle on the place now can be bought at the market price. The owner has 1,500 more on another ranch that can also be bought. Shipping facilities are the best, 2½ miles to a station on The Cuba R. R. Houses and corrals on the ranch. Price, \$7.25 an acre.

No. 382.—4,000 acres, fine COLONIZATION PROPOSITION, on the main line of The Cuba Railroad, and near the Canadian Colony of Bartle. Unusually well watered and well drained. Some timber. Soil ideal for pineapples, citrus fruit and gardening. Price \$8 an acre

No. 383.—5,000 acres across the Railroad from No. 382, and extending to the through road from Havana to Sanitago, which is being macadamized. Good timber. Soil cannot be beaten. Adjoining Chatham Colony. Land at Bartle and Chatham selling for \$50 and higher an acre. Price, \$8 an acre.

Nos. 382 and 383, taken together, make as fine a colonization proposition as can be found.

No. 401.—100 acres of FINE FRUIT LAND, one-half mile from the nursery of Thomas R. Towns, at Holguin. Price, \$3,000.

No. 387.—11,766-acre TIMBER TRACT. Located in Camaguey Province, midway between the Cuba Railroad and the north coast, and almost on the line of the projected North Coast R. R. Good river for floating the timber to the coast. A conservative estimate of the timber is 5,000,000 feet of mahogany, 5,000,000 feet of cedar, and 30,000,000 feet of valuable native hardwoods. Land will be A 1 for cultivation of cane, tobacco, and fruits when cleared. We consider this the best timber proposition on the island. Price \$4.75 an acre.

No. 399.—40,000-acre SUGAR CANE PROPOSITION. Located on the north coast of Camaguey Province. Enough timber on the land to pay for it. Large river on the land to aid in getting the timber out. Soil very fertile, and adapted to sugar cane, tobacco, citrus fruits and gardening. Price \$3 per acre.

No. 400.—27,000 acres adjoining No. 399. Price \$2.80 an acre. If No. 399 and No. 400 are taken together the 67,000 acres can be bought for \$2.85 an acre.

The above are only a few of the good things on our list

STREET & STRICKLAND

Cuban Land and Investments, Camaguey, Cuba.

Office, Ignacio Sanchez, 8.

P. O. Box 191

CANADA LAND AND FRUIT CO.

LOS INDIOS

Owners

ISLE OF PINES

CANADA AND LOS INDIOS TRACTS

Location: Siguanea Bay. The Deep-Water Harbor of the Island.

We have at our new and progressive town of Los Indios a sawmill, planing-mill, general store, school, hotel, church, post office and nursery, all under the supervision of Americans. A strictly American town.

We also have rowboats and gasoline launch for pleasure parties. Fishing and hunting the best.

We own the finest citrus fruit, vegetable and tobacco land on the island. We offer same for sale in acres to suit purchaser, either for cash or on installments. Special inducements to actual settlers.

Write for prospectus and further information to our general office,
Marinette, Wisconsin.

WILLETT & GRAY, Brokers and Agents

FOREIGN AND
DOMESTIC

SUGARS

RAW AND
REFINED

82 WALL STREET, NEW YORK

Publishers of Daily and Weekly Statistical Sugar Trade Journal—the recognized authority of the trade.
TELEGRAPHIC MARKET ADVICES FURNISHED

PURE
DISTILLATION
OF
SUGAR CANE

BACARDI RON

Sole United States Agent

D. S. de JONGH 128 Water St.

BEST MIXER
FOR
HIGHBALLS
AND
OTHER DRINKS

“SUGAR NEWS FROM CUBA”

is the title of the interesting correspondence from the tropical island, appearing in every issue of “THE AMERICAN SUGAR INDUSTRY AND BEET SUGAR GAZETTE.”

Capable correspondents, in every part of the world, write regularly, covering reliable sugar news for “THE AMERICAN SUGAR INDUSTRY AND BEET SUGAR GAZETTE.”

In the United States, Cuba and Mexico, \$2 per annum. In Foreign Countries, \$2.50 per annum.

Subscribe for it if you want to keep posted. Sample copy free. Send for advertising rates.

Address: BEET SUGAR GAZETTE CO.

No. 5 Wabash Avenue,

Chicago, Ill., U.S.A.

MAGNOLIA

THE COMING AMERICAN CENTER

With best of soil, very favorable location, cheap water transportation right through the colony, good water, perfect title, and plans perfected by experience.

At Magnolia we offer you all the delights possible in the most favored land on earth. Here you can grow the largest crops of the finest quality, and the market is at your door.

We produce a very wide range of crops, which sell at top prices.

Write the Cuba Land and Improvement Company, No. 516-517 The Murray, Grand Rapids, Michigan, for literature and full information.

H A V A N A

CUBA

National Bank of Cuba

Government Depository

Capital, Surplus and Undivided Profits
\$6,000,000.00

HEAD OFFICE, HAVANA

FIFTEEN BRANCHES IN CUBA

New York Agency, 1 Wall Street

COLLECTIONS

THE TRUST COMPANY OF CUBA HAVANA.

Capital
and Surplus \$540,000

Transacts a General Trust
and Banking Business

REAL ESTATE DEPARTMENT

Examines Titles, Collects Rents,
Negotiates Loans on Mortgages

Correspondence Solicited from
Intending Investors

OFFICERS

J. A. Gonzales Lanuza, . . . President
Norman H. Davis, . . . Vice-President
F. J. Sherman, . . . 2nd Vice-President
O. A. Hornsby, . . . Secretary and Treasurer
J. M. Hopgood, . . . Asst. Treasurer

Offices: CUBA 31, HAVANA

The Royal Bank of Canada

INCORPORATED 1869

Fiscal Agent of the Government of the Republic of
Cuba for the Payment of the Army of Liberation

CAPITAL AND RESERVE, \$8,200,000.00

TOTAL ASSETS, . . . \$45,500,000.00

Head Office, MONTREAL

NEW YORK AGENCY, 68 William St.

Branches in Havana: Obrapia 33, Galliano 92;
Matanzas, Cardenas, Manzanillo, Cienfuegos,
Camaguey and Santiago de Cuba.

ESTABLISHED 1844

H. UPMANN & CO. Bankers

TRANSACTION A GENERAL BANKING BUSINESS
CORRESPONDENTS AT ALL THE PRIN-
CIPAL PLACES OF THE ISLAND

Safe Deposit Vaults

Manufacturers of the Famous H. Upmann
Brand of Cigars

FACTORY: Paseo de Tacon 159-163
OFFICE: Amargura 1-3

Established 1876

N. GELATS & COMPANY

Bankers

Transact a general banking
business.

Correspondence at all the prin-
cipal places of the island.

SAFE DEPOSIT VAULTS

Office: Aguiar 108

MOLINA BROTHERS

Customs Brokers

Forwarders, Lighterage and Ship Agents

Officios 52, Havana

HAVANA

United Railways of Havana

Cuba's First and Foremost Railroad. (First Section opened to Traffic in 1837)

Takes you to All Parts of the Island East of Havana Comfortably and Quickly through Varied and Beautiful Scenery and Past Extensive Sugar Plantations

Parlor, Observation and Sleeping Cars attached to principal trains.

Full information and through tickets to all points in Cuba reached via the United Railways of Havana can be obtained of the following:

| | | |
|---------------------------|-----------------------------------|------------------------------|
| Thos. Cook & Son | Ward Line | Southern Pacific R. R. |
| Seaboard Air Line R. R. | Florida East Coast Railway | Mobile & Ohio R. R. |
| Foster & Reynolds | Washington Southern Railway | Raymond & Whitecomb Co. |
| Atlantic Coast Line R. R. | Peninsular & Occidental S. S. Co. | Louisville & Nashville R. R. |
| Illinois Central R. R. | | Munson Line |

LA AMBROSIA

MANUFACTURERS of the well-known brand of Chocolate, "LA AMBROSIA," Biscuits, Macaroni, Bonbons, all kinds of Confectionery

GUAVA PASTE AND EXTRA FINE GUAVA JELLY

ORDERS RECEIVED FOR EXPORT

BALDOE, FERNANDEZ & CO.

Write for quotations.

Sol 21 & 23, Havana, CUBA

'PHONE No. 401

P. O. BOX 741

FERNANDO de CARDENAS

CUSTOM HOUSE BROKER

:: Import and Export Agent ::

Munson S. S. Line Building

Obispo No. 1, Havana, Cuba

JAMES S. CONNELL & SON

Sugar Brokers

Established 1836, at 105 Wall Street

Cable Address—"Tide, New York"

If Cuba doesn't make a go of it this time no one need despair. The United States will be quite willing to untangle her problems and put her on her feet once more.

But the talk of annexation is not getting any encouragement in this country. We have a race problem, and don't need another, and Cuban independence is best for the United States.—Syracuse (N. Y.) Post-Standard.

THE HERRADURA LAND COMPANY

Office: No. 3 Bernaza Street, Habana, Cuba

CAPITAL, \$440,000.00

Own 22,000 acres of land in the Province of Pinar del Rio, suitable for Oranges, Vegetables, Cotton, Corn and Tobacco. The land has all been surveyed and sub-divided into 40-acre tracts and is offered for sale in acres to suit the purchasers, for Cash or on instalments.

We have a new and progressive American town with Railroad Station, Telegraph, Telephone, Stores, Hotel, American School, all within short distance from Havana City.

Titles perfect. Transportation from Havana free for buyers.

WRITE OR CALL FOR INFORMATION.

Telephone 825 Broad

THE MARINE WORKS

Ship Plumbers and Sheet Metal Workers. Manufacturers, Suppliers and Repairers of Steamship Galley and Cabin Utensils; Tanks, Lights and Ventilators. Tinning of every description.

31 Coenties Slip

New York

Journal d'Agriculture Tropicale

Founded by J. VILBOUCHEVITCH
164 Rue Jeanne d'Arc Prolongée.

Subscription, One Year - - - - 20 Francs

Deals with the leading questions of the hour, agricultural and commercial, of interest to tropical countries. International in character. Illustrated. Monthly. Descriptions of machines for tropical crops a speciality. Complete review of new agricultural publications. Commercial part intelligible for every one and always interesting. 150 contributors in West and East Africa, East and West Indies, Java, Mauritius, Central and South America, and throughout the tropical world.

PURDY & HENDERSON, Inc.

Engineers and Contractors

New York Chicago Boston

Cuba Office, Empedrado 32, Havana

HENRY E. BROWN
Pharmacist

Shipping and Export Chemist and Druggist, Ships' Medicine Chests Furnished and Replenished. Prescriptions Compounded by a Graduate in Pharmacy.

Trusses, Surgical Appliances, etc.

Office and laboratory, Room 36.

116 BROAD ST., NEW YORK

Telephone Call: 274-A Hamilton.

JOHN M. DONOVAN

13 Summit St. (Atlantic Dock) - BROOKLYN

Dealer in

Dunnage Mats

FOR BAG FLOUR, BAG AND BULK GRAIN AND GENERAL CARGOES.

—BAGS AND BAGGING—

PASO ESTANCIA—Oriente Province—Cuba

The healthiest and most fertile spot on the island, in the rich valley of the Cauto River 400 feet above sea level.

One of the prettiest spots in Cuba.

Paso Estancia is right on the main line of the Cuba Railroad, only 40 miles from its terminus at Nipe Bay, 39 miles from Santiago.

The soil is rich, dark, sandy loam; no rocks or swamps.

Two hundred acres now under cultivation demonstrate by prolific production the richness of the soil.

A comfortable hotel at **Paso Estancia** accommodates visitors.

Paso Estancia offers the best opportunities in Cuba.

Choice land on easy terms.

Visit there and confirm all we say. You will be well received.

Full particulars from

Cuba Properties Limited

56 Bank of Ottawa Bldg.
MONTREAL

111 German Savings Bank Bldg.
NEW YORK

Paso Estancia
CUBA

THE BIG FOUR ROUTE

3 Daily Trains Each Way 3

Parlor Cars, Sleepers, Dining Cars.

Through Train Service
BETWEEN

Cincinnati, Toledo and Detroit

(Via Michigan Central R. R.)

Ask for Tickets Via

BIG FOUR

BARTLE

Twenty-five thousand acres of the richest and best watered land in Cuba on the main line of the Cuba Railroad, with the finest station on the line, 120 miles from Nipe Bay—the best harbor on the Island; also the nearest to New York. No swamps or insect pests.

BARTLE is not in the wilderness—we offer all the comforts of civilization, GOOD STORES, HOTEL, CHURCH, SCHOOL, SAW-MILL, Etc.

TWO MAILS DAILY.
SUGAR, FRUITS, TOBACCO AND VEGETABLES produce wonderful crops at BARTLE.

When you consider Soil, Transportation, Social, Religious and Educational advantages, BARTLE offers something not to be had elsewhere in Cuba. Write for particulars.

"Ten Days in Cuba," just published by Hon. Nicholas J. Whalen, Speaker of the Michigan Legislature, may be had through newsagents at 25 cents per copy, or will be sent free to any address by the owners of the Bartle Colony. Address, Duncan O. Bull, Gen'l Mgr. Cuban Realty Company, Limited, Temple Building, Toronto, Can., or 141 Broadway, New York City.

DUNCAN O. BULL, General Manager

CUBAN REALTY CO., Ltd. Temple Bldg., Toronto, Canada
141 Broadway, New York Bartle, Cuba

MOBILE, ALA.

HOME INDUSTRY IRON WORKS

Engines, Boilers and Machinery

Manufacturing and Repairing of all kinds. Architectural Iron and Brass Castings. Light and Heavy Forgings. All kinds of Machinery Supplies.

Steamship Work a Speciality

A. KLING, Prop.
JAS. S. BOGUE, Supt.

MOBILE, ALA.

The Principal Hotels in Mobile, Ala.

THE CAWTHON **THE BIENVILLE**
(FIREPROOF) (MODERN)

European, 175 Rooms

European, 150 Rooms

\$1.50 Up

\$1.00 Up

Both Hotels in Heart of City, Facing Bienville Square

OLLINGER & BRUCE DRY DOCK CO.

Ship Builders and Repairers

Operating seven Sectional Dry Docks, capacity 1,000 tons, and one Balance Dock, capacity 3,000 tons. Equipped with Air Plant for operating Pneumatic Tools, and Steam Pump for cleaning vessel's bottoms.

25-TON DERRICK BARGE AND STEAM PILE DRIVER.

Material of all kinds kept on hand. Shipwrights, Caulkers, Painters, Sparmakers and Riggers furnished promptly, and at reasonable rates. Correspondence solicited.

MOBILE, ALA.

BUSINESS FIRMS OF CAIBARIEN

ANGEL MATA

Comerciante.
Caibarién, Cuba.

Apartado 114. Cable: "Mata."

Ferretería, Mueblería y Locería
LA LLAVE

DE INCHANSTI Y HNO.
Caibarién, Cuba.

Marti 11 y 13. Apartado 24.

R. CANTERA Y CA.

(S. en C.)

Comerciantes Importadores,
Escobar 28. Caibarién.

A. ROMANACH

Almacenistas Importadores de Viveres,
(S. en C.)
Caibarién.

P. B. ANDERSON,

Ship Broker. U. S. Consular Agent,
Caibarién, Cuba.
Agent for Munson Steamship Line and Lloyds.

MARTINEZ & CO., S. en C.

Comerciantes Banqueros,
Importadores de Viveres,
Exportadores de Azucar.

Apartado 115. Telegrafo: Urquiza.

COMERCIO,
Hotel - - Restaurant - - Cafe
De José Urquiza.

Calle de Marti num 16 y 18 - - Caibarién

LA MARIPOSA DE EVARISTO BERGNES

Importador de Peletería y Talabartería, Fabricante
de Calzado.
Caibarién.

Apartado 104. Telegrafo: "Bergnes."

YMAZ Y CA.

Ymportadores de Ferreteria en General.
Apartado de Correos Num. 15,
Caibarién, Cuba.

Calle Justa Num. 27. Cable: "Imaz."

ARIAS Y COMP

Provisiones, Loza y Mueblera.
Cuba Num. 20, Esquina a Marti,
Caibarién, Cuba.
Correo Apartado Num. 15. Telegrafo: "Arias."

ZARRAGA Y CA.,

Caibarién, Cuba.
Casa Banca. Exportadores de Azucar.

BONIFACIO DIAZ,

Gran Peletería y Sombrereria.
Marti 17. Caibarién
Constantes novedades en los dos giros de esta casa.

RODRIGUEZ Y VINA, S. en C.,

Almacenistas Importadores de Viveres en General,
Comisiones y Consignaciones,
Consignatarios de Buques.
"Depositos de Carburo."

Telephone, 33 Hamilton
Night Call, 411 Hamilton

Cable Address:
"Abiworks," New York

Atlantic Basin Iron Works

Engineers and Boiler Makers

Machinists, Plumbers, Tinsmiths, Pipe Fitters, Blacksmiths, Coppersmiths,
Pattern Makers, Sheet Iron Workers, Iron and Brass Castings. Steamship
Repairs a Specialty.

Cor. Imlay and Summit Streets

Brooklyn, N. Y.

John Munro & Son

Steamship and
Engineers' Supplies

13 Conover Street, Brooklyn, N. Y.

Cable Address: Kunomale, New York

Telephone, 196 Hamilton

Telephone
215 Hamilton

Box 186
Maritime Exchange

YULE & MUNRO SHIPWRIGHTS

Caulkers, Spar Makers

Boat Builders, Etc.

No. 9 SUMMIT STREET
Near Atlantic Dock BROOKLYN

WINTER HAVEN NURSERIES

A. M. KLEMM, Proprietor

Established 1884.

Winter Haven, Fla.

Wholesale Growers of Citrus Stock of the best commercial varieties. We guarantee our extensive Stock to be well grown, free of insects and true to name.

Silver Cluster Grape Fruit our leading Specialty.

Prices right. Grading and Packing perfect.

Write for Catalogue.

CUBA INFORMATION

IS THE TITLE OF A BOOK WHICH GIVES DEFINITELY and concisely just such information concerning Cuba as is desired by the business man or prospective investor who is interested in this fertile island—*climate, soil, products, fruit growing, live stock, tobacco, sugar, customs duties, banking, investments, colonies, land titles, laws, and a hundred other matters.*

SEND 25 CENTS FOR A COPY

and if you want any specific information that could not be covered in such a book,

Ask Mr. Foster No. 1 Madison Avenue, NEW YORK

Mr. Foster also has information offices in Philadelphia, Washington, Atlantic City, Jacksonville, St. Augustine, Daytona, Palm Beach and Miami, Florida, and in Havana and Camaguey, Cuba. FREE INFORMATION—no fees ever asked or accepted.

The Standard Guide to Cuba—

Reliable—accurate—maps—illustrations.

50 cents.

FOSTER & REYNOLDS, 1 Madison Avenue, New York.

BUSINESS FIRMS OF SANTIAGO

E. GIRAUDY & CA.

ALMACEN DE VIVERES

Marina baja n. 33, Santiago de Cuba.

Agentes de Schlitz Beer.

JULIAN CENDOYA

Steamship Agent and Broker

COMMISSION MERCHANT

CABLE: Cendoya. Santiago de Cuba.

VALLS, RIBERA & CA.

(S. en C.)

Importadores de Ferreteria y Machinery.

Telégrafo: Valribe.

Santiago de Cuba y Manzanillo.

A. B. C. Code, 5th Edition. Telephone, 190.

P. O. Box, 95. Cable address: SILVAPA.

SILVA Y PARRENO H.

General Commission Merchants.

Custom House Brokers—Forwarding Agents.

Consignees of the Cuban steamers of the Carlos J.

Trujillo, S. en C., Line, formerly Menéndez & Co.

References:—J. Cendoya and Nat'l Bank of Cuba.

CAMP HERMANOS, Santiago de Cuba.

Ron Selecto "Golondrina" y "Carta Cuba."

Medalla de Oro, St. Louis, 1904.

RON BACARDI

DE BACARDI & CO., Distillers, Proprietors.

43 San Ignacio, cor. Santa Clara, Havana,

Santiago de Cuba.

LARREA Y BESEALIE

Importers of General Groceries and Exporters of

Cocoa, Wax, Honey and Woods.

Apartado 65, Marina Baja 46. Cable: Larrea.

Importación.

Exportación.

L. ABASCAL Y SOBRINOS

Agentes de las líneas Pinillos Izquierdo y Ca., de

Cadiz. Larrinaga y Ca., de Liverpool. Compañía

de Seguros, Aachen & Munich, Aix-la-Chapelle.

BROOKS & CO.

Bankers and General Commission Merchants.

Santiago and Guantánamo.

VINEGAR BEND LUMBER CO.

Manufacturers and Exporters

Long Leaf Yellow Pine Lumber and Timber

Cuban Business Our Specialty VINEGAR BEND, ALA., U. S. A.

Daily Capacity, 200,000 Feet

Cable Address: "TURNER"

Codes: A B C, Fourth Edition; Southards; Watkins; Western Union



SOBRINOS DE BEA & CO.

Bankers and Commission Merchants
Importación directa de todas los centros
manufactureros del mundo.

Agents for the
Munson Steamship Line, New York and
Mobile.

James E. Ward & Co., New York.
Serra Steamship Company, Liverpool.
Vapores Transatlánticos de A. Folch & Co.
de Barcelona, España Independencia
Street 17/21.

MATANZAS, CUBA.

JOHN W. McDONALD

COAL, WOOD, LUMBER
and TIMBER of Every
Description

112 WALL STREET

Near South Street NEW YORK

Yard: 58-68 Beard Street, Erie Basin

Telephones:

Office, 1905 John Yard, 316 Hamilton

The World Watching Cuba.

The eyes of the world are upon Cuba and the time given by the prophets as to when she will again be in the throes of a revolution extend from six months to three years.—Cincinnati (O.) Com. Tribune.

"The Comfortable Way"

Between the East and the West is
via the Toledo, St. Louis and
Western Railroad

"Clover Leaf" Route

Rates lower than by any other
direct line. Send four cents in
stamps for copy of "Get Out or
Get in Line," a booklet by Mr.
Elbert Hubbard, Chief of the Roy-
crofters.

GEO. J. CHARLTON,
General Passenger Agent,
Chicago, Ill.

THE SNARE AND TRIST COMPANY

CONTRACTING ENGINEERS

Steel and Masonry Construction
Piers, Bridges, Railroads and Buildings

We are prepared to furnish plans and estimates
on all classes of contracting work in Cuba.

N. Y. Office

Havana Office

143 LIBERTY ST.

LA LEAL BUILDING

W. H. Bennett

F. W. Hvoslef

Bennett, Hvoslef & Co.

18 Broadway, New York

Steamship Agents and Ship Brokers

Cable: "Benwalsh"

Munson Steamship Line

GENERAL OFFICES

82 BEAVER STREET, NEW YORK

NEW YORK-CUBA SERVICE PASSENGER AND FREIGHT

| Steamer | New York | Nipe | Nuevitas | Nipe | Banes | Gibara and Vita | Pto. | Nuevitas | Nipe | New York |
|-----------------|----------|--------|----------|--------|--------|--------------------|---------|----------|---------|----------|
| | Sail | Arr. | Arr. | Arr. | Arr. | Arr. | Arr. | Sail | Sail | Arr. |
| Curityba | May 19 | | May 24 | May 26 | May 28 | May 29 | | June 3 | June 4 | June 9 |
| Olinda | June 2 | June 7 | June 9 | | | June 12 | June 15 | June 17 | June 18 | June 23 |

Steamers sail from PIER 9, EAST RIVER, foot of Old Slip, New York

SAILINGS SUBJECT TO CHANGE WITHOUT NOTICE

FREIGHT ONLY

NEW YORK TO CAIBARIEN, MATANZAS, CARDENAS AND SAGUA

MOBILE-CUBA SERVICE

FREIGHT ONLY

REGULAR SAILINGS—MOBILE TO HAVANA—MOBILE TO N. S.—S. S. CUBAN PORTS.

BALTIMORE-COLON SERVICE

FREIGHT ONLY

REGULAR SAILINGS—BALTIMORE TO COLON

AGENTS IN CUBA

ASMUS LEONHARD

Cuban Freight and Passenger Agent

76 Cuba Street, Havana

| | |
|-------------------------|-----------------------------|
| BERNABÉ SANCHEZ É HIJOS | Nuevitas |
| FRANCISCO PLA | Puerto Padre |
| BEOLA & CO. | Gibara |
| M. J. CABANA | Camaguey |
| J. L. DAUTERIVE | Antilla (Nipe Bay), Oriente |

For Southbound reservations address the General Offices, New York
For Northbound reservations address the agent at the port of embarkation

Lillie Multiple Evaporators

Model of 1904-1905 (Patented)

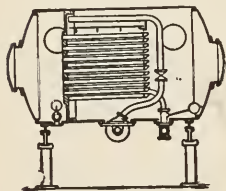

Model 1904-1905
ECONOMY its BOAST

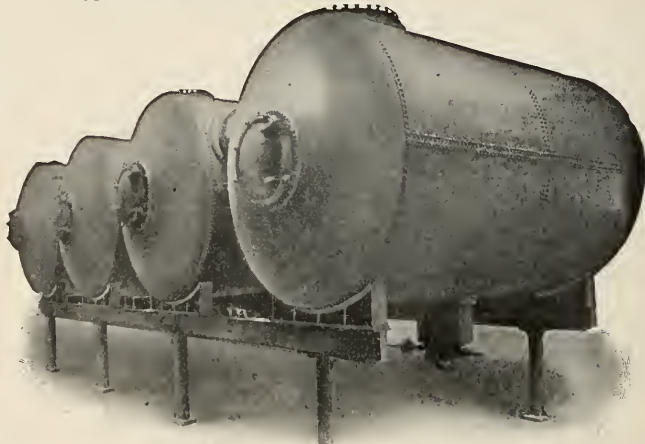

Lillie Quadruple effect for Nipe Bay Co., Cuba (Model 1904-1905. Condensers not shown.) Capacity, 600,000 gallons cane juice per 24 hours.

Apply for reading matter and information to

The Sugar Apparatus Manufacturing Co.

328 Chestnut St., Philadelphia, Pa.

S. MORRIS LILLIE, President.

LEWIS C. LILLIE, Secretary and Treasurer

BALDWIN LOCOMOTIVE WORKS

Broad and Narrow Gauge

Single Expansion and Compound

LOCOMOTIVES

Compressed Air Locomotives. Electric Locomotives with Westinghouse Motors

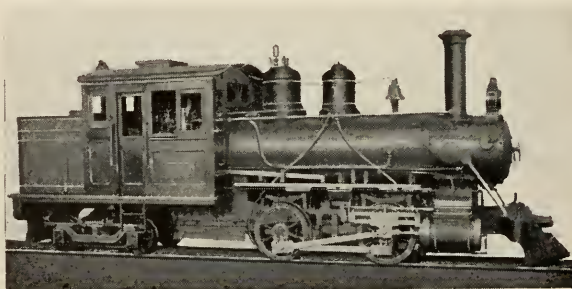

PLANTATION LOCOMOTIVES

For all Gauges of Track. To meet all conditions of service. Specifications furnished on application.

BURNHAM, WILLIAMS & CO.

Philadelphia, Pa., U. S. A.

Cable Address: "Baldwin, Philadelphia"

Agents for Cuba, Krajewski-Pesant Co., Aguiar 92, Havana, Cuba.

THE CVBA REVIEW



50 Cents A Year JUNE 1909 5 Cents A Copy
Published by the Munson Steamship Line-82-92 Beaver Street New York City

Ceballos "The Garden Spot of Cuba"



*A CEBALLOS Orange Grove three years from planting.
The best three-year-old Grove in the World.*

The TIME to invest in Cuba is now The PLACE is in the "Garden Spot," Ceballos
The OPPORTUNITY is offered by the Development Company of Cuba, owners of Ceballos

Write for information to

Geo. H. Gillett, Secretary, 43 Exchange Place, New York

"PRATT IMPERIAL"

Sugar Cane Machinery and Evaporating Apparatus.
Complete Plants Erected and Delivered to Owner Under
Guaranteed Capacity of Mills and Quantity.
Sugar House Pumps.

We have nearing completion for June Shipment one 34" x 72" Pratt "IMPERIAL" Mill Complete, with Hydraulics, Compound Gearing & Corliss Engine, also one 26" x 72" Pratt "IMPERIAL" Cane Crusher, complete with Hydraulics, Compound Gearing and Corliss Engine. For description see page 34.

STEAM PUMPS

SPECIAL PARTS of MACHINES, any size or kind; and
HEAVY CASTINGS famous for quality.

We maintain Export Sales Offices at 80 Wall St., New York, in charge of Mr. N. A. Helmer, an eminent Sugar Mill Engineer of wide experience. We solicit your business with the assurance of every courtesy and perfect satisfaction.

Pratt Engineering & Machine Co. ATLANTA, GA.
U. S. A.

Successors to FULTON FOUNDRY & MACHINE WORKS, Atlanta, Ga.

Tivoli Beer

—*Enough said.*

Havana Brewery

Havana

BUCKEYE NURSERIES

M. E. GILLETT, Proprietor

TAMPA, FLORIDA, U. S. A.

ORANGE, LEMON AND GRAPE FRUIT TREES

LARGEST CITRUS NURSERY IN THE WORLD

QUALITY VARIETY DELIVERY

Price may be forgotten—Quality NEVER.

We grow nothing but standard Varieties which we can recommend to the trade as Money-Makers. Having had 29 years' experience we thoroughly understand packing trees for long distance shipments.

We guarantee our trees to be True to Name, Free from White Fly and to ARRIVE AT DESTINATION IN GOOD CONDITION.

Consider the future and protect your investment by planting reliable trees from

THE BUCKEYE NURSERIES

La Gloria has Arrived. All other American colonies in Cuba have yet to come.

La Gloria has Better soil, climate, water, schools, docks, cheaper transportation, living, more American people, push and natural advantages.

The Oldest, Largest and Best American Colony.

First Prize for citrus fruits Havana Exposition, 1908.

The La Gloria Transportation Company's fine mail and passenger steamer connects with Munson Line steamers at Nuevitas. Sailings Tuesdays, Thursdays and Saturdays.

Boulevard Completed. The Cuban Government has completed a fine macadamized boulevard from the townsite to Port Viaro, costing \$80,000.

La Gloria is All its Name Implies.

Not a promoter's dream but an assured fact. Our West Canasi tract, just opened, is the finest orange land in Cuba. We have also a few choice town lots for sale.

Send for our new booklets showing pictures of homes and plantations, and giving terms and conditions.

Cuban Land and Steamship Company

32 Broadway, New York City

OF VALUE IN CUBA

Dixon's Silica Graphite Paint. Protects all iron work from rust and destruction. Equally useful for wood or metal.

JOSEPH DIXON CRUCIBLE CO.

Jersey City, N. J.



Sugar Plantation—Cuba Railroad.

The Cuba Railroad

This new line completing the railroad connection between Havana and Santiago, and Antilla, on the Bay of Nipe, is of standard gauge and similar in its construction and equipment to the better class of northern lines. All of its important bridges are of steel and masonry, and the line generally is rock-ballasted. The main line passes along the center of the eastern and wider half of Cuba, and opens up a matchless and most picturesque agricultural region, and passes through the tropical forests of mahogany, cedar, lignum vite, ebony and many other trees, hung with vines and millions of orchids. Palm trees of magnificent aspect and great variety abound everywhere. The famed Parana and Guinea grasses, covering most of the open districts and standing from six to twelve feet high and green the year round, together with frequent running streams, make this an ideal cattle country. No food has to be put up and no shelter is required. The rich soils everywhere are adapted to sugar, tobacco, cotton, corn and an endless variety of products. The swamps which occur at places along the coasts of Cuba are absent from the interior, which is high, dry and exceptionally healthy. The trade winds blow across Cuba every day, and bring to all parts fresh sea air; the extreme heat of northern summers is consequently unknown and the humidity of other tropical countries is also unknown.



A Corridor, Hotel Camaguey.

The Cuba Railroad Company's **Hotel Camaguey**, at Camaguey (formerly Puerto Principe) is by far the most popular resort in Cuba, Spanish in style, and provided with bath rooms and other modern conveniences, and is first-class in all respects.

This old city has about 40,000 inhabitants, is picturesque and is situated in a beautiful and remarkably healthy district. The hotel is especially favored by those wishing to spend some weeks or months in a matchless sub-tropical climate.



Map of The Cuba Railroad.

THE CUBA REVIEW

"ALL ABOUT CUBA"

An Illustrated Monthly Magazine, 82-92 Beaver Street, New York

MUNSON STEAMSHIP LINE, Editors and Publishers

SUBSCRIPTION

50 Cents Per Year - - - - - 5 Cents Single Copy
Advertising Rates on Application

Vol VII.

JUNE, 1909

No. 7

Contents of This Number

The cover illustration is of a beautiful scene at La Atalaya. The old watch-tower of Nuevitas Harbor is now the site of a promising American colony.

Government matters on pages 7 to 13. There is much important news from the Island just now and our readers should diligently study these pages. Havana's sewerage works, the proceedings of the Cuban congress, the annulment of various wireless concessions, and important improvements at Sagua, are all described.

Some interesting information as to how Cuba guards against yellow fever and other diseases, and investigations of the President of the Louisiana State Board of Health, are given on page 12.

Cuba's financial condition is now attracting the world's attention. The budget for the coming year is nearly seven millions in excess of the last budget under Gov. Magoon. Why this is so is told on page 13.

Some Cuban comment on matters in the Island, with some characteristic cartoons, on pages 14 and 15.

Comments of the United States press, with cartoon, will be found on pages 16 and 17.

The growth of Havana's suburbs is described and handsomely illustrated with some fine specimen residences on pages 18 and 19.

Railroads and financial matters are discussed on pages 20 and 21. There are important Cuban Railway reports of earnings and the official statement of the Secretary of the Treasury to April 30. Further railway reports and some commercial items on page 22.

Cuba encourages new industries, and conditions governing new enterprises, together with an item on increased duties on beef, mutton, etc., on page 23.

Various interesting items on labor differences: How Mrs. Palma's home in New York State was saved, and a new idea for the disposal of the wreck of the Maine, on pages 24 and 25.

Isle of Pines notes, with an illustration of a colonist's home, on page 26.

Agricultural notes begin on page 27. There are many valuable items of great interest and help to our readers in Cuba, and these, together with the numerous illustrations, should be carefully studied.

The monthly Sugar Review, by Messrs. Willett & Gray, the well-known authorities, will be found on pages 31 and 32. Nearly 1,400,000 tons are in sight.

Many Beautiful Illustrations.

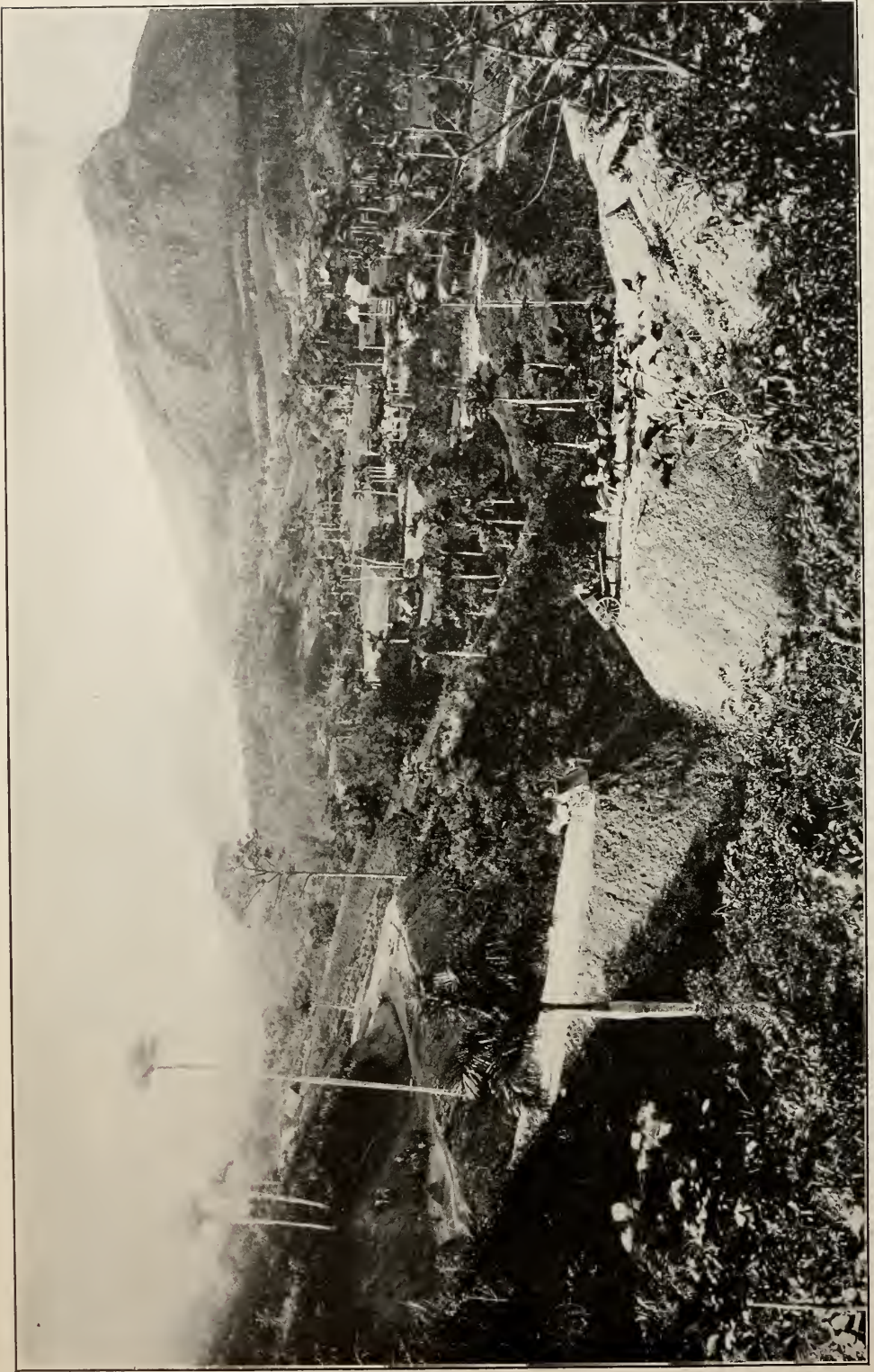

Modern Road Making in Cuba. A magnificent highway now almost completed in Pinar del Rio Province. Note the fertile patches of cultivated land in the bottoms. The old means of transport was by pack train.
Courtesy of the Scientific American.

THE CUBA REVIEW

LIBRARY
NEW YORK
BOTANICAL
GARDEN.

"ALL ABOUT CUBA."

Copyright, 1908, by the Munson Steamship Line.

Volume VII.

JUNE, 1909.

NUMBER 7.

GOVERNMENT MATTERS.

The Cuban Treasury Exhausted—Consular Changes—Supreme Court Appointments —Sagua Improvements, Etc.

The Cuban Treasury. Señor Diaz de Villegas, Secretary of Finance, declared May 7 that the treasury was exhausted, there having been only \$300,000 in cash on hand at the end of last month, most of which will be required to pay the police and meet a few sundry emergencies, but according to his calculation the revenue will amount to \$26,000,000 this year, adding \$2,000,000 from the lottery, if that is established, and \$1,000,000 from the various municipalities. He thinks some taxes may be cut down and others more rightly increased, but considers it unnecessary to impose new taxes, remarking that industry, agriculture and commerce show encouraging prospects. The coming fiscal year's budget is estimated at \$29,000,000, an increase of \$5,000,000 over the previous year. Three millions are for the permanent army, recently organized, one million is to care for the first installment of the public debt, due in April next, and one million goes to the departments of Justice and Sanitation.

The Lottery Bill Passed. The national lottery bill was passed by the House May 12, 53 to 20, those voting for the measure belonging to all political parties. The first eight articles of the bill were discussed, and the remainder will be taken up at the next session.

The general terms of the project, from which the government expects to draw an annual revenue of from \$1,000,000 to \$2,000,000, call for three drawings monthly. The number of tickets and the

amount of prizes are to be left to the discretion of the Secretary of the Treasury.

Supreme Court Appointments. Announcement was made May 20 that the three vacancies existing in the bench of the Supreme Court would be filled by the appointments of Aurelio Hevia, Joaquin Demestre and Juan Gutierrez Quiros.

The retirement of justices now seventy years old and in future those above sixty is in contemplation.

Arturo Hevia was sub-secretary of justice during the Palma administration. Juan Gutierrez Quiros is now fiscal of the criminal branch of the Audiencia of Havana, and Joaquin Demestre is at present a judge. The two latter have not been identified with politics, but Hevia was General Menocal's campaign manager for President of Cuba.

Consular Changes. President Gomez has sent to Congress a message recommending the appointments of ministers at Chile, Brazil, Uruguay and Argentina. The appointment of a minister to Norway is also recommended.

The fact that Congress has not been consulted in these matters has excited surprise. The present budget does not contain any appropriations for these posts, nor is there a law authorizing them, but the Department of State maintains that the President can go ahead and make the nominations and leave the question of authorizing the new legations

JUN 21 1909

to the new budget law which has been prepared and will go to Congress shortly.

The nominations are. Cesar Pinto, transferred from Belgium to the Republic of Argentine; Francisco Zayas Alfonso from Antwerp to Brussels; Manuel Marquez Sterling from the Argentine Republic to be minister resident to the United States of Brazil.

Mariano Aranburu Machado, nominated minister resident to Chile. Benjamin Giberga, formerly consul-general at Shanghai, and acting chargé d'affaires, recently transferred as consul-general at Montevideo, to be minister resident in the republic of Uruguay, and Ainceto Valdivia to be minister resident to Norway. It was expected that the latter was to be sent to Rome. The legation which the President requested has been already approved by the Senate.

May 20th
Celebration. The seventh anniversary of the establishment of the Cuban republic in 1902 was celebrated with more than the usual enthusiasm on May 20. The principal event was the review at Columbia by President Gomez of the new army. Four thousand infantry and cavalry paraded, under command of General Pino Guerra. They presented a fine appearance.

Former Governor Magoon cabled his congratulations on the success of the new Cuban government, which act of thoughtfulness was very generally appreciated. The public was entertained at the palace by Mrs. Gomez and her daughters.

Wireless
Concessions
Annulled.

May 5 President Gomez signed a decree annulling the concession granted the United Fruit Company, by a decree of the Provisional Governor, to erect a wireless station at Cape San Antonio. It is understood that the company has already expended a large sum on the work, as the permission was granted in September, 1907.

President Gomez has also annulled the privilege conceded the De Forest Wireless Company to operate a wireless station in the Vedado.

Señor Castellanos, the President's private secretary, gave as a reason for these decrees that it is the policy of the government to hold wireless telegraphy a government function, and that privileges granted by President Palma and Governor Magoon were revocable at any time. The government wants its own wireless installation, and will not tolerate any other wireless stations within the territory of the republic.

The beginning of some public works at Nuevitas is asked for to afford employment to many who are now idle owing to the sugar mills having finished grinding. The President will communi-



Senor Martin Morua Delado, Presidente del Senado de Cuba y Senador por la Provincia de Santa Clara.

The President of the Cuban Senate and Senator from Santa Clara Province.

cate with a firm which long since proposed to build a railroad in that section.

English
Tuition
Praised.

"La Escuela Moderna," published on April 30, devotes three pages exclusively to the teaching of English in the public schools of Cuba under the provincial supervisor, Miss Abbie Phillips. It says: "The teaching of the English language in the public schools of the city and province of Havana during the past two years has obtained a high grade of progress under the intelligent supervision of Miss Phillips. The practical-objective method adopted in October, 1908, has given excellent results. The attractive manner and the professional spirit in which this method has been presented has won the co-operation of all the teachers and pupils, who have come to regard the English work of the schools as sessions both as an advantage and a pleasure.

"In the system taught in the public schools the child is compelled to describe each action in English during the first year, and has at the end of that time acquired a vocabulary of from 1,000 to 1,500 words."

New Post Offices.

A money order department has been added to the post office at Yara, Oriente Province.

Post offices have been established at Playa de la Esperanza, Pinar del Rio Province, at Mayajigua and at Aguada de Pasajeros, Santa Clara Province.

THE CUBAN CONGRESS.

SESSION OF MAY 3.

Bill on subsidizing railways referred to the Committees of the Treasury, Budget and Codes.

Bill soliciting an appropriation of \$6,000 as contribution to the Second Cuban Medical Congress was referred to the Treasury Committee.

SESSION OF MAY 5.

It was agreed to ask the Executive for all the data referring to the construction of a bridge over the Almendares River.

SESSION OF MAY 10.

Reading of the report of the Committee on Military Affairs favorable to the Bill approved in the Chamber creating three offices of dentists of the permanent Army, with the rank of Captain and Lieutenant.

Reading of various messages from the Executive, among them one soliciting an appropriation of not less than \$100,000 to buy in Washington a house for the Legation of Cuba.

SESSION OF MAY 12.

Bill ordering that horses, beef cattle, sheep, goats and hogs, pay 3c. per kilo on entering Cuba, to favor national stock-raising and its industries. It was referred to the Committees of the Tariff and of the Treasury. Under Governor Magoon the duty was $2\frac{3}{4}$ cents per kilo.

Reading of the Report of the Committee of Agriculture favorable to granting a credit to find remedies for the coconut palm disease.

SESSION OF MAY 14.

Message from the Executive transmitting the regulation by which cock-fights were governed. It was referred to the Committees on Social Reforms and Codes.

Motion of Mr. Gonzalo Pérez to solicit from the Executive the sending of a report about the contract for sewers and pavements in Havana, and to learn to what extent and with what powers it had been modified by the Secretary of Public Works. Such modifications, it was contended, were illegal, Congress having power exclusively to make changes. The motion was carried.

SESSION OF MAY 15.

A bill to divide municipal judges into three classes and to provide salaries instead of fees which have long been deemed excessive and oppressive on people of small means. A bill on the same date removes the four-year renewal clause for justices of the Audiencia. It tends to their protection as under the new Judiciary law they are susceptible to removal every four years.

SESSION OF MAY 3.

Bill granting an appropriation of \$11,000 for the construction of the Aqueduct at Songo, Oriente Province. Referred to the Committees of Public Works and of the Budget.

An appropriation of \$2,385 for the purchase of X-ray apparatus for the Mercedes Hospital, was approved.

SESSION OF MAY 5.

A bill was introduced making an 8-hour day for employees of the State, the Province, and the Municipality. It was voted down and the report disapproved.

A report of the Committee of Public Instruction, unfavorable to the Bill that made the reading of the Constitution obligatory in the schools, was approved.

A Bill prohibiting the circulation of tickets, badges or medals, in place of wages, was approved.

The preamble of this bill says that "over \$2,000,000 of these pay checks and medals are paid to laborers, which are exchangeable only at the stores within the confines of the mill or farm at discounts amounting to from 10 to 40 per cent."

A Bill creating a commission for liquidating the Army Debts was referred to the Auditing and Treasury Committees.

SESSION OF MAY 7.

A Bill to qualify for trade the ports of Esperanza and Colonia, in the Province of Pinar del Río, was referred to the Committee of Agriculture, Industry and Commerce.

SESSION OF MAY 10.

A Bill authorizing the Executive to effect a loan of \$2,500,000 for public works in the provinces, was referred to the Committees of the Treasury, Budget and Public Works.

A Bill conceding an appropriation for the construction of five kilometers of highways (wagon roads) between Santa Rita and Jiguani, from Bayamo to Baire, was referred to the Committee on Public Works.

SESSION OF MAY 12.

Debate on Lottery Bill continued. Representative Colloro made the statement that the last American intervention brought about the economic trouble which made such expedients at the National Lottery necessary for revenue purposes.

A Bill appropriating \$75 monthly for José Maceo, son of Major General José Maceo, for his education, was referred to the proper committee.

SESSION OF MAY 15.

Amendment offered that 10 per cent. of the net proceeds of the lottery be devoted to fighting tuberculosis.

A bill to establish a sanitarium for consumptives at Sierra in Cienfuegos was referred to the proper committee.

A Bill increasing by 600 men the Rural Guard Corps was referred to the Committees of Military Affairs and Treasury and Budget.

The debate on the Lottery Bill opened. Mr. Martínez Ortiz spoke against the establishment of the Lottery, saying that to obtain a problematical revenue of \$3,000,000, they were going to draw \$10,000,000 from the country.

Havana's Sewerage Works. Senor Lagueruela, Secretary of Public Works, on May 12 called on the Superintendent of Sewerage and

Paving for the city for an explanation of the report that works are being carried on as if Havana were a city of two million inhabitants, whereas provision for six hundred thousand would be enough. Expenditure would go as high as \$20,000,000 if the present plans are carried out, he said, instead of the \$16,000,000 originally estimated.

The tunnel under the Cabañas hill to carry the sewer pipe which will be the outlet for the sewer system to be constructed for the city of Havana, is now under way.

The tunnel starts at Casa Blanca and going under the Cabañas hill will reappear on the shore side where the sewer pipe will continue out to sea.

Under the plans the city's refuse is all to be taken across the bay to Casa Blanca where a pumping station is to be installed. To carry the refuse to a place along the shore where it will not return, the tunnel was planned.

An Important Decision. That merchants need not pay storage charges to the Government, when they pay these charges to private owners of the stores, is the decision of the Secretary of the Treasury of Cuba, who on May 7, in order to protect the merchants and to facilitate the discharging and warehousing of merchandise, ordered that merchants depositing their goods in private custom warehouses (such as the San José and others) shall not pay to the State storage charges as heretofore has been the custom. These charges will only be incurred by goods deposited on wharves and in warehouses which are the property of the Government.

R. Winthrop Pratt, chief engineer of the Ohio State Board of Health, has been appointed by the Cuban Board of Public Works as director of sanitary engineering for the island of Cuba. The salary is \$4,000.

Envoy to South America.

General Loinaz del Castillo has accepted the appointment as Cuban Envoy Extraordinary in South American countries, succeeding General Ruis Reveia, an appointee of ex-President Palma. Congress has not yet approved the selection. It is expected that the General will visit all these countries, the tour to take about two years and that an appropriation of \$40,000 will be made to cover the costs.

The State Department has just been officially informed of the proposed tour of South America by General Loinaz Del Castillo. The general will be accompanied by two aides, including one of President Gomez's sons. President Gomez has asked the Congress for \$40,000 for the trip. The State Department does not look upon this venture with much favor. General Castillo is anti-American, and may do the United States irreparable harm in Latin-America.

Governor Magoon's Work Praised.

President Taft in a message to Congress on June 5, praised Governor Magoon's work in Cuba and that of the American Army. He said:

"The administration by Gov. Magoon of the Government of Cuba from 1906 to 1909 involved the disposition and settlement of many very difficult questions and required on his part the exercise of ability and tact of the highest order. It gives me much pleasure to note in this public record the credit due to Gov. Magoon for his distinguished service.

The hearing of the appeal of Sergeants Francisco and Vicente Cortes of the rural guard, who were sentenced to death as leaders of the Taguayabon revolt, came before the supreme court of Cuba on June 2 and was denied.

Their appeal was based against Article 10 of the Military Penal Code, which the counsel claimed was unconstitutional, as it sentenced them to death for a political crime. President Gomez must now make a decision but it is generally believed that Sergeant Cortes and his son will not be shot, for public opinion strongly favors a commutation of the death penalty. There has not been a single case of shooting a political offender since colonial days.

A commission composed of Messrs. John R. Stanley, Rafael Rodriguez, Cal Pablo Guerrin and José Trujillo are trying to obtain a subsidy for an electric line from Cienfuegos to Manicaragua, opening up the rich Manicaragua Valley.



Scene at Isabella de Sagua, the port of Sagua la Grande on the north coast, and one of the streets. Important improvements are under construction here.

*An
Important
Work.*

The deepening of the Sagua river inaugurated May 2 is vitally necessary, for floods cause devastation in the entire district because the present channel cannot properly discharge the accumulated waters in the rainy season. The floods have been an annual occurrence and a great and populous section made practically impassable. This section extends north and south of the main line of railway for leagues. Houses have been washed away, stock drowned and the beautiful steel bridge built high over the water damaged at such times.

Serious sicknesses have usually followed the subsidence of the waters, and the government has been compelled to restore towns to former sanitary conditions. When the improvements are completed deep draught vessels can steam to the city itself.—Havana Post.

The work of dredging the port of Isabella de Sagua will be done by the Department of Public Works and not by private contract. The estimated cost is \$1,000,000.

Senor Pablo Soler of Guardiola succeeds Senor Ramon Gaytan de Ayala as Spain's representative to Cuba.

President Gomez has authorized the organization of the Cuban Red Cross Society, which will be so organized as to conform to the Cuban laws. It was founded about three months ago.

For the purpose of facilitating the work of shipping between Norfolk, Va., and Cuba, business men and shippers are circulating a petition asking the Cuban government to establish a consular office in Norfolk. At present it is necessary to make a trip to Newport News when such consular business is to be transacted.

The Cuban cabinet adopted a resolution May 6 joining with other Pan-American countries in asking that the Nobel Peace Prize be awarded the next time to United States Senator Elihu Root as a recognition of his services in behalf of peace while Secretary of State.

New telegraph offices have been opened in Havana at the Hotel Pasaje, Hotel Sevilla and several other places.

Messages will be taken for any part of the city at the rate of one cent per word, with a minimum charge of 10 cents.

How Cuba Guards Against Yellow Fever.

Dr. J. Harvey Dillon, president of the Louisiana State Board of Health, with Dr. Hamilton P. Jones, State Chemist, and an acknowledged expert on yellow fever, recently returned from a sanitary inspection of Cuba.

The trip was undertaken, says the New Orleans Picayune, because of the repeated rumors of yellow fever in the island and that a Cuban physician had written a series of postal cards to the president of the Louisiana State Board of Health, to the New Orleans Board and to the newspapers, stating that there was yellow fever in the island. Among the first things the doctors did on their arrival in Havana was to call upon the signer of the postal cards, Dr. Fernandez de Ybarra. "We found," said Dr. Dillon, "that he had formerly held office in the Health Service and was disgruntled, and our subsequent investigations convinced us that his statements were not based upon accurate information."

After quietly making investigations themselves Dr. Dillon found "everything in very fine shape and Havana the cleanest city I ever saw in my life." The doctors visited every town in which a suspicious case of yellow fever had been reported in the last three months and found excellent sanitary conditions everywhere.

"A case could not be hid in all Cuba," said Dr. Dillon, "for with two political parties and the outs keenly alert to find anything detrimental against the ins. there could hardly be any yellow fever in Cuba without its being known to the world, and then there are Marine Hospital surgeons constantly traveling over the island."

Dr. Jones gives an interesting account of the keen supervision of the Cuban hospital authorities over all communicable diseases. He said:

"The hospitals are all equipped with screened wards, and are visited every day by inspectors of the Sanitary Department. All cases of fever not plainly diagnosed, or not diagnosed within twenty-four hours, are placed in these screened wards and shown to the inspectors of the National Sanitary Department, and if they are at all suspicious a yellow fever commission, composed of Dr. Gutierrez, Dr. Agramonte, Dr. Bango, Dr. Carlos Finley, Dr. Albertini and Dr. Martinez, makes a careful examination every day until it is determined whether the case is yellow fever or not.

"The same supervision is practiced over private cases. It is made compulsory to report to the Department all cases of fever of a doubtful nature and all cases of any character that cannot be diagnosed in twenty-four hours. Failure to report such cases subjects the attending physician or the hospital to a fine of \$50, imposed

directly by the Sanitary Department without the intervention of a court of trial. Subsequent violations lead to severer penalties.

"But the thing that strikes everyone is the pronounced and absolute cleanliness of every city and town, and the evidence is there that the Government and people of Cuba are trying to do the right thing. That portion of the Platt amendment which provides for intervention by the United States if the island should become a menace to the health of the world is by itself a strong incentive for the maintenance of sanitary conditions.."

For the purpose of eliminating the slightest possibility of fever again being imported into New Orleans from Havana or any other point on the Isle of Cuba, the Louisiana State Board of Health on May 19 decided to appoint a medical inspector, who will be required to make his home in Cuba and send in weekly reports.

Further Precautions Against Disease.

On May 28 it was stated that President Gomez had appointed a special commission for the diagnosis of infectious diseases, with headquarters in Havana.

The commission is made up of some of the most eminent experts on tropical diseases and sanitary specialists in the world, headed by Dr. Aristides Agramonte, who is well known in New York, Emilio Martinez, A. Albertini, M. Rango, Carlos Finlay and Juan Guiteras. They will keep a sharp lookout for all suspicious cases and immediately conduct a minute examination, isolating the case and keeping it under surveillance.

Four \$4,800 Mercedes automobiles will be purchased by the Cuban government, one for the President's use, another for the Secretary of the Interior, another for the commander of the Cuban army and the fourth for the Director-General of Posts and Telegraphs.

Charges were made May 6 of fraudulent dealings in the army pay office amounting to more than \$3,000,000, the New York Herald says. Several vouchers, dating from some months back, are said to lack the proper legalization and entering. Several arrests were made on May 25.

Secretary of Sanitation and Charities Matras Duque is sending boys and girls from the State Orphan Asylums out into the country to responsible and worthy farmers and business people to be taught useful occupations. The saving thus effected to the State will be employed in a campaign against tuberculosis.

FINANCES OF CUBA.

On May 26 President Gomez sent to the Cuban congress a message transmitting the budget for the coming fiscal year. The figures do not differ materially from those given out recently by Secretary of the Treasury Villegas, the annual budget being \$30,004,392, and the fixed budget \$3,821,056, a total of \$33,825,448.

The receipts reach the same sum and are expected to be derived from the following sources: Customs, \$24,215,088, consular fees \$385,000, post-office and telegraph \$897,500, internal taxes \$910,000, income from state lands \$329,000, receipts from various sources \$1,388,860, internal revenue \$3,700,000, estimated receipts from the national lottery \$2,000,000.

The increase over the previous budget, amounting to \$7,500,000, is accounted for by the decrees of the provisional government and other extraordinary obligations, of which the principal costs were the permanent army, \$2,103,000; the Havana sewer system, \$1,500,000; water works at Cienfuegos, \$700,000; railway subsidies, \$300,000; obligations created by decrees, \$1,000,000; indemnity for the last revolution, \$348,305; the share of the nation and of the government in the cost of the Havana police, \$504,000; sinking fund of foreign loan for three months, \$255,000; increase for the department of agriculture, \$500,000.

Pres. Gomez also said that he is unwilling to increase existing taxes or impose export duties on sugar and tobacco. That he is unable at present to introduce economies on account of recently imposed heavy obligations, such as the cost of the army, but on the restoration of normal conditions he feels the fullest confidence in his ability to satisfy his earnest desire to institute important economic reforms.

The publication of the budget and its large increase over previous estimates caused alarmists' despatches to be sent to United States newspapers, and these with few exceptions took a very gloomy view of the island's financial situation, and expressed the opinion that the revenues would not be sufficient and that a serious deficit was in sight. The New York Tribune said, "There can be no urgent reason for so greatly increasing expenditures." The Journal of Commerce said it was unfortunate that "Recklessness in financial expenditures should have so soon brought the problem of a stable government for Cuba once more into the field of discussion." It was pointed out that Governor Magoon's administration of the island had been specially strong on its financial side. Under American control the budget for the fiscal year which will end June 30, was \$24,250,000 and the revenues were \$27,000,000, leaving a comfortable surplus for the year of \$2,750,000.

The general opinion seemed to question whether the Cuban government could meet its obligations out of the ordinary sources of revenue?

It was said also that contractors who have claims against the government are unable to get their money. Two of these are W. J. Oliver, of Knoxville, Tenn, and the McGivney-Rokeby firm, which has the contract for sewerage and paving Havana. There is

more than \$400,000 due to the former for road work completed.

The press also said that President Taft was very much disturbed and that gulf troops were being held for a call to Cuba. This latter rumor was promptly denied, however, by a statement from a "high authority" in Washington to the New York Herald to this effect.

The government has not received any information from Cuba that can make it apprehensive about the situation there or in any way repent of the United States' action in turning over the government of Cuba to the officials elected by the Cuban people. On the contrary, news from there is that President Gomez is doing very well in the short time of his administration. Also that the articles published in this country dated from Washington or elsewhere about the American government intending to land troops in Cuba, or establishing in Havana a mixed government, have no foundation whatever.

El Triunfo, the government organ, said that it was sheer exaggeration to consider as excessive the estimates of \$34,000,000 in the budget for the coming fiscal year, insisting that on the contrary it would prove a positive saving over the present budget.

Gen. Garcia Valez, the Cuban minister here, made a statement on May 28.

"There appears to be an organized movement to misrepresent in this country Cuban affairs and to spread alarm through the United States with a view of arousing public opinion against the Cuban government," said Gen. Valez. "There is no cause whatever for criticism, and the financial problems of Cuba can be easily solved without tying up the treasury with the issue of the new loan which President Gomez is authorized to make by a decree of the provisional government.

"Another proof that the financial situation in Cuba does not warrant any concern is the fact of the suspension of the export tax on sugar, tobacco, cigarettes, cut tobacco and liquors. In case of an emergency this tax can be again enforced."

He issued an extended statement in detail of estimates and expenditures to support his assertion that the finances of Cuba are in good condition.

The last word was that officials of the State Department had received advices from American diplomatic representatives on the island bearing out in detail the version of the Cuban authorities. Desire is shown in official circles to ascertain who is at the bottom of the apparent plans to make it appear that the President and the United States government are worried about Cuban finances and that American intervention again is imminent.

CUBAN NEWSPAPER COMMENT.

Una cura en falso

EL MEDICO:—¿Como te sientes?

CUBA:—¡Mal Doctor! De estos granos que usted me curó tan bien en 1899, uno se ha abierto ya, otro me está doliendo y este ¡mire como va!

Uncle Sam as the doctor is inquiring regarding the health of his fair patient Cuba. The latter tells him she is not feeling very well and points to the marks on her arm, named, respectively, lottery, bull fighting and cockfighting, and says: "You cured me of these things very well in 1899, but one has opened again and the others pain me." Pointing to the lottery mark she adds: "See how this is growing."—From *La Lucha*, Havana.

No Sign of Revolution.

Jose de Armas, editor of the *Diario de la Marina*, one of the most influential newspapers of Cuba, while in Washington on May 17 was interviewed by several newspaper men and spoke in part as follows:

"You hear more about revolution in Cuba when you come to the United States than you do in Cuba. If the people of this country would cease to talk about fighting in Cuba and let the people of the island work out their own salvation they would be able to get on a working basis much sooner. Mind you, I

don't say that it may not be necessary again for Uncle Sam to intervene. But at present there is no sign of revolution, although I'll admit there has been some talk among some of the malcontents.

"The conservatives went into the recent election with the understanding that if defeated they were to accept defeat gracefully, and I believe the leaders of the conservative party will abide by the result. Naturally, the leaders of the conservatives in the Cuban congress are on the alert for any mistake the liberals may make, but this fact does not signify that they are seeking trouble. Alto-

CUBAN NEWSPAPER COMMENT

gether, the political conditions are such that there is no cause for anxiety. We shall have no revolution."

Another Intervention.

El Diario de la Marina, the oldest and most important daily in the island, commenting May 19 on rumors coming from the United States of a prompt third intervention in the island's affairs, says they undoubtedly were started by persons who would personally profit thereby. It adds that if such intervention should come without sufficient cause, as it insists would be the case just now, things would by no means move on as smoothly as during previous interventions, for soldiers and civilians would be kept busily engaged in unpleasant little errands, the former out in the woods and the latter in the towns.

Public pleasure resorts would be deserted, the paper asserts, and if at last the peace of the grave reigned over Cuba, Central and South America republics would learn thereby how little they were to trust Mr. Root's fraternal policy of promises and complaisance. El Diario closes the subject by saying that such rumors are baseless and have surely been hatched by those who in the two interventions had all the money they wanted.



The Cuban government proposes buying a suitable house in Washington for its representative, to cost not less than \$100,000. The cartoon shows one Cuban viewpoint.

It might not be very hard for Minister Garcia Velez to name just exactly who those schemers are, who are making the campaign of vilification against Cuba.—La Lucha, Havana.

"We shall have a lottery because such is the wish of the majority of the people and because the lottery forms part of the political program of the Liberal coalition, which to-day governs, administers and directs the destinies of Cuba."—La Lucha.

Uncle Sam might use that seven millions in playing the Cuban lottery and getting it back in that way.—La Lucha.

LA CARGA DE LA GOLETA

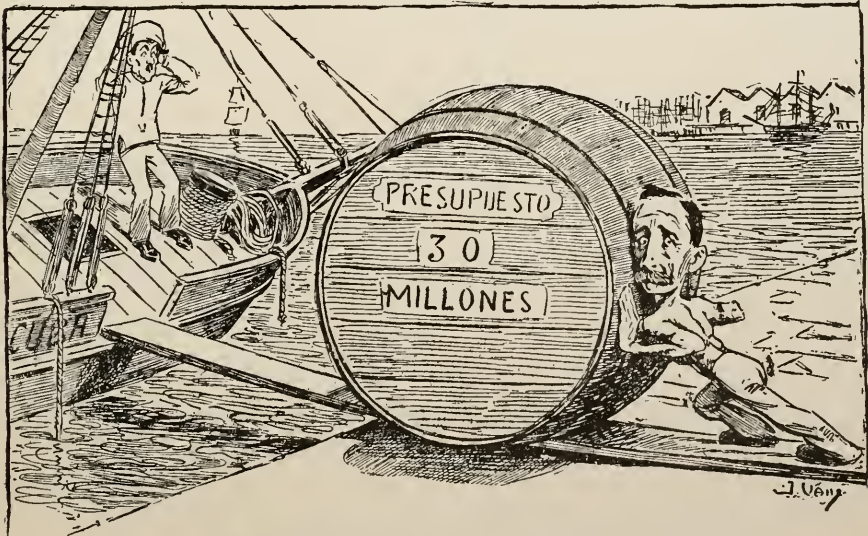

EL PATRON:—No arrempujes, Marcelino, que ni cabe por la escotilla y hasta nos podemos virar!...

The cartoon concerns the \$30,000,000 budget which it is declared the little vessel Cuba cannot take on board without great danger of sinking the boat.

THE PRESS OF THE UNITED STATES.

The National Lottery.

Cuba expects to win \$2,000,000 a year from the new lottery. Let us hope that it won't be sent down there by Americans. There is still that little bill of \$7,000,000 unpaid and we want Cuban money for it.—Phila. (Pa.) Inquirer.

The tendency of late years in all progressive countries has been to put as many checks on gambling of all kinds as possible. When a government itself goes into the business it is getting down to a pretty low level.—Albany (N. Y.) Press.

It is a cruelly heavy tax, says the Providence (R. I.) Tribune, falling in the main on those who can least afford to pay. To be sure, several European states of respectable standing still raise a good part of their revenues in this wicked way; but Cuban legislators are showing a shameful disregard of ethical responsibilities in following their foolish example.

The United States has much the same right to protest against the establishment of a lottery in Havana as it would to the maintenance there of conditions that kept yellow fever alive and always ready to invade our cities. The Cuban lottery tickets will be sure to come here in greater or less numbers, and will be a constant nuisance to the police, a constant danger to the foolish part of our population.—N. Y. Times, May 17.

While we in this country sanction and legalize stock gambling and corners in foodstuffs, criticism of the Cuban government for encouraging lotteries doesn't come with a good grace from us.—Fall River (Mass.) Globe.

Cuba is going to have a national lottery as a means to raising an extra \$2,000,000 a year to meet the deficit in the revenues. So are we; tariff revision is getting to be a lottery.—Washington (D. C.) Times.

It is not strange that the Cuban House of Representatives has passed a bill authorizing the establishment of a national lottery. A people that can stand for bullfights probably looks upon a lottery as an evidence of patriotism.—Jersey City (N. J.) Journal.

The United States government, which closed the mails to the Louisiana lottery, will close them to the Cuban scheme.—Lowell, Mass., Courier-Citizen.

The Intervention Costs.

At present the Government of the United States marks the bill against Cuba on the national ledger. The Bureau of Insular Affairs of the War Department has kept a careful account. Several members of the House of Representatives are seeking information on the subject, and they are reported to be inclined to believe that, under the act of Congress which gave authority for the intervention in Cuban affairs, the United States really assumed responsibility for the cost of the government.—Washington (D. C.) Times.

The intervention cost the United States some \$6,000,000. And Cuba is expected to "pay the freight." But the terms are easy. The President is empowered by Congress to receive from the Cuban Government "from time to time such amounts to reimburse the United States as he may consider the Cuban Treasury then able to pay without serious embarrassment." There is a chance here for a difference of opinion between the Cuban Secretary of the Treasury and the President of the United States in regard to the meaning of the last six words of the condition. We know who will have the delaying part of the argument. But eventually we will be paid when we annex Cuba and be done with the matter.—Lancaster (Pa.) Examiner.

It is by no means a settled question that the United States has a legitimate claim upon the Government of Cuba for the reimbursement of the sums expended in the pacification of the island. The obligation was one voluntarily assumed by this country for its own protection and for the furtherance of the national policy of preventing Cuba from passing into other control. Under these circumstances the maintenance of orderly government in Cuba is cheap at the price.—Philadelphia (Pa.) Ledger.

The matter is to be brought before Congress, but if there was no understanding with the Cuban government it is not clear how the Cubans can be asked to foot the bill.—Mobile (Ala.) Register.

It cost this country about eight millions of dollars to make its last visit to Cuba, but the little republic has done nothing toward meeting the bill. It costs a good deal sometimes to be a generous neighbor.—Haverhill (Mass.) Gazette.



Uncle Sam Teaching the Cuban How to Shoot.

Captains Golderman, Parker and Gatley of the United States Army were assigned recently by the Secretary of War to drill the Cuban Army. They are already at work. Some Cuban newspapers wanted Spanish officers. The cartoon illustrating their efforts is from the Cairo (Ill.) Bulletin.

Third Invasion of Cuba.

The New York American of May 14 printed a Washington despatch to the effect that a third invasion of Cuba by the United States was not improbable in the near future. It said:

"Each day the island government is becoming more involved and plunging deeper and deeper in the mire of financial difficulties. There is said to be a rapid relapse in the conditions left by the United States a few months ago. It is recognized by the administration that intervention is slowly becoming more imperative."

The Boston, Mass., Advertiser refers to this story and says there is probably enough of truth in it to give some basis for belief to imaginative army officers. It is not impossible that the War Department has considered some general scheme of occupation should the authori-

ties believe it to be necessary. It says further:

"But it is not impossible that plans have been considered for other expeditions which may never take place. It is the business of the War Department not to be unprepared, no matter what sudden emergency may arise.

"That, however, is very different from any admission that the administration has definitely resolved to wipe out the national existence of Cuba, after the United States has so recently aided the republic in the work of beginning a new and peaceful administration by its own people. No man who has talked with the President can doubt that it is his earnest wish that the experiment of the Cuban republic shall be proven a success by time, through the good sense and the broad patriotism of its people. So far as the public can judge, affairs in Cuba are not by any means in such a state as to convince any friend of the island republic that the experiment in self-government has been proven hopeless. On the contrary, the prevailing belief is that the new government has done very well, considering the history of so many other of the Latin-American republics, in their earlier progress towards national stability."



Drawing-room in Mr. Edmund G. Vaughan's handsome residence on the Malecon. It is a two-story building of stone, facing the sea, with a fine view of the entrance to Havana Harbor and of the Morro. The Malecon, with its pleasant drive along the sea, is one of the most picturesque and attractive places in the Cuban capital.

SUBURBS OF HAVANA—VEDADO AND JESUS DEL MONTE.

The suburbs of Havana have both the old and the new world air, says the New York Evening Post. Reviewed in order of importance and development the first to notice is Vedado, meaning reservation, probably named from having been held as a pleasure place, a deer park or restricted district in the old days. It lies to the west of the city along the gulf of which an extended view may be had by residents on the cazada as the Spanish highways are called, while houses built on the hill back of the turnpike have a fine view of the shore as well as the sea and of the bay to the eastward, with the walls of Morro castle for a background.

This section has within eight years seen a phenomenal rise in value; a lot that, during the first intervention, was offered to an American here for \$400, sold this season for \$50,000, it being in what is now the most fashionable district where very beautiful homes are being erected. The "Americanization" that has been said to have been made

in architecture, consists in having put verandas along the fronts or sides of the houses where an unscreened entrance or corridor of Spanish fashion or the Italian pergola style was formerly followed. The interiors of these new houses have also a few American conveniences, such as sanitary plumbing, hallways to connect rooms that formerly opened out upon the inner courts or patios, gas stoves, or coal ranges in place of the native fagon (charcoal brazier) and more windows to the outside than are usual in the Latin's idea of a house. In other respects the customs of the country are carried out in the new buildings that to a new arrival would look as foreign though not so old, as any other house. Parquets of tiles or marble are the only sensible floors for this climate, where, on a midwinter day, the windows must be open for comfort, and in summer insects must be kept at bay, as they could not be so well from wood floors.

Of course, the much traveled and cul-



Homes in Havana's Suburbs. Mr. Adolf B. Horn's villa, "Bella Mar," near Camp Columbia. It is a fine specimen of modern architecture in Cuba and the house is built in accordance to hygienic requirements, and is supplied with all the modern improvements.

tured Cubans have homes very similar to those of people in their class in any land, but the above is the average, and is seen daily as one passes open doors and windows.

In the suburb of Jesus del Monte, an American company bought 10 years ago the deserted farm of Cubans too poor to hold them, and of Spaniards who were leaving the island. This district has now become one of the most beautiful of the resident sections. One property secured for \$16,000 has been cut up into lots, of which a third only had been sold when the investor had trebled the price paid for the farm. A small building lot sells here for \$300. One house just built in the so-called American style, as above described, cost, with the lot, \$20,000. Some of the finest old Cuban homes are at Jesus del Monte. The Yznaga place, the childhood home of Consuelo, duchess of Manchester, and the residence still of her relatives, is here.

Laundry Workers Out.

The women ironers' strike, which did not seem far-reaching in its consequences

when it first began some weeks ago, has developed into quite a serious affair, threatening to drag along indefinitely. Both the workers and the laundry owners are holding fast to their position, and the Secretary of Agriculture's efforts to bring about an understanding thus far have been fruitless.

The Rev. Dr. Charles L. Thomson, of New York, secretary of the Board of Home Missions, in an address at the Presbyterian General Assembly on May 25 at Denver, Colo., praised the United States government's work in Cuba during the intervention, and said that the Stars and Stripes had no sooner vanished out of Havana Harbor than Cuba started backward, gambling and bull fighting having new sway.

The President on May 14 ordered the payment of \$26,000 to private citizens whose lands were appropriated to establish the United States naval and coaling station at Bahia Honda.

RAILROADS AND FINANCIAL MATTERS.



New Branch Bank Building at Cienfuegos, of the National Bank of Cuba. Opened for business May 8.

Condition of the Treasury of Cuba, on
April 30, 1909.

Official Report of the Secretary of the
Treasury.

ASSETS.

General Treasury.

| | | |
|---|------------------------|----------------|
| Cash on hand.. | \$265,984.47 | |
| Deposited with the Banco Na- cional (cash) | 10,659.39 | |
| Deposited with the Royal Bank of Canada (cash) | 300,000.00 | |
| | <u>\$576,643.86</u> | |
| In bonds of the Foreign Debt. | 1,000,000.00 | \$1,576,643.86 |
| Collections: | | |
| Cash on hand..... | 119,410.53 | |
| Public Taxes: | | |
| Balance against this account | 8,546,642.32 | |
| | <u>\$10,242,696.71</u> | |

LIABILITIES.

| | |
|---|------------------------|
| Advance orders in transit.... | \$99,147.30 |
| Postal Money Orders..... | 340,863.37 |
| Debts pending | 18,468.34 |
| Honorary Consuls | 1,175.80 |
| Taxes on the loans..... | 829,397.67 |
| On deposit for the loan 1st 50% | 289,373.92 |
| Balance due to the Army of Liberation, 2d half..... | 373,222.82 |
| Epidemic diseases | 22,183.02 |
| Individual contracts | 50,960.47 |
| Special Laws of 1906..... | 1,487,400.23 |
| Special Laws of 1909..... | 1,191,848.45 |
| Decree of the Provisional Gov- ernor | 4,372,932.46 |
| Maintenance of detained immi- grants | 331.55 |
| Sewering and paving of the City of Havana..... | 1,165,391.31 |
| | <u>\$10,242,696.71</u> |
| Marcelino Díaz de Villegas, Secretary of the Treasury. | |

Both the United and the Cuba roads are making arrangements to increase the traffic between Havana and Santiago. It is planned to have four daily trains between Santiago and Camaguey, and to

extend the route of the daily Santa Clara train to Camaguey, so as to have a twice-a-day service between Havana and Santiago.

RAILROAD AND FINANCIAL MATTERS.

Jucaro Railway Company.

On May 14 President Gomez signed a decree extending the lease of the Jucaro and Moron Railway, which is government property, to the present lessees.

The lessees of the road, Messrs. Mari-bona and Warren, have now incorporated their interests, and the extension is granted to the Jucaro & San Fernando Railway and Transportation Company, and the extension of the lease is made until 1911.

Under the terms of the extension the company is obliged to finish the construction of the second sugar mill along the line within a period of two years and to pay as an indemnity to the government the sum of \$5,000.

The company is also obliged under the contract to comply with the conditions of the lease signed in 1907 to establish a service of tugs in the Moron and Jucaro waters as a complementary service of the road.

Cuban Bonds Sold for 103.

On May 25 the government sold to the National Bank of Cuba \$1,000,000 of the bonds of the loan of \$35,000,000 financed by Speyer & Co., of New York, for the payment of the army of liberation. The purchase price was 103. The bonds have been in the Cuban treasury since 1905. It is presumed, says the New York Times correspondent, that the government intends to apply the proceeds to the reduction of the prospective deficit in the budget.

Havana Electric Railway Earnings.

| | 1909. | 1908. |
|----------------------|-----------|-----------|
| Week ending May 2... | \$38,237 | \$34,427 |
| Week ending May 16.. | 39,557 | 36,882 |
| Week ending May 23.. | 39,140 | 35,580 |
| Week ending May 30.. | 38,124 | 34,393 |
| From Jan. 1 | 1909. | 1908. |
| To May 23, inc..... | \$796,354 | \$763,321 |
| To May 30, inc..... | 834,478 | 797,714 |

Another Branch Bank Opened.

The Cienfuegos branch of the National Bank of Cuba was opened in its new building on May 8. The bank building is a superb structure of the Corinthian type and equipped with every convenience for the present prompt and effective handling of banking needs. The builders were Purdy & Henderson of Havana.

United Railways of Havana Earnings.

| | 1909. | 1908. |
|--------------------|---------|---------|
| Week ending May 1. | £30,886 | £14,839 |
| Week ending May 15 | 22,117 | 12,425 |
| Week ending May 22 | 18,066 | 12,514 |

For the 45 weeks and 6 days of the present fiscal year the earnings to May 1 were £982,995 in 1909 and £853,860 in 1908.

Earnings include those of the Marianao Railroad, but not the Regla warehouses.

Gas and Electric Company Report.

Of the various items contained in the report of the Gas and Electric Company of Havana for the year 1908, just published, the following are the most important:

| | |
|-----------------------------------|----------------|
| Property | \$9,209,002.45 |
| Cash on hand | 473,240.43 |
| Bills in process of collection... | 199,288.29 |
| Securities on hand | 963,031.96 |
| Material, lamps, meters, etc. . . | 613,035.60 |

The total includes various accounts, furnishings, chattels, Municipality of Matanzas shares for conversion, reduced bonds, and dividends, etc., which make a total of \$11,912,042.08.

The profits for the year 1908 amounted to \$629,316.65, which sum has been distributed as follows:

| | |
|-------------------------------|--------------|
| 9% dividend to stockholders.. | \$455,184.00 |
| Exchange | 45,518.40 |
| Reserve fund | 29,066.85 |
| Surplus | 95,547.40 |

The Cuba Railroad Company.

The statement of earnings and expenses for the month of April and ten months ended April 30, compares as follows:

| | 1909. | 1908. |
|-------------------|----------------|----------------|
| April gross | \$226,657.45 | \$209,758.28 |
| Expenses* | 121,773.29 | 123,436.01 |
| April profits .. | \$104,884.16 | \$86,322.27 |
| Charges | 34,579.16 | 31,892.18 |
| April surplus . | \$70,305.00 | \$54,430.09 |
| Ten mos. gross.. | \$1,766,920.64 | \$1,720,385.36 |
| Net profits* | 769,576.68 | 607,506.83 |
| Fixed charges .. | 329,937.48 | 301,618.12 |
| Surplus | \$439,639.20 | \$305,888.71 |

*Included in working expenses are the following expenditures for extraordinary replacements:

| | |
|-------------|-------------|
| This month. | To date. |
| \$8,000.00 | \$80,000.00 |

FINANCIAL AND COMMERCIAL MATTERS.

Cuban Central Earnings.

| | 1909. | 1908. |
|----------------------------|----------|----------|
| Week ending April 24... | £4,305 | £8,871 |
| " " May 2 | 14,607 | 8,784 |
| " " May 9 | 12,537 | 7,035 |
| Total receipts for year to | | |
| | 1909. | 1908. |
| April 24 | £356,948 | £304,426 |
| May 2 | 371,555 | 313,210 |
| May 9 | 384,092 | 320,245 |

Western Railways of Havana Earnings.

| | 1909. | 1908. |
|--------------------------|----------|----------|
| Week ending April 24... | £4,830 | £4,929 |
| " " May 1.... | 4,936 | 5,240 |
| " " May 8.... | 4,618 | 4,883 |
| Total receipts for year: | | |
| | 1909. | 1908. |
| Week ending Apr. 24. | £231,536 | £220,375 |
| " " May 1.. | 236,472 | 225,615 |
| " " May 8.. | 241,090 | 230,498 |

Salt Importations.

Salt is mainly imported into Cuba from New Orleans. The cost of a bag of salt weighing approximately 200 pounds is about 80 cents and freight. The duty imposed on salt under the present tariff is \$1 per 100 kilos on salt in bulk, and \$1.30 when imported ground. This represents about 100 per cent. duty and is considered a sufficient protection for the Cuban production. The annual importations reach about 5,000,000 pounds.

Legislation toward increasing the duty on salt is now pending before the lower house of congress.

Present U. S. Consular and Diplomatic Service in Cuba.

Corrected to April 20, 1909.

Diplomatic Service.

Edwin V. Morgan, E. E. and M. P., born in New York; residence, Havana.
 Fred Morris Dearing, Sec. of Legation, born in Missouri; residence, Havana.
 C. Cornell Tarler, 2d Sec. of Legation, born in New York; residence, Havana.

Consular Service.

Cienfuegos—Max J. Baehr, C., born Germany; Buenaventuro Caibo, V. and D. C., born in Cuba.
 Caibarien—P. B. Anderson, Agt., born in Sweden.
 Nuevitas—Dean R. Wood, Agt., born in New York.
 Sagua La Grande—John F. Jora, Agt., born in Cuba.

Havana—James Linn Rodgers, C. G., born in Ohio, Joseph A. Springer, V. and D. C. G., born in Maine; Henry P. Starrett, D. C. G., born in Massachusetts.

Cardenas—Pedro M. Mederos, Agt., born in Cuba.

Matanzas—Alfred Heydrich, Agt., born in Cuba.

Santiago de Cuba—Ross E. Holaday, C., born in Ohio; Henry M. Wolcott, V. and D. C., born in Vermont.

Antilla—George Bayliss, Agt., born in England.

Baracoa—Arthur Field Lindley, Agt., born in New York.

Manzanillo—Francis B. Bertot, Agt., born in Cuba.

Abbreviations.

Agt., Consular Agent.
 C., Consul.
 C. G., Consul-General.
 D. C., Deputy Consul.
 E. E. and M. P., Envoy Extraordinary and Minister Plenipotentiary.
 V. O., Vice Consul.

Beer Production in Cuba.

According to statistics issued by the Bureau of Special Internal Tax of the Treasury Department, the number of liters of beer manufactured during April was 1,499,469 which paid a tax of \$8,330.38.

Cuban Ore.

The present duty on iron ore is 40 cents a ton. Cuba gets a 20 per cent. differential so that Cuban ore now pays 32 cents a ton. The Aldrich bill puts the duty on ore at 25 cents. If Cuba continues to receive its 20 per cent. advantage that ore would hereafter come in at 20 cents a ton. These figures are of direct interest to Philadelphia investors, since the Pennsylvania Steel Company owns Cuban ore, which it will import.—Phila. (Pa.) Press.

Industrial Notes.

The Pratt Engineering & Machine Company, of Atlanta, Ga., has found it necessary to augment its New York selling force, and has employed Mr. R. E. S. Geare as manager of the New York office.

Mr. N. A. Helmer, who has heretofore been in charge of the New York office, will now be enabled to direct sales of sugar machinery in all sections, and have better opportunity to supervise the manufacture of sugar machinery in the Company's shops at Atlanta.

The Company will shortly open a permanent office in Havana, Cuba.

COMMERCIAL MATTERS.

New Industries Encouraged.

A bill to provide for the admittance free of duty of the machinery, prime material and other utensils for a period of five years, to be used in the establishment of any industry and carrying other protections for the development of manufacturers in Cuba, was introduced May 18 in the Cuban Senate by Senator Martin Morua Delgado.

The bill provides that when a new industry shall have been established, the government shall prohibit the opening of a similar manufacture during a period of eight years.

A condition is that sixty-five per cent. of the employees be Cuban citizens, to the exclusion of others. The bill was referred to the committee on Custom Tariffs for report.

Companies desirous of establishing and operating new industries in Cuba must make application to the President of the Republic through the Department of Agriculture, Commerce and Industry, stating the nature of the industry to be established, the raw material required, place where the factory is to be established, name and address of the applicants, and other details, and must pay into the treasury of the Republic, as a deposit of guarantee of good faith, a sum, either in cash or values, equal to 2 per cent. of the declared capital.

When one of these companies has been duly authorized and established, the government will prevent the establishment of another company devoted to the same industry during eight years from the date on which the authorized company shall have commenced operations. Should the company fail to begin operations within two years from the date of application, it shall forfeit the sum deposited in the national treasury.

Increased Duties on Beef, Mutton, Etc.

A bill introduced into the House early in May, while raising the duty on cattle, also proposes to raise the duty to \$13.60 per hundred pounds on all beef, mutton or pork imported into the island, excepting fancy breeds with pedigree, imported into the island for the improvement of the breed, which shall be allowed free entry.

All salt meats, excepting hams, to be assessed a duty of \$22.72 per 100 pounds. Lard, \$18.18 per 100 pounds; all imitations, \$22.72 per 100 pounds; tallow, \$13.63 per 100 pounds; tasajo, \$22.72 per hundred pounds; bacon, \$22.72 per hun-

dred pounds; hams and shoulders, \$22.72 per hundred pounds; fresh meats, in cans or otherwise, \$27.27 per hundred pounds; cheese, \$27.27 per hundred pounds.



Foreign Consuls accredited in Cuba.

Mr. Carlos Arnoldson, Consul-General of Netherlands and of Switzerland at Habana.

The Consul-General of Netherlands and of Switzerland, Carlos Arnoldson, was born in Hamburg in 1870, and came to Cuba in 1893. He was married in 1896 and decided to make his home in Habana. Shortly after he opened a banking house, and in 1900 he was appointed consul of Netherlands and a few years later promoted to consul-general, an office he holds with credit and to the satisfaction of his government.

Mr. Arnoldson is a member of the German Club, of the Casino Español and vice-president of the Produce Exchange. It is due to his efforts that the handsome building for the Produce Exchange has been erected on San Francisco Square, which is one of the most costly edifices in Habana.

Havana's Custom House Collections.

| | 1909. | 1908. | 1907. |
|--------|----------------|----------------|----------------|
| May .. | \$1,343,434.38 | \$1,370,880.04 | \$1,573,055.22 |

GENERAL NOTES.

Interesting Items from Various Sources Regarding the Island's Activities.



Motoring in Cuba.

Mr. H. S. Firestone, president of the Firestone Tire & Rubber Company, Akron, Ohio, and Mr. James Cousins, secretary and treasurer of the Ford Motor Co. of Detroit, who are enthusiastic over the subject of good roads, recently completed an extensive tour through Cuba, he says:

"While in Cuba we did considerable motoring and found most excellent roads for motoring in the western part of Cuba. There is no place on this side of the Atlantic where the pleasures of motoring are so great. The government seems to be alert in extending the good work begun by the United States in building splendid thoroughfares of the highest class throughout the island. The roads are mostly made of the coral stone formation which works down into a hard surface almost like asphalt."

Artesian wells are being sunk in various parts of Cuba by W. E. Powers, the well expert. Flowing wells are secured at a depth of from 250 to 400 feet. Most of these wells are sunk for irrigation purposes.

The Havana Telegraph announces that the daily edition has been discontinued, to resume October 1 next. It began on Sunday, May 16, the publication of a 12 or 14-page weekly edition.

Mrs. Palma's Home Saved.

Mrs. J. Estrada Palma, widow of Cuba's first president, was surprised on arrival at Central Valley, N. Y., to learn that her old homestead, which she supposed had been sold, was still her property, says the Utica Press.

When General Palma went to Cuba seven years ago to become its president, he placed the homestead in the hands of Carlos Zaldo and O. A. Zayas, business men of Havana, to be sold. In due time Mr. Palma received a check for \$10,000 from the United States Mortgage and Trust Company, ostensibly from the sale of the Central Valley property. It was more money than he had expected for it. The real fact was that these two friends, as a mark of appreciation and friendship for the unfortunate former president, paid that \$10,000 out of their own pockets and took over the property, all without General Palma's knowledge. Then they placed it in trust with the United States Mortgage and Trust Company for Mrs. Palma, during her lifetime, and thereafter for her two daughters, Candelaria and Luz.

Investigating a School.

Catherine Tingley known as the "Purple Mother," a mystic, and as well remembered in Cuba as she is in Chicago and San Francisco, conducts a school called Raja Yoga at Point Loma, California, attended by a number of Cuban children. "La Defensa," a publication of Santiago de Cuba, recently called attention to alleged cruelties put upon two of the Cuban pupils. The Cuban government at once ordered an investigation and officials at the Cuban legation in Washington have been ordered to look into the matter. Mrs. Tingley has written President Taft, demanding the fullest inquiry.

Miguel de la Torre, the paymaster of the Fiscal Zone of Havana, who was sentenced to fourteen years in the penitentiary and to make good the sum of \$185,455 which he embezzled, filed an appeal through his attorney to the Supreme Court on May 18.

The trial court of the audiencia of Havana has granted the certificate of appeal and the case has been forwarded to the Supreme Court, where it will be set for hearing shortly.

The Stevedores' Differences.

An amicable settlement of the stevedores' and steamship men's trouble, regarding the loading tariff paid at the port of Havana is still far off. Union men are insisted upon.

For years the stevedores of Havana have been trying to obtain the old tariff made up by the Wood administration, fixing certain rates for loading charges, while the steamship men have maintained that the present rate of \$2.50 cy., for a nine-hour day is right.

These rates are now \$2.50, maximum for loading and unloading, with a minimum of \$1.25 for a half day; the night rate is \$4. For loading sugar the stevedores gets 3½ cents a bag for day work and 7 cents a bag for night work.

After comparison with the hour rate paid in New York, Porto Rican and Mexican ports, the steamship interests proposed 30 cents per hour for day and 45 cents for night work, with the rates for loading sugar to remain unchanged.

The companies are to be at liberty to employ any good worker selected by the foreman and acceptable to the stevedores.

Flag Presentation.

Prominent business men of Havana's American colony are arranging an unusual July 4th celebration. According to the plans among other manifestations of good will toward the Cuban people, there will be a presentation of five national and five regimental flags to the two infantry regiments of the permanent army and the three artillery corps.

The offer was made by Mr. George M. Bradt, publisher of the Havana Post, and President Gomez, replying to Mr. Bradt, said he considered the gifts a proof of the sincere friendship of Americans toward Cuba and gladly accepted.

The Cuban press very generally commends the gift.

The San José sugar mill at Hatuey closed grinding May 15. The output is 61,733 bags.

Construction has begun of the electric plant in Holguin to supply that ancient city's lighting and power requirements.

Second Cuban Medical Congress.

The organization committee of the Second Cuban National Medical Congress has fixed the date for the coming congress for February 24, 1910, to be held in Havana. Members of the profession generally will receive an invitation to attend. A fee of \$3 for membership will be charged.

The first Cuban national congress was held in Havana in November, 1907, and was highly successful. The second congress was scheduled to take place last August, but plans were abandoned in view of the refusal of the last intervention to grant any government aid.

Disposal of the Maine.

Admiral Sigsbee, who as Captain Sigsbee commanded the Maine when that vessel was blown up in Havana harbor, discussed in a lecture delivered in Washington, May 16, the raising of the Maine as an engineering problem. He thought the task would be one of enormous expense and difficulty if it were performed in such a way as to bring the hulk to the surface entire.

"People have forgotten," he said, "how much the Maine suffered from the explosion. The few parts still above the surface of the water give but little indication of the torn and twisted wreckage out of sight. To raise the shattered parts would require the construction of a coffer dam around the whole wreck, and this would involve the prolonged exposure of a lot of mud as noxious as is to be found in the world for a considerable period to the tropic sun, with consequences to the health of the city that might be serious."

He said also that

"The Maine on the bottom occupies much less harbor space than she did when swinging at anchor, so the need of her removal is not desperate on that account, and his suggestion as to final disposition was that she be blown up in detail, with no systematic attempt to recover the fragments."

A correspondent in Washington (D.C.) Star proposes a much better disposition of the wreck. It is to build a substantial wall around it, making of the spot "a beautiful island of appropriate size and design, in the center of which should rise a properly inscribed shaft." "To blow it up," he says, "would cause widespread horror that we had blasted out the grave containing the remains of sixty-three of our sailors and marines and made impossible the honorable burial of the battleship." The island idea would appeal strongly to patriotism and sentiment as the Bunker Hill monument and the memorials erected at Arlington and Gettysburg.

The question of the island obstructing navigation and as aiding in filling up the harbor with sand bars, etc., the writer dismisses as unworthy of serious consideration. Resolutions embodying the above were recently unanimously adopted by the Board of Trade of Newark, N. J.

ISLE OF PINES NOTES.

Poor Mail Service.

The Isle of Pines is suffering from the neglect of the Havana postal authorities, says The Appeal. There is not only mal-service in the transportation of the mails to and from the island, but there are inadequate facilities at the local offices for the handling of the mails.

The postmaster at McKinley is petitioning the government for the removal of the post office to a more convenient location on the townsite. He mentions a demand for 150 lock boxes, which cannot be provided with present accommodations. He suggests also a carrier system to Nueva Gerona and the installment of a money-order system at McKinley.

There is a rumor that the school board of the Isle of Pines has recommended the suppression of the English language in the primary grades of the public schools in Nueva Gerona. The order establishing English instruction was given by Governor Magoan.

Cave exploring will be made one of the attractions of Nueva Gerona for winter tourists. New caves are constantly being found.

Change in Schedule.

Beginning May 8 the Isle of Pines Steamship Company will change the sailing dates of the steamer Cristobal Colon, and in future and until further notice there will be but two sailings each week between the island and Batabano. Hereafter the steamer will sail from this island on Mondays and Fridays, and from Batabano on Wednesdays and Saturdays.

Colonel C. S. Brown, president of the Cañada Land & Fruit Co., recently returned from the Isle of Pines, reports the Cañada and Los Indios tracts in a flourishing condition. The company purposes many new public improvements to their property.



Colonists' Homes on the Isle of Pines. Cottage of Messrs. Wilcox & Tracy.

The Santa Fe Lumber Co. recently sold its plant to Warren M. York, a young man from Washington, D. C. The former owners of the Santa Fe Lumber Co. are removing to the United States, and the new purchaser has arranged for the making of extensive improvements and promises to furnish in the immediate future all building materials usually manufactured by a sawmill. The new company expects also to make crate material, which will be of immense value to the citrus fruit and vegetable growers in the Isle of Pines.

J. J. Hill at Santa Fe shipped, a few weeks ago, three hundred and twenty-five fine watermelons to Havana. The melons weighed from twenty-five to forty pounds.

School Inspection.

Miss A. F. Phillips, Supervisor of English in the city of Havana and province and superintendent of the American public schools in the Isle of Pines, returned May 16 from a visit to the island.

Her report to the superintendent of schools showed that efficient work was being done in the schools and that the equipment provided by the Cuban government was generous. Her report further states that four of the eight American schools on the island will probably be suspended another year owing to the limited attendance of children.

A local branch of the Cuban Red Cross Association has been established at Nueva Gerona.

AGRICULTURAL MATTERS.

Sanitation of Coconut Groves Essential—Retirement of Station Director J. T. Crawley.

Diseased Coconut Trees.

United States Department of Agriculture,
Bureau of Plant Industry,
Laboratory of Plant Pathology,
Washington, D. C., May 20, 1909.

To the Editor of the CUBA REVIEW:

Permit me to urge you in writing any letter to cocoanut planters in Cuba to assure them that careful cutting out of diseased trees and destroying them, in general complete "sanitation" of the grove, would more than repay any work involved, although it might not absolutely eradicate the disease. There are more planters in Cuba careless of their cocoanut groves than in any place I have been.

Very truly yours,
(Signed) JOHN R. JOHNSTON,
Scientific Assistant.

Director Crawley Out.

Josiah T. Crawley, director of the Government Agricultural Station at Santiago de las Vegas, resigned May 5. No reason is given.

Director Crawley has held the post since about six years ago and has been enthusiastic about his work.

He had collected about him a corps of experts, who were hard and intelligent workers. Nearly all of these were a few weeks ago discharged from the service.

Cuba's Pineapple Exportations.

| | 1909. | 1908. |
|--------------------------|---------|---------|
| January | 22,149 | 16,785 |
| February | 27,589 | 16,349 |
| March | 36,430 | 17,171 |
| April | 337,878 | 169,124 |
| May (2 weeks) | 221,541 | 420,153 |
| Total (crates) | 645,587 | 639,482 |

"Gum disease" is very common in citrus fruits in California. An illustrated pamphlet (Bulletin No. 200) has lately been issued by the Experiment Station, Berkeley, which deals in a thorough manner with the causes and methods of control of this disease.



Colonists' Homes in Cuba. Residence of Mr. L. Rose, an American settler at La Atalaya, a colony on the beautiful bay of Nuevitas. La Atalaya, which means watch-tower, is the site of an old sugar plantation.

AGRICULTURAL MATTERS.

A Celebrated and Valuable Animal—The Aguacate, One of the Most Delicate Fruits—Papaws and Chickens.



Mercedes Julip's Pietertje's Paul, No. 29830.

Courtesy of Collier's Weekly.

A High Priced Animal.

Collier's Weekly finds the animal pictured above celebrated and his record impressive. He has thirty-two daughters of A. R. O. (Advanced Registry Official), which corresponds in the bovines to the two-minute class in race horses, and a son with fourteen daughters in this coveted division. He is the cousin of Colantha and is held at \$20,000. He is great not in himself alone, but in those who are to uphold his name and glory after him—\$10,000 has been offered for one of his sons. Paul himself weighs a ton and a quarter.

The Aquacate Easily Damaged.

The great susceptibility of aquacates to damage by bruising is a great obstacle in the way of building up an export trade. It is undoubtedly one of the most delicate of West Indian fruits and it is necessary to use the greatest care in gathering and handling it. The slightest bruise is sufficient to cause the pear to rot in a very short time; indeed, it is often much bruised by its own seed if carelessly shaken.

Nevertheless it is possible to ship avocados successfully for very considerable distances, if due care is exercised in gathering, packing, etc. West Indian pears have been exported in small quantity to New York and to England, and experimental shipments from the Hawaiian Islands to the Pacific Coast of

the United States gave satisfactory results. Cases in which avocados are packed for transport should be small in size and contain but few fruits. The crate found most satisfactory in the Hawaiian experiments (with medium-sized fruits) was of the following dimensions, inside measurement: 13 x 14 x 3¾ inches. This crate contained about one dozen fruits, necessarily in a single layer, the fruits being merely wrapped in a single paper cover.

With most other fruits, the vegetative method of propagation is to be recommended in preference. Budding has proved very successful with this tree, the simplest form of the operation—that known as shield budding—being the best to employ with the avocado.—Agricultural News, Barbados.

The Papaw.

Papaw trees have usually male and female flowers on separate trees. A paper in "Science," by an officer connected with the Porto Rico Experiment Station, reports a change of sex observed in some papaw trees there, brought about apparently by removing the terminal bud. A tree which had previously borne male flowers only, had its terminal bud injured, and shortly afterwards was noticed to bear female flowers also. These flowers set and yielded fruit, and this was repeated in the second year.

AGRICULTURAL MATTERS.

Cocoanut Palm Yield—Fruit Packing for Export—An Ingenious Fertilizer Distributor.

Cocoanut Palm Yields.

A good cocoanut tree should yield an average of 100 nuts per year, and under favorable conditions 200 have been obtained. In Porto Rico, however, a return of sixty-five nuts per tree is probably about the average figure. This low return emphasizes the general want of care and attention from which the industry is suffering. The cocoanut palm will continue in bearing for so long as seventy or eighty years. During the early years of its growth, catch crops of various kinds, as provision crops, etc., may be planted between the trees or, better still, leguminous plants, as cowpeas or velvet beans.

In planting, select only fine, ripe seed nuts, the produce of healthy, well developed trees, of good bearing capacity. The ripe nuts are first set out at distances of one foot from each other in holes two feet deep, and with about two inches of the surface of the nut exposed. The seed bed should be kept moist, but not wet. After a period of from four to six months the young seedlings can be transplanted. They should be set thirty feet each way and the soil around the young trees should be mulched with leaves.

The cocoanut palm responds well to cultivation and applications of manure. Green manuring is frequently recommended, and by growing crops of beans between the trees and digging the vegetation into the ground growth is considerably hastened. They bear transplanting well, and if the young trees do not appear to be flourishing they may be taken up, some manure and trash worked into the hole, and the trees replanted.

The period at which the cocoanut palm begins to bear fruit varies from five to ten years, depending largely upon the location and the care given to it.—Barbados Agricultural News.

Citrus Fruits for Export.

The best months to export citrus fruits to England are in August and September, although there is a good market for high-class oranges and mandarins in June and July also. In packing for export fruits should in all cases be wrapped separately in glazed or thin wax paper.

Trial shipments of mandarins and other kinds of oranges from South Africa have lately been placed on the English market. Exporters have adopted the

plan of packing these in fancy trays which hold only one layer of fruit, and then binding five of the trays together in one package. This method of packing appears to be a new one, but is giving satisfactory results.

Bananas to England sent green from the Canary Islands are packed each bunch in a separate crate. The bunch is first wrapped in a layer of cotton wool, then in paper and then in straw or dry leaves.

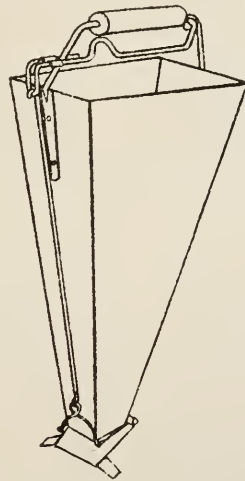

Saves the Fertilizer.

Fertilizer is expensive. By the old method of distributing it there was usually enough wasted to represent a pretty penny. Then came along a Virginia man and invented the hand fertilizer dropper. This device consists of an odd-shaped bucket, running to a point at the bottom and having a small opening there, through which the contents filter. A hinged valve, operated by a rod that leads to the handle of the bucket, controls the flow. The top of the rod is connected to a crossbar, which runs under the handle of the bucket. This bar is in close reach, and, when resting on the top of the bucket, the valve is open. To close the valve the operator merely extends a finger and lifts the bar, thus shutting off the flow of the fertilizer. The valve flares at the bottom, spreading the fertilizer in a broad, fine stream. For small farms, gardens and lawns this device is of great convenience, and is a money-saver.

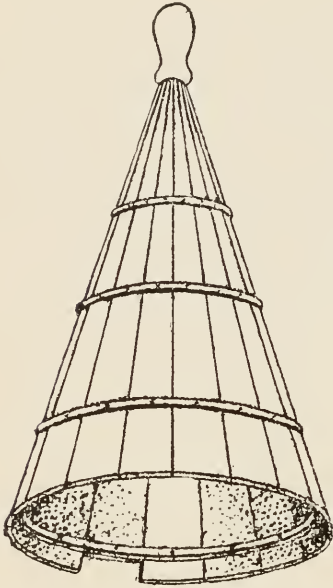

A Safe Device for Swarming Bees.

An Ohio man, says the Philadelphia Record, has invented a safe device for catching bee swarms without danger of stings. The illustration shows what the device looks like. In appearance it resembles a megaphone, being a conical device with a handle at the pointed end and made of slats. One of these slats is movable and can be slid up a short distance to form an opening, like the opening in a hive. When the bees have been collected in the device the slide can be pushed shut and kept closed until it is desired to liberate the insects within.

Tobacco from Cuban Seed.

Seed selection offers a wide field for improvement. Under the advice of the Department of Agriculture the best tobacco plants in a field have paper bags tied over their flowers. The self-fertilized seed thus obtained is put through a machine invented by a government expert, which fans out the lighter seed, leaving only the heaviest, which is best for planting.

Cuban seed has been acclimated in Texas and is yielding 800 pounds to the acre, good Havana wrapper and filler. The United States Government is encouraging the growing of tobacco from Cuban seed in Alabama and is meeting with success. In Ohio the agricultural department has been carrying on tobacco investigations for a number of years, and good fillers and wrappers from Havana seed are being grown.

Frederic J. Haskin.

Cuban Grape Fruit.

In the week ending May 22 there were some small lots of Cuban and Jamaica grape fruit on the New York market, but in the main the quality and condition were only fair. Here and there good Cuban stock was held up to the outside figures, but the mixed counts were easy and the tendency lower.

In the week of May 28 Cuban grape fruit sold at auction at from \$5 to \$5.37½ per box on desirable sizes. There were some lots in the same offering that sold down to \$2 per box. This wide range in auction values illustrates the situation here. There is a demand for fancy stock in the medium sizes, but no interest is shown in the choice or low grades in any size. The season so far as this market is concerned may be said to be over. Several small lots have sold in a jobbing way up to \$5.50 per box in both Cuban and Florida stock, but as a rule the tone is weak, with demand restricted to jobbing lots here and there. It is expected that the stocks to arrive from now on to the end of the season will be small, since late arrivals have shown a good deal more waste than usual up to now. There is, however, a fairly active call for the best stock in all offerings.—N. Y. Fruitman's Guide.

Cuban Pineapples.

The week's business in pineapples (to May 28) was on a liberal scale and the market, in spite of the large arrivals, showed a strong tone. On the large sizes there was an advance of from 10c. to 15c. per crate. The week's arrivals included 124,500 crates from Havana, 1,000 crates from Nipe Bay, 22,200 crates from Porto Rico and 566 crates from Florida. The market on Monday, May 24, showed a very steady tone on all sizes in good sound Cuban stock suitable for shipping. There was a steady and higher tendency at the auction on Tuesday, with the general range as follows: 18s, \$1.35 to \$1.70; 24s, \$1.40 to \$1.70; 30s, \$1.20 to \$1.55; 36s, \$1.30 to \$1.40, and 42s, \$1.25 to \$1.35 per crate. There was an advance of the full equivalent of 10c. per crate over these figures at the sale on Wednesday so far as 24s, 30s and 18s were concerned.

The total imports of pineapples so far this month have been the largest in the history of the business, figuring up to approximately 462,214 crates from Havana and Porto Rico, compared with 262,686 crates in the same period last year. The April imports were 212,709 crates, compared with 73,937 crates in April last year.—N. Y. Fruitman's Guide.

REVISTA AZUCARERA.

Una zafra visible de 1,344,400 toneladas ya hechas—Perspectiva favorable para una mejora constante en los precios del mercado.

Escrita expresamente para la CUBA REVIEW por Willett & Gray, de Nueva York.

Nuestra última revista azucarera para esta publicación estaba fechada el 7 de Mayo. En aquella fecha los centrífugas cubanos se cotizaban á 2 9/16 cents. la libra, costo y flete, para su embarque en Junio, y á 3.86 cents. la libra para entrega inmediata y embarques á corta fecha.

Las cotizaciones en el momento de escribir estas líneas son 3.89 cents. la libra para entrega inmediata y embarques á corta fecha, y 2 9/16 cents. la libra para embarque á fines de Junio. Estas cotizaciones acusan una pequeña alza en los precios durante el mes en el mercado americano, y las cotizaciones extranjeras del azúcar de remolacha indican un curso semejante en los mercados europeos.

El 7 de Mayo se cotizó el azúcar de remolacha á 10s. 4½d. la de análisis 88° l. á b. en Hamburgo, subió á 10s. 7½d. el día 17, bajo á 10s. 6¾d. el día 19, después subió constantemente hasta que el día 22 la cotización era 10s. 8¾d., y desde entonces bajó á 10s. 6¾d. á cuyo precio cerró.

La equivalencia en precio de los centrífugas es ahora 33 cents. menos en las 100 libras que el precio de los de remolacha, habiéndose adelantado muy poco en el esfuerzo de colocar los centrífugas al nivel del precio del azúcar de remolacha. Esto se logrará, sin duda, en el futuro ya por la subida en la cotización de los azúcares centrífugas ó por la bajada en la de los de remolacha. Sin embargo, el límite de la subida de precio de los centrífugas puede resultar que sea el precio obtenible por el azúcar de Java, que serán probablemente los que suplirán la deficiencia en el abasto americano mientras se pone á la venta el azúcar de la próxima zafra de Cuba. Al presente, los azúcares de Java para su embarque en Junio y Julio pudieran comprarse á 11 chelines costo y flete, equivalente á 4.13 cents. por la de polarización 96° puesta en el muelle.

El curso del mercado azucarero depende mucho al presente de los resultados anunciados semanalmente con respecto á la zafra de Cuba. En estos momentos se sabe que el azúcar molido ya asciende á 1,344,000 toneladas, necesitándose sólo 56,000 toneladas para completar una zafra de 1,400,000 toneladas, incluyendo el azúcar retenido en los ingenios necesario para el consumo local en lo que resta de año.

La partida del arancel de aduanas concerniente al azúcar en el proyecto de ley para la revisión de los aranceles, ha sido aprobada en el Senado en la misma forma que lo fué en la Cámara de Representantes, y probablemente será aprobada por la Comisión de Conferencia y promulgada ley sin alteraciones importantes. Mucho se batalló en el Senado para eliminar el tipo holandés del colorido núm. 16, así como también el derecho diferencial de 7½ cents. en libra sobre los azúcares refinados, pero esas enmiendas fueron rechazadas, la primera por 11 votos solamente, y se ha anunciado que dicha enmienda volverá á ponerse á votación. No se espera una reducción general en los derechos arancelarios.

Con respecto á las cosechas de remolacha, se espera que haya un promedio de 2% de aumento en la siembra, en conjunto, sobre lo sembrado el año pasado. En Rusia puede que el aumento sea de un 7%, pero esa nación no puede exportar más de 300,000 toneladas á los países comprendidos en la convención.

Un importante detalle concerniente al azúcar cubano, es la apertura de la nueva y grande refinería de la American Sugar Refining Co. en Chalmette, cerca de Nueva Orleans, La., la cual habrá de surtirse en gran parte con azúcar de Cuba.

También se habla de un proyecto, que puede ó no cuajar, de establecer una nueva refinería de azúcar en Norfolk, Va., que se abastecería con azúcar de Cuba por medio de carros cargados al granel y transportados de la Habana á la estación terminal del nuevo ferrocarril en la Florida y de allí por vía férrea á Norfolk. Mencionamos este proyecto simplemente para que se vean los esfuerzos que hacen algunos para facilitar la refinación del azúcar mascabado en mayor escala.

La demanda de azúcar refinado en este mercado está encalmada, pues los consumidores están bien abastecidos por el presente. Ya están llegando cargamentos de frutas de la nueva cosecha, por lo que el consumo de azúcar continuará acusando aumento.

En resumen, todos los indicios son favorables para una continuada alza en las cotizaciones una vez que las existencias actuales se hayan agotado.

Nueva York, Junio 2 de 1909.

SUGAR REVIEW.

A Visible Crop of 1,344,000 Tons Already Made—Outlook Favorable for a Steady Improvement in Market Values.

Especially written for The CUBA REVIEW by Willett & Gray, of New York.

Our last sugar review for this magazine was dated May 7.

At that time, Cuba Centrifugals, 96 test, was quoted at 2 9/16c. c & f for June shipment, and 3.86c. per lb. for spot and near-by shipments.

The quotations at this writing are 3.89c. per lb. for spot and prompt shipment, and 2 9/16c. per lb. c & f for late June shipment. This shows only a slight rise in values for the month in our home market and the foreign quotations for beet sugar show a similar course in the European markets.

May 7, beet sugar opened at 10s. 4½d. for 88 analysis f. o. b. Hamburg, rose to 10s. 7½d. by the 17th, declined to 10s. 6¾d. on the 19th, then steadily advanced to 10s. 8¼d. on the 22d., and has since reacted to 10s. 6¾d., at which it closes.

The parity of Centrifugals is now 33c. per 100 lbs. below beet sugar, but little progress having been made in bringing Centrifugals to the level of beet sugar values. This will, no doubt, be done in the future either by the rise in Centrifugals or by a decline in beets. However, the limit of advance in Centrifugals may prove to be the price obtainable for Javas which are likely to supply the deficiency in American supplies pending the marketing of the next Cuban crop. At the moment Javas for June-July shipment might be bought at 11 shillings c & f, equal to 4.13c. landed for 96 test.

The course of the market at present is largely influenced by the results reported weekly from the Cuba crop. At this writing, there is a visible crop already made of 1,344,000 tons, requiring only 56,000 tons to complete a crop of 1,400,000 tons, including an amount held on plantations necessary for the local consumption for the remainder of the year.

The sugar schedule of the tariff bill has passed the Senate as it came from the House of Representatives and will probably go through the Conference Committee and become a law without material change. Quite an effort was made in the Senate to do away with the No. 16 Dutch Standard of color and, also, with the 7½c. per lb. differential on refined, but these amendments were rejected, the former by 11 votes only, and notice has been given that this amendment may be voted on again. There is no expectation of a general reduction of duty rates.

Regarding European beet crops, it is expected that there will be an average of about 2% increase in sowings as a whole from last year. Russia may increase 7%, but cannot export but 300,000 tons to convention countries.

An important feature of the sugar trade for Cuba is the opening of the big new refinery of the American Sugar Refining Company at Chalmette, near New Orleans, La., which must draw a large part of its supplies from Cuba.

There is, also, a project talked about which may or may not be put through of a new sugar refinery at Norfolk, Va., to be supplied with sugar from Cuba, by cars loaded with sugar in bulk and transported from Havana to the terminus of the new railroad in Florida, and then by rail to Norfolk. We merely mention this as showing what progress is making in some minds to facilitate the turning of raws into refined by new facilities.

Our refined sugar market is now quiet, the trade generally being fairly well supplied. Large fruit crops are now coming in and consumption of sugar should continue to show increases.

Altogether, the outlook is favorable for a steady improvement in market values after the present surplus stocks have been absorbed.

New York, June 2, 1909.

The Sugar Mills of Cuba.

Eastward from Havana for hundreds of miles there is little to be seen but the miles and miles of sugar-cane, each estate dominated by its "house," or enormous mill for grinding. At night one of these mills looks like some great fortification, or more like one of the English cathedrals, with its picturesque skyline towering high in the air. All its salient points are accentuated by arc lights. The massive machinery within is illuminated by incandescents gleaming

through the clouds of steam, redolent of cane juice, boiling molasses, and from time to time the sulphurous gases from the little locomotives moving back and forth along the tracks outside, while the dim workmen stand at their various stations, or move to and fro upon their diverse occupations. The gigantic machinery plies its ponderous arms, converting the rivers of cane into juice, flowing along in streams into tanks, then pumped up into the converters, where it is boiled to the thickness of molasses.

CABLE ADDRESS: Turnure.

NEW YORK,
64-66 Wall Street.**LAWRENCE TURNURE & CO.****BANKERS**

Deposits and Accounts Current. Deposits of Securities, we taking charge of Collection and Remittance of Dividends and Interest. Purchase and Sale of Public and Industrial Securities. Purchase and Sale of Letters of Exchange. Collection of Drafts, Coupons, etc., for account of others. Drafts, Payments by Cable and Letters of Credit on Havana and other cities of Cuba; also on England, France, Spain, Mexico, Puerto Rico, Santo Domingo, Central and South America.

CORRESPONDENTS:

HAVANA—N. Gelats y Ca.
MEXICO—Banco Central Mexicano.

LONDON—The London Joint Stock Bank, Ltd.
PARIS—Heine et Cie.

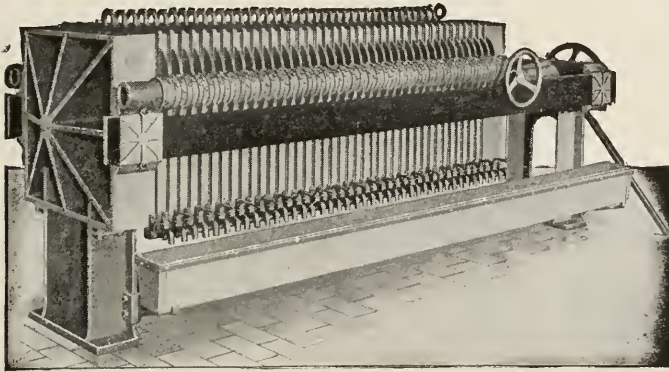

**Prensas de
Filtrar
para Ingenios**

**SHRIVER
Filter Presses**

Write us for Cata-
logue, Prices and
Information.

T. SHRIVER & CO.
814 Hamilton Street
HARRISON, N. J.

Sole Agents for Porto Rico
McMurtrie-Guiler Co.
SAN JUAN, P.R. and BEAVER BLDG.,
BEAVER STREET, NEW YORK

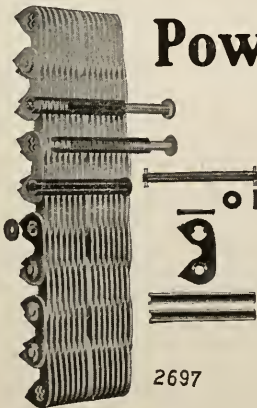
RENOLD - The MAXIMUM**Power-Transmission****CHAIN**

2697

Write for Booklet

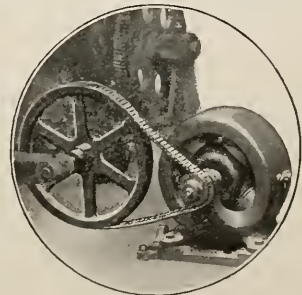
**LINK-BELT COMPANY****299 Broadway, New York City**

When the crystallization has progressed sufficiently, the centrifugals take hold of it and whirl all the moisture out of it, and the sugar is made, ready for the refineries.

Outside, all is commotion and stir, the locomotives plying along the network of tracks bringing wood, or cane, or taking away thousands of bags of sugar, while the great cane-laden carretas, drawn by six or eight oxen yoked by the horns, creak and groan beneath their tons of cane.

And this continues all throughout the season, day and night, without ceasing, unless there may be some breakdown.

In Cuba there are hundreds of these mills, representing millions and millions of dollars, and more than one hundred distinct companies. All sorts and conditions of men are employed in them, from the peons in the fields to the college-bred man at the desk, in the laboratory, or directing the workmen.—Living Church, Milwaukee, Wis.

The Advertising Rates

OF THE

CUBA REVIEW

permit of the use of attractive space at moderate cost.

Rates on Application

FOR SALE JUNE DELIVERY

We offer for June delivery one 26" x 72" Pratt "IMPERIAL" Cane Crusher complete with Compound Gearing, Hydraulics and Corliss Engine. Open Hearth Steel Shafts, Krajewski type rollers. One 34" x 72" Three-Roller Pratt "IMPERIAL" Cane Mill, complete, with Compound Gearing, Hydraulics and Corliss Engine. Open Hearth Steel shafts, heavily built for highest pressures. LARGE JOURNALS.

EXTREMELY NARROW TURN PLATE

The above Cane Mill and Crusher can be worked together. For full information, particulars, prices, etc., address

PRATT ENGINEERING AND MACHINE COMPANY

Atlanta, Georgia, U. S. A. 80 Wall St., New York City

THE EXETER MACHINE WORKS

PITTSTON, PA.

MANUFACTURE

Steam and
Electric
Hoists

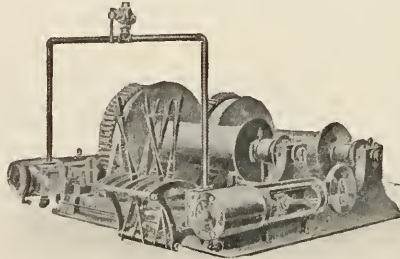

Elevators
Conveyors
and
Handling
Machinery

**CARROS
PARA
CAÑA**

De todas
clases

Fabricados
de madera
ó áceró

Dirección
Telegráfica
RAMALIAM

**RAMAPO
IRON WORKS**

30 Church St.
New York, N. Y.

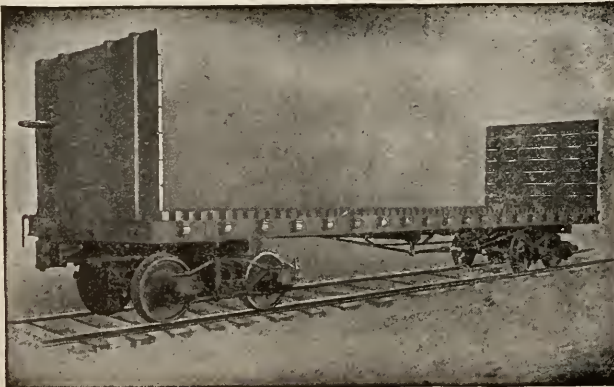

**CANE
CARS**

OF EVERY
DESCRIPTION
OF STEEL
OR WOOD

Cable Address
RAMALIAM

**RAMAPO
IRON WORKS**

30 Church St.
New York, N. Y.

CANADA LAND AND FRUIT CO.

LOS INDIOS

Owners

ISLE OF PINES

CANADA AND LOS INDIOS TRACTS

Location: Siguanea Bay. The Deep-Water Harbor of the Island.

We have at our new and progressive town of Los Indios a sawmill, planing-mill, general store, school, hotel, church, post office and nursery, all under the supervision of Americans. A strictly American town.

We also have rowboats and gasoline launch for pleasure parties. Fishing and hunting the best.

We own the finest citrus fruit, vegetable and tobacco land on the island. We offer same for sale in acres to suit purchaser, either for cash or on installments. Special inducements to actual settlers.

Write for prospectus and further information to our general office,
Marinette, Wisconsin.

WILLETT & GRAY, Brokers and AgentsFOREIGN AND
DOMESTIC**SUGARS**RAW AND
REFINED**52 WALL STREET, NEW YORK**

Publishers of Daily and Weekly Statistical Sugar Trade Journal—the recognized authority of the trade.
TELEGRAPHIC MARKET ADVICES FURNISHED

PURE
DISTILLATION
OF
SUGAR CANE

BACARDI RON

Sole United States Agent

D. S. de JONGH 128 Water St.

BEST MIXER
FOR
HIGHBALLS
AND
OTHER DRINKS

“SUGAR NEWS FROM CUBA”

is the title of the interesting correspondence from the tropical island, appearing in every issue of “THE AMERICAN SUGAR INDUSTRY AND BEET SUGAR GAZETTE.”

Capable correspondents, in every part of the world, write regularly, covering reliable sugar news for “THE AMERICAN SUGAR INDUSTRY AND BEET SUGAR GAZETTE.”

In the United States, Cuba and Mexico, \$2 per annum. In Foreign Countries, \$2.50 per annum.

Subscribe for it if you want to keep posted. Sample copy free. Send for advertising rates.

Address: BEET SUGAR GAZETTE CO.

No. 5 Wabash Avenue,

Chicago, Ill., U.S.A.

TWO IMPORTANT MAPS

Blue-prints of Cuba, showing the location of the Sugar Plantations and the Rural Guard Stations of the Island. Specially prepared for The CUBA REVIEW. Each 60 cents. Either map with a year's subscription, 75 cents. Both blue-prints and magazine, one year, \$1.

The Rural Guard of Cuba

The Sugar Plantations of Cuba

HAVANA

CUBA

National Bank of Cuba

Government Depository

Capital, Surplus and Undivided Profits
\$6,000,000.00

HEAD OFFICE, HAVANA

FIFTEEN BRANCHES IN CUBA

New York Agency, 1 Wall Street

COLLECTIONS

THE TRUST COMPANY OF CUBA HAVANA.

Capital and Surplus \$540,000

Transacts a General Trust
and Banking Business

REAL ESTATE DEPARTMENT

Examines Titles, Collects Rents,
Negotiates Loans on Mortgages

Correspondence Solicited from
Intending Investors

OFFICERS

J. A. Gonzales Lanuza, . . . President
Norman H. Davis, . . . Vice-President
F. J. Sherman, . . . 2nd Vice-President
O. A. Hornsby, . . . Secretary and Treasurer
J. M. Hopgood, . . . Asst. Treasurer

Offices: CUBA 31, HAVANA

The Royal Bank of Canada

INCORPORATED 1869

Fiscal Agent of the Government of the Republic of
Cuba for the Payment of the Army of Liberation

CAPITAL AND RESERVE, \$8,200,000.00

TOTAL ASSETS, . . . \$45,500,000.00

Head Office, MONTREAL

NEW YORK AGENCY, 68 William St.

Branches in Havana: Otrapia 33, Gallano 92;
Matanzas, Cardenas, Manzanillo, Cienfuegos,
Camaguey and Santiago de Cuba.

ESTABLISHED 1844

H. UPMANN & CO. Bankers

TRANSACTION A GENERAL BANKING BUSINESS
CORRESPONDENTS AT ALL THE PRIN-
CIPAL PLACES OF THE ISLAND

Safe Deposit Vaults

Manufacturers of the Famous H. Upmann
Brand of Cigars

FACTORY: Paseo de Tacon 159-163
OFFICE: Amargura 1-3

Established 1876

N. GELATS & COMPANY

Bankers

Transact a general banking
business.

Correspondence at all the prin-
cipal places of the island.

SAFE DEPOSIT VAULTS

Office: Aguiar 108

MOLINA BROTHERS

Customs Brokers

Forwarders, Lighterage and Shlp Agents

Officios 52, Havana

H A V A N A

United Railways of Havana

Cuba's First and Foremost Railroad. (First Section opened to Traffic in 1837)

Takes you to All Parts of the Island East of Havana Comfortably and Quickly through Varied and Beautiful Scenery and Past Extensive Sugar Plantations

Parlor, Observation and Sleeping Cars attached to principal trains.

Full information and through tickets to all points in Cuba reached via the United Railways of Havana can be obtained of the following:

Thos. Cook & Son
Seaboard Air Line R. R.
Foster & Reynolds
Atlantic Coast Line R. R.
Illinois Central R. R.

Ward Line
Florida East Coast Railway
Washington Southern Railway
Peninsular & Occidental SS. Co.

Southern Pacific R. R.
Mobile & Ohio R. R.
Raymond & Whitecomb Co.
Louisville & Nashville R. R.
Munson Line

THE HERRADURA LAND COMPANY

Office: No. 3 Bernaza Street, Habana, Cuba
CAPITAL, \$440,000.00

Own 22,000 acres of land in the Province of Pinar del Rio, suitable for Oranges, Vegetables, Cotton, Corn and Tobacco. The land has all been surveyed and sub-divided into 40-acre tracts and is offered for sale in acres to suit the purchasers, for Cash or on instalments.

We have a new and progressive American town with Railroad Station, Telegraph, Telephone, Stores, Hotel, American School, all within short distance from Havana City.

- Titles perfect. Transportation from Havana free for buyers.

WRITE OR CALL FOR INFORMATION.

LA AMBROSIA

MANUFACTURERS of the well-known brand of Chocolate, "LA AMBROSIA," Biscuits, Macaroni, Bonbons, all kinds of Confectionery

GUAVA PASTE AND EXTRA FINE GUAVA JELLY

ORDERS RECEIVED FOR EXPORT

BALDOE, FERNANDEZ & CO.

Write for quotations.

Sol 21 & 23, Havana, CUBA

'PHONE No. 401

P. O. BOX 741

FERNANDO de GARDENAS

CUSTOM HOUSE BROKER

:: Import and Export Agent ::

Munson S. S. Line Building

Obispo No. 1, Havana, Cuba

JAMES S. CONNELL & SON

Sugar Brokers

Established 1836, at 105 Wall Street

Cable Address—"Tide, New York"

Amelia Vera de Leus, the first woman attorney in Cuba to appear in a criminal case, or in fact to appear in a Cuban court, recently filed her notice of appearance in the Supreme Court to argue the case of "Tin" Marin or Alberto Ponce, one of the negro witches sentenced to death for the murder of little Luisa Valdes in Alacranes.

LA ATALAYA

(the best located colony in Cuba) and other Cuban lands for sale in tracts of all sizes, and for all purposes.

STREET & STRICKLAND

BOX 191

CAMAGUEY, CUBA

Journal d'Agriculture Tropicale

Founded by J. VILBOUCHEVITCH
164 Rue Jeanne d'Arc Prolongée.

Subscription, One Year - - - - 20 Francs

Deals with the leading questions of the hour, agricultural and commercial, of interest to tropical countries. International in character. Illustrated. Monthly. Descriptions of machines for tropical crops a speciality. Complete review of new agricultural publications. Commercial part intelligible for every one and always interesting. 150 contributors in West and East Africa, East and West Indies, Java, Mauritius, Central and South America, and throughout the tropical world.

PURDY & HENDERSON, Inc.

Engineers and Contractors

New York Chicago Boston
Cuba Office, Empedrado 32, Havana

HENRY E. BROWN
Pharmacist

Shipping and Export Chemist and Druggist, Ships' Medicine Chests Furnished and Replenished. Prescriptions Compounded by a Graduate in Pharmacy.

Trusses, Surgical Appliances, etc.

Office and laboratory, Room 36.
116 BROAD ST., NEW YORK

Telephone Call: 274-A Hamilton.

JOHN M. DONOVAN

13 Summit St. (Atlantic Dock) - BROOKLYN

Dealer in

Dunnage Mats

FOR BAG FLOUR, BAG AND BULK GRAIN
AND GENERAL CARGOES.

— BAGS AND BAGGING —

SUGAR CANE PLANTATIONS

Cacao (chocolate and cocoa) and Coffee Plantation—Orange and Grapefruit Groves. Land for the small settler on easy terms. In the best district of Cuba—Rio Cauto Valley. Within 40 miles of Santiago and Nipe Bay. Write for Booklet.

RIO CAUTO SUGAR COMPANY, 50 Church St., N. Y. City

WELL DRILLING

4 in. to 8 in. diameter, to desired depth

M. D. ALBERTY Ceballos, Cuba

M. J. CABANA
COMMISSION MERCHANT

P. O. Box 3, Camaguey

Solicits Correspondence from all the important cities of the United States of America.

THE BIG FOUR ROUTE

3 Daily Trains Each Way 3

Parlor Cars, Sleepers, Dining Cars.

Through Train Service
BETWEEN

Cincinnati, Toledo and Detroit

(Via Michigan Central R. R.)

Ask for Tickets Via

BIG FOUR

BARTLE

Twenty-five thousand acres of the richest and best watered land in Cuba on the main line of the Cuba Railroad, with the finest station on the line, 120 miles from Nipe Bay—the best harbor on the Island; also the nearest to New York. No swamps or insect pests.

BARTLE is not in the wilderness—we offer all the comforts of civilization, GOOD STORES, HOTEL, CHURCH, SCHOOL, SAW-MILL, Etc.

TWO MAILS DAILY.

SUGAR, FRUITS, TOBACCO AND VEGETABLES produce wonderful crops at BARTLE.

When you consider Soil, Transportation, Social, Religious and Educational advantages, BARTLE offers something not to be had elsewhere in Cuba. Write for particulars.

"Ten Days in Cuba," just published by Hon. Nicholas J. Whalen, Speaker of the Michigan Legislature, may be had through newsgagents at 25 cents per copy, or will be sent free to any address by the owners of the Bartle Colony. Address, Duncan O. Bull, Gen'l Mgr. Cuban Realty Company, Limited, Temple Building, Toronto, Can., or 141 Broadway, New York City.

DUNCAN O. BULL, General Manager

CUBAN REALTY CO., Ltd. Temple Bldg., Toronto, Canada
141 Broadway, New York **Bartle, Cuba**

MOBILE, ALA.

HOME INDUSTRY IRON WORKS

Engines, Boilers and Machinery

Manufacturing and Repairing of all kinds. Architectural Iron and Brass Castings. Light and Heavy Forgings. All kinds of Machinery Supplies.

Steamship Work a Speciality

A. KLING, Prop.
 JAS. S. BOGUE, Supt.

MOBILE, ALA.

The Principal Hotels in Mobile, Ala.

THE CAWTHON (FIREPROOF) **THE BIENVILLE** (MODERN)

European, 175 Rooms

European, 150 Rooms

\$1.50 Up

\$1.00 Up

Both Hotels in Heart of City, Facing Bienville Square

OLLINGER & BRUCE DRY DOCK CO.

Ship Builders and Repairers

Operating seven Sectional Dry Docks, capacity 1,000 tons, and one Balance Dock, capacity 3,000 tons. Equipped with Air Plant for operating Pneumatic Tools, and Steam Pump for cleaning vessel's bottoms.

25-TON DERRICK BARGE AND STEAM PILE DRIVER.

Material of all kinds kept on hand. Shipwrights, Caulkers, Painters, Sparmakers and Riggers furnished promptly, and at reasonable rates. Correspondence solicited.

MOBILE, ALA.

BUSINESS FIRMS OF CAIBARIEN

ANGEL MATA

Comerciante.
Caibarién, Cuba.

Apartado 114. Cable: *Mata.*"

Ferretería, Mueblería y Locería
LA LLAVE

DE INCHANSTI Y HNO.
Caibarién, Cuba.

Marti 11 y 13. Apartado 24.

R. CANTERA Y CA.

(S. en C.)

Comerciantes Importadores, Caibarién.
Escobar 28.

A. ROMANACH

Almacenistas Importadores de Viveres,
(S. en C.)
Caibarién.

P. B. ANDERSON,

Ship Broker. U. S. Consular Agent,
Caibarién, Cuba.
Agent for Munson Steamship Line and Lloyds.

MARTINEZ & CO., S. en C.

Comerciantes Banqueros,
Importadores de Viveres,
Exportadores de Azucar.

Apartado 115. Telegrafo: Urquiza.

COMERCIO,

Hotel - Restaurant - Cafe
De José Urquiza.

Calle de Marti nums 16 y 18 - Caibarién

LA MARIPOSA DE EVARISTO BERGNES

Importador de Peletería y Talabartería, Fabricante
de Calzado.
Caibarién.

Apartado 104. Telegrafo: "Bergnes."

YMAZ Y CA.

Ymportadores de Ferrería en General.
Apartado de Correos Num. 15,
Caibarién, Cuba.

Calle Justa Num. 27. Cable: "Imaz."

ARIAS Y COMP

Provisiones, Loza y Muebles.
Cuba Num. 20, Esquina a Marti,
Caibarién, Cuba.
Correo Apartado Num. 15. Telegrafo: "Arias."

ZARRAGA Y CA.,

Caibarién, Cuba.
Casa Banca. Exportadores de Azucar.

BONIFACIO DIAZ,

Gran Peletería y Sombrería.
Marti 17. Caibarién
Constantes novedades en los dos giros de esta casa.

RODRIGUEZ Y VINA, S. en C.,

Almacenistas Importadores de Viveres en General.
Comisiones y Consignaciones,
Consignatarios de Buques.
"Depositos de Carburo."

Telephone, 33 Hamilton
Night Call, 411 Hamilton

Cable Address:
"Abiworks," New York

Atlantic Basin Iron Works

Engineers and Boiler Makers

Machinists, Plumbers, Tinsmiths, Pipe Fitters, Blacksmiths, Coppersmiths,
Pattern Makers, Sheet Iron Workers, Iron and Brass Castings. Steamship
Repairs a Specialty.

Cor. Imlay and Summit Streets

Brooklyn, N. Y.

John Munro & Son

Steamship and
Engineers' Supplies

13 Conover Street, Brooklyn, N. Y.

Cable Address: Kunomale, New York

Telephone, 196 Hamilton

Telephone
215 Hamilton

Box 186
Maritime Exchange

YULE & MUNRO SHIPWRIGHTS

Caulkers, Spar Makers

Boat Builders, Etc.

No. 9 SUMMIT STREET
Near Atlantic Dock BROOKLYN

WINTER HAVEN NURSERIES

A. M. KLEMM, Proprietor

Established 1884.

Winter Haven, Fla.

Wholesale Growers of Citrus Stock of the best commercial varieties. We guarantee our extensive Stock to be well grown, free of insects and true to name.

Silver Cluster Grape Fruit our leading Specialty.

Prices right. Grading and Packing perfect.

Write for Catalogue.

CUBA INFORMATION

IS THE TITLE OF A BOOK WHICH GIVES DEFINITELY and concisely just such information concerning Cuba as is desired by the business man or prospective investor who is interested in this fertile island—*climate, soil, products, fruit growing, live stock, tobacco, sugar, customs duties, banking, investments, colonics, land titles, laws, and a hundred other matters.*

SEND 25 CENTS FOR A COPY

and if you want any specific information that could not be covered in such a book,

Ask Mr. Foster No. 1 Madison Avenue, NEW YORK

Mr. Foster also has information offices in Philadelphia, Washington, Atlantic City, Jacksonville, St. Augustine, Daytona, Palm Beach and Miami, Florida, and in Havana and Camaguey, Cuba. FREE INFORMATION—no fees ever asked or accepted.

The Standard Guide to Cuba— Reliable—accurate—maps—illustrations.
50 cents.

FOSTER & REYNOLDS, 1 Madison Avenue, New York.

BUSINESS FIRMS OF SANTIAGO

E. GIRAUDY & CA.
ALMACEN DE VIVERES
Marina baja n. 33, Santiago de Cuba.
Agentes de Schlitz Beer.

JULIAN CENDOYA
Steamship Agent and Broker
COMMISSION MERCHANT
CABLE: Cendoya. Santiago de Cuba.

VALLS, RIBERA & CA.
(S. en C.)
Importadores de Ferreteria y Machinery.
Telégrafo: Valribe.
Santiago de Cuba y Manzanillo.

A. B. C. Code, 5th Edition. Telephone, 190.
P. O. Box, 95. Cable address: SILVAPA.

SILVA Y PARENO H.
General Commission Merchants.
Custom House Brokers—Forwarding Agents.
Consignees of the Cuban steamers of the Carlos J. Trujillo, S. en C., Line, formerly Menéndez & Co.
References:—J. Cendoya and Nat'l Bank of Cuba.

CAMP HERMANOS, Santiago da Cuba.
Ron Selecto "Golondrina" y "Carta Cuba."
Medalla de Oro, St. Louis, 1904.

RON BACARDI
DE BACARDI & CO., Distillers, Proprietors.
43 San Ignacio, cor. Santa Clara, Havana,
Santiago de Cuba.

LARREA Y BESEALIE
Importers of General Groceries and Exporters of
Cocoa, Wax, Honey and Woods.
Apartado 65, Marina Baja 46. Cable: Larrea.

Importación. Exportación.
L. ABASCAL Y SOBRINOS
Agentes de las líneas Pinillos Izquierdo y Ca., de
Cadiz. Larrinaga y Ca., de Liverpool. Compañía de Seguros, Aachen & Munich, Aix-la-Chapelle.

BROOKS & CO.
Bankers and General Commission Merchants.
Santiago and Guantánamo.

VINEGAR BEND LUMBER CO.

Manufacturers and Exporters

Long Leaf Yellow Pine Lumber and Timber

Cuban Business Our Specialty VINEGAR BEND, ALA., U. S. A.

Daily Capacity, 200,000 Feet

Cable Address: "TURNER"

Codes: A B C, Fourth Edition; Southards; Watkins; Western Union



SOBRINOS DE BEA & CO.

Bankers and Commission Merchants
Importación directa de todas los centros
manufactureros del mundo.

Agents for the
Munson Steamship Line, New York and
Mobile.

James E. Ward & Co., New York.
Serra Steamship Company, Liverpool.
Vapores Transatlánticos de A. Folch & Co.
de Barcelona, España Independencia
Street 17/21.

MATANZAS, CUBA.

JOHN W. McDONALD

COAL, WOOD, LUMBER
and TIMBER of Every
Description

112 WALL STREET

Near South Street NEW YORK

Yard: 58-68 Beard Street, Erie Basin

Telephones:

Office, 1905 John Yard, 316 Hamilton

Nothing could better be calculated to make the people of the United States genuinely tired of Cuba Libre than to be told that they are to pay out of their own pockets the large sum of seven millions of dollars to defray the expenses of a Cuban picnic.—Havana Telegraph.

"The Comfortable Way"

Between the East and the West is via the Toledo, St. Louis and Western Railroad

"Clover Leaf" Route

Rates lower than by any other direct line. Send four cents in stamps for copy of "Get Out or Get in Line," a booklet by Mr. Elbert Hubbard, Chief of the Roycrofters.

GEO. J. CHARLTON,
General Passenger Agent.
Chicago, Ill.

THE SNARE AND TRIEST COMPANY

CONTRACTING ENGINEERS

Steel and Masonry Construction
Piers, Bridges, Railroads and Buildings

We are prepared to furnish plans and estimates on all classes of contracting work in Cuba.

N. Y. Office
143 LIBERTY ST.

Havana Office
LA LEAL BUILDING

W. H. Bennett

F. W. Hvoslef

Bennett, Hvoslef & Co.

18 Broadway, New York

Steamship Agents and Ship Brokers

Cable: "Benwalsh"

Munson Steamship Line

GENERAL OFFICES

82 BEAVER STREET, NEW YORK

NEW YORK-CUBA SERVICE

PASSENGER AND FREIGHT

| Steamer | New York Sail | Nipe Arr. | Nuevitas Arr. | Nipe Arr. | Banes Arr. | Gibara and Vita Arr. | Pto. Padre Arr. | Nuevitas Sail | Nipe Sail | New York Arr. |
|-----------------|------------------|--------------|------------------|--------------|---------------|-------------------------|--------------------|------------------|--------------|------------------|
| Curityba | June 16 | | June 21 | June 23 | June 25 | June 26 | | July 1 | July 2 | July 7 |
| Olinda | June 30 | July 5 | July 7 | | | July 10 | July 13 | July 15 | July 16 | July 21 |

Steamers sail from PIER 9, EAST RIVER, foot of Old Slip, New York

SAILINGS SUBJECT TO CHANGE WITHOUT NOTICE

FREIGHT ONLY

NEW YORK TO CAIBARIEN, MATANZAS, CARDENAS AND SAGUA

MOBILE-CUBA SERVICE

FREIGHT ONLY

REGULAR SAILINGS—MOBILE TO HAVANA—MOBILE TO N. S.—S. S. CUBAN PORTS.

BALTIMORE-COLON SERVICE

FREIGHT ONLY

REGULAR SAILINGS—BALTIMORE TO COLON

AGENTS IN CUBA

ASMUS LEONHARD

Cuban Freight and Passenger Agent

76 Cuba Street, Havana

| | |
|-------------------------|-----------------------------|
| BERNABÉ SANCHEZ É HIJOS | Nuevitas |
| FRANCISCO PLA | Puerto Padre |
| BEOLA & CO. | Gibara |
| M. J. CABANA | Camaguey |
| J. L. DAUTERIVE | Antilla (Nipe Bay), Oriente |

For Southbound reservations address the General Offices, New York

For Northbound reservations address the agent at the port of embarkation

Lillie Multiple Evaporators

Model of 1904-1905 (Patented)

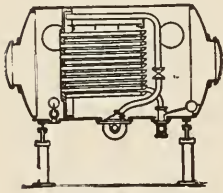

Model 1904-1905
ECONOMY its ROAST

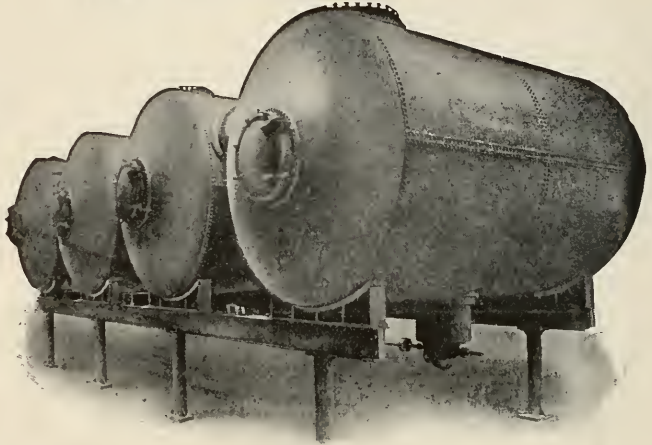

Lillie Quadruple effect for Nipe Bay Co., Cuba (Model 1904-1905. Condensers not shown.) Capacity, 600,000 gallons cane juice per 24 hours.

Apply for reading matter and information to

The Sugar Apparatus Manufacturing Co.

328 Chestnut St., Philadelphia, Pa.

S. MORRIS LILLIE, President.

LEWIS C. LILLIE, Secretary and Treasurer

BALDWIN LOCOMOTIVE WORKS

Broad and Narrow Gauge

Single Expansion and Compound

LOCOMOTIVES

Compressed Air Locomotives. Electric Locomotives with Westinghouse Motors

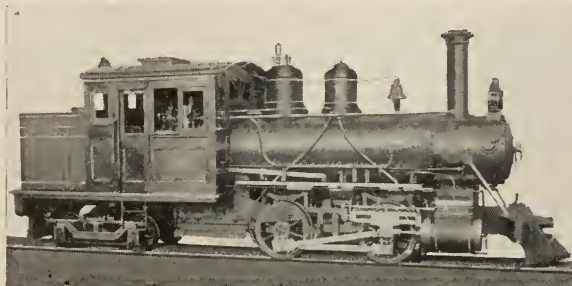

PLANTATION LOCOMOTIVES

For all Gauges of Track. To meet all conditions of service. Specifications furnished on application.

BURNHAM, WILLIAMS & CO.

Philadelphia, Pa., U. S. A.

Cable Address: "Baldwin, Philadelphia"

Agents for Cuba, Krajewski-Pesant Co., Aguiar 92, Havana, Cuba.

THE CVBA REVIEW



10 Cents A Year JULY 1909 5 Cents A Copy
Published by the Munson Steamship Line, 82-92 Beaver Street, New York City.

CEBALLOS "THE GARDEN SPOT OF CUBA"

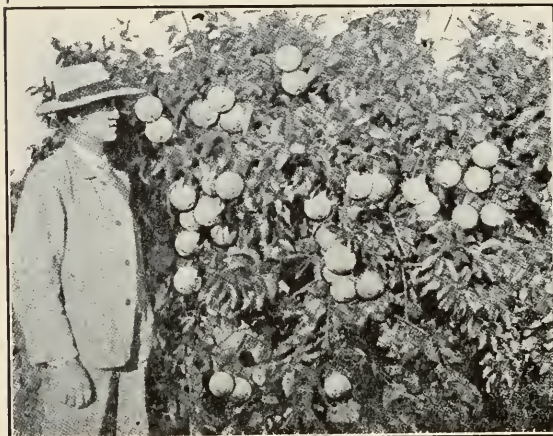

FOUR-YEAR-OLD GRAPE-FRUIT TREE AT CEBALLOS

After eight years of developing the country, creating industries, establishing conditions—paving the way—we now invite HOMESEKERS to share our prosperity. No pioneering. All conveniences of modern civilization. Send for literature.

GEO. H. GILLETT, Secretary **43 EXCHANGE PLACE, NEW YORK**

Would you like to own a
HOME
in this
Ever-Summer Land?

Intelligence, energy and moderate capital will here win a fortune for you in Fruits, Vegetables and Sugar.

PRATT "IMPERIAL"

**Sugar Cane Machinery and Evaporating Apparatus.
Complete Plants Erected and Delivered to Owner Under
Guaranteed Capacity of Mills and Quantity.
Sugar House Pumps.**

We have nearing completion, subject prior sale, September 1st delivery, one 34" x 72" Pratt "IMPERIAL" Mill Complete, with Hydraulics, Compound Gearing & Corliss Engine, also one 26" x 72" Pratt "IMPERIAL" Cane Crusher, complete with Hydraulics, Compound Gearing and Corliss Engine. For description see page 34.

STEAM PUMPS

**SPECIAL PARTS of MACHINES, any size or kind; and
HEAVY CASTINGS famous for quality.**

We maintain Export Sales Offices at 80 Wall St., New York, in charge of Mr. N. A. Helmer, an eminent Sugar Mill Engineer of wide experience. We solicit your business with the assurance of every courtesy and perfect satisfaction.

**Pratt Engineering & Machine Co. ATLANTA, GA.
U. S. A.**

HAVANA, CUBA, OFFICE: LONJA DEL COMERCIO No. 509

Successors to FULTON FOUNDRY & MACHINE WORKS, Atlanta, Ga.

Tivoli Beer

—Enough said.

Havana Brewery

Havana

BUCKEYE NURSERIES

M. E. GILLETT, Proprietor

TAMPA, FLORIDA, U. S. A.

ORANGE, LEMON AND GRAPE FRUIT TREES

LARGEST CITRUS NURSERY IN THE WORLD

QUALITY VARIETY DELIVERY

Price may be forgotten—Quality NEVER.

We grow nothing but standard Varieties which we can recommend to the trade as Money-Makers. Having had 29 years' experience we thoroughly understand packing trees for long distance shipments.

We guarantee our trees to be True to Name, Free from White Fly and to ARRIVE AT DESTINATION IN GOOD CONDITION.

Consider the future and protect your investment by planting reliable trees from

THE BUCKEYE NURSERIES

LA GLORIA

The Colony where the Best Oranges are Raised

LA GLORIA FRUIT CARRIED OFF THE BLUE RIBBONS AT THE 1908 EXHIBITIONS OF THE CUBAN NATIONAL HORTICULTURAL SOCIETY AT HAVANA. THERE IS NO OTHER "JUST AS GOOD."

WRITE FOR HANDSOME ILLUSTRATED BOOKLET.

CUBAN LAND AND STEAMSHIP CO.

No. 32 Broadway, New York City

BRENAU



**COLLEGE
CONSERVATORY**

FOR YOUNG LADIES

GAINESVILLE, GA.

300 BOARDERS—representing 28 states. All standard courses. Unusual advantages in music, art and oratory. 35 teachers with American and European Training. Healthful climate in Piedmont region of the South near Atlanta. 22 Buildings including chapter houses for sororities. Campus recently enlarged to 75 acres. Gymnasium and athletic field. Expenses \$300 to \$500. Summer School June 24th. Chautauqua July 4th to July 31st. Address P. O. Box 250 for Catalog.

OF VALUE IN CUBA

Dixon's Ticonderoga Flake Graphite for lubricating all kinds of machinery. Increases the value of all oils and greases, and saves wear, time and money. It will pay to send for free sample and pamphlet.

JOSEPH DIXON CRUCIBLE CO.

Jersey City, N. J.



Sugar Plantation—Cuba Railroad.

The Cuba Railroad

This new line completing the railroad connection between Havana and Santiago, and Antilla, on the Bay of Nipe, is of standard gauge and similar in its construction and equipment to the better class of northern lines. All of its important bridges are of steel and masonry, and the line generally is rock-ballasted. The main line passes along the center of the eastern and wider half of Cuba, and opens up a matchless and most picturesque agricultural region, and passes through the tropical forests of mahogany, cedar, lignum vitæ, ebony and many other trees, hung with vines and millions of orchids. Palm trees of magnificent aspect and great variety abound everywhere. The famed Parana and Guinea grasses, covering most of the open districts and standing from six to twelve feet high and

green the year round, together with frequent running streams, make this an ideal cattle country. No food has to be put up and no shelter is required. The rich soils everywhere are adapted to sugar, tobacco, cotton, corn and an endless variety of products. The swamps which occur at places along the coasts of Cuba are absent from the interior, which is high, dry and exceptionally healthy. The trade winds blow across Cuba every day, and bring to all parts fresh sea air; the extreme heat of northern summers is consequently unknown and the humidity of other tropical countries is also unknown.

The Cuba Railroad Company's **Hotel Camaguey**, at Camaguey (formerly Puerto Principe) is by far the most popular resort in Cuba, Spanish in style, and provided with bath rooms and other modern conveniences, and is first-class in all respects.

This old city has about 40,000 inhabitants, is picturesque and is situated in a beautiful and remarkably healthy district. The hotel is especially favored by those wishing to spend some weeks or months in a matchless sub-tropical climate.



A Corridor, Hotel Camaguey.



Map of The Cuba Railroad.

THE CUBA REVIEW

"ALL ABOUT CUBA"

An Illustrated Monthly Magazine, 82-92 Beaver Street, New York

MUNSON STEAMSHIP LINE, Editors and Publishers

SUBSCRIPTION

50 Cents Per Year - - - - - 5 Cents Single Copy
Advertising Rates on Application

Vol VII.

JULY, 1909

No. 8

Contents of This Number

- The cover illustration shows the Cuban milkman on his pony preparing to take his product to the city.
- Government matters are unusually interesting now. The Cuban budget, the claim of Spain against Cuba for sixty million dollars, the condition of the former country's trade with the island, the American protest by the United States government concerning the discrimination against American manufacturers, the Cuban census, and other information will be found on pages 7 to 10.
- The apparatus for operating the national lottery is described and illustrated on page 11. These illustrations were taken at the shops in Havana where the machinery is being made.
- New Custom House districts are described in a circular issued by the Cuban Secretary of State under date of last month. This has been translated for the CUBA REVIEW and will be found on page 13.
- How Havana hotels are being improved will be found on page 14.
- Comment of the United States newspapers on the Cuban situation, translated into Spanish, will be found on page 15.
- Current comment of the United States press, with some cartoons, on pages 16 and 17.
- What the American Steel Company is doing in Havana, and the kind of buildings they are constructing, is illustrated on page 18.
- Some general notes, together with a half-tone of the Chinese Minister's house in Havana, on page 19.
- The new locomotive repair shops of the United Railways of Havana are illustrated on page 20.
- Cuban railway earnings will be found on page 21.
- Commercial matters of great interest to manufacturers are touched upon on pages 22 and 23.
- A thriving American colony in Cuba, with some unique illustrations, on page 24.
- Tobacco exports, improvements for Havana's harbor, and other interesting items on page 25.
- Isle of Pines news is given on page 26.
- "Cuban Goats," especially written for the CUBA REVIEW by Dr. N. S. Mayo, former Chief of the Department of Animal Industry, of Cuba, will be found on pages 27 and 28, together with Cuban fruit receipts and prices at New York.
- Further agricultural items are on page 29.
- The Sugar Review to date, by Messrs. Willett & Gray, will be found on page 30.
- The same sugar article in Spanish on page 31.
- Some interesting notes of value to cane growers will be found on page 32.

MANY BEAUTIFUL ILLUSTRATIONS.

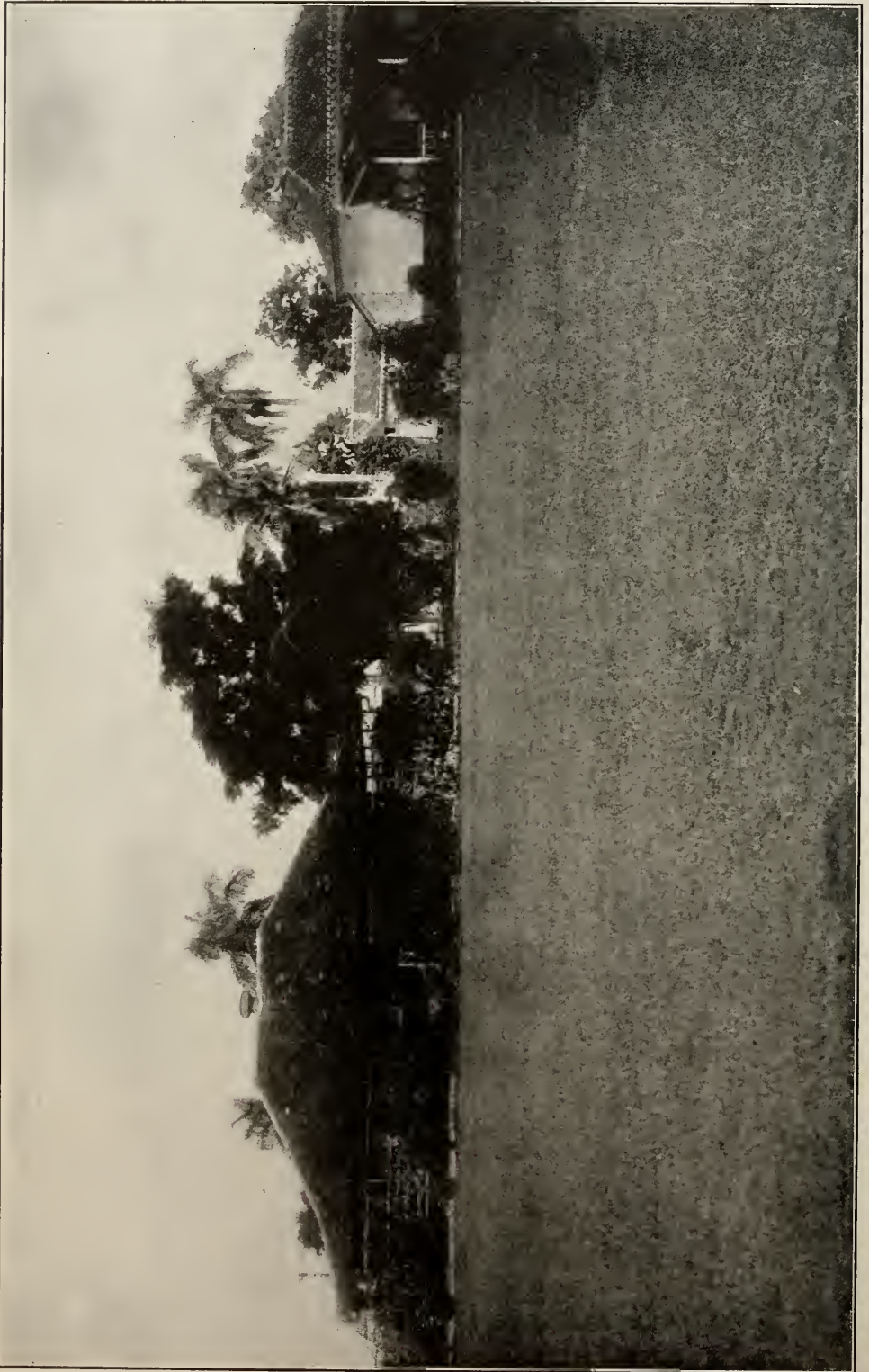

A BEAUTIFUL CUBAN COUNTRY HOME.
UNA ESPLÉNDIDA CASA DE CAMPO EN CUBA.

THE CUBA REVIEW

"ALL ABOUT CUBA."

Copyright, 1908, by the Munson Steamship Line.

LIBRARY
NEW YORK
BOTANICAL
GARDEN.

Volume VII.

JULY, 1909.

NUMBER 8.

CUBAN GOVERNMENT MATTERS.

The Budget Passed—The Spanish Claims Against Cuba—Spain's Trade With the Island—An American Protest—The National Lottery.

*Cuban
Budget
Passed.*

During the closing days of June there was much apprehension in Havana over the apparent improbability of the acceptance of the national budget by Congress for lack of time, although the Cuban constitution made it imperative that it pass not later than July 1, and this did not seem likely. Another complication was that the constitution also provides for the submission of the budget to Congress in November, but this was impossible by reason of the continuance of the Government of intervention.

On June 29 the House approved the budget in its entirety and it was expected that the Senate would also approve it. The latter body, however, on June 30, after devoting much time to a bill legalizing cock-fighting, which was passed, made sundry minor modifications in the budget, sending it again to the House, in the apparent expectation that the modifications would be accepted by the House, which in the meantime had adjourned. The adjournment of the House was not known until the Senate had also adjourned. This was the final day of the regular session of Congress, with no definite action taken on the all-important question of the approval of the budget. In default of an agreement at an extraordinary session of the Senate, on June 30, which was called before midnight, the only recourse open to the President was to declare operative on July 1 the budget of 1908-09, in accordance with a provision in the law of executive power, which, however, conflicted with an article of the constitution, de-

claring that the budget is only applicable in the year for which it was designed. Gov. Magoon's budget of 1908-09 amounted to \$24,285,000, while that of President Gomez was \$33,800,000. On the evening of the same day, at an extraordinary session of the House convoked by Speaker Ferrara, the budget was passed as amended by the Senate.

The amendments consisted of cutting out an item of \$348,305 for the payment of lands at Vedado, on which batteries were erected under Spanish rule, and \$58,840 for the establishment of a corps of police in connection with the Department of Justice.

The budget thus reduced amounts to \$33,418,302, and the income is estimated at \$33,825,448.53. This received the approval of President Gomez, the decree which was issued July 1 being canceled. The President appointed a commission of three Senators, three Representatives and the Secretary of the Treasury, who, beginning July 2, will confer with him relative to possible economies in the schedules of the budget.

On July 9 the Cuban Congress adjourned to reconvene in November. The President's last act was to annul the contract for the purchase of artillery and rifles for use in the Cuban army, made with France and Germany by Lopez Rodriguez, agent of the Cuban Government accredited for that purpose, and appointing Gen. Pino Guerra commander of the army, and two other officers, as a commission to visit the arms factories in the United States and Europe to decide upon the best types and to make new contracts.

JUL 20 1909

*The
Spanish
Claims.*

According to cables received in Havana May 27, Spain had instructed its Minister to Cuba to collect from the island republic the bill of expenses incurred in trying to retain that colony. Cuba revolted and Spain fought to retain her richest possession and lost, and now she expects Cuba to pay the expenses of her disastrous war. The amount of Spain's claim was for 300,000,000 pesetas (\$60,000,000).

On June 20, Secretary of State Justo Garcia Velez made an elaborate answer, denying the claim, pointing out that the matter was plainly disposed of at the proper time, the Cuban constitution having provided that Cuba should enter into the family of nations without any debts, which provisions were duly accepted by the Spanish government on recognizing the Republic of Cuba.

On June 12 the attention of the United States was officially called to the claims of the Spanish government merely as an act of courtesy, however, as actual representation had been made at Havana, where the negotiations would necessarily conclude.

The question which has been raised by the claim of Spain upon Cuba to pay a heavy loan procured by the former under guarantee of payment, out of resources drawn from Cuba, was brought up in the negotiation with Spain which took place in Paris in 1898. The commissioners representing the United States at that meeting refused to sustain Spain's proposed exaction.

Mr. Whitelaw Reid, now American Ambassador to Great Britain, was one of the Peace Commissioners that negotiated the Treaty of Paris. His views on the Spanish claim at that time were as follows:

"Acceptance of Spain's claim would lead to extraordinary results, as under that doctrine any oppressor would have the certain means of subduing the most righteous revolt and condemning a colony to perpetual servitude."

The American commission at the same time made this memorandum on the subject:

"From no point of view can the debts above described be considered local debts of Cuba or as debts incurred for the benefit of Cuba. In no sense are they obligations properly chargeable to that island. They are debts created by the government of Spain for its own purposes and through its own agents, in whose creation Cuba had no voice."

As pertinent to the case, the following from Professor Woolsey's work on international law is quoted:

There is another extreme case where a change of government may dissolve prior obligations. It is where a despotic government has contracted debts against a nation attempting to recover its liberties. The Government is de facto in possession of authority, and thus its acts are lawful; nevertheless, obligations entered into to subjugate the people must be regarded in this extreme case as pertaining to the Government alone and not as resting on the people.

When this subject was under discussion in the United States Senate, at the close of the Spanish War, Senator John C. Spooner, who was then, as now, regarded as an authority on such questions, characterized the Cuban debt as a Spanish one secured by a pledge of revenues which could only be collected by the exercise of Spanish sovereignty. Every man who took a bond must have taken it with notice that he depended for payment out of the hypothecated funds upon the ability of Spain to continue her sovereignty, and if Spain lost her sovereignty over the island of Cuba, she would, of course, lose her power to realize or pay the revenues pledged. To this interpretation of the case the Senate subscribed and it was under corresponding instructions that the treaty commissioners acted at Paris in 1898.

In Paris, ex-Governor Magoon when asked by a New York Herald representative for his opinion, after some hesitation spoke as follows:

"The Spanish claims were a subject discussed by the joint commission in Paris after the war. I recollect that in the course of the discussion the Spanish delegates called attention to the example furnished by some South American republics, which assumed their shares of the national debt when they were freed from Spanish sovereignty. The objection made to this argument, however, was that the republics voluntarily assumed such charges as the price of their independence."

Comment of the United States press on the Spanish claim was widespread, and with very few exceptions the almost unanimous opinion was that Cuba need not pay one penny of the claim. The Chicago Tribune took this view:

"If the so-called 'colonial debt' of about \$300,000,000 which Spain would like to unload on Cuba had been contracted for improvements made in the island—for harbor works, roads, etc.—Cuba would have been morally bound to assume the obligation. But the money was not spent thus. It went towards defraying the military expenses incurred in suppressing Cuban revolutions. The money was used against the Cubans, not for them, and Spain should pay the bill."

Senor Besada, Spain's Minister of Finance, is accredited with the conviction that Cuba would not refuse consideration to the claim. On the contrary, he expected the claim would be settled without insuperable difficulties, as he considered 300,000,000 pesetas (\$60,000,000) but a slight return for the enormous sacrifices made by Spain for Cuba's prosperity.

Some of the Spanish newspapers recently pointed out that Spain's claim was entirely just, but they were inclined to doubt the success of the plan.

There have been no new developments regarding the matter up to July 6.

In 1907, the last year for which the statistics are at hand, Spain sold to Cuba goods amounting in value to \$12,660,000, and bought from Cuba to the value of \$740,000 only. The balance of trade, in fact, is entirely in Spain's favor. Of thirty-five million kilograms of tobacco that Spain imported in 1907, only five hundred thousand kilograms came from Cuba.

The prospects for the negotiation of a Cuban-Spanish commercial treaty are considered very fair at Madrid. The feeling in Spain toward Cuba is of the most friendly nature, despite the debt difficulties, and the treaty will turn on the questions relating to tobacco and sugar. The tobacco combination is not likely to oppose the treaty, but the attitude of the sugar manufacturers is doubtful.

Since Spain's production of sugar is more than enough to supply the demand of the home market there is no probability of concessions to Cuban sugar. It is more likely that concessions will be made on raw tobacco, especially the kind known in Cuba as "partido," or the cheapest, which is grown in the eastern part of the island.

In the Provinces of Santa Clara and Santiago the Valencia manufacturers of fans expect on their part that the Spanish government will obtain advantages for them in Cuba.

Orestes Ferrara recently introduced a bill in the House providing for an increase of 30 per cent. on the imports of all countries which export to Cuba more than they import from Cuba. It is understood that this bill is directed against Spain in retaliation for that country's attempt to impose on Cuba a portion of the colonial debt.

On June 11, President Gomez commuted the sentence of death pronounced in April by court martial upon Sergeants Francisco and Vicente Cortes to penal servitude for twenty years. The father and son were members of the rural guard and were convicted of participation in the uprising in March at Taguayabon, near Vueltas. The clemency of the President is based

on a recommendation for mercy from the Supreme Court, to which an appeal from the verdict of the military court had been taken by the condemned men.



The New Cuban Consul General.

Senor Mariano Rocafort, the newly appointed Consul General of Cuba to the United States, with residence in New York, was born in Cardenas, Cuba, and belongs to one of the oldest families of Cuba. He was educated at the University of Havana and speaks several languages. He was first appointed Cuban Consul at Philadelphia by President Tomas Estrada Palma, and was later transferred to the more important post of Consul at London, Eng., which post he retained until appointed by President Gomez to the Consul Generalship at this port.

The Consul General's new post is an extremely arduous one, owing to the amount of business between New York and Cuba. The Consulate General here is probably one of the busiest offices of its kind in the United States.

President Gomez has recommended the establishment of long distance telephones throughout Cuba.

Guilio Mondello, Italian Minister to Cuba, arrived at New York July 6 from Italy. He said that when he went to Messina he found that his mother, sister, and her two children had been killed in the earthquake which desolated that part of Sicily. He left at once for his post.

Walter E. Powers, an American artesian well contractor, who had been well known here for the last ten years, died suddenly at Isabella, Santa Clara Province, of heart failure, on July 3.

American Protest to Cuba. Because of the contracts made by the Cuban government with firms in France and Germany for the purchase of rifles and artillery

for the new Cuban army were made without competition, the State Department, it was learned, on June 19 had protested and made it clear to the Havana government that in the future the United States manufacturers should at least be given an opportunity to participate in any contracts awarded by the Cuban government.

The State Department holds that this country is entitled to such consideration. It is possible that the contract for the purchase of arms will be reopened, although the United States has made no formal protest. The State Department has, however, asked many questions concerning the matter and has evinced such a decided interest that Cuba must know without the State Department going so far as actually to say so that America would be pleased should the matter be reopened.

On June 21 Senor Velez, Secretary of State, denied that any such protest had been presented, but only a request for information relative to contracts which had been answered. This denial was reiterated at late as June 28 in Cuban despatches, but the fact that such a protest had been sent was again asserted by the American newspapers. Further information leaked out that the protest or note of warning, as it was now called, dealt with the Oliver road building contract, the McGivney-Rokeby paving and sewerage contract, the proposition of an exchange of property between the United Railways of Havana and the Cuban government, which included the construction of a President's palace and other government buildings by the company, and lastly the purchase of army supplies abroad.

President Gomez approved on July 2 the law nullifying all previous legislation against cock fighting in Cuba, and another law creating a national navy, authorizing revenue cutters and gunboats to use light rapid-fire guns.

The Secretary of Public Works has authorized the commencement of work on the turnpike connecting Vedado with La Vibora.

The Centro Gallego, of Cienfuegos, will build a new hospital. The most modern scientific and sanitary apparatus will be employed. X-ray instruments and hospital supplies will be required.

The Senate approved the Lottery bill on June 29 and on July 5 the House took the same action, accepting the Senate's amendments. The President signed the bill July 9.

The Cuban Census. The official census of Cuba shows the population of the island, including all the provinces, when the work of the census enumerators was completed three months ago, to have been 2,048,980, of which 69.72 per cent. is classified as pure white and 30.28 per cent. are negroes.

The native whites number 1,225,000, the foreign whites 204,000, and there are 12,000 Mongolians, chiefly Chinese. There are only a few hundred Japanese in the island. Of the 204,000 foreign whites in Cuba, only 6,713 are of American birth. The Spaniards are largely in the preponderance among the white foreigners, for there is very little immigration into the island from the United States. More immigrants go from Spain to Cuba every year than from all the other countries combined.

Natives of the United States who are in Cuba are a little less than one out of every 300 of the aggregate population, but American capital invested in the island bears a far larger proportion to the aggregate capital than the American residents do to the total number of inhabitants. Americans own sugar plantations, sugar refineries, tobacco lands, cigar factories, and many mercantile houses. But even as property owners the Americans are exceeded by the other foreigners, in the aggregate.

The total population of the six provinces is as follows: Pinar del Rio, 210,372; Havana, 538,010; Matanzas, 238,812; Santa Clara, 457,431; Camaguey, 118,269, and Oriente, 455,086.

A census of Cuba taken in 1774 showed a population at that time of but 171,620. In 1877 the population had increased to 1,509,291, a growth of 1,337,671. From the year of the first census to the present day the population has increased 1,877,360, and from 1877 there has been an increase of 530,689.

President Gomez recently appointed Senor Lopez Leiva, Assistant Secretary of Finance, to inspect accounts of Speyer & Co., bankers, at New York, as to the loan of \$35,000,000 contracted in 1904 to pay the army of liberation. This inspection is stipulated in the contract and is to be carried out for the first time in five years.

A fire in Guantanamo June 27 destroyed the Hotel Inglaterra and a private college and damaged, a large warehouse owned by Brooks Bros.

The President has authorized the Secretary of Public Works to commence the work on the carretera between the port of Santa Cruz del Sur and Sabanilla, Puerto Principe Province.



ILLUSTRATION NO. 2.

La lotería nacional. Globo de latón destinado á contener las bolas de madera numeradas. El globo se hace girar por medio de un motor eléctrico antes de extraer una bola.

The work of completing the *The Lottery* apparatus designed for the operation of the lottery in Cuba was in full swing at the Arsenal machine shops in Havana a few days ago, and a test showed that everything was working smoothly. It is rumored that the first drawing will take place this month or next. A building on the Prado, it was said, has been selected and then it was rumored that the National Theatre would be chosen. The apparatus is all of brass, and every move is in full sight of the spectators. To the right of illustration No. 1 is a brass cage in which 40,000 numbered wooden balls are placed. The balls are about three-quarters of an inch in diameter and numbered. A spiral, see No. 1, takes the balls to a small chute, which empties them in the brass globe (illustration No. 2). This is about four feet in diameter. When the balls are in the globe it revolves by electric power for a few minutes and then one ball automatically released, drops to the table beneath. A small boy from the orphan asylum picks up the ball and calls out the number and holds it up for inspection. In illustration No. 3 a



ILLUSTRATION NO. 1.

Las bolas numeradas se ponen primero en la jaulita que está á la derecha y suben la espiral para caer dentro del globo que se ve en el grabado No. 2.



ILLUSTRATION NO. 3.

Un globo más pequeño para contener los premios. También se hace girar este globo muy rápidamente para mezclar bien su contenido antes de sacar un premio.

smaller globe is seen in which are placed slips showing the cash prizes. This is likewise revolved very rapidly, a slip automatically released and the amount called out to the spectators. The operations are entirely automatic, with the exception of the services of the boys. On June 29 the Senate passed the national lottery bill with slight modifications. The measure now goes to the Conference Committee, which probably will promptly pass it.

Neco Experiment Station Officers. All the American professors and the Director-General of the Estación Experimental Agronómica at Santiago de las Vegas were recently dismissed and their places filled by Cubans, with exception of Mr. Horne, who is an American and who retains his office. The official list of the new workers follows:

Sr. Ramón García Osés, Director-General.

Sr. José G. Couret, Vice-Director.

Sr. J. E. Pagliery, Second Director.

Dr. Emilio L. Luaces, Chief Veterinary Department.

Dr. Diego V. Tejada, Chief Chemical Department.

Dr. Antonio Ponce de León, Chief Botanical Department.

Sr. William T. Horne, Chief Department of Plant Pathology.

Sr. Eduardo H. Lamsfus, Chief Department of Horticulture.

Sr. Ricardo Poldo y Herrada, Chief Mechanical Department.

Agricultural and Industrial Exhibitions. It appears likely that there will be government supervision over future agricultural and industrial fairs in Havana, and that the Agricultural Department will control, eliminating any city council or carnival committee.

Permanent buildings, the property of the government, are contemplated for future exhibitions, and while next winter's fair may be held at Palatino Park, it is probable that a site out of the city, permitting of ample space, will be taken, on the Principe and Cerro trolley lines. Secretary of Agriculture Foyo has the matter under consideration.

The Cape San Antonio Wireless. Work on the wireless telegraph station at Cape San Antonio, belonging to the United Fruit Company, the concession for which was recently annulled by a decree of President Gomez, has been resumed, all difficulties having been removed.

The concession for placing the wireless station on Cape San Antonio was granted the United Fruit Company by Governor Magoon. It is to be used as a relay station between Panama, Honduras and other Central American stations, relaying messages to New Orleans, Key West, or even Jupiter, on the coast of Florida. It is the present policy of the administration to control the wireless business in Cuba.

It is learned that one of the terms ex-

acted of the United Fruit Company by the Cuban government was the appointment of a government inspector over the station, to be paid by the United Fruit Company. He will not be the operator, and will remain there only to give the station an official character.

The Cuban government is also given free use of the station at any time it desires it, and in case of necessity may assume complete control over it.

Yellow Fever Reports. La Discusion printed July 4 a telegram from New York that there was published a sanitary report affirming the prevalence of

yellow fever in Cuba. In reply the government supplied the press with an extract from Major Kean's letter to Secretary of Sanitation Matias Duque on Cuba's sanitary conditions.

Major Kean states that he is willing to prove that Cuban sanitary conditions are far better than at any of the southern ports of the United States, and calls it sheer arrogance on his fellow countrymen's part to think Cuban sanitation will not improve except under American rule.

Colors Given to Cubans.

The feature of the celebration of the Fourth of July in Havana was the presentation at Camp Columbia to the newly organized Cuban army of stands of colors purchased by popular subscription by the American colony in Cuba under the auspices of the Havana Post. The ceremony was attended by President Gomez, his cabinet, many members of Congress and 10,000 spectators.

The colors were presented by twelve American girls to twelve Cuban boys, who handed them to the color guards of the various regiments, which paraded before the President, the bands playing the American and Cuban anthems.

A stirring presentation address was made by Albert Wright, president of the American Club. Gen. Faustino Guerra, Commander-in-Chief of the army, responded.

Cuba's Prosperity. Former Governor Charles E. Magoon in Paris, early in June, continued his optimistic utterances on Cuba's future.

He said: "As in the United States, prosperity is spreading throughout Cuba, with it. President Gomez is an able man. He has the mastery of the political situation, and is quite able to overcome the difficulties bred by factional dissension."

Mr. Magoon would not discuss the debt.

STEEL CONSTRUCTION WORK IN CUBA.

Forty Bridges Already Built—Only Structural Steel and Bridge Plant in Latin America—Fine Amusement Buildings Under Way in Havana.

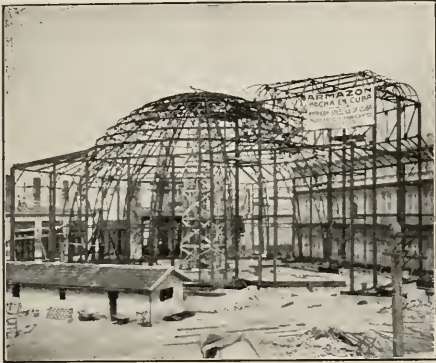

Structural steel edifice for circus and theater erected on the roof of the "Manzana de Gomez" block, Havana, for the roof-garden company, "Polyteama Enrique Rosas." Every steel member in this building was designed and detailed by the American Steel Company of Cuba, in Havana, and the entire work executed at the company's plant in that city. All the curving, cutting, punching and riveting was done entirely by Cuban labor under American supervision.

Armazón de acero para circo y teatro erigido en la azotea de la Manzana Gómez, Habana, para la compañía de espectáculos "Polyteama Enrique Rosas." Cada una de las piezas de acero de este edificio fué diseñada y hecha por dicha "American Steel Company" en sus talleres de la Habana. Todo el curvado, corte, taladro y remachado del acero se hizo exclusivamente por operarios cubanos bajo la dirección de oficiales mecánicos americanos.

Havana's Coming Attractions.

Added Attractions for Havana.

The interesting illustrations on this page indicate some new attractions for the winter tourist which, though very familiar to the northern visitor, are a novelty in Cuba. It is but another instance of the spirit of progress in Cuba's greatest and most picturesque city towards making Havana a most entertaining place to visit.

The leading hotels are rapidly equipping their buildings with all the improvements required by the American tourist, and it has long been admitted that, his comfort receiving first consideration, his amusement must also be provided. The half-tones illustrate fine steel amusement edifices to be erected on the Manzana de Gomez Block, a location very prominent, being opposite to the Central Park. A great cafe, cinematograph and vaudeville theater, and also an additional building for circus and theatrical performances, are now in process of construction.

It is understood that they will be ready for the coming winter season.

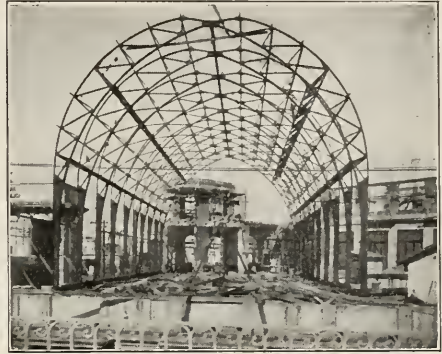

Structural steel edifice for a cinematograph and vaudeville theater erected on the roof of the "Manzana de Gomez" for the roof-garden company, made also by the same steel company.

Armazón de acero para un teatro de variedades y cinematógrafo, erigido en la azotea de la Manzana de Gómez, para dicha compañía de espectáculos, construido por la misma "American Steel Company" en sus talleres de la Habana.

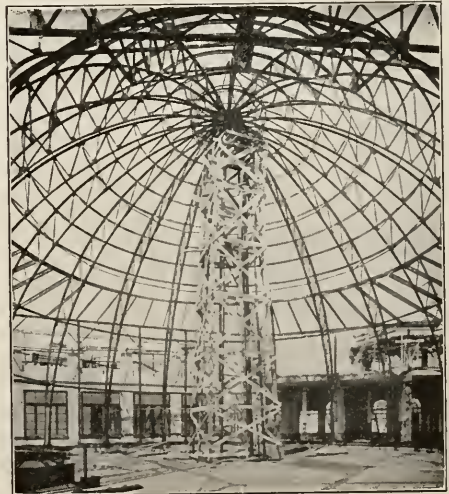

Interior view of the steel circus and theater building on the "Manzana de Gomez," Havana, showing the highest type of engineering and manufacturing of steel work executed at the company's plant. This structure has been favorably compared with the best curved work in steel of its type made by any plant in the world.

Vista interior del edificio en construcción para circo y teatro en la Manzana de Gómez, Habana, en que se ve la soberbia obra de ingeniería y armazón de acero llevada a cabo por la "American Steel Company of Cuba" en sus talleres situados en la Habana. Este edificio ha sido comparado favorablemente con las mejores obras semejantes de acero curvado, realizadas por otros talleres afamados en distintas partes del mundo.

LO QUE DICE DE CUBA LA PRENSA AMERICANA.

Opiniones de los periódicos más caracterizados.—El Gobierno de la isla es objeto de frases encomiásticas.—Vistas optimistas con respecto al futuro.

Cuando los ciudadanos cubanos libérrimamente pidan formar parte de nuestra república, cuando deseen cobijarse bajo los pliegues de nuestra bandera y así lo declaren sin ambages ni rodeos, sera cuando el asunto se tomará en consideración. Mientras tanto! Viva Cuba Libre!—Boise (Idaho) Statesman.

La situación financiera de Cuba no es exactamente lo que podría esperarse. El presupuesto arrojará un déficit al terminarse el año económico, pero los Estados Unidos, Inglaterra y varias otras naciones están en el mismo predicamento. La verdad es que es demasiado pronto para juzgar al nuevo Gobierno cubano. Deben dársele dos años por lo menos para que demuestre sus energías ó sus debilidades.—Chicago Tribune.

No hay nada absolutamente en que fundar la creencia de que los Estados Unidos tendrán que intervenir nuevamente en Cuba, á menos que la situación presente cambie por completo. * * *

Durante los últimos cuatro meses, los cubanos han dado pruebas de gran discreción política, y no hay razón para dudar de que continuarán haciéndolo.—New York Herald.

No obstante lo excesivo de los gastos, á pesar de la proposición de establecer una lotería nacional para aumentar los ingresos así como de algunas ideas extravagantes de los cubanos, la isla se encuentra en el verdadero camino de la prosperidad y del buen gobierno bajo la tutela del Presidente Gómez. Si Cuba puede lograr su salvación con sus propios esfuerzos, habrá puesto los más sólidos cimientos á la estabilidad de la pequeña república.—Haverhill (Mass.) Gazette.

Cuando recordamos el poco tiempo que hace que nuestro pueblo vino á realizar el verdadero carácter de la lotería y logró establecer leyes que hacen imposible la existencia de ninguna lotería en gran escala, y cuando pensamos que en muchos de nuestros Estados estamos aun ahora luchando por extirpar los males que envuelven las carreras de caballos, nos inclinamos á no ser tan exigentes con los insulares del sur.—Lutheran Observer, Philadelphia, Pa.

Las censuras contra Cuba por su anhelo de plantear la idea de la lotería como medio de ingresos, son abundantes pero no necesarias. Cuba no es tan moralmente pura como estos deliciosos Estados Unidos, donde las leyes se obedecen por todos y donde nunca se cometen actos que hagan sonrojar de vergüenza, digámoslo así, al mundo comercial, pero debemos conceder que Cuba está poblada por una raza distinta á la nuestra y con puntos de vista diferentes. Hubo una época en que por medio de la lotería se persiguieron y lograron fines loables en los Estados Unidos; aun la enseñanza superior pudo avanzar en su elevada misión por medio de la cómoda y productiva lotería. Algún día Cuba abandonará la lotería. En la actualidad no es éste el detalle peor de la vida y del gobierno en aquella isla.—Boston (Mass.) Advertiser.

Sacar una nación del protectorado de un gobierno experimentado, con todo el poder y el prestigio de más de un siglo de existencia presidida por el buen éxito en el manejo de los asuntos nacionales en que apoyarse, y dejarla para se maneje por sí sola sin educación ni experiencia en la administración pública á no ser una muy superficial, es una prueba muy rigurosa, y no debe esperarse la perfección inmediata.—Boston (Mass.) Advertiser.

Cuando la anexión se haga, como inevitablemente se hará antes de que pasen muchos años más, Cuba ocupará pronto un puesto prominente entre las comunidades agrícolas é industriales de América.—St. Louis (Mo.) Globe-Democrat.

Cuba, á juzgar por sus periódicos y por las entrevistas que dan sus funcionarios, parece sorprenderse de que los Estados Unidos considere las loterías y las riñas de gallos como asuntos que le incumben. La verdan es que no le incumben.—Brockton (Mass.) Times.

Si Cuba falla de nuevo en gobernarse á si misma, será á causa de la incapacidad de sus habitantes para comprender que el gobierno es tal y como ellos lo hacen y que será bueno en proporción, no á lo que ellos logren sacar del mismo, sino á lo que ellos puedan, por medio del juicio y del patriotismo, poner en el.—Columbus (Ohio) Dispatch.

Déjese á Cuba en paz.—Brooklyn (N. Y.) Citizen.

Si Cuba puede desenredar sus enmarañados asuntos y lograr su salvación, pronto se hallará el país sobre las más sólidas bases para el mantenimiento de una ordenada y próspera república.—Taunton (Mass.) Republican.



A wind-blown Cuba tree on the north coast of Cuba.

Una ceiba derribada por el viento en Cuba. Este árbol es muy abundante en las Antillas. Su madera no es aprovechable para casi nada, pero si se la sumerge en agua de cal bien concentrada, dura por bastante tiempo convertida en tablas ó tejamani.

Wood of Silk Cotton Tree.

The wood of the silk-cotton or ceiba tree, so well known in the West Indies, is soft and subject to attack by insects, which make it unsuitable for most industrial uses. In his paper "Timbers of Jamaica," appearing in the West Indian Bulletin, Vol. IX., No. 4, Mr. W. Harris, F.L.S., states that if steeped in strong lime water, the wood of this tree will last for several years, when made into boards and shingles.

Improving Havana's Hotels.

The hotel proprietors of Havana are very much alive to the necessity of providing modern conveniences which are looked for and required by American travelers, and are planning important changes which will entail the expenditure of considerable money. Tourists and business men will in a short time find their stay at the Havana hotels much more comfortable than heretofore. A good winter season is anticipated, and renovations of some of the leading hotels are

being rapidly made. The Hotel Inglaterra is boarded up, but workmen are busy building an additional story and changing the interior to permit of more rooms and bathrooms. The Hotel Pasaje is likewise undergoing extensive changes. The management expects to spend \$60,000 in important improvements, adding a bathroom to every room and rearranging the interior. The ground floor will be transformed into numerous handsome stores, and guests will find everything they need on the premises. The work at the Pasaje is being done without disturbing the guests, and though somewhat hampered by these circumstances everything promises to be ready when the season opens. The Hotel Inglaterra is closed, but it is anticipated that the changes there will be completed by January 1. The Hotel Plaza is in good shape, with private rooms and bathrooms in plenty, a roof dining room, telephones and other conveniences familiar to northern visitors. The Hotel Sevilla will also make some alterations which the first season's experiences have shown to be necessary.

Tobacco Exports for May.

The following table shows the exports of all kinds of tobacco from Cuba and the amount received for it during the month of May:

| | 1909 | | 1908 | |
|-----------------------------|------------|-------------|------------|-------------|
| | Quantity. | Value. | Quantity. | Value. |
| Bales | 22,592 | \$1,188,799 | 19,359 | \$1,140,472 |
| Cigars | 14,519,397 | 956,082 | 14,432,870 | 940,001 |
| Cigarettes (packs) | 690,967 | 18,961 | 813,544 | 26,873 |
| Smoking tobacco (kilos).... | 11,166 | 10,856 | 15,926 | 12,332 |
| | | \$2,174,698 | | \$2,119,678 |

Bronze Badges for Cuban Service.

All the officers and men of the United States Army who served in Cuba during the period of pacification from Oct. 6, 1906, to April 1, 1909, will receive from the government a service badge with ribbon in recognition of that service. The badge and ribbon will be issued as a part of the army uniform gratuitously to enlisted men and at cost price to officers. This action is taken by direction of President Taft. The badge will be of bronze and will be similar in general design to the badges previously authorized for services during the Spanish war and the Philippine insurrection.

Improvements for Havana's Harbor.

The Provisional Governor of Cuba, Hon. Chas. E. Magoon, signed on January 26, 1909, a decree ceding to Harris Bros. Co., the well-known merchants of Havana, certain lands fronting on Havana harbor, with the right to dredge the bay and fill the low lands behind the bulkhead in the harbor between Matadero and Agua Dulce creeks.

The Atares Wharf & Warehouse Co., of Havana, purchased this concession from the Harris Bros. Co., together with certain lands, rights and contracts acquired later, all of which form the basis and value of the present paid up capital of this company, \$800,000. The officers of the new company, it is believed, are: T. H. Harris, president;

I. L. Harris, vice-president; E. G. Harris, treasurer, and J. Lynchheim, secretary.

The wharf line or bulkhead is now in course of construction, and the company purposes to lay tracks connecting with all the railroad yards of the city. To complete the building plans of the company it is purposed to issue \$200,000 six per cent. first mortgage bonds to run for fifteen years. The bonds will be secured by the lands owned by the company, which on government values and prices of similarly situated lands, are worth \$850,000.

The future plans of the company contemplate an attractive income from warehouse receipts, wharf rentals, etc. Immense dredging work will have to be done, but this is supplemental to the work of the government, which provides for a channel at this part of the harbor.

American Educational Methods Please.

The Misses Narcissa and Marina Gomez, daughters of President Gomez, of Cuba, are to be enrolled as students at the Notre Dame Academy, Baltimore, Md. President Gomez is said to be greatly pleased with the American methods of education, and hence has decided to send his daughters to this country to complete their studies. Miss Gomez, a niece of President Gomez, has been a student at Notre Dame for some time.

Cuba's Insane.

A statistical statement regarding the Mazorra State Hospital for the Insane, issued May 30, showed 2,131 inmates. Of these 1,122 are men, 988 women and 21 children.

A. F. Conway, of Las Ovas, Pinar del Rio Province, says the Post, will establish a frog farm in a large pond on his farm. The flesh is pronounced by experts to be better than that of chicken and more tasty. Three pairs of legs weigh one pound of the kind he will raise.

A company has been organized in Sancti Spiritus for the manufacture and sale of ice in that ancient city and adjacent towns. Sr. Ramon de E. de la Cruz is president.



Havana Harbor. A steamer with lighters alongside unloading the cargo.

La bahía de la Habana. Un vapor con chalanas á sus costados recibiendo la carga.



A street scene in the American colony at Herradura, Province of Pinar del Rio. The fine, cozy houses would almost make the visitor believe he was in the United States instead of Cuba.

Una vista en la vía pública de la colonia americana en Herradura, provincia de Pinar del Rio. La bonita y cómoda casa que se ve en el grabado, hace pensar al viajero que se encuentra en los Estados Unidos más bien que en Cuba.

Herradura After Four Years.

Four years ago, or about June, 1905, Americans began to settle and cultivate the soil at Herradura, in the Province of Pinar del Rio—some with sufficient capital, some with very little but their labor to provide for their families. Most of them are living there now, in the best of health and prospering financially. Two hundred and ninety-six Americans and Canadians have purchased land, and every year more come to settle and improve their farms.

The present population is between one hundred and fifty and two hundred. The colony has both American and Spanish teachers in their schools, regular church services, their own agricultural and horticultural societies, ladies' social clubs, two daily mails, money-order post office, telegraph, stores, hotel, good streets, modern American style houses, packing house for vegetables on railroad siding, and are now preparing to build a canning factory and starch mill.

During the past four years over twelve hundred acres have been planted to citrus fruit trees, and for the last three years tomatoes, egg-plants, peppers and other vegetables have been grown in sufficient quantities to ship to the New York market.

The soil is a sandy loam, free from rock or stones, and underlaid with a clay subsoil. Water of excellent quality abounds in springs and creeks, and wells from thirty to sixty feet deep, which furnish water the entire year, are numerous. Some of the American farmers grow tobacco of very fine quality, which is sold at good prices.

Eight miles of the new calzada in the Province of Pinar del Rio is on the Herradura tract, and the company proposes to run automobiles from Havana to the town next winter. The Western Railroad from Havana runs for seven miles through the center of these lands, and there is also a good calzada or highway from Havana to Pinar del Rio City, passing through the northern portion. The company is ambitious of seeing the seven miles facing the railroad all planted to citrus fruits. About three and one-half acres are already planted.



Off for a ride. The pastimes of Herradura's young ladies.

Disfrutando las delicias de un paseo matutino. Pasatiempos de las señoritas que habitan en Herradura.

THE PRESS OF THE UNITED STATES.

Taking a nation out from under the protection of an experienced administration, with all the power and the prestige of more than a century of successful national existence back of it and setting it on its feet, to walk alone, without training or experience except of a most superficial sort, is a severe test, and immediate perfection is not to be looked for.—Boston (Mass.) Advertiser.

Trade is falling off. Public works are being suspended. All indications point toward bankruptcy at an early date.—St. Paul (Minn.) Pioneer Press, June 4.

Cuba has not learned her lesson.—Meriden (Conn.) Record.

When annexation comes, as it inevitably will, before many more years pass, Cuba will soon take a leading place among America's agricultural and industrial communities.—St. Louis (Mo.) Globe-Democrat.

Except that the Cuban government is showing a disposition to make the money fly, in happy-go-lucky fashion, there is no public information of prospective trouble.—Providence (R. I.) Journal.

Cuba, judging by its newspapers and the interviews given out by its officials, seems to wonder why the United States should regard lotteries or cock-fights as any of its business. They certainly are not.—Brockton (Mass.) Times.

The prediction is made that in case the epoch of extravagance is not checked a situation will be produced to make foreign creditors of Cuba turn to the United States for assistance in securing settlement of their claims, and there will then be nothing for it but another assumption of authority over the island.—Council Bluffs (Iowa) Nonpareil.

All talk about the United States being compelled to take possession of the island because of some faults in administration, or even because of some attempt of a handful of malcontents to start a revolution, are based upon a desire for this country to acquire it. In the main, though, it may be subconscious, the wish is father of the thought. If there were no desire to annex Cuba, and we sincerely hope we would never be called upon to do it, we would not be severely critical of its imperfections in its infancy.—St. Louis (Mo.) Star.

If Cuba again fails in self-government, it will be because of the inability of the people to understand that the government is what they make it, and that it will be good in proportion, not to what they can manage to extract from it, but to what they can, by wisdom and patriotism, put into it.—Columbus (Ohio) Dispatch.



The Baltimore (Md.) American says: "Uncle Sam don't like his tune. He had better change it if he wants to please."

El periódico "The Baltimore (Md.) American" dice: "A los Estados Unidos no les gusta su tonada. Mejor será que la cambie si quiere agradar." El papel en el atril dice: "No hace caso de los contratos americanos. Está comprando armas en el extranjero."

When the citizens of Cuba by their own free choice ask to be made a part of our republic, when they desire to gather under the clustering folds of our flag, and say so in no uncertain terms, it will be considered. Success to Cuba Libre!—Boise (Idaho) Statesman.

The Cuban financial situation is not quite what could be desired. There will be a deficit at the close of the fiscal year. But the United States, the united kingdom, and some other countries are in the same predicament. It is, indeed, altogether too soon to pass judgment on the new Cuban government. It should be given at least two years more in which to demonstrate its strength or weakness.—Chicago Tribune.

In spite of the heavy expenditures, the proposal of a national lottery as a source of income and a few freak notions on the part of the Cubans, the island is on the proper road toward prosperity and good government under President Gomez. If Cuba can work out its own salvation it will be a rock bottom foundation to a solid little republic.—Haverhill (Mass.) Gazette.



The Rock Island (Ill.) Argus prints this cartoon with the caption "Something we may expect in Cuban news before the summer is over."

Cuba and Alabama.

Cuba contains 45,883 square miles; Alabama, 52,251. Cuba has 1,722,953 people, and Alabama had in the last census year 1,828,697. Alabama is the larger, the richer and the better of the two.

And yet it costs Cuba at least \$30,000,000 a year to conduct its government, while Alabama gets along on less than \$3,500,000 a year.

The two cases are not exactly parallel. Cuba is a republic and she has an army to support. She has, however, no navy, and she has custom houses in which a fine income is collected. It is not possible to institute a close comparison between the two, because one is a state in a republic, while the other is a republic complete.

But it is plain that Alabama's government is more economically conducted than Cuba's.—Birmingham (Ala.) Age-Herald.

Cuban discrimination against American rifles and cannons appears to be due wholly to prejudice. And yet this country has done more for Cuba than the rest of the world combined.—Niagara Falls (N. Y.) Gazette.

When we remember how short a time it is since our own people came into the realization of the true character of the lottery, and succeeded in passing the laws which have made any lottery on a large scale an impossibility; and when we remember that in many states we are even now in the struggle with the race-track evils, it behooves us to be very patient with these island people of the South.—Lutheran Observer, Philadelphia, Pa.

There is not the slightest foundation for belief that the United States will need to intervene in Cuba unless present conditions completely change.

The Cubans during the last four months have displayed admirable political judgment, and there is no reason to doubt that they will continue to do so.—N. Y. Herald.

Cuba has plenty of use for her money in ways that make for a higher civilization. To go into heavy investment in preparation for war may please Cuban pride, but it does not square either with the idea of cultivating American friendship or proving a capacity for self-government.—Pasadena (Cal.) News.

RAILROADS AND FINANCIAL MATTERS.



Exterior view of the locomotive repair shops of the United Railways of Havana in the Cienaga. The force used is electric, and every equipment new. Construction began in the fall of 1908.

Vista exterior del taller de reparaciones de locomotoras de los Ferrocarriles Unidos, en la Habana. Se emplea la electricidad como fuerza motriz, siendo nuevas todas las herramientas y aparatos con que está habilitada. Su construcción se comenzó en el otoño de 1908.

New Locomotive Repair Shops.

The United Railways of Havana have recently taken over from the Snare & Triest Company, constructor, the handsome new and commodious locomotive repair shops at Cienaga, on the outskirts of Havana.

Every equipment of these shops is new, the motive force used is electric, and they constitute a decided advance on anything in this line in Cuba. The construction of the new shops was commenced in the fall of 1908, and while rains delayed the work to some extent, it was finished in good time.



Interior view of the repair shop pictured above. It shows a great locomotive entirely suspended by the immense crane.

Vista interior de taller de reparaciones cuyo grabado precede. Obsérvese la locomotora que está completamente suspendida por grúas locomóviles.

The Cuba Railroad Company.

Statement of earnings and expenses month of May, and eleven months ending May 31 compares as follows:

| | | |
|---------------------------------|----------------|----------------|
| | 1909. | 1908. |
| Gross earnings | \$193,540.07 | \$173,515.47 |
| Working expenses | 104,674.82 | 112,638.64 |
| Net profits | \$88,865.25 | \$60,876.83 |
| Fixed charges for month..... | 34,579.17 | 31,892.18 |
| Surplus for month..... | \$54,286.08 | \$28,984.65 |
| Gross earnings from July 1..... | \$1,960,460.71 | \$1,893,900.83 |
| Net profits from July 1..... | 858,441.93 | 668,383.66 |
| Fixed charges..... | 364,516.65 | 333,510.30 |
| Surplus | \$493,925.28 | \$334,873.36 |

Included in working expenses are the following expenditures for extraordinary replacements: This month, \$8,000; to date, \$88,000.

RAILROAD AND FINANCIAL MATTERS.

Havana Electric Railway Company.

The traffic receipts for June, 1908, and 1909 are as follows:

| | 1909 | 1908 |
|-------------------------|-----------|-----------|
| Week ending June 6.... | \$41,557 | \$35,840 |
| Car mileage..... | 154,417 | 157,775 |
| January 1 to June 6.... | \$876,035 | \$833,554 |
| Car mileage..... | 3,447,028 | 3,624,680 |
| June 13 | 41,157 | 35,962 |
| Car mileage | 154,621 | 156,105 |
| Jan. 1 to June 13.... | 917,192 | 869,516 |
| Car mileage | 3,631,649 | 3,780,785 |
| June 20 | 39,698 | 32,013 |
| Car mileage | 152,865 | 151,732 |
| Jan. 1 to June 20.... | 956,890 | 901,529 |
| Car mileage | 3,784,514 | 3,932,517 |
| June 27 | \$37,960 | \$38,231 |
| Car mileage | 155,070 | 159,839 |
| Jan. 1 to June 27.... | 994,850 | 939,760 |
| Car mileage..... | 3,939,584 | 4,092,356 |

New Ferry Houses for Havana.

An important improvement that is being undertaken by the United Railways of Havana, jointly with the Havana Central, is the construction of a new ferry house at Luz to take the place of the two old and inadequate ferry slips now serving both companies. The new ferry house will be modern in every respect, being the same design as the latest New York City ferrv houses, and will have two stories, enabling passengers to board and leave the boats on

this and the ground floor. The ferry service will be improved in every way, the boats of the two companies alternating in the slip.

The Guanabacoa branch of the United Railways will be electrified, and connection made with the Havana Central at both Regla and Guanabacoa. What this improved transit facility will mean for Regla and Guanabacoa can easily be imagined. It is said that these are only the beginnings of a long series of improvements.

Government Receipts for May.

The receipts of the national government for the month of May, 1909, were as follows. The total aggregates \$2,468,130.63.

| | |
|--------------------------------|----------------|
| Custom House | \$1,879,634.31 |
| Internal revenue | 303,632.97 |
| Internal taxes | 97,772.74 |
| Post office and telegraph.... | 760,931.37 |
| State property, rents, etc.... | 49,935.12 |
| Various sources of income.. | 27,960.92 |
| Consular fees | 31,263.13 |

The mayor of Havana recently vetoed a city council resolution authorizing the Havana Electric Company to display advertising on the exterior of its cars, as being unsightly and a special privilege, similar advertising being excluded elsewhere. The mayor holds also that the company's franchise contains no provision for an advertising business.

Cuban Central Railway.

| Weekly Receipts. | | | Receipts for Fiscal Year. | | |
|-------------------------|--------|--------|---------------------------|----------|----------|
| | 1909. | 1908. | | 1909. | 1908. |
| Week ending May 22. . . | £7,587 | £5,087 | To week end. May 22. | £401,236 | £331,730 |
| “ “ June 5. . . | 5,652 | 4,227 | “ “ “ June 5. | 414,888 | 341,471 |
| “ “ June 12. . . | 5,323 | 4,817 | “ “ “ June 12 | 420,211 | 346,288 |
| “ “ June 19. . . | 5,990 | 5,428 | “ “ “ June 19 | 426,201 | 351,716 |

United Railways of Havana.

| Weekly Receipts. | | | Receipts for Fiscal Year. | | |
|---------------------------|---------|---------|---------------------------|----------|-------|
| | 1909. | 1908. | | 1909. | 1908. |
| Week ending May 23 | £18,066 | £12,514 | £1,001,059 | £866,376 | |
| “ “ June 5 | 15,225 | 11,944 | 1,032,152 | 889,334 | |
| “ “ June 12 | 14,895 | 11,955 | 1,047,047 | 901,789 | |
| “ “ June 19 | 14,876 | 11,268 | 1,061,923 | 913,057 | |
| “ “ June 26 | 14,590 | 11,367 | 1,076,514 | 924,422 | |

Western Railways of Havana.

| Weekly Receipts. | | | Receipts for Fiscal Year. | | |
|---------------------------|--------|--------|---------------------------|----------|-------|
| | 1909. | 1908. | | 1909. | 1908. |
| Week ending May 22 | £4,806 | £4,966 | £251,044 | £240,479 | |
| “ “ June 5 | 5,072 | 5,456 | 261,082 | 251,521 | |
| “ “ June 12 | 4,866 | 4,911 | 265,948 | 256,432 | |
| “ “ June 19 | 4,787 | 3,883 | 270,735 | 260,315 | |

COMMERCIAL MATTERS.

American Shoes in Cuba.

A consular report recently issued says of the import shoe trade of Cuba. The import shoe trade of Cuba is now controlled by the United States. We find in competition, aside from the native manufactured product, Spanish shoes and extremely limited number of women's fine goods of French origin. The following table shows the imports of all footwear into Cuba for the following years, according to Cuban statistics.

MEN'S FOOTWEAR.

| Countries— | 1903. | 1905. | 1907. |
|------------------|-----------|-------------|-------------|
| Spain | \$433,623 | \$692,689 | \$446,896 |
| United States.. | 162,003 | 458,081 | 1,123,405 |
| Other countries. | 709 | 1,041 | 2,642 |
| Total | \$596,335 | \$1,151,811 | \$1,572,943 |

WOMEN'S FOOTWEAR.

| | | | |
|------------------|-------------|-------------|-------------|
| Spain | \$565,936 | \$376,756 | \$240,037 |
| United States.. | 530,231 | 981,202 | 1,445,155 |
| Other countries. | 785 | 610 | 1,867 |
| Total | \$1,096,952 | \$1,358,568 | \$1,687,059 |

CHILDREN'S FOOTWEAR.

| | | | |
|------------------|-----------|-----------|-----------|
| Spain | \$106,986 | \$108,384 | \$151,257 |
| United States.. | 94,255 | 177,824 | 434,140 |
| Other countries. | 9 | 313 | 326 |
| Total | \$201,250 | \$286,521 | \$585,723 |

The American shoe is light and preferred by the large majority (the United States now holds about 85 per cent. of the total trade of Cuba), both for its good wearing qualities and the great variety of shapes and styles which our manufacturers produce.

A Tireless Business Competitor.

It goes without saying that the American manufacturer seeking the trade of other countries, must improve on his methods. Our consuls have many times warned our business men against inexcusable carelessness and indifference in all the details of crating, packing, shipping and invoicing their goods. The Boston Transcript praises the German traders' thoroughness. It says:

Because Cuba will purchase the rifles for the Cuban army in Germany we need not conclude that the Kaiser is promoting a "conspiracy" in the Caribbean. He is pleased to see an order placed in Germany which might have gone to the United States, and it is only natural that he should be. He frankly backs with all his prestige every German effort to obtain trade. His policy is well known and entirely respectable. But our real competitor is not the Kaiser except so far as he seconds the enterprise of German traders. Our competitor is the German "drummer," who is tireless, tactful, and what is more, trained. Throughout South and Central America, and in the West Indies, an army of drummers from "the fatherland" who speak

the language of the country in which they exhibit their wares, are "pushing for business." The result of their intelligent energy is seen in a great expansion of German trade. German houses follow the German drummer. German steamers, subsidized, bring German goods direct to all the leading ports to the southward of us. One of the congressional party which has just returned from a tour of inspection of the Panama Canal noted that many if not most of the leading commercial and banking establishments on the Isthmus were German. There were others still retaining Spanish, English or American signs, which are manned by German clerks. Throughout the West Indies so far as he observed on his return journey, "the German invasion" was a fact, or on the way towards becoming one.—Transcript.

We remember hearing an Englishman say in substance the same thing, comments the Leominster (Mass.) Gazette. As we were going up to London, he referred to the fact that Germans were fast getting the trade in England, and said that the Germans were ready to make goods just the style the customer wanted and could sell, but the Englishman must insist upon making an article as he always had made it. The German, of course, secured the trade. It is this invasion which is to be feared.

American Manufactures in Cuba.

Among the various articles of American manufacture sent to Cuba in 1908, a report of the U. S. Department of Commerce and Labor mentions the following:

\$85,000 worth of American plows and cultivators.

\$2,000 worth of American billiard balls.

\$188,000 worth of candles.

\$167,000 worth of American automobiles.

Copper in Cuba.

In Cuba, the only producers of copper of any account are the mines of El Cobre, near Santiago Bay, which up to 1868 produced ore valued at \$50,186,225, probably in depreciated Spanish currency. Under the management of the Cuba Copper Co., organized in 1907, they are producing about 6,400,000 pounds of fine copper yearly.—Wall Street Journal, June 9, 1909.

To Introduce the Lace Industry.

The commission appointed by the boards of trade throughout the island to study the proposed introduction of the lace industry in Cuba has made a favorable report. The necessary raw material will be produced in the country. About 4,000 workers will find employment should this industry be established. At present most of the lace is imported from England.

NEW CUSTOM HOUSE DISTRICTS.

For the benefit of the shippers of the United States, Circular No. 12 of the Cuban Secretary of State, dated June, 1909, has been translated for The CUBA REVIEW. This circular defines the new custom house districts of the island of Cuba, which are as follows:

Havana.—From the union of the provinces of Havana and Matanzas, on the northeast coast, turning at the Cape San Antonio at the union of Matanzas, Santa Clara and Havana, on the south coast, and including the subaltern ports of Batabanó and Nueva Gerona, in the Isle of Pines, which will also be included in this District.

Matanzas.—From the union of the provinces of Matanzas and Havana, on the north coast, to Cape Hicacos.

Cardenas.—From Cape Hicacos to the union of the provinces of Matanzas and Santa Clara, on the north coast.

Sagua.—From the union of the provinces of Matanzas and Santa Clara on the north coast to Rio Sagua la Chica.

Caibarien.—From the Rio Sagua la Chica, to the union of the provinces of Santa Clara and Puerto Principe on the north coast.

Nuevitas.—From the union of the provinces of Santa Clara and Puerto Principe on the north coast to the union of the provinces of Santiago and Puerto Principe on the north coast.

Gibara.—From the union of the provinces of Santiago and Puerto Principe on the north coast, to Cabonico and Lebisa.

Baracoa.—From Cabonico and Lebisa, to Punta Maisí.

Guantanamo.—From Punta Maisí to Rio Bacanao.

Santiago.—From the River Bacanao to Cape Cruz.

Manzanillo.—From Cape Cruz to the union of the provinces of Santa Clara and Puerto Principe, on the south coast.

Santa Cruz.—From the union of the provinces of Santiago and Puerto Principe, on the south coast, to the union of the provinces of Santa Clara and Puerto Principe, on the south coast.

Tunas de Zaza.—From the union of the provinces of Santa Clara and Puerto Principe, on the south coast, to the Rio Agabama.

Trinidad.—From the Rio Agabama to the Rio San Juan.

Cienfuegos.—From the Rio San Juan, to the union of the provinces of Santa Clara, Matanzas and Havana, on the south coast.

Nipe.—The limits of said Custom House is from the Punta de Mangle to the Punta de Barlovento of the Sagua de Tanamo River, inclusive.

Jucaro.—Limits are from the mouth of the "Jatibonico River del Sur," which separates the province of Camaguey from the Santa Clara, to that of "Vertientes" on the same south coast of the province of Camaguey; this is to avoid in the future possible mistakes or conflicts of jurisdiction which belongs to the custom house of Jucaro, will extend to the brink of the River Jatibonico to that of the "Vertientes" province. There has been much trouble over the custom house boundary at this port.

V. H. BARRANCO.

CUBAN GOVERNMENT CATTLE STATISTICS.

In existence Dec. 31.

| | 1907. | | 1908. | | | |
|-----------------|-----------|-----------|-----------|-----------|-----------|-----------|
| | Males. | Females. | Total. | Males. | Females. | Totals. |
| Cattle | 1,352,398 | 1,401,132 | 2,753,530 | 1,429,109 | 1,539,858 | 2,968,967 |
| Horses.. . . . | 222,948 | 229,894 | 452,842 | 253,918 | 245,741 | 499,659 |
| Mules.. . . . | 26,726 | 28,270 | 54,996 | 28,150 | 28,946 | 57,096 |
| Burros.. . . . | 1,426 | 1,497 | 2,923 | 1,528 | 1,586 | 3,114 |

General Orestes Ferrara, President of the House of Representatives, fought a sword duel with Representative Severo Moleon on July 4. Each was slightly wounded. They both belong to the Liberal party. The quarrel was over personal affairs.

President Gomez signed a decree June 30 dismissing all departmental employes, but leaving them temporarily in office pending their re-appointment under the civil service law.

FINANCIAL AND COMMERCIAL MATTERS.



Mr. Warren E. Harlan, Consul General of Peru at Habana.

The Consul General of Peru at Habana, Mr. Warren E. Harlan, was born in Iron-ton, Ohio, in 1870, and in 1897 he was appointed Attaché to the United States Legation at Lima, Peru, in September of that year, an office he held until September, 1902, at which time he was transferred from the State Department to the Department of Justice, and served with the Spanish Treaty Claims Commission in Cuba, from March, 1903, until July, 1904, when he tendered his resignation in order to engage in business in Havana. Mr. Harlan is now the Havana representative of the Cuban-American Sugar Sugar Company and resides in the Vedado.

Mr. Warren E. Harlan was appointed Consul General of Peru at Habana, October 30, 1907, and the government he represents appointed him Special Envoy to represent Peru at the recent inauguration of President José Miguel Gomez, January 28, 1909, upon the restoration of the Cuban Republic.

Proper Translation Necessary.

Frederic J. Haskin finds that one of the amusing things about the nicety with which the manufacturer has to handle his Spanish or Portuguese correspondent is the fact that the American is scarcely able to write a letter that can be translated to suit him. The English is such a direct language that a thought literally translated from it into Spanish will often give offense to the punctilious Castilian; so that it has become advisable for the exporter who seeks trade relations with

Spaniards to have his letters translated by some one whose native tongue is Spanish, rather than by some person who has simply studied the language.

Cuba for the twelve months ending December 31, 1908, shows a decrease of \$20,000,000 in her imports.—Official figures of the U. S. Bureau of Statistics.

INDUSTRIAL NOTES.

The Baldwin Locomotive Works.

Notices under date of July 1, 1909, have been sent out by the Baldwin Locomotive Works, calling attention to the dissolution by mutual agreement of the firm of Burnham, Williams & Co. Its entire property and interests in the locomotive business have been bought by the Baldwin Locomotive Works, which also assumes all its assets and liabilities. The officers of the new corporation are as follows: John H. Converse, president; William L. Austin, vice-president; Alba B. Johnson, vice-president and treasurer; Samuel M. Vauclain, superintendent; William De Kraaft, secretary and assistant treasurer.

The capital of \$20,000,000 which the firm has hitherto had invested in the business will be the amount of the capital stock of the new company. No stocks or bonds will be placed on the market.

The property of the company comprises the Baldwin Locomotive Works in Philadelphia, with a large branch at Eddystone, Pa., the two having a combined capacity of 2,650 locomotives per annum. The same company will also own the Standard Steel Works Company, manufacturers of steel tires and rolled steel wheels, steel and iron castings, forgings and springs, located at Burnham, Mifflin County, Pa. The business was founded by Matthias Baldwin in 1831.

The Pratt Engineering & Machine Co., of Atlanta, Ga., which was organized last January to acquire the properties and business of the Fulton Foundry & Machine Works, and which has been preparing to continue the work of its predecessor in sugar machinery, fertilizer works and sulphuric acid works machinery field, has opened offices for Cuba and Porto Rico in Lonja Del Comercia, No. 509, Havana, Cuba. This office will be under Mr. W. A. Parsons, as manager for Cuba and Porto Rico, who has lived in Havana for a number of years and is well known. All parties interested who may be visiting Cuba are invited to call at the company's office and meet Mr. Parsons, who will be glad to assist them in any way he can.



HOMES IN VEDADO—Residence of former Minister from China to Cuba.

Quinta á orillas del mar en el Vedado, un barrio de la Habana, propiedad del Sr. Liao Ngantow, ex ministro enviado de China en Cuba. El edificio es obra de arquitectos y decoradores cubanos.

Seaside Villa in Vedado of Mr. Liao Ngantow, ex-Minister from China to Cuba.

This seaside villa in the Vedado is unique and beautiful, and Cuban architects and artists have carried out the building and decoration plans. It is a three-story building, with a tower of turrets and slate roof of variegated hue in contrast to gray stone and white columns outside.

The grounds are laid out with tropical plants and flowers, and the chief attraction is a Chinese boat house, surrounded by an artificial lake and a rustic bridge and grotto beyond, with a passage leading to the dining room. The boat house is luxuriously

furnished in teakwood inlaid in mother of pearl, and there are handsome panels in Chinese script, original compositions of Mr. Liao, who is a poet.

Mr. Liao has a charming wife who speaks English fluently, and they have nine children. Their eldest son was at school in the United for some time.

The Electric Light & Traction Co. of Santiago de Cuba will build a new wharf in En Senada de Salinas, near the city of Santiago.

Plans are being prepared for the extension of the Sagua R. R. to Rancho Veloz and Corralillo.

QUOTATIONS FOR CUBAN SECURITIES.

Supplied by LAWRENCE TURNURE & CO., New York City, July 10, 1909.

| | Bid. | Asked. |
|---|------|--------|
| * Republic of Cuba 5 per cent. bonds | 103 | 104 |
| Republic of Cuba 6 per cent. bonds | 100 | 101 |
| Republic of Cuba 5 per cent. new bonds (interior loan) | 93½ | 94½ |
| Havana City first mortgage 6 per cent. bonds | 106 | 108 |
| Havana City second mortgage 6 per cent. bonds | 105 | 107 |
| Cuba Railroad first mortgage 5 per cent. bonds | 98 | 100 |
| Cuba Railroad preferred stock | 62 | none |
| Cuba Company 6 per cent. debentures | 85 | 95 |
| Havana Electric consolidated mortgage 5 per cent. bonds | 80½ | 91½ |
| Havana Electric preferred stock | 87 | 90 |
| Havana Electric common stock | 60 | 62 |
| Matanzas City Market Place 8 per cent. bonds cts. | 103 | 104 |

* All prices of bonds quoted on an "and interest" basis.

ISLE OF PINES NOTES.

Some Geographical Facts.

The Isle of Pines is situated off the south coast of the western part of Cuba, between latitude 21° 24' 40" and 21° 56' north, and longitude 82° 30' and 83° 12' west. The island's area is 614.34 square marine miles, or 521,381 acres, of which the northern portion occupies 328,643 acres and the southern 192,738 acres. The greatest length is from the eastern extremity to French Cape, 43½ miles, and the greatest width 33 miles.

In general, the island's surface is a plateau of 50 to 100 feet above sea level, broken by ridges and hills or cliffs. The most remarkable summits are the Sierra de Caballos, 1,674 feet high; the Sierra de la Canada, 1,630 feet high; Daguila, 1,500 feet high, and Mount Casas, composed of most beautiful marbles of various colors, and Mount Cristales, abundantly covered with green rock crystals.—Isle of Pines Appeal.

The McKinley Colonies are to have a modern, up-to-date canning establishment for pineapples and vegetables, which will be installed and in operation in time for the next fall and winter vegetable growing season.

The government workmen who for a year have been engaged in repairing and improving the Santa Fe-Nueva Gerona calzado, have almost completed their work. Gangs worked from either end and are now about to meet in the neighborhood of Santa Rosalia Heights.

The steamer *Veguera* which formerly plied between this island and Batabana, is said to be off the run permanently.

Parrots Damage Fruit Trees.

The stopping of the traffic in parrots is calculated to do a great amount of harm to fruit interests on the isle, says the *Isle of Pines News*, and a movement is on foot to petition the government to strike out that portion of the game law relating to these birds, the taking of which keeps the numbers down a little and saves grove men a great deal of trouble and annoyance in keeping them off their groves.

One parrot, it has been stated, will ruin a tree in a short time. They bite off blossoms and fruit, especially on orange trees. Most other birds have an unsatisfied appetite for insects, but parrots prefer fruits.

On June 30 the Cuban cabinet granted a permit to allow the exportation of parrots from the Isle of Pines because the garrulous birds are destroying the fruit of the island.

Mr. Sage, of Washington, D. C., the owner of a tract of property in the San Carlos Tract, has imported from the United States rubber seed, which he will plant on his holdings, believing that the Isle of Pines offers a better climate and better conditions for the producing of commercial rubber than any of the countries he has visited. He is enthusiastic over the possibilities for rubber tree growing here.

The new budget of the Cuban Republic which has just been approved by President Gomez, provides for eight American schools in the Isle of Pines and one at La Gloria, Cuba.



Uno de los cobertizos mejor dispuestos usados en Cuba para curar el tabaco. Un cobertizo del tamaño de este puede contener más de \$10,000 de tabaco para capas, y los más pequeños errores cometidos en el tratamiento del tabaco durante su curación, pueden ocasionar su pérdida parcial ó total.

CUBAN MILCH GOATS.

Especially written for THE CUBA REVIEW by DR. N. S. MAYO, formerly Chief of the Department of Animal Industry, Cuban Agricultural Experiment Station.

An important branch of the animal industry in Cuba, and yet one that has received practically no attention from a scientific or economic point of view is that of milch goats.

There is no record of the numbers of goats kept in the live stock registers of Cuba, but to one who has traveled about the island the large numbers of milch goats kept, particularly in the smaller towns and villages, is surprising. The amount of milk furnished by goats for family use, and particularly for infants and children, is very large.

The milch goats of Cuba are probably descended from goats brought from Spain and the Canary Islands. It is a common opinion among Cubans that the goats from the Canary Islands are the best for milking purposes, as they give a larger quantity.

The Cuban milch goats are of good size and excellent disposition. They vary in color from jet black to pure white, the great majority being spotted, and often marked with brown. The hair is coarse, but the coat is not heavy. The udder is of good size and form. The females are prolific, usually giving birth to twins, and frequently to triplets, and they breed at any season of the year.

A good Cuban milch goat will give two quarts of milk daily under favorable conditions, and reports of much larger amounts are common. Very little attention is given to developing the milking qualities of the goats. A goat is similar to a dairy cow. With careful attention as to feeding and handling the quantity of milk secreted can be greatly increased, and the value of the animal correspondingly augmented. Without these good conditions a milch goat, like a milch cow, may be of little value for milking purposes.



SELLING WATER—Goat and wagon in the Isle of Pines.

Vendiendo agua en una población de campo en Cuba.

The advantages of milch goats over cows, where a comparatively small quantity of milk is required for family use, are many. The original cost of the goat is much less. A good Cuban milch goat can be purchased from five to twenty dollars, according to the quality, age, and circumstances. There is practically no business in buying or selling milch goats carried on at present. A milch goat can be kept under conditions where it is impracticable to keep a cow, while the cost of keeping a goat as compared with a cow is very little. Goats are omnivorous feeders, eating a great variety of foods and living where other herbivorous animals would starve. Still a reasonable quantity of suitable food is indispensable to the development of the best milking qualities. Goats are healthy animals, and in Cuba they are free from transmissible diseases and very seldom suffer from disease of any kind. Another good trait is their ability to defend themselves against attacks of dogs. In Cuba, where there are more dogs than goats, the dogs have learned to let the goats severely alone. On account of the healthfulness of goats, and the fact that goats' milk approaches human milk in composition, the milk of goats seems especially adapted to the rearing of infants. Since such a vigorous campaign is being carried on in the United States and other countries against tuberculosis, and as it has been demonstrated that a surprisingly large number of milch cows are infected with bovine tuberculosis, it would seem that the selection and breeding of Cuban milch goats for exportation to the United States, for supplying milk for infants and invalids, should prove a profitable industry.

For breeding milch goats hilly, rocky land, partially covered with brush, is preferable, for goats like to browse on brush and to pasture over dry, rocky hills. A shed as a protection against severe storms when the kids are small, is all the buildings necessary. Preparations should be made to feed the young new milch goats grain in order to stimulate the flow of milk to its greatest capacity. The goats should be milked thoroughly and frequently, as this greatly aids in the development of the udder and the milking qualities. It is to be hoped that some intelligent breeder will take up this important subject in an intelligent way, for there is no reason why milch goats cannot be developed as well and as profitably as milch cows.

CUBAN FRUIT, RECEIPTS AND PRICES.

Pineapple Receipts and Prices.

New York, July 2.

The decidedly more moderate arrivals of pineapples this week, coupled with the fact that there is a good deal of demand, both locally and for out-of-town shipment, for good, sound fruit added to the strength of the market both at auction and from store. Much of the stock of pineapples from both Porto Rico and Havana showed waste due to the heated conditions in transit. The general auction results were unsatisfactory to the importers and values were decidedly irregular on the small sizes, and the medium sizes showed declines on ordinary stock in some instances. At the auction sale of some 12,400 crates on June 30 the range was from 85c. to \$1.05 per crate on the 42s. The 36s sold at \$1 to \$1.15 per crate, and 30s sold up to \$1.45 per crate. A few lots went down to \$1.15 per crate. The range on the 24s was from \$1.90 to \$2.10 per crate at auction. At auction sale on June 29 Havana pines sold at from 90c. to \$2.65 per crate. The receipts for the season have touched the record for importations and on the whole the business has been unsatisfactory for the shippers and the importers.

Chicago commission houses would like shippers to note that lima beans in the pod are unsalable and are not wanted.

Orange Receipts and Prices.

New York, July 2.

Very liberal supplies of oranges this week and the fact that other descriptions of fruits are monopolizing the attention of the trade, made the market close weak at a decline of from 25c. to 35c. per box on all ordinary to choice grades in large and medium sizes. The decline was noticeable on both the navels and the sweets. There was also a weakness in the ordinary stock Valencia lates and seedlings. The receipts for the week were among the largest recorded for this season of the year, the total including close to 120 carloads for the week.

Grape Fruit.

New York, July 2.

There was a fair supply of grape fruit on the spot for the season, and prices were a little irregular as to quality and condition. The supply of Florida grape fruit is said to be exhausted.

If you would eat a Cuban instead of a Florida pineapple, the United States Senate decrees that you must pay on it a duty 128 per cent. higher than that fixed in the House bill.—Portland (Me.) Argus.

AGRICULTURAL MATTERS.

Useful Information on Citrus Fruit Cultivation—Orange Varieties Favored in Dominica—Home Grown and Imported Seeds—Butter-making, etc.

Citrus Fruit Cultivation.

A paper which contains a large amount of useful information on the methods of citrus fruit cultivation which have been shown to be most suited to Dominica—and incidentally for other parts of the West Indies—was prepared by Mr. A. J. Brooks, Officer-in-charge of the Dominica Agricultural School, to be read at the Colonial Fruit Show held in London at the end of November last, under the auspices of the Royal Horticultural Society.

The report in the Barbados Agricultural News says in part:

The most suitable altitudes for orange groves is from 800 to 1,200 feet above sea-level. The fruit will thrive, however, up to 2,500 feet. It is important that the grove be sheltered, either naturally or by artificial wind-breaks. Orange trees prefer an open, well-drained soil, which is rich in plant food, and which retains a good supply of moisture without producing stagnation. Very dry soils are especially undesirable. A high rainfall is necessary for the trees to do their best. A fall of 100 to 200 inches per annum is required.

With the exception of the lime, all citrus fruit trees (oranges, grape-fruit, shaddock, lemon, etc.) are best propagated by budding, in preference to raising from seed or from cuttings. Budded trees bear earlier, yield superior fruit, and also bear more true to the original variety than seedling trees.

The sour orange, the Seville orange, and the rough lemon are best suited for stocks on which oranges, etc., are to be budded. The first two kinds are stated to be immune to root rot, while the third suffers but slightly. The sour orange is an especially hardy stock, and thrives well on good retentive soils, such as are found in the interior lands of Dominica. Both the Washington naval orange and the grape-fruit are said to do better on this stock than on any other, and it is therefore used very extensively in the West Indies. The Seville orange stock does best at low altitudes, while the rough lemon flourishes on high, dry soils, but is not suited for moist ground at lower levels. The growth of trees on the rough lemon stock is much more rapid than in the sour or Seville orange. The grape-fruit does exceedingly well on this stock. Shaddock seedlings may also be used as stocks for budding purposes. Root rot can be kept in perfect check if care be taken to see that there is effective drainage, and that sunlight is allowed free entrance to the base of the stems.

Varieties Favored in Dominica.

In regard to oranges, the "Washington navel" is recommended as an excellent variety to cultivate, and if the grower desires to confine himself to the cultivation of one good all-round variety, this is undoubtedly the kind for him to grow. Good early fruiting varieties are "Parson Brown" and "Bonne's Early." "Valencia Late" is an excellent late-ripening kind. The "Satsuma" mandarin oranges, and the "King" tangerine are also referred to in high terms. Varieties of grape-fruit which, it is remarked, are difficult to surpass for general health and prolificness, are the "Triumph" and "Jamaica."

Home-Grown and Imported Seeds.

In raising crops from seed, a review of all the evidence available on the subject strengthens the opinion that the seed likely to give the best results in any locality is that which has been wisely selected and carefully bred under the conditions peculiar to that locality. The seed should be good, selected, home-grown seed, in fact, and this is likely to be more reliable than high-priced, high-bred seed brought from a distance. Colonists should give increased attention to the work of raising and selecting their own seed.—From the Bulletin of the Nebraska Experiment Station.

Butter Making.

There is no doubt but that with due attention to the feeding rations given to cows, cleanliness in milking, skill in ripening the cream, and churning and washing, etc., better butter might often be turned out, says the Barbados Agricultural News. In the tropics it is better to use a small separator than to wait for the cream to rise to the top and then to skim it off. A larger quantity of butter of superior flavor is obtained from "ripe" or acid cream than from the same volume when fresh, and therefore the cream should always be allowed to stand until acid.

Agriculturists Form Association.

The Anglo-Cuban Agricultural and Commercial Association was recently formed at Bartle, Cuba. The association will gather for the benefit of its members all helpful information concerning agricultural pursuits in the island. The officers are W. Graham Smith, president; Bruce Dick, vice-president, and Leonard Van Regemorter, secretary. The co-operation of every one interested is earnestly invited.

SUGAR REVIEW.

Especially written for The CUBA REVIEW by Willett & Gray, of New York.

Our last sugar review for this magazine was dated June 2.

At that time, Cuba Centrifugals of 96 test were 3.89c. per lb. for spot quotation and 2 9/16c. per lb. c. & f. for June shipment, equal to 3.92c. landed, and 2 5/8c. c. & f. July shipment, equal to 3.985c. landed.

The quotations now are 3.92c. per lb. for spot and 2 9/16c. to 2 19-32c. c. & f. for July shipment and nothing said about August shipments.

During the intermediate time, quotations have been 3.86c. for sugar in port and early arrival. The principal business has been done on basis of 2 9/16c. c. & f. or 3.92c. landed 96 test basis.

June 2, European beet sugar was 10s. 6 3/4d., the changes since were to 10s. 8 1/4d. to 10s. 7 1/2d. to 10s. 6d. to 10s. 6 3/4d. to 10s. 5 1/4d., at which it closes for July, with August at 10s. 6d. and Oct.-Dec. new crop at 9s. 10 1/2d. The European markets have been quiet and dull during all the time. All reports for the



The newest sugar mill in Cuba, Central Jayüegal, at Morón, Province of Camaguey, owned by an American company, the Jucaro and Morón Land Co., Jerry J. Warren, president.

El ingenio de azúcar más moderno en Cuba. El Central Jagüeyal, ubicado en Morón, provincia del Camaguey. Pertenece á la compañía americana, "Jucaro and Morón Sugar and Land Company."

new European beet crop have been favorable, though somewhat cold, and warmer weather is now needed to develop the beets.

The Cuba crop is virtually ended, with 1,385,000 tons visible to date and 6 centrals still grinding. Interest now centers on the growing crop, for which the weather is favorable and a full crop year is anticipated.

The Java crop prospects are now of special interest and importance to Cuba. Our last cable received July 1 says the harvesting of the crop is delayed by heavy rains, which means that not as large an amount as usual will be pressed for sale as early in the season; in fact, up to the present only two cargoes of new crop have been sold to American refiners and the price asked for June-July shipment 11s. per cwt. cost and freight, which equals 4.13c. per lb. landed for 96 test is 21c. per 100 lbs. above the parity of Cuba centrifugals.

Considering the fact that a few hundred thousand tons of this Java crop must eventually find a market in the United States, it is evident that either Cuba must advance or Java must decline before business results.

The tone and tendency of our market is now to continued firmness, with eventual improvement in prices to meet the Java values.

Unlike last year, at this time, the amount of stock held by refiners in warehouse and for arrival is insufficient for future wants and liberal purchases must continue to be made to end of season.

Our figures of consumption just completed for the first half of 1909 show 1,602,907 tons actually gone into consumption, against 1,586,889 tons for first half of 1908, an increase of 16,018 tons, or 1% for the six months.

The fruit crops are good throughout the country, which gives promise of a continued good consumptive demand for sugar for rest of year.

Taken altogether, the sugar outlook is very favorable for all sugar planters for another season.

New York, July 8, 1909.

REVISTA AZUCARERA.

Escrito expresamente para la CUBA REVIEW por Willett & Gray, de Nueva York.

Nuestra última revista azucarera para esta publicación estaba fechada el 2 de Junio. En aquella fecha, el azúcar centrifuga de Cuba polarización 96 grados se cotizaba á 3.89 centavos la libra para entrega inmediata, y á 29/16 cents. la libra, costo y flete, para su embarque en Junio, equivalente á 3.92 cents. puesta en el muelle, y á 2 $\frac{3}{8}$ cents., costo y flete, para su embarque en Julio, equivalente á 3.985 cents. puesta en el muelle.

Las cotizaciones ahora son 3.92 cents. la libra para entrega inmediata y de 29/16 á 2 19/32 cents., costo y flete, para su embarque en Julio, no haciéndose ninguna transacción para embarque en Agosto.

Durante el tiempo intermedio, la cotización ha sido 3.86 cents. por azúcar en el puerto y pronta á llegar. Las transacciones principales se hicieron sobre la base de 29/16 cents., costo y flete, ó 3.92 cents. polarización 96 grados, puesta en el muelle.

En Junio 2 el azúcar de remolacha europeo se cotizaba á 10s. 6 $\frac{3}{4}$ d., habiendo sido las fluctuaciones desde entonces á 10s. 8 $\frac{1}{4}$ d., á 10s. 7 $\frac{1}{2}$ d., á 10s. 6d., á 10s. 6 $\frac{3}{4}$ d. y 10s. 5 $\frac{1}{4}$ d., á cuyo precio cerró para Julio, con Agosto á 10s. 6d. y la nueva cosecha de Octubre á Diciembre á 9s. 10 $\frac{1}{2}$ d. Los mercados europeos han estado calmados y paralizados durante todo el tiempo. Todas las noticias referentes á la nueva cosecha de remolacha europea han sido favorables si bien un tanto desanimadas, necesitándose de temperatura cálida para el desarrollo de la remolacha.

La zafra en Cuba puede considerarse como terminada, acusando una producción evidente de 1,385,000 toneladas hasta la fecha, habiendo 6 centrales moliendo todavía. La atención se fija ahora en la caña sembrada para cuyo crecimiento ha sido favorable el tiempo, esperándose que la cosecha este año sea muy abundante.

Al presente tiene interés é importancia para Cuba la perspectiva de la zafra en Java. Nuestro último cablegrama recibido el día primero de Julio dice que el corte de la caña se ha retardado á causa de lluvias torrenciales, lo que significa que no se forzará á la venta tan grande cantidad como se hizo á principios de la estación; en verdad, hasta estos momentos sólo se han vendido dos cargamentos de la nueva zafra á refinadores americanos, y el precio pedido por azúcar para su embarque en Junio y Julio es 11s. el quintal, costo y flete, lo que equivale á 4.13 cents. la libra polarización 96 grados puesta en el muelle, ó sean 21 cents. más en las 100 libras que el precio equivalente del centrífuga de Cuba.

Teniendo en cuenta la probabilidad de que algunos centenares de miles de toneladas del azúcar de Java de esta zafra encuentren al fin compradores en los Estados Unidos, es evidente que ó Cuba sube sus precios ó Java reduce los suyos antes de que los azúcares de esta última procedencia puedan competir.

El tono y tendencia de nuestro mercado ahora es continuar la estabilidad en los precios con subidas ocasionales para igualar las cotizaciones de los azúcares de Java.

Este año, á diferencia del años pasado para este época, las existencias en las refinarias y almacenes y el azúcar por llegar, son insuficientes para satisfacer la demandas futuras, por lo que habrán de continuarse haciendo compras en grande escala hasta el final de la estación.

Nuestra estadística del consumo en el primer semestre de 1909, que acabamos de completar, arroja un consumo real de 1,602,907 toneladas, contra 1,586,889 toneladas en el primer semestre del año 1908, lo que representa un aumento de 16,018 toneladas ó el 1% en el semestre.

Las cosechas de frutas son buenas en todo el país, lo cual hace esperar que continúen muy activa la demanda de azúcar para el consumo en lo que resta del año.

Considerando todas las circunstancias, la perspectiva del mercado azucarero es muy favorable para todos los hacendados para toda una zafra.

Nueva York, Julio 8 de 1909.

Sugar Mill Changes Hands.

The sugar mill Aguada, located in Aguada de Pasajeros, Santa Clara Province, was purchased recently by Miguel Diaz, owner of the Perseverancia mill, from Carol & Company.

The Aguada has just finished grinding after making 40,000 bags.

With the transfer of this mill another sugar plantation passes into the hands of a foreigner, for Carol & Company are Cubans, while Mr. Diaz is a Spaniard.—Havana Post.

The Application of Nitrogen to the Sugar Cane.

There can be no question that the old system of exhausting the soil by growing cane year after year (and often the same variety of cane) and neglecting to return to the land those plant food constituents which have necessarily been removed in large quantities, has frequently been responsible for poor crops, and a consequent decrease in profits, says the London Tropical Life. No soil is rich enough to stand such a system for any length of time, and there is moreover no excuse for it in these enlightened days.

The main object of the planter is to produce as much sugar as he can from his crop, and success means that his crop will consume a large amount of nitrogen, potash and phosphoric acid, the three main constituents of plant food, and their loss must be systematically replaced if soil fertility is to be kept up. As a considerable quantity of both the phosphoric acid and the potash contained in the stripped cane is returned to the soil in the form of bagasse ash, less has to be supplied in artificial form.

Nitrate of soda and other nitrogenous manures exert a very favorable influence upon the yield of the sugar cane—in fact it has been authoritatively stated* that "Nitrogen is without doubt the manurial constituent, the supply of which governs the yield of the plant." Again the same authority states that "The effect of nitrogenous manurings appears to somewhat retard the maturation of the canes, and thus the juice of the canes manured with them is, as a rule, not so rich in saccharose as is that of canes grown without manure. But this is more than offset by the larger yields resulting from their application. The increases produced by the nitrogen are principally due to the development of the stalks and not to tops and leaves, or the production of new shoots to the stool."

Two points must first be considered. (1) The land should be manured early with a suitable complete manure—e. g., farm-yard manure—so that, in the event of a drought in the early part of the year, the young plants may be better able to withstand its effects. (2) In the second portion of the year, when the cane stool has well developed its roots and is in a state of very active growth, a much more soluble and active manure is required than that used at an earlier period, so that the artificial manures should be carefully selected with this object in view. This second manurial dressing should contain a fair amount of potash and phosphoric acid—a larger amount of the former than the latter being applied, unless that has been done in the original complete manure.

With regard to the nitrogenous manure nothing is so good as nitrate of soda. It

is immediately "available" by the plants, and is easily applied if mixed with three or four times the amount of dry earth. Far better results will be got by applying it in two or even three dressings of small quantities than in one big dressing. "Little and often" is a good motto in this case, and will more than repay the small cost of extra labor involved.

With regard to the quantities of nitrate of soda a careful study of the results of manurial experiments on sugar cane leads to the conclusion that from 200 to 300 lbs. per acre is the most profitable amount, and that it should be applied in two or even three dressings. It is well to remember that it is quite easy to allow the soil to get into a "run-down" condition. To keep it in good condition pay attention to these three main points: (1) Careful and thorough preparation of the land; (2) systematic stirring of the soil; (3) the judicious use of manures with the object of replacing those elements of plant food of which the soil has been depleted. By these means the farm-maintained and even increased, and worn-out and exhausted land made fertile.

To show the advantages of adequately supplying the canes with the nourishment that they require one has only to turn to any of the following official tables of yields at the various centres where this is done.

| | Tons of cane per hectare (2½ acres) | Per cent. of sugar |
|-------------------------|---|--------------------|
| Java, intense culture.. | .80 | 14 to 15.5 |
| Hawaii, " " .. | 82 | 15 " 15.5 |
| Egypt, with irrigation. | 38.5 | 11 " 13 |
| Argentina, " " .. | 40 | 11 " 12 |
| Demarara | .62 | .. " .. |
| Louisiana | .50 | 11 " 13 |
| Cuba | .50 | 13 " 15 |
| Queensland | .46 | .. " .. |
| Sao Paulo..... | .50 | 13 " 14.5 |
| Campos (Rio)..... | .50 | 14.5 " 15.5 |

The Mapos Central Sugar Co.

The Mapos Central Sugar Company is a concern recently incorporated entirely by Baltimoreans. The headquarters in Baltimore are in the Equitable Building, the following being the officers: Mr. Charles T. Westcott, president; Winfield S. Cahill, vice-president; William H. Evans, secretary and treasurer. Mr. Ormand Hammond is the general manager in Cuba.—Baltimore Star.

*Newlands. "Sugar," price 25s. (New edition, just published, for Planters and Refiners.) Pp. 856, with many illustrations. Messrs. Spon and Chamberlain, 123 Liberty Street, New York.

CABLE ADDRESS: Turnure.

NEW YORK,
64-66 Wall Street.**LAWRENCE TURNURE & CO.****BANKERS**

Deposits and Accounts Current. Deposits of Securities, we taking charge of Collection and Remittance of Dividends and Interest. Purchase and Sale of Public and Industrial Securities. Purchase and Sale of Letters of Exchange. Collection of Drafts, Coupons, etc., for account of others. Drafts, Payments by Cable and Letters of Credit on Havana and other cities of Cuba; also on England, France, Spain, Mexico, Puerto Rico, Santo Domingo, Central and South America.

CORRESPONDENTS:

HAVANA—N. Gelats y Ca.

MEXICO—Banco Central Mexicano.

LONDON—The London Joint Stock Bank, Ltd.

PARIS—Heine et Cie.

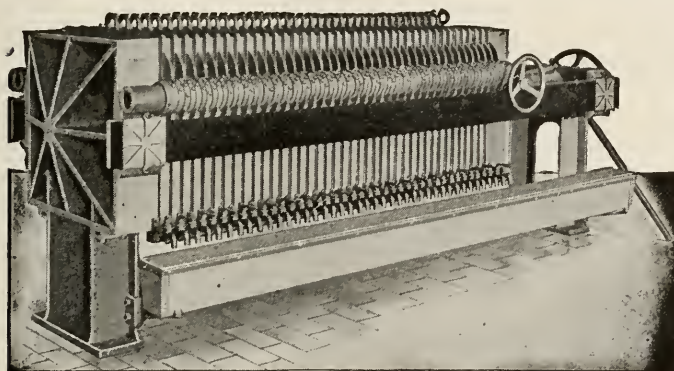

**Prensas de
Filtrar
para Ingenios
SHRIVER
Filter Presses**

Write us for Cata-
logue, Prices and
Information.

T. SHRIVER & CO.
814 Hamilton Street
HARRISON, N. J.

Sole Agents for Porto Rico
McMurtrie-Guiler Co.
SAN JUAN, P.R., and BEAVER BLDG.,
BEAVER STREET, NEW YORK

**“LINK - BELT” CANE UNLOADERS**

are fitted with the DODGE AUTOMATIC SLING-HOOK; the transfer of the load is, therefore, made quickly and with great facility.

Write to us about conveyers, bagasse feeders, chains, wheels, clutches, buckets, boots, etc. - NEW CHAIN CATALOG No. 75 A.

LINK - BELT COMPANY

299 BROADWAY, NEW YORK CITY

Trouble Again Brewing.

Mr. Atkins of Boston, who, by reason of his large investments in Cuba and his long residence on the island, speaks as an authority, thinks that trouble is again brewing on the island. He was an advisor of the Administration in the troublous times of 1898, and those in charge of public affairs in Washington at the present day have been given the benefit of his expert opinion as to the existing conditions in Cuba and its probable political future.—Providence (R. I.) Journal.

FOR SALE

We offer, subject prior sale, September 1st delivery, one 26" x 72" Pratt "IMPERIAL" Cane Crusher complete with Compound Gearing, Hydraulics and Corliss Engine, Krajewski type rollers.

One 34" x 72" Three-Roll Pratt "IMPERIAL" Cane Mill, complete, with Compound Gearing, Hydraulics and Corliss Engine, heavily built for highest pressures. LARGE JOURNALS.

EXTREMELY NARROW TURN PLATE

For full information, particulars, prices, etc., address

PRATT ENGINEERING AND MACHINE COMPANY

Atlanta, Georgia, U. S. A. 80 Wall St., New York City

Havana, Cuba, Office: Lonja del Comercio 509.

THE EXETER MACHINE WORKS

PITTSTON, PA.

MANUFACTURE

BRONZE AND BRASS CASTINGS

"VITA" ACID-RESISTING BRONZE

EXETER BEAR BABBITT. The best in the world for anti-friction purposes

No. 7 RAILWAY BRONZE, For all bearing purposes

PHOSPHOR BRONZE AND GUN METAL

CARROS PARA CAÑA

De todas
clases

Fabricados
de madera
ó áccero

Dirección
Telegrafica
RAMALIAM

RAMAPO
IRON WORKS

30 Church St.
New York, N. Y.

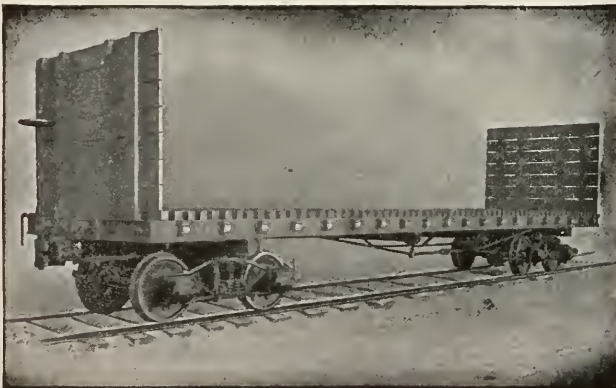

CANE CARS

OF EVERY
DESCRIPTION
OF STEEL
OR WOOD

Cable Address
RAMALIAM

RAMAPO
IRON WORKS

30 Church St.
New York, N. Y.

INVEST IN CUBA

Consult us

Specialists in Cuban Investments

Confidential investigations and reports made on all propositions. Have several large tracts of land which can resell for purchaser in small farms at triple purchase price. 1st MORTGAGES, 10% INTEREST; 50% VALUATION

SUGAR MILL SECURITIES PAY 20%

INVEST—DOUBLE YOUR MONEY. Let us tell you why and where.

CONSULT US, OTHERWISE "DON'T INVEST IN CUBA"

The Johnson-Harding Company

34 Empedrado, Havana, Cuba

CANADA LAND AND FRUIT CO.

LOS INDIOS

Owners

ISLE OF PINES

CANADA AND LOS INDIOS TRACTS

Location: Siguanca Bay. The Deep-Water Harbor of the Island.

We have at our new and progressive town of Los Indios a sawmill, planing-mill, general store, school, hotel, church, post office and nursery, all under the supervision of Americans. A strictly American town.

We also have rowboats and gasoline launch for pleasure parties. Fishing and hunting the best.

We own the finest citrus fruit, vegetable and tobacco land on the island. We offer same for sale in acres to suit purchaser, either for cash or on installments. Special inducements to actual settlers.

Write for prospectus and further information to our general office,
Marinette, Wisconsin.

WILLETT & GRAY, Brokers and AgentsFOREIGN AND
DOMESTIC**SUGARS**RAW AND
REFINED**82 WALL STREET, NEW YORK**

Publishers of Daily and Weekly Statistical Sugar Trade Journal—the recognized authority of the trade.
TELEGRAPHIC MARKET ADVICES FURNISHED

PURE
DISTILLATION
OF
SUGAR CANE

BACARDI RON

Sole United States Agent

D. S. de JONGH 128 Water St.

BEST MIXER
FOR
HIGHBALLS
AND
OTHER DRINKS

“SUGAR NEWS FROM CUBA”

is the title of the interesting correspondence from the tropical island, appearing in every issue of “THE AMERICAN SUGAR INDUSTRY AND BEET SUGAR GAZETTE.”

Capable correspondents, in every part of the world, write regularly, covering reliable sugar news for “THE AMERICAN SUGAR INDUSTRY AND BEET SUGAR GAZETTE.”

In the United States, Cuba and Mexico, \$2 per annum. In Foreign Countries, \$2.50 per annum.

Subscribe for it if you want to keep posted. Sample copy free. Send for advertising rates.

Address: BEET SUGAR GAZETTE CO.**No. 5 Wabash Avenue,****Chicago, Ill., U.S.A.****TWO IMPORTANT MAPS**

Blue-prints of Cuba, showing the location of the Sugar Plantations and the Rural Guard Stations of the Island. Specially prepared for The CUBA REVIEW. Each 60 cents. Either map with a year's subscription, 75 cents. Both blue-prints and magazine, one year, \$1.

The Rural Guard of Cuba**The Sugar Plantations of Cuba**

H A V A N A

CUBA

National Bank of Cuba

Government Depository

Capital, Surplus and Undivided Profits
\$6,000,000.00

HEAD OFFICE, HAVANA

FIFTEEN BRANCHES IN CUBA

New York Agency, 1 Wall Street

COLLECTIONS

THE TRUST COMPANY OF CUBA HAVANA.

Capital
and Surplus \$540,000

Transacts a General Trust
and Banking Business.

REAL ESTATE DEPARTMENT

Examines Titles, Collects Rents,
Negotiates Loans on Mortgages

Correspondence Solicited from
Intending Investors

OFFICERS

J. A. Gonzales Lanuza, . . . President
Norman H. Davis, . . . Vice-President
F. J. Sherman, . . . 2nd Vice-President
O. A. Hornsby, . . . Secretary and Treasurer
J. M. Hopgood, . . . Asst. Treasurer

Offices: CUBA 31, HAVANA

The Royal Bank of Canada

INCORPORATED 1869

Fiscal Agent of the Government of the Republic of
Cuba for the Payment of the Army of Liberation

CAPITAL AND RESERVE, \$10,200,000.00
TOTAL ASSETS, - 56,000,000.00

Head Office, MONTREAL

NEW YORK AGENCY, 68 William St.

Branches in Havana: Obrapla 33, Gallano 92;
Matanzas, Cardenas, Manzanillo, Cienfuegos,
Camaguey and Santiago de Cuba.

Mayari, Sagua, Caibarien

ESTABLISHED 1844

H. UPMANN & CO. Bankers

TRANSACT A GENERAL BANKING BUSINESS
CORRESPONDENTS AT ALL THE PRIN-
CIPAL PLACES OF THE ISLAND

Safe Deposit Vaults

Manufacturers of the Famous H. Upmann
Brand of Cigars

FACTORY: Paseo de Tacon 159-163
OFFICE: Amargura 1-3

Established 1876

N. GELATS & COMPANY

Bankers

Transact a general banking
business.

Correspondence at all the prin-
cipal places of the island.

SAFE DEPOSIT VAULTS

Office: Aguiar 108

MOLINA BROTHERS Customs Brokers

Forwarders, Lighterage and Ship Agents

Officios 52, Havana

H A V A N A

United Railways of Havana

Cuba's First and Foremost Railroad. (First Section opened to Traffic in 1837)

Takes you to All Parts of the Island East of Havana Comfortably and Quickly through Varied and Beautiful Scenery and Past Extensive Sugar Plantations

Parlor, Observation and Sleeping Cars attached to principal trains.

Full information and through tickets to all points in Cuba reached via the United Railways of Havana can be obtained of the following:

Thos. Cook & Son
Seaboard Air Line R. R.
Foster & Reynolds
Atlantic Coast Line R. R.
Illinois Central R. R.

Ward Line
Florida East Coast Railway
Washington Southern Railway
Peninsular & Occidental SS. Co.

Southern Pacific R. R.
Mobile & Ohio R. R.
Raymond & Whitcomb Co.
Louisville & Nashville R. R.
Munson Line

THE HERRADURA LAND COMPANY

Office: No. 3 Bernaza Street, Habana, Cuba

CAPITAL, \$440,000.00

Own 22,000 acres of land in the Province of Pinar del Rio, suitable for Oranges, Vegetables, Cotton, Corn and Tobacco. The land has all been surveyed and sub-divided into 40-acre tracts and is offered for sale in acres to suit the purchasers, for Cash or on instalments.

We have a new and progressive American town with Railroad Station, Telegraph, Telephone, Stores, Hotel, American School, all within short distance from Havana City.

Titles perfect. Transportation from Havana free for buyers.

WRITE OR CALL FOR INFORMATION.

LA AMBROSIA

MANUFACTURERS of the well-known brand of Chocolate, "LA AMBROSIA," Biscuits, Macaroni, Bonbons, all kinds of Confectionery

GUAVA PASTE AND EXTRA FINE GUAVA JELLY

ORDERS RECEIVED FOR EXPORT

BALDOR, FERNANDEZ & CO.

Write for quotations.

Sol 21 & 23, Havana, CUBA

'PHONE No. 401

P. O. BOX 741

FERNANDO de CARDENAS

CUSTOM HOUSE BROKER

:: Import and Export Agent ::

Munson S. S. Line Building

Obispo No. 1, Havana, Cuba

JAMES S. CONNELL & SON

Sugar Brokers

Established 1836, at 105 Wall Street

Cable Address—"Tide, New York"

If Cuba is to remain free and independent—and no one desires otherwise—the line should be drawn at the time when in 1901 this government released its jurisdiction after setting her house in order and paying all back bills, and this last eight millions should be a collectable charge against the island.—Waterbury (Conn.) Republic.

LA ATALAYA

(the best located colony in Cuba) and other Cuban lands for sale in tracts of all sizes, and for all purposes.

STREET & STRICKLAND

BOX 191

CAMAGUEY, CUBA

Journal d'Agriculture Tropicale

Founded by J. VILBOUCHEVITCH
164 Rue Jeanne d'Arc Prolongée.

Subscription, One Year - - - - 20 Francs

Deals with the leading questions of the hour, agricultural and commercial, of interest to tropical countries. International in character. Illustrated. Monthly. Descriptions of machines for tropical crops a specialty. Complete review of new agricultural publications. Commercial part intelligible for every one and always interesting. 150 contributors in West and East Africa, East and West Indies, Java, Mauritius, Central and South America, and throughout the tropical world.

PURDY & HENDERSON, Inc.

Engineers and Contractors

New York Chicago Boston

Cuba Office, Empedrado 32, Havana

HENRY E. BROWN

Pharmacist

Shipping and Export Chemist and Druggist, Ships' Medicine Chests Furnished and Replenished. Prescriptions Compounded by a Graduate in Pharmacy.

Trusses, Surgical Appliances, etc.

Office and laboratory, Room 36.

116 BROAD ST., NEW YORK

Telephone Call: 274-A Hamilton.

JOHN M. DONOVAN

13 Summit St. (Atlantic Dock) - BROOKLYN

Dealer in

Dunnage Mats

FOR BAG FLOUR, BAG AND BULK GRAIN AND GENERAL CARGOES.

— BAGS AND BAGGING —

SUGAR CANE PLANTATIONS

Cacao (chocolate and cocoa) and Coffee Plantation—Orange and Grapefruit Groves. Land for the small settler on easy terms. In the best district of Cuba—Rio Cauto Valley. Within 40 miles of Santiago and Nipe Bay. Write for Booklet.

RIO CAUTO SUGAR COMPANY, 50 Church St., N. Y. City

One of the surprises of Taft's administration is that Governor Magoon, lately of Cuba, hasn't been offered a good position yet, at least so far as the public knows.—Gardiner (Me.) Reporter.

M. J. CABANA
COMMISSION MERCHANT
P. O. Box 3, Camaguey

Solicits Correspondence from all the important cities of the United States of America.

THE BIG FOUR ROUTE

3 Daily Trains Each Way 3

Parlor Cars, Sleepers, Dining Cars.

Through Train Service
BETWEEN

Cincinnati, Toledo and Detroit

(Via Michigan Central R. R.)

Ask for Tickets Via

BIG FOUR

BARTLE

Twenty-five thousand acres of the richest and best watered land in Cuba on the main line of the Cuba Railroad, with the finest station on the line, 120 miles from Nipe Bay—the best harbor on the Island; also the nearest to New York. No swamps or insect pests.

BARTLE is not in the wilderness—we offer all the comforts of civilization. GOOD STORES, HOTEL, CHURCH, SCHOOL, SAW-MILL, Etc.

TWO MAILS DAILY.

SUGAR, FRUITS, TOBACCO AND VEGETABLES produce wonderful crops at BARTLE.

When you consider Soil, Transportation, Social, Religious and Educational advantages, BARTLE offers something not to be had elsewhere in Cuba. Write for particulars.

"Ten Days in Cuba," just published by Hon. Nicholas J. Whalen, Speaker of the Michigan Legislature, may be had through newsagents at 25 cents per copy, or will be sent free to any address by the owners of the Bartle Colony. Address, Duncan O. Bull, Gen'l Mgr. Cuban Realty Company, Limited, Temple Building, Toronto, Can., or 141 Broadway, New York City.

DUNCAN O. BULL, General Manager

CUBAN REALTY CO., Ltd. Temple Bldg., Toronto, Canada
141 Broadway, New York **Bartle, Cuba**

MOBILE, ALA.

HOME INDUSTRY IRON WORKS

Engines, Boilers and Machinery

Manufacturing and Repairing of all kinds. Architectural Iron and Brass Castings. Light and Heavy Forgings. All kinds of Machinery Supplies.

Steamship Work a Specialty

A. KLING, Prop.
 JAS. S. BOGUE, Supt.

MOBILE, ALA.

The Principal Hotels in Mobile, Ala.

THE CAWTHON THE BIENVILLE

(FIREPROOF)

(MODERN)

European, 175 Rooms

European, 150 Rooms

\$1.50 Up

\$1.00 Up

Both Hotels in Heart of City, Facing Bienville Square

OLLINGER & BRUCE DRY DOCK CO.

Ship Builders and Repairers

Operating seven Sectional Dry Docks, capacity 1,000 tons, and one Balance Dock, capacity 3,000 tons. Equipped with Air Plant for operating Pneumatic Tools, and Steam Pump for cleaning vessels' bottoms.

25-TON DERRICK BARGE AND STEAM PILE DRIVER.

Material of all kinds kept on hand. Shipwrights, Caulkers, Painters, Sparmakers and Riggers furnished promptly, and at reasonable rates. Correspondence solicited.

MOBILE, ALA.

BUSINESS FIRMS OF CAIBARIEN

ANGEL MATA

Comerciante.
Caibarién, Cuba.

Apartado 114. Cable: Mata."

Ferretería, Mueblería y Locería
LA LLAVE

DE INCHANSTI Y HNO.
Caibarién, Cuba.

Marti 11 y 13. Apartado 24.

R. CANTERA Y CA.

(S. en C.)

Comerciantes Importadores,
Escobár 28. Caibarién.

A. ROMANACH

Almacenistas Importadores de Viveres,
(S. en C.)
Caibarién.

P. B. ANDERSON,

Ship Broker. U. S. Consular Agent,
Caibarién, Cuba.
Agent for Munson Steamship Line and Lloyds.

MARTINEZ & CO., S. en C.

Comerciantes Banqueros,
Importadores de Viveres,
Exportadores de Azucar.

Apartado 115. Telegrafo: Urquiza.

COMERCIO,
Hotel - Restaurant - Cafe

De José Urquiza.
Calle de Marti num 16 y 18 - Caibarién

LA MARIPOSA DE EVARISTO BERGNES

Importador de Peletería y Talabartería, Fabricante
de Calzado.
Caibarién.

Apartado 104. Telégrafo: "Bergnes."

YMAZ Y CA.

Ymportadores de Ferrería en General.

Apartado de Correos Num. 15,
Caibarién, Cuba.

Calle Justa Num. 27. Cable: "Imaz."

ARIAS Y COMP

Provisiones, Loza y Muebles.
Cuba Num. 20, Esquina a Marti,
Caibarién, Cuba.

Correo Apartado Num. 15. Telégrafo: "Arias."

ZARRAGA Y CA.,

Caibarién, Cuba.

Casa Banca. Exportadores de Azucar.

BONIFACIO DIAZ,

Gran Peletería y Sombrería.

Marti 17 - - - Caibarién

Constantes novedades en los dos giros de esta casa.

RODRIGUEZ Y VINA, S. en C.,

Almacenistas Importadores de Viveres en General,
Comisiones y Consignaciones,
Consignatarios de Buques.

"Depositos de Carburo."

Telephone, 33 Hamilton
Night Call, 411 Hamilton

Cable Address:
"Abiworks," New York

Atlantic Basin Iron Works

Engineers and Boiler Makers

Machinists, Plumbers, Tinsmiths, Pipe Fitters, Blacksmiths, Coppersmiths,
Pattern Makers, Sheet Iron Workers. Iron and Brass Castings. Steamship
Repairs a Specialty.

Cor. Imlay and Summit Streets

Brooklyn, N. Y.

John Munro & Son

Steamship and
Engineers' Supplies

13 Conover Street, Brooklyn, N. Y.

Cable Address: Kunomale, New York

Telephone, 196 Hamilton

Telephone
215 Hamilton

Box 186
Maritime Exchange

YULE & MUNRO SHIPWRIGHTS

Caulkers, Spar Makers

Boat Builders, Etc.

No. 9 SUMMIT STREET
Near Atlantic Dock BROOKLYN

WINTER HAVEN NURSERIES

A. M. KLEMM, Proprietor

Established 1884.

Winter Haven, Fla.

Wholesale Growers of Citrus Stock of the best commercial varieties. We guarantee our extensive Stock to be well grown, free of insects and true to name.

Silver Cluster Grape Fruit our leading Specialty.

Prices right. Grading and Packing perfect.

Write for Catalogue.

CUBA INFORMATION

IS THE TITLE OF A BOOK WHICH GIVES DEFINITELY and concisely just such information concerning Cuba as is desired by the business man or prospective investor who is interested in this fertile island—*climate, soil, products, fruit growing, live stock, tobacco, sugar, customs duties, banking, investments, colonies, land titles, laws, and a hundred other matters.*

SEND 25 CENTS FOR A COPY

and if you want any specific information that could not be covered in such a book,

Ask Mr. Foster No. 1 Madison Avenue, NEW YORK

Mr. Foster also has information offices in Philadelphia, Washington, Atlantic City, Jacksonville, St. Augustine, Daytona, Palm Beach and Miami, Florida, and in Havana and Camaguey, Cuba. FREE INFORMATION—no fees ever asked or accepted.

The Standard Guide to Cuba— Reliable—accurate—maps—illustrations.
50 cents.

FOSTER & REYNOLDS, 1 Madison Avenue, New York.

BUSINESS FIRMS OF SANTIAGO

E. GIRAUDY & CA.

ALMACEN DE VIVERES

Marina baja n. 33, Santiago de Cuba.

Agentes de Schlitz Beer.

JULIAN CENDOYA

Steamship Agent and Broker

COMMISSION MERCHANT

CABLE: Cendoya. Santiago de Cuba.

VALLS, RIBERA & CA.

(S. en C.)

Importadores de Ferrreteria y Machinery.

Telégrafo: Valribe.

Santiago de Cuba y Manzanillo.

A. B. C. Code, 5th Edition. Telephone, 190.

P. O. Box, 95. Cable address: SILVAPA.

SILVA Y PARRENO H.

General Commission Merchants.

Custom House Brokers—Forwarding Agents.

Consignees of the Cuban steamers of the Carlos J.

Trujillo, S. en C., Line, formerly Menéndez & Co.

References:—J. Cendoya and Nat'l Bank of Cuba.

CAMP HERMANOS, Santiago de Cuba.

Ron Selecto "Golondrina" y "Carta Cuba."

Medalla de Oro, St. Louis, 1904.

RON BACARDI

DE BACARDI & CO., Distillers, Proprietors.

43 San Ignacio, cor. Santa Clara, Havana,

Santiago de Cuba.

LARREA Y BESEALIE

Importers of General Groceries and Exporters of

Cocoa, Wax, Honey and Woods.

Apartado 65, Marina Baja 46. Cable: Larrea.

Importación. Exportación.

L. ABASCAL Y SOBRINOS

Agentes de las líneas Pinillos Izquierdo y Ca., de

Cadiz. Larrinaga y Ca., de Liverpool. Com-

pañía de Seguros, Aachen & Munich, Aix-la-

Chapelle.

BROOKS & CO.

Bankers and General Commission Merchants.

Santiago and Guantánamo.

VINEGAR BEND LUMBER CO.

Manufacturers and Exporters

Long Leaf Yellow Pine Lumber and Timber

Cuban Business Our Specialty VINEGAR BEND, ALA., U. S. A.

Daily Capacity, 200,000 Feet

Cable Address: "TURNER"

Codes: A B C, Fourth Edition; Southards; Watkins; Western Union



SOBRINOS DE BEA & CO.

Bankers and Commission Merchants
Importación directa de todas los centros
manufactureros del mundo.

Agents for the
Munson Steamship Line, New York and
Mobile.

James E. Ward & Co., New York.
Serra Steamship Company, Liverpool.
Vapores Transatlánticos de A. Folch & Co.
de Barcelona, España Independencia
Street 17/21.

MATANZAS, CUBA.

JOHN W. McDONALD

COAL, WOOD, LUMBER
and TIMBER of Every
Description

112 WALL STREET

Near South Street NEW YORK

Yard: 58-68 Beard Street, Erie Basin
Telephones:

Office, 1905 John Yard, 316 Hamilton

From our own point of view, says the St. Louis (Mo.) Globe-Star, we have conferred a great blessing upon the Cubans and given them a stable republican government for which they ought to be glad to pay, but this may not be their viewpoint, believing we did it to promote our own interests.

"The Comfortable Way"

Between the East and the West is
via the Toledo, St. Louis and
Western Railroad

"Clover Leaf" Route

Rates lower than by any other
direct line. Send four cents in
stamps for copy of "Get Out or
Get in Line," a booklet by Mr.
Elbert Hubbard, Chief of the Roy-
crofters.

GEO. J. CHARLTON,
General Passenger Agent,
Chicago, Ill.

THE SNARE AND TRIEST COMPANY

CONTRACTING ENGINEERS

Steel and Masonry Construction
Piers, Bridges, Railroads and Buildings
We are prepared to furnish plans and estimates
on all classes of contracting work in Cuba.

N. Y. Office
143 LIBERTY ST.

Havana Office
LA LEAL BUILDING

W. H. Bennett

F. W. Hvoslef

Bennett, Hvoslef & Co.

18 Broadway, New York

Steamship Agents and Ship Brokers

Cable: "Benwalsh"

MUNSON STEAMSHIP LINE

GENERAL OFFICES

82 Beaver Street New York

NEW YORK-CUBA SERVICE PASSENGER and FREIGHT

| steamer | New York | Nipe | Nuevas | Nipe | Banes | Gibara | Pto. | Nuevas | Nipe | New York |
|----------|----------|--------|---------|---------|---------|----------|---------|---------|---------|----------|
| | Sail | Arr. | Arr. | Arr. | Arr. | and Vita | Padre | Arr. | Sail | Arr. |
| Curityba | July 14 | | July 19 | July 21 | July 23 | July 24 | | July 29 | July 30 | Aug. 4 |
| Olinda | July 28 | Aug. 2 | Aug. 4 | | | Aug. 7 | Aug. 10 | Aug. 12 | Aug. 13 | Aug. 18 |

SAILINGS SUBJECT TO CHANGE

WITHOUT NOTICE

FREIGHT ONLY

NEW YORK to CAIBARIEN, MATANZAS, CARDENAS and SAGUA

MOBILE-CUBA SERVICE

Freight Only

REGULAR SAILINGS-MOBILE to HAVANA-MOBILE to N.S. S.S. CUBAN PORTS.

BALTIMORE-COLON SERVICE

Freight Only

REGULAR SAILINGS-BALTIMORE to COLON.



AGENTS IN CUBA
ASMUS LEONHARD

Cuban Freight and Passenger Agent
76 Cuba Street, Havana

BERNABÉ SANCHEZ É HIJOS
FRANCISCO PLA
BEOLA & CO.
M.J. CABANA
J.L. DAUTERIVE

Nuevas
Puerto Padre
Gibara
Camaguey
Antilla (Nipe Bay) Oriente

For Southbound reservations address the General Offices, New York
For Northbound reservations address the agent at the port of embarkation

Lillie Multiple Evaporators

Model of 1904-1905 (Patented)

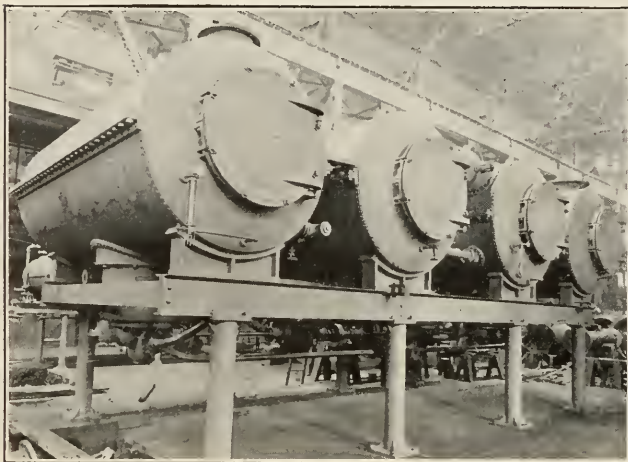

"One of three Lillie quadruple effects installed in 1907, in sugar factories in Formosa, belonging to the Taiwan Seito Kabushiki Kwaisha, of Tokio, Japan. Two more quadruple effects, one to handle 550,000 gallons of cane juice per twenty-four hours, and the other to handle 325,000 gallons in the same period, are now (July 1st, 1909) being built for the same Japanese Company, also for service in Formosa. These quadruple effects are arranged for reversing the course of the vapors and heat at will, a mode of operation peculiar to the Lillie and which has proven of great value for solutions depositing incrustations on the evaporating tubes."

The Sugar Apparatus Manufacturing Co.

328 Chestnut St., Philadelphia, Pa.

S. MORRIS LILLIE, President.

LEWIS C. LILLIE, Secretary and Treasurer.

BALDWIN LOCOMOTIVE WORKS

Broad and Narrow Gauge

Single Expansion and Compound

LOCOMOTIVES

Compressed Air Locomotives. Electric Locomotives with Westinghouse Motors

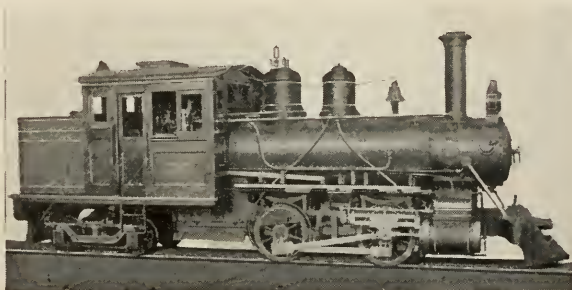

PLANTATION LOCOMOTIVES

For all Gauges of Track. To meet all conditions of service. Specifications furnished on application.

Principal offices and works, 500 North Broad Street
Philadelphia, Pa., U. S. A.

Cable Address: "Baldwin, Philadelphia"

Agents for Cuba, Krajewski-Pesant Co., Aguiar 92, Havana, Cuba.

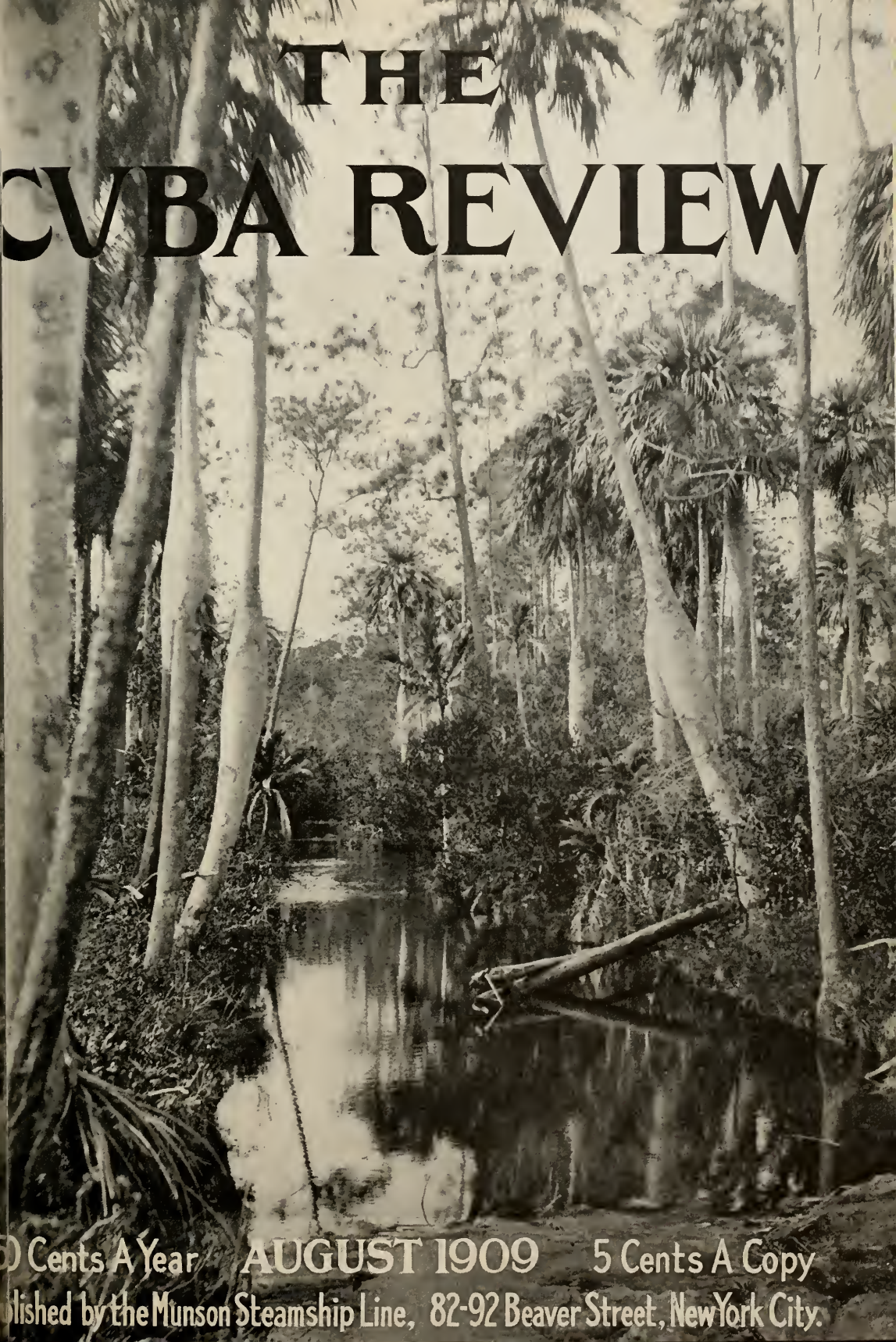

THE CVBA REVIEW

50 Cents A Year AUGUST 1909 5 Cents A Copy
Published by the Munson Steamship Line, 82-92 Beaver Street, New York City.

CEBALLOS "THE GARDEN SPOT OF CUBA"



FOUR-YEAR-OLD GRAPE-FRUIT TREE AT CEBALLOS

After eight years of developing the country, creating industries, establishing conditions—paving the way—we now invite HOMESEEEKERS to share our prosperity. No pioneering. All conveniences of modern civilization. Send for literature.

GEO. H. GILLETT, Secretary **43 EXCHANGE PLACE, NEW YORK**

Would you like to
own a
HOME
in this
Ever-Summer Land?

**Intelligence, energy
and moderate capital
will here win a fortune
for you in Fruits, Vege-
tables and Sugar.**

PRATT Imperial



**Sugar Cane Machinery and Evaporating Apparatus.
Complete Plants Erected and Delivered to Owner Under Guaranteed Capacity
of Mills and Quantity. Sugar House Pumps.**

**We have nearing completion, subject prior sale, September 1st
delivery, one 34" x 72" Pratt "IMPERIAL" Mill Complete, with
Hydraulics, Compound Gearing & Corliss Engine, also one 26" x 72"
Pratt "IMPERIAL" Cane Crusher, complete with Hydraulics, Com-
pound Gearing and Corliss Engine. For description see page 34.**

STEAM PUMPS

**SPECIAL PARTS of MACHINES, any size or kind; and
HEAVY CASTINGS famous for quality.**

**We maintain Export Sales Offices at 80 Wall St., New York, in charge of
Mr. N. A. Helmer, an eminent Sugar Mill Engineer of wide experience. We
solicit our business with the assurance of every courtesy and perfect satisfaction.**

**Pratt Engineering & Machine Co. ATLANTA, GA.
U. S. A.**

HAVANA, CUBA, OFFICE: LONJA DEL COMERCIO No. 509

Successors to FULTON FOUNDRY & MACHINE WORKS, Atlanta, Ga.

Tivoli Beer

—*Enough said.*

Havana Brewery

Havana

BUCKEYE NURSERIES

M. E. GILLETT, Proprietor

TAMPA, FLORIDA, U. S. A.

ORANGE, LEMON AND GRAPE FRUIT TREES

LARGEST CITRUS NURSERY IN THE WORLD

QUALITY

VARIETY

DELIVERY

Price may be forgotten—Quality NEVER.

We grow nothing but standard Varieties which we can recommend to the trade as Money-Makers. Having had 29 years' experience we thoroughly understand packing trees for long distance shipments.

We guarantee our trees to be True to Name, Free from White Fly and to ARRIVE AT DESTINATION IN GOOD CONDITION.

Consider the future and protect your investment by planting reliable trees from

THE BUCKEYE NURSERIES

La Gloria has Arrived. All other American colonies in Cuba have yet to come.

La Gloria has Better soil, climate, water, schools, docks, cheaper transportation, living, more American people, push and natural advantages.

The Oldest, Largest and Best American Colony.

First Prize for citrus fruits Havana Exposition, 1908.

The La Gloria Transportation Company's fine mail and passenger steamer connects with Munson Line steamers at Nuevitas. Sailings Tuesdays, Thursdays and Saturdays.

Boulevard Completed. The Cuban Government has completed a fine macadamized boulevard from the townsite to Port Viaro, costing \$80,000.

La Gloria is All its Name Implies.

Not a promoter's dream but an assured fact. Our West Canasi tract, just opened, is the finest orange land in Cuba. We have also a few choice town lots for sale.

Send for our new booklets showing pictures of homes and plantations, and giving terms and conditions.

Cuban Land and Steamship Company

32 Broadway, New York City

OF VALUE IN CUBA

Dixon's Silica Graphite Paint. Protects all iron work from rust and destruction. Equally useful for wood or metal.

JOSEPH DIXON CRUCIBLE CO.

Jersey City, N. J.



Sugar Plantation—Cuba Railroad.

The Cuba Railroad

This new line completing the railroad connection between Havana and Santiago, and Antilla, on the Bay of Nipe, is of standard gauge and similar in its construction and equipment to the better class of northern lines. All of its important bridges are of steel and masonry, and the line generally is rock-ballasted. The main line passes along the center of the eastern and wider half of Cuba, and opens up a matchless and most picturesque agricultural region, and passes through the tropical forests of mahogany, cedar, lignum vitæ, ebony and many other trees, hung with vines and millions of orchids. Palm trees of magnificent aspect and great variety abound everywhere. The famed Parana and Guinea grasses, covering most of the open districts and standing from six to twelve feet high and green the year round, together with frequent running streams, make this an ideal cattle country. No food has to be put up and no shelter is required. The rich soils everywhere are adapted to sugar, tobacco, cotton, corn and an endless variety of products. The swamps which occur at places along the coasts of Cuba are absent from the interior, which is high, dry and exceptionally healthy. The trade winds blow across Cuba every day, and bring to all parts fresh sea air; the extreme heat of northern summers is consequently unknown and the humidity of other tropical countries is also unknown.



A Corridor, Hotel Camaguey.

The Cuba Railroad Company's **Hotel Camaguey**, at Camaguey (formerly Puerto Principe) is by far the most popular resort in Cuba, Spanish in style, and provided with bath rooms and other modern conveniences, and is first-class in all respects.

This old city has about 40,000 inhabitants, is picturesque and is situated in a beautiful and remarkably healthy district. The hotel is especially favored by those wishing to spend some weeks or months in a matchless sub-tropical climate.



Map of The Cuba Railroad.

THE CUBA REVIEW

"ALL ABOUT CUBA"

An Illustrated Monthly Magazine, 82-92 Beaver Street, New York

MUNSON STEAMSHIP LINE, Editors and Publishers

SUBSCRIPTION

50 Cents Per Year - - - - - 5 Cents Single Copy

Advertising Rates on Application

Vol VII.

AUGUST, 1909

No. 9

Contents of This Number

- Cuban Government matters are unusually interesting this month. The changes in the Cabinet, the State Lottery, the new Cuban loan, the Cabinet resignations, the Budget reductions, are all described on pages 7 to 11.
- Some portions of Havana's sewerage and paving works are illustrated on page 12. A great work is under way.
- On page 13 are further interesting illustrations of sanitary work, showing the construction of a great drain in Havana to take care of the terrific rain-falls that inundate the city's streets.
- Further comment from United States newspapers on Cuban matters will be found on page 14.
- A Spanish translation of other important United States comment will be found on page 15.
- The United States Coaling Station at Guantanamo, with an illustration, on page 17, and some general news items, one especially interesting on Dr. O'Reilly's investigations into the sanitary condition of Cuba's cities.
- Some further interesting notes, together with an illustration of cement houses for workmen in Havana, are on page 19.
- Pages 20 to 22 are devoted to information regarding Cuba's financial interests. The condition of the Treasury of the Republic on June 30, the report of the National Bank of Cuba, and the traffic receipts of the various railroads of the Island are given.
- Tobacco exports and duties on page 23.
- Isle of Pines notes on page 24.
- Some important information regarding the juices of the Paw Paw, with illustrations, is given on page 25.
- On pages 26 and 27 is an article, from a resident in Cuba, on the sowing of the lablab bean as a cover crop in citrus fruit groves.
- On the latter page are also given some fruit-shipping pointers, and New York prices on fruit.
- Pages 28 and 29 are devoted to a very informing article, condensed from a publication of the United States Department of Agriculture, on home canning of vegetables. Full details of the operations are given.
- The Sugar Review, by Messrs. Willett & Gray, the well-known authorities, is on page 30. A very large crop is in sight for this year, with good prices, and next year promises to be equally good.
- The same article in Spanish on page 32.
- On page 34 some notes regarding sugar cane enemies, which will interest all those who are engaged in the industry.

MANY BEAUTIFUL ILLUSTRATIONS.

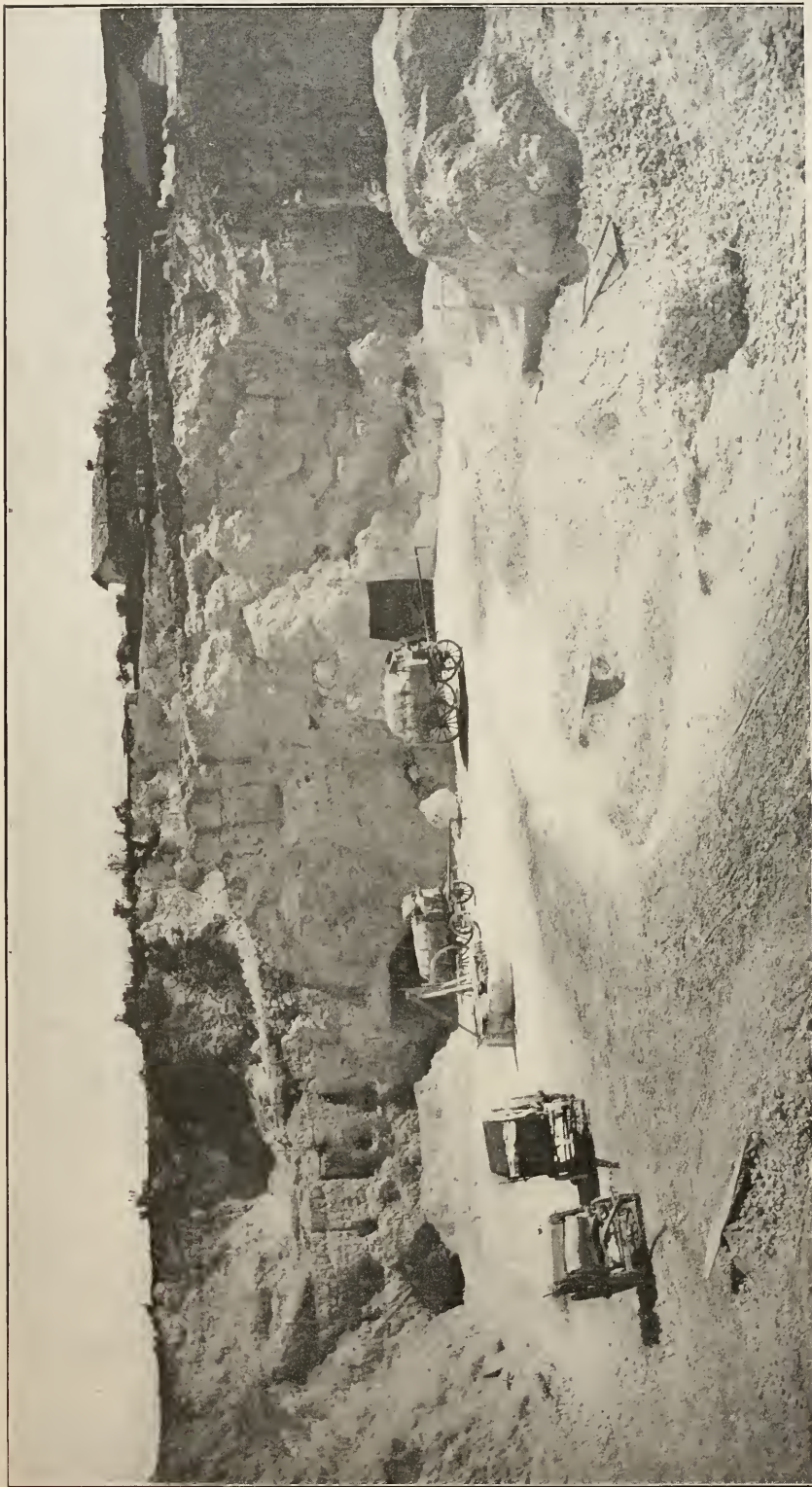

A limestone quarry near the Almendares River. Central and western parts of the Island, and, in fact, Cuba's entire foundation is more or less limestone, according to known investigators as Humboldt and others. Referring to mountains he speaks of them, as calcareous groups. Around Guines, in Havana Province, the limestone is mixed with gypsum, and is of a reddish white color. In its antiquity the limestone of this section is the same as the conglomerate limestone of the keys south of Batabanó and those east of the Isle of Pines. The hills of Morro and Cabanas are also of limestone.

Una cantera de piedra caliza cerca del río Almendares. La parte central y la occidental de la Isla, y en realidad el asiento de Cuba toda es más ó menos de piedra caliza, según comprobados investigadores, como Humboldt y otros. Refiriéndose á las montañas, habla de ellas como de grupos calcáreos. Cerca de Güines, en la provincia de la Habana, la piedra caliza se mezcla con yeso, y es de un color blanco rojizo. Cuando está vieja, la piedra caliza de dicha sección es igual á la piedra caliza conglomerada de los cayos al Sur de Batabanó y al Este de la isla de Pinos. Los cerros del Morro y de la Cabaña son también de piedra caliza.

THE CUBA REVIEW

LIBRARY
NEW YORK
BOTANICAL
GARDEN.

"ALL ABOUT CUBA."

Copyright, 1908, by the Munson Steamship Line.

Volume VII.

AUGUST, 1909.

NUMBER 9.

CUBAN GOVERNMENT MATTERS.

Congress Adjourns With Little Done—The Page Matter—Political Friction Very Much in Evidence—The Lottery—New Cuban Loan, Etc.

Cuba's first Congress under a restored republic adjourned July 9, after an almost continuous session of five months, with but little accomplished. Debates on matters of small importance, instead of serious legislative constructive work, marked the session, and it was only toward the closing days that some important bills passed both houses and received the President's signature.

The first bill enacted into law was declared unconstitutional when submitted to the Supreme Court. It was a political measure to take the appointing power from the mayors and vest it in councils. Among the measures approved were those authorizing a national lottery and legalizing cockfighting. Another bill that became law permits the installing of long distance telephones throughout the island. This was opposed on the theory that the telephones would afford means of communication between conspirators. The proposition to legalize bull fights was killed.

The complete fusion of the two wings of the Liberal party, the Miguelistas and the Zayistas, as the political followers of the President and Vice-President are called, seems a little nearer now, but there are unmistakable signs of discontent.

Zayistas on July 23 sent a committee to President Gomez protesting against alleged discrimination in the matter of political patronage. Their leader, Vice-President Zayas, while optimistic regarding fusion, confessed that his party is now in a critical condition.

Rumors were also in circulation of the formation of a new organization to be called the Cuban National party, which seemed designed to absorb the present Miguelista party, thereby absolving the latter from carrying out its ante-election pledges made to the Zayistas, among which was an agreement to support that party's leader, Senor Zayas, for President in 1913.

The latter on hearing of the new organization is quoted as saying that if it were true he would not feel inclined longer to sustain the administration. That there is opposition to him is evident from the fact that some Miguelistas objected to him as chairman of the fusion organization committee, General Eusebio Hernandez being preferred.

On July 24 the Cuban navy was placed under the Treasury Department, an act provided for by a recent law of the Cuban Congress.

By this legislation the revenue cutter service of the country became the national navy, a change in name rather than in fact. The act gives increased importance to the marine service, and may lead the Cuban Government to purchase gunboats and other

small armed craft. The number of officers needed in the service is to be determined by the Secretary of the Treasury.

Among the duties of the national navy as defined by the act are to defend the interests and rights of the nation, to protect the customs revenues, the sponge and turtle fisheries in Cuban waters, to prevent unlawful traffic in firearms and spirituous liquors and to put down mutinies aboard merchant ships.

*The
Cuban
Navy.*

AUG 16 1909

Cuba's State Lottery. The lottery bill went through only at the last moment, the long delay being due to the usual wrangling and also the settlement of the question of who should receive the much coveted post of director. Senator Morua Delgado having persistently refused to accept the appointment of General Director of the new National Lottery, President Gomez on July 28 appointed Señor Gustavo Alonso y Castanedo, a lawyer and journalist, to the directorship.

On the same day the State Department at Washington received from the American Minister at Havana full details.

Under the law the State is given a monopoly by prohibiting the importation of any other kind of policy tickets and also forbids any private lotteries, raffles or any other similar competitions for prizes.

Seventy per cent. of the receipts must be distributed in prizes. Drawings are to be held four times a year, under the supervision of a board of seven men. Children from the Foundlings' Home and National Orphan Asylum are to draw the lucky numbers. Tickets range from 25 cents to \$1.

The Cuban Government expects a net annual revenue of \$2,000,000 from it.

Havana brokers report large orders for tickets from the United States and will try and fill them, but it is believed that no large or profitable sale of tickets can be made if the American authorities co-operate to prevent them.

At the office of the Cuban Consul at New York an immense amount of correspondence is being received in relation to the new lottery scheme of Cuba for raising government funds. The number of inquiries as to how tickets in this lottery may be obtained in the United States is rapidly increasing as news of the governmental character of the lottery spreads.

United States postoffice inspectors are carefully watching for evidence of lottery tickets which are expected soon to make their appearance.

The authorities say that not only is it a violation of the law to send lottery tickets, lottery literature, or the proceeds through the United States mails, but it is contrary to law to send it by express or freight from one State to another, and for one man to carry it on his person from one State to another.

President Gomez issued an order directing the bureau in charge of the national lottery to reserve at the first drawing ticket No. 1,895 for his personal account, the number commemorating the outbreak of the final war of independence. He has purchased this number for all the succeeding drawings, a privilege given purchasers under the lottery laws.

The Cienfuegos Concession. The Reilly concession at Cienfuegos has developed a very interesting situation, said the Toronto Mail and Empire on July 24. There

are four interests contending over the railway concessions, asserting that Judge Reilly's grant had expired because he had not complied with conditions. The Camaguey Company, owning an electric line at Camaguey, had obtained a concession for a street railway in Cienfuegos, through Robert Betancourt, who was killed by his brother some weeks ago. The United Railways also have a claim and there is further dispute over the concession for a road from Cienfuegos to Manicaragua which the same paper states had been given first by Sir William Van Horne and also to the Cuban Central Railway. The Canadian claimants, it says, have the City Council with them against Judge Reilly, but the latter counts on the support of the Railway Commission and the Mayor of Cienfuegos, to win. If this should happen the Canadians will take issue through diplomatic channels, when some embarrassing questions may be asked, as the concession granted to the Canadians is said to be legal in every respect.

On August 2 President Gomez declined an invitation to attend the ceremonies at Cienfuegos of the inauguration of Judge Reilly's trolley line. He had received a telegram from C. C. Gile, representing the Montreal Engineering Company at Cienfuegos, urging him not to attend as his company had a claim against Mr. Reilly's concession as outlined above.



An old stone watch tower in the Vedado used in ancient times as a lookout for approaching pirates.

Una antigua torre de piedra en la parte de la Habana que mira hacia el Golfo, que se usaba en antigüedad como atalaya para espías la proximidad de los piratas.

The New Cuban Loan.

On July 21 President Gomez issued circulars inviting bankers to bid for the loan of \$16,500,000, authorized by Provisional Governor Magoon on Jan. 15. The official purpose of the issue is to cover the payment of contracts for the Cienfuegos water works and the Havana sewer system. The loan was to be secured by internal taxes. Havana bankers took the view that as the security on the internal taxation is subject to the conditions under which the first army pay loan of \$35,000,000 was placed by Speyer & Co. of New York, and no other security being mentioned, that the same firm could best negotiate the additional loan.

The same day a conservative daily said that English capitalists have offered to unify the Cuban debt, loaning \$50,000,000 at a cheaper rate than was named by Mr. Speyer's New York banking firm. But the latter firm agreed to loan \$35,000,000 to pay the army ten years ago, providing that any future loans would be made through the firm.

It would appear from this that Speyer & Co. would be likely to receive first consideration. On July 31 announcement was made that Speyer & Co. had been awarded the \$16,500,000 Cuban bonds, of which \$5,500,000 are to be issued in the near future, and the balance within two years. Numbers of tenders were submitted, nearly every prominent banking house in New York and many European firms having submitted their competing bids for the loan. It will be recalled that Cuba cannot create any bonded debt without, under the Platt amendment, getting the consent of the United States Government thereto, but the present flotation was directly authorized by the United States Government, acting through its appointee, the Governor General of Cuba.

The customs receipts of Cuba for the last few years have averaged about \$23,000,000 annually, without taking into account the special taxes amounting to nearly \$3,500,000 a year since they were created as a special revenue applicable to the service of the \$25,000,000 loan placed with the Speyers a few years ago.

The N. Y. Sun said that "J. P. Morgan & Co. refused to bid on more than the first installment of \$5,000,000, not caring to discount the future."

The Page Matter.

Mr. James Page, an American citizen, who was appointed chief engineer of the water supply and sewer system of Cienfuegos, by former Governor Magoon on Sept. 10, 1908, was discharged early in July by the Cuban Public Works Department.

Mr. Page protested, denying the department's authority and claiming that his dismissal would be in direct violation not only of the decree issued by Gov. Magoon, but also of the Reilly contract, under which the water and sewer systems of Cienfuegos are being constructed.

Secretary of State Knox having had his attention called to the matter, instructed Mr. Morgan, the American minister at Havana, to insist upon the retention of Mr. Page until all the documents had been submitted to President Gomez, which agreement was reached July 15. Article 5 of Governor Magoon's decree provides that the engineer "shall hold office during the term of this contract, but may be removed by the Provisional Governor or other chief executive of the state for good cause after notice and public hearing."

There was indignation expressed by some of the Havana papers over the action by the U. S. Government.

The Diario said: "Our tutors must not go too far, for desperation even of a weak people can give trouble."

The Discussion says "that Minister Morgan tells President Gomez daily what he may do or may not do."

Cuba advises that as the country must obey Washington it would be wiser to inquire as to Washington's wishes before acting.

Senor Enrique J. Montoulieu had been appointed to succeed Mr. Page on July 20. He is a Harvard graduate.

Commenting on the matter the Buffalo (N. Y.) Courier said: "When Cuba is told from Washington that a certain officeholder must not be displaced, one has to think that Cuban independence is quite a hollow mockery."

All the documents in the case have been given to President Gomez.

The Spanish Claims.

A semi-official communication from Madrid, July 8, stated that Cuba's refusal to recognize the Spanish debt claim is not regarded as final. It is intimated that the terms of the proposed treaty of commerce between the two countries will have some influence on Cuba's attitude. In the event of Cuba finally refusing to arrange a settlement the claim will be referred to arbitration by the Hague tribunal.

The Secretary of the Department of Public Works has authorized the purchase of a pumping station for the city of Melena del Sur. The work on the station will be done by the administration and paid for out of the national funds.

The commission appointed by President Gomez, of three Senators, three Representatives and the Secretary of the Treasury, to consider possible economies in the budget schedules, recommends some drastic reductions, which are printed in the "Gaceta," July 16, reduces the budget from \$33,710,648 to \$30,955,612. The reductions, aggregating \$2,755,036.90, are apportioned among the departments as follows:

| | |
|--|--------------|
| Executive uses | \$1,480.00 |
| Public works | \$376,060.00 |
| Agriculture | 423,080.00 |
| Interior (includes Army and Rural Guard) | 956,188.43 |
| Public Instruction | 158,258.00 |
| Treasury Dept. | 173,790.00 |
| Judiciary Dept. | 53,670.00 |
| Sanitation and Charities | 415,850.47 |
| Loans | 51,440.00 |
| Legislative power (no change) | |
| Dept. of Justice | 78,100.00 |
| State Dept. | 67,120.00 |

Total \$2,755,036.90

July 9, President Gomez signed the bill commissioning General Loynaz del Castillo to conduct a diplomatic mission to the South and Central American republics. President Gomez's son Mariano is a member of the commission, whose work will occupy two years. The sum of \$40,000 has been appropriated for its expenses. The date for the departure of the commission has not yet been fixed. Our State Department, from newspaper talk, has been somewhat concerned over this trip of Gen. Castillo, fearing that he will talk to South Americans in a manner damaging to this country, as he is charged with being anti-American.

On July 29 the Cabinet crisis, which for some time has been impending, reached a climax when all the seven ministers, Miguelistas and Zayistas, as well as the President's private secretary, Senor Castellanos, sent in their resignations.

On August 1 the President made some changes and the cabinet now stands as follows:

Secretary of State, Justo Garcia Velez.
 Secretary of Justice, Luis Octavio Diviño.
 Secretary of the Interior, Francisco Lopez Leiva.
 Secretary of the Treasury, Marcelino Diaz de Villegas.

Secretary of Public Works, Arturo Chalons.

Secretary of Agriculture, Commerce and Labor, Ortelio Foyo.

Secretary of Public Instruction, Ramon Meza.

Secretary of Sanitation and Charities, Matias Duque.

Secretary to the President, Damaso Pasalodos.

The outgoing Secretary of the Interior, Dr. Nicholas Alberdi, was appointed August 2 delegate from Cuba to the International Congress for the Prevention of Cruelty to Children, to be held at Budapest on the 28th inst.

Dr. Jose Lorenzo Castellanos will study a project for reforming the present prison system. Salary \$6,000 a year.

El Comercio, of Havana, commented on July 9 on the *New Reprisals Threatened* conference held between President Gomez and Minister Morgan, affirming that Mr.

Morgan discussed the disagreeable effect produced in Washington by the bill Señor Ferrara presented in the Cuban Congress some time ago proposing a reduction in duties on machinery imported into Cuba which would certainly affect American manufacturers, who are unable to compete with French and Belgian exporters.

Mr. Morgan, it is said, has indicated the advisability of avoiding reprisals which may be made by the American Congress, as in the affair of raising the duty on Cuban pineapples.

Commenting on this matter General Garcia Velez, the Cuban Minister at Washington, pointed out that almost at the same time Señor Ferrara presented a bill to the Cuban Congress framed in such a manner as to be greatly beneficial to American interests because intended to favor nations buying most from Cuba. The measure reads:

"Article 1.—The National Executive is authorized to increase up to thirty per cent. over and above the present tariff the custom duties upon articles imported from nations whose exportation is greater than their importation, in respect to our own.

"Article 2.—This law shall take effect from the date of its publication in the official gazette of the republic."

Dr. John Guiteras, the yellow fever expert, on July 29 resigned as Chief Sanitary Officer at Havana. He states his department has been crippled by unwise reductions in expenses and declines further responsibility for holding yellow fever in check.

The Cuban Civil Service Law.

In submitting to Provisional Governor Magoon the draft of a civil service law, the Cuban Advisory Commission reported "the non-existence, so far, of a law of this nature, has presented opportunities which unfortunately have been excessively availed of for the passion and vehemence of political strife." That much of the turbulence of the Cuban Republic has been due to the desire for office is undoubted. One of the chief

to the Cuban Republic a legacy, which, if cherished and faithfully observed, will prove an effective safeguard against selfish partisan domination.—Good Government.

The Custom House collections for the port of Havana for the month of July for the last four years are as follows:

| | |
|----------------|----------------|
| 1909.. | \$1,509,947.37 |
| 1908.. | 1,313,839.41 |
| 1907.. | 1,623,661.82 |
| 1906.. | 1,534,538.38 |



A view of the picturesque surroundings of the building occupied by Cuba's Secretary of State, Justo Garcia Velez. It fronts on Havana's harbor.

Una vista del bonito panorama que rodea el edificio ocupado por el Secretario de Estado de Cuba, Sr. Justo Garcia Velez. Está frente a la bahía de la Habana.

difficulties which beset the provisional government was the insistent clamor of the various political factions for their share of the patronage.

The provisions of the law are, in general, comprehensive and rigorous, and the law is as excellent an act as any in the United States. A strict system of competitive examination, both as to appointment and promotion, is established for the national, provincial and municipal governments, and embraces the great majority of the public offices. Political assessments are prohibited, as is also political activity in the discharge of official duty. No removals may be made for political or religious reasons, and the civil service commission is given power to set aside any removal so made. A civil service law in Cuba, to use the phrase of the Advisory Commission, is a "very substantial innovation," and the law was therefore drawn with much attention to detail, and includes a great many regulations as to general administrative procedure not usually found in other civil service laws.

In decreeing so wise and thorough a law, the provisional government has left

Señor Orestes Ferrara, Speaker of the Cuba House of Representatives, on his way to Europe, was interviewed in New York, July 14, and said:

"President Gomez nullified the contract with the United States dealers," said Senor Ferrara, "because the models submitted did not come up to the standard of the Cuban government. Any rumors that we expect war with the United States are unfounded. Among the majority of Cubans there is absolutely no feeling against the United States. We wanted our independence, and now we have complete government for ourselves. We think of the United States as a benefactor. We know that the United States desires our independence, for you have demonstrated that twice. Our prosperity depends upon our favorable commercial relations with your country."

Cuban Army Troubles.

Insubordination of the enlisted men, especially the negroes, in the recently established permanent army of Cuba, and bickerings between the officers, are considered serious. Charges against Gen. Rovas, Col. Valiente and other officers brought an order for a court martial, which was countermanded by President Gomez on July 29. He also pardoned the enlisted men imprisoned for insubordination. The army opinion is that the Presi-

HAVANA'S SEWERING AND PAVING WORKS.

Illustrations of the Beginnings of This Great Work.

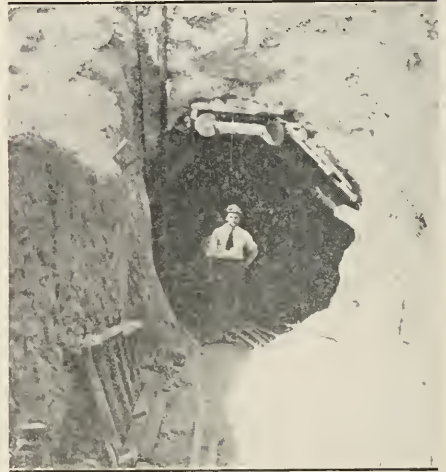

Entrance to the tunnel through Cabanas hills.



The illustrations on this page and on the next page show some of the public works of the Cuban Government in and around Havana. The two upper pictures show the cut of the Cabanas hills and the tunnel now being constructed, through which Havana's sewage will be pumped into the Gulf. The bottom illustration is of the sewer excavation work in the suburbs of Havana. It will be noted that the streets are so narrow the debris is piled up against the houses. There is no paving to be done in these sections.

Los fotografados que aparecen en esta página y en la siguiente, representan algunas de las obras públicas que el Gobierno cubano está llevando á cabo en la Habana y sus alrededores. Los dos fotografados que se insertan en la parte superior de la página, dejan ver el corte en los cerros de la Cabaña y el túnel en construcción por el cual se bombearán las aguas inmundas de la Habana para derramarlas en el Golfo. El fotografado al final de la página representa los trabajos de excavación para el alcantarillado, en las afueras de la Habana, en el que se verá que por ser la calle tan estrecha, hay que apilar la tierra contra las casas. En esas secciones no se va á hacer empedrado alguno.

CONSTRUCTION OF DRAIN IN HAVANA.

Views of the Work Now Going on—An Improvement Long Needed.



The illustrations on this page show different views of the construction of a drain at the foot of Amargura Street, Havana. This drain will dispose of the accumulated rainwater which in heavy storms makes Havana's streets impassable, especially in the neighborhood of Cuba and Obispo streets. The new drain will effectually prevent these inundations.

Los fotograbados que publicamos en esta página, son dos vistas de las obras de construcción de un desaguedero al final de la calle de la Armagura en la Habana. Ese desaguedero dará salida al agua que tanto se acumula cuando hay grandes aguaceros y que hace impasables las calles de la Habana, especialmente en las inmediaciones de las calles de Cuba y del Opispo. El nuevo desaguedero evitará absolutamente esas inundaciones.

THE PRESS OF THE UNITED STATES.

Cuban advices indicate that President Gomez is confronted by conditions and tendencies precisely similar to those which proved fatal to the second administration of his predecessor. Chief among these is the inclination of the insular Congress to neglect its legislative duties. Many laws which were urgently needed were left unmade, while others were passed at the last moment under direct Presidential pressure. The budget itself failed of enactment before the original adjournment of the Congress, and would have had to be put into force by Executive decree had not the Congress come together again in special session for the express purpose of performing that neglected duty.

President Gomez happily shows himself to be possessed of decision and vigor sufficient to deal with such emergencies. He practically forced the Congress to enact some laws and would not have hesitated to enforce the budget by decree. But, of course, it is not desirable for the President to assume such an attitude toward the legislative department of the government, and there is danger that he will be censured by the very men who have compelled him to do so. That is precisely what happened to Estrada Palma.

It is much to be regretted that Cuban politicians persist in pursuing this course, for it is certain to injure the country and it is not unlikely to end in disaster.—New York Tribune.

It is plain from these events (the Page matter and the European arms purchase) that the administration proposes to maintain a vigilant guardianship over Cuban affairs. It is eminently reasonable to suppose that President Taft and Mr. Knox have good ground for the course they have taken. It would be absurd to imply that either of them desire to treat Cuba with injustice or harshness. But this country, which made heavy sacrifices to free the island from Spanish domination, has a paramount interest in its welfare and the orderly management of its concerns.—Philadelphia (Pa.) Bulletin.

It is well to observe that whereas Cuba has just settled the question of establishing a national lottery by the passage of a bill which gives President Gomez the authority to appoint a manager, France has reached the conclusion that the lotteries existing within her jurisdiction should be abolished, and steps will be taken to enact a law which will close all of them by December, 1910. The action in Cuba and that in France will indicate the higher degree of civilization which has been

reached by the people of the latter country, for it is quite well understood that the lottery bill was passed by the Congress of Cuba in order to satisfy the desire of the Cubans to indulge in that kind of gambling. On the other hand the lotteries in France will be closed because the people have discovered that thrift is a surer road to fortune than dependence on chance.

The French are among the most thrifty people in the world, while the Cubans have a very slight acquaintance with thrift, and like all peoples poorly advanced in civilization they have more faith in chance or luck to provide them with a fortune than in attention to the work which they are often compelled to do because chance did not come their way.—New Orleans (La.) States.

Taking the case at its worst possible aspect, however, it is only fair to give the Cubans more of a chance than they have had yet to prove their ability or inability to govern themselves. Too many of the errors urged against them could be urged with equal justice against Americans. We are likely to demand that they obey a sterner code than we ourselves are willing to follow. It must be remembered, too, that the Cubans cannot justly be judged by the same standards that hold sway here. Their racial peculiarities must be taken into full consideration.—Cleveland (O.) Plain Dealer.

At present the United States imports less than 1,000,000 tons of iron ore a year, of which more than half comes from Cuba. These Cuban mines are owned by Americans, employ American labor for their skilled work and there is no more reason for protecting the mines of Wisconsin from their competition than for protecting the mines of New York from the competition of Alabama. At best the Cuban mines cannot produce enough ore to affect prices materially in the United States.—Buffalo (N. Y.) Express.

There would undoubtedly be trouble if the Cuban game of chance should be started and attempts should be made to do business in this country through the mails or otherwise. Officially, it is probably none of our business. It is a resort that will prove obstructive to honest and steady industry, such as is requisite for the industrial development of the island, and is, therefore, a method which all friends of the second-time launched republic will deplore.—Baltimore (Md.) American.

LO QUE DICE DE CUBA LA PRENSA AMERICANA.

Opiniones de los periódicos caracterizados—El Gobierno de la isla es objeto de frases encomiásticas—Vistas optimistas con respecto al futuro.

Se están poniendo en juego influencias para lograr la anexión de la isla de Cuba de un modo más directo que por medio de la intervención del gobierno. El pueblo cubano no quiere la anexión; el pueblo de los Estados Unidos tampoco la quiere, pero una clase de hombres en ambos países ven sus fines personales beneficiados con ese paso. Lo que no pueda hacerse con el consentimiento gubernamental ó con el popular, podrá hacerse por medio de coacciones económicas. No pasará mucho tiempo antes de que veamos si la fruta está madura.—Macon (Ga.) Telegraph.

La mejor política que debe seguirse es dejar á Cuba quieta. Ella vendrá á la Unión por su propio acuerdo.—Memphis (Tenn.) Commercial Appeal.

Los Estados Unidos, sin embargo, no tienen por que ser tan severos en el asunto. No hace muchos años que las autoridades norteamericanas se mostraban bien tolerantes con aquella gigantesca estafa llamada la lotería de Louisiana, y no sólo le permitieron el uso del correo sino que le proporcionaron todas las facilidades posibles para que llevara á cabo su negocio.

La creencia general es que Cuba está asentándose sobre sus cimientos y que merece que la dejen quieta.

Si en la faz de la tierra hay algún país en el cual los cubanos deben confiar más ímplicitamente que en ningún otro, son los Estados Unidos. Tanto á la Isla como á sus habitantes sólo les hemos hecho el bien, y no sabemos que exista al presente, ni es probable que lo haya jamás en el futuro, ningún siniestro designio con respecto á los cubanos. Si alguna vez los Estados Unidos emplean la fuerza en Cuba, sera únicamente para bien de sus habitantes.

A Zayas se le ocurre ahora que Gómez intenta "derribarle." Se habla de la organización de un nuevo partido político que se denominará Partido Nacional Cubano, al cual se fusionará el partido Miguelista, en el que figuran los partidarios de Gómez. De esta manera, la gente de Gómez espera eludir la promesa que tienen hecha de apoyar á Zayas en las próximas elecciones, y el Presidente podrá, sin en realidad faltar á su palabra, lograr que se le designe como candidato presidencial para un segundo periodo. Naturalmente, ésto es combatir á los zayistas.

La insistencia de España en que Cuba pague parte de los gastos incurridos por el Gobierno español al tratar de impedir que los cubanos obtuvieran su independencia, no es de ningún modo lá manera de alentar el espíritu de amistad entre las dos naciones. España hizo una jugada arriesgada en Cuba, y perdió. La independencia de Cuba se ganó sin la menor cooperación por parte de España, pues por el contrario, ésta se mantuvo firme hasta el último momento, y sólo cuando los Estados Unidos intervinieron para poner fin á la contienda, fué cuando los lazos entre España y su colonia se rompieron irrevocablemente. Cuba no debe nada á España.

Conviene observar, que mientras Cuba acaba de resolver la cuestión del establecimiento de una lotería nacional al aprobarse la ley que autoriza al Presidente Gómez para que nombre un administrador de la misma, Francia ha decidido que las loterías que existen en su territorio deben abolirse, y se darán los pasos necesarios para la aprobación de un proyecto de ley determinando que desde el mes de Diciembre de 1910 quedarán abolidas todas las loterías en territorio francés. Lo hecho en Cuba y lo que se va á hacer en Francia viene á demostrar el grado más alto de civilización á que ha llegado el pueblo francés, pues es bien sabido que la ley estableciendo la lotería nacional fué aprobada por el Congreso de Cuba para satisfacer el deseo de los cubanos de entregarse á esta clase de juego. Por otra parte, en Francia se abolirán las loterías porque su pueblo ha descubierto que la economía y el ahorro son caminos más seguros para alcanzar fortuna, que el depender de los azares del juego.

El pueblo francés es uno de los más frugales del mundo, mientras que los cubanos tienen muy ligera idea de lo que es frugalidad, y al igual de los pueblos poco avanzados en la civilización, tienen más fe en el azar ó en la suerte para procurarse una fortuna, que en la aplicación al trabajo que suelen verse compelidos á hacer porque la suerte no les ha protegido en la forma que ellos esperan.

Camaguey and Santiago.

"Not one of the old Spanish towns of Cuba but is a source of inspiration to a painter," writes Sir Harry Johnston, in the *Chicago Daily News*. "Camaguey is nearly 400 years old as a Spanish city, but it was a place of Indian settlement for a long antecedent period. It is the 'all-white' town, where the 60,000 inhabitants are for the most part of pure Spanish descent, and the handsomest people in Cuba. No town in Spain is more Spanish or more picturesque. It has narrow streets, projecting balconies screened by carved wood or iron grilles, tiled rooms, thick walls, patios glowing with sunlit vegetation, a sixteenth and seventeenth century cathedral, churches, chapels, monasteries and convents. The steeples and doorways of some of these churches (and of a good many Cuban buildings generally) almost suggest the Moorish influence in architecture which prevailed in Southern Spain down to the period of Columbus' voyage. Several of the ecclesiastical buildings of Camaguey contain magnificent altar-pieces and handsome shrines of hammered silver.

skirtings. One house is ultramarine blue and white, another dull mauve and white or pale green, maize yellow, pink, terra cotta, sky blue, greenish-blue, of apricot hue and gray-brown.

"The effect, combined with the fronds of palm trees and bananas, the dense foliage of figs, ilexes, mimosas, orange trees and giant laurels, the brilliant flowers of bushes and creepers, the brown-red tiled roofs, the marble seats and monuments, the graceful balconies, the white-stone colonades, the blue waters of the harbor, and the magnificent encircling mountains, was daring, but eminently successful. One might undergo at Santiago de Cuba a color cure for melancholia."

The Raja Yoga Schools Praised.

The investigation requested by Mrs. Tingley, into the condition of the Raja Yoga School on Point Loma, California, by C. Barranco, the chancellor of the Cuban legation at Washington, has resulted in hearty praise of the institution's system of education. The State Department at Washington, likewise at Mrs. Tingley's request,



A Street in Santiago. The city is surrounded by great mountains, and these, with the beautiful harbor, make Santiago a picture to be remembered.

"In Santiago, the eastern capital of Cuba, and now one of the most beautiful places in the world, the solidly constructed houses—the Spaniards, among many great qualities, had that of building appropriately and permanently—were painted in tempera almost every attainable tint, combined with white copings, window frames, doorways, parapets and

made an investigation of the school and gave a most favorable report. It will be remembered that recently articles appeared in Cuban newspapers charging that Cuban children were not well treated at the institution. The director of the Raja Yoga writes the *Cuba Review* that legal proceedings have been instituted against the newspaper publishing the story.

THE NAVAL COALING STATION, GUANTANAMO, CUBA.

Territory Acquired at the Termination of the Spanish-American War—A Modern High-Speed Coaling Station Installed.

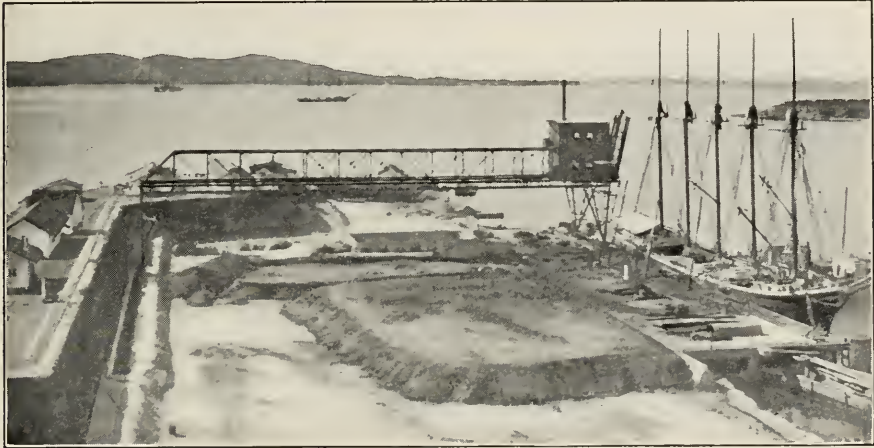

Courtesy of The Iron Age.

General view of the coal-handling equipment installed for the United States Government at Guantanamo, Cuba.

El grabado representa la instalación hecha en Guantánamo, Cuba, por el Gobierno de los Estados Unidos, para la descarga del carbón. La maquinaria para el trabajo está montada en el puente de acero, y funciona por medio de motores eléctricos. La instalación se aceptó en Noviembre de 1908, y desde entonces está funcionando, reduciendo el número de brazos de 70 hombres que se empleaban primitivamente á 2 maquinistas y 1 fogonero.

At the termination of the Spanish-American War, the U. S. Navy Department acquired certain territory bordering on Guantanamo Bay, Cuba, for a naval station, including, among other equipment, a plant to store coal from colliers and also to coal vessels using Southern waters. The Government engineers finding an available location near Hospital Cay, dredged a channel for water approach, and built a wharf, having a frontage of 340 feet, and a coal storage area in the rear of 68,000 square feet.

A temporary coal handling and storing equipment was promptly installed, but the small tonnage—350 to 400 tons per day—meant the employment of a stevedore force of 70 men and a high labor charge per ton handled, besides the remoteness of the station from any labor center or community from which labor of this type could be drawn, caused many delays. As soon, therefore, as additional appropriations were available a modern high-speed coaling station to transfer coal from colliers to the storage area and from this storage area to the naval vessels, was installed.

The illustration gives a general view of the new plant. The operating machinery is mounted on a steel bridge spanning the storage area, with a distance center to center of tracks of 261 feet. It is supported by structural steel legs, mounted on a universal truck. The bridge is moved by electric motors, one geared to the driving wheels of each truck. These motors are controlled by one controller stationed in the operating room of the bridge.

The coal handling machinery, however, is operated by means of steam power, for the designers, C. W. Hunt Co., West New Brighton, N. Y., believe that reliability of operation in emergencies, economy of maintenance, and easy regulation of operating speed are all on the side of steam.

The operating machinery is housed at a central point and requires two operators, one to control the lowering, filling and raising of the 2½-ton grab bucket, and the other to control the running in and out of the trolley truck over the boom and the discharging of the bucket over the storage area. The plant was accepted November, 1908, and the ma-

chinery has been in continuous operation since that time, reducing the labor force from 70 men, as in the first installation, to two engineers and a fireman, besides working to a capacity not approached by the previous system. The bucket, it is stated, can enter the hatchway, be automatically loaded with 2½ tons of coal, hoisted vertically 50 to 70 feet, transferred along the boom and over the storage area a distance of 110 to 300 feet, be automatically dumped, and returned to the hatchway in 40 to 45 seconds. During the official test the working speed was found to be 75 seconds for an eight-hour consecutive run.—Iron Age.

No Yellow Fever in Cuba.

The American governors of Cuba have suppressed yellow fever in the island. But the disease always lurks in Mexico and Central America, and with a return of conditions of filth in Havana, Cienfuegos, Matanzas or Santiago, the scotched reptile of pestilence may raise its head and render another suppression necessary.—New York Mail and Express, July 19.

Comment similar to the above constantly makes its appearance in United States newspapers despite the vehement denials of Cuban sanitary officials, American Intervention officers and Louisiana Health Board doctors. Major Jefferson R. Kean, says Cuba is clean, and the latest testimony to the same effect is the statement printed in the New Orleans Picayune a few weeks ago of Dr. W. T. O'Reilly, President New Orleans Board of Health. He says:

"No Southern port has anything to fear from Cuba from a sanitary standpoint."

He had just returned from Cuba, having taken advantage of his vacation to look into the health conditions of the island, and visited many of the large and small cities and towns.

"I not only did not find any yellow fever in Cuba," he continued, "but I also saw very few mosquitoes, and these were only the gutter breed or mulex. I did not see a single specimen of the stegomyia, the fever-carrying kind."

"The sanitary condition of the Island of Cuba was a revelation to me. The system of work is ideal, and there are many American cities that have not the system of street cleaning and garbage disposal that these cities have. The garbage is collected at night, and is carried into the gulf and dumped, and the necessary offal on the streets does not remain hardly twenty minutes before it is picked up by the 'white wings.' The work of

keeping the island clean is so perfect that last week there were 17,000 inspections reported to general headquarters. Every citizen seems imbued with the idea of keeping things clean, and as a result you will find hardly a single piece of paper on the streets."

The following towns were visited and inspected by me, each presenting a truly remarkable condition of affairs from a sanitary standpoint: Havana, Matanzas, Guinness, Guanaba, Gelpi, Juraco, Rio Peco, Los Pezas, Sabanilla, Neura Pazas and Urión del Rey.

The constant inspections made of premises in these towns and the fining of a few violators of ordinance in the sum of \$100, has had the effect of compelling compliance with ordinances in the smallest details.

To Improve Havana's Morals.

An anti-vice league has been organized in Havana under the name *Por la Moral*, with the following officers: Bishop of Havana as president; Gen. Enrique Loimaz del Castillo, acting president; Dr. Diego Tamayo and Dr. Joaquin Pascual, vice-presidents; Senor Joaquin Gelato, treasurer; Col. Manuel Aranda, assistant treasurer; Dr. Gerardo Rodriguez de Armas, secretary; Senor Oliva Crespo, assistant secretary. Many other prominent people are in the long list of directors.

A circular was addressed recently by the Secretary of the Interior to all the provincial governors and mayors of the Republic, urging them to strictly forbid all immoral performances at the different theaters of the island, as frequent complaints had reached his department of immoral exhibitions advertised and actually presented to the public.

Telegraph Stations and Post Offices.

President Gomez has ordered a telegraph station to be installed at Cristo Key, his summer residence.

A new postoffice has been established at Rio Seco in Pinar del Rio province.

A new telegraph station has been established at San José de los Ramos, Matanzas province.

Bureau of Cuban Information.

With the beginning of the present fiscal year the Republic of Cuba established a Bureau of Information, President Gomez appointing Leon J. Canova, an American newspaper man, as its director.

Parties wishing information of any nature concerning Cuba, can obtain same by addressing the Utility and Information Bureau, Department of Agriculture, Commerce and Labor, Havana, Cuba.



A group of cement houses for working men erected in the Vedado, Havana. These houses each contain six rooms and a bath room, and are beautiful to look at and well constructed. They rent for \$20 a month, and there are facilities afforded to thrifty working men to purchase them on the installment plan.

Un grupo de casas de hormigón para trabajadores, construidas en el Vedado, Habana. Cada una de esas casas tiene seis habitaciones y un cuarto de baño, son de muy buen aspecto y están bien construidas. Se alquilan á razón de \$20 al mes, ofreciéndose facilidades á los trabajadores que saben ahorrar, para que las compren á plazos.

The Spanish Treaty Claims Commission.

Judge D. M. Massie, who for the last seven years has been in Havana and other cities of Cuba taking testimony and acting as referee for the Spanish Treaty Claims Commission appointed by President McKinley to settle the claims growing out of the destruction of the Maine and of property in Cuba, returned to New York on July 8. Judge Massie finished taking testimony on June 30.

The commission was to investigate 542 claims made against Spain after the close of the Spanish-American War which were assumed by the United States. The total amounted to \$61,000,000. All but five of the claimants—except those in connection with the Maine—were found in Cuba. The commission decided seventy cases in favor of the claimants and made awards aggregating \$1,000,000. Thirty cases are still undecided and 442 were thrown out for various reasons. When the thirty cases are passed on by the commission a report will be made to Congress and an appropriation made from the Treasury to settle the accounts.

Assistant Surgeon-General Gorgas says that the United States has shown in Cuba that the white man can live in as good health there as in more temperate zones, and the returns from his labor are many times greater there than in the north. Debility, caused principally by malaria, will disappear in the presence of perfect sanitation.

Trouble Brewing for Cuba.

United States Representative John A. Martin, of Colorado, has written a letter

to a Porto Rican commission, printed in the New York Tribune on July 28, in which the following reference to Cuba occurs:

"Trouble is brewing for Cuba. I am satisfied there is a powerful element in this country determined to regain and keep control of that island. The pretext will be easily discovered. We have our own serious internal disturbances. We are not by any means out of the woods in the solution of our own problems, but that will not prevent us from seizing upon such a crisis in Cuba as a pretext for its seizure."

Caravonica Cotton in Cuba.

The caravonica cotton is being cultivated experimentally in Cuba. Near Baracoa, in the most easterly part of Cuba, 1,500 feet above sea-level, there were planted last autumn about fifteen acres with Caravonica "silk," and about fifty acres with Caravonica "wool-cotton." Although the planting could not be done till the first days of December, as the seeds ordered from Australasia did not come before that time, the result is stated to be most satisfactory for both varieties; the trees have borne and are still bearing very richly. Samples of the cotton have been sent to several experts in America and Europe, and have been praised for strength, gloss, and length of staple.—Textile Mercury, London, England.

Carlos Manuel de Cespedes sailed July 1 from New York to take charge of the Cuban legation at Rome. He is the first minister of Cuba to Italy, and formerly was Governor of the Province of Oriente in Cuba and Vice-President of the Cuban House of Representatives.

THE TREASURY OF CUBA.

Official Report of the Secretary of the Treasury, Showing Condition on
June 30, 1909.

| ASSETS. | LIABILITIES. |
|---|--|
| General Treasury. | Advance orders in transit.. \$492,415.22 |
| Cash on hand....\$437,722.21 | Postal money orders 384,091.83 |
| Deposited with the | Debts pending 18,556.36 |
| Banco Nacional | Honorary consuls 1,197.50 |
| (cash) 129,464.98 | Taxes on the loans 942,646.35 |
| Deposited with the | On deposit for the loan 1st |
| Royal Bank of | 50% 280,169.92 |
| Canada (cash) . 280,000.00 | Balance due to the Army of |
| 847,187.19 | Liberation, 2d half 363,462.32 |
| Collections: | Epidemic diseases 32,410.52 |
| Cash on hand \$119,832.86 | Individual contracts 67,411.57 |
| Public Taxes: | Special Laws of 1906 1,457,786.74 |
| Balance against this acc't 9,000,763.51 | Special Laws of 1909 1,046,018.73 |
| | Decree of the Provisional |
| | Governor 3,528,055.26 |
| | Maintenance of detained im- |
| | migrants 762.00 |
| | Sewering and paving of the |
| | City of Havana 1,352,799.24 |
| \$9,967,783.56 | \$9,967,783.56 |
| | Marcelino Díaz de Villegas, |
| | Secretary of the Treasury. |

Cuba Railroad Receipts.

The Cuba Railroad Co. report for 11 months ended May 31, 1909, is as follows:

| | |
|-----------------------------|-------------|
| Gross earnings | \$1,960,461 |
| Operating expenses | 1,102,019 |
| Net operating income | \$858,442 |
| Interest on bonds | 364,517 |
| Net income | \$493,925 |
| Surplus, June 30, 1908..... | 1,093,287 |
| Surplus, May 31, 1909..... | \$1,587,212 |

Havana Electric Dividend.

The Havana Electric Railway Co. announces a dividend of one dollar and fifty cents on each share of preferred stock of this Company, to be paid on August 14, 1909, to stockholders of record at the close of business July 24, 1909. The preferred stock transfer books will be closed from July 26 to August 14, 1909, both inclusive.

Western Railway Extension.

The Railroad Commissioners discussed on July 16 a project of the Western Railway of Havana to extend its lines to Remates in Pinar del Río, passing through Grifa and Las Martinas. The line at present ends at Sábalo. The distance to Remates is 130 kilometers and the cost is estimated at \$6,000 per kilometer.

The National Bank of Cuba.

The annual report of the National Bank of Cuba to June 30, 1909, is as follows, United States currency:

| ASSETS. | |
|---------------------------------------|-----------------|
| Cash in vaults | \$5,059,819.16 |
| Due from banks and | |
| bankers | 1,545,421.12 |
| Remittances in transit.. | 1,051,344.21 |
| \$7,656,584.49 | |
| Bonds and Stocks: | |
| Government bonds | \$3,513,778.69 |
| City of Havana bonds.. | 884,219.91 |
| Other bonds and stocks | 398,686.53 |
| 4,796,685.13 | |
| Loans, discounts, time | |
| bills, etc. | 9,457,423.20 |
| Bank buildings and real | |
| estate | 726,006.05 |
| Furniture and fixtures.. | 101,688.12 |
| Sundry accounts | 44,895.80 |
| Securities on deposit... | 1,206,321.30 |
| Total | \$23,989,604.09 |
| LIABILITIES. | |
| Capital | \$5,000,000.00 |
| Reserve | 800,000.00 |
| Undivided profits | 323,621.72 |
| \$6,123,621.72 | |
| Due to banks & bankers | 474,982.50 |
| Deposits | 16,184,678.57 |
| Deposits (securities) ... | 1,206,321.30 |
| Total | \$23,989,604.09 |
| Attention is called to the following: | |
| Deposits December 31, 1908..... | \$14,316,720.04 |
| Deposits June 30, 1909 | 16,184,678.57 |
| Increase in six months | \$1,867,949.53 |

RAILROAD REPORTS AND TRAFFIC RECEIPTS.

Cuba Railroad Report.

The general balance sheet of the Cuba Railroad Co., as of May 31, 1909, compares with those of June 30, 1908 and 1907, as follows:

| | Assets. | | |
|--|---------------------|---------------------|---------------------|
| | May 31, '09. | June 30, '08. | June 30, '07. |
| Cost road and equipment | \$25,305,858 | \$24,686,540 | \$23,637,287 |
| Material and supplies | 385,418 | 362,100 | 411,633 |
| Treasury bonds | | 100,000 | |
| Cash | 64,093 | 913,899 | 739,967 |
| Indiv. and companies | 181,689 | | |
| Other railroad companies | 60,541 | | |
| Insur. paid in advance | 5,031 | | |
| Loans on securities | 195,874 | | |
| Agents and conductors | 11,096 | | |
| | <u>\$26,819,600</u> | <u>\$26,062,539</u> | <u>\$24,788,887</u> |
| Liabilities. | | | |
| Preferred stock | \$10,000,000 | \$10,000,000 | \$10,000,000 |
| Common stock | 6,126,000 | 6,126,000 | 6,126,000 |
| Bonds | 8,299,000 | 7,843,000 | 6,799,000 |
| Current liabilities | 315,105 | 343,304 | 362,973 |
| Deferred and suspended liabilities | 492,283 | 656,949 | 802,882 |
| Profit and loss, surplus | 1,587,212 | 1,098,286 | 698,032 |
| | <u>\$26,819,600</u> | <u>\$26,062,539</u> | <u>\$24,788,887</u> |

Havana Electric Railway Co.

| Weekly Receipts. | | | | Receipts from January 1. | | | |
|------------------|----------|-----------|-----------|--------------------------|----------|-------------|------------|
| | | 1909. | 1908. | | | 1909. | 1908. |
| Week ending | July 4.. | \$ 41,808 | \$ 36,451 | Week ending | July 4.. | \$1,036,658 | \$ 976,211 |
| " | " 11.. | 42,045 | 39,877 | " | " 11.. | 1,078,703 | 1,016,088 |
| " | " 18.. | 36,839 | 36,866 | " | " 18.. | 1,115,542 | 1,052,954 |
| " | " 25.. | 39,726 | 34,508 | " | " 25.. | 1,155,268 | 1,087,462 |

United Railways of Havana.

| Weekly Receipts. | | | | Receipts for Fiscal Year. | | | |
|------------------|--------------|---------|---------|---------------------------|--|---------|---------|
| | | 1909. | 1908. | | | 1909. | 1908. |
| Week ending | July 3 .. | £14,422 | £11,870 | | | £ 6,416 | £ 6,896 |
| " | " July 10 .. | 14,585 | 12,826 | | | 21,001 | 19,722 |
| " | " July 17 .. | 14,365 | 12,480 | | | 35,366 | 32,202 |
| " | " July 24 .. | 13,971 | 11,349 | | | | |

Western Railways of Havana.

| Weekly Receipts. | | | | Receipts for Fiscal Year. | | | |
|------------------|--------------|--------|--------|---------------------------|--|----------|----------|
| | | 1909. | 1908. | | | 1909. | 1908. |
| Week ending | June 26 .. | £5,230 | £4,683 | | | £275,965 | £264,998 |
| " | " July 3 .. | 4,634 | 4,924 | | | 2,090 | 2,814 |
| " | " July 10 .. | 4,710 | 5,199 | | | 6,800 | 8,013 |
| " | " July 17 .. | 4,813 | 6,025 | | | 11,613 | 14,038 |

Cuban Central Railway.

| Weekly Receipts. | | | | Receipts for Fiscal Year. | | | |
|------------------|--------------|---------|--------|---------------------------|--|----------|----------|
| | | 1909. | 1908. | | | 1909. | 1908. |
| Week ending | June 26 .. | £ 5,883 | £5,379 | | | £432,084 | £357,095 |
| " | " July 3 .. | 5,300 | 4,027 | | | 2,896 | 2,192 |
| " | " July 10 .. | 4,806 | 4,404 | | | 7,702 | 6,596 |
| " | " July 17 .. | 5,037 | 4,731 | | | 12,739 | 11,327 |

FINANCIAL AND COMMERCIAL MATTERS.

Sale of the Cuba Eastern.

A decree of foreclosure and sale of the Cuba Eastern Railroad, signed by Judge Hough, was filed July 29, at New York, in the United States Circuit Court by Frank Gledhill and Henry H. Parmelee, who succeeded the Knickerbocker Trust Company as trustees under the first and refunding six per cent. fifty-year gold bonds mortgage for \$2,859,000, dated March 1, 1907.

In March, 1907, the defendant road issued \$2,859,000 of first and refunding mortgage bonds. The mortgage was duly delivered to the Knickerbocker Trust Company together with title to all the road's property, including franchise, privileges, etc.

On March 31, 1909, the trust company resigned its trust and the plaintiffs, Gledhill and Parmelee, were appointed trustees in its stead.

The complainant states that the Eastern Railroad of Cuba has defaulted in the payment of the interest coupons of the first mortgage bonds due March 1, 1908, as well as on those due September 1, 1908, and March 1, 1909. The amount of the principal of the bonds and the amount of interest due make a total of \$3,185,878.50.

Besides the property of the Cuban Eastern Railroad Co. to be sold, the decree of foreclosure describes: \$1,154,000 first mortgage 50-year 5% gold bonds of the Northeastern Cuban Railroad Co., with March, 1908, coupons and all other coupons maturing subsequent thereto, attached; \$126,000 first mortgage 6% gold bonds of the Cuban Eastern Terminals Co., with February, 1908, coupons and all other coupons maturing subsequent thereto, attached; \$450,000 (par value) of 6% debenture bonds of the Northeastern Cuban Railroad Co., with February, 1908, coupons and all other coupons maturing subsequent thereto, attached.

The road owns forty-two miles of trackage and leases fifty-three, making a total of ninety-five miles.

The properties are to be offered for sale as an entirety by Henry Melville who has been appointed special master by the court, and the auction is to take place in the Post Office Building in New York.

Canada and Cuba.

With banking, railroad building, electric railway service, insurance and shipping in Cuba, Canadian interests are most prominently identified. In other fields of effort, Canadians also have contributed materially to the advancement of Cuba.

Canadians are grasping trade opportunities offered, particularly in those lines of which, to use a recent statement of Sir William Van Horne, "the Americans have lost sight." The Dominion Government, foreseeing the growing character of Canada's trade with this Island Republic, established a Canadian Trade Commissioner at Havana. The total trade of Canada with Cuba last year was in the vicinity of \$2,000,000, a very satisfactory initial showing.—Halifax Morning Chronicle.

The Cuba Railroad Company.

Statement of earnings and expenses for the month of June, 1909:

| | 1909. | 1908. |
|-------------------------------|--------------|--------------|
| Gross earnings ... | \$196,704.41 | \$145,567.12 |
| Working expenses.* | 105,057.53 | 92,663.19 |
| Net profits | \$91,646.88 | \$52,903.93 |
| Fixed charges for month | 34,773.61 | 32,353.04 |
| Surp. for month | \$56,873.27 | \$20,550.89 |

Gross earn. from

| | | |
|-----------------------|----------------|----------------|
| July 1..... | \$2,157,165.12 | \$2,039,467.95 |
| Net prof. fr. July 1. | 950,088.81 | 721,287.59 |
| Fix. chgs. " " " | 399,290.26 | 365,863.34 |

Surplus " " \$550,798.55 \$355,424.25

*Included in working expenses are the following expenditures for extraordinary replacements:

| | |
|----------------------|------------|
| This month.. | \$8,000.00 |
| To date | 96,000.00 |

Lower Prices Wanted.

General Carlos Garcia Velez, the Cuban Minister to the United States, made recently an extended trip through the Middle West, studying conditions affecting prices of American goods in Cuba. The Minister found that the prices of corn, lard, flour and other products are about doubled by the time they reach Cuba. This is partly due to transportation and freightage, and the Cuban government is understood to be anxious to bring about a remedy in this line so that prices may be lowered.

Storage Charges.

Through a circular issued by the Cuban Treasury Department, July 17, the sums of 3, 3½ and 7 cents per hundred kilos are fixed as the charges to be applied for storage of goods placed at the general stores of the custom houses.

TOBACCO EXPORTATION AND DUTIES.

Cuba's exportations from January 1 to June 30, 1909, were as follows:

| Countries. | Bales. | Cigars. | Cigarettes. |
|------------------|---------|------------|-------------|
| Untd. States.. | 149,171 | 72,123,603 | 722,054 |
| Nor. of Europe | 635 | 1,086,200 | 1,500 |
| France | 1,209 | 8,463,400 | 37,480 |
| Spain | 1,774 | 4,370,281 | 244,837 |
| Mexico | | 169,870 | 608,820 |
| Other parts. . | 119 | 838,550 | 4,328,152 |

| | | | |
|------------|---------|------------|-----------|
| Total 1909 | 152,908 | 87,151,904 | 5,802,843 |
| Total 1908 | 116,111 | 78,701,912 | 7,101,791 |

—Official Bulletin of the Cuban Secretary of Agriculture, Commerce and Labor.

Germany Advances Duty on Cigars.

The news of an advance in the duty of Havana cigars in Germany seems to be confirmed by general reports. Tobacco (N. Y.) says: "The tax on leaf tobacco is not known officially, but it is supposed

to be of much smaller proportions than the increase on cigars, which naturally does not please local cigar manufacturers, who see in this only a tendency to protect the German industry in prejudice to the local cigar business. This is making the talk of an export tax on leaf tobacco all the more accentuated. There being many reports as what the duty really amounts to on cigars in Germany, but I have been informed that it has been raised from 35 cents a pound to 50 cents a German pound, which is equal to ½-kilogram and 40 per cent. ad valorem additional."

Cigar shipments from Havana for the first half of June showed poor results, but the last two were more satisfactory there being an increase of about 3,000,000 cigars as compared with the same period in 1908. The record for the month showed an increase in exports of 1,271,526 cigars over May.



Hand Packing Department at the "El Siboney" factory, Havana. Cigarettes seen in the belt conveyor are of the well known brand of Cabañas. The cigarettes are packed by women and tied in bunches of 26 packs. The room is well ventilated and kept clean. The belt conveyor takes the bundles down to the floor below, where they are packed into boxes for export or sent out in boxes for the city delivery.

Departamento en la Fábrica de Cigarrillos "El Siboney" donde se encajetillan los cigarrillos á mano. Las cajetillas que se ven en el conductor de correa son de la muy acreditada marca de Cabañas. El encajetillado lo hacen mujeres empleadas para esa labor, quienes al mismo tiempo amarran paquetes de 26 cajetillas. El conductor de correa lleva esos paquetes al piso de abajo, donde se encajonan para exportarlos ó se envían en cajas á los distintos puntos de venta en la ciudad.

THE ISLE OF PINES.

Americans Own More Than Ninety Per Cent. of the Island—Freeing Parrots.

A Settler's Views.

We Americans own about 95 per cent. of the island, and feel and act the same as if we were in Ohio. We have two American newspapers, both weeklies, the Isle of Pines News and Isle of Pines Appeal. They never mention politics, but are for the Isle of Pines against the world. Our largest town, which is the seat of government, is Nueva, a pretty little city of about 3,000 population. The town of Columbia, which is my address and was settled by our company, now numbers about 1,500 inhabitants. Our company also started the first American school and we have a teacher who was formerly a well-known teacher in the Cincinnati schools, Miss Jennie Kennedy of Lockland. Our schools are now supported by the Cuban government.

When asked about the crops and temperature of the country Mr. Durham said: "Our first interest in the way of crops is citrus fruits. We have equally as good tobacco land as Cuba, but

Havana has discriminated against us in the price of the product, so that we don't cultivate it as much as we would otherwise. We raise vegetables of all kinds, which we market in New York. Our temperature the year round ranges from 55 deg. minimum to 90 deg. maximum. The atmosphere in summer is humid, but not oppressive. I may be here several weeks," continued Mr. Durham, "but really I am homesick now."—George W. Durham in the Cincinnati (O.) Commercial Tribune.

Freeing Parrots.

Juan Frederico Centellos, chief game warden of Havana Province, recently visited the Isle of Pines, and found about 1,400 parrots in the possession of the agent for United States dealers, who has been buying the birds each year.

He ordered the agent to pay a fine of \$50 and release the birds in the presence of the Alcalde of the Isle, a detachment of Rural Guards and the inspector, which was done.—Isle of Pines News.



Colompo Mountain and Beach. Isle of Pines.

PAPAYA JUICE.*

Possesses Great Digestive Virtues—The Fruit Itself Very Palatable—It is the Pawpaw of Commerce.

Papaya juice is extracted from the fruit of the papaw tree, which grows rapidly, attaining its full bearing capacity in a year. It produces from 40 to 50 papaws of a dark green color, ripening to a deep yellow, in shape resembling a squash. A very light superficial incision is made in the fruit, and a clear water-like juice exudes therefrom, which becomes opaque on exposure to the air. As it drips from the fruit it is received in a porcelain lined receptacle.



No. 1.—Native female papaya tree with fruit growing in Singalong, Philippine Islands.

Los grabados que aparecen en esta página son de la papaya procedente de las Islas Filipinas. El núm. 1 es un papayo indígena; el núm. 2 es una variedad obtenida con semilla de la India, y en núm. 3 es una variedad redonda obtenida con

As it is very corrosive, metal receptacles would injure its appearance and qualities. It possesses great digestive virtues, and the refined article is considered superior to all animal pepsins.

After the desired quantity has been collected, the juice is placed in shallow porcelain or glass-lined pans and allowed to evaporate. While this is not a very delicate or difficult operation, it requires considerable attention, so that the juice will dry uniformly and the pro-



No. 2.—Long variety of papaya grown from Singapore seed.

duct be white and well granulated. In its granulated state it is shipped to the United States, where it undergoes a refining process, and is sold as the papaw of commerce for medicinal purposes.

The ripe papaw is palatable and an excellent aid to digestion. Meat wrapped in papaw leaves for a short time becomes quite tender without any impairment in appearance or taste.

semilla del Hawaii. La papaya madura es excelente para ayudar á la digestión. La carne envuelta en hojas de papayo por corto espacio de tiempo, se pone muy tierna sin que se afecte su aspecto ni su sabor. El jugo de la papaya se vende en los Estados Unidos á razón de \$4 á \$6 la libra.



No. 3.—Round variety from Hawaiian seed.

*Extract from annual report of United States Consul A. J. Lespinasse, Tuxpam, Mexico.

In extracting the juice the hands should be protected by rubber gloves, as in its crude state it attacks the tissues. An average tree will produce about one-fourth of a pound of the granulated juice. It sells in the United States for from \$4 to \$6 per pound in the crude state.

"Papaya, *Carica papaya*, L. (Passifloraceae). A tree commonly cultivated for its edible fruits, introduced from America. The papaw. Merrill." A great many types of this tree grow in these islands. It is subject to great variations in growth, gives a heavy yield per acre, and makes a good hog feed. When set out 10 by 10 feet apart and cultivated it improves greatly in quality and quantity of yield.—Editor, Philippine Agricultural Review, March, '09.

Cover Crops for Citrus Groves.

Ceiba Mocha, Cuba.

Editor The CUBA REVIEW:

Dear Sir:—As a good many readers of the Review are interested to some extent in the citrus fruit industry in Cuba, my experiments with cover crops for the groves may prove of value.

The accompanying pictures were tak-

en in the same grove at different times—No. 1 seven months, and No. 2 fourteen months from planting. The crop shown in the pictures is the "Dolichos Lablab," or, as it is generally called, the lablab bean. These beans were planted early in May, 1908, and just as they were coming up the cutworms destroyed a good many of them, and as I had no more beans I planted cowpeas and thereby learned a valuable lesson. The cowpeas grew much faster in the start than the lablab beans and covered the ground quickly, holding down the weeds and grass until the lablab vines could cover the ground, by which time the cowpeas were ready to pick. The pea vines soon dried up, furnishing a lot of vegetable mould in addition to the valuable nitrates deposited in the soil. The lablab beans began to ripen in December, and continued blooming and bearing until April. I found the green shelled beans very good for table use, and our chickens fed on the dry beans in the patch.

As soon as the beans began ripening the vines began shedding leaves, furnishing a continuous supply of humus. I have examined the ground frequently under the bean vines and always found it in fine condition. Even in the dry sea-



Lablab Bean, seven months after planting.

Las habichuelas "Dolichos Lablab" en Cuba. Se siembra entre las hileras de cidros, y muy pronto cubren la tierra manteniéndola en perfecto estado aun en el tiempo de seca, cuando los terrenos descubiertos se ponen duros como piedra. Las habichuelas frescas son buenas para comer, y cuando se secan se echan a las gallinas. En el grabado que antecede se ven las plantas siete meses después de sembradas, y en la página siguiente se ven a los catorce meses de sembradas.

son the ground remained mellow, while uncovered land was baked almost as hard as brick.

I claim that this method of handling a young grove is far better than clean culture, and the cost is less than one-third. The grove should be gone over every week or so to pull down the vines that are taking hold of the trees. This is an easy job and quickly done—nothing like fighting weeds and grass when the ground is so wet you can neither plow nor hoe. I think that the most of the people who have attempted clean culture in the groves in Cuba are pretty sick of the job and would like to find a cheaper, easier and a better way. I would recommend planting the grove with cowpeas and lablab beans at the beginning of the rainy season, planting alternate rows of peas and beans, with rows about two feet apart and three or four seeds in each hill, eighteen inches apart. This should give a good stand and the pea vines will soon cover the ground. The ground should be well plowed and pulverized before planting, and the young crop be kept clean until the vines cover the ground. I think best to plant peas in the rows next to the trees, as they will be out of the way in a few months and leave the permanent cover crop of lablab close enough. When the vines get too thick near the trees I cut a few of them and throw them around the trees. I don't know how long the lablab beans will last, but they look now as if they might go on forever.

D. H. HOWELL.

Fruit Shipping Pointers.

The Chicago Daily Trade Bulletin says:

It is advantageous always to pack goods with care, and that the quality runs uniform throughout, also mark contents neatly on the package.

Fancy goods always have a sale; common goods never sell well, and in times of abundant supply are hardly salable.

The mark on packages is not always a criterion of the contents, and buyers always examine the inside.

It is no use to write the commission man that goods were fancy when they were not; the commission man knows.

The best goods sell to the best trade and other goods to the cheap trade, and each has its level of prices.

If perishable goods come on the market late in the day, they never sell so well or for so much as when in early.

The stock of coconuts at New York week of July 16 was liberal, and prices weakened. Baracoa nuts brought \$21.00 to \$22.00 per thousand. Demand was dull



Lablab Bean, fourteen months after planting.

New York Prices for Cuba Fruit.

New York, July 23.

Bananas—Cuban 9s sold at 75 to 87½c. per bunch. The 8s ranged at from 45 to 50c. per bunch. No. 7s sold at from 32½ to 40c. per bunch.

Cocoanuts—There is a continued complaint in most circles among importing interests on the score of the dull demand for cocoanuts, and in a good many cases the tone of the market is reported easy. Baracoa cocoanuts are in good local demand for the small lots, but there seems to be no important movement to report here. The range here is given as from \$21.50 to \$22 per 1,000, but it is possible on firm offer to shade the inside figure here and there. Buyers are seemingly cautious about taking stock. In some cases it is said that the fruit is not keeping as well as usual, and a report is current that a good many lots have been rejected by buyers on poor selection on this market.

Pineapples—There was a firmer and stronger market here on the pineapples of all descriptions, and the tendency was toward a higher level on the large sizes in both Havana and Florida stock.

The market closed strong and active on the best stock in the Havana pineapples. Sales for the week covered a total of about 4,500 crates all told. The closing sales showed a fairly firm tone, though the results are a good deal less than the goods are selling at from the stores. The range was as follows on the several sizes: 18s, \$2.40 to \$2.45; 24s, \$2 to \$2.15; 30s, \$1.60 to \$1.80; 36s, \$1.35 to \$1.65, and 42s, \$1.40 per crate.

HOME CANNED VEGETABLES.

A Constant Supply for the Table—Vegetables Easy to Can—How to Sterilize— The Best Kind of Jar.

(Condensed from Farmers' Bulletin No. 359 of the U. S. Department of Agriculture.)

Every American housewife in Cuba may run a miniature canning factory in her own kitchen, and this is especially economical and desirable. Enough vegetables annually go to waste from the average garden to supply the table during the off season. But while tomatoes are canned, and fruits are preserved everywhere the most wholesome and nutritious vegetables are left to decay in the field under the impression that it is impossible to keep them. This is a great mistake. It is just as easy to keep okra, lima beans, string beans, asparagus, etc., as it is to keep tomatoes if you know how.

Complete sterilization is the secret. The air and water, all fruits and vegetables, are full of bacteria, or molds or germs, and these are the sole cause of decomposition. If the air which reaches the preserves has been sterilized it will not affect them, for the germ is excluded. If a glass bottle is filled with some vegetable which ordinarily spoils very rapidly—string beans, for instance—and instead of a cork, it is stoppered with a thick plug of raw cotton and heated until all germ life is destroyed, it will keep

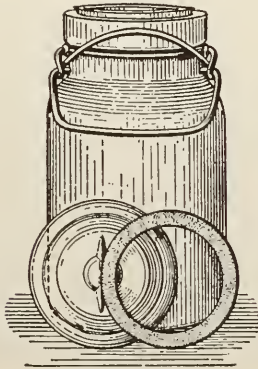

Fig. 4.—Spring-top jar.

indefinitely. Air can readily pass in and out of the bottle. In order to completely sterilize a vegetable, heat it to the boiling point of water and keep it at that temperature for about one hour, upon two or three successive days, or else keep it at that temperature for about five hours continuously. The process of boiling upon successive days is always employed in scientific work and is much to be preferred. The first day's boiling

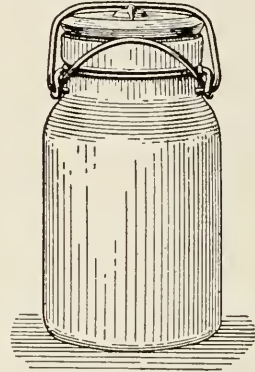

Fig. 7.—Position of spring during sterilizing.

kills molds and nearly all bacteria, but not the spores or seeds. As soon as the jar cools these seeds germinate and a fresh crop of bacteria begin work on the vegetables. The second day's boiling kills the bacteria before they have had time to develop spores. The third day's boiling is not always necessary but considered advisable to assure complete sterilization. This "fractional sterilization," as it is called, constitutes the whole secret of canning, and bearing it in mind every housewife will be able to can any meat, fruit or vegetable.

The use of so-called "preserving powders" is condemned as being dangerous in the hands of inexperienced persons, to children and invalids.

Molds attack jellies and preserves, bacteria the vegetables.

A good jar is requisite to success. Tin, though lacquered inside, is to be avoided, as being more or less soluble in the juices. While the amount of tin dissolved is very small and may not be injurious, it gives an undesirable color. Glass is best. The directions apply to pint and quart jars only.

The most satisfactory jar found by the writer is shown in figures 4, 7 and 8. It has a rubber ring and glass top, held in place by a simple wire spring. There are several brands on the market and there should be no difficulty experienced in obtaining them. Look out for defective rubber. Do not buy cheap ones or use them the second time. As a general rule black rubbers are more durable than white ones. Buy a good jar and select those with a wide mouth.

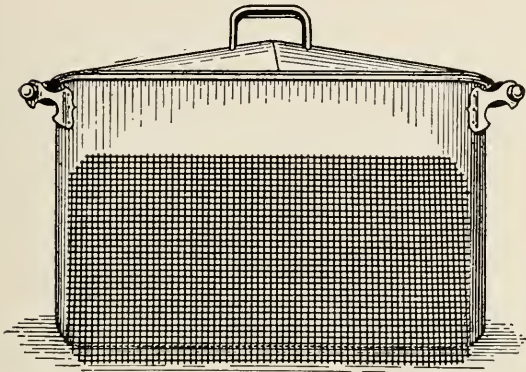

FIG. 5.—Sterilizer, showing false bottom.

For sterilizing, the writer uses a tin clothes boiler with a false bottom made of medium sized galvanized wire (No. 16), with one-half inch mesh, cut to fit it. (See illustration No. 5.) There are patent steamers on the market, but expensive, but the clothes boiler with a light-fitting cover will answer every purpose.

The last word is, never attempt to can any vegetable that has matured and commenced to harden or begun to de-

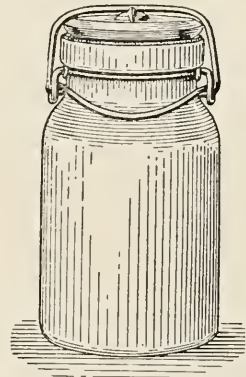

FIG. 8.—Position of spring after sterilizing.

cay. As a general rule young vegetables are superior in flavor and texture, especially string beans, okra and asparagus. Vegetables are better if gathered in the early morning while the dew is still on them. If it is impossible to can them at once put them in cold water or in a cool place so they cannot wither, until you are ready. The principle of sterilization is the same for all meats, fruits and vegetables.

Success With Milking Machines.

The Nebraska Agricultural Experiment Station has been experimenting with milking machines. It was found that most cows yield their milk as freely and fully when milked with a machine as when milked by hand, but with some individual cows the use of the machine is not entirely successful. Heifers accustomed to the machines from the first appear to do better than older cows which have been milked by hand.

Candied Pineapple.

Boil together, without stirring, a pound of granulated sugar and a gill of water. When a little dropped into iced water is brittle, take the saucepan from the fire and set it in an outer pan of boiling water, adding to the syrup a tablespoonful of lemon juice. Have the fruit ready, wiped perfectly dry. Run a slender skewer through each piece of fruit and dip it quickly into the hot syrup. If you have not skewers, a slender pickle fork will do as well. Lay the fruit on waxed paper until dry.—Philadelphia Record.

To Kill Water Hyacinths.

Spraying is the method followed at the present time by the United States Gov-

ernment in destroying the water hyacinth, which has proved a serious impediment to navigation on many rivers of this country. Two government boats are equipped with tanks for the boiling of a mixture of white arsenic, sal soda and water. This is sprayed on the plants, and as the latter are about 98 per cent. water there is very little residue after they wilt down under the action of the poisonous solution. That the solution kills the plants absolutely has been proved in every case where the conditions were such as to prevent the introduction of new plants within the area sprayed.

Exporting Mangos.

Jose Diez, of La Maya, Oriente, writes the Havana Post that for two months he has been exporting mangos to the American market and that of 1,000 crates not one reached its destination in good condition. He has been using crates one foot high by 1½ long containing from 110 to 130 mangos, each wrapped in tissue paper. The fruit was crated green and placed in a cool place on the steamer. Ten days were consumed in the journey.

Exportations of aquacates were likewise unsuccessful and he asked for advice.

SUGAR REVIEW.

A Tendency Towards Higher Prices — Duty in New Tariff Unchanged — A Crop of 1,450,000 Tons in Sight.

Specially written for The Cuba Review by Willett & Gray of New York.

Our last review for this magazine was dated July 8.

The sugar quotations at that time were 3.92c. landed for 96 test Centrifugals for prompt shipment, and 10s. 5¼d. f. o. b. Hamburg for European beet, July delivery, with refined sugars in New York selling on basis of 4.70 to 4.75c. less 1% basis of granulated.

The market continued quiet and steady without important change until the 19th, when considerable Centrifugals for July and August clearance were sold at 2 19/32c. c. & f., equal to 3.95c. landed, European markets being without change. There was a slight reaction on the 20th, followed by a recovery on the 22d, with a good business doing here and an advance of ¾d. in Europe.

On the 20th a strong buying movement set in, which advanced prices to 2½c. c. & f. for Cuba Centrifugals, equal to 3.985c. landed, 200,000 bags being sold on that day, including some Porto Rico sugars on same parity, and the refined sugar market responded with an advance to basis of 4.85c. less 1% for granulated.

This improvement caused an advance in sellers views for Java sugars for July shipment to 11s. c. f. and i., equal to 4.09c. landed basis, 96 test.

During the greater part of July discouraging reports of the European beet crop were received, the weather being cool and showery, causing a firmer market over there and an advance on the 27th to 10s. 8¼d. for beet, which has since been maintained; mail advices received by us yesterday from Hamburg, however, state that, with good weather from now until October, the beet sugar crop can recover from the effects of the recent unfavorable conditions, but F. O. Licht cabled us yesterday that the weather was still unfavorable for the growing crop in some sections.

On the 30th, a further advance here was made in full duty sugars to 4.02c. for 96 test and Javas for July-August shipment were sold to the United Kingdom at 10s. 9d. c. & f., equal to 4.06c. for 96 test if sold here.

Yesterday (August 3) a lot of St. Croix Centrifugals for prompt shipment were sold at 4.05c. duty paid for 96 test, equal to 2 11/16c. c. & f. for Cubas, showing a further advance of .03c. This sale encouraged Cuba holders to advance their views to 2¾c. c. & f.

To-day, European markets are firmer and have further advanced to 10s. 9¾d. for beet, the parity of 4.28c. for Centrifugals at New York.

The local market is now very strong, with the tendency of still higher prices before the close of the season.

Stocks at the four ports U. S. are steadily decreasing each week, and if the demand for refined sugars continues good, as expected, the sugars still held in Cuba will be wanted at full prices and it will be necessary to draw on Java for supplies to meet the requirements of the refiners until new crop sugars become available.

The lowest price named for Javas afloat (sailed early in July) is 11s. 1½d. c. f. and i., equal to 4.11c. landed basis 96 test, and equal to 2¾c. c. & f. for Cubas, which may soon be paid.

The new tariff bill will probably be finally passed and signed by the President this week; the duty on raw sugar has been agreed upon at the same rate as before, say, basis of 1.685c. per pound on 96 test from non-privileged countries and the 20% concession on Cuba sugar is continued, under the Reciprocity Treaty which remains in force, as especially provided for in the bill.

Cuba has prospered under the Reciprocity Treaty, and her prosperity will doubtless increase, as will her sugar crop from year to year. The visible production to date of the present Cuba crop is 1,420,000 tons, and 5 Centrals are still grinding, giving promise of a total production this year of approximately 1,450,000 tons.

The extent of new plantings and recent weather conditions favor a much larger sugar crop in Cuba next year.

The United States cane and beet crops are doing well, the present indications pointing to an increased output of each of them. In California the beet crop is a large one and harvesting has already commenced in the southern section.

Consumption is going on on a scale large enough to absorb the crops as produced, and the outlook, generally, is a good one.

New York, August 4, 1909.

CABLE ADDRESS: Turnure.

NEW YORK,
64-66 Wall Street.**LAWRENCE TURNURE & CO.****BANKERS**

Deposits and Accounts Current. Deposits of Securities, we taking charge of Collection and Remittance of Dividends and Interest. Purchase and Sale of Public and Industrial Securities. Purchase and Sale of Letters of Exchange. Collection of Drafts, Coupons, etc., for account of others. Drafts, Payments by Cable and Letters of Credit on Havana and other cities of Cuba; also on England, France, Spain, Mexico, Puerto Rico, Santo Domingo, Central and South America.

CORRESPONDENTS:

HAVANA—N. Gelats y Ca.

MEXICO—Banco Central Mexicano.

LONDON—The London Joint Stock Bank, Ltd.

PARIS—Heine et Cie.

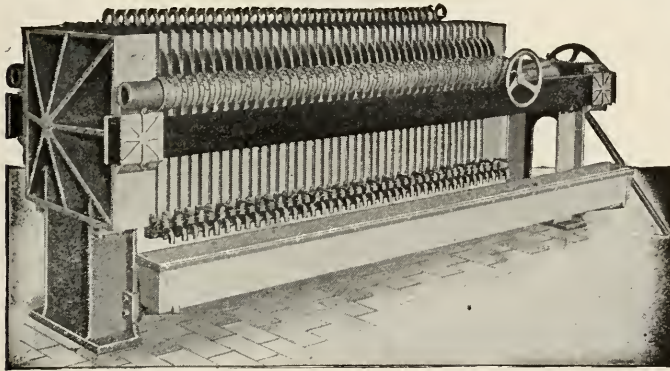

**Prensas de
Filtrar
para Ingenios**

**SHRIVER
Filter Presses**

Write us for Cata-
logue, Prices and
Information.

T. SHRIVER & CO.
814 Hamilton Street
HARRISON, N. J.

Sole Agents for Porto Rico
McMurtrie-Guiler Co.
SAN JUAN, P.R. and BEAVER BLDG.
BEAVER STREET, NEW YORK

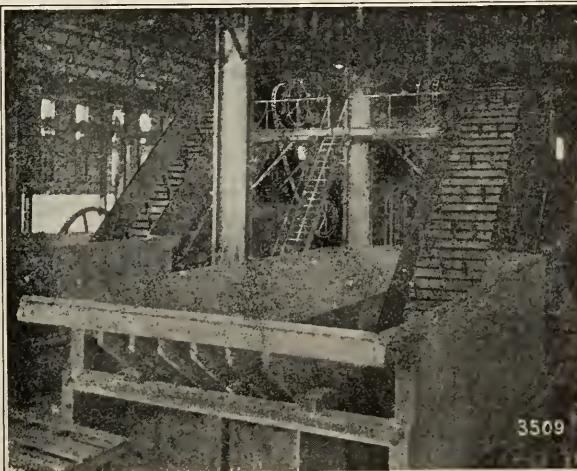
CANE-HANDLING MACHINERY

Sugar Minglers,
Water-Jacketed
Screw Conveyors,
Bagasse Feeders,
etc.

>**FLINT RIM**<
Sprocket Wheels and
Original "Ewart" De-
tachable Link-Belt.

New Chain Catalog
No. 75A

LINK-BELT COMPANY**229 BROADWAY****NEW YORK CITY**

REVISTA AZUCARERA.

Escrita expresamente para la CUBA REVIEW por Willett & Gray, de Nueva York.

Nuestra última revista para esta publicación estaba fechada el 8 de Julio. En aquella fecha las cotizaciones del azúcar eran 3.92 cents. puesta en el muelle por la de polarización 96° para su embarque inmediato, y 10s. 5¼d. l. á b. en Hamburgo por la de remolacha europea, para su entrega en Julio, vendiéndose los refinados en Nueva York de 4.70 á 4.75 centavos, menos 1% por pago al contado, basándose la cotización en los granulados.

El mercado continuó encalmado y firme sin alteración importante hasta el día 19, en que se vendió considerable cantidad de centrífuga para entregar en Julio y Agosto, á razón de 2 19/32 centavos, costo y flete, equivalente á 3.95 en el muelle, no habiendo ocurrido ningún cambio en las cotizaciones de los mercados europeos. El día 20 hubo una lijera baja seguida de un alza el día 22, con muy activa demanda aquí y un aumento de ¾d. en Europa.

El día 20 fué tan activa la demanda, que hizo subir los precios de los centrífugas cubanos á 2½ centavos, costo y flete, equivalente á 3.985 centavos puesta en el muelle. En ese día se vendieron 200,000 sacos, incluyendo algún azúcar de Puerto Rico á igual precio, y ésto hizo que la cotización del azúcar refinado granulado subiese á 4.85 centavos menos el 1%.

Esta alza hizo que los vendedores de azúcar de Java pidieran á razón de 11s. costo y flete, para embarque en Julio, equivalente á 4.09 centavos polarización 96° puesta en el muelle.

Durante la mayor parte del mes de Junio se recibieron noticias desalentadoras con respecto á la cosecha de remolacha europea á causa de lo frío y lluvioso del tiempo, lo cual hizo que los precios en Europa se hicieran más firmes y que el día 27 hubiera una subida á 10s. 8¼d. en los precios del azúcar de remolacha, que se ha mantenido desde entonces. En cartas que ayer recibimos de Hamburgo nos dicen que si hay buen tiempo de aquí á Octubre, las siembras de remolacha podrán reponerse de los efectos del mal tiempo habido recientemente, pero F. O. Licht nos telegrafió ayer que el tiempo continuaba siendo desfavorable para la cosecha en algunas regiones.

El día 30 hubo aquí otra alza en los azúcares que pagan el derecho completo, cotizándose los de polarización 96° á 4.02 centavos, y en Inglaterra se vendieron azúcares de Java para embarque en Julio y Agosto, á 10s. 9d., costo y flete, equivalente á 4.06 centavos la de polarización 96° si se hubiera vendido aquí.

Ayer (3 de Agosto) se vendió una partida de azúcar centrífuga de Santa Cruz polarización 96° para su embarque inmediato á 4.05 centavos incluso los derechos, equivalente á 2 11/16 centavos, costo y flete, por los cubanos, acusando una subida de .03 de centavo. Esta venta animó á los que tienen azúcar cubano almacenado á subir sus precios á 2¾ centavos, costo y flete. Hoy, los mercados europeos están más firmes, habiendo subido la cotización del azúcar de remolacha á 10s. 9¾d., equivalente á 4.28 centavos por los centrífugas en Nueva York.

El mercado local está ahora muy sostenido, con tendencia al alza, esperándose un aumento en los precios antes de que termine la zafra.

Las existencias en los cuatro puertos de los Estados Unidos están disminuyendo constantemente cada semana, y si la demanda por azúcares refinados continúa siendo buena, como se espera, los azúcares que aun están en Cuba se necesitarán y se pagarán á buen precio, y habrá que acudir á Java para obtener abasto con que satisfacer las demandas de los refinadores hasta que los azúcares de la nueva zafra estén disponibles.

El precio más bajo cotizado por azúcar de Java á flote (embarcada á principios de Julio), es 11s. 1¼d., costo y flete, equivalente á 4.11 centavos puesta en el muelle la de polarización 96°, y equivalente á 2¾ centavos, costo y flete, por la de Cuba, cuyo precio se pagará pronto probablemente.

El nuevo arancel de aduana quizás sea aprobado y firmado por el Presidente esta semana. El derecho sobre azúcar mascabado se ha convenido que siga siendo el mismo que antes, ó sea, 1.685 centavo en libra de la de polarización 96° procedente de países no privilegiados, y la concesión de 20% en los azúcares de Cuba continúa, con sujeción al Tratado de Reciprocidad que sigue vigente, según se determina especialmente en el proyecto de ley.

Cuba ha prosperado con motivo del Tratado de Reciprocidad, y su prosperidad aumentará, sin duda, de año en año, como aumentará también su producción de azúcar. Hasta la fecha se calcula que la presente zafra de Cuba asciende á 1,420,000 toneladas, con 5 centrales aun moliendo, lo que hace esperar que el total de lo producido este año llegue aproximadamente á 1,450,000 toneladas.

El haberse sembrado más caña y el buen tiempo que ha reinado recientemente, son indicios de que la próxima zafra en Cuba sea mucho mayor.

Las siembras de caña y de remolacha en los Estados Unidos están desarrollándose muy bien, siendo todas las indicaciones de que la producción de ambos frutos será mayor. La cosecha de remolacha en California es muy abundante, habiéndose comenzado ya el recolecta en la parte sur.

El consumo se hace en una escala lo bastante grande para absorber el azúcar según se vaya produciendo, y el aspecto general de la situación azucarera es muy satisfactorio.

Nueva York, 4 de Agosto de 1909.

Sugar Cane Enemies.

Among the pests attacking the sugar cane in Cuba is the borer, which is responsible for most of the damage done to the plant. The borer, says E. T. Ferro in *The Demeter*, of the Louisiana State University, "attacks the white cane more than the other varieties, such varieties as the crystallina and red striped, which have a thick rind and are not frequently found attacked by it.

"The borer always tries to get to the sweetest part of the cane, therefore very few are found in the tops of the cane; most of them are found in the butts and middles where most of the sugar is accumulated. Some lands upon which cane has been in cultivation for more than twenty years, without systematic rotation or resting of the land are greatly infested with this pest. This happens to the entire province of Matanzas, where cane alone has been grown since it was in existence.

"This pest is partially checked by the system of planting. Infected cane when cut in pieces for seed, one to one and a half feet long, will show a red stripe running through the center of the stalk, and in this way they are easily sorted without much trouble and expense. On the other hand, if the trash is not burned every year, the borer will make its home again in that trash and multiply itself, thus increasing and spread-

ing out from year to year. Trash burning is not practiced in Cuba because well spread between the rows it serves as a mulch, preserving the soil moisture during the long droughts which some times last five or six months; second, when burned a great amount of heat is given off, which will retard the growth and weaken the stubble stand, especially during the dry season. Therefore the only means to check the infection is by the selection of sound cane for seed and by using only the more resistant varieties, such as the crystallina and red striped."

Better Transportation Facilities.

An auxiliary schooner, the Arazoza, is now on semi-weekly service between Cabañas and Havana. The trip takes about six hours. Arrangements have been made for the transportation of the products of the settlers at San Claudio direct to Havana.

A fast line of high-class automobiles was also inaugurated August 1 between Guanajay and Cabañas, making the run, which heretofore has taken about three hours in a guagua, in something like one hour. Colonists in San Claudio can now visit Havana and return home the same day.

SAN CLAUDIO

Only thirty-six miles from Havana, on the splendid deep-water harbor of Cabanas

Deep, fertile soil, high, healthful and well watered. Land all cleared, ready for the plow. Government stone highway direct to Havana. Regular Freight Service direct from San Claudio Wharf by boat to northbound steamers in Havana harbor; low freight rates, no re-handling. Fine American Hotel, General Store, School, American neighbors, daily mail, boating, hunting, fishing, three sugar mills near by. Farms on easy terms.

For full particulars and Illustrated Book on Cuba and Tropical Agriculture, write

**FRED C. BECKER, Manager, 277 BROADWAY
NEW YORK**

Colonial Sugar Company Meeting.

A special meeting of this company will be held in New York, August 11, to consider the following matters:

First—A proposal to sell all the property of the company, under Sec. 33 of the Stock Corporation Law, to a domestic corporation engaged in a similar business.

Second—The allowance of compensation to certain directors and other persons for their services and advances in connection with the properties and the proposed sale.

Third—A plan of distribution of the proceeds.

FOR SALE

We offer, subject prior sale, September 1st delivery, one 26" x 72" Pratt "IMPERIAL" Cane Crusher complete with Compound Gearing, Hydraulics and Corliss Engine, Krajewski type rollers.

One 34" x 72" Three-Roll Pratt "IMPERIAL" Cane Mill, complete, with Compound Gearing, Hydraulics and Corliss Engine, heavily built for highest pressures. **LARGE JOURNALS.**

EXTREMELY NARROW TURN PLATE

For full information, particulars, prices, etc., address

PRATT ENGINEERING AND MACHINE COMPANY
Atlanta, Georgia, U. S. A. 80 Wall St., New York City
Havana, Cuba, Office: Lonja del Comercio 509.

THE EXETER MACHINE WORKS

PITTSTON, PA.

MANUFACTURE

**Steam and
Electric
Hoists**

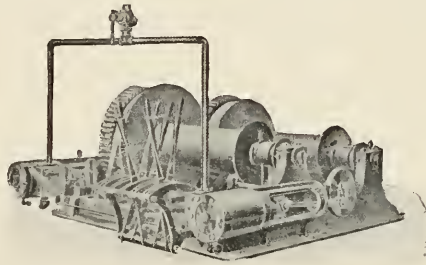

**Elevators
Conveyors
and
Handling
Machinery**

New York Office: 50 Church Street

CARROS PARA CAÑA

De todas
clases

Fabricados
de madera
ó ábero

Dirección
Telegráfica
RAMALIAM

**RAMAPO
IRON WORKS**

30 Church St.
New York, N. Y.

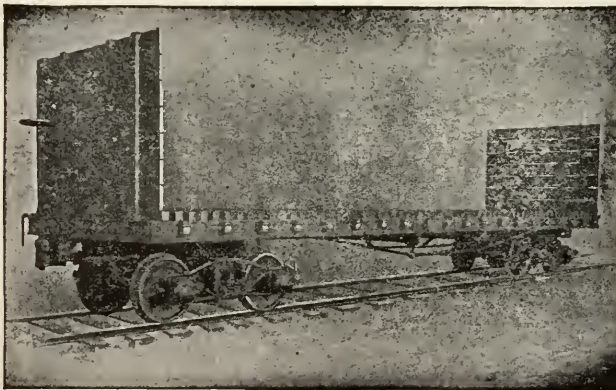

CANE CARS

OF EVERY
DESCRIPTION
OF STEEL
OR WOOD

Cable Address
RAMALIAM

**RAMAPO
IRON WORKS**

30 Church St.
New York, N. Y.

INVEST IN CUBA

Consult us

Specialists in Cuban Investments

Confidential investigations and reports made on all propositions. Have several large tracts of land which can resell for purchaser in small farms at triple purchase price.

1st MORTGAGES, 10% INTEREST; 50% VALUATION

SUGAR MILL SECURITIES PAY 20%

INVEST—DOUBLE YOUR MONEY. Let us tell you why and where.

CONSULT US, OTHERWISE "DON'T INVEST IN CUBA"

The Johnson-Harding Company

64 Empedrado, Havana, Cuba

CANADA LAND AND FRUIT CO.

LOS INDIOS

Owners

ISLE OF PINES

CANADA AND LOS INDIOS TRACTS

Location: Siguanea Bay. The Deep-Water Harbor of the Island.

We have at our new and progressive town of Los Indios a sawmill, planing-mill, general store, school, hotel, church, post office and nursery, all under the supervision of Americans. A strictly American town.

We also have rowboats and gasoline launch for pleasure parties. Fishing and hunting the best.

We own the finest citrus fruit, vegetable and tobacco land on the island. We offer same for sale in acres to suit purchaser, either for cash or on installments. Special inducements to actual settlers.

Write for prospectus and further information to our general office,
Marinette, Wisconsin.

WILLETT & GRAY, Brokers and Agents

FOREIGN AND
DOMESTIC

SUGARS

RAW AND
REFINED

82 WALL STREET, NEW YORK

Publishers of Daily and Weekly Statistical Sugar Trade Journal—the recognized authority of the trade.
TELEGRAPHIC MARKET ADVICES FURNISHED

PURE
DISTILLATION
OF
SUGAR CANE

BACARDI RON

Sole United States Agent

D. S. de JONGH 128 Water St.

BEST MIXER
FOR
HIGHBALLS
AND
OTHER DRINKS

"SUGAR NEWS FROM CUBA"

is the title of the interesting correspondence from the tropical island, appearing in every issue of "THE AMERICAN SUGAR INDUSTRY AND BEET SUGAR GAZETTE."

Capable correspondents, in every part of the world, write regularly, covering reliable sugar news for "THE AMERICAN SUGAR INDUSTRY AND BEET SUGAR GAZETTE."

In the United States, Cuba and Mexico, \$2 per annum. In Foreign Countries, \$2.50 per annum.

Subscribe for it if you want to keep posted. Sample copy free. Send for advertising rates.

Address: **BEET SUGAR GAZETTE CO.**

No. 5 Wabash Avenue,

Chicago, Ill., U.S.A.

TWO IMPORTANT MAPS

Blue-prints of Cuba, showing the location of the Sugar Plantations and the Rural Guard Stations of the Island. Specially prepared for The CUBA REVIEW. Each 60 cents. Either map with a year's subscription, 75 cents. Both blue-prints and magazine, one year, \$1.

The Rural Guard of Cuba

The Sugar Plantations of Cuba

H A V A N A

CUBA

National Bank of Cuba

Government Depository

Capital, Surplus and Undivided Profits
\$6,000,000.00

HEAD OFFICE, HAVANA

FIFTEEN BRANCHES IN CUBA

New York Agency, 1 Wall Street

COLLECTIONS

THE TRUST COMPANY OF CUBA HAVANA.

Capital and Surplus \$540,000

Transacts a General Trust
and Banking Business

REAL ESTATE DEPARTMENT

Examines Titles, Collects Rents,
Negotiates Loans on Mortgages

Correspondence Solicited from
Intending Investors

OFFICERS

J. A. Gonzales Lanuza, President
Norman H. Davis, Vice-President
F. J. Sherman, 2nd Vice-President
O. A. Hornsby, Secretary and Treasurer
J. M. Hopgood, Asst. Treasurer

Offices: CUBA 31, HAVANA

The Royal Bank of Canada

INCORPORATED 1869

Fiscal Agent of the Government of the Republic of
Cuba for the Payment of the Army of Liberation

CAPITAL AND RESERVE, \$10,300,000.00
TOTAL ASSETS, - 58,300,000.00

Head Office, MONTREAL

NEW YORK AGENCY, 68 William St.

Branches in Havana: Obrapia 33, Galiano 92;
Matanzas, Cardenas, Manzanillo, Cienfuegos,
Camaguey and Santiago de Cuba.
Mayari, Sagua, Caibarien

ESTABLISHED 1844

H. UPMANN & CO. Bankers

TRANSACTION A GENERAL BANKING BUSINESS
CORRESPONDENTS AT ALL THE PRIN-
CIPAL PLACES OF THE ISLAND

Safe Deposit Vaults

Manufacturers of the Famous H. Upmann
Brand of Cigars

FACTORY: Paseo de Tacon 159-163
OFFICE: Amargura 1-3

Established 1876

N. GELATS & COMPANY

Bankers

Transact a general banking
business.

Correspondents at all the prin-
cipal places of the world.

SAFE DEPOSIT VAULTS

Office: Aguiar 108

MOLINA BROTHERS

Customs Brokers

Forwarders, Lighterage and Ship Agents

Officios 52, Havana

HAVANA

United Railways of Havana

Cuba's First and Foremost Railroad. (First Section opened to Traffic in 1837)

Takes you to All Parts of the Island East of Havana Comfortably and Quickly through Varied and Beautiful Scenery and Past Extensive Sugar Plantations

Parlor, Observation and Sleeping Cars attached to principal trains.

Full information and through tickets to all points in Cuba reached via the United Railways of Havana can be obtained of the following:

Thos. Cook & Son
Seaboard Air Line R. R.
Foster & Reynolds
Atlantic Coast Line R. R.
Illinois Central R. R.

Ward Line
Florida East Coast Railway
Washington Southern Railway
Peninsular & Occidental S. S. Co.

Southern Pacific R. R.
Mobile & Ohio R. R.
Raymond & Whitecomb Co.
Louisville & Nashville R. R.
Munson Line

THE HERRADURA LAND COMPANY

Office: No. 3 Bernaza Street, Habana, Cuba

CAPITAL, \$440,000.00

Own 22,000 acres of land in the Province of Pinar del Rio, suitable for Oranges, Vegetables, Cotton, Corn and Tobacco. The land has all been surveyed and sub-divided into 40-acre tracts and is offered for sale in acres to suit the purchasers, for Cash or on instalments.

We have a new and progressive American town with Railroad Station, Telegraph, Telephone, Stores, Hotel, American School, all within short distance from Havana City.

Titles perfect. Transportation from Havana free for buyers.

WRITE OR CALL FOR INFORMATION.

LA AMBROSIA

MANUFACTURERS of the well-known brand of Chocolate, "LA AMBROSIA," Biscuits, Macaroni, Bonbons, all kinds of Confectionery

GUAVA PASTE AND EXTRA FINE GUAVA JELLY

ORDERS RECEIVED FOR EXPORT

BALDOE, FERNANDEZ & CO.

Sol 21 & 23, Havana, CUBA

Write for quotations.

PHONE No. 401

P. O. BOX 741

FERNANDO de CARDENAS

CUSTOM HOUSE BROKER

:: Import and Export Agent ::

Munson S. S. Line Building

Obispo No. 1, Havana, Cuba

JAMES S. CONNELL & SON

Sugar Brokers

Established 1836, at 105 Wall Street

Cable Address—"Tide, New York"

Soy Beans and Cowpeas.

Its great value is its power to withstand excessive drought and also much wet weather.

A test of cow peas as a forage crop for hogs, at the South Carolina experiment station, showed that 6.02 pounds of corn and 4.91 pounds of cowpeas were necessary to produce one pound of pork.

Cuba reluctantly relinquished by an imperialism-mad administration because public sentiment and the nation's solemn pledge required it, is causing trouble. Conditions there, we are informed, are in very unsatisfactory form and it may be necessary for the United States gov-

ernment to intervene. "If we set foot there again we will stay" it is significantly added. It is not recorded that the Cubans have requested a resumption of our regulation—but what have Cuba's wishes to do with the matter if we see fit to interfere?—Titusville (Pa.) Courier.

BRENAU

FOR YOUNG LADIES



COLLEGE CONSERVATORY

GAINESVILLE, GA.

300 BOARDERS—representing 28 states. All standard courses. Unusual advantages in music, art and oratory. 35 teachers with American and European Training. Healthful climate in Piedmont region of the South near Atlanta. 22 Buildings, including chapter houses for sororities. Campus recently enlarged to 75 acres. Gymnasium and athletic field. Expenses \$300 to \$500. Summer School June 24th. Chautauqua July 4th to July 31st. Address P. O. Box 250 for Catalog.

Journal d'Agriculture Tropicale

Founded by J. VILBOUCHEVITCH
164 Rue Jeanne d'Arc Prolongée.

Subscription, One Year - - - - 20 Francs

Deals with the leading questions of the hour, agricultural and commercial, of interest to tropical countries. International in character. Illustrated. Monthly. Descriptions of machines for tropical crops a specialty. Complete review of new agricultural publications. Commercial part intelligible for every one and always interesting. 150 contributors in West and East Africa, East and West Indies, Java, Mauritius, Central and South America, and throughout the tropical world.

PURDY & HENDERSON, Inc.

Engineers and Contractors

New York Chicago Boston
Cuba Office, Empedrado 32, Havana

HENRY E. BROWN
Pharmacist

Shipping and Export Chemist and Druggist, Ships' Medicine Chests Furnished and Replenished. Prescriptions Compounded by a Graduate in Pharmacy.

Trusses, Surgical Appliances, etc.
Office and laboratory, Room 36.
116 BROAD ST., NEW YORK

Telephone Call: 274-A Hamilton.

JOHN M. DONOVAN

13 Summit St. (Atlantic Dock) - BROOKLYN

Dealer in

Dunnage Mats

FOR BAG FLOUR, BAG AND BULK GRAIN AND GENERAL CARGOES.

—BAGS AND BAGGING—

SUGAR CANE PLANTATIONS

Cacao (chocolate and cocoa) and Coffee Plantation—Orange and Grapefruit Groves. Land for the small settler on easy terms. In the best district of Cuba—Rio Cauto Valley. Within 40 miles of Santiago and Nipe Bay. Write for Booklet.

RIO CAUTO SUGAR COMPANY, 50 Church St., N. Y. City

Having curbed Cuba's inclination to fight, Uncle Sam now has on hand the harder task of showing little brother how to live within his income.—Hamilton (O.) Rep.-News.

M. J. CABANA
COMMISSION MERCHANT
P. O. Box 3, Camaguey

Solicits Correspondence from all the important cities of the United States of America.

THE BIG FOUR ROUTE

3 Daily Trains Each Way 3

Parlor Cars, Sleepers, Dining Cars.

Through Train Service
BETWEEN
Cincinnati, Toledo and Detroit
(Via Michigan Central R. R.)

Ask for Tickets Via

BIG FOUR

BARTLE

Twenty-five thousand acres of the richest and best watered land in Cuba on the main line of the Cuba Railroad, with the finest station on the line, 120 miles from Nipe Bay—the best harbor on the Island; also the nearest to New York. No swamps or insect pests.

BARTLE is not in the wilderness—we offer all the comforts of civilization, GOOD STORES, HOTEL, CHURCH, SCHOOL, SAW-MILL, Etc.

TWO MAILS DAILY.
SUGAR, FRUITS, TOBACCO AND VEGETABLES produce wonderful crops at BARTLE.

When you consider Soil, Transportation, Social, Religious and Educational advantages, BARTLE offers something not to be had elsewhere in Cuba. Write for particulars.

"Ten Days in Cuba," just published by Hon. Nicholas J. Whalen, Speaker of the Michigan Legislature, may be had through newsagents at 25 cents per copy, or will be sent free to any address by the owners of the Bartle Colony. Address, Duncan O. Bull, Gen'l Mgr. Cuban Realty Company, Limited, Temple Building, Toronto, Can., or 141 Broadway, New York City.

DUNCAN O. BULL, General Manager

CUBAN REALTY CO., Ltd. Temple Bldg., Toronto, Canada
141 Broadway, New York **Bartle, Cuba**

MOBILE, ALA.

HOME INDUSTRY IRON WORKS Engines, Boilers and Machinery

Manufacturing and Repairing of all kinds. Architectural Iron and Brass Castings. Light and Heavy Forgings. All kinds of Machinery Supplies.

Steamship Work a Speciality

A. KLING, Prop.
JAS. S. BOGUE, Supt.

MOBILE, ALA.

The Principal Hotels in Mobile, Ala.

THE CAWTHON

(FIREPROOF)

European, 175 Rooms

\$1.50 Up

THE BIENVILLE

(MODERN)

European, 150 Rooms

\$1.00 Up

Both Hotels in Heart of City, Facing Bienville Square

OLLINGER & BRUCE DRY DOCK CO.

Ship Builders and Repairers

Operating seven Sectional Dry Docks, capacity 1,000 tons, and one Balance Dock, capacity 3,000 tons. Equipped with Air Plant for operating Pneumatic Tools, and Steam Pump for cleaning vessels' bottoms.

25-TON DERRICK BARGE AND STEAM PILE DRIVER.

Material of all kinds kept on hand. Shipwrights, Caulkers, Painters, Sparmakers and Riggers furnished promptly, and at reasonable rates. Correspondence solicited.

MOBILE, ALA.

BUSINESS FIRMS OF CAIBARIEN

ANGEL MATA

Comerciante,
Caibarién, Cuba.

Apartado 114. Cable: *Mata.*"

Ferretería, Mueblería y Locería
LA LLAVE

DE INCHANSTI Y HNO.
Caibarién, Cuba.

Marti 11 y 13. Apartado 24.

R. CANTERA Y CA.

(S. en C.)

Comerciantes Importadores,
Escobar 28. Caibarién.

A. ROMANACH

Almacenistas Importadores de Viveres,
(S. en C.)
Caibarién.

P. B. ANDERSON,

Ship Broker. U. S. Consular Agent,
Caibarién, Cuba.
Agent for Munson Steamship Line and Lloyds.

MARTINEZ & CO., S. en C.

Comerciantes Banqueros,
Importadores de Viveres,
Exportadores de Azucar.

Apartado 115. Telegrafo: Urquiza.

COMERCIO,
Hotel - Restaurant - - Cafe
De José Urquiza.

Calle de Marti num 16 y 18 - - Caibarién

LA MARIPOSA DE EVARISTO BERNES
Importador de Peletería y Talabartería, Fabricante
de Calzado.
Caibarién.

Apartado 104. Telegrafo: "Bergnes."

YMAZ Y CA.

Ymportadores de Ferrería en General.
Apartado de Correos Num. 15,
Caibarién, Cuba.

Calle Justa Num. 27. Cable: "Imaz."

ARIAS Y COMP

Provisiones, Loza y Muebles.
Cuba Num. 20, Esquina a Marti,
Caibarién, Cuba.
Correo Apartado Num. 15. Telegrafo: "Arias."

ZARRAGA Y CA.,

Caibarién, Cuba.
Casa Banca. Exportadores de Azucar.

BONIFACIO DIAZ,

Gran Peletería y Sombrereria.
Marti 17 - - Caibarién
Constantes novedades en los dos giros de esta casa.

RODRIGUEZ Y VINA, S. en C.,

Almacenistas Importadores de Viveres en General.
Comisiones y Consignaciones,
Consignatarios de Buques.
"Depositos de Carburo."

Telephone, 33 Hamilton
Night Call, 411 Hamilton

Cable Address:
"Abiworks," New York

Atlantic Basin Iron Works

Engineers and Boiler Makers

Machinists, Plumbers, Tinsmiths, Pipe Fitters, Blacksmiths, Coppermiths,
Pattern Makers, Sheet Iron Workers. Iron and Brass Castings. Steamship
Repairs a Specialty.

Cor. Imlay and Summit Streets

Brooklyn, N. Y.

John Munro & Son

Steamship and
Engineers' Supplies

13 Conover Street, Brooklyn, N. Y.

Cable Address: Kunomalc, New York

Telephone, 196 Hamilton

Telephone 215 Hamilton Box 186
Maritime Exchange

YULE & MUNRO SHIPWRIGHTS

Caulkers, Spar Makers

Boat Builders, Etc.

No. 9 SUMMIT STREET

Near Atlantic Dock BROOKLYN

WINTER HAVEN NURSERIES

A. M. KLEMM, Proprietor

Established 1884.

Winter Haven, Fla.

Wholesale Growers of Citrus Stock of the best commercial varieties. We guarantee our extensive Stock to be well grown, free of insects and true to name.

Silver Cluster Grape Fruit our leading Specialty.

Prices right. Grading and Packing perfect.

Write for Catalogue.

CUBA INFORMATION

IS THE TITLE OF A BOOK WHICH GIVES DEFINITELY and concisely just such information concerning Cuba as is desired by the business man or prospective investor who is interested in this fertile island—*climate, soil, products, fruit growing, live stock, tobacco, sugar, customs duties, banking, investments, colonies, land titles, laws, and a hundred other matters.*

SEND 25 CENTS FOR A COPY

and if you want any specific information that could not be covered in such a book,

Ask Mr. Foster No. 1 Madison Avenue, NEW YORK

Mr. Foster also has information offices in Philadelphia, Washington, Atlantic City, Jacksonville, St. Augustine, Daytona, Palm Beach and Miami, Florida, and in Havana and Camaguey, Cuba. FREE INFORMATION—no fees ever asked or accepted.

The Standard Guide to Cuba— Reliable—accurate—maps—illustrations.
50 cents.

FOSTER & REYNOLDS, 1 Madison Avenue, New York.

BUSINESS FIRMS OF SANTIAGO

E. GIRAUDY & CA.

ALMACEN DE VIVERES

Marina baja n. 33, Santiago de Cuba.

Agentes de Schlitz Beer.

JULIAN CENDOYA

Steamship Agent and Broker

COMMISSION MERCHANT

CABLE: Cendoya. Santiago de Cuba.

VALLS, RIBERA & CA.

(S. en C.)

Importadores de Ferrreteria y Machinery.

Telégrafo: Valribe.

Santiago de Cuba y Manzanillo.

A. B. C. Code, 5th Edition. Telephone, 190.
P. O. Box, 95. Cable address: SILVAPA.

SILVA Y PARRENO H.

General Commission Merchants.

Custom House Brokers—Forwarding Agents.

Consignees of the Cuban steamers of the Carlos J.

Trujillo, S. en C., Line, formerly Menéndez & Co.

References:—J. Cendoya and Nat'l Bank of Cuba.

CAMP HERMANOS, Santiago de Cuba.

Ron Selecto "Golondrina" y "Carta Cuba."

Medalla de Oro, St. Louis, 1904.

RON BACARDI

DE BACARDI & CO., Distillers, Proprietors.

43 San Ignacio, cor. Santa Clara, Havana.
Santiago de Cuba.

LAREA Y BESEALIE

Importers of General Groceries and Exporters of

Cocoa, Wax, Honey and Woods.

Apartado 65, Marina Baja 46. Cable: Larrea.

Importación.

Exportación

L. ABASCAL Y SOBRINOS

Agentes de las lineas Pinillos Izquierdo y Ca., de

Cadiz. Larrinaga y Ca., de Liverpool. Com-

pañia de Seguros, Aachen & Munich, Aix-la-

Chapelle.

BROOKS & CO.

Bankers and General Commission Merchants

Santiago and Guantánamo.

VINEGAR BEND LUMBER CO.

Manufacturers and Exporters

Long Leaf Yellow Pine Lumber and Timber

Cuban Business Our Specialty VINEGAR BEND, ALA., U. S. A.

Daily Capacity, 200,000 Feet

Cable Address: "TURNER"

Codes: A B C, Fourth Edition; Southards; Watkins; Western Union



SOBRINOS DE BEA & CO.

Bankers and Commission Merchants
Importación directa de todas los centros
manufactureros del mundo.

Agents for the
Munson Steamship Line, New York and
Mobile.

James E. Ward & Co., New York.
Serra Steamship Company, Liverpool.
Vapores Transatlánticos de A. Folch & Co.
de Barcelona, España Independencia
Street 17/21.

MATANZAS, CUBA.

JOHN W. McDONALD

COAL, WOOD, LUMBER
and TIMBER of Every
Description

112 WALL STREET

Near South Street NEW YORK

Yard: 58-68 Beard Street, Erie Basin
Telephones:

Office, 1905 John Yard, 316 Hamilton

An appropriation of \$120,000 asked for by the Department of Agriculture for the purpose of holding an agricultural and industrial exposition next winter will probably be provided. Palatino Park will be secured and permanent buildings constructed.

"The Comfortable Way"

Between the East and the West is via the Toledo, St. Louis and Western Railroad

"Clover Leaf" Route

Rates lower than by any other direct line. Send four cents in stamps for copy of "Get Out or Get in Line," a booklet by Mr. Elbert Hubbard, Chief of the Roycrofters.

GEO. J. CHARLTON,
General Passenger Agent,
Chicago, Ill.

THE SNARE AND TRIEST COMPANY

CONTRACTING ENGINEERS

Steel and Masonry Construction
Piers, Bridges, Railroads and Buildings

We are prepared to furnish plans and estimates on all classes of contracting work in Cuba.

N. Y. Office
143 LIBERTY ST.

Havana Office
LA LEAL BUILDING

W. H. Bennett

F. W. Hvoslef

Bennett, Hvoslef & Co.

18 Broadway, New York

Steamship Agents and Ship Brokers

Cable: "Benwalsh"

MUNSON STEAMSHIP LINE

GENERAL OFFICES

82 Beaver Street New York

NEW YORK-CUBA SERVICE PASSENGER and FREIGHT

| Steamer | New York | Nipe | Nuevitas | Nipe | Banes | Gibara | Pto. Padre | Nuevitas | Nipe | New York |
|----------|----------|---------|----------|---------|---------|---------|------------|----------|----------|----------|
| | Sail | Arr. | Arr. | Arr. | Arr. | Arr. | Arr. | Sail | Sail | Arr. |
| Curityba | Aug. 11 | | Aug. 16 | Aug. 18 | Aug. 20 | Aug. 21 | | Aug. 26 | Aug. 27 | Sept. 1 |
| Winda | Aug. 25 | Aug. 30 | Sept. 1 | | | Sept. 4 | Sept. 7 | Sept. 9 | Sept. 10 | Sept. 15 |

SAILINGS SUBJECT TO CHANGE

WITHOUT NOTICE

FREIGHT ONLY

NEW YORK to CAIBARIEN, MATANZAS, CARDENAS and SAGUA

MOBILE-CUBA SERVICE

Freight Only

REGULAR SAILINGS-MOBILE to HAVANA-MOBILE to N.S. S.S. CUBAN PORTS.

BALTIMORE-COLON SERVICE

Freight Only

REGULAR SAILINGS-BALTIMORE to COLON

AGENTS IN CUBA
ASMUS LEONHARD

Cuban Freight and Passenger Agent
76 Cuba Street, Havana

BERNABÉ SANCHEZ É HIJOS
FRANCISCO PLA
BEOLA & CO.
M. J. CABANA
J. L. DAUTERIVE

Nuevitas
Puerto Padre
Gibara
Camaguey
Antilla (Nipe Bay) Oriente

For Southbound reservations address the General Offices, New York
For Northbound reservations address the agent at the port of embarkation

Lillie Multiple Evaporators

Model of 1904-1905 (Patented)

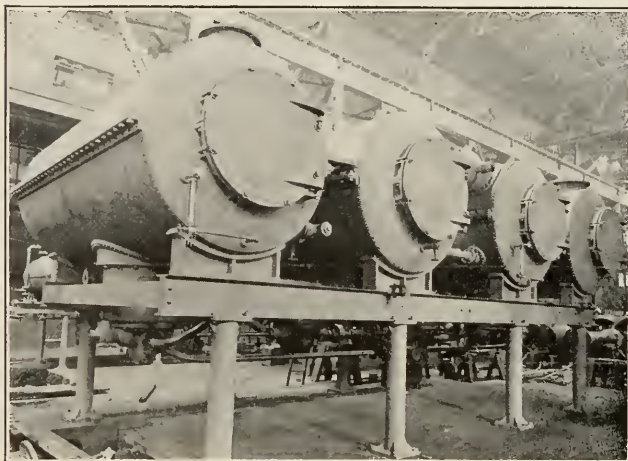

"One of three Lillie quadruple effects installed in 1907, in sugar factories in Formosa, belonging to the Taiwan Seito Kabushiki Kwaisha, of Tokio, Japan. Two more quadruple effects, one to handle 550,000 gallons of cane juice per twenty-four hours, and the other to handle 325,000 gallons in the same period, are now (July 1st, 1909) being built for the same Japanese Company, also for service in Formosa. These quadruple effects are arranged for reversing the course of the vapors and heat at will, a mode of operation peculiar to the Lillie and which has proven of great value for solutions depositing incrustations on the evaporating tubes."

The Sugar Apparatus Manufacturing Co.

328 Chestnut St., Philadelphia, Pa.

S. MORRIS LILLIE, President.

LEWIS C. LILLIE, Secretary and Treasurer.

BALDWIN LOCOMOTIVE WORKS

Broad and Narrow Gauge

Single Expansion and Compound

LOCOMOTIVES

Compressed Air Locomotives. Electric Locomotives with Westinghouse Motors

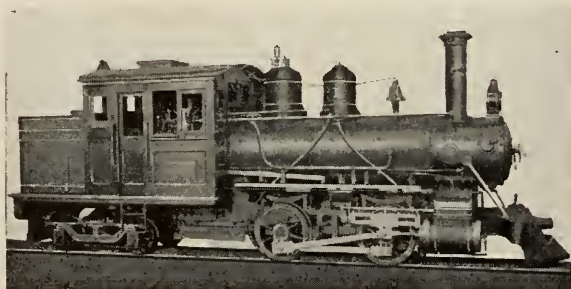

PLANTATION LOCOMOTIVES

For all Gauges of Track. To meet all conditions of service. Specifications furnished on application.

Principal offices and works, 500 North Broad Street
Philadelphia, Pa., U. S. A.

Cable Address: "Baldwin, Philadelphia"

Agents for Cuba, Krajewski-Pesant Co., Aguiar 92, Havana, Cuba.

THE CVBA REVIEW

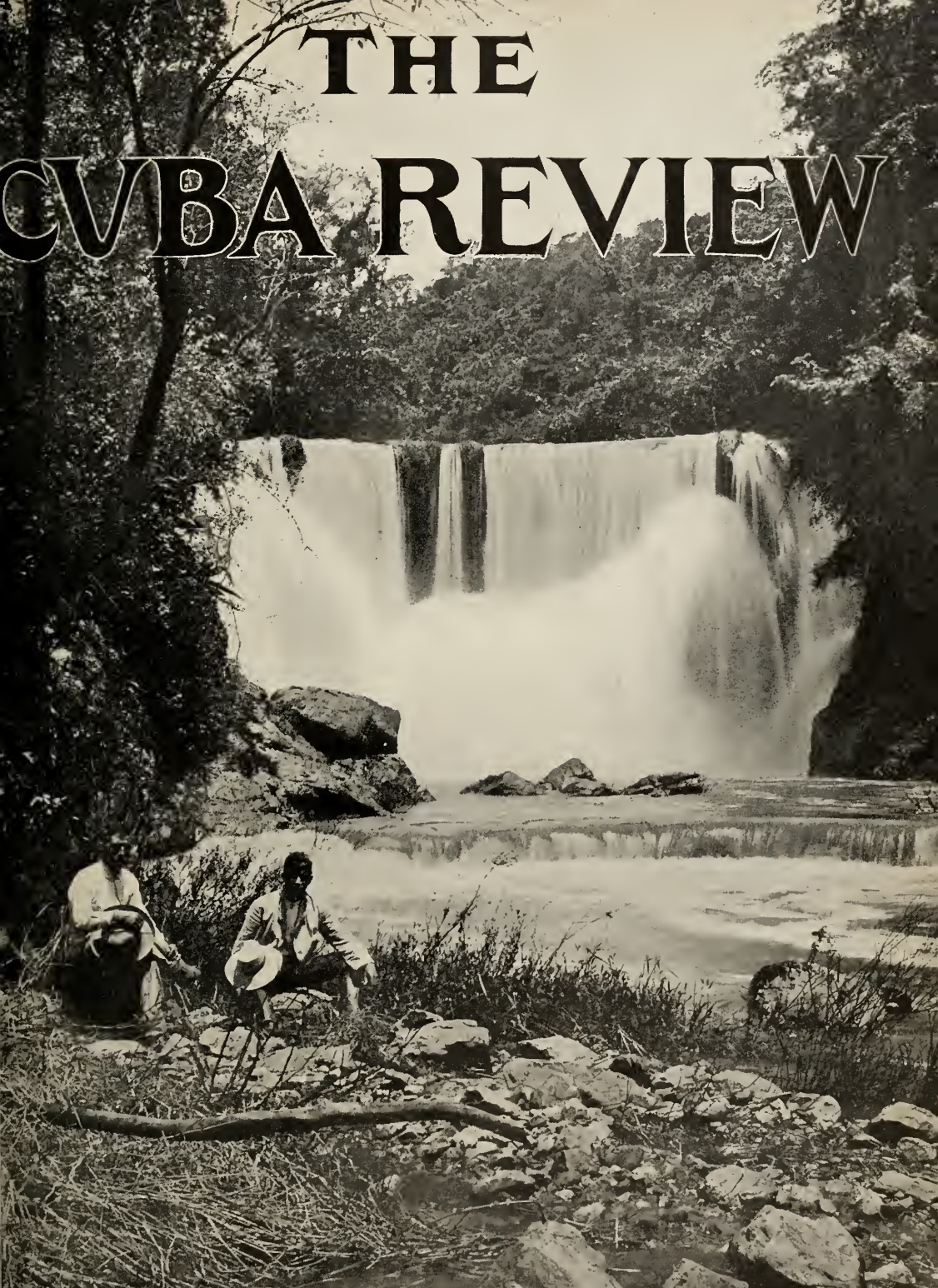

10 Cents A Year SEPTEMBER 1909 5 Cents A Copy
Published by the Munson Steamship Line, 82-92 Beaver Street, New York City.

CEBALLOS "THE GARDEN SPOT OF CUBA"



FOUR-YEAR-OLD GRAPE-FRUIT TREE AT CEBALLOS

After eight years of developing the country, creating industries, establishing conditions—paving the way—we now invite **HOMESEEKERS** to share our prosperity. No pioneering. All conveniences of modern civilization. Send for literature.

GEO. H. GILLET, Secretary

43 EXCHANGE PLACE, NEW YORK

Would you like to own a
HOME
in this
Ever-Summer Land?

Intelligence, energy and moderate capital will here win a fortune for you in Fruits, Vegetables and Sugar.

PRATT Imperial



Sugar Cane Machinery and Evaporating Apparatus.
Complete Plants Erected and Delivered to Owner Under Guaranteed Capacity of Mills and Quantity. Sugar House Pumps.

We have nearing completion, subject prior sale, October 1st delivery, one 34" x 72" Pratt "IMPERIAL" Mill Complete, with Hydraulics, Compound Gearing & Corliss Engine, also one 26" x 72" Pratt "IMPERIAL" Cane Crusher, complete with Hydraulics, Compound Gearing and Corliss Engine. For description see page 34.

STEAM PUMPS

SPECIAL PARTS of MACHINES, any size or kind; and HEAVY CASTINGS famous for quality.

We maintain Export Sales Offices at 80 Wall St., New York, in charge of Mr. N. A. Helmer, an eminent Sugar Mill Engineer of wide experience. We solicit your business with the assurance of every courtesy and perfect satisfaction.

Pratt Engineering & Machine Co. ATLANTA, GA.
U. S. A.

HAVANA, CUBA, OFFICE: LONJA DEL COMERCIO No. 509

Successors to *FULTON FOUNDRY & MACHINE WORKS, Atlanta, Ga.*

Tivoli Beer

—*Enough said.*

Havana Brewery

Havana

BUCKEYE NURSERIES

M. E. GILLETT, Proprietor

TAMPA, FLORIDA, U. S. A.

ORANGE, LEMON AND GRAPE FRUIT TREES

LARGEST CITRUS NURSERY IN THE WORLD

QUALITY VARIETY DELIVERY

Price may be forgotten—Quality NEVER.

We grow nothing but standard Varieties which we can recommend to the trade as Money-Makers. Having had 29 years' experience we thoroughly understand packing trees for long distance shipments.

We guarantee our trees to be True to Name, Free from White Fly and to ARRIVE AT DESTINATION IN GOOD CONDITION.

Consider the future and protect your investment by planting reliable trees from

THE BUCKEYE NURSERIES

LA GLORIA

The Colony where the Best Oranges are Raised

La Gloria fruit carried off the majority of the prizes of the 1908 and 1909 Exhibitions of the Cuban National Horticultural Society at Havana.

There is no other "just as good"

WRITE FOR HANDSOME ILLUSTRATED BOOKLET.

CUBAN LAND AND STEAMSHIP CO.

No. 32 Broadway, New York City

DE VALOR EN CUBA

Plombagina en Láminas, marca Ticonderoga, de Dixon, para lubricar todas clases de maquinaria. Aumenta el valor de todos los aceites y las grasas, y ahorra desgaste, tiempo y dinero. Vale la pena pedir gratis una muestra y un folleto.

JOSEPH DIXON CRUCIBLE CO.

Jersey City, N. J.



Sugar Plantation—Cuba Railroad.

The Cuba Railroad

This new line completing the railroad connection between Havana and Santiago, and Antilla, on the Bay of Nipe, is of standard gauge and similar in its construction and equipment to the better class of northern lines. All of its important bridges are of steel and masonry, and the line generally is rock-ballasted. The main line passes along the center of the eastern and wider half of Cuba, and opens up a matchless and most picturesque agricultural region, and passes through the tropical forests of mahogany, cedar, lignum vitæ, ebony and many other trees, hung with vines and millions of orchids. Palm trees of magnificent aspect and great variety abound everywhere. The famed Parana and Guinea grasses, covering most of the open districts and standing from six to twelve feet high and green the year round, together with frequent running streams, make this an ideal cattle country. No food has to be put up and no shelter is required. The rich soils everywhere are adapted to sugar, tobacco, cotton, corn and an endless variety of products. The swamps which occur at places along the coasts of Cuba are absent from the interior, which is high, dry and exceptionally healthy. The trade winds blow across Cuba every day, and bring to all parts fresh sea air; the extreme heat of northern summers is consequently unknown and the humidity of other tropical countries is also unknown.

The Cuba Railroad Company's **Hotel Camaguey**, at Camaguey (formerly Puerto Principe) is by far the most popular resort in Cuba, Spanish in style, and provided with bath rooms and other modern conveniences, and is first-class in all respects.

This old city has about 40,000 inhabitants, is picturesque and is situated in a beautiful and remarkably healthy district. The hotel is especially favored by those wishing to spend some weeks or months in a matchless sub-tropical climate.

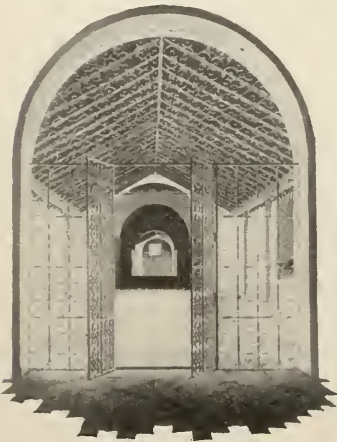

A Corridor, Hotel Camaguey.



Map of The Cuba Railroad.

THE CUBA REVIEW

"ALL ABOUT CUBA"

An Illustrated Monthly Magazine, 82-92 Beaver Street, New York

MUNSON STEAMSHIP LINE, Editors and Publishers

SUBSCRIPTION

50 Cents Per Year - - - - - 5 Cents Single Copy
Advertising Rates on Application

Vol VII.

SEPTEMBER, 1909

No. 10

Contents of This Number

The cover-page illustration is of a proprietor's fine residence on one of the large sugar plantations.

Pages 7 to 12 are devoted to Cuban Government matters. President Gomez' stirring speech on August 22 is well worth reading. The latest news concerning the National Lottery and half-tones of the two new members of the President's cabinet, together with information of Havana's paving work, installation of new automatic telephones in the city, and a description of the new Post Office, are all recorded and illustrated.

Cuban cartoonists' views of the general situation are given on page 13.

Pages 14 and 15 give opinions of some United States leading newspapers.

On page 16 are valuable opinions of the United States press translated into Spanish, for our Spanish readers.

Pages 18, 19, 20 and 21 are given over to financial and commercial information. There are reports of earnings of the various railroads of Cuba, together with information as to improvement work constantly going on. On page 19 is the official report of the Cuban Secretary of the Treasury. Cuban Custom House collections for the six months of 1909 are on page 20.

Page 22 is devoted to tobacco.

On page 23 is an interesting article by a French engineer chemist on the manufacturer of banana alcohol.

Pages 24 and 25 are given over to a condensation of a bulletin issued by the United States Department of Agriculture on the protection from lightning, describing an inexpensive method of wiring.

Isle of Pines matters on page 26.

Agricultural information, with numerous interesting illustrations, will be found on pages 27, 28 and 29. Some of the articles treated are ground-nuts, lemons, etc.

The monthly Sugar Review by the well-known authorities, Messrs. Willett & Gray, will be found in English on page 30, and the Spanish translation of the same article will be found on page 32.

On page 33 is the conclusion of the Spanish sugar article, and some interesting notes regarding the output of the plantations.

MANY BEAUTIFUL ILLUSTRATIONS.

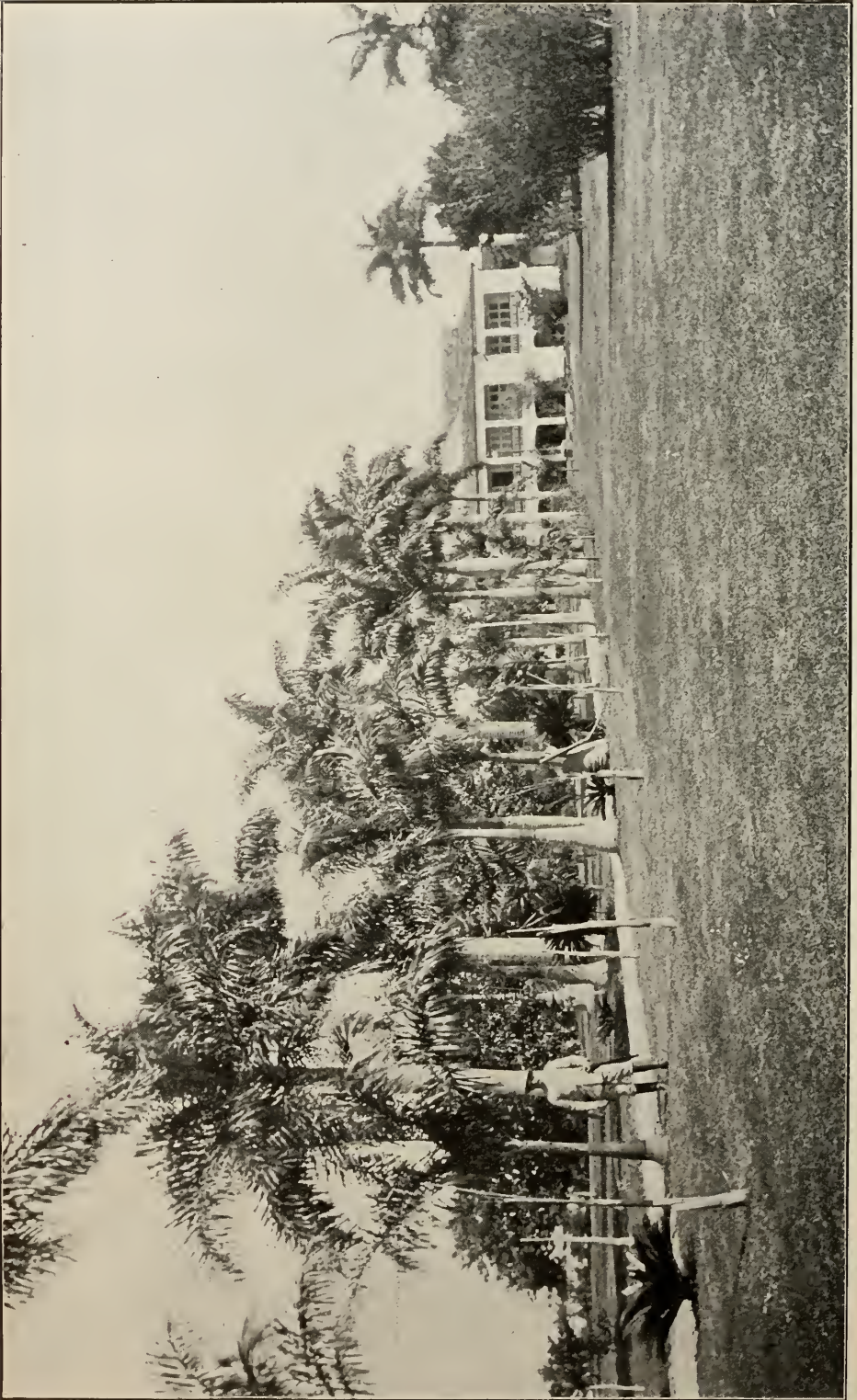

LIVING HOUSE ON A CUBAN SUGAR PLANTATION.
LA CASA EN UN CENTRAL CUBANO.

THE CUBA REVIEW

"ALL ABOUT CUBA."

Copyright, 1908, by the Munson Steamship Line.

LIBRARY
NEW YORK
BOTANICAL
GARDEN.

Volume VII.

SEPTEMBER, 1909.

NUMBER 10.

CUBAN GOVERNMENT MATTERS.

The Lottery—The President's Address Pleases—The New Members of the Cabinet
—Automatic Telephones—New Post Office—Etc., Etc.

The National Lottery. A circular issued August 17 by Director of the Lottery Gustavo Alonso Castañeda says that all persons receiving appointments as collectors of the lottery must be native born Cubans or naturalized citizens.

The lottery law provides that these offices should be held only by Cuban citizens, but when the lists were published there appeared among the appointments the names of a number known to be Spaniards.

The United States postal authorities are beginning to exercise a close supervision of the mails in the hope of holding up money which is sent from that country for the purchase of lottery tickets in Cuba. Naturally the Cubans looked to the United States for most of the support for their national lottery, which is just going into operation at Havana. A revenue of from \$2,000,000 to \$5,000,000 a year is expected from the drawings, and it is believed that a great part of this money would be likely to come from the United States unless some sort of barriers were opposed.

U. S. Postmaster General Hitchcock gave orders to all the postal officials of the country to exercise a close supervision of mails consigned to Cuba to see that they contained no remittances for lottery tickets.

For this reason Cuban business houses, says the Brooklyn Times, and people generally are notifying their clients and friends in the United States that it would be well hereafter in the sending of checks to Cuba to specify on the checks the purpose for

which they are sent. Otherwise if the commission deems the least suspicious the checks may be held up pending investigation. Preparations for the opening of the lottery are rapidly being completed.

A Stirring Speech.

President Gomez on his return to Havana from Cayo Cristo, on August 22, delivered from the balcony of the palace the following stirring address to the people who had gathered to welcome him:

"As a result of alarming rumors gratuitously circulated about a third intervention, I have received telegrams from all parts of the island, from San Antonio to Cape Maisi Point, expressing the Cuban people's decided support of the liberal government.

"I have given up my summer vacation, which I had well earned, I may say without false modesty, for I had previously worked a great deal on account of the many difficulties I had encountered ever since I took my post. I have now come to reorganize the public administration, if it has changed. I come to solve whatever is awaiting solution, and to punish, if punishment is necessary, for I am resolved to act with full energy to save the Republic, for I wish when my day comes to leave this palace whoever my successor may be shall find that I have delivered the Republic into his hands as I received it—free, independent and sovereign.

"Meanwhile I count on all and every Cuban to help me along toward the salvation of the Republic.

"Countrymen, long live the Republic of Cuba!"

His speech produced a good impression. The press commented upon it favorably, and he received more than a thousand congratulatory telegrams offering him most earnest support.

NEW MEMBERS OF PRESIDENT GOMEZ'S CABINET.



Hon. Joaquin Chalons, the new Secretary of Public Works, appointed August, 1909.

Señor Joaquin Chalons, Secretario de Obras Publicas.

Señor Joaquin Chalons, Secretary of Public Works, is a native of Santiago de Cuba and was graduated as a civil engineer in Spain in 1887. His professional services took him to Santiago de Cuba in 1890 and later in 1896 to Spain, where he was in charge of an office in connection with the railway company from Madrid to Alicante. After the end of the Spanish-American War Señor Chalons returned to Cuba and was for some time in charge of the public works at Santiago de Cuba and was also counsellor or legal adviser of the Banco de Fomento.

*Chil's
First
Cuban
Minister.*

Señor Mariano Aramburo y Machado, the first Minister appointed by the Cuban Government to Chile, arrived in New York, August 14.

Señor Aramburo said he was proud to be the first man in the diplomatic service of his country to represent Cuba in Chile. He left on August 20, going first to the Argentine Republic.

Señor Aramburo is a well-known man of letters in Cuba; he has been editor of several prominent newspapers, among them being the "Diario de la Marina," "Discusion" and "Nuevo Pais."



Hon. Francisco Lopez Leiva, the new Secretary of the Interior, appointed August, 1909.

Señor Francisco Lopez Leiva, Secretario de Gobernacion.

Señor Francisco Lopez Leiva, Secretary of the Interior, was promoted from Assistant Secretary of the Treasury to the office he now holds. He is a man of letters, journalist and poet. He began a crusade to improve and purify the stage in Havana, something very much needed. He has already closed several places of amusement for violations of the laws of morality and decency.



The Hatney, Cuba's Flagship.

El Hatney, el buque almirante de Cuba, representará la República en la Celebración Hudson-Fulton, Nueva York, Septiembre 25-Octubre 29.

At the Hudson-Fulton celebration, September 25 to October 9, Cuba will be represented by the Hatney, flagship of the Cuban nation. She mounts two two-inch guns and three rapid fire batteries.

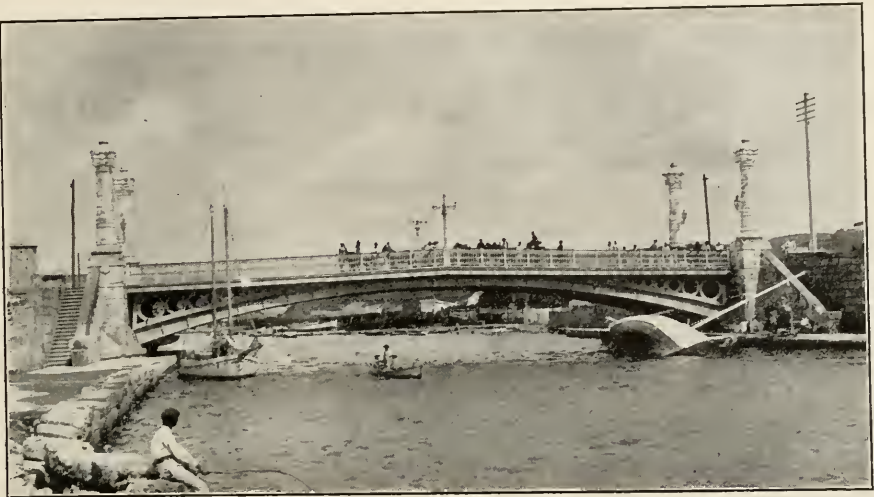

La Concordia bridge over the Yumuri River, Matanzas, connecting the old and the new parts of the city.

El puente de La Concordia sobre el río Yumurí en Matanzas.

*Havana's
Paving
Material.*

So soon as Havana's new sewer system is installed it is planned to pave the streets in modern style. J. M. Babe, the chief engineer of the bureau of highways and bridges in the department of public works, was the Cuban delegate to the International Highway Congress, held in Paris in 1908. His report, which he has recently submitted to the President, has an important bearing on the question of paving of the streets of Havana.

Sr. Babe recommends that Havana be paved for the most part with wood; that the small, narrow streets running north and south, where there is little or no sun, be paved with asphalt; that the suburbs be paved with brick; and that special drives, such as the Malecon, be paved with tar macadam, a substance which has proved very durable and satisfactory in London and New York.

Granite blocks, such as Havana's streets are paved with at present, are going out of use.

*Automatic
Telephones
Promised.*

The Havana Telephone Company, operating the old "Red Telephone" service of 3,700 'phones, will soon install a Chicago automatic system of 25,000 telephones at a cost of \$2,000,000.

No operator or "central" is required by the automatic system. The person desiring to talk turns a dial attached to his 'phone until it registers the num-

ber he wishes to call. He then pushes a button which rings a bell and calls the party desired. When the receiver is returned to the hook the connection is discontinued.

On April 3, and by Presidential decree, the Cuban government rented the public telephone service for eighteen years to this company. On August 16 this decree was attacked in the Supreme Court in the name of a citizen, who considers the Cuban treasury damaged to the extent of \$11,000 a year by the transaction.

*Against
Adultera-
tions.*

Cuban health officials will make war upon imported adulterated foods, claiming that goods shipped to Cuba would in many instances be denied a sale in the United States. Cuba has a pure food law sufficiently drastic to cope with infractions. The Bromatological Bureau, provided for in the sanitary regulations, but which heretofore has existed only in name, is now at work and after analysis products condemned are destroyed. The stores selling sweets and confectionery are now obliged to keep them in glass cases or otherwise screened and protected against dust and indiscriminate handling.

Regarding medicines and drugs Dr. Tremois, of the Pharmaceutical Bureau, is also preparing a campaign against adulterations. He said recently that bottles which originally contained standard preparations have been refilled with poor and cheap substitutes. He purposes to stop these practices.



One of Havana's picturesque side streets, showing the narrow walk, the entrance and quaint steps and porch built inside the walls, and the curious wooden windows, which one finds in the other cities of the Island. Travelers have said that such identical windows are seen in Cairo, Egypt.

Una calle muy pintoresca en la Habana, mostrando las aceras angostas, la entrada y los peldaños raros, así como el portal construido por la parte de adentro y asimismo mostrando las ventanas tan especiales con enrejado de madera, cosas todas muy comunes en las demás ciudades de la Isla. Según han dicho algunos viajeros, en el Cairo, Egipto, se ven en las casas ventanas idénticas á éstas.

The work of the dredging of the estuary and channel at Sagua Isabela de Sagua is to be pushed. Up to August 6, the work done has been the removal of mud from the bottom of the channel, but there are some rocks and sand bars which will have to be dynamited. A driller is already on the way to the scene.

The Havana Telegraph calls the dredging work at Sagua a fiasco. It says editorially:

"Thé dredging of that harbor has been progressing very slowly for a long time under government auspices and has proven tremendously costly. From three to four dollars the cubic meter, though any well equipped contractor could do it for a dollar to a dollar and twenty cents, and make a fair profit. A glimmering of this fact has begun to dawn upon the governmental mind, and bids on the work will probably be called for."

The New Postoffice. The fitting up of Havana's new postoffice building at the corner of Mercaderes and Teniente Rey is progressing rapidly. The new building is five stories and has a total floor space of 2,500 square meters, 1,000 square meters more than in the old building. The government will pay a monthly rental of \$1,400 to the owner, Sra. Gomez Mana.

The first three floors will be devoted to local business. The first floor will be occupied by the money order department, the stamp-selling department, the telegraph receiving station and the mailing division. On the second floor will be the general delivery, the parcel post, the registry department, the custom house office and the offices of the Postmaster. On the third floor will be the telegraph sending station and the letter carriers' division. The fourth floor will be utilized for the office of the Postmaster-General of Cuba, the bureaus of inspection and appointment and the sub-director's office, and the fifth floor by the bureaus of registry and delivery, money orders and accounting. Wireless telegraph apparatus on the roof for short distances will be installed.

A new postoffice has been established at Banaguises, Matanzas Province, and a money order office at Felton, Oriente Province.



The present Havana Postoffice.

La actual Oficina de Correos de la Habana al fin de Calle O'Reilly.

August 3 it was announced that Dr. Juan Guiteras, the well-known yellow fever expert, would remain at his post as chief sanitary officer of Havana, and that ample financial support would be given his department. Dr. Guiteras had resigned because the appropriation for his work had been cut to a point where he refused to assume any further responsibility for the work of his department.

MINOR NOTES.

On August 6 D. E. McComb, chief engineer of the sewer and paving work in Havana, said to a La Discussion representative that "Within two months great activity will be noted about the city on account of the new impulse to be given to the works. Within that time, he said, the loan negotiated with Speyer & Co. will be available.

"Meanwhile the same firm has offered to advance \$2,000,000 to meet all the necessities of the moment. Five electric digging machines are now on the way from the United States."

Dr. Francisco Zayas was recently appointed Cuban minister to Belgium. Dr. Zayas is a brother of Alfredo Zayas, Vice-President of Cuba. He sailed from New York for his new post on August 15.

The second of November has been selected as the official date for the inauguration of the monument set up on the battlefield of El Caney and San Juan to honor the Spanish dead, of the Spanish-American war, which has been erected by the Spanish colony.

The total number of lunatics secluded at the state insane asylum at Mazorra, including the criminal insane, according to the last statement, is 2,155. Of these 1,143 are men, 991 women and 21 children. There is no increase in the number of the women insane from the last statement, although the number of men has increased.

The opening of the school of cavalry instruction for the riders in the rural guard and the permanent army will take place this month. The school will be under the direction of Captain Parker, U. S. A.

The governing committee of the Indianapolis Board of Trade August 3 decided to send an invitation to Gen. Carlos Garcia-Velez, minister to the United States from Cuba, asking him to come to Indianapolis following his visit to Chicago, October 7, to address the business men of the city in regard to opening up trade between Indianapolis manufacturers and merchants with Cuban consumers.

On August 24 the President canceled a number of contracts for public sup-

plies which had been made without public bidding.

Arturo Betancourt, who on June 26 shot and killed his brother, the trolley car magnate, at the Union Hotel in Cienfuegos, has been declared insane by physicians who examined him by order of the court.

The Havana City Council on August 7 considered the application of Rafael Tarrafa for the exemption of tax to a new industry established by him for the manufacture of henequen bags. Under the law new industries receive the benefit of an exemption from tax for a fixed period.

The Department of Public Works in Havana is placing a system of road signs and directions throughout the highways of the island, of which there are now 1,400 kilometers. The signs not only show where the road leads, but further contain explanations for the benefits of motorists and people unfamiliar with the vicinity.

The Civil Service law which went into effect on July 1 last, is the cause of many removals of government employees. The commission is composed of two Liberals and one Conservative.

Howard Chandler Christy has gone to Cuba for the purpose of painting the battlefields of San Juan and Caney. Mr. Christy will reproduce on canvas these famous battlefields for Scribner's and Harper's.—New Bedford (Mass.) Standard.

Spanish clubs in Cuba are taking subscriptions for a relief fund for the benefit of the families of Spanish soldiers killed in the fights with the Moors. The officers of the various associations expect to secure \$100,000 in this way.

On August 24 President Gomez inaugurated a series of personal conferences with the editors of the newspapers which had been recently attacking the government, his purpose being to establish a more friendly understanding. Since then two prominent dailies have been more moderate in their criticisms.

Ban on Cuba has placed severe
Firarms. restrictions upon the im-
portation and sale of fire-
arms throughout the re-
public, with the exception of ordinary
shotguns and the .32 caliber gallery rifle,
says the New York World. Ammunition
for these two classes of firearms is pro-
hibited except through the ports of
Havana, Matanzas, Nuevitas, Trinidad
and Santiago de Cuba.

Retail dealers in guns, rifles and re-
volvers will not be hereafter permitted
to have in stock in excess of ninety-nine
weapons at one time, and can only with-
draw in case of sales, up to the ninety-
ninth weapon, must report all sales to
the government, giving name of pur-
chaser (who must secure a license), num-
ber of license, date of issue and author-
ity. Dealers will be allowed to keep in
stock over 100 charges for each weapon,
and excess stock of weapons over ninety-
nine must be deposited in the national
armory and withdrawn as sales demand
only after receiving the permission of
the government. Arms may be sold
only to persons who have proved them-
selves authorized to use them.

On Aug. 25 President
The New Gomez signed the \$16,500-
Loan. 000 loan contract with
Speyer & Co., of New
York, negotiating through Frank Stein-
hart. The basis of the loan is as fol-
lows: Bonds of \$100, \$500 and \$1,000, cor-
responding to an A, B, C series, respec-
tively, will be issued paying 4½ per cent.
per annum on Feb. 1 and Aug. 1 each
year, these bonds to be taken by Speyer
& Co. at 88½ per cent. of the nominal
value. Redemption will begin on Aug.
1, 1919, and end in 1949, interest to be
paid from Aug. 1, 1909. Speyer & Co.
hold the privilege to buy from the Cuban
government any bonds which may be
negotiated before the redeeming period
begins on Aug. 1, 1919.

Of the dozen foreign loans placed here
within the last decade, the Cuban bonds
have probably remained longest in the
hands of American investors. A large
portion of the \$35,000,000 offering sold
by the Speyers in April, 1904, are still
held here. These bonds carried 4 per
cent. and were placed at 97.—Banker
and Tradesman, Boston.

Contracts President Gomez has
Annulled. issued a decree Aug. 24
declaring annulled all con-
tracts affecting govern-
ment works which have not been made
by public bidding. All expenses incurred

by the contractors shall be indemnified.
If, when revising the contracts made up
to this time, any irregularity or intended
action to profit thereby is detected, the
persons responsible will be indicted.

Engineer James Page, the Ameri-
Page can chief engineer of the
Retained. water and sewer system
of Ciefuegos, Cuba, has
been permanently appoint-
ed to the place by President Gomez. Mr.
Page was to have been discharged on
July 20 last, but the American govern-
ment asked that he be given an oppor-
tunity to prove his innocence of the al-
legations made against his administra-
tion, and a committee appointed by
President Gomez completely exonerated
him.

Some Mr. F. Vidal Crus, a promi-
Cubans nent citizen of Havana, who
Want has extensive business inter-
Annexation. ests in Cuba, is spending
some time in Baltimore. In
conversation with a Baltimore
American representative recently he said:

"The situation in Cuba is not so happy as the
best friends of that country could desire. The
trouble arises over uncertainty as to the political
destiny of the island. In the opinion of many
high-class men who view matters from a patriotic
and unselfish standpoint, it would be far better
if the flag of the United States had never been
hauled down in Cuba. These men do not think
that a local government of stable character can
be established in Havana, for they have small
confidence in the politicians who are in control
of affairs. With them the wish of speedy an-
nexation to the United States is the dominant
sentiment and they are impatient for that con-
summation."

On Sept. 1 the United Fruit Com-
pany had been authorized to maintain
the wireless station at San Antonio
Cape, installed by the authorization of
Mr. Charles E. Magoon when governor.
This concession had been rescinded by
the Cuban government some time ago.

President Gomez recently invited the
various editors to confer with him per-
sonally, apparently for the purpose of
ending the unfriendly criticisms of the
administration.

Dr. N. S. Mayo, for the past five years
vice-director and chief of the department
of animal industry of the Estacion Cen-
tral Agronomica, Santiago de las Vegas,
Cuba, has accepted the chair of animal
husbandry and veterinary science in the
Virginia Polytechnic Institute (Agricultural
and Mechanical College) at
Blacksburg, Va. He entered on his new
duties Sept. 1.

VIEWS OF CUBAN CARTOONISTS.

¡Y TAN CRÍTICA!



"Estoy muy penetrado de la situación crítica que atraviesamos."—A. Zayas.

AND SO CRITICAL (HEADING)

Government of Coalition (on automobile).

"I am very well aware of the critical situation that we are passing through." A. Zayas.—From La Discusion, Havana.

Trampa política

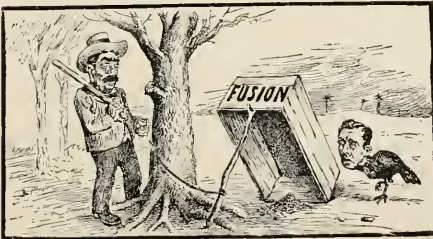

José Miguel: Si tranco al pájaro en el cajón digan ustedes que se hizo la fusión.

A POLITICAL TRAP.

José Miguel: If I catch the bird in the box, you may say that the fusion was made.—Politica Comica, Havana.

There has been an attempt to make a permanent fusion of the two factions of the dominant party (the Miguelistas and the Zayistas), and Señor Zayas has been elected chairman of the combined forces. Utterances of the press, however, indicate a lack of public confidence in the fusion movement. El Comercio of Havana, the organ of the business men of the island, said recently as follows:

"The political condition of this country is really very critical, because there is a

Fonógrafo americano

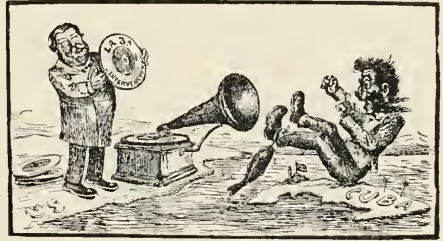

El Pueblo: Por tu madre: no pongas esa pieza, que me voy á arrebatar de la cabeza.

THE AMERICAN PHONOGRAPH.

The People: Do not put on that piece, which I wish to drive out of my head. The record is labeled "The Third Intervention."—Politica Comica, Havana.

Las dos safras



El Pueblo: Si yo llego á saber esto, no me hubiese equivocado. Yo lo que quiero es azúcar; no me hace falta el pescaço.

THE TWO CROPS.

The People: If I had known this, I would not have made a mistake. What I want is sugar; I am in no need of fish.—Politica Comica, Havana.

serious crisis among the Liberals, and notwithstanding their efforts to keep it hidden, every one knows that they are divided among themselves."

"The President and the Vice-President are at daggers' points, we learn, and their differences are irreconcilable."

A mixed committee is at work trying to bring an end to dissensions arising through each faction constituting itself the director of the party.

G. Cornell Tarler, at present second secretary of the American Legation at Havana, was appointed July 31 Secretary of the legation and consul-general at Bangkok, Siam.

Norvil Richardson was appointed by President Taft to this position early in August. Mr. Richardson is from Atlanta, Ga., and known in the literary world.

THE PRESS OF THE UNITED STATES.

Government Must Be Stable.

There is a deep-rooted fear in Cuba that sooner or later the United States will annex the island even against its will. This is an erroneous view of the desires of the American people and their government. Most Americans would prefer to see Cuba independent, as we are already sufficiently embarrassed with outlying possessions. At the same time this country is firmly committed to the support of a stable and orderly government in Cuba. Should the Cubans fail to maintain such a government, intervention will again become necessary and a third intervention would be pretty sure to result in permanent annexation.

The South in general, and Louisiana in particular would not welcome the annexation of Cuba, as it would add an alien population to our citizenship, as well as a horde of additional negroes, of whom we have a superabundance already. The opening of American markets to Cuban products would, moreover, be prejudicial to Louisiana's best interests.—New Orleans (La.) Picayune.

Cuba Should Be Left Alone.

If left alone there is every reason to believe that Cuba will work out her own salvation. Why then all this grief over Cuban affairs, all this solemn preaching, all these threats? If we desire to annex Cuba, let us at least do it in open robber-like fashion, not under a solemn cloak of righteous pretense.

Ever since President Gomez took charge a multitude of American newspapers have been unctuously declaring that "we would only intervene in Cuba when forced to do so." When two or three rural guards deserted down there, these excellent journals saw a revolution which was only to be suppressed by an American army. The establishment of a lottery was hailed as a safe precursor of intervention. Every wrangle in the Cuban Congress has convinced them that Cuba is only to be saved from the bow-wows by the Stars and Stripes. The minute Cuba applied for a loan it heralds the "bankruptcy of the government" and suggests an American army as the



UNCLE SAM:—"Was it for this that we poured out all our blood and treasure in the Spanish War."—The Judge, New York.

Esta caricatura es tomada del "Judge," de la ciudad de Nueva York. El Tío Samuel está observando cómo el presidente Gómez pone su firma á la nueva ley legalizando las peleas de gallos y la lotería, á lo cual dice el Tío Samuel: "Y para esto derramamos nuestra sangre y gastamos nuestro dinero en la guerra con España?" En el crespón que rodea su brazo se leen las palabras: "Acuérdese del Ma'ne." En la mano izquierda lleva un cartel que dice: "Costo de la guerra Hispanoamericana, \$50,000,000, á más de los muertos, sufrimientos y privaciones."

THE PRESS OF THE UNITED STATES.

one salvation, and every pious moan over the condition of the island begins with a wish that she would do better and ends with a threat that we'll stay the next time we go down there.—Newark (N. J.) News.

A Protectorate Best.

In the event of another intervention by the United States, Mr. H. A. Austin, who was an official in Cuba during the American occupation, declares in a recent issue of the North American Review that a protectorate by the United States would be most acceptable to the Cubans themselves, and less injurious to our own domestic interests.

He holds that in the administration of their Government there are three conditions which the Cubans desire to prevail: First, security from foreign invasion or interference; second, a force adequate to suppress interior disturbances, and, third, opportunity to hold a reasonable share of the public offices under an independent government. They believe that these ends can be accomplished with least difficulty through an American protectorate, and this scheme would undoubtedly meet the hearty approval of the Cubans at large. In Cuba it is discussed more than any other proposition, for it would not injure the pride of the people, it would allow them to hold office under the Government, it would assure peaceful conditions on the island and prevent encroachment or invasion by any other foreign nation. By this means, also, the tariff question could be allowed to remain *in statu quo*, and thus any opposition could be allayed that would otherwise arise from the sugar, tobacco, fruit and other interests in this country.

Undeterred by the prospect of a deficit and not having the fear of the Platt amendment before his eyes, President Gomez is arranging such an extension of the Cuban diplomatic service as will provide a number of nice, fat, juicy offices for some of the clamorous claimants to whom he is politically indebted. There is an old proverb which tells us where the beggar will ride if set on horseback. The Cuban politicians appear to be headed in that direction.—Phila. (Pa.) Inquirer.

Certainly if the United States cannot steady Cuba a little nation with less than 3,000,000 people, it would seem that there must be something lacking in our statesmanship.—Boston (Mass.) Transcript.

This country rendered Cuba a great service when it assured the island independence of Spain, cleaned up its harbors and showed its people how to live under sanitary conditions.—Manchester (N. H.) Union.

Was It a Blunder?

There is a question whether the last intervention in Cuba, supervised by Mr. Taft, was not a blunder—not as an intervention, but in its political operation. The Palma government, whatever its faults, was our government—suggested, sanctioned and set up in business by the United States. Yet it was permitted and even encouraged to fall, on the apparent assumption that the "majority" were against it, and ought to rule.

Cuba was ours by right of conquest. It was our lawful prize of war. Instead of taking what belonged to us, and all that belongs to us, we paltered and shirked.

We could not quite cut Cuba adrift altogether. Geographic facts made that impossible. But we pretended to set Cuba up in business as an "independent republic." We could not with all our power make Cuba really "independent." All we could do was to make a pretense.

Cuba cannot be really "independent" because of the character of her people and because of her economic situation. Her people, as a whole, have no real conception of what the rule of a democratic majority means or how to work its machinery. And Cuba would starve into anarchy within a year without fiscal favor from some great nation needing her chief product.

Let us hope that the next requirement of intervention in Cuba will find the government at Washington ready to quit playing the universal benefactor and ready to deal with Cuba in accordance with the facts.

Paper constitutions and grandmotherly advice do not make nations. And shirking a responsibility does not solve a problem.—Chicago Inter-Ocean.

Influences are at work to bring the annexation of the island forward in a more indirect manner than by government intervention. The people of Cuba do not want it; the people of the United States do not want it, but a class in both countries sees its own purposes furthered by such a step. What cannot be done by government or popular consent may be done by economic forces. It will not be long before we shall see whether the fruit it ready to be picked.—Macon (Ga.) Telegraph.

The best policy to pursue is to leave Cuba alone. She will come into the Union of her own accord.—Memphis (Tenn.) Commercial Appeal.

LO QUE DICE DE CUBA LA PRENSA AMERICANA.

A Cuba debería dejársele que se gobierne por sí sola.

Si á Cuba se le dejase gobernarse á sí misma, hay motivos para creer que saldría adelante. Por que, pues, el preocuparse tanto sobre los asuntos de Cuba, y el dar tantos consejos y lanzar tales amenazas? Si deseamos anexar á Cuba, hagámoslo al menos abiertamente, como el ladrón se apodera de su presa, pero no á la encubierta.

Aun desde que el nuevo Presidente Gómez se hizo cargo de las riendas del gobierno gran numero de periódicos norteamericanos han estado declarando mansamente que "debiéramos intervenir en los asuntos de Cuba solamente cuando nos viéramos obligados á ello." Cuando dos ó tres guardías rurales desertaron de sus filas en ese país de las Antillas, estos mismos periódicos vieron en ello una revolución que sólo podía sofocarse por medio de un ejército de tropas norteamericanas. El establecimiento de una lotería en la Isla fué aclamado como un seguro presagio de intervención. Todo altercado en el Congreso cubano les ha convencido de que Cuba sólo puede salvarse del cataclismo por medio del pabellón de las Barras y las Estrellas. En el momento que Cuba acude á un empréstito, augura la "bancarrota del gobierno" y sugiere un ejército norteamericano como el único recurso de salvación, y empiezan á oírse de nuevo los lamentos plañideros respecto al estado de esa Isla, con los plausibles deseos de que debiera obrar de mejor manera, terminando con la amenaza de que le próxima vez que vayamos allí será para no salir jamás.—Newark (N. J.) News.

El gobierno debe ser estable.

En Cuba se abriga el temor arraigado de que más tarde ó más temprano los Estados Unidos se anéxaran la Isla aun contra su voluntad. Esta es una idea errónea respecto á los deseos del pueblo norteamericano y su gobierno. La mayoría de las masas en este país preferiría ver á Cuba independiente, pues ya estamos bastante agobiados con nuestras diseminadas posesiones. Al mismo tiempo, este país está solemnemente comprometido á prestar su apoyo á un gobierno estable y de orden en Cuba. Pero si los cubanos dejasen de sostener tal clase de gobierno, entonces la intervención sería necesaria una vez más, y una intervención por tercera vez con seguridad daría por resultado la anexión permanente.

A los Estados del Sur en general, y á la Luisiana en particular, no les agrada la anexión de Cuba, pues ese paso significaría la ciudadanía de una población de procedencia extranjera á nuestras filas, así como el aumento de una turba de gente color afiliada á nuestra bandera, de la cual ya tenemos en abundancia.—New Orleans (La.) Picayune.

Fué un error despues de todo?

Cabe la duda de si la última intervención del gobierno de los Estados Unidos en los asuntos de Cuba, sancionada por el Presidente Taft, fué después de todo un error é no lo fué—no precisamente bajo el punto de vista de la intervención, sino como cuestión de política. El gobierno del expresidente Estrada Palma, cualesquiera que hubieran sido sus faltas, era un gobierno obra nuestra—sugerido, sancionado y planteado por los Estados Unidos. Y sin embargo, se permitió y aun se contribuyó moralmente para que viniera abajo, en las suposición aparente de que la "mayoría" estaba opuesta á él, y que por lo tanto debían prevalecer los deseos de esa mayoría.

Cuba es nuestra por derecho de conquista; era nuestro legítimo botín de guerra. En vez de apropiarnos lo que nos pertenecía, en todo y para todo, sin embargo titubeamos y evadimos la responsabilidad de tal acto.

No podíamos dejar á Cuba enteramente lanzada á la ventura; su posición geográfica respecto á este país hacía que eso fuera un imposible. Pero en cambio pretendimos que Cuba se gobernase bajo la capa de una "república independiente."

Cuba no puede ser realmente "independiente" á causa del carácter de los cubanos y á causa de su situación económica. El cubano, por regla general, no tiene idea de lo que significa la verdadera acepción de gobernarse por medio de una mayoría de principios democráticos ni sabe cómo llevar á cabo tal sistema de gobierno. Y Cuba se sumiría en la anarquía en el plazo de un año ó aun en menos tiempo si no llegase á contar con la ayuda financiera de alguna gran nación que necesite sus principales productos.—Chicago Inter-Ocean.



A Scene in Santiago. A pack train at rest near the old Cathedral.
 Una vista en Santiago; mulos de cargo descansándose cerca al viejo Catedral.
 (Courtesy the Publicity League of Cuba.)

Injurious Cheap Drinks.

In Havana there are any number of cheap "gasiosas" and so-called refrescos on the market which are sold at the grocery stores for 2 and 3 cents a bottle, and I understand that the factories sell their products for as low as 30 cents a case of twenty-four bottles. From the very nature of things a pure soda-water cannot be put up and sold at a profit for 30 cents a case. Hence the need of inspection of these "gasiosas" and soda-waters, which inspection would probably result in showing a great many of them to be unhealthy and injurious.
 —W. B. Goodrich in the Havana Post.

For Bravery in Action.

Among the officers awarded medals of honor for gallant conduct in action in various places was First Lieutenant James Robb Church, assistant surgeon, First United States Volunteers Cavalry (now major, Medical Corps), at Las Guasimas, Cuba, June 24, 1898. In addition to performing gallantly the duties pertaining to his position, voluntarily and unaided he carried several seriously wounded men from the firing line, to a secure position in the rear, in each instance being subjected to a very heavy fire and great exposure and danger.

Clean Vaudeville Profitable.

George B. Greenwood, manager of the Empire Theatrical Exchange, said in Havana recently to a Post representative that he believed Cuba to be a wonderfully lucrative field for first-class vaudeville, run on American ideas. Good, clean, honest vaudeville presented in the right way would be appreciated by Cubans after the questionable moving pictures presented in the island for the last two years.

For a Jewish Cemetery.

The Jewesses of Cuba are endeavoring to acquire consecrated ground for Jewish burial, says the Portland, Oregon, Jewish Tribune. Because the Jewish community is small and the people of small means, the ladies in the island are appealing to the Jews of the United States for aid. Up to now they have been dependent upon the generosity of the Catholic community to use their ground. The hope for the cemetery is that the bones of the dead Jewish soldiers and sailors scattered through Cuba, and especially those who died on the Maine, shall be reinterred in hallowed grounds. The office of the United Hebrew Congregations of Cuba is at 6 San Rafael street, Havana.

RAILROAD REPORTS AND TRAFFIC RECEIPTS.

United Railways of Havana.

| | —Weekly Receipts— | | —From July 1— | |
|----------------------------------|-------------------|----------|---------------|----------|
| | 1909. | 1908. | 1909. | 1908. |
| Week ending July 31 | £ 13,915 | £ 10,877 | £ 63,252 | £ 54,427 |
| Aug. 7 | 14,517 | 12,089 | 77,769 | 66,516 |
| " 14 | 14,200 | 12,047 | 91,970 | 78,563 |
| " 21 | 14,725 | 11,643 | 106,695 | 90,206 |

United Railways Improvements.

The company plans to electrify its Marianao line, permitting of a more frequent schedule.

As already noted in the CUBA REVIEW, the new modern ferry house at Luz wharf, Havana, is in course of construction and will be finished about November next. New stations at a cost of \$8,000 each are being built at Alacranes and Duara, and the new workshop at Cienaga, illustrated in the July issue, is in full operation. Outside of Havana the company is also making improve-

ments which include a new station at Cienfuegos and 20 miles of new track near that city. All this work will be completed by the end of the current year.

Owing to floods the track between Jovellanos and Quintana were submerged last year for a period of six months. The government is expected to drain this section and prevent the floods, but because of delays in beginning the work the railroad company is building a short connecting section of track above the flood level.

Havana Electric Railway Co.

| | —Weekly Receipts.— | | —From Jan. 1— | |
|---------------------------------|--------------------|----------|---------------|-------------|
| | 1909. | 1908. | 1909. | 1908. |
| Week ending Aug. 1 | \$39,825 | \$34,870 | \$1,195,093 | \$1,122,332 |
| " 8 | 41,309 | 36,178 | 1,236,402 | 1,158,510 |
| " 15 | 40,583 | 36,147 | 1,276,985 | 1,194,657 |
| " 22 | 39,458 | 35,380 | 1,316,122 | 1,230,037 |
| " 29 | 35,680 | 32,485 | 1,352,123 | 1,262,522 |

Havana Electric Railway Changes.

This company is at present straightening and grading their tracks and paving the roadway in the vicinity of the Jesus del Monte station, Linea street in Vedado, Calzada del Cerro in Cerro, the Marianao line and the Vives section.

The car shops in Vedado are kept busy turning out three cars a month, besides repairing the old ones. Last month the company moved their offices into the new fireproof structure in Vedado.

The company is now engaged in building a station and waiting room at the Vedado end of the Marianao line.

Western Railways of Havana.

| | Weekly Receipts. | | Receipts for Fiscal Year. | |
|---------------------------------|------------------|---------|---------------------------|----------|
| | 1909. | 1908. | 1909. | 1908. |
| Week ending Aug. 7 | £ 4,983 | £ 6,301 | £ 25,902 | £ 31,531 |
| " 14 | 4,834 | 6,368 | 30,736 | 37,899 |
| " 21 | 5,416 | 6,608 | 36,152 | 44,507 |

Western Railway's Extensions.

The Western Railways of Havana, operating at present 236 kilometers of track in Cuba, has built a shop at Cristina for manufacturing and repairing its rolling stock. It will also build in the locality a new locomotive repair shop. In

case of favorable action by the government in the matter of a subsidy the company expects to build a 47-kilometer extension from Medosa to Remates, in the extreme southwestern section of Pinar del Rio Province. The new railroad stations at Cañas and Calabagar are nearing completion.

Cuban Central Railway.

| | Weekly Receipts. | | Receipts for Fiscal Year. | |
|---------------------------------|------------------|---------|---------------------------|----------|
| | 1909. | 1908. | 1909. | 1908. |
| Week ending Aug. 7 | £ 5,480 | £ 4,882 | £ 29,067 | £ 25,256 |
| " 14 | 5,283 | 4,506 | 34,350 | 29,761 |
| " 21 | 5,055 | 4,612 | 39,405 | 34,373 |

THE TREASURY OF CUBA.

Official Report of the Secretary of the Treasury, Showing Condition July 31, 1909.

ASSETS.

| | |
|---|----------------|
| General Treasury: | |
| Cash on hand | \$350,820.32 |
| Deposited with the National Bank of Cuba..... | 176,662.28 |
| Deposited with the Royal Bank of Canada..... | 280,000.00 |
| | \$807,482.60 |
| Collections: | |
| Efectivo en su poder | \$108,829.54 |
| Public Taxes: | |
| Balance against this account..... | 8,875,488.40 |
| | \$9,791,800.54 |

LIABILITIES.

| | |
|---|----------------|
| Advance orders in transit | \$680,679.48 |
| Postal money orders | 280,365.75 |
| Debts pending | 19,995.93 |
| Honorary consuls | 1,208.00 |
| Taxes on the loans | 788,683.72 |
| On deposit for the loan 1st 50%..... | 280,169.92 |
| Balance due to the Army of Liberation, 2d half..... | 363,462.32 |
| Epidemic diseases | 38,593.52 |
| Individual contracts | 82,967.74 |
| Special Laws of 1906 | 1,443,337.66 |
| Special Laws of 1909 | 962,538.40 |
| Decree of the Provisional Governor | 3,434,736.60 |
| Maintenance of detained immigrants | 1,380.83 |
| Sewering and paving of the City of Havana..... | 1,413,680.67 |
| | \$9,791,800.54 |

Havana Electric Light & Gas Co.

The board of directors of the Electric Light & Gas Co. of Havana recently declared a dividend of \$3 per share, American money, to stockholders of date of July 31, which was payable at the office of the company after August 16. The company is greatly increasing its equipment and facilities.

It is laying large gas mains with connecting pipes and also electric cables throughout Jesus del Monte and Cerro, suburbs of Havana. When these mains are laid all sections will have up-to-date gas and electric service.

The company is also enlarging and remodeling their electric light and gas plants.

The New Cuban Bonds.

The new Cuban external bond issue is for \$16,500,000, and \$5,500,000 of the bonds are to be issued forthwith and the balance within two years. It is understood that the price paid by the successful bidders was 88½%. As the bonds, like the preceding \$35,000,000 of Cuban 5 per cents., are put out with the approval of the United States government, in accordance with the terms of the

so-called Platt amendment, it is presumed that when offered to the public they will be readily absorbed by investors.—Bradstreet's, N. Y.

Now that the Cuban loan has been awarded to Speyer & Co. bond brokers are expecting an active demand for them, owing to the unique feature attaching to the bonds. They will be issued by authority and under the decree of Governor Magoon, the provisional governor appointed by the United States government, and therefore there can be no question as to their standing. It will be recalled that Cuba cannot create any bonded debt without, under the Platt amendment, getting the consent of the United States government thereto, but in this issue the bonds were directly authorized by the United States government, acting through its appointee, the governor-general of Cuba.

The custom receipts of the last few years have averaged about \$23,000,000 annually, which is not taking into account the special taxes which have been amounting to nearly \$3,500,000 annually since they were created as a special revenue applicable to the service of the \$35,000,000 loan which the Republic of Cuba also placed with the Speyers some few years ago.—Wall Street Journal.

FINANCIAL AND COMMERCIAL MATTERS.

Santiago's Business.

"Santiago, Cuba, has made much improvement since the time the American army occupied the city," said R. E. Holaday, American consul at Santiago, in an interview printed in the Washington Post. "In 1898 Santiago had a population of 47,000; to-day there are upward of 56,000 there. There have been great improvements in the sanitation of the city. We have no yellow fever, and haven't had for a long time. The streets have been improved, and we have electric tramways running through all the principal thoroughfares and into the suburbs. There are several first-class hotels, and one can live as comfortably there as he can in the States.

"Cuba, of course, is essentially an agricultural country, and Santiago is largely the distributing point of imports and the shipping point for exports. It hasn't any big industries of its own. There are some cigar factories and a few chocolate manufacturers, who make sweets for local consumption. The American imports have increased as much as, if not more, than the imports from other countries, but the manufacturers of this country have been handicapped somewhat by the fact that the large importing houses are controlled by Spaniards, and they are slow to break away from their old customs.

"Then, too, the firms with which they deal are not overanxious to change. Another handicap on goods from the United States is that European firms are ready to extend all sorts of credit to their customers, so long as they know the latter are good, while the American manufacturer will not sell on more than 30 to 60 days' credit. However, American trade is making progress, and in time will surpass that of all other nations, no doubt."

The Camaguey Company, Limited.

The comparative statement of earnings for July, 1909, is as follows:

| Traffic Receipts. | | |
|-------------------------------------|-------------|-------------|
| | July, 1908. | July, 1909. |
| Gross | \$10,426.82 | \$11,445.48 |
| Net | 4,276.56 | 5,343.18 |
| Receipts from January 1 to July 31. | | |
| | 1908. | 1909. |
| Gross | \$63,944.40 | \$76,084.67 |
| Net | 30,256.02 | 35,233.55 |

Santiago Traction Bonds.

The Spanish Bank of the Island of Cuba, says the Post, has closed the deal whereby that institution has favorably placed a large block of bonds of the Santiago Traction and Electric Street Railway of Santiago with New York bankers.

These bonds had been held by the Spanish bank for some time, as the result of a proposition to finance the Electric Street Railway Company, and the sale of the bonds is considered an important transaction. The sale price is said to have been 92½. As a result the Spanish bank will receive the sum of \$1,500,000.

Quoting in round millions from the figures compiled by the U. S. Bureau of Statistics, our commerce with Cuba in the fiscal year ending June 30 was as follows:

| Exports. | Imports. | Total Commerce. |
|--------------|--------------|-----------------|
| \$44,000,000 | \$96,000,000 | \$140,000,000 |

The exports of locomotives by the United States to Cuba for the same period are as follows:

| | Number. | Value. |
|----------------|---------|-----------|
| 1909 | 23 | \$149,090 |
| 1908 | 59 | 594,198 |

CUBAN CUSTOM HOUSE COLLECTIONS

The collections at the Custom Houses of Cuba during the six months of 1909 ended June 30, are as follows:

| | | | |
|---------------------------|----------------|------------------------|--------------------|
| Havana | \$8,067,029.81 | Manzanillo | \$184,823.94 |
| Matanzas | 414,266.27 | Santa Cruz | 3,079.80 |
| Cardenas | 204,752.56 | Tunas | 12,874.16 |
| Sagua La Grande | 118,885.07 | Trinidad | 345.01 |
| Caibarien | 231,476.30 | Cienfuegos | 794,482.90 |
| Nuevitas | 60,145.36 | Batabano | 855.00 |
| Gibara | 57,909.51 | Nueva Gerona | 2,054.38 |
| Banes | 25,651.09 | Puerto Padre | 37,116.82 |
| Baracoa | 5,250.82 | Nipe | 255,498.35 |
| Guantanamo | 111,538.33 | Jaruco | 693.10 |
| Santiago | 792,894.70 | | |
| | | Total | \$1,178,257,386.00 |

FINANCIAL AND COMMERCIAL MATTERS.

Cuba Railroad Annual Report.

In the Cuba Railroad report for the past year ended June 30, 1909, the surplus is shown to be \$550,799, equal to 5.50 per cent. on \$10,000,000 preferred stock, as compared with 3.55 per cent. last year.

President Van Horne said that "Good crops and the settlement of political conditions had resulted in a revival of business in Cuba during the last half of the year and increased railway earnings. The ratio of working expenses to gross earnings was 55.95 per cent., as compared with 64.63 per cent. the previous year. The working expenses include \$96,000 for extraordinary replacements not pertaining to the business of the year.

"The coming sugar crop promises to be an exceptionally large one and the tobacco crop has already become an important source of earnings. New traffic is developing on all sections, and the coming year should afford gratifying results."

The income account for the year ended June 30, 1909, follows:

| | | |
|-------------------------|-------------|-------------|
| Gross.. | \$2,157,165 | \$2,039,468 |
| Expenses.. | 1,207,076 | 1,318,180 |
| Net.. | \$950,089 | \$721,288 |
| Charges.. | 399,290 | 365,863 |
| Surplus | 550,799 | \$355,425 |
| Previous surplus ... | 1,093,287 | 698,031 |
| Total surplus. | \$1,644,085 | \$1,053,456 |
| Mail earn. adj. | | 39,830 |
| P. & L. surplus.. | \$1,644,085 | \$1,093,286 |

Cuban Bonds Oversubscribed.

Speyer Bros. stated at London on September 8 that the subscriptions to the \$5,500,000 Republic of Cuba 4½ per cent. gold loan had reached a total of \$20,000,000, and had attained a premium of 3 per cent. Speyer & Co., of New York, also announced that the subscription lists

for the \$5,500,000 bonds had been closed after having been many times oversubscribed.

Cuba's exportation of tobacco from January 1 to July 31, 1909, and the total for the same period in 1908 is as follows:

| Countries. | Bales. | Cigars. | Cigarettes. |
|--------------------|---------|------------|-------------|
| United States.... | 173,908 | 77,349,603 | 742,054 |
| N. of Europe.... | 789 | 1,088,200 | 1,500 |
| France | 1,209 | 8,578,400 | 37,480 |
| Spain | 1,793 | 4,424,491 | 268,207 |
| Mexico | 4 | 169,870 | 612,820 |
| Other countries... | 119 | 840,400 | 4,529,175 |
| Total, 1909.... | 177,822 | 92,450,964 | 6,191,236 |
| Total, 1908.... | 135,059 | 91,815,151 | 7,375,873 |

Cuba Eastern Railroad.

Henry Melville, special commissioner appointed under the decree of foreclosure and sale in the suit brought in the United State Circuit Court by Frank Glebbill and other stockholders against the Eastern Railroad of Cuba, filed his report on Sept. 1 of the sale of the property of the defendant corporation.

The property was sold at public auction to I. McD. Garfield and Chauncey Anderson for the sum of \$25,000.

Prior to the sale, the purchasers, in compliance with the decree of the court, deposited with Commissioner Melville first mortgage bonds of the Eastern Railroad of Cuba, amounting to \$500,000 par value. A mortgage on the property was held by the Knickerbocker Trust Co.

Cuba's First Mortgages.

First mortgages in Havana and the surrounding country, as well as the interior cities and plantations, show considerable activity. City mortgages on good security with good title are paying 8 to 10 per cent. per annum. Country mortgages on tobacco lands and cane lands in nearly all the provinces pay from 12 to 18 per cent. per annum, with one-third valuation on the property and the title unquestioned.

QUOTATIONS FOR CUBAN SECURITIES.

Supplied by LAWRENCE TURNURE & CO., New York City, Sept. 3, 1909.

| | Bid. | Asked. |
|---|------|--------|
| *Republic of Cuba 5 per cent. bonds..... | 103 | 104 |
| Republic of Cuba 6 per cent. bonds | 98 | ... |
| Republic of Cuba 5 per cent. new bonds (interior loan) | 95½ | 96 |
| Havana City first mortgage 6 per cent. bonds | 106 | 108 |
| Havana City second mortgage 6 per cent. bonds | 105 | 107 |
| Cuba Railroad first mortgage 5 per cent. bonds | 98 | 100 |
| Cuba Railroad preferred stock | 65 | none |
| Cuba Company 6 per cent. debentures | 85 | 95 |
| Havana Electric consolidated mortgage 5 per cent. bonds | 91 | 92 |
| Havana Electric preferred stock | 87 | 90 |
| Havana Electric common stock | 68½ | 71½ |
| Matanzas City Market Place 8 per cent. bonds ctsf..... | 103 | 104 |

* All prices of bonds quoted on an "and interest" basis.

TOBACCO INDUSTRY.

Cigar Manufacturers Against Annexation.

Rafael M. Ybor, the Cuban consul at Tampa, Fla., in a recent interview, had the following to say regarding the feeling in Cuba among the cigar manufacturers concerning annexation:

"I want to be quoted that there is absolutely nothing to it, nor have any manufacturers ever intimated that they favored annexation. They want Cuba a free and independent country. They have all the confidence in the government and the stability of the country. The fact that there is a duty of \$5 a pound gross on all leaf tobacco imported into Cuba is sufficient to show that annexation is not desired. That \$5 is so much protection to the native growers which would be absorbed by the United States in the event of annexation."

As to the cigar situation in Havana, he stated that the 1909 output would exceed the output of last year. There has

been a decrease in the production of cigars the past two years caused by high duties in some countries where Cuban cigars are consumed, and by the panic in America, as well as by the strike troubles at home.

The number of cigars made at Havana for the past five years was stated as follows: 1904, 401,861,082; 1905, 441,544,496; 1906, 452,865,529; 1907, 364,400,997; 1908, 337,012,184.

He said that there are 150 factories now running, and that they are all housed in substantial buildings, many of which cost over one million dollars.

The cigars made in Cuba, he said, are all of high class and of best sizes, and practically none are made to sell for less than \$60 per thousand. The sizes run large, mainly from Victorias up.

He said that the Havana manufacturers are satisfied with the market and that as the season advances there will be greater activity about the factories.



View on the Luis Marx tobacco plantation at Alquízar, Province of Havana, where over 300 acres of tobacco are growing under cheesecloth. At the right is seen the side walls of one of the sections. The building is Mr. Marx's observatory and living apartments when he visits the plantation. His offices are on the ground floor.

Vista de una vega en Alquízar, Cuba, en la que hay más de 300 acres de terreno sembrados de tabaco, el cual está cubierto con estopilla. El edificio que se ve en el grabado es un observatorio y casa de vivienda del propietario, quien tiene su escritorio en el piso bajo.

BANANA ALCOHOL.

By René Guérin, Engineer-Chemist.

An abstract of an article in the Paris "Journal d'Agriculture Tropicale." Translated especially for THE CUBA REVIEW.

To be properly appreciated bananas must be offered for consumption at a suitable degree of ripeness. Therefore it is necessary to pick them green and let them ripen, at least partly, during the voyage to the market. But in spite of good care the loss through spoiled and rejected fruit is estimated at 20 per cent., according to information furnished by the Agricultural Society of Jamaica and which we have personally collected in Guatemala. In Jamaica alone this loss represents two million bunches.

In the face of this state of affairs producers have been trying to find some industrial use for this enormous quantity of fruit. They have tried drying and preserving, and they have cooked it with sugar and made flour of it, but experiments made in this direction in Costa Rica have been without results. It has been proved that these products cannot compete with figs. As to banana flour, the results have been nil up to date. It is useless to refer to its alimentary value, its great digestibility, etc. These have been discussed for a long time in various publications. The truth is the product does not please the public. We were very enthusiastic on this subject, and at the Exposition of 1900 we exhibited samples of banana flour which were awarded a gold medal by the International Jury. The manufacturers of the flour then begged us to find buyers, but in spite of all efforts the best offer received was 10 francs per 100 kilos at the French railway station.

In a report presented to the Colonial Society of Berlin, the conclusion was reached that the factories installed in India and Java were unable to continue producing the flour profitably. Dr. Greshof, director of the Colonial Museum of Haarlem, is of about the same opinion, and, finally, a factory installed in Costa Rica and two in Jamaica met with the same fate. It is possible that, after blending, a more acceptable product may be obtained, but the problem is not so much to increase the nutritive value of banana flour, which is acknowledged, but to make of it a food that will attract consumers.

Alcohol from Henequen.

In Yucatan more than ever devoted to the growing of henequen, experiments have been made from time to time to extract alcohol from the pulpy

Therefore it is necessary to seek for the banana not exported another outlet than those already referred to. At one time Mr. d'Hérelle, now chief of the experiment station at Yucatan, Merida, but then director of a distillery at Puerto Barrios, Guatemala, who was associated with me in the work of the Central Laboratory of Guatemala, studied a process of obtaining an alcohol for drinking. Experiments made in the laboratory with bananas which had been rejected, and were destined to be thrown into the sea or to rot on the beach, permitted us to obtain a good spirit, very much like whiskey. Samples sent to the St. Louis Exposition, that had only been in the barrel for six months, were recognized to be of superior quality. After analysis by the laboratory of the Department of Agriculture in Washington, the producers were awarded a gold medal. Alcohol ages so rapidly in tropical countries that one year in the barrel is sufficient to make the product very fine.

The question of aging is not less interesting. Corn whiskey must be kept in casks for several years before being offered for consumption, and at least five years to obtain the best qualities. Banana whiskey is ripe at the end of one year. We are sure that the samples submitted at the Exposition of St. Louis bore comparison with those that had not been less than ten years in casks.

After having demonstrated that it is possible to obtain by fermentation from banana juice a marketable product of good quality, it is in order to consider the cost of manufacture. It may be said that it is much less than that of ordinary whiskey. The yield may be estimated at 4½ liters per bunch of bananas. A memorandum of expenses made for a plant capable of producing 150 casks of whiskey daily aggregated 827,500 francs, which included buildings, machinery and apparatus; fuel, labor, administration, general expenses for two years; cases and bottles for the production of one year, and raw material for manufacture for two years (270,000 bunches at 75 centimes each).

residue of the plant after crushing the leaves. On one plantation satisfactory experiments resulted in the production of 34 barrels of alcohol, 40 grade, from each 100,000 leaves.

PROTECTION FROM LIGHTNING.

An Inexpensive System—Size of Wire Required—How to Place Wires and Rods—Proper Connections With the Earth—Wire Fence Protection.

(Condensed from Farmers' Bulletin No. 367, issued by the U. S. Department of Agriculture.)

A paper entitled *Lightning and Lightning Conductors*, by Alfred J. Henry, Professor of Meteorology, which suggests means of protection from destructive lightning strokes, has been published by the U. S. Department of Agriculture. His instructions, which follow, will enable anyone to erect comparatively inexpensive yet effective lightning conductors. The instructions are for a building on which there is neither cupola nor chimney, as is shown in figure 1.

The Materials Required

are No. 3 or No. 4 double galvanized iron telegraph wire, about one pound of galvanized iron staples, some connecting tees, and one pound of aluminum paint. While iron is not so good a conductor as copper it is less likely to cause dangerous side flashes, and it is cheaper.

Experiments by experts have tended to demonstrate that iron is in many situations a very useful material for lightning rods, as the effective energy of a flash of lightning is rapidly dissipated in iron, but the

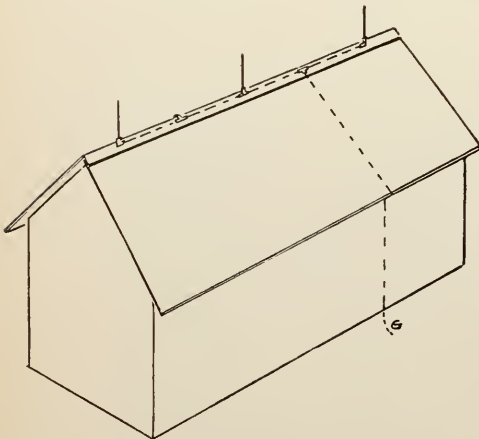

FIG. 1.—Method of placing lightning rods on a building having no cupola or chimney. Length of building, about 25 feet.

FIGURE 1.

La figura 1 muestra un edificio de 25 pies de largo protegido de las descargas eléctricas por medio de pararrayos. Para un edificio de esta clase, el alambre galvanizado No. 3 es suficiente; para un edificio de 50 pies de largo se requiere el alambre No. 4. En esta figura se muestra un alambre extendido á todo lo largo del tejado, con una inclinación de 20 pulgadas á cada lado, con otro alambre del mismo tamaño en el centro. Las conexiones, según se muestra, están colocadas á cada lado del tejado y los extremos entran en el terreno. Esta es la manera de colocar los alambres en un edificio sin cúpula ó chimenea.

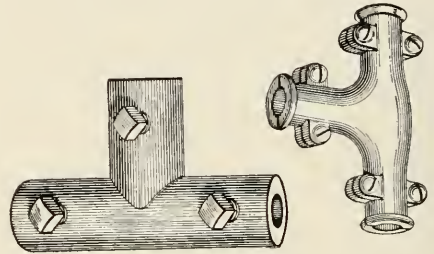

FIGURE 2.

La figura 2 muestra la clase de empalmes galvanizados que se usan para afianzar el alambre al edificio.

wire must be galvanized or even doubly galvanized. The ordinary telegraph wire has a diameter of about fifteen one-hundredths of an inch, it is often struck by lightning, yet it is seldom fused. It is probable that although a light iron wire may be melted it will have served its purpose before being destroyed. No. 3 wire is about twice the size of telegraph wire (No. 9), and the writer does not know of a case wherein that size has been fused by a lightning discharge, and therefore feels no hesitancy in recommending its use as a lightning conductor for isolated buildings of moderate height.

The T connections are shown in figure 2. They should be galvanized.

Directions for Putting Up Wires.

The conducting system is composed of a horizontal wire following the ridge of the roof, and two vertical wires connecting with the ground on both sides of the building. (See illustration No. 1.) The wires should be fastened to the building by galvanized iron staples about an inch long, or by means of small wooden blocks with screw eyes, 10 feet apart. The wire can be easily passed through these eyes from the ground to the top of the building.

The vertical rods should be connected to the horizontal wire by galvanized iron tees (figure 2). The necessary tees should be slipped on to the horizontal wire and placed at points of junction with the downward directed wires and also at points where it is wished to erect short terminal rods along the ridge of the roof.

Three terminals of rods are shown in figure 1, and these need not be more than 20 inches long. Make the end terminals a right angle bend in the wire which runs along the ridge of the roof at a distance of 20 inches from the respective ends. The

middle terminal is merely a wire 20 inches in length, held in place by a T connector. The terminals being short offer little resistance to the wind.

The end of the rods should be sharpened to a point and this point heavily painted to preserve it from rust. Rods should be erected every 18 or 20 feet along the ridge of the roof, but the number depends on the cupolas, chimneys or other points on the roof liable to be struck. These should be connected by a short terminal wire to the main conducting wire by a T. The method of running the horizontal wire around these points is shown in figure 3.

Earth Connections.

In making earth connections the essential thing is to reach permanently moist earth in the shortest distance from the roof wire. The building in figure 1 has ground connections on each side of the building. Two kinds of connections are suggested. One, the ground ends of the vertical wires should be coiled in a spiral having a diameter of about a foot. These spirals should be buried in moist earth under rain spouts or in line of the drip of the roof. This construction gives an unbroken run of wire from the ground to the roof of the building.

A second suggestion is to drive a galvanized water pipe, say an inch and a quarter in diameter, into the ground at the foot of the main conductors. Secure a cap for the top of the pipe and bore a hole through it and insert the wire into the iron pipe, filling it with powdered charcoal. The hole in the cap should be large enough to allow water to pass down into the interior of the pipe.

In figure 1 there are but two ground connections, one on each side of the building. A larger building means more vertical wires and more ground connections. A building 56 feet long should have at least two conductors on each side of the building.

Buildings With Metallic Roofs.

A metallic roof properly connected to the earth affords a reasonably good protection. When frame buildings with tin roofs prevail there is little destruction by lightning for the down rain spouts conduct the electrical discharge to the earth. If an isolated building care should be taken to see that the down rain spouts are surely connected with the ground. It will not do to stop them within a few inches of the ground. The vital points of the connection always to be remembered are to reach permanently moist earth and to secure a perfect metallic joint between the down spout and the earth conductor. If a wire is used it should be flattened out at the end and bolted and soldered to the rain spout. This form of joint should be kept well painted.

In the case of a building with a metal roof, but no spouts, run a wire conductor from each of the four corners of the roof to the earth, noting the precautions already described. If the building is small as in figure 1, use No. 4 wire. If the building is large enough to require two vertical wires on each side of the building, and a wire along the ridge of the roof, use No. 3 wire.

In figure 3 it will be noticed that the bend of the wire is gradual. Likewise in passing over the eaves of a building a goose-neck bend is preferred to a sharp one. The terminal wire for the chimney should be erected at the point shown in the drawing (figure 1).

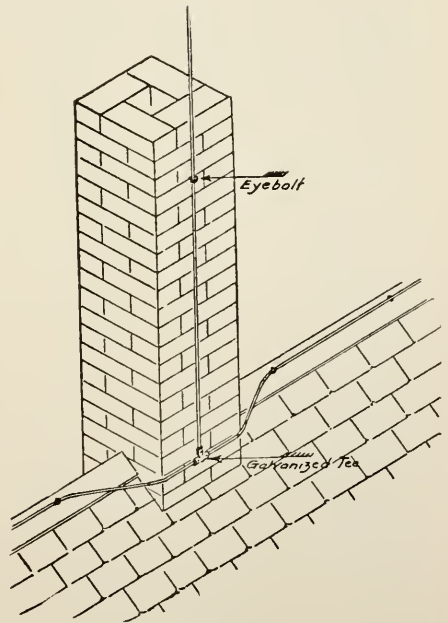

FIGURE 3.

La figura 3 muestra la manera de afianzar los alambres cuando hay en el edificio cúpulas, chimeneas ú otras proyecciones.

If the overhang of the roof is excessive a hole should be bored through it to let the wire pass close to the wall of the building.

If there are gas pipes in the building, keep the lightning conductors away from them as far as possible, but large masses of metal, such as water pipes, should be connected to the conductors. The water pipes should be in good connection with the ground.

Joints should be held together mechanically and should be frequently examined to see that they are not broken.

The whole system should receive two coats of aluminum paint and should be repainted every two years.

THE ISLE OF PINES.

The work of dredging Las Nuevas River from the sea to the proposed port of McKinley will begin very soon. In fact, the dredge which is to do the work has been purchased and is now being put into commission, and the Isle of Pines will soon have another harbor. According to estimates it will require about two months to dredge the bar and channel to a depth of nine feet, which will be deep enough to admit the entrance of any vessel now doing a coast-wise business on the island.

The Isle of Pines line of steamers with sailings on the first and fifteenth of each month, has been established from Mobile to the port of Nueva Gerona, in the Isle of Pines. Commencing with the first of November it is intended to have sailing three times a month.

Nueva Gerona is becoming quite a city. The building wave has struck the town and there are now in course of construction more than a dozen buildings and some of them very substantial stone and brick structures.

The Rev. J. P. McCullough, from Casper, Wyo., arrived at Nueva Gerona, on the Isle of Pines, with his family, with the intention of taking up work there which up to the present time has been conducted by the Archdeacon of Havana. He will probably make his residence at Santa Fe, where, it is expected that, in the autumn, he will open an academy for the more advanced children of the island. Boarding pupils will also be received. Mr. McCullough has brought with him an automobile, so that he can easily and quickly get about to the various stations on the island, which are some distance apart. Now that at last there is a resident priest on the island, the work there will be prosecuted with great vigor.—Living Church, Milwaukee, Wis.

The people of Santa Fe are advised by the Appeal to get together and build a good hotel. No mineral waters on the island are so well and favorably known as those of Santa Fe and the town could be made the mecca for the tourist.



City Hall, Nueva Gerona.

Casa del Ayuntamiento en Nueva Gerona, en la Isla de Pinos, Cuba. La cúpula y el reloj de este edificio fueron donativos de Don Benito Ortiz, Alcalde Mayor de la Isla, el cual dedica todo su sueldo á los mejoramientos de obras públicas. Este señor es también muy apreciado por los norteamericanos, que no dejan de alabar su tendencia en bien del público.

AGRICULTURAL MATTERS.



Turnip Patch at Herradura, the American Colony in Pinar del Rio Province.

Un campo de nabos en Herradura, en la Provincia de Pinar del Río. En este sitio se ha establecido una colonia americana bastante numerosa, la cual se dedica al cultivo del citrón y del tabaco, así como en cosechar hortalizas frescas para el mercado de Nueva York.

The Useful Goat.

Rank weeds, sunflowers, cocklebur and such have spoiled for cultivation millions of acres. The chaparral smothers all other vegetation in sections where originally prairies abounded for hundreds of miles and were kept clean by oft recurring prairie fires.

For all such the goat is found to be the savior. These lands would require from \$12 to \$20 to clear were men to do the work. The goat will do it for nothing. In fact, it will perform the task and in the meantime yield up abundant fleece, produce palatable goat "venison" and furnish a grade of milk that entirely outranks that of the cow.

The goat is to-day actually harnessed to the task of eating up oak brush fields in Iowa, broom sedge wastes in Virginia, cocklebur patches in Louisiana, sunflowers in Kansas, sagebrush in Nevada, lantana in Hawaii, chaparral and an unlimited miscellany everywhere.

It is the Angora goat, the aristocrat of all the tribe, that is doing the work. As they go about devouring they will continue to give up the fleece that makes

such dress goods as mohair, such commercially valuable material as the plush that covers the seats in all railway trains and such quaintly amusing articles as the wigs with which the members of the theatrical profession are wont to make sport.—N. Y. Tribune.

The brush-eating instinct of the Angora goat is being demonstrated on the Lassen National Forest in California, where they are cutting trails for fire guards through the brushy areas on the mountain slopes.

The goats have been divided into two bands of 1,500 each, and under care of herders are grazed on areas to be cleared. They have killed nearly all the brush in the course either by eating it entirely or by barking, as in the case of manzanita bushes.

Goats will just as readily attack manzanita as any other bushes where there is little else.

The goats did not begin until about the middle of June, but have made rapid progress. The trails will be kept free of sprouts by the goats, saving the government the labor of cutting them out by hand.

Ground Nuts in the West Indies.

Recognizing that ground nuts might possibly become a valuable source of profit to small holders and others in the West Indies, the Imperial Department of Agriculture has made several efforts to encourage their cultivation on a more extended scale in many of the islands. These efforts have included the introduction and trial of a number of new varieties of nuts from the United States, viz., "Spanish" and "Carolina Running." The "Spanish" is a very small nut, but one that in the United States is very popular, both among the growers and on the market. It grows well on poor soil, and takes but a comparatively short time to mature its produce. The plants are of an erect habit. "Carolina Running" is reported to be a prolific bearer in the States, and yields nuts of a fairly large size. Experiments with these two varieties resulted as follows:

At St. Lucia "Carolina Running" was the only variety which germinated well and produced a crop which was harvested on February 11, 1909. The yield was at the rate of 504 lbs. per acre. All the nuts were sown in July and were reaped toward the end of November.

At Monserrat the nuts were planted on June 26 and reaped in the last week of October. "Carolina Running" gave the highest return, which was at the rate of 889 lbs. per acre.

At Antigua "Carolina Running" yielded at the rate of 640 lbs.; "Spanish," 440 lbs.

At St. Kitt's in 1908 the "Carolina Running" nuts showed good germinating powder, and the ground was soon well covered by the vines. The nuts took from five to six months to mature, and gave a yield of nearly 1,500 lbs. per acre. Other varieties, the "Dixie Giant" and the "Tennessee Red" did not do well.—Barbados News.

Cuban Pineapples.

In a recent report Consul-General James L. Rodgers says in part as follows:

The market of the pineapple is exclusively in the United States, and the industry is the direct result of an American demand for the product. He finds that "it is not Cuban in the sense of ownership nor of cultivation, the participation of the natives being so small in both relations as to be practically inconsequential. The American market demanding a large and steady source of supply, American capital was invested with that of the Spanish growers, with the result that today nearly all the principal plantations are owned by



Interior of an American home at Herradura, Cuba.

Vista interior de una casa-vivienda americana en Cuba. El techo y las paredes están contruídos de listones, á veces de maderas naturales del país. Las lámparas, sillas, mesas, ruedas, etc., dan á la habitación una apariencia muy bonita.

Americans and Spanish and worked by them, using Cuban help at busy times."

The busy season usually runs from February to July, although shipments are made every month of the year. Total shipments for the year ended June 30, 1909, was 1,263,466 crates, of 80 pounds each.

Cultivating Lemons.

Mr. G. Harold Powell, Pomologist of the Bureau of Plant Industry of the United States, has published an interesting article on this subject in the Year-book of the Department of Agriculture, under the title "The Status of the American Lemon Industry." A condensed summary follows, conveying the salient features of the article:

"The industry supplies from one-third to two-fifths of the total number of lemons consumed in the United States. The remainder are supplied mainly from Sicily, with some from Cuba and the West Indies. The demand for lemons is steadily increasing all over America. The greatest demand occurs from May to September.

"Growers prefer a deep, loamy, well-drained, high piece of land, protected from high winds, and with the soil free from hard pan. The groves are irrigated once a month from April to October, sometimes less frequently.

"Fertilizers are applied to the tree at the rate of 1 pound per tree for each year it has been planted. Two applications are generally made, one in the autumn and one in the spring. Young trees are supplied with considerable quantities of nitrogen, but as they grow older the potash and phosphorus are



An American home at La Atalaya, Nuevitas Harbor, Cuba.

Vista de una morada americana en La Atalaya, dando frente á la habia de Nuevitas, en Cuba. Esta colonia se ha establecido en lo que era antes de la guerra un gran ingenio de azúcar. El nombre La Atalaya significa torre del vijia, y cerca de esta casa se hallaron los cimientos del edificio primitivo, desde el cual se espiaha la proximidad de los piratas.

increased. Large quantities of stable manure are also used.

"The trees are pruned in such a manner that a short, bushy growth is formed. The bottom branches are kept clear of the ground, as this prevents infection from the deadly 'brown rot' fungus, which is further prevented by the use of a cover crop, sown between the trees, since the fungus grows in the soil. It is further guarded against by using copper sulphate or potassium permanganate in the water in which the fruit is washed.

"In picking the fruit a ring 2 5-16 inches is used. All fruit which will pass through the ring is cut from the tree with shears and put into a canvas bag with which each picker is supplied. Smaller fruit which has ripened is also picked, together with the larger fruits which will not pass through the ring.

"The fruit is then cleaned from dust and 'black mold' by passing it between two cylindrical brushes in a tank full of water. It then comes on to a canvas or moving belt table, where it is sorted

by hand into three grades, dark-green or unripe, silver, green or partially mature, and yellow or tree-ripened. Great care is exercised in handling the fruit. Tree-ripened lemons are shipped at once but the others are packed carefully in standard boxes and stored in special curing houses. Here the degree of moisture and temperature is most carefully regulated by covering the boxes with tents that can be lowered or raised in such a way that there is as little change as possible. Great care and judgment are necessary here to prevent the fruit from withering, and to enable it to ripen well.

"In conclusion the following figures of expenditures and returns may be quoted. They are taken from a grove where very special care is exercised. The grove contains 20 acres and the total working expenses amounted to \$7,417.47, or \$370.87 per acre. The average returns for the last four years have been \$900 per car load, and this estate gave about 21 car loads. That is, the return was about \$18,900, or a net profit of \$11,482.53.

SUGAR REVIEW.

August Market Quiet—Stocks Decreasing and Prices Advancing—Good Prices Anticipated for the New Crop.

Specially written for The CUBA REVIEW by Willett & Gray of New York.

Our last review for this magazine was dated August 4, 1909, when quotations for Centrifugals, near by, were 4.05c. duty paid for 96 test, the equivalent of 2 11/16c. c. & f. for Cuba Sugars, and, when Javas were being sold to the United Kingdom at equal to 10s. 9d. c. & f. to New York, or, say, 4.06c. landed basis 96 test.

Throughout the month of August the market was quiet, with a strong undertone, stocks steadily decreasing, offerings very light and prices slowly advancing.

On the 11th, spot Centrifugals were sold at 4.08c. and Cubas for September clearance at 2 3/4c. c. & f. equal to 4.11c. landed. On the 18th some 90,000 bags Cubas for prompt and September shipments were sold at 2 3/4c. c. & t., equal 4.11c. landed. On the 23d an independent refinery paid 2 25/32c. c. & f. (4.14c. landed) for a small lot of near-by Cubas, but the next day a lot of Porto Rica Centrifugals sold at 4.11c., at which price the market remained steady without change until the close, when sales of Cubas for prompt shipment were put through at 2 25/32c. c. & f., equal to 4.14c. landed, with buyers willing to go on and with a strong tone to the market.

On the 6th two cargoes of Javas were reported sold to New York refiners, one shipped in July and the other for July-August shipment, each at 11s. c. & f., equal to 4.12c. landed basis 96 test; no further sales of Javas to American refiners are reported except that of a cargo which arrived at the Delaware Breakwater unsold and was finally accepted by New York refiners on private terms. Meanwhile further sales of Javas to the United Kingdom were put through at 11s. 1 1/2d. c. & f. to 11s. 6d. c. f. i., making a total of eight cargoes thus far this season taken by English buyers, or 52,000 tons, being an unusually large quantity and due to the fact that Javas, even at these prices, are relatively cheaper than European beet sugars for prompt delivery.

The exports from Java during June, July and August were much smaller than for the same time last year; the big Cuba crop is practically ended and all but about 75,000 tons has been absorbed by the United States, leaving stocks no larger than at the same time last year and little if any more sugar coming from Porto Rico this season.

The interesting question is, where will the necessary supplies be obtainable to tide over the intervening period from now until the new Cuba crop comes to market? Buyers are resisting the payment of a further advance as prices are now high, but there may possibly be a time during the next two or three months when the temporary scarcity of supplies will cause a moderately higher level of values.

On the 5th of August the new tariff bill was finally passed, leaving the duty on raw sugar from Cuba and foreign countries unchanged and reducing the duty on refined sugars .05c. per pound. The new tariff permits the admission of 300,000 tons Philippine Islands sugar free of duty each fiscal year.

Since the new tariff went into effect there were sold three sail cargoes of Philippine sugars, afloat, on private terms, understood to be around 3.40c. landed, basis 88 test, no duty, and one or two steamer cargoes for August-September shipment have also been placed.

European markets during August have been active and excited, with a squeezing of shorts and an advance on prompt beet from 10s. 8 1/4d. to 11s. 9 3/4d., and to-day September beet is quoted at 11s. 6 3/4d.; October beet, however, is now quoted at 10s. 4 1/2d., the parity of 4.19c. for Centrifugals at New York. The new European beet crop has recovered somewhat from its backwardness.

Thus far no sales are reported of European beet sugars for shipment to the United States, but it is just possible that some supplies may have to be drawn from Europe before the new Cuba crop campaign opens. There are still three centrals grinding the old crop of sugar cane in Cuba, and the visible production of sugar to date is 1,465,000 tons, making the largest crop on record; the growing crop is very promising and may considerably exceed the old crop.

Louisiana cane crop and the domestic beet crop reports continue to be favorable.

The indications are that good prices will be paid for the first new Cuba crop sugars.

New York, September 1, 1909.

CABLE ADDRESS: Turnure.

NEW YORK,
64-66 Wall Street.**LAWRENCE TURNURE & CO.****BANKERS**

Deposits and Accounts Current. Deposits of Securities, we taking charge of Collection and Remittance of Dividends and Interest. Purchase and Sale of Public and Industrial Securities. Purchase and Sale of Letters of Exchange. Collection of Drafts, Coupons, etc., for account of others. Drafts, Payments by Cable and Letters of Credit on Havana and other cities of Cuba; also on England, France, Spain, Mexico, Puerto Rico, Santo Domingo, Central and South America.

CORRESPONDENTS:

HAVANA—N. Gelats y Ca.
MEXICO—Banco Central Mexicano.

LONDON—The London Joint Stock Bank, Ltd.
PARIS—Heine et Cie.

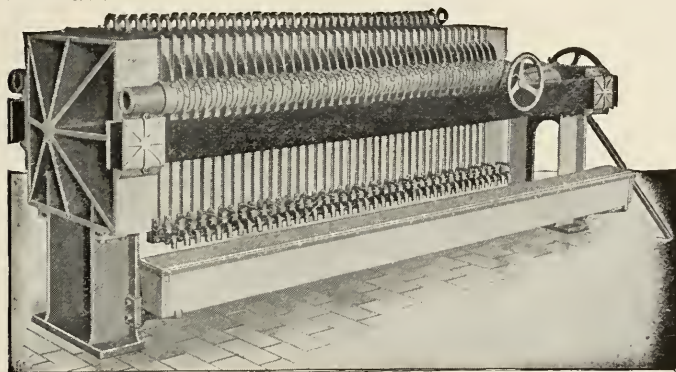

**Prensas de
Filtrar
para Ingenios**

SHRIVER
Filter Presses

Write us for Cata-
logue, Prices and
Information.

T. SHRIVER & CO.
814 Hamilton Street
HARRISON, N. J.

Sole Agents for Porto Rico
McMurtrie-Guiler Co.
SAN JUAN, P.R., and BEAVER BLDG.
BEAVER STREET, NEW YORK

CONVEYORS FOR SUGAR MILLS

RIBBON SCREW-CONVEYOR FOR MOIST SUGAR

WRITE TO US ABOUT CONVEYORS,
BAGASSE FEEDERS, CHAINS, WHEELS,
CLUTCHES, BUCKETS, BOOTS, ETC.

LINK-BELT COMPANY

299 Broadway, New York

REVISTA AZUCARERA.

Escrita expresamente para la CUBA REVIEW por Willett & Gray, de Nueva York.

Nuestra última revista para esta publicación estaba fechada 4 de Agosto de 1909, cotizándose entonces los azúcares centrífugas polarización 96° para pronta entrega, á 4.05 cents. incluidos los derechos, el equivalente de 2 11/16 cents., costo y flete, por azúcares de Cuba y, cuando el azúcar de Java se vendía Inglaterra á un precio igual á 10s. 9d., costo y flete entregado en Nueva York, ó sea 4.06 cents. la de polarización 96° puesta en el muelle.

Durante el mes de Agosto las cotizaciones estuvieron inactivas con grande tendencia al alza, debido á la constante disminución del azúcar almacenado, siendo muy pocas las ofertas y los precios subiendo poco á poco.

El día 11 se vendieron azúcares centrífugas para entrega inmediata á 4.08 cents. y azúcar de Cuba para entrega en Septiembre á 2 3/4 cents., costo y flete, equivalente á 4.11 cents. puesta en el muelle. El día 18 se vendieron unos 90,000 sacos de azúcar cubano para entrega inmediata y para embarque en Septiembre, á 2 3/4 cents., equivalente á 4.11 cents. puesta en el muelle. El día 23, una refinera independiente pagó 2 25/32 cents., costo y flete (4.14 cents. puesta en el muelle), por una pequeña partida de azúcar de Cuba para pronta entrega, pero al día siguiente se vendió una partida de centrífuga de Puerto Rico á 4.11 cents., á cuyo precio se mantuvo la cotización sin cambiar hasta cerca de fines del mes, cuando se hicieron ventas de azúcar cubano para embarque inmediato, á 2 25/32 cents., costo y flete, equivalente á 4.14 cents., siendo muy activa la demanda y muy marcada la tendencia al alza en los precios.

El día 6 se anunció la venta de dos cargamentos de azúcar de Java á refinadores de Nueva York, uno de dichos cargamentos embarcado en Julio y el otro para su embarque en Julio ó en Agosto, ambos á 11s., costo y flete, equivalente á 4.12 cents. la de polarización 96° puesta en el muelle. No se anunciaron otras ventas de azúcares de Java á refinadores americanos, con la excepción de un cargamento que llegó al Delaware Breakwater sin venderse y que fué al fin aceptado por refinadores de Nueva York á precios reservados. En el entretanto, se hicieron nuevas ventas á Inglaterra de azúcares de Java que se cotizaron de 11s. 1 1/2d., costo y flete, á 11s. 6d., costo, flete y seguro, haciendo un total de ocho cargamentos en lo que va de zafra comprados por comerciantes ingleses ó sean 52,000 toneladas, que es una cantidad extraordinariamente grande, obedeciendo esas ventas al hecho de que los azúcares de Java, aun á esos precios, son relativamente más baratos que los azúcares de remolacha europeos para entrega inmediata.

Los exportados de Java durante los meses de Junio, Julio y Agosto, fué mucho menor este año que lo fué el año anterior en los mismos meses. La grande zafra de Cuba puede considerarse terminada, de la cual los Estados Unidos ha comprado todo el azúcar con la excepción de unas 75,000 toneladas, dejando en almacén existencias que no son mayores que lo fueron el año pasado en esta época, esperando muy poco más ó ningún azúcar de Puerto Rico esta zafra.

Y ahora surge esta importante cuestión: De dónde se obtendrá el necesario abasto de azúcar para suplir la demanda durante el período que ha de transcurrir desde ahora hasta que el azúcar de la nueva zafra de Cuba llegue á esta plaza? Los compradores se resisten á pagar un nuevo aumento en los precios, los cuales son ya altos, pero es posible que durante los dos ó tres meses venideros ocurra una escasez transitoria de abasto que ocasione una pequeña subida en los precios.

El día 5 de Agosto se aprobó finalmente el nuevo Arancel de Aduanas, en el cual los derechos que pagan los azúcares mascabados de Cuba y otros países extranjeros quedan como estaban antes, y los derechos sobre los azúcares refinados se reducen .05 cents. en libra. El nuevo Arancel permite la entrada libre de derechos á 300,000 toneladas de azúcar de las islas Filipinas en cada año económico.

Desde la promulgación del nuevo Arancel, se han vendido tres cargamentos de azúcar de Filipinas embarcados en buques de vela y que están á flote, á precios reservados, si bien se cree que la cotización es poco más ó menos 3.40 centavos puesta en el muelle, polarización 88°, libre de derechos, y también se vendieron azúcares de la misma procedencia que traerán uno ó dos vapores, para su embarque en Agosto ó Septiembre.

Los mercados europeos han estado activos y excitados durante el mes de Agosto, viéndose los que vendieron para entrega en el futuro en gran aprieto para cumplir sus contratos, y ocurriendo una subida en los precios del azúcar de remolacha para entrega inmediata, ó sea de 10s. 8 1/4d. á 11s. 9 3/4d., y hoy se cotiza el azúcar de remolacha para entrega en Septiembre á 11s. 6 3/4d.; sin embargo, el azúcar de remolacha para entrega en Octubre se cotiza ahora á 10s. 4 1/2d., lo que equivale á

4.19 cents. los centrífugas en Nueva York. La nueva cosecha de remolacha europea se ha repuesto algo del retraso que sufrió.

Hasta ahora no se han anunciado ventas de azúcar de remolacha europeo para su embarque á los Estados Unidos, pero es posible que haya que adquirir algún azúcar en Europa antes de que comience la nueva zafra en Cuba. Todavía hay tres centrales moliendo en dicha isla por no haber podido concluir de moler toda su caña, y la producción de azúcar visible hasta la fecha es de 1,465,000 toneladas, que es la mayor zafra de que se tiene noticia; la caña sembrada para la zafra que viene está creciendo muy bien y quizás la producción del año entrante exceda considerablemente la del presente.

Las noticias que se reciben con respecto á la cosecha de caña en Louisiana y á la de remolacha, continúan siendo favorables.

Todos los indicios son de que los primeros azúcares de la próxima zafra de Cuba se pagarán á muy buenos precios.

Nueva York, Septiembre 1° de 1909.

Cuba's Greatest Sugar Mill.

The largest and best equipped sugar mill in Cuba, Central Chappara, in Oriente Province, of which Sr. Mario Menocal is superintendent, broke the record for the production of sugar this year, says the Tampa (Fla.) Times. Under his able management the mill is attaining a wonderful success. The mill's sugar production for this year was 483,000 sacks, with thirteen arrobas to the sack. (Arrobas is a Spanish measure consisting of twenty-five pounds to the arroba.) The price per arroba is seventy-five cents. The total amount of arrobas produced was 6,279,000, at seventy-five cents per arroba, which is \$4,709,250. Sr. Mario Menocal is being congratulated all over the island for his great success, as this production is considered the largest ever made in any part of the world by one sugar mill. Sr. Menocal was the candidate of the Conservative party in Cuba for the Presidency at the last election, but was defeated by the present chief executive. Many claim that if the republic had been in the hands of Mario Menocal* the republic would have progressed a great deal more than it has, not only because

he is the certain type of a man to govern a country, but because of his business ability and enterprise, the evidence being produced by the fact that this mill never before had such a magnificent output.

Philippine Sugar.

The tariff act approved on Aug. 5 provides for the free entry into the United States from the Philippines annually of 300,000 tons of sugar; of wrapper tobacco, 300,000 pounds; of filler tobacco, 1,000,000 pounds, and 150,000,000 cigars. The entire yearly imports are not expected to exceed these amounts of the articles for several years, and the law therefore really provides temporary free entry of sugar and tobacco.—New York Times.

The Cuban-American Sugar Company announced on July 21 a dividend of one and three-quarters per cent. on the preferred capital stock outstanding, payable on August 10, 1909. Transfer books closed July 30, and will reopen August 11, 1909.

*See cartoon on page 13.

SAN CLAUDIO

Only thirty-six miles from Havana, on the splendid deep-water harbor of Cabanas

Deep, fertile soil, high, healthful and well watered. Land all cleared, ready for the plow. Government stone highway direct to Havana. Regular Freight Service direct from San Claudio Wharf by boat to northbound steamers in Havana harbor; low freight rates, no re-handling. Fine American Hotel, General Store, School, American neighbors, daily mail, boating, hunting, fishing, three sugar mills near by. Farms on easy terms.

For full particulars and Illustrated Book on Cuba and Tropical Agriculture, write

FRED C. BECKER, Manager, 277 BROADWAY NEW YORK

The Snare & Trieste Company, which firm has the contract for building the ferry house and wharves in Havana, are driving cement piles 28 feet long and 14 inches in diameter, reinforced by steel rods their entire length, instead of timber piles.

It is the first concrete piling to be driven in Cuba and the work is being watched with interest by other firms who will also likely adopt their use. This piling is made in Regla, and the firm of Snare & Trieste have the rights to its use in Cuba.

FOR SALE

We offer, subject prior sale, October 1st delivery, one 26" x 72" Pratt "IMPERIAL" Cane Crusher complete with Compound Gearing, Hydraulics and Corliss Engine, Krajewski type rollers.

One 34" x 72" Three-Roll Pratt "IMPERIAL" Cane Mill, complete, with Compound Gearing, Hydraulics and Corliss Engine, heavily built for highest pressures. **LARGE JOURNALS.**

EXTREMELY NARROW TURN PLATE

For full information, particulars, prices, etc., address

PRATT ENGINEERING AND MACHINE COMPANY

Atlanta, Georgia, U. S. A. 80 Wall St., New York City

Havana, Cuba. Office: Lonja del Comercio 509.

THE EXETER MACHINE WORKS

PITTSSTON, PA.

MANUFACTURE

BRONZE AND BRASS CASTINGS

"VITA" ACID-RESISTING BRONZE

EXETER BEAR BABBITT. The best in the world for anti-friction purposes

No. 7 RAILWAY BRONZE, For all bearing purposes

PHOSPHOR BRONZE AND GUN METAL

NEW YORK OFFICE: 50 CHURCH STREET

CARROS PARA CAÑA

De todas
clases

Fabricados
de madera
ó á cero

Direccion
Telegrafica
RAMALIAM

RAMAPO
IRON WORKS

30 Church St.
New York, N. Y.

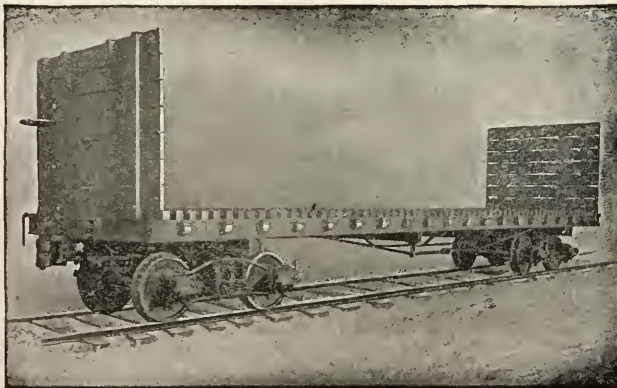

CANE CARS

OF EVERY
DESCRIPTION
OF STEEL
OR WOOD

Cable Address
RAMALIAM

RAMAPO
IRON WORKS

30 Church St.
New York, N. Y.

INVEST IN CUBA

DOUBLE YOUR MONEY

Let us tell you why and where

CONSULT US, OTHERWISE "DON'T INVEST IN CUBA"

THE JOHNSON-HARDING COMPANY

Specialists in Cuban Investments

118 PRADO, HAVANA, CUBA

CANADA LAND AND FRUIT CO.

LOS INDIOS

Owners

ISLE OF PINES

CANADA AND LOS INDIOS TRACTS

Location: Siguanea Bay. The Deep-Water Harbor of the Island.

We have at our new and progressive town of Los Indios a sawmill, planing-mill general store, school, hotel, church, post office and nursery, all under the supervision of Americans. A strictly American town.

We also have rowboats and gasoline launch for pleasure parties. Fishing and hunting the best.

We own the finest citrus fruit, vegetable and tobacco land on the island. We offer same for sale in acres to suit purchaser, either for cash or on installments. **Special inducements to actual settlers.**

Write for prospectus and further information to our general office,
Marinette, Wisconsin.

WILLETT & GRAY, Brokers and AgentsFOREIGN AND
DOMESTIC**SUGARS**RAW AND
REFINED**82 WALL STREET, NEW YORK**

Publishers of Daily and Weekly Statistical Sugar Trade Journal—the recognized authority of the trade.
TELEGRAPHIC MARKET ADVICES FURNISHED

PURE
DISTILLATION
OF
SUGAR CANE

BACARDI RON

Sole United States Agent

D. S. de JONGH 128 Water St.

BEST MIXER
FOR
HIGHBALLS
AND
OTHER DRINKS

“Sugar News from Cuba”

is the title of the interesting correspondence from the tropical island, appearing in every issue of “THE AMERICAN SUGAR INDUSTRY AND BEET SUGAR GAZETTE.”

Capable correspondents, in every part of the world, write regularly, covering reliable sugar news for “THE AMERICAN SUGAR INDUSTRY AND BEET SUGAR GAZETTE.”

In the United States, Cuba and Mexico, \$2 per annum. In Foreign Countries, \$2.50 per annum.

Subscribe for it if you want to keep posted.

Sample copy free. Send for advertising rates.

Address: **BEET SUGAR GAZETTE CO.**

No. 5 Wabash Ave. Chicago, Ill., U. S. A.

HAVANA

CUBA

National Bank of Cuba

Government Depository

Capital, Surplus and Undivided Profits
\$6,000,000.00

HEAD OFFICE, HAVANA

FIFTEEN BRANCHES IN CUBA

New York Agency, 1 Wall Street

COLLECTIONS

THE TRUST COMPANY OF CUBA HAVANA

Capital and Surplus \$540,000

Transacts a General Trust and Banking Business

REAL ESTATE DEPARTMENT

Examines Titles, Collects Rents, Negotiates Loans on Mortgages

Correspondence Solicited from Intending Investors

OFFICERS

J. A. Gonzales Lanuza, President
Norman H. Davis, Vice-President
F. J. Sherman, 2nd Vice-President
O. A. Hornsby, Secretary and Treasurer
J. M. Hoggood, Asst. Treasurer

Offices: CUBA 31, HAVANA

The Royal Bank of Canada

INCORPORATED 1869

Fiscal Agent of the Government of the Republic of Cuba for the Payment of the Army of Liberation

CAPITAL AND RESERVE, \$10,300,000.00
TOTAL ASSETS, - 58,300,000.00

Head Office, MONTREAL

NEW YORK AGENCY, 68 William St.

Branches in Havana: Obrapia 33, Gallano 92;
Matanzas, Cardenas, Manzanillo, Cienfuegos,
Camaguey and Santiago de Cuba.
Mayari, Sagua, Caibarien

ESTABLISHED 1844

H. UPMANN & CO. Bankers

TRANSACTION A GENERAL BANKING BUSINESS
CORRESPONDENTS AT ALL THE PRINCIPAL PLACES OF THE ISLAND

Safe Deposit Vaults

Manufacturers of the Famous H. Upmann
Brand of Cigars

FACTORY: Paseo de Tacon 159-163
OFFICE: Amargura 1-3

Established 1876

N. GELATS & COMPANY

Bankers

Transact a general banking business.

Correspondents at all the principal places of the world.

SAFE DEPOSIT VAULTS

Office: Aguiar 108

MOLINA BROTHERS

Customs Brokers

Forwarders, Lighterage and Ship Agents

Oficios 52, Havana

HAVANA

United Railways of Havana

Cuba's First and Foremost Railroad. (First Section opened to Traffic in 1837)

Takes you to All Parts of the Island East of Havana Comfortably and Quickly through Varied and Beautiful Scenery and Past Extensive Sugar Plantations

Parlor, Observation and Sleeping Cars attached to principal trains.

Full information and through tickets to all points in Cuba reached via the United Railways of Havana can be obtained of the following:

Thos. Cook & Son
Seaboard Air Line R. R.
Foster & Reynolds
Atlantic Coast Line R. R.
Illinois Central R. R.

Ward Line
Florida East Coast Railway
Washington Southern Railway
Peninsular & Occidental S. S. Co.

Southern Pacific R. R.
Mobile & Ohio R. R.
Raymond & Whitecomb Co.
Louisville & Nashville R. R.
Munson Line

THE HERRADURA LAND COMPANY

Office: No. 3 Bernaza Street, Habana, Cuba

CAPITAL, \$440,000.00

Own 22,000 acres of land in the Province of Pinar del Rio, suitable for Oranges, Vegetables, Cotton, Corn and Tobacco. The land has all been surveyed and sub-divided into 40-acre tracts and is offered for sale in acres to suit the purchasers, for Cash or on instalments.

We have a new and progressive American town with Railroad Station, Telegraph, Telephone, Stores, Hotel, American School, all within short distance from Havana City.

- Titles perfect. Transportation from Havana free for buyers.

WRITE OR CALL FOR INFORMATION.

LA AMBROSIA

MANUFACTURERS of the well-known brand of Chocolate, "LA AMBROSIA," Biscuits, Macaroni, Bonbons, all kinds of Confectionery

GUAVA PASTE AND EXTRA FINE GUAVA JELLY

ORDERS RECEIVED FOR EXPORT

BALDOR, FERNANDEZ & CO.

Sol 21 & 23, Havana, CUBA

Write for quotations.

'PHONE No. 401

P. O. BOX 741

FERNANDO de CARDENAS

CUSTOM HOUSE BROKER

:: Import and Export Agent ::

Munson S. S. Line Building

Obispo No. 1, Havana, Cuba

JAMES S. CONNELL & SON

Sugar Brokers

Established 1836, at 105 Wall Street

Cable Address—"Tide, New York"

(Established 1871)

DUSSAQ y CO.

Sucesores DUSSAQ & GOHIER.

GENERAL IMPORTERS

Agents for: The Royal Mail S. P. Co.; Cuban Steamship Co.; Holland-America Line.

OFICIOS 18 HAVANA.

Cuban Ore in Pennsylvania.

The duplex system of making steel will be used in the Bessemer mill at Harrisburg, Pa., after it starts in connection with the open hearth, says the Reading Eagle. This method is necessary to successfully work the ore from the company's new Cuban mines, though

this ore will not be used at first. In the duplex method the pig iron will first be sent to the Bessemer where it will be decarbonized and desiliconized when it will be taken to the open hearth. After the mill is working regularly nothing but the Cuban ore will be used.

FOR SALE.

Nearly 700 acres of

ORANGE AND PINEAPPLE LAND,

two miles back of La Gloria; for sale at a bargain, or would trade for a good farm. Address "Opportunity," care Cuba Review.

Cuban Tonnage.

| —1908— | | —1909— | |
|-------------|-----------|-------------|-----------|
| Sailing | Steamers, | Sailing | Steamers, |
| ships, | ships, | ships, | ships, |
| tons gross. | tons net. | tons gross. | tons net. |
| 60,805 | 1,459 | 61,832 | 1,343 |

—From Lloyd's Register of British and Foreign Shipping published July 19.

Journal d'AgricultureTropicale

Founded by J. VILBOUCHEVITCH
164 Rue Jeanne d'Arc Prolongée.

Subscription, One Year - - - - 20 Francs

Deals with the leading questions of the hour, agricultural and commercial, of interest to tropical countries. International in character. Illustrated. Monthly. Descriptions of machines for tropical crops a speciality. Complete review of new agricultural publications. Commercial part intelligible for every one and always interesting. 150 contributors in West and East Africa, East and West Indies, Java, Mauritius, Central and South America, and throughout the tropical world.

HENRY E. BROWN
Pharmacist

Shipping and Export Chemist and Druggist, Ships' Medicine Chests Furnished and Replenished. Prescriptions Compounded by a Graduate in Pharmacy.

Trusses, Surgical Appliances, etc.

Office and laboratory, Room 36.
116 BROAD ST., NEW YORK

Telephone Call: 274-A Hamilton.

JOHN M. DONOVAN

13 Summit St. (Atlantic Dock) - BROOKLYN

Dealer in

Dunnage Mats

FOR BAG FLOUR, BAG AND BULK GRAIN AND GENERAL CARGOES.

— BAGS AND BAGGING —

PURDY & HENDERSON, Inc.

Engineers and Contractors

New York Chicago Boston

Cuba Office, Empedrado 32, Havana

SUGAR CANE PLANTATIONS

Cacao (chocolate and cocoa) and Coffee Plantation—Orange and Grapefruit Groves. Land for the small settler on easy terms. In the best district of Cuba—Rio Cauto Valley. Within 40 miles of Santiago and Nipe Bay. Write for Booklet.

RIO CAUTO SUGAR COMPANY, 50 Church St., N. Y. City

If Cuba can straighten out its own tangles and work out its salvation it will soon be on a rock bottom foundation for a solid and substantial little republic.—Taunton (Mass.) Republican.

M. J. CABANA
COMMISSION MERCHANT
P. O. Box 3, Camaguey

Solicits Correspondence from all the important cities of the United States of America.

THE BIG FOUR ROUTE

3 Daily Trains Each Way 3

Parlor Cars, Sleepers, Dining Cars.

Through Train Service
BETWEEN
Cincinnati, Toledo and Detroit

(Via Michigan Central R. R.)

Ask for Tickets Via

BIG FOUR

BARTLE

Twenty-five thousand acres of the richest and best watered land in Cuba on the main line of the Cuba Railroad, with the finest station on the line, 120 miles from Nipe Bay—the best harbor on the Island; also the nearest to New York. No swamps or insect pests.

BARTLE is not in the wilderness—we offer all the comforts of civilization, GOOD STORES, HOTEL, CHURCH, SCHOOL, SAW-MILL, Etc.

TWO MAILS DAILY.

SUGAR, FRUITS, TOBACCO AND VEGETABLES produce wonderful crops at BARTLE.

When you consider Soil, Transportation, Social, Religious and Educational advantages, BARTLE offers something not to be had elsewhere in Cuba. Write for particulars.

"Ten Days in Cuba," just published by Hon. Nicholas J. Whalen, Speaker of the Michigan Legislature, may be had through newsagents at 25 cents per copy, or will be sent free to any address by the owners of the Bartle Colony. Address, Duncan O. Bull, Gen'l Mgr. Cuban Realty Company, Limited, Temple Building, Toronto, Can., or 141 Broadway, New York City.

DUNCAN O. BULL, General Manager

CUBAN REALTY CO., Ltd. Temple Bldg., Toronto, Canada
141 Broadway, New York **Bartle, Cuba**

MOBILE, ALA.

HOME INDUSTRY IRON WORKS

Engines, Boilers and Machinery

Manufacturing and Repairing of all kinds. Architectural Iron and Brass Castings. Light and Heavy Forgings. All kinds of Machinery Supplies.

Steamship Work a Speciality

A. KLING, Prop.
 JAS. S. BOGUE, Supt.

MOBILE, ALA.

The Principal Hotels in Mobile, Ala.

THE CAWTHON

(FIREPROOF)

European, 175 Rooms

\$1.50 Up

THE BIENVILLE

(MODERN)

European, 150 Rooms

\$1.00 Up

Both Hotels in Heart of City, Facing Bienville Square

OLLINGER & BRUCE DRY DOCK CO.

Ship Builders and Repairers

Operating seven Sectional Dry Docks, capacity 1,000 tons, and one Balance Dock, capacity 3,000 tons. Equipped with Air Plant for operating Pneumatic Tools, and Steam Pump for cleaning vessel's bottoms.

25-TON DERRICK BARGE AND STEAM PILE DRIVER.

Material of all kinds kept on hand. Shipwrights, Caulkers, Painters, Sparmakers and Riggers furnished promptly, and at reasonable rates. Correspondence solicited.

MOBILE, ALA.

BUSINESS FIRMS OF CAIBARIEN

ANGEL MATA
Comerciante.
Caibarién, Cuba.

Apartado 114. Cable: *Mata.*"

Ferretería, Mueblería y Locería
LA LLAVE
DE INCHANSTI Y HNO.
Caibarién, Cuba.

Marti 11 y 13. Apartado 24.

R. CANTERA Y CA.
(S. en C.)

Comerciantes Importadores,
Escobar 28. Caibarién.

A. ROMANACH
Almacenistas Importadores de Viveres,
(S. en C.)
Caibarién.

P. B. ANDERSON,
Ship Broker. U. S. Consular Agent,
Caibarién, Cuba.
Agent for Munson Steamship Line and Lloyds.

MARTINEZ & CO., S. en C.
Comerciantes Banqueros,
Importadores de Viveres,
Exportadores de Azucar.

Apartado 115. Telegrafo: *Urquiza.*
COMERCIO,
Hotel - Restaurant - Cafe
De José Urquiza.
Calle de Marti num 16 y 18 - Caibarién

LA MARIPOSA DE EVARISTO BERGNES
Importador de Peletería y Talabartería, Fabricante
de Calzado.
Caibarién.

Apartado 104. Telegrafo: *"Bergnes."*

YMAZ Y CA.
Ymportadores de Ferrería en General.
Apartado de Correos Num. 15,
Caibarién, Cuba. Cable: *"Imaz."*
Calle Justa Num. 27.

ARIAS Y COMP
Provisiones, Loza y Muebles.
Cuba Num. 20, Esquina a Marti,
Caibarién, Cuba.
Correo Apartado Num. 15. Telegrafo: *"Arias."*

ZARRAGA Y CA.,
Caibarién, Cuba.
Casa Banca. Exportadores de Azucar.

BONIFACIO DIAZ,
Gran Peletería y Sombrerería.
Marti 17 - Caibarién
Constantes novedades en los dos giros de esta casa.

RODRIGUEZ Y VINA, S. en C.,
Almacenistas Importadores de Viveres en General,
Comisiones y Consignaciones,
Consignatarios de Buques.
"Depositos de Carburó."

Telephone, 33 Hamilton
Night Call, 411 Hamilton

Cable Address:
"Abiworks," New York

Atlantic Basin Iron Works

Engineers and Boiler Makers

Machinists, Plumbers, Tinsmiths, Pipe Fitters, Blacksmiths, Coppersmiths,
Pattern Makers, Sheet Iron Workers. Iron and Brass Castings. Steamship
Repairs a Specialty.

Cor. Imlay and Summit Streets

Brooklyn, N. Y.

John Munro & Son

Steamship and
Engineers' Supplies

13 Conover Street, Brooklyn, N.Y.

Cable Address: *Kunomale*, New York

Telephone, 196 Hamilton

Telephone
215 Hamilton

Box 186
Maritime Exchange

YULE & MUNRO

SHIPWRIGHTS

Caulkers, Spar Makers

Boat Builders, Etc.

No. 9 SUMMIT STREET
Near Atlantic Dock BROOKLYN

WINTER HAVEN NURSERIES

A. M. KLEMM, Proprietor

Established 1884.

Winter Haven, Fla.

Wholesale Growers of Citrus Stock of the best commercial varieties. We guarantee our extensive Stock to be well grown, free of insects and true to name.

Silver Cluster Grape Fruit our leading Specialty.

Prices right. Grading and Packing perfect.

Write for Catalogue.

CUBA INFORMATION

IS THE TITLE OF A BOOK WHICH GIVES DEFINITELY and concisely just such information concerning Cuba as is desired by the business man or prospective investor who is interested in this fertile island—*climate, soil, products, fruit growing, live stock, tobacco, sugar, customs duties, banking, investments, colonies, land titles, laws, and a hundred other matters.*

SEND 25 CENTS FOR A COPY

and if you want any specific information that could not be covered in such a book,

Ask Mr. Foster No. 1 Madison Avenue, NEW YORK

Mr. Foster also has information offices in Philadelphia, Washington, Atlantic City, Jacksonville, St. Augustine, Daytona, Palm Beach and Miami, Florida, and in Havana and Camaguey, Cuba. FREE INFORMATION—no fees ever asked or accepted.

The Standard Guide to Cuba— Reliable—accurate—maps—illustrations.
50 cents.

FOSTER & REYNOLDS, 1 Madison Avenue, New York.

TWO IMPORTANT MAPS

Blue-prints of Cuba, showing the location of the Sugar Plantations and the Rural Guard Stations of the Island. Specially prepared for The CUBA REVIEW. Each 60 cents. Either map with a year's subscription, 75 cents. Both blue-prints and magazine, one year, \$1.

The Rural Guard of Cuba

The Sugar Plantations of Cuba

BUSINESS FIRMS OF SANTIAGO

E. GIRAUDY & CA.

ALMACEN DE VIVERES
Marina baja n. 33, Santiago de Cuba.
Agentes de Schlitz Beer.

JULIAN CENDOYA

Steamship Agent and Broker
COMMISSION MERCHANT
CABLE: Cendoya. Santiago de Cuba.

VALLS, RIBERA & CA.

(S. en C.)
Importadores de Ferreteria y Machinery.
Telégrafo: Valribe.
Santiago de Cuba y Manzanillo.

A. B. C. Code, 5th Edition. Telephone, 190.
P. O. Box, 95. Cable address: SILVAPA.

SILVA Y PARRENO H.

General Commission Merchants.
Custom House Brokers—Forwarding Agents.
Consignees of the Cuban steamers of the Carlos J. Trujillo, S. en C., Line, formerly Menéndez & Co.
References:—J. Cendoya and Nat'l Bank of Cuba.

CAMP HERMANOS, Santiago de Cuba.

Ron Selecto "Golondrina" y "Carta Cuba."
Medalla de Oro, St. Louis, 1904.

RON BACARDI

DE BACARDI & CO., Distillers, Proprietors.
43 San Ignacio, cor. Santa Clara, Havana,
Santiago de Cuba.

LARREA Y BESEALIE

Importers of General Groceries and Exporters of
Cocoa, Wax, Honey and Woods.
Apartado 65, Marina Baja 46. Cable: Larrea.

Importación. Exportación.
L. ABASCAL Y SOBRINOS

Agentes de las líneas Pinillos Izquierdo y Ca., de
Cadiz. Larrinaga y Ca., de Liverpool. Compañía de Seguros, Aachen & Munich, Aix-la-Chapelle.

BROOKS & CO.

Bankers and General Commission Merchants.
Santiago and Guantánamo.

VINEGAR BEND LUMBER CO.

Manufacturers and Exporters

Long Leaf Yellow Pine Lumber and Timber

Cuban Business Our Specialty VINEGAR BEND, ALA., U. S. A.

Daily Capacity, 200,000 Feet

Cable Address: "TURNER"

Codes: A B C, Fourth Edition; Southards; Watkins; Western Union



SOBRINOS DE BEA & CO.

Bankers and Commission Merchants
Importación directa de todas los centros
manufactureros del mundo.

Agents for the
Munson Steamship Line, New York and
Mobile.

James E. Ward & Co., New York.
Serra Steamship Company, Liverpool.
Vapores Transatlánticos de A. Folch & Co.
de Barcelona, España Independencia
Street 17/21.

MATANZAS, CUBA.

JOHN W. McDONALD

COAL, WOOD, LUMBER
and TIMBER of Every
Description

112 WALL STREET

Near South Street NEW YORK

Yard: 58-68 Beard Street, Eric Basin
Telephones:

Office, 1905 John Yard, 316 Hamilton

No homily on gambling is required to prove the obvious proposition that when a government gambles with its people with the officials stacking the cards and shifting the shells like the sharps that follow in the wake of a circus, some radical change is imminent.—Toledo (O.) Blade.

"The Comfortable Way"

Between the East and the West is
via the Toledo, St. Louis and
Western Railroad

"Clover Leaf" Route

Rates lower than by any other
direct line. Send four cents in
stamps for copy of "Get Out or
Get in Line," a booklet by Mr.
Elbert Hubbard, Chief of the Roy-
crofters.

GEO. J. CHARLTON,
General Passenger Agent,
Chicago, Ill.

THE SNARE AND TRIST COMPANY

CONTRACTING ENGINEERS

Steel and Masonry Construction
Piers, Bridges, Railroads and Buildings

We are prepared to furnish plans and estimates
on all classes of contracting work in Cuba.

N. Y. Office

Havana Office

143 LIBERTY ST.

LA LEAL BUILDING

W. H. Bennett

F. W. Hvoslef

Bennett, Hvoslef & Co.

18 Broadway, New York

Steamship Agents and Ship Brokers

Cable: "Benwalsh"

MUNSON STEAMSHIP LINE

GENERAL OFFICES

82 Beaver Street New York

NEW YORK-CUBA SERVICE
PASSENGER and FREIGHT

| Steamer | New York | Nipe | Nuevitas | Nipe | Banes | Gibara and Vita | Pto. Padre | Nuevitas | Nipe | New York |
|----------|----------|----------|----------|---------|---------|-----------------|------------|----------|---------|----------|
| | Sail | Arr. | Arr. | Arr. | Arr. | Arr. | Arr. | Sail | Sail | Arr. |
| Ollinda | Sept. 22 | Sept. 27 | Sept. 29 | Oct. 11 | Oct. 13 | Oct. 15 | Oct. 2 | Oct. 5 | Oct. 7 | Oct. 13 |
| Curityba | Oct. 6 | | Oct. 11 | Oct. 13 | Oct. 15 | Oct. 16 | | Oct. 21 | Oct. 22 | Oct. 27 |

SAILINGS SUBJECT TO CHANGE WITHOUT NOTICE

FREIGHT ONLY

NEW YORK to CAIBARIEN, MATANZAS, CARDENAS and SAGUA

MOBILE-CUBA SERVICE

Freight Only

REGULAR SAILINGS-MOBILE to HAVANA-MOBILE to N.S. S.S. CUBAN PORTS.

BALTIMORE-COLON SERVICE

Freight Only

REGULAR SAILINGS-BALTIMORE to COLON

AGENTS IN CUBA

ASMUS LEONHARD

Cuban Freight and Passenger Agent
76 Cuba Street, Havana

BERNABÉ SANCHEZ É HIJOS
FRANCISCO PLA
BEOLA & CO.
M. J. CABANA
J. L. DAUTERIVE

Nuevitas
Puerto Padre
Gibara
Camaguey
Antilla (Nipe Bay) Oriente

For Southbound reservations address the General Offices, New York
For Northbound reservations address the agent at the port of embarkation

Lillie Multiple Evaporators

Model of 1904-1905 (Patented)

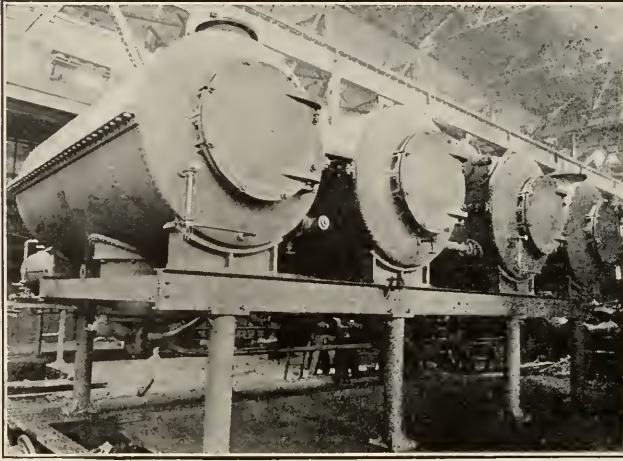

"One of three Lillie quadruple effects installed in 1907, in sugar factories in Formosa, belonging to the Taiwan Seito Kabushiki Kwaisha, of Tokio, Japan. Two more quadruple effects, one to handle 550,000 gallons of cane juice per twenty-four hours, and the other to handle 325,000 gallons in the same period, are now (July 1st, 1909) being built for the same Japanese Company, also for service in Formosa. These quadruple effects are arranged for reversing the course of the vapors and heat at will, a mode of operation peculiar to the Lillie and which has proven of great value for solutions depositing incrustations on the evaporating tubes."

The Sugar Apparatus Manufacturing Co.

328 Chestnut St., Philadelphia, Pa.

S. MORRIS LILLIE, President.

LEWIS C. LILLIE, Secretary and Treasurer.

BALDWIN LOCOMOTIVE WORKS

Broad and Narrow Gauge

Single Expansion and Compound

LOCOMOTIVES

Compressed Air Locomotives. Electric Locomotives with Westinghouse Motors



PLANTATION LOCOMOTIVES

For all Gauges of Track. To meet all conditions of service. Specifications furnished on application.

Principal offices and works, 500 North Broad Street
Philadelphia, Pa., U. S. A.

Cable Address: "Baldwin, Philadelphia"

Agents for Cuba, Krajewski-Pesant Co., Aguiar 92, Havana, Cuba.

THE CVBA REVIEW

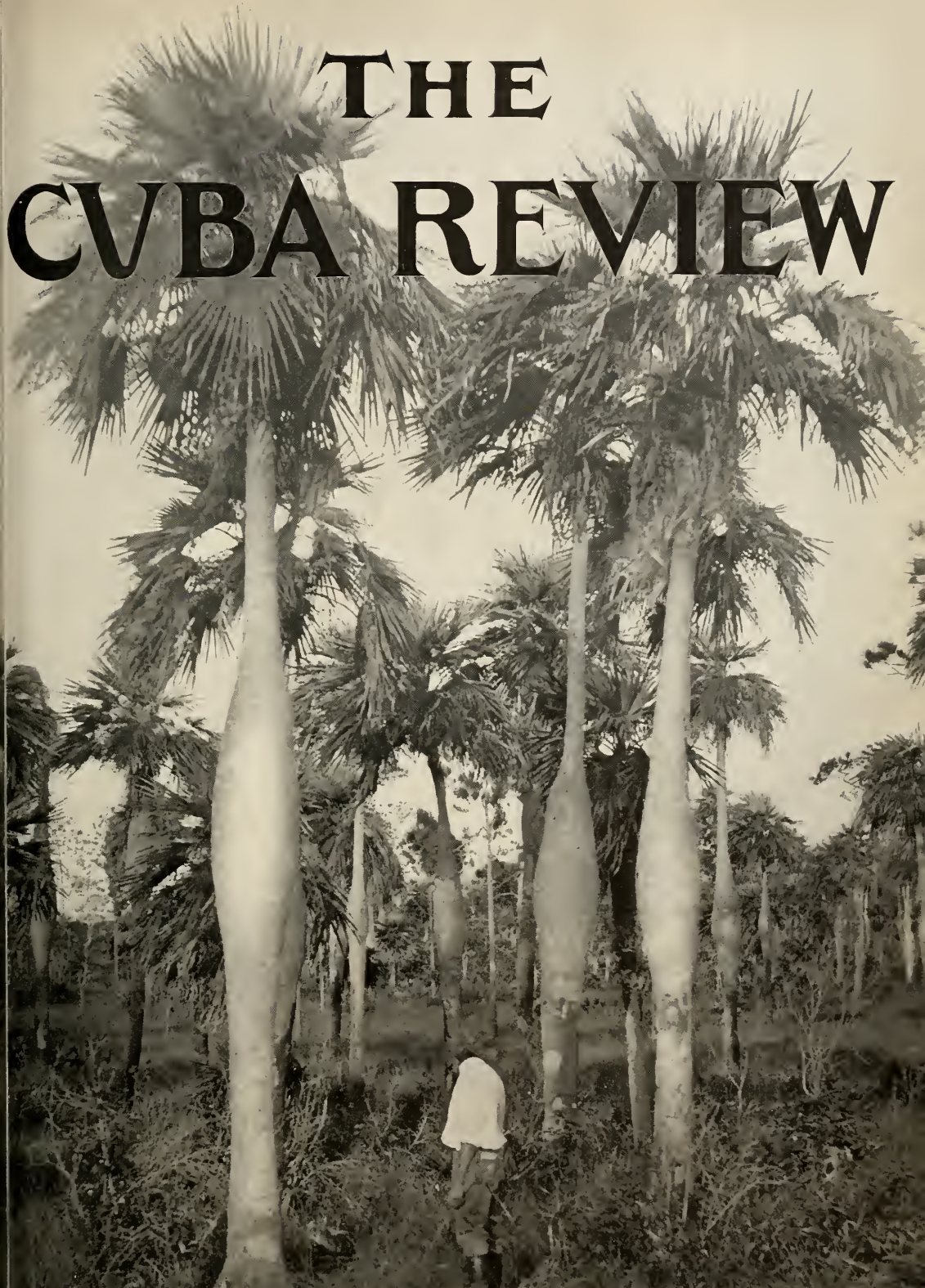

50 Cents A Year **OCTOBER 1909** 5 Cents A Copy
Published by the Munson Steamship Line, 82-92 Beaver Street, New York City.

CEBALLOS "THE GARDEN SPOT OF CUBA"



FOUR-YEAR-OLD GRAPE-FRUIT TREE AT CEBALLOS

Would you like to own a
HOME
in this
Ever-Summer Land?

Intelligence, energy and moderate capital will here win a fortune for you in Fruits, Vegetables and Sugar.

After eight years of developing the country, creating industries, establishing conditions—paving the way—we now invite HOMESEEKERS to share our prosperity. No pioneering. All conveniences of modern civilization. Send for literature.

GEO. H. GILLETT, Secretary 43 EXCHANGE PLACE, NEW YORK

PRATT Imperial



Sugar Cane Machinery and Evaporating Apparatus.

Complete Plants Erected and Delivered to Owner Under Guaranteed Capacity of Mills and Quantity. Sugar House Pumps.

We have nearing completion, subject prior sale, November 1st delivery, one 34" x 72" Pratt "IMPERIAL" Mill Complete, with Hydraulics, Compound Gearing & Corliss Engine, also one 26" x 72" Pratt "IMPERIAL" Cane Crusher, complete with Hydraulics, Compound Gearing and Corliss Engine. For description see page 34.

STEAM PUMPS

SPECIAL PARTS of MACHINES, any size or kind; and HEAVY CASTINGS famous for quality.

We maintain Export Sales Offices at 80 Wall St., New York, in charge of Mr. N. A. Helmar, an eminent Sugar Mill Engineer of wide experience. We solicit our business with the assurance of every courtesy and perfect satisfaction.

Pratt Engineering & Machine Co. ATLANTA, GA.
U. S. A.

HAVANA, CUBA, OFFICE: LONJA DEL COMERCIO No. 509

Successors to FULTON FOUNDRY & MACHINE WORKS, Atlanta, Ga.

Tivoli Beer

—*Enough said.*

Havana Brewery

Havana

BUCKEYE NURSERIES

M. E. GILLET, Proprietor

TAMPA, FLORIDA, U. S. A.

ORANGE, LEMON AND GRAPE FRUIT TREES

LARGEST CITRUS NURSERY IN THE WORLD

QUALITY VARIETY DELIVERY

Price may be forgotten—Quality NEVER.

We grow nothing but standard Varieties which we can recommend to the trade as Money-Makers. Having had 29 years' experience we thoroughly understand packing trees for long distance shipments.

We guarantee our trees to be True to Name, Free from White Fly and to ARRIVE AT DESTINATION IN GOOD CONDITION.

Consider the future and protect your investment by planting reliable trees from

THE BUCKEYE NURSERIES

La Gloria has Arrived. All other American colonies in Cuba have yet to come.

La Gloria has Better soil, climate, water, schools, docks, cheaper transportation, living, more American people, push and natural advantages.

The Oldest, Largest and Best American Colony.

First Prize for citrus fruits Havana Exposition, 1908.

The La Gloria Transportation Company's fine mail and passenger steamer connects with Munson Line steamers at Nuevitas. Sailings Tuesdays, Thursdays and Saturdays.

Boulevard Completed. The Cuban Government has completed a fine macadamized boulevard from the townsite to Port Viaro, costing \$80,000.

La Gloria is All its Name Implies.

Not a promoter's dream but an assured fact. Our West Canasi tract, just opened, is the finest orange land in Cuba. We have also a few choice town lots for sale.

Send for our new booklets showing pictures of homes and plantations, and giving terms and conditions.

Cuban Land and Steamship Company
32 Broadway, New York City

OF VALUE IN CUBA

Dixon's Ticonderoga Flake Graphite for lubricating all kinds of machinery. Increases the value of all oils and greases, and saves wear, time and money. It will pay to send for free sample and pamphlet.

JOSEPH DIXON CRUCIBLE CO.

Jersey City, N. J.

CABLE ADDRESS: Turnure.

NEW YORK,
64-66 Wall Street.**LAWRENCE TURNURE & CO.****BANKERS**

Deposits and Accounts Current. Deposits of Securities, we taking charge of Collection and Remittance of Dividends and Interest. Purchase and Sale of Public and Industrial Securities. Purchase and Sale of Letters of Exchange. Collection of Drafts, Coupons, etc., for account of others. Drafts, Payments by Cable and Letters of Credit on Havana and other cities of Cuba; also on England, France, Spain, Mexico, Puerto Rico, Santo Domingo, Central and South America.

CORRESPONDENTS:

HAVANA—N. Gelats y Ca.
MEXICO—Banco Central Mexicano.

LONDON—The London Joint Stock Bank, Ltd.
PARIS—Heine et Cie.

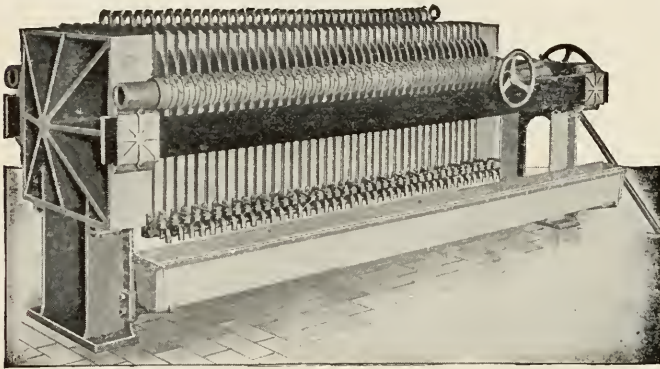

**Prensas de
Filtrar
para Ingenios**
SHRIVER
Filter Presses

Write us for Catalogue, Prices and Information.

T. SHRIVER & CO
814 Hamilton Street
HARRISON, N. J.

Sole Agents for Porto Rico
McMurtrie-Guiler Co.
SAN JUAN, P.R., and BEAVER BLDG
BEAVER STREET, NEW YORK

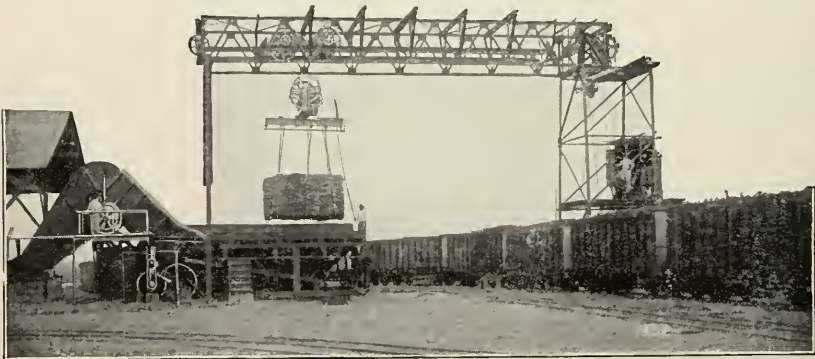
**“LINK-BELT” CANE UNLOADERS**

are fitted with the “DODGE” AUTOMATIC SLING-HOOK; the transfer of the load is, therefore, made quickly and with great facility.

Write to us about conveyors, bagasse feeders, chains, wheels, clutches, buckets, boots, etc. - - - NEW CHAIN CATALOG No. 75 A.

LINK-BELT COMPANY

299 BROADWAY, NEW YORK CITY

THE CUBA REVIEW

"ALL ABOUT CUBA"

An Illustrated Monthly Magazine, 82-92 Beaver Street, New York

MUNSON STEAMSHIP LINE, Editors and Publishers

SUBSCRIPTION

50 Cents Per Year - - - - - 5 Cents Single Copy
Advertising Rates on Application

Vol VII.

OCTOBER, 1909

No. 11

Contents of This Number

The cover page is of a beautiful scene in Los Indios, Isle of Pines, showing a grove of Bottle Palms.

Cuban government matters occupy pages 7 to 11 and include items on Cuban bonds, United States ban on the National Lottery, the cancellation of many contracts, a description of the new telephone franchise, together with a valuable list of authorized public systems now in Cuba, the great storm in Pinar del Rio, the Camaguey Waterworks, and other matters, together with illustrations and cartoons from Cuban newspapers showing the trend of public opinion there.

Pages 14 and 15 are devoted to comments on the Cuban situation from United States newspapers.

Page 16 shows Cuba's bonded debt, its revenues and the report of the Treasurer showing the condition of the Treasury on August 31.

Page 17 is devoted to railroad reports and traffic receipts, showing the income of the leading companies.

An interesting illustration of the new ferryboat which will ply between Havana and Regla, together with description, will be found on page 18.

On page 19 some news regarding duties on various commodities will be found, and other commercial matters.

Cuba from the standpoint of an American settler on page 20.

An authoritative utterance on the prospects of Caravonica cotton in Cuba by John R. Johnston, Assistant Pathologist of the Bureau of Plant Industry at Washington, on page 21.

Isle of Pines matters, with a review of Senator Clapp's article in the North American Review, and various newspaper comments thereon, together with minor items of news, on pages 22 and 23.

General Notes on pages 24 and 25.

Bees in Cuba, very handsomely illustrated, is on pages 26 and 27.

Notes regarding the Tobacco Industry on page 28.

Further agricultural matters on page 29.

The monthly Sugar Review by Willett & Gray on page 30, and various comments of United States newspapers translated into Spanish, on page 31.

MANY BEAUTIFUL ILLUSTRATIONS.

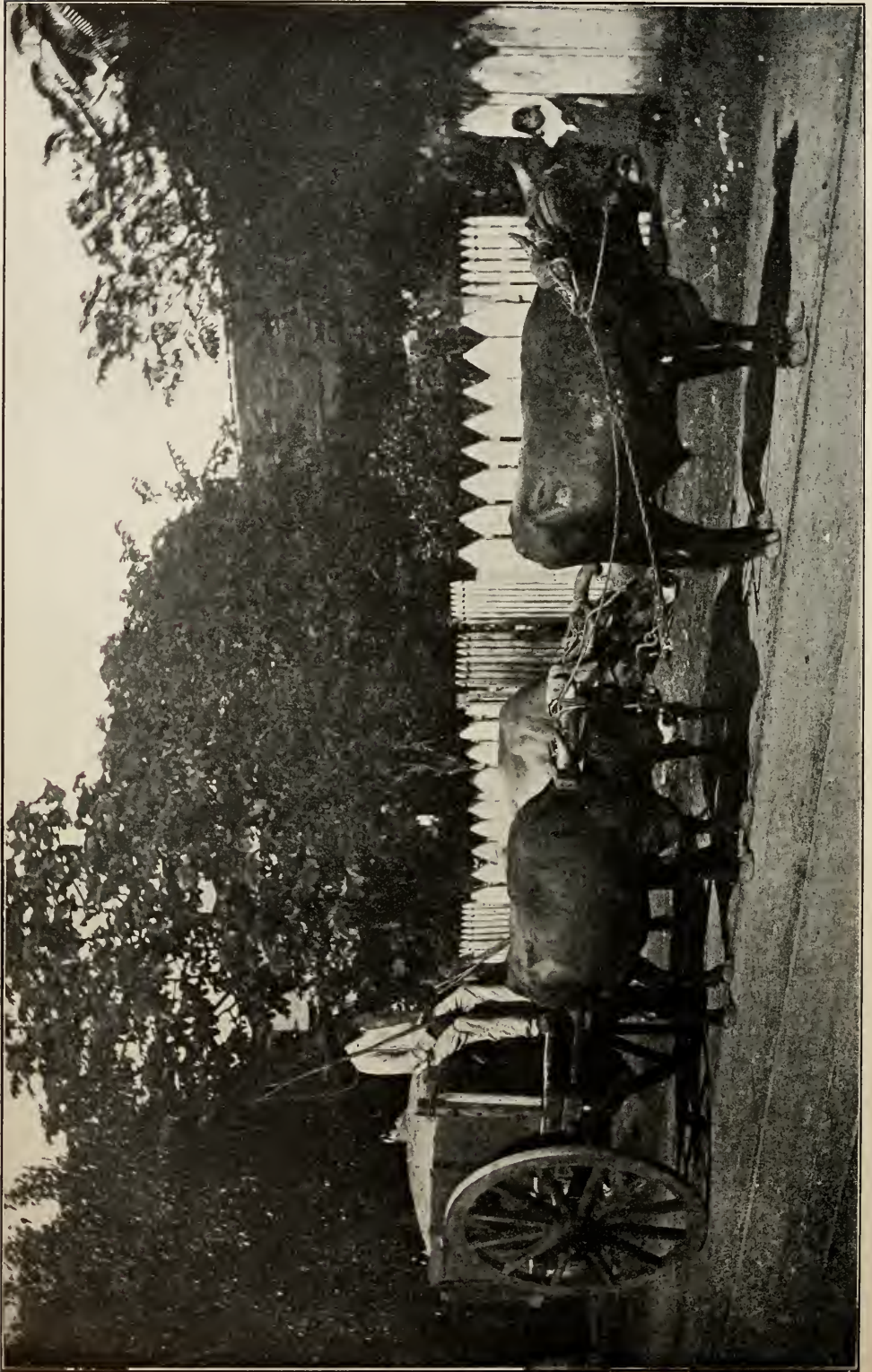

A CUBAN MERCHANDISE CART.
UN CARRO CUBANO PARA MERCANCIAS.

THE CUBA REVIEW

LIBRARY
NEW YORK
BOTANICAL
GARDEN.

"ALL ABOUT CUBA."

Copyright, 1909, by the Munson Steamship Line.

Volume VII.

OCTOBER, 1909.

NUMBER 11.

CUBAN GOVERNMENT MATTERS.

Protest Over the Cuban Bonds—Ban on the Lottery—Contracts Cancelled—Cama-guey Water-Works—Cuban Cartoons.

Advices from Havana received in New York told of a protest made to President Gomez on Sept. 16, by the unsuccessful bidders for the recent \$16,500,000 issue of 4½ per cent. bonds of the Republic of Cuba issued to Speyer & Co. on August 26, which was submitted to the Government authorities as preliminary to court action. The protestants were William Salomon & Co., Ladenburg, Thalmann & Co., and J. & W. Seligman, of New York.

The clause in Speyer & Co.'s agreement with the Republic of Cuba which is considered most objectionable is the provision which gives Speyer & Co. the preference in all loans to be made in the next ten years, provided that the terms made by that firm are as favorable as those made by other bidders. This is the clause which is said not to have been incorporated in the original call for bids, and is asserted to have had some influence on the bids submitted by Speyer & Co.

On the following day two of the protesting firms withdrew their complaint as they discovered they had been acting under a misapprehension. It developed later that the only prior right given to Speyer & Co. was to resell the present issue of bonds in case the Cuban Government should buy them in and wish to resell them, and that the firm have no prior right in bidding for new bonds.

Out of the original issue \$1,750,000 was put out in London, and the Stock

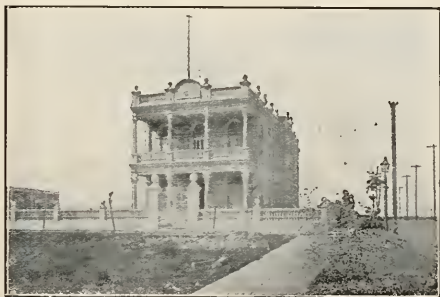

Chalet del Presidente General José Miguel Gómez, Vivora, visto de frente.

Chalet of the President, General José Miguel Gómez, Vivora. Front view.

Exchange admitted to listing temporary certificates representing subscriptions to the \$3,750,000 offered in New York. The bonds were many times oversubscribed and sold at a premium of 3 per cent. on the day the lists closed, September 8.

The increase in the customs revenue and especially at the Havana custom house, continues; the September report, issued Oct. 1, shows an increase of \$347,-820.39 over the same period in 1908.

The total revenues collected in the port of Havana during September was \$1,563,898.15, as against \$1,216,077.76 secured in 1908; and \$47,643.62 more than the amount collected in August.

U. S. Ban on the Lottery.

Arrangements have been made between the United States and Cuba to prohibit traffic in lottery tickets, and all Cuban consuls have been notified of the existence of a treaty between the postal authorities of the two countries to discountenance any such traffic through the mails.

At a meeting in New York early in September between Postmaster-General Hitchcock and the Cuban Director of Posts, Colonel Orrencio Nodarse, it was arranged that all Cuban consuls turn inquiries as to the lottery over to the police, while Cuban authorities will notify the American government of all inquiries made direct to them, in order that the police of the United States may be able to detect any attempt on the part of American dealers to invest in the Cuban lottery. The officials of the lottery will refuse to accept any cash coming from the United States and will furnish evidence which will lead to the discovery of the senders. Fraud orders will be placed on the mail of any person found to be engaged in such traffic.

The Cuban authorities have notified ticket sellers that it is absolutely prohibited to send tickets or lists to the United States. All orders must be sent at once to the Postoffice Department.

Revenue Cutters Wanted.

Cuba's revenue cutter service requires some more vessels of light draught and United States shipbuilding firms have been invited to submit proposals for building the boats, which on completion will be accepted at the port of construction.

In a report on the matter on Sept. 17 to the State Department, United States Chargé d'Affaires at Havana says that orders cannot be immediately placed because there is no provision in the last budget for payment for such vessels.

Public School Attendance.

At the commencement exercises in Havana on September 12, marking the beginning of the public school courses, Professor Gonzalo Arostegin, of the Havana University, the orator of the occasion, had this to say regarding public education in Cuba:

"In the beginning of the eighteenth century there were only two free schools in Havana. In 1899 there were 312 and six months later they had increased to over 2,000."

He praised highly the work done in this direction during the first intervention. "At



J. M. Govin, Director of El Mundo, an influential daily paper of Havana.

J. M. Govin, Director de El Mundo, Habana.

present," he continues, "there were 36,139 children from 6 to 12 years old attending the public schools, which was equal to 76 per cent. of the school population."

Many Contracts Canceled.

Some contracts rescinded by President Gomez because made without advertising and public bidding are as follows:

Central road from Santa Clara to Sagua la Grande and Cifuentes; Trinidad aqueduct; repair of the Santa Clara jail; repairs of an embankment of the rivers of Tunica, Zaza and Arrono Bejucal; Holguin school house; hospital construction at Matanzas and Santiago de Cuba; for dredging Cienfuegos harbor in front of the Fowler and Castaño piers; for dredging the channel of the port of Isabela de Sagua; for building an aqueduct at Rancho Veloz, and for all the roads and bridges ordered constructed in the 1909-10 budget.

Refrigerating Plant Established.

The first refrigerating plant established in Cuba for the cooling of meat slaughtered in the country is a part of a new abattoir opened for business August 29 in Havana, when in the presence of numerous guests, Bishop Pedro Estrada blessed the buildings. The abattoir is the largest in the island and is situated near the harbor and equipped with all modern appliances. The construction is of steel, marble and cement.



The Cuban laborer with cart and oxen, leaving his palm-thatched hut, ready for the day's work.

Un labrador cubano, saliendo de su choza cubierta de guano, listo para el trabajo del día, y su carro y bueyes.

The official signing of the *Telephone Franchise Signed.* contract allowing the Cuban Telephone Co. the franchise for a local long distance system throughout the six provinces of Cuba took place on September 10. At the same time the concession granted the Havana Telephone Co. on April 24, 1909, was annulled.

The action favoring the first named company was based on the long distance telephone act of June 18 last, whereby such service was authorized.

The annulling of the concession of the Havana Telegraph Co. was because it was a violation of the law of the executive power, which requires that all contracts and concessions must be regularly advertised and granted only to the highest bidder.

The Cuba Telephone Co., which is the

new name of the Havana Telephone Co., made application in April and this was made the subject of a special presidential message to Congress and passed July 18.

The system connecting cities and towns between Guane, Pinar del Río Province and Santiago de Cuba, Oriente Province, will be ready in two years and the extension to Baracoa from the latter city one year later. In Havana the wires will be underground.

The decree excludes the Cuban Telephone Company from towns where there are local systems established under prior rights, but it is authorized to arrange for connections with such companies and to establish long distance telephone booths connecting their island system.

An official list of these local systems throughout the island, giving name of owner of concession, locality and duration follows:

Official List of Authorized Public Service Telephone Systems in Cuba.

| Names of Concessioners. | Where Established. | Life of Concessions. |
|--------------------------|--------------------|----------------------|
| María Sánchez | Pedro Betancourt | 20 years |
| Magín Font | Cienfuegos | id. |
| José Carballo y J. Lores | Cruces | id. |
| El Gobierno | Cárdenas | id. |
| Francisco Caso | Calimete | id. |
| L. Coll y J. Lores | Camaguey | id. |
| Fermin Olivera | Colón | id. |
| L. Coll y J. Lores | Guantanamo | id. |
| María Sánchez | Jovellanos | id. |
| Augusto Roig Valerino | Manzanillo | id. |
| Empresa Concesionaria | Matanzas | id. |
| Cuban Telep. and Teleg. | Marianao | id. |
| José Sánchez Naranjo | Sti. Spiritus | id. |
| Ca Red Telefónica | Santiago de Cuba | id. |
| J. Carballo y J. Lores | Santo Domingo | id. |
| Josefa Muñoz | Sagua la Grande | id. |
| Manuel Mallo | Santa Clara | id. |
| Octavio M. Font | Unión de Reyes | id. |
| Fermin Olivera | Abreus | id. |

Ten or more lives were *Storm in* lost and property worth more *Pinar del Rio*. than \$2,000,000 was destroyed in the tornado which swept over the Province of Pinar del Rio, September 17. Communication between Havana and the storm area in the western part of the province was cut off except at two or three points.

More than 2,000 persons were made homeless, several hundred houses, herb and tobacco barns blown down, and many acres of tobacco seed beds on which the crop depends destroyed. Roads in course of construction were ruined, bridges swept away and telegraph wires broken.

President Gomez called a special session of Congress on September 24 to devise relief measures. He himself contributed \$500 to a fund for the relief of those made homeless.

Relief Measures. At the special session of the Cuban Congress, called by the President, September 24, the Senate passed a bill placing with banks the sum of \$700,000 for three years, without interest, to be loaned to farmers, land owners, tobacco growers, etc., in Pinar del Rio, who may have suffered

from the last cyclone, at a rate not higher than three per cent.

The Senate also passed an appropriation bill of \$100,000 for public works in the desolated towns and \$50,000 for tobacco seed to be distributed among the farmers.

The House on September 28 amended the Senate bill raising to \$1,000,000 the amount appropriated for the benefit of the sufferers by the recent cyclone. The Senate rejected the amendment and the discussion ended on September 30 by Congress appropriating \$75,000 on strong intimation that President Gomez would veto any bill appropriating any very large sum. The session lasted a week and adjourned October 1. The damage done by the storm has been hugely exaggerated.

The brig *San Antonio*, which was beached upon a mud shoal off Punta Castle, Havana Harbor, when she sprang a leak early in September, after striking the rocks of the "Doce Apostoles" as she was attempting the port without a pilot, sank to the bottom on September 22. The vessel now offers no danger to traffic because that part of the channel is of great depth and port pilots say that the channel is unobstructed.



Solidaridad cubana. A vuelta abajo!—La Discusion, Havana.
Cuban Solidarity. To Vuelta Abajo!

Friendly Criticism Secured. President Gomez has had many interviews with leading Havana newspaper editors recently in the endeavor to secure from them

more temperate criticism of administration activities. This has undoubtedly helped to bring about a better understanding, although by some the president's intention was attributed to a desire to muzzle the press. La Lucha, commenting on this, said such was by no means the president's idea, for in an interview the executive had plainly declared that he had a very broad opinion of everything connected with periodicals even though some treated matters most unjustifiably. Senor J. M. Govin, editor of Ey Mundo, another daily paper, also expressed himself as friendly towards the administration, although, "When General Gomez was a candidate for President I was one of those who opposed him most bitterly, but there is no need for fear for the government headed by General Gomez. Certainly no idea can be entertained in regard to annexation, for that is a faraway dream for real Cubans."

There has come since almost a complete cessation of press attacks and sensational rumors regarding the government.



A peculiar industry in Havana, that of selling flowers and palms for the numerous patios in every house. To the right may be seen the seller of mangoes with his cart shaded with fronds of the royal palm to keep his fruit fresh.

Una industria peculiar á la Habana, la venta de flores y palmeras para los numerosos patios en cada casa. A la derecha se puede ver el vendedor de mangos con su carro con abrigo de hojas de corozo para guardar fresca la fruta.

The new custom house at Santiago de Cuba, inaugurated September 20, is a massive steel and stone structure, occupying an area of about 1,000 square meters, with large and spacious warehouses, and ample offices for the collector and inspectors.

The development of the *Camaguey Water Works.* Camaguey, Cuba, waterworks, which are now nearing completion, is described in a paper prepared for the recent convention of the New England Waterworks Association by Mr. Henry A. Young, under whose direction as chief engineer the present system has been installed.

The small creeks in the vicinity of the town were not available as sources of supply, on account of their uncertain flow and a scheme of installing a number of driven wells was abandoned because these furnished no artesian effect, the water in them was hard, and when warm had a very obnoxious taste. It was ultimately decided to utilize a surface supply 14 miles north of the town, from the Rio Pontezuela Grande, a good size creek with a drainage area of about 80 square kilometers. The plans provided for the construction of a dam across this stream, 278 m. long and 10½ m. high, to impound sufficient water for four months' consumption by 46,200 people, 54 per cent. larger population than that of the town to-day. An assumed per capita consumption of 60 gal. per 24 hours was used and it is thought that this will never be exceeded. In laying out the distribution system it was impossible to lay pipe in every street so that only the business section was piped completely and skeleton lines run to the outlying districts. There are four mains across the city connected by equalizers. The city is divided into 15 valve districts in which there is a total of 68 hydrants.

The works were built under the direction of Mr. Pompeyo Sariol, chief of the Department of Public Works; Mr. Henry A. Young, chief engineer of water works, and Messrs. Earle K. Knight and John E. Shoemaker, resident engineers.

To Suppress Immoral Plays.

Cuba's government is determined to suppress all immoral plays presented in the cities, and to this end the Department of the Interior has issued a circular calling upon all authors of dramatic works, plays for the burlesque theaters, and writers of "couplets," to furnish three copies. These copies, after revision, will be sent, properly stamped, one to the author, another to the theatre and the third to the theatre inspectors. These have orders from the Mayor to follow each play closely and to see that the actors adhere to the text.

VIEWS OF CUBAN CARTOONISTS.



PROBLEMA URGENTE.

El Pueblo:—Mi buen amigo; es preciso que vea con el Congreso como me abren esa puerta.

AN URGENT PROBLEM.

In the laborer's basket are coffee and cocoa. In the bundle, lumber; on the gateway in the wall are the words "Foreign Markets—Tariffs." The man is saying to President Gomez, "My good friend, it is necessary to consult with Congress as to how to best open this door for me."



THE IRON HAND.

On the tablet is the word "Law," on the book "Cuban Constitution." The fish dangling from the mailed hand indicates President Gomez, who is very fond of fishing. The representative of the Cuban people says: "We do not want iron hands here. We only asked to be governed according to the Law and the Constitution."

LA MANO DE HIERRO.

El Pueblo.—Aquí no queremos manos de hierro; sólo pedimos que se gobierne con la Ley y la Constitución.

The public believes that real fusion is still far off. Meetings of the committee appointed for the purpose continue, but nothing much is accomplished. As indicating that harmony is not entirely prevalent a recent dispatch said that Santa Clara provincial adherents of Vice-President Zayas wrote their leader recently refusing to unite with the Miguelistas and proclaimed themselves independent.

Meetings continue in various parts of the island in the hope of settling the differences, largely concerned with the proper distribution of offices.



EL ÚLTIMO CICLÓN.

Liborio. Póngale esta tranca al botijo cubano y riase de ciclón americano.

THE LAST AMERICAN CYCLONE.

On the plank which props the Cuban hut are the words "Good Government." The sound advice to the president by the representation of the Cuban people is "Place this plank against the hut and you can laugh at the cyclone."

The Reilly concession to lay tracks in the streets of Cienfuegos for the Cienfuegos, Trolley Palmira, Cruces and Manicaragua Railroad Company, has again met with opposition from the city council, which on September 17 adopted resolutions denying the authority to the railroad commission, which had given the company any right to construct the work, and ordering the removal of all tracks already laid.

At present Contractor Reilly and the representative of a Canadian company, which also claims having received a franchise, are fighting in the courts.

Ortelio Foys, Cuban Secretary of Agriculture, Industry and Commerce, has addressed a circular to all plantation owners, asking for information concerning the number and families of immigrants they could find use for on their sugar plantations, also data describing the character of the labor required of the immigrants and the wages paid.

This is in furtherance of the government scheme long promised to supply the sugar estates with the necessary labor usually insufficient for harvesting the sugar crop.

In a suit by Raja Yoga, based on an article in La Opinion, the Cuban Court sentenced the former editor, Senor Angel Morales, to pay \$400 fine. Raja Yoga considered himself wronged in the article, which referred to the treatment given to Cuban children at Point Loma Academy, California.

MINOR NOTES.

The construction of the 710-ft. concrete bridge over the Almendares River, near Havana, is progressing satisfactorily. The work was started in December, 1908, and one small and two large spans are now in place, assuring completion during 1909. The original contract price was \$180,000, but changes in the plans will make the cost somewhat higher.

President Gomez has requested the Department of Public Works to make a special study of providing all the towns in the island, wherever lacking, with an adequate water supply. These works, like all public works, must be advertised and public bids invited.

The official act of opening the courts of justice of the Republic for the judicial year 1909-1910, in accordance with the provisions of the organic law of the judicial power, took place September 1. President Gomez presided.

Offices of the American legation in Havana are now in new quarters in the Lonja del Comercio building. The Spanish legation is also in the same building.

The new Municipal Emergency Hospital in Havana was formally opened September 3. It is housed in a modern two-story steel and stone building and is one of the best in the city.

Resulting from personalities in "El Comercio," its editor, Wilfredo Fernandez, and Maj.-Gen. Enrique Loyanz del Castillo, a former Congressman, fought a duel in a private house in Havana on September 21, with cavalry sabres, the latter being slightly wounded.

General Gerado Machado and Commander Morales Coello were appointed by President Gomez to represent the Cuban Government in the Hudson-Fulton celebration.

Arturo Betancourt, who killed his brother, Roberta A. Betancourt, general manager of the Camaguey Electric Railway Co., on June 26, and who was subsequently declared insane by examining physicians, was removed on September 17 to the insane asylum at Mazorra.

The law governing executions in Cuba provides that the executioner shall be a convict who, when he takes his office, is transferred from the penitentiary, where he does hard work, to the carcel in Havana, where he leads an easy life. He receives a considerable commutation of his sentence for good behavior and for every execution the sum of \$17 Spanish gold.

A comparative table of births and deaths in Cuba for the first six months of 1908 and 1909 show the death rate per thousand in Cuba to be in 1908 14.17, and for 1909 12.76. "Sanitary laws are enforced with scrupulous care," says Dr. Martias Duque, secretary of Public Health and Charities, "and methods are being constantly improved, which accounts for the almost complete extinction of malaria and yellow fever, and the decrease in general mortality."

Fifty-eight laundry workers, mostly women, arrested in connection with the women ironers' strike last May, face four months imprisonment if convicted of the charge against them of "conspiracy to alter prices."

The trial of the former editor of La Defensa, on charges of criminal libel, made by the Raja Yoga school in Santiago de Cuba, began September 8. The attorneys for the school entered their specifications, charging twelve counts upon which libel and calumny are alleged and ask that an aggregate sentence of thirty-six years be imposed.

The insane asylum at Mazorra has been modified radically with respect to the service of the school for nurses. An expert American lady has been placed in charge and with two others from London will thoroughly instruct the Cuban nurses in the work of caring for their insane charges. The hospital buildings will also be greatly improved and long needed appliances and equipment installed.

The Riverside (Cal.) Y. M. C. A. has introduced in its work a course of popular lectures for citrus fruit growers by leaders in the industry. These have given very helpful discourses from the preparation of soil through to the harvest. The sessions, held every two weeks, are attended by up-to-date growers and are becoming a veritable citrus institute, with short addresses and general discussion. Very helpful to all interested.

A national asylum for the poor of Cuba, with accommodations for 200, will soon be inaugurated.

A new Cuban consul, Senor Julio R. Embil, formerly of Havana, Cuba, has been appointed honorary Cuban consul in Jacksonville.

Charles E. Magoon, former Governor of Cuba, arrived in Paris September 16.

THE PRESS OF THE UNITED STATES.

The National Lottery.

The Cuban national lottery still very generally interests the press of the United States. The Utica, N. Y., Press says, "In some respects the Cuban postal laws were fashioned after those of the United States, but if there was anything therein which prevented carrying on lotteries that has been eliminated."

The Jacksonville (Fla.) Times-Union discusses the purchase of Cuban lottery tickets in the United States and asks:

"Why should the government desire to deny its citizens the opportunity to invest in lottery tickets? Not to save them from the dangers of financial speculation, because it has not attempted to interfere with gambling in stocks, which is certainly no better investment to outside parties than a flyer in a lottery. Not because the purchase of a lottery ticket is immoral, because these are still sold at church fairs in this country, and we are now advertising from Washington a lottery of our own, with all the accompaniments and the increased expense of a long journey to a specified place."

Official Cuba thinks one way, official United States another, says the New York Times. "One could let it go at that," it says further, "were it not for the fact that Cuba cannot run a state lottery without causing us a vast amount of trouble, just as she could not continue to permit her capital to be a breeding place for yellow fever without inflicting upon our coast cities enormous losses of life and property. Perhaps that does not give us a right to tell Cuba that she must not have a lottery, as we have told her that she must keep free of yellow fever, but it comes pretty near doing so."

Money earned through the lottery is tainted money, says the Columbus (O.) Despatch. "It is the price of a false standard of money-getting among the people. A few may be enriched in some degree, but by far the greater number will be impoverished, and among all there will be spread the false notion that chance, and not work, is the best means of gain."

The Columbus (O.) State Journal expects Cuba to "descend into the valley of tumult and trouble" because of the lottery. It says: "The idea that it can be prosperous on an income from a lottery is as absurd as the search for perpetual motion. They are parts of the same dream. A person cannot get anything out of nothing and thrive on it. A man must pay for what he gets some way—either in adequate reward or in misfortune or trouble."

Restricting the Sale of Firearms.

The order of President Gomez that firearms suitable for military use shall hereafter be imported only at certain designated places and under special license, and sold only in limited numbers to persons known to the government, is very generally commended. The New York Tribune says:

"There can be no legitimate objection to such an order. It is not infringement of the proper rights and privileges of the people. The only purpose there can be in importing military rifles is that of war, which only the government has the right to wage, or individual manslaughter, which is a crime. Men do not want Springfield rifles for snipe shooting, and for purposes of protection against marauders, if anything of the sort is needed, a shotgun is worth a dozen rifles. So the very possession of military arms, except under government license and supervision, may be forbidden on the ground that their only probable use is one which is unlawful."

The Boston (Mass.) Advertiser thinks the caution of the Cuban government in restricting the sale of firearms cannot be called excessive. It says:

"While no imminent danger of revolution appears, these precautions offer the "stitch in time." The Cuban government knows the working of the revolutionary idea—it knows that the same forces who defied Spain through so many costly years might be perverted to strike against the republican government in power."

The Cleveland (O.) Plain Dealer says: "Such precautions are undoubtedly wise. They would be wise in any country, but they are doubly and triply commendable in Cuba, where the guns and the people behind the guns are likely to explode at any moment."

Cuba's Favorable Condition.

The New York Tribune would like to know the source of unfavorable accounts of Cuban affairs so very generally circulated. It finds from credible information obtainable precisely contrary conditions. It says:

"The fact that railroad earnings have materially increased since the restoration of insular autonomy and that prices of all public and corporate securities have risen might be explained by the fact that similar processes have prevailed in this country and generally throughout the world this year. Yet what more can reasonably be asked than that Cuba shall share in the general prosperity and progress of the world? The decreasing death rate, the smaller number of crimes and misdemeanors, the growth of revenue, the increase of immigration, the execution of important public works, the marked abatement of political animosity and unrest and the general rallying of the various parties to the support of the government, all suggest the groundlessness of the unfavorable views which have been expressed."

THE PRESS OF THE UNITED STATES.

From Utah. The Salt Lake City Telegram hopes Cuba will never again need outside assistance. It says: "We want no Latin states in our republic; we have plenty of trouble, plenty of vexatious problems to solve, and surely do not desire to add to them. Godspeed Gomez, and give to his people a disposition to sustain him.

The Providence (R. I.) Journal calls it "Cuba's easy money producer." Nevertheless it says that:

"Judged even by the ordinary formulæ of gambling the profit in this game seems excessive; especially as the government is relieved of all risk. The Cubans are taxed thirty-three and one-third per cent. for the privilege of playing the game. Thus the lottery must be almost as heavy a burden on the Cubans as the tariff is on the Ultimate Consumer in our own country."

Uncle Sam is mulish, says the Boston Post, in his attitude toward the raising of the Maine in Havana harbor. "For ten years a hulk has obstructed navigation in the harbor of the capital of a sister republic. Neither courtesy nor law requires Cuba to longer await action on the part of the United States in abatement of this nuisance. The American government cannot decently oppose action in that direction. Its attitude is that of the dog in the manger."

Cuba makes a good truck garden for the United States, and some of our best fruit comes from "the island empire."—Norwich (Conn.) Bulletin.



LEST HE FORGET.

Cuba:—"Couldn't you spare time to remove this obstruction?"—Baltimore American.

POR MIEDO DE QUE OLVIDE.

Cuba:—No puede Ud. disponer del tiempo para quitar este obstáculo? Los encabezamientos en el periódico que el Tío Sam lee son: La disputa del Polo Norte. Los registros de vuelos.

CUBA'S BONDED DEBT AND ITS REVENUE.

The bonded debt of the Republic of Cuba and the receipts of the government from its custom revenues, special taxes and other revenues during the last few years are described in a letter to Speyer & Co., of New York, from the Treasury Department of Cuba:

There are outstanding at present the following issues of bonds of the Republic of Cuba:

\$2,196,585 6% bonds, which are to be paid off from the proceeds of the \$16,500,000 4½% bonds just sold to you; \$11,100,000 internal 5% bonds, and \$35,000,000 5% bonds, loan of 1904.

The \$11,100,000 internal bonds have no special security, but there is assigned \$50,000 in the budgets for their amortization.

The \$35,000,000 5% bonds, loan of 1904, are secured by the pledge of the "Special Taxes" and 15% of the custom receipts.

The amount required to pay the interest on the \$35,000,000 bonds is \$1,750,000 annually, and after 1910 there will be further required for the sinking fund for the retirement of these bonds the sum of \$1,080,000 per annum. The special taxes alone have, however, always realized more than the amount required for both the interest and the sinking fund of these bonds.

The custom receipts, special taxes and other revenues during the past few years have amounted to as follows:

| | Custom Receipts. | Special Taxes. | Other Revenues. |
|------------------------------------|---------------------|-------------------|--------------------|
| For year ending June 30, 1907..... | \$24,733,183.49 | \$3,987,165.37 | \$2,761,970.07 |
| “ “ “ “ 1908..... | 24,740,594.44 | 3,785,379.55 | 2,687,007.12 |
| “ “ “ “ 1909..... | 22,143,055.35 | 3,627,376.71 | 2,725,180.20 |

(Signed) JUSTO GARCIA VELEZ,
Secretary of State and Acting Secretary of the Treasury.

THE TREASURY OF CUBA.

Official Report of the Secretary of the Treasury, Showing Condition on August, 1909.

| ASSETS. | LIABILITIES. |
|--|--|
| General Treasury: | Advance orders in transit..... 401,276.15 |
| Cash on hand.....\$184,677.99 | Postal money orders..... 340,365.75 |
| Deposited with the National Bank of Cuba. 37,662.57 | Debts pending 20,054.97 |
| Deposited with the Royal Bank of Canada 180,000.00 | Honorary consuls 1,216.00 |
| Collections: | Taxes on the loans..... 835,581.12 |
| Cash on hand..... 103,103.47 | On deposit for the loan 1st 50% Balance due to the Army of Liberation, 2d half..... 363,462.32 |
| Public taxes: | Epidemic diseases 49,441.52 |
| Balance against this account... 9,067,508.00 | Individual contracts 96,442.45 |
| | Special Laws of 1906..... 1,417,043.69 |
| | Special Laws of 1909..... 962,538.40 |
| | Decree of the Provisional Governor 3,270,818.10 |
| | Maintenance of detained immigrants 1,866.43 |
| | Sewering and paving of the City of Havana..... 1,532,674.31 |
| Total.....\$9,572,951.13 | Total.....\$9,572,951.13 |

Trust Company's New Building.

The Trust Company of Cuba acquired title on September 16 to the building at No. 53 Obispo Street, Havana, the purchase price being quoted at \$55,000. The company intends to erect a new building on the plot, which will be the home office of the bank.

Gas and Electric Company Report.

The Gas & Electric Company of Havana has issued a report for the first six months of 1909 as compared with the same period in 1908, as follows:

| | Receipts. | Expenses. | Differences. |
|---------------------|--------------|--------------|--------------|
| 1909...\$945,403.15 | \$402,671.39 | \$542,731.76 | |
| 1908... 855,739.37 | 390,807.34 | 464,932.03 | |

RAILROAD NEWS AND TRAFFIC RECEIPTS.

Havana Electric Railway Co.

| | | Weekly Receipts. | | From Jan. 1. | |
|-------------|--------------|------------------|----------|--------------|-------------|
| | | 1909. | 1908. | 1909. | 1908. |
| Week ending | Sept. 5..... | \$42,430 | \$37,600 | \$1,394,553 | \$1,300,122 |
| " | " 12..... | 41,739 | 36,581 | 1,436,292 | 1,336,703 |
| " | " 19..... | 36,461 | 34,918 | 1,472,753 | 1,371,621 |
| " | " 26..... | 37,628 | 33,781 | 1,510,381 | 1,405,402 |

United Railways of Havana.

| | | Weekly Receipts. | | Receipts for Fiscal Year. | |
|-------------|----------------|------------------|---------|---------------------------|----------|
| | | 1909. | 1908. | 1909. | 1908. |
| Week ending | Aug. 28..... | £13,177 | £12,144 | £119,871 | £102,321 |
| " | " Sept. 4..... | 14,473 | 12,243 | 134,344 | 114,564 |
| " | " 11..... | 15,549 | 12,846 | 149,893 | 127,410 |
| " | " 18..... | 13,961 | 12,037 | 163,844 | 139,447 |

Cuban Central Railway.

| | | Weekly Receipts. | | Receipts for fiscal year | |
|-------------|-----------------------|------------------|--------|--------------------------|---------|
| | | 1909. | 1908. | 1909. | 1908. |
| Week ending | August 28 | £5,201 | £4,890 | £44,606 | £39,263 |
| " | September 4 | 4,934 | 5,243 | 49,540 | 44,506 |
| " | September 11 | 5,138 | 5,141 | 54,078 | 49,647 |

Western Railways of Havana.

| | | Weekly Receipts. | | Receipts for fiscal year | |
|-------------|-------------------------|------------------|--------|--------------------------|---------|
| | | 1909. | 1908. | 1909. | 1908. |
| Week ending | August 28 | £4,939 | £7,676 | £41,091 | £52,183 |
| " | " September 4 | 5,803 | 7,206 | 46,954 | 59,389 |
| " | " September 11 | 5,657 | 7,227 | 52,611 | 66,616 |

The Cuba Railroad Company Report.

Statement of earnings and expenses, month of July.

| | 1909. | 1908. |
|---------------------------|--------------|--------------|
| Gross earnings..... | \$162,429.31 | \$153,786.15 |
| Working expenses..... | 113,411.73 | 90,322.25 |
| Net profits | \$49,017.58 | \$63,463.90 |
| Fixed charges for month. | 34,995.83 | 32,262.50 |
| Surplus for month.... | \$14,021.75 | \$31,201.40 |
| Gross earnings from | | |
| July 1 | \$162,429.31 | \$153,786.15 |
| Net profits from July 1. | 49,017.58 | 63,463.90 |
| Fixed charges from July 1 | 34,995.83 | 32,262.50 |
| Surplus from July 1... | \$14,021.75 | \$31,201.40 |

Cuba Eastern Sale Confirmed.

Judge Lacombe, in the United States Circuit Court, handed down an order Sept. 24 confirming the sale of the roads, properties, assets and franchises of the Cuban Eastern Railroad Company, the Northeastern Cuba Railroad Company and the Cuba Eastern Terminals Company to J. McD. Garfield and F. Chauncey Anderson for a total of \$90,000.

The sale was made on Aug. 31 and the petitioners were the only bidders, and the masters reported that the sale was filed on Sept. 2. The order makes the sale absolute, subject, however, to the

terms and conditions of the decree of the court in the foreclosure proceedings.

Cuba's Interior Communications.

The erroneous notion of the inaccessibility of the interior of the island must be overcome at once. Cuba was the second country in America to operate a steam road, being in this respect eleven years in advance of Spain. The date of this first road was 1837. Since then the mileage has increased to about 2,500 miles, so that, compared for instance with Tennessee, which has somewhat similar geographic conditions and is almost the same size, Cuba is by no means lacking in interior communication.—John Barrett, in the New York Independent.

The Camaguey Company.

Comparative statement of earnings for August, 1909:

| | Aug., 1908. | Aug., 1909. | Increase. |
|------------------------------|-------------|-------------|-------------|
| Gross .. | \$10,279.01 | \$11,287.74 | \$1,008.73 |
| Net . . . | 4,016.38 | 5,070.94 | 1,054.56 |
| For eight months to Aug. 31: | | | |
| | 1908. | 1909. | Increase. |
| Gross .. | \$74,223.41 | \$87,372.41 | \$13,149.00 |
| Net . . . | 34,272.40 | 40,304.49 | 6,032.09 |

FINANCIAL AND RAILROAD MATTERS.

Cuban Government Flourishing.

An official pamphlet called "The Republic of Cuba in 1909," issued recently by the secretary of President Gomez, ought to influence favorably American sentiment regarding Cuba because its statements of fact will go far toward counteracting many of the malicious tales to which undeserved and unfortunate circulation has been given in this country.

It shows the attitude of investors toward various Cuban securities by a comparison of market quotations on June 30, 1908, under the Magoon administration, with those of June 30, 1909, under the Gomez administration. An advance is shown in all cases, including state and municipal bonds, and the issues of private corporations. Details of official quotations on June 30, 1908 and 1909, follow:

| | 1909. | | 1908. | |
|-----------------------|-------------------|-------------------|------------------|------------------|
| | Bid. | Asked. | Bid. | Asked. |
| Repub. of Cuba loan | 112 | ... | 110 | ... |
| Interior Debt | 101 | 109 | 95 | 99 |
| First mortgage bonds | | | | |
| "Ayuntamiento" of | | | | |
| Havana | 117 | 120 | 115 | 119 |
| Second mort. bonds. | 116 | 118 | 112 | 114 |
| Electric & Gas Co. of | | | | |
| Havana | 116 $\frac{1}{4}$ | 119 $\frac{1}{2}$ | 108 | 111 |
| Havana El. Ry. bonds | 101 | 108 | 86 | 93 |
| United Rys. of Hav. | 110 | 115 | 108 | 114 |
| Spanish Bank | 79 | 79 | 62 $\frac{1}{2}$ | 63 $\frac{1}{4}$ |
| Hav. Elec. Ry. com. | 65 $\frac{3}{4}$ | 66 $\frac{5}{8}$ | 24 $\frac{1}{8}$ | 25 $\frac{1}{4}$ |

The recapitulation of the statistics of the pamphlet which covers population, imports and exports, public works, railroads, etc., concludes with these words:

"The situation cannot be more promising. The present condition of the administration and local politics is perfectly clear and it is expected

that the republic will recover its credit shortly and demonstrate that the Cubans are able to govern themselves and that the tears shed and blood spilled for the independence of the country have not been in vain."

A New Ferryboat.

A novel type of vessel, to serve as a ferryboat at Havana harbor for the Havana Central Railroad Company, was launched Sept. 4 at Glasgow. The new vessel is named the Guanabacoa, and is now ready for service.

Her principal dimensions are: Length over all, 140 feet; breadth, moulded, 55 feet; depth, moulded amidships, 14.2 $\frac{1}{2}$ feet, and speed on trial, 10 $\frac{1}{2}$ knots. She is built of steel to Lloyd's 100 A class and under special survey.

The propelling machinery consists of one set of compound surface condensing engines with cylinders 19 inches and 42 inches diameter and 2 feet 3 inches stroke, fitted with piston slide valves to both cylinders, and working with a pressure of 150 pounds per square inch. They are designed to drive two screws (one at each end) and to steam equally well in either direction. The boiler installation consists of two marine boilers loaded to a pressure of 225 pounds per square inch. A leading feature is the small amount of deck space occupied by the casings covering the machinery.

A second boat is now being overhauled at New York and will soon be ready. It is the West Brooklyn, formerly in service on the 39th Street ferry, New York City, and is a large double-decked boat, measuring 185 feet. She will be named the Havana.

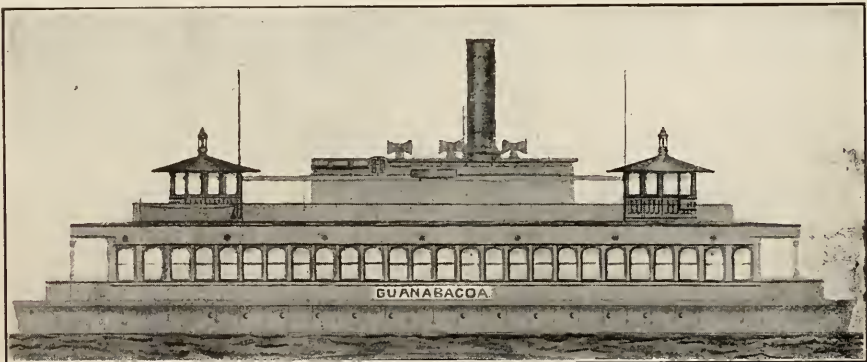

THE NEW FERRYBOAT FOR HAVANA.

Dentro de poco la Compañía del Ferrocarril Central de la Habana pondrá en operación un nuevo vaporcito para hacer la travesía entre la Habana y Regla. Este vapor acaba de ser construido en Glasgow y ya está listo para prestar servicio. Tiene 140 pies de largo por 55 de ancho, está construido de acero y equipado con dos hélices, uno a cada extremo, y en su viaje de ensayo desarrolló una velocidad de 10 $\frac{1}{2}$ singladuras por hora. Se le va a dar el nombre de "Guanabacoa." Se está construyendo asimismo otro vapor de esta clase pero mucho más grande, el cual tiene doble cubierta y mide 185 pies de largo, al cual se le va a dar el nombre de "Habana."

FINANCIAL AND COMMERCIAL MATTERS.

American Boots and Shoes.

The suicide of Antonio Cabois on Sept. 10, a prominent shoe manufacturer of Havana, was caused, his friends say, to lessening trade, country merchants' demand for his stock having fallen away materially.

His manufacture was both on Spanish and American lasts, but the latter make could not compete with those of American manufacture, either in prices or in quality, although he employed skilled workmen.

He started the business during the first American intervention, when high duties were placed upon shoes and American manufacturers began to invade the Cuban market. The higher grade of American shoes, from the time American manufacturers began to cater to Cuban preferences in footwear practically threw all other shoes out of the market, with the exception of some French made women's shoes that are yet in large demand.

The official figures of United States exports to Cuba of boots and shoes for the year ended June 30 are as follows:

| | Quantity, Pairs. | Value. |
|----------------|---------------------|-------------|
| 1907 | 1,275,687 | \$2,145,415 |
| 1908 | 1,976,901 | 2,577,966 |
| 1909 | 2,205,133 | 2,529,615 |

Duties on Soaps, Perfumes, Etc.

The Consul General of Cuba at New York answers an inquiry as to duties on soaps, perfumes, etc., entering Cuba, and quotes the Cuban customs tariff as follows: The rates are for goods of American manufacture:

Soap.—(a) Common soap in bars, including castile soap and ordinary scouring compositions, G. W.—100 kilos., \$2.73. (b) Ordinary toilet soaps in cakes or tablets, G. W.—100 kilos., \$9.10. (c) Fine toilet soaps, whether fancy, perfumed or not, and all others including so-called medicinal or medicated soaps, G. W.—100 kilos., \$15.60.

Perfumes and Essences.—(a) Of value less than \$1.25 per kilog.—Kilog., \$.195 (b) Of value more than \$1.25 per kilog.—Kilog., \$.195, and per cent ad valorem, 19 and a half.

Toilet Articles.—(a) Toilet articles, not specially mentioned, 26% ad valorem.

Cuba's Custom House Receipts.

For the first six months of 1908 the receipts totaled \$14,130,467.69 and for the same period in 1909 \$14,856,471.17, an increase in the latter year of \$726,003.48.

Cacao in Cuba.

Cuba's production of cacao in 1906 and 1907, from official reports, is as follows:

| | Kilograms.* |
|----------------|-------------|
| 1906 | 3,271,969 |
| 1907 | 1,689,668 |

In consumption of cacao for the year 1907 the United States leads, with 37,526,505 kilograms; Germany, 34,515,400; France, 23,180,300; England, 20,159,472; Holland, 12,219,249; Switzerland, 7,124,200; Spain, 5,628,239; Austria, 3,471,700; Belgium, 3,253,967; Russia, Italy, Canada, Denmark, etc., with a total of 7,619,809 kilograms.—Philippine Agricultural Review, May, 1909.

* A kilogram equals 2.20642 avoirdupois pounds.

A Project Abandoned.

The Los Nunez Company, formed about a year ago by a syndicate of Lexington and Louisville, Kentucky, business men for the purpose of establishing a breeding plant in Cuba, has decided to abandon its project.

A lot of land had been purchased and the idea was to establish a large breeding farm there and to push the breeding of the American saddle horse in Cuba. Major Castleman, who is an authority on saddle horses and who possesses some of the best stock of this kind in Kentucky, was at the head of the project.

The first known of the abandonment of the scheme was when the 30 high class saddle horses, the nucleus of the Los Nunez stud, were ordered sold at auction in Lexington on Oct. 9.

Havana Winter Festivities.

The City Council of Havana, Cuba, plans this year for an elaborate program during the winter festivities. This will call for a lot of electrical work. Manufacturers, supply houses, contractors, and others interested, should communicate with Remigio Jimenez, engineer, Malecon 240 Altos, Havana, Cuba.—Electrical Review, New York.

Havana's Custom House Collections.

| | 1909. | 1908. |
|------------------|----------------|----------------|
| August | \$1,516,254.53 | \$1,223,360.09 |

Santiago's Customs Collections.

Santiago custom house receipts for August were as follows:

| | |
|----------------|--------------|
| 1909 | \$126,664.73 |
| 1908 | 115,743.91 |

Cotton Goods and Trade Opportunities.

The splendid opportunities for increased cotton goods trade with Cuba, and methods of increasing trade are described in the report which W. A. G. Clark, the special agent of the United States Department of Commerce and Labor is about to submit to his government. Mr. Clark has been conducting an investigation along the lines of his report, not only in Cuba, but other countries, studying textile conditions.

In submitting Mr. Clark's report to Secretary of Commerce Nagel, Chief of the Bureau, John M. Carson, has this to say, which makes interesting reading for all in the textile trade:

"The report gives the results of Mr. Clark's investigation in Cuba, Mexico and the different republics of Central America. The conclusion drawn from these inquiries enforces the value of this market for the United States, Cuba, after Brazil, the Argentine Republic and Chili, is the best market for cotton goods of any country in Latin America. Its imports now amount to more than \$10,000,000 annually, and now steadily growing. Of this trade the United Kingdom has goods to the value of \$1,000,250 annually, being in this respect behind Spain. The trade has improved under the reciprocity treaty with Cuba, which grants a reduction of 40 per cent. on knit goods and 30 per cent. on other manufactures of cotton. Ultimately this trade will be controlled by the United States. In the meantime the special agent suggests that a large proportion may be obtained by a closer study on the

part of exporters of the United States of the detailed reciprocity rates. He also points out the advantages which would result if the reduction on goods from the United States were placed at 50 per cent."

Cuban Iron Ore Shipments.

The iron ores which have been mined in Cuba up to the present time consist largely of hematite and magnetite and are obtained near Santiago, in the Province of Oriente (Santiago). Recently large deposits of brown ore have been attracting considerable attention, especially those of the Mayari and Moa fields in Oriente Province and those of the Cubitas field in Camaguey Province. No ores of this type have been mined, however.

The following table, taken from a report of the United States Geological Survey, shows the shipments of iron ore from Cuba since the opening of the mines in 1884:

| SHIPMENTS OF IRON ORE (in long tons). | | | |
|---------------------------------------|---------|-----------|---------|
| 1884..... | 25,295 | 1897..... | 454,285 |
| 1885..... | 80,716 | 1898..... | 168,339 |
| 1886..... | 112,074 | 1899..... | 377,189 |
| 1887..... | 94,249 | 1900..... | 446,872 |
| 1888..... | 206,061 | 1901..... | 552,248 |
| 1889..... | 269,291 | 1902..... | 669,734 |
| 1890..... | 363,842 | 1903..... | 632,621 |
| 1891..... | 264,262 | 1904..... | 387,273 |
| 1892..... | 341,654 | 1905..... | 561,159 |
| 1893..... | 351,175 | 1906..... | 640,574 |
| 1894..... | 156,826 | 1907..... | 681,393 |
| 1895..... | 382,494 | 1908..... | 819,434 |
| 1896..... | 412,995 | | |

By far the large proportion of this ore came to the United States, the imports from Cuba in 1908 being 579,688 long tons.



North Coast Reefs.

CUBAN TRADE IN 1908 AND 1909.

Foreign Commerce During the Last Two Fiscal Years.

The following statistics were compiled in the Bureau of Manufactures from officials returns issued by the Cuban government at Habana.

The imports and exports of Cuba, by countries, during the two fiscal years ending June 30, 1908 and 1909, were as follows:

| Merchandise. | Countries. | | Imports from | | Exports to— | |
|--------------------------------|------------|--|--------------|--------------|--------------|---------------|
| | | | 1907-8. | 1908-9. | 1907-8. | 1908-9. |
| United States | | | \$46,450,908 | \$42,593,894 | \$81,715,884 | \$99,973,369 |
| Germany | | | 7,762,751 | 6,350,534 | 3,741,795 | 4,484,290 |
| Spain | | | 8,816,810 | 7,377,662 | 795,687 | 1,017,599 |
| France | | | 5,854,474 | 4,793,469 | 1,768,742 | 1,296,441 |
| United Kingdom | | | 14,550,912 | 10,639,462 | 5,145,571 | 4,950,040 |
| Other American countries | | | 8,301,268 | 7,285,289 | 2,718,605 | 2,453,336 |
| Other European countries | | | 3,624,233 | 3,336,100 | 868,179 | 980,996 |
| All other countries | | | 1,631,778 | 1,523,824 | 692,984 | 471,976 |
| Total | | | 96,993,134 | \$83,900,234 | \$97,447,447 | \$115,637,047 |
| | | | | | | |
| | Specie. | | | | | |
| United States | | | \$136,525 | \$18,348 | \$12,027,290 | \$1,483,700 |
| Spain | | | 481,516 | 13,120 | 165,171 | 442,846 |
| France | | | 1,217,022 | 2,782,928 | 2,480,644 | |
| All other countries | | | 724 | 140 | 1,915 | |
| Total | | | \$1,835,787 | \$2,814,536 | \$14,675,020 | \$1,926,546 |

CARAVONICA COTTON IN CUBA.

United States Department of Agriculture,
Bureau of Industry.

Washington, D. C., Sept. 17, 1909.

Editor of the CUBA REVIEW,
82 to 92 Beaver Street,
New York, N. Y.

Dear Sir: In the August number of the CUBA REVIEW I note another reference to the Caravonica cotton. So much has been said in praise of this variety and such high hopes have been entertained as to the prospects of a new and paying industry along this line that a statement as to the present condition of the Caravonica cotton in Cuba may not be amiss.

A year ago in August I visited the plantations at Monte Cristo, near Baracoa, Cuba, where the cotton was grown experimentally. At that time the trees were doing splendidly and had a good bearing of flowers and bolls. The climate and soil were evidently suitable for the plants. I have just returned from another trip to Baracoa and, while I did not visit Monte Cristo, I conversed with several of the owners of the cotton at that place. They told me that the prospects of a successful cotton crop are absolutely hopeless. Some time during this spring all of the bolls and flowers dropped from the trees, apparently affected by the boll weevil. This being the condi-

tion, the owners have practically given up the idea of growing Caravonica cotton at Monte Cristo. I have no proof that it was the boll weevil that caused the damage, but the planters were well read on the subject and I think were able to judge correctly for themselves. Mr. W. T. Horne, recently of the Estacion Central Agriconomica, also told me that it was the boll weevil, and, according to him, it is common throughout Cuba.

Such being the condition at Monte Cristo, where the cotton was given a trial of about a year and a half, it seems inadvisable to plant Caravonica cotton any more than any other cotton in that district. Although the boll weevil may not be in every locality at present, the probabilities are that soon after a good stand of cotton is secured the weevil will appear in great numbers.

What Cuba needs is, not so much a variety of excellent cotton, as some means of protecting what cotton they have from these insect attacks. Caravonica cotton averages a very good grade of cotton, but, unfortunately, it is not immune to the attacks of the boll weevil.

Yours very truly,
JOHN R. JOHNSTON,
Assistant Pathologist.

COFFEE IN CUBA.

(By D. H. Howell, Ceiba Mocha, Cuba)

It is claimed by many that the coffee industry is not likely to be revived in Cuba to any great extent on account of the present high price of labor. As picking the coffee is quite an item of expense, a look at the accompanying photo may suggest a partial solution of the problem, "Let the women do the work."

The picture shows Cuban coffee trees full of coffee, and an imported "coffee picker." Whether coffee can again be made a paying crop commercially in this part of Cuba I am not prepared to say, but I do say that every family of coffee drinkers settling in Cuba should follow the good example of the better class of Cuban farmers and plant enough coffee trees near their houses, under the shade of other fruit trees, to supply their own needs.

Even in many of the Cuban villages we often find a good number of beautiful coffee trees in the yards planted beneath the mango, aguacate, mame and other fruit trees. The coffee tree with its shining dark green leaves has much the appearance of the holly tree, at any time of the year, but especially so when the coffee is ripe and the berries are red. From a little distance a clump of coffee trees when in bloom, have the exact appearance of trees in the north covered with snow. The little white, starlike blossoms fill the air with a delicious perfume, similar to that of the tuberose. To attain the best success with coffee, the trees should be planted in virgin soil or at least in soil that has not been planted with other crops for many years. Where the soil and climate are right, the ideal place to plant is in a virgin forest—just cutting out enough trees to leave the required amount of shade. All the trees and brush cut being burned on the ground, helps to sweeten the land, and when two-year-old trees are set in good ground thus prepared they will begin to bear the second year from planting.

It is customary to top the trees when they reach about six feet, in order to save labor in picking, also to prevent damage by wind. There is in this vicinity a large plantation for many years used as a stock ranch, which in slavery times produced a crop of three hundred thousand pounds a year, all of which was sent to Spain.

Cocoanut Bud-Rot in Cuba.

In circular No. 36 of the Bureau of Plant Industry, United States Depart-



The "imported" coffee picker is the daughter of an American settler in Cuba.

Una señorita americana y el árbol del café en el patio de un colono americano en Cuba.

El autor del artículo en esta página insta á todas las familias á que sigan el ejemplo dado por los mejores hacendados de Cuba y propaguen el cultivo del café para sus propias necesidades domésticas.

Los cafetos ó árboles del café empiezan á dar fruto al segundo año de ser plantados, y durarán muchos años si son atendidos con cuidado. Como la recolección de las cerezas del café ocasiona un gasto crecido y los jornales en Cuba son muy altos, sugiere la idea de emplear mujeres para recolectar las cerezas del café.

ment of Agriculture, entitled "The Bud-rot of the Cocoanut Palm," and issued July 9, 1909, the present position in regard to the disease is reviewed.

Notes in regard to the bud-rot of cocoanut palms have appeared in various publications in recent years, but it may not be generally known that, apparently, this same disease destroyed many cocoanut groves in the Provinces of Matanzas and Havana, Cuba, as early as 1886. A long report on the disease was published at Havana in 1882. Its occurrence was reported in Baracoa, on the eastern end of the island, in 1888, and according to the natives, it was present at least ten years before that time.

OUR CLAIM TO THE ISLE OF PINES.

Comments of United States Newspapers on Senator Moses E. Clapp's Article.

In the current number of the North American Review Senator Clapp, of Minnesota, calls attention once more to the fact that we are letting slip our claims to the Isle of Pines. He thinks it is ours by every right and considers the time ripe to assert our rights in the premises, not only because we need it, but in justice to those Americans who have invested money there, have made it their home and are now in a most unsatisfactory condition.

Senator Clapp says that it was the understanding of all the American and Spanish commissioners that we were to have the Isle of Pines. We were specifically conceded the sovereignty over Porto Rico and the other islands of the West Indies belonging to Spain, except Cuba. Now the Isle of Pines never was a part of Cuba administratively, he says further, and was recognized as a separate island. The Cubans, instead of showing gratitude, immediately set up claim to it and we made a treaty by which the question was left to "future negotiation." Thus the matter rested for some years until the Root treaty by which we ceded the island to Cuba. That treaty has not been ratified by our Senate and probably never will be, but, unfortunately, no time limit was set for acting on it, which is contrary to the usual practice. Cuba now controls the island and will soon set up a prescriptive right unless we take some action in the premises.

In conclusion, he says:

The government cannot afford to rest under the imputation of having abandoned its enterprising citizens who relying on what they supposed were authentic official assurances, illustrated the American spirit of enterprise by embarking in schemes which looked to the development and settlement of United States territory.

Mayor Ortiz made a report September 22 to the provincial governor, that Americans in the Isle of Pines had at a meeting protested against delay in the liquidation of business relating to transactions in lands by the fiscal zone officer. They also complained of the closing of the schools for American children and some hunting regulations which forbids the shooting of many birds, described as inimical to agriculture. Written objections will be sent to President Gomez.

The Philadelphia Inquirer, commenting on the article, says:

"There is a moral obligation upon us to protect those Americans who went down there thinking it American soil."

The Boston Herald takes the opposite view and says that "any attempt to revive American claim to the island deserves to be frowned on by public opinion in the United States."

It says further:

"Against any assumption of American ownership there is the declaration of the Supreme Court, in a case which involved a thorough investigation of all claims, the declaration of President Taft when Secretary of War, the opinion of the then Secretary of State, Mr. Root, and the record of our Provisional Government, which during its tenure recognized the Isle of Pines as properly a part of the political domain of Cuba. If by any possibility there might be discovered some technicality on which the United States could base a claim to title in the island, the movement to enforce such a claim should be as vigorously opposed. President Taft, when Secretary of War, declared that any move to separate the island from Cuba would be a "violation of a sacred trust," and again, "If the island were divorced from the authority of Cuba, it would, without doubt, become the base of operation of the opposition to the established government of Cuba. It would be a convenient nursery for revolution, and constant vigilance would be required to maintain the present attitude of friendly protection which is the boast of our Cuban policy."

The Hartford (Conn.) Times thinks that the only way to obtain control of the island is to first annex Cuba. It evidently does not think that occurrence very distant for it says:

"As the capacity of the Cubans for self-government seems to be likely to result in one more failure, and that before very long, there does not seem to be much need of worrying about the status of the Isle of Pines at the present time."

The Marshalltown (Iowa) Republican speaks thus strongly:

"The rights of an American citizen who has trusted the assurances of his government and gone afar are the biggest issue in government. No American should be able to go far enough away from this country to be forgotten or unable to call confidently for the protection assured by this government. If these people in the Isle of Pines have depended upon the promises and assurances of the United States they should be backed to the limit in all their rights; if the government has been mistaken it should make good its mistake."

A first class hotel is planned for Santa Fe.

C. W. Richardson of Toledo, Ohio, died at McKinley, September 4.

Bids are being received for a new mast for the wireless station and will be forwarded to Havana. The new mast will be of steel and replace the two wooden ones destroyed in a recent storm.

Work has begun on the new 28-room hotel at Vivijagua. The building, it is expected, will be ready in December.

THE ISLE OF PINES.

Home Comforts in the Tropics.

To those settling in the Isle of Pines certain small comforts should be brought from home. An alcohol gas stove with one or two burners, with baker, suitable for burning the gas from denatured alcohol. The alcohol is sold here at forty cents a gallon. A chafing dish with alcohol lamp, and a silver tea ball with chain. A washing machine for laundry work, to be run by hand. A sewing machine by all means. High laced boots for the rainy season are best purchased at home; also high rubber boots. Wools or flannel shirts are too irritating to the skin; cotton in two weights for under and over wear. Pajamas for night wear, a few in heavy cotton, the rest of lightest weight. Mosquito nets of the finest mesh procurable. A water filter is useful at times, but as a whole a strainer is sufficient as the water on the Isle of Pines is above criticism.—Henry R. Blaney, in the Appeal.

Some nine miles of new roadways will soon be built in the Cañada and Los Indios tracts, opening up sections which have not yet been offered to the public. The work is being prosecuted by the representative of the owners of the property, the Cañada Land & Fruit Co.

Cuban Fruit Shipments.

Consul-General James L. Rodgers reports that during the fiscal year 1908-9 the shipment of Cuban-grown vegetables and fruit (exclusive of pineapples) to the United States through Havana were, in crates of about 2½ cubic feet capacity, as follows:

| | Crates. |
|---|---------|
| Onions | 16,257 |
| Potatoes | 3,235 |
| Vegetables (tomatoes, eggplant, peppers, squash, etc.) | 204,603 |
| Various fruits (alligator pears, mangos, sapote mamey, anona, etc.) | 4,781 |
| Oranges and grapefruit | 24,348 |

The consul says these exports represent American endeavor after practically 10 years' experience. He thinks there is an absolute necessity for a good local market before success is assured. His figures do not include the shipping activities of the eastern section of the island, where there are many citrus fruit groves in full bearing.

The vegetable growers, especially those who devoted their land and energy to tomatoes, eggplant, peppers, okra,

Loss of the Nicolas Castaño.

Details reached Mobile Sept. 17 of the greatest marine disaster ever known in the Isle of Pines waters, when on August 23 the steamship Nicolas Castaño, en route from Havana to Cienfuegos, went ashore on the south coast of the island, between Carapatachibey and Caleta del Inferno. All on board the ship perished. The crew numbered twenty-seven, officers and sailors, and there were two passengers. A government commission after an examination reported that the immediate cause of the wreck was the simultaneous explosion of the steamer's two boilers, combined with violent concussion of the steamer on the rocks, whither she had been thrown by the gale.

The storm of Sept. 20 did some damage to the fruit orchards in the island. It is estimated that the Mason Bros.' orange and grapefruit grove was damaged to the extent of two or three thousand dollars. The greater part of the loss was to the grapefruit trees, the fruit being almost full-sized.

The new hotel at McKinley is nearing completion and will be open for business about the 15th of this month.

squash and other things which are in demand in the American winter market, did much better in quantity at least, but it is feared not very well financially.

To show the distribution of these products it can be stated that the port of New York took nearly all the onions, 53 per cent. of the potatoes, 67 per cent. of the tomatoes, etc., 48 per cent. of the special fruits, and 60 per cent. of the oranges and grapefruit.

Uses for the Plantain.

Plantain meal is prepared by the natives of Central Africa for storing and sale. They simply slice the fruit, dry it in the sun and grind or pound it to powder. In Mexico, according to Colonel Colquhoun, the fruits are exposed to the sun, and when they begin to wrinkle they are peeled. If the skin is not removed, a bad taste is imparted to the fruit. They are kept for some time until an efflorescence of sugar appears on their surface, and are then pressed in masses of about 25 pounds each, and placed in boxes, or wrapped in dry banana leaves.—Rhodesian Agricultural Journal, June, 1909.

GENERAL NOTES.

Development in Santa Clara.

The August number of the magazine issued by the International Bureau of American Republics in Washington, contained an article on the Cuban development of roads, railroads, etc., written by Edgar W. Dennison, the Secretary of the Publicity League of Cuba.

Mr. Dennison says: "Santa Clara Province has had many miles of new calzadas or highways added to the surrounding country, and these have been a great help to the people, in many cases reducing the cost of living one-half, according to the statements of the natives. A new concrete building in Santa Clara will house the provincial and municipal officers. This building will tend to expedite the transaction of all government business on account of the departments being formerly located in half a dozen different buildings in the city. The installation of a new electric light plant, the enlargement of the gas plant, the installation of the ice plant, and the proposed street railway system all tend to brighten up that city."

He says that the Cuban Central Railway, which operates in the central section of the island, has made more extensive preparations for the handling of the business of this year than ever before in the history of the road. They have planned many extensions to near-by sugar mills, and in many cases the lines have been completed. Their new dock facilities at Sagua la Grande, Port Isabella, and at Cienfuegos are now in service.

Cuban Drug Stores.

There are two hundred and fifty drug stores in Havana for the 250,000 inhabitants, and the same ratio may be accepted for the other cities of Cuba, says the Flemington (N. J.) Advertiser. There are also many organizations and societies which employ doctors and their own pharmacists and dispense medicine to the society members. Physicians, however, do not often dispense medicine. The average number of prescriptions compounded is less than in the United States. The pharmacist is not permitted by law to prescribe, and the relation between physicians and pharmacists is friendly. Doctors prescribe a great amount of ready made or patented medicine. Prescriptions are the best part of the drug business in Cuba, as pharmacists there sell less of toilet articles, cigars, etc., than are sold in American drug stores. The customer is considered the proprietor of his prescription, which is returned to him after being entered in the prescription book.

Pharmacists in the larger Cuban cities fill foreign prescriptions as well, consulting the pharmacopoeia of the country from which it comes. Cuban pharmacists generally prepare their own tinctures and ointments.

The pay of good clerks is \$25 to \$100 per month. They are free three times a week after 6 P. M. and also every second Sunday. Pharmacies are open from 6 in the morning until 10 or 11 at night, Sunday included.

How Cubans Sow Tobacco Seed.

If it is true, that the vegueros in the storm ravaged district of Pinar del Rio have no seed with which to replant the beds, then this visitation should prove a most salutary lesson to them, says La Lucha, of Havana. It should move them to a consideration of a more practical method of planting the seed beds and prove to them the fallacy and ill advisedness of the old system of planting these beds. What their grandfathers did they continue to follow with blind faith, without ever attempting to improve on these methods. Tobacco seed is sown, according to grandpa, on virgin ground which must not be burnt over, then the seed is broadcasted over the ground, and when the young plants begin growing and it becomes necessary to worm them, or to gather them, thousands are trampled under foot and others perish for lack of care.

United Wireless Favored.

The State Department was officially advised that the President of Cuba issued a decree Sept. 10 extending until August 1, 1910, the license of the United Wireless Telegraph Company. This notice supersedes the notice which was given to the company on May 22 last that the wireless station which that company operated in the Vedada should be dismantled within a period of three months.

A Vanishing Naval Station.

Considerable money has been expended toward the erection of a naval base and dock yard at Guantanamo, in Cuba, with every prospect that the money spent there will be wasted, and the government transfer its station to another less vulnerable locality. — Washington (D. C.) Herald.

La Discusion, of Havana, recently said that the Cuban government is seeking commercial treaties with Spain, Argentina, Uruguay, Chili and Venezuela. Protection is sought for Cuban tobaccos and liquors.

AGRICULTURAL MATTERS.



Cuban apiary, with common box hives, covered with the sheath of the palm tree to shed the rain.

Un colmenar cubano hecho de colmenas comunes, en forma de caja, cubiertas con hojas de palmera para derramar la lluvia.

Bee-Keeping in Cuba.*

By Frank Reiman, Cauto, Cuba.

I believe there is no other country in the world where the output of honey has decreased as it has in Cuba. When the Spaniards and Cubans alike were depredating Cuba and eating up the cattle, it was a glorious time for the beekeeper; but now Cuba is being again well stocked with cattle, and the best honey-plant, campanilla, or bellflower (resembling the white morning-glory of the United States), is being torn up by the cattle or cut down by the machete of the Cuban because the cattle do not eat it. In Manzanillo the exports have declined from 5,000 barrels of 50 gallons each to 2,000 barrels last year. This

year, I am confident, the exports will not reach 1,000 barrels.

The destruction of the timber has caused great drouth in the summer or wet season, and nearly all the streams go dry. Three-fourths of Cuba is now cleared, and the remainder is going very fast. Where there are no woods there is not enough honey to keep the bees living and they will starve. All the large apiaries in Havana Province are dead now, and Pinar del Rio is fast diminishing. This province, Oriente, has still plenty of timber, and by locating along a stream where the bees can always get water, we can not help doing well.

There are still plenty of good locations, but it is necessary to buy all the

* El autor del artículo sobre la Cria de las Abejas en Cuba, que aparece en esta página, dice que cuando los cubanos y españoles estaban devastando á Cuba y consumiendo el ganado que habia en la Isla era una época magnífica para dedicarse al comercio de la miel, pero que ahora abunda el ganado y que la mejor planta para las abejas, ó sea la planta llamada campanilla, es destruída por el ganado ó cortada por los cubanos á causa de que el ganado no la come. La destrucción de los bosques, que continúa sin cesar, dará por resultado la destrucción de las abejas por falta de plantas con que alimentarse. Asimismo dice que en ningún otro país del mundo ha disminuído tanto el abasto de la miel de abejas como en Cuba.

ground within reach of the bees, and so control the territory. I have over 950 hives at present in three apiaries, one of the two outyards being a mile west and the other a mile south. The home yard contains 350 hives, and 200 yards from it a neighbor has 200 hives more, so there are now over 1,200 hives of bees inside of two miles. I find that the two outyards do better than the home yard—in fact, at the home yard I have to feed, while at the outyards, only a mile away, the bees are making surplus honey.

I have kept bees 27 years, and have never known them to work profitably when they had to fly over a mile for the honey.

I have extracted, from March 1 to June 1, 2,500 gallons of honey and 1,500 pounds of yellow wax. The honey, until Oct. 15, is dark; after that it is white from the bellflower. When the white honey begins I expect to change from extracted to comb honey, as my frames are only six inches deep and twenty long. I will make wide frames that take 4x5 sections, and use them in the same super. I formerly used T tins, but have found that, to raise nice comb honey, the section must be closed entirely.—Gleanings in Bee Culture.



The illustration is of a swarm of bees which have left their hive and settled upon a bunch of bananas.

La ilustración es la de un enjambre de abejas que han salido de su colmena y se han posado en un recimo de plátanos.



Un colmenar americano en Savanilla, Provincia de Matanzas.

TOBACCO INDUSTRY.

An Important Commission.

A general assembly of all branches of the tobacco trade met in Havana Sept. 7 to ask Congress for maximum rates to all countries whose duties on Cuban tobacco are prohibitive and the minimum to those with equitable duties.

The Tobacco Manufacturers' Union statement showed declines in tobacco exports in recent years and that quick and strong measures were necessary to preserve the industry.

Marcelino Diaz de Villegas, Cuban Minister of Finance, interviewed in New York on this important matter, said:

"As the planting of tobacco does not begin generally until the month of October I cannot say anything about the next crop. The Cuban leaf is always sold without any difficulty, but for several years this industry has been suffering from a drop in price; our revolutions and the unjustifiable strikes of the tobacco workers have been responsible for the increased manufacture of cigars in greater quantities in other countries, especially in the United States."

On Sept. 17, President Gomez appointed a commission to make an investigation and to report within four months.

Against Coupons.

Governor Asbert has announced that he will take action against the owners of a cigarette factory placing coupons in its packages resembling American currency.

Complaints have come from various parts of the island, and especially from Cienfuegos, stating that these coupons are being used to swindle unsophisticated farmers and country people.

Tobacco Conditions.

Maurice Winter, of Maurice Winter & Co., the leaf packers and dealers in Havana, said Sept. 6 to a representative of "Tobacco:"

"Of all the tobacco that was raised in the lowland section of the Vuelta Aabjo most is bad. A big percentage of the crop did not cure for lack of rain.

"Much of it has a greenish cast due to a rain when the tobacco was not ripe. Uncured tobacco has no sweet taste and its aroma is bad. At present there is no more good tobacco in the lowland section, because the rain came at the right time on only a small part of the crop.

"The favored section was so small a portion of the crop that the choice tobacco is not now on the market. The choice tobacco happened to be ripe when

it caught the rain. It burns much better and has a better taste. It is much better tobacco than has been raised in the last two years. The tobacco in other than the lowland Vuelta Abajo is better than we have had for years and years. In other sections, where it did not rain, or where farmers packed before it rained and did not give it time to cure it is as bad as two years ago."

Tobacco Exports.

Exports of tobacco for the months of July, 1908 and 1909, are given in the following table:

| | 1909. | |
|------------------------|-------------|-------------|
| | Quantities. | Value. |
| Bales | 26,394 | \$1,271,259 |
| Cigars | 13,882,268 | 983,640 |
| Cigarettes (pack.) . . | 1,091,544 | 29,015 |
| Picadura (kilos) . . | 33,207 | 19,343 |
| Total | | \$2,303,257 |

| | 1908. | |
|------------------------|-------------|-------------|
| | Quantities. | Value. |
| Bales | 25,467 | \$1,526,294 |
| Cigars | 14,430,076 | 929,741 |
| Cigarettes (pack.) . . | 614,230 | 18,057 |
| Picadura (kilos) . . | 18,195 | 14,620 |
| Total | | \$2,488,712 |

—El Tabaco, Havana.

The principal countries to which the greater part of the cigars were shipped, were the following:

| | | |
|---------------------------|-----------|--------|
| To England | 5,140,840 | Cigars |
| " the United States . . . | 3,897,978 | " |
| " Germany | 2,631,533 | " |
| " Canada | 662,825 | " |
| " South America | 650,197 | " |
| " Spain | 225,550 | " |

Exports of cigars from January 1 to July 31, 1909, were 105,770,837, as against 105,136,382 for the same period in 1908, when the cigarmakers strike was on.

Ever since the strike of the cigarmakers in the summer of 1907 the Cuban cigar making trade has been in bad shape, and the industry is being transferred to Tampa and Key West.

Figures taken from the official returns show the number of cigars shipped from the port of Havana to all parts of the world to be as follows:

| | |
|---|-------------|
| Total from Jan. 1, 1909, to Aug. 31, 1909 | 118,319,602 |
| Total from Jan. 1, 1908, to Aug. 31, 1908 | 122,186,215 |
| Decrease in 1909 | 3,866,613 |

AGRICULTURAL MATTERS.

Uses of the Lemon.

Two or three slices of a lemon in a cup of strong tea will cure a nervous headache.

A tablespoonful of juice in a small cup of black coffee will relieve a bilious headache.

The juice of half a lemon in a cup of hot water on awakening in the morning is an excellent liver corrective and successful substitute for calomel and other alterative drugs.

A dash of lemon juice in plain water makes a cleansing tooth wash, removing the tartar.

Lemon juice with olive oil is far superior to vinegar for a salad dressing—equal parts being used for blending.

Lemon juice and loaf sugar is good for hoarseness.

Outward application of the juice always irritates caused by insect bites.

If when boiling sago or rice a teaspoonful of lemon juice is added the kernels will be whiter and a delicate flavor imparted.

Salt and lemon juice will remove rust stains from white goods.

After the juice is extracted, the rind dipped in salt cleanses brass beautifully and conveniently. It also removes unsightly stains from the hands.

Tough meat can be made tender by adding a teaspoonful of lemon juice to the water in which it is boiled.—California Fruit Grower, Los Angeles, Cal.

The 1910 Exposition.

The Secretary of Agriculture, Commerce and Labor, Señor Ortelio Foyo, will issue a circular to the public announcing the appropriation of \$25,000 for an exposition to be held early in 1910. Palatino Park, the site of last year's fair, will in all probability be again selected.

The circular will call upon all agriculturists, horticulturists, stockmen, manufacturers, artists and women to contribute their support to the exposition by sending exhibits to it.

A New Mango.

The Peters mango from Trinidad is being tested by the U. S. Department of Agriculture. It is described as a promising specimen and the finest flavored. It is green-skinned, rosy purple bluish and mottled with small yellow dots. Skin thick, flesh pulpy, juicy and high flavored. Tree is medium in size. Weight of fruit 12 to 16 ounces, $3\frac{1}{2}$ by $3\frac{1}{2}$.

La Gloria and Nuevitas Transportation.

With the combined motor and sailboat now running, the famous Zanja or Sabinal channel is traversed in from 22 to 30 minutes, and the insects are no longer a terror there. With a fair wind the sails alone often enable the voyage to be made between La Gloria and Nuevitas in six hours.—James M. Adams, in the Havana Post.



Fisherman's wharf in Nuevitas harbor, with nets on drying frame. This harbor is one of the finest for fishing along the north coast. Tarpon abound and also the finest of other game fish, red-snapper, etc.

Muelle de los pescadores en Nuevitas. Obsérvese la conveniente disposición de los secaderos de redes.

A report from Thomas Nash, fruit importer, Plymouth, states that there should be a ready sale for limes in England during September and October if the weather is hot. Satisfactory prices for oranges can be obtained until January, when the market is depressed by the arrival of Spanish produce. Pineapples and bananas are now selling at 14s. to 15s. per cwt., green.—Barbados News, Sept. 4, 1909.

The Poland-China is an almost perfect meat-making machine. It is not excelled by any breed of any kind of live stock for converting feed into flesh. It has a voracious appetite, a good digestion, and is lazy, not using much of its energy in travel or excitement. It will stand heavy feeding and considerable neglect.—From "Raising Hogs in Colorado."

CUBAN SUGAR REVIEW.

September Summary and Prices—Reduction of Stocks, Showing Good Consumption— Java Shipments Not Large.

Specially written for The CUBA REVIEW by Willett & Gray of New York.

Our last sugar review for this magazine was dated September 1, and the present is a summary for the month of September.

Centrifugals advanced during the month from the opening quotation of 4.14c. to 4.235c. and closed at 4.20c. on a sale October 1 of a cargo of Javas in port.

During the month 60,000 to 80,000 bags sold on the 2d, from store and for prompt September shipment at 4.15c. to 4.17c., followed by a sale of 17,000 bags at 4.17c. and 4.20c. and cargo of Javas at 4.17c. on the 10th. Demerara Centrifugals were included in sales for shipment at 2.45c. to 2.52c., cost and freight, equal to 4.15c. and 4.22c., duty paid, according to location. Further sales on the 20th and 21st, amounting to 150,000 bags of Cuba Centrifugals, were made at basis of 4.235c. per pound.

The firm and improving prices for the month were owing to the scarcity of offerings of ready sugar for refiners' needs.

Stocks of sugar in the United States and Cuba, six ports together, on Sept. 1, were 316,880 tons and on Sept. 28, 194,271 tons, showing a reduction in these stocks of 122,609 tons for the month, leaving these stocks 100,928 tons below last year at same time. This indicates a remarkably good consumptive demand in the United States and sufficient to absorb the entire large Cuba crop estimated by us at 1,485,000 tons when fully complete. As regards the outlook, F. O. Licht's preliminary estimate of the European beet crop gives a minimum of 6,055,000 tons to a maximum of 6,375,000 tons, allowing a leeway for contingencies of 320,000 tons. Last crop was 462,000 tons greater than this minimum and 142,000 tons greater than this maximum.

The beet crop being the most important crop in the world in the government of prices, it would seem that Cuba, even with a larger crop than last year, will benefit in prices by the probable higher prices to rule for beet sugar in the coming campaign. Beet sugar prices for the old crop have not varied materially during the month, but have always been at a higher parity than the value of Centrifugals here, so that imports of beet sugar have been nothing and are little to nothing or very small this season. A well-managed "corner" by speculators in September beet sugar contracts ran the price up for the last two days of the month to 14s. per cwt., but the October quotation opened at 10s. 10½d.

The Java shipments, which now come in to fill the period of scarcity, are not large, so that prices are likely to be maintained until the opening of the new Cuba crop season in December or January, first sales of which may be possible on basis of 2½c., cost and freight, 96° test, or better, according to circumstances then ruling.

The hurricane, which passed over Louisiana and unroofed many sugar houses, does not appear to have damaged the standing cane more than 3 per cent., although the saccharine out-turn may be diminished by another 3 per cent. This still leaves an estimated crop of, say, 340,000 tons to be marketed.

The refined sugar market is now on a bad basis as far as cane sugar refiners' profits are concerned. The difference in value of raws and refined showing but .61c. per 100 pounds in instances, or below the current estimate of cost of refining. This is because of a favorable domestic beet granulated out-turn for sugar factories throughout the country, and the coming marketing of that sugar at considerably under even the low ruling prices for cane granulated. Cane granulated is now 4.90 less 1 per cent. at New York and beet granulated 4.75c. net New York basis.

New York, Oct. 2, 1909.

Santa Cecilia's New Crusher.

The Pratt Engineering & Machine Company, of Atlanta, Ga., has just completed a shipment of a 26 x 78" crusher to the Santa Cecilia Sugar Company, Guanatanamo, Cuba.

The interesting feature in connection

with this order is that the Santa Cecilia company investigation of the specifications and work done by Pratt "Imperial" machinery convinced them of its superiority to foreign made machinery and, accordingly, the order was given and at an advanced price.

LO QUE DICE DE CUBA LA PRENSA AMERICANA.

El Gobierno de Cuba Impone Restricciones á la Vente de Armas de Fuego.

La orden del Presidente Gómez de que las armas de fuego adaptables á usos militares en lo sucesivo serán importadas solamente en ciertos puntos designados por el gobierno, y eso por medio de una licencia especial, así como que sólo podrán ser vendidas en número limitado y á personas conocidas del gobierno, es una medida que merece la aprobación general. La New York Tribune dice á este respecto:

“Ninguna persona censata podrá poner objeción á tal orden. Esta no infringe los derechos y privilegios del pueblo. El único objeto que puede tener la importación de fusiles para usos militares es el de la guerra, la cual solamente el gobierno tiene el derecho de sancionar, ó bien la matanza individual, lo cual es un orimen. Los fusiles Springfield no se usan para cazar pájaros, y si se necesita un arma de fuego para protegerse contra los malhechores, una escopeta de oaza es de mucha más utilidad en este caso que una docena de fusiles. Así es que la posesión de armas para usos militares, excepto por medio de licencia y bajo la inspección del gobierno, puede muy bien prohibirse, por la sencilla razón de que probablemente el unico uso para que se destinan es en contra de la ley.”

El Boston Advertiser, de Massachusetts, cree que la precaución del gobierno cubano al restringir la venta de armas de fuego no puede considerarse como una medida extrema. Dice así:

“Aunque parece no haber peligro inminente de una revolución, estas precauciones son lo que bien pudiera decirse “una puntada á tiempo.” El gobierno cubano conoce á fondo las maquinaciones de las ideas revolucionarias; sabe que los mismos elementos que desafiaron el poder de España durante tantos años desastrosos pudieran muy bien pervertirse para luchar contra la forma de gobierno republicano hoy en el poder.”

El Cleveland Plaindealer, de Ohio, dice: “Tales precauciones son indudablemente muy sabias. En cualquier otro país serian medidas muy prudentes, pero en Cuba son doble y triplemente laudables, en un país donde los cañones y los artilleros pueden de un momento á otro hacer de las suyas.”

La Lotería Nacional.

La lotería Nacional de Cuba sigue interesando aún en general á la prensa de los Estados Unidos. El Utica Press, de N. Y., dice á esto: “En ciertas cosas las leyes postales de Cuba han sido modeladas á estilo de las de los Estados Unidos, pero si había en esas leyes reglamentarias cláusula que prohibiese la circulación por el correo de algo concerniente á las loterías, esa cláusula ha sido eliminada.”

El Jacksonville Times Union, de la Florida, discute la compra de billetes de la lotería cubana en los Estados Unidos y dice: “Por qué debiera el gobierno de este país abrigar el deseo de negar á sus ciudadanos la oportunidad de emplear su dinero en billetes de la lotería? No es para salvarlos de los peligros de la especulación financiera, pues no ha intentado intervenir en las jugadas de valores en la Bolsa, cuyas operaciones, seguramente para las personas no interesadas y estas especulaciones, no es mejor manera de invertir el dinero que probando la suerte en un lotería. No tampoco á causa de que la compra de un billete de lotería es un acto inmoral, pues precisamente eso tiene lugar á cada rato en las rifas de las iglesias en este país, y aun hoy mismo estamos anunciando en Washington una lotería cosa nuestra, con todos los gajes y el aumento de gastos que ocasiona un largo viaje á un sitio determinado.”

“El gobierno de Cuba piensa de una manera y el gobierno de los Estados Unidos,” dice el New York Times. “Todo esto podría pasarse por alto,” reitera este periódico, “si no fuera por el hecho de que Cuba no puede verdaderamente manipular una lotería del Estado sin causarnos muchos perjuicios, de la misma manera que no podría permitir que la capital de la Isla fuese el foco para la propagación de la fiebre amarilla sin causar á nuestras ciudades de la costa enormes pérdidas en vidas y propiedades. Tal vez eso no nos da el derecho de decirle á Cuba que no debe permitir en sus dominios una lotería, como le le hemos dicho que debe procurar la exención de la fiebre amarilla, pero bien mirado esa amonestación viene á ser una cosa parecida.”

“El dinero ganada en la lotería es dinero contaminado,” dice el Columbus Dispatch, de Ohio. “Es un principio falso, con objeto de imbuir á las masas en la idea de hacerse del dinero del prójimo á poca costa. Unos cuantos podrán enriquecerse en cierto modo de esta manera, pero la mayoría de las gentes se empobrecerán á no dudarlo, y entre todos se esparcirá la falsa creencia de que la suerte y no el trabajo es el mejor medio de obtener el lucro.”

El New York Tribune desearía saber cuál es el origen de donde dimanen las noticias tan desfavorables que respecto á los asuntos de Cuba circulan con tanta frecuencia. Dicho periódico, según informes fidedignos que ha obtenido, ha averiguado precisamente lo contrario sobre este asunto, y en este sentido dice lo siguiente:

“El hecho de haber aumentado materialmente en Cuba los ingresos gananciales de los ferrocarriles desde que se colvió á implantar la autonomía en esa Isla, y el haber sufrido un alza los precios de todos los valores públicos y de corporaciones, puede explicarse por el hecho de que en este país y generalmente en todos los países del mundo en el presente año ha prevalecido semejante estado de cosas. Y qué más puede desearse, dentro, de la esfera del buen razonamiento, sino que Cuba participe de la prosperidad general y del progreso del mundo? La disminución en el número de defunciones, la baja que ha habido en el número de orímenes y alevscias, el aumento de ingresos del Erario, el aumento que ha tenido la inmigración, el haberas llevado á cabo obras públicas de importancia, el marcado decaimiento de la animosidad política y de la inquietud, junto con haberse aliado los distintos partidos, políticos en apoyo del gubierno establecido, todo hace ver el poco fundamento en que se basan las noticias desfavorables de que se hace mención anteriormente.

REVISTA AZUCARERA.

Escrita expresamente para la CUBA REVIEW por Willett & Gray, de Nueva York.

Nuestra última revista azucarera para esta publicación estaba fechada el primero de Septiembre, y aquí vamos á hacer un resumen de las transacciones llevadas á cabo durante dicho mes.

Los centrífugas subieron durante el mes desde la cotización con que comenzó el mismo de 4.14 cents. á 4.235 cents., y cerró á 4.20 cents. en una venta que se hizo el primero de Octubre de un cargamento de azúcar de Java que se hallaba en puerto.

El día dos de Septiembre se vendieron de 60,000 á 80,000 sacos de azúcar almacenado y de azúcar para entrega inmediata y para embarque en Septiembre á razón de 4.15 á 4.17 cents. El día diez de dicho mes se vendieron 17,000 sacos á 4.17 y 4.20 cents., y un cargamento de azúcar de Java á 4.17 cents. Centrífugas de Demerara se incluyeron en ventas para embarque futuro á razón de 2.45 á 2.52 cents., costo y flete, equivalente á 4.15 y 4.22 cents., derechos pagados, según donde se encontrara el azúcar. En los días veinte y veintiuno se hicieron ventas que ascendieron á 150,000 sacos de centrífuga cubano á razón de 4.235 cents. la libra.

La firmeza y alza de los precios durante el mes, se debió á la escasez de existencias de azúcares para entrega inmediata á propósito para abastecer las refinarias.

El azúcar almacenado en los Estados Unidos y en los seis puertos de Cuba en el primero de Septiembre, ascendía en total á 316,880 toneladas, y en Septiembre veintiocho ascendía á 194,271 toneladas, acusando una disminución del dulce almacenado de 122,609 toneladas durante el mes, quedando almacenado 100,928 toneladas menos que el año anterior en la misma fecha. Esto indica una notable buena demanda para el consumo en los Estados Unidos que es suficiente para absorber toda la zafra grande de Cuba que se calcula en 1,485,000 toneladas cuando se haya terminado completamente. Con respecto á la perspectiva del mercado azucarero, el cálculo preliminar de F. O. Licht con respecto á la cosecha de remolacha en Europa da como mínimo 6,055,000 toneladas y como máximo 6,375,000 toneladas, dejando un margen de 320,000 toneladas para contingencias. La última cosecha fué de 462,000 toneladas más que dicho mínimo y 142,000 toneladas más que dicho máximo.

Siendo como es la cosecha de remolacha la más importante en el mundo en lo que se refiere á regular los precios, parecería natural que Cuba, aun con una zafra mayor que la del año pasado se beneficiara obteniendo mayores precios á

causa de la subida en las cotizaciones del azúcar de remolacha que tendrá lugar para la zafra próxima. Los precios del azúcar de remolacha de la zafra pasada no variaron mucho durante el mes, pero han estado siempre á un equivalente mayor que el precio cotizado aquí por los centrifugas, por lo que la importación de azúcar de remolacha ha sido nula, y es muy pequeña en la actualidad. Un bien manejado "acaparamiento" por parte de algunos especuladores, de contratos de azúcar de remolacha para Septiembre, hizo que el precio subiera en los dos últimos días del mes á 14s el quintal, pero la cotización para Octubre abrió á 10s. 10½d.

Los cargamentos de azúcares de Java que vienen á llenar el período de escasez, no son grandes, por lo que es probable que los precios se mantengan firmes hasta que comience la nueva zafra en Cuba allá en Diciembre ó Enero, cuando las primeras ventas se harán probablemente sobre la base de 2½ cents. ó más, costo y flete, polarización 96°, según las circunstancias que imperen entonces. entonces.

El huracán que pasó por Louisiana y destechó muchos almacenes de azúcar, no parece haber dañado la caña parada en más de un 3%, si bien es posible que el rendimiento de la caña se haya disminuido en otro 3%. Esto deja todavía una cosecha que se calcula sea de 340,000 toneladas de azúcar.

El mercado de azúcar refinado se halla al presente en condiciones muy desventajosas en cuanto se refiere á la utilidad para los refinadores de azúcar de caña. La diferencia en los precios de los azúcares refinados y de los mascabados es en algunos casos sólo de 0.61 de centavo en libra ó sea menor del costo corriente que se calcula por refinar el azúcar. Esto es debido á que las fábricas de azúcar de remolacha en todo el país han tenido una abundante producción de azúcar de remolacha granulada, y el haberse puesto á la venta ese azúcar á precio muchísimo menor que el más bajo cotizado por azúcar de caña granulada. El azúcar de caña granulada se vende ahora á 4.90 menos el 1% en Nueva York, y el azúcar de remolacha granulada se cotiza á 4.75 cents., neto en Nueva York.

Nueva York, Octubre 2 de 1909.

Amount of Water Needed for the Maximum Development of the Sugar-Cane Plant.

From Bulletin No. 17, of the Estacion Central Agronomica de Cuba, on Irrigation, by J. T. Crawley, director, the following notes are taken:

The Hawaiian sugar planters have probably done more and better work in irrigating sugar-canes than any other people, and therefore the experience acquired in Hawaii as to the amount of water required for the maximum development of the cane will be of interest in all sugar-growing countries.

In Hawaii it is not known just what amount of water is used per acre, but a good approximate estimate may be arrived at from the known capacity of the pump, and of the streams supplying water for irrigation.

Where the annual rainfall is 50 inches or less, it is estimated that 5,000,000 gallons are sufficient and this is equal to 184 inches of rainfall per annum. The 50 inches of actual rainfall and the 184 inches supplied by irrigation give a total of 234 inches.

The greater part of the rainfall in Hawaii comes during the winter, when the rate of growth of the cane is not rapid, and the evaporation from the soil is comparatively slow.

In Cuba, on the other hand, the larger part of the rain falls in the summer, a season of great heat and rapid growth and rapid evaporation, and consequently at a season when it does the greatest amount of good, with the result that 50 inches of rainfall in Cuba is generally of greater value to the crops than the same amount would be in Hawaii, and consequently the need of irrigation will not be as great in the former as in the latter place.

Cane is a crop that needs for its best development a large amount of water. It is given as the opinion of the writer of the bulletin that 100 inches of water, if applied at regular intervals and in quantities proportional to the needs of the

cane, would probably be sufficient, but that with the loss experienced in the surface run-off and seepage, at least 125 inches are necessary for the full development.

Some modifications of these figures would however result if the nature of the soil were taken into consideration, since the power of absorption, retention of the water by the soil, and the nature of the subsoil are factors that would somewhat alter the local conditions.

Church Work on Sugar Estates.

The great sugar estates of Cuba offer exceptional opportunity for effective work by the church. The employees on some of the estates number thousands, and the heads of the companies, chiefly American business men, show a gratifying desire to care for the moral and religious welfare of the Cubans workmen and their families. They have come to Bishop Knight at Havana asking that he recommend Spanish-speaking clergy and teachers to live on the estates and carry on among the people what to all practical purposes is effective missionary work. The bishop is doing his best to take advantage of these opportunities, but finds himself hampered by the lack of Spanish-speaking American clergy.—The Churchman, N. Y.

The Tingura Sugar Company has been authorized to extend its telephone line from the sugar mill "Tinguaro," to the one called "Nueva Luisa," in Jovellanos.



Bridge over the Sagua River, Sagua la Grande.

Rebels Pardoned.

The Cortes prisoners, father and son, sergeants of the Rural Guard, who rebelled last March and were condemned to death in June, the sentence being commuted to twenty years' imprisonment, were pardoned by President Gomez October 8.

A Tax Problem.

Canadian settlers in Pinar del Rio Province complain that both the municipalities of Guane and Mantua try to collect taxes on their lands, which each asserts to be within its boundaries. If a prompt solution of the difficulty is not found the settlers will appeal to the British Minister.—New York Herald.

M. J. CABANA
COMMISSION MERCHANT
P. O. Box 3, Camaguey

Solicits Correspondence from all the important cities of the United States of America.

HENRY E. BROWN
Pharmacist

Shipping and Export Chemist and Druggist, Ships' Medicine Chests Furnished and Replenished. Prescriptions Compounded by a Graduate in Pharmacy.
Trusses, Surgical Appliances, etc.

Office and laboratory, Room 36.
116 BROAD ST., NEW YORK

Quantity and Quality of circulation (5,000 copies monthly) and advertising rates make the Cuba Review an attractive advertising medium. Address 82 Beaver St., New York.

Telephone Call: 274-A Hamilton.

JOHN M. DONOVAN

13 Summit St. (Atlantic Dock) - BROOKLYN

Dealer in

Dunnage Mats

FOR BAG FLOUR, BAG AND BULK GRAIN AND GENERAL CARGOES.

— BAGS AND BAGGING —

Journal d'Agriculture Tropicale

Founded by J. VILBOUCHEVITCH
164 Rue Jeanne d'Arc Prolongée.

Subscription, One Year - - - - 20 Francs

Deals with the leading questions of the hour, agricultural and commercial, of interest to tropical countries. International in character. Illustrated. Monthly. Descriptions of machines for tropical crops a speciality. Complete review of new agricultural publications. Commercial part intelligible for every one and always interesting. 150 contributors in West and East Africa, East and West Indies, Java, Mauritius, Central and South America, and throughout the tropical world.

FOR SALE

We offer, subject prior sale, October 1st delivery, one 26" x 72" Pratt "IMPERIAL" Cane Crusher complete with Compound Gearing, Hydraulics and Corliss Engine, Krajewski type rollers.

One 34" x 72" Three-Roll Pratt "IMPERIAL" Cane Mill, complete, with Compound Gearing, Hydraulics and Corliss Engine, heavily built for highest pressures. **LARGE JOURNALS.**

EXTREMELY NARROW TURN PLATE

For full information, particulars, prices, etc., address

PRATT ENGINEERING AND MACHINE COMPANY
Atlanta, Georgia, U. S. A. 80 Wall St., New York City
Havana, Cuba, Office: Lonja del Comercio 509.

THE EXETER MACHINE WORKS

PITSTON, PA.

MANUFACTURE

BRONZE AND BRASS CASTINGS

"VITA" ACID-RESISTING BRONZE

EXETER BEAR BABBITT. The best in the world for anti-friction purposes

No. 7 RAILWAY BRONZE, For all bearing purposes

PHOSPHOR BRONZE AND GUN METAL

NEW YORK OFFICE: 50 CHURCH STREET

CARROS PARA CAÑA

De todas
clases
Fabricados
de madera
ó ábero

Dirección
Telegráfica
RAMALIAM

**RAMAPO
IRON WORKS**

30 Church St.
New York, N. Y.

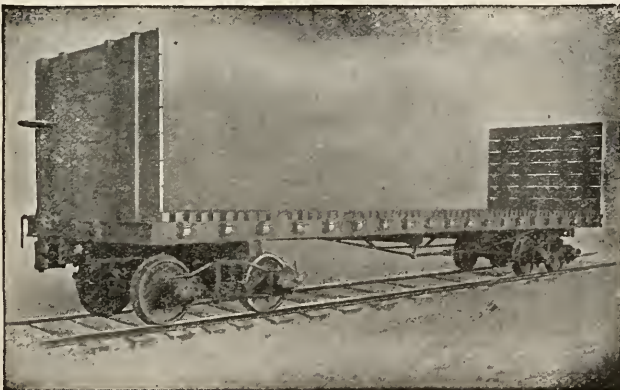

CANE CARS

OF EVERY
DESCRIPTION
OF STEEL
OR WOOD

Cable Address
RAMALIAM

**RAMAPO
IRON WORKS**

30 Church St.
New York, N. Y.

INVEST IN CUBA

DOUBLE YOUR MONEY

Let us tell you why and where

CONSULT US, OTHERWISE "DON'T INVEST IN CUBA"

THE JOHNSON-HARDING COMPANY

Specialists in Cuban Investments

118 PRADO, HAVANA, CUBA

H A V A N A

CUBA

National Bank of Cuba

Government Depository

CAPITAL, SURPLUS AND
UNDIVIDED PROFIT
\$6,100,000.00

Head Office—Havana
15 BRANCHES IN CUBA
New York Agency
1 WALL STREET

COLLECTIONS

THE TRUST COMPANY OF CUBA HAVANA

Capital
and Surplus **\$540,000**

Transacts a General Trust
and Banking Business

REAL ESTATE DEPARTMENT

Examines Titles, Collects Rents,
Negotiates Loans on Mortgages

Correspondence Solicited from
Intending Investors

OFFICERS

J. A. Gonzales Lanuza, President
Norman H. Davis, Vice-President
F. J. Sherman, 2nd Vice-President
O. A. Hornsby, Secretary and Treasurer
J. M. Hopgood, Asst. Treasurer

Offices: CUBA 31, HAVANA

The Royal Bank of Canada

INCORPORATED 1869

Fiscal Agent of the Government of the Republic of
Cuba for the Payment of the Army of Liberation

CAPITAL AND RESERVE, \$10,300,000.00
TOTAL ASSETS, - 58,300,000.00

Head Office, MONTREAL

NEW YORK AGENCY, 68 William St.

Branches in Havana: Obrapla 33, Gallano 92;
Matanzas, Cardenas, Manzanillo, Cienfuegos,
Camaguey and Santiago de Cuba.
Mayari, Sagua, Caibarien

ESTABLISHED 1844

H. UPMANN & CO. Bankers

TRANSACTION A GENERAL BANKING BUSINESS
CORRESPONDENTS AT ALL THE PRIN-
CIPAL PLACES OF THE ISLAND

Safe Deposit Vaults

Manufacturers of the Famous H. Upmann
Brand of Cigars

FACTORY: Paseo de Tacon 159-163
OFFICE: Amargura 1-3

Established 1876

N. GELATS & COMPANY

Bankers

Transact a general banking
business.

Correspondents at all the prin-
cipal places of the world.

SAFE DEPOSIT VAULTS

Office: Aguiar 108

MOLINA BROTHERS

Customs Brokers

Forwarders, Lighterage and Shp Agents
Lonja Building 541 HAVANA

H A V A N A

United Railways of Havana

Cuba's First and Foremost Railroad. (First Section opened to Traffic in 1837)

Takes you to All Parts of the Island East of Havana Comfortably and Quickly through Varied and Beautiful Scenery and Past Extensive Sugar Plantations

Parlor, Observation and Sleeping Cars attached to principal trains.

Full information and through tickets to all points in Cuba reached via the United Railways of Havana can be obtained of the following:

| | | |
|---------------------------|---------------------------------|------------------------------|
| Thos. Cook & Son | Ward Line | Southern Pacific R. R. |
| Seaboard Air Line R. R. | Florida East Coast Railway | Mobile & Ohio R. R. |
| Foster & Reynolds | Washington Southern Railway | Raymond & Whitcomb Co. |
| Atlantic Coast Line R. R. | Peninsular & Occidental SS. Co. | Louisville & Nashville R. R. |
| Illinois Central R. R. | | Munson Line |

THE HERRADURA LAND COMPANY

Office: No. 3 Bernaza Street, Habana, Cuba

CAPITAL, \$440,000.00

Own 22,000 acres of land in the Province of Pinar del Rio, suitable for Oranges, Vegetables, Cotton, Corn and Tobacco. The land has all been surveyed and sub-divided into 40-acre tracts and is offered for sale in acres to suit the purchasers, for Cash or on instalments.

We have a new and progressive American town with Railroad Station, Telegraph, Telephone, Stores, Hotel, American School, all within short distance from Havana City.

Titles perfect. Transportation from Havana free for buyers.

WRITE OR CALL FOR INFORMATION.

'PHONE No. 401

P. O. BOX 741

FERNANDO de CARDENAS

CUSTOM HOUSE BROKER

:: Import and Export Agent ::

Munson S. S. Line Building

Obispo No. 1, Havana, Cuba

JAMES S. CONNELL & SON

Sugar Brokers

Established 1836, at 105 Wall Street

Cable Address—"Tide, New York"

(Established 1871)

DUSSAQ y CO.

Sucesores DUSSAQ & GOHIER.

GENERAL IMPORTERS

Agents for: The Royal Mail S. P. Co.; Cuban Steamship Co.; Holland-America Line.

OFICIOS 18 HAVANA.

SUGAR CANE PLANTATIONS

Cacao (chocolate and cocoa) and Coffee Plantation—Orange and Grapefruit Groves. Land for the small settler on easy terms. In the best district of Cuba—Rio Cauto Valley. Within 40 miles of Santiago and Nipe Bay. Write for Booklet.

RIO CAUTO SUGAR COMPANY, 50 Church St., N. Y. City

CANADA LAND AND FRUIT CO.

LOS INDIOS

Owners

ISLE OF PINES

CANADA AND LOS INDIOS TRACTS

Location: Siguanea Bay. The Deep-Water Harbor of the Island.

We have at our new and progressive town of Los Indios a sawmill, planing-mill general store, school, hotel, church, post office and nursery, all under the supervision of Americans. A strictly American town.

We also have rowboats and gasoline launch for pleasure parties. Fishing and hunting the best.

We own the finest citrus fruit, vegetable and tobacco land on the island. We offer same for sale in acres to suit purchaser, either for cash or on installments. Special inducements to actual settlers.

Write for prospectus and further information to our general office,

Marinette, Wisconsin.

WILLETT & GRAY, Brokers and Agents

FOREIGN AND
DOMESTIC

SUGARS

RAW AND
REFINED

82 WALL STREET, NEW YORK

Publishers of Daily and Weekly Statistical Sugar Trade Journal—the recognized authority of the trade.

TELEGRAPHIC MARKET ADVICES FURNISHED

PURE
DISTILLATION
OF
SUGAR CANE

BACARDI RON

Sole United States Agent

D. S. de JONGH 128 Water St.

BEST MIXER
FOR
HIGHBALLS
AND
OTHER DRINKS

“Sugar News from Cuba”

is the title of the interesting correspondence from the tropical island, appearing in every issue of “THE AMERICAN SUGAR INDUSTRY AND BEET SUGAR GAZETTE.”

Capable correspondents, in every part of the world, write regularly, covering reliable sugar news for “THE AMERICAN SUGAR INDUSTRY AND BEET SUGAR GAZETTE.”

In the United States, Cuba and Mexico, \$2 per annum. In Foreign Countries, \$2.50 per annum.

Subscribe for it if you want to keep posted.

Sample copy free. Send for advertising rates.

Address: **BEET SUGAR GAZETTE CO.**

No. 5 Wabash Ave. Chicago, Ill., U. S. A.

BARTLE

Twenty-five thousand acres of the richest and best watered land in Cuba on the main line of the Cuba Railroad, with the finest station on the line, 120 miles from Nipe Bay—the best harbor on the Island; also the nearest to New York No swamps or insect pests.

BARTLE is not in the wilderness—we offer all the comforts of civilization, GOOD STORES, HOTEL, CHURCH, SCHOOL, SAW-MILL, Etc.

TWO MAILS DAILY.

SUGAR, FRUITS, TOBACCO AND VEGETABLES produce wonderful crops at BARTLE.

When you consider Soil, Transportation, Social, Religious and Educational advantages, BARTLE offers something not to be had elsewhere in Cuba. Write for particulars.

"Ten Days in Cuba," just published by Hon. Nicholas J. Whalen, Speaker of the Michigan Legislature, may be had through newsagents at 25 cents per copy, or will be sent free to any address by the owners of the Bartle Colony. Address, Duncan O. Bull, Gen'l Mgr. Cuban Realty Company, Limited, Temple Building, Toronto, Can., or 141 Broadway, New York City.

DUNCAN O. BULL, General Manager

CUBAN REALTY CO., Ltd. Temple Bldg., Toronto, Canada
141 Broadway, New York **Bartle, Cuba**

MOBILE, ALA.

HOME INDUSTRY IRON WORKS

Engines, Boilers and Machinery

Manufacturing and Repairing of all kinds. Architectural Iron and Brass Castings. Light and Heavy Forgings. All kinds of Machinery Supplies.

Steamship Work a Specialty

A. KLING, Prop.
 JAS. S. BOGUE, Supt.

MOBILE, ALA.

The Principal Hotels in Mobile, Ala.

THE CAWTHON (FIREPROOF) **THE BIENVILLE** (MODERN)

European, 175 Rooms

European, 150 Rooms

\$1.50 Up

\$1.00 Up

Both Hotels in Heart of City, Facing Bienville Square

THE BIG FOUR ROUTE

3 Daily Trains Each Way 3

Parlor Cars, Sleepers, Dining Cars.

Through Train Service
 BETWEEN

Cincinnati, Toledo and Detroit
 (Via Michigan Central R. R.)

Ask for Tickets Via

BIG FOUR

Telephone, 33 Hamilton
Night Call, 411 Hamilton

Cable Address:
"Abiworks," New York

Atlantic Basin Iron Works

Engineers and Boiler Makers

Machinists, Plumbers, Tinsmiths, Pipe Fitters, Blacksmiths, Coppersmiths,
Pattern Makers, Sheet Iron Workers, Iron and Brass Castings. Steamship
Repairs a Specialty.

Cor. Imlay and Summit Streets

Brooklyn, N. Y.

John Munro & Son

Steamship and
Engineers' Supplies

13 Conover Street, Brooklyn, N.Y.

Cable Address: Kunomale, New York

Telephone, 196 Hamilton

Telephone
215 Hamilton

Box 186
Maritime Exchange

YULE & MUNRO SHIPWRIGHTS

Caulkers, Spar Makers

Boat Builders, Etc.

No. 9 SUMMIT STREET

Near Atlantic Dock

BROOKLYN



Copyrighted, 1909.

IT COVERS THE ISLAND'S
INDUSTRIES AND ACTIVITIES

FIFTY CENTS PER YEAR POSTPAID

A Handsome Map of Cuba in four colors, showing all Towns, Rivers, Mountains and
Islands, with Marginal Index, free with every subscription at fifty cents.

WINTER HAVEN NURSERIES

A. M. KLEMM, Proprietor

Established 1884.

Winter Haven, Fla.

Wholesale Growers of Citrus Stock of the best commercial varieties. We guarantee our extensive Stock to be well grown, free of insects and true to name.

Silver Cluster Grape Fruit our leading Specialty.

Prices right. Grading and Packing perfect.

Write for Catalogue.

CUBA INFORMATION

IS THE TITLE OF A BOOK WHICH GIVES DEFINITELY and concisely just such information concerning Cuba as is desired by the business man or prospective investor who is interested in this fertile island—*climate, soil, products, fruit growing, live stock, tobacco, sugar, customs duties, banking, investments, colonies, land titles, laws, and a hundred other matters.*

SEND 25 CENTS FOR A COPY

and if you want any specific information that could not be covered in such a book,

Ask Mr. Foster No. 1 Madison Avenue, NEW YORK

Mr. Foster also has information offices in Philadelphia, Washington, Atlantic City, Jacksonville, St. Augustine, Daytona, Palm Beach and Miami, Florida, and in Havana and Camaguey, Cuba. FREE INFORMATION—no fees ever asked or accepted.

The Standard Guide to Cuba— Reliable—accurate—maps—illustrations.
50 cents.

FOSTER & REYNOLDS, 1 Madison Avenue, New York.

TWO IMPORTANT MAPS

Blue-prints of Cuba, showing the location of the Sugar Plantations and the Rural Guard Stations of the Island. Specially prepared for The CUBA REVIEW. Each 60 cents. Either map with a year's subscription, 75 cents. Both blue-prints and magazine, one year, \$1.

The Rural Guard of Cuba

The Sugar Plantations of Cuba

BUSINESS FIRMS OF SANTIAGO

E. GIRAUDY & CA.

ALMACEN DE VIVERES

Marina baja n. 33, Santiago de Cuba.

Agentes de Schlitz Beer.

JULIAN CENDOYA

Steamship Agent and Broker

COMMISSION MERCHANT

CABLE: Cendoya. Santiago de Cuba.

VALLS, RIBERA & CA.

(S. en C.)

Importadores de Ferrreteria y Machinery.

Teléfono: Valribe.

Santiago de Cuba y Manzanillo.

A. B. C. Code, 5th Edition. Telephone, 190.

P. O. Box, 95. Cable address: SILVAPA.

SILVA Y PARRENO H.

General Commission Merchants.

Custom House Brokers—Forwarding Agents.

Consignees of the Cuban steamers of the Carlos J.

Trujillo, S. en C., Line, formerly Menéndez & Co.

References.—J. Cendoya and Nat'l Bank of Cuba.

CAMP HERMANOS, Santiago de Cuba.

Ron Selecto "Golondrina" y "Carta Cuba."

Medalla de Oro, St. Louis, 1904.

RON BACARDI

DE BACARDI & CO., Distillers, Proprietors.

43 San Ignacio, cor. Santa Clara, Havana.

Santiago de Cuba.

LARREA Y BESEALIE

Importers of General Groceries and Exporters of

Cocoa, Wax, Honey and Woods.

Apartado 65, Marina Baja 46. Cable: Larrea.

Importación.

Exportación

L. ABASCAL Y SOBRINOS

Agentes de las líneas Pinillos Izquierdo y Ca., de

Cadiz. Larrinaga y Ca., de Liverpool. Com

pañía de Seguros, Aachen & Munich, Aix-la

Chapelle.

BROOKS & CO.

Bankers and General Commission Merchants.

Santiago and Guantanamo.

VINEGAR BEND LUMBER CO.

Manufacturers and Exporters

Long Leaf Yellow Pine Lumber and Timber

Cuban Business Our Specialty VINEGAR BEND, ALA., U. S. A.

Daily Capacity, 200,000 Feet

Cable Address: "TURNER"

Codes: A B C, Fourth Edition; Southards; Watkins; Western Union



SOBRINOS DE BEA & CO.

Bankers and Commission Merchants
Importación directa de todas los centros
manufactureros del mundo.

Agents for the
Munson Steamship Line, New York and
Mobile.

James E. Ward & Co., New York.
Serra Steamship Company, Liverpool.
Vapores Transatlánticos de A. Folch & Co.
de Barcelona, España Independencia
Street 17/21.

MATANZAS, CUBA.

JOHN W. McDONALD

COAL, WOOD, LUMBER
and TIMBER of Every
Description

112 WALL STREET

Near South Street NEW YORK

Yard: 58-68 Beard Street, Erie Basin

Telephones:

Office, 1905 John Yard, 316 Hamilton

PURDY & HENDERSON, Inc.

Engineers and Contractors

New York Chicago Boston

Cuba Office, Empedrado 32, Havana

"The Comfortable Way"

Between the East and the West is
via the Toledo, St. Louis and
Western Railroad

"Clover Leaf" Route

Rates lower than by any other
direct line. Send four cents in
stamps for copy of "Get Out or
Get in Line," a booklet by Mr.
Elbert Hubbard, Chief of the Roy-
crofters.

GEO. J. CHARLTON,
General Passenger Agent,
Chicago, Ill.

THE SNARE AND TRIST COMPANY

CONTRACTING ENGINEERS

Steel and Masonry Construction
Piers, Bridges, Railroads and Buildings

We are prepared to furnish plans and estimates
on all classes of contracting work in Cuba.

N. Y. Office

143 LIBERTY ST.

Havana Office

LA LEAL BUILDING

W. H. Bennett

F. W. Hvoslef

Bennett, Hvoslef & Co.

18 Broadway, New York

Steamship Agents and Ship Brokers

Cable: "Benwalsh"

MUNSON STEAMSHIP LINE

GENERAL OFFICES

82 BEAVER STREET, NEW YORK

New York-Cuba Service

PASSENGER AND FREIGHT

Proposed Passenger Sailings for OCTOBER, NOVEMBER and DECEMBER, 1909

| STEAMERS | NEW YORK | | NUEVITAS | | BANES | GIBARA and VITA | PUERTO PADRE | NUEVITAS | | NEW YORK |
|----------------|----------|--------------|--------------|--------------|---------|--------------------|-----------------|----------|---------------|----------|
| | Sail | NIPE Arr. | NIPE Arr. | NIPE Arr. | Arr. | Arr. | Arr. | Leave | NIPE Leave | Arr. |
| CURITYBA | Oct. 6 | | Oct. 11 | Oct. 13 | Oct. 15 | Oct. 16 | | Oct. 21 | Oct. 22 | Oct. 27 |
| OLINDA | Oct. 20 | Oct. 25 | Oct. 27 | | | Oct. 30 | Nov. 2 | Nov. 4 | Nov. 5 | Nov. 10 |
| CURITYBA | Nov. 3 | | Nov. 8 | Nov. 10 | Nov. 12 | Nov. 13 | | Nov. 18 | Nov. 19 | Nov. 24 |
| OLINDA | Nov. 17 | Nov. 22 | Nov. 24 | | | Nov. 27 | Nov. 30 | Dec. 2 | Dec. 3 | Dec. 8 |
| CURITYBA | Dec. 1 | | Dec. 6 | Dec. 8 | Dec. 10 | Dec. 11 | | Dec. 16 | Dec. 17 | Dec. 22 |
| OLINDA | Dec. 15 | Dec. 20 | Dec. 22 | | | Dec. 25 | Dec. 28 | Dec. 30 | Dec. 31 | Jan. 5 |
| CURITYBA | Dec. 29 | | Jan. 3 | Jan. 5 | Jan. 7 | Jan. 8 | | Jan. 13 | Jan. 14 | Jan. 19 |

SAILINGS SUBJECT TO CHANGE WITHOUT NOTICE.

Steamers sail from PIER 9, EAST RIVER, N. Y., at 12 o'clock noon

NEW YORK-CUBA SERVICE

FREIGHT ONLY

New York to Caibarien, Matanzas, Cardenas and Sagua

MOBILE-CUBA SERVICE

FREIGHT ONLY

Regular Sailings: Mobile to Havana, Mobile to Northside and Southside Cuban Ports

BALTIMORE-COLON SERVICE

FREIGHT ONLY

Regular Sailings: Baltimore to Colon

AGENCIES AT HAVANA AND ALL CUBAN PORTS.

Lillie Multiple Evaporators

Model of 1904-1905 (Patented)

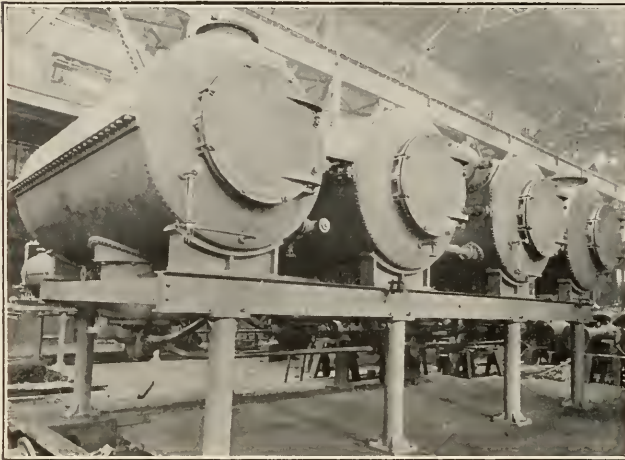

"One of three Lillie quadruple effects installed in 1907, in sugar factories in Formosa, belonging to the Taiwan Seitō Kabushiki Kwaisha, of Tokio, Japan. Two more quadruple effects, one to handle 550,000 gallons of cane juice per twenty-four hours, and the other to handle 325,000 gallons in the same period, are now (July 1st, 1909) being built for the same Japanese Company, also for service in Formosa. These quadruple effects are arranged for reversing the course of the vapors and heat at will, a mode of operation peculiar to the Lillie and which has proven of great value for solutions depositing incrustations on the evaporating tubes."

The Sugar Apparatus Manufacturing Co.

328 Chestnut St., Philadelphia, Pa.

S. MORRIS LILLIE, President.

LEWIS C. LILLIE, Secretary and Treasurer.

BALDWIN LOCOMOTIVE WORKS

Broad and Narrow Gauge

Single Expansion and Compound

LOCOMOTIVES

Compressed Air Locomotives. Electric Locomotives with Westinghouse Motors



PLANTATION LOCOMOTIVES

For all Gauges of Track. To meet all conditions of service. Specifications furnished on application.

Principal offices and works, 500 North Broad Street
Philadelphia, Pa., U. S. A.

Cable Address: "Baldwin, Philadelphia"

Agents for Cuba, Krajewski-Pesant Co., Aguiar 92, Havana, Cuba.



THE CVBA REVIEW

50 Cents A Year **NOVEMBER 1909** 5 Cents A Copy
Published by the Munson Steamship Line, 82-92 Beaver Street, New York City.

CEBALLOS "THE GARDEN SPOT OF CUBA"

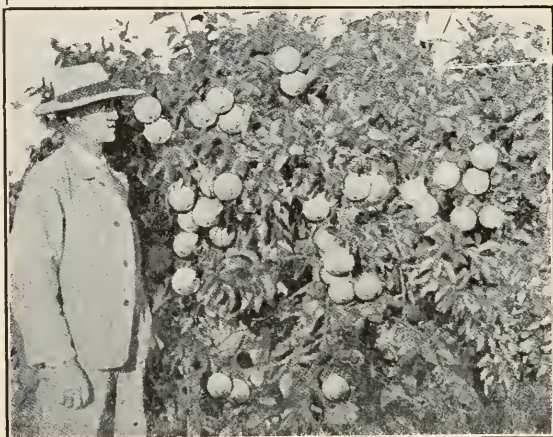

FOUR-YEAR-OLD GRAPE-FRUIT TREE AT CEBALLOS

After eight years of developing the country, creating industries, establishing conditions—paving the way—we now invite **HOMESEEEKERS** to share our prosperity. No pioneering. All conveniences of modern civilization. Send for literature.

GEO. H. GILLET, Secretary **43 EXCHANGE PLACE, NEW YORK**

Would you like to
own a
HOME
in this
Ever-Summer Land?

**Intelligence, energy
and moderate capital
will here win a fortune
for you in Fruits, Vege-
tables and Sugar.**

PRATT Imperial



Sugar Cane Machinery and Evaporating Apparatus.

**Complete Plants Erected and Delivered to Owner Under Guaranteed Capacity
of Mills and Quantity. Sugar House Pumps.**

We have nearing completion, subject prior sale, December 1st delivery, one 34" x 72" Pratt "IMPERIAL" Mill Complete, with Hydraulics, Compound Gearing & Corliss Engine, also one 26" x 72" Pratt "IMPERIAL" Cane Crusher, complete with Hydraulics, Compound Gearing and Corliss Engine. For description see page 36.

STEAM PUMPS

**SPECIAL PARTS of MACHINES, any size or kind; and
HEAVY CASTINGS famous for quality.**

We maintain Export Sales Offices at 80 Wall St., New York, in charge of Mr. N. A. Helmar, an eminent Sugar Mill Engineer of wide experience. We solicit our business with the assurance of every courtesy and perfect satisfaction.

**Pratt Engineering & Machine Co. ATLANTA, GA.
U. S. A.**

HAVANA, CUBA, OFFICE: LONJA DEL COMERCIO No. 509

Successors to FULTON FOUNDRY & MACHINE WORKS, Atlanta, Ga.

Tivoli Beer

—*Enough said.*

Havana Brewery

Havana

BUCKEYE NURSERIES

M. E. GILLET, Proprietor

TAMPA, FLORIDA, U. S. A.

ORANGE, LEMON AND GRAPE FRUIT TREES

LARGEST CITRUS NURSERY IN THE WORLD

QUALITY

VARIETY

DELIVERY

Price may be forgotten—Quality NEVER.

We grow nothing but standard Varieties which we can recommend to the trade as Money-Makers. Having had 29 years' experience we thoroughly understand packing trees for long distance shipments.

We guarantee our trees to be True to Name, Free from White Fly and to ARRIVE AT DESTINATION IN GOOD CONDITION.

Consider the future and protect your investment by planting reliable trees from

THE BUCKEYE NURSERIES

LA GLORIA

The Colony where the Best Oranges are Raised

La Gloria fruit carried off the majority of the prizes of the 1908 and 1909 Exhibitions of the Cuban National Horticultural Society at Havana.

There is no other "just as good"

WRITE FOR HANDSOME ILLUSTRATED BOOKLET.

CUBAN LAND AND STEAMSHIP CO.

No. 32 Broadway, New York City

OF VALUE IN CUBA

Dixon's Silica Graphite Paint. Protects all iron work from rust and destruction. Equally useful for wood or metal.

JOSEPH DIXON CRUCIBLE CO.

Jersey City, N. J.

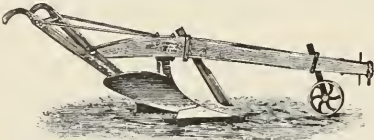

FARQUHAR

All Cuban Dealers in Hardware, and Planter's are acquainted with the merits of
FARQUHAR Plows and Agricultural Implements
 which can be found on sale at every hardware store in every city and town on the Island

Write for illustrated catalogues or apply to our

AGENTS: AMERICAN TRADING COMPANY, NEW YORK AND HAVANA

A. B. FARQUHAR & CO.

Cotton Exchange Building

New York, U. S. A.

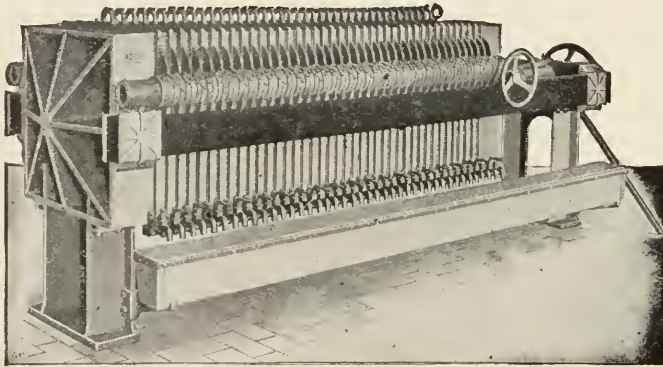

**Prensas de
 Filtrar
 para Ingenios
 SHRIVER
 Filter Presses**

Write us for Cata-
 logue, Prices and
 Information.

T. SHRIVER & CO.
 814 Hamilton Street
 HARRISON, N. J.

Sole Agents for Porto Rico
McMurtrie-Guiler Co.
 SAN JUAN, P.R., and BEAVER BLDG
 BEAVER STREET, NEW YORK

GENUINE "EWART" LINK-BELT



and our other approved Chains,
 Attachments, etc., described and
 illustrated in latest Chain Catalog

No. 75

LINK-BELT COMPANY

299 Broadway, New York City

THE CUBA REVIEW

"ALL ABOUT CUBA"

An Illustrated Monthly Magazine, 82-92 Beaver Street, New York

MUNSON STEAMSHIP LINE, Editors and Publishers

SUBSCRIPTION

50 Cents Per Year - - - - - 5 Cents Single Copy

Advertising Rates on Application

Vol VII.

NOVEMBER, 1909

No. 12

Contents of This Number

The cover illustration is of a natural monument in the Isle of Pines.

Political and government affairs are discussed on pages 7 to 13.

The President's message, on page 7, is a very valuable and optimistic document and will be read with interest. There have been changes in the Cabinet, and there are activities in the various public departments of the Island, which will be found chronicled on these pages.

On page 14 are some interesting illustrations of havoc caused by the recent storm.

Pages 15, 16 and 17 are devoted to the Island's railroad reports and earnings, the condition of the Island's treasury and other matters of financial interest.

A paragraph on the immense iron ore deposits of Cuba, together with an illustration of the steam drill at work at the Daquiri mines, in Oriente Province, are on page 18.

Pages 20 and 21 contain a most interesting analysis of Cuban conditions as they are to-day, written by the Rev. Albion W. Knight, Episcopal Bishop of Cuba.

Isle of Pines matters are described on page 24.

A noteworthy article on the "Status of Foreigners in Cuba," written by a well-known lawyer of Havana, will interest Americans.

Tobacco industry matters, with a brief recital of the damages caused by the recent storm, are on page 28.

On pages 27 and 30 will be found some very valuable Cuban agricultural station notes, giving the results of experiments with tropical fruits and vegetables since 1904.

The Sugar article, by Willett & Gray, in Spanish and in English, with some very important data from foreign journals on sugar-cane planting, also in Spanish, will be found on the succeeding pages.

MANY BEAUTIFUL ILLUSTRATIONS.

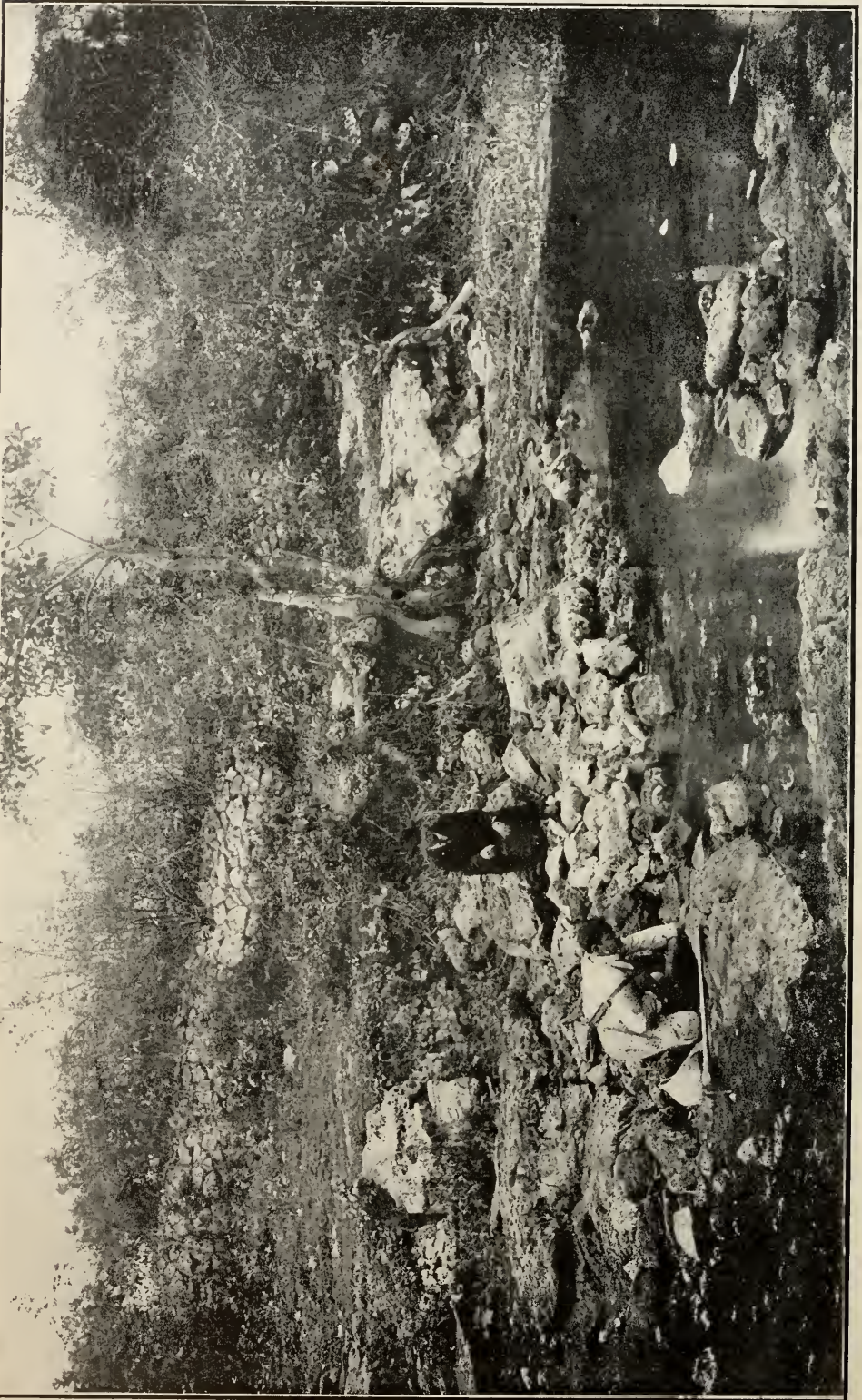

Cuba is a country of underground streams and springs, and wells as a rule supply, at a comparatively slight depth, the finest of water. The view shows a spring on the bank of a small stream such as the traveler will frequently find.

THE CUBA REVIEW

"ALL ABOUT CUBA."

Copyright, 1909, by the Munson Steamship Line.

LIBRARY
NEW YORK
BOTANICAL
GARDEN.

Volume VII.

NOVEMBER, 1909.

NUMBER 12.

CUBAN GOVERNMENT MATTERS.

The President's Message Optimistic—New Treaty with Spain—Conservatives Hostile to Administration—Public School Education Plans.

President Gomez's Message. The Cuban Congress convened November 1, the sessions of both houses being devoted to a reading of the President's message. It was long, but hopeful in sentiment, and closely reviewed conditions, making many important recommendations. He said in part that the economic condition of the country could not be more flattering at the close of the greatest sugar crop in Cuba's history, with the promise that the coming crop would be even greater. Life and property everywhere were secure, and the government was receiving the support of its political opponents and the entire press. He referred also to important railroad extensions in Oriente Province, details of which will be found on another page, and the opening up of large districts for cultivation, the increasing demand for labor, recommending that Congress should support this movement by encouraging immigration and establishing agricultural loan institutions.

The condition of the National Treasury he found satisfactory as compared with its condition at the beginning of the present government. The last eight months showed increased receipts amounting to \$1,570,303 over the corresponding period of last year. When the Treasury was turned over to the government, January 28, 1909, it contained \$2,685,228, with obligations amounting to \$8,404,956. The receipts since then amounted to \$25,439,426, making a total of \$28,124,554.

The expenditures reached \$27,089,353, leaving in the Treasury on September 30 a balance of \$1,035,301.

By pursuing a course of severe economy, the President said, the country would soon wipe out the obligations left over by the government of intervention.

The President also called attention to the discrimination against Cuban products by several European countries, notably France, which was contemplating an increase in duty of 30 per cent. on Cuban tobacco, and made another recommendation that Congress reform the tariff, fixing maximum and minimum rates at the discretion of the Executive, which would place in his hands a formidable weapon of economic defence. He also urged an appropriation to keep up the great system of highways recently completed. The health of the island was said to be excellent, sanitary measures having been carried on with vigor and skill. It was pointed out that the only epidemic this year was a slight outbreak of diphtheria in Pinar del Rio Province, which was promptly checked. The presentation of the budget to Congress will be made November 15.

New Treaty With Spain. That Spain and Cuba will soon reach an agreement on a treaty of commerce is the interesting prognostication made in a special cable dispatch to the New York Herald, November 2. A renewal of important and more cordial trade relations between the

two countries will result. It is also likely that the end of Spain's claims upon Cuba to pay the old colonial debt is now in sight. While the general press opinion was absolutely opposed to the payment of the claims they were present and irritating.

The dispatch to the Herald says "that a decisive step toward an agreement on a treaty of commerce between the two countries was taken November 1, at Madrid, Senor Moret, Minister to the Interior, stating to the editor of the Havana "Diario" that the Spanish Government was absolutely convinced of the necessity of rushing negotiations, in order to prevent the loss to Spain of the Cuban market, which Spain ranks in importance next to the markets of France and England, and represents 60,000,000 pesetas yearly." Should the Cuban Congress, now in session, take measures against Spanish products it would mean the ruin of many leading Spanish exporters."

"Señor Rivero, editor of the 'Diario,'" continues the dispatch, "after a conversation with Señor Moret, declared that the treaty can be considered already negotiated, the only points to be settled being matters of detail, which will be based on the continuation by Cuba of the advantages granted at present to Spanish products, with a few new concessions.

Spain, on her part, will reduce by from forty to fifty per cent. the duties on Cuban tobacco, cocoa and fruits."

The Venezuelan Minister, General Andrade, expects also to perfect a commercial treaty between his government and Cuba. This is now being negotiated.

A meeting of the national *Conservatives* committee of the *Conservative* Party was held in *Hostile*

Havana on October 29 to determine the future policy of the party. General Menocal, its candidate for President of the Cuban Republic at the last election, Antonio Gonzalez Lanuza, leader in the House, and other prominent representatives made addresses.

All agreed that the administration of President Gomez was a failure and that it was the duty of the Conservatives to abandon the policy of sustaining the government, which hitherto they had followed for the purpose of giving it a fair trial, and to begin an active anti-administration campaign in Congress and the press. A resolution to this effect was unanimously adopted. A number of other resolutions, including one opposing a budget exceeding \$18,000,000, were laid over for consideration.

The New York Tribune says it is rumored that President Gomez probably will attempt to placate the Conservatives by offering them positions in the Cabinet, in which already there are two vacancies, and from which there is a strong probability that the Secretary of the Treasury, Senor Villegas, soon will retire. The continued failure of the Miguelistas and Zayistas to effect a permanent fusion, has aroused hopes among Conservative members of holding the balance of power in the lower house.

The report of Mr. *Encouraging* Dearing, American Chargé *Financial* d'Affairs at Havana, on *Report.* Cuba's financial condition,

recently forwarded to the State Department at Washington, proves to be very encouraging. He found that when the present administration assumed control of the Treasury it held \$2,685--228.74, with obligations amounting to \$8,404,956.34, while on September 30, 1909, there was on hand \$1,035,302.28, with obligations amounting to \$5,117,151.82.

It appears therefore that although the cash on hand in September was less than last January, the debts have been decreased \$3,287,804.52. The budget for the first quarter of the present year, the report also states, has been more than met by the ordinary revenues, showing an economical administration of affairs.

Lottery
Tickets
Kept Out.

With the aid of the Cuban Director of Posts, the United States Post Office Department has succeeded in confining the sale of Cuban national lottery tickets in the United States to a minimum. When money is sent by persons in this country for Cuban lottery tickets, the money is returned to the sender by the Cuban officials with a statement that it is a violation of the postal laws of the United States to transmit matter relating to lotteries through the mails. When the Post Office Department receives information that persons or concerns in Cuba are sending matter such as tickets, circulars, newspapers or advertisements to this country, the Cuban authorities are notified, so action may be taken to prevent it.

Members of the city council of Caibarien are attempting to give the town the status of a city. The citizens claim that the only thing needed is the title because the taxes they pay are equal to those of a first-class city. Caibarien has 10,053 inhabitants.

Philatelists generally will be interested in the announcement that a new issue of Cuban postal and telegraph stamps is contemplated for January 1, 1910.

Portraits of Cuban patriots will appear on the new stamps, according to the plan prepared by Director of Post and Telegraphs Orencio Nodarse.

The new issue will be in two colors and of the usual size stamps in present use, which bear the Columbus photo, and the Cuban palms will be discarded.

The one-cent stamps will be dark green and black, and bear the portrait of General Bartolomé Maso. The two-cent stamps will be read and dark green and will show the photo of General Maximo Gomez. The three-cent stamps will be of violet and dark blue and carry General Julio Sanguily's picture. The three-cent stamp will be blue and brown and show the features of General Ignacio Agramonte. The eight-cent stamp will be of blue and lilac and will have the photo of General Calixto Garcia. The ten-cent stamp will be extra large, bearing two ovals and will be sepia and green. In the right oval the photo of General Juan Bruno Zayas, brother of Vice-President Zayas, will appear. On the left oval will be seen a messenger mounted on a bicycle. Besides the usual script of "Republica de Cuba," the ten-cent issue will have the words "immediate delivery." The ordinary ten-cent stamp will be of orange and light blue. It will bear the photo of General "Mayia" Rodriguez. The fifty-cent stamp of black and lilac will have the photo of General Antonio Maceo, and finally the dollar stamp of black and yellow will have the picture of General Carlos Roloff.

Stamped envelopes will also be put in use again. These envelopes will be of small and large size and of one, two and five-cent denominations. The stamps will bear the likenesses of General Sorain Sanchez, Colonel Enrique Villuondas and Joaquin Aguero, the Camagueyan patriot.

Under orders of Dr. Matias Duque, Cuban Secretary of Sanitation, Dr. Juan Geieteras issued October 15 a circular ordering the local health office to proceed with the work of vaccination and revocation. Vaccination is to be made on all persons in the first year of life, who have not been previously vaccinated, the operation to be repeated at the end of ten years. All persons who were never before vaccinated are also included, and those that were vaccinated six years ago. All vaccine which does not take must be repeated at the end of two months.

According to reliable information obtained, the Hon. Edwin V. Morgan, United States minister to Cuba, will return to Havana within a short time, again to resume his diplomatic duties, says the Havana Post. This news is contradictory of the reports issued from Washington recently that General Upham had been mentioned to replace Mr. Morgan, who was to be given another post in the service of the United States.

Señor Salustio Garcia Cordero, Inspector of Public Schools of the Province of Camaguey, Cuba, was recently on a visit to Philadelphia and other cities, and made a tour of the public schools. Interviewed regarding public education in Cuba in recent years, he said yesterday:

"Cuba's present system of public schools began under the American intervention, but has reached its present high state of efficiency under self-government. The administration of President Gomez is bending its best efforts toward education.

"We have in Cuba 200,000 children of school age. Under the Spanish Colonial Government barely 20,000 went to school. Now we have 150,000 children attending school, and in three or four years every child of school age will be under instruction. The teaching of English is compulsory. New buildings are being put up in all the provinces. There are now 3,600 public schools, which are absolutely free to all. Some of the teachers are Americans, but most are Cubans. In the sections where there are large American populations special schools are built for them and paid for by the Cuban Government.

"The building of normal schools for the training of teachers will be the next step in Cuba's educational progress. Our teachers now are good, but we want the best. We will adhere to the American system. There are already special schools for manual training, cooking and sewing."

A committee of the board of navigation, headed by President Julio Blanco Blanco Herrera, petitioned President Gomez on October 14 for improvements at the Luz wharves, and an extension to the Paula wharf in Havana. The committee also presented a board resolution asking the rescission of an old military order which establishes dockage charges.



The October storm in Havana. View on the Prado facing the Hotel Pasaje, showing the damage done to the beautiful shade trees.

Another most serious storm ravaged western Cuba on October 11. In Havana many minor buildings were blown down or unroofed, five persons killed and about twenty-five injured. The greatest damage was done in the harbor, where forty or fifty lighters, launches and small tugs either were sunk or blown ashore. In Pinar del Rio Province the orange and other fruit crops suffered severely. There were heavy floods at Vuelta Abajo, the tobacco region, but the tobacco crop has not been seriously affected. The vortex of the tornado was a short distance west of Havana. At Arroyo Naranjo, Havana Province, the new tuberculosis hospital was blown down and many of the patients injured.

When the storm struck the bay it swept away buildings and boats before it, demolishing every small structure on the east side, sinking full half a hundred boats of various kinds and making a sorry wreck of the plants and docks of the Havana Coal Company, which probably suffered the heaviest financial loss of any one concern. The officers of the company estimate the damage at between \$100,000 and \$130,000.—Post.

F. L. Clinton, Cuban honorary consul at Pensacola, Florida, recently forwarded his resignation to the Department of State. The resignation was accepted.

According to Direct Garcia Oses, only a few of the trees planted at the Government Agricultural Station at Santiago de los Vegas were left standing by the October storm, all the experimental plants were torn up or killed by the wind; the botanical garden is a veritable ruin; the acclimation department, where innumerable plants of commercial value to this country were planted, also suffered and the new tobacco barn, which was built recently, was blown to the ground. The rain driving through the broken windows caused considerable damage to the interior of the laboratories.

Cattle breeders of Camaguey province are asking more protection for the Cuban cattle industry. They state that they are being driven to ruin by the importation of foreign cattle. Because of their agitation last year Governor Magoon increased the duty on foreign cattle a fraction of a cent per kilo. This extra protection is said by the cattle dealers to mean no protection to them at all. Senators and Representatives promise more favorable legislation when Congress convenes.

President Gomez has appointed James Luke to be honorary consul of Cuba at Calcutta, India.

Congress by its act of July 3, 1909, authorized the segregation of Banes from the municipality of Gibara, and in consequence Banes, a full fledged municipality with 17,251 inhabitants, must provide for municipal and school elections by November 30.

The Council of Oriente Province has approved the charter of constitution of the new municipality, which includes the boroughs of Cañadon, Banes, Arroyon de Flores, Mula, Sama, Arriba, Rio Seco, and Yayujay. Under Article 15 of the municipal law, the inhabitants of the municipality, according to the last census, entitles it to fifteen city councilmen.

The candidate for Mayor, Lieutenant Colonel Juan Vicente Cardenas, of the Conservative party, is a native of Santiago, de Cuba, thirty-nine years old, and won the rank of colonel in the war for independence. At present he is engaged in business in this place, and is a large property holder.

Dr. Juan Ruiz Ariza, the Liberal nominee, is a native of Havana, 43 years old. He settled in this place about seven years ago and is employed by the United Fruit Company as head of the hospital founded by that company at this port. He also holds the office of port doctor attached to the Cuban Marine Hospital Service.

The removal of Ricardo Alvarez Fernandez, a Spaniard alleged to be insane, from this city, says the Tampa, Fla., Tribune, has opened up a new route by which such cases can be sent back to that country. Heretofore insane Spaniards had been deported by way of New York, but so much red tape had to be gone through with in the arrangements with the United States Government that the Spanish Consul here has in the case of Fernandez appealed to Cuban Consul Ybor to have Fernandez sent back by way of Cuba to Spain. In answer to his application to the Havana government, the latter wrote to Consul Ybor that all similar cases hereafter may be sent by the same route, being transferred from one boat to another in Havana.

On October 9, President Gomez used the constitutional prerogative and granted twenty-six pardons and six commutations to commemorate the forty-first anniversary of the Grito de Yara, the day on which Carlos Manuel de Cespedes rose against Spain at Yara, marking the Commencement of the Ten Years' War, October 10, 1868.

Among those liberated were Sergeants Francisco and Vicente Cortez, father and

son, formerly members of the rural guard, who in March last were sentenced to life imprisonment for taking part in an attempted insurrection.

Street sweepers and minor employes in the city's cleaning department went on strike Oct. 17, alleging a reduction in their wages and irregular payment as the reasons.

These complaints have frequently occurred since the cleaning works have been transferred to the Sanitary Department from the Public Works Department. President Gomez sided with the men, restored their salaries and the strike ended.

Out of the trouble arose, however, serious dissension between two members of the Cabinet, Justo Garcia Velez, Secretary of State, and Gen. Matias Duque, Secretary of Sanitation, and a pistol duel resulted, at which no one was hurt. The principals had previously sent their resignations to President Gomez, who promptly accepted them. Last advices are that Señor Velez will be reinstated or given an important foreign diplomatic post. Further Cabinet changes are predicted.

On October 29, President Gomez signed a decree providing for the registration and periodical inspection of all banks and other corporations. Men prominent in commercial life and bankers say that if the decree is permitted to become operative it will have a bad effect on all classes of business, especially that of foreign corporations in Cuba whose methods of accounting render impossible compliance with the terms of the decree. It also will tend, they say, to discourage investment of foreign capital in Cuban enterprises. Prominent American and Cuban lawyers say that the decree obviously is unconstitutional and efforts will be made to bring the matter before the Supreme Court.

The Yale football team has been invited by the students of the University of Havana, through A. Garcia-Rey, to one game of football with the university team. The latter guarantee, by means of a bill of exchange drawn to the order of the Yale team, the cost of the trip first-class, and lodging for one week at any leading hotel.

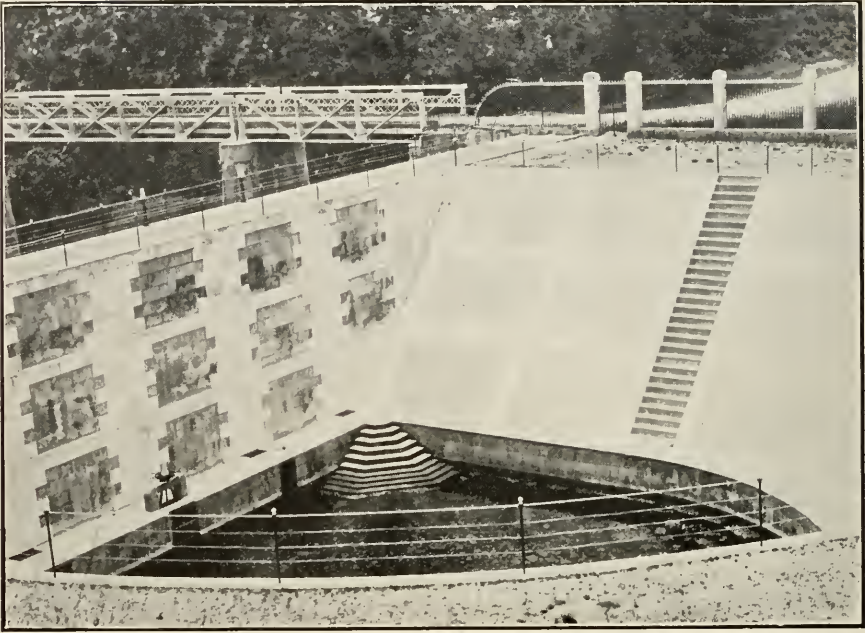

Havana's Water Works.—La Taza de Vento, Vento Springs, on the bank of the Almendares river. These springs yield 45,000,000 gallons a day, although all Havana at present uses is about 32,000,000. Surface water is carefully kept out of the Taza, with the result that the supply of water is free from organic matter. The water is very hard with lime and magnesia, but this only serves to make it safer against organic impurities and disease germs.

El Depósito de Aguas de la Habana.—El Canal de Vento. Surtidero de Vento en la ribera del río Almendares. Este surtidero rinde 45,000,000 de galones de agua al día, aunque al presente la ciudad de la Habana sólo consume unos 32,000,000. El agua superficial está cuidadosamente resguardada en la Taza ó canal, dando por resultado que el abasto de agua está exento de contaminarse con materias orgánicas. Al agua contiene gran cantidad de calcio y magnesia, pero esto sólo sirve para resguardarla contra las impurezas orgánicas y los gérmenes morbosos.

Havana, which lost the control of the Vento Water Works, has requested the State Government to return the works to the control of the municipality.

The aqueduct is at present under the administration of the Department of Public Works.

In reply Secretary Chalors said the petition could not be complied with until military order 163 of 1902 was annulled.

It appears that the city of Havana does not derive any water rents at present from property owners, the water fees going to the Banco Español de la Isla de Cuba to satisfy the bonds issued when the aqueduct was built.

The Secretary of Public Works is now engaged in studying a way to improve the supply of water in quantity and pressure for Havana. Works have been started at Vento aqueduct, and new and

more powerful engines have been designed to pump six million gallons in twenty-four hours. Improvements now under way are estimated to be good for the coming twenty years.

The first working session of the House of Representatives, November 3, was devoted to reading a bill

providing for an export tax on sugar of \$1 per bag of 325 pounds, when produced by wage labor, and 50 cents per bag when produced by tenant sharers. The bill is presumably aimed at the American companies who employ laborers at wages instead of raising sugar on shares. The measure was referred to a committee by a vote of 37 to 22, the Speaker saying that its reference was merely a courtesy to the members. The general opinion is that the bill is absurd and impossible.

MINOR NOTES.

The provincial council of Oriente has consented to the erection of a monument to Dr. Joaquin Castillo Duany, a general in the Army of Liberation, in Liberty Park, Santiago de Cuba.

Señor Jose F. Godoy, Minister from Mexico to Cuba, is now in New York for a three months' stay. He is on a special mission of inquiry into immigration in the United States. After concluding his labors he returns to Cuba.

President Gomez has ordered expropriation proceedings commenced to acquire lands in Bahia Hondo for the United States naval station there against such owners as have refused to accept the valuation placed by the government.

The large still of Messrs. Viña and Hermanos at Colon was burned to the ground October 14, causing a loss of over \$20,000.

Inquiries have been sent to the different police departments in the United States for two instructors to be asked to come to Cuba to direct the work of the police academy. The Department of the Interior wants the service improved.

The Institute de Segunda Enseñanza of Havana contains, it is said, one of the finest collections of tropical fauna, forestry and marine specimens in the world, contributed by the great Cuban savant, Francisco Poey.

Henry J. Meagher has been appointed honorary consul of Cuba at Martinique, with residence at Fort de France, vice Estanislao Ducret, resigned.

Plans are now ready to extend the water supply in the city of Pinar del Rio, and work on the new aqueduct will begin at once.

La Lucha of Havana says that "The issue of lottery tickets to the collectors is not an hour old before every ticket is snapped up, and it is very likely that an issue of three times the size would be taken up on the island in the same way."

The work of cleaning the Camaguey aqueduct has been completed. About twenty thousand cubic meters of mud has been taken out.

New post offices have been established at Anton Recio, Santa Clara Province, and at Hato de Guane, Pinar del Rio Province.

It is reported that the lighthouse at Cayo Jutia, between Dimas and Esperanza, was badly damaged in the October storm and is in need of immediate repairs, as it stands on a very important section of the north coast, Pinar del Rio province.

A new ice plant is promised for Havana, to be ready March 1. The machinery necessary will be of the most modern type.

Secretary of Agriculture Foyo has received a petition from the Centro Nacional de Fomento Febril é Industrial, asking that the present system of marking cattle with irons should be changed, at least to the extent of making the size of the irons smaller. It is stated that the present large-sized iron injures the hide to a great extent, and is prejudicial to the tanning industry.

A. Souhart, French Minister to Colombia, has been appointed Minister to Cuba in place of the late M. Bonnardet, formerly counsellor of the embassy at Berne.

As the result of investigations of irregularities in Guantanamo city accounts regarding contracts, the special examination court appointed for the purpose has found indictments against Mayor Pedro Beruff, City Treasurer Arias, and others.

By the closing on October 16 of the last open link in the construction work, the high road was completed connecting Herradura on the east with Havana, and on the west with Pinar del Rio city and all good roads in the province. There was an interesting celebration by all the residents of the colony.

The steam yacht Nourmahal, with the owner, Colonel John Jacob Astor, and party on board, arrived at Cienfuegos on October 20 from Jacksonville, on a hunting trip. The party has visited Hanabanilla River Falls and the neighboring country for game.

Manuel Marquez Sterling has been appointed minister to the Republic of Brazil.

The Attorney General on October 24 asked that Señor Orencio Nodarse, Director General of Posts and Telegraphs in Cuba, and a close friend of President Gomez, be sentenced to three years' imprisonment for shooting the editor of *Politica Comica* Torriente through the hand, on July 31.



The October Storm in Havana. Plaza de Armas, at O'Reilly Street side. The branches of the trees were pruned close to the trunk, and the trees themselves set upright and supported. Visitors this winter will see these bare trunks sprouting into new life. Royal palms were not injured.

The illustration below is of the damage caused the coal discharging apparatus of the Havana Coal Co. at Casa Blanca, across the harbor.

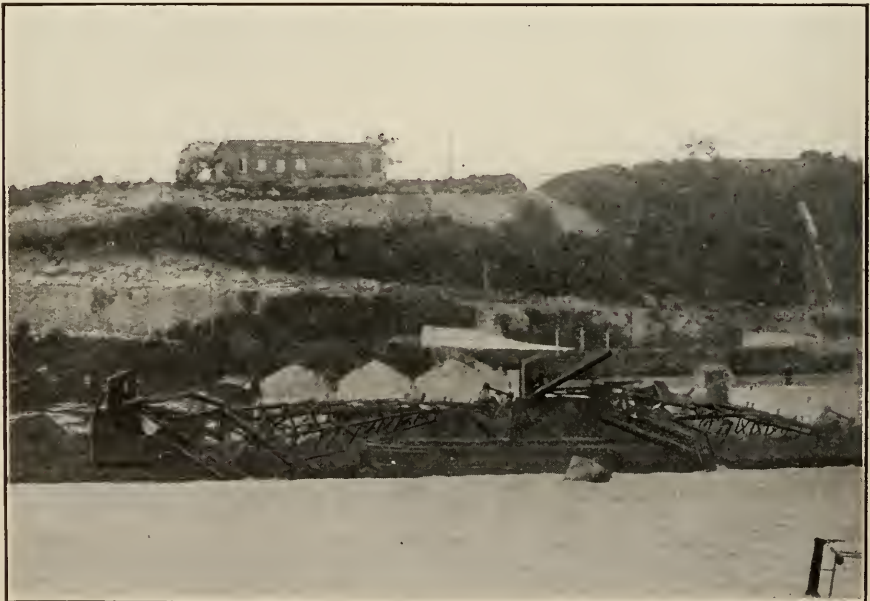

THE TREASURY OF CUBA.

Official Figures Showing Condition to Date of October 18, 1909.

| ASSETS. | | LIABILITIES. | |
|---|----------------|--|----------------|
| Cash on hand | \$1,037,411.86 | Advance orders in transit.. | \$274,077.74 |
| National Bank | 229,190.73 | Postal money order funds.. | 356,715.43 |
| Royal Bank | 160,000.00 | Debts pending | 20,297.24 |
| | | Honorary consuls | 1,220.15 |
| Total | \$1,462,602.59 | Taxes on loans | 926,581.15 |
| In the hands of revenue col- lectors on hand | 168,727.21 | First loan deposit of 50%.. | 270,169.92 |
| | | Balance due on pay of the Army of Liberation 50%. | 353,939.32 |
| REVENUES. | | Epidemic diseases fund.... | 58,273.02 |
| Balance against this ac- count | 5,809,830.09 | Individual contracts | 105,309.87 |
| | | Special laws, 1906 | 1,292,048.58 |
| | | Special laws, 1909 | 732,174.59 |
| | | Decrees of the Provisional Governor | 2,168,990.49 |
| | | Sustenance for detained im- migrants | 2,545.63 |
| | | Deposit of the new \$16,500,- 000 loan | 687,806.86 |
| | | National lottery | 190,999.90 |
| Grand total | \$7,441,159.89 | Total | \$7,441,159.89 |

The Gulf Ports and Cuba.

Galveston's exports to Cuba in the decade ending in 1909, increased from 1,000,000 dollars to 2 3/4 millions.

New Orleans exports to Cuba in the same period increased from \$1,000,000 to nearly \$3,000,000.

Mobile's exports increased from 1 1-3 million dollars in 1899 to over 7,000,000 dollars in 1909.

Key West's exports are chiefly to Cuba, for of the \$621,550 worth of merchandise exported in the fiscal year of 1909, \$558,750 worth went to Cuba.

Eggs were by far the largest item in this total, amounting to \$234,001, while cotton cloths showed a total of \$53,286, crude phosphates \$47,634, cattle \$22,168, lumber \$12,820, and furniture and potatoes each about \$10,000. The total exports from Key West in 1909 were materially less than in 1899, when the shipments of cattle and phosphates to Cuba immediately following the close of the war were abnormally large.—Official figures, U. S. Department of Commerce and Labor.

The Camaguey Company Earnings.

The following are the gross and net earnings of this Company for the nine months ending September 30, compared with the same period in 1908, showing an increase of \$13,105.56 in the gross and \$6,434.40 in the net, viz.:

| | 1908. | 1909. | Increase. |
|-------------|-------------|-------------|-------------|
| Gross | \$86,144.89 | \$99,250.45 | \$13,105.56 |
| Net..... | 39,631.95 | 46,066.35 | 6,434.40 |

Cuba's Pineapple Exportations.

From January 1 to October 16 Cuba's exportations of pineapples, in crates, was as follows:

| 1907. | 1908. | 1909. |
|---------|---------|-----------|
| 645,989 | 992,456 | 1,272,513 |

Desk and Chair Exports.

Chairs of all kinds are the chief articles of furniture which the United States sells abroad, and of these the republic of Cuba takes by far the greater number. During the month of August we sold to Cuba chairs valued at more than \$15,000, and American desks to the amount of \$1,500.

United Railways Dividend.

An annual dividend of two per cent. on the ordinary stock of the United Railways of Havana, and Regio Warehouse, Ltd., out of the earnings for 1908-09, was declared in London on October 16. This is at the rate of \$1 Spanish gold for each 10 pounds of stock. The present condition of the company and the good earnings have caused United Railways stock to be more highly regarded.

Treaty With Uruguay.

The Consul General of Uruguay in Cuba reports that the Cuban Congress is anxious to know the attitude of the Uruguayan government about the proposed commercial treaty submitted by the Cuban government. Congress is willing to discuss the matter at its present session.

RAILROAD NEWS AND TRAFFIC RECEIPTS.

Havana Electric Railway.

| | | Weekly Receipts. | | Receipts from Jan. 1. | |
|-------------|-------------|------------------|----------|-----------------------|-------------|
| | | 1909. | 1908. | 1909. | 1908. |
| Week ending | Oct. 3..... | \$38,293 | \$34,030 | \$1,548,674 | \$1,439,432 |
| " | " 10..... | 35,478 | 34,518 | 1,584,152 | 1,473,950 |
| " | " 17..... | 37,700 | 33,859 | 1,621,921 | 1,507,809 |
| " | " 24..... | 38,229 | 34,656 | 1,660,150 | 1,542,465 |
| " | " 31..... | 39,351 | 34,697 | 1,699,501 | 1,577,162 |

United Railways of Havana.

| | | Weekly Receipts. | | Receipts for Fiscal Year. | |
|-------------|---------------|------------------|---------|---------------------------|----------|
| | | 1909. | 1908. | 1909. | 1908. |
| Week ending | Sept. 25..... | £13,125 | £11,719 | £176,969 | £151,166 |
| " | " Oct. 2..... | 13,491 | 11,753 | 190,460 | 162,919 |
| " | " 9..... | 14,244 | 12,594 | 204,704 | 175,513 |
| " | " 16..... | 12,963 | 12,781 | 217,667 | 188,294 |
| " | " 23..... | 13,291 | 13,147 | 230,965 | 201,441 |

Western Railways of Havana.

| | | Weekly Receipts. | | Receipts for Fiscal Year. | |
|-------------|---------------|------------------|--------|---------------------------|---------|
| | | 1909. | 1908. | 1909. | 1908. |
| Week ending | Sept. 25..... | £4,903 | £6,378 | £61,816 | £80,086 |
| " | " Oct. 2..... | 5,097 | 5,640 | 66,913 | 85,726 |
| " | " 9..... | 4,589 | 6,818 | 71,502 | 92,544 |
| " | " 16..... | 3,627 | 5,988 | 75,129 | 98,532 |

Cuban Central Railway.

| | | Weekly Receipts. | | Receipts for Fiscal Year. | |
|-------------|---------------|------------------|--------|---------------------------|---------|
| | | 1909. | 1908. | 1909. | 1908. |
| Week ending | Sept. 25..... | £4,999 | £5,041 | £64,339 | £59,258 |
| " | " Oct. 2..... | 4,874 | 4,451 | 69,213 | 63,709 |
| " | " 9..... | 4,804 | 4,373 | 74,017 | 68,082 |
| " | " 16..... | 4,294 | 4,740 | 78,311 | 72,822 |

Cuba Railroad Report.

The report of the Cuba Railroad Co. for the month of September and nine months ended September 30, compares as follows:

| | 1908. | 1909. |
|------------------------|-----------|-----------|
| September gross | \$141,227 | \$158,898 |
| Expenses | 81,914 | 102,503 |
| September net..... | \$59,313 | \$56,394 |
| Charges | 32,262 | 35,228 |
| September surplus... | \$27,051 | \$21,165 |
| Nine months' gross.... | 422,857 | 484,536 |
| Expense | 257,102 | 228,030 |
| Nine months' net.... | \$165,755 | \$156,506 |
| Charges | 96,787 | 105,220 |

Nine months' surp....\$68,968 \$51,286

Sir William Van Horne, president of the Cuba Railroad, says regarding the extension to the line now under construction: "Work will be rushed forward this winter and we expect to have the new line in operation by August, 1910. The rainy season will soon be over, and

the work will progress much more rapidly.

"This extension leaves the main line at Marti, in Camaguey Province, running thence to the city of Bayamo, at which point a branch turns southwestward to the port of Manzanillo, the main extension continuing southeastward to Palma Soriano, which is already connected with San Luis by a portion of the new line already in operation. The inauguration of this line will shorten the possible time between Havana and Oriente.

"The stock of the Cuba Railroad is owned by the Cuba Co., which company owns several large sugar mills in the district, through which the extension is to pass.

"Crops both in this section and in the central portion of the island from Santa Clara to Santiago, through which the main line passes, are in excellent condition, and promise a big yield.

"The Cuban Government is subsidizing to the extent of \$8,000 for each of the approximately 160 miles in the extension."—Wall Street Journal.

UNITED STATES COMMERCE WITH CUBA.

Imports and Exports for Eight Months Ending with August.

| | 1907 | | 1908 | | 1909 | |
|--|-------------|--------------|-------------|--------------|-------------|--------------|
| | Quantities. | Values. | Quantities. | Values. | Quantities. | Values. |
| Bananas (bunches) | | \$1,049,382 | 2,367,794 | \$881,612 | 2,286,768 | \$853,378 |
| Oranges (lbs.) | 159,737 | 3,806 | 216,620 | 2,923 | 148,965 | 1,713 |
| Cocoanuts | | 139,111 | | 101,252 | | 99,021 |
| Cocoa, crude and in shell (lbs.) | 1,789,574 | 216,589 | 299,018 | 41,019 | 1,712,604 | 196,098 |
| Copper ore, unate and regulus (tons) | 22,169 | 364,542 | 25,913 | 371,258 | 42,902 | 493,238 |
| Iron ore (tons) | 425,238 | 1,631,350 | 353,708 | 1,008,608 | 550,672 | 1,581,183 |
| Sponges | | 101,886 | | 66,888 | | 97,158 |
| Tobacco, leaf and all other (lbs.) | 10,919,225 | 7,809,901 | 13,625,265 | 9,242,605 | 17,630,844 | 9,698,012 |
| Cigars, cigarettes and cheroots (lbs.) | 367,173 | 1,817,094 | 354,938 | 2,006,266 | 402,791 | 2,354,914 |
| Mahogany (M feet) | 1,783 | 118,796 | 1,006 | 55,703 | 1,217 | 67,986 |
| Total imports | | \$80,500,208 | | \$66,572,913 | | \$91,883,153 |
| EXPORTS. | | | | | | |
| Agricultural implements | | \$90,268 | | \$91,778 | | \$118,193 |
| Horses (number) | 343 | 48,013 | 988 | 118,175 | 781 | 81,008 |
| Mules (number) | 1,693 | 252,134 | 1,056 | 162,680 | 737 | 96,330 |
| Corn (bushels) | 2,016,069 | 1,233,335 | 1,114,883 | 871,922 | 1,390,242 | 1,032,838 |
| Oats (bushels) | 379,942 | 184,997 | 66,648 | 40,654 | 70,499 | 39,993 |
| Wheat, flour (bbls.) | 582,110 | 2,305,992 | 494,829 | 2,420,631 | 474,474 | 2,631,520 |
| Cotton cloth (yds.) | 9,137,145 | 623,972 | 8,379,508 | 549,148 | 15,382,139 | 959,898 |
| Eggs (dozn.) | 3,822,130 | 738,684 | 2,998,579 | 541,720 | 1,040,429 | 348,094 |
| Steel rails (tons) | 18,288 | 543,843 | 8,792 | 243,470 | 15,986 | 408,682 |
| Structural iron and steel (tons) | 4,092 | 208,603 | 7,169 | 467,860 | 3,794 | 253,428 |
| Wire (lbs.) | 12,301,535 | 340,956 | 10,573,213 | 317,968 | 14,011,817 | 364,117 |
| Sewing machines | | 234,286 | | 163,866 | | 192,575 |
| Locomotives number | 36 | 284,362 | 15 | 139,806 | 16 | 133,313 |
| Typewriting machines, parts of | | 58,894 | | 68,304 | | 60,919 |
| Pipes and fittings (lbs.) | 19,151,243 | 643,195 | 21,692,752 | 449,200 | 36,823,498 | 597,054 |
| Boots and shoes (pairs) | 1,022,154 | 1,774,363 | 1,374,602 | 1,565,337 | 1,789,127 | 2,024,462 |
| Canned beef (lbs.) | 98,076 | 11,071 | 88,709 | 9,650 | 162,275 | 20,879 |
| Bacon (lbs.) | 4,272,222 | 423,847 | 2,628,377 | 229,193 | 4,501,649 | 458,390 |
| Butter (lbs.) | 238,436 | 52,616 | 2,028,377 | 229,193 | 4,501,649 | 458,390 |
| Condensed milk | | 625,065 | | 587,387 | | 382,120 |
| Crude oil (gals.) | 2,773,121 | 244,082 | 3,552,501 | 384,243 | 2,832,626 | 289,814 |
| Refined oil (gals.) | 2,585,851 | 400,078 | 2,476,473 | 245,894 | 2,589,685 | 266,282 |
| Rice (lbs.) | 275 | 17 | 600 | 40 | 112,060 | 3,333 |
| Furniture | | 485,582 | | 391,817 | | 363,639 |
| Total exports | | \$35,098,179 | | \$27,354,288 | | \$30,456,911 |

The monthly statement of the foreign commerce of the United States was completed by the Bureau of Statistics of the Department of Commerce and Labor November 1. It shows the imports and exports by principal countries during the month of September, 1909, and the accumulated months of the calendar year 1909. The trade with Cuba was as follows:

IMPORTS.

| Month of September. | Value. | Nine months ending with September. | Value. |
|---------------------|-------------|------------------------------------|--------------|
| 1908 | \$4,073,956 | 1908 | \$70,645,069 |
| 1909 | 5,641,459 | 1909 | 97,524,612 |

EXPORTS.

| | | | |
|----------------|-------------|----------------|--------------|
| 1908 | \$3,298,668 | 1908 | \$30,652,956 |
| 1909 | 3,968,923 | 1909 | 34,425,834 |

The New Ferryboat Havana.

Of two former Brooklyn, N. Y., ferryboats now being completely overhauled and rebuilt, one will be taken to Havana this month for service in the harbor by the Havana Central Railroad. This boat was formerly the West Brooklyn and ran between South Ferry, New York, and Brooklyn. The entire superstructure has been rebuilt, painted white and the lettering all translated into Spanish. The boat's new name is Havana.

The ferryboat has started on her trip to Havana. A crew of nine men will man her and a tug will tow the boat to her new field of work. It is expected that the trip will consume twenty-one days.

The Western Railways of Havana are now preparing to extend their tracks through the town of Alquizar, towards the southeast, reaching the Cojio beach, where a port will be established. This may mean much for the southern coast.

COMMERCIAL MATTERS.

The Lottery Depresses Business.

Business in Cuba, in the opinion of a member of a New York export and import house, who has just returned from the island, is unfavorably influenced by the national lottery. He says:

"Money is taken out of business channels and collections delayed.

Business Conditions:

"Despite reciprocal relations, there are many articles imported by the island from other countries than the United States."

The banks, he says, have plenty of money, but are cautious about loans. The average rate is about ten to twelve per cent.

Imports of rice, for example, which total between \$2,500,000 and \$3,000,000 a year, come chiefly from India. Shipments from India by way of Hamburg or Liverpool are laid down at Havana at a price from one-half to one cent a pound better than from this country.

Similarly, potatoes for at least eight months of the year can be brought from Nova Scotia at prices under those of this country. Canadian apples and oats are also imported. Beans, which form a large item in Cuban food, are bought from us in large quantities because of the nearness of supply. But the French and Austrian product can be bought at lower prices.—Journal of Commerce.

The Balance of Trade.

Discussing this economic question, the Washington, D. C., Post uses this illustration:

"An American cargo of staves valued at \$5,000 at the port of departure is exchanged at Havana, Cuba, for sugar worth in the American market \$10,000. One school of economics will teach you that this is criminal waste and prodigal extravagance, for our country has bought more than it has sold; but if that cargo of staves had been exchanged for sugar worth only \$2,500, then this particular school would have been in ecstasy, because we have sold goods to the amount of \$5,000 and bought goods only to the amount of \$2,500, thus making a favorable balance of trade in the sum of \$2,500.

"There are two theories as to the balance of trade. Mr. John Dalzell will tell you that an adverse balance is ruinous, and leads to hopeless bankruptcy. He will show to you that the people who buy more than they sell are doomed to beggary and misery. On the other hand, Mr. Champ Clark holds that a favorable balance only evidences that a people have not received as much for

what they exported as their goods were worth.

"There is the quarrel that has been going on in the schools of political economy ever since Adam Smith and Jeremy Benham debated it with such learning and logic in the eighteenth century.

English Goods in Cuba.

The Manchester Guardian of recent date says there are signs in the West Indies of a revival in the demand for cotton and other textile goods. Travelers and agents are forwarding orders more freely and the commercial outlook is encouraging. Regarding Cuba's market it says as follows:

"Cuba continues to be a fair market for all classes of white goods and also for fancy woven dress materials. Bleached union cloths, lawns, dyed satteens and mercerized prints are likewise in some demand. Ordinary gray drills and sheetings are, however, dull, the preferential tariff in favor of the American manufacturers affecting the sales of English qualities. Spanish made goods, especially gray domestic and colored cloths, are still in considerable favor with the old established Havana houses. The more settled conditions in the Republic are not causing much increased demand for Lancashire goods, except in low specialties and filled white shirtings. As the United States control the customs of the country and American currency is general in the larger towns, the tendency of business, both in exports and imports, is decidedly in favor of the New York commission houses, who supply the bulk of all the manufactured goods."

Cuba's Trade.

The showing of Cuba in the last fiscal year was extraordinary, says the New York Press. Her exports for the twelve months ending with June, 1909, were \$115,637,047, as against \$97,447,447 for the previous year. While she sold abroad some eighteen millions more, however, she bought some thirteen millions less, the imports for 1909 being \$83,900,234; for 1908, \$96,993,134. The United States sold Cuba four millions less than in the year before; we bought from Cuba eighteen millions more, our purchases accounting entirely for her increase of exports. For the fiscal year ending June 30, 1908 the balance of trade against us in our dealings with Cuba was thirty-five millions. For the fiscal year ending June 30, 1909, it was more than fifty-seven millions against us.

Cuban Iron Mine Decision.

A despatch from Santiago de Cuba of October 21, says: The higher court today confirmed the verdict for the plaintiff given by the Baracoa Court of First Instance in the Moa iron mine case. The plaintiffs are McLaughlin brothers, who brought suit against the Juraga Iron Company, a subsidiary of the Bethlehem Steel Company, of Pennsylvania, to secure the disputed title to eleven iron mines, covering 2,600 acres in the Baracoa district. The decision of the lower court was rendered in March last.

Dredging Sagua Harbor.

The bids for the dredging which is to be done to clear away the bar at the entrance to the harbor at Sagua la Grande were opened October 16 for the removal of rock and mud by the cubic meter and were as follows:

| | Rock. | Mud. |
|--|-------|------|
| M. J. Dady | 5.65 | 59 |
| R. R. Moore | 7.29 | 37½ |
| T. L. Huston Contracting Company | 4.50 | 25 |
| Compania del Gragado. | 5.60 | 54 |
| Sanchez Mederos | 6.85 | 95 |

Iron Ore Deposits in Cuba.

The residual brown iron ores of Cuba form the subject of a paper in the August number of the "Bulletin of the American Institute of Mining Engineers." The purpose of the writer, C. M. Weld, is to set forth certain features concerning the character and probable genesis of these deposits, which give promise of adding about 1,000,000,000 tons of iron ore to the world's supply. The most conspicuous is the Mayari deposit, situated about 15 miles south of Nipe Bay, where a company controlling over 18,500 acres of ore-bearing land containing 500,000,000 tons of ore has installed the necessary plant and equipment with docks and railways. The ore field at Moa Bay, covering from 13,000 to 15,000 acres, contains approximately 350,000,000 tons, and smaller deposits are located at Subitas, at Taco Bay, and Navas near Baracoa. The development of these huge fields has directed study toward several metallurgical problems attending their use in the manufacture of iron and steel, and it has been announced, as a result of exhaustive experiments, that steel rails of more than usual excellence have been manufactured from the ores.



Steam drill at work at the Daiquiri Mines, Oriente Province.

Daiquiri Minas. Barrenadoras de mineral a vapor.

CUBA TO-DAY.

BY THE RT. REV. ALBION W. KNIGHT, D.D., BISHOP OF CUBA.

The Antiquity of Cuba—The Weakness of the Cuban of To-day—Where the Government of Intervention Failed—Great Bulk of Capital Foreign.

"When Henry Hudson sailed his 'Half Moon' up the river which took his name, more than one city in Cuba had celebrated its centennial. When the Puritan Fathers landed on the New England coast, Havana was one hundred years old. When the Spanish flag gave place to our flag on the palace of the Governor-General of Cuba, it had been approximately four hundred years since Columbus landed on the site of Havana, only a scanty hundred yards from the spot on which the American flag was raised. But, although Cuba can claim antiquity, it is only within the past ten years that it has been touched by the great march of progress which since the days of the Reformation has marked what we term western civilization."

"She remained in isolation, and mediæval customs, conceptions, ideals, prevailed to within the past decade. Even to-day they have not altogether been removed, although fast giving way to modern civilization. To a lover of history and things antique, it is hard to see many of these older customs giving way before the insistent force of the things of to-day. On the other hand, when one realizes the general uplift to humanity which comes with modern civilization he could wish that the viewpoint of many of the Cuban citizens of to-day were changed. It is true, the Cuban is beginning to grasp the ideal, and is to a great extent an idealist; but he has not yet come to realize that lofty ideals can only be attained by the stress and struggle of daily routine. Some of them have been lifted up to the mountain top and given the glorious vision; but they do not realize how insecure is their foothold on that pinnacle. They do not yet appreciate that those who have aided them to attain that vision have themselves only reached it through centuries of toil. This is what I would point out as the weakness of the Cuban of to-day. And it is a lack of appreciation of this fact that makes other people too impatient with him. The average American citizen does not understand it, and so misjudges the Cuban and his capacity. That he has intellectual acumen of a high order none who has had any intimate dealings with him will doubt. That he possesses the polish of the Latin mannerisms many realize who have had occasion to live with him. But beneath it all there is an evident desire to attain

things without the wear and tear necessary to reach them. Some of their leaders recognize the difficulty to be contended with in bringing the great mass of the people to a sense of the difficulties in their way. None realized this more than the late Tomas Estrada Palma, who was placed at the head of the Republic as its first president; and I believe many in the present government realize fully the situation, but the leaders are dependent upon the will of the people for the power that they exercise, and they know that the will of the people is for an ideal condition without the hardship of attaining that condition. They are, therefore, confronted with the task of bringing about a condition without having the people with them. It is here, it seems to the student of Cuban affairs, that the recent government of intervention by the American people failed. The two occasions when the United States held the reins of power in Cuba gave golden opportunities to teach and train the people along different lines from those in which they were trained. During the seven years of our occupancy much could have been done to change the industrial situation. A different system of taxation and land-ownership would have wrought wonders in bringing about a more contented and stable citizenry. The one would have incurred opposition from the masses, and the other would have been opposed by the capitalists; but our government was in such a position that it was not dependent upon either of these classes, and the remedies should have been applied. It is doubtful whether any government of the Cuban people will be able to carry them into effect without losing its power. It is true that much capital has had courage to enter the island because the United States stands as sponsor before the world for the security of things, and this capital has made wonderful changes, and developed many enterprises. The custom house reports show that the exports of the island exceed in value the imports; but it should be borne in mind that the goods exported belong in very large measure to the absent capitalist, and the producing laborers are to a great extent foreigners, who save their earnings in order to return to their homes. This necessarily produces an industrial acuteness which was aggravated by the late government of intervention when it

brought about a forced period of prosperity by dissipating the treasury surplus. It left Cuba with an empty treasury and with an accumulation of unpaid bills, and contracts not yet completed. This is the condition which the present administration in Cuba has to face. In its desire to appease the people and divert their minds, it gives to them the lottery and cockpit, and bull-fighting may yet return. As *La Lucha*, one of the influential afternoon dailies, has well said: 'The people have come to think that the government must support them, and not they the government.' And who will say that our military government and our provisional government are altogether free from fault in not giving to the people of a different ideal? Had we aimed at instability in the Cuban government, it seems to me we could not have directed better. Cuba to-day stands out before the world as a Republic whose people aspire to a permanent place among the nations. Upon what does she base these aspirations? one naturally asks. Has she the population? Has she the country? In the consideration of the problems which to-day exist in the island, and the solution of which means her destiny, one cannot

ignore the people. The census taken by the United States government under General Leonard Wood showed a population of 1,560,000, of which about 30 per cent. were negroes and mulattoes. The second American intervention took another census in 1907, and the population had increased to 2,028,000, an increase of about 30 per cent. in the space of eight years. This second census, while showing a very large birth rate, indicated that a considerable portion of the increase came by immigration. This immigration was checked by the revolution of 1906, and while it is still a considerable item of increase, it has not yet reached the maximum which it attained during the last year of the Palma regime. Inasmuch as only one-tenth of the island has been developed, we may expect, when confidence in the stability of things becomes thoroughly established, the tide of immigration to set in once more with even stronger force. Taking the population of the island to-day, it may be roughly divided into three classes: (1) The native-born Cubans, white and black; (2) the Spaniard, and (3) the representatives of other nations. The mass of the population is native-born, with approximately 10 per cent.



(Courtesy of The Churchman, N. Y.)

of Spanish birth. The remainder furnish numerically an inconsiderable portion of the population. The commerce and industries of the island are in the hands of those not born in Cuba; and the great bulk of the capital is foreign. Probably one-third of the rental property in the city of Havana is owned in Spain, and the income from this property is remitted monthly. The commercial houses are almost without exception conducted by Spaniards. The railways are in the hands of English capitalists, and the dividends go to England. The mining and agricultural interests are fast becoming absorbed by Americans. A small minority of Cubans absorb the professions, and others retain small interests in sugar or tobacco lands. The Cuban is, as a rule, a salaried man or a wage-earner. He is, therefore, bound hand and foot, so far as the policy and development of his country is concerned by the foreign powers. This has been his fate since the days of the Conquest, and will continue to be so long as the small farmer has no place in his industrial scheme and there is no system of direct taxation. There is scarcely an appreciable middle class which forms the great backbone of all progressive nations. There have always been and are even to-day under the Republic which proclaims all men free and equal only two classes. It is true many of the aristocrats of the old days are now broken in fortune; but they hold their heads as proudly as ever and scorn manual labor of every kind. It is true the Republic proclaims equality—politically and socially; but the line of demarcation remains; and it has been noticeable that in spite of the asserted equality of the races no negro has been invited to any of the functions at the palace saving the representative of the Haitian Republic. The Cuban is a nervous, quick, impatient person, not yet satisfied to wait for results. He has come into his political freedom and he has been led to believe that this can relieve all the ills of the social fabric, and he finds things not much better than they were. His restless nature makes him dissatisfied to remedy things in the regular way when he looks around and sees so large a percentage of his own people without the means of livelihood. He would enact laws to prevent foreign ownership and would deprive the immigrants of work so long as any natives desire the job. In this island of unlimited possibilities the condition of the great mass of the people is deplorable. I am quite sure that I am well within bounds when I state that at least 50 per cent. of the population is not working half of the time. Many say that it is because the Cuban

is incompetent or lazy. This may be true of many, but it cannot be of all, as the products of the island go to show. To correct the sad social condition, a great reformation must be worked and, like all reformations, it must begin from the bottom. Those up at the top desire no change. The masses have looked to our government to give it to them, and while we did much for the island and the people we have failed in this respect as perhaps any government would have done.

* * * * *

"The nation entered upon its work unselfishly and accomplished much but withdrew before all that could have been accomplished was done. This was due to the sensitive nature of the democratic character of our institutions.

* * * * *

"Cuba is our neighbor and is to remain our neighbor. Her history in the future is destined to touch ours more closely than it has in the four hundred years that have passed. The island with its unlimited resources can support a population ten times as large as that she now has. With the rapid increase the population will soon double and treble. It will be a herogenous mass at first, speaking many languages; but one can expect to find a higher class of person coming out of the composite people who will occupy Cuba in the future. Shall this people be loyal to God and home? Shall they be a cause of joy and peace to the United States? These are questions which only the school teacher and missionary can determine. Amendments to their Constitution, and reprisals, military and provisional governments, after all, are only temporary expedients, and cannot bring about the result which a nation with lofty and unselfish ideas would wish for a people who have been befriended."—The Churchman, N. Y.

Pineapple Exportations in 1909.

According to official figures just promulgated at Washington, during the fiscal year which ended June 30, 1909, Cuba exported 1,263,466 crates of pineapples, the largest crop on record, exceeding that of the preceding year by 312,500 crates. New York took the largest number, 62,844 crates; Mobile, Ala., was second with 207,613; New Orleans third, with 14,807; Florida fourth, with 78,202. New York has always taken the bulk of Cuba's pineapple crop for distribution through the eastern United States, but Mobile and New Orleans are capturing increasing quantities of this fruit to supply the growing markets of the Middle and Western States.—New Orleans Picayune.

Educational Work of Methodists.

Dr. John A. Rice in the New Orleans (La.) Christian Advocate has the following to say regarding the work of Methodists in Cuba:

"The way to the future generation is through the hearts of the children of this. Only a small per cent. of the men and women can be reached. The children are open. So the church in Cuba has done well to begin with the school. We have a fine location and a very good plant in Havana and so in other cities. The day I left, Brother Bradwell told me he had just received another application to take a boarding pupil which was exactly three times as many as he could accommodate. He has bought a beautiful lot of five acres half way between Havana and Maryanao, a suburban town of several thousand inhabitants, some five miles from Havana. Here he will build for the higher classes of Candler College. This site commands a lovely view of the gulf on one side, an exquisite valley on another and the great city on another. Closely connected with the city by ample electric cars, it will be in a few years in the heart of the residence portion. The only regret is that he could not get twenty acres. It would be a splendid investment. He can easily command three times the pupils that he can teach. How different from the states! Here we send out agents to beg for pupils; there we turn them away all the time. We can get all we will provide for. It is a question of men and money. But if we would build as much better institutions here than those offered by others as we do there, we could command pupils easily also. Through these schools we are making converts all the time. The great city is ripe for the institutional church. The brethren with whom I talked are anxious to enter upon this phase of Christian work, feeling that the time is now. Our location in Havana is ideal; \$300,000 put into a plant there would yield enormous returns. So in the other cities. The most surprising thing I saw in Cuba is the Clerks' Club, a magnificent building on the Prado, the principal street, beautifully fitted and furnished with all club appliances, with night school for the children of the members, with a hospital where members are treated free in another part of the city, nursing, medical attention, medicine, nourishment, everything that the modern hospital furnishes, and the total cost is one dollar and a half per month per member for all these privileges. They have twenty-eight thousand members. And another building, even finer, is going up a few blocks away. This

shows a peculiar readiness to combine for amusement and mutual help. The church could utilize this social instinct, with sufficient means to provide what is needed."

Removing the Maine Wreck.

It is said that the movement to remove the ill-fated Maine from the harbor of Havana will be renewed when the United States Congress meets in December. Naval officers are not enthusiastic about the subject, and it is said at the Navy Department that our Government could not do anything in the matter without the consent of the Cuban Government. Occasionally the Secretary of the Navy received a letter from a contractor submitting a proposition to raise the Maine, but the Secretary is without authority and informs the writers that they must appeal to Congress. During the extra session of Congress, which adjourned last August, a number of bills were introduced appropriating money to raise the Maine, but the bills could not be considered because the committees of the House had not been appointed. However, these bills will be pressed in December, and it will be known early in the session whether or not Congress will ever take any action. There seems to be no doubt but that the wreck will have to be removed, as it interferes with navigation in the harbor.

The Cost of Feeding Troops.

According to Gen. H. G. Sharpe, United States Commissary General, in his annual report to the Secretary of War, it cost the United States \$533,822.73 more to feed the troops comprising the Cuban army of pacification than had they been stationed in this country during the same period. Taken altogether, it cost the government \$10,497,393 to feed the entire army during the past year, and the net loss on perishable supplies was \$115,693.

Disease of Coconuts.

It is now generally admitted that the rot of the crown in the district of Baracoa is caused by bacteria. A published description of a disease said to be of fungous origin in the Havana district corresponds exactly to the Baracoa disease, which some believe is the most destructive. The symptoms of bud-rot disease are the turning yellow of the outer leaves, which ultimately hang straight down; the fact that the youngest leaves do not unfold properly, but stand upright, becoming first yellow and then brown in color; the presence in the softer, inner parts of the bud of rotten, evil-smelling tissues.

THE ISLE OF PINES.

Items of Interest from the Island Condensed from the Isle of Pines Appeal—
Schools to Be Re-established—A Telephone Service Promised, Etc.

The Best Firewood.

To those people about to keep house in the Isle of Pines and using a wood-burning stove, it is suggested that the choice of wood necessary to secure a clear, hot fire, free from smoke is most important for comfort. It would be well to select an old standing tree, free from bark or pitch and cut up into short lengths, shorter than the grate.

Any tree free of bark that has stood long enough to have dried out the pitch is superior for this purpose, as it gives a clear, hot fire and sends out no smoke. In the winter, girdle the tree which is suitable for fire wood and in the spring cut it down when the pitch has run out. A young tree makes a bad smoke in burning in the cooking stove and clogs the pipe with soot.—H. R. Blaney.

To Get Rid of Stumps.

A good way to get rid of stumps is to drill a hole in the tap root, pour in sulphuric acid for pine trees and muratic acid for hardwood trees and then make the boring airtight.

Under this process the stump would rot away in six months' time, so that a plow could be run through the ground without meeting any hard obstacle.—Supt. McVean, McKinley.

Parrots Hurt Fruit Groves.

Parrots are about the worst things fruit growers have to contend with. They descend upon the fruit and when they do not pick it to pieces they pick the stems, causing the fruit to fall off the trees. A few parrots can do a great deal of damage in an orange and grape-fruit grove.—George F. Young.

The October storm did not reach the Isle of Pines.

There is no word yet concerning the reconstruction of the wireless poles destroyed in a recent storm. Meanwhile the island is without telegraphic communication with the outside world and much inconvenience is caused thereby.

It is claimed that the clay in the Isle of Pines for brickmaking purposes is excellent. A plant may be established at no distant time.

Public Schools Re-established.

Superintendent of Public Instruction Carbonell, of the Province of Havana, has been investigating the public schools of the island, in response to a petition directed to the Cuban government asking that the schools be provided for in the same manner that they were last year. Teachers appointed are not capable of giving instruction in English. There are a large number of American residents and taxpayers on the island, and these recently petitioned the government as above. La Lucha said that five teachers will be appointed capable of giving English tuition. The Appeal expects to see five American schools in operation before the middle of November.

The authorities at Havana have given promises that the American schools in the island shall be re-established, and that the annoyances incident to the delivery of deeds will be abated. One company has since received 290 of the deeds to property which for some months have been held up in the treasurers' office in Havana.

Mayor D. Benito Oediz, who recently went to Havana concerning matters of vital interest to Americans, said on his return that he had the utmost confidence in the government acceding to the several requests.

The Isle of Pines Steamship Company has been obliged to increase the number of trips of its steamer Cristobal Colon. The new schedule went into effect in October, and provides for three sailings each week between Batabanó and the Isle of Pines.

The Isle of Pines is likely to have a telephone service, taking in the towns of the island. J. I. Anderson was recently given a concession by the Cuban government. The winter may see the system completed.

Work will soon be begun dredging the New River and opening the port of McKinley.

The Vuelta Abajo Steamship Company, owning the Veguero and other vessels, which were operated by the company, has been purchased by the Western Railways of Havana. No details are given concerning the purchase price.

GENERAL NOTES.

Canadian Settlers in Trouble.

Canadian colonists at Ocean Beach are being harassed by the municipalities of Mantua and Guane, in Pinar del Rio, both claiming Ocean Beach to be within their districts, and both endeavoring to collect taxes from the residents. Mr. E. A. Kummel, of Ocean Beach, plainly depicts the unfortunate situation of his fellow colonists in a letter to La Lucha, of Havana, in which he says:

"Guane and Mantua both claim Ocean Beach as being in their territory, and Mantua is collecting taxes by force, while Guane tells us not to pay and if we do pay we will have to pay over again to Guane. Mantua informs us that on and after November 1 our farms will be embargoed if we do not pay the land taxes. Guane sends us official documents and notifications, while Mantua sends them and policemen, and inspectors, and arrests us. Both mayors show us maps which both claim are official, and both make dogmatic assertions directly antagonistic to each other. We are willing to pay proper taxes, but we wish to do so legally and correctly. The writer has filed his tax statements in the municipality of Guane, where they were accepted, and the Mantua authorities inform me officially my lands will be embargoed by them November 1 for non-payment of taxes."

Despite the fact that the Revista Municipal of Jan. 15, 1909, expressly permits settlers to use exempted farm wagons for hauling fertilizer, provisions, implements, etc., from store or station to the farm, the authorities of Mantua rule that the law only permits settlers to take stuff off of the farms, and that not even a pound of rice can be hauled to the farms without paying the full tax of \$7.80 charged public carriers. Settlers who had paid the exemption were arrested when hauling purchases from the Ocean Beach shore to their farms by the Mantua police and fined.

It is understood that Provincial Governor Sobrado will also take up the matter so as to relieve the settlers from the great annoyance which the municipal bickering has placed upon them.

Production and Consumption of Cocoa.

Cuba's cocoa production in the years 1906 to 1908, according to the "Gordian," the German paper dealing with the cocoa trade, are as follows.

| | Kilogs. |
|----------------|-----------|
| 1906.. | 3,271,000 |
| 1907.. | 1,713,000 |
| 1908.. | 862,000 |

Pecan culture should not be attempted below 28 degrees latitude, says the Florida Agricultural Department.



The Canto River in Oriente Province. The largest river in Cuba.

THE STATUS OF THE FOREIGNER IN CUBA.

The Foreigner on an Equality With the Cuban—The Constitution Protects His Civil Rights—Necessary Formalities Required for Those Intending to do Business.

BY OSGOOD SMITH, ATTORNEY AT LAW OF HAVANA.
(From the Havana Post.)

In all lines of business or professional activity in Cuba, a foreigner upon complying with the necessary legal formalities, is on an equality with the native Cuban, except that he cannot be a Notary. The right to vote and to hold public, political office is, of course, confined to Cuban citizens, who also have a limited preference in being employed on public works.

The usual prohibitions as to the entry of undesirable foreigners into the island are imposed by an immigration law enacted by the first American Intervention, and very similar to the laws of the United States on this subject. But after a foreigner is once admitted into Cuba, and is resident here, he finds himself in the unusual position of being expressly protected in his civil rights by the Cuban Constitution itself, a solemn form of guaranty that does not exist in many countries and certainly is not found in terms in the United States Constitution.

Article 10 of the Cuban Constitution expressly states that foreign residents "shall have the same rights and obligations as Cubans," as to "the protection of their persons and properties;" and "as to the enjoyment of civil rights;" and in the Bill of Rights (Title III., Sec. 1) the language is generally so broad as to cover everyone, whether Cuban or foreigner.

To this constitutional equality granted to foreigners there are two exceptions. One is that in Article 20, providing for the writ of habeas corpus, only the person detained or a "citizen" may request it. But as the language of the law governing the procedure to be followed in obtaining the writ is not so restricted, it is still a debatable question if a foreigner may not obtain it, since the Supreme Court has not passed on this point. Another exception is that while a Cuban cannot be banished from the country a foreigner may be—a right universally recognized in international law.

The equality of the foreigner is further expressly sustained by the Civil Code (Art. 27), which may be properly called the fundamental law of the land next to the Constitution; and also by the Code of Commerce (Art. 15) which

is the basis of all the commercial law.

Under these laws a foreign person, firm, association, or corporation, that properly complies with the legal formalities provided in the various cases, is absolutely on a par with a Cuban in obtaining government concessions, mines, irrigation and harbor rights, public franchises, such as steam or electric railways, in owning land and using it in any lawful way they please, and in entering into every kind of commercial pursuits, including banking, but excepting the right to issue bank notes. This statement refers to the substantive rights of foreigners and is believed to be correct. It is true that some of the administrative authorities interpret an old Spanish law to mean that the manager of a newspaper must be a Cuban; but it is believed that such interpretation is not correct, or if it is, that such provision has been overruled by the subsequently adopted Cuban Constitution. There may be some other exceptions to this broad, general statement, as the old Spanish laws still in force in Cuba on many subjects are not codified nor even collected together; but if there are any such, they are unknown to the great majority of lawyers practising in Cuba.

Under the Codes of Procedure in force here, an attachment will be granted against a foreigner when it would not be against a Cuban, which is the law of the State of New York as to a non-resident; and in some cases a foreigner must give bond when a Cuban need not. But these do not affect the foreigner's substantive rights nor his general status here.

It is believed that this completes the list of the few and unimportant non-political distinctions which exist between foreigners and Cubans.

The most important legal formality to be complied with by a foreigner intending to do business in Cuba is to obtain his inscription in the Mercantile Registry, as the failure to do so leaves him under certain disabilities. But the requisites for such inscriptions, and the disabilities consequent upon its absence, are the same for Cubans and for foreigners. Though technical, they can be readily complied with by anyone familiar with the law, and without great expense. The provisions are broadly like

those in the laws of many States of the Union as to foreign corporations doing business in them.

After ten years' residence in Cuba, the writer of this article has yet to experience any difficulty in fully sustaining the legal rights of foreigners in Cuba, and under the new judiciary law making the courts independent of the executive, there is even less danger than formerly that the rights of foreigners will not be maintained when properly presented.

The present government of the Republic is generally understood to stand ready to do all in its power to foster and protect the investment of foreign capital here. The best proof that there are no practical obstacles to such investment is that, by the estimate of the best informed foreigners, there is between \$150,000,000 and \$200,000,000 now invested here by Americans alone, in small farms, large plantations, mines, railways and commercial enterprises.



Winter home of Mr. Lewis F. Wilson at La Gloria. The house is 18 ft. x 40 ft., with porch 10 ft. x 40 ft. upstairs and down, with one-story servants' room back of kitchen 9 ft. x 8 ft. Four rooms on ground floor, and three bedrooms on second floor. It is built of native woods, with cedar siding. Ceiled throughout with cedar, with the exception of the living room, which is ceiled and wainscoted with mahogany, and the dining-room, which is ceiled and wainscoted with majagua. The floors throughout the house are mahogany and the stairs are built of sabicu. The house has one novel feature in Cuban houses, in the way of a cement chimney, extending from the ground up, with a fire-place in the dining-room and another in a bedroom on the second floor. The house is fitted with glass windows opening out, and screen windows opening in. The house cost, complete, around \$2,500.

Residencia de invierno de Mr. Lewis F. Wilson, en La Gloria. Esta casa mide 18 por 40 pies, con un pórtico de 10 por 40 pies de arriba á abajo, á más de un piso de 9 por 8 pies a la parte de atrás de la cocina para los criados. El piso de abajo tiene cuatro habitaciones, con tres dormitorios en el piso de arriba. La casa está construída con maderas del país, con madera de cedro en los costados. El techo es todo de cedro, á excepción de la habitación vivienda, que tiene techo y tabiques de caoba, y el comedor tiene techo y tabiques de majagua. El piso en toda la casa es de caoba, y las escaleras están construídas de sabicu. La casa tiene un distintivo que es una novedad en las casas cubanas, cual es una chimenea de cemento que se extiende desde la planta baja hacia arriba, con un hogar para el fuego en el comedor y otro en las habitaciones destinadas para dormitorio en el piso de arriba. Esta casa está equipada con ventanas de vidrieras que se abren hacia fuera, y persianas de alabrado que se abren hacia dentro. La construcción completa de esta casa ha costado unos \$2,500.

TOBACCO INDUSTRY.

Havana Looking to Washington.

The Havana correspondent of Tobacco of New York makes a plea for lower duties to save the cigar industry of the island. He says:

"Cubans are bent upon using all lawful means to convince the American President, Congress and the public at large, that Cuba ought to be entitled to at least a 50 per cent. reduction on the present tariff rates on cigars, as otherwise our cigar industry is bound to disappear, which would be a hard blow to the Island of Cuba. It might even cause such discontent as to finally end in another uprising, which would not suit the United States, if it could be avoided by a little letting down of the tariff bars in our favor.

"It is perfectly understood in Havana that another revolution would mean another American intervention, and which would ultimately result in the annexation of the island. Through the immigration of Americans and the vast millions of American capital employed, a gradual annexation will be brought about in the course of years, but the time is not yet ripe for this. Cuba is virtually bound hands and feet to the United States commercially, although nominally it is still an independent republic, although handicapped by the Platt amendment. No commercial reciprocity treaty could be made with any European, or any other country, unless the government at Washington had already given its sanction beforehand. If Cuba should lose the American market for its products it would become hopelessly bankrupt. Anarchy and revolution would destroy all property, and in such case the Americans would have to interfere to save their own citizens. The present reciprocity treaty is not fair to Cuba by any means, as the reduction on American products is from 30 to 50 per cent., while the United States have only conceded 20 per cent. to Cuban products. If our island should get a 50 per cent. allowance it would in return raise its tariff 50 per cent. on all articles coming from France, Spain, Germany and other European countries, thus giving the Americans a chance to supply all such manufactures and goods that are now imported from these countries.

"While there is a little more business going on in the local factories, it is, however, not equally distributed and far from what it should be at this season of the year. Where formerly every cigarmaker was employed and there was a scarcity of them, now many are still idle, while the exodus to Tampa and Key West continues. Up to the

middle of September the year 1909 shows a decrease of over three million cigars, as compared with 1908, and last year was the poorest in exports from Havana. Some even fear a greater discrepancy by the end of 1909.

"The commission recently appointed by President Gomez is hard at work, and is sending 5,000 blanks to those interested in tobacco and cigars, requesting them to answer questions and suggest remedies to help the industry. There is, however, little faith in manufacturing circles that anything practical will be evolved, although a lot of future valuable statistics may be gathered."

The October Storm's Destruction.

The tobacco barns in Havana Province have been destroyed to the extent of 80 per cent., and all seedlings which were ready for transplanting were ruined. The outlook for the coming Vuelta Abajo and Partido crop is now extremely problematical. Much valuable time has been lost; money is as scarce as ever, and while new seed beds may be provided, the planting season cannot now begin before December at the earliest.

El Tobaco is making fun of 68 questions, which might be subdivided into 600, which the commission to look into the tobacco industry appointed by President Gomez has published in the daily press and sent to all people interested or connected with the tobacco growing, handling or manufacturing, as it thinks, it will take a year to answer and tabulate them fully. A few practical recommendations would do more good, as nearly everybody knows where the shoe pinches, and there ought to be some remedy in sight. Quick action and heroic measures, if need be, ought to be taken to save the country from dissatisfaction at present and a possible revolution later on, caused by hunger.—Havana Correspondence of Tobacco (New York).

Tobacco Growers Busy.

Reports from the Pinar del Rio section state that the *vegueros* are pushing their preparations for the coming tobacco crop and many of the planters who have lost a portion of their seed beds, in anticipation of an unusual demand for posturas, have obtained additional seed and are planting additional *semilleros* so as to have posturas to sell their less fortunate neighbors.

CUBAN AGRICULTURAL EXPERIMENT STATION.

Results of Experiments With Temperate and Tropical Fruits, Grapes, Nuts, Etc. An Informing and Valuable Record of Work Done Between 1905 and 1909.

The second report of the Estacion Central Agronomica recently issued covers the period of experiment and work from June 30, 1905, to January 1, 1909. It comprises valuable reports by the then director, J. T. Crawley, and his staff, giving the results secured during the time mentioned.

Questions that have and do trouble the colonist in Cuba, and those intending to settle in the island, are here answered more or less in detail. Liberal extracts have been made of the report, and these follow:

Citrus Fruits.

C. F. Austin, at that time Chief of the Horticultural Department, visited several places in the island to note the different conditions and collect data for use in the report. He says as follows: "The places visited were San Cristobal, Taco Taco, Heradura, Pinar del Rio, Bahía Honda, Artemisa, Santiago de las Vegas, Santa Fe, Columbia, Nueva Gerona, McKinley, Ceiba Mocha, Santo Domingo, San Marcos, Barreto, Ceballos, La Gloria, Bartle, Omaja, and Holguin. The groves were looking in good condition, when proper care has been given as to the selection of soil, cultivation, pruning, etc. In many cases these operations have been very much neglected and there is little hope of the orchards being a profitable investment. In several places the trees are coming into bearing and some very fine fruit was seen. The growing of citrus fruits is rapidly passing out of the experimental stages. So far as I am able to see the conditions are all right in this country for producing a fine grade of commercial fruit when proper attention is given to the requirements of fruit culture just the same as would have to be given in any other well developed fruit growing country. Many growers have made a very poor selection of soil, largely through the fact of not being familiar with fruit lands. No person should buy land without looking it over carefully, and if he is not a good judge of soil, should hire some one who is, to go with him and examine it. There have been many mistakes made in selection of varieties, largely through several local and foreign nurserymen selling trees that were not true to name. The condition has caused many of the groves to have to be budded over before they will be of any value. A planter cannot be too careful in his selection of a nurseryman."

Temperate and Tropical Fruits.

"Apples, pears, and plums planted during December, 1904, have lived and made a fair growth, but produced no fruit. There is

little indication that this class of fruit has any value in this country.

"Peaches were planted the same time as the apples and have made a good growth and produced some fruit. The variety Red Ceylon last season gave a good crop. There is no indication that they have any commercial value in this country, but could be grown for home use.

"The first planting of figs was made during December, 1904. The trees have lived, made a fair growth, and produced a little fruit. They are so subject to scale insects and rust that there is very little indication of making a success with them except in a limited way. The cost of work to keep the insects and fungus diseases in control, is of greater value than the crop when taken on the commercial basis. We also planted a number of varieties from California during 1907, but very few of them lived, and none have produced fruit.

"A great many kinds of fruits, nuts, etc., have been planted, but the trees are too young yet to give any data as to the value of the different varieties. We are also testing a number of varieties of grapes and a few more seasons will be able to judge whether or not it is possible to build up a grape and wine industry.

"During the winter of 1905, we planted ten varieties of grapes commonly grown in the Eastern and Southern States. They have all died except Niagara and Brighton. Niagara fruited for the first time this season and the vine has made a fair growth. We have also planted a number of the scuppernong grapes and the vines have made a fine growth and seem at home in this country. The James variety fruited for the first time this season. In March, 1907, we planted 40 varieties of grapes from Texas known as the 'Munson hybrids.' The vines have made a good fair growth and this season the following varieties fruited: Captain, Beacon, Hermann Jaeger and Marguerite. All the fruit was dark colored and of fair quality. At the same time we planted 20 varieties of European grapes from California. The vines have made a fair growth, but none have fruited."

CORN.—From time to time foreign varieties of maize, chiefly from the United States, have been sown, but with little success.

The foreign varieties of corn are inclined to run to stalk with but little grain, and are subject to attacks by insects.

From experiments thus far carried out it seems that more promise of improvement lies in the systematic selection of the best types of Cuban corn, and possibly in the crossing of these with the best foreign varieties.

OXEN.—The practicability of improving the slow-moving native oxen by crossing the native cow with the Indian bull, which has a rapid gait, is a subject of the greatest interest, as is also the work done in preserving green food through the dry months by means of the silo.

ANGORA GOATS.—There is a general opinion that angora goats and other animals having a heavy coat of hair will, when taken to a tropical country, gradually lose their hair. To determine whether this belief was well founded or not one angora buck and three does were imported. Up to the present the amount of hair clipped has been a trifle less, but there seems to be a tendency for the goat to shed their hair earlier each year.

POULTRY.—We have continued breeding black Minorcas and brown Leghorn fowls, but there seems to be a decided tendency for imported fowls to degenerate in spite of the fact that we have imported cockerels of the same varieties to avoid inbreeding.

Cocoanut Prices Strong.

The market was firmer in New York on October 29 on Baracoa cocoanuts, and sales were noted up to \$34 per 1,000 for small lots. In a jobbing way even higher figures have been done. There is very little stock to be had at less than \$33 in any quarter.

"The demand for cocoanuts continues on a moderate scale, but values are high," says the New York Fruitman's Guide. "There have been few years when prices have touched the present level on the several descriptions, and it seems to be certain that the market will go higher under the stress of the light stocks. There is a good movement for the account of buyers in the interim, with a continued inquiry and business noted for shipment to points in the South and Southwest. The markets down there seem to be dependent on the supplies here. We cannot see where there is much prospect of a serious reduction in values at the moment."

Pineapple Arrivals and Prices.

The arrivals of Cuban pineapples in the week ending October 29 have been on a fair scale only. Shippers at the Havana end are said to be dissatisfied with results and are not sending up stock in any quantity. It is said that the second crop in Havana pines is of fair proportions, but that the increase in tariff rates, together with the dull market conditions, have discouraged a good many of the growers.

We have also imported some fine examples of Mammoth Bronze turkeys, but they have not given good results up to the present time. This may be due to the fact that we have not given them sufficient range, as we have had to confine them in corrals.

SWINE.—Two breeds of hogs are raised in Cuba, Berkshires and Tamworths. For corrals where food is supplied to swine the Berkshires are well adapted; but for the hills where the hogs must search for their food, the Tamworths, a bacon type, are better adapted. Both breeds when crossed with the native hogs give excellent results.

MILK.—A number of determinations of the quantity of butter fat in the milk of native cows have been made. The great majority range from three to four per cent., the average probably being between 3.4 and four per cent. It is difficult to get a correct idea of the amount of milk that the native cows give, owing to the common practice of only partially milking the cow, and then allowing the calf to suckle; but the quantity is relatively small.

A New Fungicide.

Cucasa, a soluble saccharate of copper lime, is said to be coming into use in Europe in place of bordeaux mixture. The new product yields a solution of copper that has all the fungicidal properties of bordeaux mixture, but with the added advantages, it is claimed, of affording a clear solution in any dilution and of keeping comparatively long. Being clear it does not clog the nozzle of sprays, furthermore, much less of it need be used than of the bordeaux mixture. It is also uniformly alkaline, and there can be therefore no copper sulphate present to injure the foliage.

When sprayed on the trees, the thin layer of the solution is readily changed by the atmosphere, as in the case of Bordeaux Mixture, into the insoluble film of copper compound that has the specific power to kill fungi. The thinness of this film has the advantage of interfering all the less with the important functions of the foliage, and also of sticking very close—which was found in one case to be for three months after one spraying. Cucasa consists of molecular proportions of copper sulphate, slaked lime and cane sugar, thus being distinguished from other copper and sugar solutions by the proportions in which the constituents are present in order to produce a clear, alkaline, fungicidal solution. Its inventor is Dr. C. Rumm, of Stuttgart, Germany.

The Effect of Moisture on Stored Sugar.

The following information regarding the deterioration of sugars is given in Bulletin 9, Division of Physiology and Plant Pathology, Hawaii:

About a year ago an experiment was described which was undertaken "to determine the percentage of water which it is safe to leave in sugars." Separate portions of a sample of moist sugar containing fermenting organisms were dried in a vacuum so as to contain decreasing amounts of moisture from 1.86 to 0.29 per cent.

The samples were polarized and put into tightly stoppered bottles. At the end of one and two months they were polarized again, and it was found that, in those samples containing more than 1 per cent. of moisture the polarizations were lower than originally.

These samples have been recently polarized again after standing twelve months, and the results further confirm the original conclusion that raw sugars containing 1 per cent. or more moisture are liable to deteriorate on storage. The original table with the further polarizations added is given below:

| Moisture per cent. | Polarization | | | |
|--------------------|--------------|----------------|-----------------|------------------|
| | Initial. | After 1 month. | After 2 months. | After 12 months. |
| 0.29 | 96.8 | 96.7 | 96.7 | 96.5 |
| 0.40 | 96.6 | 96.6 | 96.6 | 96.5 |
| 0.47 | 96.8 | 96.6 | 96.6 | 96.2 |
| 0.59 | 96.8 | 96.6 | 96.7 | 96.4 |
| 0.65 | 96.4 | 96.4 | 96.6 | 96.2 |
| 0.74 | 96.4 | 96.4 | 96.5 | 96.2 |
| 0.96 | 96.1 | 96.0 | 96.0 | 95.7 |
| 1.04 | 96.0 | 95.9 | 95.7 | 95.1 |
| 1.18 | 96.0 | 95.2 | 95.2 | 94.6 |
| 1.28 | 95.8 | 95.0 | 95.0 | 94.2 |
| 1.36 | 95.8 | 95.0 | 94.7 | 94.4 |
| 1.51 | 95.5 | 94.7 | 94.5 | 93.8 |
| 1.67 | 95.6 | 94.2 | 94.1 | 93.4 |
| 1.80 | 95.3 | 93.8 | 94.0 | 92.7 |
| 1.86 | 95.15 | 94.4 | 94.0 | 93.1 |

Notwithstanding that the bottles were closed with rubber stoppers, the sugar was so hygroscopic that the samples had nearly all increased slightly in moisture during the year, which accounts for the lower polarizations of those containing less than 1 per cent. of moisture.—Barbados Agricultural News.

Disinfecting Cane Cuttings.

A neat method of disinfecting cane cuttings, applicable to plantations of the size usual in the West Indies, is described by the author as follows: A series of wooden tanks two and a half feet in every direction is set up and filled with Bordeaux mixture. Stiff wire baskets are provided, into which the

canes are put, and the baskets are then lowered into the wooden tanks. The baskets are made of copper wire $\frac{1}{4}$ inch to $\frac{1}{2}$ inch mesh wire, mounted on a stiff frame, and are provided with two strong handles. Two men can work these baskets and by the time the last tank has been filled with disinfectant and cuttings the first basket is ready for removal. No time is lost and the cuttings are carried to the field with the fungicide sufficiently dried upon them.

No diseased cane should ever be used for cuttings and great care should be taken not to break the ends when cutting the cane for planting. All cane that shows red or brown discoloration of the fibers or pith at the cut ends should be rejected. Cuttings should never be allowed to become so dry that the ends split.

The above notes are taken from Bulletin No. 6 of the Division of Pathology and Physiology of the Experiment Station of the Hawaiian Sugar Planters' Association.

Santa Cecilia Sugar Co. Report.

The report of the above company under date of Oct. 5, 1909, on its property and operations for the fiscal year ended June 30, 1909, shows gratifying improvements. The following are some of the interesting items recorded:

The crop of 1909 yielded 18,159,938 pounds of sugar and 476,720 gallons of molasses from 70,155 tons of cane, as compared with 14,945,075 pounds, 505,435 gallons and 63,028 tons in 1908.

The gross income was \$457,538.90, as compared with \$398,346.29 for 1908. The net profit, after deducting interest charges, amounted to \$38,805.29, as compared with \$13,717.13 in 1908.

The report states that all requirements for betterments and additions and for handling the coming crop have been financed, without advances from sugar merchants or brokers.

The physical condition of the property, plant and equipment is excellent and is being continually improved. The average tonnage per acre of cane cut last year is claimed to be unsurpassed anywhere on the island, not "do we know of any estate where the fields yield as heavily for as many years without replanting, irrigation or fertilizers, or where the cost of cultivation is as low."

For improvements some \$50,000 was spent during the past two years, and nearly \$80,000 is being spent this year. Of the latter, approximately \$45,000 is for improvements and additions to the factory, including a battery of two new boilers of 300 H. P. each, two steel mo-

lasses tanks of 50,000 gallons capacity each, additional defecators and steel platforms for water and juice pumps and a new cane crusher to work in front of the mills, which will increase their grinding capacity 15 to 20 per cent. New buildings for employees and laborers and a new warehouse and bakery will cost about \$11,000. The balance goes into new fields, rolling stock for the

railroad, live stock and various small improvements.

The Hormiguero Central Company of Cuba announce that it will pay, on presentation at the Treasurer's office, No. 69 Wall Street, New York, Coupon No. 38, due November 1, on the First Mortgage 8 per cent. gold bonds.

SUGAR REVIEW.

Specially written for The Cuba Review by Willett & Gray of New York.

Our last sugar review for this magazine was dated Oct. 2.

The present summary covers the intermediate time to date, which time has been a period of abnormal conditions. Centrifugals closed Oct. 1 at 4.20c. per lb. for 96 test, advanced during the period to 4.36c. per lb., closing at 4.30c. per lb.

Several conditions led to this large advance, covering quite irregular movements from day to day. The most important feature has been the action of the European markets under speculative manipulation on the foreign sugar exchanges. Soon after F. O. Licht gave out his preliminary estimates of the European beet crop, as mentioned last month, the so-called factories' estimates came out, giving a total crop estimate much smaller than that of F. O. Licht. This report, although generally looked upon as improbable, yet had the effect of starting a speculative movement for which the sugar sentiment prevailing in Europe at the time was ready and willing to participate in. As a result speculation became rampant, not only in foreign beet-sugar contracts, but several of the largest speculators in Europe turned their attention toward new crop Cuba Centrifugals and bought largely for future deliveries up to March shipments from 2½c., opening price, to 2 11-16c., cost and freight, closing prices, 96 test, thus confirming our anticipations in our last review of the course of Cuba crop movements from the beginning at 2½c., c. & f.

There is quite as much power in determination in the minds of capable manipulators to move prices upward as actually exists in statistical, and this seems to be the position in Europe at the present moment. The only really sufficiently known basis for the movement now going on toward higher prices is that the world's supplies for consumption during the present campaign are so near the parity of such estimated consumption that any damage to any crop must immediately affect the markets and give these speculators their anticipated profits.

Of course, such a movement as now seems probable is very largely to the interests of Cuban planters who promise to have an unusually large stock with which to meet the speculative basis of prices. However, the United States refiners are by no means likely to keep up to the parity of European movements, so that the full benefit of current valuations in Europe need not be expected in Cuba and, in fact, such distrust in an adequate basis for this European speculation exists that we are following far behind quotations making on the foreign exchanges.

As regards crops, Cuba, of course, will exceed last year and the amount of such excess only remains in doubt.

Louisiana has been grinding two weeks and shows results considerably in excess in the way of damage to the standing cane by the last storms than have been anticipated and reduces the crop estimate to 325,000 tons maximum.

The Java and other competitive crops with Cuba promise about the same size as last season.

The refined sugar market in the United States is now largely a domestic beet granulated sugar market; all beet factories are in full work and showing anxiety to sell their product rapidly, this method having proved satisfactory in the last campaign.

As regards the prospects from the Cuban standpoint, it may prove that present values of, say, 2½c., c. & f., for February-March deliveries are high enough for the month in which the largest production is expected, but that always counting upon the good influence of European speculators upon the market considerably higher prices will be shown during the present campaign.

New York, Nov. 4, 1909.

REVISTA AZUCARERA.

Escrita expresamente para la CUBA REVIEW por Willett & Gray, de Nueva York.

Nuestra última revista azucarera para esta publicación estaba fechada el 2 de octubre próximo pasado. El resumen actual comprende las cotizaciones desde entonces hasta la fecha, en cuyo período ha reinado un estado anormal en plaza. Los azúcares centrífugos cerraron el primero de octubre á 4.20 centavos libra, polarización de 96°, con una alza durante ese período á 4.36 centavos y cerrando á 4.30 centavos.

La alza fué ocasionada por varios motivos, que dieron lugar á operaciones bastante irregulares de día en día. El acontecimiento más importante fué la manipulación especulativa de los mercados europeos en las lonjas de azúcar extranjeras. Poco después que F. O. Licht dió á conocer sus cálculos preliminares acerca de la cosecha de la remolacha en Europa, según se indicó el mes pasado, las refinerías dieron á luz sus estadísticas mostrando un cálculo total de la cosecha mucho menor que el de F. O. Licht. Este informe, aunque generalmente se consideró improbable, sin embargo dió por resultado el que se iniciara un movimiento especulativo, en el cual la tendencia azucarera que á la sazón prevalecía en Europa estaba lista y deseoso de participar. Como consecuencia de esto, la especulación empezó á predominar no sólo en las operaciones de azúcar de remolacha extranjera, sino que varios de los especuladores más importantes de Europa dirigieron sus miras hacia la nueva cosecha de azúcares centrífugas de Cuba y compraron cargamentos en grande escala desde 2½ centavos precio inicial hasta 2 11/16 centavos costo y flete precio al cerrar, polarización de 96°. para futura entrega hasta marzo, confirmando de este modo lo que anticipamos en nuestra última revista respecto al curso de las operaciones de la zafra de Cuba desde su principio á 2½ centavos costo y flete.

Reina en la mente de los especuladores hábiles tanta determinación hacia el alza en los precios como existe verdaderamente en las estadísticas, y esta parece ser la situación en Europa al presente. El único y verdadero motivo en que se fundan las operaciones que están teniendo lugar hacia el alza en los precios, según puede colegirse, es que el abasto del azúcar en el mundo durante la presente campaña azucarera está casi tan á la par con dicho consumo calculado, que al ocasionarse algún perjuicio á algunas de las zafras se resentirían inmediatamente los mercados y estos especuladores efectuarían sus ganancias anticipadas.

Por supuesto, tal movimiento al parecer ahora probable redundará en gran manera en favor de los intereses de los plantadores cubanos, los cuales prometen tener á mano existencias sumamente considerables para hacer frente á los precios de base especulativa. Sin embargo, los refinadores de los Estados Unidos no es probable que puedan sostener la paridad de las operaciones europeas, así que todo el beneficio de las valuaciones corrientes en Europa no ha de esperarse en Cuba, y en efecto, existe tal desconfianza en una base adecuada para esta especulación europea, que nos estamos quedando atrás en las cotizaciones en las lonjas extranjeras.

Respecto á las zafras, la de Cuba por supuesto excederá á la del año pasado, y sólo queda en duda á cuánto ascenderá la demasía.

En la Lousiana se ha estado llevando á cabo la molienda durante dos semanas, con resultados considerablemente en aumento respecto á los perjuicios de la caña en pie á causa de las últimas tormentas previstas, lo cual reduce el cálculo de la zafra á 325,000 toneladas en su máximo.

La zafra en Java y otras zafras competidoras de Cuba prometen rendir una cantidad próximamente igual á la del año anterior.

El mercado de azúcar refinada en los Estados Unidos es ahora en su mayor parte un mercado de azúcar granulada de remolacha del país; todas las refinerías de remolacha están trabajando completamente y muestran ansiedad por vender pronto sus productos, pues este sistema ha probado ser satisfactorio en la última campaña azucarera.

Respecto á la perspectiva bajo el punto de vista cubano, puede suceder que los precios actuales, digamos de 2¾ centavos costo y flete para entregas de febrero y marzo, sean bastante altos para el mes en que se espera la zafra más grande, pero contando siempre con el buen influjo de los especuladores europeos en el mercado se obtendrán precios mecho más altos durante la presente campaña azucarera.

COSAS DE INTERÉS.

Manera de Desinfectar Los Vástagos de la Caña.

El autor de esta reseña describe del modo siguiente un método ingenioso para desinfectar los vástagos de la caña del tamaño usual para la plantación en las Indias Occidentales: Se prepara una serie de tanques de madera del tamaño de dos y medio pies por cada lado y se llenan de la mixtura llamada Bordeaux. Los vástagos de la caña se colocan en canastillos de alambre rígido, introduciendo después los canastillos en los tanques antedichos. Estos canastillos serán hechos de alambre de cobre con mallas de $\frac{1}{4}$ á $\frac{1}{2}$ pulgada, montados sobre una armazón rígida y provisto cada uno con dos fuertes mangos. La operación de desinfectar puede llevarse á cabo por dos hombres, y cuando se ha llenado el último tanque con el desinfectante y se han metido en él los vástagos, el primer canastillo estará listo para ser sacado del tanque. De este modo no se pierde tiempo y los vástagos pueden ser llevados al campo con el desinfectante lo suficientemente seco para hacerse la plantación.

No deberán usarse vástagos cortados de caña dañada ó malsana y deberá tenerse mucho cuidado en no romper los extremos de la caña al ser cortada para la plantación. Toda la caña que muestre manchas rojas ó negruzcas en las fibras ó corazón debrá rechazarse. No deberá permitirse nunca que los vástagos se sequen del tal modo que se rajen por los extremos.

Los apuntes que anteceden están tomados del Boletín No. 6 de la División de Patología y Fisiología de la Estación Experimental de la Asociación de Plantadores de Caña de Hawaii.

Los Géneros Ingleses en Cuba.

El Manchester Guardian de fecha reciente dice que en las Indias Occidentales hay indicios de renovarse la demanda por géneros de algodón y otros tejidos textiles. Los viajeros y agentes empiezan á hacer pedidos en mayor escala y el

aspecto comercial es halagador. Respecto al mercado en Cuba dice lo siguiente:

"Cuba continúa siendo mercado bastante bueno para toda clase de géneros de lencería, así como para tejidos de fantasía, de vestir. Los paños blanqueados, linos, satenes teñidos y géneros estampados tienen asimismo alguna demanda. Sin embargo, el mercado de driles grises ordinarios y lencería para sábanas es escaso, pues la tarifa preferencial en favor de los fabricantes americanos afecta la venta de los géneros de procedencia inglesa. Los géneros de fabricación española, especialmente los paños grises y de color, son aún muy preferidos en la Habana por las casas que cuentan mucho esta Isla no es causa de aumento en la demanda por géneros de Lancashire, excepto en especialidades baratas y géneros para camisas. Como los Estados Unidos dominan las aduanas del país y la moneda americana circula en general en las poblaciones más grandes, la tendencia de los negocios, tanto en la exportación como en la importación, es decididamente en favor de las casas comisionistas de Nueva York, las cuales surten al país con la mayor parte de todos los géneros manufacturados."

Cuba es un país de corrientes de agua subterráneas, y los manantiales y los pozos por regla general proporcionan un agua riquísima á muy poca profundidad comparativamente. El grabado de la página 6 muestra un manantial burbujeante en la margen de un arroyuelo, cosa que el viajero hallará con frecuencia en todas partes de la Isla.

Exportación de Escritorios y Sillas.

El principal artículo de mueblaje que los Estados Unidos vende á países extranjeros son las sillas de todas clases, y de esos países la República de Cuba se lleva la mayor parte. Durante el mes de agosto último pasado, Cuba compró sillas en los Estados Unidos por valor de más de \$15,000, y escritorios americanos por la suma de \$1,500.

El grabado del frontispicio representa un lindo paisaje en la Isla de Pinos.

M. J. CABANA
COMMISSION MERCHANT
P. O. Box 3, Camaguey

Solicits Correspondence from all the important cities of the United States of America.

HENRY E. BROWN

Pharmacist

Shipping and Export Chemist and Druggist, Ships' Medicine Chests Furnished and Replenished. Prescriptions Compounded by a Graduate in Pharmacy.

Trusses, Surgical Appliances, etc.

Office and laboratory, Room 36.

116 BROAD ST., NEW YORK

Removal Announcement.

The Pratt Engineering & Machine Company, of Atlanta, Ga., announce the removal of its New York offices to new and commodious quarters in the Singer Building, 149 Broadway. Mr. R. E. S. Geare, assistant sales manager, will be in charge of New York office, and Mr. N. A. Helmer is the export sales manager and chief engineer of the sugar machinery department.

The Pratt Engineering & Machine Company recently succeeded to a long-established business in designing and building all necessary machinery and appliances for sulphuric acid and fertilizer works, also the manufacture of pulverizing machines, steam pumps and centrifugal dredging pumps of their own design. They also manufacture the most improved design and type of machinery for cane sugar plants and build and install complete plants.

The new plant of this company, which was only recently completed, is a model of its kind, and includes shops for the fabrication and erection of all classes of heavy, light and special work and is also provided with splendid testing shops. The machines throughout the entire plant are driven by individual electric motors, and the shops are served by powerful electric cranes to give the company every facility for the rapid, economical and expeditious fabrication of its work.

Dr. Manuel Varona Suarez has been appointed Secretary of Sanitation by

Presidential decree in place of Dr. Matias Duque, who recently resigned. He is a native of Camaguey, 40 years old, and a graduate of Havana University. He has represented the Province of Havana in Congress, where he was sent by the Liberal vote, his name occupying a high place on the ticket that carried General Gomez to the Presidential chair in November, 1908. He took possession of his office November 1.

A Washington despatch of October 30 says that General Carlos Garcia Velez, Cuban Minister to the United States, may resign his post to become the Cuban Secretary of State, which has been offered him by President Gomez. He will succeed his brother, Justo Garcia Velez, if he accepts the post.

Trees and Plants Make Property Values Climb

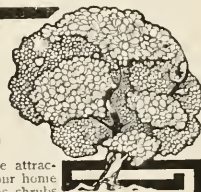

It's easy to increase the attractiveness and worth of your home place—just plant a few trees, shrubs and vines. The space may be ever so limited, yet there's a little room to spare, and trees make home a different place—more beautiful and "livable."

We grow two hundred varieties of ornamentals—strong, healthy, well-rooted, well-topped—will transplant almost anywhere. Our great stock of Fruit and Nut trees deserves the consideration of every planter. Warranted true to name and variety. Grow and watch in our fruiting orchard year after year.

Write for our handsome new Nursery Book D.

Glen Saint Mary Nurseries Co.
Glen Saint Mary, Florida

CABLE ADDRESS: Turnure.

NEW YORK,
64-66 Wall Street

LAWRENCE TURNURE & CO.

BANKERS

Deposits and Accounts Current. Deposits of Securities, we taking charge of Collection and Remittance of Dividends and Interest. Purchase and Sale of Public and Industrial Securities. Purchase and Sale of Letters of Exchange. Collection of Drafts, Coupons, etc., for account of others. Drafts, Payments by Cable and Letters of Credit on Havana and other cities of Cuba; also on England, France, Spain, Mexico, Puerto Rico, Santo Domingo, Central and South America.

CORRESPONDENTS:

HAVANA—N. Gelats y Ca.
MEXICO—Banco Central Mexicano.

LONDON—The London Joint Stock Bank, Ltd.
PARIS—Heine et Cie.

THE BIG FOUR ROUTE Through Train Service
BETWEEN
Cincinnati, Toledo and Detroit
(Via Michigan Central E. R.)
3 Daily Trains Each Way 3
Parlor Cars, Sleepers, Dining Cars.
Ask for Tickets Via
BIG FOUR

INVEST IN CUBA

DOUBLE YOUR MONEY

Let us tell you why and where

CONSULT US, OTHERWISE "DON'T INVEST IN CUBA"

THE JOHNSON-HARDING COMPANY

Specialists in Cuban Investments

118 PRADO, HAVANA, CUBA

Journal d'Agriculture Tropicale

Founded by J. VILBOUCHEVITCH
164 Rue Jeanne d'Arc Prolongée.

Subscription, One Year - - - - 20 Francs

Deals with the leading questions of the hour, agricultural and commercial, of interest to tropical countries. International in character. Illustrated. Monthly. Descriptions of machines for tropical crops a specialty. Complete review of new agricultural publications. Commercial part intelligible for every one and always interesting. 150 contributors in West and East Africa, East and West Indies, Java, Mauritius, Central and South America, and throughout the tropical world.

FOR SALE

We offer, subject to prior sale, December 1st delivery, one 26" x 72" Pratt "IMPERIAL" Cane Crusher complete with Compound Gearing, Hydraulics and Corliss Engine, Krajewski type rollers.

One 34" x 72" Three-Roll Pratt "IMPERIAL" Cane Mill, complete, with Compound Gearing, Hydraulics and Corliss Engine, heavily built for highest pressures. **LARGE JOURNALS.**

EXTREMELY NARROW TURN PLATE

For full information, particulars, prices, etc., address

PRATT ENGINEERING AND MACHINE COMPANY

Atlanta, Georgia, U. S. A. 80 Wall St., New York City
Havana, Cuba, Office: Lonja del Comercio 509.

THE EXETER MACHINE WORKS

PITTSTON, PA.

MANUFACTURE

Steam and
Electric
Hoists

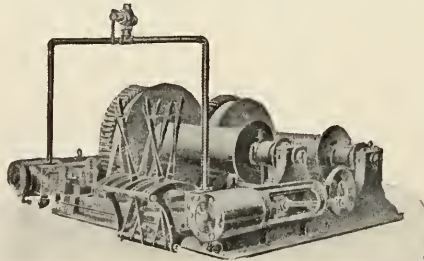

Elevators
Conveyors
and
Handling
Machinery

New York Office: 50 Church Street

CARROS PARA CAÑA

De todas
clases
Fabricados
de madera
ó acero

Dirección
Telegráfica
RAMALIAM

RAMAPO
IRON WORKS

30 Church St.
New York, N. Y.

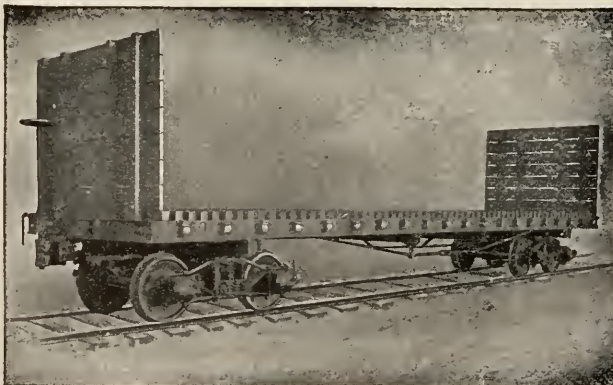

CANE CARS

OF EVERY
DESCRIPTION
OF STEEL
OR WOOD

Cable Address
RAMALIAM

RAMAPO
IRON WORKS

30 Church St.
New York, N. Y.

H A V A N A

CUBA

National Bank of Cuba

Government Depository

CAPITAL, SURPLUS AND
UNDIVIDED PROFITS
\$6,100,000.00

Head Office—Havana
15 BRANCHES IN CUBA
New York Agency
1 WALL STREET

COLLECTIONS

THE TRUST COMPANY OF CUBA HAVANA

Capital
and Surplus **\$540,000**

Transacts a General Trust
and Banking Business

REAL ESTATE DEPARTMENT

Examines Titles, Collects Rents,
Negotiates Loans on Mortgages

Correspondence Solicited from
Intending Investors

OFFICERS

J. A. Gonzales Lanuza, President
Norman H. Davis, Vice-President
F. J. Sherman, 2nd Vice-President
O. A. Hornsby, Secretary and Treasurer
J. M. Hopgood, Asst. Treasurer

Offices: CUBA 31, HAVANA

The Royal Bank of Canada

INCORPORATED 1869

Fiscal Agent of the Government of the Republic of
Cuba for the Payment of the Army of Liberation

CAPITAL AND RESERVE, \$10,300,000.00
TOTAL ASSETS, - 58,300,000.00

Head Office, MONTREAL

NEW YORK AGENCY, 68 William St.

Branches in Havana: Obrapla 33, Gallano 92;
Matanzas, Cardenas, Manzanillo, Cienfuegos,
Camaguey and Santiago de Cuba.
Mayari, Sagua, Caibarien

ESTABLISHED 1844

H. UPMANN & CO. Bankers

TRANSACT A GENERAL BANKING BUSINESS
CORRESPONDENTS AT ALL THE PRIN-
CIPAL PLACES OF THE ISLAND

Safe Deposit Vaults

Manufacturers of the Famous H. Upmann
Brand of Cigars

FACTORY: Paseo de Tacon 159-163
OFFICE: Amargura 1-3

Established 1876

N. GELATS & COMPANY

Bankers

Transact a general banking
business.

Correspondents at all the prin-
cipal places of the world.

SAFE DEPOSIT VAULTS

Office: Aguiar 108

MOLINA BROTHERS

Customs Brokers

Forwarders, Lighterage and Ship Agents

Lonja Building 541

HAVANA

H A V A N A

United Railways of Havana

Cuba's First and Foremost Railroad. (First Section opened to Traffic in 1837)

Takes you to All Parts of the Island East of Havana Comfortably and Quickly through Varied and Beautiful Scenery and Past Extensive Sugar Plantations

Parlor, Observation and Sleeping Cars attached to principal trains.

Full information and through tickets to all points in Cuba reached via the United Railways of Havana can be obtained of the following:

Thos. Cook & Son
Seaboard Air Line R. R.
Foster & Reynolds
Atlantic Coast Line R. R.
Illinois Central R. R.

Ward Line
Florida East Coast Railway
Washington Southern Railway
Peninsular & Occidental SS. Co.

Southern Pacific R. R.
Mobile & Ohio R. R.
Raymond & Whitcomb Co.
Louisville & Nashville R. R.
Munson Line

THE HERRADURA LAND COMPANY

Office: Zulueta No. 9, Plaza Hotel Building, Havana, Cuba

CAPITAL, \$440,000.00

Own 22,000 acres of land in the Province of Pinar del Rio, suitable for Oranges, Vegetables, Cotton, Corn and Tobacco. The land has all been surveyed and sub-divided into 40-acre tracts and is offered for sale in acres to suit the purchasers, for Cash or on instalments.

We have a new and progressive American town with Railroad Station, Telegraph, Telephone, Stores, Hotel, American School, all within short distance from Havana City. Titles perfect. Transportation from Havana free for buyers.

WRITE OR CALL FOR INFORMATION.

PHONE No. 401

P. O. BOX 741

FERNANDO de CARDENAS

CUSTOM HOUSE BROKER

:: Import and Export Agent ::

Munson S. S. Line Building

Obispo No. 1, Havana, Cuba

JAMES S. CONNELL & SON

Sugar Brokers

Established 1836, at 105 Wall Street

Cable Address—"Tide, New York"

(Established 1871)

DUSSAQ y CO.

Sucesores DUSSAQ & GOHIER.

GENERAL IMPORTERS

Agents for: The Royal Mail S. P. Co.; Cuban Steamship Co.; Holland-America Line.

OFICIOS 18 HAVANA.

SUGAR CANE PLANTATIONS

Cacao (chocolate and cocoa) and Coffee Plantation—Orange and Grapefruit Groves. Land for the small settler on easy terms. In the best district of Cuba—Rio Cauto Valley. Within 40 miles of Santiago and Nipe Bay. Write for Booklet.

RIO CAUTO SUGAR COMPANY, 50 Church St., N. Y. City

CANADA LAND AND FRUIT CO.

LOS INDIOS

Owners

ISLE OF PINES

CANADA AND LOS INDIOS TRACTS

Location: Siguanea Bay. The Deep-Water Harbor of the Island.

We have at our new and progressive town of Los Indios a sawmill, planing-mill general store, school, hotel, church, post office and nursery, all under the supervision of Americans. A strictly American town.

We also have rowboats and gasoline launch for pleasure parties. Fishing and hunting the best.

We own the finest citrus fruit, vegetable and tobacco land on the island. We offer same for sale in acres to suit purchaser, either for cash or on installments. Special inducements to actual settlers.

Write for prospectus and further information to our general office,
Marinette, Wisconsin.

WILLETT & GRAY, Brokers and AgentsFOREIGN AND
DOMESTIC**SUGARS**RAW AND
REFINED**52 WALL STREET, NEW YORK**

Publishers of Daily and Weekly Statistical Sugar Trade Journal—the recognized authority of the trade.
TELEGRAPHIC MARKET ADVICES FURNISHED

HOME INDUSTRY IRON WORKS.**Engines, Boilers and Machinery**

Manufacturing and Repairing of all kinds. Architectural Iron and Brass Castings. Light and Heavy Forgings. All kinds of Machinery Supplies.

Steamship Work a Specialty

A. KLING, Prop.
JAS. S. BOGUE, Supt.

MOBILE, ALA.**“Sugar News from Cuba”**

is the title of the interesting correspondence from the tropical island, appearing in every issue of “THE AMERICAN SUGAR INDUSTRY AND BEET SUGAR GAZETTE.”

Capable correspondents, in every part of the world, write regularly, covering reliable sugar news for “THE AMERICAN SUGAR INDUSTRY AND BEET SUGAR GAZETTE.”

In the United States, Cuba and Mexico, \$2 per annum. In Foreign Countries, \$2.50 per annum.

Subscribe for it if you want to keep posted.

Sample copy free. Send for advertising rates.

Address: **BEET SUGAR GAZETTE CO.**

No. 5 Wabash Ave. Chicago, Ill., U. S. A.

Telephone, 33 Hamilton
Night Call, 411 Hamilton

Cable Address:
"Abiworks," New York

Atlantic Basin Iron Works

Engineers and Boiler Makers

Machinists, Plumbers, Tinsmiths, Pipe Fitters, Blacksmiths, Coppersmiths,
Pattern Makers, Sheet Iron Workers, Iron and Brass Castings. Steamship
Repairs a Specialty.

Cor. Imlay and Summit Streets

Brooklyn, N. Y.

John Munro & Son

Steamship and
Engineers' Supplies

722 Third Avenue, Brooklyn, N. Y.

Cable Address: Kunomale, New York

Telephone, 2492 South

Telephone
215 Hamilton

Box 186
Maritime Exchange

YULE & MUNRO SHIPWRIGHTS

Caulkers, Spar Makers

Boat Builders, Etc.

No. 9 SUMMIT STREET

Near Atlantic Dock

BROOKLYN



"ALL
ABOUT
CUBA"

Copyrighted, 1909.

IT COVERS THE ISLAND'S
INDUSTRIES AND ACTIVITIES

FIFTY CENTS PER YEAR POSTPAID

Beginning with the December issue the subscription price is \$1.00 per year.

A Handsome Map of Cuba in four colors, showing all Towns, Rivers, Mountains and
Islands, with Marginal Index, free with every subscription at one dollar.

WINTER HAVEN NURSERIES

A. M. KLEMM, Proprietor

Established 1884.

Winter Haven, Fla.

Wholesale Growers of Citrus Stock of the best commercial varieties. We guarantee our extensive Stock to be well grown, free of insects and true to name.

Silver Cluster Grape Fruit our leading Specialty.

Prices right. Grading and Packing perfect.

Write for Catalogue.

CUBA INFORMATION

IS THE TITLE OF A BOOK WHICH GIVES DEFINITELY and concisely just such information concerning Cuba as is desired by the business man or prospective investor who is interested in this fertile island—*climate, soil, products, fruit growing, live stock, tobacco, sugar, customs duties, banking, investments, colonies, land titles, laws, and a hundred other matters.*

SEND 25 CENTS FOR A COPY

and if you want any specific information that could not be covered in such a book,

Ask Mr. Foster No. 1 Madison Avenue, NEW YORK

Mr. Foster also has information offices in Philadelphia, Washington, Atlantic City, Jacksonville, St. Augustine, Daytona, Palm Beach and Miami, Florida, and in Havana and Camaguey, Cuba. FREE INFORMATION—no fees ever asked or accepted.

The Standard Guide to Cuba— Reliable—accurate—maps—illustrations.
50 cents.

FOSTER & REYNOLDS, 1 Madison Avenue, New York.

TWO IMPORTANT MAPS

Blue-prints of Cuba, showing the location of the Sugar Plantations and the Rural Guard Stations of the Island. Specially prepared for The CUBA REVIEW. Each 60 cents. Either map with a year's subscription, 75 cents. Both blue-prints and magazine, one year, \$1.

The Rural Guard of Cuba

The Sugar Plantations of Cuba

BUSINESS FIRMS OF SANTIAGO

E. GIRAUDY & CA.

ALMACEN DE VIVERES

Marina baja n. 33, Santiago de Cuba.

Agentes de Schlitz Beer.

JULIAN CENDOYA

Steamship Agent and Broker
COMMISSION MERCHANT

CABLE: Cendoya. Santiago de Cuba.

VALLS, RIBERA & CA.

(S. en C.)

Importadores de Ferrreteria y Machinery.
Telégrafo: Valribe.

Santiago de Cuba y Manzanillo.

A. B. C. Code, 5th Edition. Telephone, 190.
P. O. Box, 95. Cable address: SILVAPA.

SILVA Y PARRENO H.

General Commission Merchants.

Custom House Brokers—Forwarding Agents.
Consignees of the Cuban steamers of the Carlos J. Trujillo, S. en C., Line, formerly Menéndez & Co.
References:—J. Cendoya and Nat'l Bank of Cuba.

CAMP HERMANOS, Santiago de Cuba.

Ron Selecto "Golondrina" y "Carta Cuba."

Medalla de Oro, St. Louis, 1904.

RON BACARDI

DE BACARDI & CO., Distillers, Proprietors.
43 San Ignacio, cor. Santa Clara, Havana,
Santiago de Cuba.

LARREA Y BESEALIE

Importers of General Groceries and Exporters of
Cocoa, Wax, Honey and Woods.
Apartado 65, Marina Baja 46. Cable: Larrea.

Importación. Exportación.

L. ABASCAL Y SOBRINOS

Agentes de las líneas Pinillos Izquierdo y Ca., de
Cadiz. Larrinaga y Ca., de Liverpool. Com-
pañía de Seguros, Aachen & Munich, Aix-la-
Chapelle.

BROOKS & CO.

Bankers and General Commission Merchants.
Santiago and Guantanamo.

VINEGAR BEND LUMBER CO.

Manufacturers and Exporters

Long Leaf Yellow Pine Lumber and Timber

Cuban Business Our Specialty VINEGAR BEND, ALA., U. S. A.

Daily Capacity, 200,000 Feet

Cable Address: "TURNER"

Codes: A B C, Fourth Edition; Southards; Watkins; Western Union



SOBRINOS DE BEA & CO.

Bankers and Commission Merchants
Importación directa de todas los centros
manufactureros del mundo.

Agents for the
Munson Steamship Line, New York and
Mobile.

James E. Ward & Co., New York.
Serra Steamship Company, Liverpool.
Vapores Transatlánticos de A. Folch & Co.
de Barcelona, España Independencia
Street 17/21.

MATANZAS, CUBA.

JOHN W. McDONALD

COAL, WOOD, LUMBER
and TIMBER of Every
Description

112 WALL STREET

Near South Street NEW YORK

Yard: 58-68 Beard Street, Erie Basin
Telephones:

Office, 1905 John Yard, 316 Hamilton

PURDY & HENDERSON, Inc.

Engineers and Contractors

New York Chicago Boston

Cuba Office, Empedrado 32, Havana

"The Comfortable Way"

Between the East and the West is
via the Toledo, St. Louis and
Western Railroad

"Clover Leaf" Route

Rates lower than by any other
direct line. Send four cents in
stamps for copy of "Get Out or
Get in Line," a booklet by Mr.
Elbert Hubbard, Chief of the Roy-
crofters.

GEO. J. CHARLTON,
General Passenger Agent,
Chicago, Ill.

THE SNARE AND TRIST COMPANY

CONTRACTING ENGINEERS

Steel and Masonry Construction
Piers, Bridges, Railroads and Buildings

We are prepared to furnish plans and estimates
on all classes of contracting work in Cuba.

N. Y. Office

Havana Office

143 LIBERTY ST.

LA LEAL BUILDING

W. H. Bennett

F. W. Hvoslef

Bennett, Hvoslef & Co.

18 Broadway, New York

Steamship Agents and Ship Brokers

Cable: "Benwalsh"

MUNSON STEAMSHIP LINE

GENERAL OFFICES

82 BEAVER STREET, NEW YORK

New York-Cuba Service

PASSENGER AND FREIGHT

Proposed Passenger Sailings for NOVEMBER and DECEMBER, 1909

| STEAMERS | NEW YORK | | NUEVITAS | | BANES | GIBARA and VITA | PUERTO PADRE | NUEVITAS | | NEW YORK |
|----------------|----------|---------|----------|---------|---------|--------------------|-----------------|----------|---------|----------|
| | Sail | Arr. | Arr. | Arr. | Arr. | Arr. | Arr. | Leave | Leave | Arr. |
| CURITYBA | Nov. 3 | | Oct. 11 | Oct. 13 | Oct. 15 | Oct. 16 | | Oct. 21 | Oct. 22 | Oct. 27 |
| OLINDA | Nov. 17 | Nov. 22 | Nov. 24 | | | Nov. 27 | Nov. 2 | Dec. 2 | Dec. 3 | Dec. 8 |
| CURITYBA | Dec. 1 | | Dec. 6 | Dec. 8 | Dec. 10 | Dec. 11 | | Dec. 16 | Dec. 17 | Dec. 22 |
| OLINDA | Dec. 15 | Dec. 20 | Dec. 22 | | | Dec. 25 | Dec. 28 | Dec. 30 | Dec. 31 | Jan. 5 |
| CURITYBA | Dec. 29 | | Jan. 3 | Jan. 5 | Jan. 7 | Jan. 8 | | Jan. 13 | Jan. 14 | Jan. 19 |

SAILINGS SUBJECT TO CHANGE WITHOUT NOTICE.

Steamers sail from PIER 9, EAST RIVER, N. Y., at 12 o'clock noon

NEW YORK-CUBA SERVICE

FREIGHT ONLY

New York to Caibarien, Matanzas, Cardenas and Sagua

MOBILE-CUBA SERVICE

FREIGHT ONLY

Regular Sailings: Mobile to Havana, Mobile to Northside and Southside Cuban Ports

BALTIMORE-COLON SERVICE

FREIGHT ONLY

Regular Sailings: Baltimore to Colon

AGENCIES AT HAVANA AND ALL CUBAN PORTS

Lillie Multiple Evaporators

Model of 1904-1905 (Patented)

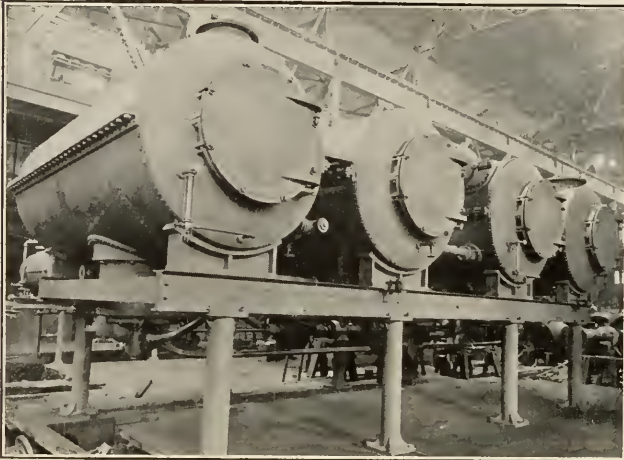

"One of three Lillie quadruple effects installed in 1907, in sugar factories in Formosa, belonging to the Taiwan Seito Kabushiki Kwaisha, of Tokio, Japan. Two more quadruple effects, one to handle 550,000 gallons of cane juice per twenty-four hours, and the other to handle 325,000 gallons in the same period, are now (July 1st, 1909) being built for the same Japanese Company, also for service in Formosa. These quadruple effects are arranged for reversing the course of the vapors and heat at will, a mode of operation peculiar to the Lillie and which has proven of great value for solutions depositing incrustations on the evaporating tubes."

The Sugar Apparatus Manufacturing Co.

328 Chestnut St., Philadelphia, Pa.

S. MORRIS LILLIE, President.

LEWIS C. LILLIE, Secretary and Treasurer.

BALDWIN LOCOMOTIVE WORKS

Broad and Narrow Gauge

Single Expansion and Compound

LOCOMOTIVES

Compressed Air Locomotives. Electric Locomotives with Westinghouse Motors

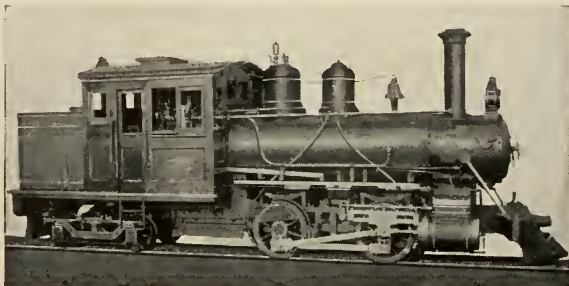

PLANTATION LOCOMOTIVES

For all Gauges of Track. To meet all conditions of service. Specifications furnished on application.

Principal offices and works, 500 North Broad Street
Philadelphia, Pa., U. S. A.

Cable Address: "Baldwin, Philadelphia"

Agents for Cuba, Krajewski-Pesant Co., Aguiar 92, Havana, Cuba.

New York Botanical Garden Library



3 5185 00293 3214

