

Class

Book

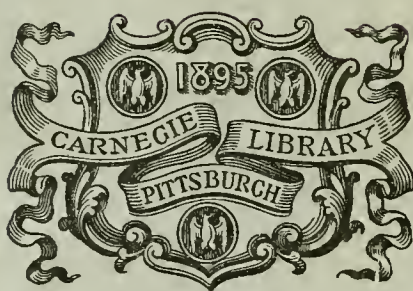







AMERICAN ENGINEER

"THE RAILWAY MECHANICAL MONTHLY"

Established 1832

INDEX TO VOLUME LXXXVI 1912

ALSO OF THE

DAILY RAILWAY AGE GAZETTE

ISSUED DURING THE

M. M. AND M. C. B. CONVENTIONS

INDEX, 1912

VOLUME LXXXVI

A

| | |
|---|-----------|
| Accident prevention | 230, 262* |
| Accident prevention in shops, by W. H. Snyder | 482* |
| Accidents, prevention of, by J. D. Kelly | 631* |
| Accident record, Pennsylvania | 372* |
| Accidents in shops and enginehouses, by Geo. Bradshaw | 579 |
| Accidents, Harriman lines | 480† |
| Accidents, hourly fluctuation of | 257* |
| Accidents, number in P. R. R. shops | 262* |
| Accidents on Illinois Central | 314† |
| Accidents to railway employees, cost of | 265† |
| Accumulator for hydraulic press | 203* |
| Acme Supply Co., box car ladder | 1509* |
| Acme Supply Co., sectional diaphragm | 1425* |
| Acme Supply Co., weatherstrip | 1454* |
| Advisory technical committee report and discussion | 1463 |
| Air Brake Association Convention. | |
| Air hose failures | 315 |
| Election of officers | 319 |
| Friction and wear of brake shoes | 316* |
| Job behind the cleaning date | 315 |
| Light and loaded air brake equipment | 315 |
| Pipe and pipe fittings | 319 |
| Triples, undesired quick action of freight | 316 |
| Westinghouse PC equipment | 318 |
| Air brake hose | 500§ |
| Air brake hose failures, report on | 315 |
| Air brake hose, new armored | 1481 |
| Air brake hose protector | 1529* |
| Air brake hose, specifications of | 1298§ |
| Air brake equipment, light and loaded cars | 315 |
| Air brake, modern, handling long trains with | 469 |
| Air brakes, schedule AMCE Westchester cars | 242 |
| Air drill, roller bearing | 1449* |
| Air motor, extension bar for supporting | 223* |
| Air pump crane, C. & N. W. | 118* |
| Air pump, extravagance of | 1368§ |
| Air pump glands, device for re boring | 224* |
| Air pump governor repairs, by J. A. Jesson | 639* |
| Air reservoir hoist, B. & O. | 618* |
| Air washer and cooler for passenger cars, Santa Fe | 86* |
| Ajax Mfg. Co., reclaiming rolls | 544* |
| American Car & Foundry Co., automatic pouch rack | 1510* |
| American Car & Foundry Co., car, 75 ton flat | 1388* |
| American Car & Foundry Co., car, all steel parlor, Long Island | 137* |
| American Engineer & Railroad Journal, history of | 3§ |
| American Engineer—Publication date changed | 163§ |
| American Locomotive Company. | |
| Boiler makers' strike settled | 97† |
| Driving boxes, 11 in. x 21 in. Locomotives | 393* |
| 2-8-2 type, B. R. & O. | 251* |
| 2-8-2 type, C. & O. | 128* |
| 2-8-2 type, C. & O., performance of | 1472* |
| 2-8-2 type, D. L. & W. | 459* |
| 2-8-2 type, Erie | 87* |
| 2-8-2 type, Rock Island | 563* |
| 4-6-2 type, B. R. & P. Ry. | 251* |
| 4-6-2 type, D. L. & W. | 391* |
| 4-6-2 type, St. L. & S. F. | 189* |
| 4-6-2 type, No. 50,000 | 5* |
| 2-8-8-2 type, P. R. R., experimental | 150* |
| 2-8-8-2 type, Virginian | 287* |
| Officers re-elected | 608 |
| Shop addition at Montreal, Que. | 270† |
| Spark arrester, Gyros | 143* |
| American Railway Master Mechanics' Association (see Master Mechanics' Association). | |
| American Sheet & Tin Plate Co., new roofing plates | 270† |
| American Society of Engineering Draftsmen, paper by W. F. Turnbull | 196 |
| Amer. Soc. of Mech. Engrs., car lighting | 614 |
| Amer. Soc. of Mech. Engrs., honorary members | 265† |
| Amer. Soc. of Mech. Engrs., paper on the Vaulchain drill | 566* |
| Amer. Soc. of Mech. Engrs. (see also Meetings). | |
| American Steam Gage & Valve Mfg. Co., pop valve | 208* |
| American Steel Foundries, cast steel brake beam | 1287* |
| American Steel Foundries, prevention of accidents | 230 |
| American Steel Foundries, Sampson bolster | 1449* |
| American Steel Foundries, truck, 75 ton | 1396* |
| American Tool Works Company, boring with a radial drill | 322* |

| | |
|--|-------|
| American Tool Works Company, lathe, releasing attachments for | 488* |
| American Tool Works Company (see also Machine Tools). | |
| Analysis of wood working machinery, by L. R. Pomeroy | 509 |
| Anderson, Olaf, stresses in steel underframes | 71* |
| Angle cock grinding machine, P. R. R. | 134* |
| Anthracite coal for locomotive fuel, report on | 295 |
| Anthracite, output in Pennsylvania | 552† |
| Appeal for protection of employees, So. Pac. | 546† |
| Apprentices, car shop, report and discussion on | 1401 |
| Apprentices, handling of, by Wm. G. Ryer | 43 |
| Apprenticeship and high schools, Ill. Cent. | 622 |
| Apprenticeship, car department | 1400§ |
| Apprenticeship course for car department | 1399§ |
| Apprenticeship in boiler shop, P. R. R. | 281 |
| Apprenticeship, new plans on Illinois Central | 622 |
| Around the world in 39 days | 458† |
| Articulated connection, Can. Pac. Mallet | 350* |
| Aseo weatherstrip for car windows | 1454* |
| Ash pan for narrow firebox, by P. F. Smith | 356* |
| Ash pan wheel cover, formers for | 226* |
| Ashmore, C. D., flangeless shoes and wedges | 599* |
| Ashmore, C. D., solid end main rod | 478* |
| Associations, advantages of railway mechanical, by C. C. Leech | 13 |
| Associations, mechanical, date of meetings | 211 |
| Atchison, Topeka & Santa Fe (see Santa Fe). | |
| Atkins & Co., E. C., hack saw | 649* |
| Atlanta, employees' blacklist on roads entering | 652† |
| Atlantic City convention, list of exhibitors | 1289 |
| Atlantic City conventions, entertainment at | 612§ |
| Atlantic City conventions (see Master Car Builders' and Master Mechanics' Associations). | |
| Augur, R. C., effect of wheel load on brake shoes | 316* |
| Automobile car, C. M. & St. P. | 253* |
| Automobile production in 1913 | 539† |
| Axle centering jig | 361* |
| Axle grinding machine (see Machine Tools). | |
| Axle light equipment, report on | 591 |
| Axle light system | 615 |
| Axles, grinding car and locomotive | 107§ |
| Axles, Cambria steel | 1454* |
| B | |
| Babbitt heating furnace, portable, Can. Pac. | 198* |
| Back pressure, power consumption in | 300* |
| Baker, Geo. H., fuel campaign, C. & A. | 547 |
| Baker valve gear, by R. S. Mounce | 575* |
| Baker valve gear on old power | 1481 |
| Balance compound locomotive, 4-6-2 type, Santa Fe | 517* |
| Baldwin Locomotive Works. | |
| Incorporation of Chicago plant | 215 |
| Land for western plant | 49 |
| Locomotives. | |
| 2-8-2 type, C. B. & O. | 619* |
| 2-8-2 type, Erie | 87* |
| 2-8-2 type, Rock Island | 563* |
| 2-10-2 type, C. B. & O. | 231* |
| 2-10-2 type, Santa Fe | 517* |
| 4-6-2 type, balance compound, Santa Fe | 517* |
| 4-6-2 type, C. of G. | 372* |
| 4-6-2 type, N. C. & St. L. | 141* |
| 2-8-8-0 type, Great Northern | 587* |
| 2-8-8-2 type, Iron Mountain | 420* |
| Electric, So. Pac. | 581* |
| Loyal legion button | 155† |
| New plant at Gary, Ind. | 106 |
| Rights of Garret type locomotives | 50 |
| Semi-automatic starting valve | 421* |
| Ball joint, Franklin, in air pipes | 394* |
| Baltimore & Ohio | |
| Boiler tube testing machine | 484* |
| Club organized | 1459 |
| Driving boxes, accuracy in finishing | 127* |
| Drop testing machine | 91* |
| Emery wheel guard | 431 |
| Labor bureau established | 546† |
| Maintenance of locomotive boilers | 519* |
| Safety committee work | 155† |
| Saving fuel on | 1511§ |
| Shop kinks | 618* |
| Steel car shop kinks | 122* |
| U. S. Court dismisses suit | 324† |
| Pand saw safeguards | 431* |
| Bangor & Aroostook, locomotives destroyed by fire | 45† |
| Barber side bearing truck | 1326* |
| Barco Brass & Joint Co., steam and air pipes | 432* |
| Barco flexible joints | 432* |
| Barnes Drill Co., all geared drill | 208* |
| Barney & Smith Car Co., history of | 1471 |
| Baseball game, Atlantic City, report of | 1435 |
| Baxter, H. M., paint brush storage | 307* |
| Beaudry & Co., Peerless hammer | 541* |
| Beech Grove, Ind., passenger car shops at | 167* |
| Beland, A. J., all-steel pilot | 380* |
| Bell ringers, repairing, L. & N. | 146* |
| Belnap, H. W., B. & O., address on safety of employees | 490 |
| Benefits of convention attendance, by W. M. T. Gale | 151 |
| Bentley, H. T., address at blacksmiths' convention | 444 |
| Bentley, H. T., address at M. M. convention | 1460 |
| Bentley, H. T., address at Traveling Engineers' convention | 476 |
| Bentley, F. W., Jr., removing a stuck wedge | 56* |
| Besley, C. S. & Co., pattern makers' grinder | 487* |
| Bessemer & Lake Erie, car, steel box | 193* |
| Beyer, O. S., Jr., electric welding | 57* |
| Beyer, O. S., Jr., standard practice cards | 15* |
| Beyer, Peacock & Co., locomotive, Garratt type | 623* |
| Bickford, H., & Co., vertical chucking machine | 598* |
| Big Four Ry. (see Cleveland, Cincinnati, Chicago & St. Louis). | |
| Bits for boring in wood, B. & M. | 573* |
| Black, Geo., piston, piston rod and cross-head repairs | 559* |
| Blacksmiths' Association Convention. | |
| Address by H. T. Bentley | 444 |
| Carbon and high speed steels | 444 |
| Case hardening | 446 |
| Drop forgings | 445 |
| Election of officers | 454 |
| Frame repairing | 448* |
| Flue welding | 444 |
| Forging machines, dies and formers | 446 |
| Heat treatment of metals | 449 |
| Oxy-acetylene welding | 453 |
| Piecework | 450 |
| President's address | 444 |
| Sec. & Treas. report | 444 |
| Shop efficiency | 454 |
| Shop kinks | 450* |
| Spring making | 447 |
| Blacksmith shop kinks (see shop kinks). | |
| Blacksmith shop, pneumatic hammer for, by Sam Lewis | 454* |
| Blacksmiths, convention, notes on | 441§ |
| Block, Isaac, obituary | 438 |
| Blue prints, more information on | 163§ |
| Boges, C. H., reclaiming of scrap | 410 |
| Boiler, 2-8-2 type locomotive, C. & O. | 128* |
| Boiler, 4-6-2 type locomotive, D. L. & W. | 395* |
| Boiler, 4-6-2 type locomotive, No. 50,000 | 7* |
| Boiler, 2-10-2 type locomotive, C. B. & O. | 233* |
| Boiler, cracking of flue sheet | 286 |
| Boiler, electric welding of | 57* |
| Boiler inspection, B. & O. | 520 |
| Boiler inspection rules amended | 602† |
| Boiler lagging, using old | 121† |
| Boiler, largest locomotive, Virginian | 287* |
| Boiler, location of check valve, report on | 280* |
| Boiler, maintenance of locomotive, by Walter R. Hedeman | 519* |
| Boiler maintenance with superheated steam, report on | 285 |
| Boiler sheets, flanging | 201* |
| Boiler shop apprentices, P. R. R. | 281 |
| Boiler shop kinks (see shop kinks). | |
| Boiler, stay bolt, spiral | 308* |
| Boiler tests, low water | 1502* |
| Boiler tube cleaner, Matthews | 1453* |
| Boiler tube cleaner, Ryerson | 358* |
| Boiler tube department, An ideal, by L. R. Pomeroy | 357* |
| Boiler tube expander with knockout attachment | 485* |
| Boiler tube sheets, formers for | 226* |
| Boiler tube testing machine, by R. C. Powers | 484* |
| Boiler tube welding, report by J. P. Kane | 444 |
| Boiler tubes, car for transporting, Can. Pac. | 359* |
| Boiler tubes, care of, by W. R. Hedeman | 414* |
| Boiler tubes, maintenance of | 387§ |
| Boiler tubes, repairing | 332§ |
| Boiler tubes, \$10 for a suggestion | 441§ |
| Boiler washing system, Winslow | 18* |
| Boilermakers' Convention. | |
| Apprenticeship | 281 |
| Brick arch | 282 |
| Cracking of flue sheets | 286 |
| Election of officers | 280 |
| Feed water admission, location of | 280 |
| Meeting place for 1913 | 286 |
| Spark arresters | 282 |
| Superheated steam and boiler maintenance | 285 |
| Weakest condition of boiler | 281 |

Boilers, report and discussion on..... 1487*
 Bolster, Sampson..... 1449*
 Bolsters, specifications for, report and discussion on..... 1412
 Bolt centering machine, Eastern Ry. of N. M. 188*
 Bolt, extension clamping, P. R. R..... 132*
 Bolt header, automatic feed for..... 376*
 Bolt header (see machine tools).
 Bolts, eye, dies for making..... 451*
 Bolts, wedge, dies for making..... 453*

Books.

Accident Prevention and Relief, by Ferd C. Schwedman and James A. Emery..... 220
 Addresses to Engineering Students..... 220
 Baltimore & Ohio, Early Motive Power on, by J. Snowden Bell..... 110
 Bearings, by R. L. P. Alford..... 55
 Boundaries and Landmarks, by A. C. Mulford..... 613
 Catechism of the Locomotive, Forney, Part I, by G. L. Fowler..... 166
 Catechism of the Locomotive, Forney, Part II, by G. L. Fowler..... 443
 Coal and Coke, Methods of Analyzing, by Stanton and Fieldner..... 442
 Coal, Coking of, at Low Temperatures, by Park and Olin..... 558
 Coal Trade, by F. E. Seward..... 390
 Cylinder Performance of Reciprocating Engines, by J. Paul Clayton..... 390
 Dynamics of Machinery, by Gaetano Lanza..... 390
 Early Motive Power on the Baltimore & Ohio, by J. Snowden Bell..... 110
 Effect of Cold Weather on Train Resistance and Tonnage Rating, by E. C. Smith and F. W. Marques..... 390
 Efficiency as a Basis for Operation and Wages, by Harrington Emerson..... 110
 Electric Injuries—Causes, Prevention and Treatment, by Chas. A. Lanfer, M. D..... 390
 Elementary Applied Mechanics, by Arthur Morley..... 55
 Forney's Catechism of the Locomotive, Part I, by G. L. Fowler..... 166
 Forney's Catechism of the Locomotive, Part II, by G. L. Fowler..... 443
 Fuel Association, International Railway, Proceedings..... 501
 Gasoline and Alcohol Engines, Comparative Trials of, by W. L. Cathcart and J. I. Chaffee..... 55
 Grinding Book, American Machinists', by Calvin and Stanley..... 558
 International Blacksmiths' Association Proceedings..... 220
 International Railway Fuel Association, Proceedings of..... 4
 Light, Its Use and Misuse..... 557
 Locomotive, Forney's Catechism, by George L. Fowler..... 166
 Locomotive, the Modern, by E. Edgar Allen..... 442
 Manufacturers' Standard Flange Fittings..... 601
 Master Car Builders' Association, 1911 Proceedings..... 165
 Master Mechanics' Association, 1911 Proceedings..... 166
 Master Mechanics' Association Proceedings, 1912..... 613
 Master Car & Locomotive Painters' Association, Proceedings..... 4
 Maximum Production in Machine Shop and Foundry, by C. E. Knoepfel..... 110
 Mechanical World pocket book, 1913..... 613
 Mechanical World pocket book and year book..... 220
 Methods of Analyzing Coal and Coke..... 389
 Modern Organization, by Charles De Lano Hine..... 558
 New York Air Brake System..... 55
 Operating Costs, Railroad, by Suffern & Son..... 442
 Organization, Modern, by Charles De Lano Hine..... 558
 Planers, Treatise on..... 275
 Prevention of Railway Accidents, by Geo. Bradshaw..... 220
 Scientific Management, Applied Methods of, by Frederick A. Parkhurst..... 557
 Signal Dictionary, revised edition..... 165
 Storekeepers' Association, 1912 Proceedings..... 558
 Technology, Congress of, Proceedings..... 110
 Tool Foremen's Assoc. Proceedings, 1912..... 613
 Train Resistance, Effect of Cold Weather on, by E. C. Smith and F. W. Marques..... 390
 Traveling Engineers' Association, 1911 Proceedings..... 166
 Unit System of Organization, by Chas. De Lano Hine..... 558
 Valve Gear, Walschaert, by W. W. Wood..... 389
 Valves, Valve Gear and Valve Design, by F. DeR. Furman..... 443

Books (continued).

Walschaert Locomotive Valve Gear, by W. W. Wood..... 389
 Western Railway Club, 1912 Proceedings of..... 558
 Westinghouse air brake system..... 55
 Boring machines (see machine tools).
 Boring mill chuck for tires..... 344*
 Boring tool for car wheels..... 541*
 Borsig Locomotive Works, total output..... 286†
 Boston & Maine, analysis of wood working machines in Fitchburg shop..... 509
 Boston & Maine, car shop kinks..... 573*
 Boston & Maine, new shops at Bellocria..... 159, 384
 Boston Elevated uses articulated car..... 601†
 Box cars, defective..... 1368§
 Box cars, improved..... 1369§
 Box cars, overhead inspection of, report and discussion on..... 1378
 Boxes, hot, causes of..... 312
 Bradshaw, Geo., accidents in shops and engine-houses..... 579
 Brake beam, cast steel..... 1287*
 Brake beam strut, duplex..... 1287*
 Brake beam support..... 1428*
 Brake beam hangers, manufacture of, by R. S. Mounce..... 625*
 Brake beams, report and discussion..... 1309*
 Brake fittings, malleable iron..... 1426*
 Brake for lathe..... 147*
 Brake hangers, dies for making..... 453*
 Brake rigging, Westchester steel cars..... 241
 Brake shaft bearings, forming, B. & M..... 573*
 Brake shoe heads, removing from brake beams..... 451*
 Brake shoes..... 1297§
 Brake shoes, effect of wheel load, report on Brake shoes, friction and wear of, report on..... 316*
 Brake shoe tests, B. R. T..... 164§
 Brake shoes, test of, report and discussion..... 1309
 Brake testing at terminals, by F. B. Farmer..... 19
 Brakes (see also Air Brakes).
 Brakehead, adjustable..... 1510*
 Braking methods, improved..... 1266§
 Braking power on freight cars..... 1265§
 Brazil, hydro-electric plant in..... 191†
 Brekenfeld, J. C., machine shop kinks..... 176*
 Brick arch, the..... 274§
 Brick arch and hard coal..... 388§
 Brick arch, comparative test of, on B. R. & P..... 529*
 Brick arch, cost of maintaining..... 282
 Brick arch on switch engines, by D. R. McBain..... 583*
 Brick arch on Virginian Mallet..... 289*
 Brick arch, relation to fuel economy, committee report..... 467
 Brick arch, report on, at boiler-makers' conv. Bridge plates for shop hose, B. & O..... 122*
 Brombacher, Max H. C., efficiency engineer, reports on foreign shop management..... 490
 Brotherhood of Locomotive Engineers, tri-annual convention..... 324†
 Brush, long handled, for painting freight cars..... 586
 Buell, D. C., report on proper method of firing locomotives..... 295
 Buffalo Brake Beam Co., brakehead..... 1510*
 Buffalo Forge Co., a new steam turbine..... 153*
 Buffalo, Rochester & Pittsburgh, locomotive 4-6-2 and 2-8-2 types..... 251*
 Buffalo, Rochester & Pittsburgh, tests of locomotives..... 529*
 Buffalo & Susquehanna, tender wheel lubricator..... 459*
 Buffer, radial, for engine and tenders..... 489*
 Buildings and shops (see Shops, New).
 Burke Electric Company, motor application to machine tools..... 322*
 Burrhus, H. L., machine shop kinks, second prize..... 147*
C
 Caillé feed water heater, Seaboard Air Line Caledonian Railway, interesting designs on, by G. S. Hodgins..... 35*
 California industrial accident board, first decision..... 324†
 Callaghan, J. H., report on line inspection..... 313
 Cambria Steel Co., locomotive and car axles..... 1454*

Canadian Pacific Railway.

Boiler tube car..... 359*
 Calliper for boring driving boxes..... 279*
 Clamp for crown brasses..... 278*
 Centering device for Mallet..... 351*
 Damages by fire..... 209†
 Exhaust nozzle, variable..... 349*
 Gage for marking brasses..... 278*
 Locomotive, 0-6-6-0 type, simple..... 347*
 Locomotive, articulated connection..... 350*
 Numbers, locomotive and car..... 432*
 Oil fuel for locomotives..... 45†
 Piston, piston rod and crosshead repairs..... 559*
 Driving boxes, repairing..... 276*
 Reverse gear, power..... 347*
 Shop kinks..... 197*
 Telegraphers win appeal..... 546†
 Canadian Railroad Club (see Meetings).
 Canal, New Jersey, ship..... 421†
 Capacity marking of cars, report and discussion on..... 1413

Car.

Air brakes on Westchester..... 242
 Automobile, C. M. & St. P..... 253*
 Automobile, door details..... 255*
 Axles, grinding machine for..... 152*
 Bolster, combination underframe and truck..... 1328*
 Box, all steel..... 164, 499§, 502*
 Box, double deck, C. M. & St. P..... 253*
 Box, Summers all steel..... 193*
 Box, steel roof, P. R. R..... 504*
 Brass sash for passenger..... 1424*
 Built in 1911..... 45†
 Capacity, marking of, report and discussion on..... 1413
 Center sills, designing, by A. E. Helffelfinger..... 111*
 Cleaning coaches, by J. H. Whittington..... 85
 Coupler centering device..... 594*
 Defective freight..... 333§
 Department scrap, reclaiming, by C. F. A. Design, stresses in steel underframes..... 71*
 Details of steel interior finish, Long Island..... 138*
 Dining, without vestibule, Pennsylvania Door, Crispy steel..... 263*
 Door, freight, all steel, P. R. R..... 502*
 Door, ice car..... 355*
 Door, lock for..... 1397*
 Door, steel formers for..... 230*
 Dynamometer, recording apparatus of Santa Fe..... 185*
 Dynamometer, Santa Fe 1,000,000 lbs. capacity..... 181*
 Dynamometer, steel framing of Santa Fe..... 183*
 End frame, cast steel, for passenger..... 1430*
 Facilities for repairing steel..... 109§
 Fan, electric, for passenger..... 650*
 Flat, 50 ton Barber..... 1326*
 Flat, 75 tons capacity, Erie..... 1388*
 Flat, 100 ton capacity, P. & L. E..... 125*
 Floors, concrete, report on..... 533*
 Freight, earning capacity of..... 555§
 Gondola, 46 ft., New York Central..... 1286*
 Heating, automatic regulator..... 486*
 Heating, Gold thermostat, for..... 1423
 Heating, pressure regulator..... 207*
 Heating system, Thermo jet..... 1426*
 House, steel frame, P. R. R..... 502*
 Ice, Central of Jersey..... 353*
 Inspection and interchange bureau organized..... 209†
 Jointed, on Boston elevated..... 454†
 Ladder, steel..... 1509*
 Lighting, axle light equipment, report on..... 591
 Lighting, electric, features for indirect..... 1288*
 Lighting, electric system for..... 614
 Lighting fixtures..... 1396*
 Lighting, indirect method..... 37*
 Lighting, indirect, with Pintsch gas..... 1529
 Lighting on different roads, tabular arrangement..... 616
 Lunch counter in..... 638†
 Motor, gas electric, S. L. & S. F. 379*..... 1324*
 Number of steel passenger on P. R. R. Observation platform, enclosed, I. C..... 198*
 Ore, 70 ton..... 1398*
 Ore, self-clearing, Pressed Steel Car Co. Painting, freight equipment, T. J. Hutchinson..... 21
 Painting passenger, report on..... 535
 Painting, removing interior finish..... 532
 Painting steel passenger, by J. W. Lawrence..... 594
 Parlor, all steel, Long Island..... 137*
 Passenger, maintenance of paint on steel and wooden, report on..... 536
 Pullman, number of..... 647†
 Refrigerator, door fixtures, Garland..... 139*
 Refrigerator, Pacific Fruit Express..... 491
 Refrigerator, steel frame, P. R. R..... 502*
 Refuse and cinder, by C. C. Leech..... 250*
 Repair material for, rate changed..... 325†
 Roofs, freight, report on..... 537
 Roofs, steel passenger, care of, report on..... 535
 Seats, plush for..... 1395
 Seats, simplified..... 1327*
 Sectional diaphragm for..... 1425*
 Shapes for steel formers..... 229*
 Shop, analysis of tools required in, L. R. Pomeroy..... 509*
 Shop apprentices, report and discussion on..... 1402
 Shop kinks (see Shop Kinks).
 Shops, C. C. C. & St. L., at Beech Grove, Ind..... 163§, 167*
 Shops, wood working tools for..... 501§
 Side bearing motion, mirror for inspecting..... 200*
 Side framing, unit pressed steel..... 238*
 Standardization of grain doors, report on..... 314
 Steel center sill design..... 108§
 Steel frame freight, P. R. R..... 502*
 Steel, maintenance of, report on..... 531
 Steel passenger..... 601†
 Steel passenger in wrecks..... 53§
 Steel passenger, insulated..... 571†
 Steel passenger, number in service..... 555§
 Steel passenger on Pennsylvania..... 621†
 Steel suburban, Westchester..... 218§

Page numbers under 1,000 refer to *American Engineer*; those over 1,000 refer to the *Daily Railway Age Gazette*. * Illustrated article; § editorial; † short non-illustrated article or note; ‡ communication.

Car (continued).

Stock, steel frame, P. R. R. 502*

Street, experimental double deck. 491†

Striking plate 355*

Suburban, Westchester 238*

Tank, report and discussion on. 1407

Tank, steel underframe. 1278*

Treated lumber for. 164§

Truck, Barber 1326*

Truck, Summers side bearing. 194*

Truck, 100 ton flat car, P. & L. E. 126*

Truck pedestal, for 100 ton car, P. & L. E. 125*

Truck, side frames, rolled steel. 375*

Truck, Westchester steel passenger. 241*

Trucks, non-parallel axle type. 642*

Underframe and truck combined. 1328*

Underframe, C. R. R. of N. J. 354*

Underframe, 100 ton flat, P. & L. E. 125*

Underframe, designing steel center sills. 111*

Underframe, house cars, P. R. R. 502*

Underframe, stresses in steel, by Olaf Anderson 71*

Underframe, Westchester all-steel. 238*

Unit side framing, steel passenger. 1427*

Unloaders 1367§

Ventilation in Germany. 643†

Vestibule, end finish, report on. 532

Ventilator, utility 1429*

Ventilator, for passenger in. 586†

Weight per passenger in. 1275‡, 1416‡

Wheel, chilled iron. 362*

Wheel, hooks for lifting. 1314

Wheel, proposed specifications. 1312*

Wheel, report and discussion. 362*

Wheel, testing warped. 362*

Wheel tire fastener for passenger, Caledonian 36*

Wheels 1298§

Wheels, cast iron. 1265§

Window weather strip, Asco. 1454*

Car article, \$50 for best. 612§

Car construction, poor. 219§

Car exhibits, steel passenger. 1399§

Carboys for paint vehicle, G. T. 586*

Card index, a simple, by R. S. Mounce. 140*

Cards, standard practice on the Erie. 15*

Carlin, Louis E., obituary. 438

Carolina, Clinchfield & Ohio, locomotive test Case hardening, report by M. Nicholson and G. Creeden 1476

Case hardening, report by M. Nicholson and G. Creeden 446

Case hardening, report by M. Nicholson and G. Creeden 1399§

Cast steel wheels. 50, 106, 162,

Catalogs. 330, 386, 440, 498, 554, 609

Centering device for couplers, Forsyth. 1287*

Centering device for Mallet, Can. Pac. 351*

Centering device for Mallet, Can. Pac. 624*

Central of Georgia, adjusting safety valves. 155†

Central of Georgia establishes educational bureau 372*

Central of Georgia, locomotive 4-6-2 type. 526*

Central of Georgia, piston, piston rod and crosshead repairs 250*

Central of Georgia, portable electric motor. 353*

Central Railroad Club (see Meetings).

Central Railroad of New Jersey, ice car. 111*

Center sill design for steel cars. 602†

Chamber of Commerce of U. S. starts new publication 1451*

Chambersburg Engineering Co., steam hydraulic forging press. 641*

Chart for obtaining tractive efforts, L. R. Pomeroy 624*

Check valve, repairing, by Charles Markel. 427

Checking system for small tools, committee report 418*

Chenoweth, E. G., filing and indexing tracings 622*

Chesapeake & Ohio, enginehouse facilities for Mallets 128*

Chesapeake & Ohio, locomotive, 2-8-2 type. 1472*

Chesapeake & Ohio, locomotive, 2-8-2 type, performance of 107§

Chesapeake & Ohio, motive power on. 85

Chicago & Alton, coach cleaning on. 547

Chicago & Alton fuel campaign 97†

Chicago & Eastern Illinois advances wages

Chicago & North Western.

Blow-off valve for locomotives. 485*

Driving box construction, improved. 522†

Eccentric blades, preventing slipped. 546†

Hygiene award 481*

Link grinding machine. 518†

Passenger traffic in Chicago. 652†

Result of safety campaign. 478*

Rod, solid end main. 265†

Safety committee, report of. 45†

Safety committee, results of work. 53§

Scrap material, reclaiming. 599*

Shoes and wedges, flangeless. 70*

Shop kinks 118*

Spark arrester, Gyrus. 143*

Test of superheater locomotives. 413*

Tire mandrel 308*

Tire transfer cart. 56*

Wedge, removing a stuck. 381

Chicago & Western Indiana safety committees 381

Chicago Association of Commerce committee observing smoke stacks. 324†

Chicago, Burlington & Quincy, fined by U. S. court. 324†

Chicago, Burlington & Quincy, locomotive, 2-8-2 type 619*

Chicago, Burlington & Quincy, locomotive, 2-10-2 type 231*

Chicago, Burlington & Quincy, Relief Dept., report of 265†

Chicago, Burlington & Quincy, safety committee appointed 98†

Chicago, density of locomotive smoke in. 596

Chicago Great Western employs only careful workmen 601†

Chicago Great Western, meeting of employees 324†

Chicago Great Western, *The Maize*. 209†

Chicago, Milwaukee & St. Paul, automobile car 253*

Chicago, Milwaukee & St. Paul, double deck box car 233*

Chicago, Milwaukee & St. Paul, indicted for collision 381

Chicago Railway Equipment Co., brake beam support 1428*

Chicago, Rock Island & Pacific (see Rock Island).

Chicago, smoke problem in. 651†

Chicago, St. Paul, Minneapolis & Omaha, ash pan 356*

Chilean Government Railway statistics. 552†

China, wages in. 208†

Chisel bars, guard for, B. & O. 618*

Christy steel box car door. 263*

Chuck (see Shop Kinks).

Chucking machine (see machine tools).

Cincinnati Planer Co., frog and switch plainer 597*

Claims for live stock. 346†

Claypool, Z. B., yoke riveter. 542*

Cleveland, Cincinnati, Chicago & St. Louis, shops, passenger car. 167*

Cleveland, Cincinnati, Chicago & St. Louis, shop kinks 627*

Club, employees', on So. Pac. 652†

Coach cleaning, aspirator for, by Francis P. Mann 434*

Coach cleaning, by J. H. Whittington. 85

Coal analysis, standard, report on. 308†

Coal, amount of, in Canada. 308†

Coal exports, British. 434†

Coal exported, the value of. 72†

Coal for locomotive stokers. 52§

Coal for Belgium railways. 582†

Coal mines, death rate in American. 530†

Coal production in the United States. 552†

Coal shipments 206†

Coal supply, new factor in. 127

Coatesville tests, low water. 1502*

Coatesville tests of boilers. 366*

Coatesville tests, progress report on. 321

Collar on engine truck axle. 394*

Collett, Robert, report on fuel performance sheet 292*

Combustion chamber, 2-8-8-2 type locomotive, Virginian 287*

Combustion, effect of fire box volume on, by F. F. Gaines. 94*

Commerce, U. S. foreign. 264†

Committees of Master Car Builders' Assn. 511

Committees, Master Mechanics' Assn., 1913 548

Committee of locomotive engineers discusses wages 155†

Commonwealth Steel Co., cast steel end frame for passenger cars. 1430*

Commonwealth Steel Co., engine truck frames 1450*

Competition, model contribution to. 108§

Competition, piston heads, etc. 274§

Competition, reclaiming scrap material, first prize 107§

Competition, repairing driving boxes. 108§

Competition, shop kinks. 107§

Competition, shop safety devices. 217§

Compound locomotive, semi-automatic starting valve 421*

Concrete car floors. 533*

Conference committee methods in legislation 79

Conservation of material, prize article, by Ernest Cordeal 117

Consolidation of M. M. & M. C. B. Assoc. 1484§

Constitution, revision of M. C. B. 1302

Construction (see Shops, New).

Contour of tires, report and discussion on. 1497*

Convention, Blacksmiths', report of. 444*

Controller, automatic, for electric motors. 259*

Convention, Air Brake Assn., report of. 315

Convention, Boiler Makers' Association, report of 280*

Convention, Chief Car Inspectors and Car Foremen's Assn. 548

Convention, Electrical Engineers' Assn., report of 591

Convention, Fuel Assn., report of. 295

Convention, General Foremen's Assn., report of 398

Convention, M. M. & M. C. B. Assn., report of 1300

Convention, Painters' Assn., report of. 500

Convention, Storekeepers' Assn., report of. 309

Convention, Tool Foremen's Assn., report of 427

Convention, Traveling Engineers' Assn., report of 464

Convention (see also under name of association).

Convention season 217§

Convention suggestions 219§

Conventions, benefits of attending, by C. C. Leech 13

Conventions, the May, 1912. 273§

Co-operation of railway associations. 1455§

Copyright, notice of, for daily Ry. *Age Gaz.* 1265§

Cordeal, Ernest, conservation of material. 117

Cordeal, Ernest, engine failures. 23*

Cordeal, Ernest, engine house facilities and equipment 455

Cordeal, Ernest, engine house reports and records 339*

Cordeal, Ernest, engine house organization 221

Cordeal, Ernest, time feature of engine failures 56

Cornell dinner, list of those attending. 1434

Coulter, Harry, honorary member M. C. B. Assn. 1317

Counterbalance weights inside of frame, C. B. & Q. 236*

Coupler and draft equipment, report and discussion of 1383*

Coupler centering device, Forsyth. 1287*

Coupler centering device, gravity. 1325*

Coupler, new freight car. 1299§

Coupler side clearance. 1287*

Coupler yoke, radial. 1520*

Crane, battery truck. 118*

Crane for air pumps, C. & N. W. 644

Cravens, George W., shop electrification. 1526

Crawford, D. F., biography. 446

Creeden, G., report on case hardening. 332§

Criticisms of shop practice. 132*

Crosshead pin brass, boring, P. R. R. 559*

Crosshead repairs, by Geo. Black. 250*

Crosshead shoes, mold for tuning, by C. C. Leech 75*

Crossheads, repairing, W. G. Reyer. 614

Currie, H. A., car lighting. 618*

Curtis, C. A., Jr., shop kinks. 601†

Cut flowers, transportation of. 225*

Cutter for flue holes. 366

Cutting speed of planers, obtaining. 89*

Cylinders, 2-8-2 type locomotive, Erie. 348*

Cylinders, 4-6-2 type locomotive, No. 50,000 279*

Cylinders, 0-6-6-0 type locomotive, Can. Pac. 76*

Cylinder head carrier, by F. H. Hinkley. 62*

Cylinder heads, grooving. 62*

Cylinder repaired by electric welding. 62*

D

Daly, J. M., address on train tonnage. 472

Damage to freight equipment by unloading machines, report and discussion on. 1376*

Damon, Wm. H., layout of a spiral. 14*

Davis Boring Tool Co., expansion boring tool 541*

Davis, A. R., milling cutters and reamers 379*

Davis, Wm. L., valve gears, attachment on Delaware, Lackawanna & Western, locomotive, 2-8-2 type. 459*

Delaware, Lackawanna & Western, locomotive, 4-6-2 type 391*

Delaware, Lackawanna & Western, tests of locomotives 543*

Delaware, Lackawanna & Western, water gas for shop furnaces. 27*

Denver & Rio Grande, electrification on. 652†

Denver & Rio Grande, safety organization. 435

Department of Labor created by House of Representatives 435

Dersch, F. H., link grinding machine. 481*

Design of locomotive boilers, report and discussion of 1487*

Detroit Lubricator Co., eight feed lubricator 1452*

Detle, R. E., shop kinks in locomotive shop, P. R. R. 132*

De Voy, J. F., address at General Foremen's Assn. 398

Diaphragm, Acme sectional. 1425*

Dickert, C. L., adjusting safety valves. 624*

Dickert, C. L., advance information on engines to be shipped. 401

Dickert, C. L., piston, piston rod, and crosshead repairs 526*

Dickinson, Paul, ventilator, exhaust. 544*

Dies and formers for forging machines, committee report 446*

Dies for forging side rod jaws. 148*

Donovan, P. H., report on pipe and pipe fittings 319

Doors, rack for storing, G. T. 586*

Dow, T. W., air hose failures. 315

Draft gear, radical yoke, Forsyth. 1287*

Draftsmen, fair treatment of. 630

Draftsmen, hints to, by William F. Turnbull 196

Draw bar carrier for tenders, Santa Fe. 121*

Drawing room, management of a, by F. A. Schmidt 629

Drill, electric 82*

Drill, forged twist. 322*

Drill, radial as a boring machine. 260*

Drill socket, "Wear Ever" type. 224*

Drill twisting device. 566*

Drill, Vauclain, by Vauclain and Wille. 178*

Drilling machine (see Machine Tools).

Driving box brass, chuck for, St. L. & S. F. 159†

Driving box brasses, renewing without dropping wheels 178*

Driving box chuck, St. L. & S. F. 599*

Driving box construction, improved, by C. D. Ashmore

Page numbers under 1,000 refer to *American Engineer*; those over 1,000 refer to the *Daily Railway Age Gazette*. * Illustrated article; § editorial; † short non-illustrated article or note; ‡ communication.

Driving box liners, device for casting.... 223*
 Driving box repairing, competition announced..... 163§
 Driving box, truck for handling..... 147*
 Driving boxes, repairing..... 274§
 Driving boxes, accuracy in finishing, by John V. LeCompte..... 127*
 Driving boxes, repairing, by E. T. Spidy..... 276*
 Driving boxes, repairing, by M. H. Westbrook..... 369*
 Driving boxes, repairing, by H. Wanamaker..... 429*
 Driving boxes, repairing, by J. V. LeCompte..... 334‡
 Driving boxes, tongs for lifting..... 646*
 Driving boxes, 11 m. x 21 in., Amer. Loco. Co..... 393*
 Driving wheel, speeds, formula for..... 230‡
 Driving wheel tires, device for handling..... 225*
 Drop forgings, report by H. E. Gamble..... 444
 Drop pits arranged for Mallets, C. & O..... 622*
 Drop pits in enginehouses..... 456
 Drop testing machine..... 51§
 Drop testing machine, B. & O., by Andrew Lauterbach..... 91*
 Drury, C. J., shop kinks..... 188*
 Dudley, E. L., shop kinks..... 22*
 Duluth & Iron Range, all-steel pilot..... 380*
 Duluth & Iron Range, ore car..... 319*
 Duluth, Missabe & Northern, ore car..... 319*
 Dunn, S. O., address at Traveling Engineers' convention..... 463
 Duntley Mfg. Co., air washer and cooler..... 86*
 Dynamometer car, 1,000,000 lbs. capacity, Santa Fe..... 181*

E

Eastabrook, H. M., elected president Barney & Smith Car Co..... 385
 Eastern Car Co., incorporated..... 386
 Eastern Railway of France, repairs to piston valves..... 633*
 Eastern Ry. of New Mexico, shop kinks..... 188*
 Eccentric blades, jig for, Santa Fe..... 643*
 Eccentric blades, preventing slipped, C. & N. W..... 522‡
 Eccentrics, laying out keyways for, by Chas. Markel..... 261*
 Eccentrics, template for drilling..... 149*
 Edison Storage Battery Co., batteries for train lighting..... 1284*
 Educational Bureau of the Union Pacific, new instruction pamphlet..... 325‡
 Efficiency committees formed on Pere Marquette..... 490
 Efficiency, how can foremen best promote, by W. G. Reyer..... 398
 Efficiency of railway employees, by W. W. Finley..... 355
 Efficiency of railway employees, S. O. Dunn..... 463
 Efficiency, reclaiming lost, by H. M. Fitz..... 237
 Efficiency, engine house, by Wm. Hall..... 403
 Electric cars, all-steel, Westchester..... 238*
 Electric Controller & Mfg. Co., machine tool motor controller..... 259*
 Electric ignition of gas lamps..... 1481
 Electric lighting systems for cars..... 614
 Electric locomotive designing, problem of, by N. W. Storer..... 569*
 Electric locomotive, d. c., freight..... 1528*
 Electric locomotive, Southern Pacific..... 581*
 Electric locomotive hoist..... 205*
 Electric locomotives, eight motor, N. Y. & N. H. & H..... 363*
 Electric motor, portable, for erecting shop..... 439
 Electric Properties Co., sold..... 54§
 Electric shop kinks..... 600*
 Electric speed indicator..... 57*
 Electric welding, cost of..... 57*
 Electric welding in railway shops, by O. S. Beyer, Jr..... 57*

Electrical Engineers' Convention.

Axle light equipment..... 591
 Shop practice..... 591
 Steam turbines..... 592
 Industrial lighting..... 592
 Postal car lighting..... 592
 Election of officers..... 593
 Electrical Engineers' Assn., meeting of..... 1417
 Electrical Engineers, meeting of..... 1432§
 Electrical equipment of railway shops, by George W. Cravens..... 644
 Electrification of French railways..... 622‡
 Electrification of Italian railways..... 628‡
 Electrification of shops, by George W. Cravens..... 744
 Electrification of steam roads..... 165§
 Elgin, Joliet & Eastern, safety committee..... 381
 Emery wheel guard, by E. L. Dudley..... 431*
 Employees, cash value of..... 200‡
 Employees' compensation bill, passed by Senate..... 325‡
 Employees' liability act upheld by Supreme Court..... 97‡
 Engine failures, eliminating, by Chas. Maier..... 149
 Engine failures and their elimination, by Ernest Cordeal..... 23*
 Engine failures, reducing..... 2§
 Engine failures, time feature of, by Ernest Cordeal..... 56
 Engine truck frames, cast steel..... 1450*
 Engine truck with collar on axle..... 394*
 Engineers' Society of Western Pennsylvania, paper on protective coatings..... 179
 Engineers' wind shield..... 51§

Engine house and shop foremen..... 218§
 Engine house equipment..... 442§
 Engine house equipment, how to select..... 455
 Engine house facilities and equipment, by Ernest Cordeal..... 455
 Engine house facilities for Mallets, C. & O..... 622*
 Engine house, forms for reporting work, N. Y. C. & H. R..... 336*
 Engine house kinks, by C. C. Leech..... 248*
 Engine house organization and operation, by Ernest Cordeal..... 221
 Engine house problems..... 219§
 Engine house records of locomotive failures..... 23*
 Engine house reports and records..... 332§
 Engine house reports and records, by Ernest Cordeal..... 339*
 Engine house signals, importance of..... 458
 Engine house supervision, by A. C. Loudon..... 572
 Engine house trucking system, Eastern Ry. of N. M..... 188*
 Engine houses, accidents in, by Geo. Bradshaw..... 579
 Engine houses, new (see Shops, new).
 Enginemen, interesting in economical use of fuel and lubricants..... 473
 Engine truck boxes with chilled faces..... 644*
 Entertainment at Atlantic City conventions, 217, 1485§
 Equipment, give it a fair show..... 51§
 Erecting shop kinks (see Shop Kinks).
 Erie barge canal lock opened..... 209‡
 Erie Railroad, car, 75 ton flat..... 1388*
 Erie Railroad, damage to repair shops at Dunmore..... 435
 Erie Railroad, dust remover for hair picking machine..... 514*
 Erie Railroad, electric welding..... 57*
 Erie Railroad, Employees' Relief Assn., meeting..... 601‡
 Erie Railroad, locomotive, 2-8-2 type..... 87*
 Erie Railroad, manufacture of brake beam hangers..... 625*
 Erie Railroad, purchases locomotive No. 50,000..... 602‡
 Erie Railroad, small whistle on locomotives..... 98‡
 Erie Railroad, standards for filing and indexing tracings..... 418*
 Erie Railroad, standard practice cards..... 15*
 Erie Railroad, simple Mallet for high speeds..... 347*
 Evans, G. L., simple Mallet for high speeds..... 349*
 Exhaust, variable, Can. Pac..... 1289
 Exhibitors, at Atlantic City, list of..... 1289

F

Faessler, J., Mfg. Co., new tube expander..... 485*
 Fairbanks, Morse & Co., igniter for motor cars..... 1325
 Fairbanks, Morse & Co., oil engine and pump..... 1424*
 Fan, bracket for cars..... 650*
 Farmer, F. B., brake testing at terminals..... 19
 Farm products, condition of, Nov. 1, 1912..... 638‡
 Feed water admission to boiler, location of, report on..... 280*
 Feed water heater, Caillé, Seaboard Air Line..... 538*
 Feed water heater, locomotive, London & South Western..... 199*
 Feed water heater, relation to fuel economy, committee report..... 467
 Federation of shop employees organized..... 265‡
 Ferry boat, largest..... 225‡
 Finley, W. W., efficiency of railway employees..... 344
 Firebox, Gaines, C. of G..... 372*
 Firebox, Gaines, Virginian Mallet..... 289*
 Firebox sheets, formers for..... 228*
 Firebox, sling stays, London & Southwestern..... 462*
 Firebox volume, effect of, on combustion, by F. F. Gaines..... 94*
 Fire hose, tool for repairing..... 646*
 Firemen, instructions to..... 298
 Firing locomotive, proper methods of, report on..... 295
 Fitz, H. M., reclaiming lost efficiency..... 237
 Flange lubrication..... 1512§
 Flange lubrication, report and discussion on..... 1513*
 Flange press work, by Lewis D. Freeman..... 201*
 Flanging sheets, cost of..... 201*
 Flat car (see Cars).
 Flint & Chester, Inc., C. B. Flint elected president..... 50
 Floors, car (see Car).
 Floors for railway shops..... 2
 Florida East Coast open for traffic..... 98‡
 Flue setting, report and discussion on..... 1489
 Flue sheet, cracking of, report on..... 286
 Flue swedging machine, Eastern Ry. of N. M..... 188*
 Flue welding furnaces..... 1451*
 Foley, D. G., report on location of feed water admission..... 280*
 Foot valve for air lines, P. R. R..... 133*
 Foote-Burt Co., drill, double, with independent heads..... 373*
 Foreign railway notes..... 1281, 1323, 1390
 Foreign practice worthy of study..... 18
 Forest fires..... 617‡
 Forging machines, dies and formers, report on..... 446*
 Forging press, steam hydraulic..... 1451*
 Forgings, drop, report by H. E. Gamble..... 445
 Formers for hydraulic press work, by Lewis D. Freeman..... 226*, 334‡

Forsyth Brothers Co., radial coupler yoke..... 1287*
 Forsyth Brothers Co., steel passenger car framing..... 1427*
 Frame repairing, report at Blacksmiths' convention..... 448*
 Frames and braces, 4-6-2 type locomotive, Santa Fe..... 68*
 Frames, locomotive, cast steel..... 1457§
 Frames, 2-10-2 type locomotive, C. B. & Q..... 235*
 Frames, 2-8-2 type locomotive, Erie..... 89*
 Frames, Mallet, Can. Pac..... 351
 France, repair to piston valves on Eastern Railway..... 614§, 633*
 Franklin ball joint for steam and air pipes..... 394*
 Freeman, Lewis D., flange press work..... 201*
 Freeman, Lewis D., formers for hydraulic presses..... 226*
 Freeman, Lewis D., steel car shop kinks..... 122*
 Freight traffic in Chicago..... 413‡
 French railways, electrification of..... 622‡
 Frink, I. P., New York agents appointed..... 160
 Fruit exhibit, interesting..... 508‡
 Fuel and lubricants, economical use of, committee report..... 473
 Fuel as a factor in locomotive capacity, report on..... 290

Fuel Association Convention.

Anthracite coal for locomotive fuel..... 295
 Coal analysis..... 306
 Election of officers..... 306
 Firing locomotives, proper method..... 295
 Fuel as factor in locomotive capacity..... 290
 Fuel inspection..... 306
 Fuel performance sheet..... 292*
 Locomotive drafting, its relation to fuel consumption..... 300*
 Secretary & Treasurer's report..... 290
 Fuel campaign, Chicago & Alton..... 547
 Fuel convention, notes on..... 275‡
 Fuel economy by perfect combustion..... 35‡
 Fuel economy, comparative test on B. P. & R..... 529*
 Fuel economy, relation of locomotive appliances to..... 467
 Fuel, inspection of, report on..... 306
 Furnace, oil for heating babbitt, Can. Pac..... 198*
 Fusible plugs, composition of..... 85‡

G

Gage for wheel fit..... 362*
 Gaines, F. F., effect of firebox volume on combustion..... 94*
 Gaines combustion chamber..... 94*
 Gaines combustion chamber, relation to fuel economy, committee report..... 467
 Gaines firebox, 4-6-2 type locomotive..... 372*
 Gaines firebox, Virginian Mallet..... 289*
 Gale, W. M. T., benefits of the General Foremen's Association..... 151
 Gamble, H. E., report on drop forgings..... 445
 Gardner, Henry, shop scheduling and routing system..... 539
 Garland refrigerator car door fixtures..... 139*
 Garratt type locomotives for the Tasmanian Railway..... 623*
 Gas, consumption of, in shop furnaces..... 33
 Gas for shop furnaces at Scranton..... 27*
 Gas, vs. oil for shop furnaces, cost of each..... 35
 General Electric Co., adoption of pension plan..... 546‡
 General Electric Co., battery truck crane..... 1530‡
 General Electric Co., fan, electric, for cars..... 650*
 General Electric Co., motor car..... 379*
 General Electric Co., motor car, S. L. & S. F..... 1324*
 General Foremen's Association..... 332, 388‡
 General Foremen's Association, benefits from, by W. M. T. Gale..... 151
 Graphite lubricator for locomotives..... 648*
 Greenwood, B. E., engine truck boxes..... 644*

General Foremen's Association Convention.

Address, J. F. DeVoy..... 398
 Address by C. E. Gossett..... 407
 Address of W. L. Park..... 396
 Advance information on engines to be shopped..... 401
 How foremen can best promote efficiency..... 398
 Officers..... 413
 President's address..... 396
 Reclaiming of scrap..... 409
 Relation of tests to shop efficiency..... 412
 Roundhouse efficiency..... 403
 Shop specialization..... 408
 Shop supervision..... 402
 Subjects and committees for 1913..... 413
 Georgia & Florida, line system of organization..... 97‡
 German church passes..... 206‡
 German express trains..... 454‡
 German vacations..... 200‡
 Glass engine numbers, Nor. Pac..... 321*
 Gold Car Heating & Lighting Co., pressure regulator..... 207*
 Goodwin duplex water glass..... 458*
 Goss, W. F. M., progress report on boiler test..... 321
 Goss, W. F. M., report on fuel as a factor in locomotive capacity..... 290
 Gossett, C. E., address at General Foremen's convention..... 407

Page numbers under 1,000 refer to *American Engineer*; those over 1,000 refer to the *Daily Railway Age Gazette*. * Illustrated article; § editorial; ‡ short non-illustrated article or note; † communication.

| | | | | | |
|--|------------|--|------|--------------------------------|--|
| Gould & Eberhardt, 24 in. shaper..... | 597* | Inspection of fuel, report on..... | 306 | Locomotive (continued). | |
| Grain doors, standardization of, report on..... | 314 | Inspection of locomotives, committee report..... | 476 | | |
| Grand Trunk Pacific, forging flat wrenches..... | 489* | Inspection of Mallet locomotives, New York Central..... | 336* | | |
| Grand Trunk Pacific, pneumatic hammer for blacksmiths' shop..... | 454* | Inspection, overhead, of box cars, report and discussion on..... | 1378 | | |
| Grand Trunk Railway, apprentices win prizes..... | 601† | Instructions and information, distribution of..... | 46 | | |
| Grand Trunk Railway, paint shop kinks..... | 585* | Insulation for refrigerator cars, P. R. R..... | 508* | | |
| Grand Trunk Railway, shop kinks at Battle Creek..... | 343* | International Railway Fuel Association (see Fuel Association). | | | |
| Grate shaker rods, dies for making..... | 451* | International Railway General Foremen's Association (see General Foremen's Association). | | | |
| Grates with Barnum stoker..... | 234* | International Railway Master Blacksmiths' Association (see Blacksmiths' Association). | | | |
| Great Britain, electric traction in..... | 590† | International Safety Congress, meeting at Milan..... | 324† | | |
| Great Northern, locomotive, 2-8-8-0 type..... | 587* | Interstate Commerce Commission to make physical valuation..... | 209† | | |
| Grinder for milling cutters, reamers and drills..... | 601* | Interstate Commerce Commission, Prouty elected chairman..... | 97† | | |
| Grinders (see Machine Tools). | | Intoxicants forbidden, D. L. & W. and I. C. Iron ore, shipments of..... | 490 | | |
| Grinding car and locomotive axles..... | 107‡ | Italian railways, electrification of..... | 628† | | |
| Guard for emery wheel, by E. L. Dudley..... | 431* | Italy, locomotive development in..... | 18† | | |
| Guides, steel..... | 568† | | | | |
| Gyrus spark arrester for locomotives..... | 143* | | | | |
| H | | | | | |
| Hack saw (see machine tools). | | | | | |
| Hack saw blade..... | 651* | | | | |
| Hale, J. W. L., report on boiler shop apprentices..... | 281 | | | | |
| Hall, Wm., reclaiming of scrap..... | 409 | | | | |
| Hall, Wm., enginehouse efficiency..... | 403 | | | | |
| Handling and accounting for material at contract shops, report on..... | 314 | | | | |
| Hammer, Beaudry Peerless..... | 541* | | | | |
| Hammer, pneumatic, for blacksmiths' shop, by Sam Lewis..... | 454* | | | | |
| Harriman Lines, safety committees..... | 324† | | | | |
| Hays, W. C., address at Traveling Engineers' convention..... | 464 | | | | |
| Headlight law in Indiana..... | 98† | | | | |
| Headlights, minimum requirements for, report and discussion on..... | 1518 | | | | |
| Heat, steam, pressure regulator..... | 207* | | | | |
| Heating in a drawing room..... | 630 | | | | |
| Heating surface, value of firebox..... | 321 | | | | |
| Hedeman, W. K., care of boiler tubes..... | 414* | | | | |
| Hedeman, W. K., maintenance of locomotive boilers..... | 519* | | | | |
| Heffelfinger, A. E., center girders for cars..... | 111* | | | | |
| Henderson, G. R., triple compound locomotive..... | 528* | | | | |
| Henrikson, B., tempering in an electric furnace..... | 426 | | | | |
| Hinkley, F. H., cylinder head carrier..... | 279* | | | | |
| History of American Engineer & Railroad Journal..... | 3 | | | | |
| Hitt, J. E., report on inspection of fuel..... | 306 | | | | |
| Hocking Valley, Walbridge shops burn..... | 97† | | | | |
| Hodgins, Geo. S., engaged by National Transcontinental Ry..... | 265† | | | | |
| Hodgins, Geo. S., feed water heater, L. & S. W..... | 199* | | | | |
| Hodgins, Geo. S., foreign rolling stock designs..... | 35* | | | | |
| Hodgins, Geo. S., novel design of sling stay on L. & S. W..... | 462* | | | | |
| Hoeffle, F. F., president's address..... | 444 | | | | |
| Holdbrook, A. W., car shop kinks..... | 573* | | | | |
| Holder-on, pneumatic..... | 224* | | | | |
| Holtzer-Cabot Electric Co., speed indicator..... | 600* | | | | |
| Hooks, dies for making..... | 450* | | | | |
| Hornell shops, electric welding at..... | 57* | | | | |
| Hose, air brake, new armored..... | 1481 | | | | |
| Hose, coupler, steam..... | 1482* | | | | |
| Hose failures, report of..... | 315 | | | | |
| Hutchinson, T. J., freight car painting..... | 21 | | | | |
| Hutchinson, T. J., paint shop kinks..... | 585* | | | | |
| Hydraulic press, formers for..... | 226* | | | | |
| Hydraulic press work, by Lewis D. Freeman..... | 201* | | | | |
| Hydraulic press, 100 ton, B. & O..... | 123* | | | | |
| Hygiene, award to C. & N. W..... | 546† | | | | |
| I | | | | | |
| Ideas are worth money..... | 52‡ | | | | |
| Igniter for small motor cars..... | 1325 | | | | |
| Illinois Central, accidents on..... | 314† | | | | |
| Illinois Central, collision at Kinmundy, Ill..... | 98† | | | | |
| Illinois Central, earning capacity of cars..... | 555‡ | | | | |
| Illinois Central, Edison motor cars..... | 98† | | | | |
| Illinois Central, educational bureau to give legal aid..... | 210† | | | | |
| Illinois Central, enclosed observation platform..... | 198* | | | | |
| Illinois Central, experimental farms..... | 209† | | | | |
| Illinois Central, gives away lumber..... | 97† | | | | |
| Illinois Central, mechanical department organization..... | 110‡, 119* | | | | |
| Illinois Central, new apprenticeship plans..... | 622 | | | | |
| Illinois Central, pay for useful ideas..... | 266† | | | | |
| Illinois Central, safety committee formed..... | 490 | | | | |
| Illinois Central, vacuum relief valve..... | 508* | | | | |
| Independent Pneumatic Tool Co., electric drill..... | 1509 | | | | |
| Independent Pneumatic Tool Co., new type of drill..... | 105 | | | | |
| Independent Pneumatic Tool Co., roller bearing air drill..... | 1449* | | | | |
| India railways..... | 574† | | | | |
| Indiana headlight law upheld..... | 209† | | | | |
| Information, advance, on engines to be shipped, by C. L. Dickert..... | 401 | | | | |
| Injector, exhaust steam..... | 518† | | | | |
| Injector with automatic overflow..... | 1508* | | | | |
| Inspection, locomotive..... | 339* | | | | |
| Inspection of boilers, report and discussion on..... | 1487 | | | | |
| Inspection of fuel, report on..... | 306 | | | | |
| Inspection of locomotives, committee report..... | 476 | | | | |
| Inspection of Mallet locomotives, New York Central..... | 336* | | | | |
| Inspection, overhead, of box cars, report and discussion on..... | 1378 | | | | |
| Instructions and information, distribution of..... | 46 | | | | |
| Insulation for refrigerator cars, P. R. R..... | 508* | | | | |
| International Railway Fuel Association (see Fuel Association). | | | | | |
| International Railway General Foremen's Association (see General Foremen's Association). | | | | | |
| International Railway Master Blacksmiths' Association (see Blacksmiths' Association). | | | | | |
| International Safety Congress, meeting at Milan..... | 324† | | | | |
| Interstate Commerce Commission to make physical valuation..... | 209† | | | | |
| Interstate Commerce Commission, Prouty elected chairman..... | 97† | | | | |
| Intoxicants forbidden, D. L. & W. and I. C. Iron ore, shipments of..... | 490 | | | | |
| Italian railways, electrification of..... | 628† | | | | |
| Italy, locomotive development in..... | 18† | | | | |
| J | | | | | |
| Jacobs-Shupert firebox, 4-6-2 type boiler..... | 67* | | | | |
| Jacobs-Shupert firebox, low water tests..... | 366* | | | | |
| Jacobs-Shupert firebox, progress report on test..... | 321 | | | | |
| Jacobs-Shupert U. S. Firebox Co., boiler tests..... | 97† | | | | |
| Jerguson Manufacturing Co., water gage..... | 649* | | | | |
| Jennings, J. F., advantages and disadvantages of lead..... | 477 | | | | |
| Jesson, J. A., air brake kinks..... | 191* | | | | |
| Jesson, J. A., air pump governor repairs..... | 639* | | | | |
| Jesson, J. A., pneumatic clamp for testing triple valves..... | 522* | | | | |
| Jesson, J. A., repairing bell ringers..... | 146* | | | | |
| Journal bearings, pressure on..... | 1280† | | | | |
| Journal boxes, engine truck, with chilled faces..... | 644* | | | | |
| Judgments for violation of safety appliance law..... | 209† | | | | |
| K | | | | | |
| Kane, J. P., report on flue welding..... | 444 | | | | |
| Kavanaugh, D., report on standardization of grain doors..... | 314 | | | | |
| Kelly, J. D., the safety habit..... | 631* | | | | |
| Kelly, J. W., report on cracking of flue sheets..... | 286 | | | | |
| Keyways for eccentrics, laying out..... | 261* | | | | |
| Klinger water gage..... | 649* | | | | |
| Kopenhoefer, F., report on carbon and high speed steels..... | 444 | | | | |
| Kropidowski, V. T., machine shop kinks..... | 70* | | | | |
| L | | | | | |
| Labor bureau established on the B. & O..... | 546† | | | | |
| Laborers out of work in New York..... | 209† | | | | |
| Ladder, steel for box cars..... | 1509* | | | | |
| Ladder, steel freight car, tested by Pennsylvania..... | 435† | | | | |
| Lake Shore & Michigan Southern, fast run..... | 97† | | | | |
| Lake Shore & Michigan Southern, smoke on switch engines..... | 583* | | | | |
| Lake Shore & Michigan Southern (see also New York Central Lines). | | | | | |
| Lathe, brake for..... | 147* | | | | |
| Lathe, mandrel for turning driving tires..... | 413* | | | | |
| Lathe, relieving attachments for..... | 488* | | | | |
| Lathes, power required to drive..... | 596† | | | | |
| Lathes (see Machine Tools). | | | | | |
| Lauterbach, Andrew, drop testing machine, 60 ft..... | 91* | | | | |
| Lawrie, J. W., painting steel passenger cars..... | 594 | | | | |
| Lead, advantages and disadvantages of..... | 477 | | | | |
| LeCompte, J. V., finishing driving boxes..... | 127* | | | | |
| Leech, C. C., advantages of mechanical associations..... | 13 | | | | |
| Leech, C. C., car shop kinks..... | 361* | | | | |
| Leech, C. C., engine house kinks..... | 248* | | | | |
| Leech, C. C., shop improvements at Buffalo..... | 83* | | | | |
| Leech, C. C., shop kinks..... | 645* | | | | |
| Legislation on mechanical matters, by C. A. Seley..... | 79 | | | | |
| Legislature, Massachusetts, reject merger bill..... | 324† | | | | |
| Lewis, S. H., removing wheels from Mallets..... | 642* | | | | |
| Lewis, Thomas, report on spark arresters..... | 282 | | | | |
| Lewis, Sam, forging flat wrenches..... | 489* | | | | |
| Lewis, Sam, pneumatic hammer for blacksmiths' shop..... | 454* | | | | |
| Life insurance, employees..... | 600† | | | | |
| Lighting, Edison storage battery for..... | 1284* | | | | |
| Lighting, indirect, for railway cars..... | 37 | | | | |
| Lighting requirements for various services..... | 38 | | | | |
| Lignite, burning, in locomotives..... | 108‡ | | | | |
| Lignite, spark arrester for burning..... | 143* | | | | |
| Line inspection, report on..... | 313 | | | | |
| Linen in dining cars..... | 337† | | | | |
| Link grinding machine, C. & N. W..... | 481* | | | | |
| Liquor, Pennsylvania forbids sale of, on trains..... | 435 | | | | |
| Lloyd, T. S., report on anthracite coal for locomotive fuel..... | 295 | | | | |
| Locomotive. | | | | | |
| Appliances, relation to fuel economy..... | 467 | | | | |
| Articulated connection, Can. Pac..... | 350* | | | | |
| Ash pan for narrow firebox..... | 356* | | | | |
| Back pressure..... | 568† | | | | |
| Back pressure horse-power, report on..... | 300* | | | | |
| Boiler, 2-8-2 type, C. & O..... | 128* | | | | |
| Boiler, 2-8-2 type, D. L. & W..... | 461* | | | | |
| Boiler, 2-8-2 type, Erie..... | 89 | | | | |
| Boiler, 2-8-2 type, Rock Island..... | 565* | | | | |
| Boiler, 2-10-2 type, C. B. & O..... | 233* | | | | |
| Boiler, 4-6-2 type, D. L. & W..... | 395* | | | | |
| Boiler, 4-6-2 type, Santa Fe..... | 67* | | | | |
| Boiler, 4-6-2 type, No. 50,000..... | 7* | | | | |
| Boiler, fusible plug, Southern Pacific..... | 637* | | | | |
| Boiler, Mallet, Can. Pac..... | 352* | | | | |
| Boiler test..... | 501‡ | | | | |
| Boiler tests, low water..... | 1502* | | | | |
| Boiler tubes, repairing..... | 332‡ | | | | |
| Boiler tubes, repairing, by L. R. Pomerooy..... | 357* | | | | |
| Boilers..... | 1485‡ | | | | |
| Boilers, design, construction and inspection, report on..... | 1487* | | | | |
| Boilers, maintenance of, by Walter K. Hedeman..... | 519* | | | | |
| Buffer, radial..... | 489* | | | | |
| Built for the Chesapeake & Ohio..... | 107‡ | | | | |
| Built for the Santa Fe..... | 500‡ | | | | |
| Bumper beam, pressed steel..... | 12 | | | | |
| Burning lignite in..... | 108‡ | | | | |
| Costs on a ton-mile basis..... | 219‡ | | | | |
| Counterbalance weights inside of frame..... | 236* | | | | |
| Check valve, repairing..... | 624* | | | | |
| Cylinder, double ported valve..... | 142* | | | | |
| Cylinder heads, removing large..... | 146† | | | | |
| Cylinders, 0-6-6-0 type, Can. Pac..... | 348 | | | | |
| Cylinders, 2-8-2 type, Erie..... | 89* | | | | |
| Cylinders, 4-6-2 type, No. 50,000..... | 89* | | | | |
| Development in Asia..... | 104† | | | | |
| Drafting, relation to fuel consumption, report on..... | 300* | | | | |
| Driving box construction improved, C. & N. W..... | 599* | | | | |
| Driving boxes, 11 in. x 21 in..... | 393* | | | | |
| Driving boxes, accuracy in finishing, J. V. LeCompte..... | 127* | | | | |
| Driving boxes, repairing..... | 274‡ | | | | |
| Driving boxes, repairing, by J. V. LeCompte..... | 334† | | | | |
| Driving boxes, repairing, by E. T. Spidy..... | 276* | | | | |
| Driving boxes, repairing, by H. Wanamaker..... | 429* | | | | |
| Driving boxes, repairing, by M. H. Westbrook..... | 369* | | | | |
| Driving wheel, electric welding on..... | 61* | | | | |
| Economy on the C. & O..... | 107‡ | | | | |
| Electric..... | 556‡ | | | | |
| Electric, articulated, N. Y., N. H. & H..... | 363* | | | | |
| Electric, d. c. freight..... | 1528* | | | | |
| Electric, problem of designing, by N. W. Storer..... | 569* | | | | |
| Electric, twin motor arrangement, N. Y., N. H. & H..... | 365* | | | | |
| Electric, Southern Pacific..... | 581* | | | | |
| Exhaust, loss of power in..... | 1512‡ | | | | |
| Exhaust nozzle, variable, Can. Pac..... | 349* | | | | |
| Exported from Germany in 1911..... | 127† | | | | |
| Failures, eliminating, by Chas. Maier..... | 149 | | | | |
| Failures, eliminating, by Ernest Cordeal..... | 23* | | | | |
| Feed water heater, Caillé..... | 538* | | | | |
| Feed water heater, London & South Western, by Geo. S. Hodgins..... | 199* | | | | |
| Firebox, combustion chamber, Great Northern..... | 588* | | | | |
| Firebox, electric welding of..... | 57* | | | | |
| Firebox, Gaines..... | 289† | | | | |
| Firebox, progress report of test..... | 372* | | | | |
| Firebox volume, effect of..... | 52‡, 94* | | | | |
| Firing, relation to fuel economy, report on..... | 300* | | | | |
| Frames and braces, Santa Fe..... | 68* | | | | |
| Frames, cast steel..... | 1457‡ | | | | |
| Frames, 2-8-2 type, Erie..... | 89 | | | | |
| Frames, 2-10-2 type, C. B. & O..... | 235* | | | | |
| Frames, Mallet, Can. Pac..... | 351* | | | | |
| Frames, repairing, report at Blacksmiths' convention..... | 449 | | | | |
| Front end arrangement, 4-6-2 type, Santa Fe..... | 69* | | | | |
| Front end arrangement for lignite, C. & N. W..... | 144* | | | | |
| Fuel performance sheet, report on..... | 292* | | | | |
| Garratt type, Tasmanian Railway..... | 623* | | | | |
| Grates, 2-10-2 type, C. B. & O..... | 234* | | | | |
| Guides and yoke for balanced compound..... | 67* | | | | |
| Headlight, electric..... | 1452* | | | | |
| Hoist, electric..... | 205* | | | | |
| Induced draft..... | 305 | | | | |
| Inspection committee report..... | 476 | | | | |
| Inspection of Mallet, New York Central..... | 336* | | | | |
| Jackets, removing paint from, report on..... | 534 | | | | |
| Javanic type..... | 555‡ | | | | |
| Largest, Virginian Ry..... | 1321* | | | | |
| Largest non-articulated..... | 231* | | | | |
| Low water alarm..... | 52‡, 77* | | | | |
| Lubricator, eight feed, Detroit..... | 1452* | | | | |
| Lubricator for graphite..... | 648* | | | | |
| Mallet, centering device, Can. Pac..... | 351* | | | | |
| Mallet for switching..... | 387‡, 420* | | | | |
| Mallet, maintaining..... | 331‡ | | | | |
| Mallet, maintaining on New York Central..... | 335* | | | | |
| Mallet, removing wheels from, Virginian..... | 642* | | | | |
| Mallet, simple, Can. Pac..... | 347* | | | | |

Locomotive (continued).

Mallet, simple, P. R. R. 150*
 Mallet, simple, on P. R. R., record run 265†
 Mikados, comparative dimensions of 619
 Narrow gage, largest 623*
 No. 50,000, service results of 164‡
 Nozzle, rectangular, Lake Shore 583*
 Nozzle, variable 578
 Number built in 1911 45†
 Number in the United States 495†
 Numbers, glass 321*
 Operation, time feature of engine failures 56
 Operation (see Locomotive Tests).
 Painting, by N. J. Watts 136
 Parts, weight of 5*
 Performance, a record on the C. & O. 1472*
 Pilot, all-steel, by A. J. Island 380*
 Pilot, pressed steel 12*
 Piston, new design of 42*
 Piston rod, extension guide 9*
 Piston speed 555‡
 Piston speeds, diagram for, by L. R. Pomeroy 562*
 Piston valve, double ported, N. C. & St. L. 141*
 Piston valves, maintenance of, Eastern Railway of France 633*
 Proposed, with 150 sq. ft. grate area 290
 Relief valve, vacuum, Ill. Central 508-9
 Reverse gear power, Can. Pac. 347*
 Reverse gear, screw 9
 Reverse gear (see also Reverse Gear).
 Rod brasses, by J. E. Osmer 26*
 Rod, solid end main, C. & N. W. 478*
 Rods 1457‡
 Rods, main and side, report and discussion on 1467*
 Rods, side, spherical bearing 235*
 Safety valves, adjusting, C. of G. 624*
 Safety valves, report and discussion on 1468*
 Safety valve, new modified 208*
 Service of Mikados, Rock Island 563*
 Service tests of 499‡
 Shoes and wedges, flangeless, C. & N. W. 599*
 Smoke abatement 109‡
 Smoke, density of, in Chicago 596
 Smoke, reducing 583*
 Spark arrester, Caledonian Railway 35*
 Spark arrester for lignite 143*
 Starting valve for compound, Baldwin 421*
 Steam pipes outside 8*
 Steam piping, simple Mallet, Can. Pac. 349*
 Stoker, Barnum 233*
 Stoker, improvements in Street 81*
 Stokers 1456‡
 Stokers, coal for 52‡
 Stokers, mechanical, report and discussion on 1463
 Superheater, maintenance of, report and discussion on 1518
 Superheater, Schmidt, No. 50,000 7*
 Superheater, test on Chicago & North Western 2
 Superheater (see also Superheater) 244*
 Tee head, device for applying, B. & O. 618*
 Tender journals, curved, Caledonian Ry. 36*
 Tender, coal pusher for 154*
 Tenders, improvements in 108‡
 Terminal facilities, importance of 1455‡
 Terminals, organization, by Ernest Cordal 221
 Terminals, record of engine failures 23*
 Terminals, Winslow boiler washing system 18*
 Test, A. S. M. E. code for 612‡
 Test, C. C. & O. 1476
 Test in service, B. R. & P. 529*
 Test, low water, results 366*
 Test of 2-8-2 type, C. & O. 129*
 Test of freight, D. L. & W. 543*
 Test of temperature on superheater 637*
 Test of three-cylinder in England 314
 Tractive effort chart, by L. R. Pomeroy 641*
 Triplic compound proposed 11*
 Truck journal boxes with chilled faces 528*
 Valve gear, Baker 644*
 Valve gear, Baker, by R. S. Mounce 556‡
 Valve gear for compounds 575*
 Valve gear, variable lead attachment on Walschaert 379*
 Valve stem guide, No. 50,000 9*
 Water gage, Wiltbonco, W. 649*
 Water glass, Goodwin duplex 458*
 Work report, New York Central 336*
 Work reports, Santa Fe 339*
 2-8-0 type, Santa Fe 517*
 2-8-2 type, B. R. & P. 251*
 2-8-2 type, C. & O. 128*
 2-8-2 type, C. B. & O. 619*
 2-8-2 type, D. L. & W. 459*
 2-8-2 type, Erie 87*
 2-8-2 type, Rock Island 563*
 2-10-2 type, C. B. & O. 218‡, 231*
 2-10-2 type, Santa Fe 515*
 4-6-2 type, balanced compound, Santa Fe 65*
 4-6-2 type, No. 50,000 517*
 4-6-2 type, B. R. & P. 251*
 4-6-2 type, Central of Georgia 372*
 4-6-2 type, D. L. & W. 391*
 4-6-2 type, L. & N. 1446*
 4-6-2 type, N. C. & St. L. 141*

Locomotive (continued).

4-6-2 type, St. L. & S. F. 189*
 4-6-2 type, tabular comparison with No. 50,000 7*
 0-6-6-0 type, Can. Pac. 347*
 2-8-8-0 type, G. N. 587*
 2-8-8-2 type, Iron Mountain 420*
 2-8-8-2 type, P. R. R., experimental 150*
 2-8-8-2 type, Virginian 287*
 Locomotive Improvement Co., solid end main rod 478*
 Locomotive Superheater Co., description of superheater 244*
 Lodge & Shipley Mach. Tool Co., lathe 322*
 Loew Mfg. Co., pipe threading machine 206*
 London & South Western, feed water heater 199*
 London & South Western, sling stay 462*
 Long Island R. R., cars, all steel parlor 137*
 Long Island R. R., electric battery car train on 546†
 Long materials, rules for loading, report and discussion on 1374*
 Loss to workmen by blacksmiths' strike on I. C. 155†
 London, A. C., engine house supervision 572
 Louisville & Nashville, air pump governor repairs 639*
 Louisville & Nashville, reborer engineer's valve 191*
 Louisville & Nashville, bell ringers, repairing 146*
 Louisville & Nashville locomotive, 4-6-2 type 1446*
 Louisville & Nashville, pneumatic clamp for testing triple valves 522*
 Low water alarm for locomotive boilers 52‡
 Low water alarm, Southern Pacific 77*
 Lowe, T. W., report on superheated steam and boiler maintenance 285
 Lubricant for drills 149
 Lubrication of locomotive cylinders and valves 1432‡
 Lubricator, eight feed, for locomotives 1452*
 Lubricator, flange, by James Stevenson 96*
 Lubricator for graphite 648*
 Lubricator for tender wheels 459*
 Lubrication and superheated steam, foreign practice 187
 Lucas Machine Co., horizontal boring machine 204*
 Lumber, treating, for car construction 164‡
 Lyndon, G. W., chilled iron car wheels 1275‡
 Lyndon, G. W., chilled iron car wheels under 50 ton cars 1416†
 Lyons, Thos. F., Westinghouse PC equipment 318

M

Machine for centering bolts, Eastern Ry. of N. M. 188*
 Machine tool equipment for enginehouses, selecting 457
 Machine tools, Beech Grove car shops 167
 Machine shop kinks (see Shop Kinks).
 MacFarland, H. B., report on locomotive drafting 300*
 MacFarland, H. B., Santa Fe dynamometer car 181*
 Machine tool exhibits at Atlantic City 1367‡
 Machine tools, selecting 1511‡

Machine Tools.

Arrangement for manufacturing brake beam bangers 625*
 Arrangement of, for driving box repairs 277*
 Axle grinding machine, Norton 152*
 Bolt header, automatic feed for 376*
 Boring machine, floor type, Rochester 648*
 Boring machine, horizontal, Lucas Machine Co. 204*
 Boring mill, Rochester, horizontal 376*
 Car shops at Beech Grove, Ind., list of tools 167
 Chucking machine, vertical, Bickford 598*
 Controller, automatic, for electric motors 259*
 Drill, double, with independent heads, Foote-Burt 373*
 Drilling machine, all geared, Barnes 208*
 Forging machines, dies and formers, committee report 446*
 Forging press, steam hydraulic 1451*
 Grinder for milling cutters, reamers and drills 601*
 Grinder for pattern makers 487*
 Hack saw, high speed 649*
 Hot saw and expander for tubes 360*
 Hydraulic press 72*
 Lathe, 18 in. Mueller 593*
 Lathe, heavy duty, Lodge & Shipley 322*
 Lathe, journal turning, Niles-Bement-Pond Co. 258*
 Lathe, relieving attachment for 488*
 List of, for boiler tube department 358*
 Metal saw and rotary planer 650*
 Motor application to old tools 322*
 Pipe threading and nipple machine 206*
 Planer, frog and switch, Cincinnati 597*
 Planer, rotary 433*
 Press for shearing and riveting coupler yokes 486*
 Radial drill as a boring machine 322*

Machine Tools (continued).

Rolls for reclaiming scrap iron, Ajax 544*
 Safe end machine, Mettrath 360*
 Shaper knee support 260*
 Shaper motion, discussion of quick return crank 43*
 Shaper, 24 in. Gould & Eberhardt 597*
 Tube welder, Hartz 360*
 Wheel press, 600 ton, car 143*
 Wood working, analysis of, by L. R. Pomeroy 509
 Maier, Chas., eliminating engine failures 149
 Mail, amount franked 628†
 Mail tubes, pneumatic, in New York 652†
 Main rod, solid end, C. & N. W. 478*
 Maintenance of freight cars 1298‡
 Maintenance of locomotive boilers, by Walter R. Hedeman 519*
 Malay States railway, equipment 639†
 Mallet locomotives for yard service 387‡
 Mallet locomotives, maintaining, New York Central 331‡, 335*
 Mallet locomotive (see Locomotive).
 Mallets, terminal care of 1431‡
 Mann, Francis P., aspirator for coach cleaning 434*
 Manufacturing in the United States 530†
 Markel, Chas., countersinking reamers 417
 Markel, Chas., keyways, laying out for eccentricities 261*
 Markel, Chas., locomotive shop kinks 118*
 Markel, Chas., reamer for ball joints 116*
 Markel, Chas., repairing boiler check valve 624*
 Markel, Chas., tire mandrel 413*
 Massachusetts, new railway bill signed 324†
 Master Blacksmiths' Association (see Blacksmiths' Association).
 Master Boiler Makers' Association (see Boiler Makers' Association).
Master Car Builders' Association.
 Committees for 1913 548
 Defect cards, restoration of 155†
 Dues 1302
 Early meetings of 1266‡
 Exhibitors, list of 1289
 Officers and committees, 1912 1267
 Past presidents, list of 1529
 President's address 1300
 Program at 1912 convention 1267
 Registration 1276, 1319, 1389, 1415
 Rate on repair material changed 325†
 Reports and discussion on:
 Brake shoes, test of 1309*
 Car shop apprentices, by I. S. Downing 1401*
 Car wheels 1312*
 Capacity marking of cars 1413
 Constitution, revision of 1302
 Coupler and draft equipment 1383*
 Damage to freight cars by unloading machines 1376*
 Overhead inspection of box cars 1378*
 Prices for labor and material 1373
 Rules for loading materials 1374*
 Rules of interchange, revision of 1371*
 Specifications for freight car truck sides and bolsters 1412
 Springs for freight car trucks 1385*
 Standards and recommended practice, revision of 1304
 Tank cars 1407
 Train brake and signal equipment 1308*
 Train lighting 1386
 Train pipe and connections for steam 1404*
 Rules on St. Louis terminal lines 265†
 Secretary's report 1302
 Stuart, A., address of 1500
 Treasurer's report 1302

Master Mechanics' Association.

Committees for 1913 548
 Election of officers 1526
 Honorary members elected 1471, 1527
 Officers and committees, 1912 1598
 Past presidents, list of 1529
 President's address 1460
 Program of 1912 convention 1432
 Registration 1444, 1474, 1504
 Reports and discussion on:
 Advisory, technical 1463
 Boilers, design, construction and inspection of 1487*
 Contour of tires 1497*
 Consolidation 1487
 Flange lubrication 1513*
 Headlights, minimum requirements for 1518
 Increased power obtained by superheater 1499
 Main and side rods 1467*
 Maintenance of superheater locomotives 1518
 Mechanical stokers 1463
 Safety valves 1468*
 Standardization of tinware 1518
 Steel tires 1501
 Secretary's report 1463
 Treasurer's report 1463
 Master Painters' Association (see Painters' Association).
 Material, conservation of, prize article 117
 McBain, D. R., reducing locomotive smoke 583*
 McConway & Torley, coupler 1325*

Page numbers under 1,000 refer to *American Engineer*; those over 1,000 refer to the *Daily Railway Age Gazette*. * Illustrated article; ‡ editorial; † short non-illustrated article or note; ‡ communication.

| | | | | | | |
|---|-------------------------|---|-------|---|----------------------|------|
| McCord Manufacturing Co., air hose protector | 1529* | Mounting air brake hose | 217§ | Paint shop kinks, by T. J. Hutchinson, G. T. | 585* | |
| McCord Manufacturing Co., deck sash ratchet | 1509* | Moving pictures to teach locomotive firing | 295 | Paint shop kinks, by A. G. Pancost | 25* | |
| McCord Manufacturing Co., weather strip | 1453* | Moving pictures, training employees with | 1484§ | Paint shop practice, locomotive painting | 136 | |
| McCord & Co., machine for testing journal friction | 1430* | Mudge, Burton W., & Co., refrigerator car door fixtures | 139* | Paint shop, storeroom for paint brushes | 307* | |
| McCord & Co., pressure on journal bearing wedges | 1280† | Mueller Machine Tool Co., lathe, 18 in. | 593* | Paint storeroom practice, N. & W. | 192* | |
| McEwen Brothers, shaft coupling | 051* | Murphy Equipment Co., rolled steel truck side frames | 375* | Paints, test of, report on | 531 | |
| McGill, Samuel, shop kinks | 043* | N | | | Paint testing bureau | 499§ |
| McGinnis, C. P., the job behind the cleaning date | 315 | Nashville, Chattanooga & St. Louis, improved shop practice | 73* | Painter foremen, qualification of, report on | 536 | |
| McGraw-Hill Book Co., sales agent for <i>Railway Age Gazette</i> books | 155† | Nashville, Chattanooga & St. Louis, locomotive, 4-6-2 type | 141* | Painters' Association | 500§ | |
| McIntosh, J. F., member Victorian order | 146† | Nashville, Chattanooga & St. Louis, locomotive painting | 136 | Panama Canal toll | 621† | |
| McKeen Motor Car Co., ships cars to Australia | 49† | Nathan Manufacturing Co., injector | 1508* | Painters' Association, Convention. | | |
| McSweeney, J. T., report on shop efficiency | 454 | Nathan Manufacturing Co., Klinger water gage | 1450 | Car, exterior passenger, painting | 535 | |
| Mechanical department crafts, organization proposed | 209† | National Graphite Lubricator Co., lubricator | 648* | Care of steel passenger car roofs | 535 | |
| Meeting of steel postal car committee | 155† | National Machinery Co., automatic feed for bolt header | 376* | Concrete car floors | 533 | |
| Meetings. | | | | | | |
| Air Brake Association, annual convention | 266 | National Malleable Castings Co., brake fittings | 1426* | Election of officers | 538 | |
| Air Brake Association program and date for convention | 99 | New England Railroad Club (see Meetings) | | Freight car roofs | 537 | |
| American Society for Testing Materials, papers at New York convention | 156 | New Jersey railroad valuation | 594† | Interior car renovators | 532 | |
| American Society of Mechanical Engineers | 492, 603 | New Shops (see Shops, New) | | Interior passenger car painting | 535 | |
| American Supply & Machinery Manufacturers' Association | 99 | New York Central Lines, 46 ft. gondola car | 1286* | Maintenance of steel cars | 531 | |
| Associations, regular meetings | 267 | New York Central Lines, maintaining Mallet locomotives | 335* | Maintenance of steel and wooden passenger cars | 536 | |
| Canadian Northern Railway Club | 325 | New York Central Lines, Oswego shops, kinks from | 223* | Qualifications for a foreman painter | 536 | |
| Canadian Railway Club | 99, 156, 492 | New York Central Lines, repairing driving boxes | 429* | Removing paint from locomotive jackets | 534 | |
| Chicago Car Foremen's Association | 603 | New York Central Lines, shop scheduling and routing system | 539 | Stains, removing from natural finish | 536 | |
| Chief Car Inspector & Car Foremen's Association | 548 | New York, Chicago & St. Louis, veterans meet | 546† | Test of paint | 531 | |
| Cleveland Engineering Society | 602 | New York, New Haven & Hartford, electric locomotives | 363* | Vestibule end finish | 532 | |
| Co-Operative Safety Congress | 547 | New York Railroad Club (see Meetings) | | Painting freight cars, by T. J. Hutchinson | 21 | |
| Fuel Association | 99, 157, 266 | New York, Susquehanna & Western, shop safeguards | 482* | Painting steel passenger cars, by J. W. Lawrie | 594 | |
| General Foremen's Association, convention | 398* | New York, Westchester & Boston Railway, all-steel cars | 238* | Pancost, A. G., shop kinks | 25* | |
| General Foremen's Association, list of reports | 210 | News section started in <i>American Engineer</i> | 1§ | Parcel post | 632 | |
| Illuminating Engineering Society, convention | 492 | Newton Machine Tool Works, rotary planer | 433* | Parker H. H. Caille, feed water heater | 538* | |
| International Association for Testing Material | 547 | Nicholson, William, report on case hardening | 446 | Park, W. L., address at General Foremen's convention | 396 | |
| International Congress of Engineers | 99 | Niles-Bement-Pond Co., lathe, journal turning | 258* | Parlor cars (see Cars) | | |
| International Railway Congress, 1915 meeting | 382 | Niles-Bement-Pond Co., wheel press, 600 ton | 143* | Passenger car lighting (see Car, lighting) | | |
| International Safety Congress, committee from America | 156 | Northern Pacific, glass engine numbers | 321* | Passenger traffic in United States | 518† | |
| Master Blacksmiths' Association, convention | 444 | Norton Grinding Co., axle grinding machine | 152* | Passenger trains, speed of limited on P. R. R. | 546† | |
| Master Boiler Makers' Association, convention | 267 | Norfolk & Western orders more Street stokers | 608 | Pattern makers' grinder | 487* | |
| Master Painters' Association | 157, 436 | Norfolk & Western, paint storeroom practice | 192* | Paterson & Allen Engineering Co., spiral staybolt | 308* | |
| National Association of Manufacturers, meeting of | 326 | Northern Railroad Club (see Meetings) | | Pearce, H. C., report on reclaiming scrap material | 309 | |
| National Council for Industrial Safety | 603 | Nozzle, rectangular, Lake Shore | 583* | Penalization clause, elimination of, Master Car Builders' Assn. | 546† | |
| National Machine Tool Builders' Association | 547, 603 | Nozzles, variable exhaust | 578 | Penn freight car coupler | 1325* | |
| New England Railway Club | 99, 156 | Numbers, new headlight and car, Can. Pac. | 432* | Pennsylvania Railroad. | | |
| New York Railroad Club | 100, 156, 492, 547, 547 | Nut facing machine, attachment for | 346* | Accident prevention | 262* | |
| Northern Railway Club | 266 | O | | | | |
| Railroad Club meetings | 603 | Oakland, Antioch & Eastern, locomotive, electric | 1528* | Boiler shop apprentices | 281 | |
| Railway Business Association dinner | 603 | Observation platform enclosed, I. C. | 198* | Box for dirty waste | 338* | |
| Railway Storekeepers' Association, convention | 266 | Officers of M. C. B. Assn., election of | 1415 | Cars, freight, steel frame | 502* | |
| Railway Supply Manufacturers' Association | 99, 1447 | Officers, M. C. B. Assn., candidates for | 1297§ | Car, dining, without vestibule | 378* | |
| Railroad Y. M. C. A. Conference, meeting | 603 | Officers, Master Mechanics' Assn., election | 1526 | Compiles statistics on injuries to employees | 602† | |
| Richmond Railroad Club | 211 | Ogden, T. H., reclaiming of scrap | 410 | Dynamometer car given away | 155† | |
| St. Louis Railway Club | 547 | Oil burner, portable, for heating cylinders, Can. Pac. | 197* | Extent of relief benefits | 210† | |
| Southern & Southwestern Railroad Club | 603 | Oil, locomotive fuel in Russia | 78† | Expenditures account trespassing | 490 | |
| Tool Foremen's Association, convention | 427 | Oil replaced by water gas for shop furnaces | 27* | Fires on property of | 209† | |
| Western Canada Railway Club | 99 | Oil torch, portable | 344* | Flange lubricator | 96* | |
| Western Railway Club | 100, 325, 547, 540* | Oil and waste, report on | 310 | Injuries to employees reduced | 98† | |
| Metal cutting machine, high speed | 265† | Ore car, self-clearing | 319* | Inspection trip for engineers | 45† | |
| Mexican railways, protest to | 489† | Ore car, 70 ton | 1398* | Lectures on first aid | 265† | |
| Mexican way of handling strikes | 542* | Organization, mechanical department, Illinois Central | 119* | Locomotives equipped with fire pumps | 546† | |
| Micrometer boring tools for car wheels | 209† | Organization and operation of enginehouses, by Ernest Cordeal | 221 | Locomotive, 2-8-2 type, experimental | 150* | |
| Michigan Railway Commission rate rulings | 652† | Osmer, J. E., rod brasses | 26* | Number of men on car repairs | 600† | |
| Midvale Steel Co., gift to University of Illinois | 422* | Osmer, J. E., piston design | 42* | Number of men on locomotive repairs | 598† | |
| Milling cutters and reamers, by A. R. Davis | 324† | Osmer, J. S., blow-off valve | 485* | Passenger train speed limit | 546† | |
| Miners agree on wage rates | 200* | Otto, Henry, standardization of carbon tool steel | 425 | Pays men for ideas | 98† | |
| Mirror for inspecting side bearing motion | 209† | Overhead inspection of box cars, report and discussion of | 1378 | Relief Dept., \$34,000,000 distributed | 601† | |
| Missouri, Kansas & Texas, safety committees | 601† | Oxy-acetylene cutting and welding, by J. A. Warfel | 256 | Safety "don't" book | 652* | |
| Missouri Pacific transfers hospital and funds to employees | 325† | Oxy-acetylene welding, report at Blacksmiths' convention | 453 | Sand dryer | 338* | |
| Missouri Pacific-Iron Mountain system, annual passes for faithful service | 490 | P | | | | |
| Missouri Pacific, hospital system for employees | 345* | Pacific fruit express refrigerator car | 491 | Shop improvements at Buffalo | 83* | |
| Molds for casting hub liners | 148* | Packing, metallic, chuck for facing | 346* | Shop kinks | 639* | |
| Molds for metallic packing rings | 119* | Packing, metallic, molds for | 148* | Shop kinks in locomotive shop | 132* | |
| Motive power department organization, Illinois Central | 322 | Packing ring, facing chuck | 645* | Steel passenger car equipment on | 621† | |
| Motor application to machine tools | 651* | Paddach, C. E., machining valve packing rings | 116* | System reports of relief department | 490 | |
| Motor application to punch and shear | 562† | Paint and varnish, by Walther Riddle | 179 | Tire truck | 338* | |
| Motor omnibuses for London | 575* | Paint brush storage, by H. M. Baxter | 307* | Trespassing greatly reduced | 97† | |
| Mounce, R. S., Baker locomotive valve gear | 140* | Paint brushes, rack for holding, G. T. | 585* | Wages and earnings | 381 | |
| Mounce, R. S., card index, a simple | 625* | Paint mixing, N. & W. Ry. | 192* | Pere Marquette reduces time in shops | 155† | |
| Mounce, R. S., manufacture of brake beam hangers | | Paint shop, C. C. C. & St. L., at Beech Grove, Ind. | 173* | Pere Marquette, motor application to punch and shear | 651* | |
| | | | | Permanent Mfrs. Exhibit, opened in Chicago | 209† | |

Personals (continued).

Personals (continued).

Personals (continued).

Arnold, H. P., Rock Island, El Dorado, Ark. 654
 Ashcroft, James, Grand Trunk Pacific. 549
 Asher, A. H., Denver & Rio Grande, Lelida, Colo. 213
 Ashman, C. W., Rock Island, Cedar Rapids, Ia. 47
 Ayers, A. R., New York Central Lines, Chicago, Ill. 212
 Bahcock, A. H., Southern Pacific Company, San Francisco, Cal. 492
 Baker, Geo. H., Chicago & Alton. 549
 Baldwin, C. D., Bangor & Aroostook, Milo Junction, Me. 655
 Bauers, C. A., M. S. P. & S. S. M., Stevens Point, Wis. 437
 Baum, P. E., Denver & Rio Grande, Salida, Colo. 269
 Baumbush, A. J., New York Central. 492
 Baumgardner, F. M., Illinois Central, Clinton, Ill. 157
 Barnes, Joshua B., obituary. 214
 Barthell, John D., Illinois Central, Mounds, Ill. 494
 Bathie, J., Canadian Pacific, Cranbrook, B. C. 494
 Becker, E., Escamaba, Mich. 604
 Heber, John, Santa Fe, Richmond, Cal. 494
 Beland, B. A., St. Louis & San Francisco, Birmingham, Ala. 326
 Belcher, G. A., Santa Fe, Deming, N. M. 606
 Bell, Raymond E., Gulf, Colorado & Santa Fe, Galveston, Tex. 604
 Bender, J. H., Denver, Laramie & Northwestern, Utah Junction, Colo. 604
 Benedict, R., Santa Fe, Bakersfield, Cal. 550
 Benizes, John, Rock Island, Chicago, Ill. 549
 Bertram, T. S., Canadian Pacific, Moose Jaw, Sask. 327
 Bertram, T., Canadian Pacific, Revelstoke, B. C. 606
 Bevelle, J. C., El Paso & Southwestern, El Paso, Tex. 437
 Beyer, O. S., Jr., Rock Island, Chicago, Ill. 157
 Bieser, Joe, St. Louis Southwestern, Tyler, Tex. 494
 Birch, A. V., Minneapolis, St. Paul & Sault Ste. Marie. 654
 Black, A. W., Grand Trunk, Coteau Junction, Que. 605
 Black, R. L., Norfolk & Western, Columbus, O. 269
 Blackburn, John, New York Central, Depew, N. Y. 47
 Blake, W. C., Mobile & Ohio, Jackson, Tenn. 103
 Boss, C. E., Fort Worth & Rio Grande, Big Springs, Tex. 100
 Bowden, J. F., Baltimore & Ohio, Garratt, Ind. 48
 Rowers, Chas., M. St. P. & S. S. M., Fond du Lac, Wis. 159
 Boyden, Joseph A., Erie, Cleveland. 101
 Braley, L. L., Rock Island, Cedar Rapids, Ia. 494
 Branton, John W., Illinois Central, Centralia, Ill. 493
 Brendel, J. P., Southern Pacific, Sacramento, Cal. 550
 Brennan, E. J., Buffalo, Rochester & Pittsburgh, Du Bois, Pa. 549
 Brennan, John C., New York Central. 436
 Brewer, J. W., Baltimore & Ohio. 550
 Bronner, E. D., Michigan Central, Detroit, Mich. 326
 Brown, A., Canadian Pacific, Port William, Ont. 605
 Brown, Chas., Canadian Pacific, North Bend, B. C. 605
 Brown, R. W., Cincinnati, Hamilton & Dayton, Indianapolis, Ind. 605
 Brown, Samuel, obituary. 48
 Brown, T. L., Norfolk & Western, Kenora, W. Va. 269
 Buck, W. F., obituary. 103
 Buckler, W. S., Southern Pacific, Sacramento, Cal. 550
 Bull, G. W., Canadian Pacific, Eastern Lines. 159
 Burch, J. J., Norfolk & Western. 327
 Burdick, E. L., Santa Fe. 492
 Burg, Alfred, Lake Shore, Buffalo, N. Y. 47
 Burgis, E. W., New Orleans So. & Grand Isle, Algiers, La. 157
 Burgyone, C. J., Pennsylvania. 494
 Burke, J. A., Santa Fe, Clovis, N. M. 654
 Burham, H. G., Northern Pacific, St. Paul, Minn. 492
 Burns, T. J., Michigan Central, Detroit, Mich. 382
 Bussing, G. H., Mexico North Western, Madera, Mexico 604
 Bussing, G. H., New Orleans & Great Northern, Boyalusa, La. 549
 Cage, Newton, Baltimore & Ohio. 549
 Callahan, T. W., Great Northern, Superior, Wis. 654
 Cannon, T. E., Great Northern, Superior, Wis. 211
 Carey, J. J., Baltimore & Ohio Southwestern, Washington, Ind. 332

Carroll, J. T., Baltimore & Ohio, Baltimore, Md. 158
 Carroll, W. P., New York Central, West Albany, N. Y. 212
 Carson, F. L., Chicago Great Western, Des Moines, Ia. 383
 Carson, F. L., San Antonio & Aransas Pass, Yoakum, Tex. 493, 605
 Chaffee, J. M., New York Central, Mohawk Div. 326
 Chamberlin, W. A., Pere Marquette, Saginaw, Mich. 605
 Chambers, C. H., Santa Fe, Dodge City, Kan. 654
 Chandler, R. L., New York Central, New York 604
 Chase, F. T., Missouri, Kansas & Texas, Smithville, Tex. 606
 Chenoweth, E. G., Rock Island, Blue Island, Ill. 494
 Clark, F. G., C. & N. W., East Clinton, Ill. 607
 Clark, G. W., Grand Trunk, St. Lambert, Que. 606
 Clewer, H., Rock Island, Chicago. 654
 Cloud, B. F., Rock Island, Wilburton, Okla. 605
 Clough, J. A., Southwestern Railway, Archer City, Tex. 493
 Coddington, H. W., Norfolk & Western 326
 Coleman, W. J., Canadian Pacific, Calgary, Alberta 213
 Coles, F. L., Rock Island, Herington, Kan. 494
 Coniff, P., Baltimore & Ohio, Mt. Clare, Baltimore, Md. 606
 Connors, Luke, Lake Shore & Michigan Southern, Ashtabula, O. 47
 Cook, J. R., Santa Fe, Clovis, N. M. 550
 Copp, C. E., Boston & Maine, Concord, N. H. 48
 Corbett, W. H., Michigan Central, Michigan City, Mich. 326
 Corkran, C. C., Chesapeake & Ohio, Richmond, Va. 492
 Cosgrove, J. T., Baltimore & Ohio, Benwood, W. Va. 213
 Costello, J. D., Santa Fe, Clovis, N. M. 606
 Costello, P. J., Santa Fe, Las Vegas, N. M. 606
 Costello, Patrick, Santa Fe, La Junta, Colo. 494
 Coxedge, J. A., Santa Fe, Albuquerque, N. M. 213
 Craig, James, Boston & Maine, Boston, Mass. 100
 Crandall, W. J., New York Central, Rochester, N. Y. 211
 Crew, A. L., Santa Fe, San Bernardino, Cal. 436
 Crofton, R. A., Houston, East & West Texas, Houston, Tex. 157
 Crosby, W. F., Central Vermont, St. Albans, Vt. 550
 Cross, C. W., New York Central Lines, Chicago, Ill. 48
 Crouch, J. W., St. Louis & San Francisco, Springfield, Mo. 605
 Cundiff, L. E., Denver & Rio Grande, Cuchara Jc., Colo. 213
 Cunningham, D. W., Missouri Pacific, Little Rock, Ark. 437
 Curtain, H. C., Santa Fe, Barstow, Cal. 437
 Darlow, A. M., Buffalo & Susquehanna, Galeton, Pa. 269
 Davies, H. W., Norfolk & Southern, Norfolk, Va. 159
 Davies, B. L., Chesapeake & Ohio, Hammond, Ind. 494
 Davis, J. H., Santa Fe, Albuquerque, N. M. 213
 Davis, W. L., Santa Fe, Chicago, Ill. 382
 Davis, W. T., Chicago & Alton, Bloomington, Ill. 655
 Davis, William Linn, Santa Fe, Chanute, Kan. 494
 Delacy, Martin, Chicago & North Western, East Clinton, Ill. 655
 Delaney, S. J., New York Central, West Albany, N. Y. 211
 Delmida, D. L., Ill. Cent., Springfield, Ill. 655
 Derby, William A., obituary. 495
 Dillon S. J., Trenton Terminal Division, P. R. R., Camden, N. J. 492
 Dillon, S. J., Pennsylvania, Camden, N. J. 549
 Doig, J. A., Canadian Pacific, Red Deer, Alberta 213
 Douglas, Chas. H., Central Vermont, St. Albans, Vt. 550
 Dovitt, W. J., Rock Island, McFarland, Kan. 550
 Doyle, James, obituary. 48
 Drake, I. H., Santa Fe, Raton, N. M. 550, 655
 Dressel, W. H., O. W. R. & N., Portland, Ore. 212
 Drury, M. J., Santa Fe, Topeka, Kan. 383
 Duncan, V. B., Trinity & Brazos Valley, Teague, Tex. 158
 Dum, C. E., Denver & Rio Grande, Hoisington, Kan. 268

Dunlop, P. T., Gulf, Colorado & Santa Fe. 100
 Dunn, P. T., Pennsylvania, Wellsville, Ohio 100
 Durborrow, Richard N., obituary. 48*
 Durthe, Henry, Eric, Kent, O. 494
 Eddy, W. J., Rock Island, Chicago, Ill. 212
 Edgecombe, Wm. H., Santa Fe, Eastern Lines 213
 Egan, C. E., Missouri, Kansas & Texas, Waco, Tex. 550
 Eldridge, B. A., Santa Fe, Arkansas City, Kan. 606
 Ellet, H., Rock Island, Valley Jct., Ia. 47
 Elmes, C. C., Texas & New Orleans, Houston, Tex. 493
 English, H. A., Canadian Northern, Winnipeg, Man. 268
 Enockson, J. O., St. Paul, Minneapolis & Omaha, Sioux City, Ia. 493
 Erskine, W. H., Minneapolis & St. Louis, Cedar Lake, Minn. 157
 Evans, G. J., Canadian Pacific, Angus, Montreal, Que. 550
 Fairlie, F. A., Nitrate Railway, Ltd., Iquique, Chile 492
 Farley, J. A., Chesapeake & Ohio, Richmond, Va. 493
 Fee, W. J., Grand Trunk, Lindsay, Ont. 213
 Fellows, P. S., Pennsylvania, Kenova, Pa. 606
 Ferguson, C. E., Grand Trunk Pacific, Rivers, Man. 158
 Fero, S. J., Great Northern, Breckenbridge, Minn. 211
 Fillmore, A. L., Minneapolis, St. Paul & Sault Ste. Marie, Stevens Point, Wis. 654
 Fisher, F. G., St. Louis & San Francisco, Chaffee, Mo. 655
 Fitz, R. A., Lake Shore, Nottingham, O. 550
 Fitzsimmons, Edward S., Erie, Cleveland, O. 100, 158
 Fitzsimmons, J. E., Central Vermont, St. Albans, Vt. 268
 Fletcher, J., Rock Island, St. Louis, Mo. 213
 Flynn, Walter H., Michigan Central, St. Thomas, Ont. 327
 Foote, George B., New York Central, Cleveland, O. 493
 Forsythe, Geo. B., Pennsylvania, Conway, Pa. 605
 Fries, A. J., New York Central, Depew, N. Y. 48
 Gable, W. H., M. S. P. & S. S. M., North Fond du Lac, Wis. 437
 Gaden, W. S., Southern Railway, Memphis, Tenn. 493
 Gallagher, Hugh, Santa Fe, La Junta, Colo. 654
 Caraghty, Wm. C., Baltimore & Ohio. 211
 Garber, A. O., Illinois Central, Paducah, Ky. 326
 Gardner, P. L., Trinity & Brazos Valley, Teague, Tex. 606
 Gemlo, William, Minneapolis & St. Louis, Watertown, So. Dak. 100
 Gibson, J. A., Peoria & Eastern, Urbana, Ill. 100
 Gibson, J. A., Illinois Traction System, Urbana, Ill. 268
 Gilbert, E. A., Southern Pacific, San Francisco, Cal. 327
 Gilbert, J. F., Santa Fe, Waynoke, Okla. 605
 Gill, Chas. A., Cincinnati, Hamilton & Dayton, Cincinnati, O. 383
 Gillaspie, C. F., Minneapolis, St. Paul & Sault Ste. Marie, Central Vermont, St. Albans, Vt. 654
 Gillespie, W. A., Frisco Lines, De Quincy, La. 551
 Gilliland, O. E., Rock Island, El Reno, Okla. 549
 Gladson, George, St. Louis & San Francisco, Francis, Okla. 655
 Golithon, J. S., Bellingham Bay & British Columbia, Bellingham, Wash. 550
 Good, G. W., New York Central Lines, Chicago 100
 Goodrich, J. F., Arizona Eastern, Phoenix, Ariz. 382
 Goodnow, T. H., Armour Car Lines, Chicago 103
 Goodnow, T. H., Chicago & North Western, Chicago, Ill. 494
 Gorman, R. T., Santa Fe, Needles, Cal. 551
 Gossett, C. E., Minneapolis & St. Louis, Minneapolis, Minn. 100, 158
 Gould, J. E., Raleigh, Charlotte & Southern 157
 Gould, J. R., Chesapeake & Ohio, Richmond, Va. 382-604
 Gouldsbury, J. C., Pittsburgh & Lake Erie, Beaver Falls, Pa. 494
 Graham, A. H., St. Louis, San Francisco & Texas, Sherman, Tex. 100
 Grame, B. F., Minneapolis, St. Paul & Sault Ste. Marie, Glenwood, Minn. 654
 Grant, Thomas, Delaware & Hudson, Watervliet, N. Y. 606

Page numbers under 1,000 refer to *American Engineer*; those over 1,000 refer to the *Daily Railway Age Gazette*. * Illustrated article; § editorial; † short non-illustrated article or note; ‡ communication.

Personals (continued).

Graves, W. H., Rock Island, Pratt, Kan. 213
 Gray, C. B., Pennsylvania, Enola, Pa. 47
 Gray, W. E., International & Great Northern, Palestine, Tex. 494
 Grimes, L., Illinois Central, Jackson, Tenn. 100
 Grimshaw, F. G., Pennsylvania, Pittsburgh, Pa. 549
 Guess, J. H., Grand Trunk, Montreal, Que. 103
 Hahn, H. L., Santa Fe, Albuquerque, N. M. 494
 Hair, John, Baltimore & Ohio Southwestern, Baltimore, Md. 327
 Hale, H. H., Cincinnati, Hamilton & Dayton 327
 Haley, J. A., Bellingham Bay & British Columbia, Bellingham, Wash. 326
 Hall, James, Southern Pacific, San Francisco, Cal. 605
 Hamilton, Paul D., Santa Fe, La Junta, Colo. 606
 Hamilton, W. W., Santa Fe, Shopton, Ia. 654
 Hanchott, S. F., Rock Island, Estherville, Iowa 327
 Hanse, E. C., Georgia & Florida, Douglas, Ga. 654
 Hanson, F. H., Lake Shore, Cleveland, Ohio 101
 Hanson, William H., Chicago & North Western, Council Bluffs, Ia. 494
 Harding, L. A., Chicago & North Western, Boone, Ia. 494
 Hartman, G. T., Copper Range, Houghton, Mich. 157
 Hartough, E. W., Pere Marquette, Grand Rapids, Mich. 655
 Hasbrouch, F. C., Chicago & Eastern Illinois, Terre Haute, Ind. 494
 Hass, H. M., Canadian Pacific, Eastern Lines 159
 Hassman, L. E., Illinois Central, Clinton, Ill. 100
 Hatch, M. C. M., New Haven, Boston 47
 Hatch, M. C. M., D. L. & W., Scranton, Pa. 327
 Hause, E. C., Georgia & Florida, Douglas, Ga. 606
 Hawkins, W. P., Missouri Pac. 268
 Hayes, O. B., Pennsylvania, Steubenville, O. 211
 Hayward, H. S., Pennsylvania, Jersey City, N. J. 47
 Hayward, J., Canadian Pacific, North Bend, B. C. 493
 Hayward, W. E., Canadian Pacific, Vancouver, B. C. 606
 Hawker, Wm. H., Chicago, St. Paul, Minneapolis & Omaha, Altoona, Wis. 494
 Hedge, G. H., Canadian Nor., Winnipeg, Man. 157
 Hegberg, G. L., Rock Island, Argenta, Ark. 437
 Heidler, J. T., Norfolk & Western, Bluefield, W. Va. 269
 Helwig, P. W., Minneapolis & St. Louis, Minneapolis, Minn. 103
 Hendry, J. W., Minneapolis, St. Paul & Sault Ste. Marie, Thief River Falls, Minn. 654
 Henry, J. M., Pennsylvania, West Philadelphia, Pa. 47
 Hess, C. G., St. Louis, San Francisco & Texas, Forth Worth, Tex. 103
 High, W. K., obituary 384
 Hill, J. F., Wheeling & Lake Erie, Brewster, O. 605
 Hine, Major Charles, Southern Pacific of Mex., Tucson, Ariz. 103
 Hinman, H. W., Santa Fe, Topeka, Kan. 384
 Hitch, C. H., Cincinnati, Hamilton & Dayton, Lima, O. 103
 Hoffer, P. S., Santa Fe, Shopton, Ia. 213
 Hogan, C. H., New York Central, Albany, N. Y. 48
 Hollub, J. H., National Railway at Mexico 551
 Holtz, David, obituary 384
 Honaker, F., St. Louis & San Francisco, Fort Scott, Kan. 326
 Honaker, H. H., Frisco, Fort Scott, Kan. 268
 Hood, H., Cotton Belt, Tyler, Tex. 606
 Hopper, F., Rock Island, Cedar Rapids, Iowa 327
 Hopper, G. H., Lake Shore, Sandusky, O. 550
 Hopkins, J. W., Pennsylvania, Toledo, O. 100
 Hoskin, W. J., Illinois Central, Paducah, Ky. 327
 Houston, C., Nacozari railroad, Nacozari, Mex. 326
 Howard, W. F., Santa Fe, Cleburne, Tex. 606
 Hughes, E. P., Reid Newfoundland Co. 157
 Humbert, C. J., I. & G. N., Palestine, Tex. 213

Personals (continued).

Hurley, W. J., New York Central. 268
 Hutson, Harry M., Baltimore & Ohio, Grafton, W. Va. 605
 Isaminger, F. A., Trinity & Brazos Valley, Teague, Tex. 550
 Jackson, J. H., Canadian Pacific, Rogers Pass, B. C. 213, 384
 Jacobs, Henry W., Santa Fe. 382
 James, Howard, obituary. 656
 James, J. M., Pennsylvania, Pittsburgh, Pa. 47
 James, John Moore, Pennsylvania, Pittsburgh, Pa. 102*
 James, William H., Chicago & North Western, Council Bluffs, Ia. 494
 Jefferson, Mark, Lehigh Valley, Buffalo, N. Y. 494
 Johnson, Rance, Santa Fe, Dodge City, Kan. 655
 Jones, F. L., Canadian Pacific, Eastern Lines 159
 Jones, H. F., Denver & Rio Grande, Salida, Colo. 269
 Jones, J. S., Chicago & Northwestern, Clinton, Ia. 606
 Jones, R. A., Canadian Pacific, Saskatoon, Sask. 493
 Johnston, C. E., Santa Fe, Bakersfield, Cal. 606
 Johnson, G. E., Santa Fe, Gallup, N. M. 551
 Johnson, L. R., Canadian Pacific, Montreal, Que. 436
 Johnston, W. D., Rock Island, Valley Junction, Ia. 655
 Johnson, Rance, Santa Fe, La Junta, Colo. 551
 Johnston, J. T., Santa Fe, Los Angeles, Cal. 604
 Johnson, W. D., International and Great Northern 436
 Kapp, J. B., Pennsylvania, Philadelphia 47
 Kapp, J. B., Pennsylvania, Oil City, Pa. 268
 Karter, A. H., St. Louis Southwestern, Pine Bluff, Ark. 606
 Kass, P., Rock Island, Chicago. 269
 Kaufman, H., Santa Fe, San Bernardino, Cal. 213
 Keating, W. E., Rock Island, Argenta, Ark. 213
 Kellogg, W. L., Pere Marquette, Wyoming, Mich. 604
 Kelly, J. P., Canadian Pacific, Field, B. C. 327
 Kempf, Geo. P., Chicago, Milwaukee & St. Paul, Milwaukee, Wis. 604
 Kendig, R. B., New York Central, New York 211
 Kendrick, J. P., Buffalo, Rochester & Pittsburgh, Punxsutawney, Pa. 550
 Kenzel, C. H., Elgin, Joliet & Eastern, Chicago, Ill. 103
 Kesterson, A., St. Louis & San Francisco, Springfield, Mo. 605
 Keswich, H. A., Canadian Pacific. 384
 Killfoyle, J. M., St. Louis Southwestern, Tyler, Tex. 494
 Kilpatrick, J. B., Rock Island, Des Moines, Ia. 437
 Kilpatrick, J. B., Rock Island, Des Moines, Ia. 211
 Kilpatrick, J. B., Rock Island, Davenport, Ia. 268
 King, George, Rock Island, Pratt, Kan. 605
 Kline, W. A., Central of Georgia, Columbus, Ga. 493
 Klunder, T. H., Rock Island, Valley Junction, Ia. 550
 Koester, H. J., Virginia Southwestern, Bristol, Va., Tenn. 103
 Kroft, Chas., Santa Fe, Wellington, Kan. 606
 Kuhns, J. C., Illinois Central, Chicago 103
 Kuhns, J. Z., Santa Fe, Clovis, N. M. 551
 Kuhlke, F. W., Charleston & Western Carolina 213
 Kyle, J., Canadian Nor., Edmonton, Alberta 157
 La Belle, S., Rock Island, Eldon, Mo. 213
 Ladd, W. R., O. W. R. & N. Co., Portland, Ore. 211
 Laizure, L. R., Erie, Hornell, N. Y. 100
 Lally, T. E., Lake Shore, Elyria, O. 103
 Lalar, J. Q., Union Pacific, Denver, Colo. 47
 Lamars, W. S., Santa Fe, Newton, Kan. 213
 Langton, C. E., Marshall & East Texas 550
 Langton, George, Texas & Pacific, Marshall, Texas 211
 Latham, I., Nevada & Copper Belt, Mason, Nev. 100
 Laughlin, C. E., Great Northern, Grand Forks, N. D. 211
 Lawler, F. W., C. C. C. & St. L., Brightwood, Ind. 101
 Leaton, Robert, Santa Fe, Sweetwater, Tex. 47
 Leavette, Frank, O. W. R. R. & N. Co., La Grande, Ore. 213

Personals (continued).

Leland, W. C., El Paso & Southwestern, Douglas, Ariz. 494
 Lendrum, J. T., Santa Fe, Dodge City, Kan. 213
 Lewis, J. D., Denver & Rio Grande, Salida, Colo. 269
 Lewis, Henry, Santa Fe, Clovis, N. M. 606
 Leyden, W. T., Minneapolis & St. Louis, Marshalltown, Ia. 101
 Leysaht, L., St. Louis & San Francisco, Kinesville, Tex. 654
 Linck, George F., Santa Fe, La Junta, Colo. 494
 Lindeman, C. E., Santa Fe, Richmond, Cal. 551
 Lindman, S., Lake Shore, Nottingham, O. 103
 Lindman, S., Lake Shore, Youngstown, O. 550
 Linn, J. A., El Paso & Southwestern, Douglas, Ariz. 494
 Linn, F. C., San Antonio & Aransas Pass, Yoakum, Texas 606
 Little, C. A., Canadian Pacific, Red Deer, Alta. 493
 Lothian, D. B., Rock Island, Topeka, Kan. 549
 Loux, J. P., Lehigh Valley, Hazleton, Pa. 550
 Lowell, W. W., obituary 103
 Lozo, F., Grand Trunk Pacific, Fitzhugh, Alberta 213
 Lydton, J., Santa Fe, Barstow, Cal. 269
 Lyle, C. P., St. Louis & San Francisco, Hugo, Okla. 384
 Lyons, W. B., Santa Fe, Bakersfield, Cal. 551
 Luscombe, J. T., C. C. C. & St. L., Bellefontaine, Ohio 157-212
 Macha, J. H., Santa Fe, Shawnee, Okla. 606
 Macklin, H. C., Tampa & Northern. 655
 Madden, D. J., Erie, Cleveland, O. 47
 Maine, M. N., Chicago, Milwaukee & Puget Sound, obituary 327
 Majors, G. F., Rock Island, Rock Island, Ill. 654
 Mallov, M. A., obituary 656
 Mansfield, Z. B., Rock Island 605
 Mann, A. C., Illinois Central, Chicago 103
 Marsh, Henry, Minneapolis & St. Louis, Marshalltown, Ia. 158
 Mason, John H., Jersey Central, Mauch Chunk, Pa. 47
 Mason, Wm., Santa Fe, Arkansas City, Ark. 213
 Mayo, W. C., Canadian Pacific, Port McNicoll, Ont. 327
 McDonald, D. G., Canadian Pacific, Red Deer, Alberta 384
 McDonald, M. J., Rock Island, Trenton, Mo. 605
 McDonald, W. H., Florida East Coast, St. Augustine, Fla. 494
 McDonald, W. H., Santa Fe, Clovis, N. M. 655
 McDonnell, F. V., Pennsylvania, Logansport, Ind. 47
 McDonough, J. F., Santa Fe, Shopton, Ia. 436
 McDougal, A. G., Denver & Rio Grande, Salt Lake City, Utah. 551
 McGill, A. M., Lehigh Valley, South Bethlehem, Pa. 604
 McGrath, J. T., Chicago & Alton, Bloomington, Ill. 549
 McHattie, T., Grand Trunk, Montreal, Que. 268
 McHugh, L. J., Lake Shore, Air Line Co., Ohio 551
 McKenna, R. F., obituary 214
 McLaughlin, L. J., Grand Trunk, Brockville, Ont. 605
 McLaw, H. D., Missouri, Kansas & Texas, Greenville, Tex. 606
 McLean, W. J., Duluth, Winnipeg & Pacific, West Duluth, Minn. 654
 McMurray, J. P., Santa Fe, Albuquerque, N. M. 382-437
 McPherson, W., Canadian Pacific, Moose Jaw, Sask. 213
 McPherson, R., Canadian Pacific, Brandon, Man. 327
 McNeill, J. J., Erie, Cleveland, O. 47-213
 McQuade, T. E., Rock Island, Peoria, Ill. 655
 McQuaid, Peter, Prince Edward Island, Charlottetown, P. E. I. 382
 McCarra, M. F., Louisiana Ry. & Nav. Co., Shreveport, La. 550
 McCarthy, C. A., Rock Island, Shawnee, Okla. 605
 McCarthy, J. L., Santa Fe, Richmond, Cal. 494
 McAmis, W. H., Central of Georgia, Columbus, Ga. 494
 McAnany, J., Canadian Pacific, Revelstoke, B. C. 211
 McArthur, S., Canadian Pacific, Sutherland, Sask. 605
 Merrifield, T. A., Santa Fe, Las Vegas, N. M. 437

Personals (continued).

Merritt, T. E., El Paso & Southwestern, Douglas, Ariz. 494
 Mhlheisen, G., Santa Fe, La Junta, Colo. 655
 Miller, B. H., Baltimore & Ohio, Rockwood, Pa. 550
 Miller, E. O., Southern Railway, Memphis, Tenn. 494
 Miller, L. J., Rock Island, Pratt, Kan. 213
 Mirtz, P. P., New York Central, Cleveland, O. 212
 Mobile, W. R., Rock Island, Winfield, La. 655
 Moeller, F. C., Rock Island, Burr Oak, Ill. 655
 Moher, W. E., Grand Trunk Pacific 550
 Moler, A. L., Charlotte Harbor & Northern, Arcadia, Fla. 654
 Mont, Amos, Santa Fe, Gallup, N. M. 494
 Mooney, W. D., Lake Shore, Collinwood, O. 103
 Moore, G. W., St. Louis & San Francisco, Kansas City, Mo. 655
 Moore, R. P., Duluth & Iron Range, Duluth, Minn. 159
 Morgan, J. K., Rock Island, Little Rock, Ark. 103
 Morrison, J. C., Chicago, Burlington & Quincy, Omaha, Neb. 382
 Morrow, H. E., International & Great Northern 495
 Morton, W. H., Canadian Pacific, Rosebery, B. C. 493
 Morton, W. O., Rock Island, Chicago 606
 Mosley, Harry W., Erie, Hornell, N. Y. 606
 Mounce, R. S., Erie, Cleveland 326
 Mountain & Pacific, Cimarron, N. M. 654
 Mourme, J. E., Rock Island, Trenton, Mo. 654
 Mullen, J., Canadian Pacific, Cranbrook, B. C. 495
 Mullinix, S. W., Rock Island, Topeka, Kan. 268
 Mulroy, J. R., Pullman Co., Pullman, Ill. 655
 Mulvihill, Thos., Rock Island, Argenta, Ark. 437
 Murphy, F. K., C. C. C. & St. L., Brightwood, Ind. 100
 Murphy, W., Missouri, Kansas & Texas, Dallas, Tex. 551
 Nanney, T. H., Buffalo & Susquehanna, Galeton, Pa. 606
 Needham, H. C., Pennsylvania, Richmond, Ind. 47
 Neild, R. R., Canadian Pacific 384
 Neuman, E. J., Norfolk & Western, East Radford, Va. 269
 Neyer, L. C., Rock Island, Cedar Norton, Edward, Santa Fe, Dodge City, Kan. 654
 Rapids, Ia. 159
 Osborne, H. J., Rock Island, Eldorado, Ark. 550
 Osborne, H., Canadian Pacific, Montreal, Que. 436
 Osgard, B. E., Great Northern, Superior, Wis. 211
 Osgard, Nels, Great Northern, Superior, Wis. 327
 Osgard, Nels, Great Northern, Superior, Wis. 654
 Owens, E., Missouri, Kansas & Texas, Gainesville, Tex. 551
 Page, O. J., Rock Island, Argenta, Ark. 269
 Palmer, H. O., El Paso & Southwestern, Hochita, N. M. 495
 Parker, Geo. E., El Paso & Southwestern, Douglas, Ariz. 606
 Parsons, J. G., New York Central, Depew, N. Y. 47
 Parker, C. F., Illinois Central, Chicago, Ill. 103
 Parker, C. F., Central of Georgia, Chicago, Ill. 269
 Passmore, A. G., Toledo & Ohio Cent., Bucyrus, O. 157
 Patterson, Robert, Florence & Cripple Creek, obituary 214
 Pelley, W. H., Trinity & Brazos Valley, Teague, Tex. 213
 Pendleton, H. E., Santa Fe 436
 Pentland, A., Canadian Pacific, Moose Jaw, Sask. 327
 Perine, D. M., Pennsylvania, Jersey City, N. J. 102*
 Perris, F. T., Santa Fe, Olinda, Cal. 326
 Pickard, F. C., D. L. & W., East Buffalo, N. Y. 605
 Pontius, John, Pennsylvania, Columbus, Ohio 211
 Porter, C. D., Pennsylvania, Pitearn, Pa. 47
 Potiet, A. A., Texarkana & Ft. Smith, Port Arthur, Tex. 495
 Powers, Chas., Canadian Pacific, Montreal, Que. 159
 Powers, James, Lehigh Valley, Sayre, Pa. 495
 Powers, M. J., Canadian Pacific, Montreal, Que. 495
 Prendergast, A. P., Baltimore & Ohio Southwestern, Cincinnati, Ohio 326
 Pullar, John, Santa Fe, Richmond, Cal. 47

Personals (continued).

Purcell, John, Santa Fe, Chicago, Ill. 327
 Queenman, William, Chicago, Burlington & Quincy, Aurora, Ill. 494
 Ramsdell, T. M., Chicago & Alton, Bloomington, Ill. 655
 Randolph, V. C., Erie, Aron, N. Y. 268*
 Raquet, E. H., New York, New Haven & Hartford, Boston, Mass. 383
 Raymond, L. H., New York Central, Depew, N. Y. 47
 Reeves, John R., Guayaquil & Quito, Ecuador 605
 Renix, W. J., Canadian Pacific, Brandon, Man. 327
 Reynolds, B. R., Santa Fe, La Junta, Colo. 606
 Reynolds, J. A., Denyer, Northwestern & Pacific, Fraser, Col. 103
 Rhodes, J. C., Rock Island, Eldon, Iowa 605
 Riley, James, Missouri, Kansas & Texas, McAlester, Okla. 604
 Ripley, F. C., Santa Fe, Midvil, Cal. 326
 Ritsman, C. L., Wheeling & Lake Erie, East Toledo, O. 495
 Roberts, A. J., Grand Trunk Pac., Regina, Man. 159
 Roberts, D. G., Delaware & Hudson, Watervliet, N. Y. 606
 Robertson, Robert, Guayaquil & Quito, Huigra, Ecuador 493
 Robertson, E., Rock Island 213
 Robinson, Maynard, Gulf, Colorado & Santa Fe 100
 Robinson, W. L., Baltimore & Ohio, Baltimore, Md. 268, 604
 Rogers, C. J., White Pass & Yukon, Vancouver, B. C. 437
 Rogers, R. H., obituary 607
 Rolosen, W. M., Santa Fe, Fort Madison, Ia. 213
 Root, James M., obituary 48
 Rose, W. G., Cincinnati, Hamilton & Dayton 383
 Ross, D. C., Michigan Central, Detroit, Mich. 269
 Rotureau, B. H., Central of Georgia, Macon, Ga. 495
 Rouse, C. M., Santa Fe, Gallup, N. M. 213
 Rusch, Frank, Chicago, Milwaukee & Puget Sound, Tacoma, Wash. 383
 Rusling, W. J., Pennsylvania, Elmira, N. Y. 47
 Russel, T. N., Cincinnati, Hamilton & Dayton, Cincinnati, O. 103
 Runney, T., Rock Island, Chicago, Ill. 436
 Ryan, T. T., Santa Fe, Raton, N. M. 551
 Sanjule, E. M., Santa Fe, Riverbank, Cal. 551
 Sapp, William, Santa Fe, Sweetwater, Tex. 606
 Sargent, M. E., C. & N. W., East Clinton, Ia. 606
 Satterlee, J. C., St. Louis & San Francisco, Birmingham, Ala. 655
 Schackelford, L. A., International & Great Northern, Taylor, Tex. 103
 Schlaefel, Wm., Erie, New York 101*
 Schultz, E., Northern Wisconsin & Lake Shore, Green Bay, Wis. 605
 Scott, W. L., Pennsylvania, Columbus, Ohio 268
 Scott, W. W., Pere Marquette, Saginaw, Mich. 48*
 Seal, Arthur, Buffalo & Susquehanna, Galeton, Pa. 607
 Sealey, W. C., Grand Trunk, Toronto, Ont. 654
 Searles, E. J., B. & O., Pittsburgh, Pa. 157
 Seeger, J. C., Lehigh Valley, Sayre, Pa. 607
 Seibert, W. G., Mo. Pac., Hoisington, Kan. 436
 Senger, J. W., Lake Shore, Englewood, Ill. 103
 Sentman, John E., Baltimore & Ohio, Philadelphia, Pa. 213, 436
 Sexton, J. R., Santa Fe, La Junta, Colo. 383, 436, 607
 Shayne, Chas., Erie, Huntington, Ind. 551
 Shea, R. T., New York Central 551
 Sheahan, J. F., Georgia & Florida, Douglas, Ga. 47, 101*
 Sheahan, J. F., Atlanta, Birmingham & Atlantic, Fitzgerald, Ga. 654
 Shelby, C. K., Pennsylvania, Olean, N. Y. 47, 158
 Shelling, Chas. R., Chicago & North Western, Council Bluffs, Ia. 495
 Shields, A., Canadian Northern, Winnipeg, Man. 211
 Shipley, E. C., Baltimore & Ohio 605
 Shone, B. E., New York Central, Depew, N. Y. 327
 Shroeve, J. C., Joliet, Elgin & Eastern, Joliet, Ill. 605
 Shremp, E. J., Pennsylvania, Conway, Pa. 606
 Siemantel, G. D., St. Louis, Rocky Mountain & Pacific, Cimarron, N. M. 654
 Simpson, I. F., obituary 269
 Sindall, J., Canadian Pacific, Cranbrook, B. C. 607
 Sisson, D. J., New York Central 268

Personals (continued).

Sisco, G. E., Pennsylvania, Columbus, O. 47
 Sivers, R. W., Rock Island, Trenton, Mo. 605
 Slater, F., Chicago & North Western, Kaukauna, Wis. 605
 Small, J. W., Southern Pacific, Houston, Tex. 47, 101
 Smith, C. D., Grand Trunk Pacific 550
 Smith, C. F., Rock Island, Chicago 607
 Smith, C. M., Santa Fe, Richmond, Cal. 213
 Smith, Ernest V., Seaboard Air Line, Jacksonville, Fla. 495
 Smith, G. E., Louisiana Ry. & Navigation Co., Shreveport, La. 269
 Smith, J. G., Nitrate Railway, Ltd., Iquique, Chile 493
 Smith, Pearl F., C. St. P. M. & O., St. Paul, Minn. 268*
 Smith, P. F., Jr., Pennsylvania, Columbus, O. 47
 Smith, W. C., Missouri Pacific, Kansas City, Mo. 436
 Smith, Weaver D., Santa Fe, Argentine, Kan. 495
 Snyder, Chas., Elgin, Joliet & Eastern, Spaulding, W. J., El Paso & Southwestern, Bisbee, Ariz. 495
 Spaulding, Cal., Chicago & North Western, Boone, Ia. 493
 Squires, Arthur, Chilean State Railways, Santiago, Chile 493
 Stanley, A. K., Houston & Texas Central, Sherman, Tex. 550
 Stark, C. W., New York Central 326
 Stark, D. A., St. Louis, Brownsville & Mexico, Kingsville, Tex. 103
 Starks, Perry, Chicago & North Western, Boone, Ia. 494
 Starr, F. A., St. Louis & San Francisco, Springfield, Mo. 607
 Stevens, J. E., Mobile & Ohio, Meridian, Miss. 159
 Stevenson, W. T., Santa Fe, La Junta, Colo. 655
 Stewart, C. E., Grand Trunk Pacific, Biggar, Sask. 605
 Stewart, Geo. K., Missouri Pacific, Coffeeville, Ky. 212
 Stoll, L. A., Chicago, Burlington & Quincy, Aurora, Ill. 495
 Stone, B. F., New York Central, Depew, N. Y. 47
 Strauss, M. H., New York Central, New Durham, N. J. 211
 Strieber, Frank, Lake Shore, Ashtabula, O. 47
 Stroeh, E. F., Missouri Pacific, Kansas City, Mo. 436
 Strubel, J. A., Detroit, Toledo & Ironton, Detroit, Mich. 437
 Sturock, A., Canadian Pacific, Ft. William, Ont. 384
 Sullivan, T. F., Santa Fe, Cleburne, Tex. 607
 Sullivan, T. F., San Antonio & Aransas Pass 436
 Summers, Fred E., Santa Fe, Vaughn, N. Mex. 494
 Sweeley, E. A., Rock Island, Inver Grove, Minn. 269
 Switzer, E. M., Chicago, Burlington & Quincy, Chicago 100
 Syfan, H. P., Denver & Rio Grande, Chama, N. M. 607
 Tangney, J., Inver Grove, Minn. 437
 Taylor, C. M., Rock Island, El Reno, Okla. 268
 Taylor, F. W., Illinois Central, Waterloo, Ia. 326
 Taylor, Wm. B., Rock Island, Liberal, Kan. 213
 Teague, A. R., Mobile & Ohio, Meridian, Miss. 159
 Thomas, Edward, R. R. & Co., La Grande, Ore. 213
 Thomas, F. W., Santa Fe, Topeka, Kan. 326
 Thompson, Samuel G., Philadelphia & Reading, Reading, Pa. 100, 383
 Tierney, J. E., Louisiana & Arkansas, Stamps, Ark. 382
 Tollerton, W. J., Rock Island, Chicago 268
 Tracy, W. L., Missouri Pacific, Kansas City, Mo. 437
 Trumbull, A. G., Erie, Jersey City, N. J. 100
 Tucker, E. W., Santa Fe 437
 Tune, Ben Franklin, Nashville, Chattanooga & St. Louis, Nashville, Tenn. 495
 Turnbull, R. J., Missouri Pacific, St. Louis, Mo. 102, 437
 Turner, J. H., Lake Shore, Cleveland, O. 493
 Tyler, J. S., Chicago & North Western 495
 Velasco, J. M., National Rys. of Mexico, San Luis Potosi, Mex. 551
 Venamon, E. W., Rock Island, Eldorado, Ark. 606
 Vickers, T. M., San Pedro, Los Angeles & Salt Lake 211

Page numbers under 1,000 refer to *American Engineer*; those over 1,000 refer to the *Daily Railway Age Gazette*. * Illustrated article; † editorial; ‡ short non-illustrated article or note; § communication.

Personals (continued).

Voigt, W. H., Trinity & Brazos Valley, League, Tex. 607

Vosen, Peter, Washash, Decatur, Ill. 157

Wagar, S. J., Buffalo, Rochester & Pittsburgh 493

Wagar, Stanley S., B. R. & P., DuBois, Pa. 549

Wagner, A. A., Rock Island, Valley Junction, Ia. 606

Wallace, Robert, Cincinnati, Hamilton & Dayton, Cincinnati, O. 494

Wallace, W. F., Santa Fe, Cleburne, Tex. 607

Walker, W. H., Grand Trunk, Turcot, Can. 607

Wallis, J. T., Pennsylvania, Altoona, Pa. 102

Wallis, L. E., Santa Fe, Cleburne, Tex. 607

Walsh, F. J., Chesapeake & Ohio, Hinton, W. Va. 106

Walsh, James F., Chesapeake & Ohio, Richmond, Va. 383

Walters, T. L., Central of Georgia, Macon, Ga. 655

Wanamaker, H., New York Central, West Albany, N. Y. 327

Wanamaker, H., New York Central, Depew, N. Y. 47

Waring, Elmer, Santa Fe, Waynoka, Okla. 655

Warner, Glen, Pere Marquette, Detroit, Mich. 382

Watson, D. H., Baltimore & Ohio, Garrett, Ind. 47

Watson, James, Canadian Pacific, Saskatoon, Sask. 211

Watt, A., Grand Trunk Pacific, Prince Rupert, B. C. 495

Webb, E. R., Michigan Central, St. Thomas, Ont. 326

Weber, Geo. W., Great Northern, Great Falls, Mont. 47

Weir, H. D., Santa Fe, Richmond, Cal. 213

Wellman, I., Santa Fe, Newton, Kan. 436

Wells, Keuben, obituary. 655

Welsh, C. A., Rock Island, Little Rock, Ark. 103

Wenke, W. H., Rock Island, Cedar Rapids, Ia. 159

Wene, W. L., Tennessee Central, Nashville, Tenn. 551

Wheeler, E. J., C. B. & Q., Lincoln, Neb. 158

White, Fred H., Duluth, Missabe & Nor., Duluth, Minn. 159

White, C. S., Pennsylvania, Columbus, Ohio 211

Whitebread, Edgar E., C. & N. W., East Clinton, Ill. 607

Whitford, J., Illinois Central, Centralia, Ill. 605

Whiturst, J. A., Orient Ry., San Angelo, Tex. 551

Whitney, C. F., St. Louis & San Francisco, Memphis, Tenn. 655

Wilson, A. B., Southern Pacific, Albany, Ore. 103

Wilson, F., Rock Island, Cedar Rapids, Ia. 550

Wilson, L. J., Rock Island, Armourdale, Kan. 550

Willard, A. S., Norfolk & Western, Williamson, W. Va. 213

Williams, W. H., B. R. & P., East Salamanca, N. Y. 550

Windle, T., Minn. & St. L., Marshalltown, Ia. 159

Winkel, T., International & Great Northern, Palestine, Tex. 605

Winterrowd, W. H., Canadian Pacific, Montreal, Que. 549

Wood, J. H., Rock Island, 494

Woods, R. O., Mobile & Ohio, Meridian, Miss. 607

Wortham, Elliott S., Chicago & Alton, Chicago, Ill. 495

Wright, A. S., Grand Trunk Pacific, Regina 550

Young, A. H., St. Louis & San Francisco, Springfield, Mo. 655

Young, J. D., Missouri Pacific, Falls City, Neb. 436

Yingling, W. J., Norfolk & Western, Crewe, Va. 213

Zeleny, Frank, C. B. & Q., Aurora, Ill. 436

Zerbe, F. J., C. C. & St. L., Indianapolis, Ind. 212

Zimmer, E. M., S. P. & S. S. M., North Fond du Lac, Wis. 437

Pickard, F. C., president's address. 396

Piece work, report at Blacksmiths' convention 450

Pilliod Company, The, valve gear on old locomotives 1481

Pilot, all-steel, by A. J. Beland. 380*

Pilot, pressed steel 12

Pipe and pipe fittings, report on. 319

Pipe rack 646*

Pipe threading machine, Loew Mfg. Co. 206*

Piston heads, solid 77*

Piston packing rings, tools for. 134

Piston, piston rod and crosshead repairs by Geo. Black 559*

Piston, piston rod and crosshead repairs by C. L. Dickert 526*

Piston, piston rod and crosshead repairs, prize article, by G. H. Roberts 523*

Piston rod extension guide No. 50000 9

Piston speed of locomotives. 556§

Piston speeds, diagram tor, by L. R. Pomeroy 562*

Piston valve, double ported, N. C. & St. L. 141*

Piston valve packing rings, machining. 116*

Piston valves and bushings, repair of, in France 633*

Pittsburgh & Lake Erie, 100-ton flat car. 125*

Pittsburgh & Lake Erie, safety movement 209†

Pittsburgh Steel Foundry Co., Pittsburgh Planer, frog and switch, Cincinnati. 271†

Planers, obtaining cutting speed on. 366

Planing mill, C., C. & St. L., at Beech Grove 173*

Plush for car seats. 1395

Pneumatic clamps for holding work. 345*

Pneumatic clamp for testing locomotive triple valves 522*

Pneumatic drive for tool room, Eastern Ry. of N. M. 189*

Poles, reinforced concrete telegraph. 260†

Postal car lighting, report on. 592

Pomeroy, L. R., analysis of wood working machines 509

Pomeroy, L. R., cutting speed on planers. 366

Pomeroy, L. R., chart for tractive efforts. 641*

Pomeroy, L. R., diagram for piston speeds 562*

Pomeroy, L. R., ideal boiler tube dept. 357*

Pop valve, new muffled. 208*

Pouch rack, automatic. 1510*

Powers, R. C., boiler tube testing machine 484*

Powers, Robert E., coupler centering device 594*

Press, Flanging, work on. 201*

Press, Forging, steam hydraulic. 1451*

Press, hydraulic for coupler yokes. 486*

Press, hydraulic for driving boxes. 72*

Pressed Steel Car Co., self-clearing ore car 319*

Pressed Steel Car Co., Westchester steel cars 238*

Prize Winner in shop practice competition 409§

Prize Winners in competition. 387§

Protective coatings, by Walther Riddle. 179

Proper methods of firing locomotives, report on 295

Protractor for locating eccentric keyways. 225*

Prices for labor and material, report and discussion of. 1374*

Pyle National Electric Headlight Co., improved turbine 206*

Pyle National Electric Headlight Co., headlight 1452*

Public Service Commission, New York, annual report 97†

Pulleys, driving efficiency of. 259*

Punch and shear, motor application to. 651*

Purdue dinner, list of those attending. 1434

Q

Quayle, Robert, address at fuel convention 290

Quayle, Robert, address at Tool Foremen's Association 422

R

Racine Tool and Machine Company, metal cutting machine 540*

Rack for holding paint brushes, G. T. 585*

Rack for storing coach doors. 586*

Rack for washing stencils, G. T. 586*

Radial Buffer Co., buffer for engine and tenders 489*

Radiator paint 104†

Railroad Supply & Equipment Club, Chicago, lectures 608

Railway Business Assn., duty of the political parties to the shippers. 1270

Railway Club of Pittsburgh (see meetings).

Railway Club Secretaries, annual meeting, 1912 1433

Railway Electrical Engineers' Assn. (see Electrical Engineers' Assn).

Railway Fuel Assn. (see Fuel Assn.).

Railway General Foremen's Assn. (see General Foremen's Assn.).

Railway Master Blacksmiths' Assn. (see Blacksmiths' Assn.).

Railway Master Painters' Assn. (see Painters' Assn.).

Railway Materials Co., flue welding furnaces 1451*

Railway revenues, January, 1912. 178†

Railway Storekeepers' Ass'n. (see Storekeepers' Ass'n.).

Railway Supply Manufacturers' Annual Meeting 1447

Railway Supply Manufacturers' Assn., Biograph of Officers 1272

Railway Supply Manufacturers' Association Committees for 1912 1274

Railway Tool Foremen's Assn. (see Tool Foremen's Assn.).

Railway Utility Co., car ventilator. 1429*

Railway Utility Co., lock for box car doors 1397*

Railway Utility Co., steam hose coupler. 1482*

Railway Utility Co., temperature regulator, automatic 486*

Rainfall, record at Panama. 45†

Ratchet for deck sash. 1509*

Rate on material for repairs. 325†

Rauch, H. S., shop kinks. 223*

Rawley, James, obituary. 417*

Reamers countersinking, C. & N. W. 116*

Reamer for ball joints, C. & N. W. 339*

Records in enginehouse. 1484§

Registration at convention. 266†

Relations of Railway Operation to Legislation, report of special committee. 145*

Reliance Electric & Engineering Co., speed dial 210†

Relief fund, Pennsylvania Railroad. 508*

Relief valve testing machine. 147*

Relief valve, vacuum, Illinois Central. 559*

Repairs to pistons, piston rods and cross-heads, by Geo. Black. 526*

Repairs to pistons, piston rods and cross-heads, by C. L. Dickert. 553*

Repairs to pistons, piston rods and cross-heads, by G. H. Roberts. 452*

Retaining rings, dies for making. 393*

Reverse gear, ball joint, Amer. Loco. Co. 347*

Reverse gear, power, Canadian Pacific. 9

Reverse gear, screw. 1400†

Review of M. C. B. Convention. 400

Reyer, W. G., promoting shop efficiency. 43

Reyer, Wm. G., handling of apprentices. 18*

Richmond, Fredericksburg & Potomac, boiler washing system 18*

Richmond Railroad Club (see meetings).

Richmond Staybolt Drilling Machine Manufacturing Co., staybolt drill 433*

Riddle, Walther, protective coatings. 179

Rink, G. W., ice car design. 353*

Rivet cutter, pneumatic, B. & O. 122*

Riveter, yoke by Z. B. Claypool. 542*

Road roller, improved. 552†

Roads, good, mileage of. 180†

Roads, wagon in United States. 243†

Roberts, G. H., piston, piston rod and crosshead repairs 523*

Rochester Boring Machine Co., floor type boring machine. 648*

Rochester Boring Mill Co., horizontal boring mill 376*

Rock Island Lines, benefit of pensions. 155†

Rock Island Lines, increase in pensions. 379

Rock Island Lines, meeting of board of pensions 435

Rock Island Lines, operation affected by bad weather 324†

Rocker arm repaired by electric welding. 62*

Rod brasses, new arrangement, by J. E. Osmer 26*

Rod, main, solid end, C. & N. W. 478*

Rods, main and side. 1457†

Rods, main and side, report and discussion on 1467*

Rods, spherical bearing on C., B. & O. 235*

Rolling stock built in New Foundland shops 45†

Roundhouse efficiency by Wm. Hall. 403

Roundhouse (see enginehouse).

Rules of interchange, changes in. 556†

Rules of interchange, revision of, report and discussion of. 1371*

Ryan-Johnson Co., coal pusher. 154*

Ryerson, Jos. T., & Son, tube cleaner. 358*

Ryerson, Jos. T., & Son, forged twist drill 82*

Ryder, G. E., highly superheated steam. 244*

S

Safeguards for band saws. 431*

Safeguards in shops, by W. H. Snyder. 482*

Safety Appliances Act, effect on interchange 1297§

Safety appliances, Government regulation of 1369§

Safety Car Heating & Lighting Co., electric ignition for gas lamps. 1481

Safety Car Heating & Lighting Co., fixture for indirect car lighting. 1288*

Safety Car Heating & Lighting Co., indirect lighting 1529

Safety Car Heating & Lighting Co., lighting fixtures 1396*

Safety Car Heating & Lighting Co., regulator, type F. 1327*

Safety car heating & Lighting Co., thermo jet heating system. 1426*

Safety committee, C. & N. W., results of work 652†

Safety committee, P. R. R., work of. 652†

Safety committee, Vandalia. 579

Safety Congress, accidents in shops. 453*

Safety chain eyes, dies for making. 491

Safety committees appointed on various roads 381

Safety committees, Chicago & Western Ind. 381

Safety committees, New York Central Lines 165§

Safety devices, competition announced. 97†

Safety devices decrease accidents. 1367§

Safety devices on machine tools. 490

Safety of employees, address by H. W. Belnap 631*

Safety habit, by I. D. Kelly. 546†

Safety rally in Kansas City. 624*

Safety valves, adjusting, by C. L. Dickert. 1455§

Safety valves, calibration of. 1468*

Safety valves, report and discussion on. 196†

Safety valves, steam wasted at 458*

San Pedro, Los Angeles & Salt Lake, duplex water glass 584*

San Pedro, Los Angeles & Salt Lake, volute spring, designing. 118*

Sand blast apparatus, portable, C. & N. W. 338*

Sand dryer, Pennsylvania. 338*

Page numbers under 1,000 refer to *American Engineer*; those over 1,000 refer to the *Daily Railway Age Gazette*. * Illustrated article; § editorial; † short non-illustrated article or note; ‡ communication.

Santa Fe, accidents, prevention of..... 631
 Santa Fe, air washer and cooler..... 86*
 Santa Fe, change in pension rules..... 155†
 Santa Fe, change in length of working day..... 435
 Santa Fe, chemically treated water on..... 465
 Santa Fe, conservation of material..... 117
 Santa Fe, drawbar carrier for tenders..... 121*
 Santa Fe, dynamometer car..... 181*
 Santa Fe, electric headlights applied..... 652†
 Santa Fe, employees killed and injured in 1911..... 153†
 Santa Fe, enginehouse at San Angelo, Tex., destroyed by fire..... 601†
 Santa Fe, fewer injuries than in 1911..... 601†
 Santa Fe, fire losses..... 546†
 Santa Fe, locomotives on..... 500‡
 Santa Fe, locomotive, 2-8-0 type..... 517*
 Santa Fe, locomotive, 2-10-2 type..... 515*
 Santa Fe, locomotive, 4-6-2 type, balanced compound..... 517*
 Santa Fe, type locomotive (see locomotive, 2-10-2 type).
 Santa Fe organizes historical society..... 435
 Santa Fe, record mileage of locomotives..... 209†
 Santa Fe, shop kinks..... 643*
 Santa Fe, smoke abatement on switch engines..... 109‡
 Santa Fe, tool outfits, checking of..... 641*
 Sash clamp, adjustable, B. & M..... 573*
 Sash clamp, four sided, B. & M..... 574*
 Saw, cold metal, as a rotary planer..... 433*
 Saw, high speed metal..... 541*
 Saw, swing cutoff, B. & M..... 573*
 Sawdon, Prof., driving efficiency of pulleys..... 259*
 Schmidt, Prof. E. C., associate member M. C. B. Assn..... 1317
 Schmidt, Folbert, A., management of a drawing room..... 629
 Schmidt superheater, description of..... 244*
 Scientific management in a drawing room, by F. A. Schmidt..... 629
 Scott, W. W., shop supervision..... 402
 Scranton shops, water gas for furnaces..... 27*
 Scrap iron, reclaiming, rolls for..... 544*
 Scrap material, reclaiming..... 117
 Scrap material, reclaiming, competition on..... 273‡
 Scrap material reclaiming, report on..... 309
 Scrap, reclaiming, by C. H. Boges..... 410
 Scrap, reclaiming, by Wm. Hall..... 409
 Scrap, reclaiming, by T. H. Ogden..... 411
 Scrap, reclaiming, by W. L. W..... 124
 Scrap, reclaiming, car dept., by C. L. A..... 139
 Scullin-Gallagher Iron & Steel Co., blow-off valve..... 261*
 Scully, Jones & Co., "Wear Ever" drill socket..... 260*
 Seaboard Air Line, engine truck boxes with chilled faces..... 644*
 Seaboard Air Line, feed water heater..... 538*
 Seley, C. A., conference committee methods shaft coupling for motor drive..... 79
 651*
 Shaper (see machine tools).
 Shaper, motion, quick return crank, discussion of..... 43*
 Sheafe, J. S., relation of tests to shop efficiency..... 412
 Sheafe, J. S., report on standard coal analysis..... 306
 Shoes and wedges, flangeless, by C. D. Ashmore..... 599*
 Shonfelt-Vaughan fusible plug, by E. S. Dewey..... 637*
 Shop, boiler, tube department..... 357*
 Shop, coach repair at Beech Grove, Ind..... 171*
 Shop controversy settled on the Alton..... 546†
 Shop efficiency, report at Blacksmiths' Convention..... 454
 Shop, electric apparatus in, report on..... 591
 Shop electrification, by George W. Cravens..... 644
 Shop floor material..... 2
 Shop floors..... 2‡
 Shop furnaces, water gas for fuel..... 27*
 Shop improvements at Buffalo, P. R. R., by C. C. Leech..... 83*
 Shop improvements during 1911, prize winners..... 51‡
 Shop kink competition..... 107‡
 Shop kink contribution, a model..... 108‡
 Shop kink prize winners..... 2‡

Shop Kinks.

Air motor, extension bar for..... 223*
 Air pump crane, C. & N. W..... 118*
 Air pump glands, device for reboring..... 224*
 Air pumps, device for applying, Pennsylvania..... 639*
 Air reservoir hoist, B. & O..... 618*
 Axles, tongs for handling..... 361*
 Bits for boring in wood, B. & M..... 573*
 Bolt centering machine, Eastern Ry of N. M..... 188*
 Bolt, extension clamping, P. R. R..... 132*
 Bolt stripping machine, Bangor & Aroostock..... 451*
 Boring bar for bell stand, by E. L. Dudley..... 22*
 Boring mill, chuck for tires, G. T..... 344*
 Box for dirty waste, P. R. R..... 338*
 Brake shaft bearings, bending, B. & M..... 573*
 Brake shoe heads, removing..... 451*
 Bridge plates for shop hose..... 122*
 Brush, long handled paint, for freight cars..... 586*
 Caliper for boring driving boxes..... 279*

Shop Kinks (continued).

Car department, by W. H. Wolfgang..... 39*
 Car wheel flange gage, adjustable..... 362*
 Car for refuse and cinders..... 250*
 Carboys for paint vehicle..... 586*
 Carrier for cylinder head..... 279*
 Carrier irons, forging..... 40*
 Chuck for boring rod packing, by E. L. Dudley..... 22*
 Chuck for bull rings..... 76*
 Chuck for driving box brasses..... 178*
 Chuck for driving boxes..... 76*
 Chuck for metallic packing..... 346*
 Chuck for turning crown brasses..... 429*
 Clamp for crown brasses..... 278*
 Clamp for holding piston rods..... 525*
 Clamp for piston packing rings, Eastern Railway of France..... 634*
 Clamp for testing triple valves..... 522*
 Clamp, pneumatic..... 345*
 Contrast of different shops..... 42
 40*
 Crane for handling timber..... 248*
 Crank pin truing machine..... 250*
 Crosshead shoes, mold for tining..... 136*
 Crosshead shoes, reclaiming..... 639*
 Crow-bar support, Pennsylvania..... 225*
 Cutter for flue holes..... 225*
 Dies and formers for hooks, valve end rods, grate shaker rods, eye bolts, brake hangers, safety chain T's, grab irons, wedge plate and retaining rings..... 450*
 Dies for forging brake beam hangers..... 625*
 Dies for forging side-rod jaws..... 148*
 Dies for forming grab irons..... 74*
 Dog for driving wheel lathe..... 133*
 Drill twisting device..... 224*
 Driving box chuck, St. L. & S. F..... 178*
 Driving box liners, form for casting..... 223*
 Driving boxes, tongs for lifting..... 646*
 Dust remover for hair picking machine..... 514*
 Easel for paint shop..... 25*
 Eccentric blades, jig for, Santa Fe..... 643*
 Electric motor, portable, C. of G..... 256*
 Engine house, trucking system..... 188*
 Fire hose, tool for repairing..... 646*
 Flue swedging machine..... 188*
 Foreign machine for fire hooks..... 77*
 Forms for pouring shoe and wedge liners..... 370*
 Furnace for melting babbit, portable..... 198
 278*
 Gage for marking crown brasses..... 524*
 Gage for taper of piston rod keys..... 362*
 Gage for wheel fit..... 26*
 Glass cutting board..... 134*
 Grinding machine for angle cocks..... 618*
 Guard for chisel bars..... 430*
 Heater for preheating driving boxes..... 370*
 Holder-on for driving box flange rivets..... 224*
 Holder-on, pneumatic..... 362*
 Hook for lifting car wheels..... 123*
 Hydraulic press, 100 ton, B. & O..... 371*
 Jig for boring crown brass..... 361*
 Centering jig for car axles..... 371*
 Jig for machining hub liners..... 40*
 Journal box cooler..... 147*
 Lathe, brake for..... 147*
 Lever for operating overhead steam valves, P. R. R..... 135*
 Link grinding machine, C. & N. W..... 481*
 Lock for grease plug, C. C. C. & St. L..... 628*
 Lubricant for drills, relief valves..... 149*
 Machine for testing relief valves..... 147*
 Mold for casting hub liners, G. T..... 345*
 Molds for driving box hub faces..... 430*
 Mold for metallic packing rings..... 148*
 Nut facing machine attachment, G. T..... 346*
 Oil burner, portable, for heating cylinders, Can. Pac..... 197*
 Oil Torch, portable, Grand Trunk..... 344*
 Packing ring facing chuck..... 645*
 Pine rack..... 646*
 Piston packing, guide for entering in cylinder..... 561*
 Piston rod, wedge for separating in crosshead..... 561*
 Piston rods, jig for drilling, Can. Pac..... 560*
 Pistons, jig for lifting, Can. Pac..... 561*
 Platform for scrap material..... 39*
 Platform for steel car sides..... 39*
 Pneumatic drive for tool room, Eastern Ry. of N. M..... 189*
 Protractor for locating eccentric keyways..... 225*
 Quartering machine, automatic feed for Rack for coach doors, G. T..... 74*
 586*
 Rack for holding paint brushes, G. T..... 585*
 Rack for storing iron and steel stock..... 41*
 Rack in paint shop for signal blades..... 25*
 Radius attachment for slotting quadrants, C. C. C. & St. L..... 628*
 Reamer, countersinking, C. & N. W..... 412*
 Reamer for ball joints, C. & N. W..... 116*
 Removing yokes from couplers, Wabash Report at Blacksmiths' Convention..... 450*
 Rivet cutter, pneumatic, B. & O..... 122*
 Sand blast apparatus, portable, C. & N. W..... 118*
 Sand dryer, P. R. R..... 338*
 Sash clamp, adjustable, B. & M..... 573*
 Sash clamp, four sided, B. & M..... 574*
 Saw, swing cutoff, B. & M..... 573*
 Sheave for transfer table..... 41*

Shop Kinks (continued).

Side rod keys, chuck for planing, Santa Fe..... 643*
 Smoke box blower connection..... 248*
 Smoke stacks, clamp for handling..... 224*
 Table, revolving for painting, G. T..... 585*
 Tank for paint brushes..... 26*
 Tee head, device for applying, B. & O..... 618*
 Telephone pole, temporary, for wrecking crews..... 647*
 Tell-tale holes, jig for drilling..... 225*
 Template for drilling eccentrics..... 149*
 Templet for keyways, adjustable, by E. L. Dudley..... 22*
 Tire gage..... 248*
 Tire thickness gage..... 363*
 Tire transfer cart..... 308*
 Tire truck, P. R. R..... 338*
 Tires, mounting driving wheel, device for..... 225*
 Tongs for handling hot plates, B. & O..... 122*
 Tool bar for slotter..... 75*
 Tool for cutting packing rings, Eastern Railway of France..... 633*
 Tool, pneumatic for flaring boiler tubes..... 77*
 Tool post of slotting machine..... 70*
 Tools for piston packing, P. R. R..... 134*
 Truck for driving boxes..... 147*
 Truck for journal boxes, Can. Pac..... 197*
 Truck for mounted wheels, W. H. Wolfgang..... 39*
 Truck for rods or axles, Can. Pac..... 198*
 Truck for transporting tender wheels, C. & N. W..... 118*
 Valve, engineer's, reboring equalizing cylinders, L. & N..... 191*
 Valve setting machines, C. C. C. & St. L..... 627*
 Valves, foot, for air lines, P. R. R..... 133*
 Wheel boring mill attachment..... 362*
 Wheel gages, B. & M..... 574*
 Wheel lathe, attachment for drivers, St. L. & S. F..... 176*
 Wrenches, forging flat, G. T. P..... 489*
 Shop kinks, electric..... 188*
 Shop lighting, report on..... 593
 Shop practice and the small shop..... 108, 274‡
 Shop practice competition..... 332‡
 Shop practice, criticism of..... 108, 332‡
 Shop practice, improved, at Nashville, by W. G. Reyer..... 73*
 Shop safeguards, by W. H. Snyder..... 482*
 Shop scheduling and routing system..... 539
 Shop specialization, by W. T. Gale..... 402
 Shop supervision, by W. W. Scott..... 167*
 Shop, tank, cab and pilot, at Beech Grove..... 579
 Shops, accidents in, by Geo. Bradshaw..... 579
 Shops, car, analysis of machine tools, by L. R. Pomeroy..... 509*
 Shops, car repair, at Beech Grove..... 163‡
 Shops, clean and neat..... 441‡
 Shops destroyed by fire, C. B. & Q., at Creston, Ia..... 155†
 Shops, investigation of repair, resolution in Congress..... 97†

Storekeepers' Association Convention.

Election of officers..... 314
 Grain doors, standardization..... 314
 Line inspection..... 313
 Material, accounting and handling of..... 314
 Oil and waste..... 310
 Reclaiming scrap material..... 309
 Storer, N. W., electric locomotive design, problem of..... 569*
 Street locomotive stoker, improvements in Suez Canal, traffic in..... 116†, 584†
 Summers, E. W., tender derailments..... 513*
 Summers Steel Car Co., steel box cars..... 193*
 Summers Steel Car Co., truck, side bearing..... 194*
 Superheat, increased power obtained with, paper and discussion..... 1499*
 Superheated steam and boiler maintenance, report on..... 285
 Superheater locomotive discussion..... 1511‡
 Superheaters on switch engines..... 218‡
 Superheaters prove economical..... 2‡
 Superheated steam and the large locomotive..... 1447
 Superheated steam, by Gilbert E. Ryder..... 244*
 Superheated steam, lubrication with, foreign practice..... 189
 Superheater and brick arch, comparative test of, D. L. & W..... 543*
 Superheater, comparative tests of, on B. & P..... 529*
 Superheater, Emerson..... 589*
 Superheater, list of users..... 1283
 Superheater locomotives, maintenance of, report and discussion on..... 1518
 Superheater on locomotive No. 50,000..... 7*
 Superheater, relation to fuel economy, committee report..... 467
 Superheater, Schmidt, Santa Fe, 4-6-2 type locomotive..... 69*
 Superheater, test of, on Chicago & North Western..... 2
 Superheater tests..... 244*
 Superheaters and switch engines..... 1471
 Superheaters and low operating costs..... 1417
 Superheaters applied to old engines..... 1387
 Superheaters, number on different railroads of the world..... 1284

Page numbers under 1,000 refer to *American Engineer*; those over 1,000 refer to the *Daily Railway Age Gazette*. * Illustrated article; ‡ editorial; † short non-illustrated article or note; ‡ communication.

Superheaters on Mallets..... 1503
 Superheaters, temperature limits on..... 1483§
 Supply Association, election of executive members..... 1417

Supply Trade Notes.

Acme Supply Co..... 496
 Adams & Westlake Co..... 328
 Alexander Milburn Co..... 657
 Allen, Edgar, & Co., Ltd..... 270
 Allis-Chalmers Co..... 215, 385
 Allison, W. L., American Arch Co..... 438
 American Arch Co..... 438
 American Car & Foundry Co..... 657
 American Car & Foundry Co., Bixby, W. J..... 49
 American Mason Safety Tread Co..... 385
 American Railway Supply Co..... 270
 American Steel Foundries..... 161, 328
 Anderson, Stewart D., Standard Railway Equipment Company, obituary..... 553
 Ashton Valve Co., Gettrust, J. F..... 49
 Ashton Valve Co..... 328
 Askew, H. G..... 546
 Atkinson, C. J., Fairbanks, Morse & Co..... 657
 Austin, W. A., Lima Loco. & Mach. Co..... 385
 Auto. Refrigeration Co..... 496
 Automatic Ventilator Co..... 328
 Baker, E. H..... 105
 Baushe Mach. Tool Co..... 160
 Baxter, H. M., Kip Brush Co..... 270
 Beaghen, Thomas, Jr., Union Tank Line Co..... 271
 Best Mfg. Co., Evans, H. W..... 160
 Bethlehem Steel Co..... 552
 Biddle Hardware Co..... 49
 Booth, Chas., Chicago Pneumatic Tool Co..... 160
 Bowser, S. F., & Co..... 608
 Boye & Enmes Machine Tool Co..... 215
 Brady, James B..... 105
 Briggs, E. H..... 608
 Brownell Co..... 438
 Browning Engineering Co..... 270
 Buckingham, J. E..... 329
 Bucyrus Co..... 215
 Buffalo Brake Beam Company..... 552
 Buffalo Brake Beam Co., Edwin Strassburger..... 657
 Buffalo Foundry & Machine Co..... 270
 Burdick, E. L..... 496
 Burrows, W. R..... 49
 Burt, C. H., Robinson Coupler Co..... 657
 Buss, Frederick B., obituary..... 496
 Cambria Steel Co..... 270
 Cambria Steel Co., Donner, Wm. H..... 553
 Campbell, R. M..... 608
 Canadian Car & Foundry Co..... 328
 Canadian Gen. Elec. Co..... 608
 Canadian Locomotive Co..... 552
 Canadian Steel Foundries..... 438
 Carbon Steel Co..... 608
 Carseadin, C. A..... 608
 Case Crane & Engineering Co..... 496
 Central Loco. & Car Wks., H. F. Wardwell..... 160
 Chicago Bearing Metal Co..... 657
 Chicago Car Door Co., H. M. Percy..... 49
 Chicago Car Heating Co., F. P. Coggin..... 160
 Chicago-Cleveland Car Roofing Co..... 328
 Chicago Pneumatic Tool Co., Chas. Booth..... 160
 Chicago Pneumatic Tool Co., E. M. Richardson..... 160
 Chicago Railway Equipment Co..... 161
 Chicago Steel Car Co..... 438
 Chisholm, J. E..... 385
 Cincinnati Locomotive & Car Works..... 386
 Coggin, F. F..... 160
 Commercial Acetylene Co..... 608
 Connell, Wm. H., Jr..... 49
 Conradson, Dr. P. H..... 215
 Corbin, Wm. H., obituary..... 608
 Cornett, Gardner..... 270
 Crane, Chas. R..... 105
 Crane Company..... 657
 Crane, R. T., obituary..... 105
 Craig, E. A., Westinghouse Air Brake Co..... 160
 Crockier-Wheeler Co..... 105, 328
 Damascus Brake Beam Co..... 270, 160
 Darling, L. A..... 496
 Darwin, James R..... 438
 Davenport Locomotive Works..... 328
 Davis, A. E..... 438
 Davis, W. K..... 105
 Delancey, C. A..... 49
 Dickinson, Wm. H..... 608
 Dixon, Joseph, Crucible Co..... 271, 553
 Donner, Wm. H..... 385
 Dugan, R. A..... 270, 352
 Duncan, J. McCay..... 160
 Egan-Rogers Steel & Iron Co..... 160
 Ehrenhaft, A. H., Vulcan Engineering Sales Co..... 329
 Electric Locomotive & Car Co..... 657
 Evans, H. W..... 160
 Exhibit of Railway Supplies..... 162
 Fairbanks, Morse & Co., Cyril J. Atkinson..... 657
 Ford, Oscar R., obituary..... 160
 Fowler, Geo. W..... 105
 Frame, Robert E..... 270

Supply Trade Notes (continued).

Fries, J. E..... 328
 Fulton, S. T..... 162
 Gallagher, Thomas M., Scullin-Gallagher Iron & Steel Co., obituary..... 160
 General Electric Co..... 496
 Georgeson, J. T..... 385
 Gettrust, Jos. F..... 49
 Gill, John..... 439
 Gilmore, F. M..... 105
 Goodrich, B. F. Co..... 497
 Green, Samuel W. & Co..... 270
 Greenfield Tap & Die Co..... 271
 Griffin Car Wheel Co..... 496, 608
 Grip Nut Co..... 50, 160, 496
 Guggenheim, Benjamin, obituary..... 270
 Hagar, Edward M., Universal Portland Cement Co..... 329
 Harlan & Hollinsworth Corp..... 270
 Haskell & Barker Car Co..... 270, 328
 Hawley, C. S., Lacoma Car Co..... 215
 Heffelfinger, F. T., American Arch Co..... 438
 Heine Safety Boiler Co..... 496
 Hess-Bright Mfg. Co..... 496
 Higgins, Chas. C..... 497
 Hildreth & Co..... 328
 Holcomb Steel Co..... 496
 Hunt, Robert W., & Co..... 496
 Hunt-Spiller Mfg. Corp..... 328
 Independent Pneumatic Tool Co., W. A. Johnson..... 160, 608
 Independent Pneumatic Tool Co., W. A. Johnson..... 657
 Industrial Car Co., Electric Locomotive & Car Co..... 657
 Irwin, F. L., obituary..... 496
 Jacobs, H. W., Oxweld Railroad Service Co..... 497, 657
 Jacobs-Shupert U. S. Firebox Co..... 439
 Jaquette, W. O., Amer. Shop Equip. Co..... 553
 Jamison, C. R., Danville, Pa..... 657
 Janney, Eli H., obituary..... 386
 Jarvis-Adams, S., Pittsburgh Iron & Steel Foundries Co..... 657
 Jeffrey Manufacturing Co..... 496, 552
 Jenks, Chas. B., Edwin S. Woods..... 160
 Jerguson Manufacturing Co..... 438
 Jerome Metallic Packing Co., Wm. H. Dickinson..... 49
 Johns-Manville, H. W. Co., 105, 160, 385
 Johnson, J. Will, Pyle Nat. Elec. Headlight Co..... 49*
 Johnson, W. A., Independent Pneumatic Tool Co..... 657
 Joliet Ry. Supply Co..... 657
 Kay & Ess Co..... 438
 Keefe, J. J., obituary..... 657
 Keith Car Co..... 552
 Kelley, Wm. V..... 161
 Kelly Reamer Co..... 329
 Kennicott Co..... 328
 Kent, Frank J..... 385
 Kerr Turbine Co..... 552
 Kimball, D. G., Walcott & Wood Mach. Tool Co..... 105
 King, Henry C., American Safety Tread Co..... 552
 Kip Brush Co..... 329
 Kittredge, Arthur H..... 271
 Knight, S. S., Scullin-Gallagher Iron & Steel Co..... 160
 Kramer, LeRoy, Pullman Co..... 657
 Laconia Car Co..... 270
 Lake Superior Corporation..... 330
 Lamont, R. P., American Steel Foundries..... 161
 Langtim, R. L., Western Ry. Equipment Co..... 270
 Lantz, Jesse, obituary..... 215
 Lassiter, C. K., Baushe Machine Tool Co..... 160
 Lavis, Fred, Buenos Aires, Argentina..... 657
 Lawrence, W. H., H. W. Johns-Manville Co..... 105
 Lee, Chas. E., Commercial Acetylene Co..... 553
 Leech, C. C..... 105
 Lichtenhein, A., obituary..... 657
 Lillis, DeF., Grip Nut Co..... 106
 Lima Loco & Mach. Co..... 270, 385, 439
 Locomotive Equipment Co..... 160
 Locomotive Superheater Co..... 608
 Long, John H., United Engr. & Foundry Co..... 270
 Lucas, John, & Co..... 270
 Lyle, Chas. M., Niles-Bement-Pond Co. M.C.B. Company..... 105, 386
 Mack, I. W., obituary..... 270
 MacEnulty, I. F., Western Steel Car & Foundry Co..... 329
 Magnolia Metal Co., I. W. Wright..... 657
 Maley, Frederick, Alexander Milburn Co..... 215
 Manning, Maxwell & Moore..... 105
 Markham, Joseph T., St. Louis Car Wheel Co..... 552
 Marlotte, J. H., Jos. T. Ryerson & Son Marshall, William, obituary..... 105, 657
 Matthews, W. D., Canadian Gen. Elec. Co..... 608
 Meisinger, E. F. G., S. F. Bowser & Co..... 608
 Memphis, Dallas & Gulf..... 601
 Mesker, L. H., Manning, Maxwell & Moore..... 160

Supply Trade Notes (continued).

Mid-Western Car Supply Co..... 1328*
 Miller, E. A..... 45
 Mitchell, John..... 435
 Mitchell, John H., obituary..... 160
 Monarch Pneumatic Tool Co..... 105
 Monroe, J. M., Hunt-Spiller Mfg. Corp..... 328
 Moore, C. B., Jacobs-Shupert Co..... 439
 Moore Patent Car Co..... 496
 Muleahy, Frank J., obituary..... 496
 National Steel Car Co., Ltd..... 439
 National Tube Co..... 271, 608
 Newcastle Steel & Iron Co..... 496
 Niles-Bement-Pond Co..... 105, 270
 Niles Tool Wks. Co..... 160
 Norton, Paul T., Case Crane Engr. Co..... 496
 Nystrom, K. F., Acme Supply Co..... 496
 Odenheimer, J. M., B. Tilden Co..... 496
 Olin, Gibersin & Hilands, Inc..... 553
 O'Malley-Beare Valve Co..... 270
 Ontario & Western Car Co., Ltd..... 270
 Osborn, C. H., Mid-Western Car Supply Co..... 497
 Osbourn, Milliard P., Samuel W. Green & Co..... 270
 Osburn, B. N., Auto Refrigeration Co..... 496
 Owens, C. C., Westinghouse Elec. & Mfg. Co..... 215
 Owitz, Nathan, Wheeler Condenser & Engr. Co..... 270
 Oxweld Railroad Service Co., H. W. Jacobs..... 657
 Pearsall, Gilbert H., Jacobs-Shupert U. S. Firebox Co..... 439
 Pennsylvania Tank Car Co..... 270
 Percy, H. M., Chicago Car Door Co..... 439
 Permanent Mrs. Exhibit..... 49
 Peter Smith Heater Co..... 215
 Billiod Company..... 552
 Pittsburgh Iron & Steel Foundries Co., S. Jarvis-Adams Co..... 657
 Pittsburgh Testing Laboratory..... 385
 Porter, Howard K., U. S. Metal & Mfg. Co..... 329
 Post, Geo. A., Jr., Standard Coupler Co..... 161
 Pomeroy, L. R..... 50, 270
 Pratt & Whitney Co..... 552
 Prehn, Martin, Revolute Machine Co..... 215
 Pressed Steel Car Co..... 49
 Preston Car & Coach Co..... 552, 608
 Price, George, Flintkote Mfg. Co..... 329
 Prindle & Wright..... 160
 Pullman Co., Le Roy Kramer..... 657
 Pyle National Electric Headlight Co..... 49, 328, 608
 Pyrene Mfg. Co..... 496
 Quigley, W. S., Quigley Furnace and Foundry Co..... 329
 Quist, John S., M. M. Rogers Co..... 385
 Railway & Mill Equipment Co..... 105
 Railway Materials Co..... 270
 Railway Motor Car Co..... 438
 Railway Steel Spring Co., S. T. Fulton..... 162
 Ralston Steel Car Co..... 270, 496
 Reed-Prentice Co..... 270
 Reemer, F. D..... 328
 Reinhardt, C. W..... 215
 Remy Electric Co..... 160
 Replogle, Leonard J., Cambria Steel Co. Republic Iron & Steel Co..... 553, 608
 Richardson, E. M., Chicago Pneumatic Tool Co..... 160
 Riley, Willis L., Moore Patent Car Co..... 215
 Roberts & Schaefer Co..... 328
 Roberts & Shaefer Co., C. L. Wright..... 657
 Robison Coupler Co., C. H. Burt..... 657
 Ross, Coleman B., Independent Pneumatic Tool Co..... 160
 Ross, M. A., Pyle Nat'l Headlight Co..... 608
 Rowland, W. I. B. & O..... 327
 Rumsey Car Door & Equipment Co..... 657
 Ryan, Philip H., Amer. Steam Gauge & Valve Co..... 215
 Ryerson, Jos. T. & Son..... 105, 438
 Schlesinger, Ferdinand..... 328
 Scullin-Gallagher Iron & Steel Co..... 160, 270
 Scully, Jones & Co..... 214
 Sellers, Wm., & Co., Inc..... 328
 Sharp, W. E., V-P, Grip Nut Co..... 50
 Sheridan, Richard J., Chicago Ry. Equipment Co..... 553
 Sherwin, William, Co..... 328
 Smith, Abram E..... 271
 Smith, Robert M., Burton W. Mudge & Co..... 385
 Southwark Foundry & Machine Co..... 330
 Spencer, Otis, Co..... 105, 608
 Stalley, Geo. F., Browning Engineering Co..... 270
 Standard Coupler Co., Geo. A. Post, Jr..... 161
 Standard Railway Equipment Co..... 98, 105
 Standard Steel Works Co..... 105
 Stevens, Arthur J., Barney & Smith Car Co..... 385
 Stevens, F. H., U. S. Cast Iron Pipe & Foundry Co..... 438
 Stillman, F. H., Watson Stillman Co., obituary..... 161
 Storrs Mica Co..... 271
 Strassburger, Edwin, Buffalo Brake Beam Co..... 657
 Suffern & Son..... 497

Page numbers under 1,000 refer to *American Engineer*; those over 1,000 refer to the *Daily Railway Age Gazette*. * Illustrated article; § editorial; † short non-illustrated article or note; ‡ communication.

Supply Trade Notes (continued).

Symington, Chas. J., T. H. Symington Co. 329
 Symington, Harrison E., obituary 553
 Taylor & Arnold, Ltd. 160
 Templeton, Kelly & Co., Ltd. 438
 Thomas, C. E., Central Material & Construction Co. 270
 Tildin, B. E., Co. 496
 Titanium Alloy Manufacturing Co. 496
 Toledo Machine & Tool Co. 270
 Tripp, C. E., Westinghouse Elec. & Mfg. Co. 105
 Turner, Harry N., Kay & Ess Co. 438
 Union Draft Gear Co. 328
 Union Tank Line Co. 271
 United Car Co. 105
 United Engineering & Foundry Co. 270
 U. S. Metal & Mfg. Co. 329, 439
 United States Cast Iron Pipe & Foundry Co. 438
 Valentine, Henry C., Valentine & Co., obituary 105
 Vulcan Engineering Sales Co. 215, 329, 496
 Walcott & Wood Mach. Tool Co., D. G. Kimball 105
 Wallis, John Mather, obituary 271
 Ward, Morris E., Chicago-Cleveland Car Roofing Co., obituary 105
 Wardwell, H. F. 160, 496
 Warner & Swasey Co. 438
 Watson-Stillman Co. 105, 385, 329
 Wells Fargo Co. 385, 552
 Western Electric Co. 270
 Western Ry. Equip. Co. 160, 329
 Western Steel Car & Foundry Co. 105, 271, 496, 553, 657
 Westinghouse Air Brake Co. 608
 Wharton, Wm., Jr., & Co. 270
 Wheeler Condenser & Engineering Co. 160
 Whipple Supply Co. 161
 Williams, C. H., Chicago Ry. Equip. Co. 553
 Williams, Chas. P., National Lock Washer Co., Baldwin Locomotive Works 438
 Winterrowd, William H., Damascus Brake Beam Co. 270, 329
 Wolff, Herbert, Amer. Car & Foundry Co. 270
 Wood, Bowers & Co. 329
 Wood, Edwin S., Chas. B. Jenks 160
 Wood, Guilford S. 106
 Worcester, Edward, Jr., National Tube Co. 160
 Wright, C. L., Roberts & Shaefer Co. 657
 Wright, Edward E., McKean Motor Car Co. 329
 Wright, Frank G., Ohio Steel Foundry Co. 552
 Wright, J. W., Magnolia Metal Co. 657
 Wyles, T. R., Detroit Graphite Co. 215
 Supreme Court of the United States fellow servant decision 209†
 Switch engines, reducing smoke on, by D. R. McRain 583*
 Symons, W. E., value of variable exhaust nozzle 578

T

Table, revolving, for painting sash, G. T. 585*
 Tallman, C. H., report on oil and waste 310
 Tank cars, report and discussion on 1407
 Tashkent Railway, temperature tests in superheater 637*
 Tasmanian Railway, Garratt type locomotives 623*
 Taylor, W. O., report on oil and waste 310
 Technical journals, writing for 218§
 Telegraph lines, length of 600†
 Telegraph service record 438†
 Telegraph, wireless 237†
 Telephone pole, temporary, for wrecking crews 647*
 Tell-tale holes, jig for drilling 225*
 Temperature regulator, automatic, for cars 486*
 Tempering in an electric furnace, by B. Henrickson 426
 Template for drilling eccentrics 149*
 Tender, buffer, radial 489*
 Tender derailments, by E. W. Summers 513*
 Tender, drawbar carrier, Santa Fe 121*
 Tender journals, curved, Caledonian Ry. 36*
 Tender wheel lubricator, Buffalo & Susquehanna 459*
 Tenders, improvements in 108§
 Test of brakes at terminals, by F. B. Farmer 19
 Tests of temperature on superheater locomotives 637*
 Test of twist drills 568
 Test of 2-8-2 type locomotive, C. & O. 129*
 Testing department, drop test machine 51§
 Testing department, 60 ft. drop testing machine 91*
 Testing journal friction, machine for 1430*
 Testing locomotive boilers, rules for, B. & O. 520
 Testing machine for boiler tubes, B. & O. 484*
 Tests, boiler, low water 366*
 Tests of brake shoes, B. R. T. 164§
 Tests of freight locomotive, D. L. & W. 543*
 Tests of locomotive boilers 501§

Tests of locomotives in service, B. R. & P. 529*
 Tests, relation to shop efficiency, by J. S. Sheafe 412
 Tests, road, Mallet vs. consolidation, C. C. & O. 1476
 Texas Railway Commission, petition from strikers 209†
 Texas & Pacific, new motor cars 97†
 Timber, 102 ft. long, shipped on Pennsylvania 321
 Time study, repairing driving boxes 276*
 Time study, repairs to pistons, piston rods and crossheads 533
 Tinware, standardization of, report and discussion on 1518
 Tire gage, by C. C. Leech 248*
 Tire mandrel, C. & N. W. 413*
 Tire retaining rings, machining 343*
 Tire thickness gage 363*
 Tire transfer cart, C. & N. W. 308*
 Tire truck, Pennsylvania 338*
 Tires, contour of 1483§
 Tires, contour of, report and discussion on 1497*
 Tires, handling driving wheel 225*
 Tires, steel, report and discussion on 1501
 Tongs for handling car axles 361*
 Tongs for handling hot plates, B. & O. 122*
 Tonnage rating of trains, address of J. M. Daly 472
 Tool Foremen's convention, notes on 389§

Tool Foremen's Association Convention.

Care of shop tools 427
 Checking system for small tools 427
 Milling cutters and reamers 422
 Officers 428
 Standardization of carbon tool steel 425
 Tempering of tool steel in electric furnace 426
 Tool outfits, checking, on the Santa Fe 641*
 Tool room, pneumatic drive for Eastern Ry. of N. M. 189*
 Tool steel, standardization of carbon, by Henry Otto 425
 Totten, E. C., report on oil and waste 310
 Towels absorbent vs. waste 274§
 Tracings, filing and indexing, by E. G. Chenoweth 418*
 Tractive effort, chart for obtaining, by L. R. Pomeroy 611§
 Trailer truck, outside bearing 11*
 Train brake and signal equipment, report and discussion 1308*
 Train pipe and connections for steam heat, report and discussion 1404*
 Train lighting, regulator for electric 1327*
 Train lighting, report and discussion on 1386
 Train markers, P. & R. 641†
 Train resistance, Baldwin Locomotive Wks. formula 200†
 Train service in New York State in October 45†
 Train tonnage, address by J. M. Daly 472
 Trainmen laid off 265†
 Tramp, long distance ride of 601†
 Traveling Engineers' Association, subjects for 1913 478
 Traveling Engineers' convention 442§

Traveling Engineers Convention.

Address of President Hays 464
 Address of J. M. Daly 472
 Address of S. O. Dunn 463
 Address of B. A. Worthington 469
 Air brake equipment, handling long trains with modern 469
 Election of officers 478
 Fuel and lubricants, economical use of 473
 Inspection of locomotives 476
 Lead, advantages and disadvantages of 477
 Mechanical appliances, relation of, to fuel economy 467
 Water, chemically treated 465*
 Trespassing on railroads 1455§
 Triple valve, pneumatic clamp for testing, Louisville & Nashville 522*
 Triple valves, undesired quick action of 318
 Trolley car, stepless 395†
 Truck, Barber side bearing 147*
 Truck for driving boxes 197*
 Truck for journal boxes, Can. Pac. 198*
 Truck for rods or axles, Can. Pac. 198*
 Truck for transporting tender wheels, C. & N. W. 118*
 Truck for 100 ton flat car, P. & L. E. 126*
 Truck pedestal jaw, 75 ton capacity 1396*
 Truck side frames, rolled steel 375*
 Truck sides and bolster, specifications for, report and discussion on 1412
 Truck, Summers side bearing 194*
 Trucks, freight car 1368§
 Trucks, non-parallel axle 642*
 Trucks, springs for freight car, report and discussion on 1375*
 Trucks, Westchester steel cars 241*
 Tube cleaner, Matthews 1453*
 Tubes, care of locomotive, by Walter R. Hedeman 414*
 Tubes, maintenance of boiler 387§
 Tubes, prevention of leaking, rules for 417
 Tubes, repairing boiler 332§
 Tubes, rules for renewal, application and maintenance, by W. R. Hedeman 414*

Tube (see also Flues).
 Turbine blower for locomotive draft 301
 Turbine, improved, for headlight 206*
 Turbine, new type of steam 153*
 Turbine, remarkable steam 237†
 Turbines, steam, report on 592
 Turnbull, W. F., hints to draftsmen 196
 Turner, W. V., light and loaded brake equipment 315
 Turner, W. V., resolutions of appreciation to 315
 Tyrone shops, P. R. R., kinks from 338*

U

Underframe, 100 ton flat car, P. & L. E. 125*
 Union Pacific, fast run 45†
 Union Pacific, motion pictures used 381
 United States Bureau of Mines, bulletin No. 18 on transmission of heat into steam 490
 United States Civil Service, examination postponed 546†
 United States Metal Products Co., car seats 1327*
 University of Illinois, books presented to 435
 University of Illinois, gift for testing plant 652†
 University of Illinois, new buildings 324†
 University of Illinois, publishes addresses 435
 University of Pittsburgh, investigates smoke nuisance 602†, 435†
 Unloading machines, damage to freight cars by 1376*
 Utility steam hose coupler 1482*

V

Valve, blow-off, everlasting 261*
 Valve, blow-off, for locomotive, C. & N. W. 485*
 Valve gear, Baker 556§
 Valve gear, Baker, by R. S. Mounce 575*
 Valve gear, Baker, instructions for setting 577*
 Valve gear, guide for valve stem 9*
 Valve gear, independent cut-offs in compound, G. N. 589
 Valve gear, Walschaert, variable lead attachment on 379*
 Valve gears on compound locomotives 556§
 Valve packing rings, machining 116*
 Valve, piston, double ported, N. C. & St. L. 141*
 Valve rod ends, dies for making 450*
 Valves, safety, report and discussion on 1468*
 Vanadium exhibit at M. M. convention 1482
 Variable exhaust nozzle, Can. Pac. 349*
 Variable exhaust nozzles, value of 578
 Vaulain drill 566*
 Ventilation in a drawing room, importance of 630
 Ventilation, ozonized air for subway 264†
 Ventilator, exhaust for buildings 544*
 Verein Deutscher Ingenieure, meeting of 546†
 Veteran Association, N. Y. C. & St. L., annual meeting and dinner 546†
 Virginian Railway, locomotive, 2-8-8-2 type 287*
 Vokes, C. H., shop kinks 627*
 Vogle, W. S., address at fuel convention 290
 Volume of locomotive fireboxes 52§
 Volute springs, designing, by H. C. Weaver 584*
 Vulcan Engineering Sales Co., metal saw 650*

W

Wabash, fuel economy on 435
 Wabash, safety committees organized on 435
 Wages, increase in 1911 210†
 Wages, railway 343†
 Wages and earnings, increase on Pennsylvania 381
 Wagstaff, George, report on the brick arch 282
 Walker, J. W., report on undesired quick action of brakes 318
 Wanamaker, H., repairing driving boxes 429*
 Warfel, J. A., Oxy-acetylene cutting and welding 256
 Warner, Glenn, report on inspection of fuel 306
 Warner International and Overseas Engineering Co., Ltd., non-parallel axle truck 465*
 Warner, W. W., dust remover for hair picking machine 514*
 Waste, iron box for dirty, Pennsylvania 338*
 Waste, reclaiming of packing 311
 Waste vs. absorbent towels 274§
 Water, chemically treated, committee report on 465*
 Water consumption of Detroit 279†
 Water famine at the Isthmus 428†
 Water gage, Klinger 1450
 Water gage, Wilthonco, W. 649*
 Water gas, cost of, at Scranton 30*
 Water gas replaces oil for furnaces 27
 Water glass, duplex, Goodwin 458*
 Water stations, oil engines for 1424*
 Watertown Arsenal, Mass., examination for engineer of tests 490
 Watson-Stillman Co., hydraulic driving box press 72*
 Watson-Stillman Co., press for coupler yokes 486*
 Watts, N. J., locomotive painting 136
 Weather strip for passenger car windows 1453*
 Weaver, H. C., designing volute springs 584*
 Wedge, removing a stuck 56*
 Wedges, pressure on journal bearing 1280†
 Welding, electric, in railway shops, by O. S. Beyer, Jr. 57*
 Welding, oxy-acetylene, report at Blacksmiths' convention 453

Page numbers under 1,000 refer to *American Engineer*; those over 1,000 refer to the *Daily Railway Age Gazette*. * Illustrated article; § editorial; † short non-illustrated article or note; ‡ communication.

| | | | | | |
|--|-------|--|-------|--|------|
| Westbrook, M. H., repairing driving boxes. | 369* | Wheel grinding record..... | 1530 | Winslow boiler washing system..... | 18* |
| Westbrook, M. H., shop kinks..... | 343* | Wheel lathe attachment, St. L. & S. F.... | 176* | Winterrowd, W. H. (see also Personals). | |
| Westchester (see New York, Westchester & Boston). | | Wheel lathe, driving dog for, P. R. R.... | 133* | Wireless telegraph | 323† |
| Western Railway Club (see Meetings). | | Wheel load, effect on brake shoes..... | 316* | Wireless telegraph for aeroplanes..... | 306† |
| Western Weighing Association, new form of card | 265† | Wheel press, 600 ton car..... | 143* | Wolfgang, W. H., car department kinks... | 39* |
| Westinghouse Elec & Mfg. Co., locomotive, Southern Pacific | 581* | Wheel repair shop, C. C. C. & St. L., at Beech Grove | 175* | Wood, B. F., car lighting..... | 614 |
| Westinghouse exhibit at M. M. convention | 1508 | Wheels, car, report and discussion..... | 1312* | Wood working machines, analyses of, by L. R. Pomeroy | 509 |
| Westinghouse, PC equipment, report on.... | 318 | Wheels, solid steel truck and car..... | 109§ | Wood working tools for car shops..... | 501§ |
| Wheel boring mill attachment..... | 362* | Wheeling & Lake Erie, safety committees.. | 265† | Wooten firebox, 4-6-2 type locomotive.... | 395* |
| Wheel, driving, electric welding of..... | 61* | Whiting Foundry Equipment Co., locomotive hoist | 205* | Work reports, engineers' and inspectors'.. | 339* |
| Wheel flange gage, adjustable..... | 362* | Whittington, J. H., coach cleaning..... | 85 | Workmen's compensation law, I. C., first settlement | 490 |
| Wheel flange lubrication, report and discussion on | 1513* | Wilkins, O. P., paint storeroom practice... | 192* | Worthington, B. A., address at Traveling Engineers' convention | 469 |
| Wheel gages, B. & M..... | 574* | Wilmarth & Norman Co., grinder..... | 601* | Wrenches, forging flat, by Sam Lewis..... | 489* |
| | | Winnipeg shops, repairing driving boxes at | 276* | | |

Page numbers under 1,000 refer to *American Engineer*; those over 1,000 refer to the *Daily Railway Age Gazette*. * Illustrated article; § editorial; † short non-illustrated article or note; ‡ communication.

AMERICAN ENGINEER

"THE RAILWAY MECHANICAL MONTHLY"

(Including the Railway Age Gazette "Shop Edition.")

PUBLISHED ON THE FIRST WEDNESDAY OF EVERY MONTH, BY THE
SIMMONS-BOARDMAN PUBLISHING COMPANY,
83 FULTON STREET, NEW YORK, N. Y.

CHICAGO: Plymouth Bldg. CLEVELAND: New England Bldg.
LONDON: Queen Anne's Chambers, Westminster.

EDWARD A. SIMMONS, *President*. HENRY LEE, *Secretary*.
L. B. SHERMAN, *Vice-President*. A. E. HOOVEN, *Business Manager*.

The address of the company is the address of the officers.

ROY V. WRIGHT, *Editor*. R. E. THAYER, *Associate Editor*.
E. A. AVERILL, *Managing Editor*. WILLIAM FORSYTH, *Associate Editor*.
GEORGE L. FOWLER, *Associate Editor*.

Subscriptions, including the eight daily editions of the *Railway Age Gazette* published in June in connection with the annual conventions of the Master Car Builders' and American Railway Master Mechanics' associations, payable in advance and postage free:

United States, Canada and Mexico\$2.00 a year
Foreign Countries (excepting daily editions)..... 3.00 a year
Single Copy 20 cents

Entered at the Post Office at New York, N. Y., as mail matter of the second class.

VOLUME 86. JANUARY, 1912. NUMBER 1.

CONTENTS

EDITORIAL:

| | |
|---|---|
| Study Foreign Practice..... | 1 |
| Our General News Section..... | 1 |
| Another Shop Kink Competition..... | 1 |
| Locomotives Need More Lungs..... | 1 |
| Competition on Reclaiming Scrap Material..... | 2 |
| Reducing Engine Failures..... | 2 |
| Shop Kink Prize Winners..... | 2 |
| Superheaters Prove Economical..... | 2 |
| Railway Shop Floors..... | 2 |
| The American Engineer..... | 3 |
| New Books..... | 4 |

ILLUSTRATED:

| | |
|--|----|
| Experimental 4-6-2 Type Locomotive..... | 5 |
| Layout of a Spiral..... | 14 |
| Standard Practice Cards on the Erie..... | 15 |
| Boiler Washing System..... | 18 |
| Shop Kinks..... | 22 |
| Engine Failures and Their Elimination..... | 23 |
| Paint Shop Kinks..... | 25 |
| Locomotive Rod Brass..... | 26 |
| Water Gas Replaces Oil for Furnaces..... | 27 |
| Interesting Designs from Abroad..... | 35 |
| Indirect Lighting for Railway Cars..... | 37 |
| Car Department Kinks..... | 39 |
| New Designs of Piston..... | 42 |
| Quick Return Crank Shaper Motion..... | 43 |

MISCELLANEOUS:

| | |
|--------------------------------------|----|
| Railway Mechanical Associations..... | 13 |
| Terminal Brake Testing..... | 19 |
| Freight Car Painting..... | 21 |
| A Contract..... | 42 |
| Handling Apprentices..... | 43 |

GENERAL NEWS SECTION:

| | |
|-------------------------------|----|
| Notes..... | 45 |
| Meetings and Conventions..... | 46 |
| Personals..... | 47 |
| New Shops..... | 49 |
| Supply Trade Notes..... | 49 |
| Catalogs..... | 50 |

Study Foreign Practice

Experience in the past has shown that there are many features of locomotive and car design and arrangement in common use on foreign railways which can be adapted to American conditions with great advantage. The Walschaert valve gear and the superheater are prominent recent examples. While we have looked on the French and German railways as being the source of the most advanced practice, the English and Scottish roads should by no means be overlooked. This is indicated by some of the minor details on the Caledonian Railway of Scotland described by Mr. Hodgins in an article on another page.

Our General News Section

With the widening of the scope of the work of the *American Engineer* it has seemed wise to enlarge the field covered by the news items and to include them in a section by themselves. While the General News Section in this first issue of the new *American Engineer* is not perfect, and falls far short of the ideals of its editors, still it gives a fair idea of what we are trying to accomplish. To make it a real success we shall need the hearty co-operation of our readers. We shall greatly appreciate prompt advice as to all changes or promotions in the motive power department and for items of interest concerning new shops and engine houses, or for information concerning the addition to or rebuilding of old shops or repair plants. Also for any other items which may be included in the news department.

Another Shop Kink Competition

A shop kink competition will be held, to close March 15, 1912. A first prize of \$50 will be awarded for the best collection of three kinks, and a second prize of \$25 will be given for the next best collection. Any kinks or labor saving devices used in the maintenance of equipment in the mechanical department will be eligible. Each kink should be clearly described, both as to its construction and operation. In most cases it will be necessary to use illustrations in order to bring out these points properly, and these illustrations may consist of either blue-prints, drawings, pencil sketches or photographs. More than three kinks may be submitted in a collection, allowing the judges to base their decision on what they consider to be the best three in each collection. The kinks need not necessarily have been devised by the party who submits the descriptions, but, as far as possible, the name of the parties responsible for their design should be mentioned. Kinks not awarded a prize, but accepted for publication will be paid for at our regular rates.

Locomotives Need More Lungs.

A locomotive designer when asked concerning the future of the high speed, heavy passenger locomotive said: "The present types are satisfactory, if they had more 'lungs.'" More lungs, however, means more weight, and the limitations of axle loads make it impossible to go very far with mere size. Believing, however, that the possibilities of the Pacific type locomotive had not yet been exhausted, the American Locomotive Company has at its own expense designed and built a locomotive for the purpose of obtaining information as to the exact possibilities in this direction. It desired to see what could be done toward obtaining a maximum power per unit of weight with conservative axle loads, and has built No. 50,000 with an average of 57,500 lbs. per pair of drivers. The object throughout was by the use of the most careful designing and of the very best materials to reduce the weights of the running gear so far as possible and use the weight thus saved in the boiler. Then, by the application of a knowledge gained by a long experience, to proportion the boiler to give the greatest output and to use approved fuel saving devices as far as practicable. This locomotive has been in service for some time, and has

clearly demonstrated its superiority for high speed work over all other Pacific types. It has developed an indicated horse power for each 121.4 lbs. of total weight, which probably stands as a record, in this country at least. Even in this short time the effect of the service of this locomotive is noticeable in the latest designs being built for the various railways, and the American Locomotive Company is to be commended for its aggressive and broad minded action.

Competition on Reclaiming Scrap Material

A competition on this subject, held last summer, brought out some splendid papers, but the subject is such a big and important one that much still remains to be said, and so we have announced another competition on the same subject to close February 15, 1912. A prize of \$35 will be awarded for the best paper on the subject, and a prize of \$20 for the second best. Tell us clearly just how you have gained results in reclaiming scrap or second-hand material, and what the net results were. Can the work of reclaiming scrap be carried too far? Are the services of an efficiency engineer necessary in order to know where to begin and when to stop? Will it do any good to educate the men to realize the value of the materials which they work with, and how can it best be done? There are a hundred different ways in which the subject may be treated. Articles not awarded a prize, but accepted for publication will be paid for at our regular space rates.

Reducing Engine Failures

It is suggested by Mr. Cordeal in his paper on this subject, page 23, that investigation of the causes of each engine failure should be continued until the blame is placed directly on the shoulders of some person or persons, either the builders, the designer, the train despatcher, engine house foreman, engineer, workman, or whoever may be at fault. In this way it is believed, by means of the proper publicity given to the reports that all concerned will be more careful to avoid any possibility of the blame resting on them, and also that the tabulating of information obtained from these investigations will permit a quicker and more accurate correction of parts poorly designed or built of poor material. Mr. Cordeal's ideas are based on principles which have worked very successfully in other lines, and there would seem to be no reason why they should not be equally valuable in connection with this very important feature.

Shop Kink Prize Winners.

Ninety-three shop kinks were submitted in the competition which closed September 15, 1911. Ordinarily the prize winners are announced in the first issue following the close of the competition. In this instance the judges were unable to report sooner. The first prize of \$50 has been awarded to R. E. Dette, foreman of the South Pittsburgh machine shop of the Pennsylvania Railroad, at Pittsburgh, Pa. The second prize of \$25 was awarded to H. L. Burrhus, assistant to the general foreman of the Erie Railroad, Susquehanna, Pa. The other competitors, many of whose contributions were in the prize winning class, and all of which have been accepted for publication, were C. L. Dickert, assistant master mechanic, Central of Georgia, Macon, Ga.; C. J. Drury, master mechanic, Eastern Railway of New Mexico and the Southern Kansas Railway Company of Texas, Amarillo, Tex.; W. T. Gale, shop demonstrator, Chicago & North Western, Chicago, Ill.; J. A. Jesson, air brake foreman, Louisville & Nashville, Corbin, Ky.; C. C. Leech, foreman, Pennsylvania Railroad, Buffalo, N. Y.; Walter B. Lyons, apprentice instructor, Atchison, Topeka & Santa Fe, Topeka, Kans.; E. T. Spidy, assistant general foreman, Canadian Pacific, West Toronto, Can.; M. H. Westbrook, Battle Creek, Mich. and W. H. Wolfgang, Toledo, O.

Superheaters Prove Economical

Reports of service tests of locomotives, equipped with the high degree superheaters of the Schmidt type, have been universally very favorable as concerns the saving of coal and water, which is only another way of saying increased capacity of the locomotives. On the Chicago & North Western the service of the passenger engines fitted with Schmidt superheaters has proved very satisfactory and freight locomotives are now being so equipped at the rate of about 40 per month. A test was made last spring on two superheater freight engines of the consolidation type, comparison being made with two of the same class engines without the superheater. The boiler pressure in both cases was 170 lbs., the cylinders measured 25 in. x 32 in., the driving wheels 69 in. in diameter and the non-superheater engines had 436 2-in. flues and a total heating surface of 2,657 sq. ft. The superheater engines had 261 2-in. flues and 36 5 $\frac{3}{8}$ -in. flues, giving an evaporative heating surface of 3,629 sq. ft., and a superheating surface of 610 sq. ft.

The tests were made on the Iowa division between Belle Plaine, Iowa, and Boone, a distance of about 85 miles. A dynamometer car was used, but the locomotive was not indicated and all figures for horse power are on the basis of the dynamometer car records. The average for the superheater engines against the non-superheater gave a saving of 27.51 per cent. in coal per horse power hour in one direction and 23.78 per cent. in the opposite direction. The water saving was somewhat larger, being 31.19 per cent. and 30.30 per cent., respectively.

Careful examination of the data of these tests indicates that these figures are probably too high, owing to the fact that in both cases the non-superheater engines were longer on the side track and as the coal wasted in this way was not subtracted from the total amount, it gives them slightly too high figures in these particulars. On equal time basis, the tests indicate that the ton-miles per ton of coal were increased somewhat over 20 per cent. on the superheater engines.

This result checks very well with other tests that have been published, where the non-superheater engine was being worked within its capacity. In cases where the comparison is made between the heaviest load the saturated steam and the superheated engines will handle over the road without stalling, the full advantage of the superheater is much more evident, as one of its most prominent characteristics is a continually increasing efficiency as greater demands are made upon it.

Railway Shop Floors

There appears to be almost as much difficulty in obtaining a satisfactory floor for railway shops as there is in making a roadway covering which will resist the wear of automobile traffic. There is such a degree of similarity in the requirements for the surface of shop floors and roadways that something may be learned from experience in road building which may be profitably applied to floor construction. The necessity for further investigation is seen in the failure of the floors in two large new erecting shops where maple covering has been used and where no expense was spared to secure a permanent and satisfactory floor. The mistake has been made in treating the whole locomotive shop as a unit and in using wooden flooring in all departments.

While maple flooring may answer for dry shops where there is slight abrasion and little warping, it has failed completely in the erecting shops where the surface is frequently wet from boiler testing and is subject to considerable wear from the rough handling of heavy castings. The thin boards have warped so badly that they have split and broken, creating a surface which is the very opposite of what a good floor should be. It takes but a short time for a thin wood floor covering of the best material to be badly injured by moisture. In one of the shops referred to the floor has been laid less than a year and now requires repairs or replacement; in the other not only has the

surface failed, but the bedded timber, to which the maple flooring was nailed, has decayed in 4 years so that there is no solid foundation on which to build up a new floor. These timbers may fail from dry rot even where there is little or no surface moisture. When laid on cinder they settle so that the surface is not level, and when bedded in concrete they shrink, leaving an air space, and the floor is not then fireproof. If a wood floor is used in a dry shop the supporting timbers should be treated to prevent decay and the foundation should be concrete. While such a floor may answer for light machinery and where there is little wear, it cannot be regarded as satisfactory for the rough service of a locomotive shop.

In the search for a better material concrete has been recommended, as it has the advantages of being fire and water proof, it will not decay and the general surface is well maintained, but with this also a special surface is required where the heaviest work is done. The advantages and disadvantages of concrete floors for machine shops were considered in a paper on Factory Construction by L. P. Alford, which was published in the *Journal of the American Society of Mechanical Engineers*, October, 1911. The paper states that in those sections containing the largest machine tools and receiving the heaviest castings the concrete floor should have a special surface by adding $1\frac{1}{2}$ in. of a 1 to 2 granolithic mixture. The first cost of the granolithic floor surface is about the same as that of the $\frac{7}{8}$ -in. maple flooring, but in order to make it sufficiently durable to resist the rough usage of the machine shop it must be made of hard material with a high percentage of tough elastic aggregate, so that the wear due to trucking is borne almost exclusively by the aggregate itself. The finish need not be over $\frac{3}{4}$ in. thick, but it is important that the granolithic surface should be laid on the floor slab while the latter is still green, a condition difficult to obtain in railway shop construction.

While a hard concrete floor is desirable to resist wear, it is objectionable on account of the damage to machine parts and hand tools which may drop on it, and the floor itself is also likely to be damaged in this way. It also crumbles at the edges of cracks and wears holes where there are soft spots subjected to heavy pressure. Repairs in such places have been made by avoiding the use of cement and substituting an asphaltum mixture which is applied to the surface in a plastic condition and is then bonded to the concrete by heating with a gasoline blow torch. Another objection to the concrete floor is its apparent coldness—most railway shop floors are in contact with the ground. As concrete is a better conductor of heat than wood a cold concrete floor will withdraw bodily heat from the feet of the workmen, but if the shop is well heated the floor will become nearly as warm as the surrounding air, and for workmen who move about at their work there should be little objection to concrete on this account. Where the men stand in one place at machine tools it is desirable to provide a small wood platform for their comfort. In a recently built locomotive shop a cement concrete floor is used for the tank shop, and the car truck shop is furnished with diamond steel plates $\frac{3}{8}$ -in. thick laid on the concrete and held by countersunk bolts with expanding nuts embedded in the concrete.

While the concrete and granolithic surface will be found satisfactory for the machine shop it is not suitable for the erecting shop, where its waterproof qualities should recommend it, the principal objection being that it disintegrates by the rough handling of heavy castings and forgings, and it injures the finished machinery and hand tools which fall on it. It is possible that a concrete made of fine, hard stone with an asphalt binder could be used for the surface finish of the floors of erecting shops and engine houses, and would have sufficient hardness to resist wear and would also possess the slight elastic quality which would overcome the objectionable injury to machinery and tools above referred to.

The experience in making roads for automobile traffic should

help in solving this problem. As we have shown that the thin maple flooring and the concrete with cement surface are not satisfactory for erecting shop floors, there remains another kind of roadway material which appears to have the desirable qualities, and that is the creosoted wooden block laid on end. If these blocks are laid on a good concrete foundation and thoroughly waterproofed they should meet all requirements. We believe that creosoted wood blocks have not been used heretofore for shop floors, and their use is recommended especially for engine houses and erecting shops where a waterproof and yielding floor is required and where most other materials have failed. It is true that wood blocks have been used for shop floors and when kept dry have been satisfactory, but when the floor is wet the wood swells, and the surface is bulged or the tracks are forced out of gage. A wood block floor properly waterproofed would not act in this way, as is demonstrated by its action when used as street paving. Here the blocks are constantly exposed to rain and extremes of heat and cold, but the surface remains smooth.

While thin wood floors may answer well for dry shops and concrete for wet ones, where they are exposed to light loads and slight abrasion, they are not suited to the unusual requirements of engine houses and erecting shops; for such places creosoted wood blocks laid on end may be recommended as the best material.

The American Engineer

While the first locomotive to be operated on rails in this country was imported from England in 1829, because of the fact that it was not successful, it is believed that the credit for the first locomotive in the country should be given to Peter Cooper's "Tom Thumb," which was successfully operated on the Baltimore & Ohio in August, 1830. About 15 months later the first railway paper in history—*The American Railroad Journal*—made its appearance, being published by D. K. Minor at 35 Wall street, New York. Although the first issue bore the date of January 2, 1831, it was evident from the future issues of the same volume that this was a typographical error and should have been January 2, 1832. This journal antedated its nearest contemporary in the same field by at least 3 years.

It is stated by the publisher in the first issue that "the principle object in offering the proposed work to the public is to diffuse a more general knowledge of this important mode of internal communication which at this time appears to engage the attention of almost every section of our country." The paper was published weekly, and in addition to the articles on railways, it also contained considerable literary, miscellaneous and news matter. A notice of a locomotive built by Bursom & Co., of Philadelphia, appeared in the first issue, and it was stated that this locomotive, "is as simple as a common cart or wheelbarrow," and "works complete and justifies the belief that it will outrun the far famed 'Rocket' and 'Novelty.'"

The heading of the first edition was an illustration of the Novelty attached to a carriage for passengers of a size to accommodate 18 persons inside. This heading was changed the next year and in the third year it was again changed, showing a view of the "Philadelphia," built at the West Point Foundry Works for the Philadelphia, Norristown and Germantown Railway. It was shown attached to a freight car, a passenger coach and a flat car carrying a private carriage, which it is stated, "indicates the advantages and facilities that may be enjoyed by the inhabitants living in the vicinity of railroads."

At the start, each number contained 16 pages, and during the first two years it had a fairly prosperous appearance, but in 1834 it was announced that it was not paying expenses, and in 1835 it was stated that a larger number of patrons must be obtained. It apparently existed in some manner until 1837, when Mr. Minor associated himself with George C. Schaeffer. In August

of that year, however, publication was suspended, and the September and subsequent numbers did not appear. In July, 1838, it was revived, the *Mechanic's Magazine* being combined with it, and the title was changed to *American Railroad Journal and Mechanic's Magazine*. In June, 1839, Mr. Minor disposed of his interest to Egbert Hledge. In 1843, however, he apparently again became interested in it, as his name appears on the title page, with that of Mr. Schaeffer, as one of the editors and proprietors. In November, 1844, it was announced that on the first of January, 1845, the journal would again be issued in its original form of 16 pages, which has apparently been reduced. It was also stated that when the journal was first started "the details of construction occupied the prominent place, whereas now the management of railways, their cost, income and dividends will especially receive our attention."

In November, 1846, the office of the publication was moved to Philadelphia, but in January, 1849, it was again returned to New York, and Mr. Minor disposed of his interest in it to Henry V. Poor, who was its editor until 1862. In 1849 the name of John H. Schultz and Co. appears on the title page as publishers. Mr. Schultz retained an interest in the paper until 1882, and then another company was organized to publish it with George F. Swain as president. From that date it was conducted by a number of different editors until October 1, 1886, when it was purchased by N. M. Forney, whose name appears on the title page as editor and publisher. In January, 1887, it was consolidated with *Van Nostrand's Engineering Magazine* under the title of the *Railroad and Engineering Journal*, Mr. Forney being the sole proprietor.

On January 1, 1893, the name was changed to the *American Engineer and Railroad Journal*, and the title page contains the names of N. M. Forney as proprietor and editor, Frederick Hobart as associate editor, and Frank J. French as business manager. It was stated in this issue that Mr. Chanute's articles on the progress of flying machines would be continued and concluded in that volume.

Another change in ownership took place on January 1, 1896, when Mr. Forney disposed of his interests to R. M. Van Arsdale, who for a number of years previous had published the *National Car and Locomotive Builder*. The two papers were consolidated under the title of the *American Engineer, Car Builder and Railroad Journal*, Mr. Forney continuing as editor, and Waldo H. Marshall became associate editor. George H. Baker, who had been editor of the *National Car and Locomotive Builder* for the four years previous, retired at this time. For the first six months of 1896 it was published on the $9\frac{1}{2} \times 14$ in. type page of the *National Car and Locomotive Builder*, but in June it was changed to its previous and present standard size.

Mr. Van Arsdale continued as its proprietor up to the time of his death, November 23, 1909. He shortened the name to its previous form—*American Engineer and Railroad Journal*—on June 1, 1899. On June 1, 1897, Mr. Forney retired from active service and Mr. Marshall resigned to take the appointment of assistant superintendent of machinery, Chicago & North Western Railway. G. M. Basford, who at that time was an editor on the *Railway Review* at Chicago, became editor. Mr. Basford remained as editor until October, 1905, when he was succeeded by R. V. Wright, who continued in charge of the editorial department until March, 1910. On Mr. Van Arsdale's death, the publication was continued by R. M. Van Arsdale, Inc., of which Mrs. Van Arsdale was president and J. S. Bonsall, who for the previous 12 years had been business manager, was vice-president and general manager.

With this issue a new era is begun. As was announced in the December number, the property has been purchased by the publisher of the *Railway Age Gazette*, and the *American Engineer* will now include the matter which has previously appeared once each month as the Shop Section of the *Railway Age Gazette*, in addition to its usual articles on other

activities of the mechanical or motive power department.

The Shop Edition of the *Railway Age Gazette* was started October 1, 1909. That number contained part of the results of the first shop kink competition, which had been announced in the issue of August 27. The idea met with so much appreciation that the scope of the work was gradually extended, and a few months later all of the mechanical material in the first issue of the month was grouped together in a section of the paper, known as the Shop Section.

The work of this department increased in importance to such an extent that it was decided by the publisher of the *Railway Age Gazette* to purchase the *American Engineer & Railroad Journal* and combine it with the Shop Section. Hence the following announcement in the December, 1911, Shop Section: "The reason for this change is that our work in the interests of shop efficiency and economy has grown to such proportions that the results, when reduced to type, have become too great a burden for any one issue of the *Railway Age Gazette*. Again, our plans for the future with respect to mechanical department problems that must necessarily be covered thoroughly in the columns of the *Railway Age Gazette*, because of their value and interest to officers in other departments, influenced the change."

Motive power department problems, interests and activities in all of their different phases and sub-divisions will be the field of the *American Engineer*. The plans of the editors are for a continual growth along the lines already clearly marked to those familiar with the two publications now combined in it.

NEW BOOKS

Proceedings of the Third Annual Convention of the International Railway Fuel Association, held at Chattanooga, Tenn., May 15, 1911. Secretary, D. B. Sebastian, fuel agent, Rock Island Lines, La Salle Street Station, Chicago. 238 pages. Price, paper, 35 cents; cloth, 75 cents.

The growing importance of the Fuel Association is indicated by the valuable papers relating to locomotive fuel published in this volume of the proceedings of the third annual convention. The secretary reports that the membership is now 367, showing a gain of 116 members. The list of papers is as follows: Fuel Investigation under the Bureau of Mines, by J. E. Holmes; Organization of a Railway Fuel Department, by T. Duff Smith, fuel agent, Grand Trunk Pacific; The Use of Petroleum for Locomotive Fuel, by Eugene McAuliffe, fuel agent, Frisco Lines; Purchase of Coal on a Mine Run Basis, by A. A. Steel, professor of mining at the University of Arkansas; Railway Fuel in Relation to Railway Operation, by R. Emerson; Testing of Locomotive Fuel, by F. O. Bunnell, engineer of tests, Rock Island Lines.

Proceedings of the Master Car and Locomotive Painters' Association. 136 pages. 6 in. x 9 in. Secretary, A. P. Dane, Reading, Mass.

The proceedings of the forty-second annual convention, held at Atlantic City, N. J., September 12 to 15, have recently been issued. As is usual it contains a list of the members of the association, mentioning those present at the last convention. This convention was one of the best the association has held for a long time, and the committees are to be congratulated upon the very complete reports presented. Among the interesting topics are the reports of the Information Committee, Test Committee, the papers on the Best Method of Finishing the Interior of Steel Passenger Cars, the essay on the Value of Chemical and Practical Tests of Railway Paint Shop Materials and papers on the Experience and Suggestions as to How Other Departments May Hinder or Help the Paint Department. The complete addresses given by F. W. Brazier and Eugene Chamberlain, both of the New York Central Lines, are included. An account of this convention was given in the Shop Section of the *Railway Age Gazette* for October 1, 1911.

EXPERIMENTAL 4-6-2 TYPE LOCOMOTIVE

Pacific Type Locomotive No. 50,000 Designed and Built by the American Locomotive Company at Its Expense Has Developed in Actual Service 1 Horse Power for Each 121.4 lbs. Total Weight. Twenty-five Per Cent. More Efficient than the Ordinary Pacific Type Locomotive.

Desiring to determine the limits to which the efficiency and capacity of a passenger locomotive of standard wheel arrangement could be developed without exceeding conservative weight limitations, the American Locomotive Company designed and built at its own expense locomotive No. 50,000 which in its own field of service marks as striking an advance in locomotive construction as did the Mountain type of the Chesapeake & Ohio.* Maximum sustained capacity per unit of weight was the object of the designers and advantage was taken of the latest approved developments in locomotive design and of fuel saving devices. It embodies the latest knowledge of proportions and improvements in the design of details, combined with the use of the very best materials obtainable.

In working up the design the builders were untrammelled by any outside specifications, or the necessity of conforming to any railway's existing standards, and thus had a free hand to embody their ideas of the best locomotive engineering practice. This is probably the first instance in the history of American locomotive development in which locomotive builders on their own initiative and at their own expense have constructed a locomotive—not to introduce a new principle—but to secure information as to the maximum possibilities in economy and capacity inherent in already accepted principles with the view of advancement of locomotive design. As might be expected the de-

wheel loads. The result of this is particularly striking in connection with the cylinders in which vanadium cast steel was used with cast iron bushings in the cylinder and valve chambers, resulting in a saving of about 4,000 lbs. as compared with cast iron cylinders having inside steam pipes. Also with the trailer truck where a saving of nearly 3,000 lbs. was effected by improved design. Again the use of the pressed steel bumper beam and pilot saved 1,500 lbs. as compared with the cast steel bumper

| Parts. | Weights. | |
|---------------------------|------------|------------|
| | 50,000. | Loco. X. |
| Frame cross ties (2)..... | 1,380 lbs. | 1,630 lbs. |
| Link supports | 1,014 lbs. | 1,350 lbs. |
| Link yoke | 720 lbs. | 1,058 lbs. |
| Link yoke bracket | 180 lbs. | 540 lbs. |
| Bumper bracket | 1,150 lbs. | 1,580 lbs. |
| Equalizer fulcrum | 554 lbs. | 1,148 lbs. |
| Front bumper | 575 lbs. | 1,750 lbs. |
| Pilot | 343 lbs. | 700 lbs. |

beam and wooden pilot. Similar methods were followed throughout the whole design, as is illustrated in the accompanying table, with the most gratifying results, not only in saving of weight, but of actual improvement and strengthening of the various details.

As an indication of what was accomplished in saving weight

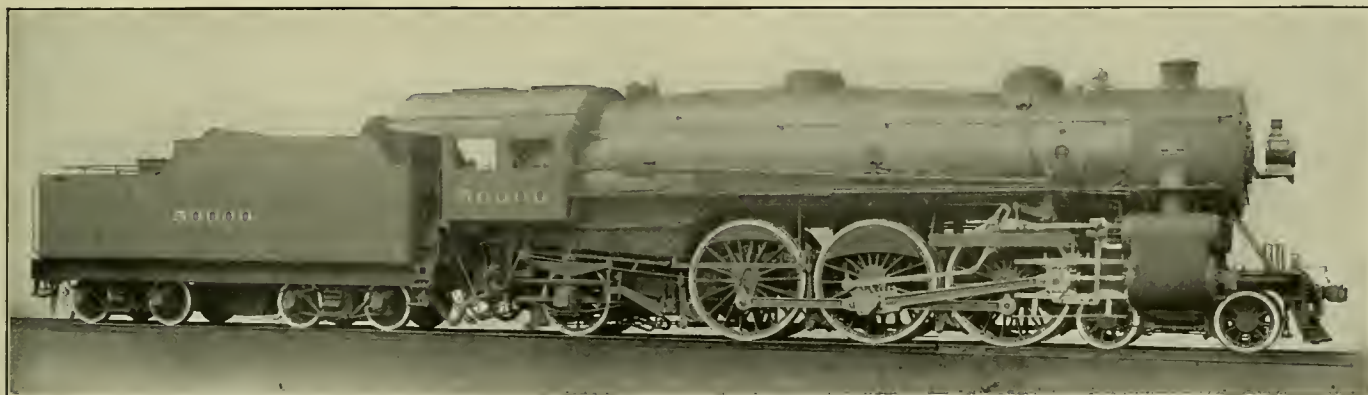

"Maximum Power Per Unit of Weight" Was the Object of the Design of This Locomotive.

sign incorporates a number of innovations, several of which have, even in the short time which this locomotive has been in service, proved to be so great an advance that they have already been applied to other locomotives built by this company and can now almost be regarded as standard practice. This is particularly noticeable in the case of the outside steam pipes connecting to the top of the steam chest. The advantage of this arrangement is so apparent as to meet with practically universal adoption on recent orders.

Maximum sustained capacity of course means maximum boiler capacity, and every effort was made to hold the weight of all other parts of the locomotive to the minimum, both by the use of improved designs and of the very best quality of materials, so that the boiler could be enlarged without exceeding conservative

of various parts by improved design and material, the above comparison with a Pacific type of approximately the same size, but of conventional design, is very impressive.

In the larger boiler thus secured, the utmost care was taken to give it the best proportions and the most carefully designed details. Approved fuel saving devices, viz., the superheater and brick arch, were of course applied, the former being the largest of the Schmidt type yet installed on an American locomotive. A moderate steam pressure was decided on and the cylinders were carefully proportioned to the boiler, so as to give the most economical point of cut-off at the maximum boiler capacity. In the table on the next page are given the boiler dimensions of No. 50,000, as compared with five other locomotives.

In this table the equivalent heating surface is figured on the basis of 1 sq. ft. of superheater heating surface being equivalent to 1½ sq. ft. of evaporative heating surface. Service tests cu

*For illustrated description see *American Engineer*, October, 1911, page 381, and *Railway Age Gazette*, September 22, page 555.

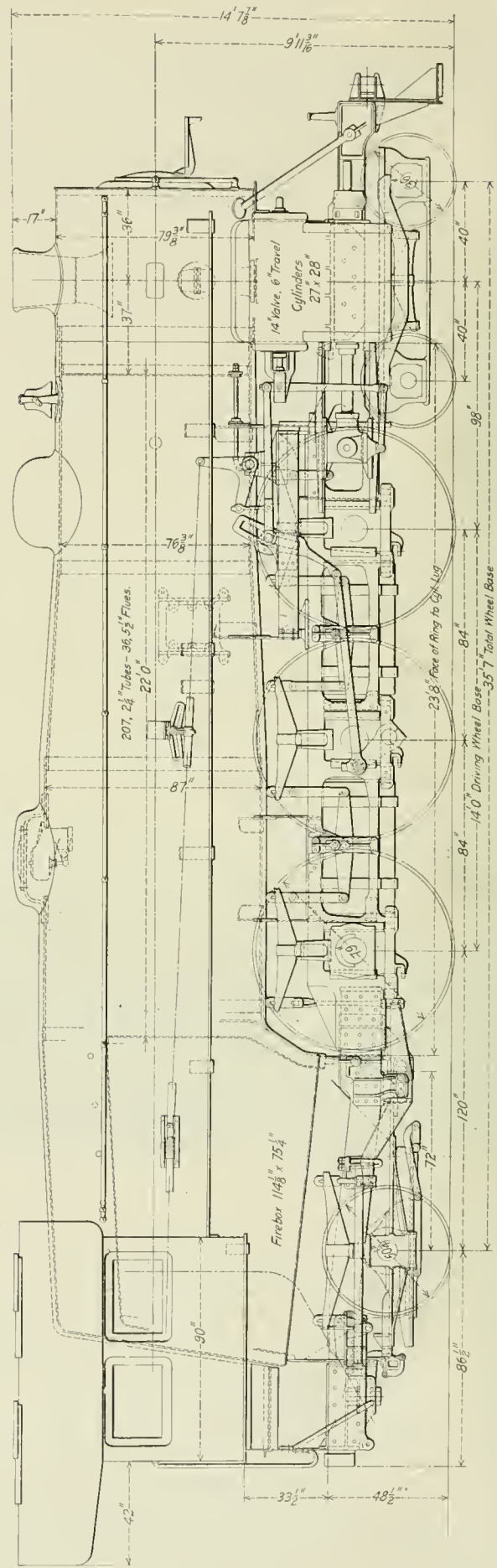
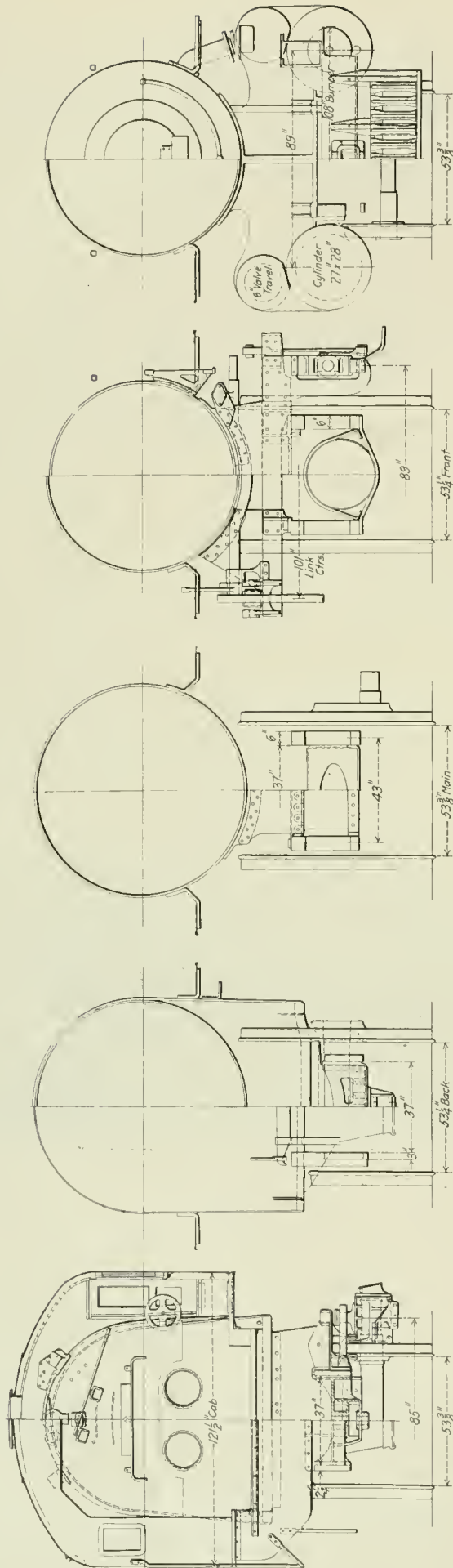

Locomotive No. 50,600 Designed and Built by the American Locomotive Company to Secure Information as to the Maximum Possibilities of the Pacific Type Within Reasonable Weight Limitations.

superheater locomotives indicate that while this value may be approximately correct for average conditions, when the boiler is forced to its maximum the superheating surface becomes more

of a greater proportionate capacity than is indicated by the figures of equivalent heating surface. Compared with another locomotive of equal weight, also equipped with a superheater,

| Locomotive. | 50,000 | A. | B. | C. | D. | E. |
|-----------------------------|---------------|---------------|---------------|---------------|---------------|---------------|
| Total weight | 269,000 lbs. | 269,000 lbs. | 271,000 lbs. | 270,000 lbs. | 266,500 lbs. | 263,800 lbs. |
| Type of boiler | Conical | Conical | Conical | Straight | Conical | Ext. W. T. |
| Steam pressure | 185 lbs. | 200 lbs. | 200 lbs. | 210 lbs. | 200 lbs. | 205 lbs. |
| Diameter drivers | 79 in. | 79 in. | 79 in. | 80 in. | 79 in. | 74 in. |
| Tractive effort | 40,800 lbs. | 30,900 lbs. | 30,900 lbs. | 33,400 lbs. | 29,200 lbs. | 43,400 lbs. |
| Diameter at front | 76 3/4 in. | 72 in. | 72 in. | 79 3/4 in. | 72 in. | 78 in. |
| Largest diameter | 87 in. | 83 in. | 83 in. | 83 3/4 in. | 83 in. | 84 in. |
| Firebox, length | 114 in. | 108 1/2 in. | 108 1/2 in. | 111 in. | 108 1/2 in. | 120 in. |
| Firebox, width | 75 1/4 in. | 75 1/4 in. | 75 1/4 in. | 80 1/4 in. | 75 1/4 in. | 84 in. |
| Grate area | 59.75 sq. ft. | 56.5 sq. ft. | 56.5 sq. ft. | 61.8 sq. ft. | 56.5 sq. ft. | 70 sq. ft. |
| Tubes, number | 207 | 175 | 242 | 343 | 382 | 389 |
| Flues, number | 36 | 32 | 28 | | | |
| Tubes, diameter | 2 1/4 in. | 2 1/4 in. | 2 in. | 2 1/4 in. | 2 in. | 2 1/4 in. |
| Flues, diameter | 5 1/2 in. | 5 1/2 in. | 5 3/4 in. | | | |
| Tubes, length | 22 ft. | 21 ft. 6 in. | 21 ft. 6 in. | 21 ft. | 20 ft. | 21 ft. |
| Total heating surface | 4,048 sq. ft. | 3,424 sq. ft. | 3,784 sq. ft. | 4,427 sq. ft. | 4,210 sq. ft. | 5,017 sq. ft. |
| Superheater heating surface | 897 sq. ft. | 765 sq. ft. | 705 sq. ft. | | | |
| Equivalent heating surface | 5,394 sq. ft. | 4,572 sq. ft. | 4,842 sq. ft. | 4,427 sq. ft. | 4,210 sq. ft. | 5,017 sq. ft. |

valuable in proportion, and therefore for maximum service conditions the boiler capacity of the superheater locomotives in this table are probably under-rated and the boiler on No. 50,000 is

but having less superheating surface, the 50,000 in service tests showed an average economy of 13 per cent. in fuel per indicated horse power hour. In these tests the average superheat

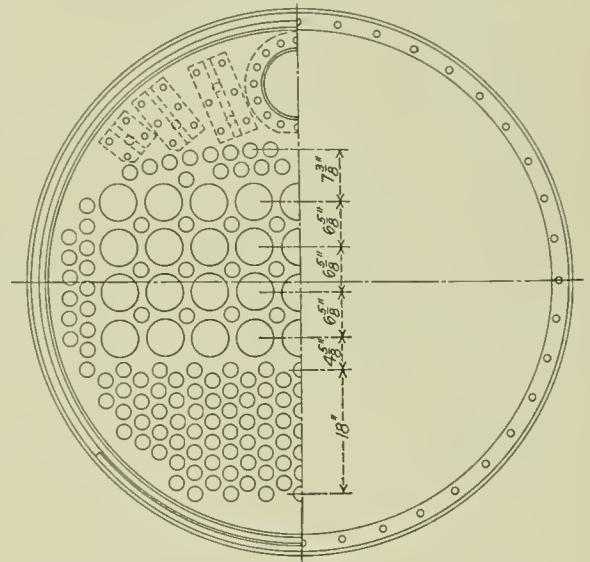
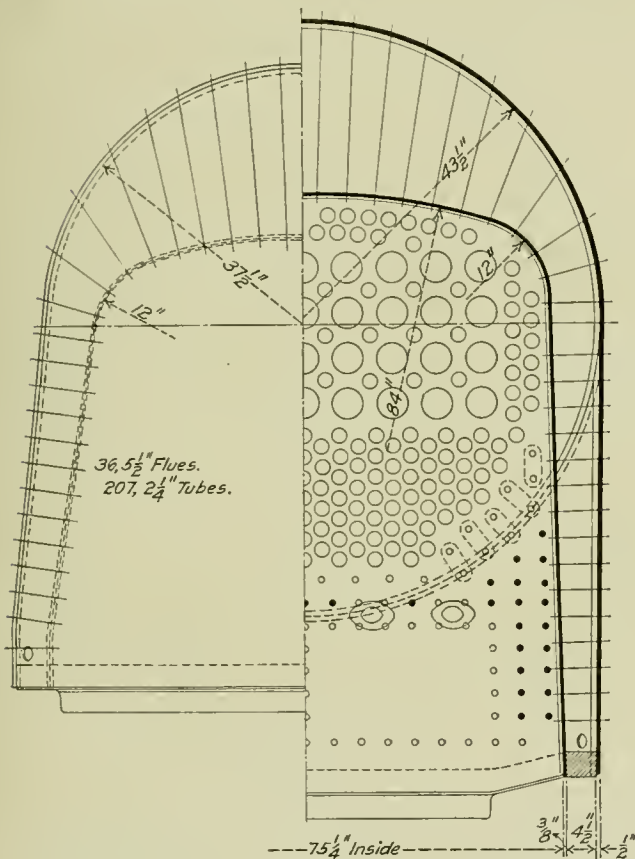

Half-Sections and End Elevations of Boiler Showing Arrangement of Superheater Tubes.

was 276 deg., and the maximum 341 deg., which is the greatest amount of superheat ever obtained on an American locomotive. The superheater is of the Schmidt design, known as the type "A" of the Locomotive Superheater Company. It has a top header and 36 double looped superheater elements.

In addition to the superheater this boiler is also fitted with a Security brick arch of the latest design which further increases its capacity by at least 10 per cent.

Reference to the illustration will show that in general features of construction this boiler does not differ noticeably from

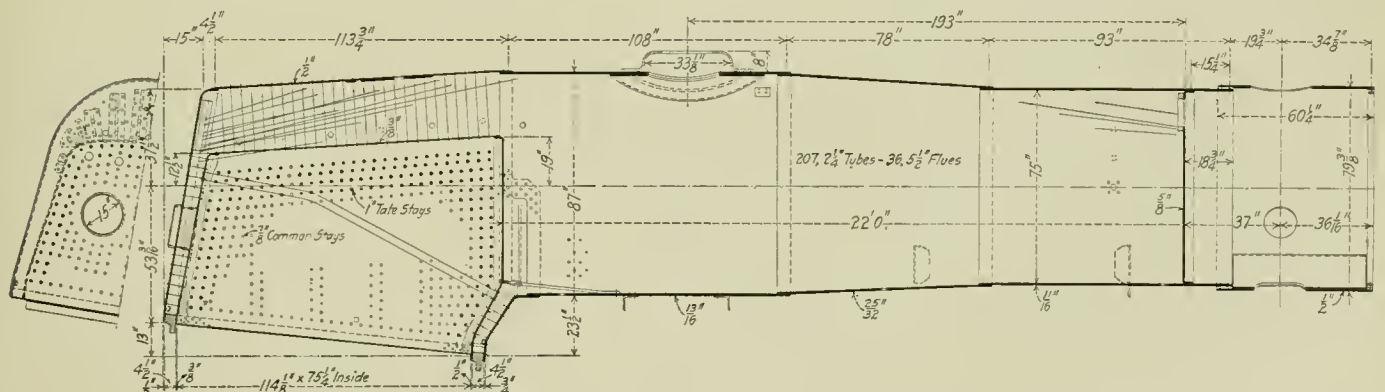

The Keypoint of Sustained Locomotive Capacity—the Boiler—Has Been Most Carefully Proportioned.

previous designs of the same builders. The increase in diameter between the front end and the dome course is considerable, resulting in maximum steam space with minimum weight and off-setting to a considerable extent the effect of the very low dome on the moisture in the steam. The 2¼-in. tubes are arranged with ¾-in. bridges, and are carefully located to give the best circulation. A liberal depth of throat sheet has been obtained, allowing plenty of space below the brick arch for a liberal depth of fire. There are two 15-in. circular fire doors. Although the boiler carries but 185 lbs. pressure, it is evident from the thickness of the sheets that it is capable of an increase in this respect, if desirable.

Outside Steam Pipes.—One of the illustrations shows the design of the outside steam pipe, which is the latest arrangement of the American Locomotive Company. It is made of a 7-in. wrought iron pipe bent to the proper form and terminating in an elbow connecting to the superheater header at the upper end, and to a cast iron flange at the lower end. The pipe is secured to these castings by a double row of soft iron rivets. Where it passes through the smokebox there is a stuffing box arranged to permit a movement of the pipe due to expansion, but to prevent the entrance of air around it. One of the illustrations shows a view of the front end well illustrating the arrangement and advantages of this design.

Cylinders.—This is the first instance of the use of vanadium cast steel for cylinder castings. The use of this material together with the outside steam pipes has not only saved about 4,000 lbs. in weight, but results in a decided simplification and improvement of the casting. The elimination of the high pressure steam passage in the cylinder casting also reduces the probability of the cylinders being cracked in service by temperature stresses. The cylinders are fitted with vanadium cast iron bushings ¾-in. thick, and the valve chamber bushings are of the same material. The bushings in both cases are secured in place. It will be noted that provision is made for lubrication at the center of the piston stroke. The use of the outside steam pipes permits a much bet-

ter attachment between them and the cylinders, where 8 bolts are used in this case in place of the customary 4 or 6. It will also be noted that a leak at this joint is not as serious a matter as when the joint is inside of the smokebox, as it will have no effect upon the vacuum.

Vanadium steel is also used for driving wheel centers, frames,

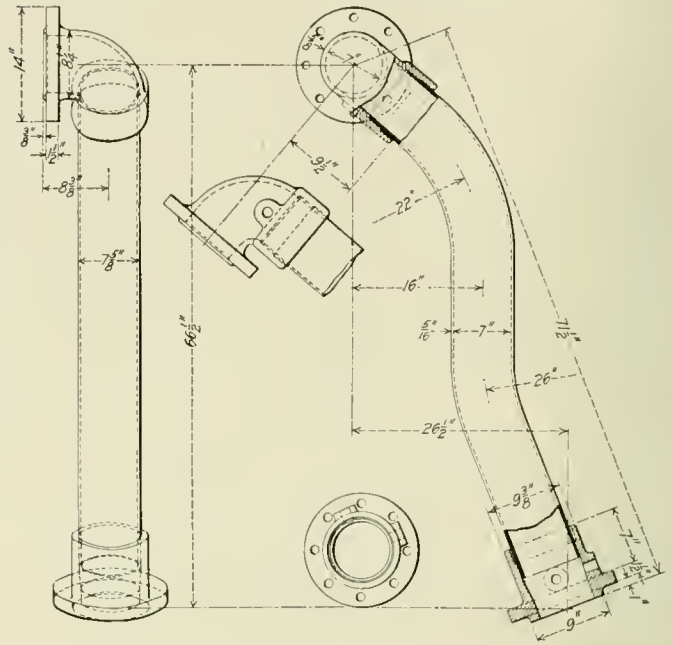

Outside Steam Pipes Were First Tried on No. 50,000.

ter attachment between them and the cylinders, where 8 bolts are used in this case in place of the customary 4 or 6. It will also be noted that a leak at this joint is not as serious a matter as when the joint is inside of the smokebox, as it will have no effect upon the vacuum.

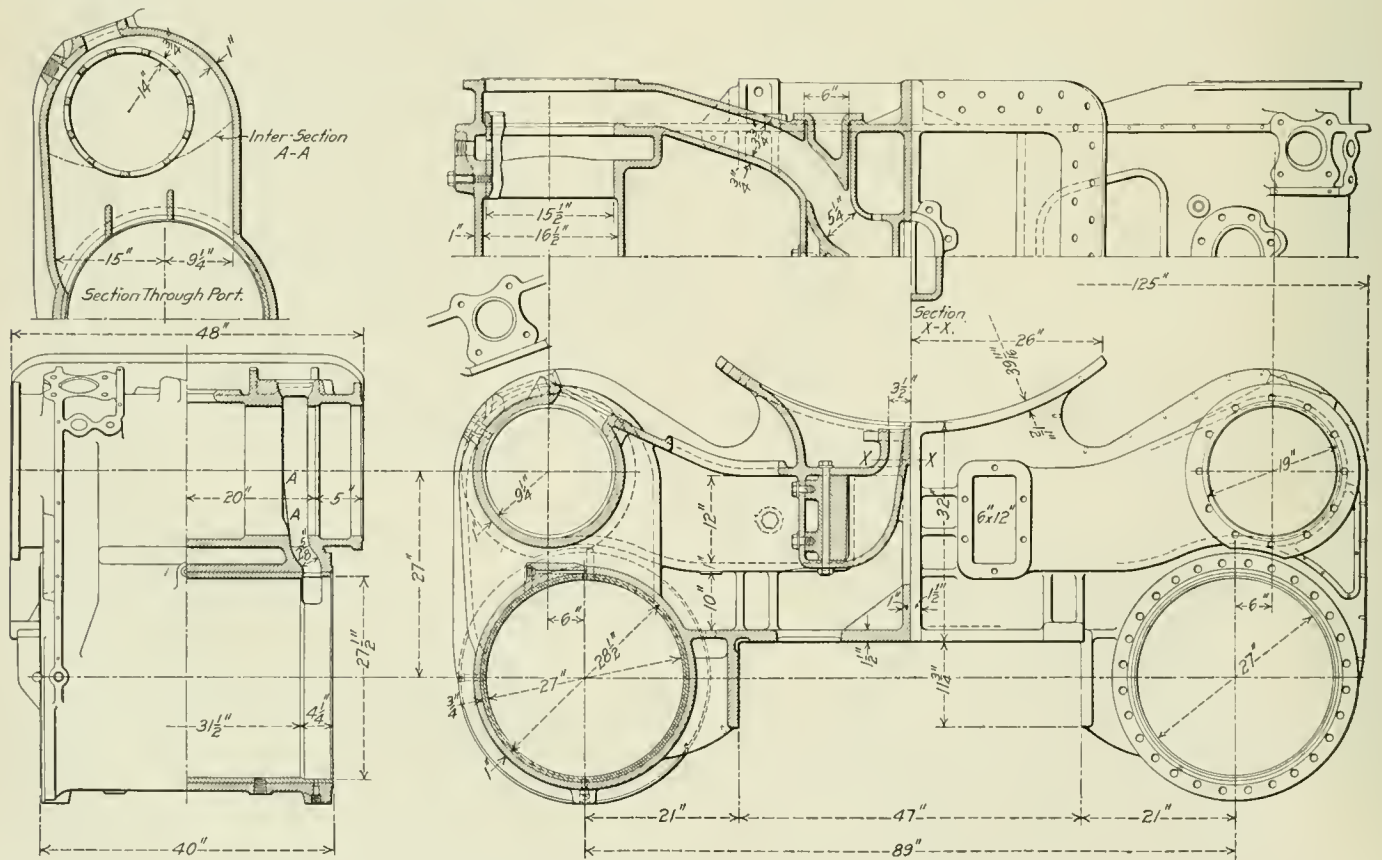

Vanadium Cast Steel Cylinders Were Used for the First Time on No. 50,000.

Screw Reverse Gear.—Locomotive No. 50,000 was the first one in this country to use the screw reverse gear, which was illustrated and described in connection with the Mountain type locomotive of the Chesapeake & Ohio.* It is generally recognized that in the larger locomotives, other than the Mallet type, where a power reverse gear is generally used, it is becoming very difficult to handle the ordinary reverse lever, and there is no doubt but that there is considerable loss in economy in opera-

tion from the fact that it is often dangerous to alter the point of cut-off when operating at high speed. The screw reverse gear as designed for this locomotive gives about 11 times the leverage obtained from the usual reverse lever, and of course permits the adjustment of cut-off to any desired point. One of the illustrations shows a view in the cab well illustrating how conveniently this apparatus may be located. With the screw reverse

gear the engine can be reversed completely in from 4 to 6 seconds. While the screw reverse gear is not new, having been in use for many years on foreign roads, the design as applied on this locomotive differs in many particulars from the usual foreign practice. It provides a straight line pull without off-sets and the use of the screw inside of tubular connections on the same longitudinal axis as the reach rod better adapts it to the greater weights of valve motion parts in American practice.

Valve Stem Guide.—An important improvement in detail design first introduced on locomotive No. 50,000, but which has now become somewhat familiar because of its use on other locomotives, recently built by the same company, is the self-centering guide for the valve stem. As will be seen from the illustration of the builder's standard arrangement of this device, it consists of a guide made integral with the back head of the piston valve chamber and so constructed as to be easily adjusted for wear. The chief advantages of this arrangement are that it can be erected, taken down and replaced without any lining up, at the same time insuring that the valve stem guide is absolutely in line with the piston valve chamber. This saves all the time that is spent in lining up the valve stem guide of the ordinary construction employed with the Walschaert valve gear when it is necessary to take down the valve motion. This arrangement is self supporting, so that no bracing from the guides or any other source than the cylinder is required. It permits the use of a straight design of combination lever without forks, which is connected to the valve stem crosshead by a pin passing through its wings, thus affording greater lateral stability than is obtained in other designs.

Extended Piston Rod Guide.—A design of guide for the extended piston rod, which in view of the general adoption of this practice on locomotives equipped with superheaters has a wide usefulness, is shown in one of the illustrations. This device, like the valve stem guide, is self-centering, and can be removed and replaced in position without lining up, and at the same time exactly coincides with the longitudinal axis of the cylinder. It

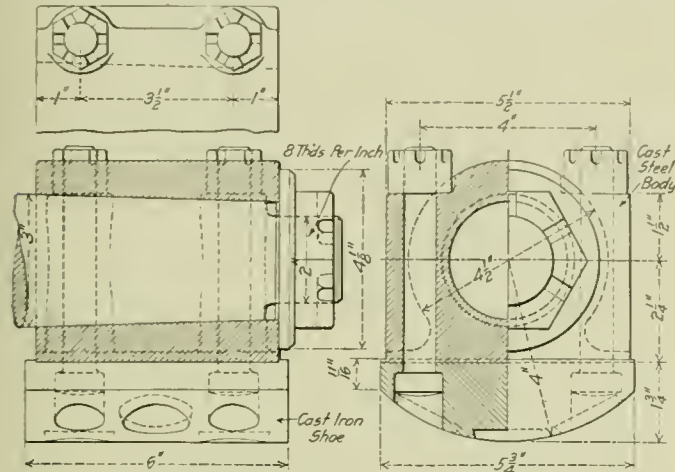

Shoe on End of Extended Piston Rod.

tion from the fact that it is often dangerous to alter the point of cut-off when operating at high speed. The screw reverse gear as designed for this locomotive gives about 11 times the leverage obtained from the usual reverse lever, and of course permits the adjustment of cut-off to any desired point. One of the illustrations shows a view in the cab well illustrating how conveniently this apparatus may be located. With the screw reverse

*See *American Engineer*, October, 1911, page 387, and *Railway Age Gazette*, September 22, page 553.

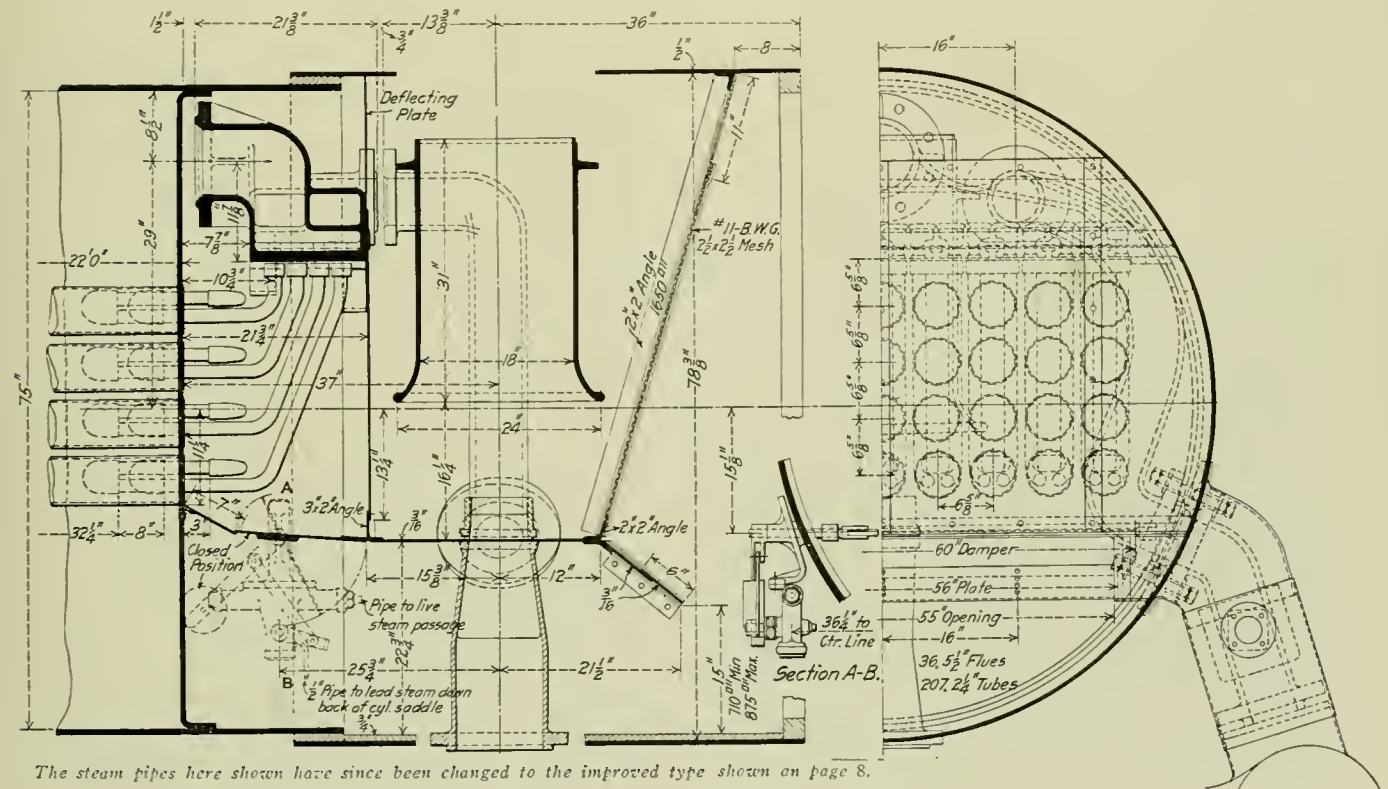

The steam pipes here shown have since been changed to the improved type shown on page 8.

Front End Arrangement of Locomotive No. 50,000.

consists of a cast iron shoe fitted to the extended end of the piston rods and composed of a cast steel body to which the shoe is firmly screwed by four bolts. The shoe slides on a guide

and the guide is so constructed that it may be bored out and faced off at one setting of the machine. The bearing surfaces of the shoe and guide are made radial to provide sufficient wear-

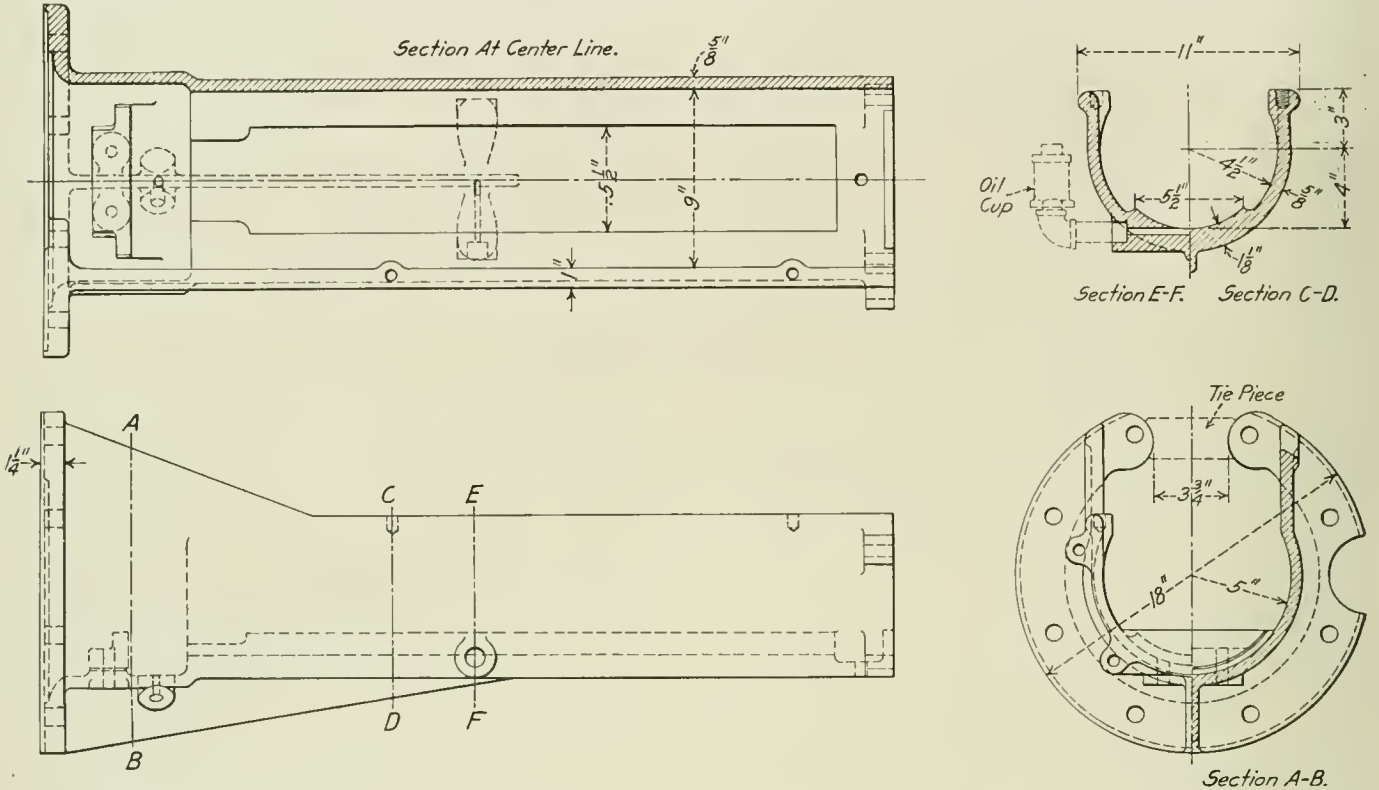

Latest Self-Centering Guide for Piston Rod Extension Which May Be Removed and Replaced Without Lining Up.

secured to the cylinder head. The circular face of the guide registers with a corresponding face on the front cylinder head. The guide surface is struck from the center of the cylinder

ing surface to insure continuous service for 2 or 3 years without requiring adjustment to linings or repairs of any kind. Furthermore, the guide surface being concentric with the center of the

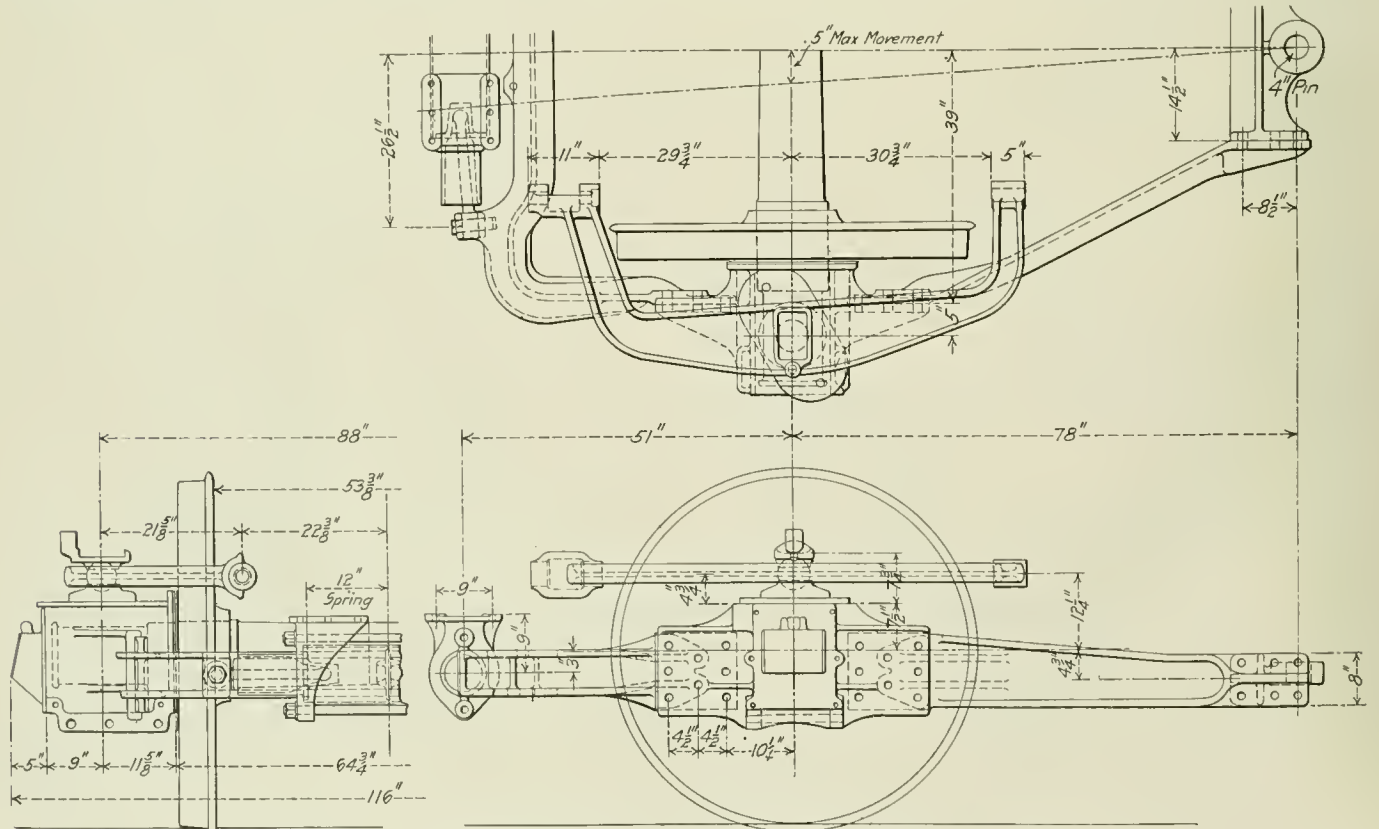

Improved Outside Bearing Radial Trailer Truck Which Saves 2 1/2 Tons Weight.

cylinder, any refinement in adjustment between the shoe on the front of the rod and the main crosshead is unnecessary, since while the crosshead works on a flat guide, the piston rod shoe will swing around on the center of the cylinder and thus always take a fair bearing without cramping. A dust proof covering is

provided, and as will be seen from the illustration, the casing and guide are so constructed, the latter being of horseshoe form, that the guide can be removed, irrespective of whether the en-

gine is on the front or back center, without removing the pilot and bumper.

Outside Bearing Trailing Truck.—A saving in weight of from 4,500 to 5,000 lbs. was effected by the application of an improved design of outside bearing radial truck in place of the former type

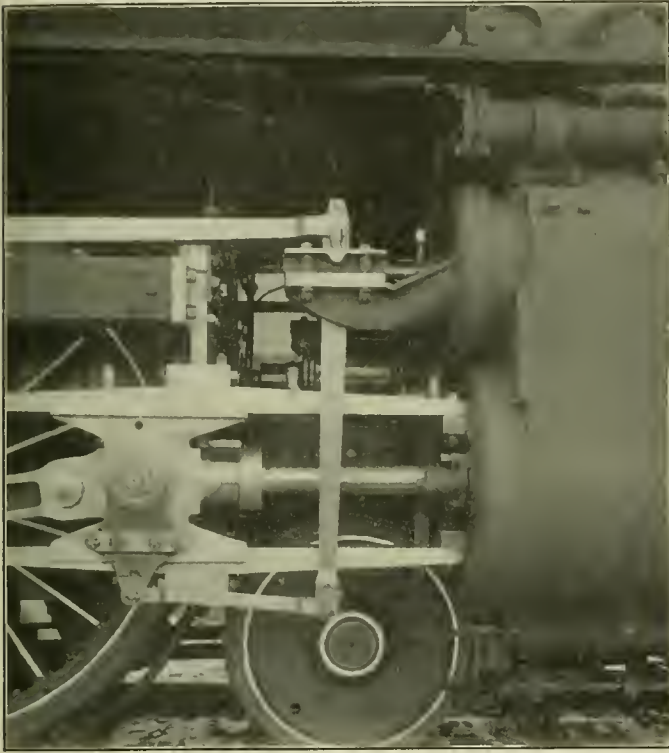

Self-Centering Valve Stem Guide.

gine is on the front or back center, without removing the pilot and bumper.

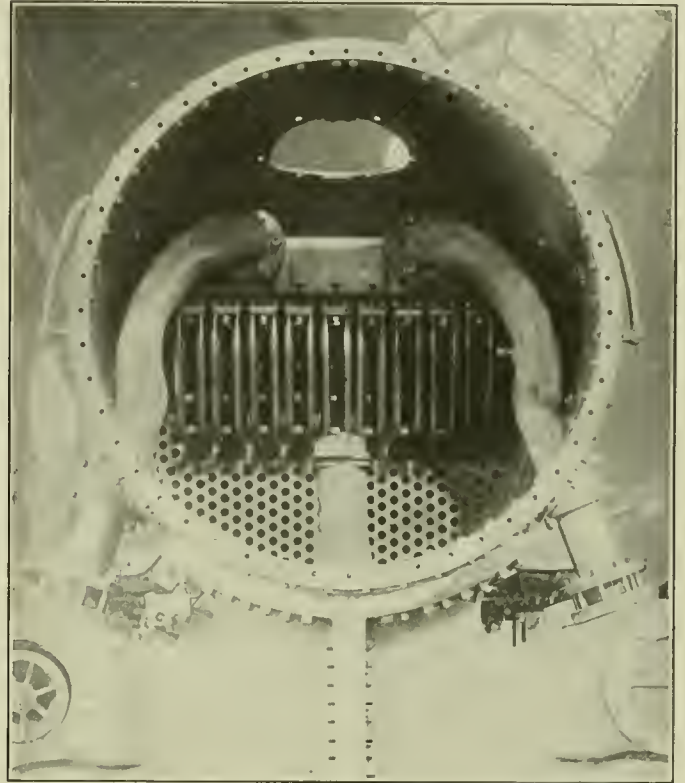

View of a Front End Showing Some of the Advantages of the Outside Steam Pipes.

applied by this company, which entailed the use of outside supplementary frames secured to the slab rear portion of the main frames by heavy cast steel filling pieces. This type of truck had been previously successfully applied and has since become the builder's standard design for Pacific and Mikado type locomotives. It provides for a universal adjustment of the springs to the rise and fall of the engine and a resistance to transverse



Operating Wheel for Screw Reverse Gear.



Outside Bearing Trailer Truck.

motion through the combined action of the spring centering device and the inclined friction plates, which operate to restore the truck to its normal central position on entering a tangent after passing through a curve. Experience shows that it greatly improves the riding qualities of the locomotive.

Certain modifications in the structural features introduced in the builder's present standard construction of this detail, which is illustrated herewith, have served to still further improve the original design. This change consists in the use of a drop forged sphere made in halves riveted together for supporting the spring seat, in place of the double trunion arrangement originally employed. This arrangement provides the same flexibility in the spring supports as before, whereby the easy riding qualities are secured, and at the same time the parts in the older construction which might be liable to accumulate lost motion and loose bolts are eliminated. Moreover, all the spring seats being in compression any wear and lost motion which may accumulate

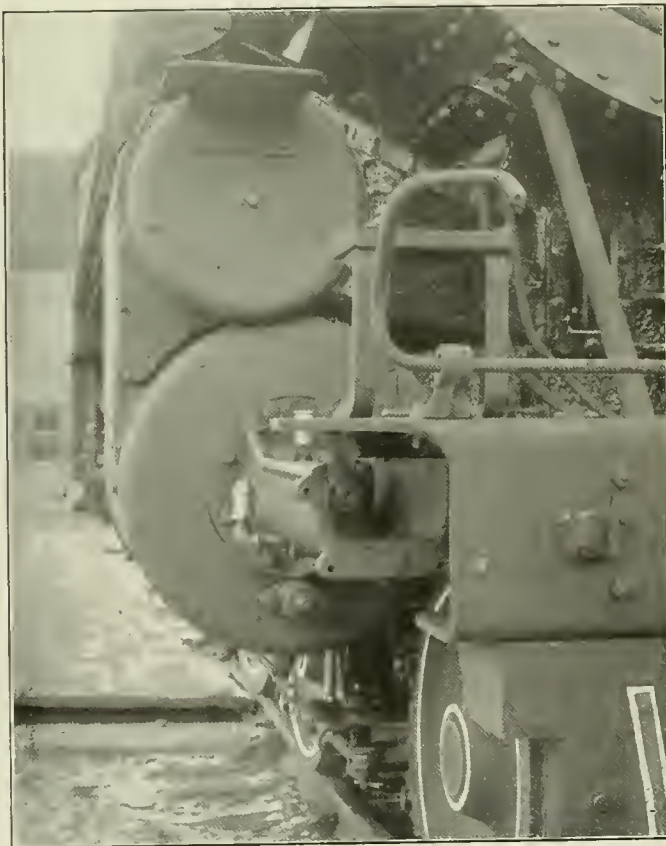

Pressed Steel Bumper Beam and Piston Rod Extension Guide.

is automatically taken up, the design of the truck being thus still further improved from the maintenance standpoint.

Pressed Steel Bumper and Pilot.—Further evidence of the refinement in detail carried out in this locomotive to keep the weight of every part down to a minimum consistent with strength is furnished by the use of a pressed steel bumper and pilot. Pressed steel pilots have been very successfully employed on the Lake Shore & Michigan Southern. Compared with an ordinary design of cast steel bumper the pressed steel type here employed weighs approximately 1,200 lbs. less, while as between the pressed steel and wooden pilot there is a difference of 350 lbs., a total saving of some 1,500 lbs. being effected in these two details alone.

Locomotive No. 50,000 sets a new high mark for the capacity and economy attainable within the limitations of conservative wheel loads in a modern passenger locomotive designed for sustained high speed service with heavy loads. It has also pointed a way by which present commonly accepted practice may be greatly improved by better proportion of boiler to engine capacity,

greater refinement in the design of details and modifications of present standards, the best use of fuel saving devices, the value of which has been tried and proved in service and the latest developments in material.

The general dimensions, weights and ratios are given in the following table:

| <i>General Data.</i> | |
|--|---------------------------------|
| Gage | 4 ft. 8½ in. |
| Service | Passenger |
| Fuel | Bit. coal |
| Tractive effort | 40,800 lbs. |
| Weight in working order | 269,000 lbs. |
| Weight on drivers | 172,500 lbs. |
| Weight of engine and tender in working order | 430,500 lbs. |
| Wheel base, driving | 14 ft. |
| Wheel base, total | 35 ft. 7 in. |
| Wheel base, engine and tender | 68 ft. 2½ in. |
| <i>Ratios.</i> | |
| Weight on drivers ÷ tractive effort | 4.26 |
| Total weight ÷ tractive effort | 6.68 |
| Tractive effort × diam. drivers ÷ heating surface* | 596.00 |
| Total heating surface* ÷ grate area | 90.50 |
| Firebox heating surface ÷ total heating surface,* per cent | 4.60 |
| Weight on drivers ÷ total heating surface* | 32.00 |
| Total weight ÷ total heating surface* | 49.60 |
| Volume both cylinders, cu. ft. | 38 in. x 12 in. 18.60 |
| Total heating surface* ÷ vol. cylinders | 298.00 |
| Grate area ÷ vol. cylinders | 3.20 |
| <i>Cylinders.</i> | |
| Kind | Simple |
| Diameter and stroke | 27 in. x 28 in. |
| <i>Valves</i> | |
| Kind | Piston |
| Diameter | 14 in. |
| Greatest travel | 6½ in. |
| Outside lap | 1¼ in. |
| Inside clearance | ¼ in. |
| Lead in full gear | Forward, ⅛ in.; Backward, ½ in. |
| <i>Wheels.</i> | |
| Driving, diameter over tires | 79 in. |
| Driving, thickness of tires | 3½ in. |
| Driving journals, main, diameter and length | 11 in x 12 in. |
| Driving journals, others, diameter and length | 10½ in. x 12 in. |
| Engine truck wheels, diameter | 36 in. |
| Engine truck, journals | 6½ in. x 12 in. |
| Trailing truck wheels, diameter | 50¼ in. |
| Trailing truck, journals | 8 in. x 14 in. |
| <i>Boiler.</i> | |
| Style | Conical |
| Working pressure | 185 lbs. |
| Outside diameter of first ring | 76¾ in. |
| Firebox, length and width | 114½ in. x 75¼ in. |
| Firebox plates, thickness | ¾ in. x ½ in. |
| Firebox, water space | 4½ in. |
| Tubes, number and outside diameter | 207—2¼ in. |
| Tubes, superheater | 36—5½ in. |
| Tubes, length | 22 ft. |
| Heating surface, tubes | 3,800 sq. ft. |
| Heating surface, firebox | 248 sq. ft. |
| Heating surface, total | 4,048 sq. ft. |
| Superheater heating surface | 897 sq. ft. |
| Grate area | 59.75 sq. ft. |
| Smokestack, diameter | 18 in. |
| Smokestack, height above rail | 14 ft. 7¾ in. |
| Center of boiler above rail | 9 ft. 11 5/16 in. |
| <i>Tender.</i> | |
| Tank | Water bottom |
| Frame | 13 in. channels |
| Wheels, diameter | 36 in. |
| Journals, diameter and length | 5½ in. x 10 in. |
| Water capacity | 8,000 gals. |
| Coal capacity | 14 tons |

*Equivalent heating surface equals 5,394 sq. ft.

NEW FACTOR IN WORLD'S COAL SUPPLY.—Statistics indicate that the coal fields of New Mexico, which produce a high grade of both bituminous and semi-bituminous coal, will play no unimportant part in the world's supply of coal. During 1910 the output was 3,508,221 short tons, with a value of \$4,887,151 against 2,801,128 tons in 1909, a gain of 707,193 short tons or 25.25 per cent. The value of the product increased from \$3,619,744 to \$4,877,151, a gain of \$1,257,407, or nearly 35 per cent. The coal produced in this district is shipped in large quantities into Mexico and the newly settled districts of New Mexico, Arizona and California. The domestic demand for New Mexico coal in 1910 was so great that the operators were unable to fill their orders promptly. According to an estimate of the U. S. Geological Survey, the original coal supply of New Mexico was 163,780,000,000 tons, so that the exhaustion to date represents approximately 0.03 of 1 per cent. of the original supply. These figures do not include several newly discovered fields.

RAILWAY MECHANICAL ASSOCIATIONS

Advantages of Membership in These Associations.
This Article Was Submitted in a Recent Competition on "The Benefits of Attending Conventions"

BY C. C. LEECH

Foreman, Pennsylvania Railroad, Buffalo, N. Y.

On the editorial page of the Shop Section of the *Railway Age Gazette* of September 1, 1911, we find this statement: "During the past four months the *Railway Age Gazette* has published reports of the annual conventions of a considerable number of railway mechanical organizations. It has been suggested that there are too many of these associations. We do not believe this is so if these associations are doing the work for which they were intended. The question is: Are they properly conducted and are they giving the best results possible? If they are then they should receive the hearty support from the higher executive officers."

To my mind the benefits of a properly conducted association are three-fold: First, to the man himself; second, to his company; and third, to the other men attending the convention, or who are members of the association. The broadening and educational advantages of attendance at a well-conducted convention are very many indeed. The man gets away from the little world of his own shop or department, and out of the rut and daily grind of shop routine. His mind is taken off the worries, large and small, of shop management, for a time at least. He warms up and expands in the sun of new acquaintances, new scenes and new ideas.

It is a pleasant sensation to be called to the office of a superior and be requested to prepare to attend a coming convention. It touches a man's pride to feel that his company or employer thus recognizes his worth, and it is an indication that his efforts along the line of self-improvement and shop improvement are not going on unnoticed. He determines to make good and to get thoroughly saturated with new ideas for the benefit of his company and others, and to be ready to give in his turn new thoughts and suggestions to the other members in attendance at the conventions. It is surprising to find how many different ideas the other fellow may have on any subject he may suggest. Perhaps for years he has performed certain work in a special way that he considered the best and thought could not be improved upon, when, lo, someone stands up in the convention who has perhaps come from some shop a thousand miles away that he has never heard about, and in a few words tells a way of performing the work that is so much better than his method that he makes the change as soon as he returns home, and as a result has the satisfaction of increased output and less unit cost.

An opportunity to see all the best and latest in tools, machinery and supplies is given to the men that attend the conventions. It is concentrated in one place and each exhibit is presided over by the best demonstrators and salesmen the manufacturers have. They recognize that the men who come to the conventions are the ones who are consulted in regard to the purchase of new machinery, and whose recommendations are received with respectful attention by their superior officers. These men are loaded up with information and facts that they gather in their travels from one city to another, and if our convention attendant makes friends with them, which he will find is not difficult, he will get many good points and valuable suggestions to take home with him. The wide-awake supply man travels more miles in a week, meets more mechanical men and sees more machinery and labor-saving devices than a master mechanic or shop foreman does in a year. At the convention we have him in the plural number, and the opportunity to extract all the information we possibly can out of him should by no means be neglected.

We may be selected to prepare a paper on one of the subjects assigned for discussion at the convention. While the first thought

is to decline the honor, on account of the additional work it will entail, the fact remains that it is really a great educational opportunity and should be accepted at once. We may think when starting in to prepare the paper that we already understand all the salient points of the subject and all there is to do is to clothe our thoughts in a readable and intelligent form. But as we begin to concentrate upon the work and further add to our store of knowledge by careful and conscientious study of the subject, it is usually found that it has many ramifications and phases that lead in directions unthought of before. The work becomes fascinating, and when the paper is finally completed and sent to the committee we cannot help but feel a pride in our work and will, at the same time, have helped ourselves in an educational way to a remarkable extent.

Then there follow the reading and discussion of the paper at the convention, sure to be of great benefit and interest, which will bring out still further thoughts and information. An excellent and striking example of this is shown in the splendid paper presented by F. C. Pickard, master mechanic of the Cincinnati, Hamilton & Dayton at the recent convention of General Foremen's Association on How Can Shop Foremen Best Promote Efficiency? I quote from the editorial note in the *Railway Age Gazette* which said: "By study and correspondence with the members of the association he arranged 44 questions under 4 heads—organization, accounting and supervision, handling of material and shop kinks and methods." When the paper came before the convention some 24 men, representing 12 different roads, took part in the discussion, and fully 250 distinct ideas were brought out bearing on the various divisions of the subject. And even at that an important part had to be omitted as time would not permit of its further discussion. Surely it needs no further argument to prove the immense benefit of this exchange of ideas to the men themselves and to their companies.

Coincident with these benefits is the confidence it gives the man to stand up in the convention and express his ideas in an orderly and intelligent manner. Not an easy matter to the majority of men, but it can be acquired by just this practice and is an invaluable experience. It is also a great aid in the daily routine of shop work. The foreman or shop superintendent who can express himself in clear, forcible style either in conversation or by letter, presenting facts in a few words, or covering information asked for in a few sentences, always attracts the notice of those in authority and commands respect. The ability to handle correspondence is an important step in the line of promotion that should not be neglected.

It was related to the writer recently that at one of the conventions held during the past summer a young man took so much interest in the proceedings and conducted himself in such an attractive way on the floor, presenting so many good ideas and practical suggestions, as to command marked attention. Later an official high in railway circles, who was looking for a man possessing just these qualities, was directed to him.

Another one of the benefits derived from convention attendance is the social companionship. Here we meet with men from north, south, east and west. Men from the village, town and city, and often if we are regular attendants we meet the same men year after year, and valuable and lasting friendships are made.

Again, while our attendance is primarily for work and study of the subjects presented for our discussion, the value and necessity of at least a little relaxation is recognized and nearly always plans are made for some pleasant form of entertainment after the business sessions. These are often enhanced by the presence of the wives and daughters of the members, rounding out these happy occasions with their charming and refining influence and adding that touch of color and brightness that makes pleasant memories of the convention hours.

Association members can do much for each other in the way of preferment and promotion, and we firmly believe that many owe their advancement in their chosen work to these influences.

In a general sense the members of any of these associations represent the ambitious and progressive men of their particular calling, men who have won promotion, because they had in greater measure than their fellows the ability and the qualifications necessary to success. They are the cream, and are the men headed straight for more responsible positions.

It is beyond any doubt to the best interests of the railways to encourage membership in the various associations, and in return the members should demonstrate their appreciation by showing in a tangible way the benefits they have received.

LAYOUT OF A SPIRAL

BY WILLIAM H. DAMON

Foreman Boiler Maker, Long Island Railroad, Richmond Hill, N. Y.

A short time ago it was found necessary to enlarge the power plant at the Morris Park shops of the Long Island Railroad, Richmond Hill, N. Y., by the addition of two water tube boilers. It was thought that the easiest and most practical way of conducting the smoke to the chimney would be by simply connecting the new flue into the old flue of the horizontal tubular boilers, as is shown by the dotted lines in the accompanying illustration. However, it was found that this arrangement greatly interfered with the draft of the horizontal boilers, and it became necessary to devise a new arrangement. It was considered advisable to enter the chimney from the side opposite the flue of the horizontal boilers, but in order to do this it was necessary to raise the new flue at an angle, and to reduce the resistance, one-half of the curve shown in the pipe had to be made in the form of a rectangular spiral. The layout of the spiral is shown herewith, the shape of the different sides being shown in their development.

Layout of Spiral.—First lay out a plan view of the spiral section as A, B, C, D . Divide the arcs into equal sections, as a, b, c , etc., and f, h, n , etc. The side view of the spiral, or its elevation, is shown by the figure $KFGM$ and $KEHM, H EFG$, representing the cross section of the flue, and the distance LK the height of the spiral. Vertical lines are then projected down from the points on the arcs AD and BC intersecting the lines KE, KF, MH and MG as shown on the diagram.

To develop the outside sheet of the flue a horizontal line is drawn such as M_1N on a line with the point M and equal in length to the arc AD . This is also divided into the same number of equal parts as AD . From these division points erect perpendicular lines. Horizontal lines are then drawn from the points on MG and KF , which intersect the perpendicular lines from M_1N at the points a_3, b_3, a_4, b_4 , etc. These points lie on the contour of the sheet and when joined by a smooth curve give the layout of the outside sheet in its development. The development of the inside sheet is obtained in a similar manner, M_2P being the length of the arc BC . Perpendiculars are erected

tained by laying off D_1O , equal to FK or MG , carrying the division points e_1, d_1, c_1 , etc., with it. Perpendicular lines are erected from these points and their intersections with the horizontal lines drawn from the corresponding points on the arc AD , locate the points e_3, d_3, c_3 , etc., on the outside edge of the sheet. The inside edge is obtained in a similar manner, C_1O being equal to KE or MH , the points m_3, n_3, h_3 , etc., being transferred to C_1O

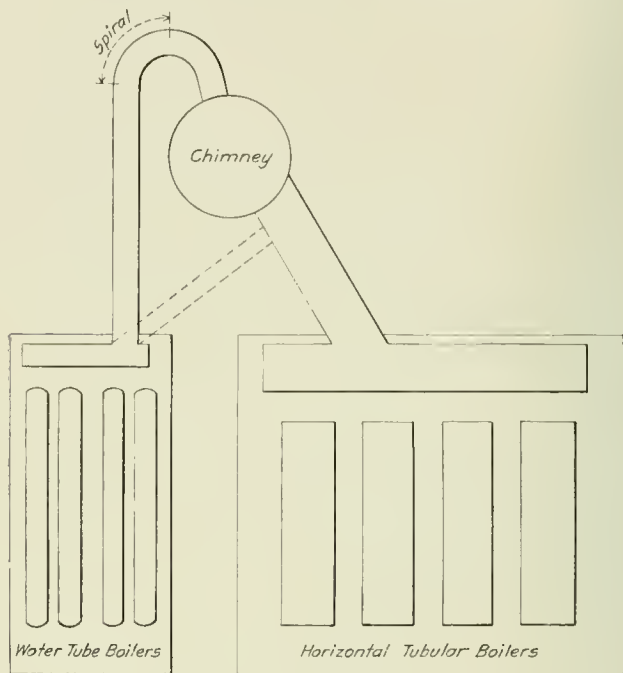

Arrangement of Boilers and Smoke Flues.

as before. The perpendicular lines from these points are intersected by the horizontal lines from the corresponding points on arc BC at m_3, k_3, n_3 , etc., which locates points on the inner edge of this sheet. These points being connected by smooth curves give

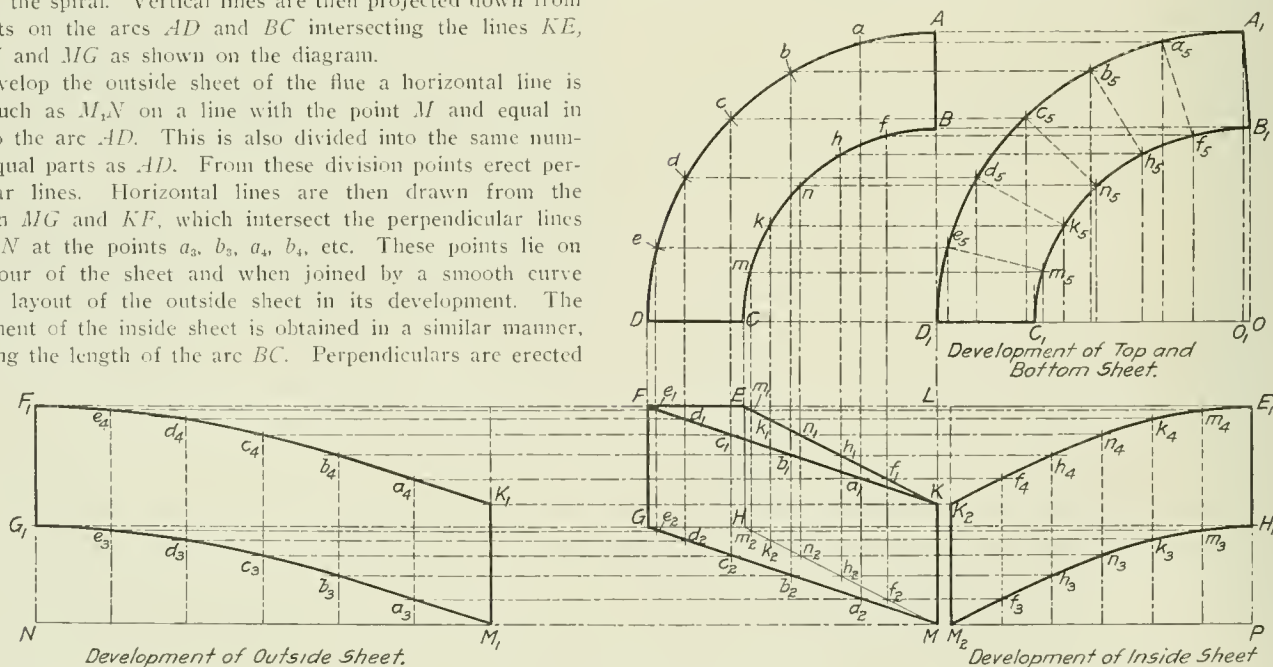

Development of Rectangular Spiral Smoke Flue.

from the division points, as before, and points f_3, h_3, f_4, h_4 , etc., are located by projecting horizontal lines across from KE and MH .

The top and bottom sheet have the same form, so the development of only one is necessary. The outside edge A_1D_1 is ob-

tained by laying off D_1O , equal to FK or MG , carrying the division points e_1, d_1, c_1 , etc., with it. Perpendicular lines are erected from these points and their intersections with the horizontal lines drawn from the corresponding points on the arc AD , locate the points e_3, d_3, c_3 , etc., on the outside edge of the sheet. The inside edge is obtained in a similar manner, C_1O being equal to KE or MH , the points m_3, n_3, h_3 , etc., being transferred to C_1O

the actual form of the top and bottom sheets. In this particular case the spiral was so small that all the different sheets could be made of one piece, but where they have to be made up of several pieces sufficient lap should be allowed on each sheet to allow for riveting.

STANDARD PRACTICE CARDS ON THE ERIE

Best Methods Outlined for Performing Different Operations or Making Repairs. Guess Work Eliminated, Improper Methods Done Away With, Untimely or Unnecessary Repairs Avoided.

BY O. S. BEYER, JR.

A system is in use on the Erie Railroad whereby those practices most universally encountered in the maintenance of equipment are standardized over the entire road, and the proper carrying out of these practices is insured. This system is known as "standard practice," and is promulgated through a book of standard practice cards. This book consists of a set of cards conveniently indexed and bound in a loose leaf binder of pocket

Considered from the view point of safety in the operation of rolling equipment, they eliminate considerable guess work at times of inspection or repair. They answer many vexatious questions. Allowable limits of wear, the conditions under which to renew worn parts, the proper pressures to use when making force fits, and many other similar points are definitely settled. In the furtherance of economy they avoid unnecessary and un-

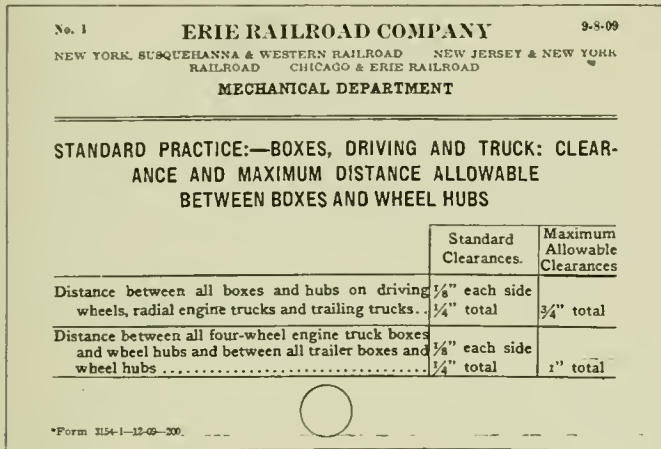

Fig. 1—Standard Practice Card for Driving and Truck Box Clearances.

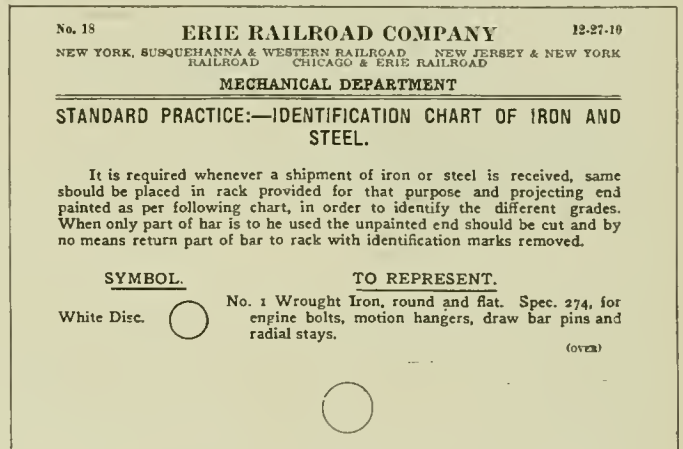

Fig. 3—Front of Standard Practice Card for Identification of Iron and Steel.

size. One book is furnished each general officer, and each division officer of both the locomotive and car departments. The different practices which are to be followed as standard are outlined clearly and concisely on these cards, and are illustrated by sketches, if necessary. The purpose of the system is primarily what its name implies—to standardize the many practices which are daily encountered and repeated at all points where equipment

timely, or enforce necessary and timely repairs. They help to prevent wasteful duplication of work. From the standpoint of efficiency they outline the best methods, all things considered, for performing different operations or making certain repairs.

Owing to the extensive territory covered by a railway, the organization required to operate, maintain and supervise it is necessarily complicated. Hence it is often a matter of great

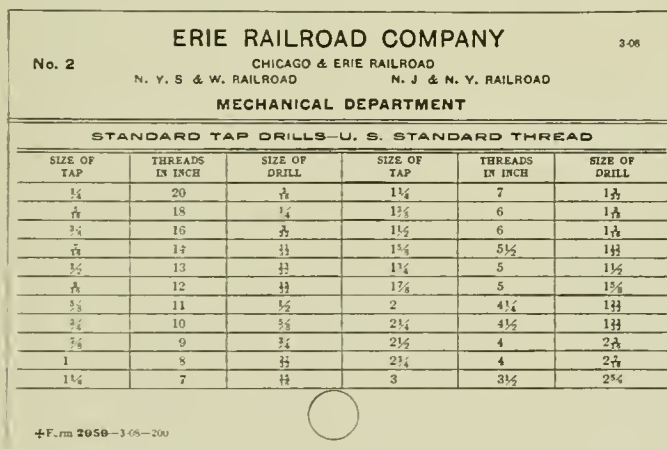

Fig. 2—Standard Practice Card for Tap Drills and Threads.

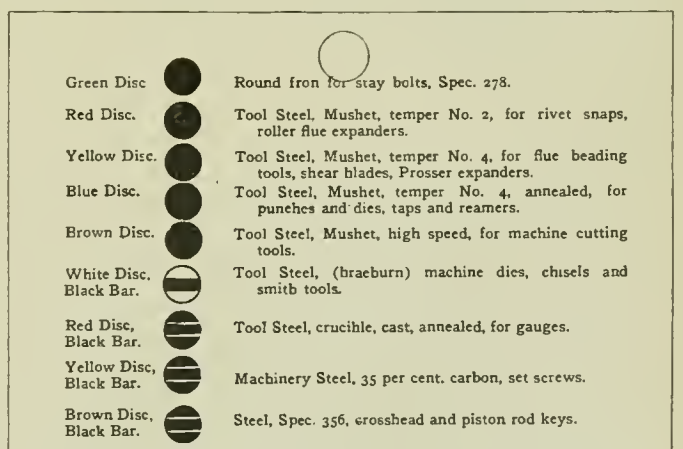

Fig. 4—Back of Standard Practice Card for Identification of Iron and Steel.

is inspected and maintained. That this is desirable will appeal to every one who realizes the possibility of failure and the waste and the inefficiency existing where the various practices, which should be standardized, are carried out according to varying individual judgment and opinion.

The benefits resulting from standardized practices are many.

difficulty for superior officers to weed out practices which should not prevail and establish the best practices. One of the greatest benefits arising from the standard practice system is the well defined channel that it opens through which correct practices may be established and enforced.

HOW ESTABLISHED.

The origination of standard practices is not the assigned duty of any one, although a competent mechanical engineer, well qualified to handle this work, has charge of the process of their adoption. To begin with, all those practices that permit of ready standardization on account of their universality and which are most apparent are taken up as fast as possible. Drafts are prepared and submitted for criticism to all the officers of the department concerned. The results of these letter-ballots are carefully considered and on the strength of them all final drafts of practices are prepared. The final drafts are then submitted to the highest officer in the department for approval. When this is received, the cards are printed and distributed.

On the other hand, if it is noticed that poor practices prevail for the accomplishment of certain objects, if repeated failures occur, instructions are issued to investigate with the object of eradicating the poor practices and establishing standard practices in their place. The investigation is made, and as a result a draft is prepared of the proper practice which should be followed. The recommendation then goes through the same process of adoption as described above. In general, every one is encouraged to make suggestions. They are always given careful consideration, and, if the practices recommended are of sufficient importance and universality to warrant adoption, they are put through the regular process of establishment. An endeavor is thus made to arouse the interest of every one.

No. 41 **ERIE RAILROAD COMPANY** 2-23-09
 N. Y., S & W. RAILROAD N. J. & N. Y. RAILROAD
 CHICAGO & ERIE R. R.
MECHANICAL DEPARTMENT

STANDARD PRACTICE:—CYLINDER HEADS

When cylinder heads are machined, the joints should be corrugated and weakening grooves cut in the studs and heads.

REFERENCES: Sketch on reverse side and card No. 8024.
 Individual drawings of cylinder heads.

GENERAL PRACTICE:—Roundhouse and Back Shop.

+Form 3154-3-09-200



Fig. 5—Front of Standard Practice Card for Cylinder Heads.

No. 47-B **ERIE RAILROAD COMPANY** 6-16-10
 NEW YORK, SUSQUEHANNA & WESTERN RAILROAD NEW JERSEY & NEW YORK
 RAILROAD CHICAGO & ERIE RAILROAD
MECHANICAL DEPARTMENT

STANDARD PRACTICE:—CLEANING INTERIOR OF REFRIGERATOR CARS (IN SERVICE)

Floor and walls to be thoroughly swept off and condition of surface noted. If soap and water is required to clean, use Erie standard soft soap, diluted. If surface is not in need of soap cleaning, scrub with the car cleaner and wipe thoroughly dry. (The interior finish should be preserved as much as possible at all times, and avoid using a strong solution when it is unnecessary.)
 The floor should be scrubbed with the same soap in full strength, rinsed with warm water, and mopped dry.

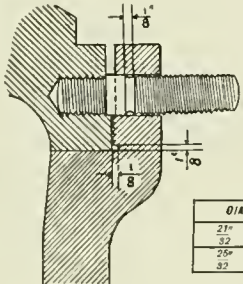

Fig. 8—Cleaning the Interior of Refrigerator Cars.



| DIAMETER AT GROOVE | |
|--------------------|---------------|
| 2 1/2" | FOR 7/8" STUD |
| 3 1/2" | FOR 1" STUD |



Fig. 6—Back of Standard Practice Card for Cylinder Heads.

No. 72. **ERIE RAILROAD COMPANY** 4-1-09
 N. Y., S. & W. RAILROAD N. J. & N. Y. RAILROAD
 CHICAGO & ERIE R. R.
MECHANICAL DEPARTMENT

STANDARD PRACTICE: Use the Following Pressures for Forcing in Axles and Crank Pins into Cast Iron and Steel Wheel Centers:

| DESCRIPTION | DIAM. OF FT. INCHES | TONS PRESSURE | |
|--------------------|---------------------|--------------------|--------------------|
| | | C. I. WHEEL CENTER | STEEL WHEEL CENTER |
| Driving Axles..... | 4 1/2" | 45 to 50 | 72 to 80 |
| " "..... | 5" | 50 to 55 | 80 to 88 |
| " "..... | 5 1/2" | 55 to 60 | 88 to 96 |
| " "..... | 6" | 60 to 65 | 96 to 104 |
| " "..... | 6 1/2" | 65 to 70 | 104 to 112 |
| " "..... | 7" | 70 to 75 | 112 to 120 |
| " "..... | 7 1/2" | 75 to 80 | 120 to 128 |
| " "..... | 8" | 80 to 85 | 128 to 136 |
| " "..... | 8 1/2" | 85 to 90 | 136 to 144 |
| " "..... | 9" | 90 to 95 | 144 to 152 |
| " "..... | 9 1/2" | 95 to 100 | 152 to 160 |
| " "..... | 10" | 100 to 105 | 160 to 168 |



Fig. 9—Standard Practice for Force Fits.

41-B **ERIE RAILROAD COMPANY** 3-16-11
 NEW YORK, SUSQUEHANNA & WESTERN RAILROAD NEW JERSEY & NEW YORK
 RAILROAD CHICAGO & ERIE RAILROAD
MECHANICAL DEPARTMENT

STANDARD PRACTICE:—PAINTING, CLASS A, OUTSIDE, FOR PASSENGER, MAIL, BAGGAGE AND EXPRESS CARS

Car to be primed with lead and oil primer; when dry, putty all holes and rough places; knife in all open grain wood; sandpaper and apply two coats standard body color ground in oil; letter on this with two coats medium chrome yellow in oil. Roof-boards to receive one coat freight paint No. 5; when dry apply canvas previously painted on under side; after being applied finish with three coats paint No. 5. Platforms and steps primed with same car primer and finished with two coats truck enamel. Outside of trucks to receive body primer in oil and puttied up and finished with two coats of truck enamel. Inside of truck to be painted with one coat of freight car paint No. 5. Edge of roof, truss rods, hand rails, &c., to receive one coat black paint. All blind ends to receive two coats sand on priming coats; stenciling to be applied to trucks as per blueprint.



Fig. 7—Standard Practice for Painting Outside of Passenger Cars.

| | | | |
|--------------------------------|--------|----------|----------|
| Eog-Truck Axles..... | 3 1/2" | 20 to 25 | 30 to 37 |
| " "..... | 4" | 25 to 30 | 37 to 45 |
| " "..... | 4 1/2" | 30 to 35 | 45 to 52 |
| " "..... | 5" | 35 to 40 | 52 to 60 |
| " "..... | 5 1/2" | 40 to 45 | 60 to 67 |
| " "..... | 6" | 45 to 50 | 67 to 75 |
| " "..... | 6 1/2" | 50 to 55 | 75 to 82 |
| " "..... | 7" | 55 to 60 | 82 to 90 |
| Car and Tender Truck Axle..... | 4" | 20 to 25 | 30 to 37 |
| " "..... | 4 1/2" | 25 to 30 | 37 to 45 |
| " "..... | 5" | 30 to 35 | 45 to 52 |
| " "..... | 5 1/2" | 35 to 40 | 52 to 60 |
| " "..... | 6" | 40 to 45 | 60 to 67 |
| " "..... | 6 1/2" | 45 to 50 | 67 to 75 |
| " "..... | 7" | 50 to 55 | 75 to 82 |
| Crank Pins..... | 3" | 15 to 20 | 24 to 32 |
| " "..... | 3 1/2" | 20 to 25 | 32 to 40 |
| " "..... | 4" | 25 to 30 | 40 to 48 |
| " "..... | 4 1/2" | 30 to 35 | 48 to 56 |

Sheet No. 1. +Form 3164-5-09-200



Fig. 10—Standard Practice for Force Fits.

HOW USED.

When the division master mechanic receives a card outlining a new standard practice, he takes it up as a subject for consideration and discussion at the next staff meeting of his subordinate officers. The new standardized practice is then carefully explained, questions are raised and answered in regard to it and its application is thoroughly discussed. The individual foremen, who will be held responsible for carrying out the instructions, make a copy of the card in their personal note books. They then go out and instruct the men whom they supervise in the use of the new practice. It has been found that these men take such an interest in the cards that during their leisure time they go into the office of the general foreman, where the cards

are kept permanently, and make a copy of them. The foreman is held directly responsible for the carrying out of the standard practices by the general foreman and the master mechanic. He is checked up continually by his superiors and by the assistant to the general foreman, whose duty it is in part to see that standards are properly maintained. It has been found that this plan is very successful and that the various established practices are conscientiously followed.

Another channel through which standard practices are thoroughly engrained is in the apprentice instruction. The apprentices are taught the use of these cards by both the school instructor and the practical instructor, and are encouraged to copy them for their own immediate and handy reference.

No. 72 **ERIE RAILROAD COMPANY** 4-1-09
 N. Y., S. & W. RAILROAD N. J. & N. Y. RAILROAD
 CHICAGO & ERIE R. R.
MECHANICAL DEPARTMENT

STANDARD PRACTICE: Use the Following Pressures for Forcing in Axles and Crank Pins into Cast Iron and Steel Wheel Centers:

| DESCRIPTION | DIAM. OF FIT INCHES | TONS | |
|--|---------------------|--------------------|--------------------|
| | | C. I. WHEEL CENTER | STEEL WHEEL CENTER |
| Crank Pins..... | 5" | 35 to 40 | 56 to 64 |
| "..... | 5 1/2" | 40 to 45 | 64 to 72 |
| "..... | 6" | 45 to 50 | 72 to 80 |
| "..... | 6 1/2" | 50 to 55 | 80 to 88 |
| "..... | 7" | 55 to 60 | 88 to 96 |
| "..... | 7 1/2" | 60 to 65 | 96 to 104 |
| "..... | 8" | 65 to 70 | 104 to 112 |
| "..... | 8 1/2" | 70 to 75 | 112 to 120 |
| Rolled and Forged Steel Wheels 5" x 9" Journals..... | 6 1/4" | | 55 to 60 |
| Rolled and Forged Steel Wheels 5" x 9" Journals..... | 6 1/2" | | 58 to 63 |

Fig. 11—Standard Practice for Force Fits.

(4) Flue to be belled with Standard Spreading Tool, Card 6222, then prosser expanded with Standard Prosser.

(5) Flue to be beaded with Standard Beading Tool No. 1.

FRONT END

(6) Front end of flues to be opened to fit holes in front flue sheet with tool provided for that purpose (See Card No. 3, Book of Special Devices) except when flues are applied without the removal of steam pipes, at which time flues will be opened after being applied to boiler. Flues to be rolled with air motor and Standard Roller Expanders and beaded with Standard Beading Tools.

Fig. 14—Back of Standard Practice Card for Flue Setting.

Rolled and Forged Steel Wheels 5" x 9" Journals..... 6 3/8" 60 to 65

Rolled and Forged Steel Wheels 5" x 9" Journals..... 6 1/4" 63 to 68

Rolled and Forged Steel Wheels 5" x 9" Journals..... 6 1/2" 65 to 70

Rolled and Forged Steel Wheels with 5 1/2" x 10" Journals..... 6 3/4" 70 to 75

Rolled and Forged Steel Wheels with 5 1/2" x 10" Journals..... 6 1/2" 75 to 80

Rolled and Forged Steel Wheels with 5 1/2" x 10" Journals..... 6 3/4" 76 to 81

Rolled and Forged Steel Wheels with 5 1/2" x 10" Journals..... 6 1/2" 78 to 83

Rolled and Forged Steel Wheels with 5 1/2" x 10" Journals..... 7" 81 to 86

Sheet No. 2. *Form 3154-5-09-200

Fig. 12—Standard Practice for Force Fits.

No. 128 **ERIE RAILROAD COMPANY** 5-2-10
 NEW YORK, SUSQUEHANNA & WESTERN RAILROAD NEW JERSEY & NEW YORK RAILROAD CHICAGO & ERIE RAILROAD
MECHANICAL DEPARTMENT

STANDARD PRACTICE:—RELAYING OLD WINSLOW INSIDE ROOFS, CLASSES Z & V.

In repairing these box car roofs where sheets are otherwise good, except cracked at ridge, apply a strip of rubberoid paper 20" wide, full length of car roof. This paper to go under the roof board longitudinal strips. After roof boards are nailed down, apply another strip of rubberoid paper 20" wide on top of roof boards, and under the running board saddles, nailing same with 3/4" nails and tin washers about 3 1/2" centers. Tighten up all bolts and solder all holes there may be in roof sheets (except at ridge). Where roof boards are good, indicating recent repairs, apply one strip of rubberoid paper under the running board saddles if leaks exist. Winslow caps that contain numerous holes should be renewed, rather than expend much money soldering up the same.

REFERENCE. Sketch on Back

Fig. 15—A Standard Practice Card for the Car Department.

No. 108 **ERIE RAILROAD COMPANY** 3-2-10
 NEW YORK, SUSQUEHANNA & WESTERN RAILROAD NEW JERSEY & NEW YORK RAILROAD CHICAGO & ERIE RAILROAD
MECHANICAL DEPARTMENT

STANDARD PRACTICE:—FLUE SETTING

FIREBOX END

(1) All burrs and scale to be removed from flue holes, back and front sheet and if holes are more than 1-32" out of round, must be reamed true.

(2) Copper ferrule .075 M.M. gauge and 1/8" wider than the thickness of the sheet to be fastened in back flue sheet with sectional expanders; ferrule to be flush with the sheet on the fire side.

(3) Flue to be swaged to proper size and scale either filed or ground off of same, applied and driven through the sheet 3-16" and rolled tight with standard roller expanders.

*Form 3154-106-6-10-30 OVER

Fig. 13—Front of Standard Practice Card for Flue Setting.

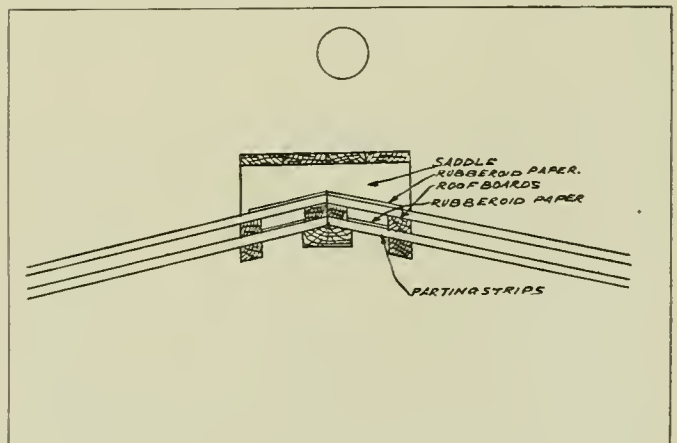

Fig. 16—Back of Card Shown in Fig. 15.

It has been found that they are of great value in the design of new equipment. Many are incorporated in new designs and specifications, with the result that the maintenance of the new equipment conforms to the practices which are already more or less universal over the entire road, thus preventing, to a certain extent, increased expense for maintenance.

EXAMPLES.

The wide range of practices which may be covered by these cards is shown by the accompanying illustrations. The cards are 4 in. x 6 in. in size, and where necessary are printed on both sides. The purpose of the card shown in Fig. 1 is obvious. It leaves no question in regard to the clearances which should be maintained between driving and truck boxes and the wheel hubs, and those which should not be exceeded.

The card shown in Fig. 2 settles once and for all the proper system of threads to be used on the entire road. It is also a handy reference for the correct sizes of drills to be used in connection with drilling and tapping holes for particular size studs, etc. Ordinarily the determination of the right sizes to use is often a matter of guess work, with the result that a good deal of drill and tap work is either done imperfectly or is spoiled.

The value gained by following out the practice shown in Figs. 3 and 4 must appeal to any one who realizes the mix-ups that result at iron racks where no system, or a loose system of material identification is employed. Valuable time is saved by men who are required to select material from the rack. Furthermore, the card designates the various uses to which the different irons and steels are to be put. It answers many troublesome questions, and also insures the correct employment of the different steels in the manufacture of tools, gages, screws, keys, etc.

A good example of a practice which might vary greatly according to individual opinions, or perhaps not be observed at all, if it were not standardized, is shown by the standard practice card for cylinders, Figs. 5 and 6.

The painting of equipment is another practice which will vary according to individual experience and judgment. The standard practice shown in Fig. 7 is the best that could be devised as a result of the experience and judgment of all those best qualified to advise in regard to it.

This standard practice for cleaning the interior of refrigerator cars in service, as shown by the card in Fig. 8, typifies to what extent the cards may be employed. Another example of a practice which should be identical at every place where force fits are made is shown by Figs. 9, 10 11 and 12. It insures against failure on the one hand, and is a check in connection with the gage records, if subsequent failures do occur.

The standard practice cards for flue setting shown in Figs. 13 and 14 indicates how standard practices may be of assistance to the apprentices. It is also the basis on which prices for flue setting are made. A good example of the application of standard practice in the repair of cars is shown by Figs. 15 and 16, which describe and illustrate the proper method of relaying certain classes of old Winslow inside roofs.

LOCOMOTIVE DEVELOPMENT IN ITALY.—For some years the most notable locomotive designs in Italy have been four-cylinder compounds of the 2-6-2 and the 0-10-0 types, and two-cylinder compounds of the 2-6-0, 4-6-0 and the 4-8-0 types. Lately, however, the Schmidt superheater has come into favor, and the tendency is to go back to the simple engines with lower boiler pressures. One of the recent interesting designs is that of a four-cylinder simple Pacific type weighing 192,600 lbs., with 116,500 lbs. on drivers. The cylinders are 18 x 27 $\frac{1}{4}$ in.; the boiler pressure is 170 lbs.; the grate area, 37.8 sq. ft.; the superheating surface, 723 sq. ft., and the total equivalent heating surface, 3,351 sq. ft. By using the superheater the boiler pressures have been reduced as much as 65 lbs.

BOILER WASHING SYSTEM.

As an addition to the former equipment of the Richmond enginehouse, the Richmond, Fredericksburg & Potomac has installed a hot water boiler washing and refilling system, designed and erected by the Horace L. Winslow Co., Chicago. This apparatus, which is shown in the accompanying illustration, differs in a number of particulars from previous systems of this kind, and after a service of two or three months is reported by those in charge to be satisfactory in every way. It has been found that any desired temperature of the washout water can be obtained up to the boiling point, but that 140 deg. is as hot as can be comfortably handled. The washout water is usually much too hot as it comes from the tanks, and it is necessary to inject cold water to hold the temperature down. No difficulty has been found in keeping the tank of filling water at a temperature of 212 without the addition of heat from an outside source.

Although up to the present time the system has not been called upon to handle more than three engines at one time, it has been found that with one engine being blown down, another filling and a third being washed out, all at the same time, thoroughly



Boiler Washing and Refilling System.

satisfactory temperatures and supplies are available. It is also reported that since the installation of this system, there has been a time saving of about 75 per cent. in the lay-over of engines at the washout points.

This system is designed on what is known as the two unit system, consisting of a combination receiver and separator and a heater with the accompanying pumps, thermostat, purifier, etc. The system as installed at Richmond has a capacity of about 15,000 gal. of water in the heater tank, sufficient to fill two locomotives at 212 deg., and when mixed with sufficient water to give a temperature of 140 deg. will also furnish a sufficient supply for washing out two more locomotives.

In operation, connection is made between the blow-off valve of the locomotive and one of the lines connecting each pit to the blow-off main around the house. These connecting lines are each protected against back flow from the main by a check valve and a gate valve. The water, scale and sludge which is blown off is carried through the main and discharged to the tank marked "receiver" in the illustration. After the main becomes heated up, most of the water which is being blown off will turn to steam upon reaching the receiver and a pressure is developed in this tank sufficient to send the steam through the cross-over line to the heater and through the series of small pipes reaching

down into the water of the heater, from which it emerges and is condensed, heating the water in this tank. The sludge, scale and such water as is condensed in the line remains in the receiving tank, which is of sufficient capacity to hold it under ordinary conditions.

If the water in the heater rises above 212 deg. and does not condense the steam, a slight pressure is developed in this tank which opens a back pressure valve and admits cold water to the tank until the pressure is entirely relieved, thus automatically holding the water in the tank at about 212 deg. If the supply of water in the heater becomes too low, a float valve opens a connection to the receiver; the water from that source, however, passed through a purifier before reaching the heater tank into which it flows by gravity. The scale and sediment carried into the receiver will very largely settle to the bottom below the outlet connecting with the purifier and is washed out by simply opening a 6 in. valve in the line connecting with the sewer; this is done about once a day. Whatever sediment may escape settling to the bottom of the receiver will pass to the inlet chamber of the purifier. Here it is permanently arrested from passing into the heater and may be washed out by opening a 3 in. valve connecting with the sewer. After cleaning the receiver and purifier some water is pumped into it backwards through the purifier, which will cleanse the purifier and make it possible to run much longer without renewal of the filtering material.

Two pumps are provided, one for refilling and one for washing out. The refilling pump takes its supply direct from the heater tank and discharges direct to the filling line without other connections. The washout pump takes its main supply from the heater tank and also from the regular cold water system in sufficient quantities to give the desired temperature for washing out. The pump discharges to the washout line direct.

as for delivering the clean water to the heater or direct to refilling line. By means of an automatic starting switch actuated by a float in the heater, the motor operating the centrifugal pump is started or stopped as the maximum and minimum water levels in the heater are attained. The two valves located in the suction pipes below the water level are equipped with extended stems with wheels above the reservoir top. A 24 in. manhole is provided both in the reservoir top and through the filter bed and filter floor, rendering all parts easily accessible for examination or repairs. The reservoir has a capacity for thoroughly filtering and cleansing all the water coming from two locomotives which may be washed at one time.

TERMINAL BRAKE TESTING.*

BY F. B. FARMER.

As we seek efficient train brakes and as the standard set by law is based on the train, it is obvious that terminal brake tests of trains must be made. Stated differently, the requirements can not be met by confining inspecting, testing and repairing to shops and repair tracks. Consideration of overtime and the sixteen-hour law, as well as expeditious train movement demand the minimum lapse of time between that for which the crew is called and the time the train departs. Hence, a train prepared for departure should require no more brake work after the engine is coupled than, at the most, stopping a few leaks in hose couplings and making the formal test. But often there are greater delays due to making other repairs, or the train proceeds with less efficient brakes than it should have. To avoid this, the repairs required must be determined with arriving trains. The incoming engineer should add to the reduction required for

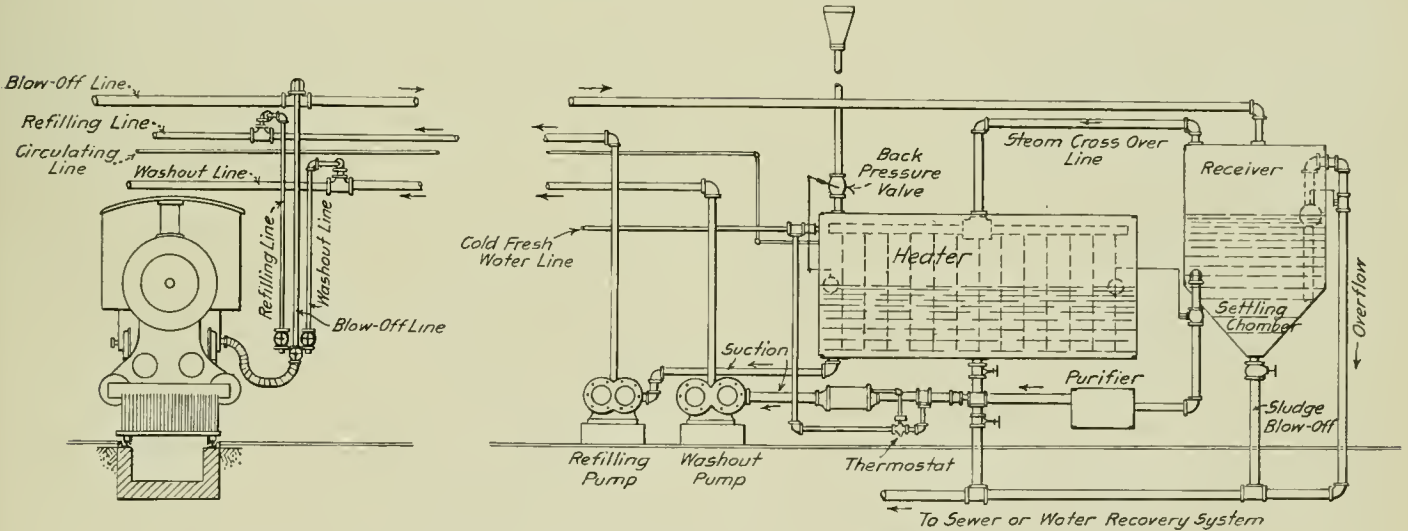

Winslow Boiler Washing and Refilling System; Richmond, Fredericksburg & Potomac.

An examination of the illustration showing the arrangement of the piping will indicate the various connections.

A concrete water conserving and filtering reservoir was installed as an auxiliary to the boiler washing and refilling system. This reservoir is constructed underground and consists of a cylindrical and a lower conical portion, the latter containing the filter bed. When washing out the locomotives the water drains into the pit and thence through the sewer into this reservoir. This water is conducted into the chamber in the conical section below the filter bed and rises through it into the cylindrical portion, where it appears as clean, filtered water available for further use in washing out or refilling. A centrifugal pump is installed with double suction and discharge pipes, properly valved in order that, at the necessary intervals, it may be employed in pumping out the sludge from the sludge chamber under the filter bed, as well

stopping enough to fully apply the brakes, and the brakeman should await his advice that this has been done before cutting off the engine. Car inspectors should be present to make an immediate examination and to bad order all defective brakes. Such repairs as ordinary brake pipe leaks, defective hose and wrong piston travel, which require little time, should be made, but cars requiring heavy brake repairs should be marked for the repair tracks.

Here is where judgment must be exercised, as perishable or other very important loads, as well as empties needed at once for such lading, must not be delayed. Neither should other less important cars be held in numbers far greater than the local force

*Abstract of a paper read at the December meeting of the Western Railway Club, Chicago. Mr. Farmer is a representative of the Westinghouse Air Brake Company.

can repair in a day if such force is as great as the regular amount of work, including such repairs, would keep busy. The car foreman and the yard master should consult to adjust this, but when the former removes bad order marks without repairs having been made, he should fill out and apply an air brake defect card to better insure prompt repairs at the earliest practicable date. However, it does not follow that the repairing of defective brakes cannot be done without delay to cars which should go forward promptly. The Minneapolis, St. Paul & Sault Ste. Marie has largely solved this problem at an important terminal yard by assigning a short track in the yard for air brake repairs to such cars. With a few men and the necessary repair materials, such cars are often ready for the first train out, are never actually delayed, and few are allowed to go forward without repairs. This is but one detail of a very comprehensive scheme of improvement in freight brake maintenance effected by this road.

As one repair point on a large system cannot maintain all freight car brakes, it is obvious that each terminal should do its share, but this does not mean that other than the outgoing test should be made on through trains at the points with small facilities. A brake well repaired will go for a long period without becoming defective, but the too common failure to do so is due to inadequate repairs. To reduce the cost of brake cleaning by leaving cylinders and auxiliary reservoirs loose on the car is to insure leaky pipes. The same result follows if the brake pipe and retaining valve pipe are not well secured. That most serious fault, brake cylinder leakage, will develop sooner than it should, sometimes immediately after the cleaning, unless a suitable lubricant is employed and packing leathers are replaced when a good inspection and a careful test would show that they should be. The practice often followed of cleaning and testing triple valves on the cars cannot insure good work. Neither is it common practice to test hose with soap suds while under maximum pressure and remove those found porous, or to examine the retaining valve weight and clean the case and small vent port. Until these and other details are given better attention in shops and on repair tracks, it will not be possible to effect the economy in time and money in terminal brake testing and the consequent repairs that will otherwise follow.

The M. C. B. requirement that cars in interchange must have retaining valves should imply the maintenance of this part and its pipe by the owning road. It is not sufficient to say that the mountain road may make needed repairs at the owners expense, as this means undue delay to traffic. However, inspections show that the average efficiency of brakes is otherwise much lower on the cars of level grade roads, a condition for which there is no warrant as that for the average mountain grade road is enough below 100 per cent. efficiency to justify making it the minimum.

That the regular terminal test of freight train brakes misses many of the defects which nullify the object sought in attaching air brakes, is conclusively demonstrated by the following: Within a few months competent parties made a test on several freight trains at the summit of a mountain grade, following a similar test by regular inspectors at the preceding division terminal, and out of which trains bound down this grade were supposed to leave with 100 per cent. efficient brakes, based on such test. The tests consisted of charging to 70 lbs., making a service reduction of 15 lbs. and rapidly examining for any brakes failing to apply or leaking off and incorrect piston travel. To show conclusively the oversights of the ordinary terminal brake test the infallible thermal brake test was made on each train at the foot of the grade. The customary plan was there followed of considering three cars with "warm" wheels equal to one with "normal" wheels; that is with a good brake. In addition to showing the results in percentage, they are given in "tons per good brake," derived by dividing the train tonnage by the number of good brakes.

The first train was a test train and had 2,501 tons. The other six were regular trains and ran from 2,252 to 2,367 tons, aver-

aging 2,286 tons. Each train had a considerable percentage of foreign cars. No tests of or repairs to retaining valves were made.

| Per Cent. Good Brakes by Test. | | Tons per Good Brake by Test. | | Cars per Train. |
|--------------------------------|----------|------------------------------|----------|-----------------|
| Standing. | Thermal. | Standing. | Thermal. | |
| 97.7 | 68.8 | 42.6 | 59.5 | 61 |
| 91.0 | 75.0 | 45.0 | 54.6 | 56 |
| 100.0 | 60.0 | 40.7 | 67.6 | 58 |
| 98.1 | 53.7 | 42.5 | 77.6 | 54 |
| 98.1 | 52.8 | 43.8 | 81.5 | 53 |
| 96.4 | 53.5 | 41.7 | 75.0 | 56 |
| 88.9 | 67.2 | 46.2 | 61.2 | 55 |

The big returns from good brakes are mainly concealed, consisting of the more expeditious train movement they make possible and the avoidance of accidents, neither of which can ordinarily be shown in dollars and cents. Their observable expenses, consisting of initial cost, maintenance, flat and cracked wheels and delays to cars and trains for brake testing and repairs, are so readily seen and tabulated as to generally render even more obscure their great but intangible credit account. The pressing need is for a more accurate and practical appreciation of the fact that good brake maintenance is economy and for better directed efforts toward improved brake maintenance with a minimum increase in time and money spent. In this the active cooperation of the yard master and the superintendent will aid greatly. Too often their efforts are directed toward showing why trains cannot be held or switching done for brake work, rather than how to accomplish the desired results with the least delay or additional switching.

While there is no question concerning the imperative need of available air pressure in car shops and on repair tracks, it is debatable as to whether it pays to pipe yards. I believe that usually it does not. If locomotives have insufficient air compressor capacity to charge their trains without material delay, they are not prepared to handle the trains safely, economically and expeditiously between terminals. Following the plan of having the brake test on incoming trains, and subsequent disposition of cars with defective brakes, will leave little need for a yard air test plant. The only safe or available time for inspectors to work on cars in yards is for a limited period after the arrival of trains and again following attachment of the outgoing locomotive.

A grave evil with many air brake test plants is the excessive amount of moisture. The ground cocks in their piping are commonly referred to as "hydrants." This should be a misnomer as it means a cock for controlling the flow of water, but it is too often quite applicable. As a brake pipe obstructed by ice is even more dangerous than an accidentally or maliciously closed angle cock (the forces cannot be seen), it is enough to say that water in test plant pipes may bring about frozen brake pipes. Triple valve and brake cylinder leakage from ice are other evils which follow. Also moisture causes corrosion of brake pipes and the rust clogs strainers and feed grooves and dries up the lubrication in triple valves and brake cylinders. The cause of water in the piping is the result of insufficient cooling of the air between the compressor and the storage reservoirs, often magnified by the inadequate number and location of such reservoirs. It is many years since the Air Brake Association investigated the same fault with locomotives and though the difficulties in the way of obtaining dry air for the brakes is there incomparably greater, solved it satisfactorily. However, it should be said in passing that many locomotives, even new ones, are not properly equipped and are a source of similar damage and danger. Questioning men using air test plants will soon disclose whether such furnish dry air, whether opening a cock will show visible moisture or moisten a surface against which the air is directed. If so, it is obvious that the remedy should be applied promptly. I venture the assertion that in comparatively few cases dry air, that free from visible moisture, is available.

In seeking means for testing and repairing air brakes without loss of time in transit, extra switching, or danger to workmen

the possibilities of the freight house tracks should always be investigated. Where the number of cars per day is considerable there is no doubt that the tracks should be supplied with compressed air and full advantage taken of this excellent opportunity for locating and remedying air brake defects. In line with this idea of conserving time and switching, it is recommended that all cars in shops or on repair tracks, and having cleaning dates over nine months old, should have their brakes cleaned and lubricated. Not only will the condition of the triple valve and brake cylinders fully warrant doing this work then, but it is improbable that such cars will again be so favorably located for many months, without causing delay and switching.

FREIGHT CAR PAINTING.*

BY T. J. HUTCHINSON.

Master Painter, Grand Trunk, London, Ontario.

Painting is given the last consideration in the general maintenance of freight equipment. This accounts for the delapidated appearance of so many cars. Freight cars are seldom shopped on account of paint conditions unless the lettering is entirely obliterated. This is easily understood, for the condition of the paint on a car does not necessarily interfere with its earning capacity. This being the fact, the master painter must co-operate with the traffic department. Scarcity of cars at certain seasons of the year and the imperative traffic demands of recent years have precluded the consideration of a rigid paint formula in maintaining this class of equipment, which means that the durability of the coating is not as important as the immediate use of the car, for the reason that in most cases a car will earn, in one day several times the cost of painting it. Competition demands that the master painter who keeps abreast of the times must be "on the spot and deliver the goods." The question arises, do substitute paint oils, turpentine and benzine, now so generally used in freight car paints, give the requisite durability to the paint structure?

If this question were asked today of the most eminent chemist or practical painter of the old school, outside the range of the modern railway paint shop, they, knowing that the life of any coating depended to a great extent on the kind and quality of the vehicle used, would unhesitatingly answer, "No," and would proceed at once to make comparisons as to the cost and probable durability of the substitutes, with that of the old time tried linseed oil and spirits of turpentine, never dreaming for an instant that the greatest durability would not be an essential in the coating under present conditions of railway freight traffic. They would be entirely unable to understand how any conditions of traffic could displace either of the old reliables with the more volatile shorter lived substitutes. Durability is a consideration but not an essential. I do not wish to be misunderstood in this. Although I am of the old school and regret the passing of the old system, I recognize the necessity of sacrificing durability so that the work may be done more quickly.

The suggestion to use a substitute for linseed oil would have been met with scorn a few years ago, yet today there is not a railway paint shop in the country that is not obliged to add quick drying japans and volatile substitute turpentines to thin and hasten the drying quality of linseed oil. The qualities of linseed oil are unquestionable, but where linseed oil is made to dry equally as fast as its substitutes, I fail to see the difference in the quality of the two materials.

Railway service is the most severe test that can be given any coating, and time or service tests are the most reliable and are the painters' guide. Experience justified us in recommending those paint pigments that have been in general use for many years,

because they have proved to be the most acceptable as to cost, durability and color. Therefore, with the exception of refrigerator and tank cars and other steel cars we are safe in accepting the oxide of iron pigment as the standard. The durability of any coating depends largely on the use and abuse of the cars, particularly in the destructive coal and iron traffic. Immunity from abrasion is not to be expected in this service, as time has proved that the construction of all hopper bottom cars makes a certain amount of abuse unavoidable, the greatest damage being done by the use of the mauls in unloading the cars during the winter season. Much of the damage done to the coating on the metal might be avoided by bolting short pieces of plank over the parts usually hammered and applying a stencil to this effect; "When necessary to use mauls strike here."

The initial painting of freight equipment is the all-important one. At this time all roofs should receive particular attention by the painter, for in this, as in everything else, the permanency of the structure depends on the foundation. All roofing material should be kept in stock, thoroughly primed and ready to be used by the builder when required. This would greatly prolong the life of all freight car roofs and reduce the number of claims for damage to merchandise through defective roofs. As all of our freight equipment is painted by the piecemeal plan, we have found it advantageous, both to the carpenter and the painter, to keep an advance supply of such staple material as car roof sheathing and flat car sills primed in the stick. This work is done by piling the sheathing on the floor, where the color is applied with the long-handled brush, removing each layer, when coated, to a wall rack to dry. We arrange to paint our supply of flat car sills in the same manner in the wood shop. This arrangement greatly facilitates the regular output of both the shop and the yard, adding much to the appearance and durability of the work when completed.

Painting new or old freight equipment expeditiously and economically depends largely on the method of doing the work, the shop temperature and the necessary shop and yard facilities. There are three methods to consider: The small short hand brush, the pneumatic paint spraying apparatus and the long handled brush. The small hand brush, except for touching up purposes, has long since been abandoned, as it is too slow to be profitable. The use of the atomizer or paint spraying machine, although having much to commend it for use out of doors, or on inaccessible parts of the under structure of trucks, etc., has not proved acceptable in the majority of shops, for the reason that because of irregular air pressure it cannot be properly adjusted to give an even distribution of the paint, and it often fills the air with atomized color much to the discomfort of the men, as well as menacing their health. On flat surfaces, such as the bodies of box cars, an even distribution of color is a necessity, and this can be most effectually obtained by the use of the long handle brush. Comparing the cost of this application with that of the sprayer, as reported in papers at conventions, we prefer the use of the brush. If good results are to be desired the temperature of the shop must be at least 60 deg. during the winter months. Not more than one coat should be applied in twenty-four hours, particularly in the northern section of the country.

Preparatory to painting the steel car it is necessary to remove all the rust possible by the use of scrapers, wire brushes and the sand blast, if available. Inert carbon blacks have proved the most durable for all metal structures for out of door use. Their many excellent qualities when the color is not objectionable, commend them for use on other classes of freight equipment. There is a limit to substitutes and a legitimate use of them. Substitutes for oil color cannot be used with impunity on metal structures. To illustrate, the following formula was obtained by the writer as the coating that was being used during the summer months on the steel coal cars of one of the largest railway systems. But when too

*Entered in the *Railway Age Gazette* competition on Paint Shop Practice which closed November 15, 1911.

cold it had to be abandoned for the regular oil black generally used:

| | |
|-----------------------|---------|
| Coal tar | 8 parts |
| Kerosene oil | 1 part |
| Portland cement | 1 part |

Portland cement with water is valuable as a vehicle for many purposes, but the difficulties one encounters in endeavoring to apply it along with paint or tar has prevented it from being used extensively. As a pigment in a mixed paint it has proved a failure, because it settles and hardens in the bottom of the pail, and when used with tar has to be added just before application. The only virtue, if any, in the above mixture as a coating for the steel car, would be in the oil which would aid a more even application of the tar, but ultimately this coating would be very brittle and would break down rapidly. When lettering, a coat of shellac must be applied to help it to dry and to prevent the discoloration of the white lead by the tar. The use of the shellac causes "alligatoring" of the surface.

SHOP KINKS*

BY E. L. DUDLEY

Special Apprentice, Baltimore & Ohio, Cleveland, O.

CHUCK FOR BORING ROD PACKING.

A chuck *A*, for boring rod packing, together with its different bushings, is shown in Fig. 1. It is made to hold nine different sizes of piston rod and valve stem packing. The chuck will fit the spindle of an ordinary lathe and is arranged in steps, as shown, to take the different sizes of packing. The cap *B* screws on the outside of the chuck and holds the packing rigidly in its cup. The packing is placed in the cups as shown at *C, D, F, K, M, O, S,* and *U*, which includes all the different sizes used on locomotives. Cup *C* is simply placed in the chuck and is held in place by the cap *B*. Where the packing is smaller, as in *D, F, K,* etc., a binding ring, such as *E, H, L, N,* etc., is inserted between the cup and the cap *B* to make up for the difference in size.

In the case of valve stem packing a still smaller series of steps has to be used than is provided in the chuck *A* and for this purpose the extra steps are made in an auxiliary chuck, *R*. When boring these packings this chuck *R* is placed in the main chuck,

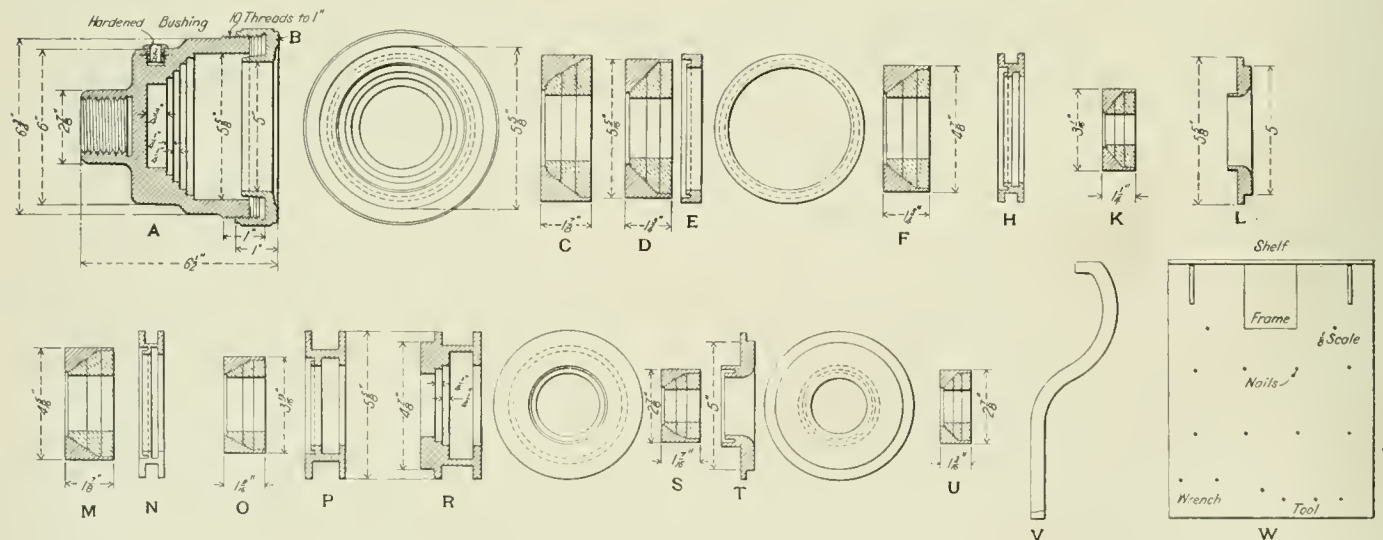

Fig. 1—Chuck and Bushings for Boring Rod Packing.

resting on the first step. The cup, such as *S*, is then placed in *R*, the binding ring *T* following. This is all held, as in the other cases, by the cap *B*, the thickness of the binding ring being such that the cap can be screwed on two or three threads before the

*These kinks were entered in the *Railway Age Gazette* shop kink competition which closed May 15, 1911.

ring bears on the packing. In the same way the packing *U* may be bored.

A standard wrench is shown at *I* which is used to remove the chuck from the spindle. A board *W* is also provided which may be placed back of the lathe to hold the rings, cups, wrench

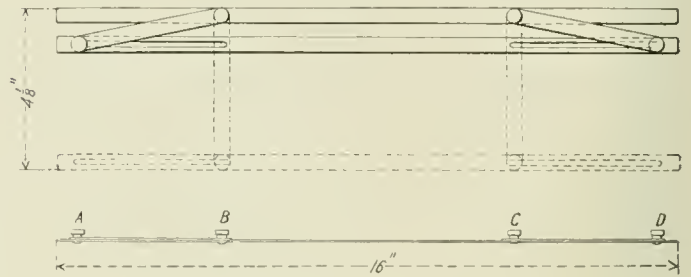

Fig. 2—Adjustable Template for Keyways.

and tools. The cup and packing number is stenciled above each nail.

ADJUSTABLE TEMPLET FOR KEYWAYS.

The templet shown in Fig. 2 is used to measure the size of keyways from $\frac{3}{4}$ in. to $4\frac{1}{8}$ in. in width. It is inserted in the keyway and adjusted as to the size and taper and is held to size by the thumb screws *A, B, C,* and *D*. By the use of this templet it is

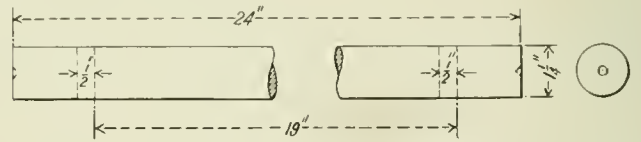

Fig. 3—Boring Bar for Bell Stand.

found to be unnecessary to plane the keys, since the blacksmith can make the keys approximately to size and they can then be easily finished on a grinding machine.

BORING BAR FOR BELL STAND.

A boring bar for reaming holes in bell stands is shown in Fig. 3. It has been found difficult where these holes are badly worn to get them parallel. With this bar the operation is com-

paratively simple. It is $1\frac{1}{4}$ in. in diameter and 24 in. long, having two $\frac{1}{2}$ -in. slots, for holding the tools, cut 19 in. apart, that being the distance between the two holes in the stand. The tools are held in place by wedges. The bell stand is clamped to the carriage of the lathe and the bar is put in the lathe centers. This bar can be used for the reaming tools also.

ENGINE FAILURES AND THEIR ELIMINATION

Engine Failures Can Always Be Traced to Errors or Negligence on the Part of Individuals. Suggestions as to How to Do This and Reduce Failures to a Minimum.

By ERNEST CORDEAL

Bonus Demonstrator, Atchison, Topeka & Santa Fe, La Junta, Col.

It is not entirely accurate to use the term engine failure to announce the fact that a locomotive has not succeeded in performing the task set for it. The perfect machine kept in proper repair does not fail. The difficulty lies in that some human brain or hand has done its work imperfectly, making it impossible for the machine to perform the duty for which it was designed. When we say that an engine fails, we really mean that the designer, the builder, the official assigning the work expected of the engine, the foreman supervising its care, the workman making repairs, the inspector, or the engineman has failed to do his part, and therefore the locomotive is unable to accomplish the work that has been laid out for it. As a preliminary step toward the elimination or minimization of failures they should be traced to the individual responsible. In only a very few cases will it be found impossible to place the blame on some person or persons, and these few cases may properly be termed unavoidable failures, as they will invariably be attributable to uncontrollable conditions.

In the analysis of engine failures for a division or a system, the initial move should be to classify them into groups, localizing the responsibility on the individual as nearly as possible. Eight general heads under which all causes of failure may be divided in such a way as to devote the individual or groups of individuals responsible are as follows:

- | | |
|------------------------------------|--------------------------------------|
| <i>First</i> , defective design. | <i>Fifth</i> , imperfect inspection. |
| <i>Second</i> , poor construction. | <i>Sixth</i> , incompetent handling. |
| <i>Third</i> , improper repairs. | <i>Seventh</i> , defective material. |
| <i>Fourth</i> , neglected repairs. | <i>Eighth</i> , outside causes. |

Under the first head, defective design, should be placed all cases of failure by new types of power occasioned by the parts not being properly designed to stand the strain, or the service demanded of or imposed on them. In this category would be failures due to breakage, inadequacy of parts or appliances, except such as can be traced to poor construction, improper repairs, or defective material. Great care should be exercised in attributing failures to this class and no part or appliance should be condemned as ill designed until it has first been given a fair trial of ample duration to preclude the possibility of an error in judgment.

Poor construction also refers to new power, and includes such failures as are due to errors or imperfections in construction for which the builder is directly responsible. Over anxiety should not be exhibited to charge failures to either of the first two classes as it may often prove, after a sufficient test, that what at first appeared to be faults of design or construction are really only failures on the part of the operating force to thoroughly understand or properly handle power varying in detail from that to which they have been accustomed.

To the third and fourth groups, improper repairs and neglected repairs, a large percentage of the total number of failures must undoubtedly be charged. Under improper repairs should be placed all failures of parts worked on by mechanics in the period of detention immediately preceding the trip during which the failure occurred. Work performed by a mechanic which does not prove defective during the first trip and is not reported a second time by the inspector or engineman should be considered as properly done, and if failure occurs on the second or any subsequent trip, the fault should be charged against the inspector, engineman, or foreman and not against the workman.

Neglected repairs covers all failures of parts reported as defective or needing attention by the engineman or inspector and not repaired by the enginehouse force. Failure to perform work reported as necessary should always place a failure under this head regardless of the reason for its not being done. Lack of time, insufficient force, or press of other matters should not be considered sufficient excuse for raising the stigma of neglect from the head of the foreman or workman, who through carelessness or lack of judgment allows the work to go undone.

Imperfect inspection includes all failures due to a defect not reported as requiring attention previous to the trip on which the failure occurred. This should be understood to apply to all cases in which it would have been possible for the inspector to have discovered the defect in time to have prevented the failure.

Improper handling covers a class of failures which, although not as frequent of occurrence now as in the past (thanks to the present methods of educating enginemen), nevertheless sometimes happen. Under this head should be placed all failures caused by ignorance or inexperience on the part of the man running the engine. Failures in this class are generally reported as due to some minor defect which in the hands of an intelligent and experienced runner would at the worst have caused but a slight delay. The judgment of an experienced official is generally necessary before a failure should be charged to the engineer, as it often happens that an apparently insignificant defect which, at other times might not seriously affect the running of the engine, will under certain circumstances render it impossible to avoid a delay.

Any failure should be carefully investigated and considered before being placed under the head of defective material. Failures caused by broken parts when not to be accounted for by defective design, poor construction, improper handling, or outside causes may generally be included under this head, but cases will be noted where the breakage was due to improper repairs, neglected repairs, or where efficient inspection should have discovered the defect or weakness in time to have avoided a breakdown.

Under outside causes should be classed only such cases as cannot be placed under any of the preceding seven heads. Such failures as are caused by broken parts due to rough track, engines failing when the demands of traffic render it necessary to keep them in service after they have completed sufficient mileage to entitle them to a shopping, engines failing on account of being doubled over the road without sufficient intervening time to accomplish necessary repairs, and failures due to poor quality of fuel should be classed under this head. Careful investigation should precede the charging of any failure to outside causes, and no case should be considered as coming under this head which could in any way have been avoided by greater diligence or exercise of judgment on the part of any individual entrusted with the care or handling of the locomotive.

Any campaign tending toward a reduction in the frequency of engine failures should at its inception be supported by immediate and accurate reports and by brief and comprehensive records. A thorough investigation of each failure should be made immediately upon notification of its occurrence and a complete report rendered. This investigation should not be delegated to an inexperienced clerk, but should be conducted

by some person thoroughly familiar with locomotive operation and repairs and conversant with existing conditions. The report should be of standard form, showing all the required information in such a way that it may be easily understood and readily compiled into the form of a permanent and valuable comparative record. A comprehensive form for the rendition of failure reports is suggested by the accompanying Form 1.

One of these forms should be filled out, for every failure by the enginehouse at which the engine was handled just previous to the trip during which the failure occurred. The cause of the failure should not be stated in general terms such as "engine leaking," "not steaming," "blowing," or "running hot," as is common practice, but should be made as definite as possible by indicating the exact nature of the defect. In cases where the engineer is unable to specifically locate the cause of the difficulty and where such cause does not develop on subsequent inspection, the failure should be considered as one of improper handling and the enginehouse force should be cleared of any responsibility. The incorrect or generalized reporting of work by engineers is one of the greatest difficulties with which the investigator of engine failures will have to contend unless his work has been preceded, or is being paralleled, by a course of instruction in the art of intelligently reporting work.

The cause of failure having been positively fixed, the work reports of the engineer and the inspector should be examined to determine whether or not any defect was reported previous to the failure, which might have been responsible for the breakdown. In case no report was made of the condition of the part failing, a further study of the cause should be made to settle whether or not the defect was of such a nature that a careful inspection previous to the failure should have discovered the necessity for repairs. If it is decided that the likelihood of failure should have been detected during proper inspection the respon-

foreman to a workman the responsibility for any failure to complete the necessary repairs in a manner such as to preclude the possibility of breakdown should be placed on the individual workman, not forgetting, however, that the foreman should bear a certain amount of the blame as it was his duty to know not only that the repairs were made, but that they were properly made. Extenuating circumstances may intervene to mitigate in some degree the severity of the criticism due foremen or workmen on account of improper or neglected repairs, as in cases where insufficient time could be allowed for the proper completion of the work or where proper material was not available.

With the data secured through this investigation, the rendering

| MONTHLY ENGINE FAILURE RECORD | | | | | |
|-------------------------------|---------------|---------------------------------------|-------|---------------------|--------------|
| By Stations | | | | | |
| Station | Little | Division | Grand | Month | Oct. 1911 |
| Date | Engine Number | Cause | Group | Persons Responsible | Action Taken |
| 1 | 1077 | Flues leaking left side of firebox | 3 | H. Smith | Reprimanded |
| 4 | 1055 | Right front frame broken back of cyl. | 1 | | |
| 5 | 1132 | LB main rod brass hot | 4 | P. Jones | Laid off |
| 7 | 1148 | Broken spring hanger No. 1 driver | 8 | | |
| 14 | 1220 | Engineer could not make time | 6 | R. White | Reprimanded |

Form II—Monthly Engine Failure Record.

of an accurate report is made possible, and if the investigator has worked with despatch a full record of the case should be in the hands of the master mechanic a few hours after the occurrence of the failure. The master mechanic, having at hand reliable information, is in a position to administer caution, censure, or discipline, as the case may require, to the individual responsible and that at a time sufficiently soon after the occurrence to lend it added weight. The placing of individual responsibility, it will be found, is one of the greatest aids in reducing failures. When it is understood by engineers, foremen, inspectors, and workmen that each failure will be traced down until the person or persons accountable are located and that the blame will fall upon the head of the individual who has failed in his duty, the quality of the service rendered by each will be noticeably improved.

At the end of each month the reports covering individual failures should be compiled into a record arranged in date order and showing all of the information which will be required at any subsequent time. Form II is suggested for such a record. This form shows the date of failure, cause, general head, person responsible, if any, and the action as to discipline which the master mechanic or other official saw fit to take. At the bottom of the report should be shown the total number of failures, also the total number for the previous month and for the same month of the previous year for purposes of comparison.

The arrangement of this record by stations is for the purpose of providing a simple means of comparing the quality of work performed at various periods. A copy should be sent to the foremen in charge for their personal information and another copy should be posted so as to be accessible to the workmen and engineers. In this way the record as to the failures, whether good or bad, will be kept before the men who are directly responsible for the condition of the power. No man will care to have his name posted as responsible for the failure of an engine and as a consequence each individual workman, inspector, foreman, and engineer will exercise a greater amount of care in the performance of his part of the work.

The posting of reports for the inspection of employees gives them, to a certain degree, a feeling of co-responsibility with the officials for the attainment and maintenance of a creditable record.

| ENGINE FAILURE REPORT | |
|--|--|
| Date | Oct. 30, 1911 |
| Division | Valley |
| Engine No. | 1011 |
| Group | 3 |
| Station handling | Denver |
| Cause of failure | Left main driving box running hot on account not properly packed |
| Work reported | Pack left main driving box |
| Work done | Left main driving box packed |
| Engine inspected by | Smith |
| Work done by | Janes (X) |
| Foreman in charge | Black |
| Engineer | Brown |
| Report rendered by | R. S. Rich |
| NOTE: Cross (X) should be placed after the name of person responsible when failure is classed under groups 3, 4, 5, or 6 | |
| Action taken | |

Form I—Individual Engine Failure Report.

sibility should be charged against the inspector and further research is unnecessary.

Suppose the defect to have been discovered and properly reported by either the engineer or the inspector. The next step is to ascertain from the records of work done whether or not the performance of the work in question was delegated to any workman by the foreman. In case the foreman did not issue instructions to have the work done, it is either an indication of poor judgment in deciding that the work reported was unnecessary or of neglect or oversight in not having the proper repairs made. In case the condition of the engine was properly reported and an order for the performance of the work was duly issued by the

It will be noticed that when the workmen are taken into confidence to the extent of letting them know how their collective performance compares with that of other points or with other periods, they will respond by evincing an added interest in the welfare of the company which employs them.

A second record of failures by divisions should be kept for the purpose of comparing the performance of various divisions during different periods. This record should be in such form as to facilitate comparison between the performance of different classes of power, showing the number of failures of each class attributable to the causes covered by the general heads, and giving the number of engine miles per failure for each individual engine and the total for each class. A suggestion for a report filling this requirement is shown in Form III. This form has a column for the class number followed by one for the number of the individual engine. The mileage per engine, number of failures, miles per failure, and number of failures coming under each of the eight general heads are shown. Totals and averages should be extended for each class of power, and at the end of the report should be given a recapitulation, showing each class separately, the grand totals, and averages for the divisions. On divisions where the pool system is not in effect, and where engineers are assigned to particular engines, the value of this record can be further enhanced by adding a column for the engineer's name. On divisions where the pool system is in effect a record may be easily compiled from Form 1 showing the failures of engines handled by each individual engineer.

The tabulation of failures by engine classes and by individual

| MONTHLY FAILURE RECORD OF INDIVIDUAL ENGINES | | | | | | | | | | | | | | | |
|--|---------------|--------------|--------------|-----------------------|-----------------------|----------|----------|----------|----------|----------|----------|----------|----------|--|--|
| By Divisions | | | | | | | | | | | | | | | |
| Division <u>Grand</u> | | | | | Month <u>Oct 1911</u> | | | | | | | | | | |
| Class | Engine Number | Mileage | No. Failures | No. Miles Per Failure | Cause | | | | | | | | Engineer | | |
| | | | | | 1 | 2 | 3 | 4 | 5 | 6 | 7 | 8 | | | |
| 1000 | 1055 | 3580 | 2 | 1790 | 1 | | | | | | | | | | |
| | 1077 | 4400 | 1 | 4400 | | 1 | | | | | | | | | |
| | 1130 | 5600 | 0 | 5600 | | | | | | | | | | | |
| | 1132 | 3800 | 1 | 3800 | | | 1 | | | | | | | | |
| | 1148 | 4250 | 3 | 1417 | | | | 1 | 1 | 1 | | | | | |
| Total | | 21630 | 7 | 3090 | 1 | 0 | 1 | 1 | 1 | 1 | 0 | 2 | | | |
| 2000 | 2001 | 2400 | 0 | 2400 | | | | | | | | | | | |
| | 2002 | 4650 | 1 | 4650 | | | 1 | | | | | | | | |
| | 2003 | 3760 | 3 | 1253 | | 2 | 1 | | | | | | | | |
| | 2004 | 3890 | 2 | 1945 | | 1 | | | | | | | 1 | | |
| | 2005 | 4530 | 2 | 2265 | | | | | 1 | 1 | | | | | |
| | 2006 | 2100 | 1 | 2100 | | 1 | | | | | | | | | |
| | 2007 | 4480 | 3 | 1493 | | 1 | 1 | 1 | | | | | | | |
| Total | | 25810 | 12 | 2151 | 1 | 0 | 4 | 2 | 1 | 2 | 1 | 1 | | | |

Form III—Monthly Failure Record of Individual Engines.

engineers will develop much interesting and valuable information. For instance it will be found that with a certain class of power a large percentage of the failures are due to some specific cause which may be remedied by a slight change of design, by the substitution of an improved type of some small appliance, or by the re-enforcement of some weak part. It will also be found that certain engineers will have a series of delays or failures attributed to some one cause, while other men running the same engines or ones of identical construction have no trouble along that line. A study of this record will develop deficiencies in the knowledge or experience of runners and render it possible to educate the individual along the line of his greatest need.

Investigating, reporting, and recording failures is of course only a preliminary step and it should not be considered when this work is done promptly and accurately that the end has been accomplished. The best reports, if made up and filed away without being given careful study, are of no more value than the poorest or none at all. In order to extract the full value from any report or record it must be carefully and intelligently studied, the points which it brings out noted, and action taken to correct improper practices and educate inexperienced workmen.

PAINT SHOP KINKS*

BY A. G. PANCOST,
Elkhart, Indiana.

RACK FOR SIGNAL BLADES.

The paint department has the care of all signal blades, repainting and cleaning them when they become dirty and smoky from use, and furnishing them for replacements or for new installations. So many blades are handled that it is necessary to have some method of storing them. The rack shown in Fig. 1, contains twenty pockets, each capable of holding ten blades, making a total of 200 blades when the rack is filled. If it were

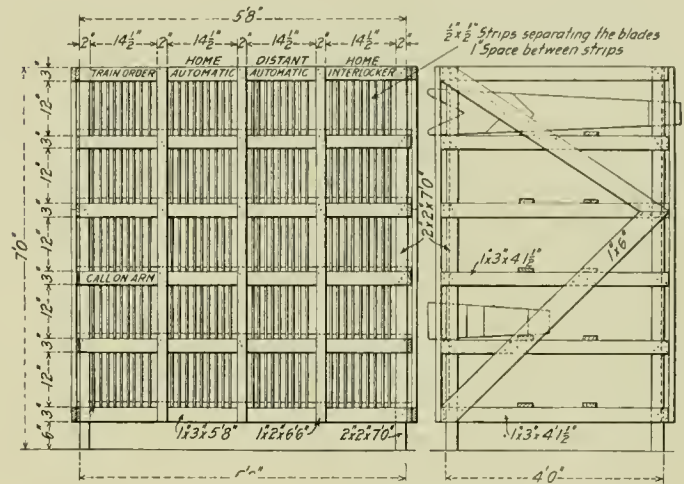

Fig. 1—Rack for Storing Painted Signal Blades.

filled with the different kinds, as indicated at the top of the rack, it would contain 50 home blades for interlocking signals, 50 each of the home and distant blades for the automatic signals, 30 train order blades and 20 call-on or short arms used on three position upper quadrant signals. The side view shows one short blade and one long blade in position in the rack. This has been found very useful, not only keeping the blades in good condition, but for classifying them so that the person in charge can determine the condition of the supply of blades almost at a glance.

EASEL FOR PAINT SHOP.

There is more or less lettering, numbering and various markings to be done in a railway paint shop on different apparatus.

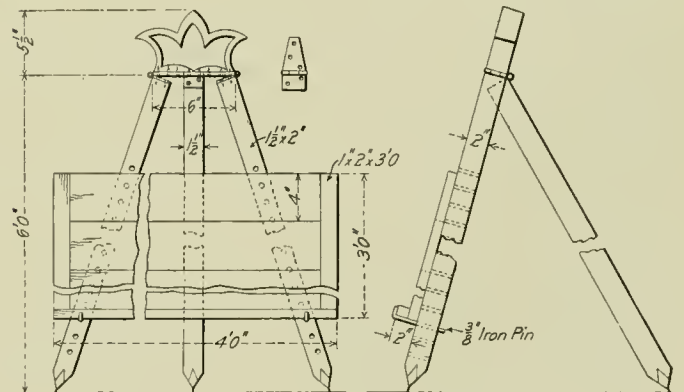

Fig. 2—Paint Shop Easel.

Any one familiar with general sign work will at once see the necessity and usefulness of possessing an easel similar to the one shown in Fig. 2. This may be spread out to accommodate most any large work, or it may be used for small work. The

*Entered in the Railway Age Gazette competition on Paint Shop Practice which closed November 15, 1911.

board shown resting on the easel is useful when lettering on cardboard, paper, glass or sheet metal, or in fact any material that will not readily stand alone. The holes bored at intervals of 2 in. along the uprights, allow the work to be raised or lowered as desired. The ends of the legs are equipped with metal points, which serve to hold the easel in place.

KEROSENE TANK FOR PAINT BRUSHES.

The construction and arrangement of a galvanized-iron tank in which paint brushes are kept when not in use, thus preserving their shape and elasticity, is shown in Fig. 3. Many brushes are spoiled from improper care when not in use. This receptacle has two apartments, one for brushes which have been used in light colors and the other for brushes which have been used in dark colors. Each apartment is equipped with a removable wooden rack, which may be removed when it is desired

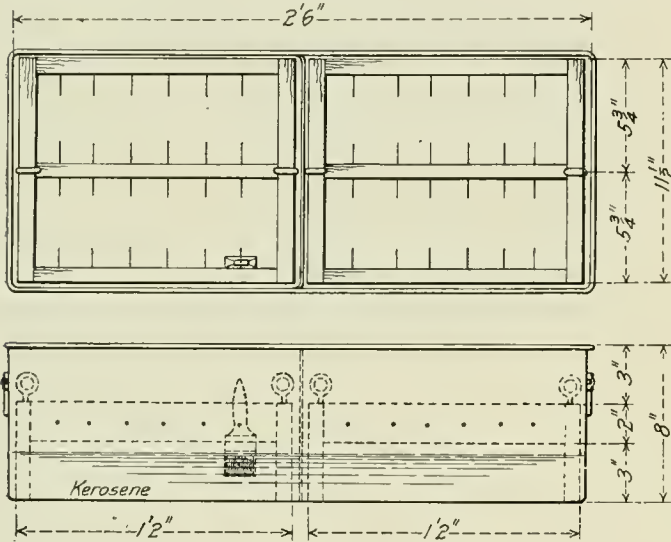

Fig. 3—Kerosene Tank for Paint Brushes.

to clean the tank. The tank is filled with about 3 in. of kerosene oil, and the brushes are hung on brads arranged around the wooden frame, holes being punched through the brush handles, so that the hair will be fully immersed in the liquid. If the brads are long enough three or small brushes may be hung on each one. The kerosene should be washed out of the brushes before they are used again.

GLASS CUTTING BOARD.

A glass cutting board with an adjustable stand is shown in Fig. 4. It should be made of hard wood, maple being the best. The left hand and lower edge should be marked and graduated in feet, inches and eighths of inches. The table will be found very useful in the paint shop, not only for cutting glass but as a drafting table.

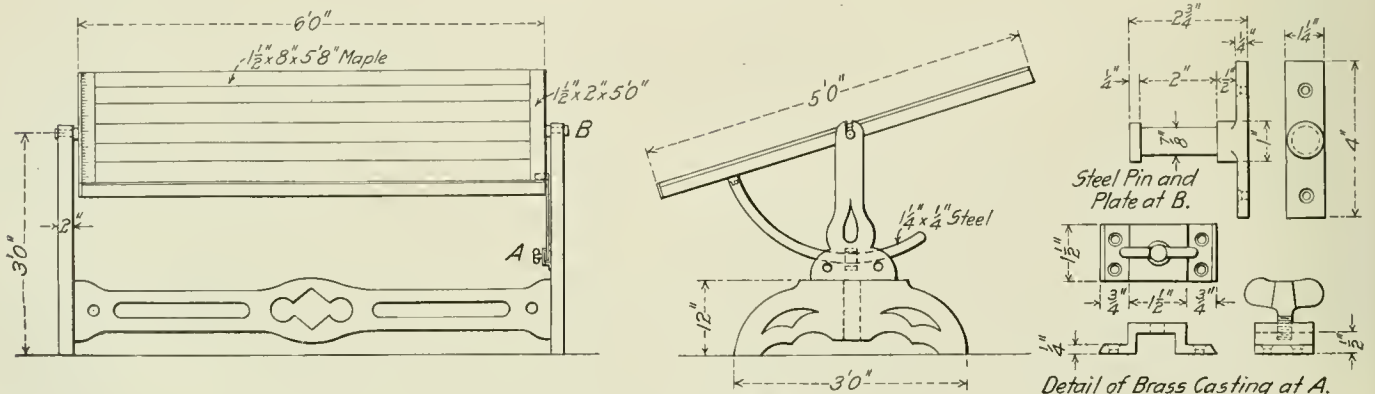

Fig 4—Glass Cutting Board.

LOCOMOTIVE ROD BRASS

BY J. E. OSMER

Master Mechanic, Chicago & North-Western, Boone, Iowa

On large modern power the cost of removing the rod brasses is quite a feature from a time and labor standpoint. The accompanying illustration shows a new type of brass which has been used with very good results. It is similar to the ordinary brass, except that it is provided with a brass key in the top and bottom, as shown in the drawing. This key has a flange on the outside only, so that when the collar and nuts, and the return

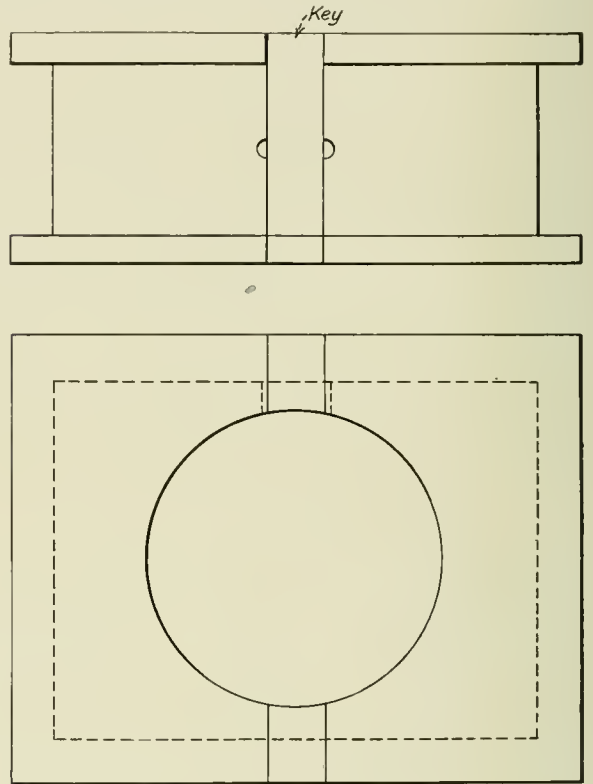

New Type of Rod Brass.

crank, if the Walschaert valve gear is used, are removed from the crank pin, it may easily be slipped out. The sides of the key are then planed and reinserted, which compensates for the wear on the brasses. The brass is then keyed up, the washer and nuts applied, and the job finished in a very short time.

Iron instead of steel for underframes has been specified in an order for 3,000 cars just placed by the Great Western Railroad, England. Iron is preferred as being less susceptible to corrosion.

WATER GAS REPLACES OIL FOR FURNACES

Furnaces at the Scranton Shops of the Lackawanna Have Been Operated with Water Gas for the Past Year with Marked Economy Compared with Other Fuels. Heats Work Rapidly, No Smoke, Easy to Regulate, No Ashes.

The installation of a gas plant and the use of gas furnaces in the Scranton, Pa., shops of the Delaware, Lackawanna & Western was such a radical departure from established practice that it attracted considerable comment at the time of its installation. This plant with its dependent furnaces have been in use for about a year, and have established themselves so thoroughly and satisfactorily as to warrant a detailed review of their operation and results. The project was a bold one. It involved not only a large initial investment, but the making of the major portion of the work of the blacksmith department dependent upon the gas plant. T. S. Lloyd, who was superintendent of motive power at the time, became convinced that the principle was economically possible, and that, this being the case, the details could be worked out in a way to make for the economic and operative success of the whole.

It is needless to tell any engineer that modifications have been made in the first designs of the furnaces installed. Neither the makers nor the users had had sufficient experience with this class of work and furnace to work with an absolute certainty on the

modeling a number of the furnaces the number of burners has been reduced from 4 to 2, and these 2 have been made sufficient by lowering the roof of the furnace. Whatever change has been made it has been in detail and never in principle.

THE PLANT AND ITS OPERATION.

The gas used is that ordinarily known as water gas, and is a mixture of about equal parts of carbonic oxide or carbon monoxide and hydrogen. The formation of the gas is accomplished by passing a current of steam through a bed of incandescent coal. The chemical process is as follows: As the steam strikes the incandescent mass of coal it is heated to so high a temperature that it is dissociated and decomposed into its component elements, oxygen and hydrogen. The oxygen thus freed at once forms a new combination with the carbon of the coal and burns into carbonic acid gas, or carbon dioxide (CO_2), but in passing through the mass of hot coals this carbon dioxide is robbed of one of its atoms of oxygen and becomes carbon monoxide (CO) in which form it issues from the other side of the

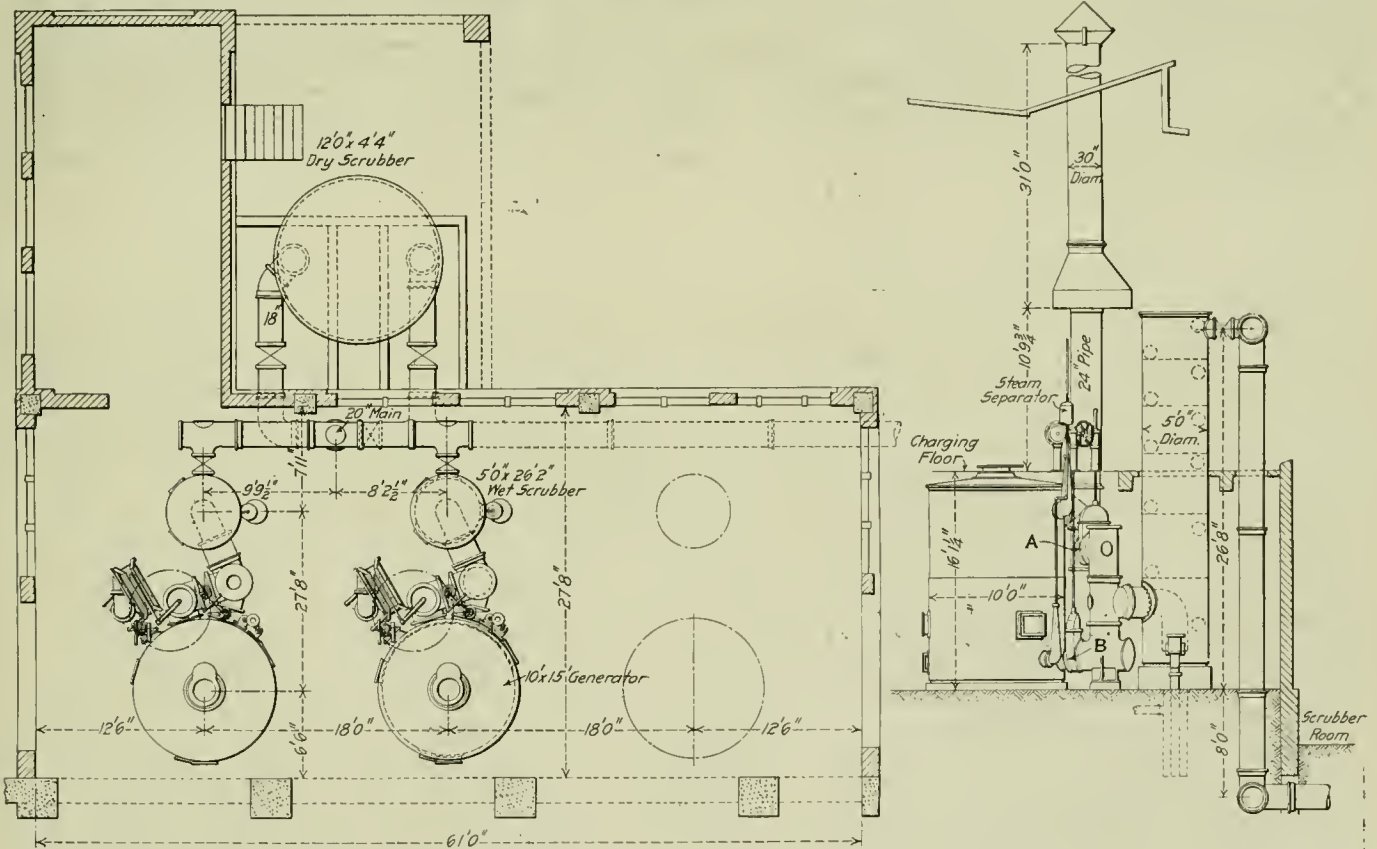

General Plan of Gas Plant and Elevation of Generator and Wet Scrubber.

designs. Hence, in every case of doubt the leaning was always on the side of insuring the accomplishment of the work, so that there has never been any delay due to a shut-down or furnace failures. Estimates were made and burners were provided that would be certain to do the work demanded, and these estimates and provisions were so liberal that in the modifications that have been made everything has tended towards a reduction instead of an increase of gas consumption. For example, in re-

bed. Meanwhile a portion of the hydrogen will combine with a little of the carbon and from such hydrocarbons as ethylene (C_2H_2) and marsh gas (CH_4).

It must be evident that the passage of steam through the incandescent mass of coals will have a cooling effect on it and that, if continued for a sufficient length of time, it would extinguish the fire. Hence the action of the generator must be intermittent, alternating between a rapid production of gas when the

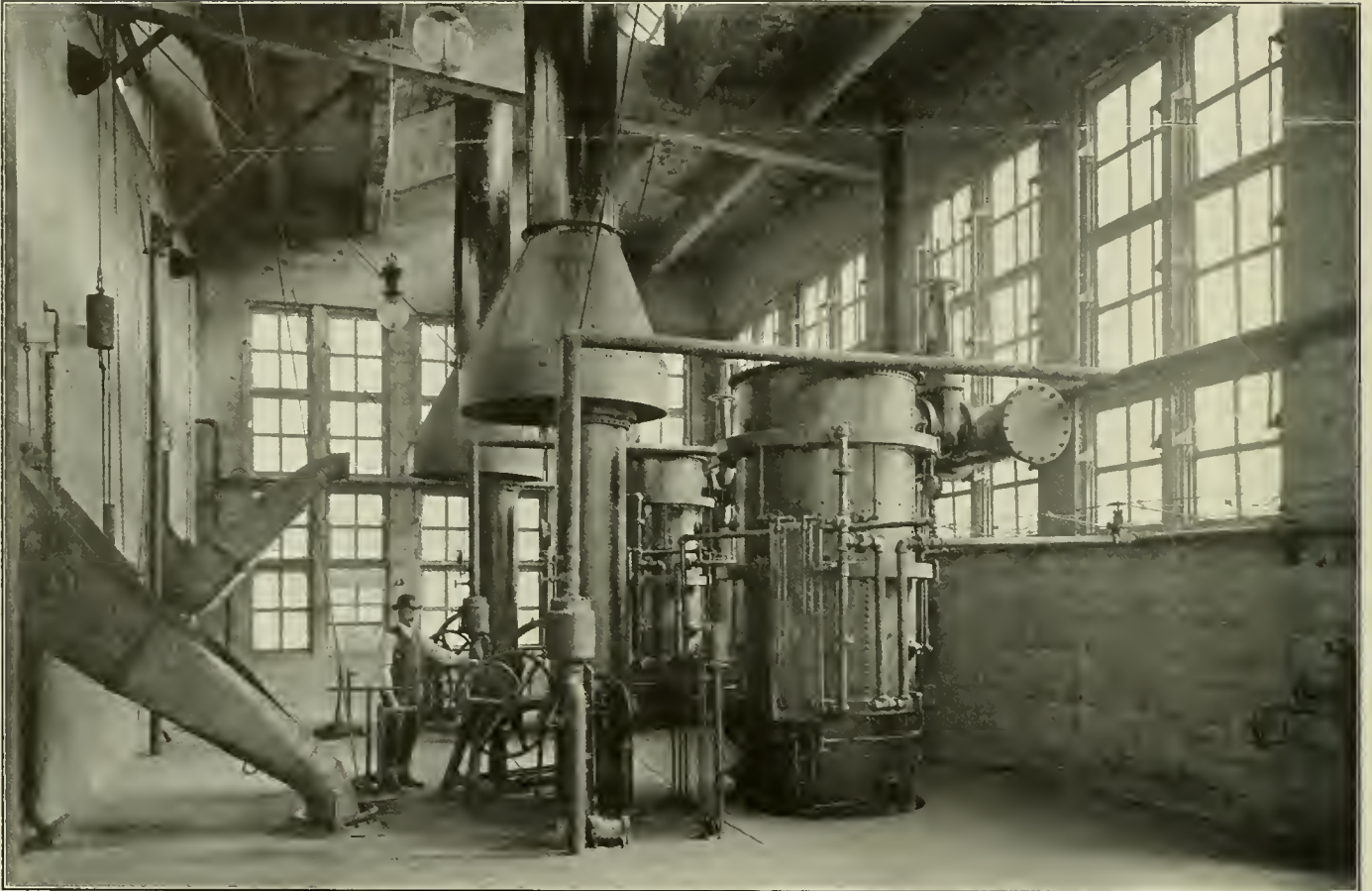

Second Floor of Gas House Showing Top of Wet Scrubber.

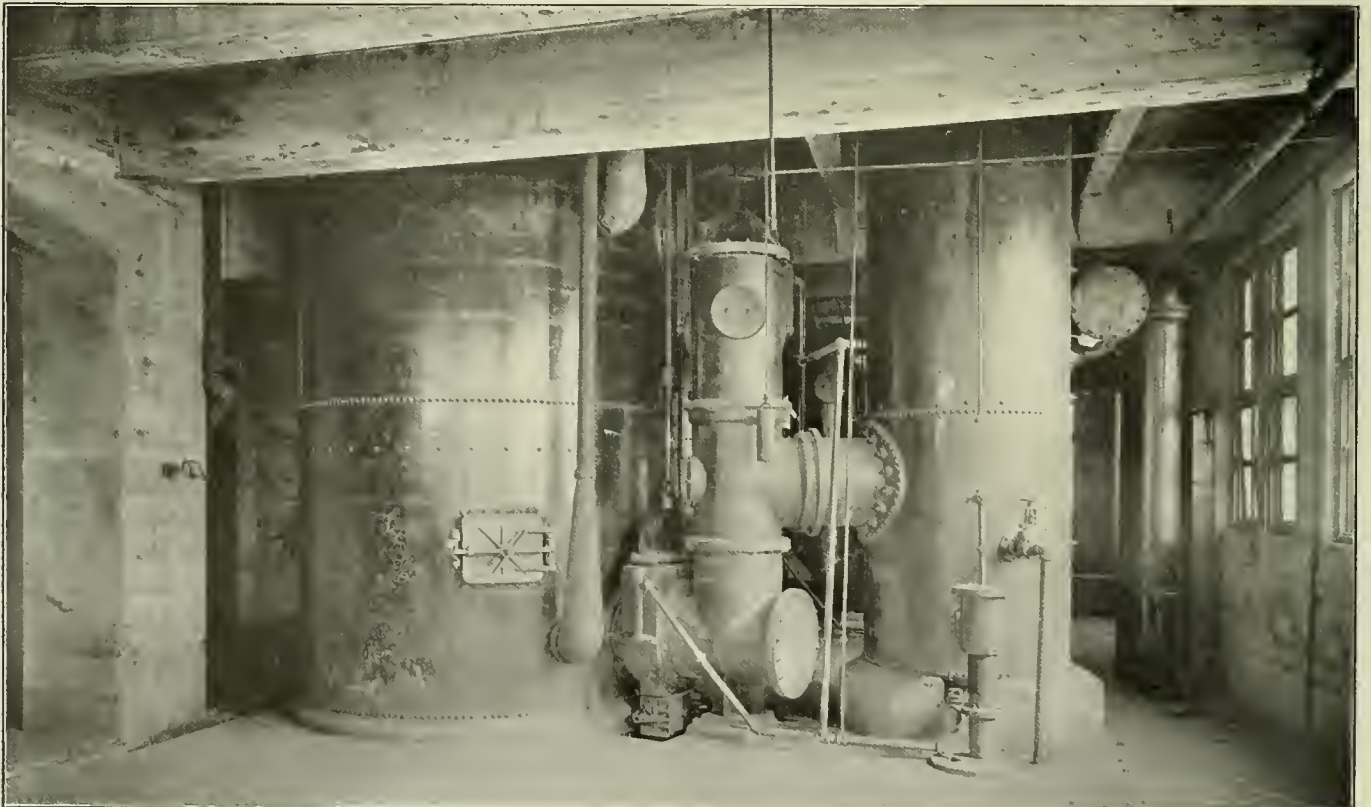

Ground Floor of Gas House Showing Generator and Wet Scrubber.

steam is first admitted, and a production that falls away and would stop entirely if the steam were not shut off. This is followed by a blowing up of the fire followed by another run.

The gas plant was built by the Power & Machinery Company of Cudahy, Wis. It is located in a building of its own situated on the ground south of the tracks leading to the shops. It consists of two generators, a wet scrubber for each, a dry scrubber, a gas holder of 10,000 cu. ft. capacity, and a motor-driven blower for each producer, having a capacity of 7,500 cu. ft. of air per minute. The air is delivered to the ash pit at a pressure of 1 lb. per square inch, and the motors used for driving the fans are of 75 h. p. each.

The generator consists of a steel shell 10 ft. in diameter lined with 13½ in. of fire brick. The height is about 15 ft. At the

second floor. These gate valves are so connected to the operating wheel that one is opened as the other is closed. The stack for the discharge of the products of combustion during the blow-up process is closed by a tight damper setting down over the top.

The wet scrubber is formed of a cylinder about 5 ft. in diameter and 26 ft. high, in which are a number of perforated partitions each carrying a layer of cobble stones, over which water is sprayed. There is one of these scrubbers for each generator, the gas being admitted at the bottom and drawn off at the top. On admission its temperature, coming as it does direct from the producer, is about 2,300 deg. F. As it rises through the stream of water and the plates it is washed free of all solid matter that may have been entrained; the steam that may have escaped

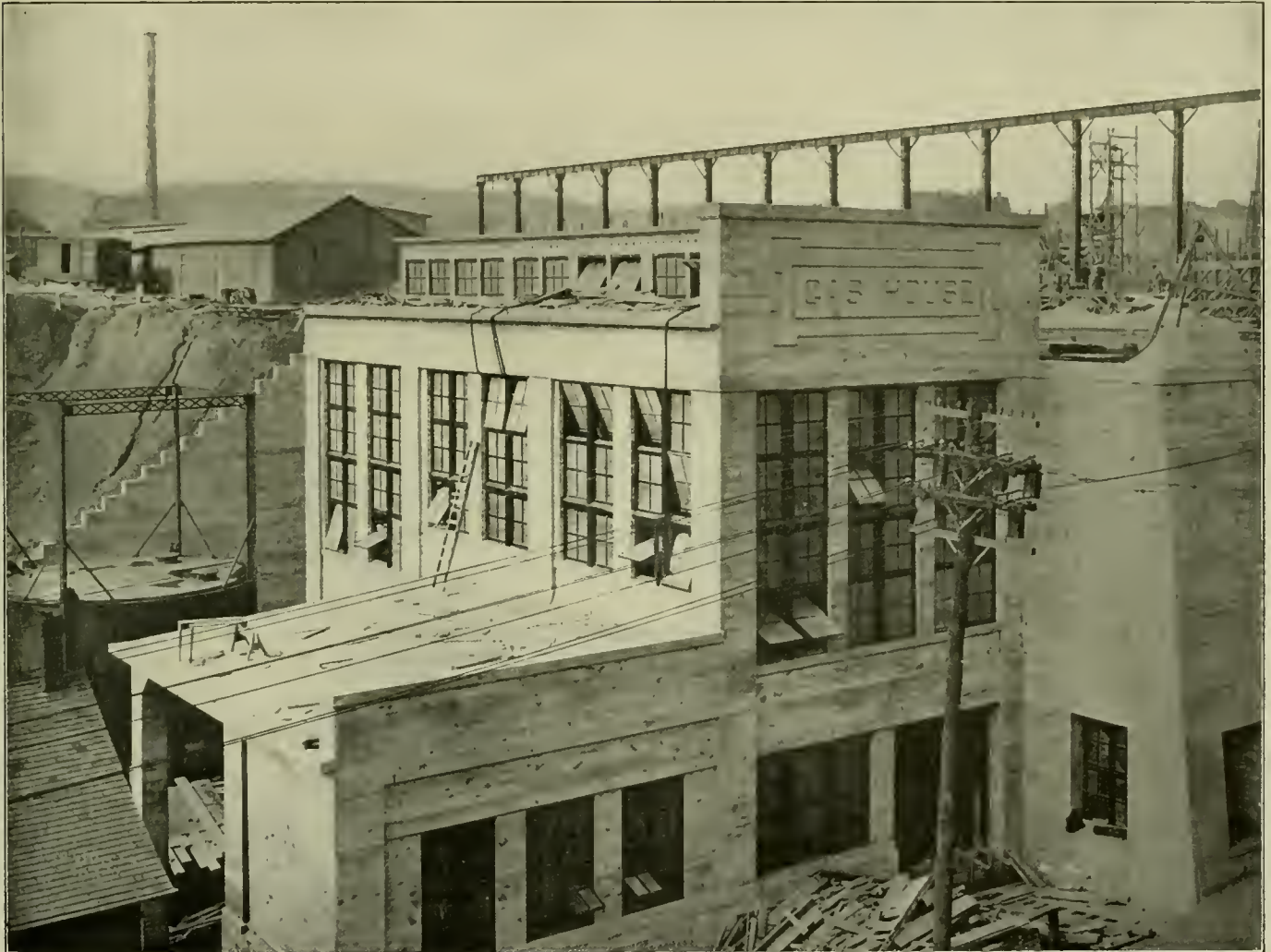

Gas Plant at the Scranton Shops; Delaware, Lackawanna & Western.

top is a circular opening, flush with the second or operating floor of the building. The opening may be sealed air tight, and it is through it that the coal is charged to the generator. A flue also leads off from the upper portion, as shown, for carrying off the gas as well as the products of combustion when the fire is being blown.

At the bottom is a closed ashpit that is hermetically sealed, above which are arched grates set rigidly in place. Around the grates are three so-called fire-doors, also closing hermetically, which are used for cleaning out the ashes at the end of a day's run. Leading off from the ashpit is also another flue, which, connecting with the one from the top, leads to the bottom of the wet scrubber. The flues are shown at A and B in the drawings, and each is fitted with a large gate valve operated from the

decomposition is condensed and the gas itself is cooled from 65 to 75 deg. F. It then passes to the main common to the two generators which are used and to a dry scrubber placed outside the building, the pressure being equal to about 10 in. of water. This scrubber is merely a box about 12 ft. in diameter and 4 ft. 6 in. high filled with coke, which takes up any moisture and solid matter that may have escaped the wet scrubber. From here the gas flows to an ordinary gas holder of 10,000 cu. ft. capacity.

The operation of the plant is exceedingly simple, but requires constant attention and care. The generators are banked for the night and, with the ashpit closed so that only a very small amount of air is admitted, the fire dies down. The ashpit door is closed upon a nail which holds it open about ⅛ in. The first thing in the morning, before six o'clock, the fans are started and

the fire is blown up by admitting the air to the ashpits; in about twenty minutes the generators are ready to make gas. The air is then shut off and the dampers are closed. Shortly after six the furnace fires in the blacksmith shop are lighted in order to have the furnaces hot for the commencement of the day's work. As soon as the indicator shows that the gas holder is dropping, the producer is started by admitting steam of 120 lbs. pressure to the ashpit. It rises through the bed of hot coals and passes out at the top as water gas. It takes about ten minutes to so cool the fire that no more gas is produced. The flow of gas to the scrubber is then shut off, the stack damper is opened and the air blast is turned into the ashpit. It takes about five minutes to blow the fire into a state of incandescence suitable for the making of gas. This done, the air is shut off, the stock damper is closed, and with the valve from the top of the generator to the scrubber closed and the one at the bottom opened, steam is admitted above the bed, forced down through it and out at the bottom to the scrubber. The object of the reversal of the flow of steam is to hold the fire at the bottom of the bed of coals.

It is essential that dry steam be used and at as high a pressure as possible. The evident reason for this is that any moisture contained in the steam must first be evaporated before it can be decomposed, and this evaporation requires so much heat that it has a strong cooling effect on the fire, and thus materially detracts from the gas-making possibilities. Hence a separator is placed in the steam pipe just above the valves controlling the flow.

At the end of the day's run the making of gas is stopped by simply shutting off the flow of steam after the gas holder has been filled. Then the fires are cleaned and banked. To do this the valves leading to the scrubber are closed and the stack damper is opened. Steam is then admitted to the ashpit and blown up through to the stack, and steam is admitted at the top and likewise blown out. The ashpit and door are then opened, and this must always precede the opening of the fire door above the grates lest an explosion occur because of the gas that has formed. The fire doors that are located immediately above the grates are then opened and the ashes are pulled out; there are usually from 800 to 1,000 lbs. With the ashpit cleared and the fire poked down from the top it is allowed to lie for an hour or so, when the generator chamber is filled with coal to within about 4 ft. of the top. It is then ready for the night.

The coal flows from the cars to the hoppers by gravity, and from them through the spouts shown in one of the photographs to the charging hole in the floor. On the lower floor the ashes are wheeled to a pit, whence they are elevated by a chain and bucket conveyor to the track and discharged into a waiting car.

The coal used is grate size of anthracite, which comes in lumps about the size of a man's fist. An average analysis of this coal may be taken as

| | | |
|---------------------------|---------------------|------------------|
| Moisture, from | .98 per cent. to | 1.16 per cent. |
| Volatile matter, from.... | 5.14 per cent. to | 5.88 per cent. |
| Ash, from | 10.40 per cent. to | 7.43 per cent. |
| Free carbon, from..... | 83.48 per cent. to | 85.53 per cent. |
| Total | 100.00 per cent. to | 100.00 per cent. |
| Sulphur, from | 0.772 per cent. to | 1.06 per cent. |
| B. t. u., from..... | 13,495 | 14,156 |

An average analysis of the gas produced would run:

| | |
|---|-----------------|
| Carbon dioxide (CO ₂)..... | 3.60 per cent. |
| Oxygen (O) | .00 per cent. |
| Ethylene (C ₂ H ₂) | .00 per cent. |
| Carbon monoxide (CO) | 41.20 per cent. |
| Hydrogen (H) | 51.50 per cent. |
| Marsh gas (CH ₄) | .00 per cent. |
| Nitrogen | 3.70 per cent. |
| Total | 100 per cent. |

The calorific value of such gas is about 312 B. t. u. per cu. ft. It will be seen that the combustible portions of the gas consist of a mixture of carbon monoxide and hydrogen, to which is added another portion of the inert gases, carbon dioxide and nitrogen, in nearly equal proportions and forming 7.3 per cent.

of the whole. The gas is, therefore, practically pure and can almost be expressed by the formula CO + H.

COST OF GAS.

The amount of gas produced varies with the demand and runs from a little more than 300,000 cu. ft. per day to nearly 1,200,000 cu. ft., with an average of about 950,000 cu. ft. An analysis of one such average day's work is as follows, it being understood that a run is the gas produced by the application of the steam between two periods of blowing up the fire.

| | |
|---|---------------|
| No. of runs, generator No. 1..... | 24 |
| No. of runs, generator No. 2..... | 22 |
| Cu. ft. of gas made in generator No. 1..... | 483,400 |
| Cu. ft. of gas made in generator No. 2..... | 466,800 |
| Total | 950,200 |
| Coal used | 28,000 lbs. |
| Water used | 205,875 gals. |
| Cost of coal | \$30.80 |
| Cost of water | 14.41 |
| Cost of labor | 7.28 |
| Total cost | \$52.49 |

There are three attendants in the gas house and two laborers for half a day for cleaning the fires.

| | |
|---------------------------------------|----------------|
| Coal per 1,000 cu. ft. of gas..... | 29.46 lbs. |
| Water per 1,000 cu. ft. of gas..... | 216.6 gals. |
| Gas per ton of coal..... | 66,443 cu. ft. |
| Cost per 1,000 cu. ft. for coal..... | 3.24 cents |
| Cost per 1,000 cu. ft. for water..... | 1.52 cents |
| Cost per 1,000 cu. ft. for labor..... | .77 cents |
| Total cost per 1,000 cu. ft..... | 5.53 cents |

The guarantee of the manufacturers of the generator was for 64,000 cu. ft. per net ton of coal, and on the acceptance trial the production was 68,000 cu. ft. It is the opinion of the man in charge of the operation, as well as the officers of the mechanical department, that a production of 96,000 cu. ft. per ton of coal is easily possible if a gasholder were to be provided sufficient to make it possible to make all runs without shutting down. The present capacity of the gasholder is 10,000 cu. ft., and the rate of consumption is rarely less than 1,200 cu. ft. per minute, and often rises to 1,800 cu. ft. and more. With this small margin between supply and exhaustion to work upon the generators must be run so as to keep the holder nearly full at all times, so that it is rarely allowed to become less than half filled. If a generator is started when the holder is in this condition, the production of gas is so rapid that the demand is not only met, but the holder filled before the run is normally completed by the chilling of the fire. The result is the steam must be shut off and the generator allowed to stand until the holder is again partly emptied. Meanwhile the fire has been cooling and, when the steam is again turned on, the total gas production for the run is much less than it would have been had the run been a continuous one. To meet this difficulty it is the intention to install a new gas holder having a capacity of 50,000 cu. ft.

It will be noticed that the costs given for the gas include no overhead charges for interest, depreciation and repairs. Taking the interest and depreciation at 10 per cent. on the cost, they will be \$4,000 per annum, or for 300 days, \$13.33 per day. This, at the average rate of production given, will add about 1.4 cents per 1,000 cu. ft. of gas. To this must be added the cost of maintenance. The plant is too young for definite figures to be given for this item as yet, but it is estimated that it will amount to about 10 per cent. of the cost of production, and this will add .55 cents to the cost per 1,000 cu. ft. of gas. To this should be added the power required to drive the fans. The motors have a total capacity of 190 h. p., and with current at 1½ cents per kilowatt hour the daily cost (12 hours) will be \$2.16, adding .23 cents more to the cost of gas per 1,000 cu. ft.

WHERE THE GAS IS USED.

Its principal consumption of the gas is in the furnaces of the blacksmith shop, where it is used for case hardening, tool dressing, and heating. There are a number of furnaces for serving heading machines, steam hammers, spring makers, drop hammers,

and for miscellaneous work. Then it is used for rivet heating throughout the boiler and machine shops, for tube welding and flanging. In the foundry it is used for the core ovens and brass furnaces; in the electrical department for melting babbitt and heating soldering irons; in the pipe department for pipe bending; in the laboratory for all heating work and in the machine shop for setting and removing tires. A list of the gas applications is as follows:

Blacksmith Shop.

- 1 Case hardening furnace.....2 burners
- 1 Barium chloride furnace.....2 burners
- 3 Tool dressing furnaces.....2 burners each
- 5 4 ft. 6 in. heating furnaces.....2 burners each
- 1 Heating furnace.....1 burner
- 1 Spring banding furnace.....2 burners
- 1 Spring fitters' furnace.....2 burners
- 1 Spring heating furnace.....2 burners
- 2 Heating furnaces.....6 burners each
- 1 Miscellaneous furnace.....2 burners
- 1 Drop hammer furnace.....2 burners

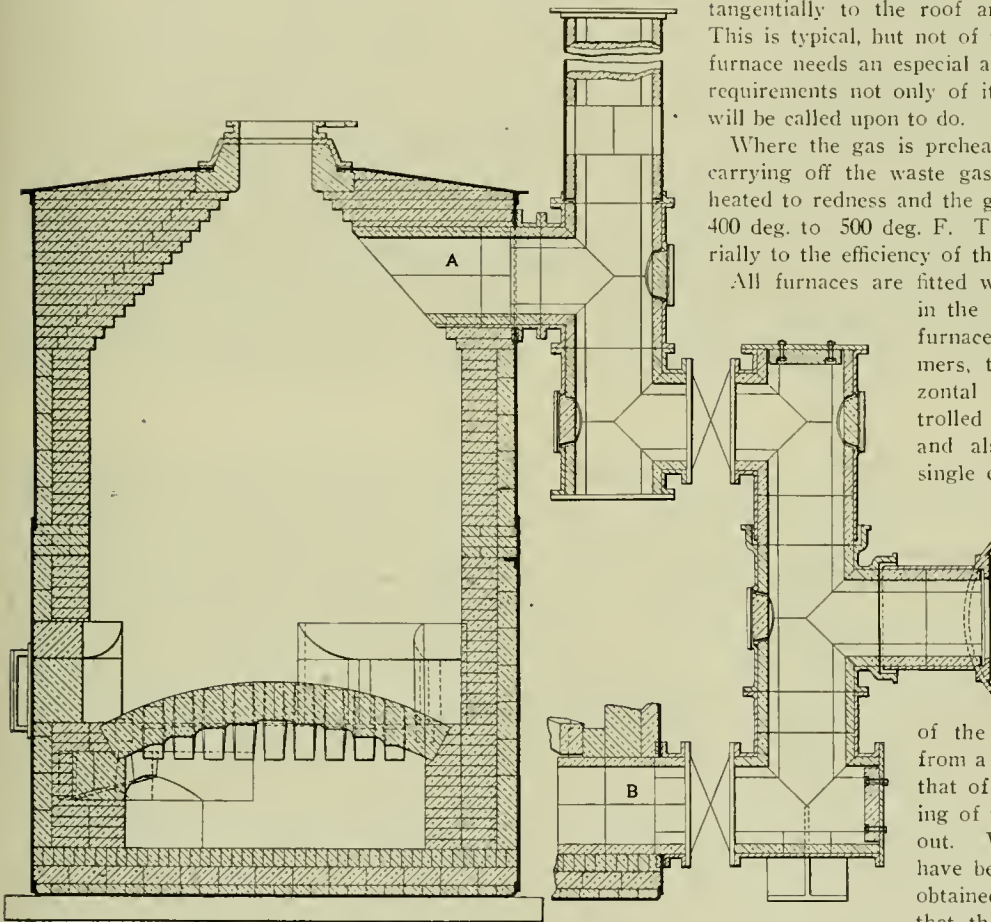

General Arrangement of the Gas Generator.

Foundry.

- 5 Core ovens.....1 burner each
- 3 Pit brass furnaces.....2 burners each
- 1 Tilting brass furnace.....1 burner
- 2 Core ovens.....2 burners each
- 1 Pipe oven.....1 burner

Electrical Shop.

- 1 Babbitt melting furnace.....1 burner
- 2 Soldering irons.
Hand torches.

Mining Department.

- 1 Babbitt melting furnace.....1 burner

Boiler Shop.

- 1 Annealing furnace.....6 burners
- 3 Flue welding furnaces.....2 burners each
- Rivet furnace.

Machine Shop.

- Rivet furnaces.
- 3 Babbitt melting furnaces.....2 burners
- Tire remover.
- 2 Pipe bending beaters.

In the machine shop connections are located at every third or fourth column throughout its length where a hose can be coupled and a rivet furnace set up. The extent to which the gas is applied can thus be appreciated.

The furnaces in the blacksmith shop and nearly all of the others were supplied by the Rockwell Furnace Company; some of the smaller ones were furnished by the American Gas Machine Company. Many have been slightly modified since they were installed by lessening the number of burners and lowering the roof. In construction the furnaces are very simple, but the adjustments of the burner location and roof heights must be carefully made in order to obtain the best results, and these rise to the highest point, both in temperature of fire and economical use of fuel, if the gas is preheated before recharging the burner.

A form of ordinary bolt heating furnace is shown in order to give an idea of the fundamental features of construction. It will be seen that the center lines of the burners are directed tangentially to the roof and floor of the furnace respectively. This is typical, but not of universal application, for each size of furnace needs an especial adaptation and adjustment to meet the requirements not only of its dimensions, but the work which it will be called upon to do.

Where the gas is preheated the pipes are run through a flue carrying off the waste gases. Here the gas pipe is frequently heated to redness and the gas is raised to a temperature of from 400 deg. to 500 deg. F. This has been found to add very materially to the efficiency of the furnace.

All furnaces are fitted with water shields in front as shown in the illustrations. In the large six-burner furnaces that serve the heavy steam hammers, the burners are arranged in a horizontal line across each end, and are controlled by valves for individual adjustment, and also by a master valve by which a single control of all the burners is obtained.

RATE OF HEATING.

As for the rate of heating it has been found to be a little more rapid than with oil, and yet not so fast as to burn the outside of a bar before the interior is heated. In fact, the opinion was expressed by one of the workmen that he thought the heat from a gas burner was more penetrating than that of either coal or oil, and that the heating of the metal was more uniform throughout. While no pyrometric measurements have been made of the furnace temperatures obtained at Scranton, it has been estimated that they run from 2,750 deg to 2,800 deg.

F. In a bolt furnace a 1½-in. round bar can be heated ready for heading in a machine in about 2 minutes without burning; a 250-lb. pile of metal can be raised to a welding heat ready for the hammer in from 40 to 50 minutes, the record for the furnace being nine heats of nine piles each in a day of ten hours.

The flue furnaces are fitted with a water back against which the tube is placed so that the scarf is protected from burning. The capacity of one of these furnaces is at the rate of one tube in about 40 seconds, though they cannot be handled at this rate. The average output of a furnace capable of holding 3 tubes is about 550 tubes a day, which is about the same as with coke and 50 per cent. more than the same men say they could do with oil. The effect of the gas on the tube seems to be about the same as that of coke, in that it forms less scale and the metal is eaten away much less rapidly than with oil.

In removing and setting tires, the speed with gas is claimed to be higher than with gasoline. Before the gas was available 45 minutes was the average time required for the heating of



Gas Furnace for Steam Hammer Work.

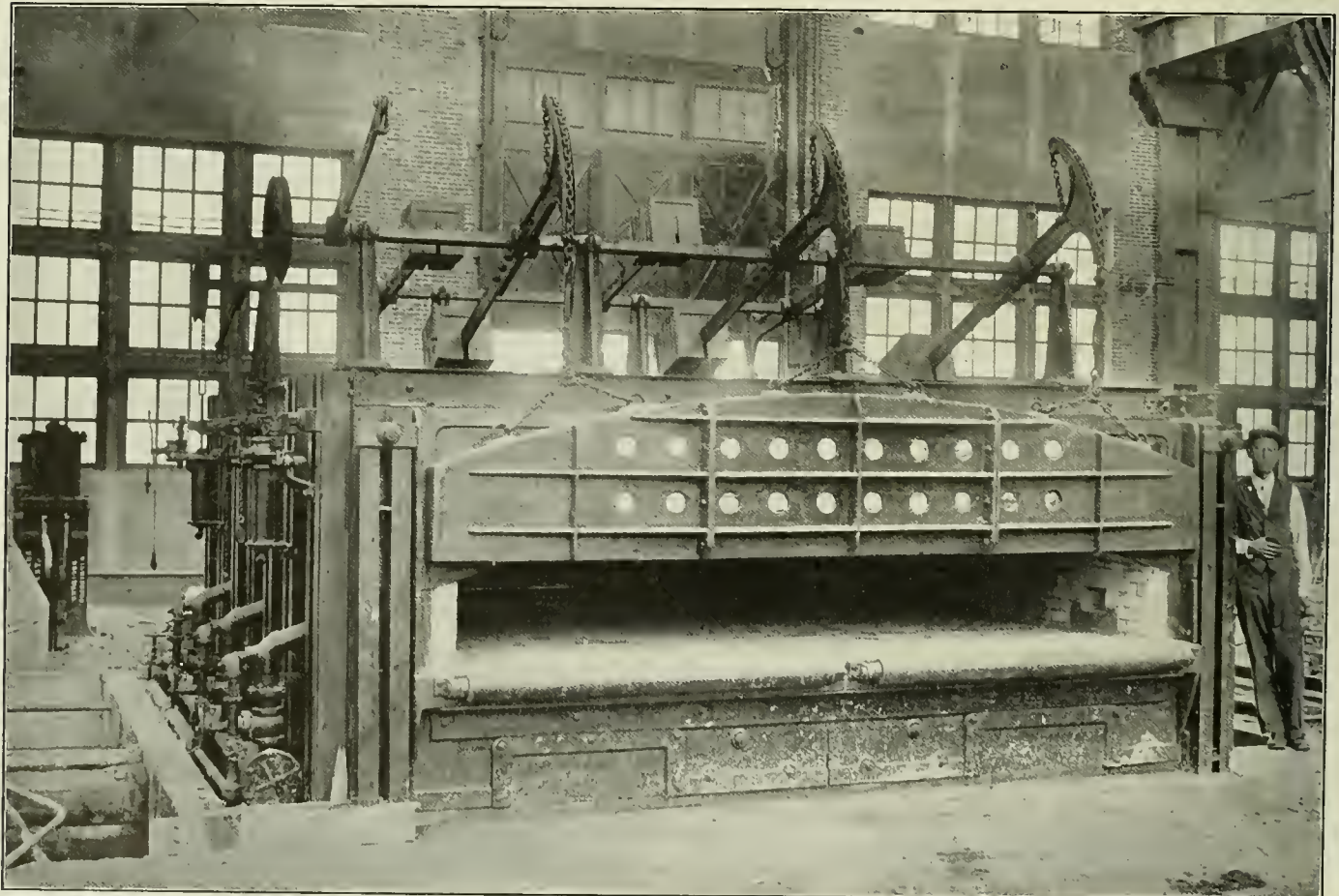

Six-Burner Gas Heating Furnace.

a tire, while with the gas this has been reduced to 30 minutes. In this it is, of course, understood that there are many variations from these figures. This gives a general idea as to the speed of heating that may be obtained.

OTHER ADVANTAGES.

One crucial test as to the satisfactory operation of a device of this kind is the attitude assumed toward it by the men. In this respect there is a unanimity of agreement. In every case where an operator was interviewed he was not merely satisfied but enthusiastic in the results he was obtaining. The tire heaters, flue welders, bolt heaters and spring makers were a unit in considering it the best fuel they had ever used. In the case of the large furnaces the freedom from smoke, the ease of regulation, the absence of ashes and the rapid rate of heating had made a reduction in piecework prices possible. The heater called attention to the ease with which any desired regulation could be obtained. It is well known that under ordinary working conditions the back of the furnace is much hotter than the front. This necessitates great care in the heating of large objects that extend all the way across the furnace, lest the part next the back wall be burned. With the gas furnace this danger is easily obviated by merely turning off a part of the gas from the back burner. In like manner any desired degree of regulation can be obtained at the center and front, so that no matter what the size or shape of the piece it can be evenly and uniformly heated throughout and be in an ideal condition for the hammer when it is taken out.

This evenness of heating is very desirable in the tool furnaces. It is the intention, however, to remove the tool furnaces from the realm of guesswork as to temperatures and equip the one that will be used for the major portion of the work with a

and results in somewhat more rapid drying than where coal was used. For example the time required to dry a cylinder core with coal was usually about 14 hours. With gas the work is always done in 12 hours and has been done in 6 hours. The average time required for the general run of cores was 6 hours for coal, while it is about 4½ hours with gas, and that too without parching or drying so hastily as to cause the cores to crumble.



Dry Scrubber.

In the melting of brass there is but little difference between the use of coal and gas with the present arrangements.

Tests have been made to determine the gas consumption of the several furnaces when working to full capacity, and this is about as follows:

| | |
|--|-------------------------|
| Brass tilting furnace with 2 burners.... | 1,980 cu. ft. per hour |
| Brass pit furnace with 2 burners..... | 2,040 cu. ft. per hour |
| Core oven with drawers (1 burner).... | 3,960 cu. ft. per hour |
| Large core ovens (1 burner)..... | 3,300 cu. ft. per hour |
| Large 6-burner heating furnaces..... | 15,000 cu. ft. per hour |
| Heating furnaces with 2 burners..... | 2,400 cu. ft. per hour |
| Miscellaneous furnaces with 2 burners.. | 4,020 cu. ft. per hour |
| Case hardening furnace with 2 burners. | 3,600 cu. ft. per hour |

From the evidence at hand it appears then that the use of gas on this extensive scale in the blacksmith shop and for miscel-



Blowers in Gas House.

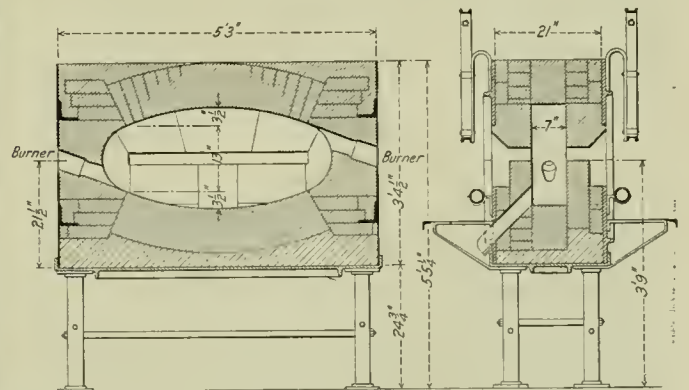

Bolt Heating Furnace.

pyrometer. This step is in accordance with the suggestions made at the New York Railroad Club at the November meeting, though the action was taken before the suggestions were made. It is expected that the heating and cooling of the tool steel in accordance with pyrometric indications will make it possible to entirely avoid all cracks in tools because of faulty hardening and tempering.

The use of gas in the foundry core ovens is also satisfactory

laneous uses throughout the plant is a success as far as mere heating qualities and general convenience is concerned. It remains to consider it from an economical standpoint.

ECONOMY OF GAS FURNACES.

When the matter was under consideration before the shops were built it was regarded mainly in the light of the heat units that would be available and their cost. From analysis of the oil in use it was known that it had a calorific value of 133,000



Gas Furnaces for the Forging Machines.



Gas Furnace in the Spring Department.

B. t. u. per gallon, and that one pound of anthracite coal contained approximately 14,000 B. t. u., and that 62,000 cu. ft. of water gas, having an average calorific value of 300 B. t. u. per cubic foot, could be produced from a ton of coal, making a total heat production per ton of 18,600,000 B. t. u., which is equivalent to 140 gal. of oil, which at 3.35 cents per gal. would cost \$4.90 as against \$2.20 for coal, making a saving of 55.2 per cent. in favor of gas. The estimated cost of fuel and capital charges for an oil consumption of 3,000 gal. per day at 3.35 cents per gal. was \$103.43, and for gas \$76.21, making a net saving of \$27.22, a saving that would be correspondingly increased by a rise in the price of oil.

As soon as the shops were ready for operation a three days' test was made, in which 1,483,905 cu. ft. of gas was made. The costs were

| | |
|--|------------|
| Coal, 57,640 lbs. | \$63.20 |
| Supplies | .30 |
| Water, 208,980 gals..... | 14.63 |
| | \$78.13 |
| Labor | 14.70 |
| Total | \$92.83 |
| Average cost of gas per 1,000 cu. ft..... | 6.25 cents |
| Average cost per day to operate gas plant with one generator | \$30.94 |
| The cost of operating the blacksmith shop with gas for three days— | |
| 845,774 cu. ft. of gas at 6.25 cents per 1,000 cu. ft.... | \$52.86 |
| Average per day of..... | \$17.62 |

Several estimates for the foundry core ovens place the cost at \$11.52 per day, and \$1.42 per day for the brass furnaces. On this basis the following comparative statements were made in connection with the costs of operating the old blacksmith shop and foundry.

| | | |
|---|-----------------|----------------------|
| Old Smith Shop. Fuel Oil. \$19.29 | New Smith Shop. | |
| | Gas. \$17.62 | Fuel Oil. \$29.32 |
| Core Ovens. | | |
| Old Foundry. Coal. \$6.40 | New Foundry. | |
| | Gas. \$11.52 | Fuel Oil. \$11.84 |
| Brass Furnaces. | | |
| Old Foundry. Coal. \$3.44 | New Foundry. | |
| | Gas. \$1.42 | Fuel Oil. \$3.52 |

These figures do not include overhead charges and may be taken to represent the maximum costs for gas when the generators are not working to full capacity.

Taking these in connection with those given earlier where the rate of production is about 950,000 cu. ft. per day, it will be seen that they are much higher. If the demand is increased it seems possible that the bare cost of making gas may be reduced to 3 cents per 1,000 cu. ft. or less.

Of course this low cost is directly due to the low cost of anthracite coal at Scranton, but if the cost were to be taken as proportional to the price of coal, and basing an estimate on the production given in the test cited of about 494,635 cu. ft. per day, it would be possible to pay \$3.65 per ton for coal and equal the cost with oil at 3.35 cents per gallon.

These figures will naturally need revision with the local conditions of the place to which they are to be applied, but as far as the Scranton plant is concerned, the officials consider it a practical and economic success, while the workmen look upon it as of value to themselves and more than satisfactory in its operation.

FUEL ECONOMY.—If 1 lb. of carbon is completely burned to CO₂, it will give out about 14,500 B. t. u., and if only partially burned to CO, it will give only 4,500 B. t. u., showing a loss of about 10,000 units. It is therefore obviously necessary, for the sake of economy, that the carbon should be thoroughly burned, which means that very little, if any, smoke should be produced.

INTERESTING DESIGNS FROM ABROAD

The Caledonian Railway of Scotland is Using Curved Tender Journals, Novel Spark Arrester and a Tire Fastening for Coach Wheels.

BY GEORGE SHERWOOD HODGINS.

During a recent trip to the British Isles the author was much interested in inspecting the present day practices and the motive power equipment on the various railways and found many arrangements and designs which were novel and apparently successful. These features were particularly noticed during a visit to the St. Rollox shops of the Caledonian Railway. Among the many things observed, the features of motive power and rolling stock equipment, illustrated and described herein, seemed to be of special interest to American railway men.

LOCOMOTIVE SPARK ARRESTER.

At first thought it would seem that in the moist climate of Great Britain the matter of spark prevention would be of considerable less importance than in this country. This, however, does not seem to be the case, and as careful attention is given

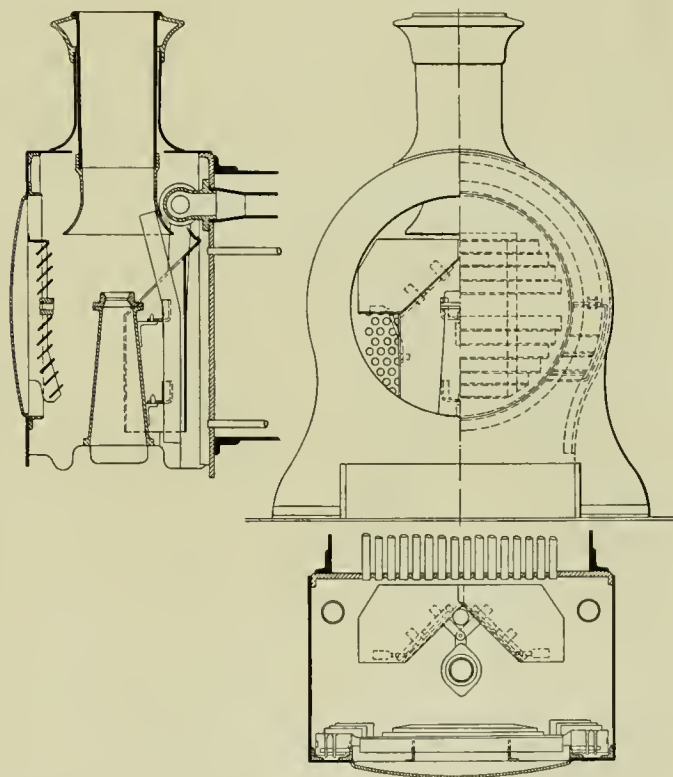

Self-Clearing Front End; Caledonian Railway.

to this feature on the Caledonian as on any American railway.

A smoke box being applied by J. F. McIntosh, locomotive superintendent, to a large number of locomotives is shown in the accompanying illustration. It consists of a pair of plates secured at right angles to each other and placed vertically behind the exhaust pipe forming a wedge at this point. From a point above the top line of flues a deflector plate is carried down to the top of this wedge, thus compelling the cinders from all of the flues, except a few at each side below the center line, to strike the sides of the wedge. From here most of them continue to the front lower corners of the smoke box. On the inside of the door is a frame carrying a number of slats, their forward edges inclined downward, and a somewhat larger set of slats is placed in the lower front corners. The action of the exhaust blast carries the cinders up through the louvers or openings between the slats and out through the stack. This baffling of

hollow when new. On all the latest express tenders, which have a capacity for 5,000 gals. of water, these journals have given satisfaction and their use is to be extended.

As used on the tenders, the journals are 12 in. long by 7 in. in diameter at the ends and 5½ in. in diameter in the center, the radius of the curved surface being 2 ft. ¼ in. The journal box and brass are ingeniously designed to suit this condition. At the center of the top of the box a certain amount of free motion is allowed the equalizer bar, which is made with a foot to engage with a rounded rib on the top of the box. An oil cellar is bolted to the bottom and a cover is secured to the front by bolts. There is a plug for draining the oil out of the cellar and one in the cover for examining the journal. The brass has a lining of white metal, and is of course curved to suit the shape of the journal. There is one oil hole in the center and two

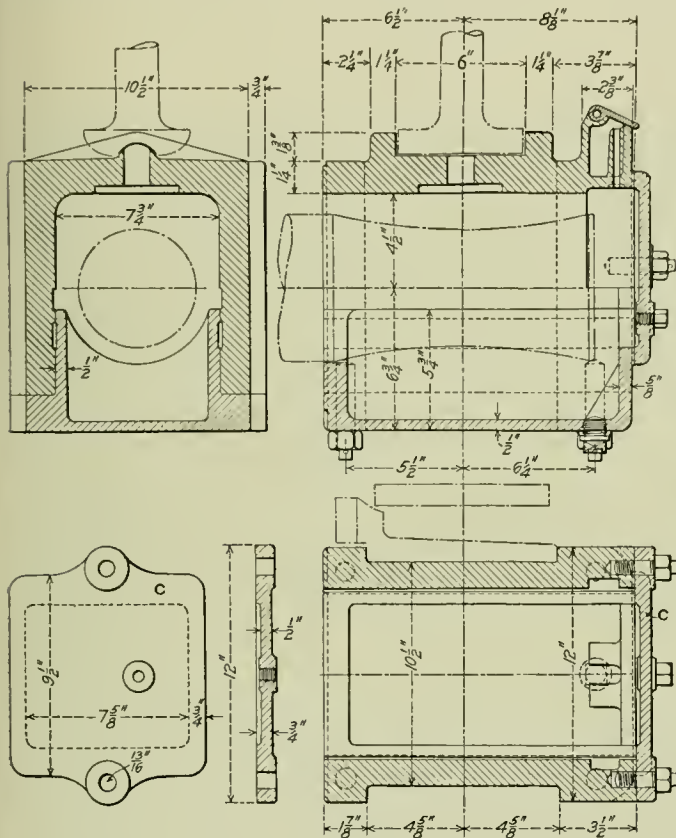

Journal Box Used With Curved Tender Journals.

oil grooves along the sides of the brass, as shown in the illustration. On the front top corner of the box is a small oil chamber cast integral, in front of which there are four ⅜ in. holes leading to the interior of the box. This oil chamber is covered by a lid and the oil is fed through the holes by cotton wicks which drip into 4 different receptacles on the front end of the brass. From one of these there is a passage feeding oil to the center of the journal, from another the passage leads to the front end of one oil groove, and from the other two the passages lead to the back end of both oil grooves. The oil passes from these receptacles to the journal by gravity.

In this manner the center and front of the axle receive equal amounts of oil while the back receives as much as the other two together. The reason for this is that in actual service the front of the brass does not carry as much weight as the center, nor does it generate as much friction as the back. The center is where the direct weight is applied and the oil from the grooves will naturally feed to this point and the extra oil feed directly to the center is intended largely as an emergency. The back end of the brass receives the most oil, as experience has shown that this point becomes dry first.

INDIRECT LIGHTING FOR RAILWAY CARS

Indirect lighting has been used to a considerable extent in hotels where it is desired to secure an even light and soft tones. It is also used in the new Washington terminal of the Pennsylvania Railroad, but in that particular case it presents a peculiar effect due to the fact that the walls and equipment in the building are white, thus reflecting the light so that it casts no shadows, in some instances making it difficult to recognize persons with whom one may be well acquainted.

The possibility of using indirect lighting in railway cars was first considered in connection with the private car of B. F.

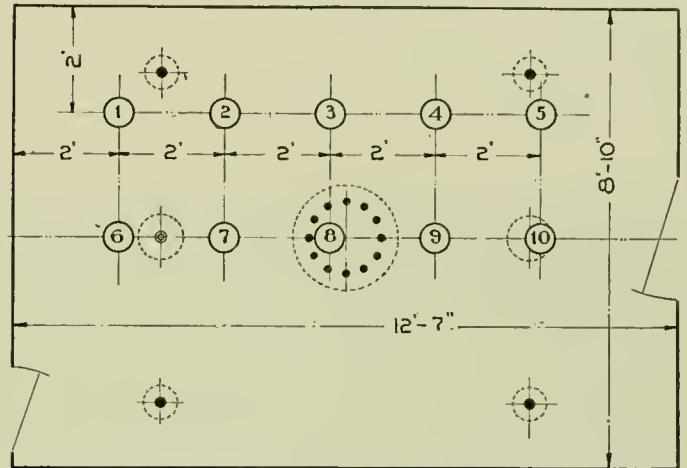

Plan of Observation Room Showing Where Illumination Readings Were Taken.

Yoakum, chairman of the board of directors of the Frisco Lines. The first cars to use the indirect lighting in actual service were the Santa Fe dining cars on the Train de Luxe, which were illustrated in the *Railway Age Gazette* of December 15, 1911, page 1207. Mr. Yoakum's car, which was built at the St. Charles shops of the American Car & Foundry Company, was slower in building than the Santa Fe diners, which preceded it in service by a few days. The indirect, or more correctly the semi-indirect,

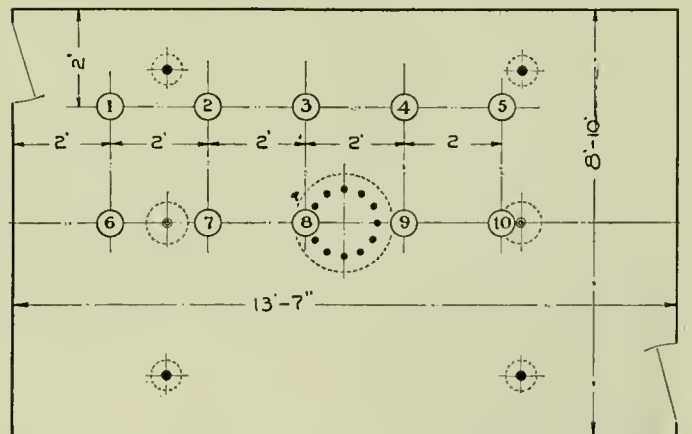

Plan of Dining Room Showing Where Illumination Readings Were Taken.

method of lighting is used in the dining and observation rooms of Mr. Yoakum's car.

The lighting fixture in the dining room is placed in the center of the room and is supported by four cast bronze chains. The bronze or metal portion is finished in verde antique and the bowl is made of leaded glass, which is of sufficient density to give a soft color when lighted by the lamps inside of the bowl. No useful light for illuminating the room passes through the bowl. Underneath the twelve 25-watt tungsten lamps is placed a metal

reflector, which redirects the downward rays of light to the ceiling of the room, allowing just enough light to pass the reflector to light the colors in the glass bowl. The ceiling of the dining room is finished in a dull ivory white, while the side walls are finished in mahogany and the carpets are green.

LIGHTING REQUIREMENTS IN FOOT CANDLES FOR VARIOUS SERVICES AS COMPILED BY BARROWS.

| | | | |
|---|-------|----|------|
| Assembly rooms, corridors, public spaces..... | 5 | to | 1.5 |
| Auditoriums, theaters | 1 | to | 3 |
| General illumination of residences..... | 1 | to | 2 |
| Reading { Good clear print | 1 | to | 1.5 |
| { Newspaper print | 2 | to | 2.5 |
| { Postal service | 2 | to | 4 |
| Churches | 2 | to | 4 |
| Library { General illumination | 1 | to | 2 |
| { Reading tables | 3 | to | 4 |
| Ball rooms | 2 | to | 3 |
| Desk lighting | 2 | to | 5 |
| General illumination of stores..... | 2 | to | 5 |
| Bookkeeping and clerical work..... | 3 | to | 5 |
| Clothing stores | 4 | to | 7 |
| Display of dark goods..... | 5 | to | 10 |
| Drafting, engraving | 5 | to | 10 |
| Street lighting by gas..... | 0.05 | to | 0.25 |
| Street lighting by electricity..... | 0.05 | to | 0.60 |
| Light from full moon..... | 0.025 | to | 0.03 |

The center lighting fixture in the observation room is similar

under the lower deck in both the dining and observation rooms. Both the center fixtures are large compared with those usually found in cars. The effect when lighted and also in the daylight

ILLUMINATION IN DINING ROOM, USING TWELVE 15-WATT TUNGSTEN LAMPS.

| Station. | Foot Candles. | Station. | Foot Candles. |
|----------|---------------|----------|---------------|
| 1 | 1.60 | 6 | 1.82 |
| 2 | 2.02 | 7 | 2.50 |
| 3 | 2.20 | 8 | 2.20 |
| 4 | 2.20 | 9 | 2.50 |
| 5 | 1.68 | 10 | 2.55 |

Average, 2.06 foot candles.

ILLUMINATION IN DINING ROOM, USING TWELVE 25-WATT TUNGSTEN LAMPS.

| Station. | Foot Candles. | Station. | Foot Candles. |
|----------|---------------|----------|---------------|
| 1 | 1.81 | 6 | 2.10 |
| 2 | 2.30 | 7 | 2.95 |
| 3 | 2.68 | 8 | 3.00 |
| 4 | 2.70 | 9 | 3.40 |
| 5 | 1.88 | 10 | 3.00 |

Average, 2.48 foot candles.



Dining Room of Frisco Private Car Showing Fixture for Indirect Lighting.

to the one in the dining room, except that the glass bowl is leaded with a combination of frosted, white granite and amber glass; the latter is used sparingly—just a spot here and there for design and to relieve the monotony of the frosted and granite glass. The ceiling of the room is finished in a cream white and the side walls are of mahogany.

Two small electric lamps, of the direct lighting type, are located

is pleasing; this is due to the severe interior treatment of the rooms. The mahogany finish is very plain, with simple molding and plain panels. The large lighting fixtures are, therefore, the only decorative spots in the rooms and lend themselves to the color schemes and finish.

That the illumination from these central fixtures is exceedingly good in both the rooms may be seen from a study of the readings

at various points, which were obtained with a Sharp Miller illuminometer. The readings were taken 3 ft. above the floor, and their value may be more readily understood by reference to the table showing the requirements in foot candles for various services, as compiled by Barrows. The location of the points at which the readings were made is shown on the accompanying

ILLUMINATION IN OBSERVATION ROOM, USING TWELVE 15-WATT TUNGSTEN LAMPS.

| Station. | Foot Candles. | Station. | Foot Candles. |
|-----------------------------|---------------|----------|---------------|
| 1 | 2.26 | 6 | 2.43 |
| 2 | 3.20 | 7 | 4.20 |
| 3 | 3.60 | 8 | 6.40 |
| 4 | 3.40 | 9 | 4.62 |
| 5 | 1.96 | 10 | 2.70 |
| Average, 3.28 foot candles. | | | |

diagrams. The direct electric lights were not in use when these readings were taken.

Indirect lighting will undoubtedly be used extensively on private cars, dining cars, and possibly parlor cars. The effect of the light is most pleasing, but a considerably larger amount of power is required than for ordinary lighting. The fixtures in Mr. Yoakum's car were supplied by the Safety Car Heating & Lighting Company. Tintsch gas is used as an auxiliary.

CAR DEPARTMENT KINKS*

BY W. H. WOLFGANG,

Draftsman, Wheeling & Lake Erie, Toledo, O.

PLATFORM FOR CARRYING SCRAP MATERIAL.

The method of removing scrap material from large shops by means of a laborer with a wheelbarrow is an expensive

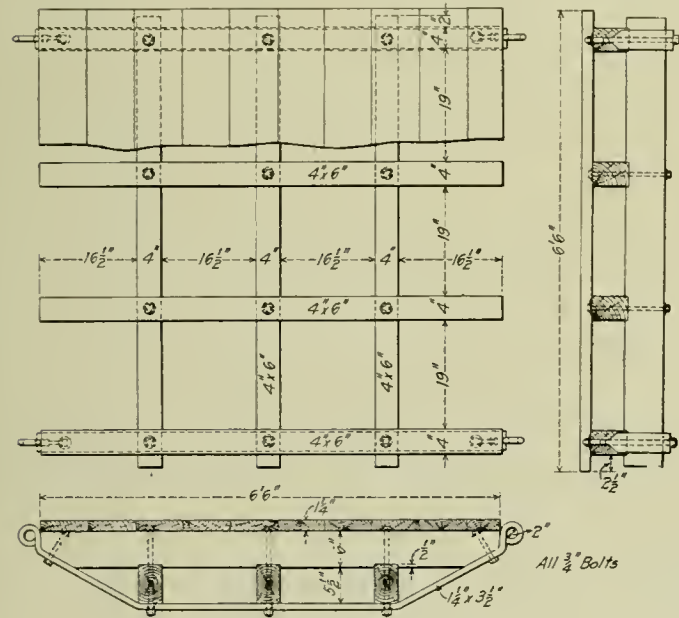

Fig. 1—Wooden Platform for Carrying Scrap.

proposition, as much time is spent in wheeling the small loads to the scrap pile. The wooden platform shown in Fig. 1 may be used for this purpose. It is 6½ ft. square, and is made of 4 in. x 6 in. timbers, which may be taken from old car sills. It is carried from place to place by means of cranes, four chains fixed in one ring being used to lift it. Each chain has a hook fastened at its other end which fits in the 2 in. eyes at the four corners of the platform. With these platforms located at various parts of the shop, scrap may be easily collected. When a platform is full the crane takes it to the end of the shop and dumps

it in a scrap car, or on the scrap heap. When unloading, two chains are removed from one side, and when the other side is lifted, the scrap will roll off the platform. The floor of the platform should be of 1¼ in. oak firmly spiked to the timbers. The 1¼ in. x 3½ in. iron truss rods are made from old arch bars with a ring forged on each end for the hooks. If desired, side boards may be added to the platform so that it will hold more

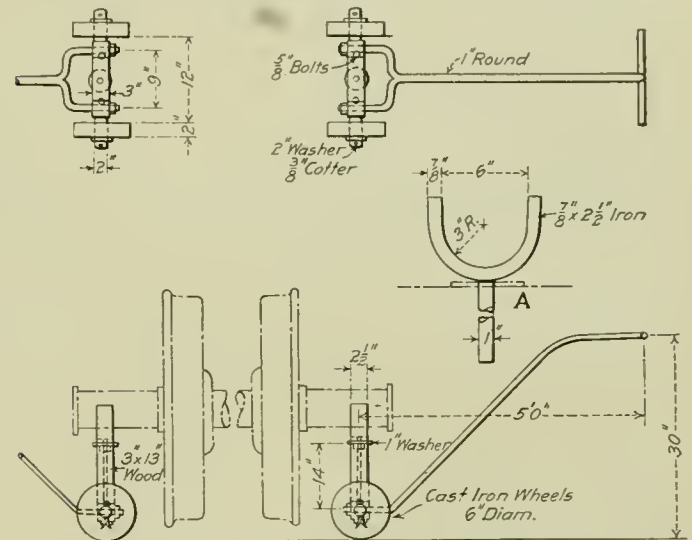

Fig. 2—Truck for Handling Mounted Car Wheels.

material. It can also be used to good advantage in transferring small material from place to place in the shop.

TRUCK FOR CONVEYING MOUNTED WHEELS.

The truck shown in Fig. 2 is used for transporting mounted car wheels, and may be made at a reasonable cost. Two 6 in. cast iron wheels are mounted on a 2 in. x 3 in. steel axle, which has a 3 in. x 13 in. oak block bolted to it. This block has a 1½ in. hole through the center for the yoke A, which is made of wrought iron or open hearth steel 7/8 in. thick by 2½ in. wide. The handle of the truck is made from open hearth steel and is bent to the shape shown. To use the truck it is tipped forward and the yoke is placed underneath the journal of the axle; by bearing down on the handle the wheel is lifted from the floor. This truck is quite similar to the one described in the *Railway Age Gazette* of December 1, page 1113.

PLATFORM FOR STEEL HOPPER CAR SIDES.

The platform shown in Fig. 3 is handy for riveting, cutting out rivets, or straightening the sides of steel hopper cars. It is

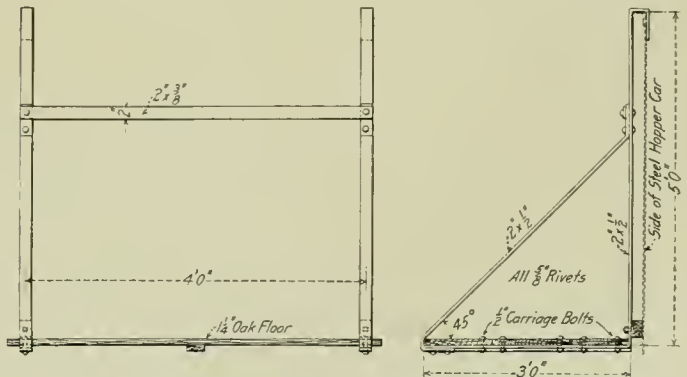

Fig. 3—Riveting Platform for Sides of Steel Hopper Cars.

made of two pieces of 1½ in. x 2 in. bar iron, which is bent at the top so as to easily slip over the top of the side of the car. A 1¼ in. oak floor is bolted to the horizontal portion of these bars. Iron braces help support the floor of the platform.

*Entered in the *Railway Age Gazette* Shop Kink Competition which closed September 15, 1911.

JOURNAL BOX COOLER.

A handy device to be carried in the emergency tool box of passenger equipment is shown in Fig. 4. It is a small tank of No. 24 galvanized iron of the general shape shown in the illustration, and is used for hot boxes. It may be readily hung underneath the cars by two chains fastened to the body side sills, and having hooks fitting in the rings *A* of the cooler. It has four legs

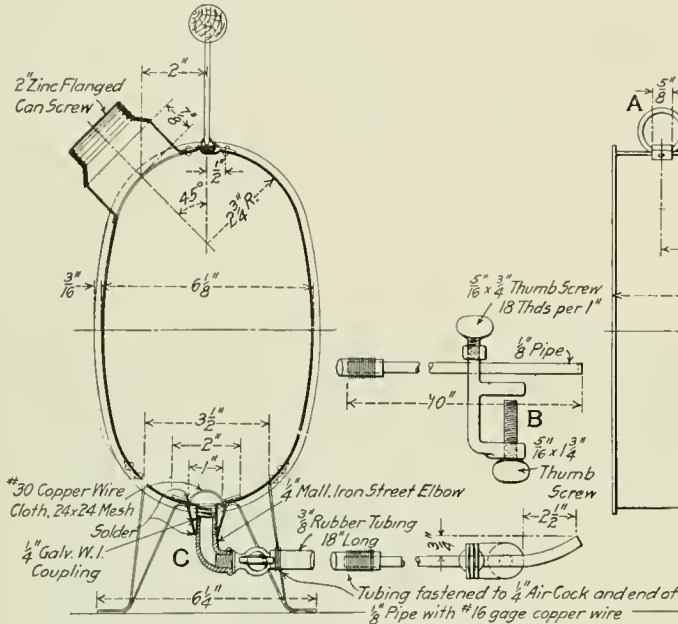
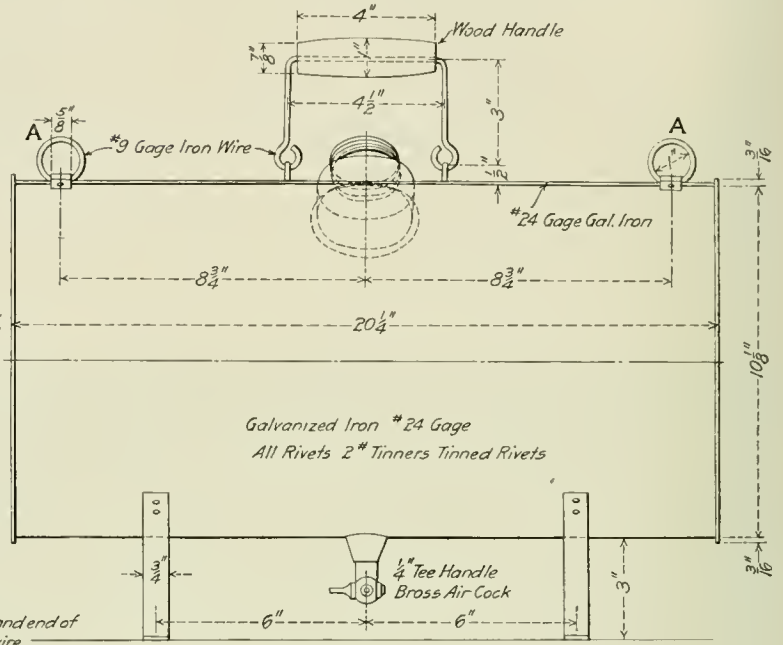

Fig. 4—Water Tank for Cooling Hot Journal Boxes.

of galvanized iron which may be set on the truck timbers, being held in place by light chains. The clamp *B* holds the rubber hose to the journal box, so that the water will keep running on the bearing. A copper wire cloth or screen is used to prevent any sediment or dirt running from the tank into the bearing; the flow of water is regulated by a cock at the end of the malleable iron Street elbow. With this device, after the journal box has once been filled, a constant stream can be played on the journal while the train is running between stations, the tank

CRANE FOR HANDLING TIMBER.

The traveling crane shown in Fig. 6 is used in the lumber yard for loading and unloading timbers under 12 ft. in length. A pneumatic hoist is used on a trolley which travels on the 12 in. I-beam, that is 50 ft. long. Two tracks are left open for cars; one is for the delivery of the lumber and the other is for a lorry truck which carries the timber in and about the shop. The



crane legs are made of 2 1/2 in. pipe, and are strengthened on each side with 1/2 in. truss rods. A brace at *A* is made of 2 1/2 in. pipe and is bolted to the 12 in. I-beam, being screwed into a special fitting on the legs. The wheels on the trucks are made of cast iron, and are 8 in. in diameter, having flanges on each side to keep them from jumping the track. Old rails are used for the track and are spiked to 6 in. x 8 in. old car sills, which run the full length of the yard. The I-beam is bolted to the top of the legs. It is strengthened by two 1/2 in. truss rods. The bottoms

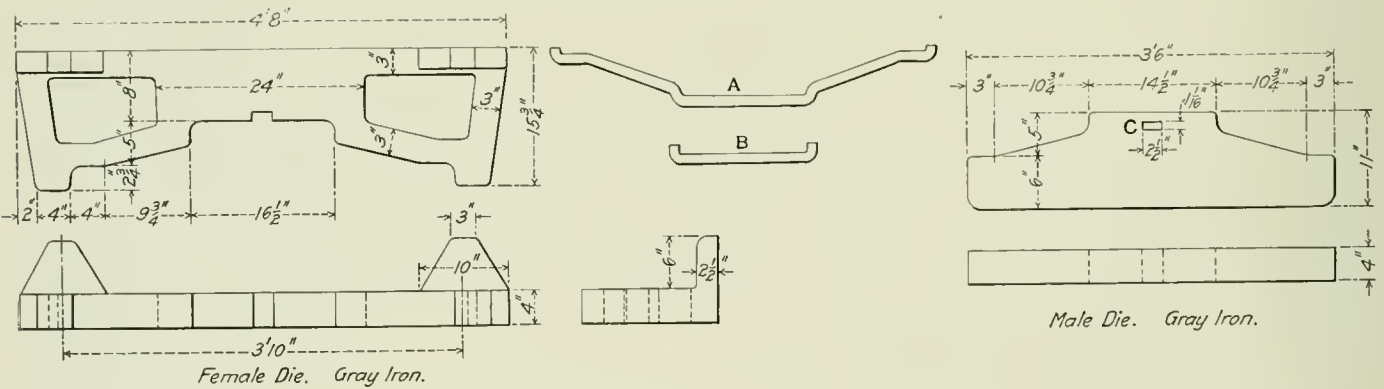

Fig. 5—Bulldozer Dies for Forming Carry Irons.

being refilled at each stop. A wooden handle is fastened at the top of the tank, so that it may be carried easily.

FORGING CARRY IRONS.

The dies shown in Fig. 5 are used for forming drawbar carry irons. The two pieces, *A* and *B*, are made with the same die. The female die is bolted to the bulldozer head and the male die to the face plate. There is a rectangular hole at *C* in the male die for the leg of a fork which holds the hot bar in place. A slot is also cut out of the female die to receive the other part of the fork.

of the legs are held in a wrought iron frame in which the wheels are mounted.

The cylinder of the hoist is made from a piece of 7 in. standard pipe with a closed head on one end and a head with a hole 1 5/8 in. in diameter for a 1 1/2 in. piston rod on the other end. The piston has a 5 ft. stroke which, with the two 8 in. cast iron pulleys, gives a lift of 10 ft. A 3/8-in. standard chain may be used for hoisting. One end is fastened to the cylinder head and the other has a timber hook fastened in a ring. Six 4 in. cast iron wheels run on the bottom flange of the 12 in. I-beam which

same material. The sheave rests on the side *B* while in use, so that the pins will not drop out. It is not so heavy but that one man can easily carry it anywhere about the plant.

IRON STORAGE RACK.

The storage of iron and steel stock is quite a problem in many shops, especially where a large variety of sizes are carried. The rack shown in Fig. 9 will hold 56 different sizes of iron. The framework is made of oak timbers and is bolted together by $\frac{7}{8}$ in. tie rods. The tie rods have pieces of a 1 in. pipe with washers slipped over them as they are passed through the members of the framework. The pipes keep the bar iron from wearing the rods. Only one of the rods is shown thus covered in the drawing, but all of them are treated in the same way. The proper size of the iron should be stenciled over each section, and if care is taken in keeping the stock in its proper place it will save the time of measuring. If the rack is placed outside the shop a roof should be built over it to protect the stock from rain and snow. It is far preferable, however, to have the rack inside of the shop.

A CONTRAST

The superintendent of motive power was busily engaged in explaining a detail of the shop organization as we stepped through the doorway leading to the machine and erecting shop. Our quiet entrance into the noisy shop undoubtedly attracted very little, if any, attention until we had advanced some 10 ft. or more into it. At that time, however, things in our end of the big shop seemed to move a little more lively, and the workmen began to work at a faster pace, at least so it seemed from the actions of some of them and the increased noise and din of the shop. Above the noise, however, could be heard a series of low, but penetrating whistles, which seemed to travel down along the shop, and were apparently signals announcing the approach of one in authority. A visitor does not like to be discourteous enough to notice such things, and so I appeared to be busily engaged in examining the finish on a crank pin in one of the driving wheels. However, glancing out of the corner of my eye, I could see a slight flush gradually extending over the face of the superintendent of motive power.

In chatting in his office later in the day I asked permission to take some photographs in the tin shop and to describe the methods which were in use in that shop. The foreman seemed to be a good executive, and, with one of his assistants, had contrived some very ingenious devices which greatly facilitated the work and reduced the cost of production.

"No!" said the superintendent of motive power, "you cannot do it."

"That seems strange," I said, "for you have such a splendid department, and the man in charge is much more capable than the average man holding the same position."

"That is just why I don't want to have you describe it."

Almost unconsciously, I gasped out, "Why?"

"Because, if you were to publish a description of John's work he would get the big head and would want more money. He would become dissatisfied or else some one would come in and offer him more money, and we would either have to raise his salary or lose him."

* * *

The scene is in another shop of about the same size as the one in which the above-mentioned incident took place. As I entered a large door at the end of the machine and erecting shop I was immediately impressed with the fact that the work seemed to be carried on at a good lively pace. I was unaccompanied by any of the mechanical department officials, and the men seemed to pay no attention to my presence. Every department in the large plant seemed to be operated to its full capacity. There was no confusion on the part of the workmen and

no loafing was apparent. I learned afterwards that the output of the shop was surprisingly large considering its size.

Naturally I was interested in meeting and studying the shop superintendent in charge, especially since the whole attitude of the men was so entirely different from the shop which I previously visited. One of the first things that he said when I met him was:

"If you have your camera with you, be sure and make good use of it in our blacksmith shop. The foreman and his assistant are doing splendid work, and you will not only secure a splendid article for your readers, but our foremen will be inspired to greater efforts when they see that their work is appreciated, not only by those of us to whom they report, but by the railways at large."

The shop superintendent then drew attention to some of the more important things which were being accomplished in a number of the other departments, and gave much active assistance in helping to get his foremen interested in furnishing all the details about the way in which the various classes of work were being handled.

* * *

The contrast between the two shops was so great that it prompted investigation into the comparative output. It was found that the second shop turned out a considerably larger amount of work with a much smaller number of men. How is your shop or your department being managed, and are you cultivating or killing the best efforts of the men under you?

NEW DESIGN OF PISTON

The accompanying illustration shows a suggestion for fitting the piston rod into the piston head. The object is to eliminate the use of follower bolts and piston rod nuts, because of the difficulties in maintaining them, and at the same time construct a piston at a less cost. When the pressure is on the rear side of the piston it pulls directly against the taper on the rod and when the pressure is on the front side a portion of it acts on the piston head and the remainder on the steel disc, or follower plate. When assembling the piston the piston head may be heated and shrunk on to the taper of the rod. When applying the disc head, rivets should be inserted so that when they cool they

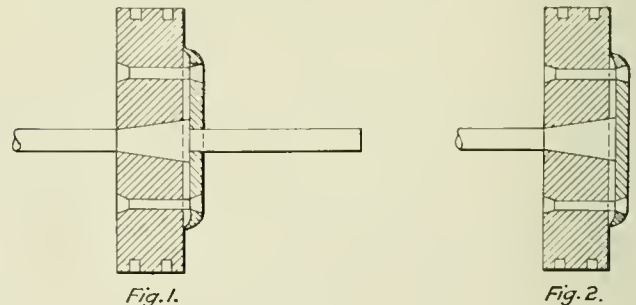

Suggestions for Connecting Piston Rods to Pistons.

will pull the plate tightly against the shoulder of the rod, as shown in Fig. 1, or against the end of the piston rod, as shown in Fig. 2. When this disc is fastened in place it is to be caulked down against the piston head, so as to make a non-pressure space between the follower plate and the head. When steam is admitted in the front end of the cylinder the pressure will be transmitted directly to the end of the piston rod through the follower plate, or, in the case of the extension rod, against the shoulder on the rod. This design has not been put in practical use, and J. E. Osmer, master mechanic, Chicago & North Western, Boone, Iowa, to whom we are indebted for this article, would be glad to have any criticisms or comments on the arrangement.

HANDLING APPRENTICES.*

BY WILLIAM G. REYER.

General Foreman, Nashville, Chattanooga & St. Louis, Nashville, Tenn.

An apprentice should be taken on probation for three months and at the end of that time, if he shows the requisite qualifications, should be accepted. In case he does not, he should not be accepted under any consideration. In nine cases out of ten the boy that makes the best mechanic is the one who has nothing but his own energy and nerve to push him along. In selecting apprentices take the one with the quick step, the one who looks you in the face and whose bright eye tells you that he will make good. He may be a little hard to handle at first, but show him you have his interests at heart and that the pranks he is playing, which are constantly getting him into trouble, must be stopped while he is in the shop. Get close to him; show him you are his friend and in the end he will go his length for you and you will find he will make a first-class mechanic. Let your apprentice boys feel they may come to you at any time for advice, not only about the work but with any trouble they may have. Try to gain their confidence, but be firm with them, letting them understand that the shop rules must be obeyed. At the same time do not let the boy feel as though he was going up against an iceberg whenever he approaches you. Have a pleasant word for all of them.

By studying each boy's disposition, you will soon be able to handle him to advantage. Should a boy be brought to you for a reprimand, point out his error; show him how important it is to start right and that he is forming habits which will remain with him through life. Show him that you are interested in his welfare and that to make a success in life he must adhere strictly to the truth and familiarize himself with every detail of his trade. He must also be energetic, at all times striving to do his work in a first-class manner. The boy that works to just make a day's pay, or the boy that thinks he knows more than the instructors, had better be excluded from the shop. If he listens to what the instructor tells him and makes a study of his work, he will find that some day his superior officers will want to place him in a responsible position.

Impress upon your apprentices the importance of study, trying to get them interested in drawing and mathematics. Point out that if they wish to hold any position of importance they must not only be masters of their trade, but must know how to make calculations and read drawings. They must also be able to control themselves. This sounds simple enough, but there are many men who have found the lack of self-control to be a stumbling block. Make each apprentice feel that you are looking to him to help raise the standard of your apprentice course. Pat him on the back once in a while, telling him you appreciate what he is doing. Stop the habit of having a grouch. A pleasant word and a smile will go farther in one day than all the cussing you can do in a week.

Mechanics and Handy Men.—In handling the men make a study of each one. Some you will find more adapted to one class of work, while others are all right wherever you put them. If a man is kept on the kind of work he takes the most pride in doing, he will soon be setting a pace for the other fellow to follow. Some men may as well be discharged at once for doing poor work or for violating the shop rules, while others, if you take the matter up with them in the proper spirit, and if they have any consideration of the company's interests will endeavor to improve and strive to increase the shop output. Let each one know that you are his friend, but that he must do his part or you cannot hold him. It is important that the men be made as comfortable as possible. If the shop is kept in a good sanitary condition, and is provided with lockers and the necessary tools, you will find that the men will be better satisfied, and when

they are satisfied they will do more work. Let the men know you have a system and make them work by it. If they are allowed to do a job any old way the shop force will become demoralized, the standard will be lowered, and the output will decrease.

Handy men are started in the erecting shop stripping engines, and are soon able to help the machinists. After some experience they will be able to do such work as reaming holes, tightening steam chests, applying cylinder heads, grinding steam pipe rings and applying steam pipes. A foreman must be governed by the class of men and boys under him; he cannot use the same methods when handling foreigners as he would with American workmen. Study the class of men that work for you and treat them as you would like to be treated.

QUICK RETURN CRANK SHAPER MOTION

A criticism of the value of the quick return mechanism of the Stockbridge shape appeared in the November, 1911, issue of the *American Engineer and Railroad Journal*. In replying to this, the Stockbridge Machine Company, Worcester, Mass., has presented the following statement:

"The writer of the criticism of our shaper says of the shape which he advocates: 'We use the simple form of quick-return mechanism, Fig. 1.' The simple quick-return referred to is actually only a small increase in the return stroke due to the

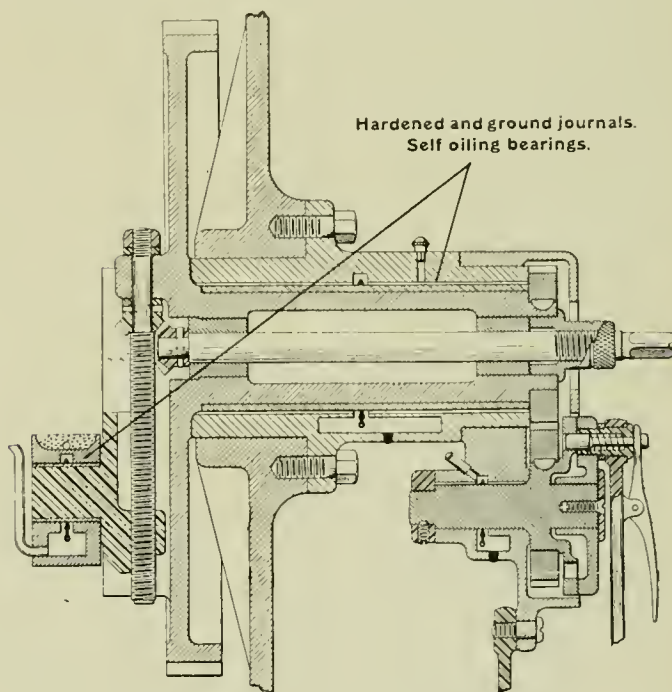

Fig. 1—Simple Quick Return Mechanism.

inclined position of the rocker arm when the shaper is on its longest strokes. As the length of stroke is shortened, this increased speed of return is cut down very rapidly as the rocker arm approaches more nearly a vertical position. The quick return of a regular crank shaper when on a stroke less than one-half its full length stroke is so small that for all practical purposes it may be neglected. An actual quick-return motion, however, is of the greatest value on the shorter strokes. The Stockbridge two piece crank motion maintains this quick-return even down to a 1-in. stroke.

"Attention is directed to the fact that in the regular crank shaper there is only one bearing surface for the bull gear. Compare the unsupported gear, Fig. 1, with the construction shown in Figs. 2 and 3, where it will be noted that the gear is given a bearing on its periphery. With this construction all strain and the

*Entered in the *Railway Age Gazette* competition on the Instruction of Workmen and Apprentices, which closed April 15, 1911.

consequent friction is taken off of the crank hub, and it is practically free from wear. The advantage of our construction over that shown in Fig. 1, with the small diameter hub compared with diameter of gear, is too evident to need comment. The amount of friction in this connection can only be determined by tests. The question of the number of bearings does not seem to be so important a factor in friction as the rigidity of the parts and the way in which they are supported against cramping. The friction of stiff, free running parts is a small matter compared to the friction troubles due to too much over-hang or to any other defect in design that allows spring or cramping. Our main bearing support for the bull gear, Figs. 2 and 3, eliminates all possibility of spring or cramping.

"In the following table are given the results of some tests made by H. P. Fairfield of the Worcester Polytechnic Institute. To make a fair comparison every condition must be identically the same and Mr. Fairfield in his tests made use of the same machine, turning it into a regular crank shaper, by simply bolting the crank and the gear together, eliminating all the parts which made up the two piece crank.

| Depth of Cut. In. | Length of Cut. In. | Feed per Cut. In. | Cutting speed. Feet per minute. | Stockbridge two piece crank. Horse power. | Regular crank. Horse power. |
|-------------------|--------------------|-------------------|---------------------------------|---|-----------------------------|
| 3/8 | 12 | 0.0294 | 15 | 2.10 | 3.08 |
| 3/8 | 12 | 0.0294 | 17 | 2.68 | 3.35 |
| 3/8 | 12 | 0.0294 | 25 | 3.22 | 3.62 |
| 3/8 | 12 | 0.0294 | 30 | 4.02 | 4.16 |

"In the first place, tests were made with the two piece crank and about 25 readings were made for each test, and an average taken; then the gear and the crank of the same shaper were bolted together, making a regular crank shaper. In other words, in the latter test the friction of the sliding blocks and the extra bearing surfaces of the two piece crank shaper were eliminated. These tests prove beyond doubt that if there is any added friction because of the two piece crank parts it is more than made up by the gain of power through the use of the two piece crank.

"The parts which are actually required to make up the two piece crank are (Fig. 4) the eccentric C, eccentric ring E, two blocks A and B, gear F, and crank G. One of these parts, the gear F, is, of course, used in both constructions. From Fig. 2 it will be noted that the assembled parts are just as compact as a regular crank. The extra parts used are not numerous or complex, and we know that the advantages obtained are altogether out of proportion to the disadvantages due to the cost of the few extra parts required.

"That it does produce the results claimed, your correspondent freely admits; however, the motion does not seem to be fully understood by him judging from further remarks in regard to the accelerated motion of the Powell planer. He draws the inference that if the accelerated motion of the Powell planer is an advantage, then the even cutting speed which we get is not. A study of the velocity curve in the October issue of the *American Engineer and Railroad Journal*, page 416, will show that what we accomplish is practically what Mr. Powell accomplishes in his accelerated motion. The velocity starting at zero increases gradually, but does not come up to full speed, on the length of stroke shown, until it has traveled about 2 in., and as 3/4 in. is all that is required for tool clearance, it will be seen that the tool strikes into the work at a slow speed, comes up to its maximum and maintains that speed until it reaches nearly the end of the stroke where it drops off gradually, accomplishing practically what the Powell motion does on a planer.

"Your correspondent states: If the quick-return is so important, why the variable speed planer with the constant return? The comparison is misleading and hardly fair. In the construction of the planer the thing that has been worrying designers is to get a number of forward or cutting speeds. The shaper already has the varying forward speeds. The constant speed return of the planer is the maximum speed at which the table can be returned. This is just what we are aiming at in our

two piece crank motion, to return the ram at the fastest possible speed at which it can be returned, returning it as near a constant speed as possible. It makes no difference whether the stroke is 2 in. or 24 in., the Stockbridge crank motion maintains a uniform speed of return.

As an illustration of how much work can be produced in a given time and at what expenditure of power under the different conditions given by the simple crank motion and the Stockbridge, the following is offered: Consider a 24 in. shaper on an 8 in. stroke, 40 strokes per minute. The regular crank shaper on this length stroke would have no quick return; with the Stockbridge two piece crank there is a return ratio of, say, 2:1 (actually a little more). Each complete revolution of the gear

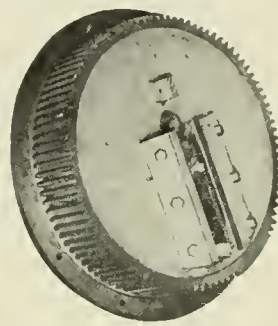

Fig. 2—Bull Ring.

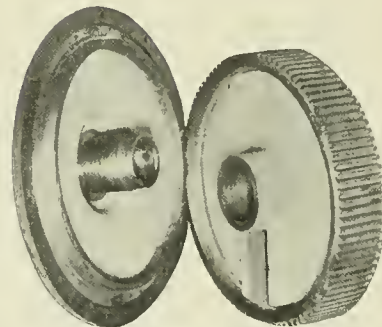

Fig. 3—Bull Ring.

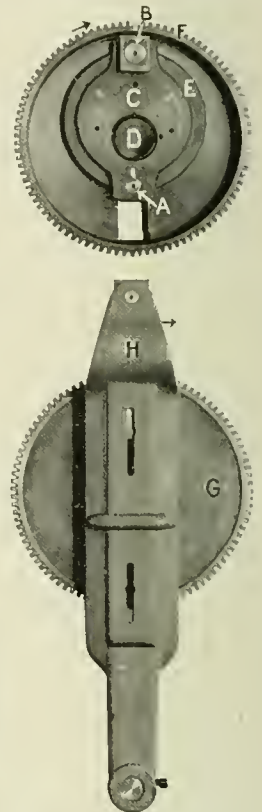

Fig. 4—Two-Piece Crank.

then takes 1 1/2 sec. The regular crank uses 3/4 sec. on the cutting stroke and 3/4 sec. on the return stroke for each revolution of the gear. The Stockbridge uses 1 sec. on the cutting stroke and 1/2 sec. on the return stroke for each revolution of the gear. The rate of regular crank tool movement over the work per

$$\frac{4}{\text{second}} \text{ equals } 8 \times \frac{60}{3} = 10 \text{ 2-3 in.; and the cutting speed equals}$$

$$\frac{32}{3} \times \frac{60}{12} = 53 \text{ 1-3 ft. per minute.}$$

"The rate of Stockbridge tool movement over the work per second is 8 in., and the cutting speed is $8 \times \frac{60}{12} = 40$ ft. per minute.

"Then, if at a given cut and feed the cutting tool will stand 53 1-3 ft. per minute on an 8 in. stroke with the regular crank shaper, with no quick return, one of three gains can be made with the Stockbridge shaper on the basis of the figures above. First, the length of the stroke can be increased to 10 2-3 in. and still maintain the same cutting speed. Second, the number of cutting strokes per minute can be increased to 53 1-3 and still maintain the same cutting speed. Third, a larger cut or feed can be used (more stock removed) and still maintain the same number of strokes of the ram with no more power used."

GENERAL NEWS SECTION

The number of emigrants arriving at the port of New York during the present year is expected to total not over 800,000, probably 30 per cent. less than the number arriving in 1910.

The number of miles of new main line built in United States during 1911, according to the *Railway Age Gazette*, was 3,066, as compared to 4,122 for 1910. This is the smallest figure since 1897, when 2,109 miles was added.

The Canadian Pacific has decided to adopt oil as a fuel on its line through the Rocky mountains between Kamloops and Field in the province of British Columbia. Arrangements are being made to make this change in the spring.

After mediation by the United States Commissioner of Labor, Dr. Charles P. Neil, the southern lines of the Queen & Crescent have granted an increase of wages to locomotive enginemen of approximately 10 per cent. for passenger runners and 7 per cent. for freight.

The Pennsylvania Company has agreed to a rule promulgated by the state railway commission of Indiana that when a conductor or engineman has to run over a division which he has not traversed for 60 days, he shall make a trip of inspection over the division before taking charge of a train or engine.

The shops of the Reid Newfoundland Company, at St. Johns, N. F., have turned out complete a new locomotive, complete passenger equipment, and two first-class sleeping cars. It is the company's intention to continue building its own engines and cars. This was the first engine built in that colony and was turned out on September 2.

E. A. Miller, superintendent of motive power of the Nickel Plate, has been elected president of the Veteran Association of that road. A veteran is one who has been in the service of the road 25 years. The oldest can have served only a little longer than that, as the road has been in operation only twenty-nine years. It now has over 300 members.

The Pennsylvania Lines have recently built 10 all-steel dining cars at the Altoona shops, which are to be used on the Pennsylvania Special, the Manhattan Limited and other expresses between Chicago and Pittsburgh. Platforms and vestibules have been omitted in these cars, allowing room for a larger kitchen and for 36 seats instead of the usual 30.

Nine locomotives were destroyed at Houlton, Me., December 20, in a fire which burned the engine house of the Bangor & Aroostook. Five locomotives were removed before the flames made it impossible to enter the structure. The blaze started from an unknown cause in a small office connected with the engine house, and both buildings were destroyed.

The State Tax Board of Indiana, having taxed refrigerator and other cars which pass through the state, but which are owned by shippers in other states, has encountered the usual remonstrances from the owners. Investigating the conditions of one Illinois concern, the Board finds that while the length of the railways owned by this car owner is only 7,850 ft., the cars owned by it aggregate a length of 15,750 ft.

On Saturday, December 9, the Los Angeles Limited on the Union Pacific was run from North Platte, Neb., to Omaha, 291 miles, in 300 minutes. The train arrived in North Platte three hours late, and the fast run was made that a sick woman might reach a hospital in time for a surgical operation. Five stops averaging 6 minutes each were made. Deducting this time from 300 minutes, the running time was 270 minutes.

All records for excessive rainfall for short periods on the Isthmus of Panama were broken at Porto Bello on the night of November 28-29, when 2.46 in. of rain fell in 3 minutes, between 2:07 and 2:10 a. m. The highest previous records of excessive rainfall were 0.75 in. in 5 minutes at Rio Grande in July, 1908, and 1.24 in. in 10 minutes at Balboa in August, 1908. The total rainfall in the shower at Porto Bello was 7.60 in.

The number of locomotives ordered during 1911, according to the *Railway Age Gazette*, was 2,850. That paper began keeping this record in 1901, and this is the smallest number ordered in any year since then, except 1904 and 1908. The number of passenger cars ordered was 2,623, which has been exceeded in 6 of the 10 years, since and including 1901. The number of freight cars ordered in 1911 was 133,117, which is the smallest number ordered in any year since 1901, except 1903 and 1908.

Statistics compiled by the *Railway Age Gazette* show that the number of cars and locomotives actually built during 1911 was smaller than the average for the past ten or twelve years, and in the case of freight cars was actually less than for any year during which that paper has made these compilations. It has received reports from the principal car and locomotive builders in the United States and Canada, and its investigation indicates that the total number of freight cars built during 1911 was 72,161; passenger cars, 4,246, and locomotives, 3,530. The figures for 1910 were: Freight cars, 180,945; passenger cars, 4,412; and locomotives, 4,755.

The number of passenger trains run on the steam railways of the state of New York for the month of October was 63,265, according to the report of the Public Service Commission. Of this number 84 per cent. were on time at the division terminals. The average delay for each late train was 23.8 minutes, and the average delay for each train run was 3.7 minutes. The principal causes of delays were: Waiting for trains on other divisions, 35.0 per cent.; waiting for train connections with other railways, 14.2 per cent.; train work at stations, 13.0 per cent.; trains ahead, 7.7 per cent.; engine failures, 6.2 per cent.; meeting and passing trains, 6.0 per cent.; wrecks, 4.7 per cent.

INCREASING SAFETY

R. C. Richards, general claim agent and chairman of the Central Safety Committee of the Chicago & North Western, described the organization and operation of the safety committee system, as worked out on the North Western during the past year, in an address before the Industrial Safety Conference. He said in part:

"There are now about 500 officers and men serving on these safety committees, and if Benjamin Franklin's old saying that the eyes of the master can do more work than both of his hands is true, surely 500 pairs of eyes trained to look for defective conditions and practices can do more work than the eyes of one person, and from the results that have been attained for the last eleven months (during which time the earnings of the company decreased less than 2 per cent.) this effort to bring about greater safety shows a wonderful improvement in matter of cleaning up yards, station platforms, shops and engine houses of obstructions, cleaning windows, putting up railings at dangerous places, and covering gearing of machines, which has not only brought about greater safety of operation, but also more efficient operation, and we also show the following reductions in our accident record:

47 per cent. in trainmen killed.
40.8 per cent. in trainmen injured.
30.7 per cent. in switchmen killed.
18.5 per cent. in switchmen injured.
50 per cent. in stationmen killed.
10.5 per cent. in stationmen injured.
32 per cent. in trackmen injured.
34 per cent. in bridgemen killed.

11.4 per cent. in shop and roundhouse men injured.
 85 per cent. in car repairers and inspectors killed.
 70 per cent. in passengers killed.
 10 per cent. in passengers injured.
 Total reduction of 17 employees killed.
 Total reduction of 2,144 employees injured.

The same safety organization as that adopted by the North Western has since been put into effect on the Delaware, Lackawanna & Western, the Elgin, Joliet & Eastern, the Baltimore & Ohio, and the Frisco system.

LOCOMOTIVE PERFORMANCE SHEET

Included in the papers for the fourth annual convention of the International Railway Fuel Association will be one on a Standard Locomotive Fuel Performance Sheet, by Robert Collett, superintendent locomotive fuel service, Frisco Lines, Springfield, Mo. In order to facilitate preparation of this paper, Mr. Collett has sent out a circular requesting answers to the following questions: Does your company make up a fuel performance sheet? If so, what is the nature of it—daily or monthly, or both? If a performance sheet is kept, is it an individual engine or engineer's record of fuel consumed? Which of the two methods do you prefer and should it in your opinion be a daily or monthly record? Give reasons. What is your opinion with reference to separating charges for fuel used at terminals from that used on the trip? What methods are used to interest engineers in their fuel performance? Please give your opinion or experience with weighing devices and coal chutes and whether or not you consider it advisable to incur the expense of installing scales at mechanical chutes and incurring the extra help needed at mechanical chutes. What methods do you recommend for taking care of the shortage between coal chute measurements and billed weights?

MEETINGS AND CONVENTIONS

The nineteenth annual convention of the Air Brake Association will be held at Richmond, Va., May 7-10, 1912.

It has been decided to hold the 9th annual meeting of the Railway Storekeepers' Association at Buffalo, N. Y., on May 20, 21 and 22, 1912. In addition to the committee on recommended practices, committees have been appointed on piece work, scrap classification, accounting, uniform grading and inspection of lumber, standard grain doors, stationery, standardization of tin ware and membership.

At a meeting of the executive committee of the International Railway General Foremen's Association which was held in Chicago, December 18, it was decided to hold the next annual convention July 23, 24, 25 and 26, 1912. The following subjects will be discussed: How Can Shop Foremen Best Promote Shop Efficiency; Shop Supervision and Local Conditions; Shop Specialization, Tools and Work; Engine House Efficiency; Reclaiming Scrap Material, and The Relation of Tests to Shop Efficiency.

At the November meeting of the Western Canada Railway Club, A. A. Hopkirk, shop engineer of the Canadian Northern at Winnipeg, presented a paper in which he clearly pointed out the fact that most railway shops do not begin to obtain the full benefits of high speed tool steel. Many of the reasons for this

condition are controllable and correctable. Mr. Hopkirk devoted most of his attention to the proper methods of forging the tools and the proper shapes to which they should be ground. With the properly formed tool in use on a machine of sufficient strength and rigidity, it was stated that locomotive driving axles could be turned at a cutting speed of 63 ft. per minute with a 3/4 in. depth of cut and 1/8 in. feed.

At the November meeting of the Central Railway Club, F. M. Whyte drew attention to the problem of determining the best mediums for furnishing instructions and information and the best method of distribution to the various members of large organizations. His ideas on the phases of the subject discussed were summarized in the last paragraph, in which he stated that the adoption of standards would be found to be most important as a beginning. Circular letters are a convenient medium, but they should be revised frequently and re-issued. Traveling representatives are valuable, but they should be teachers, not doers. In the discussion, which was very active and interesting, one member drew attention to the great importance of having instructions cover every possible detail, so that the man receiving them would only have to act and not surmise what the idea of the writer might have been or to ask questions. Along this same line Mr. Whyte, in his closing remarks, drew attention to the danger of the man preparing the instructions, knowing too much on the subject and assuming that others are better acquainted with it than is actually the case, in this way not making the instructions sufficiently clear.

The following list gives names of secretaries, dates of next or regular meetings, and places of meeting of mechanical associations.

- AIR BRAKE ASSOCIATION.—F. M. Nellis, 53 State St., Boston, Mass.; annual, May 7-10, Richmond, Va.
- AMERICAN RAILWAY MASTER MECHANICS' ASSOC.—J. W. Taylor, Old Colony building, Chicago. Convention, June 17-19, Atlantic City, N. J.
- AMERICAN RAILWAY TOOL FOREMEN'S ASSOCIATION.—M. H. Bray, N. Y., N. H. & H., New Haven, Conn.
- AMERICAN SOCIETY FOR TESTING MATERIALS.—Prof. E. Marburg, University of Pennsylvania, Philadelphia, Pa.
- AMERICAN SOCIETY OF MECHANICAL ENGINEERS.—Calvin W. Rice, 29 W. 39th St., New York.
- CAR FOREMEN'S ASSOCIATION OF CHICAGO.—Aaron Kline, 841 North 50th Court, Chicago; 2d Monday in Month, Chicago.
- INTERNATIONAL RAILWAY FUEL ASSOCIATION.—D. B. Sebastian, La Salle St. Station, Chicago.
- INTERNATIONAL RAILWAY GENERAL FOREMEN'S ASSOCIATION.—L. H. Bryan, Brown Marx building, Birmingham, Ala. Convention, July 23-26, 1912.
- INTERNATIONAL RAILROAD MASTER BLACKSMITHS' ASSOCIATION.—A. L. Woodworth, Lima, Ohio. Convention, August 15, Chicago.
- MASTER BOILER MAKERS' ASSOCIATION.—Harry D. Vought, 95 Liberty St., New York; annual convention, May 14-17, Pittsburgh, Pa.
- MASTER CAR BUILDERS' ASSOCIATION.—J. W. Taylor, Old Colony building, Chicago. Annual convention, June 12-14, Atlantic City, N. J.
- MASTER CAR AND LOCOMOTIVE PAINTERS' ASSOC. OF U. S. AND CANADA.—A. P. Dane, B. & M., Reading, Mass. Convention, 2d week in September.
- RAILWAY STOREKEEPERS' ASSOCIATION.—J. P. Murphy, Box C, Collinwood, Ohio. Convention, May 20-22, Buffalo, N. Y.
- TRAVELING ENGINEERS' ASSOCIATION.—W. O. Thompson, N. Y. C. & H. R., East Buffalo, N. Y., August, 1912.

RAILROAD CLUB MEETINGS

| CLUB. | NEXT MEETING. | TITLE OF PAPER. | AUTHOR. | SECRETARY. | ADDRESS. |
|--------------------|---------------|--|--------------------------|--------------------|-----------------------------------|
| Canadian | Jan. 9 | Transportation | U. E. Gillen..... | Jas. Powell..... | Room 13, Windsor Hotel, Montreal. |
| Central | Jan. 11 | Tonnage Rating of Locomotives..... | Prof. E. C. Schmidt..... | H. D. Vought.... | 5 Liberty St., New York. |
| New England..... | Jan. 9 | Railway Signaling | J. M. Fitzgerald.... | Geo. H. Frazier... | 9 Oliver St., Boston, Mass. |
| New York..... | Jan. 19 | Self-Propelled Motor Cars..... | W. B. Potter..... | H. D. Vought.... | 5 Liberty St., New York. |
| Northern | Jan. 6 | Lubrication | W. W. Breckenridge.. | C. L. Kennedy.... | 61 Superior St., Duluth, Minn. |
| Pittsburgh | Jan. 26 | Oxy-Acetylene Welding and Cutting... | J. A. Warfel..... | J. B. Anderson... | Union Station, Pittsburgh, Pa. |
| Richmond | Jan. 12 | Relation of the Technical College to the Railroads | Prof. L. S. Randolph.. | F. O. Robinson... | 5 O. Ry., Richmond, Va. |
| S'th'n & S. West'n | Jan. 18 | Superheaters | | A. J. Merrill..... | 18 Grant Bldg., Atlanta, Ga. |
| St. Louis..... | Jan. 12 | The Telautograph; Its Uses and Possibilities | H. J. Woods..... | B. W. Frauenthal.. | Union Station, St. Louis. |
| Western | Jan. 16 | Head End Electric Train Lighting.... | C. R. Gilman..... | Jos. W. Taylor... | 10 Old Colony Bldg., Chicago. |

PERSONALS

H. ELLET has been appointed assistant engine house foreman of the Rock Island Lines at Valley Junction, Ia.

J. F. SHEEHAN has been appointed master mechanic of the Georgia & Florida, with office at Douglas, Ga.

ALFRED BURG has been appointed foreman of the car department of the Lake Shore & Michigan Southern at Buffalo, N. Y.

JOHN BLACKBURN has been appointed foreman of the machine shop of the New York Central & Hudson River at Depew, N. Y.

L. H. RAYMOND has been appointed superintendent of shops of the New York Central & Hudson River at Depew, N. Y.

B. F. STONE has been appointed assistant general foreman of the New York Central & Hudson River at the Depew, N. Y., shops.

JOHN PARSONS, assistant general foreman of the New York Central & Hudson River, at Depew, N. Y., has been promoted to general foreman.

J. Q. LALOR has been appointed division storekeeper of the Union Pacific, with office at Denver, Colo., succeeding George Wheadon, resigned.

C. B. GRAY, assistant general foreman of the Pitcairn, Pa., shops of the Pennsylvania Railroad, has been appointed general foreman at Enola, Pa.

J. M. HENRY, master mechanic of the Pennsylvania Railroad at Olean, N. Y., shops, has been appointed master mechanic of the West Philadelphia shops.

W. J. RUSLING, general foreman of the Enola, Pa., shops of the Pennsylvania Railroad, has been appointed master mechanic of the Elmira, N. Y., shops.

C. D. PORTER, foreman of the Park shops of the Pennsylvania Railroad at Philadelphia, Pa., has been appointed assistant general foreman at Pitcairn, Pa.

J. B. KAPP, assistant general foreman of the Pennsylvania Railroad tank shop at Altoona, Pa., has been appointed foreman of the Park shops at Philadelphia.

ROBERT LEATON, boiler inspector of the Atchison, Topeka & Santa Fe at Cleburne, Tex., has been appointed foreman of the new shops at Sweetwater, Tex.

J. J. McNEILL has been appointed supervisor of locomotive operation of the Erie Railroad, with office at Cleveland, Ohio, succeeding D. J. Madden, promoted.

C. K. SHELBY, master mechanic of the Elmira, N. Y., shops of the Pennsylvania Railroad, has been transferred as master mechanic to the Olean, N. Y., shops.

FRANK STRIEBER, foreman of heavy repairs at the Ashtabula, Ohio, engine house of the Lake Shore & Michigan Southern, has been promoted to assistant general foreman.

C. W. ASHMAN has been appointed night roundhouse foreman of the Rock Island Lines at Cedar Rapids, Ia., succeeding J. Vlasak, who has been assigned to other duties.

D. J. MADDEN, supervisor of locomotive operation of the Erie Railroad at Cleveland, Ohio, has been appointed trainmaster of the Chicago and Hammond terminals of that road.

D. H. WATSON, general foreman in the locomotive department of the Baltimore & Ohio at Garrett, Ind., has been placed in full charge of the operation of the shops at Garrett.

N. WANAMAKER, general foreman of the locomotive department of the New York Central & Hudson River at Depew, N. Y., has been appointed superintendent of shops at that place.

GEORGE W. WEBER, locomotive foreman of the Great Northern at Great Falls, Mont., has been promoted to traveling engineer on the Butte division, with headquarters at Great Falls.

H. S. HAYWARD, superintendent of motive power of the New Jersey division of the Pennsylvania Railroad, at Jersey City, N. J., has been appointed consulting engineer of floating equipment.

LUKE CONNORS, assistant general foreman of the Lake Shore & Michigan Southern engine house at Ashtabula, Ohio, has been appointed general foreman of the engine house at Ashtabula, Ohio.

M. C. M. HATCH, chief draftsman of the Boston & Maine, Boston, Mass., has been appointed engineer of tests of the New York, New Haven & Hartford and the Boston & Maine, with office at Boston.

G. E. SISCO, assistant master mechanic of the Pennsylvania Lines West of Pittsburgh, has been appointed assistant engineer of motive power, with office at Columbus, Ohio, succeeding H. S. Needham, transferred.

J. M. JAMES, master mechanic of the West Philadelphia shops of the Pennsylvania Railroad, has been appointed superintendent of motive power of the Western Pennsylvania division, with headquarters at Pittsburgh, Pa.

JOHN H. MASON has been appointed road foreman of engines of the Lehigh Valley and Susquehanna division of the Central Railroad of New Jersey, with office at Mauch Chunk, Pa., succeeding A. B. Enbody, promoted.

D. M. PERINE, superintendent of motive power of the Pennsylvania Railroad at Pittsburgh, Pa., has been transferred to the New Jersey division as superintendent of motive power, with headquarters at Jersey City, N. J.

S. T. ARMSTRONG, foreman of the erecting shop of the International & Great Northern, at Palestine, Tex., has been made general foreman of the shops at that point. W. E. Gray has succeeded him as erecting shop foreman.

J. T. WALLIS, superintendent of the West Jersey & Sea Shore, has been appointed general superintendent of motive power of the Pennsylvania Railroad, with office at Altoona, Pa., succeeding R. N. Durborow, deceased.

P. F. SMITH, JR., master mechanic of the Pennsylvania Lines West, at Columbus, Ohio, has been appointed superintendent of motive power of the new Central system, which comprises the Cleveland, Akron & Cincinnati, and the Toledo, Columbus & Ohio River.

J. W. SMALL, superintendent of machinery of the Missouri Pacific at St. Louis, Mo., has been appointed superintendent of motive power of the Southern Pacific Lines in Texas, with office at Houston, Tex., succeeding J. J. Ryan, deceased.

H. C. NEEDHAM has been appointed master mechanic of the Southwest system of the Pennsylvania Lines West, with office at Richmond, Ind., succeeding J. W. Hopkins, general foreman at that place; the title of general foreman has been abolished.

F. V. McDONNELL, master mechanic of the Northwest system of the Pennsylvania Lines West, at Mahoningtown, Pa., has been appointed master mechanic of the Southwest system, with office at Logansport, Ind., succeeding J. F. Walsh, transferred.

J. T. ANDRUS, purchasing agent of the Oregon-Washington Railroad & Navigation Company at Spokane, Wash., having resigned and his position having been discontinued, the purchases for that division are made by R. Koehler, general purchasing agent, with office at Portland, Ore.

JOHN PULLAR, division foreman of the Atchison, Topeka & Santa Fe at Los Angeles, Cal., has been appointed master mechanic, with office at Richmond, Cal., succeeding E. H. Harlow,

appointed terminal master mechanic of the San Francisco Bay terminals, with office at Richmond.

C. H. HOGAN, assistant superintendent of motive power of the New York Central & Hudson River at Albany, N. Y., has been appointed assistant superintendent of motive power of the Eastern district (Hudson, Harlem, N. Y. & P., River, Mohawk and Adirondack divisions) with headquarters at Albany.

A. J. FRIES, district superintendent of motive power of the New York Central and Hudson River at Depew, N. Y., has been appointed assistant superintendent of motive power of the Western district (Buffalo, Rochester, Western, Ontario, St. Lawrence and Pennsylvania divisions) with headquarters at Depew.

J. F. BOWDEN, master mechanic of the Baltimore & Ohio, at Garrett, Ind., has had his jurisdiction extended and is now in charge of the Chicago division and the Northwest system, the latter including the Baltimore & Ohio Chicago Terminal. G. A. Schmoll, who has been superintendent of motive power of the lines west of the Ohio river, now has jurisdiction over the Wheeling system only.

C. E. COPP, master painter, Boston & Maine, has been transferred to the Concord shops, Concord, N. H., where he will have charge of the locomotive and car painting. Warner Bailey, who previously had charge, has been assigned to other duties. Mr. Copp won the first prize in the recent competition on Paint Shop Practice, his paper being published in the *Railway Age Gazette* of December 1, 1911, page 1109.

C. W. CROSS, superintendent of apprentices of the New York Central Lines, with office at New York, will report to C. E. Schaff, vice-president of the New York Central Lines, after January 1, and will have his office in the La Salle street station, Chicago. His jurisdiction will extend over the New York Central Lines west of Buffalo only. Henry Gardner, now assistant superintendent of apprentices at New York City, will be in charge of the apprenticeship work on the New York Central & Hudson River, and will report to R. T. Shea, general inspector of piece work.

W. W. SCOTT, formerly superintendent of shops for the Cincinnati, Hamilton & Dayton at Morefield, Indianapolis, Ind., has been appointed shop superintendent of the Pere Marquette at Saginaw, Mich., vice C.

K. Woods, resigned. Mr. Scott was born in Chicago and served as a machinist apprentice with the Grand Rapids & Indiana at Grand Rapids, Mich. He worked at the Fort Wayne shops of the Pennsylvania Lines West of Pittsburgh as a machinist, and after leaving there went with the Bucyrus Steam Shovel & Dredge Company at Bucyrus, O., remaining with that company until after the removal of its plant to South Milwaukee, Wis. For three years he was editor and manager of the *South Milwaukee News*, and in 1901 again entered the service of the Grand Rapids & Indiana as a machinist. Following this he was night machine foreman with the Pere Marquette at Grand



W. W. Scott.

Rapids, Mich., and master mechanic of the Kalamazoo, Lake Shore & Chicago. The latter road, being small, did not offer many opportunities for promotion, and he entered the service of the Cincinnati, Hamilton & Dayton at Indianapolis, Ind., as general foreman, later being promoted to the position of shop superintendent. Mr. Scott is an active member of the International Railway General Foremen's Association, and was elected a member of the Executive Committee at its last convention.

OBITUARY

JAMES DOYLE, master car builder of the Pullman Company, Chicago, died in Detroit, Mich., on December 3, at the age of 57. He had been with the Pullman Company 36 years.

RICHARD N. DURBOROW, general superintendent of motive power of the Pennsylvania Lines east of Pittsburgh, Pa., and Erie, with office at Altoona, Pa., died of heart disease at Philadelphia on December 9.



R. N. Durborow.

Mr. Durborow was born in Philadelphia, April 10, 1860, and was educated at Cheltenham Academy and Maryland Military Institute. He entered the service of the Pennsylvania Railroad in February, 1879, as an apprentice in the West Philadelphia machine shops. In September of the following year he was transferred to Altoona, and upon the completion of his apprenticeship entered the mechanical engineer's department. In March, 1890, he was appointed inspector in the West Philadelphia car shops, and in October, 1892, was made assistant general foreman of the same shops. He was promoted to acting master mechanic in November, 1895, and the following March became master mechanic at the West Philadelphia shops. On May 15, 1900, he was promoted to superintendent of motive power of the Philadelphia, Baltimore & Washington, and the following August was made superintendent of motive power of the Buffalo & Allegheny Valley division. In October, 1901, he was appointed superintendent of motive power at Altoona, and on June 28, 1911, was made general superintendent of motive power at Altoona. Out of respect to the memory of Mr. Durborow, all the shops of the Pennsylvania Railroad in Altoona, as well as a number of business houses, were closed December 11, the day of his funeral.

SAMUEL BROWN, a retired master painter of the New York, New Haven & Hartford, recently died at his home in Quincy, Mass., at the age of 69. Mr. Brown was an honorary member of the Master Car and Locomotive Painters' Association, and a member of Paul Revere Post 88, G. A. R.

JAMES M. ROOT, who died at his home in New York City this week, at the age of 67, was a hero of the forest fires in Minnesota in the summer of 1894. On August 31, Root was engineer of a passenger train on the St. Paul & Duluth, running from Duluth south. The fires had wiped out Hinckley and other towns. Root's train was crowded with passengers. When he was unable to proceed further he ran the train back seven miles through dense smoke to a small swamp where the passengers escaped the flames by submerging their bodies in the water. Root himself was badly burned and nearly suffocated.

NEW SHOPS

ATLANTIC COAST LINE.—This road is planning the erection of car repair shops and other buildings at Thomasville, Ga. A roundhouse, shop building, etc., will be erected.

BALTIMORE & OHIO.—A contract has been awarded to M. P. Wells, Philadelphia, Pa., to construct a coal tipple, sandhouse, ash pit, storeroom and oilhouse in the yards at Cumbo, W. Va. The cost will be about \$90,000.

CANADIAN PACIFIC.—It is announced that the contract for the shops at Calgary was let by Vice-president Bury to the Westinghouse, Church, Kerr Company, New York. It will commence work on the new buildings at once, and is to have them finished by the end of next year. They will be of the same size as the Winnipeg shops.

DELAWARE & HUDSON.—This company will complete in July, 1912, a modern locomotive and car repair shop at Watervliet, N. Y., at a cost of approximately \$2,000,000. The shop lay-out also provides for a large modern enginehouse and car-cleaning facilities. A portion of these will be available in January, 1912. During the last five years the Delaware & Hudson has spent in the neighborhood of \$17,000,000 for new equipment without making any expensive enlargement of its shop facilities, and the new shop is to take care of the needs on this account.

GRAND TRUNK.—It is reported that the capacity of the car shops at Port Huron, Mich., will be doubled.

MEXICO & NORTH WESTERN.—New shops are being installed at Chihuahua, Mex. It is also proposed to erect a new engine house.

NEW YORK CENTRAL LINES.—It is stated that plans are being made to erect a large plant at some point in Ohio for the repair of steel cars. The site has not yet been selected.

NEW YORK, NEW HAVEN & HARTFORD.—Contracts are being let for a repair shop, paint and oil house, power house, and other shop buildings at Van Nest, N. Y.

PENNSYLVANIA LINES WEST.—It is reported that this company is considering the location of yards and shops near Chicago.

PHILADELPHIA & READING.—This road is preparing to build a 40-stall roundhouse at Mill Creek, Pa.; it will be 400 feet in diameter.

PULLMAN COMPANY.—It is reported that a new addition will soon be erected to the car shops near Richmond, Cal.

SALEM, FALLS CITY & WESTERN.—A number of improvements are being planned for the shops at Dallas, Ore.

SOUTHERN PACIFIC.—The construction of a new outside yard with drill track, storage facilities, engine house, small machine shop and blacksmith shop, is being contemplated at Lafayette, La.

SOUTHERN RAILWAY.—A power house and 27-stall enginehouse are to be erected at Spencer, N. C.

TEXAS & PACIFIC.—Contracts have been let for a new 36-stall enginehouse and other buildings at Marshall, Tex., the cost of which will be about \$110,000.

SUPPLY TRADE NOTES

The Pressed Steel Car Company, Pittsburgh, Pa., has removed its office from St. Louis, Mo., to the Old Colony building, Chicago.

The Baldwin Locomotive Works, Philadelphia, Pa., is negotiating for some land near Chicago for the erection of a western plant.

W. J. Bixby, who has been appointed receiver of the Wabash, has resigned his position as a director of the American Car & Foundry Company, New York.

H. M. Percy, for several years mechanical engineer of the Joliet Railway Supply Company, Joliet, Ill., is now in the sales department of the Chicago Car Door Company, Chicago.

William H. Connell, Jr., mechanical engineer, has been made manager of the new office of Hilles & Jones Company, Wilmington, Del., in the Henry W. Oliver building, Pittsburgh, Pa.

The McKeen Motor Car Company, Omaha, Neb., has recently shipped two 70-ft., 200-h. p. gasolene motor cars to the Victorian Railways, Melbourne, Australia. The cars are adapted to a 5-ft. 3-in. gage.

Joseph F. Gettrust, for 16 years mechanical inspector of the Galena-Signal Oil Company, Franklin, Pa., has been made southern railway representative of the Ashton Valve Company, Boston, Mass., with office in Chicago.

The Biddle Hardware Company, Philadelphia, Pa., has opened a branch office at 150 Chambers street, New York. This office will be devoted to railway appliances, including the Burrows' ball-bearing jack. W. R. Burrows is manager.

J. Will Johnson, sales agent of the Pyle National Electric Headlight Company, Chicago, will be appointed general manager January 1, in charge of the sales department, with supervision of

the traveling representatives. Crawford P. McGinnis, air brake inspector, Minneapolis, St. Paul & Sault Ste. Marie, and Robert L. Kilker, brother of general superintendent John E. Kilker, were appointed representatives. Mr. Johnson was born in Charleston, S. C., September 10, 1869. He started in January, 1886, in the freight department of the St. Louis & San Francisco, Pierce City, Mo., and was brakeman for one and a half years and fireman for two and a half years. In June, 1890, he was made locomotive engineer on the St. Louis &



J. Will Johnson.

San Francisco, at Springfield, Mo. September 1, 1902, he entered the mechanical department of the Pyle company. In February, 1904, he was appointed special representative, and in September, 1908, he was appointed sales agent.

The Jerome Metallic Packing Company, Chicago, has moved its main offices to the Railway Exchange. William H. Dickinson, for 14 years connected with the Griffin Wheel Company, Chicago, has taken charge of the sales department. The company has secured the sole rights of manufacture and sale of the Stickleby pneumatic track sander, and will also handle the product of the Ruby Manufacturing Company, Jackson, Mich.

C. B. Flint, manager of the supply department of Manning, Maxwell & Moore, New York, has resigned to become president of Flint & Chester, Inc., 237 Lafayette street, New York. This firm was formed to carry on business in railway, machinists' and contractors' supplies.

The Baldwin Locomotive Works, Philadelphia, Pa., has recently acquired the right to build the Garrett type locomotives for service in the United States and Canada. The special feature of these locomotives is that they are of high capacity and will operate on lines having sharp curves.

W. E. Sharp, general superintendent of shops for the Armour Car Lines, Chicago, has resigned to become vice-president and general manager of the Grip Nut Company, Chicago. Mr. Sharp began railway work in April, 1890, as a laborer in the car shops of the Erie at Huntington, Ind. He advanced rapidly through the locomotive and car department until 1898, when he resigned as division foreman of the locomotive and car department to become assistant shop superintendent for the Armour Car Lines. In 1900 he was promoted to shop superintendent, and later to general superintendent of shops. He will retain his connection with the Armour Car Lines as consulting engineer.

L. R. Pomeroy, until recently chief engineer of the railway and industrial division of J. G. White & Company, New York, has opened an office as a consulting engineer at 50 Church street, New York. He has long enjoyed the reputation of being an authority on railway shop equipment, operation, and construction, and is prepared to design railway shops and industrial plants, to analyze machine tool operation with reference to electric and effective operation, to advise as to the rehabilitation of shops, and to make reports and appraisals of railway and manufacturing properties. Mr. Pomeroy was born at Port Byron, N. Y., in 1857, and attended the high school at Milwaukee, Wis., and the Irving Institute at Tarrytown. From 1874 to 1880 he was engaged in commercial business, bookkeeping, special auditing, drafting and designing of cars and locomotives. From 1880 to 1886 he was secretary and treasurer of the Suburban Rapid Transit Company of New York. For four years following this, he was a special representative of the Carnegie Steel Company, introducing basic boiler steel for locomotives and special forgings for railways. For nine years he was engaged in the same work with the Cambria Steel Company and the Latrobe Steel Company, jointly; this assignment involved metallurgical engineering and experimental research to adapt special steels for railway axles, crank pins and piston rods. From 1899 to 1902 he was assistant general manager of the Schenectady Locomotive Works. For six years following this he was a special representative in the railway field for the General Electric Company, this work covering the electrification of steam roads, railway shops, and the general application of electricity for all railway purposes. Following this he was for two years assistant to the president of the Safety Car Heating and Lighting Company, during which period he devoted a portion of his time to consulting work in the special field of railway shops, and machine tool operation.



L. R. Pomeroy.

CATALOGS

EXPANDERS.—Gustav Wiedeke & Company, Dayton, Ohio, have published an illustrated booklet on their expanders for locomotive boilers.

LOCOMOTIVES.—Record of recent construction No. 71 from the Baldwin Locomotive Works, Philadelphia, Pa., is devoted to industrial and contractors' locomotives.

AIR HOSE.—Guilford S. Wood, Chicago, has issued an original mailing folder illustrating the elasticity of the rubber used in Honesthose for pneumatic and air hoist hose.

LAMPS FOR TRAIN LIGHTING.—The recent improvements in the tungsten lamp, making it much more serviceable for passenger car lighting, are discussed in bulletin No. 4897 of the General Electric Company, Schenectady, N. Y.

VALVES.—The Nelson Valve Company, Philadelphia, Pa., has published a small folder on Nelson blow-off valves. These valves are made of iron for working pressures up to 300 lbs., and of steel for extreme service.

JOURNAL BOXES.—The Locomotive Equipment Company, Detroit, Mich., has a catalog devoted to an illustrated description of the Newcomb journal box. Records that have been made in fast passenger service with this design are included.

STAYBOLTS.—The Falls Hollow Staybolt Company, Cuyahoga Falls, Ohio, has issued a small folder called Boiler Construction Repairs Inspection, giving seven reasons why hollow staybolts should be used in the construction and repair of boilers.

PLANERS.—Discussion of detailed construction with illustrations occupies a considerable portion of the new catalog on the Rockford planer being issued by Joseph T. Ryerson & Son, Chicago. Specifications of four sizes, 24 in. to 36 in., are also included.

MANGANESE STEEL GEARS.—The Taylor Iron & Steel Company, High Bridge, N. J., has issued bulletin 100-B illustrating and describing Tisco manganese steel gears and pinions and bulletin 113 illustrating and describing the company's manganese steel chains and sprockets.

COUPLERS.—The National Malleable Castings Company, Cleveland, Ohio, has published catalog No. 2 on Sharon Tower, Climax, Latrobe and Chicago couplers and repair parts for freight, passenger, engine and tender service. Excellent diagrams are given of each type of couplers, and also of each repair part.

CONDENSERS.—The Wheeler Condenser & Engineering Company, Carteret, N. J., has published bulletin No. 107 on high vacuum jet condensers. Special attention is devoted to the Wheeler rectangular jet condenser, which is constructed on the counter-current principle. Wheeler barometric ejector condensers and Wheeler direct-acting jet condensers are also illustrated and described.

FIREPROOF PRODUCTS.—The Dahlstrom Metallic Door Company, Jamestown, N. Y., has published in pamphlet form the address on Reduction of Fire Waste, by Edward F. Croker, ex-fire chief of the New York fire department, at the International Municipal Congress and Exposition, held in Chicago, September 29, 1911. The pamphlet closes with a brief description of the fireproof qualities of the Dahlstrom products.

SHOT HEATING.—An interesting treatise containing practical suggestions on this subject by F. R. Still has been sent out by the American Blower Company, Detroit, Mich.

COMPRESSORS.—Bulletin 34 A 34 C and 34 E, from the Chicago Pneumatic Tool Company, Chicago, was devoted respectively to class G steam driven compressors, tandem gasoline compressors, and railroad type duplex steam driven compressors.

AMERICAN ENGINEER

"THE RAILWAY MECHANICAL MONTHLY"

(Including the Railway Age Gazette "Shop Edition.")

PUBLISHED ON THE FIRST WEDNESDAY OF EVERY MONTH, BY THE
SIMMONS-BOARDMAN PUBLISHING COMPANY,
83 FULTON STREET, NEW YORK, N. Y.

CHICAGO: Plymouth Bldg. CLEVELAND: New England Bldg.
LONDON: Queen Anne's Chambers, Westminster.

EDWARD A. SIMMONS, *President.* HENRY LEE, *Secretary.*
L. B. SHERMAN, *Vice-President.* A. E. HOOVEN, *Business Manager.*

The address of the company is the address of the officers.

ROY V. WRIGHT, *Editor.* R. E. THAYER, *Associate Editor.*
E. A. AVERILL, *Managing Editor.* WILLIAM FORSYTH, *Associate Editor.*
GEORGE L. FOWLER, *Associate Editor.*

Subscriptions, including the eight daily editions of the *Railway Age Gazette* published in June in connection with the annual conventions of the Master Car Builders' and American Railway Master Mechanics' associations, payable in advance and postage free:

United States, Canada and Mexico\$2.00 a year
Foreign Countries (excepting daily editions)..... 3.00 a year
Single Copy 20 cents

Entered at the Post Office at New York, N. Y., as mail matter of the second class.

VOLUME 86. FEBRUARY, 1912. NUMBER 2.

CONTENTS

EDITORIALS:

| | |
|---|----|
| Competition on Reclaiming Scrap Material..... | 51 |
| Give Your Equipment a Fair Show..... | 51 |
| Railway Shop Improvements During 1911..... | 51 |
| Drop Testing Machine..... | 51 |
| Engineers' Wind Shield..... | 51 |
| Low Water Alarm for Locomotives..... | 52 |
| The Next Shop Kink Competition..... | 52 |
| Good Ideas Are Worth Money..... | 52 |
| Coal for Locomotive Stokers..... | 52 |
| Volume of Locomotive Fireboxes..... | 52 |
| Steel Passenger Cars in Wrecks..... | 53 |
| Reclaiming Scrap Material..... | 53 |
| Electric Shop Kinks..... | 54 |
| New Books..... | 55 |

ILLUSTRATED:

| | |
|---|----|
| Removing a Stuck Wedge..... | 56 |
| Electric Welding in Railway Shops..... | 57 |
| Balanced Compound 4-6-2 Locomotives..... | 65 |
| Machine Shop Kinks..... | 70 |
| Stresses in Steel Underframes..... | 71 |
| Hydraulic Driving Box Press..... | 72 |
| Improved Shop Practice at Nashville..... | 73 |
| Low Water Alarm..... | 77 |
| Improvements in the Street Stoker..... | 81 |
| New Forged Twist Drill..... | 82 |
| Repair Shop Improvements at Buffalo..... | 83 |
| Air Washer and Cooler for Passenger Cars..... | 86 |
| Powerful Mikados for the Erie Railroad..... | 87 |
| 60-Foot Drop Testing Machine..... | 91 |
| Effect of Firebox Volume on Combustion..... | 94 |
| Flange Lubricator..... | 96 |

MISCELLANEOUS:

| | |
|--|----|
| Time Feature of Engine Failures..... | 56 |
| Legislation on Mechanical Matters..... | 79 |
| Coach Cleaning..... | 85 |

GENERAL NEWS SECTION:

| | |
|-------------------------------|-----|
| Notes..... | 97 |
| Meetings and Conventions..... | 99 |
| Personals..... | 100 |
| New Shops..... | 104 |
| Supply Trade Notes..... | 105 |
| Catalogs..... | 106 |

Competition on Reclaiming Scrap Material

You will still have a few days on receipt of this number to finish and send in your contribution to the competition on Reclaiming Scrap Material, which closes February 15, 1912, a prize of \$35 will be given for the best paper on the subject and one of \$20 for the second best. Articles not awarded prizes, but accepted for publication will be paid for at our regular space rates. We want to bring out all the practical information possible on the reclaiming of scrap and as to how far this work can be carried with good results. Full announcements of the competition were made in the January issue.

Give Your Equipment a Fair Show

On a locomotive equipped with a high degree superheater, a visitor was recently astonished to observe that the inside and part of the lower face of the cylinders were not lagged in any manner. This is an illustration of the reason why a device in actual practical service often does not show the economy which it did in experimental service; while the superheater appears to be able to hold up its end under the most severe handicaps, it is not improbable that carelessness of this kind might be responsible for the discarding of a device which under reasonably fair conditions would prove successful.

Railway Shop Improvements During 1911

The first prize of \$35 in the competition on Shop Improvements during 1911 has been awarded to William G. Reyer, general foreman of the Nashville, Chattanooga & St. Louis shops at Nashville, Tenn. The second prize of \$20 goes to C. C. Leech, who until recently was foreman in charge of the Buffalo shops of the Pennsylvania. Both of these men considered the subject from entirely different view points. Mr. Reyer briefly covered the general improvements which had been made and then considered a number of important time and labor saving kinks which had been introduced at Nashville during the year. Mr. Leech, on the other hand, described the changes which had been made in the arrangement of the buildings and equipment at Buffalo during the year.

Drop Testing Machine

The drop test forms a part of the specifications of a number of the more important pieces of railway equipment and in the larger railway testing departments the drop testing machines come into very frequent use. The Baltimore & Ohio, in replacing an old machine, has installed an electrically operated apparatus which gives a maximum drop of 60 ft. It is, in many respects, a very decided improvement over the customary arrangement. A magnet is used for hoisting the tups and the height of the drop may be accurately determined and quickly altered without the necessity of climbing up the column and adjusting trips. Furthermore safety devices have been most carefully provided which seem to make it practically impossible for an accident to occur which might result in the injury of the operators or in spoiling a test. This machine is fully illustrated and described in another part of this issue.

Engineer's Wind Shield

In zero weather, especially in cases of snow and sleet and on rapidly moving trains, it is necessary for an engineer to close the cab window and to operate his train with practically no view ahead except a quick survey of the signals, the exact location of which he knows. If the cabs are provided with a narrow hinged window that may be swung out and fastened and act as a wind shield and can also be quickly and easily wiped clean, the necessity and desire of closing the side window even in very cold weather is practically eliminated. These shields not only permit a clear view ahead without being blinded by snow or rain but also largely keep the cold wind out

of the cab and from the engineer's projecting arm and shoulder. They are simple, cheap and easily applied and no locomotive operating in passenger service should be without them, especially during winter weather.

Low Water Alarm for Locomotives When a locomotive boiler explodes, the evidence in a great majority of cases indicates that the cause is low water. While no engine crew would intentionally permit the water level to reach a danger point, the fact that it does do so, in some cases without any fault or inattention on the part of the crew, indicates the value of greater safeguards in this direction. On some divisions of the Southern Pacific, the locomotives are now being equipped with an apparatus which automatically blows a whistle and dampens the fire whenever the water level reaches the danger point. The passages to this apparatus are made sufficiently large, so that the possibility of their becoming clogged is very small, and even though the water glass or gage cocks may be out of commission, the alarm will probably do its duty. The apparatus, as may be seen in the description on another page, is not expensive and requires very little maintenance. The expense of a single dropped crown sheet would be sufficient to equip a whole division with an alarm of this type.

The Next Shop Kink Competition Don't forget the shop kink competition which was announced last month to close March 15, 1912. Any labor or time-saving kinks or devices which are used in the locomotive or car departments will be eligible. A prize of \$50 will be awarded to the contributor with the best collection of three kinks, and a second prize of \$25 will be given for the next best collection. More than three kinks may be submitted, allowing the judges to base their decision on what they consider to be the best three in the collection. Kinks not awarded a prize, but accepted for publication, will be paid for at our regular space rates. The devices should be clearly and fully described. Too many of our contributors err on the wrong side, making their explanations incomplete and entirely too brief. A prize winning kink may be so poorly described that its advantages will not be at all apparent. The illustrations may consist of sketches, drawings, blue prints, or photographs. While it is not necessary that the contributor should have designed the kinks it is always advisable, wherever possible, to give credit to the man or men who did design them.

Good Ideas Are Worth Money Men of all grades on a railway are in position to suggest improvements in both methods and appliances for the work with which they are most closely associated, and in many cases will go to great personal inconvenience to have an improvement installed which often results in decided economy for the company. Unfortunately, in some cases it is with so great difficulty that things of this kind can be done that the initiative of the men is completely destroyed and they not only make no suggestions, but to some extent lose their loyalty to the company. A few railway companies are recognizing the importance of stimulating the activity of their employees in this direction, and are even going to the extent of offering to pay a man for all ideas which prove practicable. The results are remarkable. Even under ordinary conditions suggestions are numerous, but when a reward is offered, the possibilities of resulting economies are surprisingly great. On the Buffalo & Allegheny division of the Pennsylvania Railroad, where prizes are given for such suggestions, it has been found that practically all classes of employees respond; while many of the suggestions are worthless, there are so many that are valuable that it pays well to carefully investigate the possibilities of each one.

Coal for Locomotive Stokers Automatic stokers for stationary boilers almost without exception, require prepared coal, but designers of stokers for locomotives have from the beginning attempted to use the regular run of mine coal; it is quite possible that this effort is largely responsible for the failure of some of the designs. Those that have proved successful, however, have by different means crushed the coal before it was actually put into the firebox and in this way have overcome the apparently serious handicap of using the unprepared run of mine coal. In the Street stoker an entirely separate apparatus has been used for this purpose, while in the Hanna and Crawford designs what is in effect a crusher forms part of the apparatus. If prepared fuel were furnished stoker locomotives, not only would their operation be more reliable and efficient, but particularly in the case of the Street stoker there would be a decided reduction in the weight and in the amount of machinery required. As is shown elsewhere in this issue, where suitable fuel can be obtained, Mr. Street is now equipping locomotives with the screw conveyor, and entirely doing away with the crusher and its engine on the tender. Coal suitable for stoker use, i. e., everything that will pass through a 2-in. screen, can be purchased at the mine at the present time at a considerable reduction over what run of mine costs. When it is considered that on a division having 100 locomotives equipped with stokers there will be 100 small crushers operating uneconomically and using power that is needed to pull trains, when a few crushers at the coaling stations would do the work better, the unsoundness of the practice is evident. It would be as sensible to have small dryers on each locomotive for preparing the sand. Some few roads are recognizing this fact and are furnishing stoker locomotives with suitably prepared fuel to the great advantage not only of the firemen, but of the fuel consumption, and the reliability of the stoker operation. Other companies considering the application of stokers should arrange to do likewise.

Volume of Locomotive Fireboxes How many cubic feet of firebox volume should be allowed for each square foot of grate area in order to get the most complete combustion? It probably varies directly as the amount of volatile matter in the fuel, but there seems to be little definite information on the subject with any grade of fuel. The government is carrying on tests on this subject which seem to indicate that the larger the volume the more efficient the combustion, but the proper limit or most efficient point has not yet been determined. Practical experience in locomotive fireboxes indicates much the same thing and tests made by blocking off a fair proportion of the grate show a decided increase in the efficiency of the boiler, in some cases, even with no decrease in capacity. Boilers with large combustion chambers give as great or greater evaporation than those having the similar space filled with tubes, and in fact with soft coal everything seems to indicate that an increase in the relative volume of locomotive fireboxes over the customary size would give an improvement, but there seems to be little information as to the rate of improvement or what the limit should be in this direction. The old narrow firebox was notoriously a better steamer for its size than the present wide type as generally constructed and it, of course, had a decidedly larger ratio of firebox volume to grate area than the present design; this fact may be responsible for some of the results.

As is recorded on another page, Mr. Gaines, of the Central of Georgia, has been most successful in some experiments in this direction. He erected a hollow brick wall across the forward end of the grates, making the firebox of sufficient length to give the required grate area back of the brick wall and thus form a combustion chamber within the firebox itself, giving an increase in relative volume of about 25 per cent. Owing to the fact that he admits air through the hollow wall, which is discharged backward at about the center of the firebox, it is difficult to determine

from the figures available how much of the increased evaporation obtained is due to the increased volume and how much to the admission of air at a high temperature at the point where it will do the most good. Some work in this direction has been done in the locomotive testing plant at Altoona and it is to be hoped that the results may later be made generally available. It will be noticed in connection with Mr. Gaines' design that the increased volume is obtained by increased length, offering an opportunity for a considerable decrease in the height of the box even to the point of the entire elimination of the front water leg permitting the installation of large wheels under the firebox in practically the same manner that is possible with the Wootten type boiler.

Steel Passenger Cars In Wrecks

Steel passenger and sleeping cars are now in sufficiently general use to give an opportunity of determining with some degree of accuracy their actions when in wrecks. On the whole there is no doubt but what they are a wonderful success in this particular, and have already resulted in a saving of many lives. In cases where they have been thrown from the track, rolled down the embankment and otherwise misused, which would have resulted in many fatalities with the ordinary wooden car, the passengers have usually all escaped with but minor injuries and no fire has been present to destroy those who were trapped in the wreck. In fact in the one feature of the absence of fire in bad wrecks, the steel car is worth all it costs.

In the case of actual collisions, however, especially those where the rear end of a train is struck by a rapidly moving locomotive and train, there have been a number of fatalities in steel cars. Possibly the most disastrous of these was in the wreck on the Chicago, Milwaukee & St. Paul at Odessa, Minn., on December 12, where 10 persons in the steel sleeping car were killed and 11 injured. In this case the steel sleeping car was the last car on the train, and just ahead of it was a heavy steel diner, and ahead of this were 5 cars and a large Pacific type locomotive. This train was barely moving after a stop when a Pacific type locomotive of the same class as the one on the passenger train, drawing 6 loaded, 30-ton, refrigerator cars and operating at very high speed, ran into it. The locomotive plunged into the rear end of the sleeper, which was the smoking compartment and, destroying the combination end sill, entered the car as far as the rear end of its cylinders. This action apparently tended to lift this end of the sleeper and to depress the forward end so that it passed under the underframe of the dining car, which then telescoped into the sleeping car for a distance of one-third of its length, demolishing the vestibule and end framing, spreading out the sides and crumpling up the roof. The underframe of the dining car, which was of the standard Pullman construction, was little damaged, and the same holds true of the forward part of the sleeping car underframe. There was practically no damage ahead of the dining car, in fact the forward vestibule of the diner itself was practically uninjured.

One of three things with this class of equipment should be provided. Either the upper plate and end construction of the vestibule should be made equal in strength with that of the underframe, so that there will be sufficient resistance to prevent telescoping even when one underframe rises above the other; or the vestibule including the underframe should be made of lighter construction as far back as the body end sill so that they will crush and absorb the shock without injury to the car body; or some method should be designed that will positively prevent one underframe from rising above the other under any circumstances. It is also possible that the body of the car could be constructed to become so distorted, in case of a collision of this type, that it would absorb the blow without being crushed. While collisions of this particular character seem to be the only vulnerable point of the steel car, and they happily, are comparatively infrequent, nevertheless the cars to be a complete success, must be prepared to withstand even this test.

Reclaiming Scrap Material

In the effort to increase the efficiency of the mechanical department several roads have been giving close attention to the question of reclaiming scrap material. On the Chicago & North Western the superintendent of motive power and machinery, Robert Quayle, the superintendent of the car department, C. A. Schroyer, and the general storekeeper, W. M. Carroll, recently made a trip of three weeks, visiting every important division and repair point on the road, and carefully examining the condition of the shops, store houses and scrap bins and their surroundings to see that usable material was not scrapped or wasted, or was not kept in excessive quantities, or in such a way that it could deteriorate. In looking over the plants, memoranda were made of things which were not as they should be, and a usable bolt or some similar part, which had found its way into the scrap pile, was picked up and used as an illustration in a little conference with the local officers which was held after the inspection was completed.

The conference was held in a business car, if there were only a few men to be present, or in a large office or hall if the car was not large enough to accommodate all those whom it was desired to have present. These gatherings were usually made up of the general superintendent, if he happened to be located at that particular division point, the division superintendent, trainmaster, bridge department foreman, traveling engineers, master mechanic, general foreman, engine house foreman and the foremen of the various departments in the shop.

Attention was directed to the fact that it is quite often necessary to reduce the expenses of the mechanical department for a period of greater or less length, and that in such cases the ordinary practice is to cut down the pay roll. Usually the first men to be laid off are the laborers employed about the shop who can be spared much more easily than the more skilled workmen, but who at the best receive a small wage and can ill afford to remain out of work for any length of time. The suggestion was then made that the same saving or economy could be brought about without the laying off of these men if all of the employees would co-operate in an effort to reduce the loss or waste of material to a minimum. On a large road the cost of material used in the mechanical department is as great or greater than the cost of labor, and the indications are that by co-operation, a sufficient saving could be made to prevent a large part of the fluctuations in the working time of the force. For instance, all the scrap is supposed to be carefully sorted out at each point and only that forwarded to the main shops which cannot be used and must be sold. In spite of this the scrap which was shipped to the main shop last year contained \$275,000 worth of usable material. It is true that this material was finally saved, but the cost of handling it and shipping it to headquarters and reshipping it to outside points for use would have gone a long way toward producing the economies which are so much needed.

The speaker would then show a bolt which was in good condition but had found its way to the scrap pile. Such a bolt might cost 6 cents. The annual report last year showed that it cost .89 cents to haul a ton of freight one mile. It would therefore be necessary to haul a ton of freight eight miles to secure enough revenue to pay for a new bolt. One man at \$1.50 per day can pick up \$12 worth of usable material. Would it not be a paying proposition to have such a man and provide him with a small amount of equipment for straightening and reclaiming damaged material?

The way in which a railway must practice economy may be illustrated by the way in which the children in a large family are clothed. The oldest boy's clothes are made over for the next boy, and so on down the line until they have been completely worn out. The cost of transportation is fixed by law, and since it is impossible to secure the necessary revenue by increasing the freight rates, ways must be devised of cutting

down the expenses in order that the property will not depreciate.

A new era has been reached in the history of railways. With government regulation as to the safety appliances for rolling stock, the care of boilers and the making of rates it is not altogether improbable that sooner or later the government will want to look into the problem of efficiency to see if the roads are properly directed. When such a time comes, in order to protect the roads from government ownership and its evils, it will be necessary for those in charge to show, like the man with ten talents, that they have handled the property wisely and have not neglected it, as did the man with one talent.

Undoubtedly those who read this will suggest that railway affairs or reforms travel in cycles, and that although great improvement may temporarily follow the inspection by this efficiency committee, as it might be called, still it will be only temporary, and in another 6 months or more the men will have forgotten all about it and the lessons which were so forcibly taught them. The men in charge of the movement, however, are big enough to prevent this, and undoubtedly for the next year they will arrange to follow the matter up at least once every 3 months to see that the movement is started right and that the men get into the habit of using material properly.

Electric Shop Kinks

The transmission of power for small portable tools, hoists, presses, etc., in railway shops is almost entirely by compressed air; the practice has grown to such an extent

that the space in the power house occupied by the air compressors required for these numerous small operations is nearly as large as that for the steam engines and electric generators which supply power to the large machine tools. In some shops the pneumatic motors, hoists and other tools require a compressor capacity of 10,000 cu. ft. per minute, representing 1,500 boiler horse power, which is nearly equal to the power required to operate all the shop equipment driven by other methods. At the passenger power house of the Pullman Company there are three air compressors with a total capacity of 12,000 cu. ft. of free air per minute, and at the new freight power house of the same company there are two air compressors each of 4,000 cu. ft. capacity, or a total of 8,000 cu. ft.; a total for the two plants of 20,000 cu. ft. of air, which, compressed to 100 lbs., represents about 3,000 h. p.

The actual useful work performed by the various pneumatic tools and motors in any shop is but a small proportion of that available in the steam used by the air compressor; in other words, the efficiency of pneumatic motors is low and there is a large loss by leakage and by friction in the transmission of compressed air at 100 lbs. pressure through pipes distributed over the large area of a railway repair shop. These are the reasons why with the increasing use of pneumatic motors and shop kinks operated by compressed air, very large and expensive air compressors are required.

It is doubtful if this low efficiency of air motors and the loss in the transmission by pipe friction and leakage has been fully appreciated by motive power officers and engineers concerned in shop and power house equipment, for it was, the superior efficiency of electric motors and electric transmission would have been more largely availed of for the smaller motors and shop kinks of various kinds which require power or pressure. The small electric motor for drills, reamers, taps and other similar portable tools has already been substituted for the air motor, and in several instances it is manufactured by the same companies. The electric drive has also been developed for hoists, riveters, chipping hammers and most other portable tools which heretofore have been driven by compressed air.

For a new plant it is possible to eliminate the majority of air appliances, and a large capacity in air compressors need not be provided. In some railway repair shops the large air compressor has been eliminated from the power house equipment and a

number of small compressors are distributed through the plant, one for each shop building where pneumatic tools are used. These compressors are electrically driven and arranged to automatically start and stop by pressure governors. Compressed air is seldom required in all departments day and night, and when the whole plant is supplied by one large compressor it must be operated at night under extremely uneconomical conditions to supply a few air tools in one shop. With the improvement of electrical appliances, covering a wider range and a greater variety of work, the size of the air compressors may be reduced and their installation confined to a few of the shop buildings, thus largely reducing the length of the main air pipe and preventing large losses by leakage.

Compressed air has its legitimate field and should not be entirely eliminated. The air hoists for lifts of three to five feet and pneumatic jacks and presses are convenient, economical and efficient appliances which have come into general use and should be retained. They have the merits of simplicity, low first cost and light repair charges, and are typical of the kind of appliances to which compressed air is best adapted. The flow of air is intermittent, its application fairly efficient and the volume of air required is comparatively small. Where a constant flow of air is required, as in rotary pneumatic motors for drilling holes, and for tapping and threading for staybolts, the volume of air is large and its application very inefficient. The same is true where an air jet is used in connection with oil furnaces, rivet forges and other places where a continuous flow through a small nozzle represents a large consumption of compressed air, compared with that required for pneumatic hoists.

We have headed this editorial Electric Shop Kinks, because most of the so-called shop kinks which require power have usually employed compressed air, and some reform in the future developments of these useful appliances is necessary in order to adapt them to the use of the electric transmission of power. The extensive application of compressed air is seen in the various devices illustrated in the book on Railway Shop Kinks, where it is almost universal, while there are only one or two examples where electric power is utilized. A conspicuous instance illustrates the limitation of air and the greater flexibility of electricity. A jib crane for a flange fire is fitted with the usual pneumatic hoist for short lifts, and on the same jib is an electric chain hoist which permits of the longer lift required for the large plates for locomotive fireboxes.

The almost universal use of compressed air for driving portable home-made shop tools and appliances is due to the fact that small pneumatic motors were easily made in the railway shops and pipes were laid for air transmission before electric motors were used for shop purposes. The ordinary machinist could readily understand the construction of the air motor, and he found numerous and ingenious methods for its application. It was easily adapted to portable tools, and this led to the extensive development of labor-saving devices where power was employed instead of hard work. Since the electric motor has been so generally introduced for driving machine tools and the shops are fully equipped for electric transmission, advantage has not been taken of its efficiency, and it has not been utilized for the smaller shop appliances requiring power, partly from habit and experience with the familiar air motors, and partly because electric devices are not so well understood by the average mechanic.

With the electric lighting of shops and passenger cars, and the general use of electric-driven machine tools, has come the "railway electrical engineer," and it should be a part of his duty to assist in the development of electric shop kinks for railway plants. At the November, 1911, meeting of the Association of Railway Electrical Engineers this responsibility was recognized in the report on shop practice, which called attention to the large increase in compressed air consumption in railway shops. In the next report the committee proposes to present definite figures

regarding the cost and efficiency of compressed air and its application to pneumatic tools and other fixtures. These will be compared with the efficiency of small electric motors and appliances which may be substituted for those driven by air. In this important investigation the railway shop superintendent and testing engineer should render all necessary assistance and co-operation, for it is one which will secure valuable data leading to a radical change in the application of power to portable tools, and resulting in important savings in the cost of shop labor. It should justify a larger substitution of electric motors for air motors, and the utilization of electric transmission in places where hand power is still employed.

The use of electrically driven small portable saws and emery wheels could be largely extended, especially in the construction and repairs of steel cars. These small grinders find a large field of application in the outside finish of steel passenger cars, and larger portable emery wheels can be used in grinding the bearing faces of locomotive frame pedestals and for sharpening milling cutters in place on the machines. The small electric motors can be used for driving fans and blowers, which may take the place of the wasteful air jet. There is also a large field for the utilization of the electric current in the magnet. Magnetic clutches are not yet fully developed, and there is wide opportunity for invention in numerous applications of this principle. There is nothing more convenient than a magnetic face plate on a lathe for turning piston packing rings, and magnetic clamps should be made so reliable that they would be utilized for holding small pieces on planers, shapers and drill presses. When the superior economy, flexibility and convenience of electrical devices for portable shop tools are better understood, there will be a development of electric shop kinks more numerous, more interesting, and more economical than that which has utilized compressed air for power transmission. We shall welcome descriptions of electric kinks.

NEW BOOKS

Elementary Applied Mechanics. By Arthur Morley, professor of mechanical engineering, and William Inchley, lecturer and demonstrator in engineering in the University College, Nottingham, England. 382 pages. 261 illustrations. 5 in. x 7½ in. Cloth bound. Published by Longmans, Green & Company, 91 Fifth avenue, New York. Price, \$1.00.

This book deals with the subject of elementary applied mechanics in a very complete way, entering into all the different phases of the subject in a concise and simple manner. It is especially useful to the young man that does not have an opportunity of attending a technical school where the subject is taught, and is a first class text book for apprentices or students who are not taking up engineering along prescribed lines. It is divided into twenty-seven chapters, which deal with the subjects of force, work, friction, power, strength of materials, statics, motion, energy and hydraulics. The book is rather small to cover so wide a field, but the subjects are treated in such a way that most any student can more or less easily assimilate the elements of the subjects considered.

New York Air Brake System. A Detailed Description and Explanation of the Operation of the New York Air Brake. Compiled and edited by leading air brake experts. Illustrated by colored diagrams. Frederick J. Drake & Company, Chicago. Cloth, 5½ in. x 8 in., 382 pages. Price, \$2.00.

The New York air brake has been changed and improved to such an extent that an up-to-date treatise describing the brake fixtures and their operation is now desirable, and the demand has been well met in this volume. It has been compiled by prominent air brake inspectors and experts, and is well illustrated by numerous colored diagrams. A good portion of the book is taken up with the examination questions and answers adopted by the Air Brake Association, and, while this may be

desirable for use in the instruction car and for preparation for examinations, it might well be left to the separate pamphlet which is published by the association. The method of describing the brake by use of questions and answers is also questionable, as it often deviates too far from the simple description and a change from this old method is desirable.

Graphic Statics. By William Ledyard Cathcart and J. Irving Chaffee. Published by D. Van Nostrand Company, 23 Murray street, New York. 5 in. x 7¾ in. 183 pages. 54 illustrations. Bound in cloth. Price, \$1.50.

The purpose of this book is to provide a brief course in graphic statics for mechanical engineering students. Treatment has been restricted to the properties and general uses of the force and equilibrium polygons, such as are met in actual practice; detailed examples have been included wherever possible. The book is divided into six chapters, which deal with polygons, trusses, stationary loads, live loads, center of gravity, moments of inertia and friction.

Westinghouse Air Brake System. A Detailed Description and Explanation of the Operation of the Westinghouse Air Brake. Compiled and edited by leading air brake experts. Fully illustrated with colored charts. Frederick J. Drake & Company, Chicago. Cloth, 5½ in. x 8 in., 475 pages. Price, \$2.00.

It is questionable whether it is worth while to include descriptions of the older forms of the air brake in a work of this kind, as much of it has become obsolete on many lines. The questions in the catechetical form occupy a large space in the volume which, in many instances, could be omitted and the description be given directly, thus saving considerable space. The examination questions and answers are already printed in the pamphlets of the Air Brake Association, and a more satisfactory book and one less bulky would omit that portion. For those who desire all the information describing the Westinghouse brake and its operation, as well as the examination questions, in one volume, this is the most satisfactory treatise thus far published. It is very complete and up-to-date, and is fully illustrated. The colored sections, which indicate the condition of pressure in various pipes, ports and chambers, will be found helpful to those who want to study the operation of the air brake. Among those who have assisted in compiling the volume are prominent air brake instructors and representatives of air brake companies, including Walter B. Turner, chief engineer of the Westinghouse Air Brake Company; L. M. Carlton, special instructor of the same company; Robert H. Blackall, air brake expert of the Delaware & Hudson, and C. B. Conger, air brake expert.

Bearings. B. L. P. Alford, editor *American Machinist.* Published by the *American Machinist*, New York. 6 in. x 9¼ in. 235 pages. Bound in cloth. Price, \$2.50.

The author has endeavored to present the underlying principles involved in the design of all bearings and to show the application of the important types. The book is divided into two parts, the first part dealing with bearings in sliding contact, and the second with bearings in rolling contact. Sliding friction is taken up in its elements, and several tables of the co-efficients of friction of woods, wrought iron, cast iron, steel, bronze and other materials working on each other are given. The materials, allowable pressures, and speeds, and the design of journal bearings are considered in three separate sections. The design of flat and sliding surfaces and special bearings is considered in another section. Lubricants and information as to how bearings should be cared for are also included. Under rolling friction are considered factors of design, construction of ball bearings of different designs and the lubrication of these bearings. The book contains data and specifications which any engineer will find very valuable. We believe there is no other book published which treats the subject in such a comprehensive manner.

TIME FEATURE OF ENGINE FAILURES

BY ERNEST CORDEAL*

The almost universal system of comparing engine failure records by the number of failures, and the engine mileage between failures, does not provide the best and most accurate data attainable regarding this all important feature of locomotive operation. The difficulty lies in the fact that the item of greatest importance, that of the actual time delay to trains, is entirely ignored. Any delay in the movement of trains means an increase in operating expense and a decrease in the net earnings, and these increases and decreases grow immeasurably with the increase in the time of such delays. A passenger train five minutes, or a freight train ten minutes late, into a terminal cause only a nominal inconvenience and expense, while the same trains arriving one hour late are accountable for a loss of hundreds, even thousands of dollars, depending of course on the effect of such delays on the movement of other trains and on the nature of their lading.

A record of the actual number of engine failures and their exact cause is of inestimable value to mechanical department officials, as it provides accurate data on which they may base changes in design or reinforcement of weak parts on the locomotives, thereby tending to minimize the occurrence of delays due to power conditions. However, any comparison which may be made from data comprehending only the number of failures and mileage will not reflect the true bearing of this item on the efficiency of operation.

If the time feature were eliminated from the railway problem, its simplicity would be ridiculous, but such a state of affairs would presuppose a condition of apathy on the part of the traveling and shipping public which would render railways unnecessary. The presence and growth of the railway is due to its ability to transport the greatest weight the longest distance in the least space of time. When air navigation has been perfected to such a degree that the mails can be safely handled more expeditiously than at present, the roads will lose the mail contract, next will go their express and passenger traffic, and it is within the range of possibility that air transportation may eventually reach a stage where the railways will occupy the relative position in the transportation world held by the ox team of today.

In order to keep the railway from oblivion, resulting from incompetency, as long as possible, everything must be sacrificed to time. When washouts occur the track must be restored in the least possible time regardless of cost; weather conditions must be fought to the limit to avoid delays; engines and cars must be repaired quickly; enginemen, trainmen and dispatchers must be keyed up to the schedule; cost, efficiency and quality efficiency must be sacrificed, or at least made subservient to the greatest of all—time efficiency.

Why, then, if the saving of time must be the ultimate aim, should not the delayed time be used as the basis for computing the efficiency of locomotive performance as effected by power failures. The fact that a locomotive part is unable to sustain the strain of the service required is important from a mechanical standpoint; the fact that the locomotive possessing the weak part caused a delay to traffic has a far wider significance in its relation to the problem of conducting transportation. It may be contended, and with a certain amount of truth, that the number of failures and miles between failures reflects a condition which may with a greater or less degree of accuracy afford comparisons between the performance of different periods, or between different classes of power, but would not a much more valuable comparison be offered if the time of delays as compared to the total time in service were used as a basis.

Take a specific actual case to illustrate the point in question. From two adjoining divisions operating over similar territory

and using identical power the following figures show that division *A*, having a greater number of failures and a less mileage between failures had a less amount of time lost by trains due to power, and therefore, from a transportation standpoint, attained a greater efficiency than division *B*:

| Division. | Engine Mileage. | Number Failures. | Miles per Failure. | Total time lost. | Total time in service. |
|---|-----------------|------------------|--------------------|------------------|------------------------|
| A | 91,055 | 7 | 13,008 | 18.5 | 9,248 |
| B | 71,463 | 4 | 17,866 | 24.3 | 6,873 |
| Ratio of lost time to total time, division A..... | | | | .02 | |
| Ratio of lost time to total time, division B..... | | | | .035 | |

In this comparison the total time lost represents all delays not only to trains being handled by the engine failing, but also to other trains in being held at meeting points or connections where such loss of time was directly chargeable to the engine failing. The total time in service includes the time of all engines between terminals. It will be seen that division *A* had seven failures against four on division *B*, and that the miles between failures stood 13,008 to 17,866 in favor of *B*. Had the comparison stopped here, the impression gained would have been that the power on division *B* was better handled and in better condition than on division *A*. However, when the item of time lost is introduced, we find that the total time lost by trains due to the seven delays on division *A* was only 18.5 hours, or an average of 2.6 hours per failure; while the total time chargeable to the four failures on division *B* was 24.3, or an average of 6.1 hours.

In order to obtain a comparison of the time lost on a basis of the amount of business handled, it is necessary to introduce some other factor, and in this case the actual hours spent by all engines in service between terminals has been used. However, practically the same results would have been obtained by using the engine mileage. The furnishing of data necessary to make comparisons of this kind possible would not impose a burden on the clerical forces, as all of the information required is already compiled for one purpose or another, and the mere process of collecting and correlating the figures would demand but a nominal amount of labor.

REMOVING A STUCK WEDGE

BY F. W. BENTLEY, JR.

Chicago & North Western, Huron, South Dakota

Many times with the limited tool equipment in the average engine house the proposition of removing a stuck wedge is a most difficult one. The accompanying illustration shows a method of removing such a wedge by means of a rod key *A* and some small pieces of flat bar iron cut so that they may be dropped between the driving box and the face of the frame jaw. The

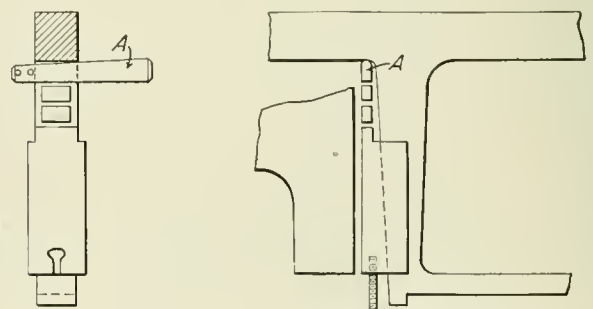

Taper Key Used for Removing Wedges.

driving wheel may be stopped so as to allow the key to be inserted between the spokes. As the wedge is driven down by forcing the key in, a piece of iron may be placed in on top of the wedge and the key used over again. The circular side of the key fits the fillet in the top corner of the frame jaw and prevents it from turning as it is driven in with a sledge.

* Bonus Demonstrator, Atchison, Topeka & Santa Fe, La Junta, Colo.

ELECTRIC WELDING IN RAILWAY SHOPS

A Number of Typical Jobs Are Illustrated and the Costs Are Compared With the Older Methods. The Process and the Apparatus Are Then Described and the Advantages of Electric Welding Are Outlined.

BY O. S. BEYER, Jr.

A process of autogenous welding by electricity, patented and known as the Siemund Wenzel process, has recently been applied in several railway repair shops. For several years it has been used in steamship, boiler and machinery repairs, and its success in marine repair work naturally suggested its use on railways. Today, but eight months from the time a complete welding outfit was first installed in the Hornell shops of the Erie Railroad, its success has been so marked that it bids fair to become as standard a railway repair device as pneumatic tools, wheel and crank pin lathes, flue welders, cylinder borers and other tools characteristic of railway shops. The extent to which the process finds successful application is very great. On steamships, where it was first used, such highly stressed parts as boiler and furnace sheets, shafts, stern frames and rudder posts have been repaired. Its use in the railway repair shop is not confined

inside of the firebox is shown in Fig. 4. In connection with the mud ring repairs the seams around the right front and left back corners of the mud ring were welded. A patch under the fire door opening, Fig. 5, was also welded around its edges in place of calking. The comparative costs for repairing this mud ring by the old method and the electric welding method are as follows:

| | |
|---|----------|
| Old method—stripping engine, removing mud ring, welding mud ring, preparing mud ring for re-application, re-applying removed engine parts, all material and labor complete; labor prices based on prevailing piece work prices..... | \$118.06 |
| Electric welding process—Preparing, welding, finishing, material, labor and electric current, complete..... | \$32.07 |

The application of electric welding in firebox repairs is shown in Fig. 6. The longitudinal seams between the side sheets and



Fig. 1—Mud Ring Partially Welded After Being Drilled and Chipped Out.



Fig. 2—It Was Necessary to Remove More of the Defective Mud Ring After Being Partially Welded.

to locomotive boilers and fireboxes, but is extended to machinery, cylinders, wheels and even to driving tires. Defective and worn parts of stationary boilers of both the fire tube and water tube types have been repaired. Broken machine tool parts have been reclaimed. Indeed, its application is suggested wherever machinery of any kind is used and maintained.

The illustrations show a few examples of electric welding done at the Hornell shops of the Erie Railroad. Figs. 1 to 4 show the different stages of welding the mud ring of a standard consolidation locomotive. The mud ring was broken through at the left front corner. If repaired in the old way it would have been necessary to remove and weld it in the blacksmith shop. The mud ring was drilled, chipped and welded out to its original size by filling in 74 cubic inches of metal. The work had been partially completed, as shown in Fig. 1, when another defect was discovered and it became necessary to drill and chip out another section of the ring, as shown in Fig. 2. The finished job is shown in Fig. 3. A view of the finished weld on the

crown sheet of the firebox were so wasted away by calking that the engine was sent to the shops for a new firebox. The seams were welded their entire length, approximately 6 ft. 10 in., by applying metal averaging 3 in. in width and $\frac{3}{8}$ in. in thickness. Had the engine received a new firebox, it would have been necessary to strip it and remove the boiler to the boiler shop. The cost of applying a new firebox, as compared to welding the seams by the electric process, is as follows:

| | |
|--|----------|
| Application of new firebox—Stripping engine, transferring boiler, laying out firebox sheets, building and applying firebox, applying staybolts, crown bolts, mud ring, etc., overhauling flues, riveting and calking, refitting engine; all labor and material, complete | \$777.18 |
| Welding seams and defects by electric process; all labor, material and electric current complete..... | \$56.40 |

Another example of electric welding on a locomotive firebox is shown in Figs. 7 to 10. The sheets of this firebox were cracked along the mud ring and a patch on one side was so

wasted away that it would have been necessary, had the electric welding process not been available, to renew the entire box. Fig. 7 shows the defects in the sheet at the left corner of the fire-box. The white line indicates where the sheet would ordinarily have been cut out and a new patch applied. Fig. 8 shows the cracks which were welded near the left front corner of the mud

process. Ordinarily the defective guide would have been scrapped and a new one forged and machined. Fig. 11 shows the crack chipped preparatory to welding. Fig. 12 shows the guide after it was welded, the weld not being dressed. Fig. 13 shows the job completed and the guide ready for service. A comparison of the cost for a new guide and the cost to reclaim the cracked one is as follows:

| | |
|--|--------|
| New guide, forged and machined, complete..... | \$5.53 |
| Cracked guide, electrically welded and machined, complete..... | \$83 |

An electric weld on the spoke of a cast steel trailer wheel center is shown in Figs. 14 and 15. This gives another idea of how and where the process may be applied with success. The wheel center in question was returned to service seven months ago and has not been heard from since. Fig. 14 shows the spoke chipped and V'd out, ready for welding. Fig. 15 shows

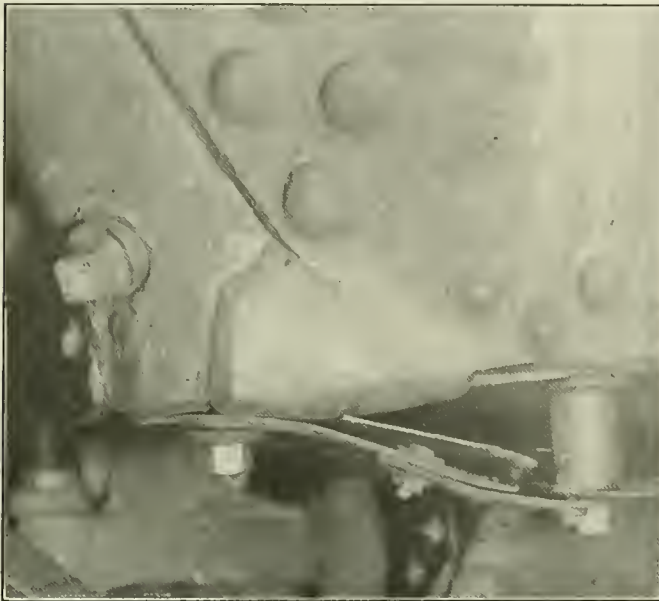

Fig. 3—The Finished Weld on the Mud Ring and Sheet.

ring, the rough surface of the weld having been chipped off and finished. The right back corner of the firebox after the cracks were properly welded is shown in Fig. 9. Had it been necessary to renew the entire firebox the cost would have been as follows:

| | |
|---|----------|
| New firebox complete, all work and material..... | \$800.68 |
| Cost of electric welding which obviated the necessity for a new fire-box, including material, current and labor complete..... | \$22.11 |

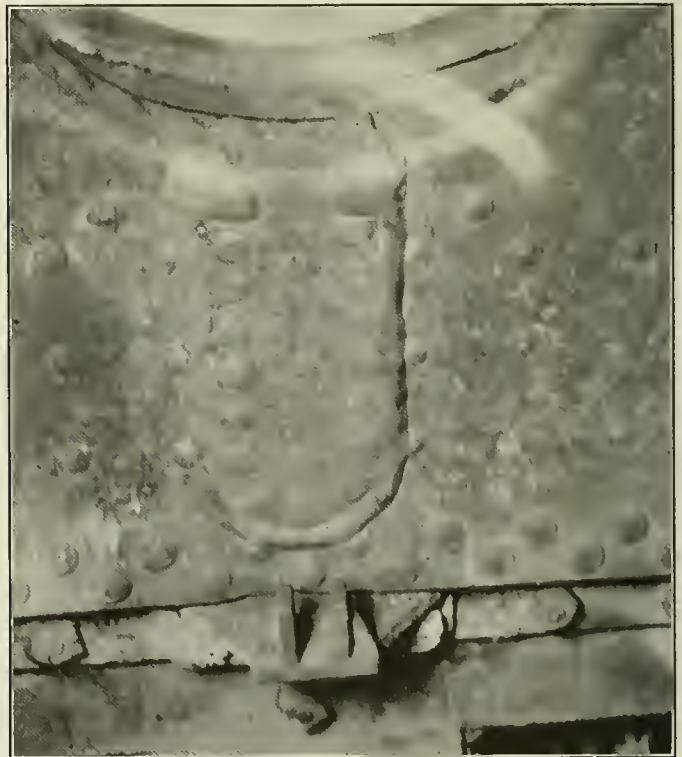

Fig. 5—Patch Under Fire Door with Edges Welded Instead of Calked.

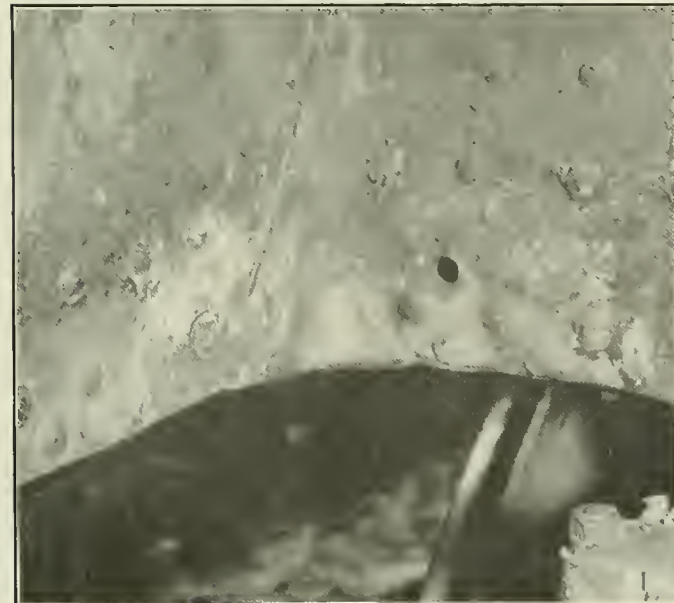

Fig. 4—Showing the inside of the Firebox Where the Mud Ring Was Welded.

An interesting example of the welding on of a vertical fire-box patch is shown in Fig. 10.

Figs. 11 to 13 demonstrate how this process is used in machinery repairs. The valve rod guide was cracked from the key-way out. The crack was chipped and welded by the electric

the spoke welded, but not dressed. The costs for doing this work by the old and the new methods are as follows:

| | |
|--|---------|
| Old method—Dropping wheels, transferring, removing tires, removing wheel from axle, cutting rim for expansion, making weld, replacing tire on wheel and wheel on axle and under engine, coupling up; all work complete, ready for service..... | \$10.30 |
| New method—Preparing weld, labor of weld, material, current, and final dressing, complete | \$3.38 |

A rocker arm which was partly cracked around the bottom of the bosses is shown in Figs. 16 and 17. By the old process it would have been necessary to cut the ends of these arms off, forge new ends, and weld them to the rocker at the forge. With the electric welding process it was only necessary to chip out the cracks, weld them up by the new method, and machine down the bosses. Fig. 16 shows the bosses chipped and V'd out ready for welding. Fig. 17 shows the rocker electrically welded and machined, complete. The costs, old method and new, are as follows:

| | |
|--|--------|
| Old method—Cutting off old arms, forging two new ones, welding them on, laying out, machining bosses and arms; material and labor complete | \$6.13 |
| New method—Preparing, welding; material, current and labor complete | \$2.93 |

Electric welding applied to locomotive cylinders is illustrated in Figs. 18 and 19. The left cylinder of a heavy consolidation locomotive is shown. Two cracks, one 9 in. and the other 8 in. long, running from the front edge inwards, were V'd out, both on the inside and the outside. They were then welded by carefully filling in metal with the electric welding process. Fig. 18 shows one of the cracks welded from the outside. Fig. 19 shows the inside of the cylinder, with the cracks completely

would probably not have strengthened the cylinder as a whole. The electric welding process stepped in, and, besides repairing the defect, reinforced the cylinder at its weak spots. The cost to make the repairs by the older method is a little greater than by electric welding.

| | |
|--|--------|
| Old method Prepare for patch, insert and dress; labor and material complete | \$3.50 |
| New method Prepare for weld, weld by electricity, dress weld; labor, material and current complete | \$2.90 |

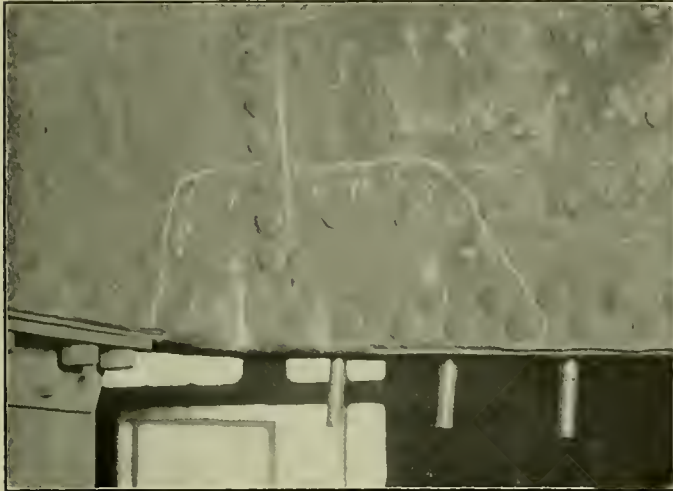

Fig. 7—Defective Firebox Sheets Repaired by Electric Welding.

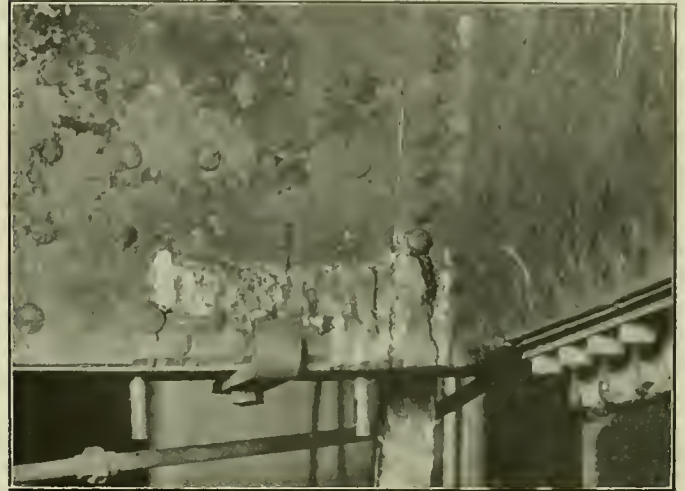

Fig. 8—Repairs to Firebox Sheets Made by Electric Welding.

welded and the cylinder finish bored. The welds may be seen distinctly and show the neat appearance of the work done by this method. Had the old method been used these cracks would have been dovetailed out and copper patches inserted, which

Part of a back flue sheet, three of whose flues were welded to the sheet for purposes of demonstration, is shown in Figs. 20 and 21. Fig. 20 shows the three flues securely welded to the sheet. Fig. 21 shows the flues after welding, chipping and trim-

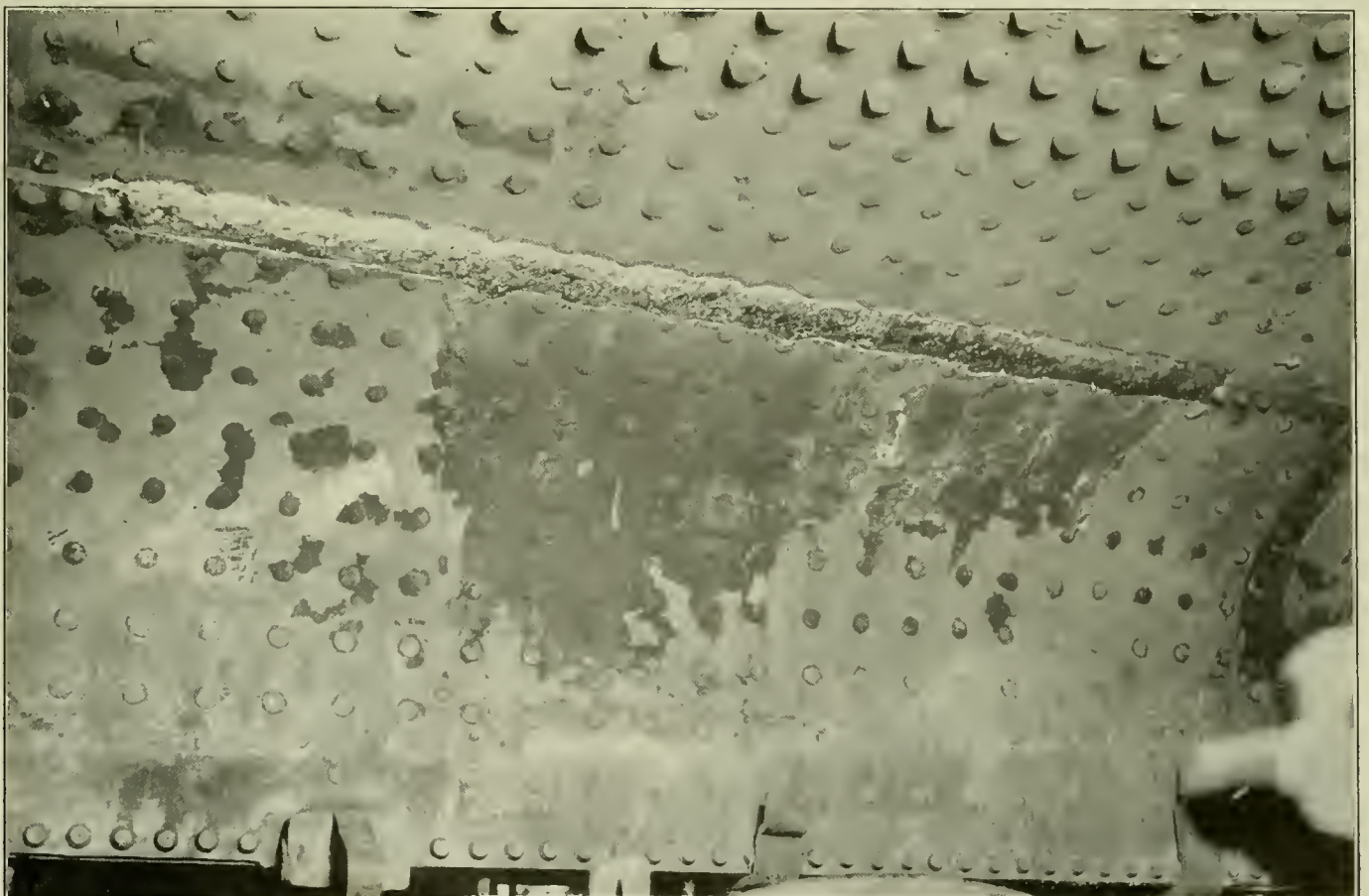

Fig. 6—A Longitudinal Seam, Over 6 ft. Long, Repaired by Electric Welding.

ming with a pneumatic hammer. Since this experiment has been made, complete sets of flues have been welded to the back flue sheets of several engines and the engines have been returned to service. Close observation of these engines indicate that the

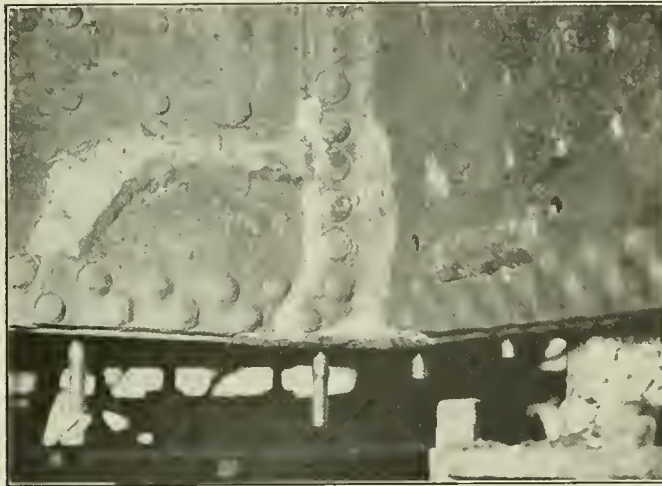

Fig. 9—Electrically Welded Crack in Corner of Firebox.

work in the engine house to keep the flues tight is considerably reduced. Three months' service of a few engines is too short to look for ultimate results. The indications, however, are that by the use of electric welding in flue applications, a step in advance in boiler construction and maintenance has been made. Add to this what will be gained by electrically welding all firebox and mud ring seams, while the boiler is being built, and the proper maintenance of locomotive boilers may be considerably simplified from its present perplexing state.

An electric welder at work on a flue sheet welding the flues and bridges is shown in Fig. 22. The welding clamp is held in one hand while the other holds a frame containing three thicknesses of ruby or green glass through which the operator ob-



Fig. 10—Side Sheet Patch Welded to Firebox.

serves his work. The electric machinery seen in the rear is a temporary installation, being a low voltage generator belt driven by a standard motor, all mounted on an improvised wooden base. A typical installation will be illustrated and described later.

DESCRIPTION OF PROCESS.

The system is of the arc type. It employs direct current supplied at potentials of 20 to 30 volts at the arc and 50 to 80 volts at the generator terminals. One lead of the welding circuit is attached to the welding clamp which holds the welding material—pencil or electrode. The current is furnished by a generator usually direct connected to a motor, properly wound for the current and line voltage available at the place of installation.

An electric arc about 3-16 in. to $\frac{1}{4}$ in. long is sprung between the welding material or pencil, and the object to be repaired. The voltage is regulated until the current is of the proper amount to suit the work in hand. The spot on the surface of the object being welded, where the electric arc strikes, is instantly brought up to a state of incipient fusion, and minute molten

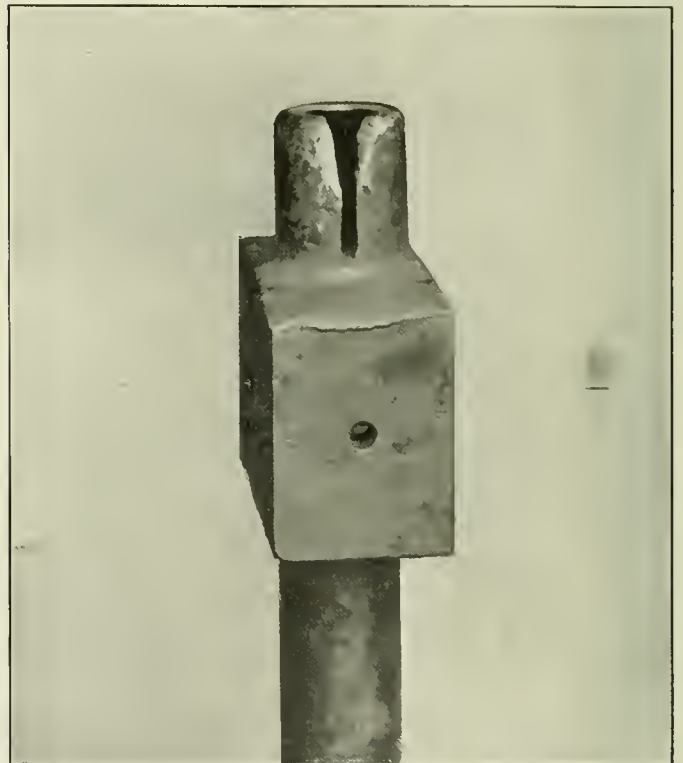

Fig. 11—Crack Chipped in Valve Rod Guide Preparatory to Welding.

particles of the pencil or electrode detach themselves progressively in a continuous rapid stream, and, following the arc, attach themselves securely at the spot where the arc strikes. This proceeds very uniformly until either the arc is interrupted or a sharp fluctuation in current takes place.

About every minute or so the actual welding operation is stopped while the operator subjects the local heated area of the weld which he is making to rapid blows from a small hand hammer. The object of this is primarily to force out any minute portions of oxide or slag that may have formed due to the presence of impurities or improper manipulation. It is also done with the object of working the metal of the weld, and to close up any small pin holes that may have formed. The repairing material is applied until the chipped and V'd out portion is entirely filled up, and then an additional amount is applied for reinforcement. This works out very satisfactorily since the additional material added adheres as securely as the material which is part of the direct weld, and thus serves to reinforce in direct proportion to the section of the material added. Consequently there is no reason why a weld thus reinforced cannot be made as

strong, or even stronger, than the original material. In practice it is found desirable to reinforce welds of this nature sufficiently to make their tensile strength about equal to the tensile strength of the original material.

a heavy series coil in such a way that a strong magnetic current is set up which travels through the pencil and in the direction of the arc. The presence of this magnetic current assists greatly in causing a very rapid deposition of the repairing ma-



Fig. 12—Valve Rod Guide After Welding.

The arc and the molten particles of material are guided by a magnetic flux which originates in the electrode holder. The welding current is led around the handle of the holder through

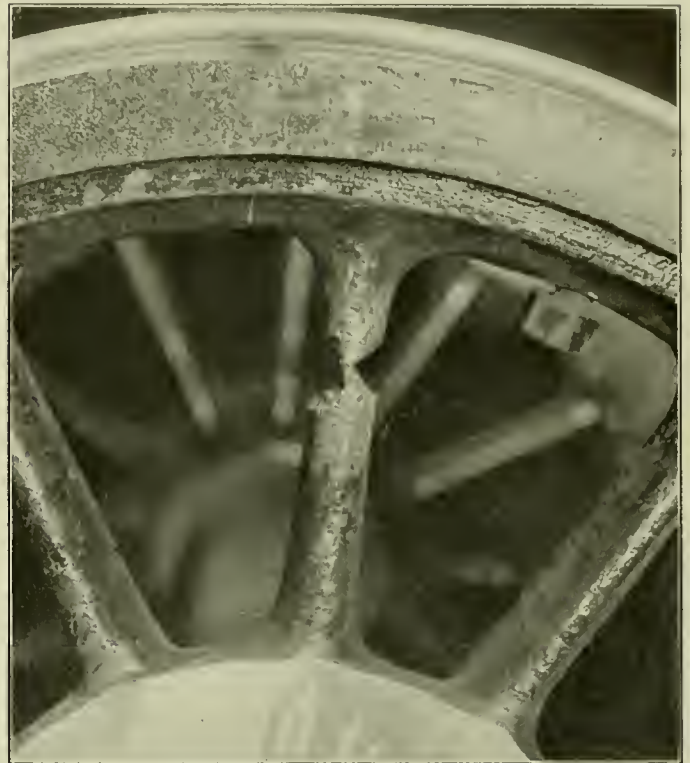

Fig. 14—Cracked Wheel Spoke Chipped Preparatory to Welding.

material and makes overhead welding possible and perfectly practical. Without this magnetic current, overhead welding could not be done with any degree of certainty as to the results. The



Fig. 13—Welded Valve Rod Guide Ready for Service.



Fig. 15—Trailer Wheel Spoke Welded But Not Dressed.

magnetic current also increases the strength of the weld owing to its concentrating influence and the cooling effect on the arc. It prevents oxidization of the molten particles while in transit and the formation of slag and pin holes that sometimes form in the weld.

The welding pencil consists of a very pure grade of Swedish iron of a definite cross sectional area. It has been determined by careful laboratory research that the quality of the repairing material and the pencil diameter have a decided influence on the

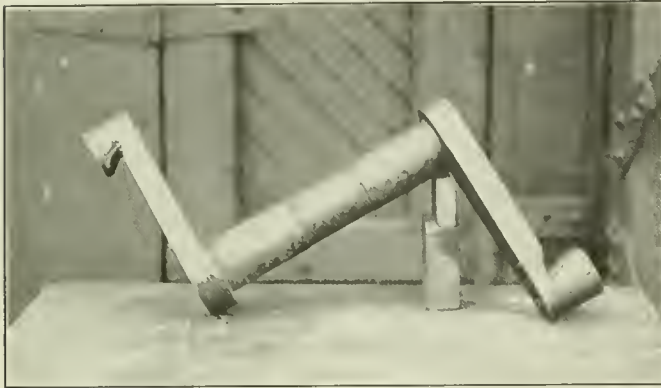

Fig. 16—Cracked Rocker Arm Chipped for Welding.

properties of the weld. A definite relation exists between the size of the pencil, the amount of the current, and the tensile strength of the weld. Hence the quality of the material and the size of the pencil must be carefully selected.

In order to prevent oxidation and the consequent formation of slag, and also to provide certain ingredients which affect the welding material chemically and so benefit it physically by making it soft and ductile, the welding pencil or electrode is covered with a flux. When the welding operation is carried on, the flux melts and vaporizes, enclosing the molten particles and the arc to the exclusion of atmospheric oxygen which attacks the re-

pairing material in its fused state, and thus improves the quality of the weld.

DESCRIPTION OF APPARATUS.

An electric welding installation consisting of a motor generator set, the necessary control apparatus, measuring instruments and protective and steadying resistances, is shown in Fig. 23. This outfit is in use in a railway shop. The motor generator is provided to convert the standard current available into direct current at voltages suitable for welding. Hence the motor may

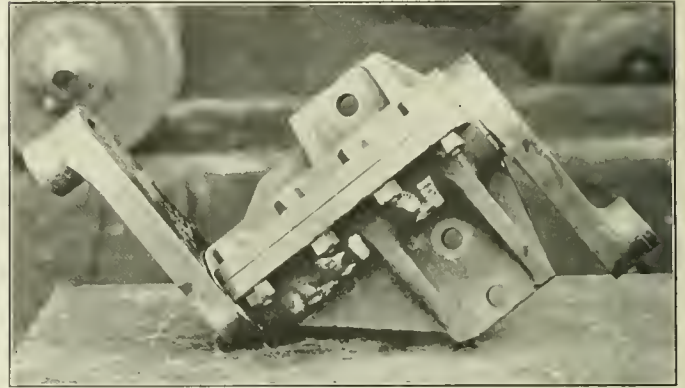

Fig. 17—Rocker Arm Repaired and Ready for Service.

be either of the direct or the alternating current type. The generator is wound to furnish a maximum constant output of 200 amperes direct current at a range in potential of 50 to 80 volts. This range in voltage is secured by varying a resistance in series with the field circuit. A variable rheostat for this purpose is mounted on the slate switchboard so that it may be conveniently manipulated by the operator.

A second resistance is placed in one leg of the welding circuit in such a position that when the generator is short circuited at the instant of striking the arc the resistance acts as a protection to the armature and commutator of the generator by limiting the



Fig. 18—Outside of Cracked Cylinder Which Had Been Repaired by Welding.



Fig. 19—Inside of Cracked Cylinder Which Had Been Repaired by Welding.

maximum current possible at a maximum voltage to the greatest permissible instantaneous overload capacity of the generator. Another resistance is provided which is automatically thrown in

the generator when the welding operation has ceased. The instant the welding is started again, this latter resistance is automatically cut out. These two resistances are so proportioned

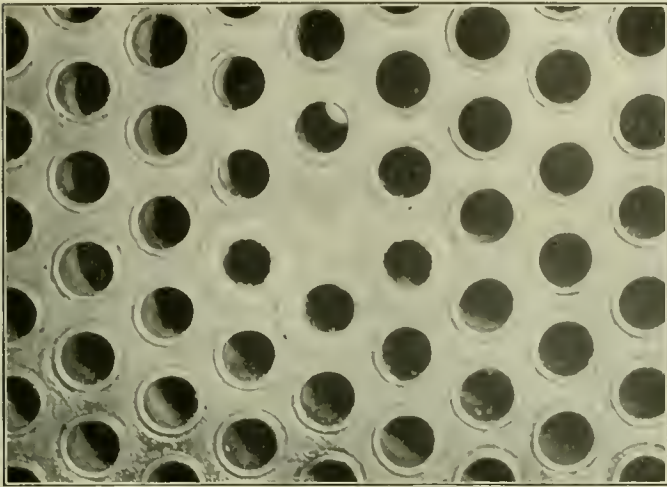

Fig. 20—Three Tubes Welded in Flue Sheet.

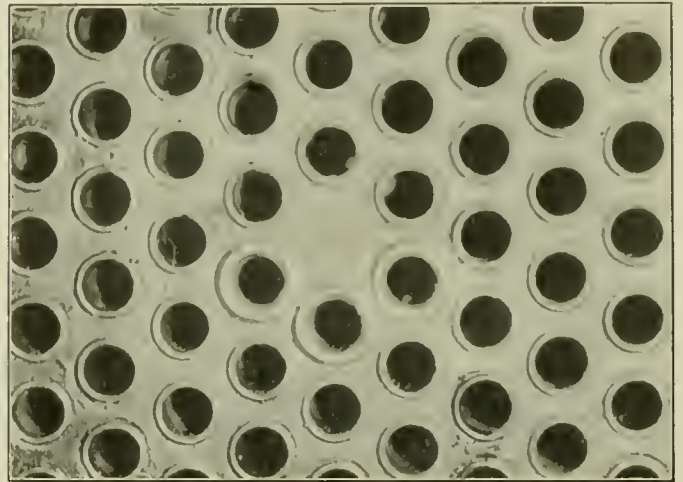

Fig. 21—Welded Tubes After Being Chipped and Trimmed.

series with the above resistance and across the terminals of the generator the instant the welding arc is interrupted. Together these two resistances serve as a secondary or temporary load on

that the load which they impose upon the generator equals the load imposed upon the generator when the welding operation is under way. In this way violent fluctuations of the load on the

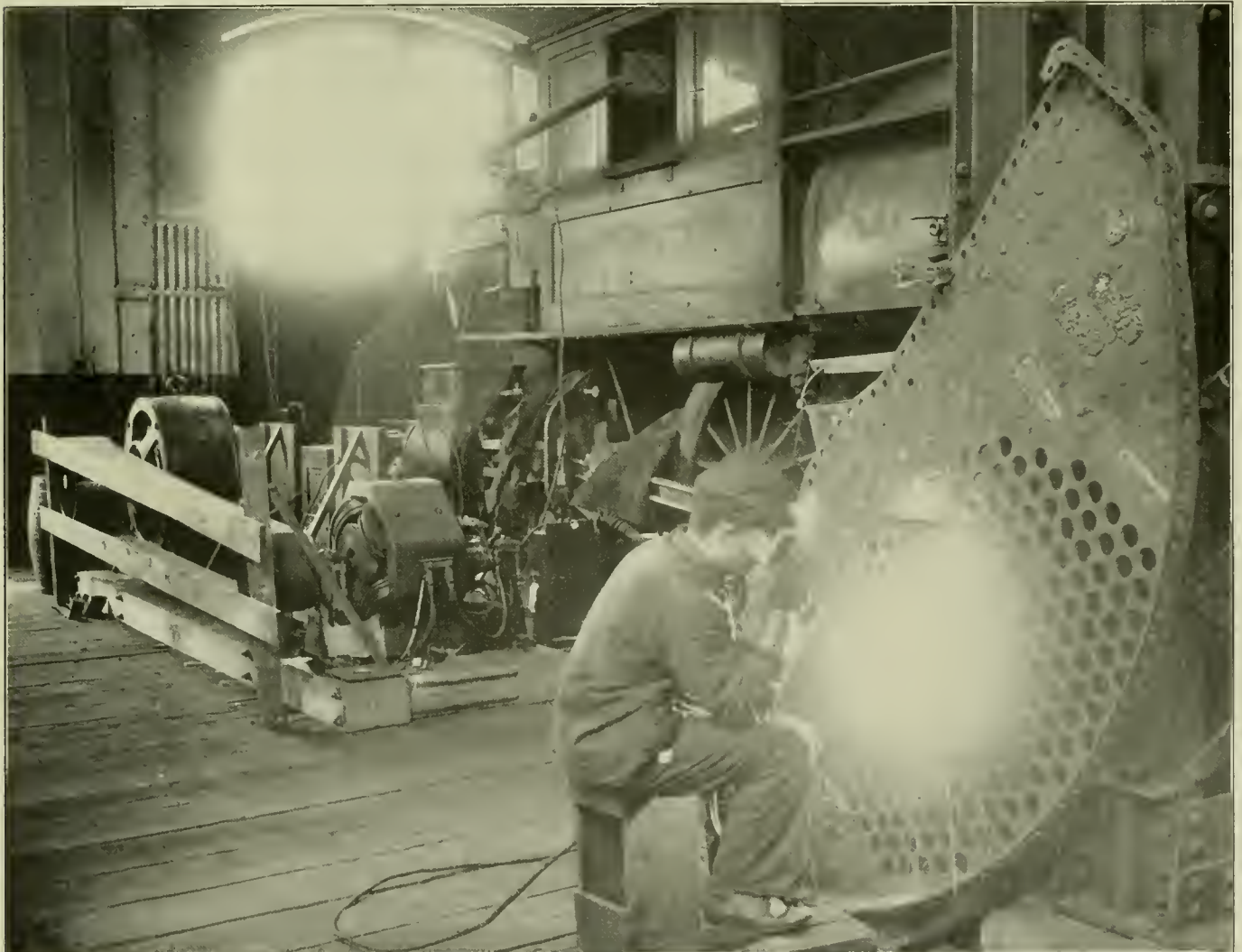

Fig. 22—Electric Welder at Work; Electrical Machinery in the Rear Is a Temporary Installation.

motor generator are avoided. Furthermore, this particular arrangement results in the best welding work. The closer the regulation and the more constant the generator voltage the less the likelihood of pin holes and defects in the weld.

An ammeter and a voltmeter, which are both connected to the welding circuit, are mounted on the switchboard. These instruments serve the purpose of indicating the amount of current and the voltage of the welding circuit. The welding clamp or holder consists of a wrought iron handle, properly insulated, around which is wound a coil. This coil in turn is insulated from the hand by a leather covering. To one end of the coil is attached one of the leads of the welding circuit; the other end of the coil is attached to the holder near the base of the clamp. The clamp consists of a projection from the holder and a piece of spring steel, so fastened together that the combination serves to hold the welding pencil or electrode rigidly. The entire welding outfit, except the holder and welding leads, is mounted on a substantial base, which in the case of the illustration is made up of standard rolled steel sections. For the machines now being built, this base is of cast iron with suitable projections on the back to which are fastened the banks of resistance which are part of the installation. The slate switchboard with its terminal lugs, fuses, switches, motor starting box, electrical measuring instruments, contactors and relay, is mounted on an angle iron frame securely fastened to the bed of the motor generator set and the machine housings. In this way a firm and compact arrangement is secured.

An electric welding installation, such as described above, is capable of furnishing sufficient electricity for one welder at a time. The welding lines are brought from the switchboard to any place desired in the shop. In fact, a main, or several main welding circuits may be installed throughout the shops with occasional taps so arranged that it is only necessary to attach limited lengths of flexible welding cables to the main circuit at the taps and run these to the places where the welding work is to be done.

ADVANTAGES OF ELECTRIC WELDING.

From the foregoing it is obvious that autogenous welding by electricity has many advantages. The simplicity of the process at first sight is its most striking feature. The art of electric welding is not difficult to learn. Welders who can turn out work with uniform success can be made in three to four weeks. The hardest thing to acquire is the ability to maintain the arc steady and keep feeding the electrode uniformly. When once this is learned, together with the way to adjust the apparatus, the welds secured will be successful.

Another feature which is greatly to the advantage of the electric welding process is the entire absence of danger from explosion and fire. There is nothing whatever to explode, and the low potential of the welding circuit, together with the protective resistances and the fuses in the welding circuit leads, reduce the fire dangers from faulty insulation or short circuiting to nothing. The fact that the voltage is so low makes this process absolutely safe to handle by the welder, considered from all view points.

The wide range of application of the process is another one of its distinct advantages. It may be used to do very heavy as well as light work. Its success in this direction has been proved more by its extended application in the repair of heavy machine parts and the framing of ships than by its application to locomotive repairs. To date it has hardly been sufficiently extended in locomotive repair work to demonstrate the limits of its possibilities. However, if highly stressed parts of ships can be repaired by this method, there certainly is no reason why the same thing will not hold true in locomotive repairs. New work is being done daily, which it had never been considered possible to do, and success is invariably the result.

By the use of the electric welding process it is possible to deposit an additional amount of metal on the part being welded

so that it will act as a reinforcement to the weld proper.

As pointed out in the description of the process, the electric arc is narrowly confined and only heats a very limited area on the surface of the object being repaired to incipient fusion. This heating is instantaneous, taking place immediately when the arc is struck. Thus the heat incidental to the welding operations, though intense, is extremely localized, being just sufficient to fuse a small spot to which the molten particles from the welding pencil attach themselves. It is not necessary to preheat a large surrounding portion so that a sufficient amount of heat is stored up in the adjacent material. Owing to this very marked characteristic—the extreme localization of the heat—no cooling strains

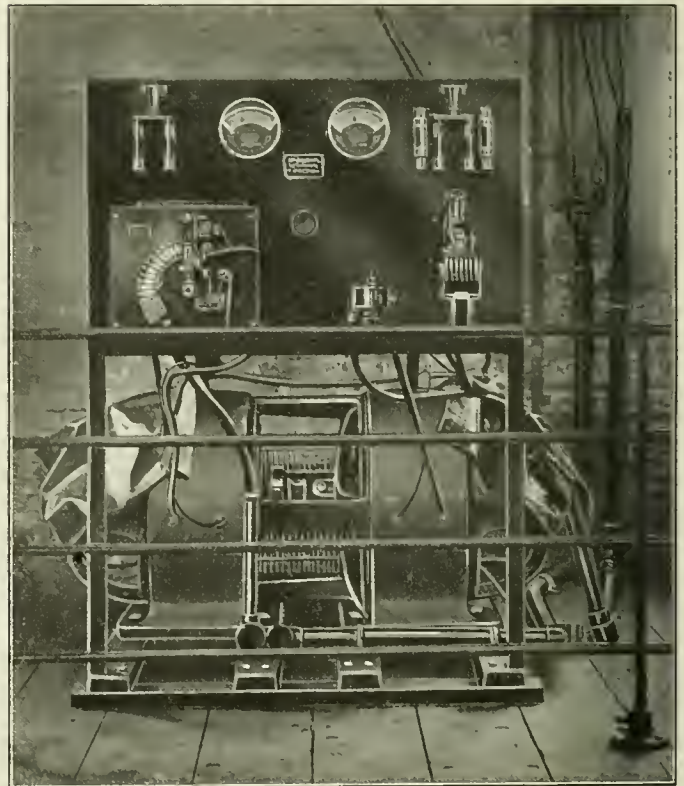

Fig. 23—A Typical Electric Welding Installation.

are set up around the weld after the work is done. Hence there are no subsequent failures from cracking or buckling at the weld or in other parts of the object repaired. It is due to this particular feature that the success of this process, wherever applied, has been so uniform.

The character of the weld itself, it being soft, ductile, and free from slag and oxides, as well as injurious carbon compounds of iron, makes the electric weld secured by the Siemens Wenzel process the most perfect secured by any system of autogenous welding. The close regulation of the current guards against injuring the original material adjacent to the weld. This, too, benefits the weld as a whole. The convenience with which overhead welding may be done is another decided advantage. The magnetic current created in the welding holder makes this possible. Overhead welds are made just as fast as welds in any other position and are equally as strong.

Owing to the comparatively small amount of power required, the simplicity of the entire installation, the fact that the machinery used is practically of standard design and manufacture throughout, embodying no untried features of construction, the rapidity with which the work is done and the absolute uniformity of the success of the work, as well as the wide range of its application, make this process the cheapest and best with which to do autogenous welding. The results secured certainly justify this conclusion.

BALANCED COMPOUND 4-6-2 LOCOMOTIVES

After Several Years' Experience with Balanced Compound Locomotives of Three Types—Prairie, Pacific, and Atlantic—the Santa Fe Has Ordered 28 More of the 4-6-2 Type.

To meet the requirements for passenger power in districts where the grades are heavy, the Atchison, Topeka & Santa Fe has developed a Pacific type locomotive which includes a number of interesting features. In designing this locomotive, the aim has been to adhere to the general principles of the older power as far as practical and yet to introduce sufficient modifications to overcome the weaknesses which had been detected. This has not only tended to retain locomotives with which the men are familiar, but also has provided an opportunity to develop new power with the introduction of a minimum number of new parts. In designing the new engines patterns were se-

lected almost exclusively from those common to the older locomotives. The cylinder, main rod and valve motion arrangement of the Prairie type rendered such service as to commend them for application to the Pacific type, thus retaining the desirable features of the former balanced compound Pacific type, and at the same time eliminating the undesirable feature of the bifurcated high pressure main rod.

Retaining these features because of satisfactory results in continued service, the design of the last lot of locomotives was developed by the selection of parts common to the existing engines and principally from the two types already mentioned. The design was prepared under the direction of the superintendent of motive

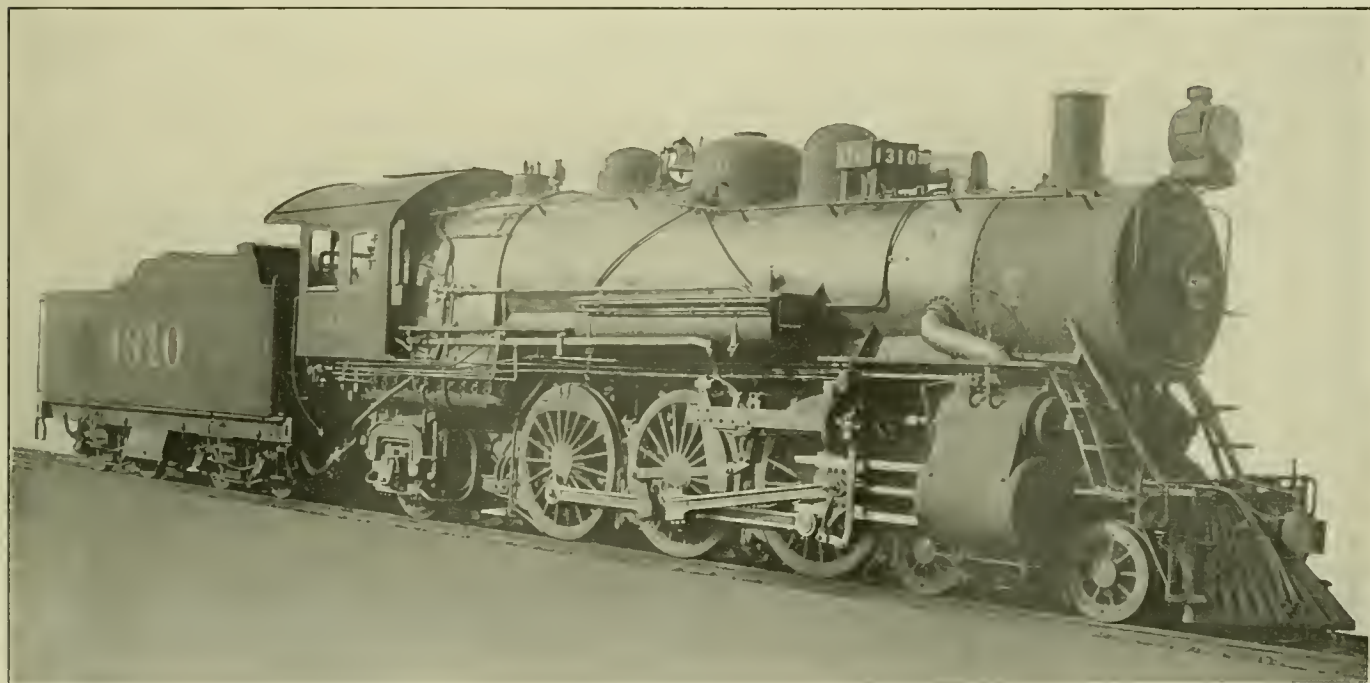

This Design Is Based on a Long Experience with Balanced Compound Locomotives of Three Different Types on the Santa Fe.

power. Most of the improvements had been introduced from time to time in revising and repairing existing engines, and therefore had been given the test of service before being embodied in the new engines.

Satisfactory service rendered by balanced compound Atlantic, Pacific and Prairie type locomotives, together with the requirement for a power at high speed greater than that given by the Atlantic type, led to the adoption of the balanced compound Pacific type. The first six-coupled locomotives with balanced compound cylinders placed in service on the Santa Fe were of the Pacific type.* All four cylinders of these older locomotives were arranged in the same horizontal plane and the engines were equipped with bifurcated high pressure main rods spanning the front driving axle. The valves were operated by the Stephenson motion, with eccentrics on the third driving axle.

A few years later a different type of six-coupled locomotive with balanced compound cylinders was placed in service. This was a Prairie type† locomotive for fast freight. In the locomotives of this type the inside or high pressure cylinders are inclined and raised to a sufficient height to permit a straight main rod to clear the front driving axle. The steam distribution is controlled by the Walschaert valve motion, actuated from the

power. Most of the improvements had been introduced from time to time in revising and repairing existing engines, and therefore had been given the test of service before being embodied in the new engines.

Twenty-eight of these new Pacific type locomotives have recently been built by the Baldwin Locomotive Works. Each locomotive develops a tractive effort of 35,000 lbs. The boilers of 22 are fitted with Buck-Jacobs superheaters of the latest design, in which the superheating chamber is built into the boiler shell, and all of them have Jacobs-Shupert fireboxes. Six of the locomotives are equipped for burning oil, while the remaining 22 burn coal. Of these, seven are arranged for burning Gallup coal, a light coal similar to lignite, mined in western New Mexico. In order to determine the relative merits of fire tube and drum type superheaters, three of the oil burners and two of the bituminous coal burners are fitted with Schmidt superheaters.

Each pair of cylinders is cast in one piece with a half saddle and a common piston valve, the center of which is 7 in. inside the low pressure cylinder center. The valve is arranged for inside high pressure admission and outside low pressure admission, and is of the type commonly used by the builders with bal-

*See *American Engineer*, December, 1905, page 454.

†See *American Engineer*, November, 1906, page 434.

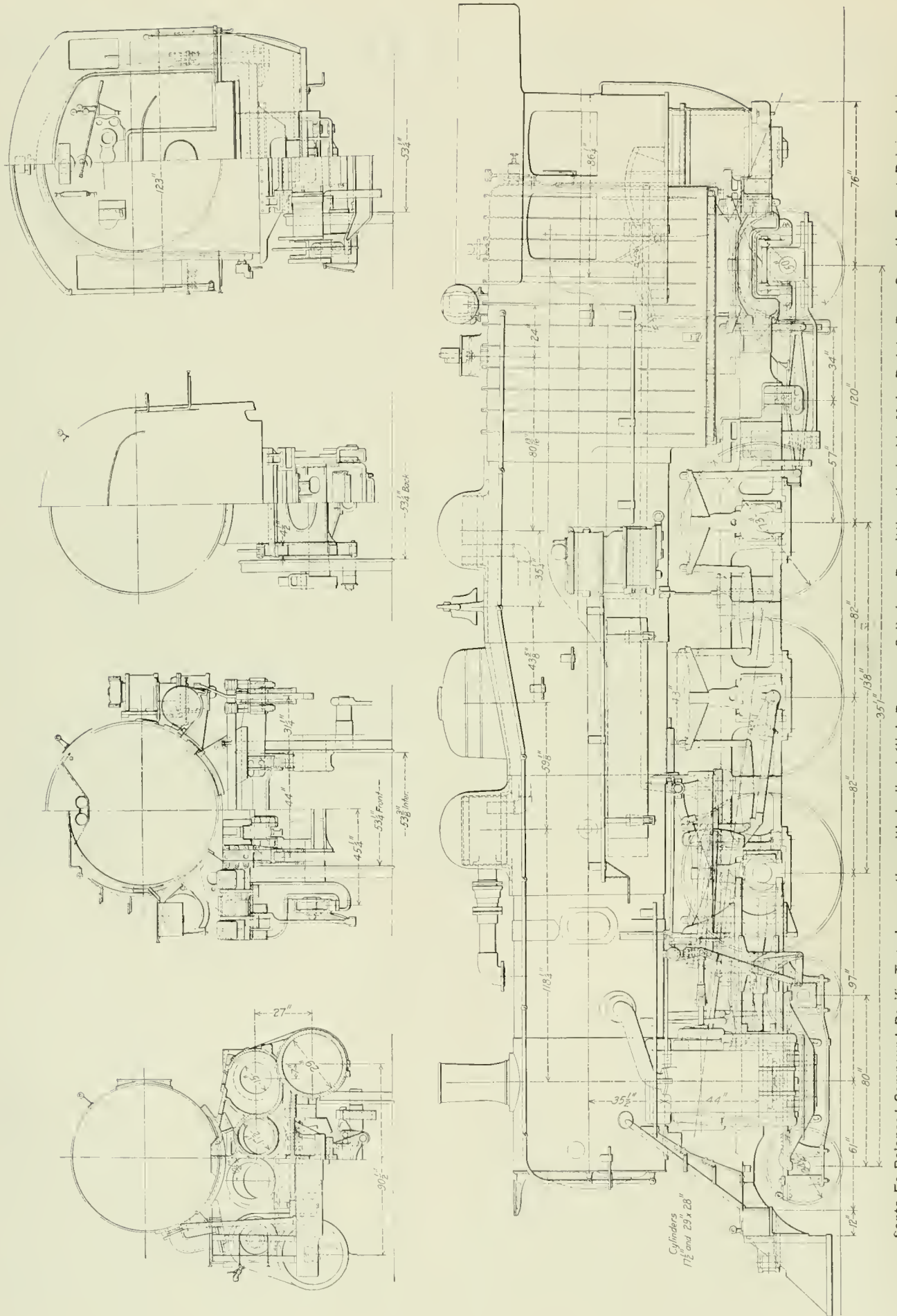

Santa Fe Balanced Compound Pacific Type Locomotive with Inclined High-Pressure Cylinders Permitting the Inside Main Rod to Pass Over the Front Driving Axle.

anced compound locomotives. The steam pipes are on the outside, where the joints are accessible for inspection and repairs, and where possible leaks will not affect the steaming of the engine. This is in accord with the latest practice of the Santa Fe, and is of the same general arrangement as applied to locomotives delivered on recent orders. The high pressure cylinders are 21 in. apart, measured transversely, and are set on a slope of $7\frac{1}{2}$ deg. Their location makes it impossible to run the front and back flanges which take the cylinder bolts the full depth of the

web and forged steel discs. Owing to the inclination of the inside cylinders, the inside and outside cranks on the same side of the locomotive are placed $187\frac{1}{2}$ deg. apart.

In the valve motion the links are carried on longitudinal bearers outside the leading pair of driving wheels, and rockers are used to transmit the motion from the combining levers to the valve rods. The rocker boxes are supported on the guide yoke, and the valve rods, which are necessarily short, are provided with knuckle joints. The rockers and all pins used in the gear

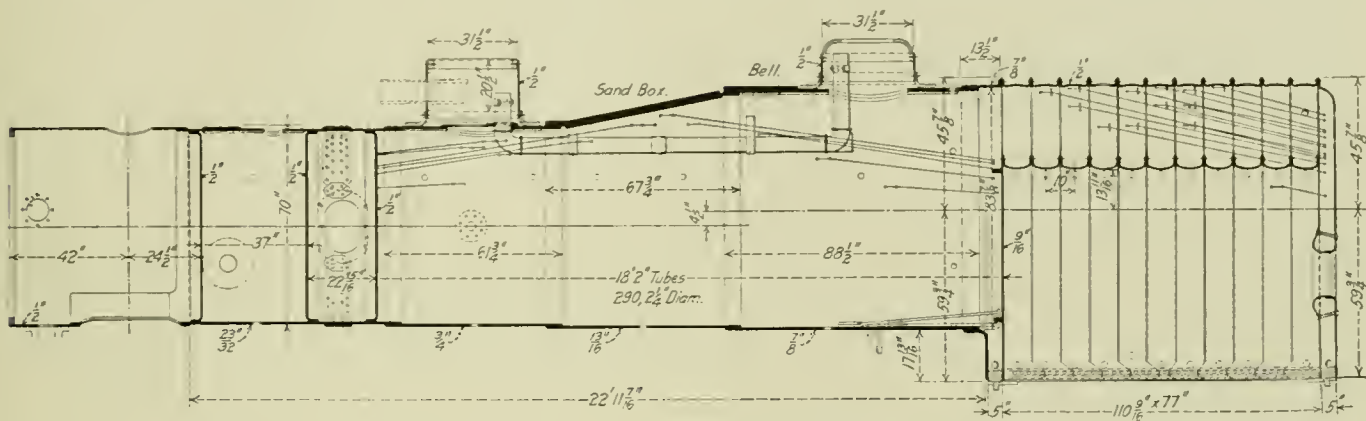

Boiler with Jacobs-Schupert Firebox and Auxiliary Throttle Valve Dome.

casting: to strengthen the joint, lugs are cast on the top of the saddle at the front and back, and two $1\frac{1}{8}$ -in. bolts pass through each lug. The opening in the smokebox is cut out sufficiently to clear the lugs.

The outside, or low pressure, guides are of the usual two-bar type, and are supported on cast steel bearers, which are bolted to a transverse yoke. The inside, or high pressure, guides are of the Laird type, this design being used in order to provide the necessary clearance above the leading driving axle.

work in bushings of Hewitt metal. The valves are set with a lead of $\frac{3}{16}$ in. on the high pressure ports, and $\frac{5}{16}$ in. on the low pressure. The details of the valve gear parts are among the many features which the Santa Fe has improved to overcome some of the annoying failures which often result from negligence of small parts. Care has been taken to avoid offset bearings in order to minimize the tendency to twist or buckle. All pins are made of ample size and are arranged in double shear. Standard castle nuts are used throughout the valve gear.

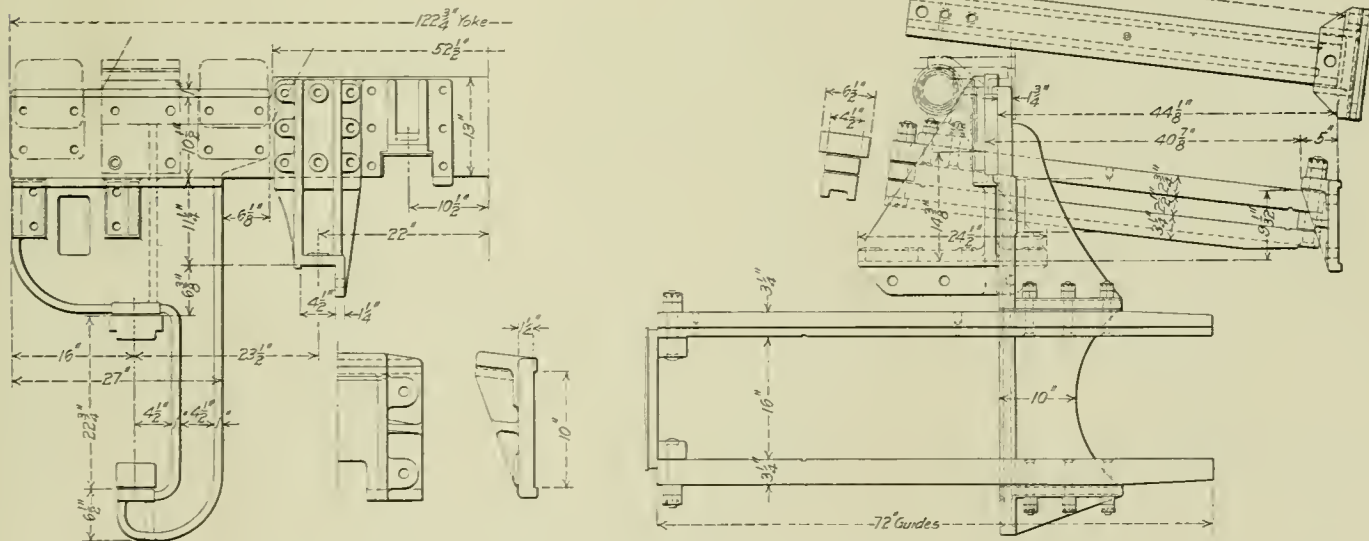

Guides and Guide Yoke—Santa Fe Balanced Compound.

Reference to the illustration will show that these guides are supported at the front end by the low pressure guide yoke, and at the back end by a cast steel frame brace, which is placed just behind the first driving axle and extends the full depth of the frame pedestals. The arrangement of the high pressure guides has resulted from the railway's experience in overcoming cylinder head troubles on older engines. The lengths of the inside and outside main rods are 100 in. and 110 in. respectively. The crank axle is of the built-up type, with a cast steel central

Lubrication of bearings is carefully provided for by large cavities made integral with the different members. No detachable oil cups are used on any part of the valve gear.

Carrying out the general scheme of adhering to its standard parts, the railway has provided a frame which may be used with its standard shoes and wedges, driving boxes, etc. The strength of the frames has, however, been increased as compared with previous engines and a more satisfactory system of transverse frame bracing has been introduced. The frames are

4½ in. wide, and are spaced 44 in. between centers. At the main driving pedestals they are offset ¾ in. on each side, thus increasing the distance between centers to 45½ in. This was done to provide sufficient room for the crank axle and driving journals. The same scheme was employed on the previous balanced 4-6-2 type. The frame rails are 6¾ in. deep over driving boxes. Between jaws the upper rail is 4¾ in. deep, and the lower rails are 3½ in. deep. The front frame sections consist

the main and rear driving wheels, being bolted to both the top and bottom frame rails. Another brace is placed at the juncture of the main and rear sections of the frames. This tie is located immediately beneath the cast steel furnace bearer, to which it is securely bolted, thus making an unusually strong construction. The same arrangement of tie and furnace bearer is used at the back of the rear frame section behind the trailer truck. In addition to the frame braces described the frames are further

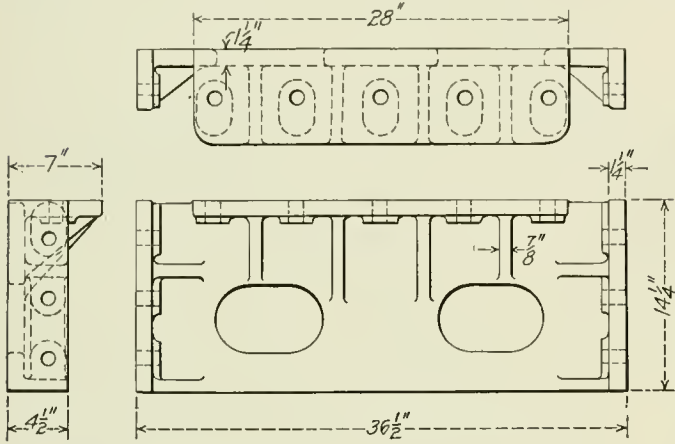

Frame Brace at Splice Between Main and Trailer Frames.

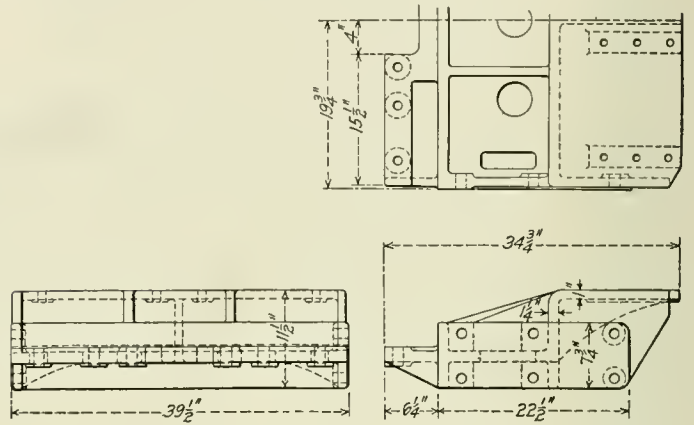

Frame Brace Just Back of Cylinders.

of single rails, measuring 4½ in. by 10 in. in section under the cylinder saddle. They are joined to the main sections by specially designed connections. The rear frame sections are in the form of slabs, and are arranged to accommodate the trailing truck, which is of the Rushton type with outside journals.

stiffened by plates connected with proper ties to the belly of the boiler. These plates are secured at the lower ends to the steel frame braces.

Close attention has been given to the transverse frame bracing as shown by the accompanying illustrations. A broad steel casting spans the front rails just back of the cylinders

The arrangement of the equalizing system and spring rigging calls for no special comment except for the equalizer between the rear driver and the trailer truck. The design was revised to place the bearings of all three pins in the same horizontal plane, thus eliminating the offset which tends to twist the equalizer.

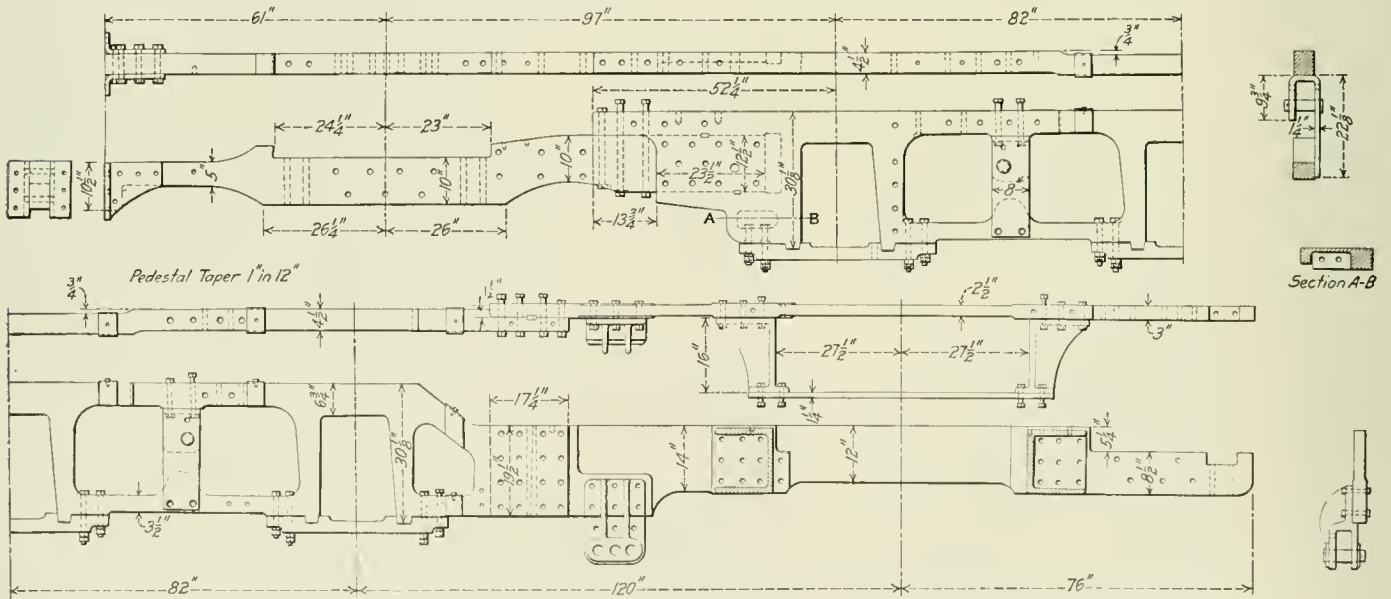

Frames for 4-6-2 Type Balanced Compound. The Offset at the Main Pedestal Is Indirectly Due to the Cranked Axle.

and is bolted to the cylinder castings. This tie also serves as a support for the driving brake cylinders. The main frame sections are provided with three cast steel braces. One is located just back of the front drivers with a bearing 37 in. in length on top of the frame. The same casting extends to the full depth of the pedestals to which it is securely bolted, additional metal being provided in the pedestals to include this bolting without weakening the frames. This brace also supports the back end of the inside guides. A wide and deep casting is located between

Another of the small details revised for the benefit of the new engines is the trailer truck oil cellar. In this the lower portion of the cover casting and the cellar are cast in one piece. This eliminates joints in the cellar which permit oil to leak out.

Wagon top boilers with two steam domes are used on all the locomotives. The rear dome is placed on the wagon-top, while the forward dome is located near the front end of the barrel. Steam is conveyed from the rear dome to the forward dome through a pair of 5-in. pipes. The forward dome contains

the throttle, and as communication between its interior and the boiler is cut off by a plate, the steam supply for the cylinders is drawn entirely from the rear dome, which is at the highest part of the boiler. The throttle takes steam through the top only, and communicates with the external dry pipe.

In the engines with Buck-Jacobs' superheaters, the superheating chamber is 37 in. in length, its forward tube sheet being 24½ in.

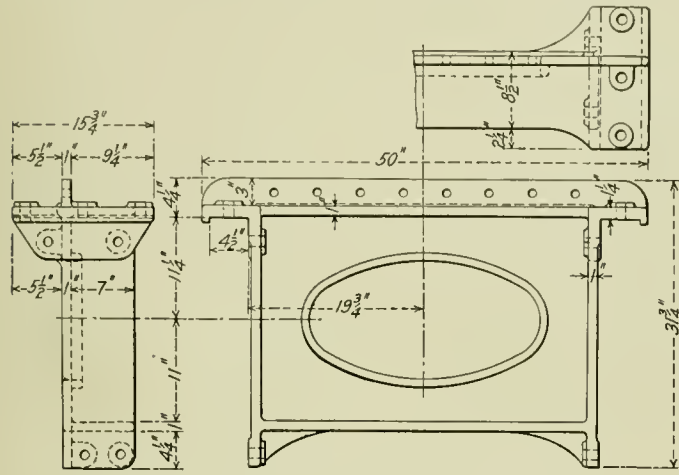

Frame Brace Ahead of Third Pedestal.

back of the center line of the stack. An intermediate chamber is placed between the superheater and the main evaporating section of the boiler, and as this chamber can be entered through a manhole the tube ends are easily accessible. The superheater tubes are welded into the tube sheet at the back end, and rolled at the front end. Steam enters the superheater on the top center line and is guided by internal baffle plates so that it fol-

above the center line of the heater and is applied to facilitate the removal of the boiler tubes. The 3 in. tubes are grouped in the lower part of the heater.

In the boilers equipped with Schmidt superheaters the front tube sheet is placed 50½ in. back of the stack center. A large opening is cut in the smokebox shell, immediately above the superheater header, and this opening is covered by a saddle-shaped casting. There are three openings through this casting. The center opening communicates with the saturated steam chamber in the header, and the side openings with the superheater chamber. The dry pipe and steam pipes are outside the boiler and communicate respectively with the saturated and superheated steam chambers in the header, by way of the openings in the saddle casting. The superheater is fitted with the usual arrangement of shut-off damper.

The fireboxes of all the locomotives are alike. The inside and outside shells are each composed of eleven channel sections. On the coal-burning locomotives the grates are mechanically shaken by a pair of steam cylinders placed under the boiler barrel, immediately in front of the firebox. Hand-shaking gear is also provided. On seven of the locomotives the grate bars have fine fingers and narrow openings and are arranged for burning Gallup coal, which resembles lignite. The fireboxes of the coal burners are provided with two 3-in. arch tubes. The oil-burning locomotives are fitted with the oil-burning equipment standard on the Santa Fe, and including the Booth burner.

The tender is designed in accordance with the Santa Fe standard practice. It has arch bar trucks with cast steel bolsters and steel tired wheels, and the frame is composed of 12-in. channels weighing 40 lbs. per foot. The end sills are of cast steel and are standard for all tenders on the system. The rear end sill is provided with a drawbar carrier of cast steel, which is cast with lugs which interlock with similar lugs on the end sill. When the carrier is in place bolts are applied from the

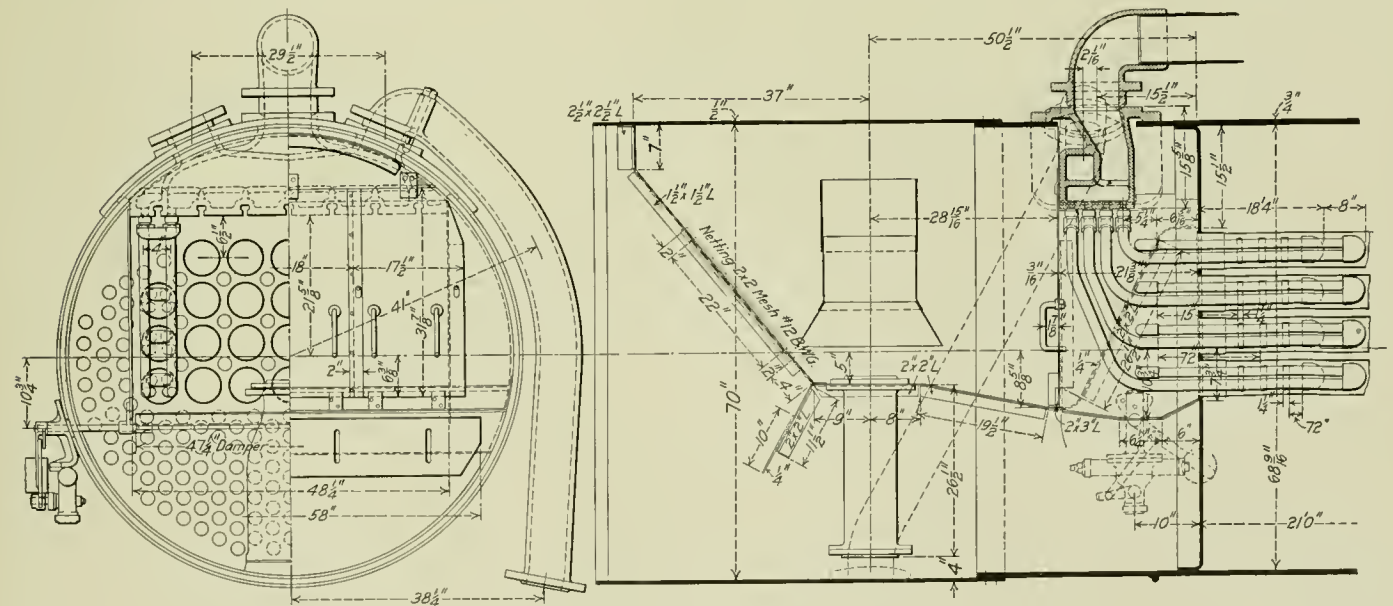

Front End Arrangement of Locomotives Fitted with Schmidt Superheaters.

lows a circuitous course among the tubes. The steam leaves the superheater through right and left hand pipes which run direct to the steam chests and have their joints outside the boiler. The superheater section of the boiler is butt-jointed to the main boiler section, the joint being secured by an external covering strip taking four circumferential rows of rivets. The superheater tubes are arranged in a manner which has proved most satisfactory, as far as superheating the steam and drafting the boiler is concerned. There are 350 2¼ in. and 67 3 in. tubes, and one large tube 6 in. in diameter. The latter is placed just

top, extending through the bottom wall of the sill and through the carrier. These bolts are for the purpose of preventing the carrier from sliding off the interlocking lugs and are subject to no stress from carrying the drawbar, as the interlocking lugs receive all the weight. Therefore, even though the nuts should become detached from these bolts they will still remain in place and perform their work properly and no inconvenience can be experienced. This carrier also has pockets on either side of the drawbar for the purpose of carrying the centering springs.

The following table gives the general dimensions of the coal-

burning locomotives equipped with Buck-Jacobs' and Schmidt superheaters respectively.

| General Data. | |
|--|---------------|
| Gage | 4 ft. 8½ in. |
| Service | Passenger |
| Fuel | Soft coal |
| Tractive effort | 35,000 lbs. |
| Weight in working order | 276,500 lbs. |
| Weight on drivers | 160,900 lbs. |
| Weight on leading truck | 54,980 lbs. |
| Weight on trailing truck | 60,620 lbs. |
| Weight of engine and tender in working order | 448,000 lbs. |
| Wheel base, driving | 13 ft. 8 in. |
| Wheel base, total | 35 ft. 1 in. |
| Wheel base, engine and tender | 66 ft. 9½ in. |

| Ratios. | |
|---|--------|
| Weight on drivers ÷ tractive effort | 4.60 |
| Total weight ÷ tractive effort | 7.90 |
| Tractive effort × diam. drivers ÷ heating surface* | 620.00 |
| Total heating surface* ÷ grate area | 71.90 |
| Firebox heating surface ÷ total heating surface*, per cent. | 5.72 |
| Weight on drivers ÷ total heating surface* | 38.90 |
| Total weight ÷ total heating surface* | 66.80 |
| Volume both cylinders, cu. ft. | 12.10 |
| Total heating surface* ÷ vol. cylinders | 342.00 |
| Grate area ÷ vol. cylinders | 4.75 |

| Cylinders. | |
|------------|--------------|
| Kind | Compound |
| Diameter | 17½ & 29 in. |
| Stroke | 28 in. |

| Wheels. | |
|---|-------------|
| Driving, diameter over tires | 73 in. |
| Driving, thickness of tires | 3½ in. |
| Driving journals, main, diameter and length | 11 × 10 in. |
| Driving journals, others, diameter and length | 9 × 12 in. |
| Engine truck wheels, diameter | 34¼ in. |

| | |
|---------------------------------|------------|
| Engine truck, journals | 6 × 10 in. |
| Trailing truck wheels, diameter | 50 in. |
| Trailing truck, journals | 8 × 14 in. |

| Boiler. | |
|------------------------------------|----------------------------|
| Style | Wagon top |
| Superheater, type | Buck-Jacobs |
| Working pressure | 210 lbs. |
| Outside diameter of first ring | 70 in. |
| Firebox, length and width | 109½ in. |
| Firebox plates, thickness | 75¼ in. |
| Firebox, water space | F. & B., 5 in.; S., 5½ in. |
| Tubes, number and outside diameter | 290-2¼ in. |
| Tubes, length | 18 ft. 2 in. |
| Heating surface, tubes | 3,088 sq. ft. |
| Heating surface, firebox | 237 sq. ft. |
| Heating surface, total | 3,325 sq. ft. |
| Superheater heating surface | 806 sq. ft. |
| Grate area | 57.6 sq. ft. |

| Tender. | |
|-------------------------------|-------------|
| Wheels, diameter | 34¼ in. |
| Journals, diameter and length | 5½ × 10 in. |
| Water capacity | 9,000 gals. |
| Coal capacity | 12 tons |

Engines equipped with the Schmidt Superheater differ in the following dimensions:

| | |
|----------------------------------|---------------|
| Weight, total | 278,840 lbs. |
| Weight on drivers | 162,760 lbs. |
| Weight on front truck | 54,260 lbs. |
| Weight on trailing truck | 61,820 lbs. |
| Diameter of tubes and flues | 2¼ & 5½ in. |
| Number of tubes and flues | 179 & 26 |
| Length of tubes | 21 ft. |
| Heating surface, tubes and flues | 2,986 sq. ft. |
| Heating surface, firebox | 237 sq. ft. |
| Heating surface, total | 3,220 sq. ft. |
| Heating surface, superheater | 742 sq. ft. |

*Includes surface of Buck-Jacobs superheater.

MACHINE SHOP KINKS

BY V. T. KROPIDLOWSKI,

Chicago & North Western, Winona, Minn.

PLANING STEAM CHEST BALANCE PLATES.

A convenient and time-saving method of planing balance plates is shown in the accompanying isometric drawing. The plate is held by four angles *A* which are clamped to the bed of the planer. These angles are made of forged steel 1 in. thick by 4 in. wide when finished. The face *c* of the top jaw and the bottom faces *f* of the foot are carefully planed parallel. The

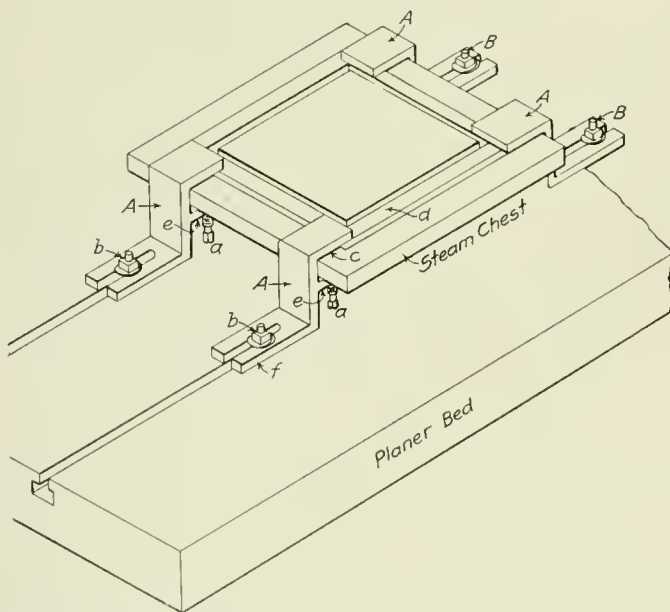

Jig for Planing Balance Plates.

set screws *a* are screwed into the lower part *e* of the jaws, and force the plate up against the surface *c*, holding it while the plate is being planed. No surface gage is required to adjust the cover when using these clamps, thus saving much time and tedious work. The surface *c* of the jaws comes on the finished surface *d* of the steam chest cover, which gives an accurate bearing.

TOOL POST FOR SLOTTING MACHINE.

A tool post of 3 in. round mild steel for use on a slotting machine is shown in the accompanying illustration. The bottom of the post has a slot which receives the end *A* of the tool holder. These two parts are held together by a pin extending through the hole *E*, which also acts as a pivot. The object of the tool post is to allow the tool plenty of clearance while being drawn up, or returned, for the next working stroke. It will be noticed on the bottom section that the surface *FG* is not in a straight line. This allows the tool to swing away from the work on the return stroke. On the down stroke the tool bearing against the work, will hold the surface *G* in contact with the surface *H* of the tool post. In order to insure the tool striking the work squarely when on its down stroke, a spring is located in the hole *C* which

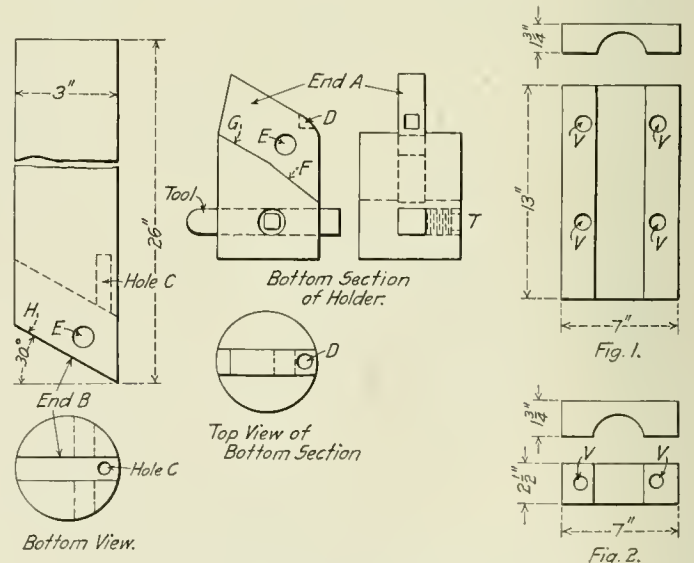

Tool Post for Slotting Machine.

bears on the seat *D* in the bottom section, causing the surfaces *G* and *H* to be in contact when the tool is free. The tool is held in the bottom section by the set screw *T*, as shown. The tool post is placed in the tool head and is held by the two clamps shown in Fig. 2, which are bolted to Fig. 1. This tool is very convenient and saves considerable time, for it can be turned to any angle on account of its being round.

STRESSES IN STEEL UNDERFRAMES

BY OLAF ANDERSON*

The car designer meets new and difficult problems in the design and construction of steel underframes for freight cars; especially in the distribution of the metal and the arrangement of the different members to the greatest advantage consistent with economical design. The great variation of sections in steel underframes at the present time, they being 8 or 10 times stronger than the wood underframe, and each claiming superiority over the other, is subject to criticism. It is believed that if the different stresses to which a car is subjected while in service could be anywhere near analyzed so as to present a comprehensive solution for all car men not familiar with the cal-

culated. Boundary lines were then drawn which showed the amount of load in each section acting directly on the center sill.

The cross bearer *N*, for example, carries part of the load between *N* and *A*, and part of the load between *N* and *B*. One-half of the sum of these loads is carried by the center sill, the other half being equally divided between the two side sills. These side sills are supported by the four load transmitters *A*, *B*, etc., and their loads are transmitted to the center sills through them. This is clearly shown by the lines on the diagram. To each section included in the boundary lines the dead load or weight of all the members and parts of members, both of the framing and the upper structure, was added. The total load acting at the points *E*, *A*, *N*, etc., may be designated by P_1 , P_2 , P_3 , etc. The overhanging load, or the load transmitted to the center sill, between

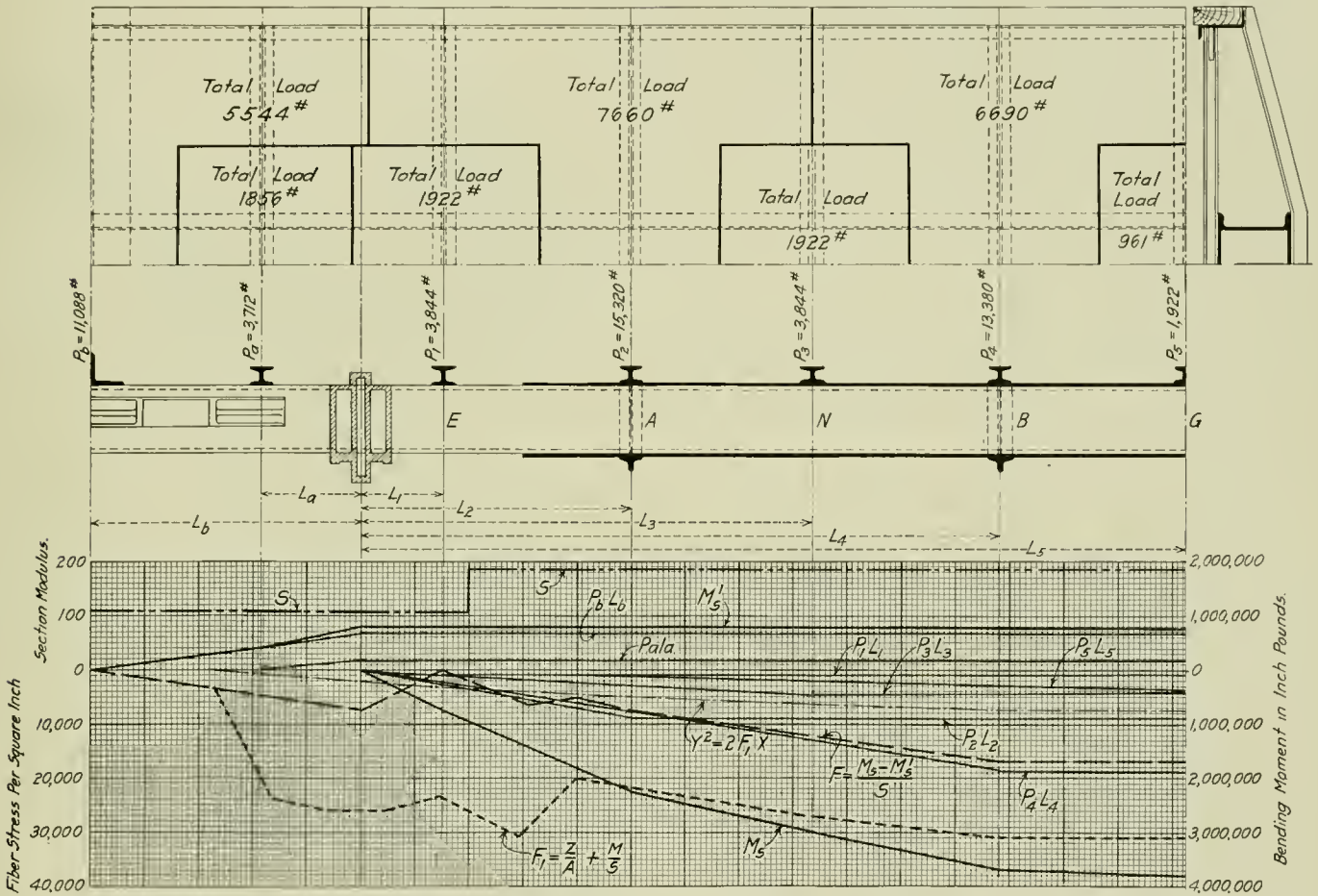

Diagram and Curves for Steel Underframe Calculations.

culations of stresses and strains, it would help towards the adoption of a standard section of center sills for all cars subjected to about the same service conditions.

The following simple method has been used with success to determine and calculate the stresses in a steel underframe box car of 80,000 lbs. capacity, which carried the entire superimposed or live load on the center sills. The underframe had four load transmitters, *A* and *B*, and two others on the other half of the underframe. In addition to this it had five other bearers, *E*, *N*, *G*, and two others, all between the center plates and bolsters, which were of the combination type. There were no side bearings and none of the load was transmitted from the sides of the car to the center plate at the bolsters. One-quarter of the floor plan was used in the calculations, as it was identical with the other three quarters. It was laid out to scale on decimal cross section paper. The live load per square foot of floor area was calculated, the weight of the floor being included as it is uniformly

distributed. Boundary lines were then drawn which showed the amount of load in each section acting directly on the center sill. The ends of the car and the center plate, is designated as P_a and P_b . The distances of the points of application of each of these loads from the bolster is designated by L_1 , L_2 , L_3 , etc.

With this information the bending moments may be calculated and plotted on the cross section plate underneath the drawing. Those to the right of the center plate are laid out below the zero line, and those to the left above. These bending moment curves are indicated by $P_1 L_1$, $P_a L_a$, etc. Each individual bending moment should be first plotted separately. As only one-half of the center sill is shown each individual moment curve must take into consideration the effect of the corresponding load on the half not shown. For instance, the moment curve $P_1 L_1$ represents the combined effect of the load at the distance L_1 from the center plate shown, and the corresponding load at the distance L_1 from the other center plate, not shown. This is done in each case so that the sum of these individual moments at any point will give the resultant bending moment at that point. To form a resultant moment curve the ordinates of all the individual moment curves

*Chicago & North Western, Chicago, Ill.

are added together and plotted, giving the curve M_s and M'_s . The M_s curve represents the sum of the moments below zero line, or to the right of the center plate, while the M'_s curve shows the sum of the moments above the zero line, or to the left of the center plate; to obtain the resultant moment acting at any point of the center sill the two corresponding values must be subtracted one from the other, for the moments on the left hand side of the center plate tend to counteract those on the right hand side.

The section modulus of the main carrying members may be calculated and plotted above the neutral line to the scale shown on the left of the diagram. Rules and formulas for calculating the section modulus of different shapes may be found in most structural catalogs or engineering hand-books. The curve of the section modulus being plotted, the unit fiber stress in the main carrying members due to the loading and weight of the car can be determined. Let F equal the fiber stress at any point in the main carrying members due to the loading and the weight of the car, and S the section modulus at the same point. M_s is the corresponding sum of moments below the zero line, and M'_s the sum of moments above the zero line. Then F equal $\frac{M_s - M'_s}{S}$ and from the bolster to the end of the car $F = \frac{M'_s}{S}$.

The different values of the F curve being found, they should be plotted below the zero line, the scale being indicated on the left of the diagram. It is now customary to allow the entire buffing force to be transmitted through the draft gear to the back check castings, as it is usual to allow from $\frac{1}{4}$ in. to $\frac{1}{2}$ in. between the horn of the coupler and the striking plate when the draft gear is solid. The resistance of all the different members on which the buffing force acts proportionately and simultaneously should not, for economical reasons, be greater than 400,000 lbs., taking as the yielding point the elastic limit of the material. It seems to be the general opinion that the buffing force in switching on gravity yards is frequently as high as 600,000 lbs., or even 800,000 lbs. This is evidently based on dynamometer tests, which, it is believed, would have registered that high if the capacity of the dynamometer car had been sufficient. It is a question whether the dynamometer car records the true force on the drawbar at times when the shocks are great and sudden. It is more likely that the momentum in the oscillation of the springs and levers causes the pointer to register a higher force than is actually imparted at the drawbar. A special case came to the writer's attention some time ago. A collision occurred between a 500,000-lb. capacity dynamometer car and a steel under-frame car equipped with 200,000 lbs. capacity friction draft gears and M. C. B. back check castings. The clearance between the coupler horn and the striking plate was $\frac{1}{2}$ in. when the draft gear was solid. The M. C. B. check castings are riveted to the center sills with 18 $\frac{7}{8}$ -inch rivets, and assuming the rivets to shear off at 40,000 lbs. per sq. in., if the buffing force was equally distributed on all the rivets, which is very unusual, the rivets would have sheared off at 432,000 lbs. In the collision the springs of the dynamometer car were compressed solid, but no damage whatever was done to the car.

Having assumed the buffing force, we may graphically plot the unit stress in the center sills, due to direct buffing. If F_1 equals the unit stress in the center sills, due to direct buffing, A , the area of the center sills at any point and Z the assumed buffing force, then, F_1 equals $\frac{Z}{A}$ to which should be added the unit stress due to eccentric buffing. Let L' be the distance from neutral axle of center sills to center line of draft. Then $L'Z$ is the bending moment at the middle of the car due to the eccentric force, and the moment curve, which is approximately parabolic, may be plotted from formula $Y^2 = 2F_1X$, and the value of the curve may be designated as M . Let S_1 equal section modulus in the center sills. Then at any point of the center sills F_1 equals $\frac{Z}{A} + \frac{M}{S_1}$, and the combined unit stress from loading and buffing forces equals $F_1 + F$, and the combined curve may be plotted to scale accordingly.

HYDRAULIC DRIVING BOX PRESS

An electric driven hydraulic press of somewhat novel construction, which was designed by F. F. Gaines, superintendent of motive power of the Central of Georgia, is shown in the accompanying illustration. It has been used for general press work in the shop, being more particularly designed, however, for pressing brasses into and out of driving boxes. It will be seen that the two pumps near the base are driven by long rods connected to eccentrics on the end of the pump shaft, which extends across the top of the press, this shaft being driven by the motor through double reduction gearing. The pump pistons are about $\frac{3}{4}$ in. in diameter and have a 2 in. stroke. The reservoir is in the pedestal legs and a single valve controls the operation of the press. A

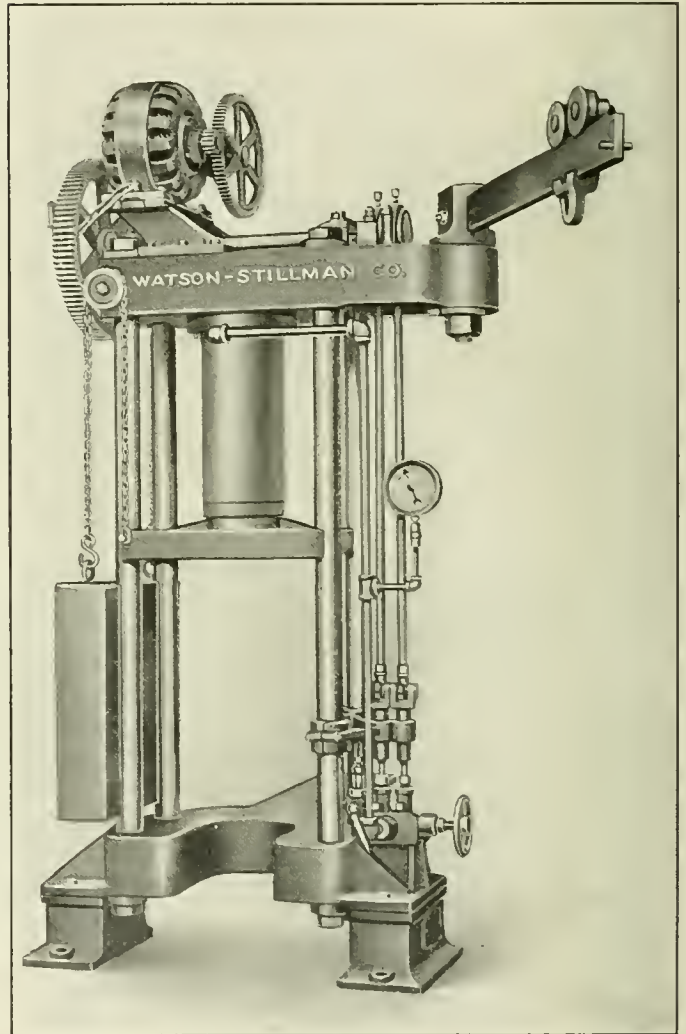

Compact Powerful Hydraulic Press for General Shop Use.

safety valve is applied to prevent dangerous overloading of the pumps.

A crane bracket and beam are provided as part of the equipment on both the 60 and 100-ton capacity sizes. Watson-Stillman Company, New York, are manufacturing the press and will furnish it either electric, hand or belt driven, as desired.

EXPORT COAL TRADE.—The great bulk of the export coal trade is to Canada, reports showing that of \$15,335,856 worth of anthracite exported, Canada received \$15,126,207 worth; of \$28,000,000 worth of bituminous coal sent out of the country, Canada received \$21,000,000 worth.

IMPROVED SHOP PRACTICE AT NASHVILLE

Awarded the First Prize in a Competition on Shop Improvements During 1911, Which Closed December 15. Includes General Shop Improvements and Descriptions of a Number of Labor Saving Methods and Devices.

BY WILLIAM G. REYER

General Foreman, Nashville, Chattanooga & St. Louis, Nashville, Tenn.

The improvements made during the past year which directly pertained to the increase of the shop output and efficiency, included changes in the layout of the shops, in the schedule of hours, in the instruction of apprentices and the addition of new shop

has been done on them than when all of the fifteen were used. This increase is attributed the greater floor space available, which allows the men to have more conveniences and to specialize more highly, as was mentioned in the *Railway Age Gazette* of February 3, 1911, page 243. The more the men specialize in their work the better the results, both in the amount and quality of the work turned out.

The apprentices are given instruction on each class of work,

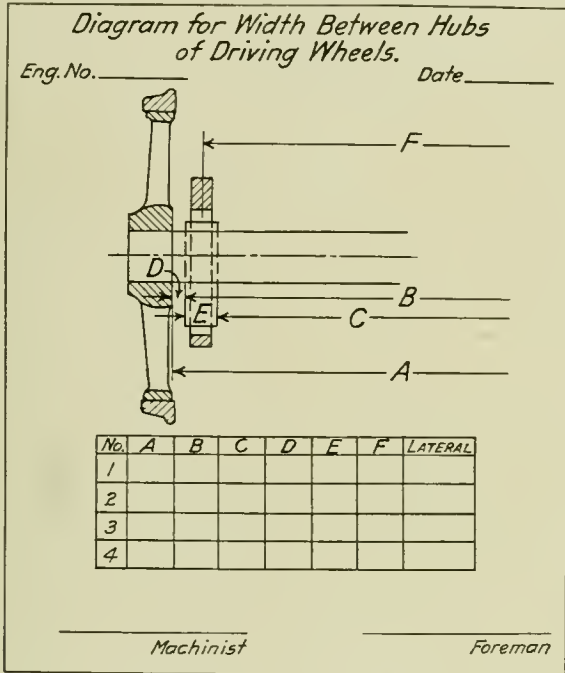

Fig. 1—Dimension Chart for Width Between Hubs of Driving Wheels, Etc.

kinks. In 1910 two of the 15 pits in the erecting shop were closed to provide more floor space for other purposes. This was found to give very good results, and since then a third pit has been closed. There are now twelve working pits, and more work

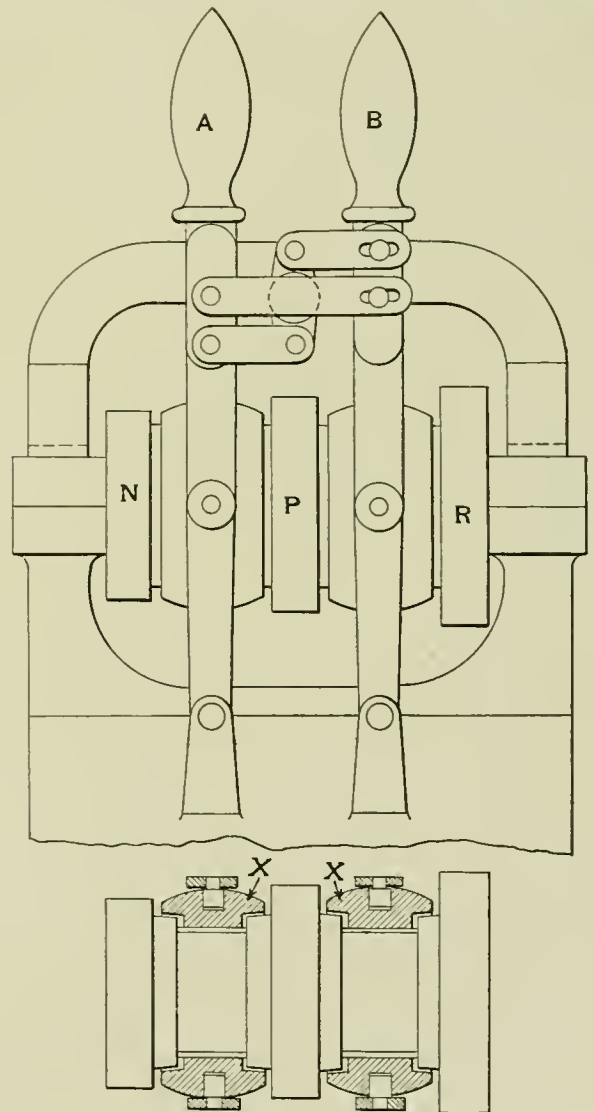

Fig. 3—Friction Clutches for Quartering Machine Feed.

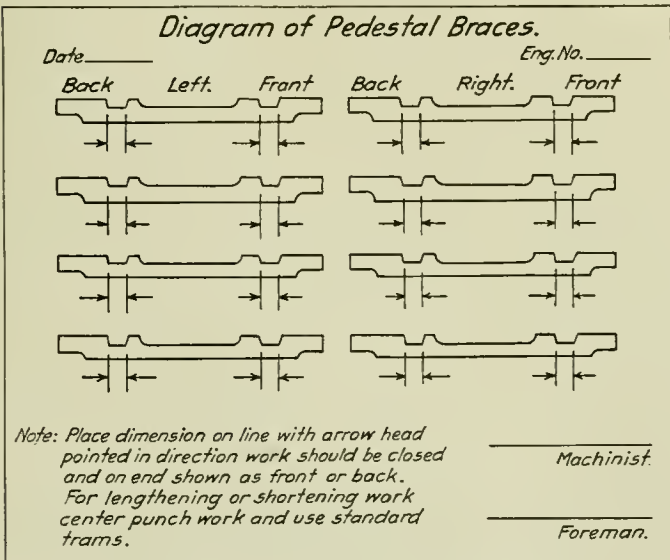

Fig. 2—Dimension Chart for Pedestal Braces.

which, together with the apprentice school, makes them all round, thorough machinists. Both the apprentices and the handy men are trained to meet the conditions of our shop. With the proper instruction the amount and class of work a good handy man can turn out is surprising. Another thing that has helped increase our output has been the half holiday given the men on Saturday, the shop closing at 12.30. I believe this is one of the best reforms

inaugurated, both from the standpoint of the men and the railway, for the men get a much needed opportunity to attend to any outside business they may have or to take any recreation they may choose. Following are some shop kinks which were recently inaugurated.

SHOP PRACTICE DATA DIAGRAMS.

The chart shown in Fig. 1 is used for recording the various dimensions between the driving wheels, hubs, etc. The machinist

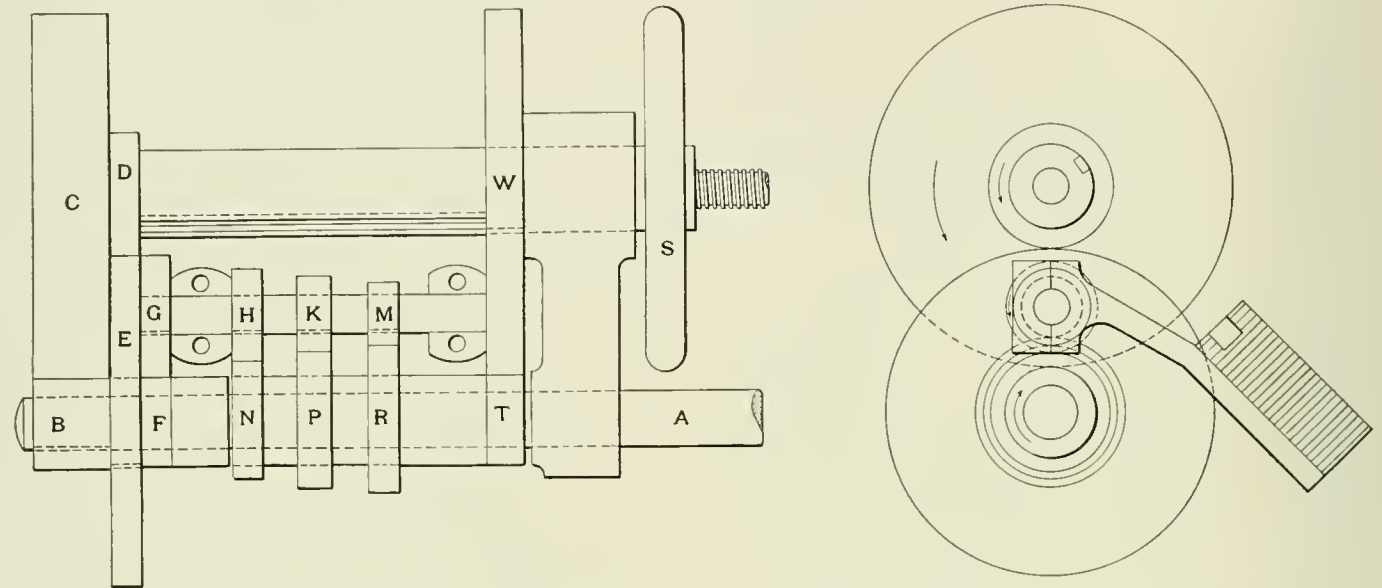

Fig. 4—Automatic Feed Attachment for Quartering Machine.

who does the work on the driving boxes gets the width between each pair of driving wheels, placing this dimension on the card at *A*. The machinist who lays off the shoes and wedges fills in the dimension *B*. The lateral play is given by the foreman, and the machinist who works on the boxes calculates the size of the flange he needs on the box and enters it at *D*.

The diagram of the pedestal brace, Fig. 2, is filled out for the blacksmith, giving him the information that he needs to repair

driven by the small pinion *T*, which is fastened on a sleeve running loose on the shaft *A*. This sleeve is driven by either of the gears *N*, *P* or *R*, which may be connected to it by friction clutches, the gears running loose on this sleeve. These gears are in turn driven by the gears *H*, *K* and *M*, respectively, they being rigidly fixed to the intermediate shaft, which is driven by the gear *G*. This gear meshes with the gear *F*, which is fastened to the sleeve with gear *E*. This sleeve is in turn driven by the

gear *D*, which is rigidly connected to the gear *C*, which is driven by gear *B*, which is keyed to shaft *A*. The friction clutches *X*, Fig. 3, are thrown in by levers *A* and *B*, which are connected so that one must be in a neutral position while the other is in use. When the lever *A* throws the clutch into the gear *N* a feed of .017 in. is obtained, and when thrown into *P* the feed is .011 in. Lever *B* thrown into the gear *R* will give a feed of .001 in. This arrangement has greatly increased the output of

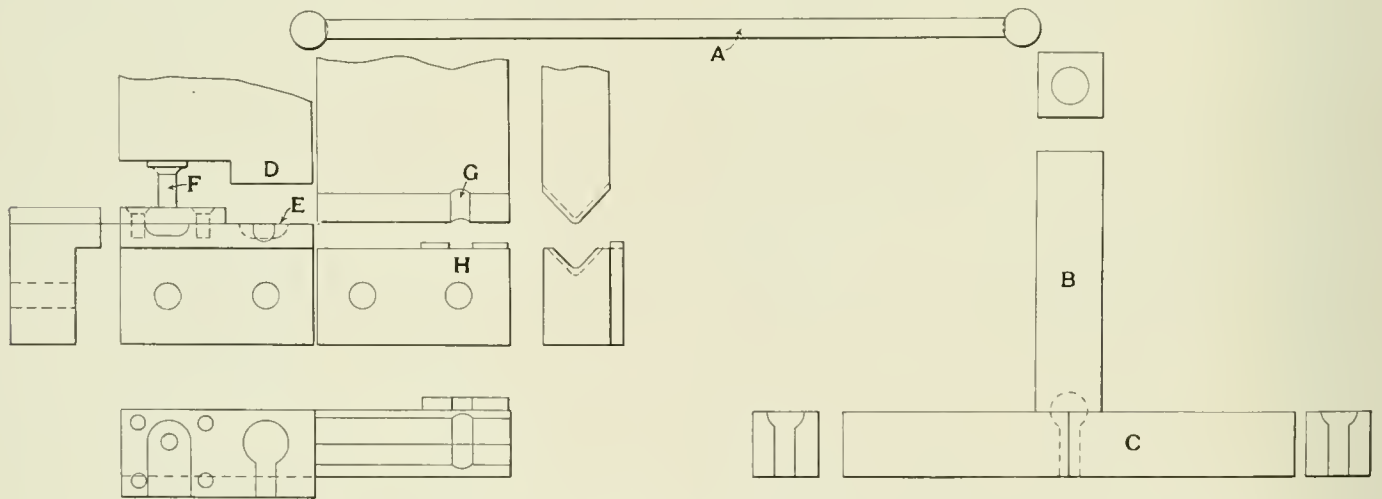

Fig. 5—Dies for Forming Grab Irons.

the braces. This helps him materially, as he does not have to go to the erecting shop for dimensions.

AUTOMATIC FEED FOR QUARTERING MACHINE.

The arrangement shown in Figs. 3 and 4 was applied to an old quartering machine that had a hand feed. This feed was operated by the wheel *S*, which was keyed to a nut. To apply the automatic feed the nut was extended through the bearing and the gear *W* was threaded and keyed to it. This gear is

the quartering machine, and we can feed 6 in. in 10 minutes. It was not necessary to make any changes in the machine to apply this device, the extra gears being held on the bracket as shown in the illustration. The device was designed by H. K. Adams.

DIES FOR FORMING GRAB IRONS.

As a result of the recent decision of the Interstate Commerce Commission concerning safety appliances, we have found it

necessary to make grab irons by the thousands. As we have no forging machine, the device shown at the left in Fig. 5 has been applied to our shears. A bolt header, with the two dies *B* and *C*, is used to form a ball on the end of the $\frac{5}{8}$ -in. rods, as shown at *A*. These are then flattened under the shears in the die *E*, and the flattened portion is then punched out with the punch *F*, forming the hole for fastening the grab irons to the cars. The irons are then placed in the dies *G* and *H* and the ends are bent to an angle of 90 degs. The bolt header will turn out about 1,000 of these irons in $9\frac{1}{2}$ hours, and 600 of them can be punched and bent in the same time. An oil furnace is used to heat the irons. This arrangement was made at the suggestion of Robert Clark, the foreman boilermaker, and John

method is used to reclaim them. The crosshead is slotted off at *B* and new pieces of the same material are machined to fit, and are welded in by the oxy-acetylene process.

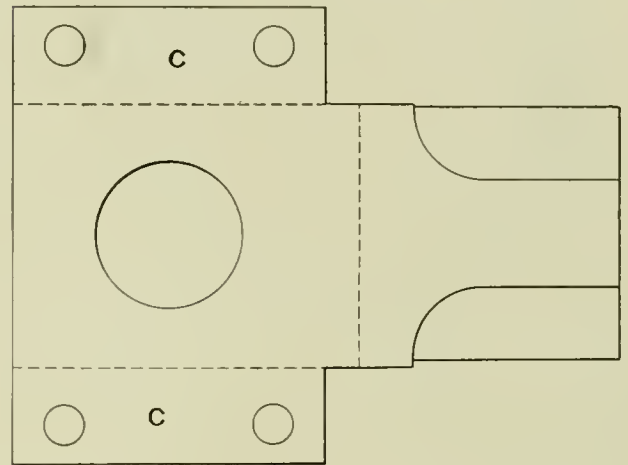
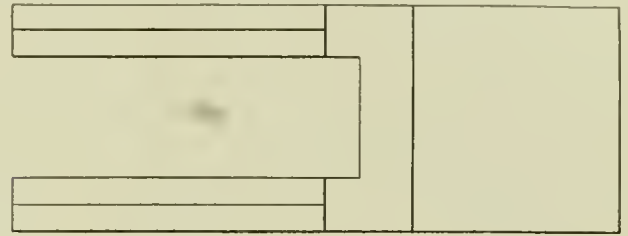
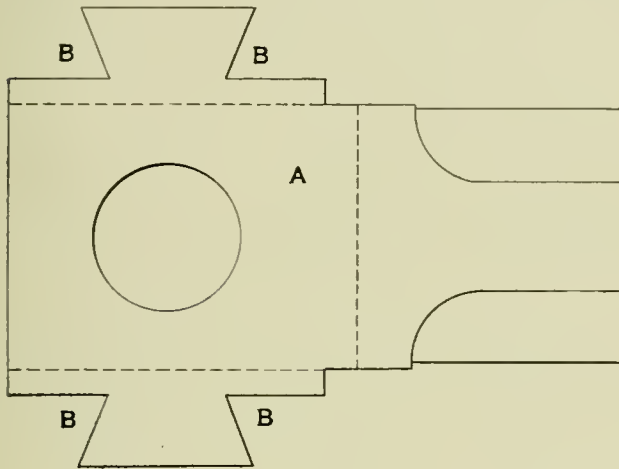

Fig. 6—Method of Reclaiming Crossheads.

Hooten, the foreman of repairs, made the dies. Twenty-four different lengths and shapes are made with this apparatus.

REPAIRING CROSSHEADS.

A number of our engines are equipped with the type of cross-

TOOL BAR FOR SLOTTER.

A new type of tool bar, which is used on driving boxes, is shown in Fig. 7. It consists of the bar *A*, with the bottom portion *B*, which fits in it as shown in the drawing, being connected

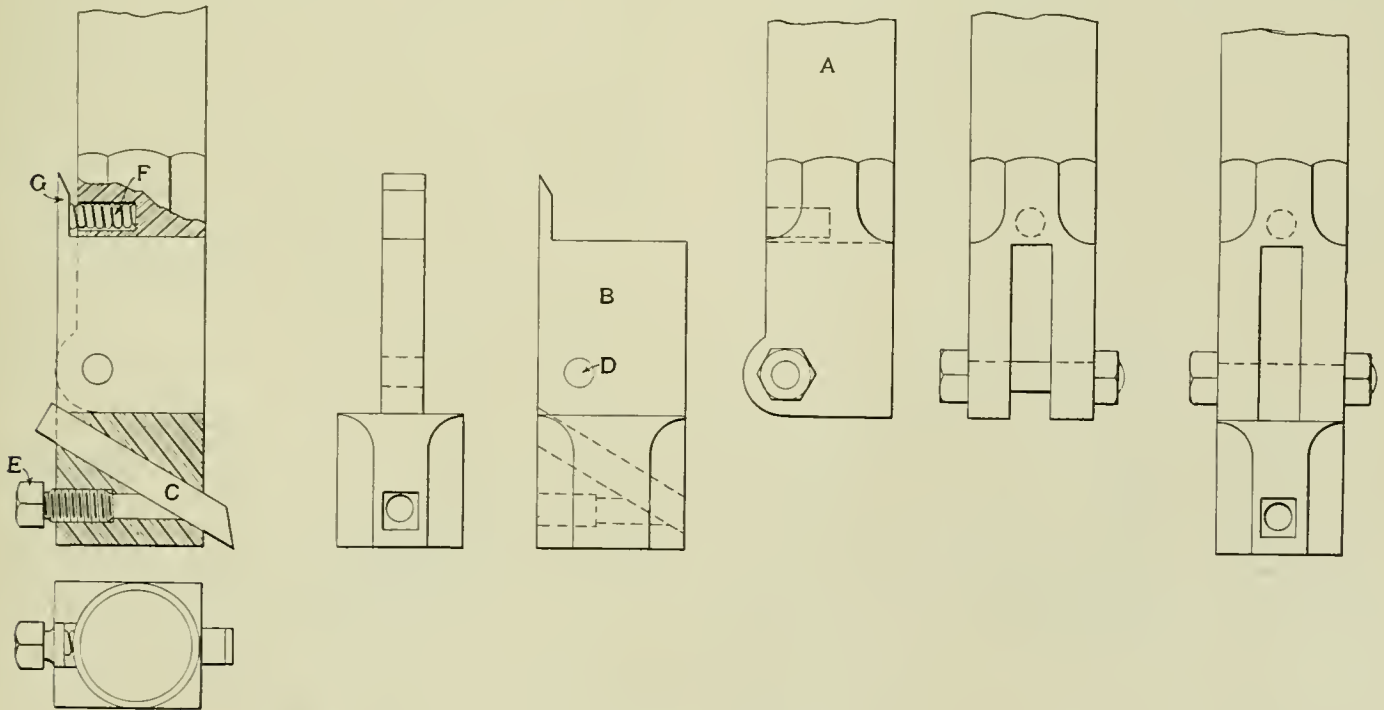

Fig. 7—Tool Bar for Slotting Machine.

head shown in Fig. 6, and each time new gibs are applied the holes in part *C* have to be reamed out. These holes soon become quite large, greatly weakening the crosshead. The following

by the pin *D*. The part *B* is free to swing about this pin, and is held in the correct position by the spring *F*, which bears against the projection *G*. When the tool is on the return stroke this

spring is compressed, allowing the tool to drag across the surface of the work without injuring it. The position of the tool *C* is of special interest, as it has proved to be a free cutter and will turn out considerable work. The point of the tool is on a level with the bottom of the tool bar, which allows a cut to be taken very near to the top of the table of the slotter. Two driv-

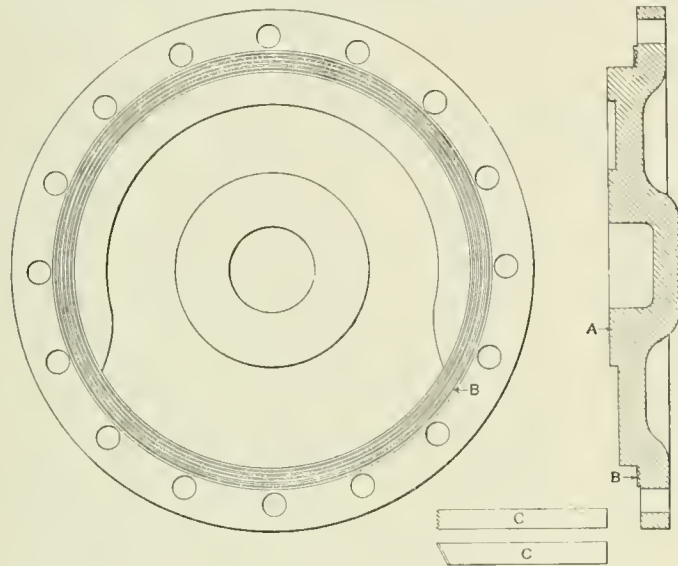

Fig. 8—Method of Grooving Cylinder Heads.

ing boxes have been turned out in an hour and a half by this arrangement. The tool was designed and made by Robert Nicks.

GROOVING CYLINDER HEADS.

The way in which we groove our cylinder heads to save grinding is shown in Fig. 8. The tool *C* is used to make the grooves. Heads treated in this way are being applied to the locomotives as fast as they go through the shop, and save much time, making

fitting in the clamps *C*, which are located at the ends of the three arms, extending out from the center of the chuck, as shown. The heads of the bolts operating the clamps fit in the slots in the face plate of the lathe. The radial adjustment is made by

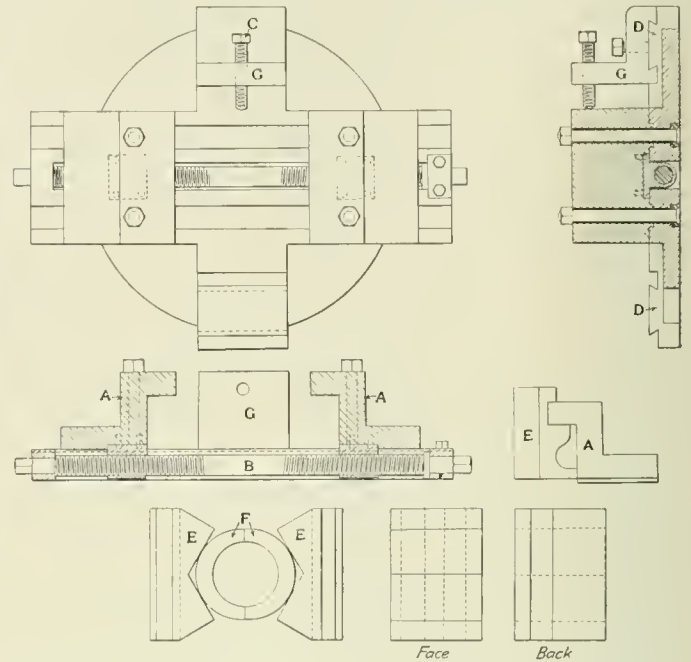

Fig. 10—Chuck for Boring Driving Boxes and Facing the Ends of Brasses.

the bevel gear *D*, which meshes with the three gears *E*. These gears operate the screws *F*, which drive the sleeves *H* in and out, as desired. The sleeves are kept from turning by the nuts *G*, which slide in slots in the sleeves. This chuck was designed by Fred Eggenberger.

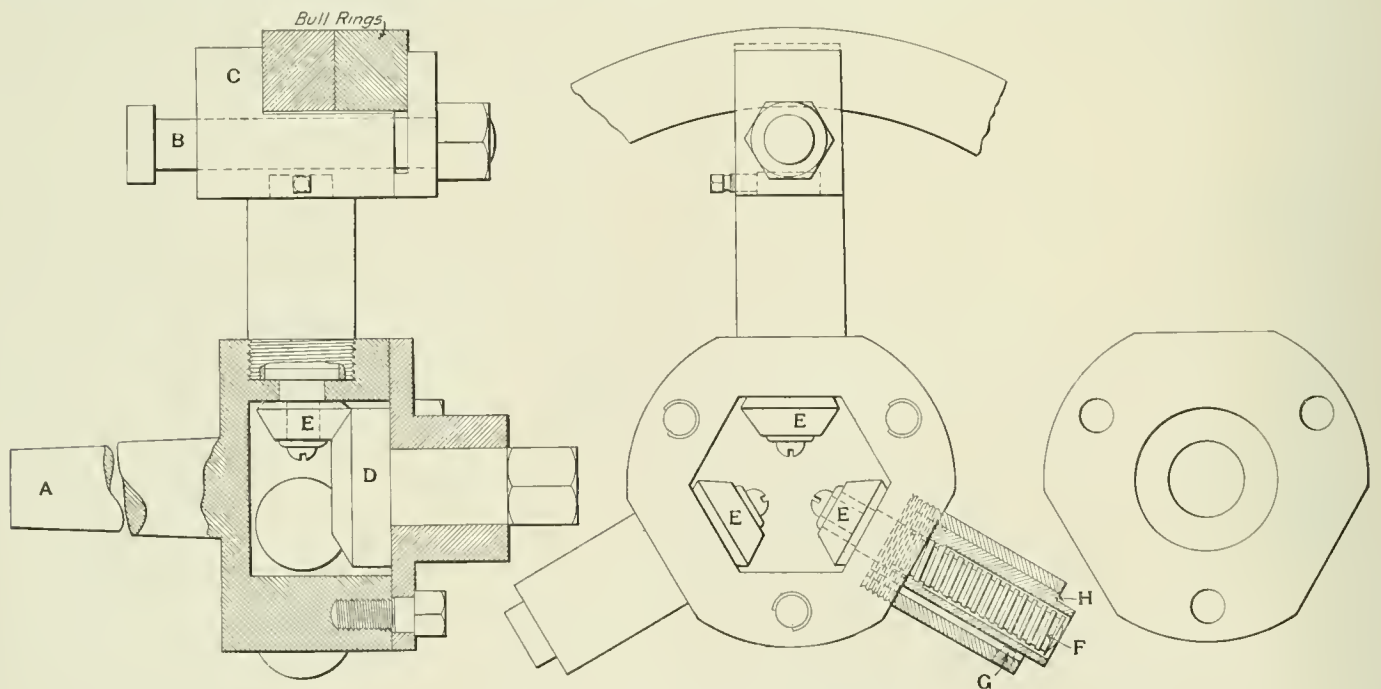

Fig. 9—Chuck for Turning Bull Rings.

sufficiently tight joints. It is believed that this surface answers the purpose fully as well as a ground surface.

BULL RING CHUCK.

A new chuck for turning bull rings is shown in Fig. 9. The taper shank *A* is fitted to the spindle of a lathe, the bull rings

DRIVING BOX CHUCK.

A handy chuck for boring driving boxes is shown in Fig. 10. It is also used for facing the ends of the driving brasses before they are applied to the box. The jaws *A* fit over the lip of the driving box and are operated by the right and left hand screw

B. The set screws *C* in the arms *G* give additional support to the box. This chuck does away with bolts and clamps and the operator can easily adjust the box for boring. To face off the driving brasses a pair of supplementary jaws *Z* are used, which hold the brasses *F*, as shown. These jaws are held in the jaws *d*

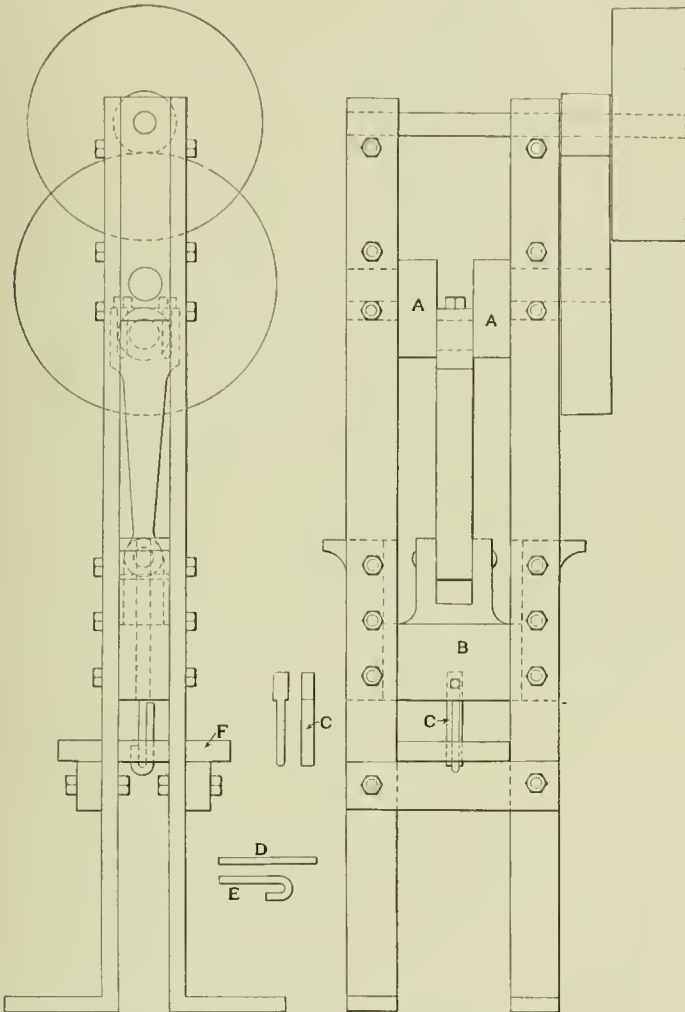

Fig. 11—Forging Machine for Forming J-Hooks.

of the chuck, as shown in the illustration. This tool was designed by Fred Eggenberger.

FORGING MACHINE FOR J-HOOKS.

The machine shown in Fig. 11 is used for forming J-hooks and other light work. It is driven by a belt, which runs on the

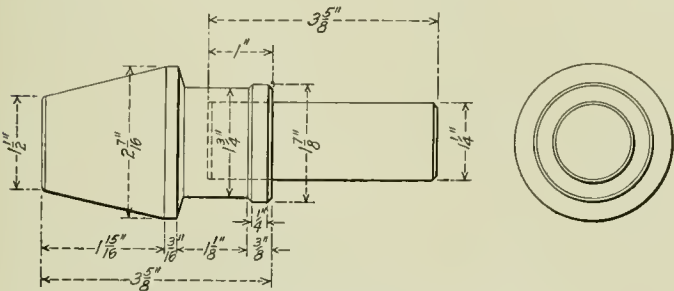

Fig. 12—Pneumatic Tool for Flaring Boiler Tubes.

pulley at the top of the machine, and the ram or crosshead is given its motion through the gears and the cranks *A*. The plunger *C* is fastened in the crosshead *B*, as shown. The round iron *D* is placed on the table *F*, and as it is pressed through the hole in the table it takes the shape shown at *E*. A small oil furnace is located near by to heat the work; about 250 J-hooks

can be bent in one hour. This machine was designed by C. B. Landrum, foreman of the blacksmith shop.

PNEUMATIC TOOL FOR FLARING BOILER TUBES.

The tool shown in Fig. 12 is used in a long stroke hammer for flaring over the ends of flues in the firebox. It saves considerable time and makes a first-class job, only a few strokes being necessary to do the work. Three hundred flues can be prepared with it for the heading tool, in one hour and ten minutes. A great deal of trouble was caused at first by the shank of the tool breaking, but this was corrected by making the tool in two pieces, as shown in the illustration.

SOLID PISTON HEADS.

As our engines go through the shop we are doing away with the built up piston heads and are replacing them with those of the solid type, shown in Fig. 13. In this way we are doing away with the bull rings, follower and piston head, making a much

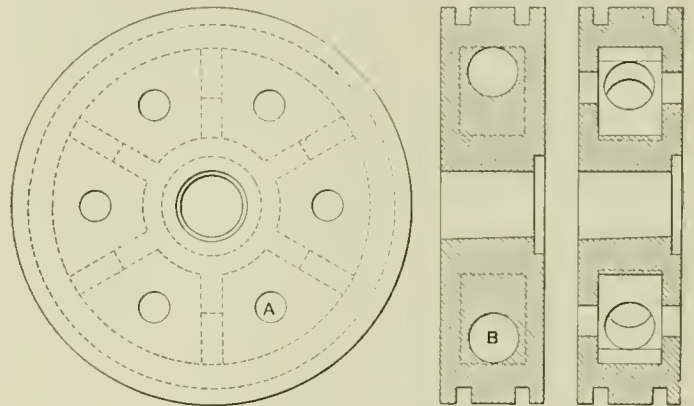

Fig. 13—Solid Type Piston Head.

more satisfactory arrangement. The solid heads are cast with six holes, as *A*, and have a hole through each web, as shown at *B*. The holes *A* are tapped out after the casting has been cleaned and studs are screwed in, being riveted over at each end.

This makes a very strong head and is finished on the boring mill in two and a half hours.

LOW WATER ALARM.

Statistics on boiler explosions, both stationary and locomotive, show that in a large proportion of cases the original cause was low water. This, of course, is generally due to the inattention of the engine crew, but sometimes results from the stopping up of the passages to the water level indicator. For use in either case, an alarm apparatus which automatically blows a whistle when the water level reaches a certain pre-determined point, has been applied to a number of locomotives on the Southern Pacific. It has been in service with excellent results for over a year, and is now being applied to all new power on this road and to some locomotives on other roads. The apparatus was designed at the Los Angeles shops of the Southern Pacific, and has been found suitable for use on stationary boilers as well as locomotives.

As shown in the illustrations, it consists of a cast iron cylindrical chamber with adjacent passages for the circulation of water and steam, which encloses a steel cylinder *B*, containing about 3 lbs. of mercury. There is a 1/4 in. space at the sides and bottom between the mercury cylinder and its enclosing casting. A 5/8-in. passage at the bottom leads through *A* to the connection on the boiler, which is located at a point below which it is believed the water should not be allowed to drop. The method of determining this point is shown in the general drawing and depends on the grade on which the locomotive is to be operated. It may be seen that the alarm is thus given before the crown sheet is bared, differing in this respect from fusible plugs. Above the

mercury is a half-inch piston suitably fitted with packing, which passes through an adjustable connection to the stem on a half-inch steam valve. This valve is held on its seat by a steel spring of sufficient size to force the piston and connecting parts down as the mercury recedes.

The space around the mercury cylinder contains water which is

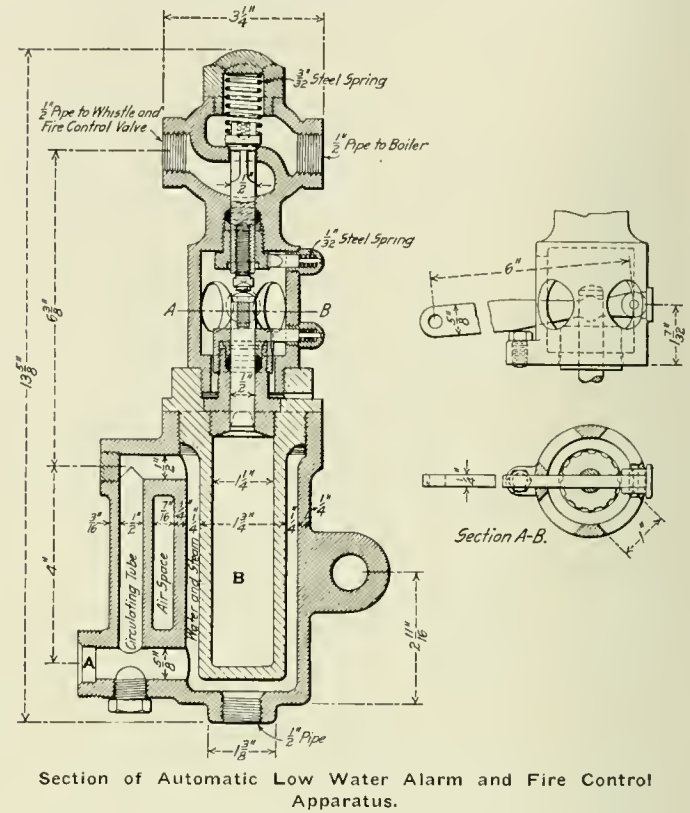
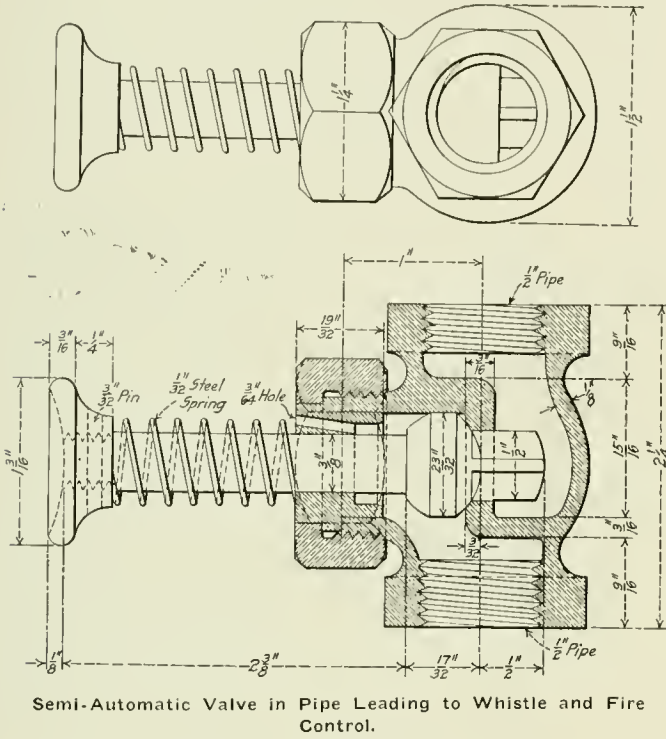

entrapped from the boiler, and since there is no opportunity for circulation, it becomes cool by radiation and is held in place by the pressure in the boiler up to the time the level drops below the opening to the apparatus. When this occurs the water is replaced by steam, which can circulate through the passages pro-

and cooled down. When the steam pressure on the semi-automatic valve is then released through the leakage port, the spring raises the valve from its seat and puts the whole apparatus into its original condition ready for service.

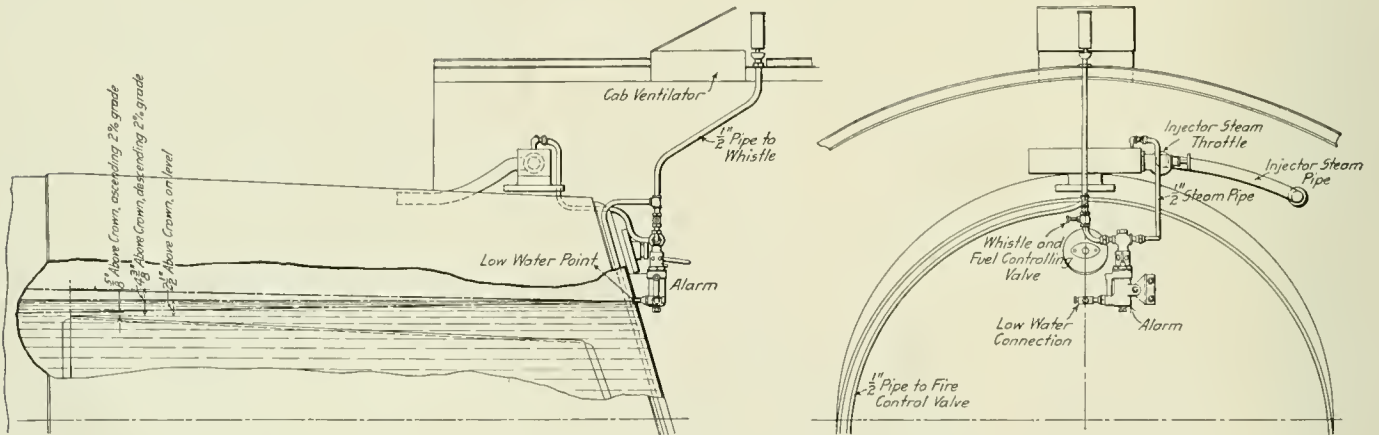

vided for the purpose, and the increase in temperature expands the mercury, forcing up the piston and raising the steam valve, thus allowing the steam to pass to a whistle and to a valve on the oil supply line in case of oil-burning locomotives, or for opening blow-off valve for spraying the fire in case of a coal-burning engine. The whistle will continue to blow and the spray continue over the fire as long as there is any steam in the boiler, unless the semi-automatic valve, which is shown in detail in one of the illustrations is closed. When this is done the flow of steam is shut off and the water level can be brought up to the proper

LOCOMOTIVE FUEL OIL IN RUSSIA.—Nearly one-fourth by weight of the locomotive fuel used in Russia in 1908 was petroleum or petroleum residuum. A ton of petroleum costs as much as 2.55 tons of coal, and in Asia it serves for a little less than twice as many miles, but in Europe for only 64 per cent. more, perhaps owing to a greater use of residuum in Europe. Sixty-nine units of petroleum are said to be equivalent to 110 of English coal, and to 273 of a coal produced in Eastern Siberia. The cost of locomotive fuel in 1908 was 14.78 per cent. of the total working expenses of the Russian railways.

LEGISLATION ON MECHANICAL MATTERS

Explanation of the Conference Committee Methods Lately Utilized for Handling This Class of Legislation*

BY C. A. SELEY

Mechanical Engineer, Rock Island Lines.

The regulation of the railways by means of administrative bodies divides itself naturally into two general classes. The one has to do with that feature of the regulation in which is involved a conformity with the law as interpreted by the courts, and the other with the administration of the physical and as distinguished from the legal. The first of these has to do mainly with the prevention of discriminations and other abuses, while the second touches the railways in the matters of every-day life, and the influence extends down into every portion of the service. As the speaker is not a lawyer, it is not his purpose to cover more than one phase of the subject wherein the engineer has been useful in shaping the details of legislation.

The laws which regulate the various functions of the railways are administered mainly under the control and direction of the Interstate Commerce Commission. Many of these require elaborate codes of rules and explanations for their proper understanding and administration, and the inquiry naturally arises as to how these rules and instructions which have to do with technical details were originally derived. Surely it would be difficult to find a department of the government dealing with more diverse subjects and on which there must be a multitude of questions arising from the various subjects covered by the regulation which the commission is empowered to direct. One might expect to find a very competent staff of legal, accounting and engineering talent in connection with such a department of the government, and there may be, but the mechanical engineer is not strongly in evidence.

It is self-evident that without the expenditure of great sums of money and a great deal of time the government cannot obtain the services of a body of experts which can compare in ability with those already in the service of the railways; and, second, that even if they could obtain such a body of experts, to bring these men to the point which has been reached by the railways' through so many years, would take another long period. As a result, it becomes peculiarly an act of good citizenship on the part of the railways to place their expert knowledge at the service of the government.

Some two years ago the idea was advanced that inasmuch as it was clearly evident that public policy required the enacting of laws and regulations further controlling the activities of the railways it might be well if the men engaged in the practical operation of the roads would interest themselves in the form which the statutes proposed to be enacted should take, not with a view to necessarily making them less comprehensive, but with the idea that the intrusion of practical thought in their formation might result in their being workable to a certain degree. At that time this was considered a very radical view; nor was it completely formulated in the first instance. This policy developed a further field of co-operation, in the fact that under most of the legislation covering physical regulation there was involved the formulation of rules and standards for the government of the carriers, and in these formulations the experience of practical men would be just as valuable, and in fact more so, than in the consideration of the primary law itself upon which the regulations were based.

Acting on this theory, during the Sixty-first Congress it was the policy of the roads whenever any bill was under consideration relating to railway operation to present before congressional

committees, men who from their knowledge and experience could tell such committees exactly what the proposed legislation meant and what the effects thereof would be. There is no question as to the necessity for this procedure. As an illustration, it is a matter of record that it was necessary for one of these witnesses to explain to a committee that the water in a locomotive boiler was not contained in the tubes; and to this co-operation between congressional committees and witnesses for the railways may be attributed the fact that such legislation affecting the physical operation of railways, as passed the Sixty-first Congress, was intelligent and of a character that it was possible to enforce without testing the matter in the courts. Under some of these statutes it was necessary to formulate certain standards and rules, notably the standards of United States safety appliances, and the rules for locomotive boiler inspection. The first of these was under consideration before any of the others. There was serious danger that the United States safety appliance standards would be formulated without due consideration as to practicability and difficulty of enforcement, and for some time there was very serious question as to whether any co-operation or assistance from the railways would be accepted on the part of those responsible for the formulation of such standards. However, after this principle was established the proceedings were rapidly conducted, and the benefits of such an arrangement were so manifest that in every case which has occurred since that time not only has this co-operation been welcomed, but in many cases has been sought by the representatives of the departments of the government charged with the enforcement of the laws.

United States safety appliances have been referred to; these are the ladders, handholds, sill steps, running boards, etc., on railway cars and locomotives. The Master Car Builders' Association, a representative body, had for years illustrated and described consistent arrangements of these appliances in its proceedings as standards, and, if all railways had fully complied with the requirements of these standards on their rolling stock it is not likely that the recent legislation on that subject would have been enacted. It is a fact that the standards of the M. C. B. Association are not obligatory on the railways, but its practice in respect to the safety appliances was satisfactory to the Interstate Commerce Commission for many years as complying with the law. The labor organizations engaged in railway transportation developed a feeling that this was not sufficient and succeeded in persuading congress to pass an act directing the Interstate Commerce Commission to prescribe the number, dimensions, location and manner of application of these various appliances, so that they would be uniform as nearly as possible on all cars.

The standards were to apply on all cars built after July 1, 1911, and the commission was authorized to name the time limits in which equipment built before that date should be changed to comply. The latter equipment, including about two and one-half millions of freight cars, was by far the most important feature, as it would be comparatively easy to change drawings and specifications for new equipment not yet built. To go over every old car and make the necessary changes to comply with a set of rather rigid requirements involved enormous expense, both direct and indirect. The secretary of the Interstate Commerce Commission asked for a committee from the railways to assist in compiling the proposed standards for new cars, and when this

*Part of an address delivered before the engineering students of the University of Illinois, January 4, 1912.

work was done the Interstate Commerce Commission had a hearing at which these proposed standards were submitted in the usual form with opportunity for argument.

The railways present by their representatives at once took the ground that the matter was not in shape for a hearing and final determination; that while they could comply with the requirements on new cars, that the rigidity of the standards should be modified, variations allowed, and that liberal time should be granted for changing the older cars. Some little time was taken in discussing the details, but it all proved that the position of the railways was correct and the hearing was adjourned to permit of a conference committee handling of the matter. This committee consisted of fifteen members, five railway mechanical men, five Interstate Commerce Commission inspectors and five labor organization chiefs, representing the locomotive engineers, firemen, conductors, trainmen and switchmen. The conference lasted several days with much argument and mutual concession and settled the matter entirely save two or three points on which no agreement could be reached. These and the agreed points, together with the respective arguments, were submitted to the Interstate Commerce Commission in a second hearing, and an order was issued under which the railways are now working.

The labor organizations were also not satisfied with the inspections of locomotive boilers, as made by the railways; at least they apparently could not understand why the engine crews were generally blamed in case of boiler explosions, and they determined to have a federal boiler inspection law. Several bills were introduced in Congress, but by intelligent presentation of information and records of the roads' methods of inspection and tests at the committee hearings the more radical and unreasonable bills were successfully opposed. It was, however, recognized by the railways that they could not consistently oppose reasonable regulation in the matter, and conferences were held with those interested to determine the essentials of a reasonable boiler inspection law. The Master Mechanics' Association had reported a set of minimum rules applying generally to all locomotives based on general practice. These were considered together with methods of administration, force and the scope of their duties, etc., and the present law was framed to include these considerations and was not opposed by the railways.

The law provided that the Interstate Commerce Commission should formulate and issue the rules under which the railways should inspect, test and report their boilers. The five railway mechanical men who had conducted the safety appliance negotiations met with the boiler inspectors of the commission and the labor organization representatives and agreed to the code of rules which by order of the commission now regulates our boiler inspection.

I will not weary you with the detail of all the routine necessary in those negotiations; of the calling of a general meeting of the railways to settle preliminaries, of the authorizing of the conference committee to represent all the roads, of the reporting to the general meeting for approval of the results reached in conference before they are submitted to the commission, and the final discharge of the conference committee, so far as that subject is concerned after the commission's order has been issued.

Recently the post office department asked for a conference with the roads in regard to formulating specifications for the construction of steel full postal cars and for the uniform arrangement of the equipment of both full postal and apartment cars. The matter was taken up by a general meeting of the roads who again authorized the conference committee of mechanical officers, reinforced by a couple of mail traffic managers, to represent them, which they did, first ascertaining the scope and extent of the general features desired to be covered. The committee, assisted by the engineers of the car building companies, who cheerfully gave of their experience and knowledge, then formulated a specification for steel full postal cars. After the specification was completed and unanimously concurred in by all members of the committee and by the assisting engineers of the car build-

ers, it was referred to and approved by a general meeting of the railways. It was then submitted to the committee of the post office department and thoroughly discussed in an extended conference. It will doubtless take some little time to entirely settle the matter, as the specification is very complete and voluminous. The post office department committee found it rather difficult to understand and assimilate the engineering portions of the specification relating more particularly to the strength of the structure, as section moduli was a term not ordinarily used in post office transactions. They were surprised that we could not give them direct comparisons of the strength of wooden and steel cars and had hoped that we could help them to arrive at a single standard of design. The specification was printed in the December issue of the *American Engineer*, page 490, and in the November 24 issue of the *Railway Age Gazette*, pages 1049 to 1051.

The work of the committee had to include several important considerations. First, the post office department had accepted several designs of steel postal cars, none of which had been demonstrated as a failure. Hence, it was obvious that the specification should be broad enough to include all of the designs.

Second, the specification, in order to be authoritative, should have the approval of all the designers of the various types included, and also of the users of the cars who by experience in handling and maintaining them could judge of their suitability to the service and the general results of the designs in normal operation as well as in repairs and wrecks. We were fortunate in having the unanimous approval of all the engineers and of the railways back of our specification.

Third, due regard must be paid to the evolution of steel car construction in the future, and the form of the specification should not be such as to bar progress in design and improvement in materials.

Fourth, Congress may pass one of the several steel passenger car bills that have been introduced, and doubtless the postal car specification would be studied as to its application to other types of steel passenger equipment cars.

It is admitted that as the postal car is generally placed next to the engine it is in a place of greater hazard than are other cars in the train in the case of a head-end collision, and we agreed to furnish a greater measure of strength in the end framing to minimize the danger of telescoping. Aside from this, however, we do not feel that the structure of a postal car should necessarily be stronger than that of other types of cars and the best results can be obtained by having consistent strength throughout the train.

The public has gained some very erroneous opinion about the strength of steel cars. If they were in fact so strong as to resist deformation in a severe wreck it must be apparent that they would pass the shock along to the contents of the cars, human and otherwise, in dissipating the stored energy. It has been amply demonstrated by experience in several wrecks that the amount of damage and injury is greatly lessened by providing a yielding resistance in the end of the car, such as the folding up of the vestibule or platform or partial failure of the end construction. If these parts are so strong as to resist failure, the shock will be transmitted until it is dissipated at a greater risk to life and the contents of the cars.

The principal advantages of steel passenger car construction are the absence of splintering and less danger of fire from external causes in case of wreck. Danger has been feared when both wooden and steel cars are used together in trains, but a wooden sleeper has been known to telescope a steel sleeper, and a prominent lumber association has spread broadcast photographs showing how well a wooden dining car in an otherwise steel train had withstood injury in a severe wreck. The truth is that wreck conditions are seldom so similar as to permit direct comparison, and, while the wooden cars are the result of an evolution covering several decades, the steel car is of very recent origin, and, that we can reasonably expect improvements in

design, reduction in weight, and cost as has been the case in development generally of equipment, machinery and other structures.

The postal car specification provides that the underframe is to be calculated on an assumed end shock equivalent to 400,000 lbs. static load, which will take care of very heavy switching and service conditions, but not of extreme collision shocks, which should be dissipated by end failure. Thus it will be seen that the duties of the conference committee have been so varied as to require a considerable range of practical information as well as technical and engineering knowledge. The handling of these questions in the conferences required skill in debate and argument suited to the caliber and character of the people with whom issue is raised.

As the conference committee represented all of the railways, the members must of necessity take the broad view and not just that of their own little or big road, as the case might be. The personnel of the committee included the highest officers in the mechanical departments of such railway systems as would practically represent all sections of the country, and while the time necessarily devoted to these protracted conferences was a heavy tax, both on the individual and to his company, yet the results obtained have been so satisfactory as to justify the expenditure of time and the methods employed.

It cannot be too strongly emphasized that the amount of work

That this co-operation has been willingly afforded is clear evidence of the desire of the railway corporation to contribute to the success of the governmental agencies upon their administrative side, and in this respect the railways, which have been a mark for every petty politician for so many years, have demonstrated the appreciation on the part of their officers of their duties as "citizens of no small country."

IMPROVEMENTS IN THE STREET STOKER

When the Street locomotive stoker was first designed it was the desire of its inventor to eliminate as far as possible the physical efforts of the firemen, and the original conception included a method for automatically transferring the coal from the tender to the elevator. The necessity of using the ordinary run of mine coal, however, made it impossible to fully carry out this idea and until such time as crushed coal could be furnished on the locomotive, it was decided to install the crusher which has formed a part of this appliance.* While the labor involved in placing the coal in the crusher is very light, this arrangement does not fulfill the ideas of the inventor and was looked upon as a temporary expedient to be used until the time arrived when there would be sufficient stokers in operation to make the preparation

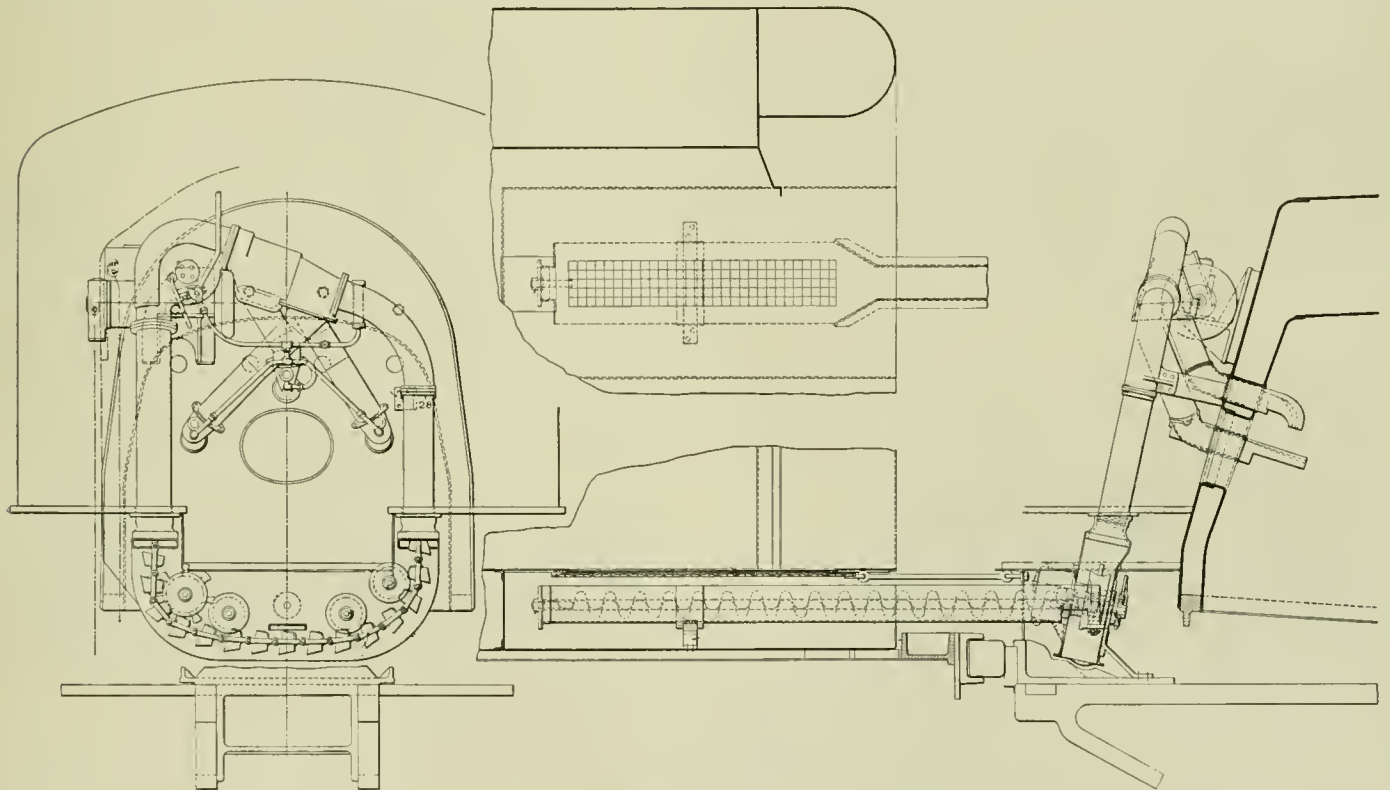

Street Locomotive Stoker of the Screw Conveyor Type.

committed to the various governmental agencies through legislation is vastly in excess of the capacity of the present organization of such agencies to perform satisfactorily. The administration of such vast interests, which should be committed to men of first rate ability in some cases, and in others to men of thorough technical equipment, is left to the tender mercies of men who, however well meaning, have not the equipment necessary for the effective administration of their offices, nor under the conditions with regard to compensation which now exist can these agencies hope to secure men of the type desired. Under these circumstances, the cordial co-operation of the railway administrations is practically essential to prevent utter demoralization in the transportation industry.

of the coal at the chutes advisable. Locomotive stokers are now becoming more common and Mr. Street has perfected a conveyor for use where suitable coal can be obtained which does away with the separate engine and the crusher on the tender, as well as making it possible to reduce to some extent the size and weight of the stoker proper and also placing the lower hopper of the elevator more convenient for inspection.

This new conveyor is of the screw type, the screw being located in a heavy sheet iron trough which extends back from the locomotive underneath the floor of the tender, as

*Illustrated and described in the *American Engineer*, June, 1911, page 232, and in the *Railway Age Gazette*, May 26, 1911.

is shown in the illustration. This trough is pivoted on a strong pin attached to the lower hopper of the elevator casing and rests on a wrought iron support bolted to the floor of the tender. A universal joint is provided for driving the screw, making the whole apparatus flexible to accommodate the different relative positions of the locomotive and tender. Over the trough is a screen made of $\frac{1}{4}$ in. wire, and having a 2 in. square mesh, which is secured in the floor of the tender and is covered by sliding plates 10 in. x 12 in. in size, so arranged that any one of them may be opened as desired

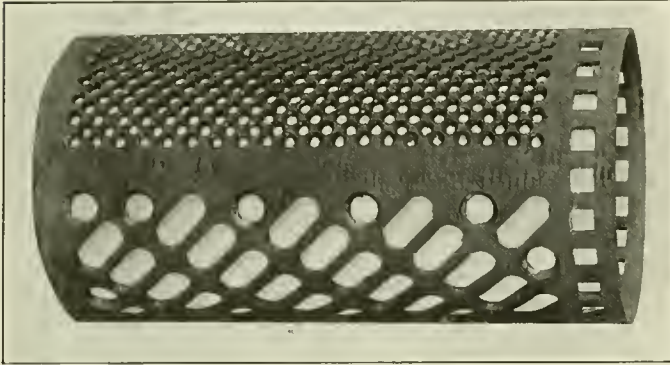

Discharge Pipe Screen; Street Locomotive Stoker.

and required by the position of the coal. The screen is not rigidly fastened to the floor and an agitator is provided which keeps it in motion when the locomotive is running and thus prevents the coal from bridging and clogging up.

The conveyor is driven through a sprocket wheel mounted on an extension of a shaft carrying the guide wheel for the elevator bucket chain. This sprocket drives through a gear box which permits three different speeds of the conveyor. The elevator engine is operated at a constant speed at all times. The handle from the gear box is located at one side of the fireman's seat and enables him to change the speed of the conveyor and therefore the amount of coal fed into

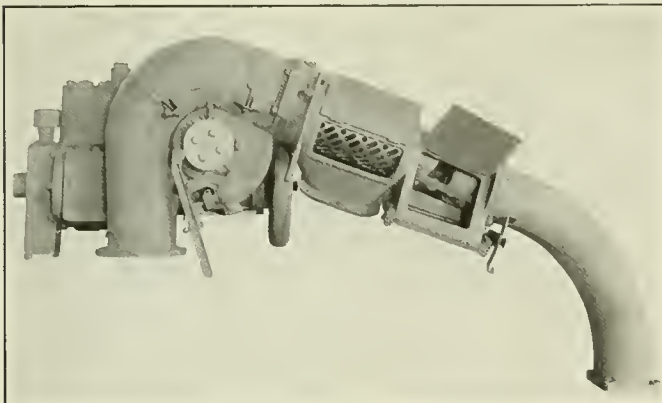

Front View of Elevator Engine, Sprocket Wheel Casing, Discharge Pipe, Return Bend, Controller and Controller Cam.

the feed box without leaving his seat. Motion is transmitted from the gear box to the conveyor by a link chain and a pair of sprocket wheels.

Reference to the accompanying illustration and to the previous description of the stoker will show that it has been possible to locate the lower hopper very much higher; in fact, to place it above the frames and just under the cab floor, which reduces the length of the elevator and the weight of the whole apparatus, as well as permitting a ready inspection of the hopper by removing a section of the cab floor while the locomotive is in operation. Movable slides have been provided in the hopper for this purpose and a

steam jet is fitted for thawing it out in case of freezing. When taking coal the plates over the conveyor hopper are closed, covering the entire space; when ready to start the stoker the front plate is slid forward uncovering an opening and allowing the coal to slide down into the conveyor until the slope will deliver no more; the second plate is then drawn forward and the others in rotation as the supply of coal is diminished. At no time is there an opening to the conveyor greater than 10 in. x 12 in., which prevents it from becoming overloaded and clogged.

Attention was directed in connection with the Street stoker on the Chesapeake & Ohio Mountain type locomotive (*American Engineer*, October, 1911, page 381), to a new design of distributor consisting of a circular screen in the elevator pipe where the buckets discharge their load. At that time there were no photographs available showing this screen and its operation. It is now illustrated herewith. This screen has four different sizes of openings and may be revolved to bring any one of these sides into operation the coal passing through the screen being carried only to the distributor which feeds the back part of the firebox. Such coal as does not pass through the opening at the bottom of the screen will be distributed to the two side distributors feeding the forward parts of the firebox. The distribution between these two is controlled by a hinged plate capable of adjustment by hand, so arranged that the rolling of the engine or inclination of the track does not affect its operation.

NEW FORGED TWIST DRILL

A high speed forged drill which has shown remarkable results in practical service has been developed after a long period of experiment by Jos. T. Ryerson & Son, Chicago. Starting with the plain flat drill, used principally for rail drilling, this company has gradually developed the forged drill up to the present product, which it is believed fulfills all requirements, both as regards capacity and durability. The drill has the same general shape and cross section as the milled drill now generally in use, but differs from it in that it is forged complete. It is believed that considerable drill breakage is due to the poor quality of material found in the center of bar stock which, after the milling, comprises a considerable portion of the drill. The

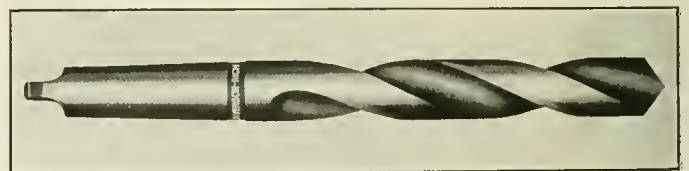

Solid Forged Twist Drill.

forging process eliminates all chances of such flaws, besides refining and improving the metal and retaining the continuity of the fibers. So far as appearance and general shape go, it is exactly the same as the most improved form of milled drill. It has a cutting lip of the same form and is constructed with the same clearance.

Records of practical service with these drills show some rather remarkable results. In one case, 6 $\frac{13}{16}$ in. drills bored 40,000 holes through structural beams from 1 in. to $2\frac{5}{8}$ in. in thickness, and were still in good condition. In another case a $2\frac{1}{4}$ -in. drill bored three holes through a 40-point carbon steel block, which was $8\frac{3}{4}$ in. thick, in 7, 7, and $6\frac{1}{2}$ minutes respectively. A $\frac{3}{4}$ -in. drill made 600 holes through a $\frac{3}{4}$ -in. steel bar without sharpening; the ordinary twist drills would have required sharpening after 50 holes. A number of users report that they have attempted to break the drill in use, but have found that its capacity was beyond that of their drilling machines.

REPAIR SHOP IMPROVEMENTS AT BUFFALO

An Account of the Improvements That Have Been Made in the Arrangement and Equipment of the Pennsylvania Shops at Buffalo, N. Y. Awarded the Second Prize in the Competition on Shop Improvements During 1911.

BY C. C. LEECH.

Ground was broken for a new power house at the Buffalo shops of the Pennsylvania Railroad in November, 1910. This was the beginning of improvements that have continued ever since and are not yet entirely completed. The general grouping of the buildings and tracks prior to the changes is shown in

was the necessity of crossing the Erie Railroad at this point. Most of this delay is eliminated by having better outgoing track facilities.

When the old sand house was located, as in Fig. 1, it was necessary in order to sand engines coming in on the ash pit, to move

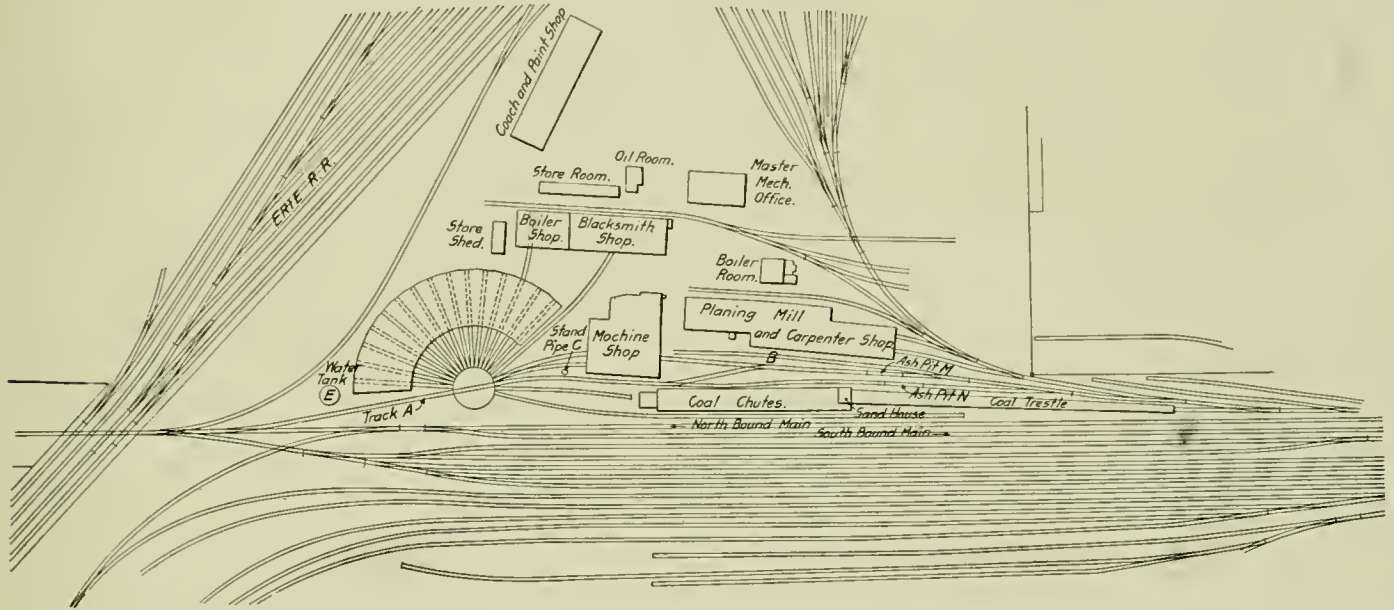

Fig. 1—Old Arrangement of the Buffalo Shops; Pennsylvania Railroad.

Fig. 1. The arrangement in Fig. 2 shows them as they are now. A conservative estimate of the increase in general efficiency of the plant due to these changes has been placed at 30 per cent. It will be noted in Fig. 2 that the ground formerly occupied by the old machine shop and planing mill is now used for storage

them down to switch B and then back along the track, an opposing movement, to reach the sand house. This arrangement not only caused great loss of time to the engines, but also blocked the way of engines coming in on ash pit N. The new location of the sand house is the logical one and the best practical solu-

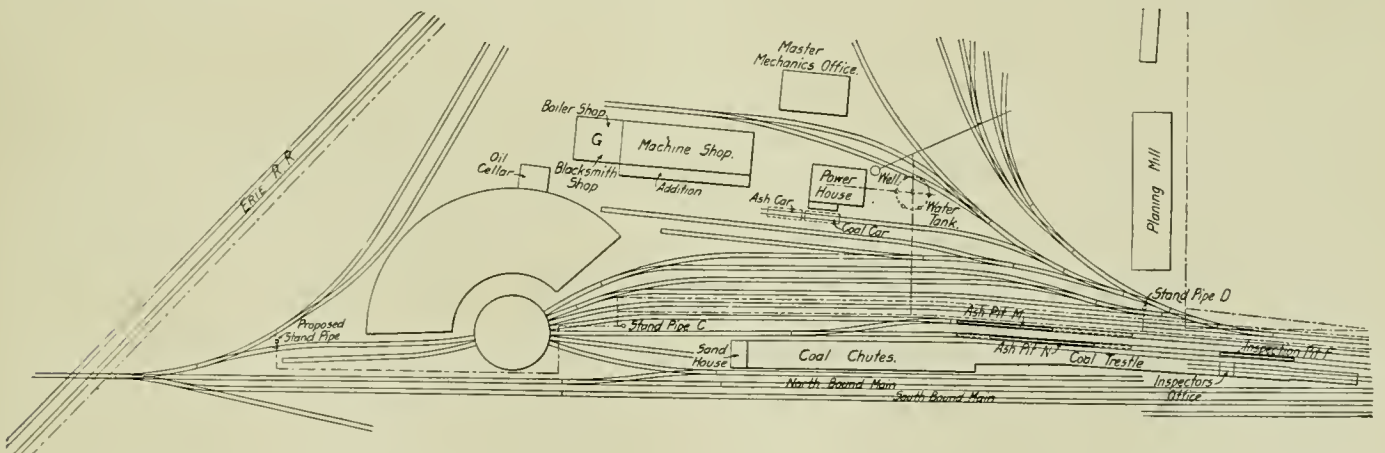

Fig. 2—New Arrangement of the Pennsylvania Shops at Buffalo, N. Y.

tracks, which provide room for 40 engines, as compared to 15 in the old arrangement. Further, in the old plan there were fewer facilities for engines leaving the storage yard or for those coming out of the engine house, it being necessary to take all of them out over track A to reach the main track. Another bad feature of the previous arrangement and a cause of much delay

tion of the problem. It is of modern construction and has a steam-drying system instead of using a coal stove, which was always an element of danger. The sand, after being dried, is forced by compressed air into the bins overhead; from there it runs by gravity to the sand box of the engine. Another improvement was made by raising the coal chutes some 2 ft. higher to

accommodate the larger and higher types of locomotive tenders. Coaling is now done in half the time that was formerly required, the increase in the height of the chutes giving a more rapid movement to the coal.

A stand pipe is shown on both plans at C; an additional one has been located on the outgoing track at D, Fig. 2. This is a

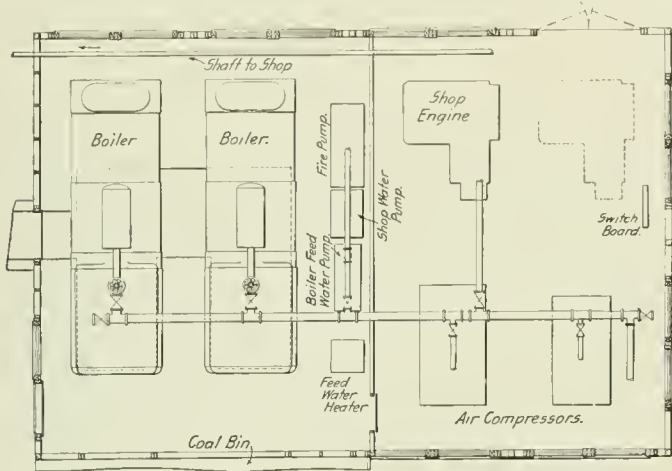

Fig. 3—Arrangement of Power House Equipment.

particularly important improvement both for outgonig engines and also for yard switching engines working in the immediate vicinity. Much time is saved by not having to go back to column C or to the water tank E. A new concrete inspection pit was put in at F, and a pneumatic message tube has been installed between the engine inspector's office and the office of the engine house foreman. Inspection reports are now sent to the fore-

heating surface, 3314 sq. ft.; grate area, 66 sq. ft.; steam pressure, 160 lbs.; size of firebox, 9 ft. x 7 ft. x 8 ft. They carry 125 lbs. pressure, but are rated at 160 lbs. The engine room contains two air compressors, a 700 k. w. generator, a shop stationary engine, a hot water heater, a fire pump, a cold water pump, and a hot water feed pump for the boilers. The general arrangement of the power house is shown in Fig. 3. Formerly the large stationary engine, one of the air compressors, two small generators and a small stationary engine were grouped in the engine room of the old machine shop, while the other air compressor, together with the fire pump and hot water pump, were located in an old power house some distance away. The cold water pump was placed at the extreme end of the engine house. The collection of these machines under one roof is a decided increase in efficiency.

A new steel water tank of 100,000 gals. capacity has also been erected just south of the power house, its height giving the water at the several stand pipes a decided increase in pressure. The old machine shop building was torn down completely, and all the machinery moved into the building which was formerly occupied by the blacksmith and boiler shops. The old machine shop building had been added to and enlarged at various times as the increase of business demanded, but it was of such an odd shape and so crowded with machines that the work was always much retarded. The problem of getting sufficient light was always a difficult one. Men cannot work to advantage in a poorly lighted shop, either by day or night, to say nothing of the increased hazard in handling the work at the benches and machines.

It was found that the blacksmith and boiler shop departments could be concentrated at one end of the building G, the general arrangement of which is shown in Fig. 4. This gave a clear floor space of 106 ft. x 43 ft. for the machine shop and furnished an

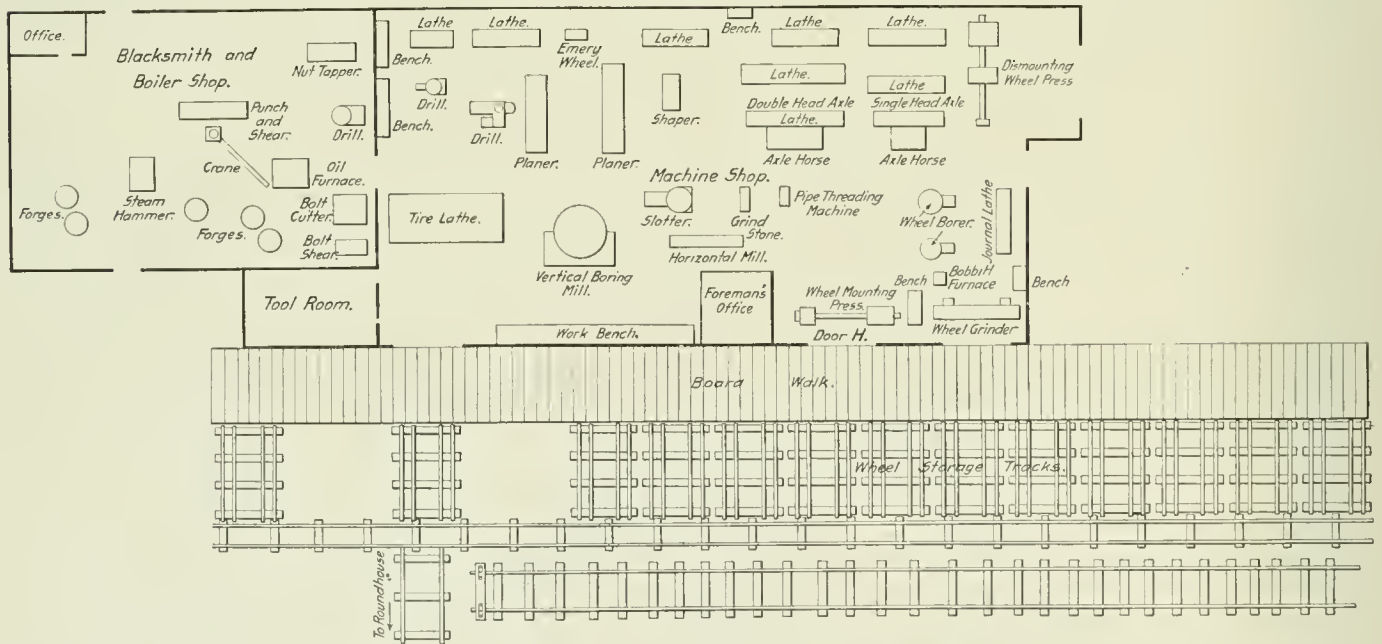

Fig. 4—Layout of Machines in Machine, Blacksmith and Boiler Shops.

man's office in a few seconds, thus saving the time it took the inspector to deliver them.

The new power house shown in Fig. 2 is much larger than the old one, and in it are installed two 350 h. p. stationary boilers of the Pennsylvania standard, which replace six old and worn-out locomotive boilers, tremendous coal eaters, and using thousands of gallons of water hourly, and yet not producing the power they should. Their general dimensions are as follows: Diameter, 96 in.; 314-3 in. flues; internal heating surface of flues, 3062.7 sq. ft.; heating surface of firebox, 251.3 sq. ft.; total

opportunity to group the machines logically and to lay out the floor space to the best advantage for handling the work. An addition, 130 ft. long by 12 ft. wide, was added to the west side of the building to take care of part of the car wheel machinery, the foreman's office, a long work bench and the tool room. A wide aisle is provided through the center of the shop from end to end. A large number of overhead tracks and runways equipped with pneumatic lifts, besides some half dozen cranes, have been installed. Part of this overhead system pertaining to the handling of car wheels was shown in the Shop Section of

the *Railway Age Gazette*, December 1, 1911, page 1136. On the same side of the building as the new addition, a sidewalk 12 ft. wide was built. This is now the thoroughfare connecting the engine house, machine shop and other buildings beyond, and is a marked improvement over the former narrow walk. It facilitates the handling and trucking of material to and from the storehouse, machine shop and engine house, an important detail in the interests of economy.

Extending out from, and at right angles to this board walk is a series of tracks for the storage of mounted wheels as they are rolled out of door *II* finished and ready for the cars or engines. There are 13 tracks, holding 117 pairs of wheels. A four-wheel truck running on a narrow gage track is located at the outer ends of these tracks. The floor of the truck is so arranged that a pair of wheels may be rolled on it from the storage tracks; the wheels are kept from rolling off by the flange dropping into square holes in the floor of the car. The truck wheels run on roller bearings, so it is an easy matter to push the truck along, and deliver a pair of wheels to the engine house, or at the opposite end of the track for loading. Further improvements will probably include a loading crane at the loading track.

The building used as a planing mill was formerly about 250 ft. long, as shown in Fig. 1. About 75 ft. of this was torn down and the balance of the building was moved some six hundred feet to the new location, shown in Fig. 2. A new roof was put on, new ends were put in and a new floor was laid. A Westinghouse high speed automatic engine of 90 h. p. was installed to furnish power. Here again an opportunity was presented to place the machines to better advantage than in the old location, and the result is a creditable shop in which everything is arranged to handle the output systematically and always in an outgoing direction.

The blacksmith and boiler shops have a floor space of 60 ft. x 43 ft., the arrangement of forges, steam hammers and other tools being shown in Fig. 4. The jib crane which formerly only served the punch and shear, has been so located that it now reaches one end of the oil furnace, one of the forges, the steam hammer and both ends of the punch and shear, thus more than doubling its usefulness and efficiency. A new iron rack has also been installed outside of the building.

New offices have been completed for the foreman of the car department and the corps of clerks in a more central location for the repair yards, mill and coach shop. There is also a locker room for the workmen in this building. Another improvement at present under way is a large sanitary washroom and rest room for the engine house forces. The general plan of improvement also includes the placing of four water columns to be operated from a steel bridge supported on concrete piers; it will be located just south of the shop yards. These columns will allow four locomotives to take water at the same time.

FUSIBLE PLUGS.—Pure tin makes the best filling for the fusible plugs of steam boilers, alloys being objectionable because those that have been tried for the purpose appear to undergo a gradual change when exposed continuously to heat, so that their melting points do not remain constant. Four closely accordant and apparently quite accurate determinations of the melting point of tin have been made, with the following results:

| Date. | Observers. | Melting Point. |
|---------------|------------------------------|----------------|
| 1892 | Callendar and Griffiths..... | 231.7 deg. C. |
| 1895 | Heycock and Neville..... | 231.9 |
| 1900 | Reinders | 232.0 |
| 1902 | Kurnakow and Puschkin..... | 231.5 |
| Average | | 231.8 deg. C. |

This corresponds to 449.2 deg. Fahr. A tin-filled plug will not melt out from the natural heat of the steam until the pressure of the steam becomes 363.3 lbs. per sq. in.

COACH CLEANING.*

BY J. H. WHITTINGTON,

Master Painter, Chicago & Alton, Bloomington, Ill.

Terminal coach cleaning should be conducted according to a fixed system in order to insure the proper sanitary conditions. We use the following system for handling the different classes of this work. Class *A* should be made at the end of each trip. Class *B* should be done when the car is too dirty to await cleaning under Class *C*, which is a general cleaning given the car every three months. The instructions for each class of cleaning accompany this article. Forms are used in making the monthly reports which show the total number of cars cleaned in each class, together with the total cost per car. One copy is sent to the office of the superintendent of rolling stock, or to the officer who controls the car cleaning department, and one copy is placed on file in the office of the terminal foreman making the report.

When the car receives a class *C* cleaning the place and date are recorded on a small piece of cardboard, which is inserted in a small tin slide about 1¼ in. wide by 3 in. long located at some convenient place in the car. If the car has received a class *C* cleaning before, the old card is forwarded to headquarters and a new one is put in its place. This system enables the office of the superintendent of rolling stock to keep a close check on the work. It makes no difference on what part of the system, or at which terminal a car may be when this class *C* cleaning is due. Each foreman must watch all cars to see that the three months are not overrun, and he must perform the work whether he has handled the car before or not. If there is any doubt as to the location of a car when the class *C* cleaning is due, the superintendent of car service can locate it. The following rules are followed for the different classes of cleaning:

Class A Cleaning.—All passenger equipment in regular service shall be thoroughly cleaned after each trip at such points as have been provided with the necessary facilities. That is, they shall be given a class *A*, or ordinary cleaning, such as dusting the car, seats and seat backs; removing, cleaning and replacing the aisle strips; cleaning out under the pipes, washing the window sills and the seat ends or arms, mopping the floor and cleaning the glass. Cuspidors should be washed with a solution of ½ pint of a good disinfectant to each 2 gals. of water used. The same solution should be used in the lower parts of the toilet rooms and the hoppers. Toilet rooms must be supplied with a sufficient amount of toilet paper. Water coolers should be emptied and washed out with scalding hot water and refilled with ice and water. Drinking glasses must be washed both inside and outside.

All cars requiring linen and soap must have a sufficient supply before leaving any terminal. All drip machines in toilet rooms shall be kept full of the drip fluid disinfectant. All lamps must be carefully looked after, cleaned, filled and put in good condition, the wicks being evenly trimmed. Ice-boxes and refrigerators in the cafe, dining or private cars shall be cleaned regularly after each trip. Air spaces in the provision boxes shall be kept covered with a perforated sheet of metal or wire netting to avoid anything falling in them where it cannot be easily removed. Special care must be taken in the method of cleaning the seat backs, cushions, curtains, carpets, etc., whenever it is necessary to do so. Vacuum cleaning is preferred in all cases. All brass and metal work must be cleaned and polished; the interior and exterior of the car and trucks, such as the steps, gas tanks, boxes, truss rods and other noticeable parts, shall be wiped regularly after each trip. Do not use oily waste on opalescent glass; wipe it with clean dry waste.

See that all the cars, equipped with either gas or electricity, have the gas tanks filled or the batteries sufficiently charged and that all the lights are in perfect order. The chair cars must have clean hoods or head rests put on at the end of each trip; all torn

*Entered in the *Railway Age Gazette* competition on Paint Shop Practice, which closed November 15, 1911.

and ragged hoods must be removed and replaced with new ones. The carpets in the dining, cafe or private cars must be removed and the floor mopped up with a disinfectant solution. The carpets must be thoroughly cleaned either by air or vacuum before they are put back in the car.

After an official or private car has completed a trip on an inspection tour, or with a private party, it must have special attention. Remove all the provisions. Close all the openings and thoroughly disinfect the interior of the car, after which remove all the linen, draperies, carpets, etc., and have them cleaned and ready to be put back in the car as soon as it has been cleaned. If the car is not wanted for service at the completion of this operation, roll up the carpet and put it in car, but do not put it down in place until the car has been ordered out of service. If this is done it will save numerous complaints caused by careless and indifferent persons walking through the car and not realizing the damage that may be done with dirty shoes.

Class B Cleaning.—This class consists of cleaning the outside of the body and washing the inside, if necessary. The operations are as follows: One man applies one gallon of shop cleaner with a car washer's brush having a handle 7 ft. long, commencing at the end of the car on the bottom and working up to the top of the letter board, being careful to get the cleaner in all of the corners. When about 12 or 15 ft. of the body of the car has been covered, another man should start with a brush and water and thoroughly wash off the cleaner. This may be done with a fountain brush or by dipping a brush in a bucket of water. When the car is dry, two men with trestles, plank and a good handful of waste well saturated with varnish renovator and squeezed out, should rub the surface well and evenly, and then wipe it dry, cleaning the glass as they go along. When a car is receiving class B cleaning, the headlining may be scrubbed with a good cleaning compound, using a brush and wiping it off with waste. This will carry the car through with pleasing appearance until a class C cleaning is due. When the headlining is cleaned it must be mentioned under "remarks" on the report form, giving the number of the car. Ceilings in the mail and baggage ends of combination cars must be scrubbed with soap and washed with water.

Class C Cleaning.—This class consists of a thorough cleaning of both the interior and the exterior of the car, and should be done every 3 months as follows: For the outside of the body, sash and glass, one man, with a gallon of shop cleaner and a car washer's brush with a long handle, should start at the end of the car and apply the cleaner, beginning at bottom of car and working up to top of letter-board, brushing the cleaner on evenly and in all the corners. When about 12 or 15 ft. of the car has been covered with the cleaner, another man with a bucket and a fountain brush should start to wash off the cleaner, letting the first man applying it keep about the same distance ahead to allow the cleaner time to soften up the dirt before it is washed off. When the cleaning process has been completed and the car is dry, two men should oil and wipe it off by thoroughly saturating a handful of waste in a varnish renovator, squeezing it out as dry as possible, and taking care to cover every part of the surface. Then wipe thoroughly with dry waste.

The glass may be cleaned at the same time to avoid going over the car a second time. Trucks, steps, gas tanks and supply boxes under the car must be cleaned in the same way. The interior of the vestibules must be cleaned in the same way as the outside of the body of the car. For interior cleaning, when the car is not very dirty, the headlining and all the wood work must be scrubbed with a brush, using a good cleaning compound and then wiping dry with waste. If it is very dirty and the dirt is hard to remove, use a scrub brush and $1\frac{1}{2}$ lbs. of soap to a gallon of water. Then wash off with clean water, and oil all the wood work with a renovator, wiping it thoroughly dry with waste. Wash the floor, cuspidors and hoppers, and spray the floor and the bottom parts of the toilet rooms and cuspidors. All uphol-

stered seats and backs must be blown or dusted out before the car is washed and oiled. All dining or private car food boxes, refrigerators, closets, drawers and cupboards should be washed with scalding hot water and treated with one or two per cent. solution of formaldehyde. The seat backs, aisle strips, water coolers, lamps, ice boxes, refrigerators, cuspidors and hoppers must have the same attention as in a class A cleaning.

AIR WASHER AND COOLER FOR PASSENGER CARS

The cars in the Santa Fe "Train de Luxe" are equipped with an air-washing and air-cooling apparatus which is intended to be used when passing over hot, dusty portions of the line. This device, which occupies only a small space, is located in a closet at the ends of the dining, sleeping and buffet cars, and consists of a sheet iron receptacle partially filled with water around which is a 3-in. space filled with ice, all enclosed in an insulated metal box. A small electric motor is suspended in a metal cylinder, open at the top and bottom, which forms the passage for the admission of air to the fan below. The motor is especially wound to be operated on the lighting circuit and runs at 1,200 revolutions per minute. The fan is 16 in. in diameter and ends in a small conical tube which projects into the water as is shown in the illustration. The rapid revolution of the fan

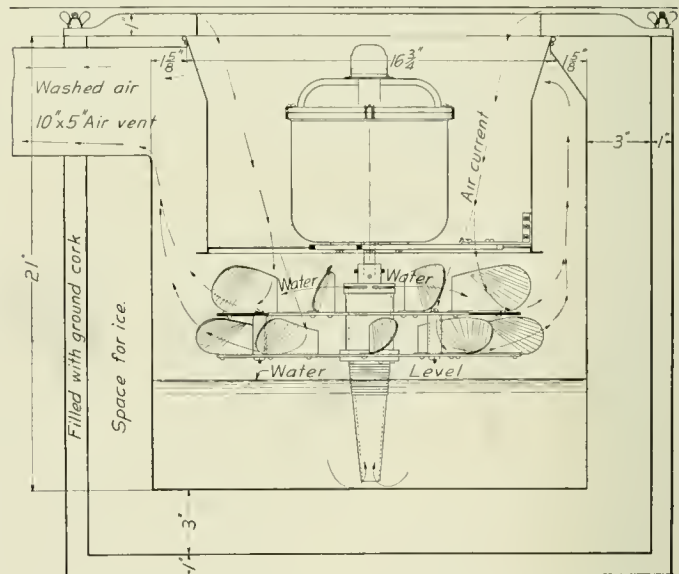

Air Washer and Cooler for Passenger Equipment.

causes the water to rise in the tube, and as it passes out through a narrow slot near the top of the fan it is caught by the upper series of blades and dashed into a spray. Air from the outside is drawn in by the fan through the central portion around the motor and after passing through the cold water spray is delivered to the car through ducts arranged in the lower deck. A number of 8-in. registers in the head lining distribute it through the car body.

This apparatus has a capacity of washing and cooling 90,000 cu. ft. of air per hour, which will greatly add to the comfort of the passengers passing through hot dusty regions. The device is made by the Duntley Manufacturing Company of Chicago.

MINERAL PRODUCTS IN THE UNITED STATES.—The United States Geological Survey has issued a table giving the production of mineral products in the United States for the past ten years. The total value of mineral products in 1910 was \$2,003,744,869 as against \$1,886,772,843 in 1909. The highest record made was in 1907, which shows a total value of \$2,071,613,741.

POWERFUL MIKADOS FOR THE ERIE RAILROAD

As Part of the Program for Relieving Traffic Congestion on the Cincinnati Division, the Erie Has Purchased 35 Locomotives of the 2-8-2 Type Sufficiently Powerful to Increase the Tonnage Per Train About 38 Per Cent.

The increase of business on the Cincinnati division of the Erie, particularly between Marion Junction, Ohio, and Kent, a distance of about 112 miles, had so congested traffic as to make the operation inefficient and unsatisfactory. This was originally a single track division and following the methods used on other parts of the system, the application of which resulted in wonderful improvement in the speed and expense of handling tonnage, a careful and systematic study was made of all conditions to determine exactly what changes were advisable to bring the division to a high state of operating efficiency. As a part of the results of this study it was decided to replace the consolidation locomotives by heavier power capable of handling heavier trains at higher speeds. Double tracking was also specified and practically the whole division is now provided with double track. Changes in yards and terminals also formed part of the program. The class H-21 consolidation locomotives had a maximum ton-

In considering the problem of new power, a most careful study was made of the advantages offered in this particular district by a powerful mikado type and two different types of Mallet locomotives; the decision finally reached favored the mikado for several reasons. For one thing, it seemed advisable to be prepared to handle traffic at a higher speed than it was felt the Mallet could be suitably designed to give. It was also found that the necessary incidental changes and improvements such as longer side tracks, revised terminal and yard arrangements, as well as engine houses, shops, and in some cases bridges, were sufficient to practically offset the reduction of operating expenses procurable with that type.

Having decided on the 2-8-2 wheel arrangement, designs were made in the mechanical engineer's office for a locomotive which would handle 1,450 tons westbound and 1,520 tons eastbound over the section of the division from Kent to Marion Junction,



Powerful Mikado Locomotive with Superheater and Pilliod Valve Gear; Erie Railroad.

nage of 1,050 tons westbound and 1,100 tons eastbound, from Kent to Marion Junction, a profile of which is shown in one of the illustrations. These locomotives have been for many years the standard freight engines of the Erie, and have the dimensions shown in the accompanying table.

GENERAL DIMENSIONS OF CONSOLIDATION LOCOMOTIVES.

| | |
|-------------------------------------|------------------------------|
| Class | 2-8-0 |
| Tractive effort | 42,500 lbs. |
| Weight in working order..... | 200,700 lbs. |
| Weight on drivers..... | 176,400 lbs. |
| Wheel base, rigid..... | 17 ft. |
| Wheel base, total engine..... | 25 ft. 11 in. |
| Cylinders, diameter and stroke..... | 22 in. x 32 in. |
| Diameter drivers | 62 in. |
| Driving journals, main | 9 $\frac{1}{2}$ in. x 12 in. |
| Driving journals, others..... | 9 in. x 12 in. |
| Steam pressure | 200 lbs. |
| Number and diameter of tubes..... | 380—2 in. |
| Length of tubes..... | 16 ft. |
| Heating surface, firebox..... | 174 sq. ft. |
| Heating surface, tubes..... | 3,165.7 sq. ft. |
| Heating surface, total..... | 3,339.7 sq. ft. |
| Grate area | 54 sq. ft. |

this being an increase of about 38 per cent. in tonnage. To handle these trains at fairly high speeds, it was found that practically the maximum weight procurable with four sets of drivers would be required. The locomotive, as finally designed, has an average weight of nearly 60,000 lbs. per driving axle. Thirty-five of these locomotives were ordered, twenty from the Baldwin Locomotive Works and fifteen from the American Locomotive Company. The former have been delivered and are proving themselves capable of all that was expected from them. The locomotive is exceptionally large and strong in all of its parts. It will be seen that while it is in general based on straightforward, well-established designs, containing no frills, advantage has been taken of many of the proved features leading to economy of operation. The Schmidt superheater of large size in connection with outside steam pipes is used. Security brick arches have been specified and the locomotives are fitted with the Pilliod valve gear.

The accompanying table gives the general dimensions and some of the more important ratios of five recent designs of the 2-8-2 type, permitting a comparison with this design and the others. It will be seen that the Erie engine is the heaviest in total weight and on drivers, and also that it has the smallest percentage of the total weight on the drivers. In other respects, as

COMPARATIVE DATA FOR RECENT MIKADO LOCOMOTIVES.

| Road | Erie. | B. & O. | M. P. | G. N. | I. C. |
|---|-----------|-----------|----------|----------|----------|
| Total weight, lbs. | 320,600 | 374,600 | 275,000 | 287,000 | 283,850 |
| Weight on drivers, lbs. | 237,150 | 219,000 | 209,500 | 220,000 | 218,300 |
| Percentage of weight on drivers | 74 | 80 | 76.3 | 76.5 | 77.1 |
| Average weight per axle, lbs. | 59,288 | 54,750 | 52,375 | 55,000 | 54,575 |
| Tractive effort, lbs. | 57,460 | 50,200 | 50,000 | 57,460 | 51,700 |
| Diameter drivers, in. | 63 | 64 | 63 | 63 | 63 |
| Steam pressure, lbs. | 170 | 205 | 170 | 170 | 175 |
| Diam. boiler, front ring, in. | 84 | 78 | 75 3/4 | 82 | 82 |
| No. and size of tubes | 232-2 1/4 | 389-2 1/4 | 224-2 | 326-2 | 262-2 |
| No. and size of flues | 36-5 1/2 | | 30-5 3/8 | 30-5 1/2 | 36-5 3/8 |
| Length of tubes, ft. & in. | 21 | 21 | 16-6 | 21 | 20-6 |
| Evaporative heating surface, sq. ft. | 4,155 | 5,017 | 2,868 | 4,720 | 4,068 |
| Superheater heating surface, sq. ft. | 1,050 | | 558† | 1,060 | 1,093 |
| Equivalent heating surface, sq. ft.* | 5,730 | 5,017 | 3,705 | 6,310 | 5,708 |
| Grate area, sq. ft. | 70 | 70 | 49.5 | 78.2 | 70 |
| Evaporative heating surface ÷ superheating H.S. | 3.95 | | 5.15 | 4.45 | 3.72 |
| Cylinders, diameter and stroke, in. | 28 x 32 | 24 x 32 | 27 x 30 | 28 x 32 | 27 x 30 |
| Diameter valves, in. | 16 | 14 | | 13 | 15 |
| Valve travel, in. | 6 | | 6 | 6 | 6 1/2 |
| Lap of valve, in. | 1 | | 1 | 1 1/8 | 1 1/2 |
| Lead, in. | 1/4 | | 3/16 | 3/16 | 1/4 |
| Total weight ÷ equiv. H.S. | 5.6 | 5.47 | 5.50 | 4.98 | 5.50 |

*Evaporative heating surface plus 1.5 times superheater heating surface. regards size, it is very similar to the Great Northern design. Comparing the Erie and Great Northern engines directly it is

located about the centre of the barrel. The diameter at the front ring is 84 in., which is increased to 87 3/4 in. outside diameter at the firebox. The seams of the barrel are all placed at the top center line, are welded at the ends and have diamond shaped welt strips inside. The dome with its base, in spite of the fact that it is 22 in. high, is flanged from one piece of steel plate. The mud ring is 6 in. in width on all sides. A single fire door is used. The throat sheet has a depth of 25 in. below the barrel, giving ample space for the brick arch, which is supported on four 3 in. water tubes. Flexible staybolts have been used at both ends of the side sheets, and the front of the crown sheet is supported by four rows of flexible stays. Provisions have been made to allow the application of an automatic stoker.

Cylinders.—One of the illustrations clearly shows the design of the cast iron cylinders which are arranged for use with the outside steam pipes. It will be seen that the casting is well braced; passages are liberal and the construction follows approved lines.

Frames.—Vanadium steel frames, 6 in. wide and with a depth of 7 in. over the pedestals have been specified for these locomotives. Their appearance gives confidence in the minimization of frame breakage. The single trailer truck frame of wrought iron is spliced to the main frames just back of the fourth pedestal. The frames are arranged for the securing of the spring links by pins through holes in the frame castings between the second and third pedestals, where the equalization system is divided.

Valve Gear.—While the studies were being carried on leading up to the design of this locomotive, practical tests were being made with the Baker-Pilliod valve gear. Following the formal tests, records were kept of two locomotives for a period of about a year with the result that it was decided to specify this type of

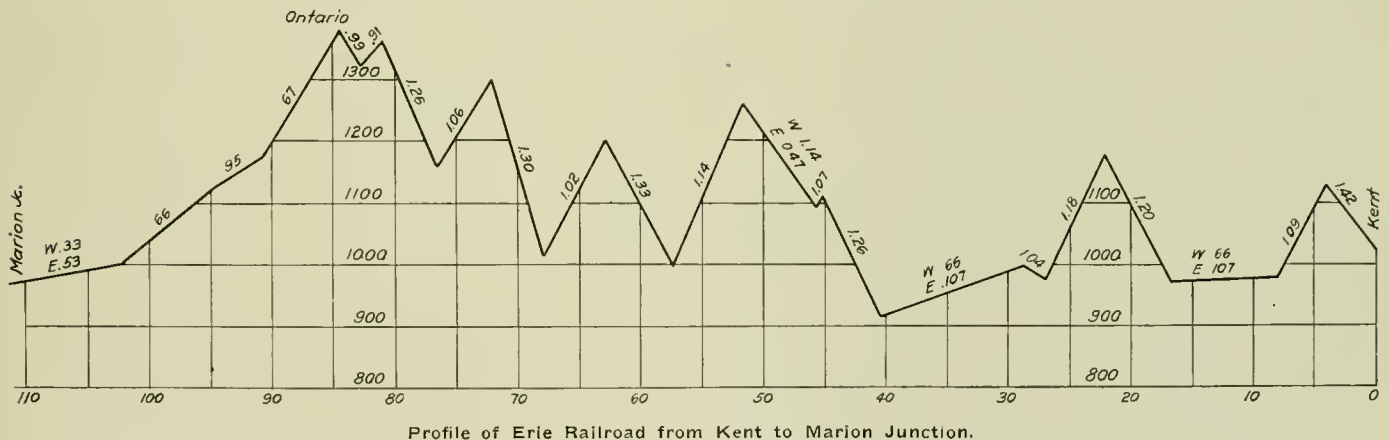

seen that the former is of considerably greater weight for practically the same power and, judged on the basis of heating surface, it has a smaller boiler. A more careful study of the details, however, shows that the greater total weight is largely accounted for in three features; first, the use of frames in 6 in. in width as compared with 5 in. in the Great Northern; the 84 in. boiler has sheets 15/16 in. in thickness as compared with an 82 in. boiler with 7/8 in. sheets on the Great Northern; there is a smaller number of 2 1/4 in. tubes giving a considerably greater water capacity and hence increased weight in the boiler. The Erie superheater has 36 elements as compared with 30 in the Great Northern, but the tubes in the latter case are 1 5/8 in. diam. as compared with 1 7/16 in. on the Erie. The ratio of superheating surface to evaporative surface, is considerably larger on the Great Northern, due to the larger number of boiler tubes. One very striking difference in the two designs is found in the 13 in. piston valves on the Great Northern as compared with 16 in. on the Erie.

Boiler.—As mentioned above, the boiler carries a pressure of 170 lbs. It is of the conical radial stay type, having the dome

valve gear on all of this order of locomotives.† The year's experience indicated that not only could considerable economy in fuel be expected, but also that the maintenance and repair charges of the valve gear would be decidedly reduced. The power reverse gear is being fitted to all of the locomotives not because any difficulty would be experienced in reversing by hand, as it has been found that this type of valve gear has considerable advantage in this respect, but because it was almost impossible to suitably locate a quadrant in the cab. Even as now arranged there is some congestion of apparatus in the cab, and the addition of the reverse lever with its quadrant would be decidedly objectionable.

Trailer Truck.—The latest improved arrangement of outside bearing, radial trailer truck, as designed by the American Locomotive Company, has been specified on these locomotives. This was fully described on page 10 of the January issue of this journal.

Tender.—For the purpose of obtaining the maximum of capacity with the minimum of weight, the Vanderbilt type of tender

†Figured on inside of superheater tubes.

†For fully illustrated description of this valve gear see *American Engineer*, November, 1910, page 442.

has been used. It has a water capacity of 9,000 gals. and coal capacity of 16 tons, and weighs about 57,000 lbs. light. The tank has a diameter of 8 ft. 9 in., and the underframe is composed of 6 in. x 4 in. angles with cast steel end sills.

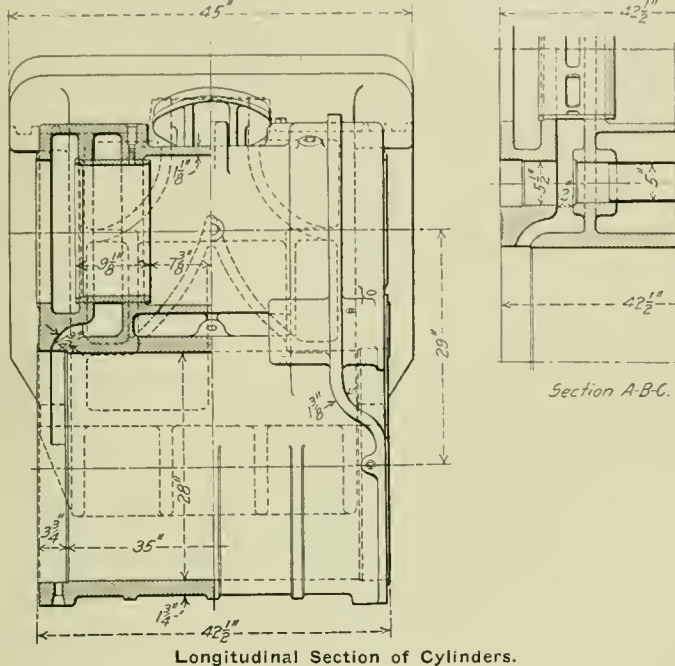

Longitudinal Section of Cylinders.

The general dimensions, weights and ratios of these locomotives are given in the following table:

General Data.

| | |
|--|-------------------|
| Gage | 4 ft. 8 1/2 in. |
| Service | Freight |
| Fuel | Bit. coal |
| Tractive effort | 57,460 lbs. |
| Weight in working order | 320,600 lbs. |
| Weight on drivers | 237,150 lbs. |
| Weight on leading truck | 29,600 lbs. |
| Weight on trailing truck | 53,850 lbs. |
| Weight of engine and tender in working order | 483,000 lbs. |
| Wheel base, driving | 16 ft. 6 in. |
| Wheel base, total | 35 ft. |
| Wheel base, engine and tender | 66 ft. 10 1/2 in. |

Ratios.

| | |
|---|--------|
| Weight on drivers ÷ tractive effort | 4.11 |
| Total weight ÷ tractive effort | 5.58 |
| Tractive effort × diam. drivers ÷ heating surface* | 629.00 |
| Total heating surface* ÷ grate area | 82.00 |
| Firebox heating surface ÷ evaporative heating surface, per cent | 5.25 |
| Weight on drivers ÷ total heating surface* | 41.30 |
| Total weight ÷ total heating surface* | 55.90 |
| Volume both cylinders, cu. ft. | 22.78 |
| Total heating surface* ÷ vol. cylinders | 252.00 |
| Grate area ÷ vol. cylinders | 3.08 |

Wheels.

| | |
|---------------------------------------|-----------------|
| Driving, diameter over tires | .63 in. |
| Driving, thickness of tires | 3 1/2 in. |
| Driving journals, diameter and length | 11 in. x 14 in. |
| Engine truck wheels, diameter | 33 1/2 in. |
| Engine truck, journals | .6 in. x 12 in. |
| Trailing truck wheels, diameter | .42 in. |
| Trailing truck, journals | 8 in. x 14 in. |

Boiler.

| | |
|------------------------------------|---------------------|
| Style | Conical |
| Working pressure | 170 lbs. |
| Outside diameter of first ring | 84 in. |
| Firebox, length and width | 120 in. x 84 in. |
| Firebox plates, thickness | 3/8 in. and 5/8 in. |
| Firebox, water space | .6 in. |
| Tubes, number and outside diameter | 232—3 1/4 in. |
| Flues, number and diameter | 36—5 1/2 in. |
| Tubes, material | Iron |
| Flues, material | Steel |
| Tubes, length | 21 ft. |
| Heating surface, tubes | 3,936 sq. ft. |
| Heating surface, firebox | 219 sq. ft. |
| Heating surface, total | 4,155 sq. ft. |
| Superheater heating surface | 1,050 sq. ft. |
| Grate area | 70 sq. ft. |

Cylinders.

| | |
|---------------------|-----------------|
| Kind | Simple |
| Diameter and stroke | 28 in. x 32 in. |

*Equivalent heating surface = 5,730 sq. ft.

| | |
|-------------------|---------|
| Valves. | |
| Kind | Piston |
| Diameter | 16 in. |
| Greatest travel | .6 in. |
| Outside lap | .1 in. |
| Inside clearance | .16 in. |
| Lead in full gear | 1/4 in. |

| | |
|-------------------------------|-----------------------|
| Tender. | |
| Tank | Vanderbilt |
| Frame | .6 in. x 4 in. angles |
| Weight, light | 57,000 lbs. |
| Wheels, diameter | 33 in. |
| Journals, diameter and length | .6 in. x 11 in. |
| Water capacity | 9,000 gals. |
| Coal capacity | 16 tons |

60-FOOT DROP TESTING MACHINE

BY ANDREW LAUTERBACH.

A new drop testing machine which has a clear drop of 60 ft., with a working space of over 30 in. between the guide rails, has been erected at the Mt. Clare shops of the Baltimore & Ohio for the use of the test bureau. Tups of three different weights are provided, permitting the machine to be used for practically all classes of drop testing work. A magnet using 550 volt direct current and having a lifting capacity for 16,000 lbs. is used for hoisting the tups. The current is delivered to the magnet by a flexible cable which passes over the top sheave and is wound on a drum of the same size and on the same shaft with that used for the hoisting cable. The hoisting is done by a 25 h. p. series wound motor, geared to the drums and provided with an emergency electric band brake, which will be described later. This apparatus is located about 7 ft. from the column and is enclosed.



New Drop Testing Machine; Baltimore & Ohio.

The operation is controlled from a small house about 70 ft. from the drop testing machine, where the operator has a full view of the machine. In this are located the necessary controller, switches, meters, pilot lamps, etc., for the hoisting and dropping of the tups.

Of the three tups, two are of forged iron, one weighing 1,640 lbs. for M. C. B. requirements and having two removable dies, and the other of 2,000 lbs. weight for rail testing, having a 5-in. radius striking face on the die. These two tups are about 7 in. thick. The third one is of cast iron, having a total weight of 9,000 lbs. for use in shearing tests on draft gear. This tup is seldom dropped over 3 ft.

Concrete, capped with 12 in. x 12 in. timbers, forms the foundation on which the base plate rests. The anvil casting is supported on a large number of coil springs, and the top of the anvil is arranged to come at about the ground level, avoiding unneces-

sary lifting and facilitating observation during the tests. The structural columns are made up of 15 in., 33 lb., channels placed back to back and braced and secured by angle iron diagonals as shown in the illustration. The bottom diagonals are bolted in place so that they may be removed, permitting the 9,000 lb. tup to be put into place. Although the present maximum drop required is but 49 ft., the columns are designed for a 60-ft. drop to provide for future specifications. Heavy angles are secured across the columns near the top for fastening the 1/2-in. guy ropes.

has been used at the bottom because of the danger of breaking the standard rail, due to the rebounds and side thrusts.

A heavy plate properly formed to fit between the guide rails carries the lifting magnet and the safety catch arrangement. To the top of this plate is secured the hoisting cable which, together with the electric cable, passes over the double sheave at the top of the column, this sheave being of the proper size to permit the down running section to pass outside of the column to sheaves near the bottom, from whence they pass to the hoisting drums.

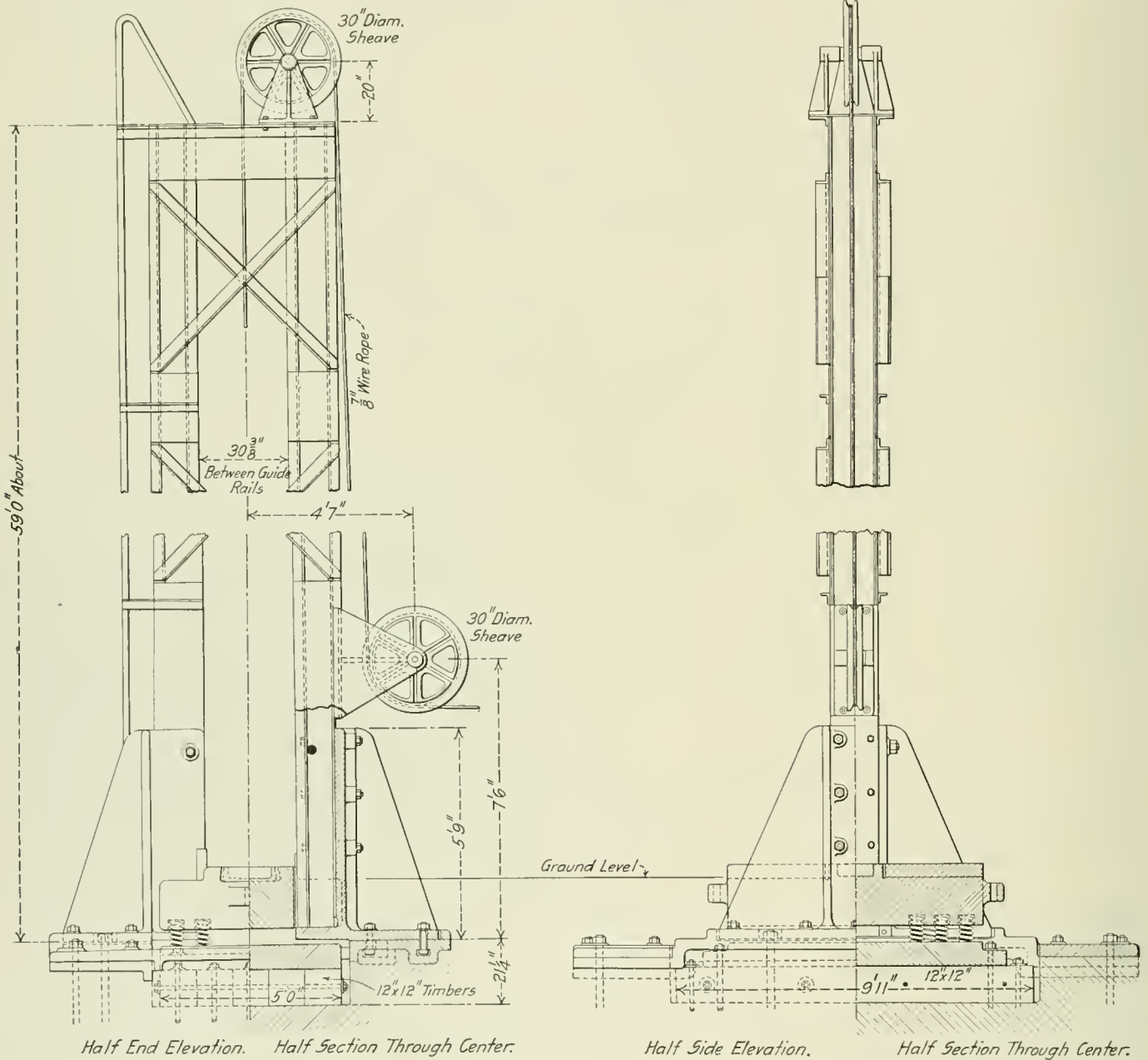

Sixty-foot Drop Testing Machine for the Baltimore & Ohio.

of which there are four, one at each corner. The bottoms of the columns are secured to special castings by bolts, arrangement being made to protect the bolts from falling pieces of broken rail, etc.

From the top of the column to a point about 10 ft. from the bottom, the guide rails are standard 30-lb. rails, 3 in. high, but from this point to the bottom each guide rail is made up of 2, 3 in. x 2 1/2 in. x 11/16 in. angles, placed back to back. This distance is divided into three sections, any one or more of which may be removed for changing the tups. This type of guide rail

On the hoisting apparatus is a band brake operated by a solenoid connected in the motor circuit. The lever arm of the band brake is held in place, i. e., in the application position, by a coil spring, the effect of which is overcome by the solenoid when it is energized, thus releasing the brake. The construction at this point is shown in one of the illustrations.

A solenoid is also used for operating the safety devices in connection with the lifting magnet. Here there are two aluminum bronze hooks, one each at diagonal corners of the plate, which interlock with forged hooks on the tups. When the tup is held

EFFECT OF FIREBOX VOLUME ON COMBUSTION

The Value of an Increased Ratio of Firebox Volume to Grate Area and of Baffling the Gases Has Been Proved in a New Type of Firebox.

BY F. F. GAINES

Superintendent of Motive Power, Central of Georgia.

In the study of the combustion of fuel in locomotive boilers, it would seem as if the value of firebox volume and heating surface had been to some extent lost sight of, or at least had not been given the weight that it deserves. It would also seem that the effect of changing the path of the gases in the firebox by means of either the brick arch or the combustion chamber with a brick wall has not been appreciated to the extent that it should be. While it is true that a few railways are using the combustion chamber and are consequently availing themselves

type of bituminous burning firebox. The flame, rising from the fire seeks the shortest course to the flue. While the sketch indicates that the portion of the flame from the rear end of the firebox travels on a nearly straight line to the top flues, it is more than probable that under the heavy forced draft the actual path would fall short of the top flues, and that the greater part of the gases and flame would pass to the flue sheet some little distance below the top row of flues. It is obvious, under these conditions, that the heating surface embodied in the back head and the back part of the crown sheet and side sheets absorbs a

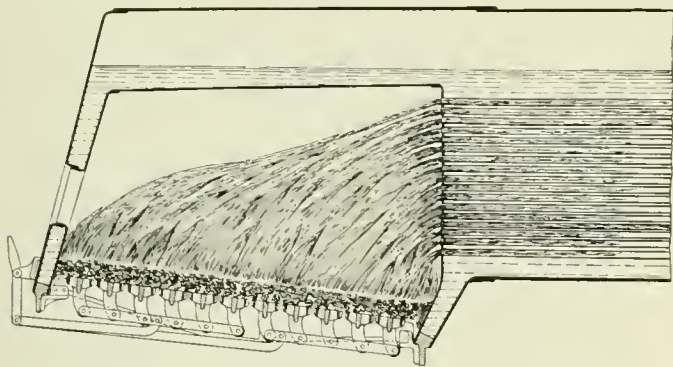

Fig. 1—Flame Action in Firebox without Brick Arch.

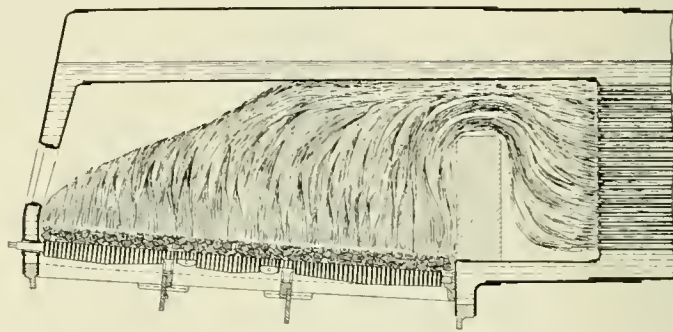

Fig. 3—Flame Action in Wooten Firebox.

of the increased firebox volume, the number so doing is comparatively small, although growing. This is equally true of the brick arch situation. On the other hand, railways that have been using the combustion chamber, properly applied, for any length of time, are aware of the value of this feature; this is also equally true of the roads using the brick arch; both of these features add greatly to economy in fuel consumption and the ability to generate a maximum amount of steam.

Personal experience with the Wooten type of firebox convinced me that both the firebox volume and the deflection of

very small proportion of the heat that they are capable of absorbing. It is also evident that any attempt at complete combustion of the gases arising from such a fire, by the introduction of air in any manner, stands very little chance of having the desired effect—the movement of the gases being so direct and no provision being made for deflection—between the time they leave the bed of the coals and the time they enter the flue sheets, where, of necessity, due to the reduced temperature, any further combustion is stopped.

The ordinary bituminous firebox with a brick arch is shown

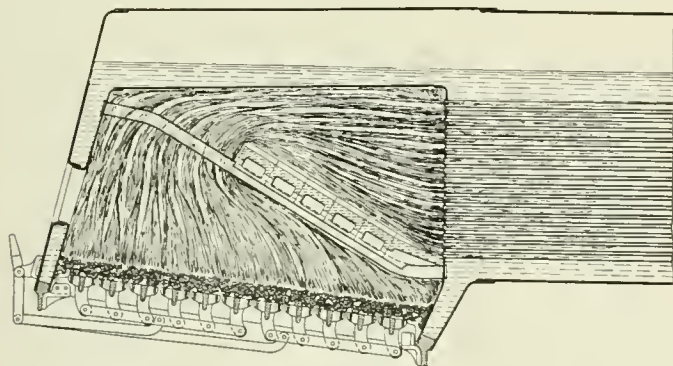

Fig. 2—Flame Action in Firebox with Brick Arch.

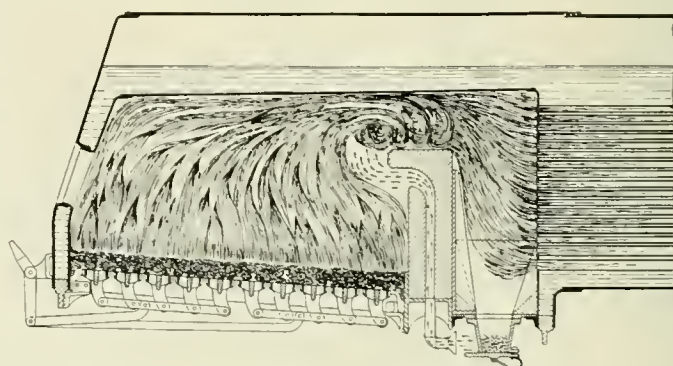

Fig. 4—Flame Action in Firebox with Gaines Combustion Chamber.

gases were important factors. A rather lengthy study of the whole matter resulted in a special design of firebox, embodying the combustion chamber, brick wall with air inlets, and means for cleaning out the cinders collecting in the combustion chamber. Three years' experience with this firebox has shown its value. The actual results will be discussed later.

A brief review of firebox design and of some of the principles embodied in it may be of interest: Fig. 1 shows the regular

in Fig. 2. It is obvious that the introduction of the arch at once brings about an entirely different state of affairs from that existing in the plain firebox. The gases and flame rise from the fire and are thrown back, passing over the top of the arch and then to the flue sheet. It is also obvious that by this means the heat has been brought in closer contact with that portion of the firebox at the rear, which in the plain type does little or no work, thus effecting considerable increase in the generation of

steam on this account. It is also easily seen that the introduction of air from any source would aid combustion and has much more opportunity for effecting this result, as the baffling of the gases by the brick arch gives a chance for the air to mix with the unconsumed gases and for the mixture to burn before striking the flue sheet. This arrangement, while effecting considerable economy over the plain arrangement, has its drawbacks when it comes to extreme widths of firebox; also where the wheels are under the firebox and limit its depth. In many cases the fireboxes on modern engines, especially the consolidation type, are so shallow that it is impossible to get the arch between the flues and fire. In many other cases, owing to the width of the firebox, it is necessary to support the arch at two or more points with arch pipes.

It is also apparent from Figs. 1 and 2 that any cold air entering the firebox is liable in the first case to strike the flue sheet and cool it to an extent that will give trouble with the flues, whether entering from a hole in the front end of the fire or during a prolonged opening of the fire door. In the second case, if the arch is of the type that is solid against the front end, there is little possibility of cold air entering the flues, as the air becomes warm before striking the flue sheet by mingling with the gases in passing over the baffle of the brick arch. In

essary, at intervals, to cool off the boiler and remove the accumulation of sparks from the combustion chamber. It will be noted, however, that for blowing out the flues when they are plugged, or working on the flues when leaking, it is not required to dismantle the brick wall. There is also another point that causes trouble due to the junction of the throat sheet with the side and crown sheets; this joint coming in the hottest part of the path of the burning gases sometimes gives trouble from leaking. On the other hand, it is almost impossible to damage the flues by cold air, either from a hole in the fire or from the prolonged opening of the fire door, as such air will be well heated before striking the flue sheet. It is certain, however, that with the Wootten firebox results are obtained in fuel economy, steaming capacity, etc., that cannot be obtained in the other two types above mentioned, and it is more than probable that the increased firebox volume, together with the deflection of the gases by the brick wall, are the most important factors in producing these results.

The problem then becomes one in which these factors can be maintained and the objections referred to eliminated. This was finally accomplished by the design shown in Fig. 4. Here the firebox volume has been increased and the deflection of the gases from the rear is provided for so as to more fully utilize the

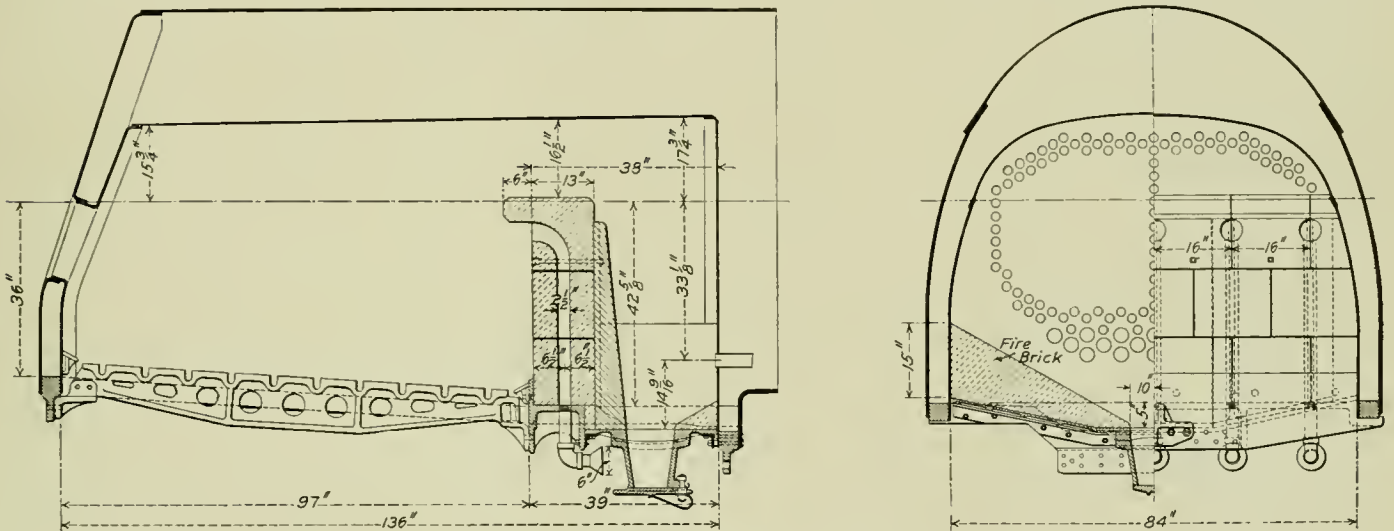

Fig. 5—Details of Construction of Gaines Combustion Chamber.

those types of engines using the open arch, or one that is open at the flue sheet, this would still hold true for the admission of air from the door, but any hole in the front end of the fire would cause considerable trouble on account of leaking flues.

The Wootten firebox is shown in Fig. 3. In this construction additional firebox volume is obtained by the use of a circular combustion chamber surrounded by a water leg, and with a brick wall built up at the back end. It is obvious that more or less of the gases are thrown backward and upward, so as to obtain the same effect as with the brick arch shown in Fig. 2. It is also evident that, as the brick wall is of some considerable height, the firebox itself may be as shallow as the design of the engine may require, as the brick wall prevents the fuel from getting into the flues. Incomplete combustion is minimized in this arrangement, as any air that is admitted is more or less intimately mixed with the gases in passing over the brick wall, and has the opportunity of burning in the combustion chamber before striking the flue sheet.

Mechanically there are some objections to this arrangement. The water leg surrounding the combustion chamber must be of sufficient width, at the bottom especially, to allow good circulation and prevent the burning of the sheets. This, in turn, cuts down the available flue sheet area and prevents the installation of the same number of flues that would otherwise obtain in boiler shell of the same outside diameter. It also becomes nec-

back portion of the firebox. Also, the introduction of air through the brick wall provides oxygen for complete combustion. This air, entering through the incandescent brick wall, is heated approximately to the temperature of the firebox before mingling with the gases, making the most favorable conditions for complete combustion. The space behind the wall allows an opportunity for their burning before striking the flue sheet. The arrangement also permits of the application of a regular spark hopper at the bottom of the chamber for cleaning, when necessary. It also eliminates the seam between the throat and side sheets at the place where it is liable to give trouble, and at the same time protects the flues from cold air and consequent damage. It will also be noted that under this arrangement the same flue sheet arrangement may be obtained for the same boiler diameter, as in Fig. 1.

To check these theories with actual practice an engine was changed, as shown in Fig. 5, by cutting off the entire back head and building a new back head with a firebox approximately equal to the length of the brick wall plus the combustion chamber. The combustion chamber was formed, as shown in the illustration, by building a brick wall on a cross bearing. The engine was put into service in February, 1909—three years ago. The flues applied to the engine at that time have never given any trouble from leaking or stopping up. The engine has been in the shop twice for tire turning, but is still running with the

original flues, having made 80,000 miles to date. On the same division sister engines, as well as engines of equal power in the same service, fail to make an average of over 26,000 to 33,000 miles before the flues require safe-ending and resetting.

A series of tests, using this engine, a sister engine without the combustion chamber, and a wide firebox consolidation of a later design and better proportions, was made in March, 1909. An additional test was also made in February, 1911. Both series of tests were made with the same crews, using a train composed of steel cars loaded with company coal, the same train being used through the series of tests, thus eliminating any variables due to the make-up of the train. All coal used in each test was from the same mine and was mined at the same time and was sacked. The two tests check very closely and show almost iden-

FLANGE LUBRICATOR

BY JAMES STEVENSON

Gang Foreman, Pennsylvania Railroad, Olean, N. Y.

The accompanying illustration shows a flange lubricator which was designed by the writer and may be very easily constructed. It is made of a 1 in. or 1¼ in. pipe flattened and bent at the lower end and ground to fit the flange of the driving wheel. This end should be filled with a closely woven felt, as shown in the drawing, so that the oil may soak through and keep the flange lubricated.

The pipe is held in position by a clamp which is located a little above the center of the pipe. This clamp is free to swing

| Engine Number. | Train Number. | Date. | Actual Time Consumed. | Stops. | | Pounds coal consumed. | | | Pounds water evaporated. | | Miles run to one ton of coal. | Tons coal used in excess, based on Engine 1014 as unit of comparison. | Relative efficiency based on coal consumption per mile. |
|----------------|---------------|---------|-----------------------|---------|----------------|-----------------------|----------------------|-----------|--------------------------|--------------------|-------------------------------|---|---|
| | | | | Number. | Time Consumed. | Total. | Per 1,000 ton miles. | Per hour. | Total. | Per pound of coal. | | | |
| *1014 | Extra | 1/13/11 | 6 hr. 34 m. | 6 | 1 hr. 4 m. | 11,950 | 93 | 1,820 | 96,800 | 8.10 | 16.74 | | |
| | 2/36 | 1/14/11 | 6 hr. 42 m. | 8 | 1 hr. 33 m. | 13,350 | 104 | 1,991 | 109,000 | 8.16 | 14.98 | | |
| 1014 | 3/37 | 1/16/11 | 6 hr. 12 m. | 7 | 49 m. | 12,450 | 97 | 2,008 | 105,750 | 8.49 | 16.08 | | |
| | 1/36 | 1/17/11 | 6 hr. 39 m. | 7 | 1 hr. 12 m. | 14,250 | 111 | 2,143 | 109,800 | 7.71 | 14.04 | | |
| | | | 26 hr. 7 m. | .. | 4 hr. 38 m. | 52,000 | 101 | 1,991 | 421,350 | 8.10 | 15.38 | | 100.00 |
| †1012 | Extra | 1/18/11 | 7 hr. 12 m. | 5 | 57 m. | 20,400 | 159 | 2,833 | 121,458 | 5.95 | 9.80 | | |
| | 1/36 | 1/19/11 | 8 hr. 4 m. | 5 | 1 hr. 16 m. | 21,900 | 170 | 2,715 | 124,887 | 5.70 | 9.13 | | |
| 1012 | Extra | 1/20/11 | 6 hr. 43 m. | 5 | 45 m. | 19,087 | 148 | 2,841 | 113,095 | 5.93 | 10.48 | | |
| | 2/36 | 1/21/11 | 7 hr. 20 m. | 8 | 1 hr. 43 m. | 22,500 | 175 | 3,068 | 121,883 | 5.42 | 8.89 | | |
| | | | 29 hr. 17 m. | — | 4 hr. 41 m. | 83,887 | 163 | 2,865 | 481,323 | 5.74 | 9.54 | 15.94 | 61.96 |
| \$1716 | Extra | 1/23/11 | 8 hr. | 9 | 2 hr. 33 m. | 15,000 | 117 | 1,875 | 110,400 | 7.36 | 13.33 | | |
| | 1/36 | 1/24/11 | 7 hr. 24 m. | 10 | 1 hr. 41 m. | 16,500 | 128 | 2,230 | 120,000 | 7.27 | 11.43 | | |
| 1716 | Extra | 1/25/11 | 6 hr. 50 m. | 9 | 1 hr. 20 m. | 13,800 | 107 | 2,080 | 102,801 | 7.45 | 14.49 | | |
| | 1/36 | 1/26/11 | 7 hr. 28 m. | 12 | 1 hr. 42 m. | 15,600 | 121 | 2,089 | 117,166 | 7.51 | 12.82 | | |
| | | | 29 hr. 42 m. | .. | 7 hr. 16 m. | 60,900 | 118 | 2,050 | 450,367 | 7.39 | 13.14 | 4.45 | 85.58 |

*Engine 1014—21 in. x 32 in. Cooke consolidation—with new firebox and combustion chamber, with hollow brick wall and provision for mixing hot air with burning gases. Total heating surface, 2,987.33 sq. ft.

†Engine 1012—Same class engine as 1014, but with original boiler unchanged, and brick arch. Total heating surface, 3,022.29 sq. ft.

§Engine 1716—22 in. x 30 in. Baldwin consolidation—brick arch. Total heating surface, 3,230 sq. ft.

Analysis of fuel: Moisture, 1.39 per cent.; volatile combustible matter, 30.56 per cent.; fixed carbon, 55.11 per cent.; ash, 12.94 per cent.; sulphur, 1.5 per cent. B.t.u. per lb. dry coal (Mahler Atwater calorimeter), 13,179; B.t.u. per lb. actual coal, 12,996.

tical results. The results from the later test are reproduced herewith and show that the economy of the arrangement is actual and quite considerable.

It has further been found that when the fuel supply is of a nature which causes steam failures on other engines running in similar service on the division, this engine has not, as yet, given a single steam failure, even when the grade of fuel was considerably below standard. The engine, when in service working steam, emits a minimum amount of smoke; in fact it is almost impossible to make black smoke by leaving both fire doors open and shoveling coal continuously; on the other hand, with an ordinarily good fire the amount of smoke emitted is almost imperceptible.

Another peculiar feature is that a very small amount of sparks are ejected from the stack, and those ejected are in all cases dead. This does not mean that there is any great accumulation in the combustion chamber, being very seldom that more than a few quarts are found in this locality, although the sparks which are found in the combustion chamber are readily removed through the spark hopper in the bottom.

Another rather important feature connected with the burning of soft coal on this engine is the fact that the flues show no indications of plugging up. In going over this matter with the foreman boilermaker of the terminal out of which the engine runs, he states positively that the engine has never been reported, as yet, to have the flues blown out.

METAL BEARINGS.—The bureau of construction and repair of the U. S. Navy department requires an alloy of 88.8 per cent. Banca tin, 7.5 per cent. regulus of antimony and 3.7 per cent. of best refined copper for all white metal bearings.

on the bolt which fastens it to the bracket, allowing the lubricator to ride easily on the flange. Should it be desired to oil the flange only when rounding a curve the cup may be arranged so that it just misses the flange when the engine is level. When the engine takes a curve the elevation of the outer rail will raise the engine sufficient to cause the cup to bear against the flange, bringing the lubricating feature into action. A 3/8-in. copper

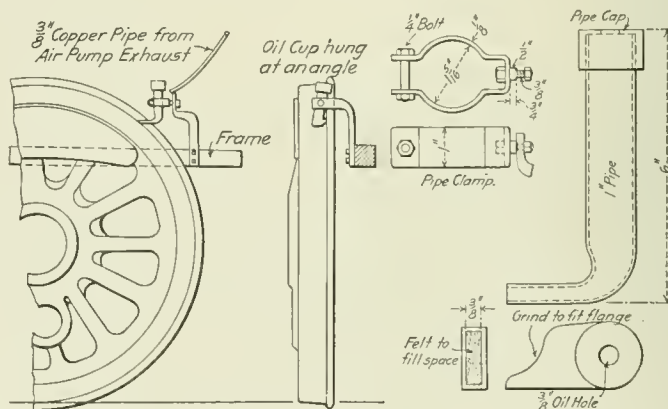

Driving Wheel Flange Lubricator.

pipe is connected to the air pump exhaust, discharging directly on the oil cup, so as to keep the oil sufficiently warm in cold weather. This feature has been found to be very necessary as the cold will congeal the oil so that it will not run. This device is not patented and the writer would be glad to receive any criticisms concerning it.

GENERAL NEWS SECTION

The Pere Marquette engine house, at Ludington, Mich., was recently partially destroyed by fire. Considerable machine tool equipment was destroyed.

The Texas & Pacific has announced its intention to run motor cars regularly between Dallas, Fort Worth and Mineral Wells, Texas. There will be three cars in service.

The Illinois Central has issued an order allowing the wood from 40 worn-out freight cars being dismantled at the Burnside shops to be given away to the poor for fuel.

The carpenter and repair shops of the Hocking Valley, at Walbridge, Ohio, were destroyed by fire January 10; loss, including a coal house, a sand house, an oil house and a material shed, \$75,000.

The boilermakers working in the shops of the American Locomotive Company, who have been on strike for three months, in sympathy with the strike of the New York Central boilermakers, have called off the strike.

The fast mail train of the Lake Shore & Michigan Southern on January 2 was run from Cleveland to Toledo, 108 miles, in 105 minutes, making up 40 minutes. The train consisted of 12 cars and was drawn by two engines.

The coroner of Allegheny County, in Pennsylvania, reports that fatalities in factories and mills have decreased 30 per cent. on account of the safety devices that have been installed by the manufacturers, the total for 1911 being 2,657 deaths.

The Hine system of organization has been installed by the Georgia & Florida, and the number of officers is increased. This is intended to abolish the practice of having clerks sign the names of officers, and increases the authority of the officers.

The Julius Pintsch Aktiengesellschaft advises that the Prussian Minister of Public Works has denied a report published in various European papers to the effect that, by action of the Reichstag, at Berlin, the Prussian state railways were to be equipped with electric light.

A statement compiled at the War Department in Washington shows that from sales of scrap iron and other unused material which was left on the Isthmus of Panama by the Frenchmen who did work on the canal fifteen years ago, the government has already realized the sum of \$2,112,000.

The Southern Pacific, by making a slight change in the train schedules and by providing for a connection at Port Costa, Cal., between the Shasta Limited from Seattle, and the "Owl" for Los Angeles, has shortened the trip for passengers between Seattle and Los Angeles to 44 hours, a saving of nearly a day.

The Chicago & Eastern Illinois has advanced the wages of enginemen, firemen, conductors and brakemen to the level of the scales paid on the Frisco lines west of the Mississippi river; this in accordance with an agreement reached last year by which the advance was to be made in two instalments. The present advance constitutes the second instalment.

Commissioner Prouty, of the Interstate Commerce Commission, has been elected chairman of the commission, to succeed Chairman Clements. This is in accordance with a rule adopted last year that the term of office of the chairman should be limited to one year and be filled from year to year by different members in the order of seniority in service.

A locomotive boiler exploded January 5 in the engine house of the Southern Pacific at Los Angeles, Cal., and killed two men and injured three. The explosion was caused by low water in the boiler; the force of the explosion lifted the boiler from

its frame, leaving the wheels standing on the track, and carried it to a distance of 100 ft. from the engine house.

Forty-six complaints have been filed in the United States district court at New Orleans against the Illinois Central, alleging violations of the safety appliance act. Eleven complaints are brought under the air brake provision of the law, 25 under the provision regarding the use of automatic couplers, and 10 under the provision relating to the use of grab irons.

The New York State Public Service Commission, First district (New York City), has made its fifth annual report. The per capita expenditure of the public of New York City for 1910 is estimated at \$16.35 for transportation, \$6.68 for gas and \$5.32 for electricity, a total of \$28.35. The expenses of the commission in supervising such public utilities were \$377,000, or a per capita expense of eight cents.

Statistics compiled by the pension department of the Southern Pacific show that since the establishment of the pension department in January, 1903, the sum of \$948,538 has been disbursed in pensions to retired employees. The total disbursements for the year 1911 were \$184,704. Since the organization of the pension department the Southern Pacific has pensioned 692 of its former employees. The number on the pension roll at the close of 1911 was 467.

The Supreme Court of the United States in an opinion by Justice Van Devanter has upheld the constitutionality of the employers liability act of 1908 in four cases before it, the principal ones being the New York, New Haven & Hartford vs. Mondon and the Northern Pacific vs. Babcock. The Court of Appeals for the state of Connecticut, which held that an action to recover under the law could not be brought in a state court is overruled, and the case remanded.

The Pennsylvania Railroad, encouraged by the reduction in the number of trespassers killed along its lines, as a result of the persistent efforts of its officers during the past four years, intends to redouble its efforts during 1912. New warning notices will be put up and the authorities will be requested to enact more stringent laws. General Manager S. C. Long has issued a circular to officers and employees, and has called upon all employees to assist in decreasing the death roll.

W. B. Spaulding, chairman of the central safety committee of the St. Louis & San Francisco, has compiled a report of the casualties on the Frisco Lines for the last six months of 1911, during which the safety committee plan has been in effect, together with a comparison with the corresponding period of 1910. There was a decrease of 15, or 14 per cent., in the number of persons killed, from 108 in 1910 to 93 in 1911. The number of injured was reduced from 2,050 in 1910, to 2,714 in 1911, a reduction of 236, or 8 per cent.

A resolution has been introduced in congress by Representative Ayres, of New York, calling upon the Interstate Commerce Commission to investigate the repair shops of the railways belonging to the Trunk Line Association. It is declared that the differences in the cost of various parts made by railways vary so greatly as between the shops of different roads that an investigation is needed. Railways are reporting higher costs for repairing cars and engines, yet the workmen in the shops do not see any benefit from the increase.

The Jacobs-Shupert U. S. Firebox Company is to conduct comprehensive tests of the Jacobs-Schupert firebox in comparison with a similar firebox of the ordinary type at Coatesville, Pa. Dr. W. F. M. Goss, Dean of the College of Engineering, University of Illinois, is to act as expert, outlining and afterwards directing the tests. The first series of tests which are to

determine the relative amount of heat absorbed by the fireboxes of the two boilers under similar conditions of operation will begin early in February. A second series, which will concern the low water tests, will begin on or about April 1.

Thomas A. Edison, the inventor, recently held a short conference with W. L. Park, vice-president and general manager; M. K. Barnum, general superintendent of motive power, and C. F. Parker, purchasing agent of the Illinois Central. Arrangements were made for an experimental test of three passenger motor cars to be equipped with storage batteries at the Edison shop. Mr. Edison asserted that the batteries could be charged in 40 minutes for a run of 200 miles. The Chicago Great Western has recently arranged for a test on a branch line of a similar car which has already been tried on the Long Island.

The Indiana Commission has filed in the Federal court a bill of exceptions protesting against the finding by Special Master N. C. Butler, handed in to the court last month, in the case involving the headlight law. The master reported to the court that the order issued by the commission a year ago requiring railways to equip locomotives with headlights of not less than 1,500 candle power, was legal in the sense that the commission had power in the premises, but that it was invalid because its provisions were not sufficiently definite. The commissioners claim that their order is sufficiently definite for use as a basis of action until the status of the law can be settled in the courts.

The Erie Railroad has equipped about 100 of its locomotives, running in suburban passenger service at the New York end of the road with 2-in. single-bell chime whistles, in addition to the ordinary whistle, and has instructed the enginemen to use this smaller and less noisy whistle on all occasions except where the louder one is required as a measure of safety. Some of these smaller whistles have been in use for several months, and the officers of the road find them satisfactory in every respect. A local report says that those suburban residents who have been disturbed and annoyed by the "wild shriek" of the 5 a. m. train may now be expected to become fast friends of the Erie.

The Supreme Court of the District of Columbia has rendered a decision sustaining the claims of Peter H. Murphy, president of the Standard Railway Equipment Company, St. Louis, Mo., against the Baltimore & Ohio, for infringement of the Murphy patents covering the Murphy outside metal car roof. The decree declares the Murphy patents to be valid and to have been infringed by the roof used by the Baltimore & Ohio. A permanent injunction was issued prohibiting the railway company from further use of this roof, except those already applied, pending an appeal to a higher court. The question of the amount of damages to be assessed was referred to the auditor of the court.

The Florida East Coast Railway was opened for traffic through to Key West, Fla., on January 22. This remarkable railway for a distance of about 70 miles is over water and so far from the land that at times the passengers cannot see it. It is a unique and expensive structure, in some places costing \$900,000 per mile. It includes six miles of solid concrete viaduct, 81 miles of embankment 30 ft. above low water level, and has 8 fixed and 2 draw bridges. The entire length of the road, from Jacksonville to Key West, is 522 miles. The cost of the road was approximately \$37,000,000, all of which was carried by Henry M. Flagler personally until 1909, when \$10,000,000 first mortgage bonds were sold.

Darius Miller, president of the Chicago, Burlington & Quincy, has addressed a circular letter to each of the 45,000 employees of the road, announcing the organization of a department of safety similar in its general plan to the safety committees formed on the Chicago & North Western, the St. Louis & San Francisco, the Baltimore & Ohio, the Chicago Great Western and the Delaware, Lackawanna & Western. The department will be in

charge of E. M. Switzer, who will have the title of superintendent of safety, and will be assisted by a central or advisory committee, with headquarters at Chicago. On each operating division there will be a sub-committee, with separate sub-committees for some of the more important shops and other places where large numbers of men are employed.

Committees of the Brotherhood of Locomotive Engineers have presented to all of the prominent railways east of Chicago and north of the Ohio river and the Norfolk & Western Railway, a request or demand for increased pay, the percentage called for being from 15 to 25 per cent. The object of the enginemen is to standardize the scale on all lines in this territory, as was done in the cases of the conductors and brakemen in 1910. The General Managers' Association has been asked to appoint a committee to negotiate with a committee of the Brotherhood in order to deal with the question collectively. A definite relation between the wages paid to enginemen and to trainmen and conductors has heretofore always existed, and the enginemen believe that they are entitled to a fixed advantage in wages over these other arms of the service.

During the past month the extreme cold throughout the country was the cause of many delays to trains. This was especially true in the northern and western states, where snow-bound trains were "too numerous to mention." At Lynchburg, Va., a passenger train with leaky pipes was frozen to the track and had to be bumped at the rear by three engines to loosen the wheels. On the Great Northern near Java, Mont., a rotary snowplow was knocked off the track by an avalanche and fell over a precipice 100 ft. high. The temperature was 26 degs. below zero. It has been stated that the roads of the country, as a whole, have suffered more from this month's cold spell than they have any other winter during the past eight years, and that the delays and difficulties for the most part were due to the men being unprepared for the severe weather.

On January 22 a rear collision took place on the Illinois Central at Kinmundy, Ill., which resulted in the death of J. T. Harahan, former president of the Illinois Central; F. O. Melcher, second vice-president of the Rock Island Lines; E. B. Peirce, general solicitor of the Rock Island Lines, and E. E. Wright, attorney for the Rock Island Lines in the State of Tennessee. The men were sleeping in Mr. Melcher's business car, which was attached to the New Orleans express, running south bound. The car was of all-wood construction, while the other cars in both trains were of all-steel construction. Four other members of the party escaped without injury, they being in the forward part of the car. The coroner's jury has returned a verdict placing the blame for the accident upon Henry Schiederjohn, operator at Edgewood, and Harry J. Broecker, flagman on train No. 25, the express train which was struck by the Panama Limited. The jury also decided that the railway erred in not maintaining a sufficient interval between the trains. The operator is blamed by the jury for the same reason.

The Pennsylvania Railroad in ten months has decreased the number of serious injuries to employees in its shops by more than 63 per cent., and in recognition of this work the American Museum of Safety, acting as agents for the Travelers' Insurance Company, presented a medal to the company as the American employer who, in its judgment, "had done the most for the protection of the lives and limbs of workmen, by means of safety devices for dangerous machines and processes." The medal was received by Vice-President W. W. Atterbury, head of the operating department. In the fall of 1910 experts from one of the large accident insurance companies were employed and, accompanied by inspectors of the motive power department, inspected all of the road's larger shops. Following this, safety committees were organized on all divisions. As a result, the number of serious injuries per thousand shop employees, which in January was 8.7, was reduced as follows: February, 7.3; March, 8.3; April,

6.0; May, 7.9; June, 5.2; July, 4.7; August, 3.4; September, 3.4; October, 3.2. During this period, the average number of employees was 33,242.

The Pennsylvania announces that its offer to pay its men for valuable ideas has already produced good results. For some reason not disclosed the offer was promulgated only on the Buffalo & Allegheny Valley division, which has only one-fifth of the road's mileage. Suggestions at once came in from all quarters. An engine house clerk won a premium by submitting a plan for increasing economy by the further use of carbon sheets which remain in repair card books, after the cards have been filled up and removed. A tinsmith discovered an improved method for fastening the boxes which contain flags, torpedoes and the medical case in engine cabs. By standardizing the heights of coal gates on tenders, a fireman saw a way to minimize the loss of coal through vibration. He was paid for the idea. At one of the terminals, an appliance for cleaning and sterilizing drinking cups used in coaches was perfected by a car inspector, and he received payment for it. Many worthless suggestions came in, but the officers say that the saving effected by those which are adopted makes it very much worth while to investigate them all. And there is the indirect gain in the added interest that the employees take in their work, and in the watchfulness and originality which is developed.

MEETINGS AND CONVENTIONS

Fuel Association.—The fourth annual convention of the International Railway Fuel Association will be held at the Hotel Sherman, Chicago, May 22-25, 1912.

American Supply and Machinery Manufacturers' Association.—The next joint convention of the American Supply and Machinery Manufacturers' Association, the National Supply and Machinery Dealers' Association and the Southern Supply and Machinery Dealers' Association will be held at the Monticello hotel, Norfolk, Va., May 13-15, 1912. F. D. Mitchell is secretary and may be addressed at 309 Broadway, New York.

Western Canada Railway Club.—Economic organization and maintenance of the freight car repair yard at a terminal point was briefly considered by J. Thomas Warde, chief clerk to general manager, Canadian Pacific, Winnipeg, in a paper presented in December. The location, arrangement and necessary structures for an ideal freight car repair yard were discussed and the more important features of the organization of the forces and the duties of its members were considered.

Canadian Railway Club.—E. B. Tilt engineer of tests, Canadian Pacific, presented an interesting paper on the work of a testing department on a railway at the December meeting. The paper reviewed the history of testing in connection with railways and gave a good description of the organization and methods used on the Canadian Pacific. The importance of the department in connection with the making of specifications, which it was the author's belief should be originated and prepared by it, being submitted to other departments for their criticisms only, was very carefully discussed.

Central Railway Club.—At the January meeting Prof. E. C. Schmidt, of the University of Illinois, presented a most interesting and valuable paper giving the results up to date of his experiments on the effect of cold weather on tonnage rating. The curves and tables included indicated the great importance of the subject, which in many cases is handled very crudely by different companies operating in cold climates. The practice in regard to the reduction of tonnage under different weather and temperature conditions, in use at present on a number of large roads, was shown in a table which accompanied the paper.

New England Railway Club.—Major Chas. Hine, recently elected vice-president and general manager of the Southern Pacific of Mexico, presented a paper on the subject of which he is considered the greatest authority—railway operating organization—at the December meeting. He reviewed the various factors entering into railroading, leading up to a very complete account of his experiments in connection with the Harriman lines, which extended over three years, and which have proved to be most beneficial to all concerned. Major Hine presented his deductions from this experience in a very clear, interesting manner.

Railway Supply Manufacturers' Association.—Circular No. 1 of this association gives such details as are at present available concerning the plans for the exhibits of the Master Mechanics' and Master Car Builders' conventions at Atlantic City, N. J., next June. The exhibits will be as usual on Young's Million Dollar Pier, and 81,764 sq. ft. of exhibit space has been provided, an increase of about 5,500 sq. ft. The arrangement of the space has been considerably improved. The price of space is 40 cents per sq. ft., as before. Space will be assigned on February 15, 1912, at the office of the secretary, J. D. Conway, Oliver building, Pittsburgh, Pa.

International Congress of Engineers.—A conference was held in San Francisco, January 15, to make plans for an engineers' congress to be held in that city in 1915, at the time of the World's Exposition, to celebrate the opening of the Panama canal. Among the societies represented at the conference were the Society of Naval Architects and Marine Engineers, American Society of Civil Engineers, American Society of Mechanical Engineers, American Society for Testing Materials, American Institute of Mining Engineers, the Mining & Metallurgical Society of America, and the American Chemical Society. The chairman of the meeting was Prof. W. W. Durand, of Leland Stanford, Jr., University.

Air Brake Association.—The nineteenth annual convention of the Air Brake Association will be held at the Hotel Jefferson, Richmond, Va., May 7-10, 1912. The program includes the following papers and reports: Friction—Recent Tests of Brake Shoes, by R. E. Auger; The Cleaning Date, by C. P. McGinnis; The Westinghouse P. C. Equipment in Service, by T. F. Lyons; Report of the Committee on Air Hose Failures, by T. W. Dow, chairman; The New York L. T. Equipment, by O. E. Moore; Right-Angled Pipe Fittings in Air Brake Service, by T. L. Burton; Report of the Committee on Recommended Practice, by S. G. Down, chairman; The Westinghouse P. C. Equipment, Questions and Answers, by S. J. Kidder, stereopticon lecture on Recent Air Brake Developments, by W. V. Turner.

RAILROAD CLUB MEETINGS

| CLUB. | NEXT MEETING. | TITLE OF PAPER. | AUTHOR. | SECRETARY. | ADDRESS. |
|--------------------|---------------|--|--------------------|---------------------|-----------------------------------|
| Canadian | Feb. 13 | Boilers—Past, Present and Future..... | J. W. Harkom..... | Jas. Powell..... | Room 13, Windsor Hotel, Montreal. |
| Central | Mar. 14 | | | H. D. Vought.... | 95 Liberty St., New York. |
| New England..... | Feb. 13 | Mechanical Handling of Freight..... | W. C. Carr..... | Geo. H. Frazier.... | 10 Oliver St., Boston, Mass. |
| New York..... | Feb. 16 | Electric Welding | O. S. Beyer..... | H. D. Vought.... | 95 Liberty St., New York. |
| Northern | Mar. 2 | | | C. L. Kennedy.... | 401 Superior St., Duluth, Minn. |
| Pittsburgh | Feb. 23 | The Use of the Telephone in Railroad Service | G. K. Meyer..... | J. B. Anderson.... | Union Station, Pittsburgh, Pa. |
| Richmond | Feb. 9 | Transportation Interests | Wm. H. White..... | F. O. Robinson.... | C. & O. Ry., Richmond, Va. |
| S'th'n & S. West'n | Feb. 15 | | | A. J. Merrill..... | 218 Grant Bldg., Atlanta, Ga. |
| St. Louis..... | Mar. 8 | Railroad Shops (Illustrated)..... | T. N. Gilmore..... | B. W. Frauenthal | Union Station, St. Louis. |
| Western | Feb. 20 | Car Wheels | C. G. Bacon..... | Jos. W. Taylor.... | 390 Old Colony Bldg., Chicago. |

Western Railway Club.—At the January meeting C. R. Gilman, chief electrician, Chicago, Milwaukee & St. Paul, presented a paper on head end electric lighting. The system used as an illustration was the turbine driven dynamo, either on the locomotive or in the baggage car, having storage batteries floating on the line to come into operation when the steam supply of the turbine was discontinued temporarily. The paper showed that a 17 car train had 872 lamps which gave a total lamp load of 20,627 watts in the case of a 104-volt circuit having 8 c. p. lamps. The losses in the machine and train lines amount to about 22 per cent., so that the dynamo load was 25,219 watts, or the full capacity of the machine. As a matter of fact, the steam pressure is not generally sufficient to allow the generator to give this output, and it was necessary to depend on the batteries to help out while the full load was on the circuit. It appeared that considerable difficulty was incurred with the 110-volt circuit in use on the trains used as an illustration, and this was recently changed to a 60-volt circuit, and the carbon lamps were replaced with tungsten lamps. This resulted in a saving of \$660. The lighting service was about 100 per cent. better, the candle power alone having increased 65 per cent.

New York Railroad Club.—Self propelled motor cars was the subject of discussion at the January meeting. W. B. Potter, engineer of the railway department of the General Electric Company, presented a paper in which he briefly considered the value of self propelled cars from the standpoint of the traffic, operating and mechanical departments. After briefly discussing the various distinct types of motor cars which have been built, he explained at some length the details of construction and operation of the gas-electric car designed by the General Electric Company. Tables showing the complete operating cost of a train consisting of a steam locomotive and two coaches compared with a General Electric gas-electric car, both operating 3,900 miles per month, were given, which indicated a gross yearly saving of nearly \$7,000 in favor of the motor car. A report of the mileage and expenses of five motor cars on the Minneapolis, St. Paul, Rochester & Dubuque, for three consecutive months in the summer, were presented and showed an expense of less than 12 cents per train-mile. A number of members criticised the figures given for the cost of the steam train in the comparative table. The operation of the storage battery car on the street railways in New York City, where a number are in use, was quite fully reported by an official having charge of them.

— — — — —
The following list gives names of secretaries, dates of next or regular meetings, and places of meeting of mechanical associations.

- AIR BRAKE ASSOCIATION.—F. M. Nellis, 53 State St., Boston, Mass. Convention, May 7-10, Richmond, Va.
- AMERICAN RAILWAY MASTER MECHANICS' ASSOC. J. W. Taylor, Old Colony building, Chicago. Convention, June 17-19, Atlantic City, N. J.
- AMERICAN RAILWAY TOOL FOREMEN'S ASSOCIATION.—M. H. Bray, N. Y., N. H. & H., New Haven, Conn.
- AMERICAN SOCIETY FOR TESTING MATERIALS.—Prof. E. Marburg, University of Pennsylvania, Philadelphia, Pa.
- AMERICAN SOCIETY OF MECHANICAL ENGINEERS.—Calvin W. Rice, 29 W. 39th St., New York.
- CAR FOREMEN'S ASSOCIATION OF CHICAGO.—Aaron Kline, 841 North 50th Court, Chicago; 2d Monday in month, Chicago.
- INTERNATIONAL RAILWAY FUEL ASSOCIATION.—D. B. Sebastian, La Salle St. Station, Chicago. Convention, May 22-25, Chicago.
- INTERNATIONAL RAILWAY GENERAL FOREMEN'S ASSOCIATION. L. H. Bryan, Brown Marx building, Birmingham, Ala. Convention, July 23-26, 1912.
- INTERNATIONAL RAILROAD MASTER BLACKSMITHS' ASSOCIATION.—A. L. Woodworth, Lima, Ohio. Convention, August 15, Chicago.
- MASTER BOILER MAKERS' ASSOCIATION.—Harry D. Vought, 95 Liberty St., New York. Convention, May 14-17, Pittsburgh, Pa.
- MASTER CAR BUILDERS' ASSOCIATION.—J. W. Taylor, Old Colony building, Chicago. Convention, June 12-14, Atlantic City, N. J.
- MASTER CAR AND LOCOMOTIVE PAINTERS' ASSOC. OF U. S. AND CANADA.—A. P. Dabe, B. & M., Reading, Mass. Convention, 2d week in September.
- RAILWAY STOREKEEPERS' ASSOCIATION.—J. P. Murphy, Box C, Collinwood, Ohio. Convention, May 20-22, Buffalo, N. Y.
- TRAVELING ENGINEERS' ASSOCIATION.—W. O. Thompson, N. Y. C. & H. R., East Buffalo, N. Y., August, 1912.

PERSONALS

GENERAL.

- L. GRIMES has recently been appointed master mechanic of the Illinois Central at Jackson, Tenn.
- J. A. GIBSON has resigned his position as master mechanic of the Peoria & Eastern at Urbana, Ill.
- F. J. WALSH succeeds H. M. Brown as master mechanic of the Chesapeake & Ohio at Hinton, W. Va.
- P. T. DUNN, master mechanic of the Pennsylvania Lines West, at Chicago, has been transferred to Wellsville, O.
- I. LATHAM has recently been appointed master mechanic of the Nevada & Copper Belt, with offices at Mason, Nev.
- L. R. LAIZURE, master mechanic of the Erie Railroad, at Cleveland, Ohio, has been transferred to Hornell, N. Y.
- E. M. SWITZER has been appointed superintendent of safety of the Chicago, Burlington & Quincy, with office at Chicago.
- JAMES CRAIG has been appointed chief draftsman of the Boston & Maine, at Boston, Mass., vice M. C. M. Hatch, promoted.
- A. G. TRUMBULL, mechanical superintendent of the Erie Railroad at Cleveland, O., has been transferred to Jersey City, N. J.
- G. W. GOOD has been appointed supervisor of piece work on the New York Central Lines west of Buffalo, with office at Chicago.
- L. E. HASSMAN, master mechanic of the Illinois Central, with office at Clinton, Ill., has resigned, effective February 1, to engage in other business.
- J. W. HOPKINS, general foreman of the Pennsylvania Lines West, at Richmond, Ind., has been appointed master mechanic, with office at Toledo, Ohio.
- E. S. FITZSIMMONS, master mechanic of the Erie Railroad at Hornell, N. Y., has been promoted to mechanical superintendent, with headquarters at Cleveland.
- A. H. GRAHAM has been appointed master mechanic of the St. Louis, San Francisco & Texas, and the Fort Worth & Rio Grande, with office at Sherman, Tex.
- F. K. MURPHY, supervisor of air brakes of the Cleveland, Cincinnati, Chicago & St. Louis, has been appointed master mechanic, with office at Brightwood, Ind.
- C. E. GOSSETT, master mechanic of the Minneapolis & St. Louis, at Minneapolis, Minn., has been appointed general master mechanic, and his authority has been extended over the Eastern division.
- MAYNARD ROBINSON, master mechanic of the Gulf Colorado & Santa Fe, has had his jurisdiction extended over that portion of the Pecos & Northern Texas between Coleman, Tex., and Mile Post 461.
- C. E. BOSS, master mechanic of the Fort Worth & Rio Grande at Sherman, Tex., has been appointed master mechanic of the Texas & Pacific, with office at Big Springs, Tex., succeeding J. Potton.
- P. T. DUNLOP, mechanical superintendent of the Gulf, Colorado and Santa Fe, has had his jurisdiction extended over that portion of the Pecos & Northern Texas between Coleman, Tex., and Mile Post 461.
- WILLIAM GEMLO has been appointed acting road foreman of equipment in charge of the Western division and the Fourth district of the Central division of the Minneapolis & St. Louis, with office at Watertown, S. Dak.
- SAMUEL G. THOMPSON, assistant engineer of motive power of

the Philadelphia & Reading, has been appointed acting superintendent of motive power and rolling equipment, with office at Reading, Pa., succeeding Howard D. Taylor, resigned.

W. T. LEYDEN, road foreman of equipment of the Minneapolis & St. Louis at Watertown, S. D., has been appointed acting master mechanic of the Eastern division, with office at Marshalltown, Ia., succeeding William Gill, granted leave of absence.

F. W. LAWLER has retired from the position of master mechanic of the Cleveland, Cincinnati, Chicago & St. Louis at Brightwood, Ind., having served the company for 41 years. The last 22 years he served as master mechanic. He will be retired on a pension.

F. H. HANSON has been appointed supervisor of materials on the Lake Shore & Michigan Southern; Chicago, Indiana & Southern; Indiana Harbor Belt; Lake Erie & Wheeling; Lake Erie, Alliance & Wheeling, and the Dunkirk, Allegheny Valley & Pittsburgh, with headquarters at Cleveland, O.

WILLIAM SCHLAFGE has been appointed general mechanical superintendent of the Erie Railroad, with office at New York. He was born in Berlin, Germany, on October 11, 1868, and after

receiving a common school education attended night school. Mr. Schlafge began railway work in the machine and car shops of the Lehigh Valley at Packerton, Pa., and left that company in 1887, to go to the Minneapolis, St. Paul & Sault Ste. Marie shops at Minneapolis as an apprentice. After completing his apprenticeship he was engaged in various railway and contract shops as mechanic and foreman, and returned to the service of the Soo Line in 1893 as engine house foreman at Gladstone, Mich. He remained in this position

until 1898, when he went to the Escanaba & Lake Superior as locomotive fireman. He was later made engineman and then promoted to master mechanic. His next position was engine house foreman at Newark, Ohio, with the Baltimore & Ohio, and three years later he was promoted to general foreman in charge of the locomotive and car departments, with office at Chicago Junction, Ohio, remaining in that position until 1903. Mr. Schlafge went to the Erie in March, 1903, as general foreman at Port Jervis, N. Y., and during the following year was made master mechanic at Jersey City, N. J. In December, 1906, he was made master car builder, with office at Meadville, Pa., and then within the next few months was made general master mechanic and assistant mechanical superintendent of the same road. In October, 1907, he was promoted to mechanical superintendent of the Erie grand division and the New York, Susquehanna & Western, with office at Jersey City, which position he held at the time of his appointment as general mechanical superintendent of the Erie system.

J. W. SMALL, whose appointment as superintendent of motive power of the Southern Pacific Lines in Texas, with office at Houston, Tex., was announced in the January issue, has been appointed also superintendent of motive power of the Louisiana Western, and of Morgan's Louisiana & Texas Railroad & Steamship Company.

JOSEPH A. BOYDEN has been appointed master mechanic of the Mahoning division of the Erie Railroad, with office at Cleveland, Ohio. He was born in September 2, 1876, at Susquehanna, Pa., and was educated at the high schools and at Wyoming Seminary. Mr. Boyden began railway work on November 6, 1892, as an apprentice at the Susquehanna shops of the Erie; after completing his apprenticeship in 1896, he spent one year in the drafting room. In January, 1898, he went to the Pere Marquette as a machinist at Saginaw, Mich., and in February of the following year returned to the service of the Erie Railroad as a machinist at Susquehanna. In August, 1899, he was transferred in the same capacity to



J. A. Boyden.

Dunmore, Pa., and in February, 1900, he was again transferred to the Baldwin Locomotive Works at Philadelphia, inspecting the engines being built for the Erie. He returned to the Susquehanna shops in September of the same year, and in January, 1901, was promoted to machine shop foreman at Port Jervis, N. Y. He was again promoted in February, 1904, to general foreman at Newburgh, N. Y., and in March, 1905, was transferred as general foreman at Bergen, N. J. Four years later he was again transferred as general foreman to Cleveland, Ohio, and since April 1, 1911, has been general foreman at Hornell, N. Y. Mr. Boyden is first vice-president of the International Railway General Foremen's Association.

J. F. SHEAHAN, master mechanic of the Georgia & Florida, at Douglas, Ga., who, as stated in the January issue of the *American Engineer*, was appointed assistant superintendent, began rail-

way work in 1880, at the Renova shops of the Pennsylvania Railroad, and was later transferred to Camden, N. J. Previous to May, 1888, he held various positions, and was then appointed master mechanic of the Orange Belt Railway, now a part of the Atlantic Coast Line, and in July, 1895, became master mechanic of the Florida Southern at Palatka, Fla. He was then for eight months master mechanic on the Plant System. In June, 1897, he was made night roundhouse foreman of the Southern Railway. The following August



J. F. Sheahan.

he was appointed erecting shop foreman, and one month later became general foreman at Alexander, Va. He was promoted to master mechanic of the Southern Railway in January, 1900, at Selma, Ala., and then served in the same capacity consecutively at Columbia, S. C., Spencer, N. C., Atlanta, Ga., and

Knoxville, Tenn. Mr. Sheahan left the service of the Southern Railway in January, 1910, and went to the International & Great Northern as master mechanic at Palestine, Tex. In December, 1911, he was appointed master mechanic of the Georgia & Florida, with office at Douglas, Ga., and on January 1, 1912, when the Hine system of organization was established by the Georgia & Florida, he became assistant superintendent, with office at Douglas.

R. J. TURNBULL, assistant superintendent of machinery of the Missouri Pacific at St. Louis, Mo., has been appointed acting superintendent of machinery, with office at St. Louis, succeeding J. W. Small, resigned to accept service with another company.

D. M. PERINE, whose appointment as superintendent of motive power of the New Jersey division of the Pennsylvania Railroad, with office at Jersey City, N. J., was announced in the January issue of the *American Engineer*, was born in Baltimore, Md., February 13, 1869, and was educated in the schools of that city, taking the full course in mechanical drawing and design at the Maryland Institute of that city. He entered the service of the Pennsylvania Railroad as an apprentice at the Mt. Vernon shops of the Northern Central on May 14, 1888. On April 1, 1894, he was appointed assistant road foreman of engines on the Pittsburgh division, and on August 1, 1895, was promoted to assistant master mechanic of the Altoona machine shops. On March 6, 1899, he was appointed assistant engineer of motive power of the Northern Central and the Philadelphia and Erie, and in 1900 was transferred to Altoona as assistant engineer of motive power of the Pennsylvania. On October 1, 1911, he was promoted to master mechanic of the Pittsburgh division, and on August 1, 1903, was transferred to West Philadelphia as master mechanic of the West Philadelphia shops. On April 1, 1906, he was advanced to superintendent of motive power of the N. C. and P. & E., and on April 1, 1907, was transferred to Pittsburgh as superintendent of motive power of the Western Pennsylvania division. On January 1, 1912, he was again transferred to superintendent of motive power of the New Jersey division. The headquarters of this division is located at Jersey City.

J. T. WALLIS, whose appointment as general superintendent of motive power of the Pennsylvania Railroad, with headquarters at Altoona, Pa., was announced in the January issue of the *American Engineer*, was born on June 11, 1868, at New Orleans, La., and was educated in the public schools of his native town, the University of Louisiana (now Tulane University), Georgetown College, and was graduated from Stevens Institute with the degree of mechanical engineer in 1891. The same year he entered the service of the Pennsylvania Railroad as an apprentice at the West Philadelphia shops, and has since then served the company as assistant foreman of engines, assistant master mechanic, assistant engineer of motive power, master mechanic, and superintendent of motive power. Mr. Wallis was appointed superintendent of the West Jersey & Seashore on May 1, 1910, which position he held at the time of his recent promotion to general superintendent of motive power.



D. M. Perine.

JOHN MOORE JAMES, whose appointment as superintendent of motive power of the Western Pennsylvania division of the Pennsylvania Railroad has been announced in the January issue of the *American Engineer*, was born on September 10, 1875, at Wellsville, Ohio, and was educated in the public schools of his native town and at the Ohio State University. He entered the service of the Pennsylvania Railroad as a machinist apprentice in the Altoona shops in 1893, and was appointed assistant foreman of car inspectors at Washington, D. C., in May, 1899. The following January he was made foreman of the Anacosta shops of the Philadelphia, Baltimore & Washington, and in May of the same year was promoted to general foreman at Washington.

He was appointed general inspector of the Buffalo & Allegheny Valley division in October, 1900, and became assistant engineer of motive power of that division in January, 1902. The following December he was appointed master mechanic at the Olean, N. Y., shops, and in November, 1908, was transferred in the same capacity to the Buffalo division. He was again transferred on May 1, 1911, as master mechanic to the West Philadelphia, Pa., shops, which position he held at the time of his recent appointment as superintendent of motive power of the Western Pennsylvania division, with office at Pittsburgh, Pa.

T. RUMNEY, general mechanical superintendent of the Erie, has been appointed assistant vice-president of the Rock Island Lines, in charge of the mechanical department, with office at Chicago. This appointment gives Mr. Rumney the most important title yet held by the head of the mechanical department of any large railway in the United States, and indicates the growing conviction that the importance of this department deserves that it shall have a representative on the executive staff, who will be clothed with sufficient authority to give the department the freedom and opportunities it requires for the best results. Mr. Rumney's rise to his present position has been very rapid, as may be seen from the following incomplete account of his railway experience, which was gathered from various sources. It appears that in 1896 he was foreman of locomotive repairs on the Central of Vermont at Malone, N. Y. In 1898 he was listed as master mechanic of the Ogdensburgh & Lake Champlain at Malone, N. Y. In 1903 he was a general inspector of machinery on the Erie at Meadville, Pa. In 1904 he was a master mechanic on the same road,



J. M. James.



T. Rumney.

with headquarters at Jersey City, N. J. In 1905 he became assistant mechanical superintendent of the Erie at Meadville, Pa., and in the early part of 1907 was promoted to mechanical superintendent, succeeding G. W. Wildin. In October, 1907, he was appointed general mechanical superintendent of the road, with headquarters at New York. He has been very active in the work of the American Railway Master Mechanics' Association during the past 6 years, and is at present second vice-president of it. He has occupied the important position of chairman of the stoker committee for the last 4 years, and was on the executive committee for 2 years. Previous to that he was a member of committees on Mallet compounds and on the history of the movement of locomotives at terminals.

J. A. REYNOLDS has been appointed district foreman on the Denver, Northwestern & Pacific, with office at Fraser, Colo. He will have charge of the Mallet helper locomotives running out of Fraser and all the locomotives in the district west of Fraser.

MAJOR CHARLES HINE, who, as special representative of the director of maintenance and operation of the Harriman Lines, has had charge of the installation of the unit system of organization on those lines, has been elected vice-president and general manager of the Southern Pacific of Mexico and the Arizona Eastern, with office at Tucson, Ariz.

CAR DEPARTMENT.

L. A. SCHACKELFORD has been appointed foreman of the car department of the International & Great Northern at Taylor, Tex.

S. LINDMAN has been appointed foreman of the car department of the Lake Shore & Michigan Southern, with office at Nottingham, O.

P. W. HELWIG, general car foreman of the Minneapolis & St. Louis at Minneapolis, Minn., will have charge of car work over the Eastern Division.

W. D. MOONEY has been appointed division general foreman car department of the Lake Shore & Michigan Southern and the Lake Erie, Alliance & Wheeling, with office at Collinwood, O.

C. H. HITCH, general car foreman of the Cincinnati, Hamilton & Dayton, has been transferred from Ivorydale, O., to Lima, and will have charge of the freight and passenger car repairs at that point.

T. H. GOODNOW, master car builder of the Lake Shore & Michigan Southern at Englewood, Ill., has been appointed general superintendent of shops of the Armour Car Lines, with office at Chicago, succeeding W. E. Sharp, resigned.

J. W. SENGER, supervisor of materials in the locomotive and car department of the Lake Shore & Michigan Southern at Cleveland, Ohio, has been appointed master car builder, with headquarters at Englewood, Ill., succeeding T. H. Goodnow, resigned.

T. N. RUSSELL, general inspector in the car department of the Cincinnati, Hamilton & Dayton at Lima, Ohio, has been appointed superintendent of the car department, attached to the office of superintendent of motive power and car department at Cincinnati, Ohio.

SHOP.

C. A. WELSH has been made engine house foreman of the Rock Island shops at Little Rock, Ark.

A. B. WILSON has been appointed shop foreman at the Albany, Ore., shops of the Southern Pacific.

T. F. LALLY has been appointed engine house foreman on the Lake Shore & Michigan Southern at Elyria, O.

D. A. STARK has been appointed master boilermaker of the St. Louis, Brownsville and Mexico with headquarters at Kingsville, Tex.

J. K. MORGAN has been made general foreman of the Rock Island shops at Little Rock, Ark., vice G. W. Cooper, resigned.

H. J. KOESTER has been appointed general foreman of locomotive repairs on the Virginia Southwestern, with office at Bristol, Va.-Tenn.

C. G. HESS has been appointed general foreman of the St. Louis, San Francisco & Texas, at Fort Worth, Tex., having been promoted from engine house foreman.

PURCHASING AND STOREKEEPING.

JOHN C. KUHN has been appointed purchasing agent of the Illinois Central at Chicago, vice C. F. Parker.

JOHN H. GUESS has been appointed general purchasing agent of the Grand Trunk, with office at Montreal, Que.

C. H. KENZEL, assistant purchasing agent of the Elgin, Joliet & Eastern at Chicago, has been promoted to purchasing agent, and his former position has been abolished.

W. C. BLAKE has been appointed division storekeeper of the J. & O. district of the Mobile & Ohio, with office at Jackson, Tenn., succeeding E. T. Bracken, transferred.

CLARENCE F. PARKER, purchasing agent of the Illinois Central at Chicago, has been elected vice-president in charge of purchases and supplies, with headquarters at Chicago, a new office.

A. C. MANN, chief clerk in the purchasing department of the Illinois Central at Chicago, has been appointed assistant purchasing agent, with headquarters at Chicago, succeeding John C. Kulms, promoted to purchasing agent.

OBITUARY

W. W. LOWELL, master mechanic of the Chicago, Burlington & Quincy, at St. Joseph, Mo., died on January 8.

W. F. BUCK, superintendent of motive power of the Atchison, Topeka & Santa Fe, with office at Chicago, died early Wednesday morning near San Bernardino, Cal., while being brought in a

special train to Los Angeles, Cal., from a hospital at Albuquerque, where he had been ill with tonsillitis. Mr. Buck entered railway service as a machinist on the Northern Pacific. In 1893 he was made shop foreman on that road, and two years later general foreman of the shops at Missoula, Mont. In 1899 he was transferred, with the same title, to Helena, Mont., and three years later was made master mechanic of the Rocky Mountain division. In 1904 he went to the Atchison, Topeka & Santa Fe as master mechanic at Needles,



W. F. Buck.

Cal. He was made mechanical superintendent of the Eastern Grand division of the same road in April, 1906, and was promoted to superintendent of motive power in January, 1908, with office at Chicago.

NEW SHOPS

ATCHISON, TOPEKA & SANTA FE.—A contract has been given to C. A. Fellows at about \$65,000, it is said, for putting up a reinforced concrete 25-stall engine house at Barstow, Cal. The contract for the engine house at Riverbank, Cal., has been relet to the Unit Construction Company, San Francisco, for about \$60,000. It is reported that an engine house and repair shop will be built at National City, Cal. The road is planning on equipping its machinery in the Kingman, Ariz., shops with electric drive.

ATLANTIC COAST LINE.—It is reported that shops for the manufacture of flat and box cars and passenger coaches will be built at Wilson, N. C.

BANGOR & AROOSTOOK.—The engine house which was recently destroyed by fire at Houlton, Me., will be rebuilt. A machine shop will also be added to the structure.

CANADIAN PACIFIC.—As was reported last month, this company will erect shops at Calgary, Alberta. They will consist of 20 buildings which will give employment to 5,000 men. The locomotive shop alone will cover six acres.

CHICAGO, MILWAUKEE & ST. PAUL.—The engine house at Perry, Iowa, will be enlarged and a mechanical coaling station will be installed.

CHICAGO, ROCK ISLAND & PACIFIC.—A new ten-stall engine house will be built at Topeka, Kans.

CLEVELAND, CINCINNATI, CHICAGO & ST. LOUIS.—This road proposes to build a new engine house this year at Elkhart, Ind., also one at Carey, Ohio, and one at Terre Haute, Ind.

CINCINNATI, NEW ORLEANS & TEXAS PACIFIC.—Preparations are being made by the motive power department for the layout of new shops at Ludlow, Ky.

EL PASO & SOUTHWESTERN.—Plans have been prepared for an 8-track yard, engine house, repair shops, freight warehouse, office building and passenger station at Tucson, Ariz.

ERIE RAILROAD.—This company, which leases the New Castle branch of the Sharon Railway, will build an engine house at Ferrona, Pa. Large locomotive and car-repair shops will also be built by this road at Marion, Ohio.

KANSAS CITY, MEXICO & ORIENT.—A 20-stall engine house and shops will be built at Fort Stockton, Tex.

KANSAS CITY SOUTHERN.—It is reported that this road will build a new engine house and shops at De Quincey, La.

LAKE SUPERIOR TERMINAL & TRANSFER COMPANY.—Construction work will be started in the early spring on a new engine house and machine shop at Superior, Wis.

LOUISVILLE & NASHVILLE.—The new shops at Boyles, which have been under construction for about two years, were recently placed in operation. The cost of the improvements was about \$1,000,000.

NEW YORK CENTRAL LINES.—Plans have been made for yards and repair shops at Miller, Ind. The shops will employ about 1,000 men.

NORTHWESTERN PACIFIC.—A contract for new shops and a 56-stall engine house at Yardley, Wash., is about ready to be let. The construction of a large engine house and machine shop at Centralia, Wash., is to be started at once.

OREGON-WASHINGTON RAILROAD & NAVIGATION COMPANY.—A contract has been given to Grant, Smith & Company, Seattle, for the erection of a machine shop, 90 ft. x 180 ft., a power house, 40 ft. x 90 ft., and a storehouse, 36 ft. x 36 ft., at Argo, Wash.

All of the buildings will be reinforced concrete construction. It is also reported that a contract for new shops at Tacoma, Wash., will soon be let.

PACIFIC ELECTRIC.—It is understood that this road will put up new shops at Dominguez, Cal., about 13 miles from Los Angeles. The estimated cost of improvements is \$250,000.

PHILADELPHIA & READING.—It is reported that this road will construct a car-repair shop in the vicinity of Pottsville, Pa.

PAN HANDLE, PECOS & GULF.—Plans are being made for the erection of shops and an engine house at Pecos, Tex.

ST. LOUIS & SOUTHWESTERN.—The machine and boiler shops of this road at Pine Bluff, Ark., were destroyed by fire, with a loss of \$80,000. They will be rebuilt.

ST. LOUIS, BROWNSVILLE & MEXICO.—It is planned to enlarge the shops at Kingsville, Tex., to almost double their capacity.

ST. LOUIS, IRON MOUNTAIN & SOUTHERN.—A new 30-stall engine house will be built at Argenta, Ark.

SEABOARD AIR LINE.—It is reported that 150 acres of land at Nortima, N. C., has been purchased for new repair shops.

SOUTHERN PACIFIC.—This road is said to be arranging for an addition to its repair shops at Sacramento, Cal., by filling in the adjacent property.

TEXAS & NEW ORLEANS.—Erection of a new engine house at Beaumont, Tex., will soon be started.

TOLEDO, PEORIA & WESTERN.—A new engine house, 50 ft. x 75 ft., is being built at Galesburg, Ill.

WESTERN PACIFIC.—An engine house will be built at Marysville, Neb.

RADIATOR PAINT.—Prof. C. L. Norton, of Boston, Mass., made a long series of experiments upon the transmission of heat through and from painted surfaces. Taking the amount of heat radiated from a new pipe as 100, Professor Norton obtains the following relative values for the heat radiated, under similar conditions, from pipe treated as indicated:

| LOSS OF HEAT AT 200 LBS. PRESSURE FROM DABE PIPE. | |
|---|-------|
| New pipe | 100 |
| Fair condition | 116 |
| Rusty and black | 119 |
| Cleaned with caustic potash, inside and cut | 116 |
| Painted dull white | 120 |
| Painted glossy white | 100.5 |
| Cleaned with potash again | 116 |
| Coated with cylinder oil | 116 |
| Painted dull black | 120 |
| Painted glossy black | 101 |

It appears from the foregoing that the color of the pipe has little or no effect upon the radiation of heat, though the condition of the surface with respect to glossiness or dullness has quite a sensible influence. Thus a dull surface, whether it be white or black, has a radiative power of 120, and a glossy surface, whether white or black, has a corresponding power of only about 101.

LOCOMOTIVE DEVELOPMENT IN ASIA.—The countries of China, Japan and Manchuria have been leaders in the adoption of American locomotives and the increase in locomotive orders during the past five years has been about four times greater than during the previous five years. The South Manchuria Railways have ordered as many as 180 locomotives at a time. These included consolidations of 38,510 lbs. tractive effort, the weight of the locomotive being 171,000 lbs.; also Pacific type engines of 25,600 lbs. tractive effort, with a weight of 197,000 lbs. One of the recent shipments was for the Korean lines of the Imperial Government railways of Japan, and consisted of 9 ten-wheel locomotives, having a total weight of 150,000 lbs., with 117,000 lbs. on drivers. The cylinders were 20 in. x 26 in., the driving wheels 66 in. in diameter, the boiler pressure of 180 lbs. and the tractive effort 24,100 lbs.

SUPPLY TRADE NOTES

E. H. Baker has been made second vice-president of the Galena Signal Oil Company, Franklin, Pa.

James B. Brady has been elected vice-president of Manning, Maxwell & Moore, New York, succeeding W. O. Jacquette.

The Standard Steel Works Company, Philadelphia, Pa., has opened a branch office in the First National Bank building, Denver, Col.

The Railway & Mill Equipment Company, New Orleans, La., has been established to sell railway supplies. Seely Dunn and J. Otho Elmer are officers.

Henry C. Valentine, president of Valentine & Company, New York, varnish manufacturers, died at his home in New York, January 15, at the age of 82.

The Columbia Nut & Bolt Company, Bridgeport, Conn., has added a complete line of hot pressed and cold punched castelated nuts to its line of railway supplies.

Morris E. Ward, general sales agent of the Chicago-Cleveland Car Roofing Company, Chicago, died in Chicago on January 7 of a complication of diseases at the age of 68 years.

D. G. Kimball, formerly with the Chicago sales office of Hill, Clarke & Company, has been appointed sales manager of the Wallcott & Wood Machine Tool Company, Jackson, Mich.

W. E. Sharp has resigned his position as master car builder of the Lake Shore & Michigan Southern to become vice-president and general manager of the Grip Nut Company, New York.

F. M. Gilmore, formerly in the railway department of the H. W. Johns-Manville Company, New York, has gone to the Chicago Car Heating Company, Chicago, with office in that city.

The Smith Locomotive Adjustable Hub Plate Company, Pittsburg, Kan., is equipping a number of new locomotives for the St. Louis & San Francisco and the Missouri Pacific with its adjustable hub plates.

W. O. Jacquette has resigned as vice-president of Manning, Maxwell & Moore, Inc., New York. He has made no plans for the future, but for the present will make his headquarters at 165 Broadway, New York.

Charles R. Crane has been elected head of the Crane Company, Chicago, to succeed his father, the late Richard T. Crane. R. T. Crane, Jr., is the new first vice-president, and R. T. Crane, 3d, was made second vice-president.

Following are the newly elected officers of the Watson-Stillman Company, New York: Vice-president, E. A. Stillman; treasurer, J. P. Bird; secretary and works manager, A. F. Stillman; chief engineer, Carl Wigtel.

C. E. Tripp, of the Stone & Webster Engineering Corporation, Boston, Mass., has been made chairman of the board of directors of the Westinghouse Electric & Manufacturing Company, Pittsburg, Pa., succeeding Robert Mather, deceased.

Charles M. Lyle has resigned his position with Manning, Maxwell & Moore, New York, to go with the Niles-Bement-Pond Company as manager of its St. Louis office. Mr. Lyle was connected with the Niles-Bement-Pond Company about nine years ago.

Joseph T. Ryerson & Son, Chicago, have opened a branch office in the Ford building, Detroit, Mich., in charge of J. H. Marlotte. This company has also moved its Minneapolis, Minn., office to 501 Third street, South Minneapolis, where larger floor space has been secured.

C. A. Delaney, for a number of years superintendent of the Dickson works of the American Locomotive Company, with

office at Scranton, Pa., and later sales representative at that place, has been made Western representative of the company with office in Chicago.

W. H. Lawrence has been made manager of the waterproofing and mastic department of the H. W. Johns-Manville Company, New York, with office in Chicago. Mr. Lawrence will have supervision of all the waterproofing work of the company throughout the country.

The Spencer Otis Company, Chicago, has recently moved its main office to room 747, Railway Exchange building, Chicago, where a new feature has been introduced in the way of exhibiting several of the company's devices. The American Kron scale for railway work is exhibited in all sizes and capacities. The company will shortly open an office in San Francisco, Cal.

The Independent Pneumatic Tool Company, Chicago, has recently placed on the market a new One Man drill, which is equipped with compound planetary gears, and is particularly adapted for drilling, tapping and screwing in staybolts and studs of all sizes up to 1¼ in. This drill is of the reversible type, weighs 20 lbs. equipped with a No. 3 Morse taper socket, and has Corliss valves.

The Standard Railway Equipment Company, Pittsburgh, Pa., and the Monarch Pneumatic Tool Company, St. Louis, Mo., will in future keep their respective orders and business transactions separate. The Standard company will receive all orders for roof materials and carlines, and the Monarch company will receive all orders for pneumatic tools. P. H. Murphy is president of the Standard company and William Miller is president of the Monarch company.

The United Car Company, with offices in the Commercial National Bank building, Chicago, which has recently been organized with C. H. Thomas, F. A. Hecht and E. R. Davis as directors, has purchased the entire plant and equipment of the American Car & Equipment Company, Chicago Heights, Ill., including a large erecting shop, blacksmith shop, offices, etc. It will build and rebuild cars and handle railway supplies in general, making a specialty of steel underframes and tank cars. Mr. Thomas is president of the company; Mr. Hecht is vice-president; and N. B. Hall is secretary.

George W. Fowler, for many years sales manager of the Garwood Electric Company, New York, and W. J. Warder, Jr., formerly chief engineer and superintendent of Roth Brothers, Chicago, and later with the Westinghouse Electric & Manufacturing Company, Pittsburg, Pa., have resigned to enter the sales department of the Crocker-Wheeler Company, Amper, N. J. A. K. Selden, Jr., for some years in charge of the design of motors for the Electro Dynamic Company, New York, has resigned to enter the engineering department of the Crocker-Wheeler Company.

Richard T. Crane, president of the Crane Company, Chicago, died at his home January 8. Mr. Crane was born in Paterson, N. J., in 1832, and worked in machine shops in Paterson, New York and Brooklyn, N. Y., until he was 23 years old, when he moved to Chicago. An uncle, Martin Ryerson, gave him a small piece of land on which he started a brass foundry. His brother, Charles S. Crane, subsequently joined him, and the machine manufacturing company of R. T. Crane & Brother was formed. This concern later grew into the Northwestern Manufacturing Company, and after that into the Crane Brothers Manufacturing Company, from which it evolved into the Crane Company. Mr. Crane was well known because of his aggressive opposition to the present methods of higher education.

Charles C. Leech, for the past ten years foreman in charge of the Pennsylvania shops at Buffalo, N. Y., has resigned to accept the position of general manager of the American Roller Bearing Company, Pittsburgh, Pa. Mr. Leech is well-known to

the readers of the *Railway Age Gazette* Shop Section and of the new *American Engineer*, because of his many contributions to the various competitions which have been held during the past two years. He was awarded the first prize in the engine house kink competition, which closed March 15, 1911; second prize in the car department kink competition, which closed November 15, 1910; first prize in the shop kink competition, which closed May 15, 1911, and second prize in the competition on shop improvements during 1911, which closed December 15, 1911.

On December 28, 1911, Judge Christian C. Kohlsaat, of the United States Circuit Court, decided the case of the Railroad Supply Company, Chicago, against the Hart Steel Company, Elyria, Ohio, and Guilford S. Wood, Chicago, pending in the United States Circuit Court for the northern district of Illinois, and dismissed the bill for want of equity, holding that, while the three Wolhaupter patents, upon which the suit was instituted, were valid under the state of the art shown by the record, the claims must be limited to the devices described in the specifications, and that when so construed the device sold by the defendants did not infringe. An appeal was at once prayed and allowed to the United States Circuit Court of Appeals for the seventh circuit, and will be heard at the April session of that court in Chicago. The companion suit against the Elyria Iron & Steel Company, Elyria, will be heard before Judge Day in the federal court at Cleveland in January, 1912.

The Baldwin Locomotive Works has recently purchased 370 acres of land in the vicinity of Gary, Ind. It is triangular in shape; on the south line are the Elgin, Jolliet and Eastern Railway and the Chicago, Lake Shore & South Bend Electric. On the north is the joint right of way of the Pennsylvania and the Baltimore & Ohio Chicago Terminal. It is the intention to start the erection of the power house, foundry and forge shop for the manufacture of castings and forgings which will supply a plant capacity of ten locomotives a week. After this portion of the plant is complete the machine and erecting shops will be erected. The whole plant when completed will provide facilities for an output of 30 locomotives a week and will employ 5,000 men. The works are located within 3 miles of the American Steel Foundry, the Standard Forging Company, the Midland Steel Company, the Universal Cement Company, the Buckeye Steel Castings Company and the American Bridge Company. The Indiana Steel Company at Gary is within five miles, and the tract purchased by the American Locomotive Company is within seven miles.

De F. Lillis, for many years connected with the New York Central Lines, has been appointed Eastern sales agent of the Grip Nut Company, with headquarters in New York. Mr. Lillis was born in Ottawa, Ill., where he received a common school, high school and business college education. He learned the printing trade and worked at it for several years in Ottawa, Peru and Chicago. In August, 1886, he entered the service of the Lake Shore & Michigan Southern as a stenographer to the local attorney at Chicago. After filling several minor positions in the law and operating departments he became chief clerk to John Newell, the president and general manager, in September, 1887. He remained in this position until Mr. Newell's death in 1894, and served in the same capacity during the administrations of three of Mr. Newell's successors, D. W. Caldwell, S. R. Galloway and W. H. Newman. In April, 1899, he came to New York as secretary to Arthur M. Waitt, superintendent of motive power and rolling stock of the New York Central & Hudson River. He was secretary and executive clerk to J. F. Deems, general superintendent of motive power, rolling stock and machinery of the New York Central Lines from April 1, 1903, to November 15, 1911. From that time until January 1, 1912, he was connected with the office of the president, W. C. Brown. It is needless to say that Mr. Lillis has a wide acquaintance both in railway and railway business circles.

CATALOGS

VALVES.—The National Tube Company, Pittsburgh, Pa., has recently issued bulletin No. 7, describing its regrinding valve.

MECHANICAL STOKERS.—The E. R. Allen Foundry Company, Corning, N. Y., has issued a pamphlet devoted to the Elliott mechanical stoker.

COMPRESSORS.—The Ingersoll-Rand Company, New York, has published form No. 3211 on Imperial type X, duplex, steam-driven compressors.

GAGE GLASS PROTECTORS.—The Ashcroft Manufacturing Company, New York, has published a small folder on the Ashcroft gage glass protectors.

FURNACES.—Tate, Jones & Company, Inc., Pittsburgh, Pa., has published an attractive 30-page catalog of its furnaces for heating, forging and welding.

CARBONIZING COATING.—The Goheen Manufacturing Company, Canton, Ohio, has published a pamphlet on carbonizing coating for preserving iron and steel construction.

FANS.—The American Blower Company, Detroit, Mich., has published "Fact Bulletin" No. 3, giving the present standing of several suits between this company and other fan manufacturers.

COMPRESSORS.—The Chicago Pneumatic Tool Company, Chicago, has published bulletin No. 34 H, which gives general instructions for installing and operating the Chicago pneumatic compressors.

REFRIGERATION AND VENTILATION.—Burton W. Mudge & Company, Chicago, have published an illustrated booklet on the Garland system of ventilation, heating and refrigeration applied to refrigerator cars.

METALLIC HOSE.—The American Metal Hose Company, Waterbury, Conn., has published a small illustrated folder on flexible metal hose for steam, oil, gas, suction, air or conduit, in which dimensions and prices are given.

BORING AND TURNING MILLS.—The Betts Machine Company, Wilmington, Del., has published a 100-page catalog illustrating and describing its heavy machine tools. They are especially adapted for locomotive and car shops.

PIPING MATERIALS.—The Best Manufacturing Company, Pittsburgh, Pa., has recently published a 395-page catalog, bound in cloth, in which is given the sizes and list prices of its piping, valves, tees, elbows, steam separators, water columns, etc.

RECORDING INSTRUMENTS.—The Uehling Instrument Company, Passaic, N. J., has recently issued bulletin No. 2, which is a condensed catalog of its recording instruments. The bulletin contains illustrations of pressure, vacuum, draft, revolution and CO₂ recorders.

PNEUMATIC TOOLS.—The Independent Pneumatic Tool Company, Chicago, has published a small illustrated folder giving the advantages and the dimensions of the various Thor pneumatic tools, including piston air drills, pneumatic hammers, staybolt drivers, air appliances, etc.

LOCOMOTIVE CRANES.—The Browning Engineering Company, Cleveland, Ohio, has published an attractive and useful catalog descriptive of the various types of Browning locomotive cranes and the many different uses to which the cranes and their various attachments are adapted.

VENTILATORS AND DOOR CLOSERS.—Burton W. Mudge & Company, Chicago, have issued two illustrated folders, one describing the Garland ventilator for passenger cars, which is now in use on about 6,000 cars of the Pullman Company, the other describing the Garland door closing and opening device for refrigerator cars.

AMERICAN ENGINEER

"THE RAILWAY MECHANICAL MONTHLY"

(Including the Railway Age Gazette "Shop Edition.")

PUBLISHED ON THE FIRST WEDNESDAY OF EVERY MONTH, BY THE
SIMMONS-BOARDMAN PUBLISHING COMPANY,
83 FULTON STREET, NEW YORK, N. Y.

CHICAGO: Plymouth Bldg. CLEVELAND: New England Bldg.
LONDON: Queen Anne's Chambers, Westminster.

EDWARD A. SIMMONS, *President.* HENRY LEE, *Secretary.*
L. B. SHERMAN, *Vice-President.* A. E. HOOVEN, *Business Manager.*

The address of the company is the address of the officers.

ROY V. WRIGHT, *Editor.* R. E. THAYER, *Associate Editor.*
E. A. AVERILL, *Managing Editor.* WILLIAM FORSYTH, *Associate Editor.*
GEORGE L. FOWLER, *Associate Editor.*

Subscriptions, including the eight daily editions of the *Railway Age Gazette* published in June in connection with the annual conventions of the Master Car Builders' and American Railway Master Mechanics' associations, payable in advance and postage free:

United States, Canada and Mexico \$2.00 a year
Foreign Countries (excepting daily editions)..... 3.00 a year
Single Copy 20 cents

Entered at the Post Office at New York, N. Y., as mail matter of the second class.

VOLUME 86. MARCH, 1912. NUMBER 3.

CONTENTS

EDITORIALS:

| | |
|--|-----|
| Shop Kink Competition..... | 107 |
| Reclaiming Scrap Material Competition..... | 107 |
| Grinding Car and Locomotive Axles..... | 107 |
| Motive Power on the Chesapeake & Ohio..... | 107 |
| A Splendid Shop Kink Contribution..... | 108 |
| Shop Practice Competition..... | 108 |
| Burning Lignite Coal in Locomotives..... | 108 |
| Improvements in Locomotive Tenders..... | 108 |
| Steel Car Center Sill Design..... | 108 |
| Solid Steel Wheels..... | 109 |
| Facilities for Repairing Steel Cars..... | 109 |
| Smoke Abatement on Switch Engines..... | 109 |
| Mechanical Department Organization..... | 110 |
| New Books..... | 110 |

ILLUSTRATED:

| | |
|--|-----|
| Fish-Belly Center Girders for Cars..... | 111 |
| Reamer for Ball Joints..... | 116 |
| Machining Piston Valve Packing Rings..... | 116 |
| Locomotive Shop Kinks..... | 118 |
| Mechanical Department Organization..... | 119 |
| Cast Steel Drawbar Carrier..... | 121 |
| Steel Car Shop Kinks..... | 122 |
| 100-Ton, 36-Ft. Flat Car..... | 125 |
| Accuracy in Finishing Driving Boxes..... | 127 |
| Mikado Locomotives of Great Power..... | 128 |
| Locomotive Machine Shop Kinks..... | 132 |
| Long Island All-Steel Parlor Cars..... | 137 |
| Refrigerator Car Door Fixtures..... | 139 |
| A Simple Card Index..... | 140 |
| Pacific Type Locomotives..... | 141 |
| 600-Ton Car Wheel Press..... | 143 |
| Gyrus Spark Arrester for Lignite..... | 143 |
| Reliance Speed Dial..... | 145 |
| Repairing Bell Ringers..... | 146 |
| Machine Shop Kinks..... | 147 |
| Experimental Mallet Locomotive for the Pennsylvania..... | 150 |
| Norton Axle Grinding Machine..... | 152 |
| A New Type of Steam Turbine..... | 153 |
| Coal Pusher for Tenders..... | 154 |

MISCELLANEOUS:

| | |
|--------------------------------------|-----|
| The Conservation of Material..... | 117 |
| Reclaiming Scrap Material..... | 124 |
| Locomotive Painting..... | 136 |
| Reclaiming Car Department Scrap..... | 139 |
| Removing Large Cylinder Heads..... | 146 |
| Eliminating Engine Failures..... | 149 |
| General Foremen's Association..... | 151 |

GENERAL NEWS SECTION:

| | |
|-------------------------------|-----|
| Notes..... | 155 |
| Meetings and Conventions..... | 156 |
| Personals..... | 157 |
| New Shops..... | 159 |
| Supply Trade Notes..... | 160 |
| Catalogs..... | 162 |

Shop Kink Competition

When this paper reaches you there will be very little time left to complete and forward your contribution to the shop kink competition, which closes March 15, if you have not already done so. As stated in the previous announcements, a first prize of \$50 will be awarded for the best collection of three kinks, while a second prize of \$25 will be awarded for the next best collection. Kinks which are not awarded a prize but which are accepted for publication will be paid for at our regular space rates. If desired, more than three kinks may be submitted, in order that the judges may select and base their decision on what they consider to be the best three in the collection.

Reclaiming Scrap Material Competition

The first prize of \$35 in the competition on reclaiming scrap material was awarded to Ernest Cordeal, bonus demonstrator of the Atchison, Topeka & Santa Fe, La Junta, Col., and the second prize was awarded to a contributor who signs himself "W. L. H.," but who, for various reasons, does not wish to have his name used. The articles are of a very different nature from those which were submitted in a similar competition last September. The important feature, which is more or less marked in all of them, is the tendency to provide means or make recommendations looking toward preventing material being consigned to the scrap bins which may be reclaimed or used again. In this way it will be possible to save the cost of handling the material to and from the scrap pile, which in many cases is a considerable item.

Grinding Car and Locomotive Axles

There are two very good reasons in favor of grinding the journals of car wheel axles—increasing of the life of the axle and the reduction in its tendency to heat when first put into service. The same feature of course also applies to driving axles. The advantages of this method have long been recognized by motive power men, but in the absence of a suitable machine for the work it has not been possible to follow it to any extent. This handicap, however, is now removed and as is shown elsewhere in this issue a grinding machine designed and built expressly for this purpose is being manufactured. A study of the arrangement of the machine indicates that the designers have made themselves thoroughly familiar with the requirements and have given the matters of rigidity in the machine and rapid handling of the product the attention they deserve.

Motive Power on the Chesapeake & Ohio

During the past two years the Chesapeake & Ohio has put into service three new classes of locomotives, each of which has given evidence of the most careful study of the conditions under which they are to be operated and of intelligent designing to deliver the required service with the greatest possible economy, not overlooking the desirability of a considerable reserve capacity. The first new type to be put into service was the Mallet for use in the mountain districts. These locomotives were of a straight-forward design, 2-6-6-2 type, and had a boiler with 24-ft. tubes and a combustion chamber 6 ft. 6 in. in length, but were not equipped with superheaters. The next new type was for passenger service in the mountains and is known as the Mountain type. These engines have superheaters, brick arches and mechanical stokers. The third new type, shown elsewhere in this issue, is a Mikado freight engine for low grade sections of the road and also has superheater brick arch and stoker.

The Mallet locomotives have now been in service about a year and a half and records covering eight months, which are available, show that they have produced a saving of 5.7 cents per thousand ton-miles in the cost of handling the traffic over

what it previously cost when using consolidations. Twenty-five of these engines were built by and 25 more have just been ordered from the American Locomotive Company, who designed all of the new types, working in conjunction with the railway officials. Superheaters and brick arches have been specified on the last order, clearly indicating that the service of these devices on the Mountain type and Mikado locomotives has been thoroughly satisfactory. The action of this road in regard to motive power forms probably the most striking example of a tendency, now becoming quite evident throughout the country, of designing motive power to obtain the greatest reduction in operating costs not only by the application of approved fuel saving devices but also from the elimination of double heading, pusher service and by the operation of fewer and heavier trains with locomotives which are designed with a thorough understanding of all the local conditions.

A Splendid Shop Kink Contribution

From time to time in making our shop kink competition announcements we have emphasized the importance of having the descriptions as clear cut and complete as possible. The great difficulty has been that the authors assume that the editors and readers are thoroughly familiar with the equipment and the shop conditions where the work is done and as a result they very often leave out information concerning the most important details; this entails a considerable expenditure of energy on the part of the editors in digging out the information required and doubtless often affects the efficiency of the article when it appears in print. One of the best prepared collections which has ever been received at this office appears elsewhere in this issue and was prepared by Lewis D. Freeman, special tool designer of the Baltimore & Ohio. We trust that prospective contributors will look it over carefully and try to emulate Mr. Freeman in making their contributions clear cut, complete and forceful.

Shop Practice Competition

Elsewhere in this issue Mr. Le Compte of the Mt. Clare shops of the Baltimore & Ohio gives in outline his idea of the proper method of finishing driving boxes. His method is a good one but the question arises as to whether it is the best one, and for the purpose of satisfying ourselves on this point we propose to offer a prize of \$25 to the person submitting an article descriptive of what is judged to be the best method of doing the driving box job complete. For the purpose of judging fairly it will be necessary to give more information than is given by Mr. Le Compte and we will require a detailed description of the different steps together with the time required for each one, the kind and size of machine used in each case, the amount of metal removed, and, in fact, all information of a like character necessary to permit the judges to come to a fair decision. This competition will close on May first, allowing nearly sixty days to prepare the material. Furnish sketches or photographs, if possible, wherever they will make the descriptive matter more clear. Articles which do not win the prize, but are accepted for publication, will be paid for at our regular space rates.

Burning Lignite Coal in Locomotives

Efforts to burn lignite in locomotives of the railways operating through districts where this fuel is procurable at a very low price, and good coal is very expensive, have been made with some degree of success for many years. In some sections the nature of the country is such that there is very little danger of the fire thrown from the locomotive stack doing any damage and under those conditions lignite has been used very successfully. At other points, however, live sparks from the stack cannot be permitted, and up to a comparatively recent date it has seemed impossible to use this fuel in these

districts. The American Locomotive Company, working in connection with the Chicago & North Western, has finally evolved a spark arrester, which bids fair to allow lignite to be burned under any conditions. The result is obtained by an apparatus and front end arrangement which holds the live sparks and continually baffles them until they are ground to a fine powder and completely extinguished. It includes an arrangement, termed a gyrus, which gives the sparks a rapid circular motion in a horizontal plane within a cage made up of cast iron vanes so that the centrifugal force which tends to throw them outward causes them to be beaten against the edges of the vanes until they are completely ground up. They are then caught in the outgoing exhaust and the front end is kept clear. The success of this device is good news to the roads operating in the lignite districts.

Improvements in Locomotive Tenders

Coal which rolls off the tender onto the right of way virtually costs the railway company twice as much as that which is put into the firebox. In some cases it may cost a great deal more due to its convenience for trespassers to start a fire near the track; there have been cases, as well, where serious personal injury has been caused to passengers on station platforms by coal falling from the tender. Altogether it would seem that the trouble is of sufficient importance to warrant more effort to prevent it than is generally shown. For many years the tenders on the Chicago, Burlington & Quincy have been so constructed as to largely prevent coal being lost. The method consists simply in continuing the side plates at the coal space upward and inward over the fuel space for a distance of about 24 in. By this arrangement coal, which does not become dislodged at the chutes, will not become loosened thereafter. In some few instances other roads are using the same or similar construction and there would seem to be no reason why this or some other method should not come into general use. When the fuel supply is low in tenders of large capacity, in most cases it is some distance between the coal pile and the fire door, requiring considerable extra labor by the fireman at the time when he is least able to stand it. In some tender designs it is even necessary to climb up and shovel it down from the top as the coal supply is reduced. With the present locomotives burning coal at a rate practically taxing the fireman to the maximum of physical endurance, anything which will avoid unnecessary labor on the fireman's part should be looked upon with favor and some recent tenders have been equipped with a device arranged to force all of the coal into a position where it can be reached by the fireman without any extra labor. A device of this kind would seem to be most desirable on the larger locomotives that are worked to their capacity for the full length of the division.

Steel Car Center Sill Design

Theoretical treatises on car design are usually so complicated that the average reader, or even the mechanical engineer, finds it difficult to comprehend and apply them. Mr. Heffelfinger's study of the design of fish-belly center girders for cars, which appears on another page of this issue, is refreshing because of its practical nature and the ease with which his methods may be followed and applied by others. The tendency in recent years has been more and more toward graphical methods for the solution of problems of this nature and the advantages of this method can readily be comprehended in this case.

It is unfortunate that the other parts of the car, including the superstructure, are not as susceptible of theoretical treatment as are the center sills. Even in the case of the latter it is necessary to make certain arbitrary assumptions as to that part of the load on the sills due to the end shocks, but in the case of other framing members in the superstructure most of the stresses, if they are calculated, must be based entirely upon assumptions. That these are sometimes wide of the mark, or that proper provision has not been made for them, is indicated by the behavior of many

cars in actual service. Leaky roofs, defective ends, poor draft attachments, unsatisfactory side door arrangements, and other similar defects are present in a large proportion of the house cars.

Often these defects may be traced directly to a lack of knowledge on the part of the designer as to the failure in service of the cars in these respects. As more and more attention is directed to these points the engineers in charge of car design will undoubtedly come to some agreement as to the standard basis or requirements which the car should be designed to meet. That this has not come about sooner is due undoubtedly in some degree to the fact that the capacity and size of the cars has grown so rapidly in the past decade and that there has been an even greater development in increased tractive effort of the locomotive in the same time.

Solid Steel Engine Truck and Car Wheels

With the steadily increasing use of solid steel wheels in freight equipment, the necessity of standardizing the designs is becoming constantly more pressing. Committees

of the Master Car Builders' Association and the wheel manufacturers are at work on the subject and it is probable that their report at the next convention of the Master Car Builders' Association will so present the subject that it can be fully settled in the comparatively near future. As an indication of the features which are liable to be the subjects of the greatest discussion, a paper by Charles G. Bacon, Jr., presented at the meeting of the Western Railway Club, was enlightening, and gave an opportunity for a preliminary skirmish that may greatly shorten the discussion at Atlantic City. Mr. Bacon favored a 2½-in. rim because his observations of wheels in service had indicated that the better material which it is possible to obtain with this thickness on account of the more thorough working which it can be given in the process of manufacture actually gave a longer life and more satisfactory service than a rim 3-in. thick. There was some disagreement with this view. If the 3-in. rim cannot be used because it is not possible to thoroughly work the metal with the present machinery, the natural inquiry would be as to the possibility of improving the machinery so that this thickness could be suitably worked. Thirty-three and one-third per cent. increase in the thickness of the wearing surface is well worth making strenuous efforts to obtain, and while no one wants a wheel which will give less mileage on a 2-in. wear than another will for 1½-in. wear, everyone desires a wheel which will give one-third more mileage before it has to be scrapped, and if Mr. Bacon's contentions are correct, it would seem to be up to the wheel makers to make improvements and furnish a wheel with a 3-in. rim with as good metal straight through as is now obtained in the 2½-in. rim. Mr. Bacon's other recommendations that a standard diameter of the inside face of the hub and a standard hub wall thickness be adopted seemed to meet with general approval.

Facilities for Repairing Steel Cars

When steel freight cars were first introduced, car department officials expressed considerable anxiety as to how they should go about to provide facilities for maintain-

ing and repairing them. It was soon found, however, that the problem was not nearly as troublesome as it first appeared. Very little new equipment was required and most of it was comparatively simple and crude. Gradually, as the number of cars in service has increased, more and more refinements have been added, although these in most cases have proved neither extensive nor expensive. The Pittsburgh & Lake Erie, one of the first roads to introduce steel freight cars, made more or less elaborate provision for handling the work by the erection of a steel frame brick steel car repair shop at McKees' Rocks, Pa., but outside of the overhead cranes for handling the cars and a steel frame repair jack for restoring the cars and their parts

to the proper shape when they became distorted, only a few other tools were provided, including the necessary furnaces for heating the damaged parts.

The Pennsylvania Railroad has a large steel car shop at Altoona but ordinarily it is used largely for building new equipment and only the heaviest repairs to steel freight cars are made in it. One of the most interesting practices at that shop is the provision of crane service for turning the bodies of hopper and gondola cars upside down for making certain classes of repairs, which it is difficult to handle when the bodies are in their normal position. The article by Lewis D. Freeman, of the Baltimore & Ohio, on steel car repair kinks, which appears elsewhere in this issue, is of special interest because it clearly describes three devices which have been developed for handling steel car repair work and which are somewhat more pretentious than similar devices which are used for the same purpose on other roads. The Baltimore & Ohio has had a long experience in the maintenance and repair of steel cars and the devices for this work have been gradually developed as the work has grown more and more extensive.

Smoke Abatement on Switch Engines

Bulletin No. 6, issued by the Committee on Smoke Abatement and Electrification of Railway Terminals in Chicago, contains some interesting data procured from a test of a Santa Fe switch engine in the Eighteenth Street yards, Chicago. The object of the test was to obtain an exact record of the smoke issuing from a switch engine in regular switching service and to determine the total amount and size of the cinders thrown out by switching locomotives. The locomotive selected was a six-wheel switcher with 20-in. x 26-in. cylinders, 51 in. drivers and a grate area of 29.2 sq. ft. It was provided with steam jets passing through 2-in. ferrules in the side of the firebox and tests were made with both Pocahontas and Illinois coal. A special device for collecting a certain definite proportion of the cinders was devised and applied and the total amount discharged was computed on the basis of those caught in it. Smoke density was measured on the basis of the Ringelmann chart and in addition to this two other terms were used,—“white” meaning the absence of any color to the exhaust at the time of observation, and “clear” when neither smoke nor exhaust could be seen, nothing but a colorless heat vapor being driven off.

A full day's run burning Pocahontas coal having over 74 per cent. fixed carbon, 17.1 per cent. volatile matter and a heating value of 14,085 B. t. u., showed the following results:—“Clear,” 42 per cent. of the time; “white,” 34 per cent. and any grade of smoke 24 per cent. There was no smoke above the grade of No. 4 observed during the test and the average duration of smoke was from 3 to 8 seconds. A day's service with Illinois coal, which had about 61 per cent. fixed carbon, nearly 31 per cent. volatile matter and a heating value of 13,331 B. t. u., showed “clear,” 2 per cent.; “white,” 18 per cent. and “smoke,” 80 per cent. During this day's test the maximum grade of smoke observed was No. 4. The duration of the smoking periods was considerably greater than with the Pocahontas coal and the average density of the smoke was considerably higher. The steam jets in the firebox were used quite frequently during this day's test, but were not used at all with the Pocahontas coal. The coal consumption with the Pocahontas coal was 386 lbs. per hour and with Illinois 457 lbs. per hour, the rate of evaporation with the former being 9 lbs. of water per lb. of coal and with the latter 7.6 lbs. of water per lb. of coal.

With the Pocahontas coal it is estimated that 3.17 lbs. of cinders were thrown from the stack per hour, while with the Illinois it amounted to 3.46 lbs. per hour. This is at the rate of .82 of one per cent. for the former and .76 of one per cent. for the latter. The cinders discharged with the Pocahontas coal had a heating value of 4,362 B. t. u. and those with the Illinois coal 6,103 B. t. u. The analysis of the smokebox gases showed

no poisonous gases or carbon monoxide present at any time for either of the coals. It is quite evident from this test that the better grade of coal gave a decided reduction in the total amount of smoke as well as an increase in evaporation, and although this coal costs 75 per cent. more than Illinois coal in Chicago, it is being very largely used on the switch engines of the Santa Fe. It is stated in the report that the most important apparatus applied to the locomotive for the reduction of smoke was the brick arch because it aids in maintaining uniformity of temperature of the firebox.

Mechanical Department Organization

As the roads have grown in size and the power and the capacity of the locomotives and cars have been increased the art of maintaining and repairing the motive power and rolling stock has grown to be a serious and complicated problem. As attention has become focused on the efficiency of the mechanical department it has become more and more evident that the best results could only be obtained by increasing the supervision and directing it more intelligently. Among the roads that have recently made radical and important developments in this direction is the Illinois Central. M. K. Barnum, who was appointed general superintendent of motive power of that road in April, 1910, has had a training which fitted him well for developing more efficient methods on that system, where they were so badly needed.

In carrying out his plans for greater efficiency, which have already resulted in remarkable results, he kept three things in view; first, that greater efficiency could be obtained by increasing the supervision; second, by eliminating all unnecessary work which would not in any way interfere with the successful operation of the equipment, and third, by the introduction of modern machinery and shop equipment. Really the last two of these depend more or less upon the first one. The present organization of the mechanical department is fully outlined in an article in another part of this issue and it is quite probable that further improvements will be made in the near future, all tending, however, toward better supervision.

A large saving was also made by cutting out unnecessary work, such, for instance, as stopping the practice of painting cabooses a bright vermilion when it would be impossible to distinguish them from the freight cars within a few months. A saving of \$25,000 a year resulted from relining journal brasses instead of selling them for scrap. The repainting of freight car trucks when passing through the shop for repairs was discontinued because a careful investigation showed that it was useless. A department was inaugurated for reclaiming scrap and second hand material. The above are only a few of the many changes which have been made along similar lines. Extensive improvements are now being planned for the shop power plants and without doubt the standard of the machinery and other shop equipment will be raised and improved as fast as conditions permit.

NEW BOOKS

Early Motive Power of the Baltimore & Ohio. By J. Snowden Bell. 154 pages, 6 in. x 9 in. Cloth. Illustrated. Published by the Angus Sinclair Company, 114 Liberty street, New York. Price \$2.

To anyone interested in locomotives, a study of their development and an examination of the drawings showing the construction of the early types has an attraction which to a large extent will be satisfied by this book. While it is confined to locomotives on the Baltimore & Ohio, the fact that this road was a pioneer in this country and exerted a very large influence on the early development of the locomotive, makes it of general interest. American locomotive development is probably more clearly portrayed by the various constructions on the Baltimore & Ohio than on any other road. The author makes no claim

that the book is complete since many of the early records have been lost or destroyed, but it is probably more complete than anything of its kind that has previously been published. It is made up quite largely of a compilation from original papers and contains many photographs and drawings collected from various sources. The typographical work has been given careful attention, and results, particularly of illustrations, made from poor photographs, are very satisfactory. In addition to the historic locomotives there is also a chapter on the present power on the Baltimore & Ohio, briefly showing the latest designs. A chapter is also devoted to the biography of the early motive power officials of this company.

Maximum Production in Machine Shop and Foundry. By C. E. Knoepfel. 5 in. x 7½ in. Cloth. 365 pages. Illustrated. Published by the *Engineering Magazine*, 140 Nassau street, New York. Price, \$2.50.

The title of this book clearly indicates its scope and object and while, of course, the complete discussion of everything that enters into maximum production could not be incorporated in one volume, the important factors have been very carefully covered. The author has based his whole discussion on personal experience, and, as a consequence, speaks most convincingly. He groups the machine shop and foundry in his discussion, stating that their work is so closely related that the problems can best be studied in this way. It appears that the foundry is given closer attention, largely because it has previously received less and offers greater opportunity for improvement. The work is divided into 16 chapters, starting with cost accounting, its importance and the best methods, and following through organization, systematic processes, deliveries, despatching and shop details. It briefly discusses the principles and the application in each case.

Efficiency as a Basis for Operation and Wages. By Harrington Emerson. Third edition revised and enlarged. 254 pages. 5 in. x 7½ in. Cloth. Published by the *Engineering Magazine*, 140 Nassau street, New York. Price, \$2.

A series of articles by Harrington Emerson, which completely demonstrated and explained his development of the efficiency system, appeared in the *Engineering Magazine* from July, 1908, to March, 1909. It was soon discovered that it would be necessary to incorporate them into book form in order to supply the demands, and in 1909 the first edition of this work was published. It has very quickly gone through two editions, and it was decided before bringing out this, the third edition, that it would be advisable to make a thorough revision of the text in view of the knowledge and experience gained during the past two years. This has been done, and in addition to more clearly illustrating certain points and adding sections, points of connection between this volume and the one shortly to follow on the twelve principles of efficiency have been established. The book inclines more to the declaration of philosophy than to direct instruction in methods.

Technology and Industrial Efficiency. Published by the McGraw-Hill Book Company, New York. 6 in. x 9¼ in. 486 pages. Bound in cloth. Price, \$3.00.

This volume contains the proceedings of the Congress of Technology, held in Boston, Mass., last April at the Massachusetts Institute of Technology. Some seventy papers are included which form a valuable and up-to-date record of the present state of industrial science, including the presentation of some of its problems and probable solutions. The six sections into which the congress was divided are represented by papers on: Scientific Investigation and Control of Industrial Processes, Technological Education and Its Relation to Industrial Development, Administration and Management, Recent Industrial Development, Public Health and Sanitation, and Architecture. These divisions are logical and comprehensive.

FISH-BELLY CENTER GIRDERS FOR CARS

A Practical Method for Determining the Length of the Cover Plate and the Flange Angles. Also a Semi-Graphic Method for Finding the Deflection at Any Point Along the Beam

BY ARTHUR E. HEFFELFINGER

The problem is to determine the elastic deflection at any point along a beam with overhanging ends and with a varying moment of inertia along the axis of the beam between span, due to the change in depth and the addition of cover plate and angles of less length than the span. For this problem the analytical solution of the equation of the elastic curve is complicated and quite laborious, requiring a refinement of calculation which costs more than it is worth, at least to the car business; anyhow, assuming a knowledge of fundamental mechanics, there is no

the bolster concentrations have no direct effect on the bending to be considered, they are ignored, leaving a net reaction equal to 50,520 lbs. at each support or center plate.

For subsequent notations:

M = Bending moment in inch lbs.

f = Allowable unit fiber stress = 13,500 lbs. per sq. in.

I = Moment of Inertia.

$\frac{I}{C}$ = Section Modulus.

E = Modulus of Elasticity = 29,000,000.

As changes in the sign in the bending moment diagram (Fig. 1) must be taken into account for the solution of deflection, the negative algebraic sign is attached to the bending moment which produces bending downward and the opposite sign to a bending moment producing bending upward.

As the loading is symmetrical about the mid-span, the point of maximum bending moment is at mid-span and equals 4,377,800 inch lbs. The bending moment over the support is 592,000 inch lbs. and the point of inflection is at I , or about $16\frac{1}{2}$ in. inside of the support. Lay off several ordinates along the beam, as through points D, E, F, G, H , etc., their location being arbitrary

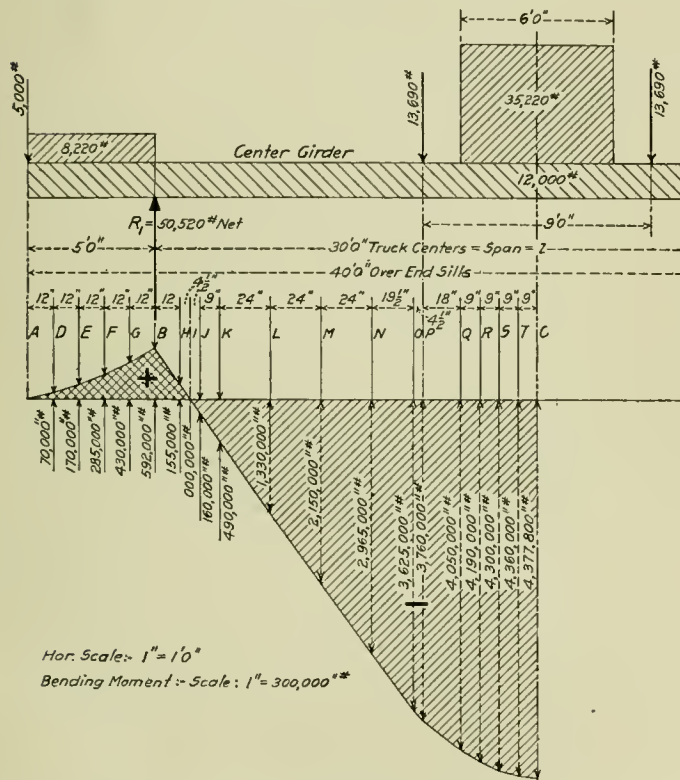

Fig. 1—Loading and Moment Diagrams for One-Half of the Center Girder Span.

earthly reason in the general assumption that a knowledge of the higher mathematics is absolutely necessary to the satisfactory solution of a great many of the problems in mechanics and the strength of materials usually treated by the methods of differential calculus. The aim of the paper, as in a previous one by the writer on the Double Open Diagonal Truss (*American Engineer & Railroad Journal*, November, 1909) will be to present practical matter only, regarding theory simply as a means to a practical end, and not as a field for the employment of mathematical research.

To make the problem typical, we will analyze the "fish-belly" center girder for a 40-ft., 80,000-lb. capacity gondola or flat car; since the loading is symmetrical about mid-span, only one-half of the loading and moment diagrams will be required, as shown in Fig. 1. The trucks are spaced 30 ft. apart, which will hereinafter be designated as the span, or l . The 13,690 lbs. between span concentrated loads comes over to the center girder through the cross-bearers, which are spaced 9 ft. apart. Because

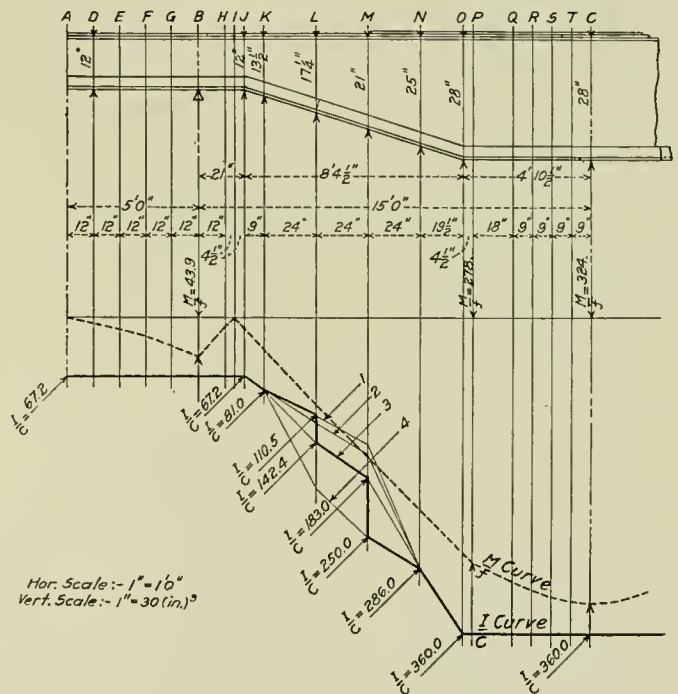

Fig. 2—General Design of Center Girders; Also Section Modulus and $\frac{M}{f}$ Curves.

rary, but not to be spaced more than 2 ft. apart, nor ranging over any sudden changes in the bending moment, particularly for that distance between span where the depth of the girder is variable. Of course, decreasing the distance between these verticals will give greater accuracy in the location of the theoretical points where reinforcements are to begin, but again, we are dealing with the practical everyday case.

Fig. 2 shows the design of the girder; note that the web, one

cover-plate and the outside bottom flange angles are continuous over the supports. The maximum section at the center is 28 in. deep, as shown in detail in Fig. 11, and continues a uniform section to a point 4½ in. beyond the centers of the cross-bearers, where it tapers up to a depth of 12 in., at a point 21 in. inside of the support, and then continues as a uniform section to end of the car.

In carrying this method into practice, it is recommended that Figs. 1, 2, 12 and 13 be plotted on one lay-out. This may be done very easily and nearly enough for all practical purposes with

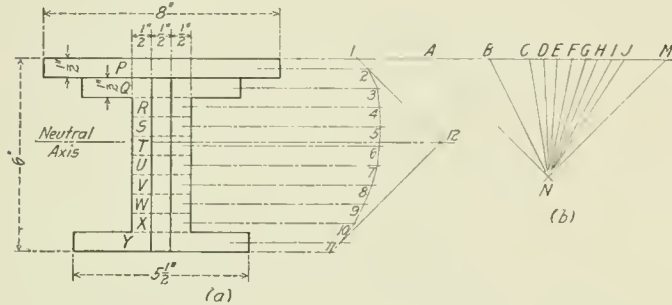

Fig. 3—Graphical Method for Determining the Neutral Axis and the Moment of Inertia of a Built-Up Section.

the scales as indicated on the illustrations, thereby saving unnecessary duplication; but to obtain a lucid exposition this cannot be done here; therefore the ordinates as located on the bending moment diagram are repeated in Figs. 2, 12 and 13. Compute the I and $\frac{I}{C}$ for sections at J, K, L, M, N and O , and in order to locate the vertical steps in the $\frac{I}{C}$ curve, compute the I and $\frac{I}{C}$ for the four possible combinations at each section; this if done numerically is quite laborious, but in plotting a considerable range of sections, any slight variation, plus or minus, will have a compensatory effect; therefore the graphical method as shown in Figs. 4 to 11 might be used to advantage. The following simple graphical method for determining the proper-

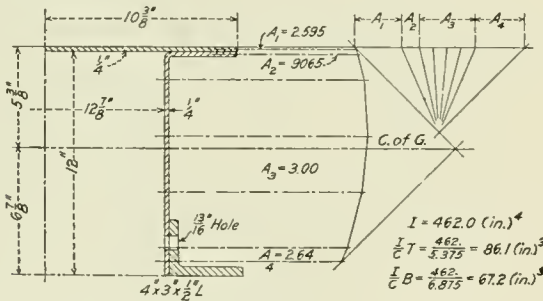

Fig. 4—Minimum Section of Center Girder.

ties of built-up sections is taken from the International Correspondence School's Building Trades Handbook.

Graphical Method.—The location of the neutral axis and the moment of inertia of any section may be obtained by the following graphical method, which is sufficiently accurate for all practical purposes.

Example.—Locate the neutral axis, and find the moment of inertia of the section shown at (a), Fig. 3.

Solution.—First, draw the section, either full size or to any scale, as at (a).

Second, divide this section by horizontal lines into strips of equal or unequal height; find the area in square inches and the center of gravity of each strip; since the strips in this case are rectangles, the centers of gravity will be at the centers of the strips, through which points dot and dash lines have been drawn.

Third, on any horizontal line lay off, from left to right, to any scale, distances proportional to the area of the strips, taking them in order from top to bottom of the section. This horizontal line may be called the load or area line. Thus, at (b), the distances AB, BC, CD , etc., are measured to a scale of, say, 1/16 in. to 1 sq. in. area, and represent the areas of the sections P, Q, R , etc., respectively, in (a).

Fourth, from the ends A and M of this line, draw lines inclined 45°

to it, and intersecting at a point N called the pole. Draw lines from N to points B, C, D , etc.

Fifth, commencing anywhere on a horizontal line through the top of the section, draw the line 1-2 parallel with the 45° line AN ; from the intersection of this line with one through the center of gravity of slice P , draw 2-3 parallel to BN ; from the intersection of 2-3 with the horizontal line passing through the center of gravity of slice Q , draw the line 3-4 parallel to CN . Continue in this manner, drawing the remaining lines 4-5, 5-6, etc., parallel, respectively, to DN, EN , etc.

Sixth, draw, from the points 1 and 11 at the end of the curve, 45° lines intersecting at the point 12, through which draw a horizontal line, cutting the section as shown at (a), Fig. 3; this line will be the neutral axis of the figure.

Seventh, the moment of inertia, I , may be found by multiplying the area in square inches of the figure, 1, 12, 11, 10, 9, 8, etc., by the entire area of the section. Thus, if in this case the area of the former is 4.67 sq. in., and that of the section at (a) is 16.25 sq. in., the moment of inertia will be equal to 16.25 sq. in. \times 4.67 sq. in. = 75.88, the value of I for this section."

Probably the quickest method for finding the area of this section-lined figure would be by the use of the planimeter,

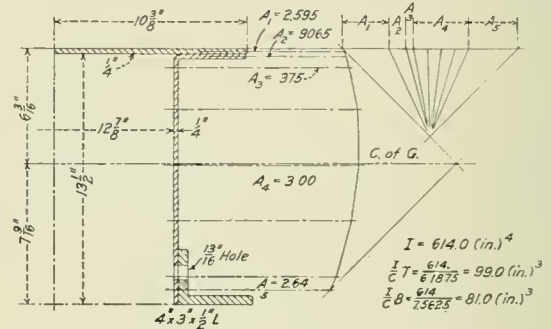

Fig. 5—Section of Center Girder at K , Fig. 2.

which should of course be set to the same scale as used in laying out the section at (a), Fig. 3. However, the common rule for finding the area of irregular figures might also be used, but in obtaining the dimensions necessary for determining the area, as with the planimeter, the same scale should be adopted as used in laying out the section.

The dotted curve in Fig. 2 is the $\frac{M}{I}$ curve plotted from the M curve, Fig. 1. The heavy line curve, Fig. 2, is the $\frac{I}{C}$, or section modulus, curve whose ordinates represent the $\frac{I}{C}$ of the various sections as found above, plotted to the same scale as the $\frac{M}{I}$ curve. The light line curves 1, 2, 3 and 4 represent plottings for the various combinations of sections; the first of these is the

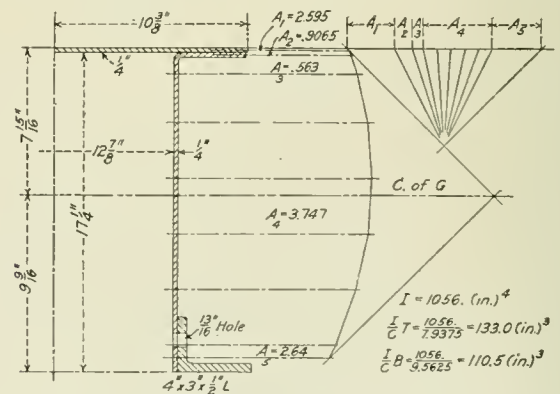

Fig. 6—Section at L , Corresponding to Curve 1, Fig. 2.

combination of a single cover-plate and single angles; the second, double cover-plate and single angles; the third, a single cover-plate and double angles; and the fourth, double cover-plates and double angles. The intersection of curves 2, 3 and 4 with the vertical through K would fall below that shown, and likewise curves 1, 2, 3 would intersect ordinate N at points above that

shown; but, inasmuch as the added plate and angles will begin somewhere between these limits, the intersections as shown are good enough. These limits are typical for the average car of this type, the only condition being, that the $\frac{I}{C}$ curve be a reasonable amount below the $\frac{M}{f}$ curve, which, as shown, is about the usual practice.

Then, beginning at the minimum section which is 12 in. deep, Fig. 4, pass along the first curve to *K* where the section is 13½

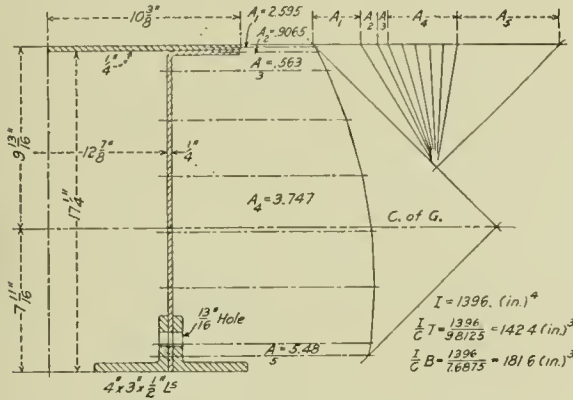

Fig. 7—Section at *L*, Corresponding to Curve 3, Fig. 2.

in. deep, Fig. 5. At this point curves 2, 3 and 4 begin. It will be seen that we can continue along curve 1 to *L*, where the section is 17¼ in. deep, Fig. 6, with a margin of safety under the $\frac{M}{f}$ curve. Continuing further along this curve would cut into the $\frac{M}{f}$ curve, making it evident that some reinforcement will be necessary; and as curve 2 would still cut the $\frac{M}{f}$ curve, step down to curve 3's intersection with *L*, which is the section shown in Fig. 7, whose depth is still 17¼ in., but it has the added inside

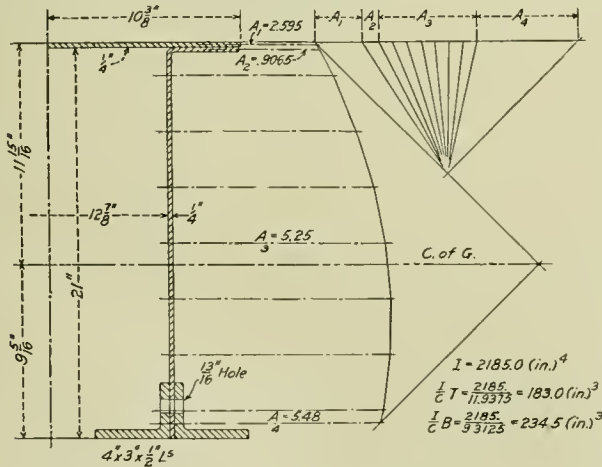

Fig. 8—Section at *M*, Corresponding to Curve 3, Fig. 2.

angle, which indicates that the inside bottom flange angles begin, theoretically, at this point. Then follow along curve 3 to *M*, where we come as close to the $\frac{M}{f}$ curve as we dare, with the section which is 21 in. deep, Fig. 8; the required additional reinforcement at this point is accomplished by stepping down to curve 4, where the section is as shown in Fig. 9; this indicates that the first or top cover plate begins theoretically at this point. Continue along curve 4 to *N* where the section is 25 in. deep, Fig. 10, and thence to *O* where the section is 28 in. deep, Fig. 11. At this point the maximum section begins and continues a uniform section to the corresponding point on the opposite side of the mid-span. The $\frac{I}{C}$ curve is now complete; note that it keeps within a safe margin below the $\frac{M}{f}$ curve. It is very irregular

because the girder for constructive reasons is only an approximation to the uniform strength, the vertical steps being caused by the sudden addition to the various sections.

In designating points where reinforcement begins as theoretical, it is understood that sufficient plate and angles must be added beyond these points to relieve the continuous portion of the flange area and assure the distribution of the stress.

DEFLECTION AT ANY POINT ALONG THE BEAM.

In investigating the deflection of beams of uniform section, or where *E* and *I* are constant, it will be apparent that the area of the bending moment diagram between two points on a beam is proportional to the difference in inclination between the tangents to the elastic curve at these two points; and from a point where

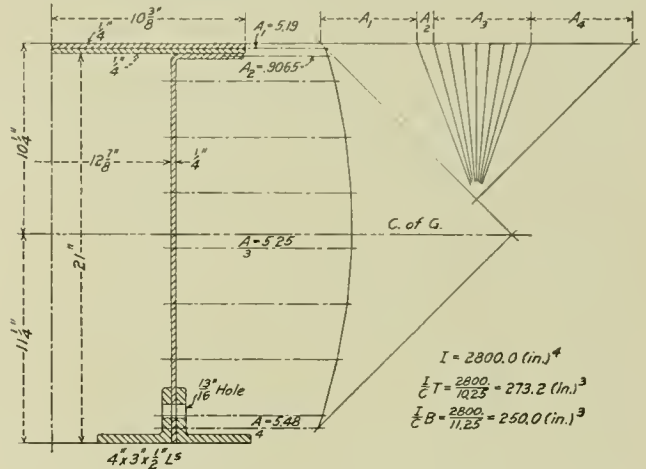

Fig. 9—Section at *M*, Corresponding to Curve 4, Fig. 2.

the tangent to the elastic curve is horizontal to any other point the area of the bending moment diagram between them is proportional to the actual inclination of the tangent at the second point; taking account, of course, of the signs of the areas. Or more generally expressed, the same kind of relation exists between the bending moment diagram and the elastic curve of deflection, as between a diagram of the load and the curve of moments.

Then taking the origin of moments at support distance *l* from

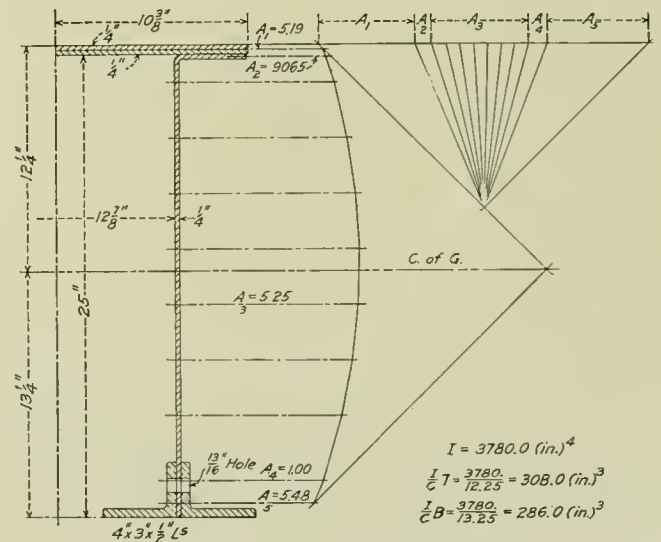

Fig. 10—Center Girder Section at *N*, Fig. 2.

B (Fig. 1), the inclination of the tangent to the elastic curve at *B* is:

$$\frac{A x_1}{E I l}$$

in which *A* is the total area of the bending moment diagram between span, and *x*₁ is the distance of its center of gravity from

the origin. And in a like manner, with the origin at *B* the inclination of the tangent to the elastic curve at support distance *l* from *B* is:

$$\frac{A(l - x_1)}{EI l}$$

With the convention of signs as established *A* is negative for a beam carrying downward loads which produce bending downward, or which produce positive downward deflections; hence, inclinations downward to the right of support *B* are taken as positive, and likewise inclinations downward to left of the support opposite *B* are taken as negative.

With *E* and *I* still constant, the deflection at *X* or any point along the beam between span is (Inclination of tangent at *B* × *x*) + (Moment about origin *X* of the area of the bending

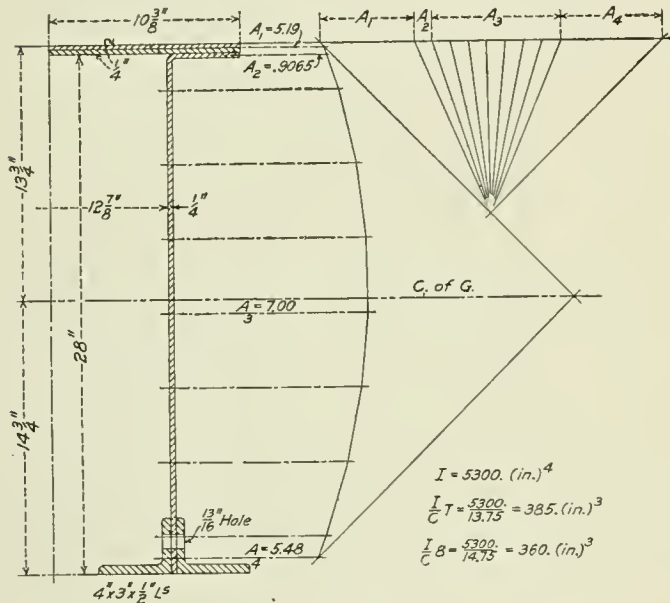

Fig. 11—Center Girder Section at *O*, Fig. 2.

moment diagram between *X* and *B*, divided by *EI*). In which *x* is the distance point *X* is located to the right of *B*. The second term represents the perpendicular displacement of the beam at *X* from the tangent to the elastic curve at *B*, remembering that it is negative for loads producing bending downward, and positive for loads producing bending upward.

APPLICATION.

The above is applicable to beams of variable section, or where *E* only is constant, by using the quantity $\frac{M}{I}$ instead of *M* throughout. This may be accomplished graphically by plotting, as in Fig. 12, values of $\frac{M}{I}$ at points *A, B, C, D, E, F, G, H*, etc., on the beam as a base line, thus producing the irregular curved $\frac{M}{I}$ diagram, whose area now supplants the bending moment diagram. The signs here are the same as for the bending moment diagram; also, only one-half of the $\frac{M}{I}$ diagram will be required (Fig. 12), as both loading and values of *I* are symmetrical about the center or mid-span; hence the point of maximum deflection is at the center and the deflections at corresponding points about the center are evidently the same.

The ordinates *A, B, C, D, E, F, G, H*, etc., serve to divide the irregular $\frac{M}{I}$ diagram into small parts or vertical strips, whose areas and the location of the center of gravity for each part is a simple computation. Fig. 12 shows the areas of these elementary parts of the $\frac{M}{I}$ diagram, and distances from mid-span to the center of gravity of each part for points between span, and from the free end of the cantilever for the overhang.

Considering the deflection at the points between span for the present, take origin *X* at *C* or mid-span and figuring from *C* to *B*, the summation of moments of areas about the origin *C* equals:

| Area. | Distance from Origin <i>X</i> . | Moment. |
|-------------|---------------------------------|-------------|
| — 7,416 | 4.50 | — 33,372 |
| — 7,353 | 13.48 | — 99,118 |
| — 7,209 | 22.47 | — 161,986 |
| — 6,993 | 31.46 | — 219,910 |
| — 13,266 | 44.87 | — 595,245 |
| — 3,141 | 56.24 | — 176,650 |
| — 14,352 | 68.48 | — 982,825 |
| — 18,648 | 89.93 | — 1,677,015 |
| — 23,232 | 113.90 | — 2,646,125 |
| — 24,696 | 137.13 | — 3,386,563 |
| — 5,148 | 153.90 | — 792,277 |
| — 778.5 | 160.50 | — 124,949 |
| + 756 | 166.50 | + 125,874 |
| + 9,696 | 175.17 | + 1,698,448 |
| — 121,780.5 | | — 9,071,713 |

Inclination of tangent to the elastic curve at *B* is:

$$\frac{Ax_1}{EI} = \frac{243,561 \times 180}{29,000,000 \times 360} = 14 \text{ min. } 26 \text{ sec., or inclination downward to the right of } B.$$

Deflection at *X* or any point along the beam between span is: (Inclination of tangent at *B* × *x*) + (Moment about origin *X* of the area of the $\frac{M}{I}$ diagram between *X* and *B*, divided by *E*), remembering the function and signs of the second term as established above; also note that the tangent at *B* is a constant.

The shaded portions in Fig. 13 represent the second term. Referring to the above summation of moments of areas about *C*, we have for the second term:

$$\frac{-9,071,713}{29,000,000} = -.313 \text{ in., or the perpendicular displacement of the beam at } C \text{ from the tangent to the elastic curve at } B.$$

For the first term of above formula, we have:
180 in. × tan. 14 min. 26 sec. = .756 in., or the positive downward deflection at *C* of the tangent to the elastic curve at *B*.

Then,
.756 in. + (−.313 in.) = .443 in. downward deflection of the beam at *C*, which is maximum for the case in point.

Origin *X* at *P*; summation of moments of areas about *P* for that portion of diagram between ordinates *P* and *B* is as follows:

| Area. | Distance from Origin <i>X</i> . | Moment. |
|----------|---------------------------------|-------------|
| — 3,141 | 2.24 | — 7,036 |
| — 14,352 | 14.48 | — 207,817 |
| — 18,648 | 35.93 | — 670,023 |
| — 23,232 | 59.90 | — 1,391,597 |
| — 24,696 | 83.13 | — 2,052,978 |
| — 5,148 | 99.90 | — 514,285 |
| — 778.5 | 106.50 | — 82,910 |
| + 756 | 112.50 | + 85,050 |
| + 9,696 | 121.17 | + 1,174,864 |
| | | — 3,666,732 |

$\frac{-3,666,732}{29,000,000} = -.1264 \text{ in., perpendicular displacement of the beam at } P \text{ from the tangent to the elastic curve at } B.$

Positive downward deflection at *P* of the tangent to the elastic curve at *B*, is:

$$126 \text{ in.} \times \tan. 14 \text{ min. } 26 \text{ sec.} = .5291 \text{ in.}$$

$$.5291 \text{ in.} + (-.1264 \text{ in.}) = .4027 \text{ in. downward deflection of the beam at } P, \text{ or the cross bearer centers.}$$

Then similarly:
Origin *X* at *M*; summation of moments of areas = −698,537.

$$\frac{-698,537}{29,000,000} = -.0241 \text{ in.}$$

$$78 \text{ in.} \times \tan. 14 \text{ min. } 26 \text{ sec.} = .32755 \text{ in.}$$

$$.32755 \text{ in.} + (-.0241 \text{ in.}) = .30345 \text{ in. downward deflection of beam at } M, \text{ or the point where the cover plate begins.}$$

Origin *X* at *L*; summation of moments of areas = 62,016.

$$\frac{62,016}{29,000,000} = .00214 \text{ in.}$$

$$54 \text{ in.} \times \tan. 14 \text{ min. } 26 \text{ sec.} = .22676 \text{ in.}$$

$$.22676 \text{ in.} + .00214 \text{ in.} = .2289 \text{ in. downward deflection of the beam at } L, \text{ or the point where the inside angle begins.}$$

It will be noticed, that here the second term of the formula has changed sign, this taking place at point *W*, where the second term would be zero; or taking origin *X* at *W*, the summation of moments of areas about *W* for that portion of the diagram between ordinates *W* and *B* is zero.

Origin *X* at *J*; summation of moments of areas = 161,286.

$$\frac{161,286}{29,000,000} = .00556 \text{ in.}$$

21 in. \times tan. 14 min. 26 sec. = .08819 in.
 .08819 in. + .00556 in. = .09375 in., downward deflection of the beam at *J*, or the point where the minimum section begins.

Origin *X* at *I*; summation of moments of areas = 115,420.
 $\frac{115,420}{29,000,000} = .00398$ in.

$16\frac{1}{2}$ in. \times tan. 14 min. 26 sec. = .06929 in.
 .06929 in. + .00398 in. = .07327 in., downward deflection of beam at *I*, the point of inflection; or the point where the bending downward changes to bending upward.

Origin *X* at *H*; summation of moments of areas = 69,520.
 $\frac{69,520}{29,000,000} = .00240$ in.

12 in. \times tan. 14 min. 26 sec. = .05039 in.
 .05039 in. + .00240 in. = .05279 in., downward deflection of beam at *H*.

The deflection at any point on the overhanging end may be determined as for a cantilever, provided the deflection due to the inclination of the tangent to the elastic curve at the support be added (algebraically). This is done by taking the origin at the point in question, and dividing by *E*, the summation of moments of areas of the $\frac{M}{I}$ diagram from origin up to the support. For convenience, the negative sign is attached to inclinations upward to the left of the support, and the positive sign to areas of the $\frac{M}{I}$ diagram which produce positive downward deflection to the left of the support.

Then, for deflection at the extreme end of the overhang, take the origin *X* at *A* where the summation of moments of areas about *A* is:

| Area. | Distance from Origin <i>X</i> . | Moment. |
|--------|---------------------------------|-----------|
| 13,248 | 54.30 | 719,366 |
| 9,264 | 42.40 | 392,794 |
| 5,904 | 30.50 | 180,072 |
| 3,120 | 18.83 | 58,750 |
| 912 | 8.00 | 7,296 |
| | | 1,358,278 |

$\frac{1,358,278}{29,000,000} = .047$ in., perpendicular displacement of the beam at *A* from the tangent to the elastic curve at *B*.

Negative upward deflection at *A* of the tangent to the elastic curve at *B* is:

60 in. \times tan. 14 min. 26 sec. = -.252 in.
 -.252 in. + .047 in. = -.205 in., upward deflection of beam at *A*.

The problem as stated, assumed a uniform section from the support to the free end of the overhang. In this case, the common formulas (where *E* and *I* are constant) for cantilever deflections

would have been sufficient, of course adding (algebraically) the deflection due to the inclination of the tangent to the elastic curve at support; but for applications of draft gear and splicing, the

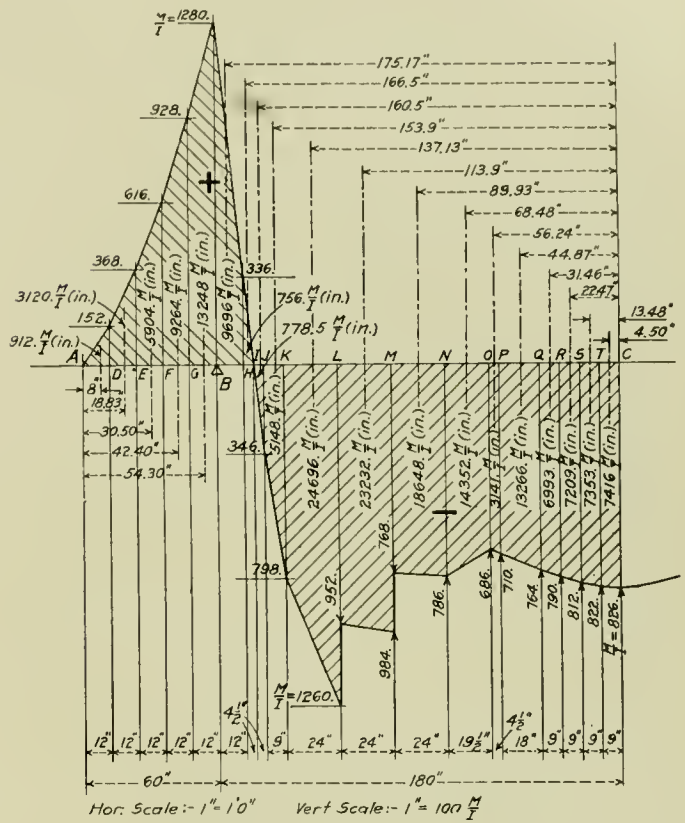

Fig. 12— $\frac{M}{I}$ Curve for Center Girder.

overhang is not usually a uniform section, therefore the same method was used for overhang as for points between span.

Fig. 13 shows the final deflection curve, greatly exaggerated, and

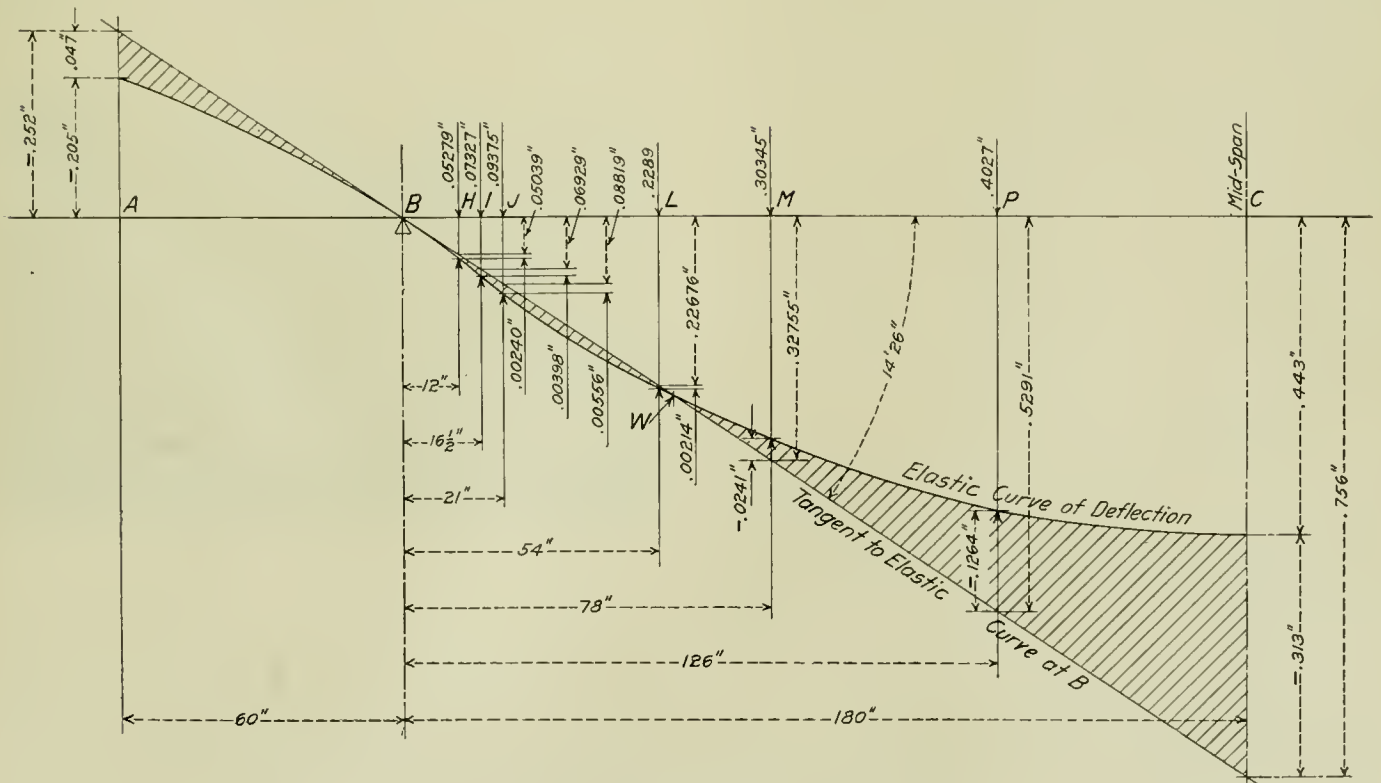

Fig. 13—Elastic Curve of Deflection for Center Girder.

on which is indicated the constant tangent to the elastic curve at B. Having worked out the deflections for several points along the beam it is evident that the same method would solve for any point and is applicable to all girders or beams of this type, its value varying directly as the irregularity of loading and section. Usually only the maximum deflection is required, when it will be seen how short and very easy of application this treatment of the question is; therefore I believe it supplies a want which has long been felt by practical car men.

All of the above is based on the theory of simple bending only, and therefore takes no account of the deflection due to shearing, which, for all practical purposes is negligible anyhow, in comparison with that caused by the bending moment. Also, it is assumed that all deflections take place within the elastic limit, and are very small compared to the span.

REAMER FOR BALL JOINTS

BY CHARLES MARKEL.

A reamer is used for refacing the ball joints of injectors, boiler checks and connections, at the Clinton shops of the Chicago & North Western which is noticeably simple and convenient. The illustration shows the tools and also an arrangement whereby the standard nut is used for centering the reamer and for feeding it. All necessity for connecting

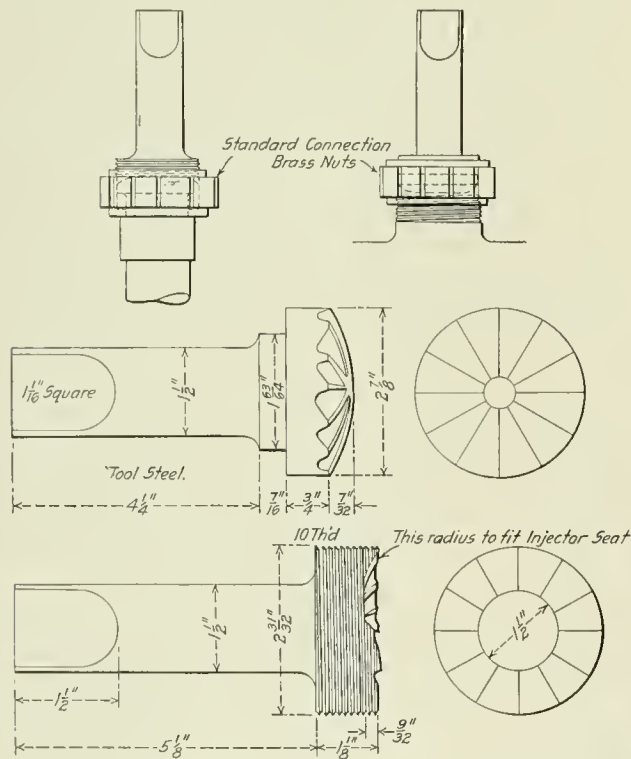

Reamers for Boiler Check Connection Joints.

up a guide bar or feeding mechanism is entirely eliminated and in practice it is simply necessary to make a few turns of the reamer with a hand wrench to face off the seat. This, of course, can be done without taking down the piping or parts. These reamers are comparatively inexpensive and are valuable time savers.

SUEZ CANAL TRAFFIC.—The number of vessels passing through the Suez Canal last year was 4,969, and the receipts of the canal amounted to 134,010,000 francs (\$26,802,000). The dredging of the canal to a depth of 35 ft. (4 ft. deeper than the former level) has been almost finished.

MACHINING PISTON VALVE PACKING RINGS

BY C. E. PADDACH.

The finishing of piston valve packing rings is accomplished by various methods, and one that has proved to be satisfactory is given herewith. The ring is held in a chuck, as shown in the illustration. The clamps have two set screws on the outside and one set screw in a projection on the inside, thus holding the ring without distortion due to eccentric clamping. Seven tools are used, three are held in the side turret head, and four in the vertical turret head. The side head contains a roughing

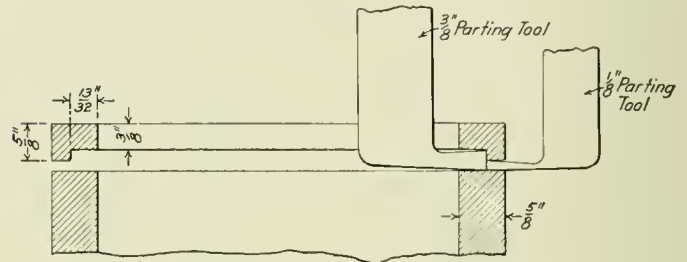

Parting Tools for Piston Valve Packing Ring.

tool, a finishing tool and a 1/8 in. parting tool. The vertical head contains a rough facing tool, a boring tool, a narrow facing tool and a 3/8 in. parting tool bent at an angle of 90 deg. The operations of roughing and finishing the ring are the same as in any of the other methods.

The interesting feature of this method is in cutting off the rings. After the top of the casting is faced with the narrow facing tool in the vertical tool head, the 3/8 in. inside parting tool is set 3/8 in. minus .002 in. lower than the finished top surface, as shown in the illustration. This allows for a good fit in the valve body. The 1/8 in. outside parting tool is then placed in position 5/8 in. below the top of the ring and is set back 3/16 in. from the casting. The power feeds for the two tools are thrown in simultaneously. This will give the required 13/32-in. niche in the bottom surface of the ring.

The cutting off may also be accomplished by allowing the inside parting tool to cut in 3/16 in. before the outside parting tool

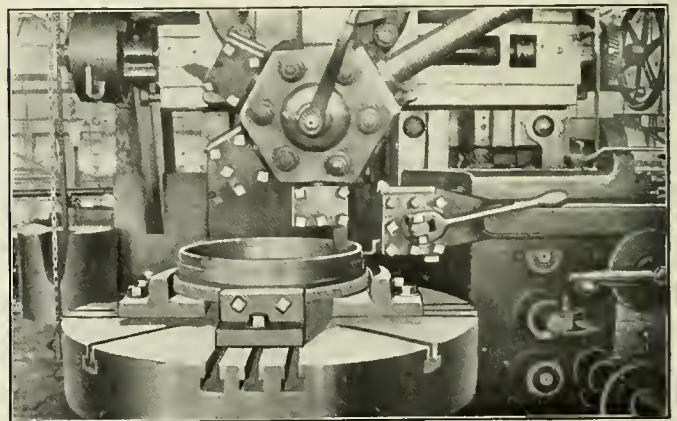

Machining Piston Valve Rings.

is allowed to cut. The 3/8 in. parting tool on the inside is rigid enough to prevent any irregularity in the thickness of the ring, which is usually caused by hard and soft spots in the iron. As the two tools work at the same time, a considerable saving will result in the time taken for cutting off in addition to not having to change tools. The only rough edge that comes on the ring when using this method, is in a place where it does no harm, and no further finish is necessary.

THE CONSERVATION OF MATERIAL

Awarded the First Prize in the Competition on Reclaiming Scrap Material.
The Methods Described Have Resulted in a Saving of about 30 Per
Cent. in the Material Account in a Group of Divisions of One Railway.

BY ERNEST CORDEAL,

Bonus Demonstrator, Atchison, Topeka & Santa Fe, La Junta, Col.

Much has been and is being done along the line of reclaiming serviceable material from scrap piles, and it is not the intention to decry or belittle the results which have been thus accomplished. However, if materials must be economized, as they certainly must, and more at the present time than ever before, why should the reclamation not take place before the serviceable parts are consigned to the scrap bins instead of afterwards? The value of the material itself is of great importance; the expense of handling and rehandling, of sorting and resorting is of hardly less. The segregation of serviceable material from that which is properly scrap is an operation which should be conducted with intelligence and forethought; not blindly and indiscriminately. Parts may be, and sometimes are, reclaimed and repaired at a cost in excess of the price of new material, and any system devised for the purpose of economizing material should be supported by accurate cost records of manufacturing and repairing the parts, such as to render the determination of what articles warrant repairs and what do not a matter of certainty rather than of personal opinion. The conservation of material should not be handled as a thing apart from the main mechanical organization but as an integral part, equal in importance to the supervision of labor.

We speak of reclaiming serviceable material from scrap, and it is true that large savings have been effected by sorting over parts which have been cast aside by workmen and foremen as no longer of use, but with the proper organization in shops, engine houses and car departments serviceable material should never reach the scrap pile. It is only possible to educate workmen within a limited range as to the importance of conserving material, and we should no more expect our mechanics without direction to exercise proper care in its use than we should expect to operate our shops without the supervision of foremen. Foremen may and should be carefully instructed as to the use of materials, and intelligent, carefully directed effort on their part will undoubtedly net large returns in the reduction of material charges. The paramount duty of the foremen, however, lies in the supervision of labor, and their efficiency in this line should not be impaired by imposing upon them too many additional duties. The foreman's first thought should be for expedition and quality in the performance of the work, and he may at times condemn certain parts (which parts may be easily and inexpensively placed in serviceable condition) in order to avoid delays, or to improve the quality of repairs.

In considering the material proposition, it would be well first to determine where the principal waste occurs. This is in the failure to properly dispose of parts when shipping; lack of judgment in ordering new parts; waste of small parts by workmen in erecting; lack of intelligent supervision in the disposal of parts removed and not replaced; inefficiency of the store department in furnishing the proper parts at proper times.

Very often when engines or cars are being stripped preparatory to making repairs, little or no attention is given to the material removed and its condition. If material charges are to be maintained at a minimum, this is the point where a strict supervision should be initially applied. Whether it be foreman, inspector or material supervisor, there should be some one in charge of the stripping who is thoroughly conversant with the material. He should not allow parts to be removed and thrown

in a heterogeneous heap to be sorted out later, as this is a practice which not only causes the loss of parts but often breaks, bends or otherwise damages material so as to render it unfit for use, or at least makes for additional labor in its repair. The time the parts are removed is the time to determine whether or not they have served their full term of usefulness, and not after they have been hauled to the scrap bins. The man in charge should inspect each part as removed to determine; first, whether it can be repaired and replaced without delay or excessive labor; second, whether it may be of use at a subsequent time although inexpedient to replace in its former position; third, whether it is of no further use or would require repairs out of proportion to its value.

In the first case the part should be immediately transferred to the department where the repairs are to be made, or if no repairs are necessary, it should be stored in a properly provided place to await the time it is required. In the second case, it should be turned over to the proper department to receive the necessary repairs, after which it should be returned to the store department and proper credit allowed. In the third case, the proper place for the part is in the scrap bins. After the engine or car is stripped and the material properly distributed it is an easy matter to determine exactly what new parts will be required and then and not until then should new material be requisitioned from the store house. This does not mean, however, that parts which are known to be defective previous to the shopping of the engine, or car, may not be drawn and machined ready for immediate application, nor that a small stock of finished parts should not be kept on hand, but it does preclude the possibility of new parts being ordered to replace old parts which are still serviceable.

The waste by workmen of small parts, such as nuts, bolts, pins, washers, fittings, etc., is undoubtedly the source of a considerable loss in many shops. For instance, a workman will draw a dozen nuts, and, having used three or four, allow the remainder to lie in the pit or on the floor where they will be lost or will find their way to the scrap bins. The education of individual workmen in habits of economy will, in a shop with a comparatively steady force, accomplish much toward the elimination of such waste. In a shop with a constantly changing force little can be done along this line, and in such cases the minimization of such losses devolves upon the foremen. Requisitions for small parts should not be indiscriminately issued on the request of workmen, but the foreman should know approximately what quantities are needed and order accordingly.

After the repairs on an engine, or car, have been completed there is always more or less material left over, some of which may be still serviceable, and these parts should be carefully checked over, the good being returned to stock, and the scrap disposed of in the regular manner. Careful supervision of the above three items will keep the amount of material so left over at a minimum, and under ideal conditions there will be none at all.

It often happens that an inefficient store department or lack of co-operation between the stores and the mechanical departments will cause waste of material. The store department failing to have on hand proper material is a frequent source of embarrassment, as this condition incurs delays or necessitates

the manufacturing of parts at high cost. The mechanical department should keep the store department informed well in advance of demand, as to the quantity and quality of material needed. The store department so informed should see that parts are on hand when needed, at the same time exercising caution to prevent an over supply being carried.

As to whether or not special men are required to effect material economies depends entirely on conditions. In a small shop, not overburdened with work, the extra expense of a special material man should be unnecessary. In a large shop where the burden of supervision is heavy a material supervisor should be an important member of the controlling force. Whatever plan is employed at individual points, whether the handling of material is delegated to the regular force or to a special man, there should be at the head of the division, or system, one man who makes the study of material efficiency his business, and who has at his command accurate data for the comparison of the performance of different divisions or points, and who possesses the personality and energy to keep the whole organization keyed up to the proper economic pitch.

So far our consideration of the material problem has been directed mainly to the shops and larger points where repairs are made. Before concluding, however, something should be said concerning the small engine houses and repair yards. It will be found that the proportionate waste of material at the smaller points is greater than at the large points and excusably so, as they are not equipped with the facilities for making extensive repairs, and must perforce apply new parts which at a larger point would be repaired and replaced.

To minimize such wastes, foremen at minor repair points should be carefully instructed as to what parts may be made serviceable without excessive cost, and such parts when removed should, instead of being relegated to the scrap, be shipped to the main shops to be repaired and returned to stock. It will also pay to have a general or division material man make a periodical inspection of the scrap bins at outlying points to see that the local foremen are exercising proper supervision over this item, and to further instruct them in the line of what material should be saved. The methods of conserving material which have been suggested are not untried theories, but have been given a thorough demonstration effecting a net saving of about 30 per cent. in the material account on a group of divisions.

LOCOMOTIVE SHOP KINKS

BY CHARLES MARKEL.

Shop Foreman, Chicago & North Western, Clinton, Iowa.

TRUCK FOR TRANSPORTING TENDER WHEELS.

The truck shown in Fig. 1 is used for carting tender or engine truck wheels. The wheel is carried, as shown, by the 2 1/4 in. x

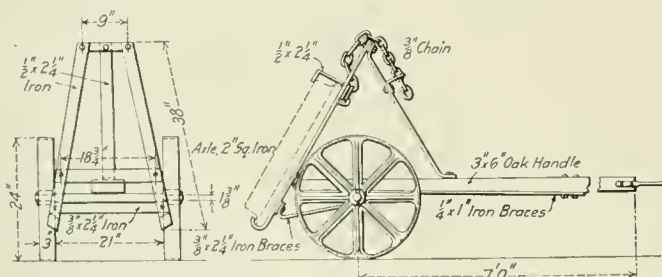

Fig. 1—Truck for Carrying Tender Wheels.

1/2 in. iron framework and is held from falling by the 3/8 in. chain and clamp. The wheels are 24 in. in diameter and are located 21 in. apart. The handle is 7 ft. long and is made of oak, 3 in. thick x 6 in. wide, provided with 1 in. x 1 1/4 in. braces. When loading the truck the handle is raised until the lower end of the frame rests on the ground and the wheel, which is lying flat

on the ground, is lifted so that the flange fits into the frame, as shown. With a fairly good floor this truck will save considerable time and will be found safer than rolling and balancing the wheels around the shop, as is often done.

PORTABLE SAND BLAST APPARATUS.

The portable sand blasting apparatus, shown in Fig. 2, has been found convenient for use out of doors, when sanding tenders, tank cars, etc. It consists of a tank 36 in. high and 26 in. in diameter, in which the sand is contained. The air hose is connected as indicated and air is delivered on top of the sand in

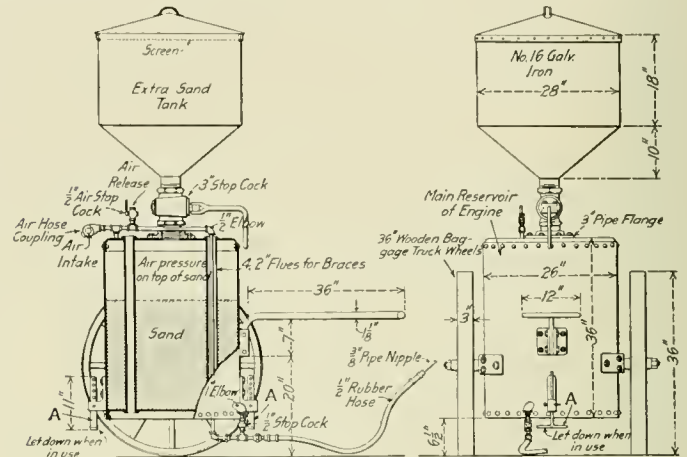

Fig. 2—Portable Sand Blast Apparatus.

the tank as well as into a nozzle which leads from the bottom of the tank. When the tank is in use the two legs A-A are let down until they rest on the ground and are then fastened in place by pins. The sand tank shown above the main tank contains an extra quality of sand, which, when the sand is exhausted from the main tank, may be allowed to flow into it through the 3 in. stop cock shown, the air being first exhausted from the main tank through the 1/2 in. air stop cock.

AIR PUMP CRANE.

The crane shown in Fig. 3 has been found very serviceable in removing or applying air pumps to locomotives. The framework is made of 1 1/4 in. pipe and a piece of 2 1/2 in. x 1/2 in. bar-iron is used for a runway. The two legs have adjustable rods which fit inside the pipe and are fastened by 1/2 in. pins, allowing the height of the crane to be adjusted. One end of the bar-iron runway is held by two pieces of 1 1/4 in. pipe, that have U's in

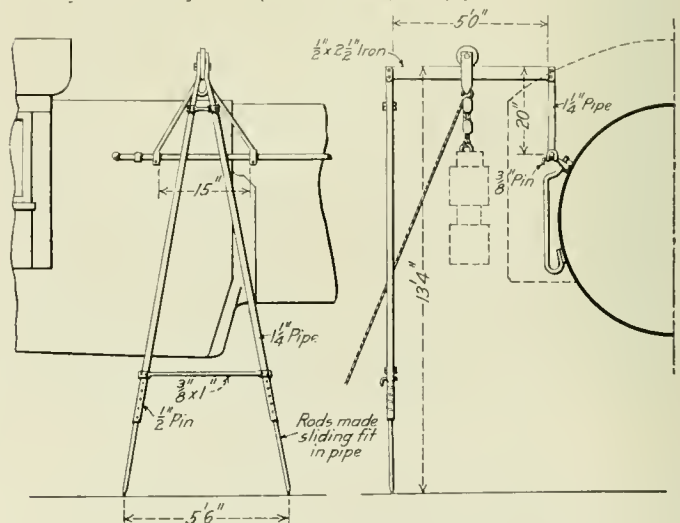

Fig. 3—Air Pump Crane.

their lower ends which slip over the handrail of the locomotive. A one-wheel trolley operates on the runway and is provided with a block and tackle. The illustration shows a pump which has been raised and is ready for application.

MECHANICAL DEPARTMENT ORGANIZATION

Increased Supervision in the Mechanical Department of the Illinois Central has Resulted in More Effective Service and Marked Improvements in Efficiency

A substantial improvement was made in the condition of the cars and locomotives on the Illinois Central during the fiscal year of 1910-11, as compared to the previous year. At the same time the cost of maintenance of freight cars was decreased from \$134.01 to \$93.96 per car, while the cost of passenger cars was reduced from \$1,001.00 to \$883.28 per car. The cost per locomotive remained about the same, but the condition of the motive power was very considerably improved. One of the most potent reasons for the splendid showing was the increased supervision which was developed under the leadership of M. K. Barnum, the general superintendent of motive power, who went to the Illinois Central near the close of the fiscal year 1909-10.

Some idea of the improvements which have been made in the organization and their possible effect on future economies may be gained from a detailed study of the organization. As may be seen from the accompanying map, the Illinois Central operates in 14 states, reaching from Minnesota and South Dakota on the north to Louisiana, Mississippi and Alabama on the south, and from Indiana and Kentucky on the east to Nebraska on the west. Compared with the Chicago, Burlington & Quincy, whose mechanical department organization was described in the *Railway Age Gazette* of May 6, 1910, page 1136, it has 6,125 miles of track or 2,950 miles less than the Burlington. On the other hand it has 188, or about 12 per cent. less locomotives, and about 5,700 more cars.

The headquarters of the mechanical department are at Chicago, and here also are located the Burnside shops, the largest on the system. These shops are under the control of a shop superintendent, while the eleven other shops on the system are operated under the direction of the master mechanics on whose divisions they are located. The fourteen divisions and the headquarters of the division master mechanics are indicated by the large circles on the map. The figures after the names of the cities and towns show the number of mechanical department employees at each point.

The organization is outlined on the accompanying chart. In increasing and perfecting the supervision it was aimed to cover

felt that the car department should receive more attention and recognition than is usual on most roads. The locomotive department is in charge of a superintendent of machinery and the car department is in charge of a superintendent of the car department. Both of these officers report direct to the general superintendent of the Burnside shops report to the superintendent of machinery on matters referring to the locomotive department and to the superintendent of the car department on matters referring to the car department. In the absence of the general superintendent of motive power, the superintendent of machinery is the highest ranking officer and is in full charge of the mechanical department.

The superintendent of the car department has charge of the maintenance of the freight and passenger cars and the terminal work on trains; where his duties overlap those of the superintendent of machinery they co-operate and work in harmony. The mechanical engineer and other members of the staff are instructed to furnish such assistance and information as may be desired by either the superintendent of machinery or the superintendent of the car department.

The superintendent of floating equipment, who reports to the superintendent of machinery, has charge of the inspection and maintenance of 23 boats, including tugs and barges, which are used for transferring cars at various places on the Ohio and Mississippi rivers. His headquarters are at Paducah, Ky. The machinery and boiler repairs are generally handled in the locomotive shops at that point, while the work on the hulls is done in a contract marine shop at Paducah.

The general boiler inspector supervises the locomotive, marine and stationary boiler inspection for the entire system, visiting the various shops and engine houses, and seeing that the local and federal laws governing boiler inspection are carried out. A record of all the locomotive boiler inspections is kept in his office.

The general locomotive inspector looks after the maintenance and upkeep of the locomotive machinery parts which affect the steam economy, and among other things has been giving special attention to cylinder packing. He also looks after special assignments in connection with the inspection and maintenance of locomotives.

The air brake instructor has charge of the air brake car and looks after the instruction of the enginemen, workmen and shopmen in the operation and use of the air brakes.

The duties of the general car inspectors are evident from their titles. One of them has charge of the territory south of the Ohio and the other of the northern and western lines. They see that the car inspectors understand their duties thoroughly and also instruct the new men. They visit the repair tracks to see that the safety appliance regulations are properly carried out and look after other special assignments. The general piece-work inspector looks after the piece work in the car department.

The mechanical engineer has supervision over the design of cars and locomotives, and also looks after the testing of mechanical devices. He is assisted by a chief draftsman, who directs the work of the drafting room. The general pattern inspector checks the designs of patterns, making sure that excess material is not used. He also looks after the pattern record, which is kept in the form of a loose leaf book. Bulletins of changes of patterns, or new patterns, are sent out under his direction periodically.

The inspector of test devices looks after the special devices which are installed for test purposes. Every road tests new devices to determine whether the standard practice should be im-

MOTIVE POWER DEPARTMENT ORGANIZATION—ILLINOIS CENTRAL.

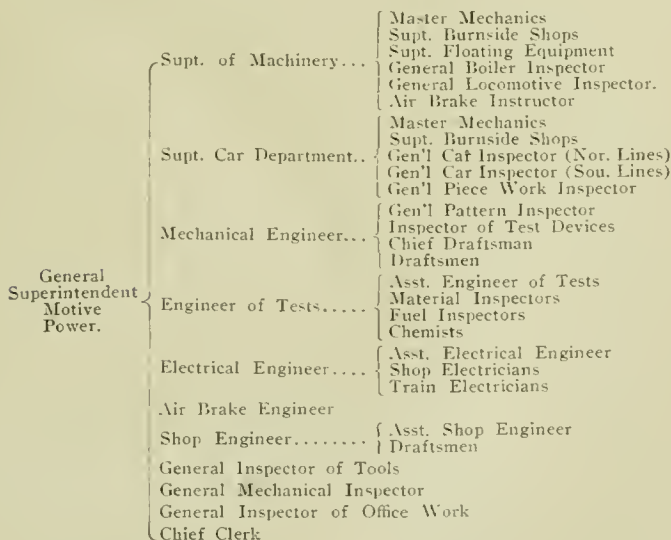

thoroughly all of the various places of the work, even at the possible danger of overlapping authority, although in actual practice no trouble of this kind has occurred. It was also



Map of the Illinois Central, Showing Distribution of Mechanical Department Forces and Division Headquarters.

proved. The value of this work, however, is often almost, or entirely, lost because the devices are not closely followed in service. The inspector of test devices keeps an accurate card index record of when each device is applied, the name of the manufacturer, the price, etc., and periodically examines the device on the car or locomotive and consults with those who come in direct contact with it. These results are immediately noted on the proper card at headquarters, so that any of the mechanical department officers and the purchasing agent can get the latest information about the test devices by referring to the card-index.

The engineer of tests has charge of the inspection of the material used by the mechanical department, including the fuel for both the locomotives and the shops. He also supervises the tests of various kinds of supplies. His force includes an assistant, material inspectors, fuel inspectors, and chemists. The chief material inspector has charge of the material inspectors, and in addition to the duties ordinarily involved in this work studies the performance of the material in service, looks into the causes of failures, and also has charge of the reclaiming of scrap or second hand material. The latter department includes a rolling mill with a head roller, heater, catcher, straightener and laborer; also a department in which air and steam hose are fitted up and repaired, the work being done by a foreman and six men; the re-lining of journal brasses is handled by a foreman and three men.

The fuel inspectors inspect the coal when it is loaded at the mines and check to see that it contains no impurities and does not have an excess of screenings. While traveling in connection with their duties they are instructed to ride on the locomotives and watch the performance. Nine of these inspectors look after the coal which is purchased from 45 mines. They work closely with the mine superintendents and miners, and are expected at all times to know the exact conditions in the mines. By following up this work closely it is possible to reduce the number of engine failures to a minimum and to greatly increase the efficiency of the motive power. The chemists look after the laboratory work and are also trained in material inspection, so that in case of a rush of this work they can be called upon to help out.

The electrical engineer has charge of the shop electricians and makes estimates for and superintends the installation of wiring for both light and power. He also has charge of the electric lighting of trains, which is done exclusively by the axle lighting system. He has an assistant and a force of shop and train electricians.

The air brake engineer is expected to keep informed as to the latest and best air brake practice, but he also looks after such details of shop practice as may be assigned to him. The air brake instructor, who was noted as reporting to the superintendent

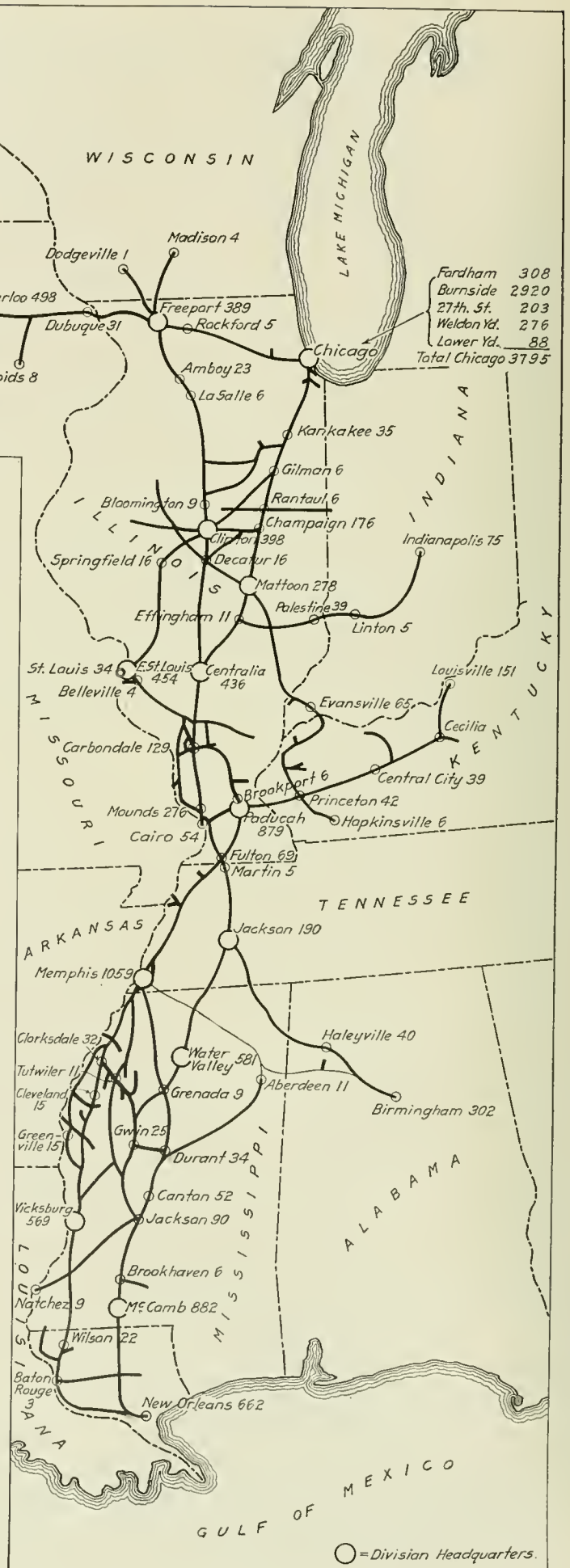

○ = Division Headquarters.

of machinery, is expected to carry out the air brake engineer's policy and instructions, but the details of his work are handled under orders from the superintendent of machinery, as indicated on the chart.

The shop engineer designs all shop additions and improvements, and supervises and carries out all plans for this class of work. In short, he is a specialist in shop design and is expected to keep informed as to the latest and best shop practice.

The general inspector of tools visits the different shops and keeps fully informed as to the condition and efficiency of the machine tools and of the portable tools which are kept in the tool rooms. He also studies the condition and efficiency of the tool rooms and checks all requisitions for tool room supplies. He is required to investigate the best designs of machine tools when lists are being made up for new tools, and he also attends to the transfer of tools between the different shops. In brief, he is expected to be fully informed on the subject of machine tools in the Illinois Central shops and as to the results which may be obtained from the latest designs of tools of the various manufacturers, so that he can advise as to the replacement of old tools, or as to their transfer from large shops to those of less importance.

The general mechanical inspector has been investigating the power situation on the Illinois Central, and has visited all the division officers; a report is in preparation which will recommend such additional new power as may seem best, and also a re-distribution of the power now in service. He will be detailed on similar investigations of various kinds, including the economical use of locomotive fuel and shop efficiency problems.

The general inspector of office work visits the various offices and confers with the master mechanic and his assistants to see that all reports are correctly and uniformly made. He also passes on new forms for reports and on other questions in connection with office work. The value of this work is shown by the reduction of about 35 per cent. in the number of mechanical department reports during the past year, although all the necessary information is now being obtained and in better shape than formerly.

The following account of the way in which he has handled the work may be of interest. After studying the reports which were received in the office of the general superintendent motive power he found it advisable to start his investigations by seeing how this data was gathered in its early stages by the master mechanic. The most important outside points were visited and a complete list of the reports made out in connection with the mechanical department was obtained. Each of the master mechanics was then consulted, local conditions were considered, and any reports which were being furnished which were not necessary, or of little or no value, were discontinued at once. The progress of these reports was then followed until they left the hands of the master mechanics; as a result it was possible on January 1, 1911, to eliminate twelve reports and to have five others kept as a local record for the inspection of the master mechanic on his visit to the shops. This left a clear field for the study of the reports coming from the master mechanic's office to the superintendent motive power. These were carefully investigated and listed, and those which were not desired were cut out. It was found that many of the report forms were obsolete and that others could be consolidated. Each separate form was discussed with the master mechanics in order to prevent the elimination of any that might be needed for recording purposes. Up to October 21, 1911, 178 of the forms had been entirely revised, 47 eliminated and 23 others were consolidated into eleven forms, thus making a total reduction of 76 forms, including the 17 which had been eliminated January 1, 1911. It is quite probable that a larger reduction will be made as the stock of certain forms runs out.

By the gradual elimination of unnecessary forms the clerks in the offices of the master mechanics have been able to give more care to necessary work. The duties of each clerk have been

studied and by a rearrangement of their work it has been possible to practically eliminate overtime among the clerks, thus creating a much better condition. Formerly the master mechanics were required to furnish the superintendents with reports different from those which were sent to the superintendent of motive power; in many instances the superintendents have found that they could use a carbon copy of the superintendent motive power's report, with a consequent reduction in clerical work.

The chief clerk, whose name appears last on the organization chart, performs the usual duties of this office for the entire mechanical department at the general offices in Chicago.

CAST STEEL DRAWBAR CARRIER

In connection with the description of the balanced compound Pacific type locomotives for the Santa Fe, given on page 65 of our February issue, it was mentioned that the rear end sill of the tender was provided with a drawbar carrier of special construction, by means of which the weight of the carrier as well as the drawbar was supported by lugs which interlocked with similar lugs on the cast steel end sill of the tender. The advantages of this construction are readily apparent. The four 1 in.

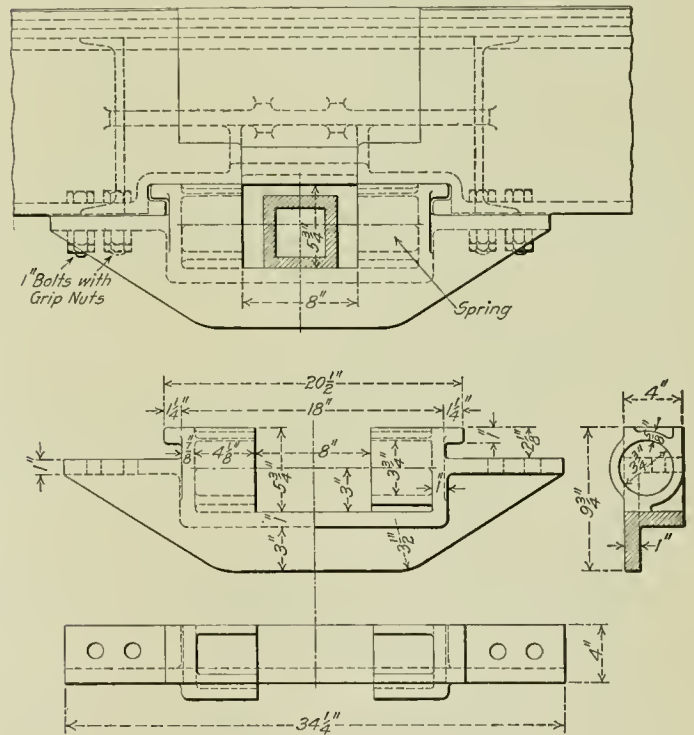

Cast Steel Drawbar Carrier for Tenders.

bolts used are intended simply to keep the carrier from becoming displaced and not for supporting any of the weight, this being carried entirely by the lugs, which are 1 in. x 1 1/4 in. x 4 in. It will be seen that even if the nuts on these bolts are lost, they will still hold the carrier in place. Pockets are provided on either side for centering springs.

USING OLD BOILER LAGGING.—The practice which is in use at a number of progressive railway shops of collecting the lagging removed from boilers when they come into the shop and placing it in a flue rattler together with some old grate bars and flues, thus grinding it up and by the addition of a small amount of new material making it suitable for use again, has proved most profitable at the Clinton shops of the Chicago & North Western. Chas. Markel, the foreman, states that the saving with this method amounts to more than \$21 per boiler and that the reworked lagging is fully as good as that which is entirely new.

STEEL CAR SHOP KINKS

BY LEWIS D. FREEMAN,
Special Tool Designer, Baltimore & Ohio, Baltimore, Md.

TONGS FOR HANDLING HOT PLATES.

Many styles of hooks are used for handling hot car sheets, but most of them are unsatisfactory, as they are awkward to handle and the sheets lose considerable heat while they are being taken from the furnace to the work. A special design of tongs is shown in Fig. 1. These not only take a firm hold on the sheets but allow the workman to handle them easily. One end has jaws made of machine steel, the upper one of which is forked to hold a cam. This cam grips the sheet firmly and is operated by a rod extending along the length of the handle. Two rods, $\frac{5}{8}$ in. in diameter, are fixed at convenient places on the handle, to provide a convenient grip for the workman. To grasp the sheet the cam rod is pushed forward which throws the cam up as far as possible; after the sheet has been inserted in the jaws the cam is pulled back and the harder it is pulled the firmer it grasps the sheet. The cam shown in this illustration will work satisfactorily on sheets up to $\frac{5}{8}$ in. in thickness, but on heavier sheets one of less radius should be used.

BRIDGE PLATES FOR SHOP HOSE.

In shops where the air hose is laid on the floor, across aisles and in the path of the shop trucks, a bridge plate such as shown in Fig. 2 will be found valuable. Without it the hose will soon become cut and worn and the usual wire covering will be crushed and bent out of shape, restricting the flow of air and causing the hose to deteriorate more rapidly. This plate may be made from scrap smokebox extensions or steel car plate ranging from $\frac{1}{4}$ in. to $\frac{1}{2}$ in. thick, and is bent as shown in the illustration. It may be made to any width, and where the gage of the trucks is wide it will be found more convenient to use two

as possible. Many times a special tool is found necessary, and the one shown in Fig. 3 has proved to be valuable as a rivet cutter for general steel car work and especially in the case of badly damaged cars. Although this device is portable it has been found more practical to bring the cars to the machine rather than to try and carry it around through the yard, for it can be set up

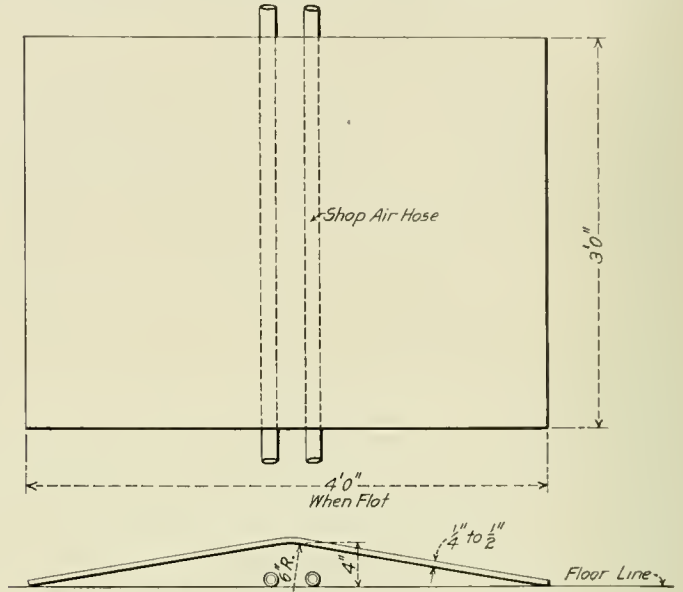

Fig. 2—Bridge Plate for Protecting Shop Hose.

and adjusted more readily where conveniences are at hand. The best way to use the machine is to anchor it to a suitable back stop or upright post.

The cylinder is made from a hot rolled seamless steel tube, $4\frac{1}{2}$

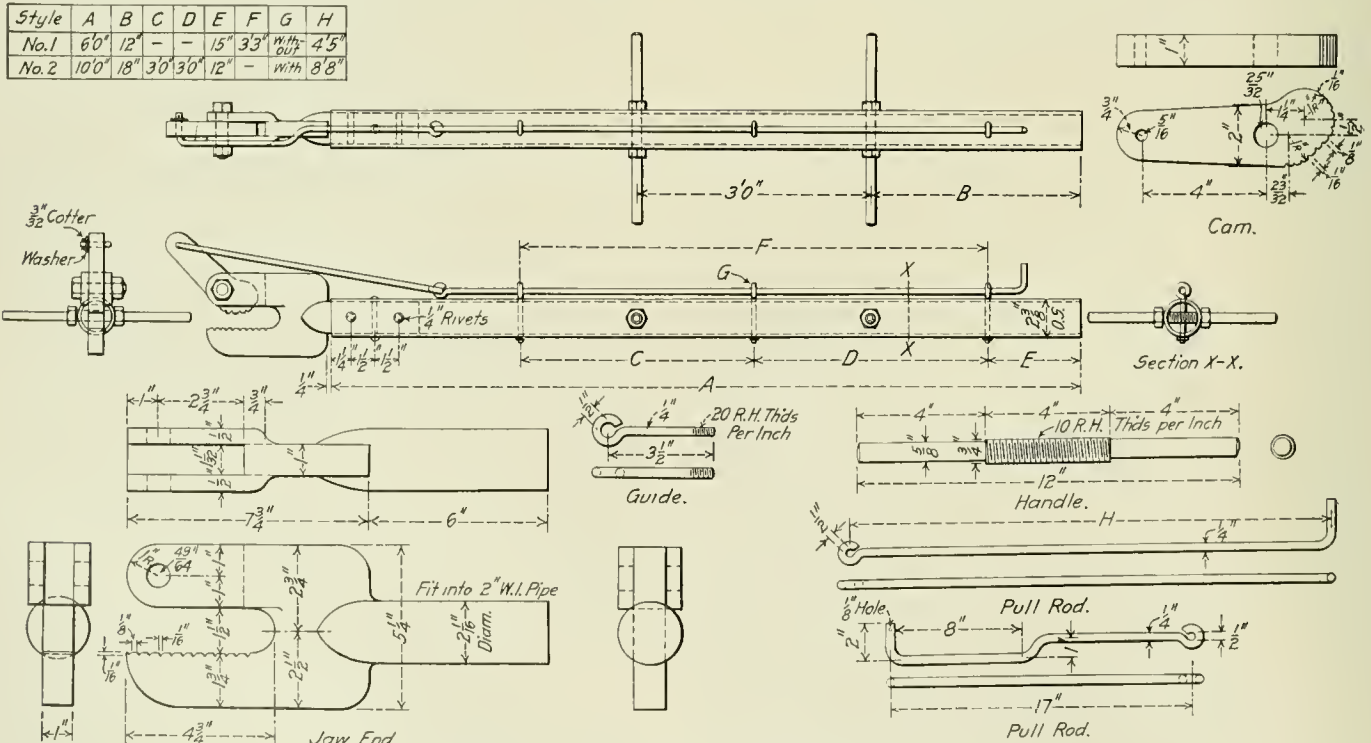

Fig. 1—Tongs for Handling Hot Steel Plates.

small plates instead of one large one, as they will be much lighter and easier to handle.

PNEUMATIC RIVET CUTTER.

Where large numbers of steel freight cars are being repaired it is necessary that the tool equipment be maintained as efficient

in. inside diameter and $5\frac{1}{4}$ in. outside diameter. This tube is supported on a framework of wrought iron which is mounted on an axle with two 18-in. wheels. Two wrought iron blocks form the connection between the cylinder and the frame, the cylinder being held to them by U-bolts, which are applied hot and shrunk on. The inside of the cylinder is reamed with a special reamer

and contains a machine steel piston 16 in. long which is provided with the necessary packing rings. A piece of tool steel is inserted in the front end of this piston and serves as a suitable surface for striking the end of the chisel bar, as will be described later. A cast iron head, having a 1 9-16 in. hole for the chisel bar, is screwed on to the front of the cylinder. This head is also bolted with four 5/8-in. bolts to a steel flange which is shrunk on the cylinder. In each end of the cylinder is a rubber cushion 1 3/4 in. thick, which prevents any heavy direct blow on the cylinder heads. The dotted lines through this rubber cushion, shown at the left in Fig. 3, indicate the location of the chisel bar, which is shown in detail in Fig. 4, in its working position. The length of the chisel bar varies from 4 ft. to 9 ft. and it is made from 1 3/4-in. hexagonal or octagonal tool steel. A U-shaped guide B is bolted on a lug in the front cylinder head and acts as a guide for the anchor cable. The back cylinder head has a lug cast on the top center line to hold the anchor cable reel. This reel is made of cast iron and is mounted on a frame made of 1 1/2-in. wrought iron plates. It is operated by a handle through two gears, as shown. On the left hand side of the reel is a ratchet wheel and pawl, which keeps the cable taut and helps to absorb the shock when cutting rivets; the outer end of the cable is fastened to the work or to some fixed object.

A brass tee is fitted into the back cylinder head by means of a nipple and the throttle lever is fastened to a block fixed in the

ing position, thus closing the 1 9-16 in. hole in the front cylinder head. It will also be noticed that the slide valve G is open, which allows the air back of the piston to escape as it is forced backward. Three holes are provided in the front end and one in the back, so as to allow a more rapid exhaust on the driving stroke and a slower exhaust on the return stroke, which will

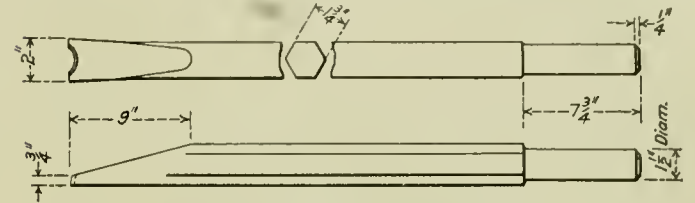

Fig. 4—Chisel Bar for Cutting Rivets.

keep the piston from striking the rear head with a very severe blow.

When the throttle lever is in its full backward position the front exhaust valve will be open and the rear valve closed, and the piston valve E will be moved over to the other side of the air connection allowing the air to go up through the tee C and drive the piston forward. The tool steel plug in the end of the piston will strike the chisel bar with sufficient force to cut off a 1 1/4-in. rivet at one stroke. This apparatus can also be used for

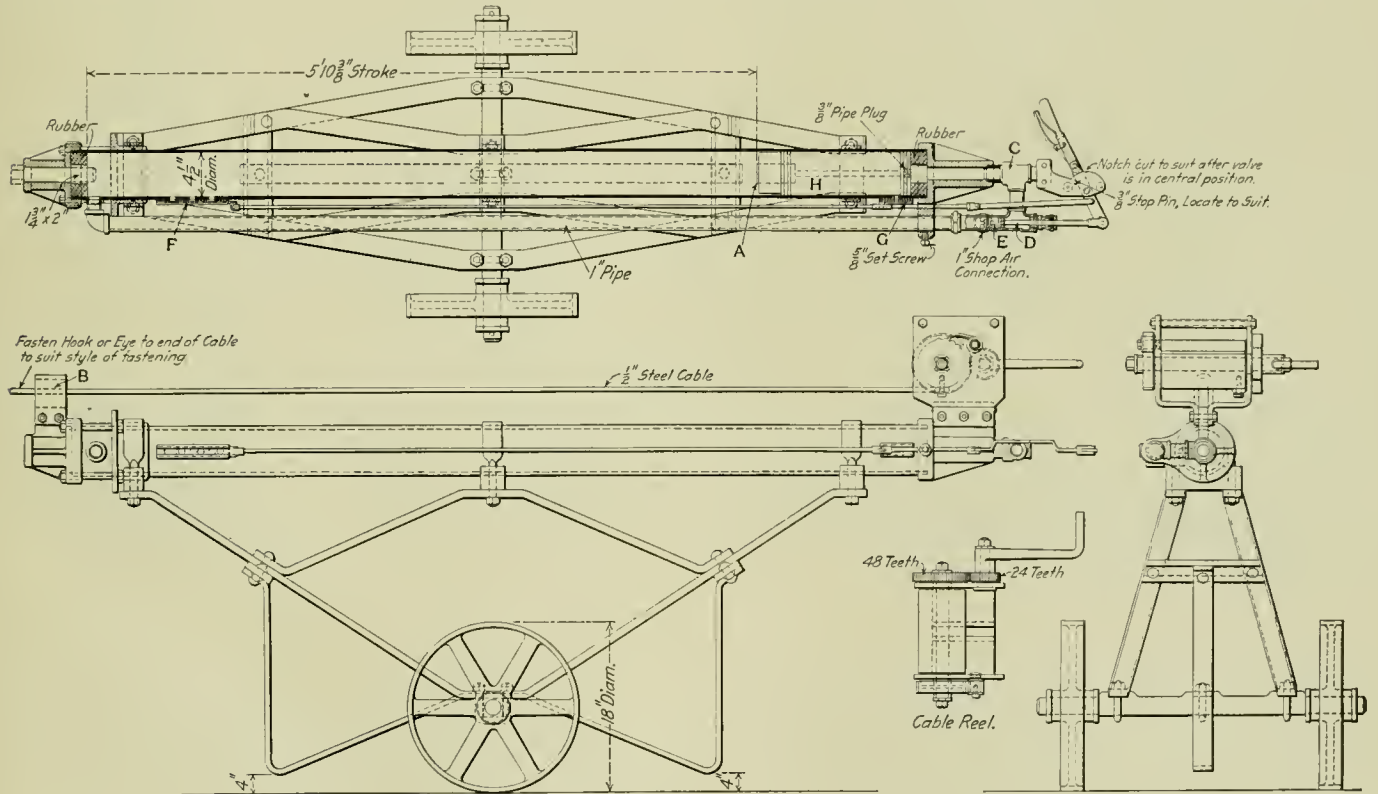

Fig. 3—Pneumatic Rivet and Stay Bolt Cutter.

opposite end of this tee. A brass manifold D is connected to the middle opening of the tee and contains a wrought iron piston valve E, which has four packing rings. Slide valves are located at F and G in the main cylinder, the front valve having three 3/8-in. holes and the rear valve having only one 3/8-in. hole. These valves are for the exhaust and they operate on brass seats, which are brazed to the steel tube. With the throttle lever in the position shown in the illustration the air enters the manifold in front of the piston valve at the point marked "shop air connection." From there it flows forward through the 1-in. iron pipe to the front end of the cylinder. The slide valve F being closed, the incoming air forces the piston back to the rear of the cylinder, provided, of course, that the chisel bar is in its work-

ing position, thus closing the 1 9-16 in. hole in the front cylinder head. It will also be noticed that the slide valve G is open, which allows the air back of the piston to escape as it is forced backward. Three holes are provided in the front end and one in the back, so as to allow a more rapid exhaust on the driving stroke and a slower exhaust on the return stroke, which will

100-TON HYDRAULIC PRESS.

A simple design of hydraulic press for making right angle bends in steel car plates is shown in Fig. 5. It has a capacity of 100 tons when operated by a hydraulic pressure of 1,000 lbs. per sq. in. The sets of 9 1/2-in. cylinders having outside packed plungers are used for the heavy work and two 14-in. cylinders operated at 100 lbs. per sq. in. air pressure, are used for light work. The capacity of the press with the air cylinders is 15 tons.

A right angle bend can be made on a plate 11 ft. long and should it be desired to flange the adjacent side, the plate can be turned and flanged again, there being sufficient clearance on each side of the die to accommodate the first flange.

Construction.—The main frame consists of four columns of 2½ in. x 5 in. wrought iron bars bolted to the base and the top cross piece with two 1½-in. bolts in each end. The lower ends of these columns are turned under the base to provide a more rigid construction. The base is built up of three 15-in. I-beams and has two ½-in. wrought iron plates on the bottom and one ½-in. wrought iron plate on the top, which serves as the cylinder support. The sides of the base are also covered with plates and cast iron separators are placed at intervals between the I-beams and the plates. The whole base is bolted together with several 1½-in. bolts. The male die is held by a similar structure on the top, two 15-in. I-beams being used instead of three. These beams also have wrought iron plates on the top and bottom and are further strengthened by two 1½-in. truss rods extending 18 in. above the I-beams at the center. The die, which is made from a 5½-in. T-rail, is fastened to a cast iron block, 3 in. thick. The

RECLAIMING SCRAP MATERIAL*

BY W. L. W.

In reclaiming scrap or second-hand material it is wise to have a committee of three appointed for about three months at a time to look over the scrap bins once or twice a week. The committee members should be men capable of using good judgment and should be thoroughly familiar with the different types of locomotives and cars. A great many of the older locomotives, when they need a heavy overhauling, find their way to the scrap bins, and unless one member of the committee is thoroughly familiar with these engines there might be a lot of material reclaimed which seemed good but would be laid aside for an indefinite time, perhaps never having any call to use it. This is not good policy. The above scheme also refers to car work, as a great quantity of good material from the cars finds its way to the scrap bins; if competent men are assigned to this work at different times a large amount of money will be saved for the company.

A good preventive for serviceable material getting to the scrap

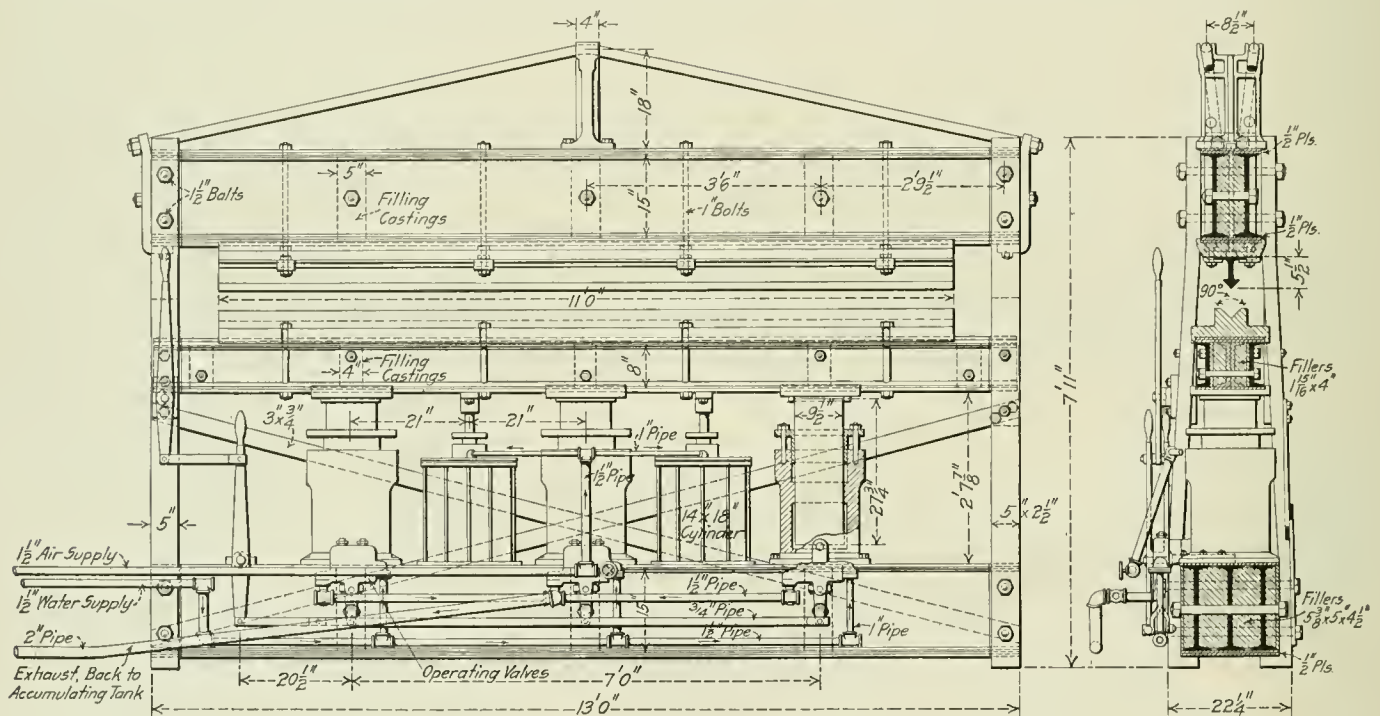

Fig. 5—100-Ton Hydraulic Press for Steel Plates.

receiving die is made of cast iron and has a V-groove 2 in. deep. This die is supported by a girder built up of four 8-in. channels with two ½-in. wrought iron plates placed vertically between them, as shown in the illustration. Cast iron pockets which receive the plungers from the hydraulic rams are fastened to a 1½-in. plate on the bottom of the girder.

Operation.—The lower die is raised by the plungers of the rams, the four corner columns serving as guides. Each hydraulic cylinder has its operating valve connected to one operating lever, while the air cylinders are operated separately. The machine is placed in a pit on a concrete foundation, so that the dies are 2 ft. above the floor. A light capacity jib crane will be found very useful for handling the material in connection with this machine. The press will be found a valuable addition to shops handling steel car work and will bend sheets cold up to 5-16 in. thick without injuring them. The chief advantage of the machine is in its arrangement for handling work which requires comparatively low pressures, as well as that which requires high pressures, but with the less expensive and more rapid method of operation.

bins would be for the foremen in charge of the different classes of work to examine the scrap before it leaves their departments. This is especially true of nuts, bolts, spring hangers, gibs, and pins; a great number of bolts removed from frames could be used again instead of being consigned to the scrap pile. For instance, on pedestal brace bolts, when the braces are taken to the blacksmith shop to be closed in, the bolts in many cases have to be removed and the holes reamed out. Some of the holes are larger than others and the old bolts could be changed around, requiring a smaller number of new ones. A great many of the old spring gibs could be used again if they were taken care of.

It is a good plan to educate the men to realize the value of the material with which they work. When they spoil a piece of work a statement should be made out showing how much the company or employer has lost by their carelessness. This ought especially to be done with apprentices; it should be part of their education to work for their employer's interest as well as his own.

*Awarded the second prize in the competition on Reclaiming Scrap Material, which closed February 15, 1912.

100-TON, 36 FT., FLAT CAR

Pittsburgh & Lake Erie.

For use in special service, and particularly for carrying heavy castings, the Pittsburgh & Lake Erie has designed and built at its McKees Rocks, Pa., shops, five 36 ft. steel cars having a capacity of 200,000 lbs. each. These cars are somewhat similar in their general construction to the 75-ton flat car built by the Lake Shore & Michigan Southern in 1907,* and are constructed entirely of structural shapes and specially designed steel castings.

Four continuous fish-belly sills form the load-carrying members of the underframe. These are in each case girders with 1/2 in. web plates and having flanges formed by angles. The center sills are 13 1/4 in. deep from the end sill to a point beyond the bolsters and 29 in. deep for 6 ft. at the center. The two sills are spaced 12 7/8 in. apart. The angles forming the flanges at both the top and the bottom are 5 in. x 3 1/2 in. x 9/16 in. This provides a sectional area for the center sills of 64.76 sq. in. The inner angle at the bottom is discontinued at the inner edge of bolster,

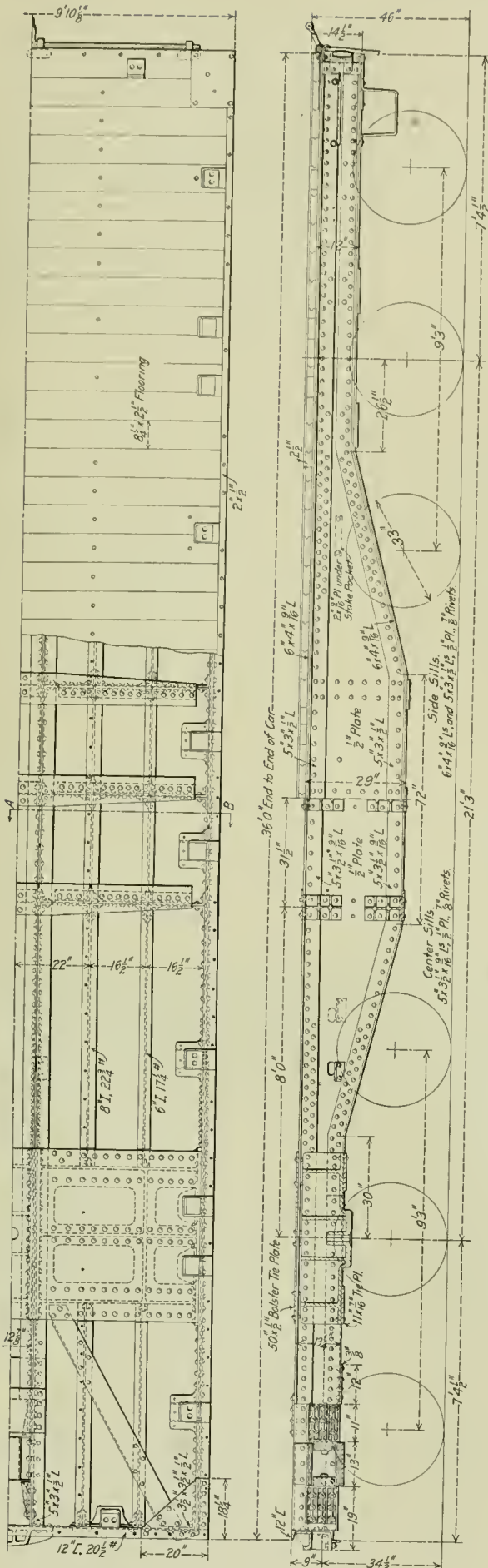

Thirty-six-foot Steel Flat Car of 200,000 Lbs. Capacity; Pittsburgh and Lake Erie.

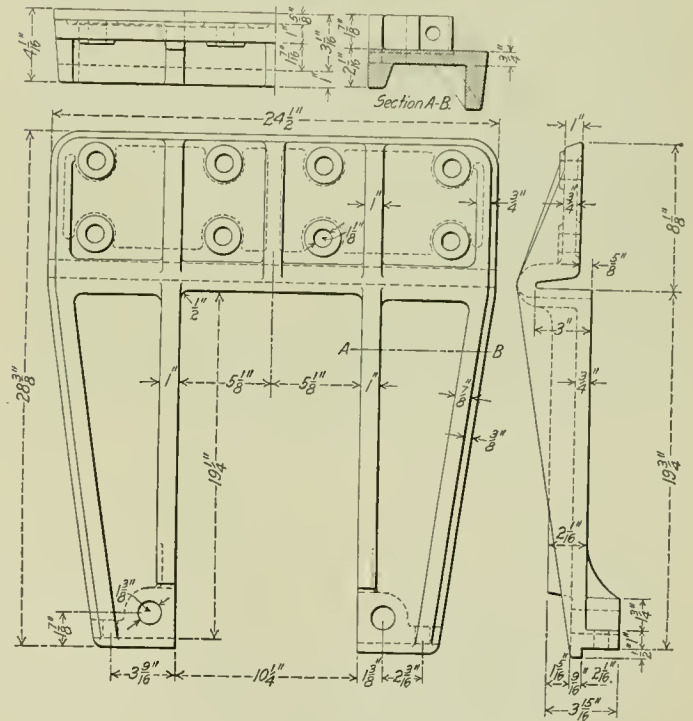

Pedestal for 100-Ton Capacity Car.

but is continued beyond the bolster to the rear draft lugs. The other three angles extend continuously through the bolster to the draft lugs. The flanges of the side sills are formed of 6 in. x 4 in. x 9/16 in. angles on the inside of the plate with the flanges extending outward and of 5 in. x 3 in. x 1/2 in. angles on the outside of the plate with their outwardly extending flanges abutting and riveted to the inner angles. The construction is the same at both the top and bottom of the sills. This gives a cross-sectional area of about 32.12 sq. in. in each side sill, or a total for the 4 longitudinal of about 129 sq. in.

Near the center are three sets of built-up cross bearers or diaphragms which are fitted between and secured to the center and side sills. That portion of the cross bearer between the center sills consists of steel castings. A 1/2-in. cover plate of the shape shown in the illustration stiffens and braces the whole construction at these points.

The cast steel bolster, 50 in. wide, is in three parts, the section between the center sills including the center plate. These castings are tied together by cover plates, the top one being 50 in.

*See American Engineer & Railroad Journal, June, 1907, page 219.

in width and 1/2 in. thick and extending continuously between the side sills; the two bottom plates are each 11 in. x 7/16 in. and end about half way between the side and center sills. An 8 in.

I beam and a 6 in. I beam are used for floor-carrying members and longitudinal stiffeners. They are secured to lugs on the bolster casting and by angles at each of the diaphragms. At the

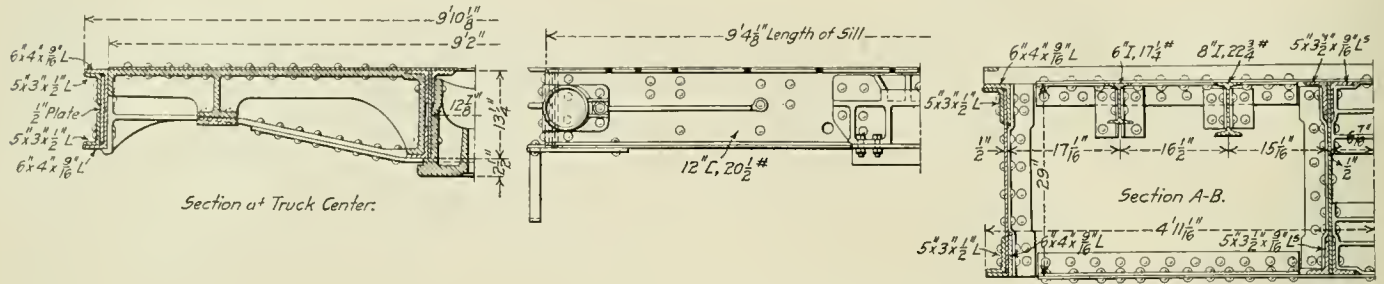

Sections of Underframe—100-Ton Capacity Flat Car.

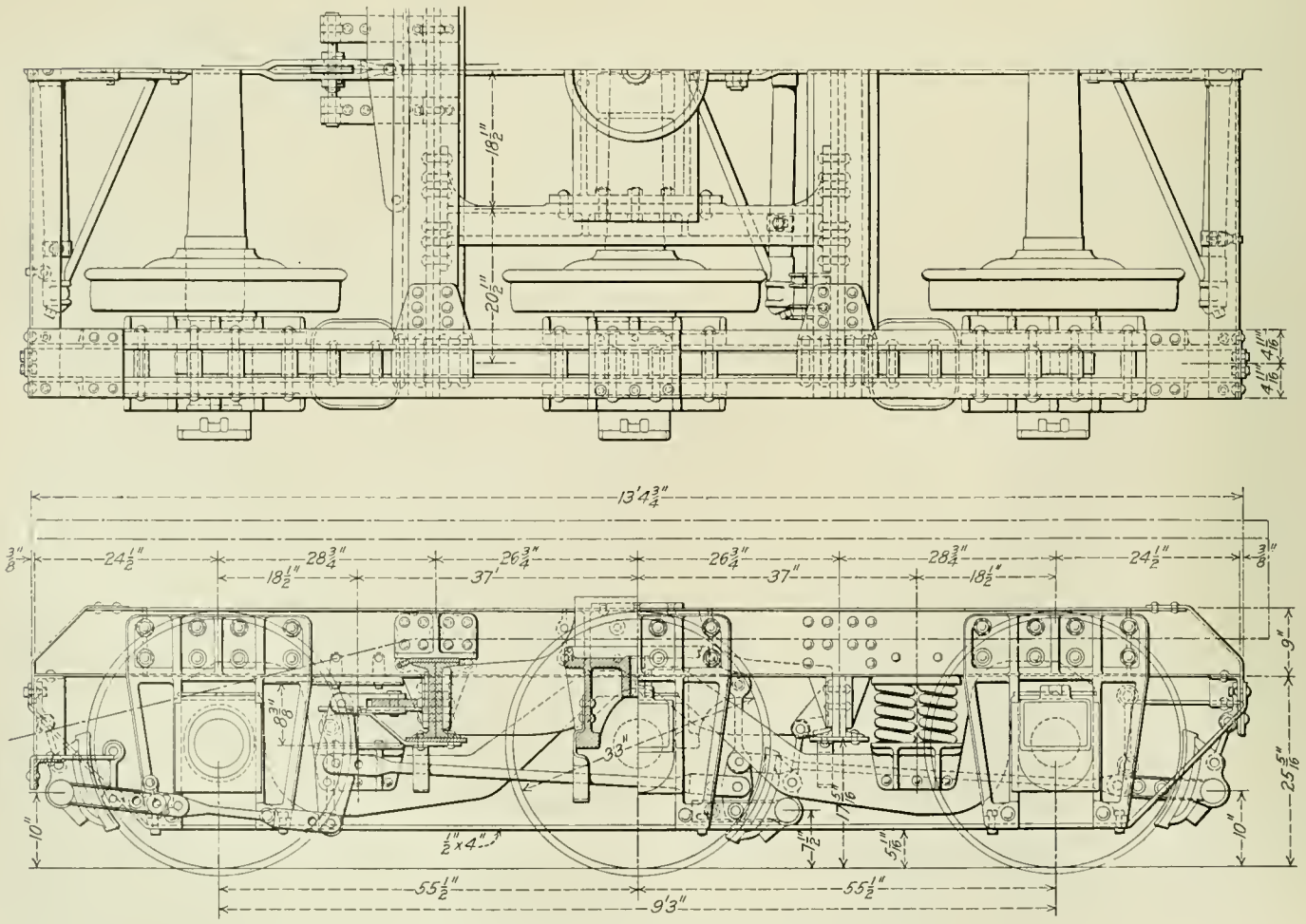
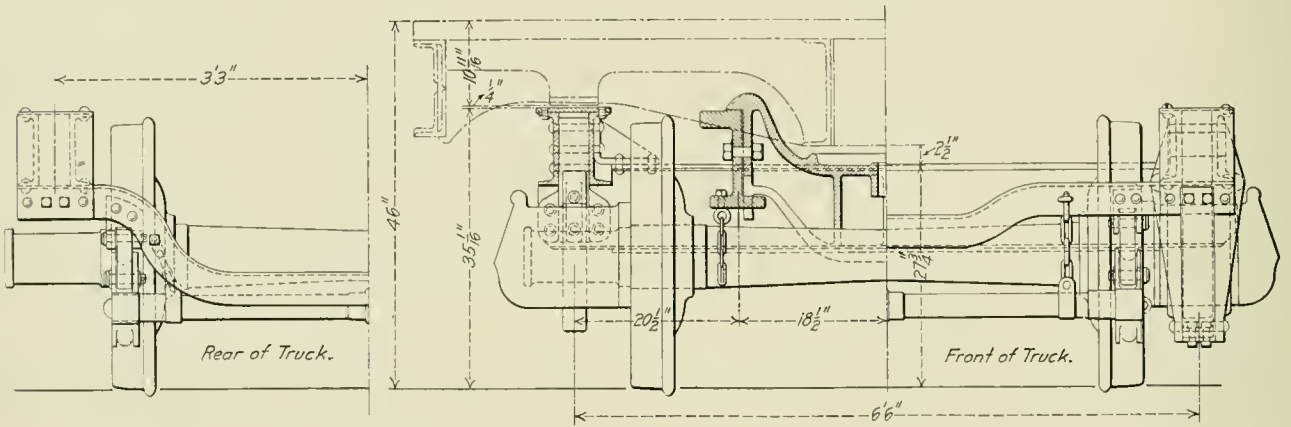

Six-Wheel Truck Used Under 200,000-Lb. Capacity Flat Car.

end sills the construction consists simply of a 12 in., 20½ lb., channel end secured to the ends of the longitudinal sills by angles. It is cut out at the center for the passage of the coupler shank, the customary buffing casting forming the re-inforcing around the opening. Diagonal braces are carried as usual from the corners to the center sills at the bolster. Large stake pockets are secured inside of the side sills, the floor being cut away to give admission to them. The 2½ in. flooring is secured to the underframe by a ½ in. plate set in at the top of the outside edges of the floor and bolted through to the flange of the side sill. It is also bolted with counter-sunk bolts to the 8 in. longitudinal I beams.

The 6-wheel trucks have side frames built up of two 9 in. channels placed back to back but spaced about 3¾ in. apart. The transoms are formed of two 10 in. channels placed back to back and secured to the side frames by heavy cast steel brackets. They have top and bottom cover plates, and the load on the truck center plate is carried to them through cast steel members of the shape and arrangement shown in the illustration. An interesting design of double pedestal is shown in detail in one of the drawings. It is made in two parts, the top of each part being arranged to fit over the flange of the truck side frame channel and to be riveted securely to the web of the channel. The bottoms are held together by two 1¾ in. bolts. The arrangement of the equalizers and springs is clearly shown in the illustration.

ACCURACY IN FINISHING DRIVING BOXES

BY JOHN V. LE COMPTE*

There is probably no operation in the general repairs of a locomotive that causes greater delay to the output of the erecting shop than the failure of the engine to tram after the shoes and wedges have all been planed and applied, the braces have been drawn up snugly in place and the pedestal wedges have been adjusted. It is true that sometimes, especially if old shoes and wedges are used and lined, that the failure to tram may be attributed to the inaccuracy of this work, but in many

instances it is directly due to the failure of the machine shop to properly handle the work.

After the driving boxes have been delivered to the machine shop and stripped of the old end-ply liner and crown brasses, if they are worn too thin for future use, the new brasses are applied and the boxes are delivered to the furnace, where the end-play liners are poured. That the end-play liner may be tight on the

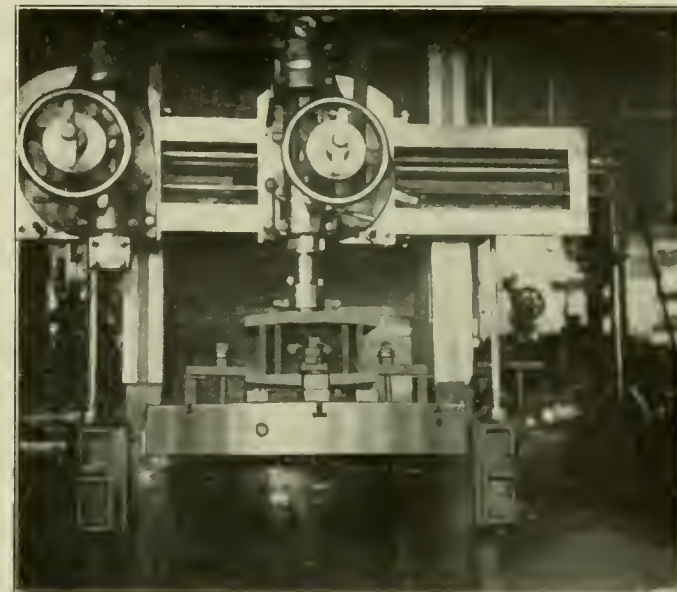

Driving Box Clamped Preparatory to Boring.

box and that the cost of drilling holes to prevent the liner from turning may be saved, the box should have the smaller dove-tail eccentric with the large one, the diameter of which should be at least as large as the diameter of the hub of the wheel on which the box is to be mounted. This operation may be done on the machine without a second handling when the old liners are removed.

The box should next be delivered to the boring mill for facing, if, because of the frames being removed for repairs or new frames being applied, it is impossible to allow for the end-play accurately and the output may be delayed because the boxes are not bored when accurate end-play data is secured, the boxes may be trued off to provide an accurate surface to work from. All boxes should be so faced that the flanges on both sides caliper accurately with the liner face.

A knee used by us for this operation to prevent the lost time necessarily required in setting the boxes is shown in the illustration. The boxes are next planed in the shoe and wedge spaces; this operation is necessary as all boxes after having the crown brass and the end-play liner applied are irregular and uneven and this space must be trued off to give the mechanic in the erecting shop an accurate surface from which to secure his sizes for laying off the faces of the shoes and wedges. The planing of the shoe and wedge fit of the boxes must be square with the end-play liner; therefore a knee should be applied to the planer, which is square with platen or bed, against which the driving box should be clamped with the liner next to knee. With this method of performing this operation absolute accuracy is obtained. In boring the crown brasses to fit the journals so that they may be square with the liner and true with the shoe and wedge space, the box must be placed on the boring mill with the hub liner toward the bed. The box should rest on parallel strips and be clamped securely. By following the above method the most accurate work is obtained and much time and money is saved in the erecting shop, as no shoes and wedges will have to be pulled because of the locomotive not traming, due to the boxes not being square and true.

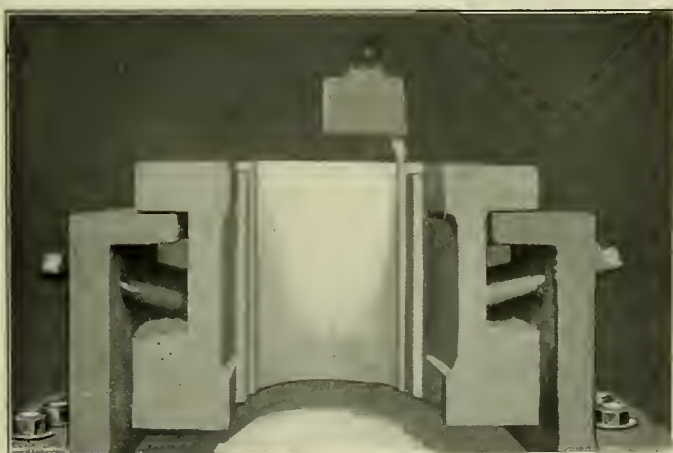

Driving Box Clamped on Boring Mill for Facing.

instances it is directly due to the failure of the machine shop to properly handle the work.

After the driving boxes have been delivered to the machine shop and stripped of the old end-ply liner and crown brasses, if they are worn too thin for future use, the new brasses are applied and the boxes are delivered to the furnace, where the end-play liners are poured. That the end-play liner may be tight on the

GERMAN LOCOMOTIVES EXPORTED.—There were 58,127 tons of locomotives exported from Germany last year. This is more than 45 per cent. greater than the number exported in either 1910 or 1909, but only 7½ per cent. more than in 1908. Of the whole weight, 13,711 tons went to France, 7,480 to Spain, 6,150 to Argentina, 5,314 to Roumania, and 2,295 to Turkey.

*Foreman, Mt. Clare Shops, Baltimore & Ohio.

MIKADO LOCOMOTIVES OF GREAT POWER

As a Part of a Comprehensive Plan to Reduce Operating Costs by the Use of the Latest Improvements in Locomotive Design, the Chesapeake & Ohio has Recently Ordered 25 Locomotives of the 2-8-2 Type.

To deliver a drawbar pull of over 27,000 lbs. at 33 miles per hour (2,390 drawbar horsepower), requires a locomotive built on a thoroughly balanced design. It must not only have a large boiler, but one of large capacity—terms which are not always synonymous—and must carry a well adjusted balance between boiler output and engine demand, and must also include capacity increasing devices capable of doing their full duty. That this result has been accomplished with the Mikado

was of the Mallet type for use in the mountains of West Virginia.* Twenty-five of these locomotives have been in service for well over a year, and 25 more have recently been ordered. Records of eight months' service show that they give a net saving of 5.7 cents per thousand ton-miles in the cost of handling traffic as compared with the cost when locomotives of the consolidation type were in use. The next class was the development of an entirely original type, termed Mountain (4-8-2) type for

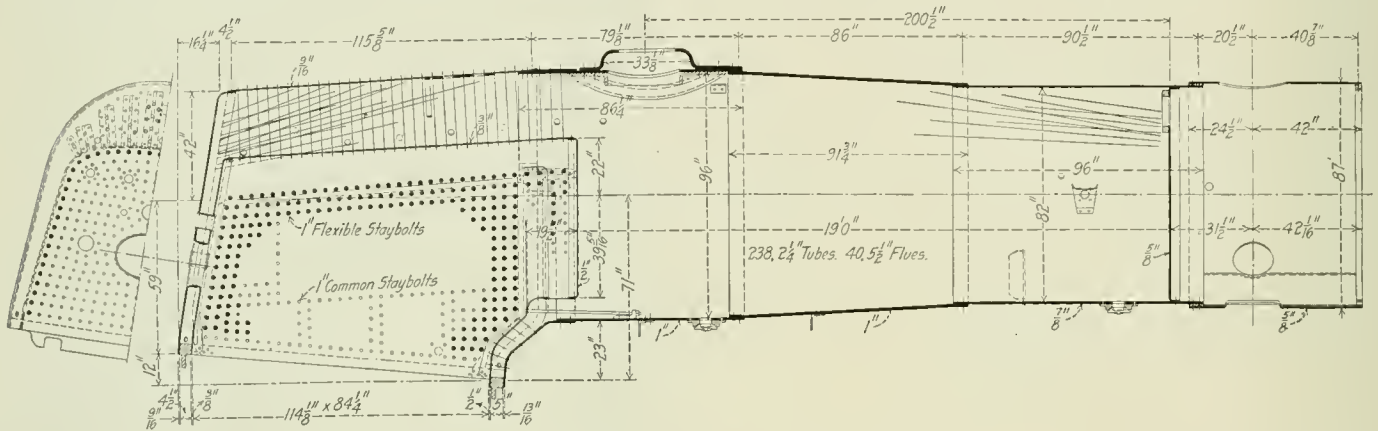

Boiler Which Has Delivered Nearly 2,400 Horse Power.

locomotive on the Chesapeake & Ohio lends particular interest to the design illustrated herewith from which there have been 24 locomotives ordered in addition to the original engine built by the American Locomotive Company, and designed by its engineers in co-operation with the officers of the railway. The sample engine was designed on the basis of hauling 4,000 tons on a .3 per cent. grade at a sustained speed of 15 miles per hour. What it is actually capable of doing is probably best illustrated

heavy passenger traffic on steep grades.† These locomotives since being put into service have been most satisfactory in every way, and easily accomplish the work that previously required two large Pacific type locomotives.

The present Mikados have been designed for use on the comparatively level sections of the road where they will haul trains at moderately high speed and of a tonnage greater even than can be handled by the Mallets in the mountains. It was prob-

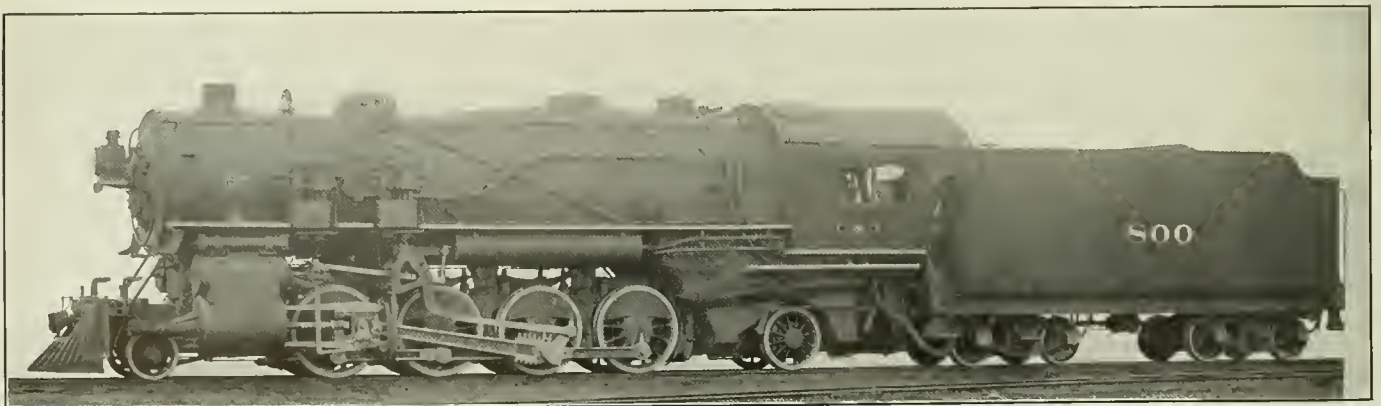

Powerful Mikado Locomotive for the Chesapeake & Ohio.

ably the service given by the Mountain type engine with 600 and 700-ton trains on heavy grades that controlled the design of the Mikado, as a careful comparison will show that outside of some boiler changes the Mikado is essentially the Mountain type, with a two-wheel truck substituted for the four wheel one. Such alterations as have been made resulted in an increase of about

by the graphical record of a test, shown in one of the illustrations, where trains of nearly 6,000 tons were handled at a speed of from 20 to 30 miles per hour over a road having the profile shown at the bottom of the illustration. This is the third new class of locomotive developed by the Chesapeake & Ohio during the past two years, forming part of the plans of the management to use the latest improvements in locomotive design to as large an extent as possible, in reducing net operating costs. The first locomotive built for this purpose

*For illustrated description see *American Engineer & Railroad Journal*, December, 1910, page 471.

†See *American Engineer & Railroad Journal*, October, 1911, page 381.

4,000 lbs. of weight on the drivers, bringing it to about 243,000 lbs., or an average of over 60,000 lbs. per driving axle. The total weight, however, was reduced from 330,000 lbs. to 315,000 lbs. While the cylinders are of the same size, 29 in. x 28 in., the use of 56-in. wheels in place of 63-in., and of 170 lbs. boiler pressure as compared with 180 lbs., has brought the theoretical tractive effort up from 58,000 to 60,800 lbs., making this the most powerful engine of its type as regards maximum tractive effort.

The changes in the boiler have been such as to reduce the

affecting the heating surface. There are also five less 2½-in. tubes in the Mikado than in the Mountain type boiler, although the diameter of the shell is the same.

The parts that are duplicated on the two classes include practically everything that requires frequent renewal or that needs to be kept in stock. This is impressively shown in the following list:

Trailer truck axles, details of ash-pan rigging, tender truck axles, boiler tubes, boiler flues, dome cap, dome casing, driving boxes, trailing truck boxes, driving box bearings, Elvin driving box cellars, trailing truck box,

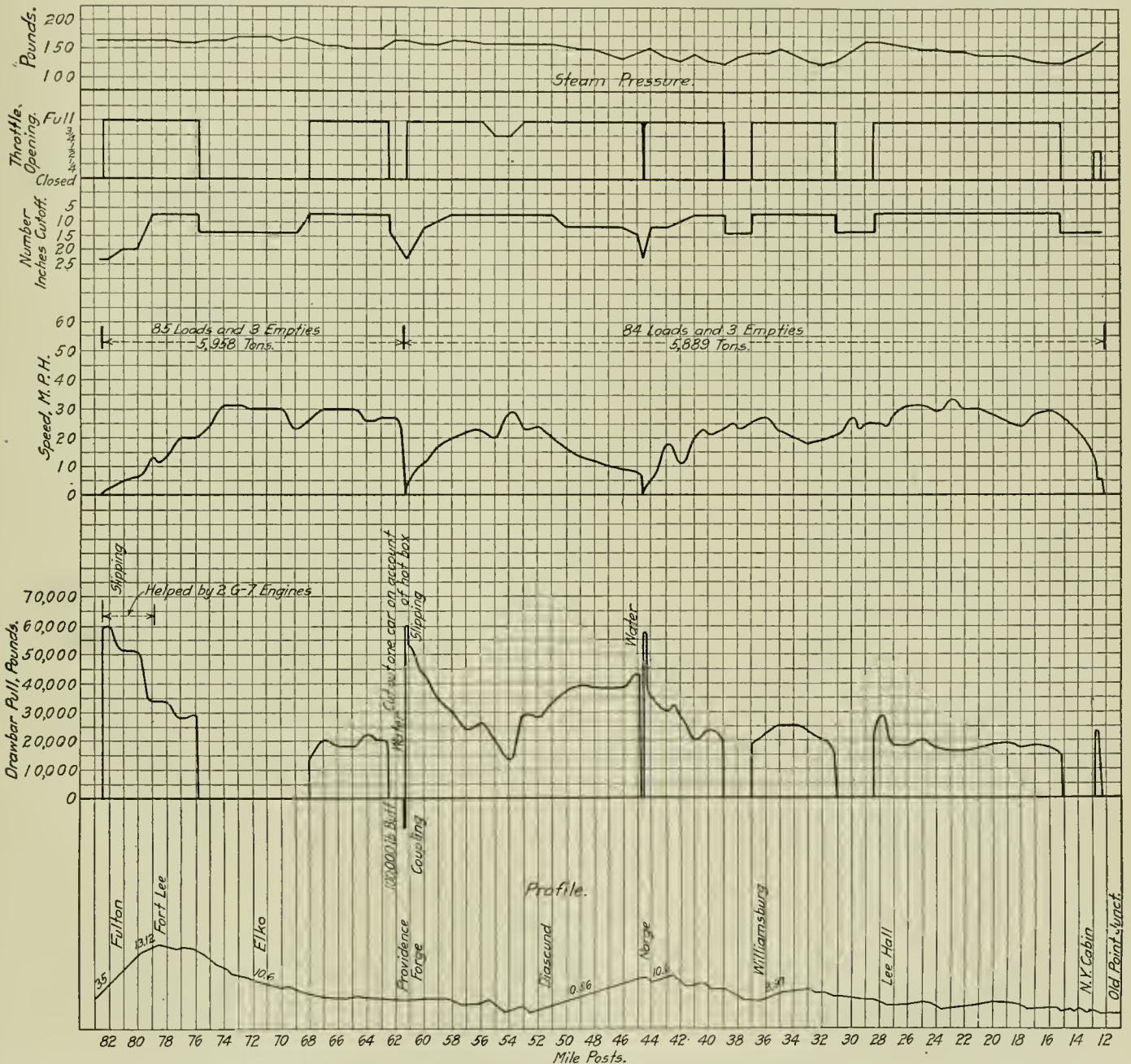

Graphical Record of a Recent Test of a Chesapeake & Ohio Mikado Locomotive.

length between the firebox and the center of the cylinders by about 35 in. This has been done with a reduction in the actual heating surface of only 81 sq. ft., since tubes of the same length are used in both boilers, and the reduction in heating surface is all confined to the combustion chamber, which in the Mikados is 19½ in. in length. The reduction in the distance from the center of the cylinders to the front tube sheet of from 51½ in. to 31½ in. accounts for the remainder, this, of course, not

trailing truck box bearings, trailing truck, cab, blow-off cocks, injector steam valves, cylinder cock operating valves, cylinder cock operating cylinders, crank pins (except front pin), cross head, cylinders, cylinder heads, cylinder by-pass valves, cylinder head relief valve, coupler (pilot), coupler pocket casting, coupler pocket pins, eccentric crank, exhaust pipe, fire door, frame pedestal caps, frame shoes and wedges, frame cross ties (between back and main drivers, between main and inter. drivers), foot plate, chafing plate, grates, grate details, grate shaker rigging, pilot, pistons, piston rod, piston rod packing, parts of screw reverse gear, side rods, main rod bearings, sand box, smoke box front and door, link motion (similar), steam

chest heads, throttle, dry pipe, valves and packing rings, valve rod and stem, valve rod guide, valve rod packing, driving springs, tender truck springs, tender and details, and tender trucks.

In view of the success of this locomotive in the service for which it is designed, it is interesting to consider the possibility of the Mountain type engine for fast freight work at speeds somewhat higher than is advisable with this engine. If we assume that the Mountain type locomotive will deliver the same horse power at the same piston speed, it will give a 27,000-lb. drawbar pull at 37 miles per hour in place of 33 miles for the Mikado. It would, of course, have a much smaller starting ability, due to the larger wheels. However, for certain classes of service it would seem to be particularly well adapted.

The Mikado, like the Mountain type, is equipped with the Street stoker, Schmidt superheater, and the Security brick arch. It has the screw reverse gear and a 6-hopper ash pan, which were fully illustrated and described in the article on the Mountain type locomotive.

Cylinders.

| | |
|----------------|--------|
| Kind | Simple |
| Diameter | 29 in. |
| Stroke | 28 in. |

Valves.

| | |
|-----------------|------------|
| Kind | Piston |
| Travel | .7 in. |
| Steam lap | 1 3/16 in. |
| Lead | 3/16 in. |

Wheels.

| | |
|--------------------------------------|--------------------|
| Driving, diameter over tire | 56 in. |
| Driving, thickness of tire | 3 in. |
| Driving journals, main, diam. | 1 1/2 in. x 14 in. |
| Driving journals, others, diam. | 1 1/4 in. x 14 in. |
| Engine truck, diameter | 30 in. |
| Engine truck, journals | 6 1/2 in. x 12 in. |
| Trailing truck, diameter | 42 in. |
| Trailing truck journals | 9 in. x 14 in. |

Boiler.

| | |
|--------------------------------------|--------------------|
| Style | Conical connection |
| Working pressure | 170 lbs. |
| Outside diameter of first ring | 83 3/4 in. |
| Firebox, width and length | 84 in. x 114 in. |
| Firebox plates, thickness | 3/8 in. |
| Firebox water space, front | 5 in. |

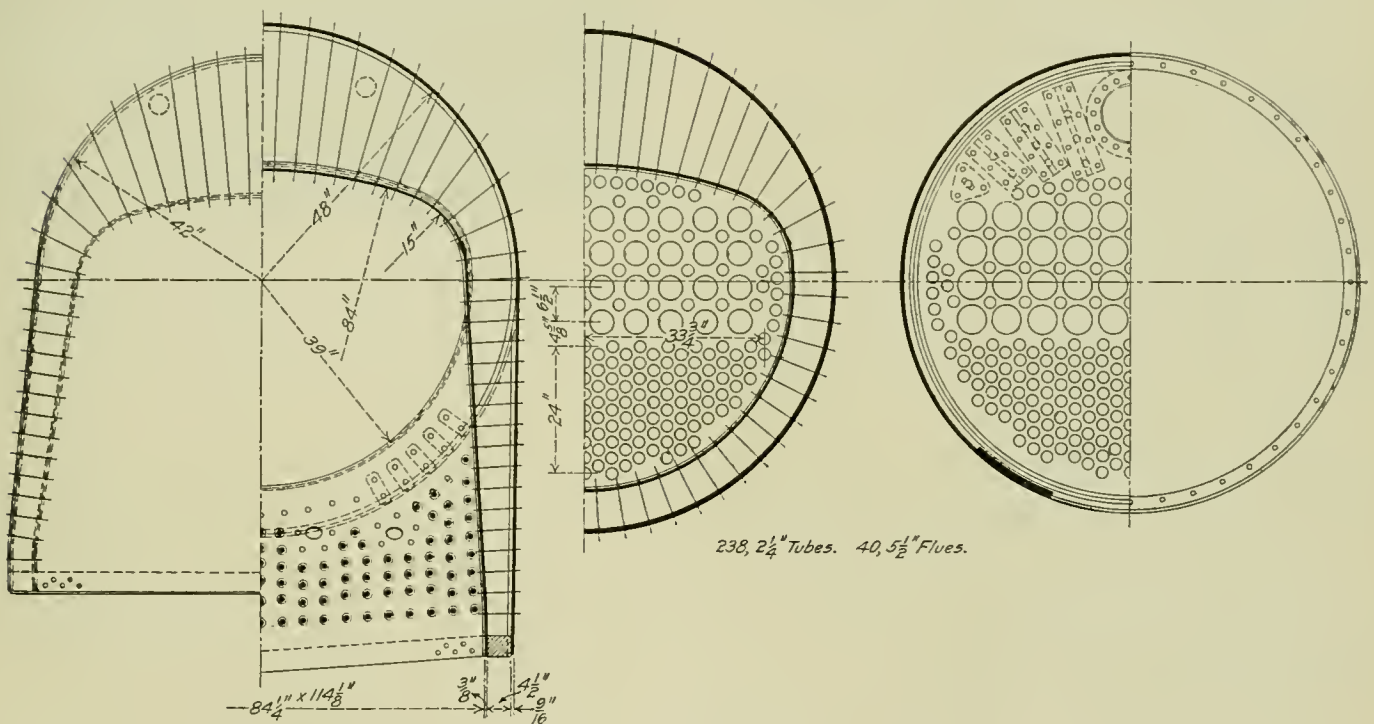

Sections of Boiler for Chesapeake & Ohio Mikado Locomotive.

The general dimensions, weight and ratios are given in the following table:

General Data.

| | |
|--|---------------|
| Type | 2-8-2 |
| Service | Freight |
| Fuel | Soft coal |
| Tractive effort | 60,800 lbs. |
| Weight in working order | 315,000 lbs. |
| Weight on drivers | 243,000 lbs. |
| Weight of engine and tender in working order | 484,700 lbs. |
| Wheel base, driving | 16 ft. 6 in. |
| Wheel base, rear driver to trailing truck | 109 in. |
| Wheel base, total | 34 ft. 10 in. |
| Wheel base, engine and tender | 67 ft. 11 in. |

Ratios.

| | |
|---|------|
| Total weight ÷ tractive effort | 5.18 |
| Weight on drivers ÷ tractive effort | 4.00 |
| Tractive effort × diam. drivers ÷ heating surface | 840. |
| Tractive effort × diam. drivers ÷ *equivalent heating surface | 640. |
| Total heating surface ÷ grate area | 60.8 |
| Total *equivalent heating surface ÷ grate area | 79.8 |
| Firebox heating surface ÷ total heating surface, per cent. | 7.00 |
| Firebox heating surface ÷ total *equivalent heating surface, per cent. | 5.31 |
| Weight on drivers ÷ total heating surface | 60. |
| Weight on drivers ÷ total *equivalent heating surface | 45.6 |
| Total weight ÷ total heating surface | 77.8 |
| Total weight ÷ total *equivalent heating surface | 59.2 |
| Volume both cylinders, cu. ft. | 21.4 |
| Total heating surface ÷ vol. cylinders | 188. |
| Total *equivalent heating surface ÷ vol. cylinders | 248. |
| Grate area ÷ vol. cylinders | 3.12 |

| | |
|---|-----------------|
| Firebox water space, sides and back | 4 1/2 in. |
| Tubes, number and diameter | 238—2 1/2 in. |
| Flues, number and diameter | 40—5 1/2 in. |
| Tubes, length | 19 ft. |
| Heating surface, tubes and flues | 3,740 sq. ft. |
| Heating surface, firebox | 283 sq. ft. |
| Heating surface, arch tubes | 28.2 sq. ft. |
| Heating surface, total | 4,051.2 sq. ft. |
| Heating surface, superheating | 845 sq. ft. |
| Heating surface, total equivalent* | 5,318.7 sq. ft. |
| Grate area | 66.7 sq. ft. |
| Center of boiler above rail | 9 ft. 10 in. |
| Top of smokestack above rail | 14 ft. 10 in. |

Tender.

| | |
|------------------------|--------------------|
| Tank, style | Water bottom |
| Frame | 13 in. channels |
| Wheels, diameter | 33 in. |
| Journals | 5 1/2 in. x 10 in. |
| Water capacity | 9,000 gals. |
| Coal capacity | 15 tons |

*Total equivalent heating surface equals total heating surface (4,051.2 sq. ft.) plus 1 1/2 times superheating surface.

ICE FOR REFRIGERATOR CARS.—During the year 1911 the Pacific Fruit Express Company used in refrigerator car service on the Southern Pacific 1,467,433 cakes of ice, each 39 in. long, 22 in. wide and 11 in. in thickness, the whole weighing 220,115 tons. This quantity would make 11,006 car loads of 20 tons each.

LOCOMOTIVE MACHINE SHOP KINKS

Awarded the First Prize in the Shop Kink Competition which Closed September 15, 1911

BY R. E. DETTE,

Machine Shop Foreman, Pennsylvania Railroad, South Pittsburgh, Pa.

EXTENSION CLAMPING BOLT.

The clamping bolt shown in Fig. 1 is for use on a drill press, or any other machine where the slots are cut through the table. The bolt shown here has 3 tees which answer the purpose of bolts 4 in., 7 $\frac{3}{4}$ in., or 10 $\frac{3}{4}$ in. in length. It reduces the number of bolts of different lengths to be kept at the drill press, and

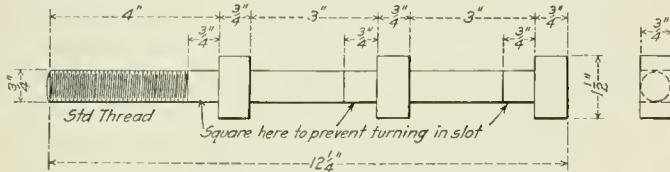

Fig. 1—Extension Clamping Bolt.

saves some time in changing them where much clamping is to be done.

BORING CROSSHEAD PIN BRASSES.

A clamp for holding the crosshead pin brasses while they are being bored out on a lathe is shown in Fig. 2. It consists of the four pieces *A, A* and *B, B*, which are bolted together as shown in the illustration. The brasses are held in this clamp by screwing up the nuts on the ends of *B*. They are placed on the centering plate *C*, which is held to the boxes by the set screw *F*. In this plate is a center hole which is used to center the

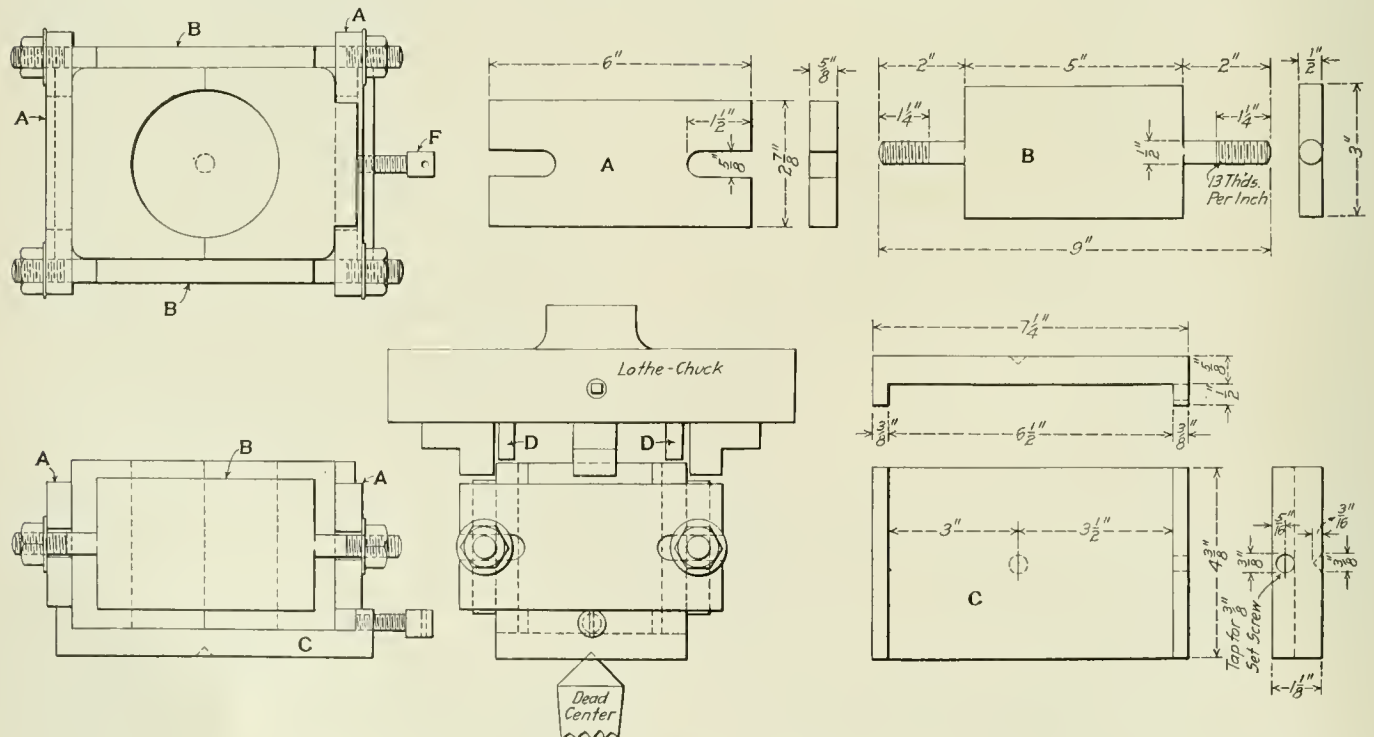

Fig. 2—Handy Chuck for Boring Crosshead Pin Brasses.

brasses in the lathe chuck. The dead center of the lathe is placed in the hole, and the tailstock of the lathe is run up until the box bears against the two parallel bars *D* on the face of the chuck. The jaws of the chuck are then tightened. The dead center is withdrawn and the centering piece is removed, leaving the box in the correct position to be bored. Much time is saved with this

device, because of the ease with which it may be centered on the chuck.

BORING SIDE RODS.

The device shown in Figs. 3 and 4 is used on a horizontal boring machine for setting and clamping the side rods for boring. This method does not require the assistance of a helper to hold

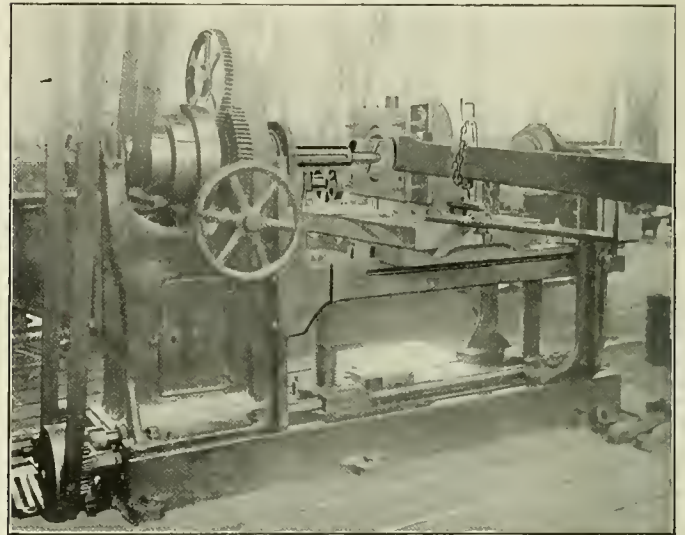

Fig. 3—Clamp for Boring Side Rods.

a straight edge while the operator is setting the work parallel to the face plate of the machine, neither is it necessary to use a square to set the work on the platen of the machine. The tongue on the base of the angle casting *C*, which fits the groove of the

platen, insures its proper location relative to the axis of the boring bar.

A $\frac{3}{4}$ -in. or $\frac{7}{8}$ -in. bolt slipped into the holes *E* of the angle casting affords a hold for the hook or the chain of a crane for lifting it on or off the machine. The slots *F* in the angle casting are provided for clamping it to the table when the bolt holes do

not come directly over the T-slots. The use of the parallel and clamping pieces *B*, held by means of the T-bolts, plainly shows how the side rod is clamped to the face plate. The L-shaped piece *D* is bolted to the table of the machine and supports the overhang of the rod.

The angle casting was made originally for boring driving boxes on the horizontal boring machine, and is still being used for that purpose. It is also used for many other jobs of boring or drilling. Nearly all shops have some type of angle casting

opening directly underneath *K* and opens the valve, allowing the air supply to pass to the cylinder. When pressure on *K* is released the valve will be closed by the coil spring, thus cutting off the air supply; the pressure in the cylinder will be released to the atmosphere through the opening around the valve stem. This valve may be made from a globe or Jenkins valve.

DRIVING DOG FOR WHEEL LATHE.

In a shop where it is necessary to turn the journals of driving

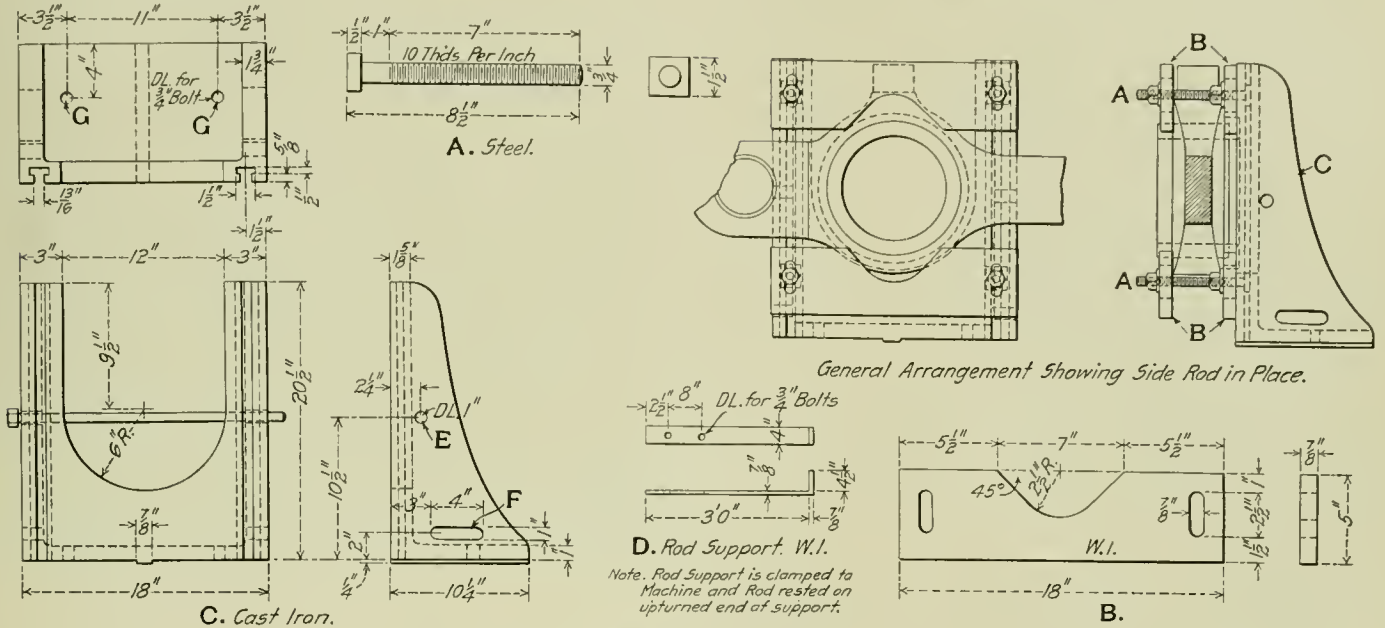

Fig. 4—Clamping Block for Boring Side Rods.

which could be converted into a clamp for this purpose, and its use would reduce the cost of the work about 33 1/3 per cent.

FOOT VALVE FOR AIR LINES.

The valve shown in Fig. 5 was designed to meet the requirement of a foot valve for operating machines and devices con-

wheels in the same machine used for turning the tires, and the machine is equipped with the Sure Grip driving dogs, a different arrangement is used when working on the journals. The device shown in Fig. 6 has been very effective for this work, and it is simple in construction. The wedge *C* is inserted in the dog and is held by the wedge *D*, the other end of *C* bearing directly on the spoke.

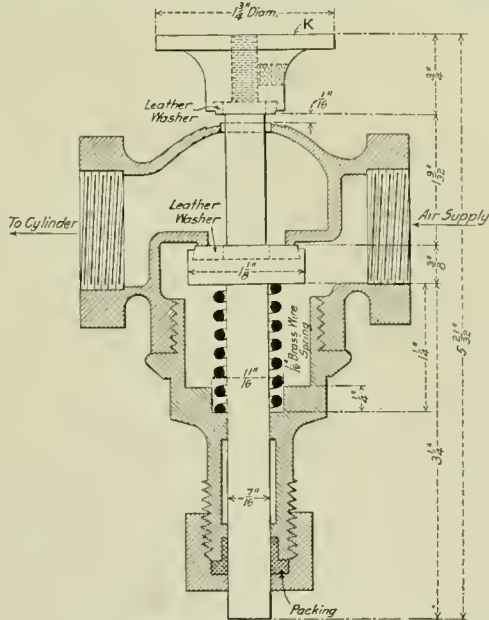

Fig. 5—Foot Valve for Pneumatic Machines.

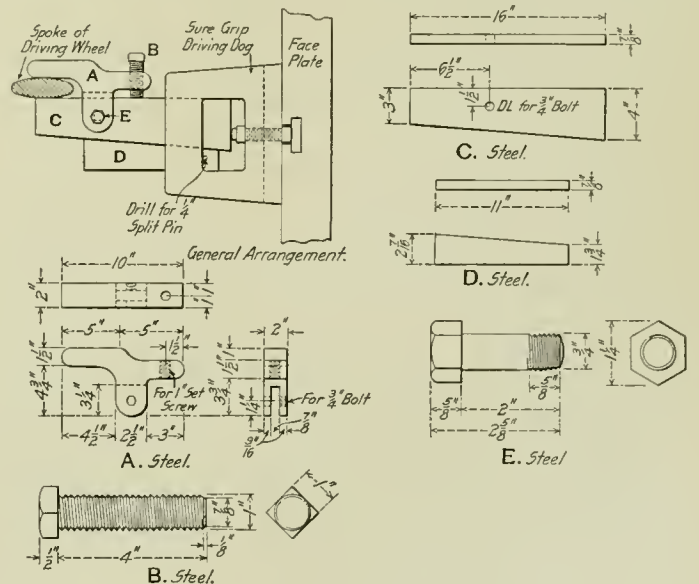

Fig. 6—Attachment for Sure Grip Driving Dog.

trolled by air pressure, such as hose stripping machines, hose clamping machines, hose clamp shearing machines, pneumatic vices, etc. The pressing down of knob *K* closes the exhaust

clamp *A* is used, being forced against the other side of the spoke by the screw *B*. A split pin is placed in the wedge *D*, as shown, to prevent its becoming loose.

driven singly or together, and are operated by lifting the lever *C*, which, with a slight lateral movement, will engage with the catch *D*.

This catch may be adjusted to suit the tension required between the friction disk and the spindle pulley *E* by raising or lowering the catch in the slot of the breast plate. The valve

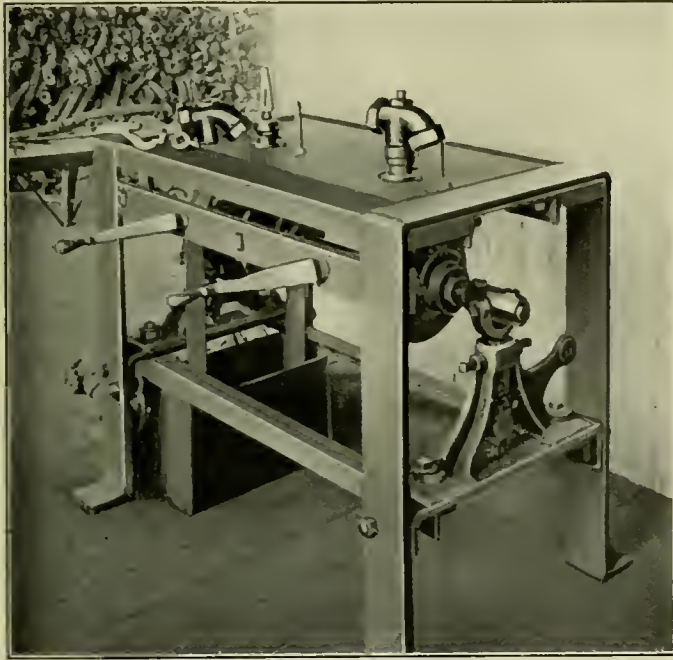

Fig. 8—Angle Cock Grinding Machine.

key or plug when screwed to the spindle stud *G* revolves with the vertical spindle. The body of the valve which rests on its key and is prevented from turning by the pin *H* is raised off its seat by the lifting collar *J* once every fifth revolution of the

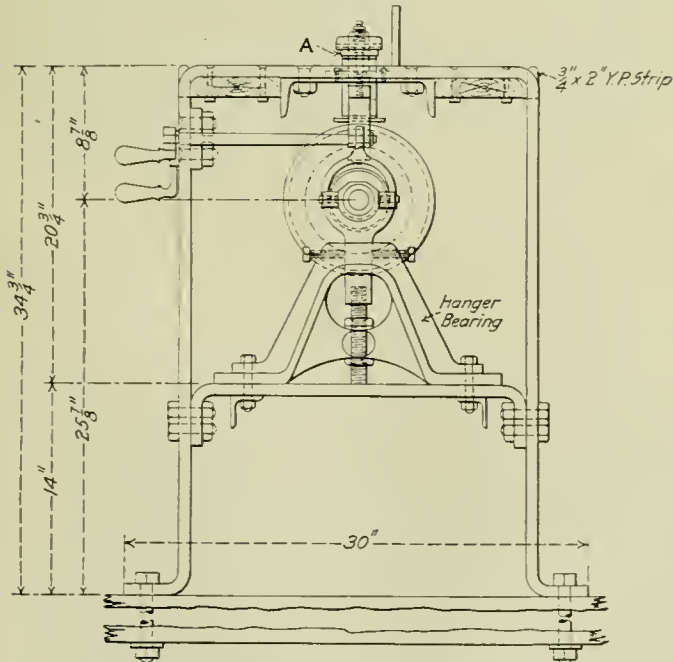

Fig. 9—Machine for Grinding Angle Cocks.

spindle. This lifting of the valve body is actuated by the cam roller *K*, which strikes the steel ball upon which rests the lifting pin. The lifting pin and lifting collar are fastened to each other with a taper pin. This pin passes through the slot of the vertical

spindle, thus allowing a lifting movement in the spindle during its rotation. A space of about 1/16 in. between the body of the valve and the lifting collar will allow the body of the valve to raise off its seat about 1/8 in.; this is to prevent the cutting of rings or grooves on the valve key or seat. The number of grinding spindles to a machine may be increased to suit the conditions and requirements of the shop. This machine was built entirely from forgings, except the pulley and bearings, which were found in the metal yard.

OPERATING LEVER FOR OVERHEAD STEAM VALVES.

The device shown in Fig. 10 is used for opening and closing the 1 1/4-in. plug valves located on the overhead steam blower line. In this case the valve is 18 ft. from the floor. The lever in engine houses has been in use for nearly 2 1/2 years, without requiring any repairs except the repacking of the valve stems. Its construction is very simple, consisting of the lever *A*, the knocker *B*

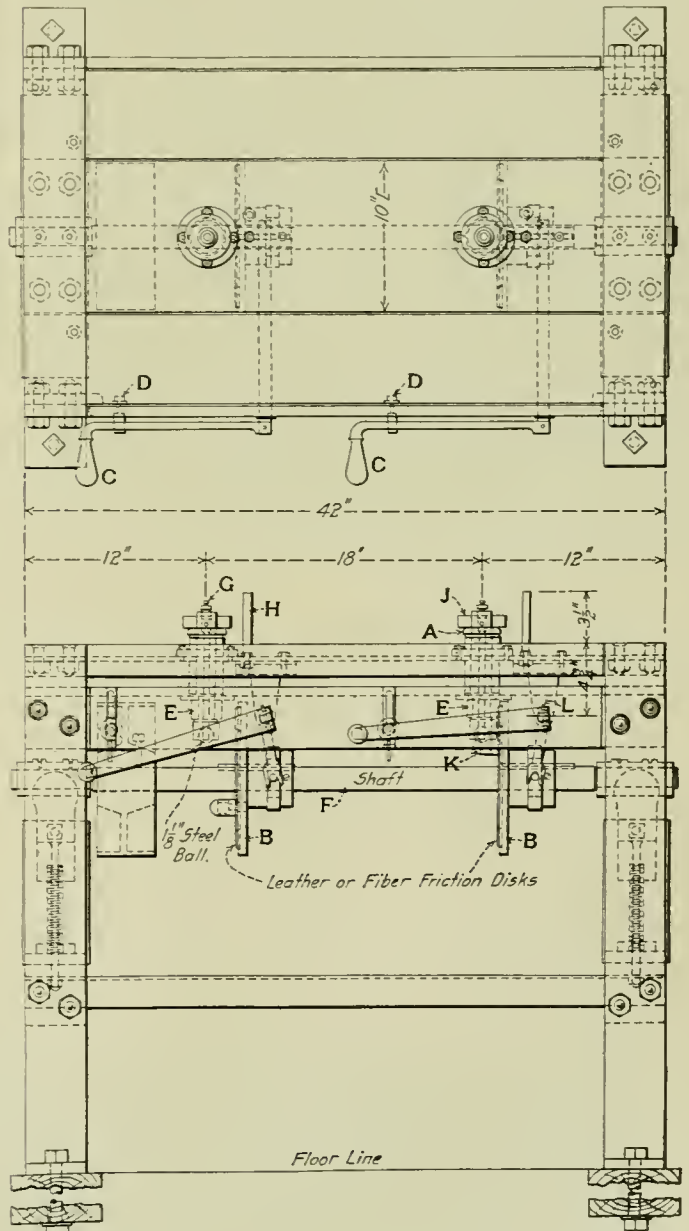

made of 1/2 in. x 1 in. iron, and a reach rod of 1/2-in. round iron, its length depending, of course, on the height of the steam line from the floor. To operate when in the closed or open position, push the reach rod up and over until the knocker *B* rests on opposite

end of the starting lever *A*; then by raising and lowering the knocker by means of the reach rod and just enough to produce a light blow on the starting lever, the movement of the valve

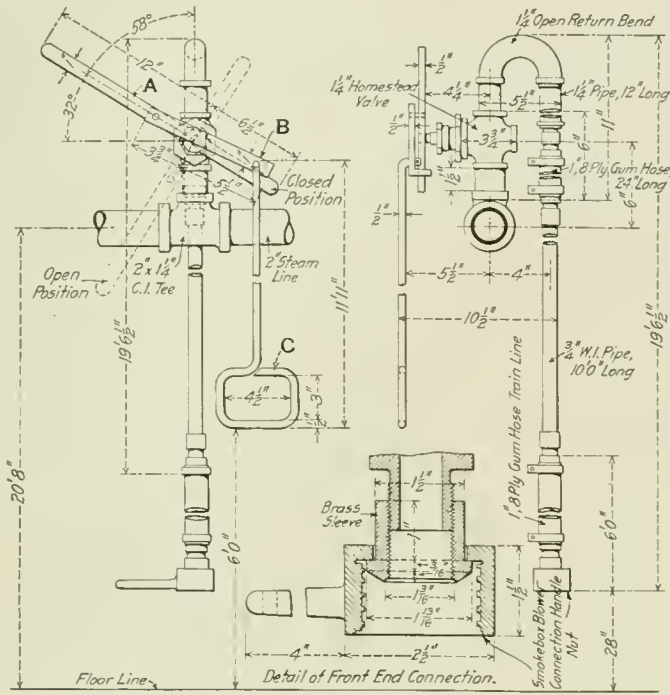

Fig. 10—Device for Operating Overhead Plug Valves.

is very easily accomplished without any excessive strain on the valve outfittings.

RECLAIMING CROSSHEAD SHOES.

Crosshead shoes that have become worn at *D* (Fig. 11), due to the lateral movement of the shoe on its center while in service are closed to the standard width by the use of the device shown

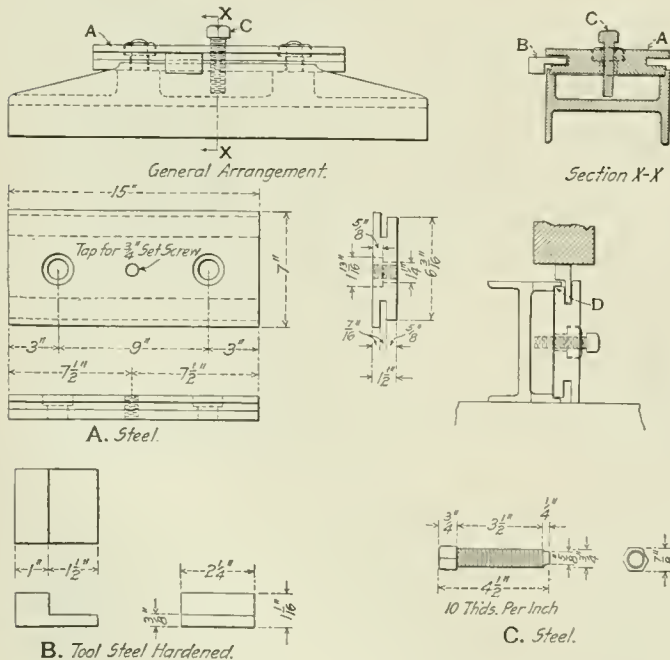

Fig. 11—Device for Reclaiming Crosshead Shoes.

in Fig. 11. A plate *A* is bolted to the back of the shoe by means of the shoe bolts. The shoe is then set on its side under a press. The L-shaped piece *B*, which is made an easy sliding fit in the groove of the plate *A*, is then forced down on the lip of the shoe, closing the entire length of the shoe lip at one operation.

The same operation is then performed on the other side of shoe. The plate *A* is taken off of the shoe after removing the nuts of shoe bolts, by screwing the set screw *C* against the back of shoe. Shoes of this type having as much as 3/32 in. lateral wear can be closed to the standard width at a lower cost and will give better results than by the application of liners.

LOCOMOTIVE PAINTING.*

BY N. J. WATTS,

Foreman Engine Painter, Nashville, Chattanooga & St. Louis, Nashville, Tenn.

Present conditions require that the old practice of painting locomotives must be abandoned and some quicker method adopted. The painter is supposed to have his work completed by the time the engine is assembled and no delay is tolerated.

We have, therefore, adopted a seven day system, as follows:

- First: Remove the old paint when necessary with some good paint remover, following it up with one coat of a good steel primer.
- Second: One coat of rough stuff.
- Third: Two coats of rough stuff.
- Fourth: Glaze all over with a good lead putty.
- Fifth: Rub with emery cloth and linseed oil; wipe dry and coat with drop black.
- Sixth: Letter, number and varnish.
- Seventh: Put on a coat of finishing varnish.

This system applies to tanks, steel cabs, steam domes and sand boxes, the rest of the engine being painted with a good engine black. The painting of locomotives is handled differently from that of passenger cars, for in the case of cars all the repairs are supposed to be made before the car goes into the paint shop. This gives the painter a clear field for his work. The engine painter has the machinists, boiler makers, pipe fitters and carpenters to contend with, but nevertheless he is supposed to have the engine painted on time. Because of all these interruptions he should have the support of the general foreman in making his work as easy as possible.

The foreman painter should have his force well organized, and should allot to each man that part of the work in which he is most efficient. He should be most careful in selecting his men, as one bad one often tends to spoil the entire organization. The best policy is to hire young men to do the cleaning and advance them as the opportunity presents. The young men become interested as soon as they have something better to look forward to. Give them each a chance as his turn comes, and if he does not make good take the next one. Often a good man may be found among those doing the rough work and by advancing him much better results may be obtained. Create harmony and good feeling among your men.

The following is a record of the work done during the month of January, 1911, with a force of 15 men. The painting work on the passenger engines was cleaned with an oil cleaner and all the necessary blacking was done.

| | |
|---|----|
| Passenger engines cleaned and paint touched up..... | 40 |
| Engines repaired in the engine house..... | 21 |
| Engines overhauled in the back shop..... | 19 |

This makes a total of 80 engines handled in one month, and does not include the running repairs, such as headlight glasses, cab glasses, etc. The report is given to show what one shop is doing, and if a better record is made elsewhere the writer would be glad to know how it is done.

IRON AND STEEL EXPORTS.—Figures compiled by the bureau of statistics, Department of Commerce and Labor, show that the United States follows England and Germany in the tonnage of iron and steel exports. The progress of the United States in that branch of commerce has been rapid, total exports of steel having increased from \$103,000,000 in 1901 to nearly \$250,000,000 in 1911. In the last ten years the United States has exported \$1,500,000,000 of iron and steel.

*Entered in the Railway Age Gazette competition on Paint Shop Practice which closed November 15, 1911.

LONG ISLAND ALL-STEEL PARLOR CARS

On a railway like the Long Island where there is a large amount of high-class passenger traffic on comparatively short hauls, especially during the summer months, attractive parlor

parlor cars, of which ten have been built by the American Car & Foundry Company. The structural part of these cars has been very fully described and illustrated in these columns.* They are 70 ft. 5¾ in. long over the body corner posts, and have been arranged for 26 chairs, a drawing room with a sofa and two movable chairs, a smoking room with five wicker chairs, or a total of 36 seats in addition to two toilets and the necessary lockers, etc.

Extreme simplicity has been the keynote of the design in the interior, and the flatness of the surfaces has been relieved



Extreme Simplicity Governs the Interior Finish.



General Interior View of Steel Parlor Car.

car equipment is an important part of the rolling stock. Recently in ordering new cars of this type the company used the framing of the standard Pennsylvania P-70 all-steel coach as the basis of what has proved to be very commodious and attractive

with small moldings only. Commodious racks of a square box design in keeping with the rest of the car have been provided in place of hooks. The only sign of ornamentation in the interior is found in the door posts and caps at either end and this, as may be seen in the illustration, is severely simple in its treatment. The interior is finished in a steel grey tone, being relieved with narrow gold stripping and a fine red line in the panels. The lower deck is of slightly darker shade than the side. Special care has been given in the interior to get smooth surfaces and nicely rounded corners at the junction of all of the

*See *American Engineer & Railroad Journal*, June, 1907, page 232.



Seventy-Foot Steel Parlor Car; Long Island.

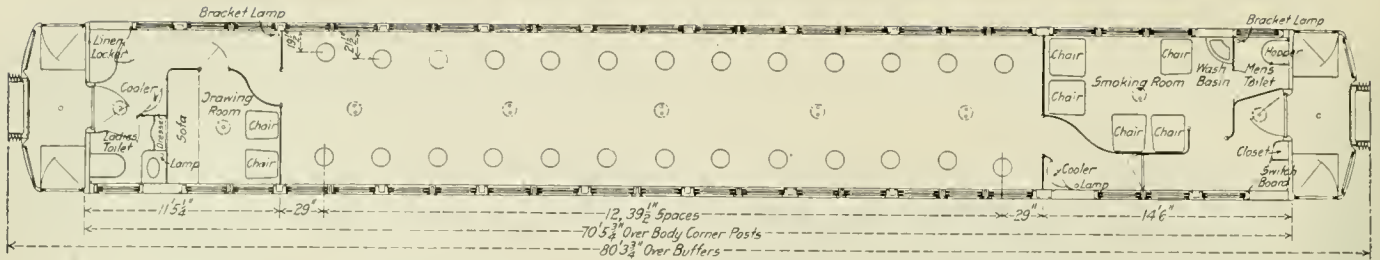

Floor Plan of 70-Ft. Steel Parlor Car; Long Island.

steel plates. The way in which this has been done is clearly shown in the detailed illustrations at the various junctions. The use of chairs with mahogany frames and rattan seats and backs with the green Wilton carpet and the light finish makes this car especially attractive for summer traffic.

Electric lighting is furnished by an axle lighting system, and several electric fans are provided. The cars are also equipped with steam heat, arrangement being made so that the system is divided into four parts, any combination of which can be put into use as required. Four-wheel trucks of the standard Pennsylv-

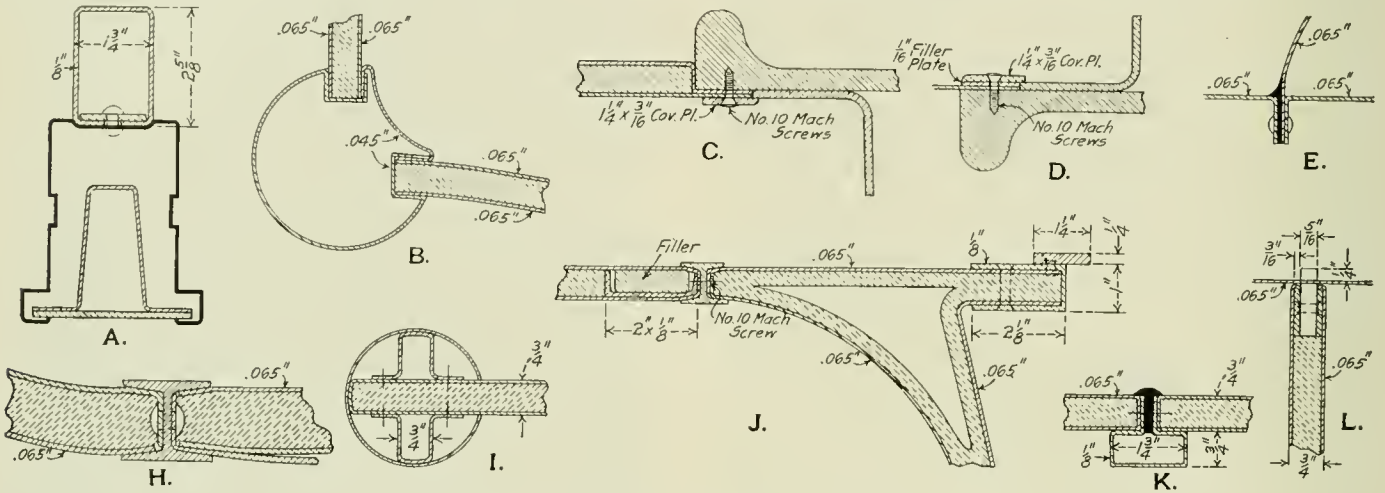

Details of Steel Interior Finish in Long Island Parlor Cars.

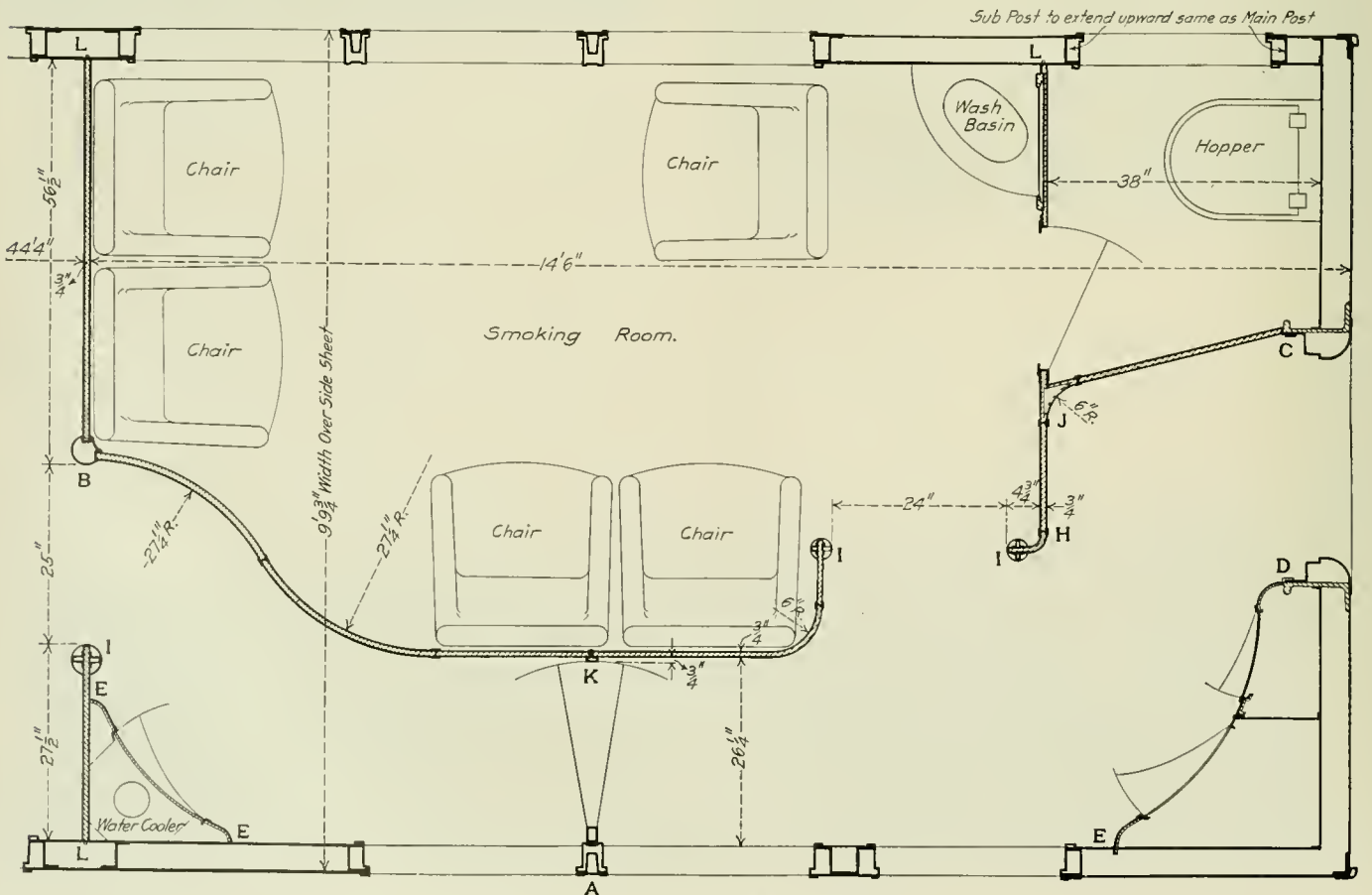

Plan of Smoking Room End of Steel Parlor Car.

vania type for this class of car, with the exception that they have an 8 ft. 6 in. wheel base and 5½ x 10 in. journals in place of a 7 ft. 1¼ in. wheel base, and 5 x 9 in. journals, have been used. The cars have a total weight of 124,000 lbs.

RECLAIMING CAR DEPARTMENT SCRAP*

BY C. L. A.

Scrap, as usually considered from a car department standpoint, is any and every class of material found on the right of way, taken from repaired cars and not used again on the car, or from wrecked or demolished cars. It is usually delivered, or should be, to a central reclamation and shipping or storage point for disposition.

Not all "scrap" is really scrap. In this heterogeneous mass is much that is fit for further use on the road without alteration or change of any kind; it is good second-hand material and ready for use again without further cost save distribution to the shops or repair tracks. All materials of this class should be reclaimed. It includes couplers, followers, springs, brake beams, journal bearings, wheels, axles and other articles too numerous to mention. There are also bent parts, such as brake beams, coupler bodies, connections, plates, followers, pockets, bolts, center pins, etc., that it is profitable to straighten and use again. Straight rods can be cut to shorter lengths, and be made into bolts, brake beam hangers, etc.

Old nuts and bolts can be recut when not too badly rusted; flat iron can be cut to short lengths for plates and for other uses. Brake beams with heads, fulcrums, compression rods, etc., broken can be fitted up again with profit. Journal bearings can be rebabbitted and used again; bolts can be cut to shorter lengths and threaded, and a discriminating man can reclaim certain material standard to foreign cars that he knows will in all likelihood be required for repairs. The man who knows just about what will be needed in a reasonable time is your true "efficiency engineer," and has got them all "skinned a mile" to use the prevailing parlance among railway men.

The reclaiming of scrap, however, can be carried too far. When any single item or part costs more to reclaim than new material delivered, then it is not only unprofitable but foolish. It is a wise man that reclaims material at a cost between scrap value and new material cost, and the margin demands the closest attention and foresight. For instance take a bent rod to be converted into bolts; it is carried to the fire where coal and labor are used to straighten it and is left to cool. It is handled again to cut to length for the header, is heated again, requiring more fuel and labor and is left to cool, after which it is threaded by bolt cutter. If it has cost more than bolts can be bought for in open market then the transaction is unprofitable.

This rule holds good on any operation involved in reclaiming scrap. It should be the policy of the supervisor to "count the cost," add this to market price of the particular class of scrap and compare it with market price of the article in question, whether it be bolts, nuts, commercial iron or what not.

This does not necessarily involve the services of a so-called efficiency engineer. It does require a bright, thorough, experienced foreman who is familiar with the needs and requirements of the company by whom he is employed. All "scrap" is not scrap, nor is all reclaimed material necessarily an asset, although it should be.

PENNSYLVANIA STEEL CARS.—There are now in service on the Pennsylvania Lines East 588 steel coaches, 58 steel dining cars, 99 steel passenger and baggage cars, 78 steel baggage cars, 94 steel postal cars and 710 steel Pullman cars. In addition, there are being built 251 steel coaches, 31 steel passenger and baggage cars and 194 steel Pullman cars.

REFRIGERATOR CAR DOOR FIXTURES

The railways pay claims to a considerable amount for damage caused by not having refrigerator car doors tightly closed and the expense of repairs to the car itself due to missue in opening doors which are stuck, make it desirable to have some device whereby these operations can be satisfactorily performed. To

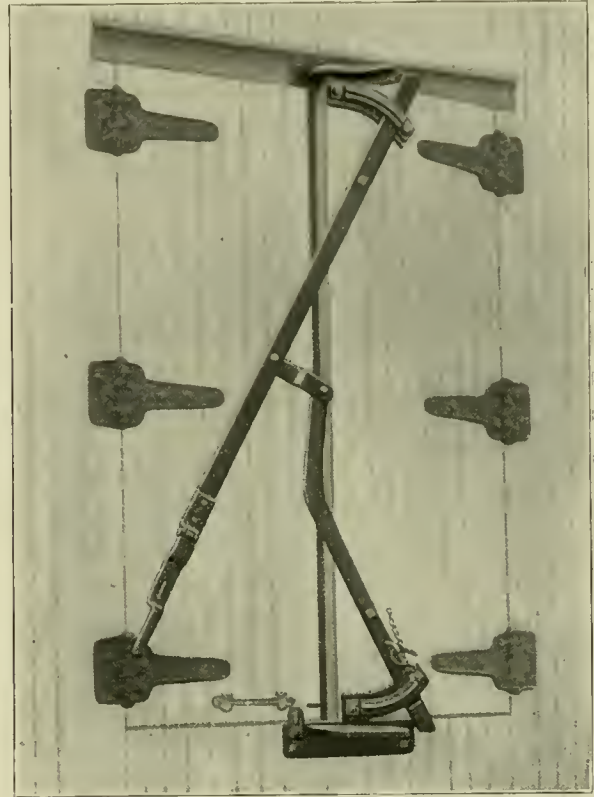

Levers of Door Opening and Closing Device in Open Position.

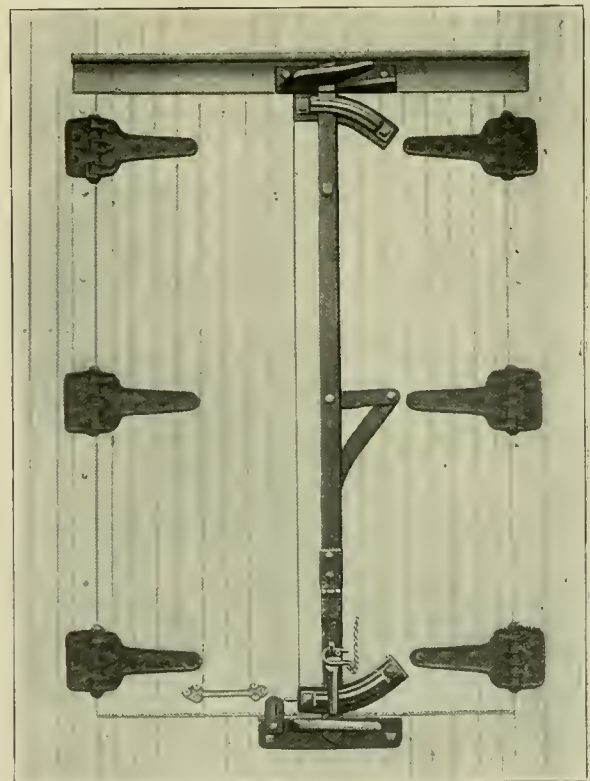

Refrigerator Car Door Closed and Ready for Sealing.

*Entered in the competition, which closed February 15, 1912.

fulfill this need the Garland refrigerator car door closing and opening device has been designed and has proved most satisfactory.

The appliance consists of two operating levers, one pivoted near the top and the other pivoted near the bottom of the door and connected by a link at the center. Each of the levers extends about 3 in. beyond the door, the extension being formed into a wedge. Bolted to the framing above the door and to the sill below it are keeper castings with beveled lugs for receiving the lever wedges. A locking handle is hinged to the upper lever and closes over a staple on the lower lever, permitting it to be sealed in the usual way. Guides hold the levers in place at the ends. The arrangement is such that when the doors are closed the levers will engage the keeper castings when the right hand door is still open 3 or 4 in.; then when the handle is pulled to the right, the incline in the keeper casting will force the door tightly closed.

In opening, the inclined faces of the keeper castings force the door outward when the operating handle is pulled to the left. The keeper castings are extended inward under the threshold plate and across the door frame and each terminates in a lug that prevents the left door from being forced inward. Pivoted to the base of the lower keeper casting is a holder to prevent the left door bulging out when the right door is being opened. This device is made and sold by Burton W. Mudge & Co., of Chicago, Ill.

A SIMPLE CARD INDEX

BY R. S. MOUNCE.

The system of card indexing outlined below is one that has been used by the writer for several years and has proved to be entirely satisfactory. By its use all literature of every sort that one may accumulate, bearing on some branch or branches of engineering, may be easily indexed without the omission of any details, provided the articles are suitably cross-indexed. Its advantage lies in its simplicity and in its elasticity. The following

| <i>Piston Valves</i> | |
|----------------------|--|
| A-25 | <i>Piston valves vs slide valves</i> |
| E-27 | <i>Leakage tests</i> |
| AEp 117, 1909 | <i>"American" semi-plug type</i> |
| M-2 | <i>Report on Very complete.</i> |
| AEpp 467-70, " | <i>For 4 cylinder simple locomotive. C.R.I. and P.</i> |
| " 205, 1910 | <i>Simple design for balanced compound.</i> |

— BROWN CARD —

Arrangement of Index Card for References to Periodicals, Pamphlets and Clippings.

description refers to railway mechanical literature, but it would apply equally well to other subjects. Two different colors of index cards are used, a white and a light yellowish brown. The white cards are used for indexing text books, proceedings of engineering societies and other similar books, and have the titles printed on them in block type, whereas the brown cards have the titles printed in small type and refer to periodicals, pamphlets and clippings.

As far as is consistent each reference is limited to one line. Periodicals, pamphlets, proceedings and the like are indicated by suitable characters. For example: a reference to the *American Engineer* would show the page and year, as follows, "AE pp. 71-4, 1911;" and the same would hold in the case of

the Master Mechanics Proceedings, as MM pp. 95-105, 1905. Pamphlets are lettered and numbered, Pf 1, Pf 2, etc., and are so shown on the index cards. Clippings are filed in envelopes (4 in. x 9½ in.), each bearing a letter. Each clipping is numbered and has the letter corresponding to the envelope containing it. For example, the fourth clipping in envelope D would be marked "D-4," and would be so shown on the index card under its proper title. When 26 envelopes have been filled, another set may be started by placing a numeral before the letter, as for

| <i>ROUNDHOUSES.</i> | |
|---------------------|--|
| MMpp 272-310, 1901 | <i>An up-to-date roundhouse. Report</i> |
| " 119-62, 1902 | <i>Complete report on</i> |
| " 325-33, 1904 | <i>Operation and organization of Independent paper.</i> |
| " 155-64, 1905 | <i>Terminal facilities, heating and ventilating. Report.</i> |

— WHITE CARD —

Arrangement of Card Used for Indexing Text Books and Proceedings of Engineering Societies.

instance, 2A to 2Z, 3A to 3Z, etc. As this may be done indefinitely, it places no limit upon the number of clippings which may be cared for by this system. The sample cards, shown herewith, indicate clearly the application of the foregoing explanation.

If it is desired to locate a certain article, which is known to be in a periodical, one has only to choose a title to fit the article (and if the cross-indexing has been carefully done the reference is easily found), to look for that title on a brown card, and then to look over the card until the desired subject is found. After a few years the number of references on some subjects will be so large that the advantage of using two sets of cards, which will separate the periodicals from the books, will be very evident.

The great value of this card index system, if properly carried out, lies in the fact that all of one's engineering literature is placed within easy reach. Nor does this system take any account of time, for it covers everything which may be accumulated in the

| <i>Organization.</i> | |
|----------------------|---|
| AEpp 453-70, 1908 | <i>Complete description of. L.S. and M.S. Ry.</i> |
| " 234-7, 1909 | <i>Efficient Foremen.</i> |
| Pf 3 | <i>Operating of U.P. and S.P. systems, by J. Kruttschnitt, before N.Y. Railroad Club.</i> |
| AEp 94, 1910 | <i>At locomotive terminals.</i> |
| " pp 106-9, " | <i>The unit system of.</i> |
| " 161-70, " | <i>Of the Santa Fe fuel department.</i> |
| " 264-5, " | <i>A consistent locomotive terminal organization.</i> |
| " 361-3, " | <i>Of East Altoona terminal.</i> |

— BROWN CARD —

Sample Index Card from Periodical, Pamphlet and Clipping File.

period during which it is kept. Indices in each year's periodicals, or in the backs of books are valuable, where there are but a few of them; but in order to keep track of a large quantity of books and magazines, a simple and efficient card index system becomes imperative and will pay many times over for the trouble of keeping it up, if not carried too far.

PACIFIC TYPE LOCOMOTIVES

Nashville, Chattanooga & St. Louis.

Three locomotives of the 4-6-2 type, designed to handle passenger trains between Nashville, Tenn., and Chattanooga, have recently been delivered to the Nashville, Chattanooga & St. Louis by the Baldwin Locomotive Works. These locomotives

An inspection of the illustration and the table of dimensions shows these locomotives to be about the same general size as locomotives built for a number of railways in the past 5 or 6 years. The heating surface when compared with the weight and tractive effort is somewhat larger than is customary and has been obtained by the use of 440 2 in. tubes, 20 ft. 6 in. in length, which are so arranged as to give $\frac{7}{8}$ in. bridges. Assuming that the maximum indicated horsepower of the locomotive will be obtained at 1,000 ft. piston speed, or 46 miles per hour, and further assuming that the water rate or steam consumption per indicated horsepower hour is 27 pounds, we find that the boiler will be called upon to evaporate 9.51 lbs. of water per sq. ft. of heating surface per hour which, with even a moderately good grade of fuel, it should be able to do with ease; in fact, it

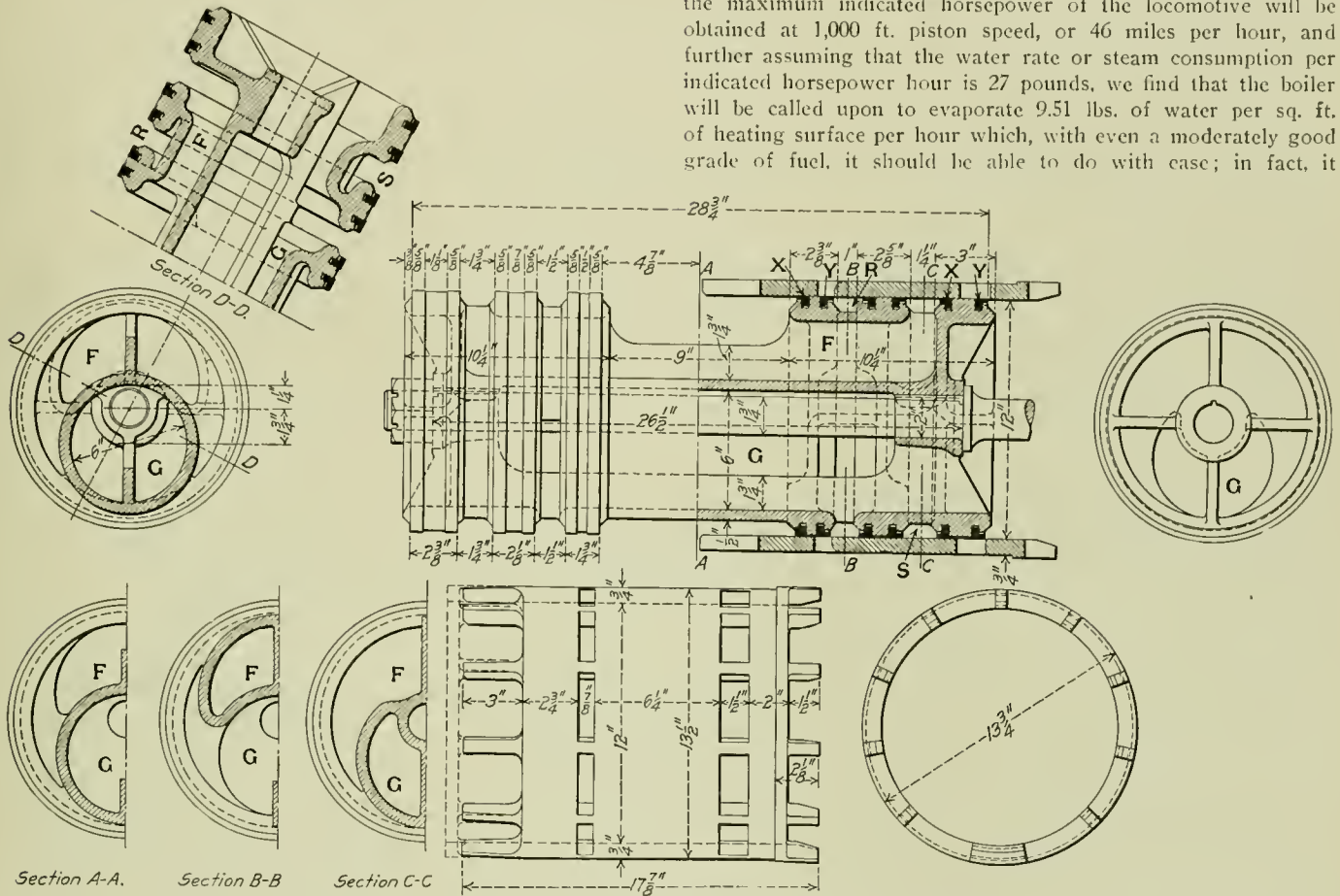

Double Ported Piston Valve and Bushing for a Simple Engine.

are intended to cover the distance of 151 miles in four hours and 17 minutes, including six stops, with a 12-car train. The hilly nature of the country makes this a very severe schedule requiring a locomotive of considerable reserve power.

should be able to do considerably better than this and the indications are that the locomotives have ample steam making capacity.

While in general the locomotives follow the usual practice and

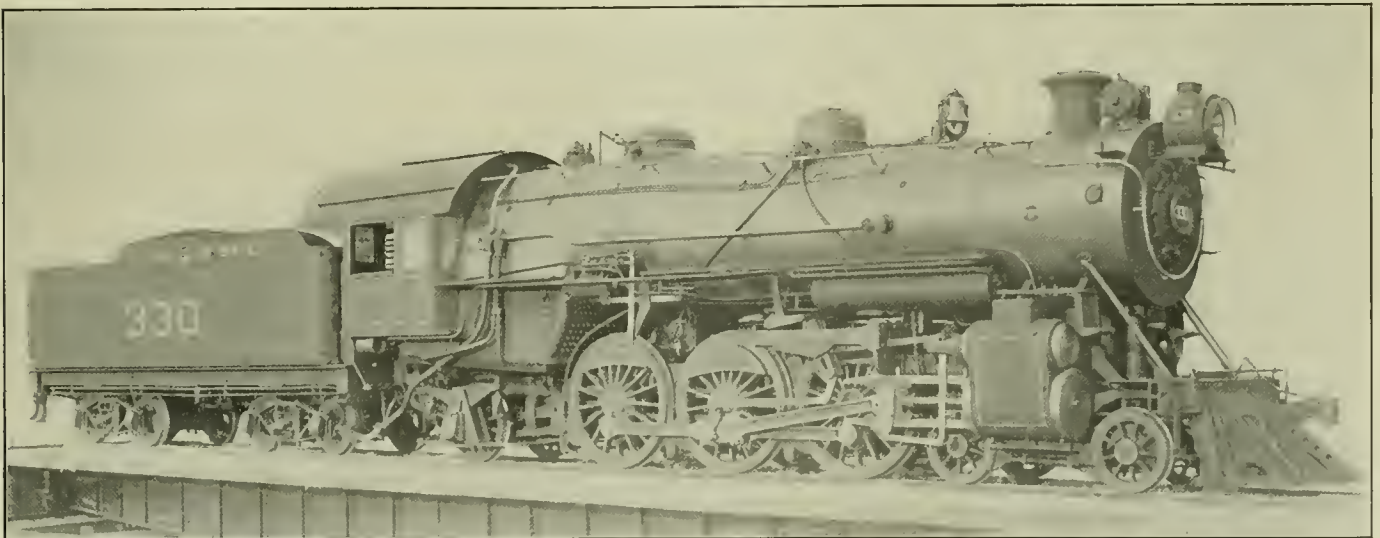

Powerful Pacific Type Locomotive for the Nashville, Chattanooga & St. Louis.

600-TON CAR WHEEL PRESS

In the accompanying illustration is shown an unusually heavy press for car wheel work recently built by the Niles-Bement-Pond Co. The general design of the press is similar to that of the Niles standard machines regularly made for car wheel work up to 400 tons capacity. The 600-ton press, however, has four tie bars, two at the top and two at the bottom, instead of two as in the standard machines. It is built with a steel cylinder and steel resistance head, the latter being inclined from the vertical so as to facilitate placing and removing wheels by means of an

GYRUS SPARK ARRESTER FOR LIGNITE

In the western sections of Nebraska, Wyoming and Colorado the cost of a good grade of coal is very high, amounting in certain sections on the Chicago & North Western to \$5.20 per ton for Iowa coal. There are large deposits of lignite in this region, however, which may be obtained at a comparatively reasonable cost, and all of the roads in that vicinity are anxious to use this fuel if possible. One of the greatest difficulties in burning lignite is the throwing of large quantities of fire from the stack. The live sparks being very light in weight are often carried some

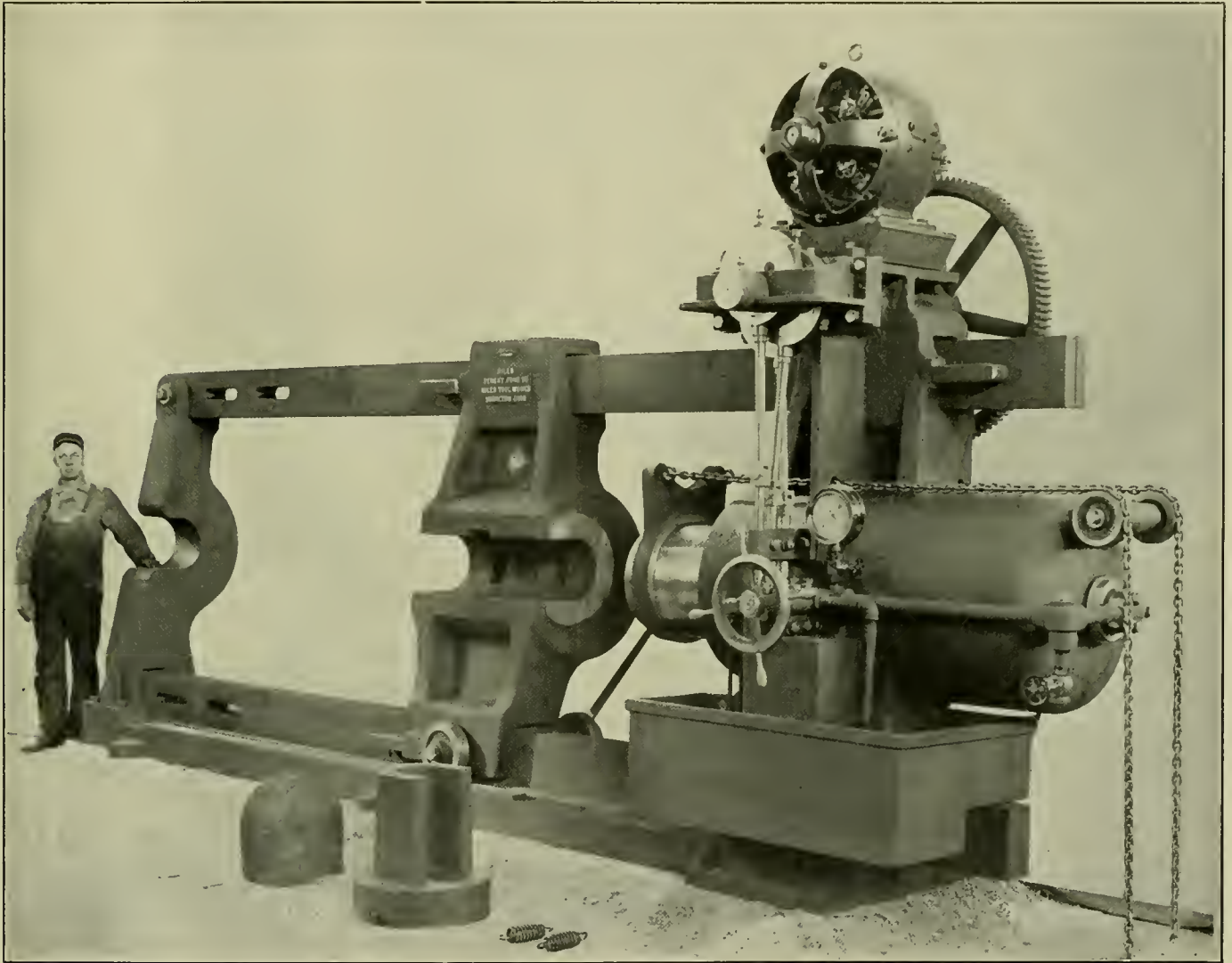

Forty-Eight Inch 600-Ton Niles Wheel Press.

overhead crane. The press is equipped with a three-plunger pump, the construction being such that any one or all of the plungers may be thrown into or out of action independently. On the back of the cylinder is a safety valve which can be set to open when the pressure reaches the capacity of the machine. The pressure gage furnished is graduated in total tons pressure on the ram as well as in pounds pressure per sq. in. The ram is counter-weighted for quick return and provision can be made for connecting the cylinder direct to the shop water mains for the rapid advance of the ram. The machine is driven by a 15 h. p. constant speed motor mounted on top of the cylinder casting and geared direct to the pump shaft. It is designed for handling standard car wheels up to 42 in. in diameter on the tread and of standard gage.

distance and form a sufficiently great fire risk to largely prevent the use of this fuel on locomotives.

On the lines of the Chicago & North Western passing through this territory there are now 21 Pacific type locomotives equipped with a special design of spark arrester that is successfully burning lignite with the minimum of fire risk. This spark arrester has been developed by the American Locomotive Company in co-operation with the railway, and is the result of a long series of very careful experiments. The locomotives have 20 in. x 26 in. cylinders, a grate area of 46.45 sq. ft., 63-in. drivers, and a total heating surface of 2119.7 sq. ft.

The arrangement of the apparatus in the front end, which has been designed with the idea of holding the sparks in the smoke-box as long as possible, and continually baffling them until they

are ground fine and completely extinguished, in the illustration is shown. The path of the live sparks, after passing out from under the diaphragm plate, is upward along the door and its ring, then back toward the flue sheet across the top past the stack extension and then downward and forward into the exhaust. Some of them of course drop down across the top of the diaphragm plate and again pass into the current. Surrounding the exhaust nozzle is a series of vanes arranged in the shape of a truncated cone with the small end downward and connecting to an extension of the stack at the top. These vanes are so shaped and arranged as to compel the incoming gases and sparks to take a circular path. The sparks after reaching the inside of the gyrus are of course thrown outward by centrifugal force and are beaten against the inside edges of the vanes until they are reduced to powder and completely extinguished, in which shape they will be caught in the exhaust and thrown out of the stack. About one-quarter of the lower end of the gyrus is cut off by a horizontal web and the sparks entering this section are drawn inward to the center of the annular exhaust and are discharged through the center of the stream, the action, however, being the same as with those entering above.

The annulus of the exhaust nozzle, the tip of which is slightly above the center line of the front end is 8 in. outside diameter and 7 in. inside diameter, giving about the same net area of discharge as a nozzle 5½ in. in diameter. The exhaust nozzle supports a cast iron base for the gyrus. Resting on this are the 16 vanes, 20⅝ in. long that are secured at their upper ends by a cast iron ring fastened to the stack extension. The shape and general construction of these vanes is shown in one of the illustrations, and it will be seen that on the outer surface there are seven curved ribs which compel the entering current to assume a nearly horizontal direction, and thus increase the centrifugal action on the interior after they pass through the vanes.

The bottom of the smokebox is covered with fire brick, and

there is a 3/16-in. sheet iron jacket protecting the front end ring and door. The diaphragm plate in front of the flues is cov-

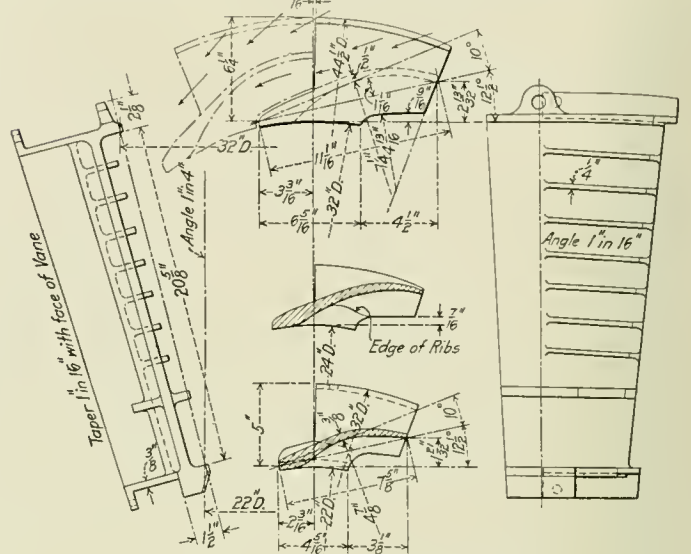

Details of the Gyru Spark Arrester.

ered with No. 12 netting, which gives the sparks an initial abrasion, and a No. 14 netting surrounds the gyrus.

| | |
|----------------------------|--------|
| Fixed carbon | 37.72 |
| Volatile combustible | 38.66 |
| Ash | 2.21 |
| Moisture | 21.41 |
| | 100.00 |
| Sulphur | 4.24 |

The fuel burned in these locomotives has the analysis shown above and costs about \$2 per ton in the district west of Long Pine, Neb., on the Chicago & North Western.

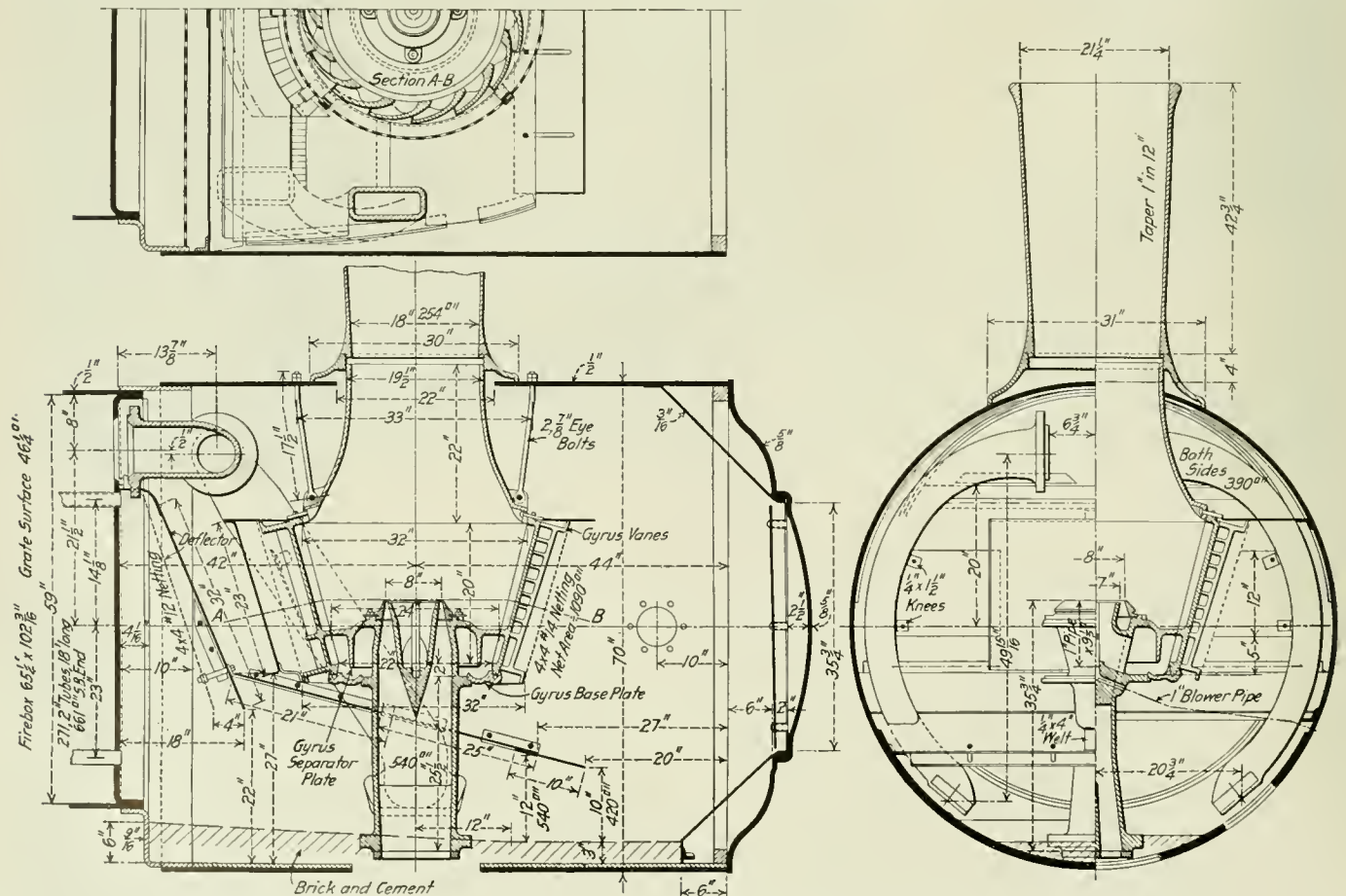

Gyrus Spark Arrester Applied to Smokebox of a Pacific Type Locomotive; Chicago & North Western.

RELIANCE SPEED DIAL

The continual trend toward more efficient methods in all machine tool operations has made it important to have some accurate method by which the machine tool operator can easily adjust his driving mechanism so as to give the prescribed speeds at the cutting tool under changing conditions of work. Where the speed changes are accomplished by means of cone pulleys or gears the spindle has a certain number of known, definite revolutions per minute, and it is a comparatively easy matter to embody in the blueprint for the work in question specific instructions showing the step of the cone pulley or gear combination at which each operation can be performed to give maximum efficiency.

With the individual adjustable speed motor drive, how-

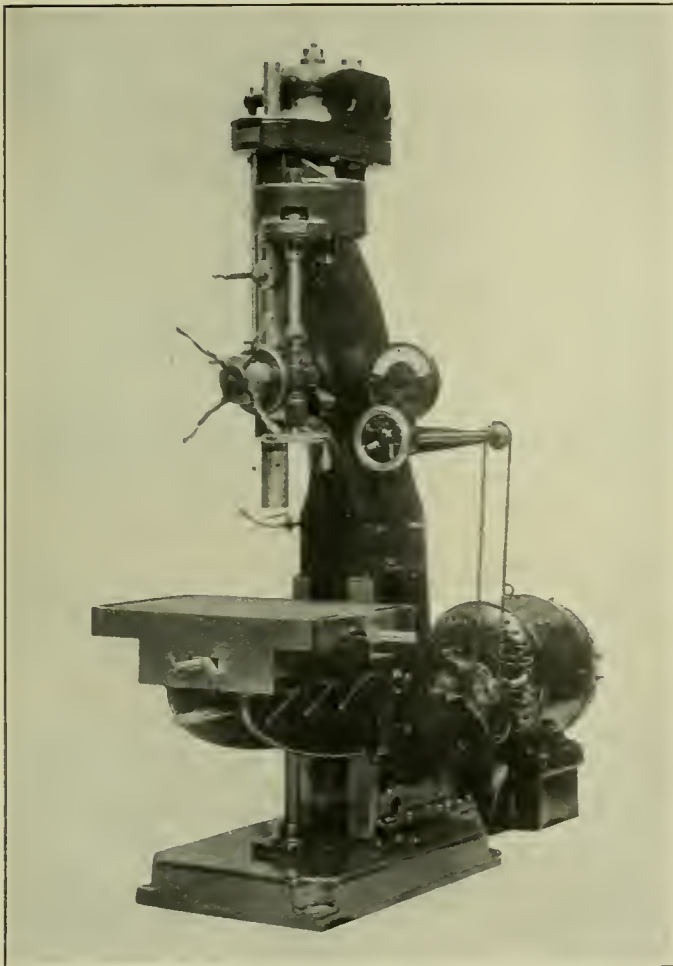

Foot-Burt Drill Fitted With a Reliance Speed Dial.

ever, the speed combinations are much greater in number, are not as easily calculated, and the proper speed setting is often a matter of considerable difficulty. In the case of the Reliance adjustable speed motor of the armature shifting type, an infinite number of speed changes can be obtained. As the armature is shifted there are no steps or jumps but a smooth, gradual, continuous change in speed, and on a machine tool driven by this type of motor, when it is necessary to make the approximations in speed setting required with other speed change devices, it is desirable for best results to give the operator some means of accurately adjusting the speed of the motor. A satisfactory device of this sort has now been developed by the manufacturers of this type of motor.

It is not a means of indicating the speed at which the motor is running, but is in reality an automatic calculator by which

the operator can instantly set the speed of the motor so as to give any desired speed at the cutting tool, taking into account all the variable factors which would affect the problem. All the operator has to do is to set the dial for the cutting speed to be used and then shift the armature of the motor in the usual manner until the pointer indicates the diameter of the cut to be taken on the proper scale for the gear combination used. It can be mounted at any convenient point on the machine tool, and it is only necessary to have some positive connection with the means employed for shifting the armature of the motor. As the armature of the motor is shifted and the gradual change in speed is obtained, a pointer moves on the scale on the dial which takes into account the different gear ratios between the motor and the work, and can be set for different cutting speeds at the cutting tool, depending on the cutting speed used and the character of the work.

The dial not only serves as a guide in setting the speed accurately, but is always in plain sight as a definite indication to the foreman or inspector of the speeds in use by the operator. These dials can be furnished properly calibrated for use with Reliance adjustable speed motors on shapers, drills, lathes, milling ma-



Reliance Speed Dial.

chines, boring mills or any other type of adjustable speed machine tool.

One of the illustrations shows a dial arranged for a crank shaper with one back gear. The upper scale, indicating the cutting speed, is stationary. The small indicator, standing at 40, is mounted on a revolving disc with the two lower scales. The lower scales, showing the length of stroke, are adjusted by means of a knurl on the front of the dial until the indicator points to the cutting speed desired. The scales are not shifted unless a new cutting speed is to be used. With the scales set for any cutting speed, the motor armature is then shifted by turning the hand wheel illustrated in the other illustration until the pointer of the dial which is geared to the hand wheel rod is opposite the stroke to be used. The dial illustrated is set for 40 ft. a minute, with the motor speed adjusted for a 20 in. stroke with the back gear in. The bottom scale shows the stroke with the back gear out.

This device is manufactured by the Reliance Electric and Engineering Company, Cleveland, Ohio.

REPAIRING BELL RINGERS

BY J. A. JESSON

Louisville & Nashville, Corbin, Ky.

Although the construction and design of the automatic bell ringer is simple, the cylinders often become worn out of round. Under such conditions the renewing of the packing rings will not be sufficient to obtain the best results, or to prevent a waste of the air. In such cases it is necessary to re bore the cylinder. The accompanying illustrations show a tool for this purpose and a rack for testing out the ringing device. Fig. 1 shows a 2 in. adjustable blade hand reamer in position for reboring the bell ringer cylinder. The long shank furnished with the reamer is discarded and a short shank grooved so as to allow the double ended wrench *A* to be keyed on is used. A specially long collar *B* is used in place of the ordinary short collar and lock nut. This is made long so as to close in the blades when removing the tool from the cylinder when it reaches the bottom.

A $\frac{25}{64}$ in. hole is drilled through the center of the reamer body in which the $\frac{3}{8}$ in. bolt, having a head $\frac{1}{8}$ in. thick and large enough in diameter to lap over the end faces of the reamer

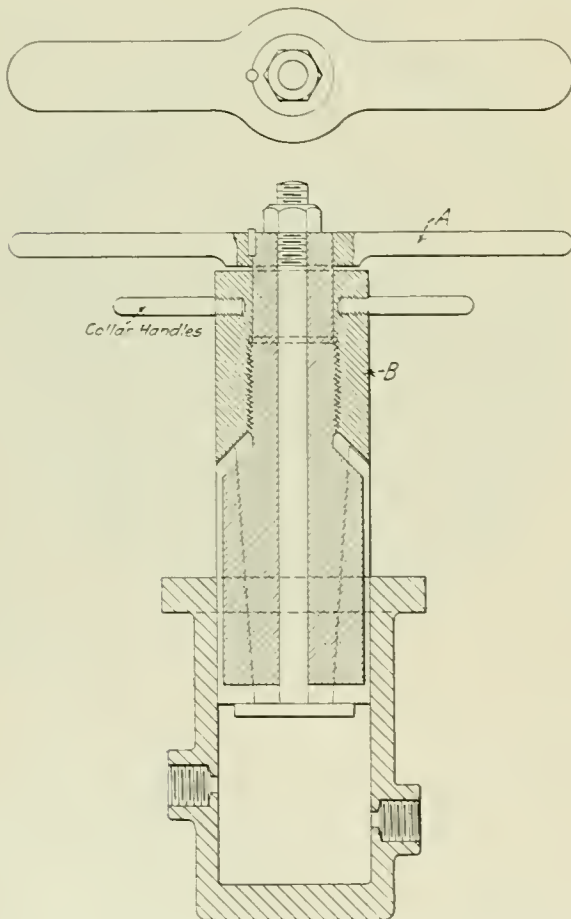

Fig. 1—Hand Reamer for Boring Bell Ringer Cylinders.

blades, is fitted and held in place by a nut at the top. After putting the reamer into the cylinder the collar *B* is slacked off and the inside bolt is tightened, forcing the tapered blades upward and outward until they bear on the sides of the cylinder; the reamer is then driven to the bottom and removed by loosening the nut on the $\frac{3}{8}$ in. bolt and screwing the collar down, thus forcing the blades downward and reducing the diameter of the reamer. The blades should be ground to about the same cutting clearance as an end mill.

A testing rack for testing out the cylinder is shown attached

to a post in Fig. 2. The frame *A* may be made of an old coupler yoke and a ball *B*, such as an old safety valve weight, may be used for the bell. This is fastened to a flattened part of the

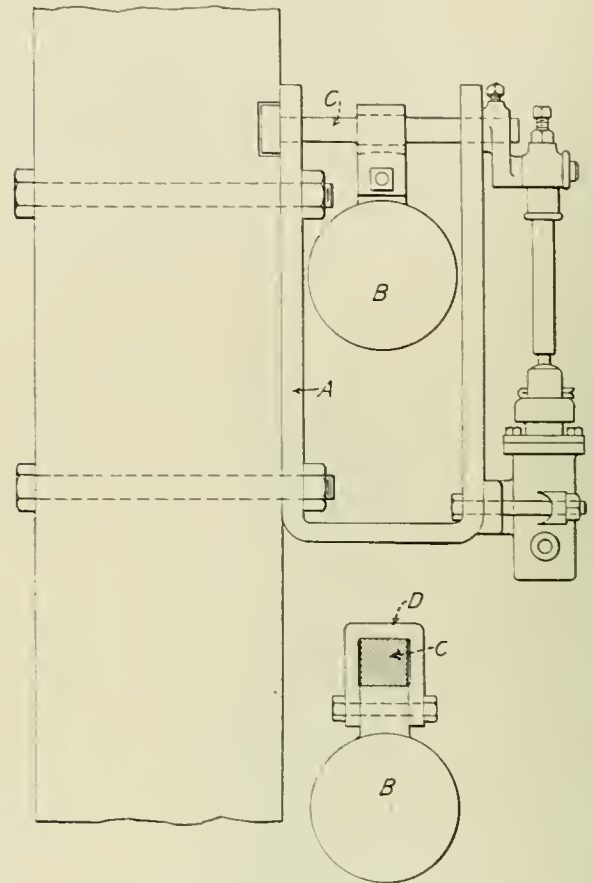

Fig. 2—Rack for Testing Bell Ringers.

shaft *C* by a U-clamp *D*. This device has proved very serviceable. The ball should be heavy enough to answer the purpose of a bell.

REMOVING LARGE CYLINDER HEADS

On large locomotives it is quite a problem to handle the front cylinder heads when they have to be removed and replaced in the engine house. A method for doing this in use on one of the western roads, which is simple and does not require a second man, is as follows: Remove the top cylinder head stud and screw in its place a round piece of iron of about the same diameter as the stud and of sufficient length to reach out to the bumper beam. The end is blocked up level at the bumper beam. When the nuts are all removed, the head is slid along the rod to the bumper beam and is out of the way until it is ready to be put back. In this manner one man can very easily handle the largest size head rapidly and without danger of jamming the threads on the studs or the joint on the head.

SCOTTISH MOTIVE POWER OFFICIAL HONORED.—John F. McIntosh, locomotive, carriage and wagon superintendent of the Caledonian Railway, has been made a member of the Victorian Order by King George V and has the distinction of being the first railway officer to have his services so recognized. It is customary in the British Isles for some responsible railway officer to travel on the locomotive of the royal train, and on a recent occasion Mr. McIntosh rode on the locomotive which drew the King's special from the Highlands to London. When the train stopped at Perth the King went to the locomotive and personally conferred the M. V. O. upon the locomotive superintendent.

MACHINE SHOP KINKS

Awarded the Second Prize in the Shop Kink Competition which Closed September 15, 1911. The Kinks were not All Originated in the Shop with which the Author is Connected but were Collected from Different Places.

BY H. L. BURRIUS.

BRAKE FOR LATHE.

A simple arrangement for stopping a lathe is shown in Fig. 1. It is made from an old piece of leather belting which is fastened loosely around the back gear shaft so that it may be easily moved from one cone of the pulley to another and not interfere

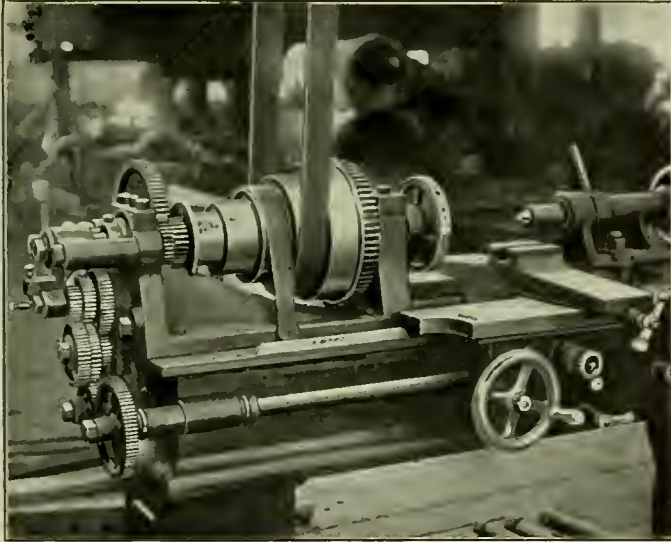

Fig. 1—Brake on Lathe Headstock.

with the driving belt. When the lathe is running the brake does not interfere in any way with the working of the machine. To stop the lathe quickly after the power has been shut off, simply pull down on the strap as it hangs over the cone. A very little weight on the end of the strap will stop the lathe in a

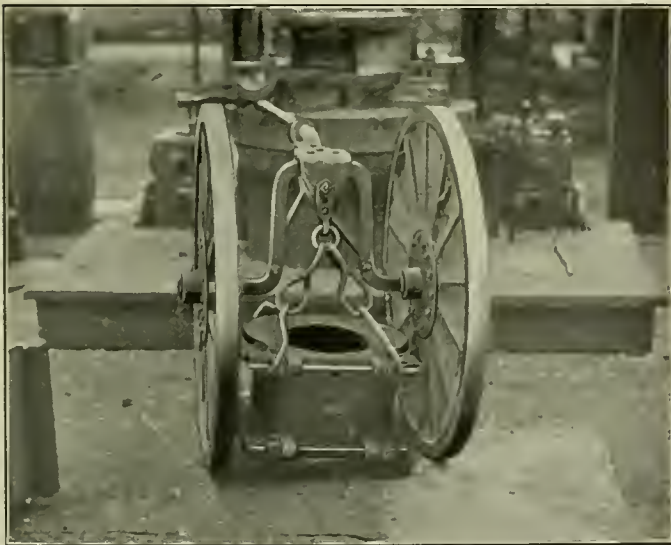

Fig. 2—Truck for Handling Driving Boxes.

few revolutions. Observations made in a large shop on high speed lathes showed that 10 per cent. of the workman's time was wasted while waiting for the machine to stop after the power had been shut off. After this brake was installed the workman's

output was materially increased. It does not in any way cause unusual wear of the bearing.

DRIVING BOX TRUCK.

The truck shown in Fig. 2 is used for conveying driving boxes in and about the shop. The box is carried by the two hooks suspended from the center of the inverted U-axle. The axle is made of hammered steel, $1\frac{3}{4}$ in. square, and is bent so that the top of the inverted U is 34 in. from the floor. The rings and hooks are made of $\frac{3}{4}$ -in. round iron and may be shaped to suit any style of driving box flange. The wheels are 36 in. in diameter and have tires $1\frac{1}{2}$ in. wide. When it is desired to load the truck the handle is raised, so that the top of the axle will dip forward and allow the hooks to be slipped under the flanges of the box. A sheet iron cover is fastened to the spokes on the inside of the wheel, so that the box will not catch in them when it is being moved. Only one man is required to handle and transport the box with this truck.

RELIEF VALVE TESTING MACHINE.

An apparatus for giving relief valves and all other valves of a similar nature a hydraulic test of 200 lbs. pressure per sq.

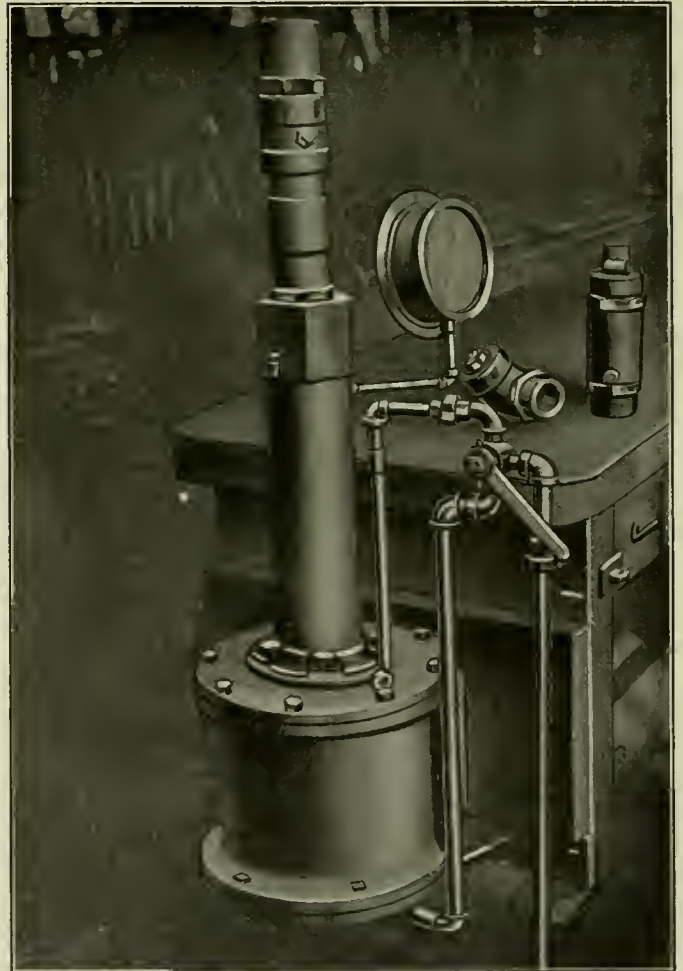

Fig. 3—Device for Testing Relief Valves.

in., by using a shop air pressure of 90 lbs., is shown in Fig. 3. It is made from an old 14-in. brake cylinder, which has a smaller cylinder 6 in. in diameter screwed into the top head. A piston rod connects the large piston to a smaller one in the top cylinder, which forces the water into the valve to be tested. By opening a three-way cock, so as to let air into the underside of the large cylinder, the piston is forced up and will compress the water in the small cylinder to a high pressure, which may be regulated by the amount of air applied. A cap is fitted

to the top of the small cylinder so that connections of different sizes may be screwed in to suit the different valves. After the valve has been tested the three-way valve is reversed, allowing the air to escape from under the large piston and turning the air in on top so as to force the piston down.

MOLD FOR METALLIC PACKING RINGS.

An arrangement for molding metallic packing rings is shown in Figs. 4 and 5. With this mold all three rings may be poured at the same time and after the metal has cooled the cores, or

to the underside of the bench. The bench shown in the illustrations is 3 in. thick, which allows for a coil spring of $\frac{1}{4}$ in. wire having a free height of 4 in. The springs are strong enough to force the arbors back in position as quickly as the foot is removed from the lever. This arrangement is much cheaper than compressed air.

DIES FOR FORGING SIDE ROD JAWS.

The dies for forging the fork or clevis end of side rods under a steam hammer so as not to require any machine work for

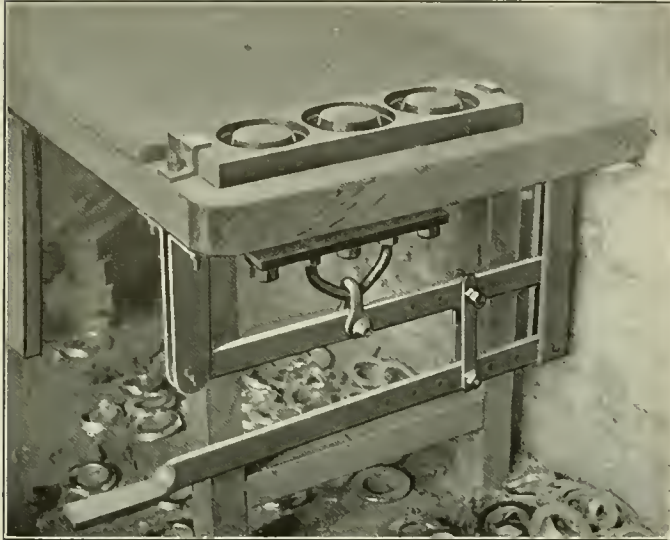

Fig. 4—Packing Ring Mold Ready for Pouring.



Fig. 5—Packing Ring Mold with Arbors Withdrawn.

arbors, are pulled down by a foot lever, allowing the rings to be easily removed. Fig. 4 shows the arbors in position ready to receive the metal, and Fig. 5 shows them withdrawn. By

finishing is shown in Fig. 6. The forging is done under a 3,000-lb. steam hammer, and from six to eight ends can be forged complete in 10 hours by one gang. As machine work on this

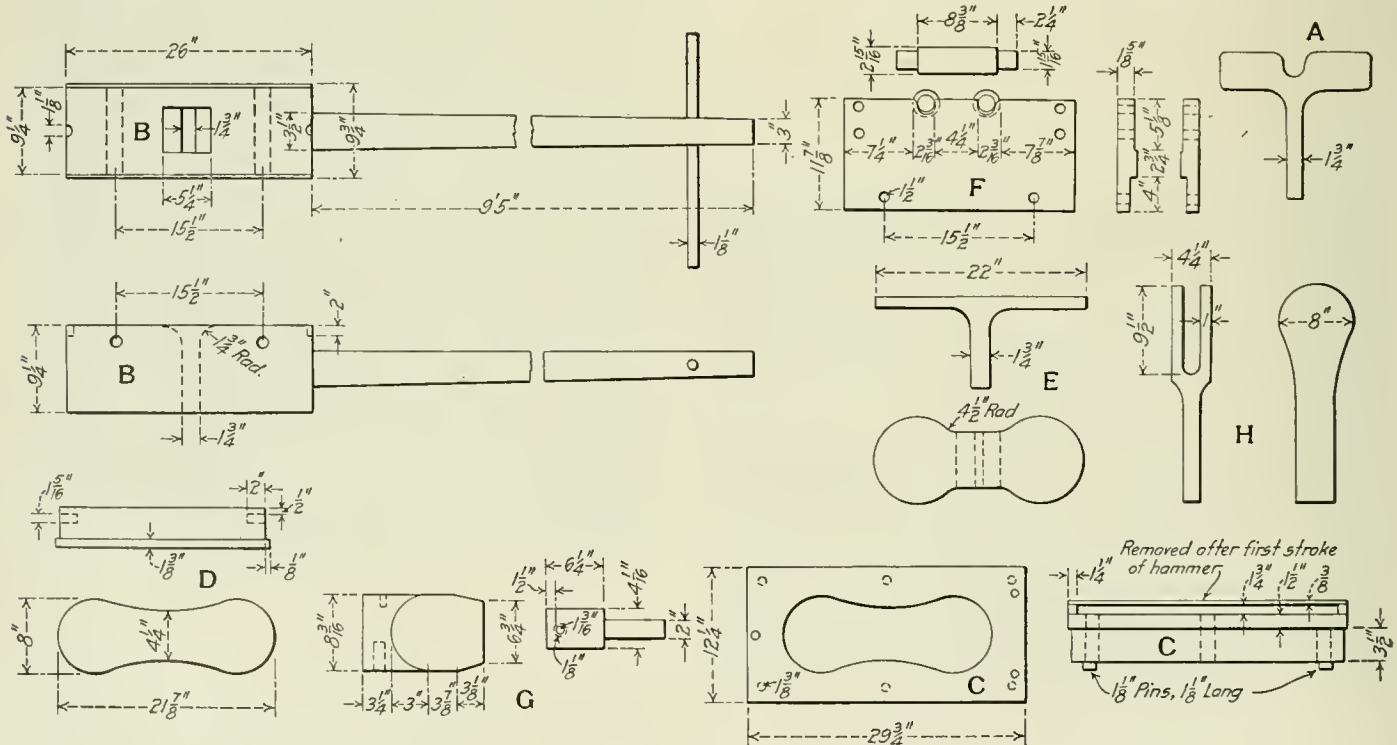

Fig. 6—Dies for Forging Side Rod Jaws.

having different sized molds and arbors this same arrangement could be used for all sizes of packing. Each arbor is held in place by a coil spring, which rests on a sheet iron plate bolted

job costs approximately \$5 an end, this method means a saving of nearly that amount for every end forged. To forge an end the piece is first worked to the shape shown at A. The piece is

then placed on the die *B* and the sides or wings are hammered to the proper thickness, after which the piece is placed on the dies shown at *C*, and is punched by the die *D* to the shape shown at *E*. The two ends are then bent to a U-shape in a bending box made with the two pieces *F*, which are fastened to the die *B* by 1½-in. bolts. Two rolls are placed in the grooves, as shown, and *E* is placed on them with the tail of the *T* extending down between them and into the hole in *B*. It is then forced down by the plunger *G* and takes the finished shape as shown at *H*. These ends can be forged about 18 in. long, so as to be easily welded to the rod.

TEMPLATE FOR DRILLING ECCENTRICS.

The use of the jig shown in Fig. 7 for drilling holes in eccentrics greatly facilitates the operation, as it is not necessary to lay out the holes, and the drilling operation is also made easier. The holes for the set screws can easily be drilled accurately, and at the proper angle, which otherwise prove a difficult job. The jig is made so that it hooks over the lips on the large half of the eccentric and fits into the grooves on



Fig. 7—Template for Drilling Eccentrics.

the small half. The eccentric and the jig are clamped to an angle plate, and after the bolt holes are drilled it is easily set to the proper angle for drilling the set screw holes. The holes in the jig are larger than those to be drilled so that a hardened steel bushing or guide can be used. This also allows the same jig to be used for different size holes, the steel bushing being changed as desired.

DRILLING COMPOUND.

A drilling compound made of 5 bars of common soap, 10 lbs. of sal soda and about 50 gals. of water, and placed in barrels located at convenient points around the shop, is not only handy for the workmen, but is so much cheaper than oil that quite a saving is made by its use. By having it placed at different points, especially in large shops where some departments are quite a distance from the tool or supply room, no time is lost in getting a supply. This compound gives good service on the drill press or for air motor drilling and saves the oil, which costs approximately \$20 a barrel.

GRINDING STEAM PIPE JOINTS.

Exceptionally good results are secured in grinding steam pipe joints or rings by using the dust or loose emery that collects around emery wheels. This dust contains enough steel and iron grindings so that being mixed with the loose emery it makes a combination that not only grinds quickly but also makes a good joint. It should be screened before using. It takes the place of emery or steel abrasive, costing from 4 to 15 cents per lb.

ELIMINATING ENGINE FAILURES

BY CHARLES MAIER.

The statement was made in Mr. Cordeal's article on engine failures in the January issue of the *American Engineer* that they can always be traced to errors or negligence on the part of individuals. To do this he carefully outlines a system of placing the responsibility of the failure and immediately locating it and imposing discipline or taking any other action necessary. He also states that the perfect engine kept in perfect repair cannot fail. These two statements represent the two extremes. One deals with the perfect engine while the other deals with the failure. In between these two extremes lies the practical part of the locomotive maintenance problem.

Unless some definite limit is set as to where the perfect engine ceases to be perfect, I do not think it is always fair to impose discipline, even though it may be due to apparent carelessness. An engine may be run in pooled or partially pooled service and make a big mileage and no one part show excessive wear. However, the general condition of the working parts may be such that a nut will jar loose, a pipe vibrate to the breaking point or a clean fracture of some kind be invited with the resulting engine failure. In tracing this failure it may be found that the part had been worked on, in which case the party doing the work is censured or disciplined. If no work was done to it, the inspector is considered responsible, and if he made no report it is up to him. Now, the idea of imposing discipline is to make men careful, so that the same mistake will not happen again. Where men are careful, but working under such conditions, the effect of discipline is demoralizing. Good mechanics will not work under such conditions, except through absolute necessity, and inspectors can only stay until they have been disciplined out of a job, or quit in disgust.

Another feature of this method, or, rather, lack of method, of engine maintenance is that work piles up and accumulates to such an extent that the engine house forces can hardly handle it, with the result that repairs are always made in such a hurried manner that the foreman cannot insist on a satisfactory standard of workmanship. Experience has shown the necessity of setting a limit of wear on certain parts, or of making periodical examinations of other parts. If this has been found necessary and has proved desirable in connection with certain parts of an engine it should be equally necessary and desirable as applied to the entire engine. After an engine has made a certain mileage the tires and flues may still be in excellent condition, but the valve motion, brake rigging, boiler pads, etc., may be worn so that an engineman or an inspector would not be justified in reporting any particular part, but they should all be completely overhauled. Unless a practice is made of taking an engine out of service after it has made a certain predetermined mileage and overhauling all working parts, putting them back in perfect condition, engine failures will continue to occur in spite of any discipline that may be imposed.

Some engines will wear out faster than others or some parts of them will wear out faster than the corresponding parts of others, but a fair average mileage can be determined where an engine should be considered as worn out. Where such a practice is established it should be strictly lived up to and all parts that are scheduled to be overhauled should be taken down, thoroughly cleaned, carefully examined for cracks, and put back in as perfect a condition as when the engine was new. This practice can be gradually inaugurated by starting in with engines that have recently had a thorough overhauling. Before the engine has made the full mileage allowed, preparations should be made to have repaired duplicate parts on hand and in this way the engine would only be out of service a comparatively short time. This practice, systematically followed out, will not cost any more for repairs per mile than the system of not doing the work until forced to by a failure, or by a threatened failure. While some

and perhaps considerable unnecessary work may be done, this will be more than made up by the saving effected by eliminating the numerous jobs that are worked at on each end of the division several times before a thorough repair job can be made. It will also tend to raise the standard of the regular running repair work, because the general condition of the engine will be better and less work will be required. The engines will always be in good condition and will not vary from very good to very bad.

It may be said that this should be a matter of judgment on the part of the foreman; that he should not allow an engine to become so run down that there is a liability of failure. This might hold true where all engines are taken care of at one repair point only, but it would not where engines from several divisions come to one roundhouse. What a foreman on one end of the division might consider as serviceable another might consider as worn out, and he would probably not be in a position to maintain all engines coming to his shop in the condition that he thought they should be. If he asked for an increase of force, a comparison would immediately be made with some other point handling the same number or more engines, and he would thus be compelled to as others did.

Where the maintenance of locomotives is systemized the work can be planned out ahead of time and be distributed so that it can be handled to the best advantage. Where it is not systemized the work comes in bunches and at times cannot be handled

EXPERIMENTAL MALLET LOCOMOTIVE FOR THE PENNSYLVANIA

For the first time in this country a Mallet locomotive having four simple cylinders and using high-degree superheated steam has been built. The American Locomotive Company recently completed a single example of this kind for the Pennsylvania, and it is now in experimental service out of Altoona. The locomotive has the largest boiler ever built, and is equipped with a Schmidt superheater having 1,257 sq. ft. of superheating area. There are 282—2¼ in. tubes and 45—5½ in. tubes, 24 ft. 8⅞ in. long between tube sheets, which together with the fire-box give an evaporative heating surface of 6121.1 sq. ft., and an equivalent heating surface of 8006.6 sq. ft.

It was desired to use a steam pressure of 160 lbs., and compound cylinders of sufficient size to develop the capacity of the boiler would make the low pressure cylinders too large to pass the clearance limits. Furthermore, by the use of high-degree superheated steam it was thought that there would be no loss in economy from the absence of the compounding, and therefore four simple cylinders, 27 in. x 28 in., were applied. This arrangement, of course, necessitates the carrying of a high pressure pipe from the superheater connection in the front end back to a swivel joint near the pivot pin and then forward to the cylinders on the front engine. This has been so carefully de-

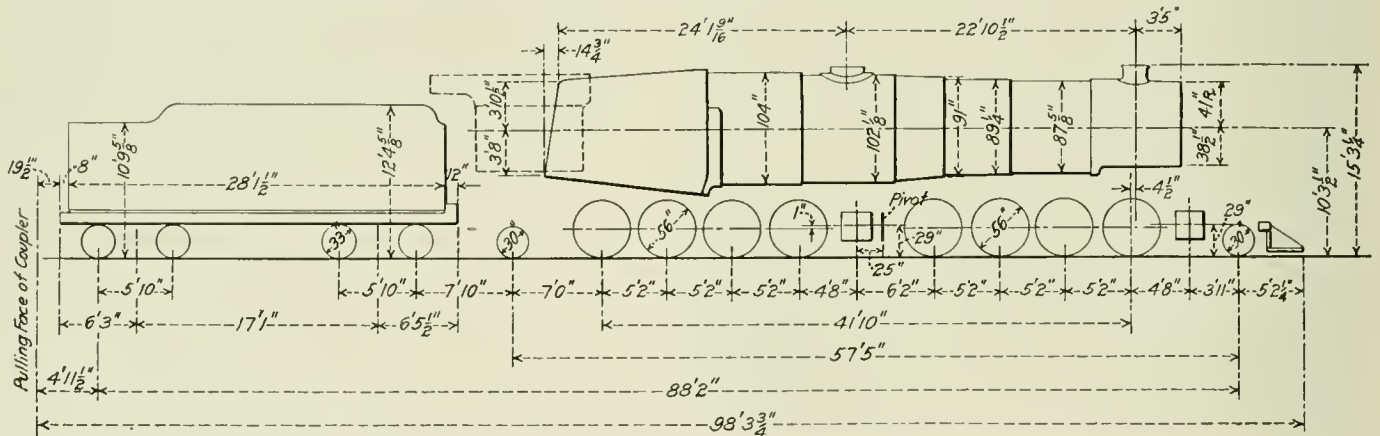

General Arrangement of the Simple Articulated Locomotive for the Pennsylvania.

properly. The question arises as to what parts should receive the periodical overhauling. This depends on the class of engines handled and the service in which they are used. A study of engine failure records will also help to determine this.

During an experience of about 12 years as an engine house foreman, at points where engines in through and local passenger service were handled, I found that after an engine had made about 25,000 miles the valve motion, especially on engines equipped with the Stephenson gear, would be considerably worn and in a condition where it should be overhauled. The brake rods, hangers, pins and connections would be found to have considerable lost motion and the cotter pins would also be worn. Boiler pads at the frame connections would be worn so that the boiler worked on the frames. Babbitt-lined bearings in engine truck, trailer and tender truck boxes would be worn to a condition that justified their renewal. Air pipe clamps and reservoir fastenings needed attention. Engines equipped with piston valves should be examined and any shoulders on the bushings should be taken care of by renewing or boring them. Crossheads and rod brasses might be classed with regular running repair work, but if these were worn out at this time they should be refitted. The flues and some other parts of the engine may be found to need periodical attention more frequently and some of the parts mentioned may not need attention as frequently, but this can be readily adjusted to suit conditions. The main thing is to get the work systematized.

signed and constructed, however, that it is believed that no trouble will be experienced with leakage. Because of its experimental character comparatively little information concerning the details of the design is available at this time. The engine has a total weight in working order of 482,500 lbs., of which 437,500 lbs. is on the drivers. The theoretical tractive effort figured at 85 per cent. boiler pressure is 99,200 lbs. The general dimensions are given on the accompanying diagram.

FIELD FOR AMERICAN EQUIPMENT.—The cost of new railway construction in New Zealand could probably be considerably reduced if American labor-saving appliances were more largely used. In many instances neglect to use American tools and machinery for such work is due merely to neglect of American manufacturers in calling attention to the advantages of using them to save labor cost, which is very high in New Zealand. Unless, however, American firms arrange for some representation in New Zealand, preferably at Wellington, the capital, they can hardly expect to secure orders, as too much time would be required in correspondence. In case there is not enough promise of business to justify sending their own representatives out here it is best to arrange for some well-established local firm to take on an agency. When goods are indented for the New Zealand Government no duty has to be paid, although duty must be figured in case they are not indented directly, but are bought from local stocks.—Daily Consular and Trade Report.

GENERAL FOREMEN'S ASSOCIATION.*

BY W. M. T. GALE,

Shop Demonstrator, Chicago & North Western, Chicago, Ill.

I cannot conceive of any better medium for the interchange of practical experience along proper and well defined lines in engine house and shop practice, than by an interested participation in the conventions of this association. The progressive, up-to-date mechanic reads the best mechanical papers suitable to his particular needs, with resultant benefits to himself and employer. The railway shop foreman can also greatly improve his executive ability and mechanical education, and, incidentally, have an opportunity of conferring upon others the benefit of his practical experience through the medium of the General Foremen's Association.

The address of H. T. Bentley, assistant superintendent motive power and machinery, Chicago & North Western, at the recent convention was full of incentive and action. He brought the convention to its feet when he stated that the railway companies were amply repaid by the foremen's presence at the conventions. His statement that in order to be a live wire and a successful executive, it is necessary to read good mechanical papers, visit each other's shops, and keep in touch with the supplymen, was received with considerable approval by all present. The matters discussed at the convention covered plans of organization, methods of supervision, the economical handling of material, the multifarious and ingenious shop kinks and handy time saving devices, methods of handling locomotives in and out of shops and engine houses, the handling of material at shops and outlying points, the system of arriving at the cost of locomotive repairs, and the relation of officers to the subordinates. The efforts of general foremen along these lines should receive the approval and support of every railway official. The association should have the support and co-operation of all railway officials, for it is obvious, that its educational work is along up-to-date lines and that it must of a necessity inspire its membership to the standard of efficiency so much desired by the railways in general.

The opinion seems to prevail that some executive officers are more or less skeptical as to the value of these associations. It is a recognized fact that there is no organization so perfect that improvements cannot be introduced to advantage, and possibly the General Foremen's Association is no exception to the rule. The general foreman is the practical mechanic with a knowledge of economy in production, knowing the best and cheapest ways of utilizing the waste, and building up an efficient business organization. He has devoted a large portion of his own leisure time to his employer's interest. He cannot be called guilty of being a drone in his chosen calling; his devotion and skill is born of constant practice in the mechanical arts. He is an inventor of no small ability. Untiring effort is his keynote to success. He is a pioneer in initiative in railway shop management and, because of his practical experience, is familiar with the needs of the service. He is generally far-sighted and a master of detail, and has an intelligent understanding of workmen. He knows their peculiarities and wants and understands how to get results from his men with the least effort. He is an expert in diplomacy and understands thoroughly how to handle men.

With men of this caliber as officers and members, participating in the active work of the association for the purpose of building up an organization whose principles and teachings are along lines of economical operation, there is no question as to the usefulness of its conventions and the practical advantages to be attained by attending them.

*Entered in the *Railway Age Gazette* competition on the Benefits of Convention Attendance, which closed October 15, 1911.

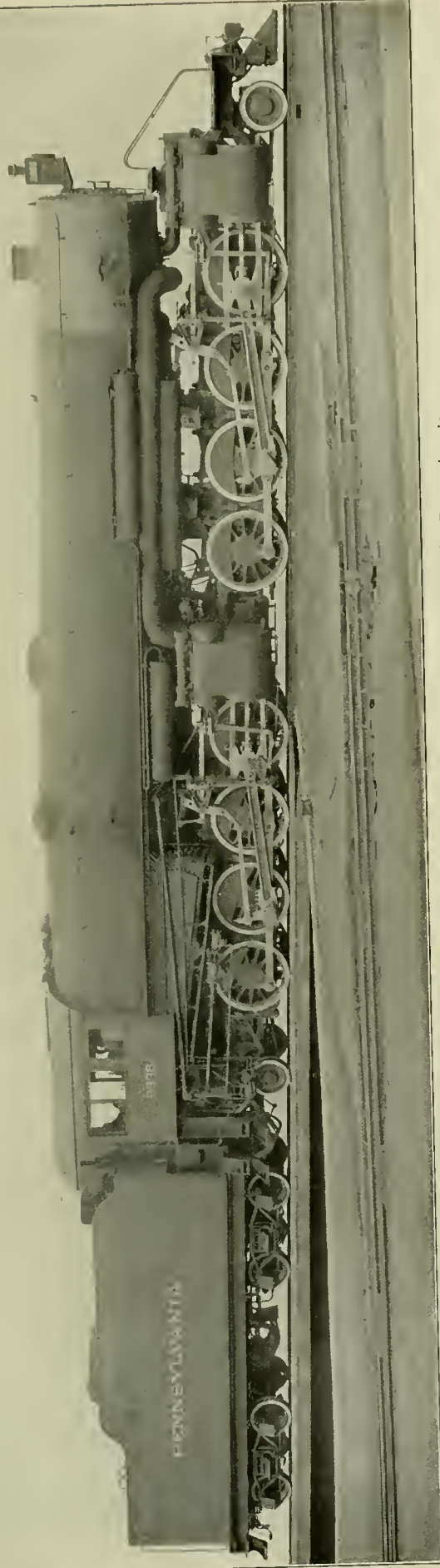

Simple Mallet Articulated Locomotive with Superheated Steam; for the Pennsylvania.

NORTON AXLE GRINDING MACHINE

It has been evident that there could be a considerable saving made by grinding the journals and wheel fits of car axles if a grinding machine of suitable size and arrangement was available. In some cases axles have been placed in piston rod grinding machines, which are not at all suited for the purpose, but have given fairly satisfactory results with an occasional axle. When an axle is turned it is necessary to remove more metal than is required to just clean up the journal, and since there is comparatively small variation allowed in the size of journals this means that a considerable part of the life of the axle is lost

quarter. It is provided with a crane as part of the machine; also an air operated lift in the center and air operation of the tailstock. These labor-saving devices are so complete that after the axle is dropped into the saddles provided for the purpose, it does not require further handling by the operator. He has simply to turn on the air which lifts the axle to the centers of the machine; the driving mechanism, of the floating type, is then clamped on, allowing the axle to revolve on the two dead centers. The next operation is to clamp the tailstock and proceed to grind.

When the grinding is completed on one end of the axle the tailstock clamp is released; air is turned on, which

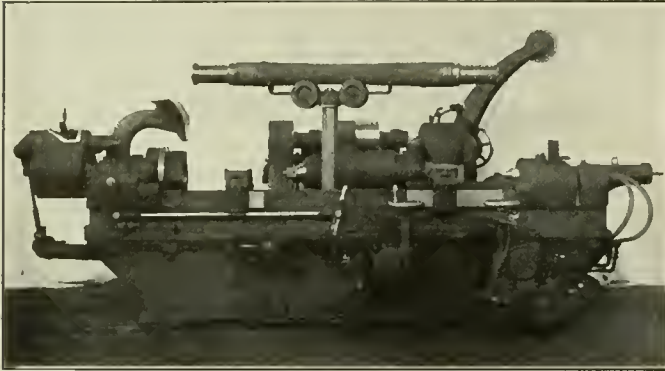

Axle Raised Preparatory to Reversing in Grinding Machine.

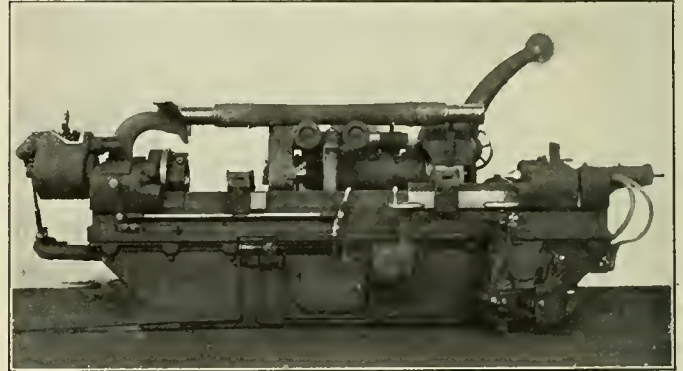

Axle Being Lowered in Grinding Machine After Reversal.

without corresponding mileage. In grinding, on the contrary, there is absolutely no loss and in addition the trueness of the bearing is an attractive feature.

Recognizing the importance of this, the Norton Grinding Company, of Worcester, Mass., has now perfected a lathe designed expressly for grinding car axles. It is arranged for the most convenient and rapid handling of the axles and the maximum of accuracy in the work. The machine is remarkably heavy and rigid, weighing about 23,000 lbs., of which the weight of the grinding wheel with its revolving parts forms nearly one

first draws back the tailstock, automatically removing the axle from both centers. Then another air valve is opened and the axle is raised by the center plunger and is swung around on a ball-bearing pivot and dropped into place for grinding the other end.

The machine is motor-driven, one motor supplying the power for all purposes. A pump is provided which delivers about 50 gals. of water or lubricant on the wheel and work per minute. This lubricant is contained in a tank forming part of the base of the machine. On the headstock is a gear box containing speed

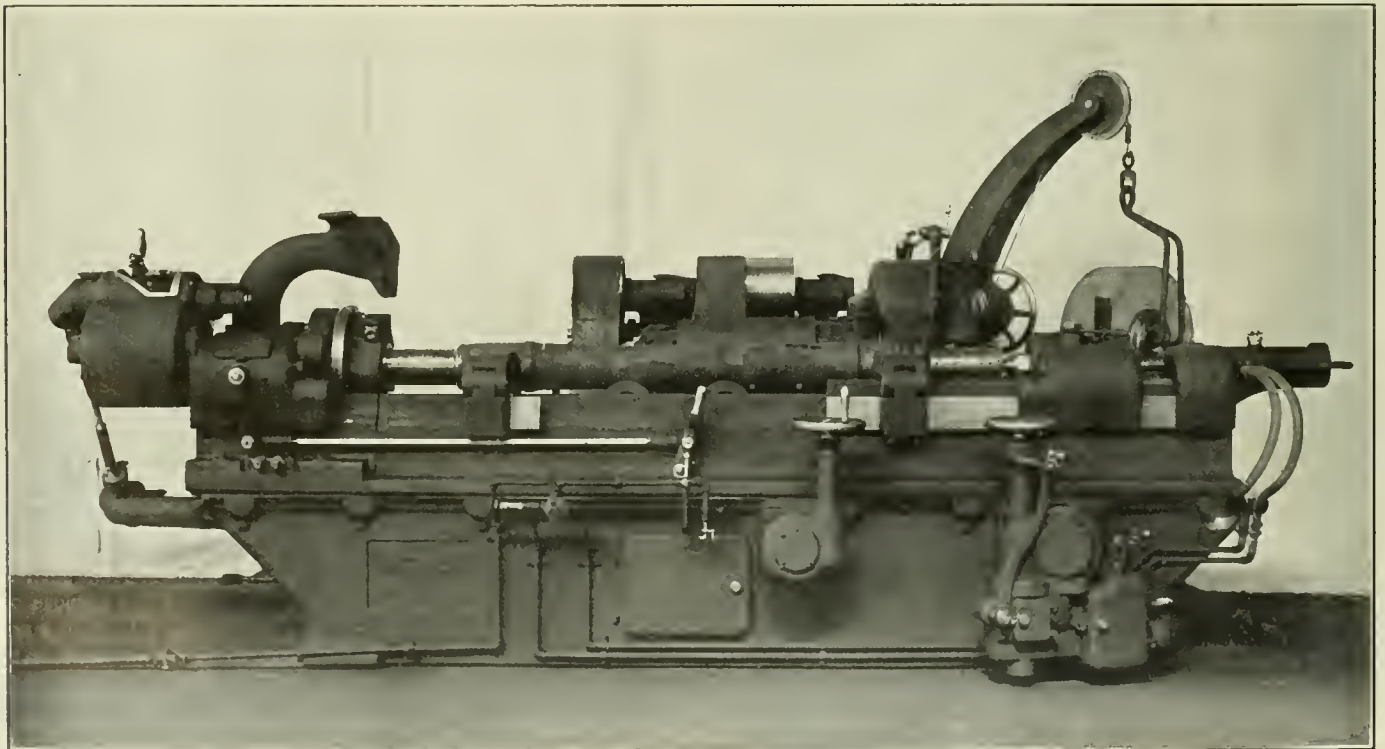

Norton Axle Grinding Machine; Axle on Centers Ready for Grinding.

change gears; a lever for starting and stopping the work is conveniently located near the center of the machine. The driving gear, of the floating type, revolves on a roller bearing designed especially for this purpose, which is calculated to make the machine durable for the severe service and assures that there will be no wearing or wobbling of the driving gear under hard service. Other parts of the machine are designed with equal care to stand the maximum of misuse with a minimum of trouble. All revolving parts are of high grade steel and are heat treated where necessary. Ball bearings are liberally used throughout, and where worm gearing is used it runs in an oil bath.

To test the value of the different methods of finishing axles, so far as the accuracy of the work was concerned, three separate pieces were completed, one being turned and polished in the usual manner, the second being turned and roller burnished and the third being ground on this machine. Bronze rings, made with perfectly cylindrical bearings and exact fits on the test pieces, were rubbed parallel with the axles so that the bronze would slightly abrade the high spots. In this manner it was clearly shown that the first two specimens had a number of high and low places which were eccentric with each other and did not continue around the entire circumference. In other words, the film of oil between the box and a revolving journal finished in this way cannot be uniform throughout the entire revolution. The ground journal, on the contrary, showed an almost perfectly level surface, although it did not have the high polish of the other two. It is believed, however, that this grain on the surface will give a more perfect lubrication, particularly at

A NEW TYPE OF STEAM TURBINE

A new type of steam turbine, called the Spiro, has recently been placed on the market by the Buffalo Forge Company, Buffalo, N. Y. This turbine was invented by John H. Van Deventer, superintendent of the Buffalo Forge Company, who has been developing and perfecting it for the past three years, and now the Buffalo Forge Company is making it as a com-

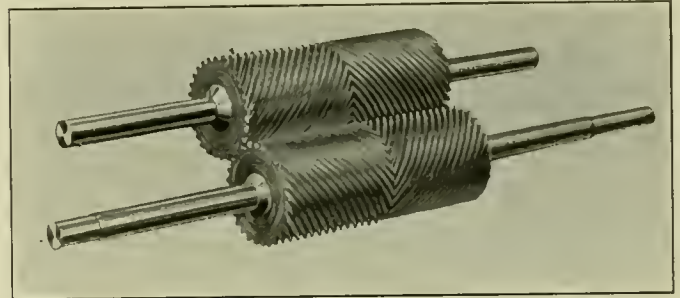

Rotors for Spiro Steam Turbine.

mercial product. Although small in size it has a large range of power, the one illustrated herewith being rated at 185 h. p. At the present time, however, the commercial sizes range only from 1 to 50 h. p., non-condensing, but patterns are being completed to run these sizes up to 300 h. p.

The construction of the turbine is very simple, it consisting of two rotors with herringbone teeth or value, the case of the

AVERAGE REDUCTION OF DIAMETER, IN INCHES, ON JOURNALS AND WHEEL FITS.

| Axle No. | Left Hand End. | | | | | | Right Hand End. | | | | | |
|----------|----------------|------------|---------------|-------------|------------|---------------|-----------------|------------|---------------|-------------|------------|---------------|
| | Journal. | | | Wheel Fit. | | | Journal. | | | Wheel Fit. | | |
| | Rough Diam. | Fin. Diam. | R'duct. Diam. | Rough Diam. | Fin. Diam. | R'duct. Diam. | Rough Diam. | Fin. Diam. | R'duct. Diam. | Rough Diam. | Fin. Diam. | R'duct. Diam. |
| 2..... | 5.482 | 5.452 | 0.030 | 6.869 | 6.846 | 0.023 | 5.485 | 5.464 | 0.021 | 6.893 | 6.880 | 0.013 |
| 3..... | 5.493 | 5.488 | .005 | 7.013 | 7.004 | .009 | 5.484 | 5.466 | .018 | 7.015 | 7.005 | .010 |
| 5..... | 5.464 | 5.446 | .018 | 6.815 | 6.798 | .017 | 5.414 | 5.400 | .014 | 6.815 | 6.797 | .018 |
| 6..... | 5.508 | 5.493 | .015 | 7.021 | 7.000 | .021 | 5.513 | 5.506 | .007 | 7.020 | 7.009 | .011 |
| 8..... | 5.500 | 5.482 | .018 | 7.008 | 6.994 | .014 | 5.500 | 5.487 | .013 | 7.011 | 6.987 | .034 |
| 10..... | 5.438 | 5.409 | .029 | 6.922 | 6.900 | .022 | 5.442 | 5.422 | .020 | 6.943 | 6.926 | .017 |
| 11..... | 5.497 | 5.476 | .021 | 7.007 | 6.990 | .017 | 5.494 | 5.483 | .011 | 7.012 | 7.001 | .011 |

the start. There seems to be little doubt but that the journal with the mirror finish but containing the high and low spots will not lubricate as well at the start as would a perfect cylinder with a grained surface.

The accompanying tables show the time and horsepower required for grinding the journals and wheel fits of seven different axles which have the reduction of diameter given. The letters refer to the two fillets, the journal and the wheel fit in order.

Since the demonstration from which these data were made there has been a considerable reduction in the time required for

turbine and the two heads which hold the rotors. The vanes of the rotors are cut from a solid cylindrical piece of steel with a special tool, which does away with all inserted vanes. The steam is applied at the center of the rotors at the apex of the vanes, being deflected so as to strike the vanes in the angle. The steam is pocketed between the vanes and casing, and as it expands, it drives the rotors. The force of the steam jet tends to give additional power and on that account the builders call it a "reaction and expansion turbine." However, no special provision is made to increase the velocity of the jet.

TIME REQUIRED FOR GRINDING THE VARIOUS ELEMENTS OF THE AXLE.

| Axle number | 2 | | 3 | | 5 | | 6 | | 8 | | 10 | | 11 | |
|----------------------------|-------|-------|------|------|-------|-------|------|------|------|------|------|-------|-------|-------|
| Time | Min. | Sec. | Min. | Sec. | Min. | Sec. | Min. | Sec. | Min. | Sec. | Min. | Sec. | Min. | Sec. |
| Putting in | 7 | 20 | 1 | 12 | | | 1 | 32 | 1 | 27 | 0 | 56 | 1 | 06 |
| Grinding right hand end | (A) | 0-45 | 0 | 34 | | | 1 | 14 | 0 | 18 | 1 | 03 | 0 | 28 |
| | (B) | 7-20 | 5 | 51 | | | 2 | 58 | 7 | 51 | 6 | 22 | 4 | 09 |
| | (C) | 1-45 | 1 | 30 | | | 2 | 22 | 0 | 42 | 1 | 34 | 1 | 55 |
| | (D) | 3-00 | 2 | 51 | | | 5 | 44 | 2 | 12 | 4 | 15 | 1 | 46 |
| Turning work on centers | | | 1 | 25 | | | 1 | 32 | 1 | 25 | 1 | 17 | 0 | 48 |
| Grinding left hand end | (A) | 1-45 | 0 | 37 | | | 1 | 14 | 0 | 44 | 1 | 04 | 0 | 56 |
| | (B) | 7-15 | 3 | 30 | | | 8 | 02 | 5 | 07 | 7 | 58 | 8 | 05 |
| | (C) | 3-05 | 0 | 57 | | | 1 | 58 | 0 | 58 | 1 | 07 | 2 | 18 |
| | (D) | 4-00 | 2 | 14 | | | 3 | 52 | 3 | 11 | 4 | 03 | 2 | 56 |
| Removing work from machine | | | 1 | 40 | | | 1 | 16 | 0 | 59 | 1 | 03 | 1 | 12 |
| Total time | | | 33 | 25 | | | 27 | 14 | 20 | 16 | 32 | 42 | 27 | 41 |
| Maximum horsepower | | | 42.0 | 29.1 | | | 40.1 | 29.2 | 34.0 | 32.0 | 35.4 | 35.4 | 35.4 | 35.4 |
| Average horsepower | | | 17.1 | 11.9 | | | 16.3 | 11.5 | 17.1 | 13.5 | 13.5 | 12.75 | 12.75 | 12.75 |

Motor running light requires 3 1/4 horsepower.
 Motor and machine running light require 6.44 horsepower.
 Wheel, 24 in. diameter, 9 in. face; speed of wheel, 1,036 r.p.m.; surface cutting speed, 6,500 ft. per min.

grinding and the manufacturers now state that an average production of three complete axles per hour can be guaranteed with this machine.

The maintenance of the whole outfit is slight, as the steam forms an elastic cushion between the vanes, which tends to decrease the wear. The leakage will be small between the

GENERAL NEWS SECTION

The engine house of the Missouri, Kansas & Texas at Hillsboro, Tex., was destroyed by fire on February 10.

The repair and machine shops of the Chicago, Burlington & Quincy at Creston, Ia., were destroyed by fire early in February.

The Pere Marquette has reduced the working time in its shops at St. Thomas, Saginaw, Grand Rapids and Ionia from six 9-hour days a week to five 8-hour days a week.

J. W. Cline, president of the International Association of Blacksmiths and Helpers, estimates that the strike last autumn on the Harriman Lines, exclusive of the Illinois Central, cost the men who struck about \$9,000,000 in wages.

The Pennsylvania Railroad has recently granted the Pennsylvania State College the use of its old dynamometer car. This car was used by the Pennsylvania in establishing the tonnage ratings before it received its present dynamometer car; it originally cost \$30,000.

A report issued by the Atchison, Topeka & Santa Fe, shows that in the six months ending January 31, 1912, during which the officers of the road have been conducting an active safety campaign, there were 36 employees killed and 3,608 injured, a decrease of ten killed and 447 injured, as compared with the corresponding period of the previous year.

A report compiled by the pension department of the Chicago, Rock Island & Pacific shows that \$65,000 has been paid to employees in pensions since the pension system was established January 1, 1910. During this time 132 employees have been placed on the pension roll and of that number 16 have died. The ages of the pensioners range from 54 to 73 years.

The McGraw-Hill Book Company, New York, now has the exclusive sales agency for the technical books of the *American Engineer*, the *Railway Age Gazette*, and *The Signal Engineer*. This makes the McGraw-Hill Book Company publishers and distributors of books for the three journals, but it does not affect the publication of the papers themselves in any way.

The Atchison, Topeka & Santa Fe has made a change in its pension rules so that an employee who has been continuously in the service of the company for 15 years or more may receive a pension, if permanently incapacitated, without the necessity for showing that the disability was caused by employment in the service of the company, provided it has not been due to misconduct.

The Central of Georgia has established an educational bureau for the benefit of its employees, which is to be identical with that on the Union Pacific and the Illinois Central. D. C. Boy, a special representative of the educational system now in vogue on these roads mapped out the preliminary work incident to the organization of this new department, and will for the present have charge of the work on the Central of Georgia.

The committee of the postoffice department and that of the mechanical officers of the railways having in charge the preparation of a uniform specification for steel postal cars, met in Washington, February 23. After a brief discussion the specification as previously prepared and printed in circular No. 26 of the Special Committee on Relations of Railway Operation to Legislation dated Chicago, November 16, 1911, was agreed to with some slight modifications.

The central safety committee of the Baltimore & Ohio is making a trip over the western lines of the system for the purpose of meeting the division safety committees and addressing meetings of employees on the importance of promoting safety in railway operation. The addresses are being made by C. W.

Egan, chief claim agent, and W. L. Robinson, special inspector of the motive power department; and are accompanied by stereopticon pictures, illustrating conditions which often result in accidents.

A committee composed of thirteen general managers and vice-presidents has been appointed by the eastern railways to meet the representatives of the Brotherhood of Locomotive Engineers to discuss the requests for higher wages. This united method of meeting the situation is an important step; heretofore there has been no concerted action on the part of the eastern railways in meeting these labor problems. This lack of unity was severely felt in the adjustment of the wages of the conductors and trainmen in 1910 where there was a wide difference of wages between the different roads which was highly unsatisfactory to the roads paying the minimum rate. The committee has called on the roads concerned to prepare figures showing what would be the results of putting the proposed scale in effect. Roughly, it is estimated that the aggregate increase would be \$10,000,000 a year. The percentages of increase vary from 15 to 50 per cent. in different classes of work. The meeting will take place in New York, March 14.

BALDWIN LOCOMOTIVE WORKS LOYAL LEGION.

The Baldwin Locomotive Works, Philadelphia, Pa., has instituted the B. L. W. Loyal Legion as a form of recognition of the loyal and faithful service of all its employees who continued in the active service of the company during the strike last June in spite of the extreme pressure that was brought to bear to make them become disloyal, including intimidation and personal violence. Each member has been given a solid gold button containing in the outer rim the words "B. L. W. Loyal Legion," and in the center, in gold figures on black enamel, the number of years of faithful service rendered by the recipient. The accompanying illustration shows this button, actual size. These tokens of appreciation and good will by the employer have been highly appreciated by those entitled to them and have served to create a certain rank based upon loyalty and service. The numbers are to be changed each year, as the center of the button is removable. The total force at work on February 13, 1912, was 8,543 men, and the number enrolled in the legion was 3,562, or 42 per cent. of the total force. This enrollment includes commercial and engineering officers and the technical staff, as well as the workmen employed in the shops. It comprises 2,055 men who have served faithfully and continuously for from one to 10 years; 936 men from 11 to 20 years; 390 men from 21 to 30 years; 132 men from 31 to 40 years, and 49 men from 41 to 50 years. There are 11 men who have been employed upwards of 50 years, the senior in point of employment being George Johnson, a traveling engineer, who has been continuously in the service of the company for 62 years, and is still at work. The percentage of the members of the legion to the total number of employees is, of course, subject to fluctuation, as the working force is continually changing. Men who enter the service of the company in the future will not be eligible to the legion unless a similar emergency should test their faithfulness and loyalty.



RESTORATION OF M. C. B. DEFECT CARDS.

A strong effort is being made by transportation officers throughout the country to bring about a restoration of the practice of applying M. C. B. defect cards at the time of the interchange of cars. At a meeting of the executive committee of the Chief Interchange Inspectors' and Car Foremen's Association

in Chicago on February 10, recommendations to the arbitration committee of the Master Car Builders' Association with respect to changes in the Master Car Builders' code of interchange rules were agreed upon, and in addition resolutions were passed heartily endorsing the undertaking of the American Association of Railroad Superintendents, working in conjunction with the Master Car Builders' Association and the Association of Transportation and Car Accounting Officers, to restore the M. C. B. rules.

The resolutions declare that the Master Car Builders' code represents a signed and binding contract entered into by the executive officers, and that the practice of applying M. C. B. defect cards at the time of interchange in accordance with M. C. B. rules is entirely practicable; and pledge the utmost support of the committee to the end that the M. C. B. code shall be restored at all interchange points. It was ordered that a copy of the resolutions be sent to each member of the association, "that their hearty co-operation may be secured in bringing about this much needed reform effective if possible on April 1, 1912, the date the carding practice becomes effective in Chicago and other important interchange centers."

The American Association of Railroad Superintendents through President E. H. DeGroot, Jr., has called a special meeting for the purpose of aiding in the restoration of the carding practice at as many interchange points throughout the United States as possible, effective on April 1, at the time the practice of carding cars in interchange will be instituted within the entire Chicago switching district. It is understood that many railway officers are desirous of having the plan adopted.

MEETINGS AND CONVENTIONS

New York Railroad Club.—Electric welding was the subject of an excellent paper by O. S. Beyer, Jr., presented at the February meeting. The paper was well illustrated and covered practically the same ground as the article by the same author which appeared on page 57 of the February issue of this journal.

International Safety Congress.—The honorary committee which will represent the United States at the International Safety Congress in Milan, Italy, May 27-31, will be composed of James McCrea, president of the Pennsylvania Railroad; E. A. S. Clarke, George B. Cortelyou, Philip T. Dodge, S. C. Dunham, Elbert H. Gary, chairman of the finance committee of the United States Steel Corporation; John Hayes Hammond, A. Barton Hepburn, Seth Low, Charles Nagel and James Speyer. Representatives of 38 various industries and other interests will serve on the national committee.

American Society for Testing Materials.—The committees of the society will report on the following subjects at the next convention which will be held in New York, March 28-29: Magnetic Testing of Iron and Steel, Tempering and Testing of Steel Springs and Standard Specifications for Spring Steel, Hardness Tests, Standard Specifications for Coal, Standard Specifications for Steel Standard Specifications for Wrought Iron, Standard

Specifications for Cast Iron and Finished Castings, Standard Specifications for Cement, Standard Tests for Lubricants, and Standard Methods of Testing.

New England Railroad Club.—At the January meeting J. M. Fitzgerald, engineer maintenance of signals, New York Central and Hudson River, presented a paper on railway signaling. It consisted largely of a description of the latest general practice in signaling and pointed out the changes which are constantly being made toward greater uniformity throughout the whole country. He divided his subject into two parts, interlocking and block signaling, and discussed each separately, although it was stated that, with the extensive installation of track circuit control now being generally used, the two classes were gradually being combined.

Canadian Railway Club.—Locomotive boilers, their development and troubles, was the subject of the paper presented by J. W. Harkom, construction engineer, Melbourne, Que., at the February meeting. The author briefly traced the development of locomotive boilers from the beginning, pointing out the difficulties which had arisen, and how they had been corrected, and quickly bringing his subject up to present methods. Broken staybolts, leaky tubes and other detail features were discussed at some length and recommendations were made as to the best method of avoiding these troubles. Mr. Harkom advocated some new features of construction, one of the most novel being the use of a steel casting covering the whole surface of the back head of the firebox which requires staying. This casting would include the attachment for the stay rods and avoid the double plate generally used. The construction of Wood's boiler was briefly discussed.

International Railway Fuel Association.—The fourth annual meeting of the International Railway Fuel Association will be held at the Hotel Sherman, Chicago, on May 22-25. The program, as announced, includes the following papers: "Standard Locomotive Performance Sheet," by R. Collett, superintendent locomotive fuel service, Frisco Lines; "The Use of Anthracite for Locomotive Fuel," by T. S. Lloyd, formerly general superintendent motive power and equipment of the Delaware, Lackawanna & Western; "Drafting of Locomotives to Obtain Maximum Fuel Efficiency," by H. B. McFarland, engineer of tests, Atchison, Topeka & Santa Fe; "Proper Method of Firing Locomotives" (illustrated with motion pictures and colored slides), by D. C. Buell, chief of the educational bureaus, Union Pacific and Illinois Central; "Inspection of Fuel from the Standpoint of the Producer and Consumer," by J. E. Hitt and Glenn Warner, representing the Burnwell Coal Company and the Cincinnati, Hamilton & Dayton Railway, respectively; special paper by Prof. W. F. M. Goss, University of Illinois.

American Railway Tool Foremen's Association.—The annual convention of the American Railway Tool Foremen's Association will be held at Chicago, beginning July 9. Following is a list of the committees and of the topics which will be discussed:

Standardization of Steel for Small Tools. Henry Otto (A. T. & S. F.), chairman; W. J. Eddy (Erie), A. M. Roberts

RAILROAD CLUB MEETINGS

| CLUB. | NEXT MEETING. | TITLE OF PAPER. | AUTHOR. | SECRETARY. | ADDRESS. |
|--------------------|---------------|--|-----------------------|--------------------|-------------------------------------|
| Canadian | Mar. 12 | Technical Education and the Operating Department | Prof. H. O. Keay... | Jas. Powell..... | Room 13, Windsor Hotel, Montreal. |
| Central | Mar. 8 | Committee Report on M. C. B. Rules of Interchange, and Paper on Safety Appliances and Injury to Employees. | W. O. Thompson... | H. D. Vought... | 95 Liberty St., New York. |
| New England..... | Mar. 12 | Man and the Railroad..... | Edward Hungerford. | Geo. H. Frazier... | 10 Oliver St., Boston, Mass. |
| New York..... | Mar. 15 | Annual Electrical Night..... | W. J. Harahan..... | H. D. Vought... | 95 Liberty St., New York. |
| Northern | Apr. 6 | | | C. L. Kennedy... | 401 Superior St., Duluth, Minn. |
| Pittsburgh | Mar. 22 | M. C. B. Rules of Interchange..... | R. S. Kleine, ch'man. | J. B. Anderson... | Union Station, Pittsburgh, Pa. |
| Richmond | Mar. 8 | Mechanical Stoker | C. F. Street..... | F. O. Robinson... | C. & O. Ry., Richmond, Va. |
| S'th'n & S. West'n | Mar. 21 | Has the Cast Iron Wheel Reached Its Limit? | | A. J. Merrill..... | 218 Grant Bldg., Atlanta, Ga. |
| St. Louis..... | Apr. 12 | How an Engineering Contractor Would Run a Railway..... | A. P. Greensfelder... | B. W. Frauenthal | Union Station, St. Louis, Mo. |
| Western | Mar. 18 | | | Jos. W. Taylor... | 390 Old Colony Bldg., Chicago, Ill. |

(B. & L. E.), C. A. Cook (C. I. & L.), J. Martin (C. C. C. & St. L.), and A. Sterner (C. R. I. & P.).

Milling Cutters, Their Formation, Tempering, Etc. A. R. Davis (Ga. Cent.), chairman; Gnst Gstoettner (C. M. & St. P.), W. A. Fairbairn (N. Y. C. & H. R.), J. A. Shaw (Cent. of N. J.), F. W. Luggen (C. C. C. & St. L.), and A. W. Meitz (P. M.).

Care of Shop Tools. J. W. Pike (C. R. I. & P.), chairman; H. I. Derby (A. T. & S. F.), O. H. Dallman (Pennsylvania), Thos. Grant (D. & H.), E. R. Purchase (B. & A.), and G. L. Linck (H. & T. C.).

Checking Systems. J. T. Fuhrman (G. N.), chairman; J. B. Hasty (A. T. & S. F.), Wm. Greilich (C. H. & D.), H. E. Blackburn (Erie), Gilbert Mitchell (Erie), and F. Peterson (C. & S.).

Treating Steel in Electric Furnaces. G. W. Jack (I. C.), chairman; B. Hendrickson (C. & N. W.), J. C. Breckenfeld (St. L. & S. F.), and C. A. Shaffer (I. C.).

Master Car and Locomotive Painters' Association.—The advisory and executive committee of the Master Car and Locomotive Painters' Association held its annual meeting in New York City, February 22, and decided on the following subjects for the next convention, which is to be held at the Albany Hotel, Denver, Colo., September 10, 11, 12 and 13, 1912: What is the most appropriate finish for the interior of vestibule ends? Specifications for standard paint materials for railway equipment. Treatment and care of steel passenger car roofs. Modern method of exterior passenger car painting, including primers and surfacers. Relative difference in cost of maintenance between steel and wooden passenger cars. The following subjects were also chosen for Essays: Qualifications of the present day foreman painter. Finish and treatment of passenger car concrete floors. The following Queries were also decided upon for discussion: What is the most economical process for removing old paint from locomotive jackets? Would you advise the use of interior car renovators, and why? What are the essentials of a protective paint making material? When natural finished ash, oak or mahogany have become stained or discolored by exposure to water or the weather can the stains be permanently bleached or removed without scraping the wood and how should it be done to obtain the best results. Would you advise painting a wooden roof of a freight car, considering its treatment after going into service?

The following list gives names of secretaries, dates of next or regular meetings, and places of meeting of mechanical associations.

AIR BRAKE ASSOCIATION.—F. M. Nellis, 53 State St., Boston, Mass. Convention, May 7-10, Richmond, Va.

AMERICAN RAILWAY MASTER MECHANICS' ASSOC.—J. W. Taylor, Old Colony building, Chicago. Convention, June 17-19, Atlantic City, N. J.

AMERICAN RAILWAY TOOL FOREMEN'S ASSOCIATION.—M. H. Bray, N. Y., N. H. & H., New Haven, Conn. Convention, July 9, Chicago.

AMERICAN SOCIETY FOR TESTING MATERIALS.—Prof. E. Marburg, University of Pennsylvania, Philadelphia, Pa. Annual convention, March 28-29, New York.

AMERICAN SOCIETY OF MECHANICAL ENGINEERS.—Calvin W. Rice, 29 W. 39th St., New York.

CAR FOREMEN'S ASSOCIATION OF CHICAGO.—Aaron Kline, 841 North 50th Court, Chicago; 2d Monday in month, Chicago.

INTERNATIONAL RAILWAY FUEL ASSOCIATION.—D. B. Sebastian, La Salle St. Station, Chicago. Convention, May 22-25, Chicago.

INTERNATIONAL RAILWAY GENERAL FOREMEN'S ASSOCIATION.—L. H. Bryan, Brown Marx building, Birmingham, Ala. Convention, July 23-26, 1912.

INTERNATIONAL RAILROAD MASTER BLACKSMITHS' ASSOCIATION.—A. L. Woodworth, Lima, Ohio. Convention, August 15, Chicago.

MASTER BOILER MAKERS' ASSOCIATION.—Harry D. Vought, 95 Liberty St., New York. Convention, May 14-17, Pittsburgh, Pa.

MASTER CAR BUILDERS' ASSOCIATION.—J. W. Taylor, Old Colony building, Chicago. Convention, June 12-14, Atlantic City, N. J.

MASTER CAR AND LOCOMOTIVE PAINTERS' ASSOC. OF U. S. AND CANADA.—A. P. Dane, B. & M., Reading, Mass. Convention, September 10-13, Denver, Col.

RAILWAY STOREKEEPERS' ASSOCIATION.—J. P. Murphy, Box C, Collinwood, Ohio. Convention, May 20-22, Buffalo, N. Y.

TRAVELING ENGINEERS' ASSOCIATION.—W. O. Thompson, N. Y. C. & H. R., East Buffalo, N. Y., August, 1912.

PERSONALS

GENERAL.

J. KYLE has been appointed master mechanic of the Canadian Northern, with office at Edmonton, Alberta.

G. H. HEDGE has been appointed master mechanic of the Canadian Northern, with office at Winnipeg, Man.

A. SHIELDS has been appointed general master mechanic of the Canadian Northern, with office at Winnipeg, Man.

PETER VOSEN has been appointed assistant master mechanic of the Wabash at Decatur, Ill., succeeding E. O. Shively, transferred.

F. M. BAUMGARDNER has been appointed master mechanic of the Illinois Central, with headquarters at Clinton, Ill., succeeding L. E. Hassman, resigned.

E. P. HUGHES has been appointed traveling engineer on the Reid Newfoundland Company, covering the territory between St. Johns, N. B., and Clarendville.

E. W. BURGIS, master mechanic of the New Orleans Southern & Grand Isle at Algiers, La., has been appointed superintendent, with office at Algiers, succeeding J. S. Landry, deceased.

A. G. PASSMORE, division master mechanic of the Toledo & Ohio Central, at Kenton, Ohio, has been appointed division master mechanic, with headquarters at Bucyrus, vice J. T. Luscombe, resigned.

E. J. SEARLES, assistant to the general superintendent of motive power of the Baltimore & Ohio, has been promoted to superintendent of motive power at Pittsburgh, Pa., succeeding Mr. Carroll, promoted.

J. T. LUSCOMBE, division master mechanic of the Toledo & Ohio Central, at Bucyrus, Ohio, has been appointed master mechanic of the Cleveland, Cincinnati, Chicago & St. Louis, with office at Bellefontaine, Ohio.

J. E. GOULD, superintendent of motive power of the Norfolk Southern, with office at Berkeley, Va., has also been appointed superintendent of motive power of the Raleigh, Charlotte & Southern, a new line in North Carolina.

W. H. ERSKINE, assistant master mechanic of the Minneapolis & St. Louis, at Minneapolis, Minn., has been appointed division master mechanic with jurisdiction over the Central and Western division, with headquarters at the Cedar Lake shops, Minneapolis.

R. A. CROFTON has been appointed assistant general manager in charge of motive power of the Houston East & West Texas; the Houston & Texas Central; the Texas & New Orleans, and the Galveston, Harrisburg & San Antonio, with office at Houston, Tex., vice J. T. Connor, granted leave of absence.

G. T. HARTMAN, assistant superintendent of the Copper Range, at Houghton, Mich., will have jurisdiction over the mechanical and supply departments, and the present heads of these departments will report to him. Mr. Hartman is to continue to report to the general superintendent, and will devote his entire time to the above departments, relinquishing his present duties in train and station matters, etc.

O. S. BEYER, JR., an inspector on the Erie Railroad, and formerly on the personal staff of T. Rumney, mechanical superintendent, has accepted a similar position with Mr. Rumney on the Rock Island Lines. Mr. Beyer was graduated from the mechanical engineering department of Stevens Institute in 1907. He was a machinist apprentice and draftsman with the E. W. Bliss Company, Brooklyn, N. Y., and later was connected with the tire rolling department of the Midvale Steel Company at

Nicetown, Pa. In 1908 he went with the Erie Railroad at Jersey City as a special apprentice, and a few months later was detailed for special work in the office of the mechanical superintendent, Mr. Rumney, later receiving the title of inspector. While at Philadelphia Mr. Beyer attended the Wharton School of the University of Pennsylvania, taking an evening course in accounting, business law and finance. He was the author of the article on Standard Practice Cards on the Erie in the January, 1912, issue of the *American Engineer*, and of the article on Electric Welding in Railway Shops in the February issue.

C. K. SHELBY, whose appointment as master mechanic of the Pennsylvania Railroad at Olean, N. Y., shops, was announced in the January issue of the *American Engineer*, was born on September 18, 1870, in Allegheny county, Pa., and after attending St. Paul's School, Concord, N. H., he was graduated from Lehigh University in 1892, with the degree of mechanical engineer. He entered the service of the Link Belt Engineering Company, and later went to the Baldwin Locomotive Works. In November, 1894, he became a special apprentice at the Altoona shops of the Pennsylvania Railroad, and was appointed assistant foreman of passenger car inspectors in February, 1899. One year later he was made assistant master mechanic at the Juniata shops, and in December, 1902, he was transferred in the same capacity to the Renova shops, and was acting master mechanic at those shops from May until June, 1903. Mr. Shelby was appointed assistant engineer of motive power of the Philadelphia & Erie Railroad division and of the Northern Central Railway in July, 1903, with office at Williamsport, Pa., and was made master mechanic of the Elmira division of the Northern Central in April, 1906, which position he held at the time of his recent appointment as master mechanic of the Buffalo division.

J. T. CARROLL has been appointed assistant general superintendent of motive power of the Baltimore & Ohio, with office at Baltimore, Md. He was born on June 12, 1875, at Cassadaga, N. Y., and was graduated from Purdue University, Lafayette, Ind. Mr. Carroll entered the service of the Brooks Locomotive Works as draftsman in September, 1891, remaining with that company until January 1, 1896. He was then consecutively draftsman on the Erie, the Chicago, Rock Island & Pacific, and the Chicago & North Western. In August, 1899, he was appointed mechanical engineer of the New York, Chicago & St. Louis. In 1904 he went with the Lake Shore & Michigan Southern, where he filled various positions, including general foreman, assistant superintendent of shops, assistant master mechanic and master mechanic. He was appointed superintendent of motive power of the Baltimore & Ohio, with office at Pittsburgh, Pa., in 1910, which position he held at the time of his recent appointment as assistant general superintendent of motive power.



John T. Carroll.

CHARLES E. GOSSETT, whose appointment as general master mechanic of the Minneapolis & St. Louis, with office at Minneapolis, Minn., was announced in the February issue of the *American Engineer*, was born January 25, 1869, at Millerstown, Ky. He received a common school education and began railway

work in 1887 with the Kansas City, Fort Scott & Gulf, now a part of the St. Louis & San Francisco. He subsequently served as machinist apprentice after which he became a locomotive fireman. In 1892 he was made a locomotive engineer and served in that capacity on the Hannibal & St. Joseph, now a part of the Chicago, Burlington & Quincy; on the Wabash; the Chicago & Alton; the Atchison, Topeka & Santa Fe, and the old Rock Island & Peoria, now a part of the Chicago, Rock Island & Pacific. In 1899 he was made traveling engineer of the Rock Island at Chickasha, Okla.; in March, 1905, he was promoted to master mechanic, with office at Eldon, Mo., and two years later was transferred to Kansas City. He later resigned to become master mechanic of the Iowa Central at Marshalltown, Iowa, and two years afterward was transferred to Minneapolis as master mechanic of the Minneapolis & St. Louis. On January 10, 1912, subsequent to the absorption of the Iowa Central by the Minneapolis & St. Louis, he was made general master mechanic of the entire line.

EDWARD S. FITZSIMMONS, whose appointment as mechanical superintendent of the Erie Railroad, with office at Cleveland, Ohio, was announced in the February issue of the *American Engineer*, was born in April, 1876, at Columbus, Ohio, and was educated at the high school and the night business school at Horton, Kan. He also took a correspondence school mechanical engineering course, and began railway work on August 6, 1890, with the Chicago, Rock Island & Pacific at Horton. He remained with that company until May, 1899, and then went to the Delaware, Lackawanna & Western as foreman boiler maker at Scranton, Pa. In February, 1904, he was sent by the same company to the Baldwin Locomotive Works as inspector of new equipment. Mr. FitzSimmons went to the New York, New Haven & Hartford in August, 1904, as general boiler inspector, with headquarters at New Haven, Conn., and in February of the following year was appointed general foreman boiler maker of the Erie, with office at Meadville, Pa. He was promoted to master mechanic of the Cincinnati division in August, 1907, with office at Galion, Ohio, and the following February was transferred in the same capacity to the Allegheny and Bradford Divisions, with office at Hornell, N. Y., which position he held at the time of his recent appointment as mechanical superintendent.



Edward S. FitzSimmons.

CAR DEPARTMENT.

C. E. FERGUSON has been appointed foreman of the Grand Trunk Pacific at Rivers, Man.

V. B. DUNCAN has resigned as foreman of the coach department of the Trinity & Brazo Valley at Teague, Texas.

E. J. WHEELER has been appointed general car inspector of the Chicago, Burlington & Quincy Lines west, with headquarters at Lincoln, Neb., vice William Hanson, resigned.

HENRY MARSH, general car foreman of the Minneapolis & St. Louis at Marshalltown, Iowa, has been appointed district car

foreman of the eastern division, with headquarters at Marshalltown. His former position has been abolished.

SHOP.

J. E. STEVENS has been appointed assistant foreman of the Mobile & Ohio at Meriden, Miss., vice W. M. Snyder assigned to other duties.

A. R. TEAGUE has been appointed general foreman of the Mobile & Ohio at Meriden, Miss., vice E. G. Brooks assigned to other duties.

A. J. ROBERTS has been appointed locomotive foreman of the Grand Trunk Pacific at Regina, Man., vice C. E. Brooks transferred to Wainwright.

W. H. WENKE has been promoted to day engine house foreman of the Chicago, Rock Island & Pacific at Cedar Rapids, Ia., vice J. A. Wilkinson, resigned.

LEE C. NEYER has been promoted to assistant day engine house foreman of the Chicago, Rock Island & Pacific at Cedar Rapids, Ia., vice W. H. Wenke, promoted.

H. M. HASS has been appointed apprentice instructor on the Eastern lines of the Canadian Pacific. He will also advise in the maintenance and operation of cars and locomotives.

G. W. BULL has been appointed apprentice instructor on the Eastern lines of the Canadian Pacific. He will also advise in the maintenance and operation of cars and locomotives.

F. L. JONES has been appointed apprentice instructor on the Eastern lines of the Canadian Pacific. He will also advise in the maintenance and operation of cars and locomotives.

CHARLES BOWERS, foreman of the Ashland, Wis., engine house of the Minneapolis, St. Paul & Sault Ste. Marie, has been promoted to engine house and shop foreman at Fon du Lac, Wis.

T. WINDLE, assistant master mechanic of the Minneapolis & St. Louis at Marshalltown, Iowa, has been appointed general foreman of the Marshalltown shops and his former position has been abolished.

CHARLES POWERS has been appointed locomotive inspector of the Canadian Pacific, with headquarters at Montreal, Can. He will co-operate with the master mechanics in the matter of standard shop practice and economical handling of engines.

PURCHASING AND STOREKEEPING.

RALPH P. MOORE has been appointed purchasing agent of the Duluth & Iron Range, with office at Duluth, Minn., succeeding Fred H. White, resigned to accept service with another company.

H. W. DAVIES, purchasing agent of the Norfolk & Southern, with office at Norfolk, Va., has also been appointed purchasing agent of the Raleigh, Charlotte & Southern, a new line in North Carolina.

FRED H. WHITE, purchasing agent of the Duluth & Iron Range at Duluth, Minn., has been appointed purchasing agent of the Duluth, Missabe & Northern, with headquarters at Duluth, succeeding Sanford F. McLeod, resigned to engage in other business.

RENEWING DRIVING BRASSES WITHOUT DROPPING WHEELS.—The method followed on the Chicago & North Western of holding the driving brass in the box by means of a wedge which permits the brass to be removed and re-applied without the assistance of a drop pit or crane was illustrated and described in the May issue of the *American Engineer & Railroad Journal*, page 188. The advantage of this method was recently shown when a switch engine came into the house at 8 a. m., had a main brass taken out and a new one fitted and applied and was returned to service at 1 p. m., with total labor cost of \$3.10.

NEW SHOPS

ABILENE & SOUTHERN.—The engine house and machine shop, which were recently burned at Abilene, Texas, will be rebuilt. The new engine house will contain 4 stalls and the shop building will be 138 ft. long and 32 ft. wide. They will be of concrete construction.

ATCHISON, TOPEKA & SANTA FE.—The re-construction of the shops at Clovis, N. M., has begun.

ATLANTIC, OKEECHOBEE & GULF.—Car repair shops will be built at Fort Lauderdale, Fla., and at Garden City, a suburb of Tampa, Fla. Plans are now ready and the cost has not been decided upon.

BALTIMORE & OHIO.—New shops will be erected at South Cumberland, Md., which will cost between \$300,000 and \$400,000. It is expected that the work will commence on them in the Spring, although the plans have not yet been completed. This road has also purchased land at Garrett, Ind., for an engine house and shops.

BOSTON & MAINE.—Bids are being received for the erection of the shops to be built at Billerica, Mass.

CHICAGO, ROCK ISLAND & PACIFIC.—This road will build large shops at Hurlburt, Ark., near the terminus of the new bridge that crosses the Mississippi river at that place. It is also reported that \$60,000 will be expended for improvements to the shops and engine house at Biddle, Ark.

DELAWARE & HUDSON.—A new engine house has been built at Binghamton, N. Y., and plans are being made for the installation of a small machine shop.

ILLINOIS CENTRAL.—It is reported that this road has purchased 700 acres of land at Meridian, Miss., as a site for shops to cost about \$2,000,000.

LOUISVILLE & NASHVILLE.—Plans have been made to spend \$200,000 on improvements to the shops and yards at Evansville, Ind.

MISSOURI, KANSAS & TEXAS.—It is reported that the construction of shops, engine house, turntable and a water-softening plant at East Waco, Tex., is about to begin.

NASHVILLE, CHATTANOOGA & ST. LOUIS.—It is reported that 35 acres of land have been purchased at Berclair, Tenn., for an engine house, a machine shop and new yards. The property and improvements will cost about \$100,000.

NEW ORLEANS, MOBILE & CHICAGO.—A new 12-stall engine house and an 80-ft. turntable will be built at Laurel, Miss. The company's force will do the erecting.

NEW YORK CENTRAL & HUDSON RIVER.—A contract has been let to the Lackawanna Bridge Company for the construction of a car shop at West Albany, N. Y.

NORFOLK & WESTERN.—An 85-ft. addition will be made to the erecting shop at Roanoke, W. Va., and traveling cranes will be installed.

NORTHERN PACIFIC.—This company will receive bids for a 37-stall engine house, a machine shop, car shop, supply house, coal bunker, ice house and storehouse for Parkwater, Wash.

PERE MARQUETTE.—This road is planning on building a large engine house at Ludington, Mich.

QUEEN & CRESCENT.—Plans have been completed for additions to the shops of this road at both Ludlow, Ky., and Somerset.

SOUTHERN PACIFIC.—The machine shops at Tucson, Ariz., will be rebuilt at a cost of \$300,000.

UNION PACIFIC.—It is reported that the shops at Denver, Col., will be enlarged.

SUPPLY TRADE NOTES

E. M. Richardson has been elected a director of the Chicago Pneumatic Tool Company, Chicago, to succeed Oliver Wrenn.

S. S. Knight has been elected vice-president and general manager of the Scullin-Gallagher Iron & Steel Company, St. Louis, Mo.

Thomas M. Gallagher, formerly a vice-president of the Scullin-Gallagher Iron & Steel Company, St. Louis, Mo., died at his home in St. Louis on February 1.

Prindle & Wright, counsellors-at-law, who have made a specialty of patent practice, have removed their offices to the Trinity building, 111 Broadway, New York.

Oscar R. Ford, general eastern manager of the Chicago Varnish Company, Chicago, with office in New York, died at his home in New York on February 8 at the age of 74.

Coleman B. Ross, formerly with the Linde Air Products Company, Buffalo, N. Y., has gone to the Independent Pneumatic Tool Company, Chicago, with office in Pittsburgh, Pa.

The office of E. A. Craig, southeastern manager of the Westinghouse Air Brake Company and the Westinghouse Traction Brake Company, has been moved from Wilmerding, Pa., to Pittsburgh.

The Independent Pneumatic Tool Company, Chicago, has secured larger floor space in the Farmers' Bank building, Chicago. The old office was at 1426, and the new office is located at Nos. 1208 and 1209.

Howard W. Evans, formerly general sales manager of the Crane Company, Chicago, has been made general sales manager of the Best Manufacturing Company, Pittsburgh, Pa., makers of pipes and pipe fittings.

L. A. Darling, formerly chief engineer of the R. G. Peters Manufacturing Company, Grand Rapids, Mich., has gone to the Remy Electric Company, Anderson, Ind., as engineer of the locomotive headlight department.

Taylor & Arnold, Ltd., Montreal, Can., has become the sole representative in Canada of the American electric headlight equipment for locomotives, a product manufactured by the Remy Electric Company, Anderson, Ind.

C. K. Lassiter, mechanical superintendent of the American Locomotive Company, has purchased a controlling interest in the Banshe Machine Tool Company, Springfield, Mass. Mr. Lassiter will not assume active control at present.

H. F. Wardwell has resigned as superintendent of power and equipment of the Chicago & Western Indiana and the Belt Railway of Chicago to become assistant manager of the Central Locomotive & Car Works, with office at Chicago.

The H. W. Johns-Manville Company, New York, has acquired the sole selling agency for the entire products of I. P. Frink, New York, manufacturer of Frink reflectors and fixtures, and is now in a position to design and sell lighting systems for all forms of artificial illumination.

The Locomotive Equipment Company, Detroit, Mich., has been incorporated with a capital of \$350,000. This company will manufacture a new type of journal box and driving box, and a patented superheater for locomotives. Those interested in this company are Charles R. Richardson, Edward Smith and John A. Ott.

A. L. Whipple, for some years in the railway supply business, and for the last two years president and general manager of the Whipple Supply Company, New York, has resigned, and the company has been dissolved. Mr. Whipple will continue in the railway supply business with the Ward Equipment Company, New York.

J. Howard Mitchell, one of the founders of the William Butcher Steel Works, which was afterward the Midvale Steel Works, Nicetown, Pa., and senior member of the firm of Philip S. Justice & Company, Philadelphia, Pa., dealers in railway supplies, died on February 6 at his home at Hatboro, from a general breakdown, due to old age.

Frank F. Coggin, for several years representative of the Chicago Car Heating Company in New England territory, and who for the past six months has been connected with the Ward Equipment Company, New York, has returned to his former position with the Chicago Car Heating Company, with headquarters at 170 Broadway, New York.

The Western Steel Car & Foundry Company, Chicago, has purchased the plant and property of the Illinois Car & Equipment Company, occupying about 100 acres at Hegewisch, Ill. The company has occupied the property since 1902 under lease, and is now exercising its option to purchase.

At the annual meeting of the stockholders of the Niles Tool Works Company, Hamilton, Ohio, held January 30, the following officers were re-elected: James K. Cullen, president; George T. Reiss, vice-president; James L. Blair, secretary; Miles T. Watts, assistant secretary; Charles Cornell, treasurer, and Lucius B. Potter, assistant treasurer.

Charles Booth, who has been connected with the Chicago Pneumatic Tool Company, Chicago, since its organization, has been made district manager of the company's New England territory, with office in Boston, Mass., succeeding J. M. Towle, resigned. Mr. Booth was a vice-president of the company until September 1, 1911, when he resigned on account of ill health.

Edward Worcester, Jr., formerly district sales manager of the National Tube Company, Pittsburgh, Pa., at Atlanta, Ga., has been transferred to the St. Louis, Mo., office, vice Edward A. Downey, deceased. H. P. Nelson of the St. Louis, Mo., office has been transferred to the Atlanta, Ga., office. R. R. Lally, Jr., has been transferred from the Pittsburgh, Pa., office to the St. Louis, Mo., office, succeeding Mr. Nelson.

L. H. Mesker, who has heretofore been connected with the Cleveland, Ohio, branch of Manning, Maxwell & Moore, New York, has been appointed manager of the St. Louis, Mo., branch, with office in the Frisco building, succeeding C. L. Lyle, resigned. Frank P. Smith, who was formerly connected with the sales department, has again become associated with the railway department. C. L. McCullough, formerly connected with the Packard Motor Car Company, Detroit, Mich., has joined the sales organization, and will make his headquarters in Detroit.

The Eagan-Rogers Steel & Iron Company has been incorporated in Pennsylvania, with \$100,000 capital. It has acquired a five acre tract on the Pennsylvania Railroad between Crum Lynne, Pa., and Eddystone, and is now erecting steel buildings, the contract for which has been let to the McClintic-Marshall Construction Company, Pittsburgh, Pa. The company will make light steel castings weighing up to 200 lbs., in addition to grey iron castings and other specialties. Steel made by the electric process will be furnished, as the company has obtained American rights for a successful process now in use in England. The principals are Daniel C. Eagan and John I. Rogers.

Charles B. Jenks, western sales manager of the Standard Coupler Company, New York, has been made sales manager for Edwin S. Woods & Company, Chicago. Mr. Jenks was for eight years employed in the traffic department of the Pennsylvania Railroad, and for six years was in the engineering and construction department of the Atlantic Refining Company, Philadelphia, Pa. In 1892 he went to the Pressed Steel Car Company, Pittsburgh, Pa., and for two years was in the operating department as assistant to the vice-president at Pittsburgh. For the next five years he was in the sales department at Chicago. In 1909 he

resigned to go to the Standard Coupler Company as western sales manager.

Charles Haines Williams, of the Chicago Railway Equipment Company, Chicago, was elected third vice-president of the company at its recent annual meeting. Mr. Williams was educated



Charles Haines Williams.

in the public schools of Baltimore, Md., and at the Baltimore Polytechnic Institute, from which he was graduated in 1893, and also took a special course in mechanical drawing and machine design at the Maryland Institute, and several private courses in different branches of engineering. He spent four years as special apprentice in the Mount Clare shops of the Baltimore & Ohio, working in the machine and locomotive shops, the erecting shops and in the foundry, drawing room and test departments. He left the Baltimore & Ohio to

become connected with the Chicago Railway Equipment Company as mechanical inspector.

Francis H. Stillman, president of The Watson-Stillman Company, New York, died suddenly on February 18 of intestinal hemorrhage at his home in Brooklyn, N. Y. Mr. Stillman was



Francis H. Stillman.

born in New York on February 20, 1850, and was graduated from the Sheffield Scientific School, Yale University, in the class of 1874. In 1883 he organized and became president of the firm of Watson & Stillman. The firm was incorporated in 1904 as The Watson Stillman Company, Mr. Stillman remaining its president up to the time of his death. He was a member of the Hanover Club of Brooklyn, the Engineers' Club, the American Society of Mechanical Engineers, and treasurer and, continuously throughout its existence,

a director of the National Association of Manufacturers. He organized and was first president of the Machinery Club of New York, and was also first president of the National Metal Trades' Association. In addition to being president of The Watson-Stillman Company at the time of his death, he was also president of the Bridgeport Motor Company, Bridgeport, Conn., and of the Pequannock Commercial Company, and a director in other manufacturing firms.

George A. Post, Jr., has been made western sales manager of the Standard Coupler Company, New York, with office in Chicago, succeeding Charles D. Jenks, resigned to engage in another business. Mr. Post was graduated from Cornell University with

the degree of mechanical engineer in 1905. He began work in the Westinghouse Machine Company's works in Wilmerding, Pa., and was in its New York sales office for a year and a half, after which he entered the employ of the Standard Coupler Company in its sales department. Upon the organization of the Railway Business Association he was appointed assistant to the president, which position he held for two years; he has had personal charge of the business details of the dinners of that association. A year ago he returned to the service of the Standard Coupler Company as eastern sales manager.

William V. Kelley has resigned as president of the American Steel Foundries, an office he has held since 1905, and has been elected chairman of the company, a newly-created position, with



William V. Kelley.

office at Chicago. Charles Miller retains the position of chairman of the board of directors. Robert P. Lamont, who has been first vice-president of the company since 1905 was elected president in place of Mr. Kelley. Mr. Kelley's retirement as president was due to a desire to obtain relief from some of the responsibilities of active office in view of his extensive other interests. George H. Scott, second vice-president of the company, will be promoted to first vice-president, succeeding Mr. Lamont. R. H. Ripley, third vice-president, will

be advanced to the second vice-presidency, and Warren J. Lynch, fourth vice-president, to the office of third vice-president. Mr. Kelley was born at Gratis, Ohio, February 13, 1861, received a high school and commercial education, and began his business career as clerk and bookkeeper in a hardware store at Springfield, Ohio, in 1883. From 1885 to 1888 he was sales agent of the



Robert P. Lamont.

Springfield Malleable Iron Company, and from 1888 to 1897 of the Charles Scott Spring Company, Philadelphia, Pa. In 1897 he organized the Simplex Railway Appliance Company, of which he became president and treasurer. In January, 1905, the stock of this company was sold to the American Steel Foundries, and in August Mr. Kelley was elected president of that company, holding the office until his recent election as chairman of the company. He is also a director of the Allis-Chalmers Company, the Continental and Commercial National Bank and the South Side Elevated Railroad, Chicago. Robert Patterson Lamont was born at Detroit, Mich., December 1, 1867, and was graduated from the University of

Michigan with the degrees of B. S. and C. E. in 1891. After leaving college he was employed at the World's Columbian Exposition in 1891 and 1892. From 1892 to 1897 he was secretary and engineer of Shailer & Schinglan, a contracting company. From 1897 to 1905 he was associated with Mr. Kelley as first vice-president and a director of the Simplex Railway Appliance Company, and in 1905, when Mr. Kelley became president, he was made first vice-president of the American Steel Foundries.

Plans are being made for a formal opening of the Permanent Manufacturers' Exhibit of Railway Supplies and Equipment in the Karpen building, 900 South Michigan boulevard, Chicago, during the week beginning March 16. Nearly 50,000 invitations will be sent out to railway and supply men, and admission tickets may be obtained from V. Courtright, secretary. The exhibit booths occupy 36,000 sq. ft. of space, or the entire twelfth floor of the building. A large assembly room and committee rooms, handsomely furnished, as well as a club room for the use of the exhibitors have been located on the eleventh floor. Invitations have been extended to a large number of railway associations to make use of the assembly and committee rooms free of charge for their meetings, and several organizations have the matter under consideration.

Samuel T. Fulton, western manager of the Railway Steel-Spring Company, New York, with office at Chicago, has been appointed general sales agent of the company, with office at New York, effective March 1. The greater part of Mr. Fulton's career has been in the railway service, and he enjoys a wide acquaintance among both railway and supply men. He was born January 11, 1866, at Topeka, Kan., and after being educated in the public schools entered the railway service July 1, 1879, as messenger in the telegraph office of the Kansas Pacific at Topeka. He was telegraph operator and agent at various stations on the Kansas Pacific and Union Pacific, and for two years was telegraph operator for the Western Union Telegraph Company at Topeka. In 1885 he became secretary to the superintendent of machinery of the Atchison, Topeka & Santa Fe; in 1888 secretary to the general superintendent at Chicago; in 1889 train dispatcher of the Chesapeake & Ohio, and in 1890 he was made secretary to the freight traffic manager of the Cleveland, Cincinnati, Chicago & St. Louis. In 1891 he became stenographer to the chairman of the Central Traffic Association at Chicago; in 1892 secretary to the freight traffic manager of the Kansas City, Ft. Scott & Memphis; in 1893 chief clerk to the general superintendent; in 1895 chief clerk to the president and general manager, and in 1899 assistant to the president of that road. In August, 1901, he became chief clerk to the vice-president and general manager of the St. Louis & San Francisco at St. Louis, and from January, 1902, to February, 1903, was general manager of the Crowe Coal & Mining Company of Kansas City. In 1903 he returned to railway service as assistant to the vice-president of the St. Louis & San Francisco, and in April, 1904, was appointed assistant to the president of the Chicago, Rock Island & Pacific at Chicago.



Samuel T. Fulton.

CATALOGS

DRILLS.—The Cleveland Twist Drill Company, Cleveland, Ohio, has published an effective folder on Paragon Flatwist drills. The special feature of the folder is the reprint of an article on tests made with this drill at the M. M. and M. C. B. convention last June.

FRICTION CLUTCHES.—The Carlyle Johnson Machine Company, Manchester, Conn., has published a booklet entitled *The Johnson Friction Clutch as Applied in Machine Building*. The booklet includes illustrations of various machine tools which have been equipped with these clutches.

GRINDING WHEEL SAFETY.—The Norton Company, Worcester, Mass., has published an interesting booklet entitled *Safety as Applied to Grinding Wheels*, describing and illustrating modern preventive and protective safeguards which may be easily applied in the use of grinding wheels and machines.

LOCOMOTIVE ACCESSORIES.—The Locomotive Improvement Company, Clinton, Ohio, has issued catalog No. 2, describing Markel's removable driving box brasses, lateral motion plates, flangeless shoes and wedges and solid head main rods. The recent improvements in these articles are considered in the pamphlet.

CAR SPECIALTIES.—The General Railway Supply Company, Chicago, has issued a 22-page pamphlet giving a general description and illustrations of various special devices used in passenger cars. They include metal sheathing, car insulation, vestibule trap doors, floor covering, curtain and window fixtures, and car roofing.

AUTOMATIC STARTING CONTROL.—The Reliance Electric & Engineering Company, Cleveland, Ohio, has published bulletin No. 7010 on automatic starting control, in which the advantages of this method as a power saver are pointed out. Illustrations include various machine tools which have been equipped with this device.

DRAFT RIGGING.—The T. H. Symington Company, Baltimore, Md., has issued a new booklet illustrating and describing the Farlow draft rigging. The best method of assembling is illustrated and described for the benefit of car foremen and others interested in the proper application of the draft rigging to the car frame.

CHAINS.—The Morse Chain Company, Ithaca, N. Y., has published bulletin No. 11 on the Morse silent chain. This chain is described in detail and illustrated by photographs and diagrams. An interesting comparison between rope and chain drive is included. On the last page of the bulletin data is given to be used in the design of the Morse silent chain drive.

TURBO-GENERATOR SETS.—The General Electric Company, Schenectady, N. Y., has published bulletin No. 4887 on Small Turbo-Generator Sets in capacities of from 5 to 300 k.w. All of these sets are of the horizontal type and may be arranged to operate either condensing or non-condensing and at any steam pressure above 80 lbs. for the smaller sizes and 100 lbs. for the larger.

DRILLS.—The Morse Twist Drill Company, New Bedford, Mass., has published a 350-page catalog, illustrating and giving the prices and dimensions of its twist drills, reamers, chucks, milling cutters, taps, machinists' tools, etc. A separate pamphlet published by this company illustrates and describes a new indexed case for drills from which the proper size drill can be quickly selected.

ELECTRIC HOISTS.—The Sprague Electric Works (New York) of the General Electric Company has devoted a small illustrated booklet to the advantages and illustrations of the various types of Sprague electric hoists for handling loads which, on account of their location, are inaccessible to the ordinary traveling crane, or which are too small to be economically handled by such a large and expensive machine.

AMERICAN ENGINEER

"THE RAILWAY MECHANICAL MONTHLY"

'Including the Railway Age Gazette "Shop Edition."

PUBLISHED ON THE FIRST THURSDAY OF EVERY MONTH, BY THE
SIMMONS-BOARDMAN PUBLISHING COMPANY,
83 FULTON STREET, NEW YORK, N. Y.

CHICAGO: Plymouth Bldg. CLEVELAND: New England Bldg.
LONDON: Queen Anne's Chambers, Westminster.

EDWARD A. SIMMONS, *President.* HENRY LEE, *Secretary.*
L. B. SHERMAN, *Vice-President.* A. E. HOOVEN, *Business Manager.*

The address of the company is the address of the officers.

ROY V. WRIGHT, *Editor.* R. E. THAYER, *Associate Editor.*
E. A. AVERILL, *Managing Editor.* WILLIAM FORSYTH, *Associate Editor.*
GEORGE L. FOWLER, *Associate Editor.*

Subscriptions, including the eight daily editions of the *Railway Age Gazette* published in June in connection with the annual conventions of the Master Car Builders' and American Railway Master Mechanics' associations, payable in advance and postage free:

United States, Canada and Mexico \$2.00 a year
Foreign Countries (excepting daily editions)..... 3.00 a year
Single Copy 20 cents

Entered at the Post Office at New York, N. Y., as mail matter of the second class.

VOLUME 86. APRIL, 1912. NUMBER 4.

CONTENTS

EDITORIALS:

| | |
|---|-----|
| More Information on Blue Prints..... | 163 |
| Finishing Driving Boxes..... | 163 |
| Beech Grove Car Shops..... | 163 |
| Treated Lumber for Cars..... | 164 |
| All-Steel Box Cars..... | 164 |
| Brake Shoe Tests..... | 164 |
| Service Results of Locomotive No. 50,000..... | 164 |
| Safety Competition..... | 165 |
| Electrification of Steam Roads..... | 165 |
| New Books..... | 165 |

ILLUSTRATED:

| | |
|--|-----|
| Passenger Car Shops at Beech Grove, Ind..... | 167 |
| Machine Shop Kinks..... | 176 |
| Santa Fe Million Pound Dynamometer Car..... | 181 |
| Shop Kinks..... | 188 |
| Powerful Pacific Type Locomotive..... | 189 |
| Air Brake Kinks..... | 191 |
| Paint Storeroom Practice..... | 192 |
| All-Steel Box Cars..... | 193 |
| Erecting Shop Kinks..... | 197 |
| Enclosed Observation Platform..... | 198 |
| Locomotive Feed Water Heater..... | 199 |
| Inspecting Side Bearing Motion..... | 200 |
| Flange Press Work in Railway Shops..... | 201 |
| Horizontal Boring, Drilling and Milling Machine..... | 204 |
| Electric Locomotive Hoist..... | 205 |
| Pipe Threading and Nipple Machine..... | 206 |
| Improved Headlight Turbine..... | 206 |
| Gold's Ideal Pressure Regulator..... | 207 |
| All-Geared Sliding Head Drill..... | 208 |
| New Muffled Pop Valve..... | 208 |

MISCELLANEOUS:

| | |
|------------------------------------|-----|
| Protective Coatings..... | 179 |
| Superheated Steam Lubrication..... | 187 |
| Hints to Draftsmen..... | 196 |

GENERAL NEWS SECTION:

| | |
|-------------------------------|-----|
| Notes..... | 209 |
| Meetings and Conventions..... | 210 |
| Personals..... | 211 |
| New Shops..... | 214 |
| Supply Trade Notes..... | 215 |
| Catalogs..... | 216 |

Our readers are requested to note that the date of publication has been changed to the first Thursday in the month. This means that the paper will be mailed on the preceding Wednesday night and that it should be delivered to cities near the office of publication on the next day. However, because of the action recently taken by the post office department whereby the papers are carried over certain districts by freight instead of entirely by fast mail, as formerly, some delay in the delivery of the paper is to be expected by those subscribers at a distance from New York. If too great a period occurs between the time of publication and the delivery of the paper we would suggest that you take the matter up with your postmaster, and also notify this office.

More Information on Blue Prints

It has been suggested that the standard practice, particularly in the case of wear limits, be placed in clear language on the blue print of the part affected, so that this information would be available to the workman. This is an excellent suggestion, and while men who are steadily engaged on the same job generally carry such information in their heads, there is no reason why it should not be on the blue print and thus avoid the danger of any misunderstanding or mistake. It would relieve the foreman of considerable trouble in many cases, and would frequently prevent useless machine work. This practice would be particularly applicable to the wear limits for axles, crank pins, piston rods, cylinder bores, piston head clearances and driving wheel tire thickness.

Finishing Driving Boxes

The competition on the best method of finishing driving boxes closes on May 1. A prize of \$25 will be awarded for the method that is judged to be the best. This is one of the most important jobs in the shop, and one to which many shop superintendents have given careful study. In awarding the prize full consideration will be given to any unusual handicaps, if you make them clear in your description. Simply furnish a statement of facts giving detailed particulars for each step of the work, blue prints or photographs of any special tools or equipment used, and a record of the time required for each part of the work. There is still plenty of time for you to prepare the matter before the closing date, if you start to work on it at once. A more extended announcement of the contest will be found in our March issue.

Beech Grove Car Repair Shops

The second stage toward the completion, as originally planned, of the repair shops of the Big Four at Beech Grove, Ind., was marked by the recent transfer of all coach repairs to that point. The next step will be the erection of freight car repair shops and of the locomotive terminal, which will take place when the large classification yards to be located here are installed. The new coach shop at Beech Grove provides practically perfect facilities for repairs to this class of equipment. The manner in which crane service is provided to meet all reasonable requirements, but without extravagance either in the equipment or structure, is particularly interesting. Cranes are available for lifting car bodies, handling and transporting trucks, large sills, wheels, underframe castings, and in fact all heavy parts, and still they serve less than half the floor area of the building. A study of the whole plant develops but one possible point of criticism, and that is in the placing of the cabinet shop on the second floor of the planing mill, which necessitated extremely heavy steel work in the roof trusses to give a clear floor area on the first floor. It would hardly seem that the advantages of having the cabinet shop in this location were sufficient to justify this expense, particularly at a point where there is

little restriction imposed by the value of the land. To be sure the present arrangement is very satisfactory, but the disadvantages of having this shop as an extension either on the planing mill or coach shop would hardly seem great enough to warrant this expense. The facilities provided for repairs to tenders in the new tank, cab and pilot shop are probably not surpassed at any point in the country and a building of this kind would undoubtedly prove a source of economy at many other shops. The same thing also applies to the wheel shop, which is so located as to give storage room on all sides and direct transportation to and from each to any desired point about the shops.

Treated Lumber for Cars

Decay is an important factor in the life of the underframe, floors and posts on certain classes of wooden freight equipment, particularly stock cars. While timbers treated with a preservative have occasionally been used in small amounts in car construction, the Chicago, Burlington & Quincy is the first company to go into the matter extensively, and is now using the creosote zinc chloride or "Card" process for the sills and flooring of a thousand stock cars being built at its Aurora, Ill., shops. The sills are of Oregon fir, and the floors of Norway pine, and it is stated that the cost of treating the lumber for one car is but \$7. The treating is being done at the tie treating plant at Galesburg, Ill. The disadvantages of the treated lumber to the workmen are overcome by the use of mittens when handling it, and by goggles to protect the eyes when nailing. It would seem that the same process would also be applicable to certain classes of gondola cars, and while the creosote method could not be used for box or refrigerator cars, it is possible that some other preservative that would not affect the lading could be found which could be applied to the timber for such cars.

All-Steel Box Cars

All-steel box cars have been considered for several years, and two or three experimental cars of this type have been built. It has remained for the Bessemer & Lake Erie to take the first important step in introducing such equipment, and that road has recently ordered 100 of these cars, similar to a sample car which was constructed a couple of years ago by the Summers Steel Car Company of Pittsburgh, Pa. The sample car has given very good satisfaction, and no difficulty has been encountered because of moisture condensing on the inside of the car and damaging the lading. In one instance a consignment of tin plate was carried from Pittsburgh to the Pacific coast during the spring season without any damage to it; in fact, it is said to have been received in better condition than similar consignments which were carried in wooden cars. These cars will undoubtedly have higher temperatures inside during the hot weather than the wooden cars. There is a question, however, as to whether the heat will be great enough to cause any damage, and if it does, means will undoubtedly be found for using some sort of insulation on the inside of the roof and sides of the car above the wooden lining. It is estimated that at the present prices of wood and steel the all-steel car can be built in competition with the wooden one, either with or without a steel underframe, and if the price of lumber should increase at a faster rate than that of steel, and it undoubtedly will, it is quite possible that it will prove economical to introduce such cars extensively.

Probably the most difficult problem in connection with the introduction of these cars will be to provide a truck of sufficient flexibility and so designed that the weight on it will be equally distributed on all four wheels at all times. A rigid car body placed on the ordinary type of freight car truck is liable to cause considerable expense and inconvenience due to derailments. Realizing this, and that the steel box car will not prove a success with the

ordinary truck, Mr. Summers has developed a special truck which is deserving of the most careful consideration. New refrigerator cars, which have a far more rigid construction than box cars, frequently give trouble from derailments, and undoubtedly this could be largely overcome by the application of a truck such as Mr. Summers proposes to use under the steel box cars.

Brake Shoe Tests

An extensive series of tests has been made during the past year by the Brooklyn Rapid Transit System to determine what type of brake shoe would give the best results on its cars. The conditions of service on this road differ so radically from those on steam roads that the conclusions from the tests do not apply to the latter. Nevertheless several important features were developed which are worthy of consideration by the steam railway men. For instance, it was demonstrated that the harder the brake shoe the longer its life and the lower its co-efficient of friction. The softer shoes, however, did not wear the wheels nearly so much, so that taking into consideration both the brake shoe wear and the wheel wear it was a question which shoe it was best to use. If the brake shoes are purchased on the basis of a fixed price per 1,000 car miles it would be possible to pay between 15 and 20 cents more per 1,000 car miles for the plain cast iron shoe than for the one with the chilled ends. George L. Fowler, who was in charge of the tests, stated in his report that the ideal scrap weight of the surface car shoes should be about 30 per cent. of the weight when new and 25 per cent. for the shoes used on the elevated railway cars. This condition is possible of attainment where the foundation rigging is in good condition and the shoes are of a uniform texture, but if the head of the shoe is tilted so that the scrap shoe is thicker at one end than the other, the additional metal which it is necessary to scrap amounts to from 10 to 20 per cent. of the weight of the shoes when new, thus adding a corresponding amount to the cost of the shoe.

Service Results of Locomotive No. 50,000

Number 50,000, the experimental Pacific type locomotive built by the American Locomotive Company to determine the limits to which the efficiency and capacity of a passenger locomotive of standard wheel arrangement could be developed, has been in use on the New York and Delaware divisions of the Erie during the past winter. Between November 17, 1911, and February 25, 1912, a period that included the most severe weather conditions, this engine made 170 runs with trains that averaged nine cars, and frequently had eleven or twelve cars. During this time it made schedule speed or better on 163, or 96 per cent. of the trips. The railway company's performance sheets show that the locomotive made up 1,379 minutes, or an average of 8 minutes per trip, and on the 7 trips when it lost time there were contributory causes for delays for which the locomotive could not be held responsible. There are long heavy grades in both directions on these divisions and sharp curves are numerous. The schedule speed of trains No. 5 and 6, to which No. 50,000 was assigned, is 35 miles per hour, including frequent stops, and there is a rigidly enforced rule limiting the maximum speed to 60 miles per hour. The capacity of the locomotive is possibly best illustrated by the service during the coldest days in January, from the 5th to 8th, when in 8 runs it made up a total of 120 minutes, or an average of 15 minutes per trip in a distance of 193 miles with 9-car trains. While there is nothing particularly spectacular about this performance, it clearly indicates the value of surplus power. Any locomotive that can make up 15 minutes per trip with a 9-car train during the coldest day of last winter is a big asset to the company owning it. A fully illustrated description of No. 50,000 appeared on page 5 of the January issue of the *American Engineer*.

Safety Competition

Railways and industrial organizations have awakened to the necessity of giving more attention to the safety and welfare of their employees. Several roads have adopted the slogan of "safety first," and considerable attention has been given to safeguarding the machines in the shops and of taking measures for the prevention of accidents in engine houses and car repair yards. A prize of \$25 will be awarded for the best article on the subject which is received before June 1. The article may consist either of detailed descriptions of a device or devices which have been provided for safeguarding tools and protecting the workmen, or of methods which have been used or may be used to awaken the employees to a realization of their part in the campaign. This competition has been suggested by one of our readers, and the following is an extract from his letter and may suggest methods of treating the subject which may appeal to some of our readers. "Another interesting competition could be conducted on safety appliances in railway shops, guards around machines—showing how they are made and applied. Or guards under high speed belts to prevent the workmen being hurt when they break. The best system of periodical inspection of safety appliances and machinery, or descriptions of any device or appliance that is used in any way to prevent or eliminate accidents to employees might be considered. Manufacturers of machinery are now compelled to put guards over all gears, as far as possible, and such guards should not be considered in the competition. What we want to know about is the home made guards and protections." Articles which are not awarded the prize, but which are accepted for publication, will be paid for at our regular space rates.

Electrification of Steam Roads

The problem of electrifying steam roads was given considerable attention during March, it being the subject of a paper by William J. Clark, of the General Electric Company, before the Franklin Institute of Philadelphia, as well as the subject for discussion at the New York Railroad Club meeting. The most important point developed by Mr. Clark was that the problem of handling traffic over heavy grades or mountainous districts might be solved far more advantageously by electrifying such divisions, rather than by going to heavy expense in eliminating the grades, or by introducing extremely heavy and powerful motive power. An instance was cited of a proposed western railway, about 160 miles long, located in a mountainous district. The surveys were made, one for grades which would permit of steam operation, and another for grades which could easily and economically be operated by electricity. The engineers estimated a saving in favor of electricity on 6½ miles of the proposed line which would more than cover the expense of electrifying the entire 160 miles. They also estimated that the expense of operating by electricity would be less than for operating by steam.

The New York Railroad Club meeting was what is known as the annual electrical night. The most important feature of the meeting was that the electrical engineers, now that they have had several years experience with electrification, are not quite so sure that it can be universally applied to steam railways as they were a few years ago. There is no question but what electrification is a desirable feature under many conditions, but the great first cost of electrifying will stand in the way of its being adopted, particularly where there is any question as to the possibility of sufficient new business being developed to off-set the additional financial burden which will be imposed.

George Gibbs, electrical engineer of the Pennsylvania Railroad, gave some data concerning the first year's electrical operation of the Pennsylvania at the New York terminal. The main line from Harrison to the terminal station is about nine miles long. Of this 6½ miles are on the level and the rest of the line through the tunnels and its approaches has some very heavy grades. The

service is largely handled by electric locomotives. The tunnel is much drier than was anticipated, and there is therefore a better factor of adhesion. The locomotives have made a total of 909,000 miles during the year, of which 650,000 miles was road service, while the remainder was for switching and transfer. The locomotives averaged 26,000 miles for the year, and the service was entirely satisfactory. The cost of repairs per mile run was 5.91 cents. This is greater than was expected and was largely due to the cost of maintenance of the brake shoes, to tire turning, and to a number of structural changes which it was necessary to make after the locomotives were placed in service. On the New Jersey division the cost of repairs to steam locomotives was 8.83 cents per mile, while for the Pennsylvania as a whole the cost was 11.91 cents per mile. The lubrication of electrical locomotives cost .25 cents per mile, or about the same as for the steam locomotives. The engine house expense for the electric locomotives amounted to .58 cents per mile, while for steam locomotives on the Pennsylvania it amounted to 2.58 cents per mile. The important savings were, therefore, in the repairs and the engine house expenses. The electric locomotives are given a daily inspection and after every 2,500 miles run are given a detail inspection which requires about four hours' time. When the electrical operation was first started the locomotives were given a detail inspection after every 800 miles, but this has been gradually increased to 2,500, as the reliability of these locomotives has become more evident. There were only 16 failures of electric locomotives during the year, and for the multiple unit trains, which made about 300,000 miles, there were only three detentions.

NEW BOOKS

Proceedings of the Forty-Fifth Annual Convention of the Master Car Builders' Association, held at Atlantic City, N. J., June, 1911. 800 pages. Cloth. Published by the association, J. W. Taylor, secretary, 390 Old Colony building, Chicago. Price, \$7.50.

Beyond doubt there is no association in the mechanical department of railways whose work has as far reaching and important effect as the Master Car Builders' Association. Each convention makes distinct progress in some important particular, as well as many improvements in minor affairs. Probably the most important work done at the last convention was in connection with the new design of coupler and of the action on safety appliances. This volume contains the full account of the reports and discussions, as well as the standards of the association, list of members, committees to report in 1912, constitution, by-laws, etc.

The Signal Dictionary, Second Edition. Revised by A. D. Cloud, editor of the *Signal Engineer*, and H. H. Simmons, associate editor, *Railway Age Gazette*. 9 in. x 12 in. 566 pages; 3,899 illustrations. Published by the *Railway Age Gazette*. Distributed by the McGraw-Hill Publishing Company, New York. Price, leather, \$6; cloth, \$3.50.

The Railway Signal Association Signal Dictionary, first published in 1908, has been revised and published in the second edition under the supervision of a committee of the association. The aim in revising the book, as stated in the preface, has been to "retain descriptions and illustrations of apparatus which, although no longer made, is and will remain for some time in rather extensive use, as well as to reflect the latest work of the manufacturers." That the book is not merely a catalog of manufacturers' devices is shown, however, by the fact that it contains practically all of the standards of the Railway Signal Association and a great many standards adopted by the signal departments of prominent railways of this country and England. Another change which will be found almost as valuable as the addition of up-to-date apparatus and standards is the rearrangement of the material in a form which is intended for ready reference. The definition section, or dictionary proper, was amplified considerably with special attention to the terms used in connection with alternating current apparatus, and the whole sec-

tion was revised and brought up to date. All definitions which can be illustrated by the figures in the descriptive part of the book are referred to by their figure numbers. The descriptive part of the book is divided into five sections, which are clearly marked by title pages and subdivided to arrange each branch of the subject under distinct headings, and a complete cross reference index is added. The divisions of the descriptive part are: Signal symbols and signal indications; block signaling; interlocking; highway crossing signals, and accessories. The last-named division contains 18 subdivisions, in which the apparatus and devices used in railway signaling are illustrated and described.

Proceedings of the Forty-Fourth Annual Convention of the American Railway Master Mechanics' Association, held at Atlantic City, N. J., June, 1911. 516 pages. Cloth. Published by the association, J. W. Taylor, secretary, 390 Old Colony building, Chicago. Price, \$2.50.

Reports and papers on the following subjects presented at the last convention are given in full in this volume: Mechanical stokers; smoker consuming devices for terminals; construction of locomotive frames; main and side rods; formulae for designing piston rods and crossheads; equipment for engine houses; best method of treating feed water when water treating plants are not practicable; lubrication of locomotive cylinders; locomotive performances under different degrees of superheated steam; safety appliances; design, construction and inspection of locomotive boilers; contour of tires; flange lubrication and standards. Full specifications and drawings of the standards of the association are included in the volume; also the list of members and their addresses, the committees and subjects for the next meeting, and the constitution and by-laws of the association.

Proceedings of the Nineteenth Annual Convention of the Traveling Engineers' Association, held at Chicago, August 29-September 1. 495 pages. Flexible covers. Published by the association, W. O. Thompson, secretary, Buffalo, N. Y. Price, \$1.50.

In the selection of subjects and the character of the discussion the members of this association indicate that they propose to obtain all the real benefit possible from the time spent at the conventions. More real valuable information will be found in these proceedings on the subjects discussed, expressed clearly and frankly, than is available from any other source. Reports and papers on the following subjects were presented: Actual demonstration vs. oral instruction in air brake operation; value of practical instruction on fuel economy; lubrication of high pressure and superheater locomotives; efficient handling of the electric locomotive; development and improvement in automatic stokers; Mallet compound locomotives in road service; benefit from chemically treated feed water, and benefits derived from the use of the brick arch. The volume contains a list of the subjects which have been discussed at each of the annual conventions of the association since 1893. There is also a list of the subjects which will be brought up at the next annual meeting.

Forney's Catechism of the Locomotive. Third Edition, Revised and Enlarged. Part I. By George L. Fowler, associate editor *Railway Age Gazette*. 6 in. x 9 in.; 644 pages; 475 illustrations. Bound in cloth. Published by the Simmons-Boardman Publishing Company. Distributed by the McGraw-Hill Book Company, 239 W. 39th street, New York. Price, \$3.

The Catechism of the Locomotive, by M. N. Forney, was probably the best known and most widely studied book on the subject that has ever been published. The first edition was issued in 1873. It was afterwards revised by Mr. Forney, and the second edition was published in 1889. Since that time the methods of locomotive design, construction and operation have been revolutionized and a third revised edition became necessary in order that the book might adequately describe the loco-

motive of today. The preparation of the third edition of the book was intrusted to George L. Fowler, who for many years had been an intimate friend of Mr. Forney and who had been asked by the latter to undertake the work.

The growth of the locomotive in size and the complexity of its details during the past twenty years necessitated the introduction of a great deal of new matter, and the discarding of a little that was old. The years intervening between the appearance of the second and this third edition, have witnessed the rise and partial decadence of the compound locomotive; the birth of the Mallet; the introduction of the superheater; the development of the Atlantic and allied types where the wide firebox is carried by a trailing truck, the use of oil as a fuel; the application of the Walschaert valve gear to American locomotives; the rise of the stoker and the improvements of the air brake, as well as the growth of innumerable details that go for efficiency, to which must be added the great increase in the size and weight of the locomotives of today, as compared with those of two decades ago.

Each of these themes is treated fully, clearly and concisely in the first part of the book under review. But in preparing this matter, it was found "that, with the growth and development of the locomotive during the past two decades, more has been added than taken away, and that the requirements as to space are much greater than they were in 1889. It was, therefore, decided to break the book into two volumes or parts, making each complete in itself. The first part is devoted to the practical construction and operation of the locomotive, with such slight theoretical discussion of the matter as to make it intelligible to men who have not had the advantage of a technical training. The second part will discuss the same points more theoretically."

The first part concerns the presentation of the practical details of locomotive work. There are a few introductory chapters dealing with the elemental laws of force and motion, the steam engine and the expansive action of steam. After this follows descriptions and tables of the various types of locomotives in use; and the various details, such as throttle, cylinders, the machinery, and the Stephenson and the Walschaert valve gears. The valve gears are clearly explained, and at some length, so that their action can be fully understood. The various kinds of compound locomotives, the several types of superheaters and the three stokers upon the market are fully described and their operation explained. Other details, such as the spring suspension, the running gear, tenders, tanks, lubricators and miscellaneous parts receive full attention. A chapter preceding that on mechanical stokers is devoted to the general subject of combustion, where, without entering into too minute detail as to theory, the reader is given a clear-cut idea of how combustion takes place and the method to be pursued to obtain the best results on a locomotive. A special chapter is devoted to the air brake with instructions as to its construction, care and manipulation.

There are 742 questions with their answers in this Part I, and it closes with chapters on the care and inspection of the locomotive, the handling of the machine on the road, the avoidance of accidents and first aid to the injured; and finally a very complete index by which a direct reference may be obtained to any topic in the book. Throughout the text is a profusion of illustrations, to which are added six folding plates of steam engines, valve gears, locomotives and air brakes.

The language is simple, concise and readable. Mathematical demonstrations have been avoided. As it stands it is undoubtedly, the most complete presentation of the subject that has appeared, and is in such a form that no locomotive engineer or fireman, regardless of how scanty may have been his early advantages, can fail to grasp the full meaning of what is there offered. Part II is on the press, and its appearance is promised for an early date.

PASSENGER CAR SHOPS AT BEECH GROVE

All Passenger Car Repairs for the Big Four Will Hereafter Be Made at the New Beech Grove Car Shops. A Special Shop for Tender Work and One for Car Wheels Are Included in the Additions.

When the Beech Grove shops of the Cleveland, Cincinnati, Chicago & St. Louis were started about five years ago, the design provided complete facilities for repairing locomotives, passenger cars and freight equipment. Owing to conditions which developed shortly after the work was started, however, it was decided to erect only the locomotive department buildings at that time and the construction of only five main buildings was undertaken.

During the past few months the shops for passenger car work have been completed and put into operation at Beech Grove and all repairs of this character for the system are now being made at this point. The new buildings erected for this work consist of a coach shop, a paint shop and a planing mill. At the same time the tank, cab and pilot shop, provided for in the original plans, has been built and also

coach shop is parallel to and 75 ft. from the present forge shop abutting the midway crane runway, and the paint shop is parallel to it and 255 ft. away, allowing room for a 75 ft. transfer table and a 90 ft. space between the building and table pit on either side. The miscellaneous shop building will be parallel to the paint shop and 75 ft. from it, this being the minimum distance permitted between buildings. Across the midway from the paint shop is the planing mill which lies with its longest dimension parallel to the cranes. Between it and the power house is to be erected a stock shed for dry lumber and at the opposite end there will be a dry kiln and another dry lumber shed surrounded by the lumber storage yard. All of these buildings are of the same general construction and appearance as those in the locomotive department, having reinforced concrete foundations and curtain



General View of Tank, Cab and Pilot Shop; Machine and Erecting Shop in the Background.

the car wheel shop. While the miscellaneous building in which upholstery, electrical repairs, varnishing, etc., is to be performed, is not yet completed, it is expected that it will be built in the very near future. Work which is eventually to be done in that building is now given temporary quarters in the coach and paint shops.

The buildings just completed are located practically as originally planned. The tank shop is parallel to the boiler shop and adjacent to the opposite end of the erecting shop, being practically the only large building in the group which does not abut on the runways of the midway crane. The wheel shop is located convenient to the car repair tracks and the freight car shops to be erected later. It is also near the proposed location of the foundry and so arranged as to give ample yard room for storage outside of the building. The

walls of Colonial shale brick with slate covered roofs, except in a few flat portions where composition asbestos roofing is used.

TANK, CAB AND PILOT SHOP.

This shop is about 73 ft. wide and 500 ft. long and provides facilities for all repairs to ash pans, tanks, tender underframes, and trucks, as well as the construction of new cabs, pilots and running boards. It is served by a 30-ton double trolley Shaw crane running the full length of the building. The full gage industrial track which passes outside at the end of the locomotive shop and has a turntable connection to the longitudinal tracks entering that shop, as well as connections and turntables giving access to all other parts of the plant, enters this building for a distance of about 30 ft. in the east end. At the opposite end a track from the regular yard

system enters one corner for a distance of about 50 ft. A track leading from the turntable pit also passes through this shop and has a turntable connection with the industrial track passing along the south side of the building, as shown on the general plan on the opposite page.

All metal working tools are located in the end of the building nearest the locomotive shops and here all ash pans are repaired and the plates fabricated for use in repairs to tanks or steel underframes. The machinery in this section, like

the ends. The trestles, shown in one of the illustrations, are built of rails, base upward, set in cast iron pedestals located about six feet apart. Here the tanks are completely repaired and painted. Beyond this is a space which accommodates about 20 underframes which are set on wooden trestles, leaving an aisle in the center and at either end. This accounts for the shop space up to the place where the transverse track from the turntable enters. Beyond this track are four sets of rails imbedded in the floor on which all truck repairs are

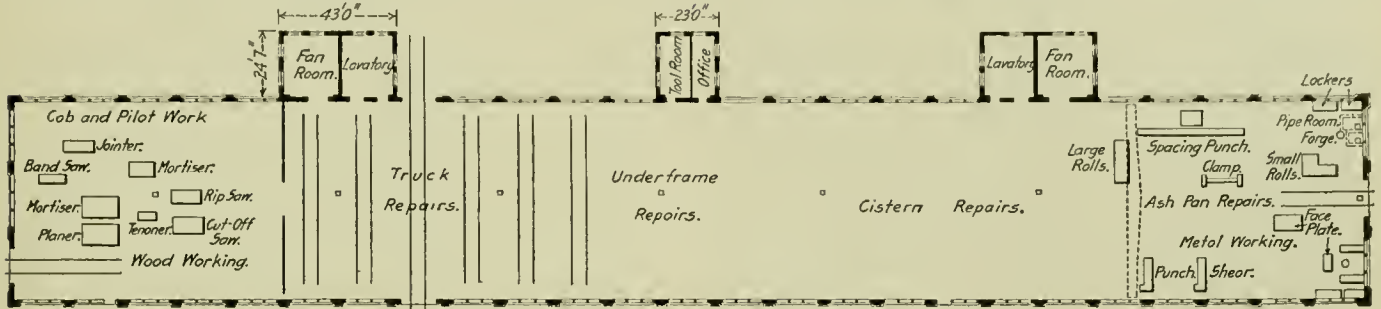

Plan and Tool Location; Tank, Cab and Pilot Shop.

all other constant speed machines in the shop, is driven by direct connected induction motors. The size of machines and motors is given in the following table:

| Machine. | Motor. |
|--|-------------|
| Small rolls | 7 1/2 h. p. |
| Shear, Long & Alstatter No. 2..... | 7 1/2 h. p. |
| Punch, Long & Alstatter No. 2..... | 7 1/2 h. p. |
| Spacing punch, Long & Alstatter No. 2..... | 7 1/2 h. p. |
| Large bending rolls | 7 1/2 h. p. |

In addition there are the open fires, face plates, small flanging clamps and benches required for work of this character. The floor is of concrete throughout the building and ample space is provided for the storage of a sufficient stock of plates, angles, etc.

The ash pans are repaired on the open floor; only those on which actual work is being performed are within the building; those waiting for repairs are stored outside alongside the entering track. The sheets and angles are sheared, punched and formed on the different machines and riveting is done with an air hammer. A jib crane with a chain hoist

made. Following this are racks for bolts and standard truck parts and beyond is the wood working department in which the following machines are located:

| Machine. | Motor. |
|---|----------|
| Cross cut saw, Fay & Egan..... | 20 h. p. |
| Rip saw, Fay & Egan..... | 10 h. p. |
| Planer, Fay & Egan..... | 15 h. p. |
| Band saw, Fay & Egan..... | 5 h. p. |
| Hollow chisel mortiser, Fay & Egan..... | 20 h. p. |
| Tenoner, Fay & Egan..... | 5 h. p. |
| Horizontal mortiser, Fay & Egan..... | 5 h. p. |
| Jointer, Fay & Egan..... | 5 h. p. |

Heavy wooden parts, such as tender sills, bumper beams, etc., are planed and cut to standard lengths in the planing mill and stored in a shed just outside of this building from which they are brought into the shop on push cars. In the same way a stock of finished dry lumber for cab and pilot work is stored under cover near this shop, it being only necessary to form and fit it here. A comparatively small amount of room is required for the cab and pilot work, as only new work is done in this shop, repairs being made in the erecting shop.

A sub store with a stock of the journal boxes, brasses,

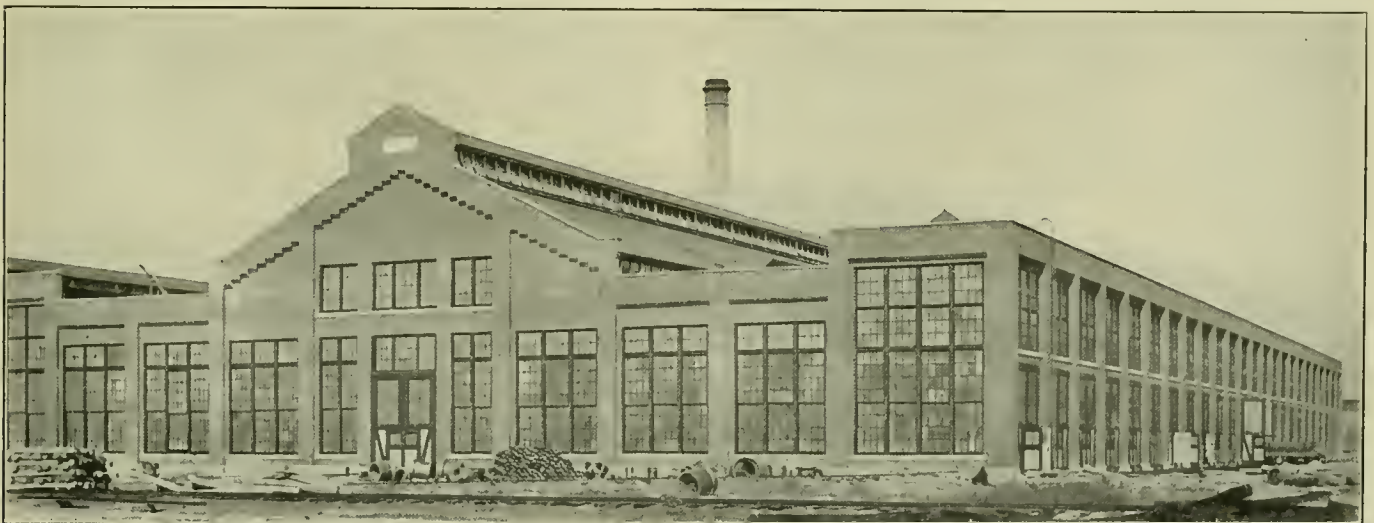

General View of Coach Shop at Beech Grove.

serves the large punch. Tank sheets which are too large to be handled by hand are transported by the traveling crane.

Beyond the open space for sheet metal work the cisterns or tanks are set on special trestles of a length to permit ten cisterns on either side with a wide aisle in the center and at

springs, etc., needed for tender truck repairs is maintained in this building. New wheels come from the wheel shop, being transported on a flat car which is loaded and unloaded by a locomotive crane. Machined parts required for tank repairs are brought into the shop by a push car on the industrial tracks.

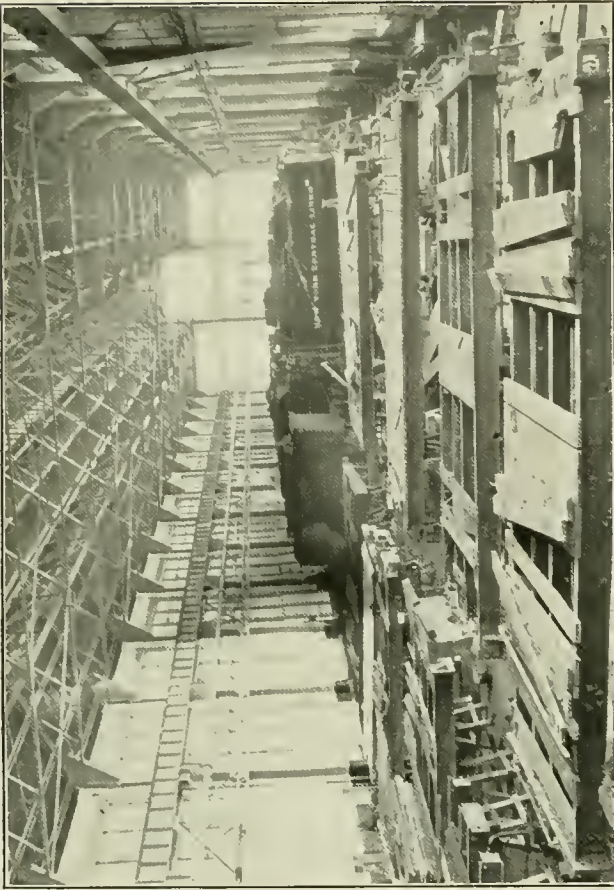

General View of the Tank Shop; Beech Grove Shops.

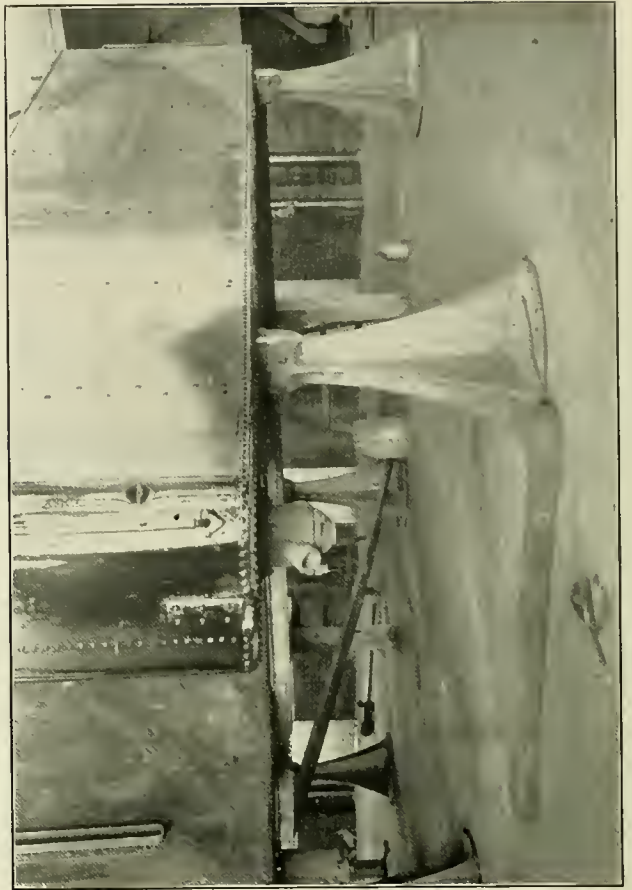

Special Trestles for Supporting Tender Tanks.

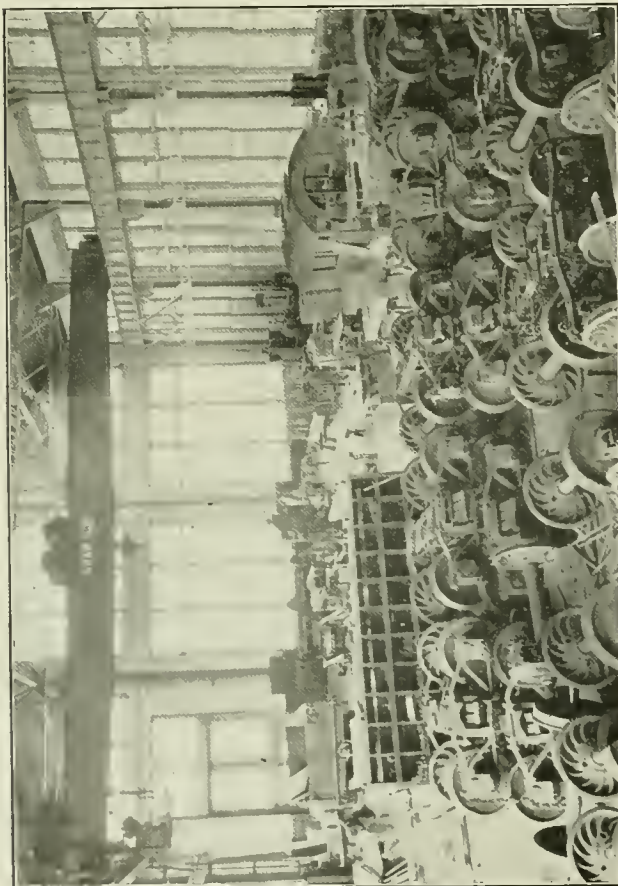

View Showing Wood Working Section of the Tank, Cab and Pilot Shop.



Section of Tank Shop Devoted to Ash Pan Repairs.

With the present tender equipment, which consists partially of wooden underframes and partially of steel, about two days are required for repairing the trucks—three days on an average for the underframes and from five to seven days for the tank or cistern—and it is therefore the practice to pile the trucks up in tiers after they are repaired and do likewise with the underframes, thus allowing more space for the tanks if it is required. The work of dismounting and locating different parts of a tender coming in for repairs, or of assembling it afterwards, is, of course, performed very rapidly by the crane.

The shop is heated by hot air, the fans and coils being located in two small wings at the side of the building. Two Sturtevant fans each have a capacity of 34,500 cu. ft. of air per minute and are driven by 20 h. p. motors. The air is distributed through concrete ducts under the floor. Artificial light is provided by Cooper-Hewett lamps suspended from the roof; there are also numerous sockets for portable lamps. The floor of the building is of 6 in. gravel concrete laid on a 12 in. bed of rolled cinders and finished with a 3/4 in. coat of cement blocked in squares.

COACH SHOP.

This building has an inside area of 210 ft. x 324 ft. 5 in. For a distance of 40 ft., the full width of the building at the end adjoining the midway, the space is given up to truck repair-

on lines between the tracks. A row of large arc lamps is suspended in the center bay.

Repairs on all of the passenger equipment of the Big Four, which now amount to about 800 cars are to be made at this point. It is designed to turn out on an average of two cars per working day, which means that it will be possible to put each car through the shop on an average of once every 16 months. The cars coming to the shop are first brought alongside the miscellaneous shop building where all carpets, upholstery and detachable parts are removed and distributed to the proper sections of this shop through the medium of push cars. The car then goes to the transfer table and is placed on any desired track in the coach shop. An electric winch with a long cable is provided on the transfer table for spotting the cars in the shop. The modern cars when placed in the 60 ft. bays will extend somewhat beyond either end so that they can be lifted by the cranes, the trucks rolled out and the body lowered on the trestles. The trucks are then picked up by the cranes and carried to the truck repair section where the transverse crane can reach them.

In making repairs, all wood machine work is done in the planing mill and cabinet shop and sills, posts, plates, cabinet work, etc., are brought to the coach shop on push cars passing over a transverse track under the midway from the end of the planing mill and connecting by a turntable to one of

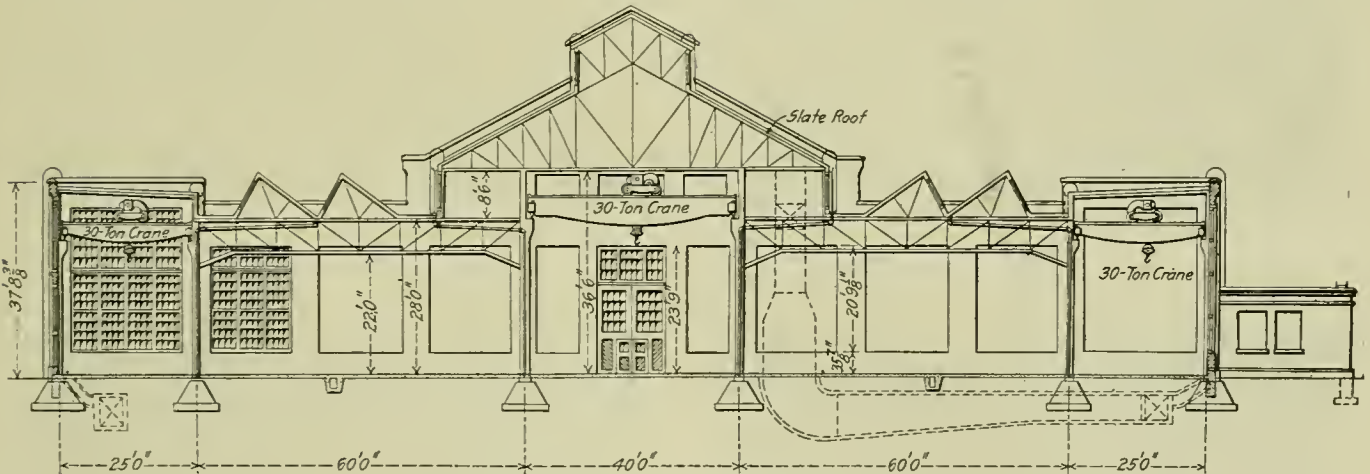

Cross-Section of the Coach Shop at Beech Grove.

and is served by a 15-ton single trolley Shaw crane running across the building. The remainder of the building has 22 tracks, which pass through double doors to the transfer table pit, and is divided into 5 bays longitudinally. The center 40 ft. bay has a 30-ton single trolley Shaw crane running the entire length of the building with the exception of the truck repair space. On either side of this are 60 ft. bays, not provided with crane service, and beyond these are 25 ft. bays which have 30-ton cranes operating parallel to and for the same distance as the one in the center bay. All four of the cranes in this building are arranged for operation and control from the floor.

The cross section of the building, shown in one of the illustrations, shows the method employed for obtaining a strong thoroughly diffused natural lighting over the whole floor area. The heating is by the hot air system, the fans and coils being located on platforms supported on the roof trusses—the distribution of hot air is made through concrete ducts below the floor level, with outlets along the side walls and at the center posts. The floor is of 6 in. concrete with a 3/4 in. cement finish throughout the building except in the truck repair section where 3/8 in. diamond steel plates are placed on a concrete foundation. Artificial lighting is by 200 candle power tungsten lamps with large enamel metal reflectors distributed

the tracks entering this shop. From here they can go by means of the transfer table to any track or can be brought directly into the shop and transferred to any desired location by means of the cranes. In cases where new forgings are required they are brought from the adjacent forge shop by push cars on a track directly connecting the two buildings. All machine work on metal parts is performed in the locomotive machine shop and they are distributed over the industrial tracks in the same manner. A track will be seen which runs the full length of the building in the center bay. It has a turntable connection to the general shop system just outside at either end and also to one of the transverse tracks in the center and permits convenient distribution to all points by push cars.

In the truck repair section is a Niles wheel lathe of the latest design, driven by a Westinghouse 50 h. p. variable speed motor. This machine has a capacity for turning 22 pairs of steel tired wheels in 10 hours. A 6 ft. radial drill is also to be located in this shop. Arrangements have been made for storing the finished wheels on a track just outside the building where they can be conveniently rolled in and out. Where new axles or new wheels are required, they will be prepared in the wheel shop and will be transported on a flat car which will be loaded and unloaded by a locomotive crane.

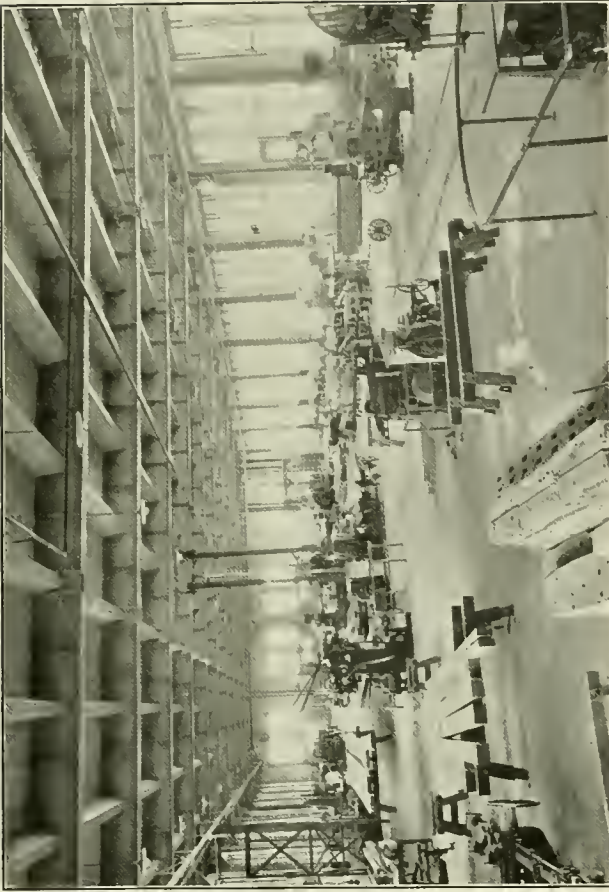

Interior of the Planing Mill; Beech Grove Shops.

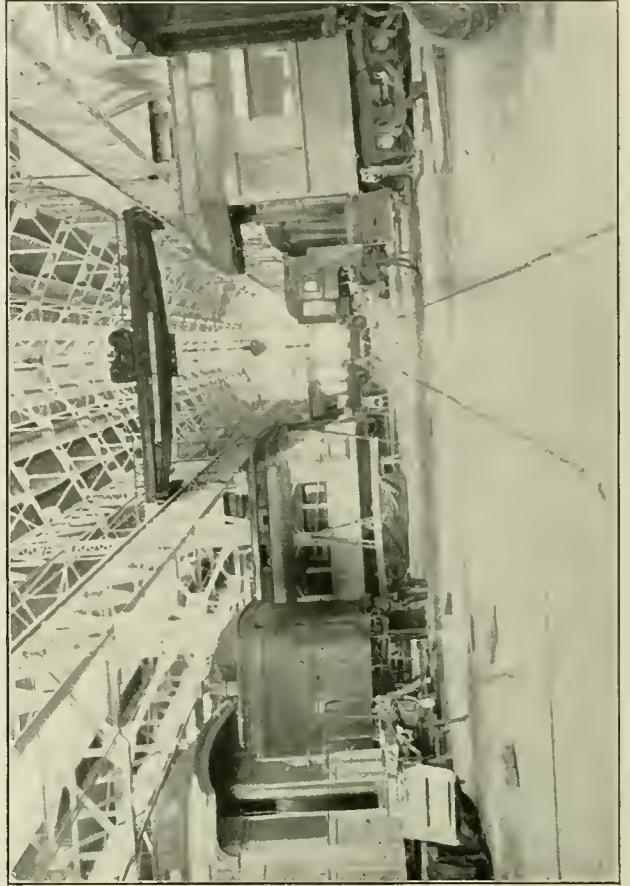

Looking Down the Center Bay of the Coach Shop.



Interior of Cabinet Shop Showing Massive Roof Trusses.

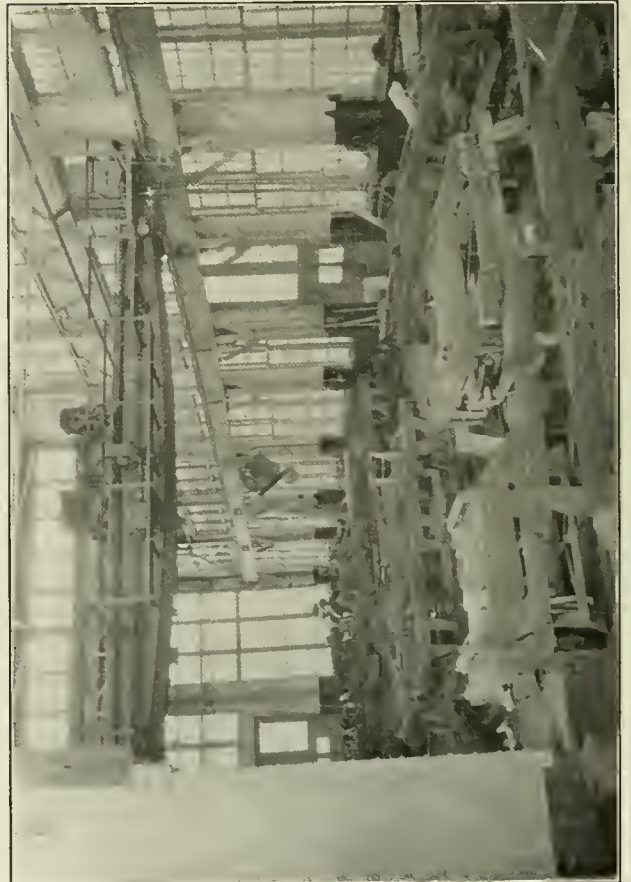

Repairing Trucks in the Coach Shop; Beech Grove Shops.

Racks containing a supply of bolts and parts for truck repairs are provided alongside this section of the shop. There are air and electric plugs at practically every post throughout the shop and riveting, chipping, etc., of metal parts is done with the aid of air hammers and portable forges. A small building between the coach and forge shops will contain a complete stock of the bolts required in coach repairs. Portable pipe bending machines and benches with pipe vises are provided for air brake work.

No special provision has been made for repairs on badly

and the floor is of concrete the same as in the coach shop. A complete drainage system permits the floor to be rapidly and thoroughly flushed with water. The paint supplies will be in the adjacent miscellaneous building when it is completed, but temporarily they are placed in one of the two additions which are provided for wash rooms and toilets.

MISCELLANEOUS BUILDING.

One of the illustrations shows the general arrangement of the building to be erected in the near future for taking care of coach trimmings. An upholstery room with separate

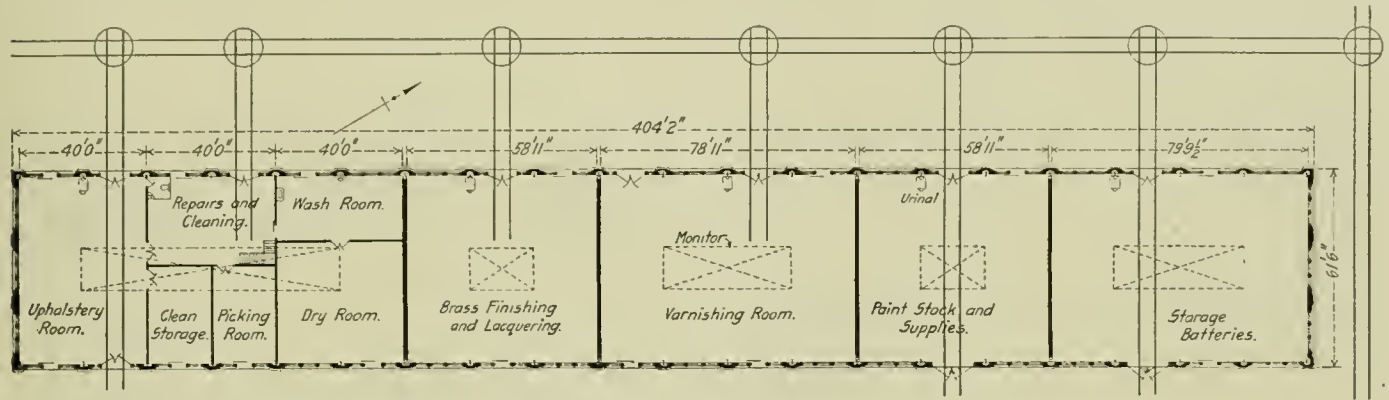

Miscellaneous Shop Plan Showing Also the Connections to the Industrial Track System.

damaged all-steel equipment since such occasions will be rare and the complete system of industrial tracks will permit the easy transportation of sheets and shapes to the different metal working shops where they can be properly handled.

PAINT SHOP.

Between the coach and paint shop is a 75 ft. Nichols transfer table and the latter shop is made somewhat shorter than the former permitting two tracks coming from the transfer table to pass alongside of it. The building has a floor area of 180 ft x 440 ft. and is quite similar in its cross section to the coach shop when the outer two bays of the latter are eliminated. No crane service is provided. The windows in the saw-tooth section and in the louvre may be opened from

storage and cleaning rooms is provided in one end. Next to this is a section for brass finishing and lacquering; then come the varnishing room and the paint stock supplies, while the end. Each section of this building has a direct track communication to the shop industrial system and material will be transported to and from it through the medium of push cars for the lighter material. The coaches themselves, or freight cars with supplies, can be brought into the section for electrical repairs and for the paint stock and supplies. Cars can also be brought directly into the upholstery room, if desired. This building is 58 ft. x 400 ft. 8 in., inside dimensions. Upholstery work and electrical repairs are now being temporarily made in one end of the coach shop and a section of

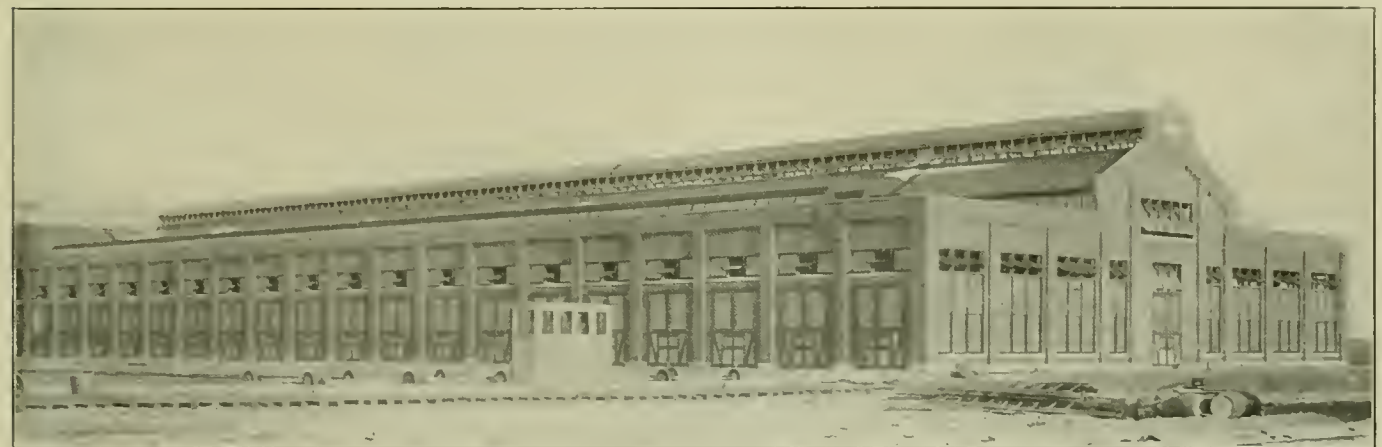

Paint Shop and Transfer Table at Beech Grove.

the floor, the mechanism for operating the sash in this and other shops being supplied by the King Construction Company, North Tonawanda, N. Y.

Direct radiation is used instead of hot air for heating this building. The radiating system is extensive, consisting of cast iron radiators, continuous below the windows and for the full height of the wall between the doors, and also of four groups of pipe radiators supported on the roof trusses for the full length of the building. Lighting is by tungsten lamps

the paint shop is being used for a varnishing room and brass finishing.

PLANING MILL AND CABINET SHOP.

The only two-story shop building in the group contains the planing mill and cabinet shop, the former being on the first floor. For convenience in handling large material it was specified that there should be clear floor space in the planing mill and it was thus necessary to support the second floor, which is of heavy steel and concrete construction carrying

moderate sized high speed machine tools, largely from the roof trusses. This required very heavy steel work in this building, the design and arrangement of which is clearly shown in the sectional elevation and in one of the photographs. The building has an inside width of 79 ft. 7 in. and a length of 340 ft. Two 5-ton electric elevators of sufficient size to take a locomotive cab are provided. These are so located that a spur from the shop industrial system reaches one

the storage yard and locomotive cranes will also be available for handling parts anywhere on the industrial tracks.

In arranging the machine tools in the planing mill careful attention was given to the continuous movement of the raw material coming in at the east end of the shop. There are three separate routes arranged, the one along the north being for long sills, plates and similar timbers; the middle section for short heavy timbers, and the southern section for light

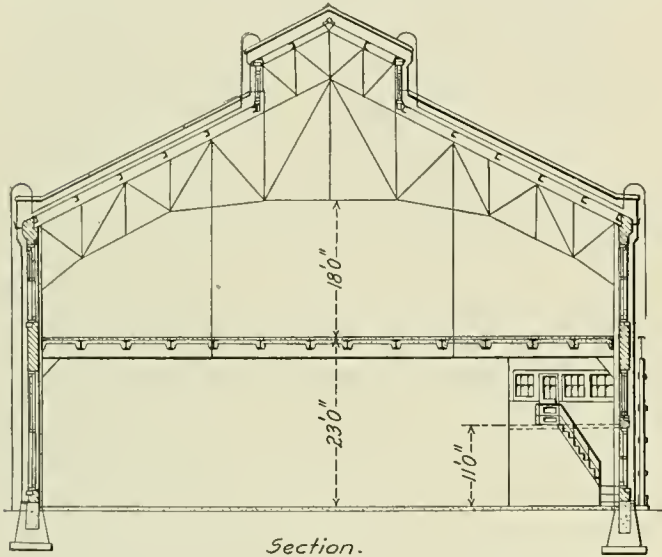

Section.

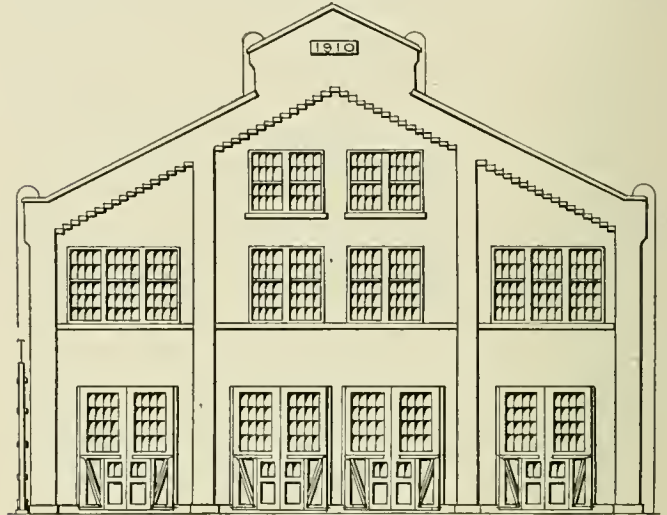

End Elevation.

Sectional and End Elevation of the Planing Mill.

of them and a track from a dry kiln reaches the other. There is also a track passing continuously through the center of the building which communicates to the dry lumber shed, the shop industrial system and to the storage yard. Two other spur tracks enter for a short distance at either end of the building and all material in and out of this building will be handled on push cars. These, however, in the case of heavy sills or other timbers, will be loaded by a locomotive crane in

material like siding and flooring. Reference to the floor plans of the building will show the arrangement of the tools which are given in the list below.

| <i>Machine.</i> | <i>Motor.</i> |
|--|---------------|
| Sill planing machine, Berlin..... | 50 h. p. |
| Band rip saw, Berlin..... | 15 h. p. |
| Cut off saw, Greenlee..... | 15 h. p. |
| Self feed rip saw, Greenlee..... | 5 h. p. |
| Planing and matching machine, Woods..... | 50 h. p. |
| Vertical cut off saw, Fay & Egan..... | 15 h. p. |



General View of Planing Mill and Cabinet Shop.

| | |
|-----------------------------------|----------|
| Boring machine, Greenlee..... | 10 h. p. |
| Cut off saw, Fay & Egan..... | 10 h. p. |
| Tenoning machine, Fay & Egan..... | 10 h. p. |
| Rip saw, Fay & Egan..... | 5 h. p. |

Space has also been provided for several future machines as shown in the illustration. All tools, with three exceptions, are driven by direct connected motors. The motors are of

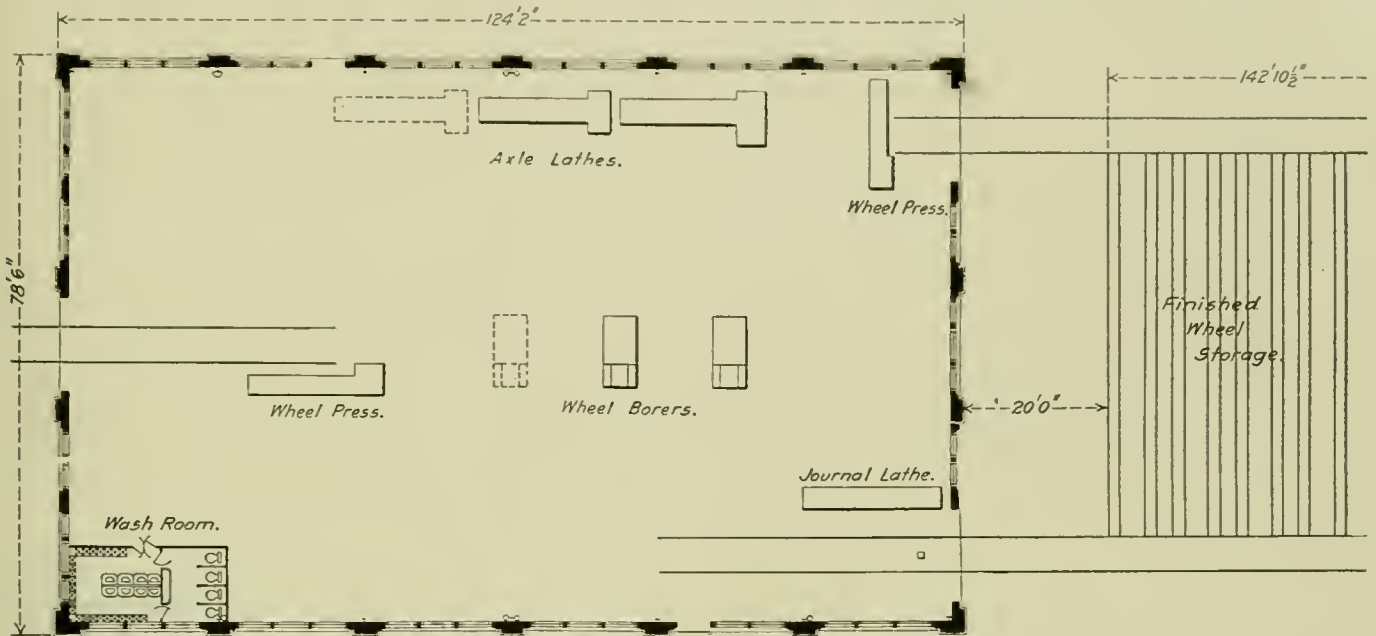

Plan of the Wheel Shop at Beech Grove.

| | |
|-----------------------------------|----------|
| Pony planer | 15 h. p. |
| Band saw, Fay & Egan..... | 5 h. p. |
| Chisel mortiser, Woods..... | 5 h. p. |
| Gang machine, Greenlee..... | 10 h. p. |
| Tenoning machine, Greenlee..... | 15 h. p. |
| Vertical mortiser, Greenlee..... | 15 h. p. |
| Three-spindle boring machine..... | 15 h. p. |
| Wood worker, Greenlee..... | 5 h. p. |
| Band saw, Fay & Egan..... | 5 h. p. |

the General Electric 60 cycle, 440 volt type controlled with General Electric oil immersed starting compensators having no load and an overload release. The large tools are also equipped with a push button stopping device whereby it is possible to instantly stop the motors by pressing a button located convenient to the operator. All wiring is run in con-

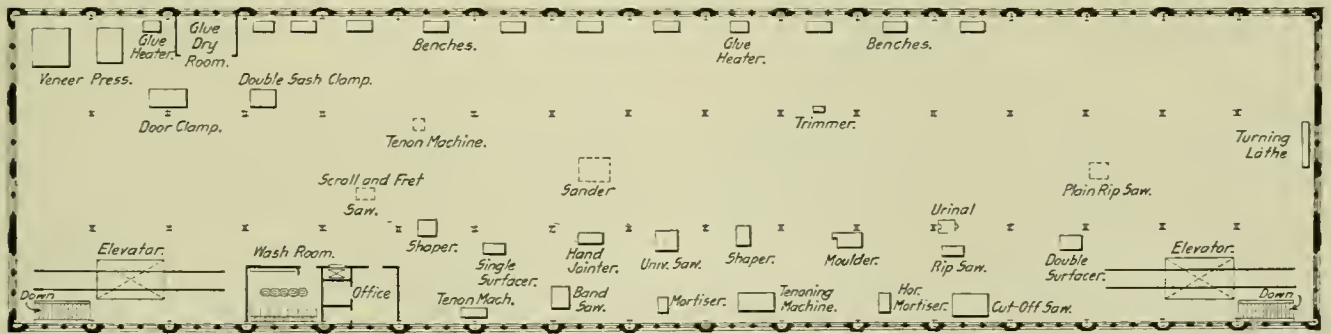

Plan of Second Floor.



Plan of Tool Room on Balcony.

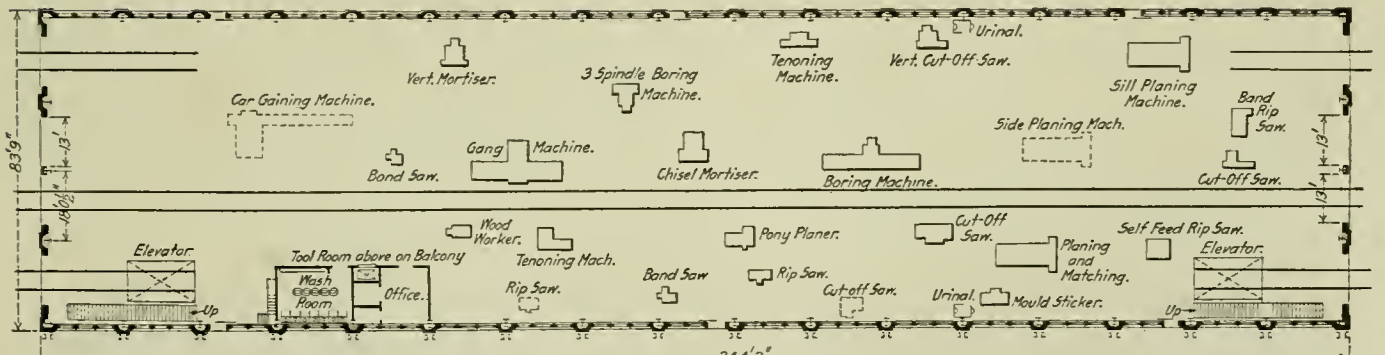

Plan of First Floor.

Floor Plans and Tool Location for the Planing Mill and the Cabinet Shop.

duits under the floor. The heavy tools have flexible couplings for connections to the motor, consisting of two discs with two pins projecting from each and a thick leather belt bent around them. This coupling is made by the Berlin Machine Company, Berlin, Wis.

In the cabinet shop the following machines are located:

| Machine. | Motor. |
|------------------------------------|----------|
| Surfacer, Berlin | 15 h. p. |
| Rip saw, Fay & Egan..... | 7 h. p. |
| Cut off saw, Fay & Egan..... | 10 h. p. |
| Horizontal mortiser, Greenlee..... | 5 h. p. |
| Molder, Fay & Egan..... | 15 h. p. |
| Tenoning machine, Greenlee | 5 h. p. |
| Shaper, Berlin | 5 h. p. |
| Rip saw, Greenlee..... | 5 h. p. |
| Mortiser, Greenlee | 5 h. p. |
| Jointer, Berlin | 5 h. p. |
| Band saw, Fay & Egan..... | 5 h. p. |
| Surfacer, Fay & Egan..... | 15 h. p. |

In addition there are also a number of hand machines and provision for future machines is shown in the illustration.

The pattern shop is located in one end of the cabinet shop. A tool room is located on a mezzanine floor in the planing mill and the foreman's office and the general wash room are below it. A dumb waiter gives communication from the tool room to both floors.

Special attention has been given to fire protection throughout the building and hose reels are conveniently located at numerous points.

WHEEL SHOP.

All tools for wheel and axle work are in a special building. They consist of two Niles car wheel boring machines of the latest type, a large wheel press, a journal turning lathe, two axle lathes and a journal polishing lathe. All are driven by direct current motors and are arranged as shown in the accompanying illustration. The building is so located

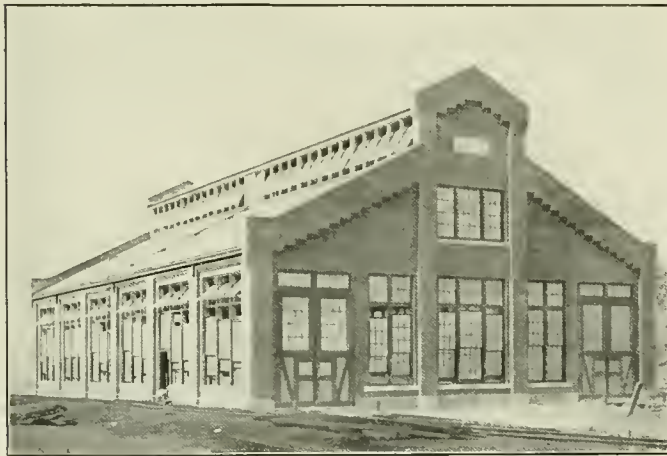

Wheel Shop Before Storage Tracks were in Place.

that there is ample storage room on all sides of it and the handling of stock in and out of it will be either by tracks or by hand. The storage of old wheels will be in the yard just west of the building and they will be rolled in to the wheel press on the special track. From this point the good wheels will be taken directly to the boring mill and scrap wheels will be rolled out of the building to a scrap platform on the north side. The axles will be taken from the press by a trolley and distributed in front of the axle machines or if condemned will be taken to the scrap platform. New wheels will be stored at the south of the building and will be rolled in to the boring machine by hand. Wheels leaving the boring machines will be stored at the east end of the building near the wheel press located in the northeast corner. The trolley carrying the axles from the other press passes the lathes and the stock of finished axles and continues to the press where the wheels are to be again mounted. After being pressed on,

the wheels emerge and are stored on special tracks provided at the east end of the building. Such mounted wheels as require only turned journals are brought from the storage yard at the southeast corner of this building where the lathe for this purpose is located in a pit, permitting them to be easily handled in and out of it. After the journals are finished the wheels will be returned to the storage yard.

The heating of this building is by direct radiation, the lighting by tungsten lamps and the floor is of heavy timber. At the present time one corner of the building is devoted to air brake repairs and cleaning, which work will eventually be done in the car shops to be built later.

MACHINE SHOP KINKS

BY J. C. BREKENFELD,

Assistant Machine Shop Foreman, St. Louis & San Francisco, Springfield, Mo.

DRIVING WHEEL LATHE ATTACHMENT.

Locomotive driving wheel lathes that have tool slides for truing journals and facing hub plates are as a rule equipped with the ordinary tool post as used on engine lathes, which forms a poor support for the tools used in this class of work. The tools are liable to chatter and will leave marks on the

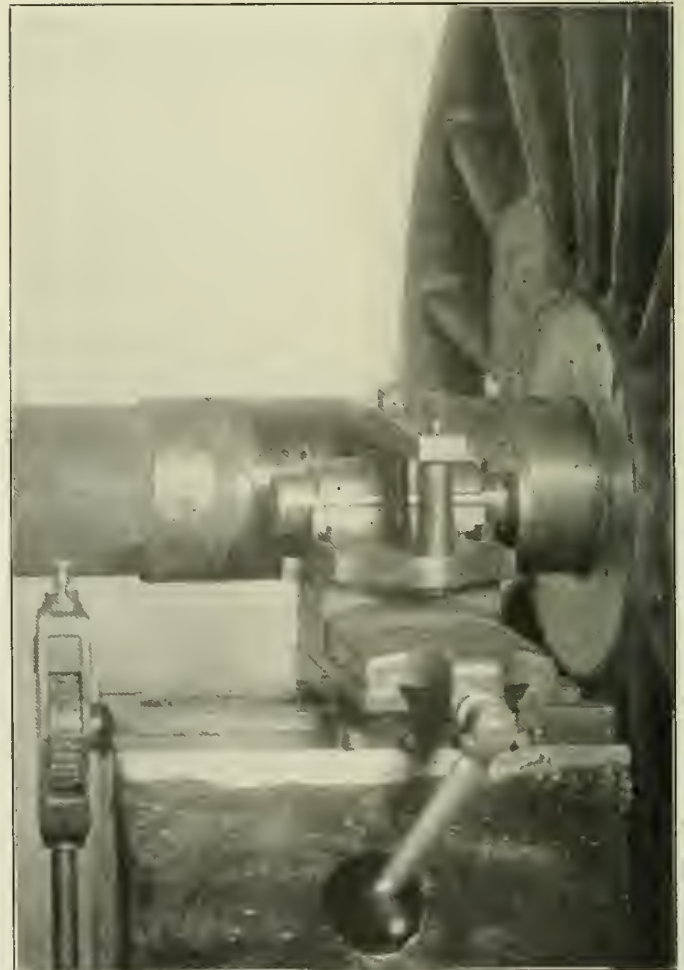

Fig. 1—Special Tool Holder on Driving Wheel Lathe for Truing Journals.

journal that are hard to roll out. Also with the old fashioned tool post it is almost impossible to hold a roller square with the journal and keep it rolling smooth. The ordinary tool slides have T-slots for the tool post to set in, and the projection on the base of the improved attachment shown in Figs. 1 and 2 fits snugly in them. Two 5/8 in. set screws on

account of its rigidity and the heavy cuts it can stand. The whole attachment is easy to apply and handle.

CHUCK FOR DRIVING BRASSES.

The arrangement shown in Figs. 3 and 4 is used for holding driving brasses on a shaper for finishing the ends that fit in the driving box. The chuck is made of an old driving box shoe and has a tongue planed on the bottom of it to fit in the slot of the table to hold the work parallel to the tool. Two

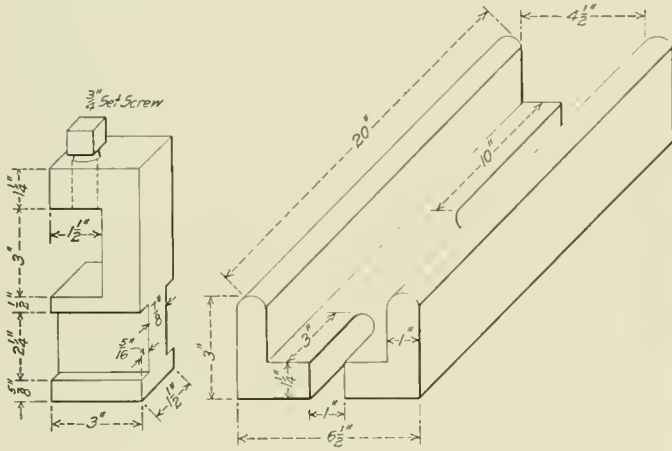

Fig. 4—Chuck for Driving Box Brasses.

slots, one 3 in. and the other 10 in. long and 1 in. wide, are cut into the middle of the shoe at the ends for the T-clamps, one of which is shown at the left of the shoe. The clamp fits in the T-slots of the table and the set screw bears down on the brass, holding it rigidly in place. With this arrangement cuts 1 in. deep can be readily taken. The chuck is easily made and produces excellent results.

DRIVING BOX CHUCK.

The chuck shown in Figs. 5 and 6 is used for boring driving boxes. The base *A* is made of cast iron and has a projection

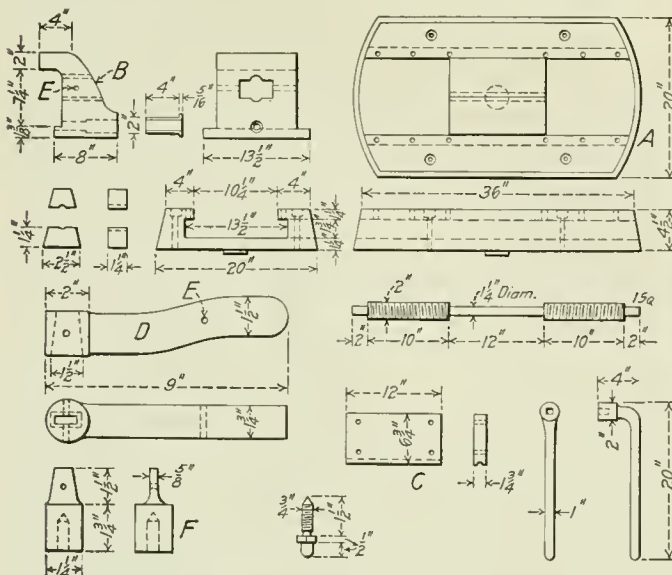

Fig. 5—Driving Box Chuck for Boring Brasses, Etc.

on the bottom to fit in the hole in the center of the boring mill table. The outer ends of the chuck extend to the edge of the table and it is fastened to the machine by four 1 in. bolts so located as to have them enter the slots in table. The holes for these bolts are counterbored at the top of the chuck so that the nuts will clear. The jaws *B* slide in the ways of the base and are actuated by a right and left hand screw which

is held in the center of the chuck body by a large split plate *C* which is set in a slight recess and is held by fillister head screws. Provision for taking up wear and keeping the jaws a snug working fit in the base is made by two taper gibs, one for lateral and one for vertical lost motion. The jaws alone were not sufficient to hold the boxes firm while they were being bored with coarse feeds, so the clamping levers *D* were provided. These levers pass through the jaws and rest on the driving box flange. Each one is held by a 3/4 in. pin at *E* so that when the outer end of the clamping lever is raised, by means of the screw and sleeve *F*, pressure is applied to the driving box which holds it down firmly on the chuck body. The pin

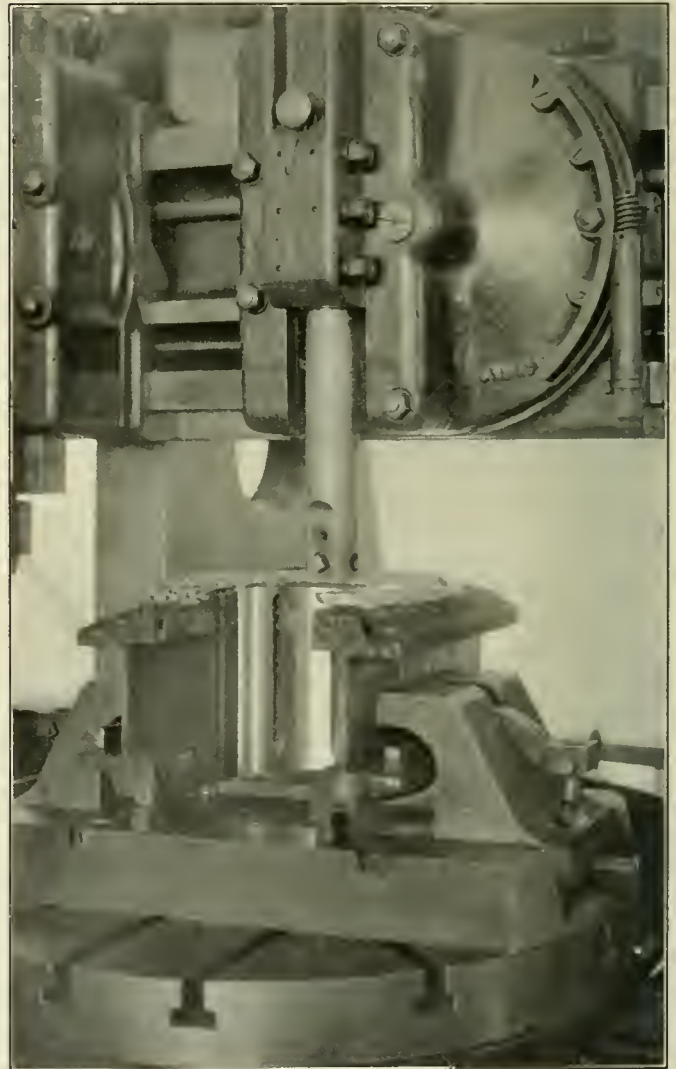

Fig. 6—Application of Driving Box Chuck to Boring Mill.

E is held in the split bearing, shown in the details, which fits in the opening in the jaws. The chuck being self-centering, all boxes are bored central with the shoe and wedge faces, and it is not necessary to "lay off" the boxes for this purpose. Twenty minutes is the average time required to bore a driving box brass and face it for lateral bearing. The faces of the jaws where they bear on the shoe and wedge faces of the boxes are lined with 1/2 in. hardened steel plates and are scored to hold the box firmly.

RAILWAY REVENUES.—The total operating revenues of 93 per cent, of all steam railway mileage in the United States for the month of January, 1912, amounted to \$203,143,118. Compared with January, 1911, the total operating revenues of these railways show a decrease of \$2,886,149, or 2.8 per cent.

PROTECTIVE COATINGS*

BY WALTHER RIDDLE

In coating iron or steel the surface should be clean and dry before anything is applied. This is a point which cannot be too often repeated. Should the preparation of the surface be neglected, the metal will itself attempt to protest by pushing away the coating to show us its wounds. Another point to be watched is that the placing of one type of coating upon another may not bring about an inter-reaction which will perhaps destroy both. A coal-gas tar paint, which by itself would do its work well, when placed over an oil coating, has dissolved and combined with the latter to form a sort of "porridge," which could be entirely rubbed off by the hand. Various engineering societies are at work standardizing specifications for mixing, and for the application of coatings. This work is complicated, especially in our own country, by the extremely variable climatic and atmospheric conditions. A pigment which may be the proper one in the higher inland districts is found utterly inadequate upon the coast. Again, that which is good for the farm wagon may not be at all suitable for the overhead signal bridge of the railway, exposed to flying cinders and sulphurous fumes from locomotives. The varnish which is serving well upon furniture would soon become discouraged upon the leads of a street railway motor where flexibility as well as resistance to dust and moisture are necessary.

In any coating which has an oil base, the choice of the oil is of particular moment. The principal oils of commerce which can be classed as drying oils, that is, those which when spread in a thin layer take up oxygen and become solid, are: linseed oil, China wood oil and soya bean oil. Linseed oil is by far the most satisfactory, and the real reason for the agitation in favor of using other oils, has been the very high price of linseed oil during the last year or two. China wood oil is crushed from the seeds of two oriental plants. It has a specific gravity of 0.937 to 0.940, and a solidifying point of about—13 deg. cent. Its color is brownish yellow, and it has a very characteristic and persistent odor. In the laboratory it may be distinguished from linseed oil by the fact that with nitrous acid it forms a semi-solid substance. A sample of soya bean oil which was recently examined, had a specific gravity of 0.928, and a color similar to crude petroleum, although lighter. It had the latter's fluorescent appearance when the light struck it and was not very clear. It had no rapid tendency to dry when in a thick layer, but spread out thinly with a little manganese dryer giving a rather good coat. It contains about 25 per cent. of free acid. In China and Japan it has long been used in making lacquer and also in the kitchen for cooking and at times for purposes for which we use olive oil. It is pressed from the seeds of the *soja hispida*.

As it comes to the consumer the raw linseed oil of commerce has a specific gravity of about 0.935 at 60 deg. F. Its color is a golden yellow when clear, slightly tinged with green from the chlorophyl of the flax plant. It has a not unpleasant taste and a smell similar to refined New Orleans molasses. Any considerable admixture of another single oil for purposes of adulteration will be shown in the specific gravity. A mineral oil will make it too light and rosin oil or rosin will make it too heavy. A carefully made mixture of both might be used without changing the gravity. However, the large crushers being in a very considerable and staple business, will not descend to such methods. A little oil rubbed in the palm of the hand and then smelled will generally give a good deal of information to the trained nose. In many parts of the world other crops are grown with or near the flax and the seeds from these may be

carried along to the presses and thus affect the oil. Such contamination is accidental and does not obtain to any large extent in this country.

The most important property of linseed oil is its power to take up oxygen from the air to form a skin. For some years there has been dissatisfaction expressed in regard to raw linseed oil. While it is the best, and for many purposes the only oil to use, it is a somewhat different product from the oil of 30 or 40 years ago, and this has led many to assume adulteration. The chief source of this difference is the desire of the crusher to obtain as much oil as possible per pound of seed. The pressure has been increased, and instead of the crushing operation being undertaken cold, the seed is saturated with steam and the apparent yield is increased. The flax seed, however, contains only a certain quantity of oil, and the increase is not oil but a mucilaginous matter which should have remained in the press. This mucilaginous matter or "foots and mucilage," as it is termed, is highly soluble in water, and when the oil containing it is used in coating, the film, of course, contains this soluble matter. When rain comes in contact with a coating containing this soluble ingredient, it gradually dissolves and minute flaws occur in the coating through which air and moisture enter, and the destruction of the material coated begins.

Long storing and filtration will help to purify the oil, but these are usually not sufficient. The manufacturer should put the oil through some process to completely remove the source of trouble and leave an oil which will dry thoroughly and form an unbroken film when applied. In order to ascertain what takes place when the oil dries, whether the reaction is the simple addition of oxygen from the air or of a more complex nature, a carefully weighed body of oil was placed in a container and a constant current of air was passed through it. The air was analyzed before and after contact with the oil. An absorption apparatus was set up to make determinations of the oxides of carbon, oxygen, and of water as moisture. The samples were collected over mercury every three hours. The process was continued over a period of ten days until the oil had become so heavy that the air could no longer be made to uniformly react with it, and to a point where the oil could no longer be readily poured. By comparison of its specific gravity with that of completely oxidized oil, in a film, it was judged to be about $\frac{3}{4}$ of its journey towards complete dryness. In any case it was far enough to give an inkling of what takes place.

The average results from the absorption were as follows:

| OXYGEN. | |
|---------------------|--|
| Inlet Air | =20.95 per cent. |
| Outlet Air | =19.97 per cent. |
| Difference | 0.53 per cent., representing oxygen absorbed by oil. |
| CARBON DIOXIDE. | |
| Inlet | 0.05 per cent. |
| Outlet | 0.12 per cent. |
| Difference | 0.07 per cent. = CO ₂ generated by the drying action. |
| WATER. | |
| Inlet Current..... | 52.30 decimilligrams per liter. |
| Outlet Current..... | 67.00 decimilligrams per liter. |
| Difference | 14.70 = water generated and driven off. |

Figured on a basis of 10 lbs., which we will assume to have been the amount of oil used, there were passed 320.99 cu. ft. of air.

DIFFERENCE BETWEEN INLET AND OUTLET CURRENTS:

| |
|--|
| In oxygen = 17.01 cu. ft. = 1.52 lb. absorbed by the action. |
| In CO ₂ = 2.25 cu. ft. = 0.277 lb. given off. |
| Water given off = 0.295 lb. |
| Oxygen needed for 0.295 lb. water = 0.260 lb. |
| Hydrogen needed for 0.295 lb. water = 0.033 lb., which would represent the hydrogen given off. |
| Oxygen needed for 0.277 lb. CO ₂ = 0.202 lb. |
| Carbon needed for 0.277 lb. CO ₂ = 0.076 lb. |

It is a question whether the CO₂ was formed simply from the oil, or was formed by the decomposition of certain products of the oxidation. So far as can be judged, either would have the same effect upon the formula of the final product. The

*From the address of the retiring president of the Engineers' Society of Western Pennsylvania. Presented at the annual meeting, January 16, 1912. Mr. Riddle is vice-president of the Sterling Varnish Company, Pittsburgh.

total weight of oxygen absorbed by 10 lbs. of oil during the experiment was 1.52 lb. The water, in excess of that in the inlet current = 0.2946 lb.

| | |
|---|---------------|
| CO ₂ in excess of amount in inlet air..... | = 0.277 |
| Oxygen absorbed | = 1.51840 lb. |
| CO ₂ and water given off..... | = 0.57195 lb. |

Difference = 0.94645 lb.

This difference should represent the gain in weight of the 10 lbs. of oil during oxidation, which we found by weighing was about right. No traces of CO were found in the outlet air at any time. The increase in weight is very nearly 10 per cent., which is much in excess of that generally claimed.

The drying action is not, therefore, a simple additive process, but is more complex. It is known that a film of paint will not dry as well in wet weather as in dry. From the above experiment it is apparent that the surrounding atmosphere must take up water and CO₂ from the film as well as give up oxygen to it. If the air is already pretty well saturated, its appetite is decreased.

Pigments.—The leads, oxides of iron, tars, asphalts and carbons in various forms, all have their advocates, and all are good. The principal point to watch is that the pigment is pure, dry and finely ground. It should be stirred well into the oil and be thinned just before being applied, in order that the coat may be uniform. One great advantage which carbon, in the form of lamp-black, has is that its specific gravity is lighter than that of metallic pigments and there is less tendency to settle. Pigments must be well ground and well mixed with the oil vehicle.

Gums.—The gums which may be used in paints and varnishes are many. The hardest, most expensive, and if used without special treatment, the best are the fossil resins. Nearly all natural gums in solution give off an acid reaction, and this acidity should be neutralized before use. Amber is an example of a very high type of fossil resin. Kauri gum in various grades is used for fine, hard finishes. The chemistry of colophony, or common rosin, has been well looked into and it is the most generally used gum. It is usually used in the form of a metallic resinolate.

Dryers.—Manganese and lead compounds are the most common driers. These aid the oil in its efforts to take oxygen from the air. They either act by taking it up and passing it on to the oil, or perhaps by a catalytic action. Too much dryer should not be used, and with oil coatings slow drying in general means long life for the coat.

Thinners.—Turpentine, benzole, benzine and higher naphthas are used, and each has its place. Turpentine also seems to aid in the drying and is a good solvent. Its fault is that having performed its mission as a thinner it does not leave quickly enough. Benzine is better in this respect. Probably a mixture will be better than either by itself for many purposes.

Protection of Steel.—The steel should be clean and dry. The coating should present a good resistance to the abrasive action of dust as well as to the gases and water-vapor in the atmosphere. It is the custom with many to use different colors for the different coats, to facilitate inspection, so that the engineer can tell at a glance whether the required number of coats has been applied. This long-distance and "at a glance" inspection is not thorough. The inspection should be close enough so that color is a small factor. Objection is made at times to "shop coating," as we are told that this obliterates the marks and numbers. This objection is overcome if a clear transparent coating is used, and shop-coating removes the danger of rusting between the time when the steel is finished and the final painting in place.

For steel which is to be embedded in concrete special top-coatings are now being developed. Claim is made that the concrete itself preserves the steel, but there seems to be a demand for concrete steel coatings. The water used in mixing con-

crete must be a great factor. One of the tests which is being used by certain large railways and other corporations is to coat steel plates with the paint to be examined, allow them to dry thoroughly, and place them in a mixture of concrete made of 4 parts cinders, 2 parts sand, and 1 part Portland cement.

After periods of one, two or three months, etc., the blocks are broken and the coat examined. This is a severe test, but it should be in order to allow of speedy conclusions. Generally the coating which survives the setting period and the first month, will last through many months. In many tests part of the coating will adhere to the concrete and part to the steel when the block is broken. If the exposed places on the steel are bright, it shows that the coating has done its work. Good materials cost more but are, of course, more economical. The labor cost is usually overwhelmingly greater than the material cost. The number of repaintings on exposed work will tell the story.

Testing.—There are a few simple tests which will help the user to check up the manufacturer as regards uniformity. One of these is the specific gravity which, in some cases, may be taken by the hydrometer, in others where there are heavy pigments the sample is taken from a well stirred lot and a known volume is accurately weighed and compared with the weight of the same volume of water.

Oil and Water Resistance.—Strips of copper ribbon or small steel plates are coated and thoroughly dried, or if time is a factor, baked for a proper period, and then hung in a vessel filled about two-thirds full of water upon which a layer of oil is poured. A burner is placed underneath the vessel and the water is boiled. If, after the boiling has been continued for two hours, the coating is still intact, it may safely be used in places where moisture and oil are present.

Elasticity.—Copper ribbons, or paper or steel plates, are coated and thoroughly dried or baked. These may then be bent and twisted, thus giving an idea of the elasticity. These tests may be undertaken at different temperatures by placing first in warm water and immediately afterwards plunging the samples in vessels containing ice, etc.

Slip and Flow.—What is known as "slip" is the wedging of a coat of varnish or paint. If any object be dipped vertically the coating near the top will be thinner than that further down. If a strip of paper be dipped and air dried, or baked, its coat may be measured with a micrometer at different points. The difference between the thickness at a 2 in. line and at a 12 in. line, will give the "slip" in 10 in. The smaller the "slip" the better the result. The flow may be examined on the same papers.

Penetration.—For certain uses, especially for the insulation of coils in electric machines and similar places the penetration is important. This may be measured by clamping a pad of filter papers, by suitable means, to the bottom of a tube which, during the test, is kept filled to a constant level. At the end of the test the number of papers impregnated is counted. Experience shows that a 10-in. head or pressure, and a 20 min. period are very convenient.

GOOD ROADS.—The Department of Agriculture reports the following data concerning public roads:

| | Mileage Improved. | |
|-----------------|-------------------|--------|
| | 1909. | 1904. |
| Indiana | 24,955 | 23,877 |
| Ohio | 24,106 | 23,460 |
| New York | 12,787 | 5,876 |
| Wisconsin | 10,167 | 10,633 |
| Kentucky | 10,114 | 9,486 |
| Illinois | 8,914 | 7,924 |

The gain in New York is due largely to the fact that the state has bonded itself for \$50,000,000, and that \$5,000,000 a year or more is being expended by the state, in addition to an equal sum by the counties, in building state highways. New York is leading all the states in actual progress at the present time.

SANTA FE MILLION LB. DYNAMOMETER CAR

The Exceptionally High Recording Capacity and the Strong Construction, Including the Steel Frame for the Superstructure, are of Unusual Interest.

BY H. B. MAC FARLAND,
Engineer of Tests, Topeka, Kan.

An exceptionally high capacity dynamometer car, 1,000,000 lbs., having a steel frame for the superstructure, has just been placed in service on the Atchison, Topeka & Santa Fe. The dynamometer was built by the Locomotive Finished Material Company, Atchison, Kan., and the recording apparatus by the Burr Ma-

being composed of a built-up box girder for the center sill, channels for the intermediate sills, and Z-bars for the side sills. The side frame is of angles and the roof frame of I-beams.

The center sills are of the fish-belly type, 28 in. deep at the center and 13 in. deep at the bolster. The web of the girder is

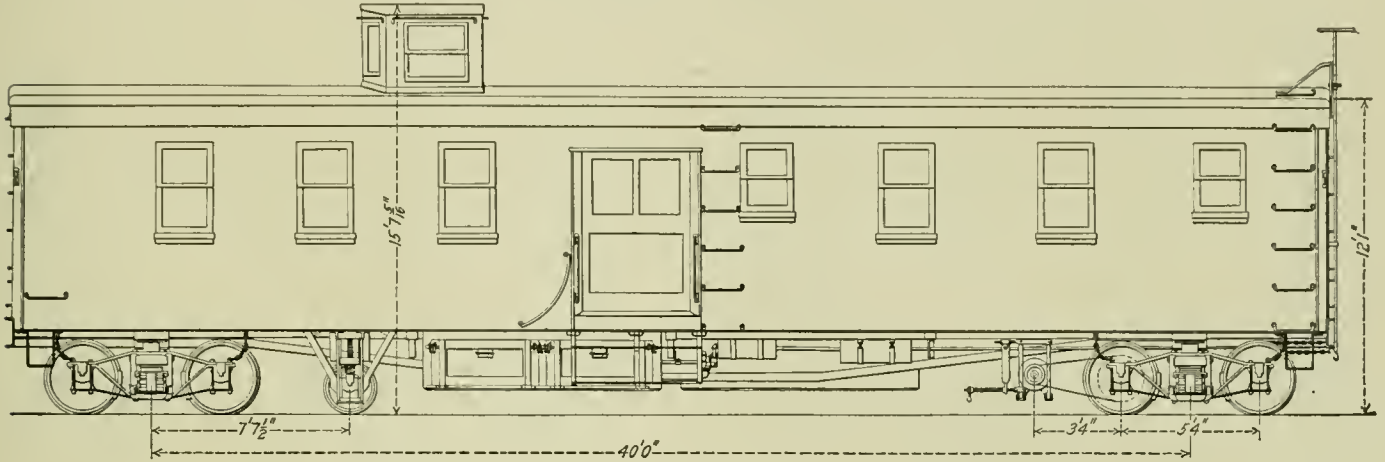

Side Elevation of Santa Fe 1,000,000 Lbs. Capacity Dynamometer Car.

chine Company, Champaign, Ill., from drawings furnished by the railway. The steel frame for the car was built by the Crawford Locomotive Works at Streator, Ill. The car was finished and the apparatus installed at the Topeka shops. The underframe, side and roof frame are entirely of steel, the underframe

$\frac{3}{8}$ in. thick, with a $3\frac{1}{2}$ in. by $3\frac{1}{2}$ in. by $\frac{3}{8}$ in. angle at the top, and two $3\frac{1}{2}$ in. by $3\frac{1}{2}$ in. by $\frac{1}{2}$ in. angles at the bottom; there is also a $\frac{3}{8}$ in. top cover plate the full length of the car. A $\frac{1}{4}$ in. steel plate covers the entire floor from the end sill to the inner edge of the body bolster at the dynamometer end. The body bolster is en-



Dynamometer Car of 1,000,000 Lbs. Capacity; Atchison, Topeka & Santa Fe.

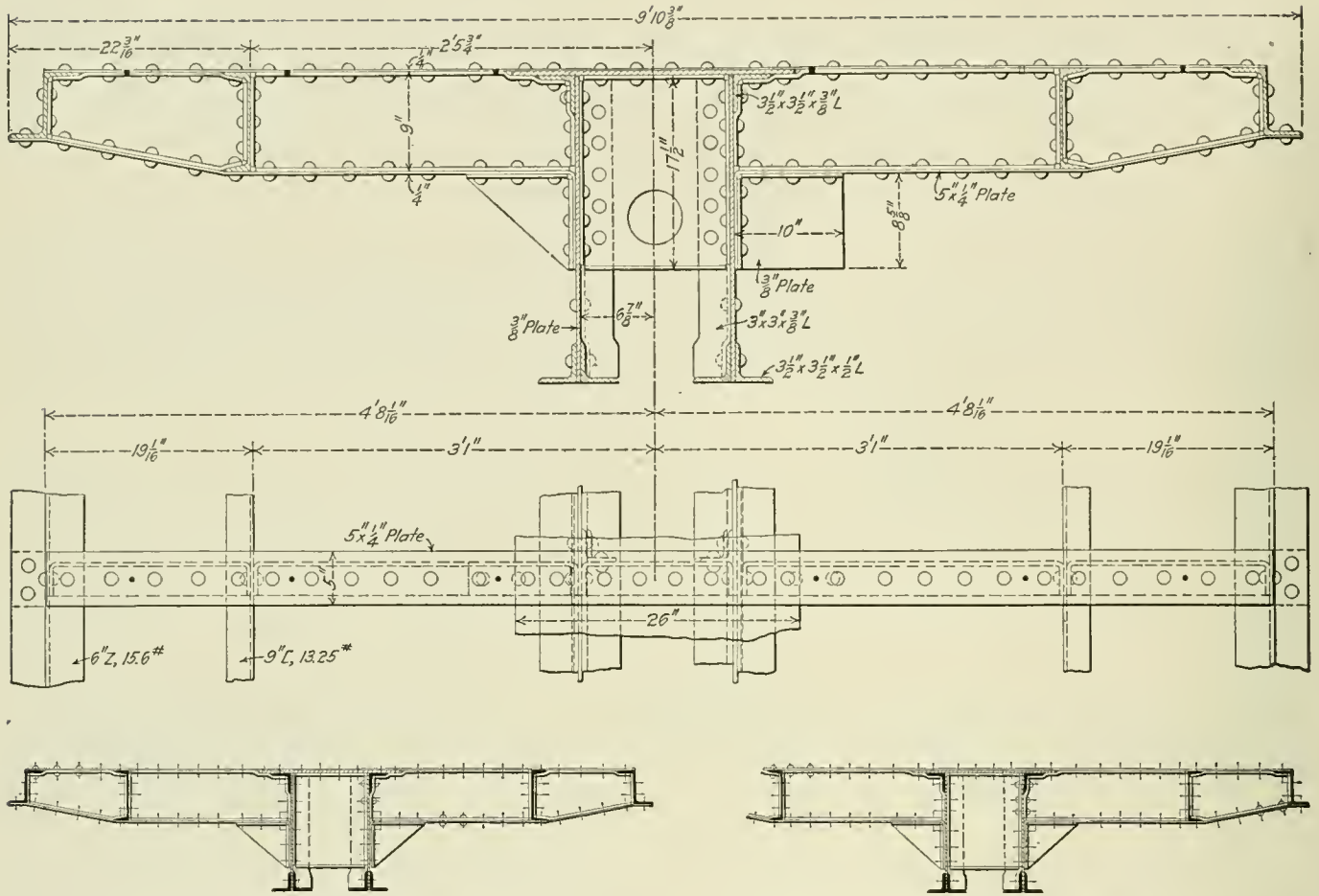

Crossie At Dynamometer End Looking Towards Center of Car.

Crossie Opposite Dynamometer End Looking Towards Center of Car.

Sections Through Underframe of Dynamometer Car Showing Arrangement of Crossies.

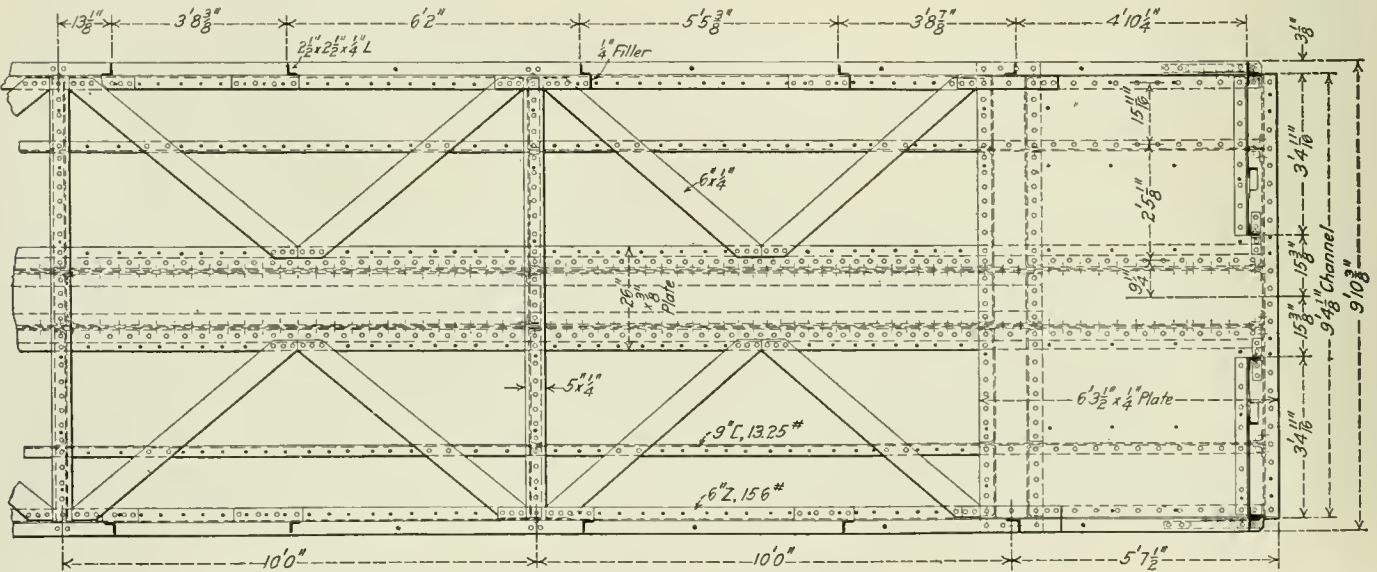
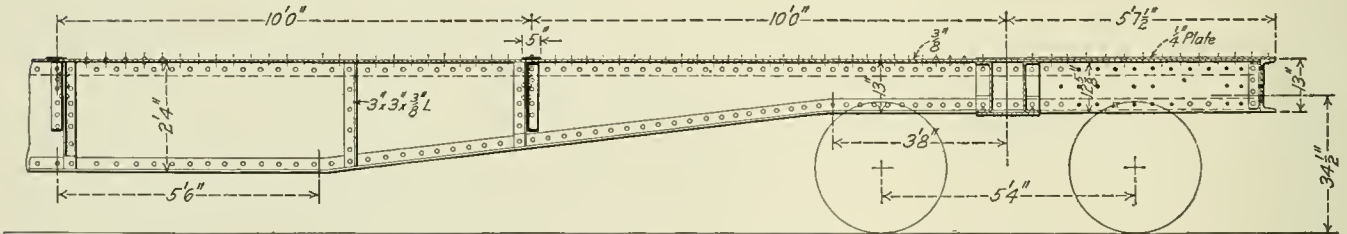

Steel Underframe of Santa Fe Dynamometer Car at End Opposite Dynamometer.

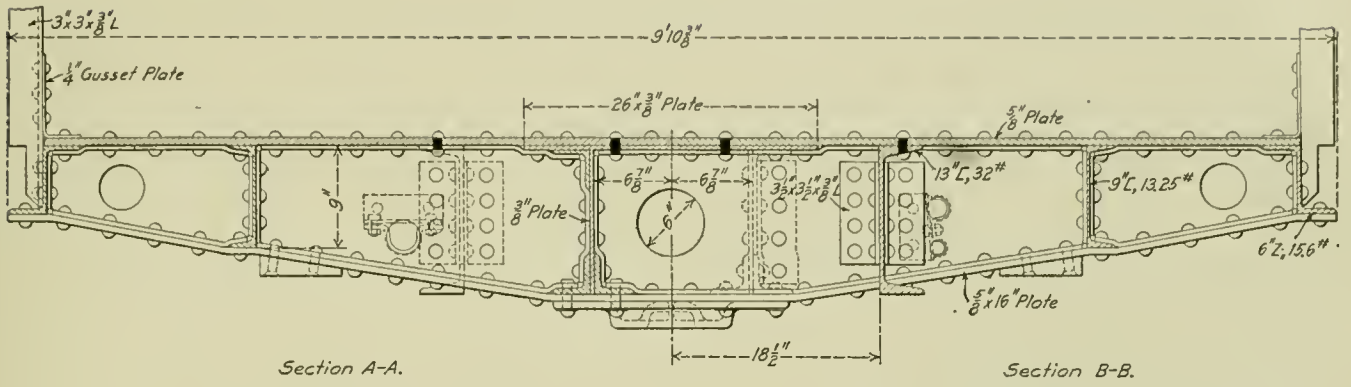

Body Bolster at Dynamometer End of Santa Fe Dynamometer Car.

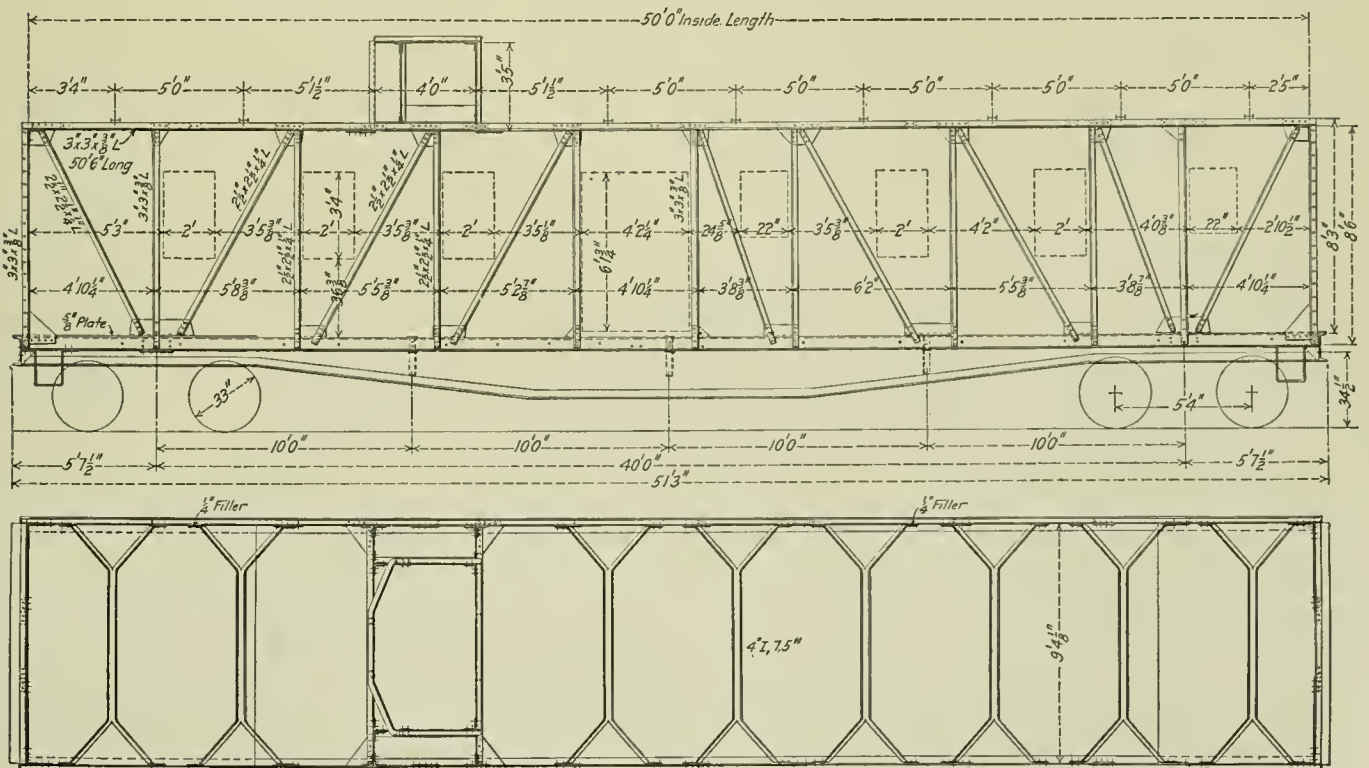
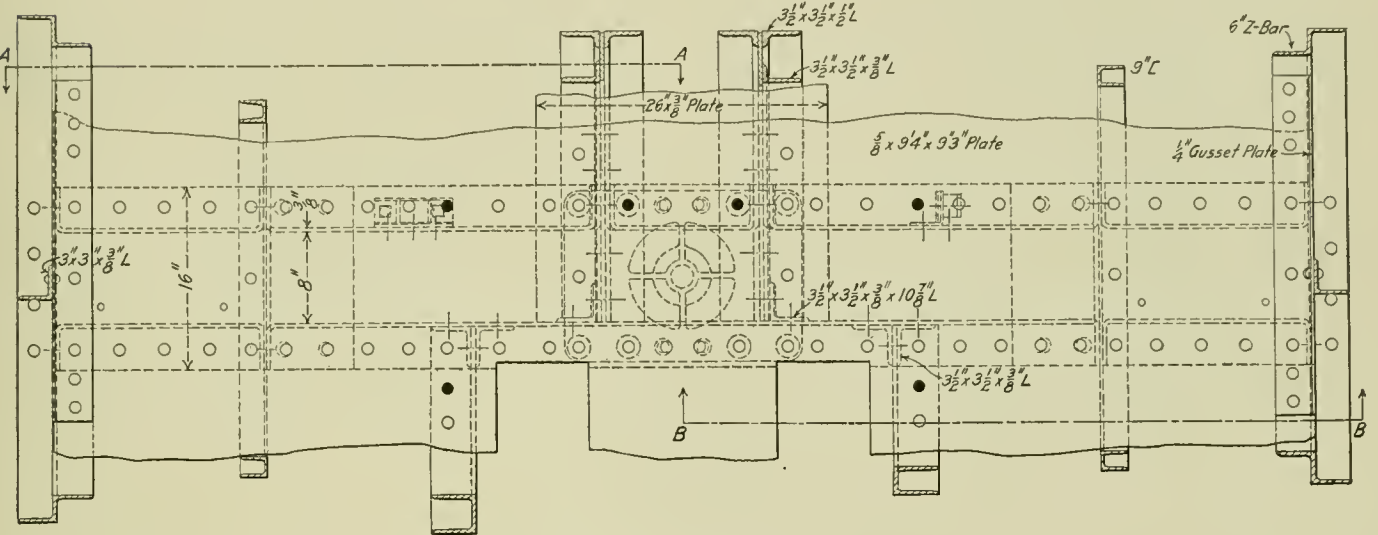

Steel Side and Roof Frame of Santa Fe 1,000,000 Lbs. Capacity Dynamometer Car.

tirely of rolled and flanged steel parts with $\frac{5}{8}$ in. by 16 in. top and bottom plates, and two $\frac{3}{8}$ in. webs spaced 8 in. apart. The end sill is a 13 in., 32 lb., channel. The cross-ties have 5 in. by $\frac{1}{4}$ in. top and bottom plates with single flanged webs $\frac{3}{8}$ in. thick. The posts, braces and plates in the side and end framing are steel angles with the dimensions shown on the general plan. The earlines are 4 in. I-beams split near the end, so as to form diagonal bracing at the plate.

A $\frac{3}{8}$ -in. steel plate covers the front end of the car for a height

DYNAMOMETER.

The dynamometer is of the double diaphragm type, recording both drawbar pull and drawbar push. The lever arms, with a ratio of five to one, are connected at one end to a filler block in the drawbar yoke and at the other end to a double piston, 20 in. in diameter, whose heads press against blind rubber gaskets, covering the liquid chambers. The piston is suspended by means of knife edges, in order to eliminate all friction. The bearings for the lever arms are small hardened tool steel pins surrounding

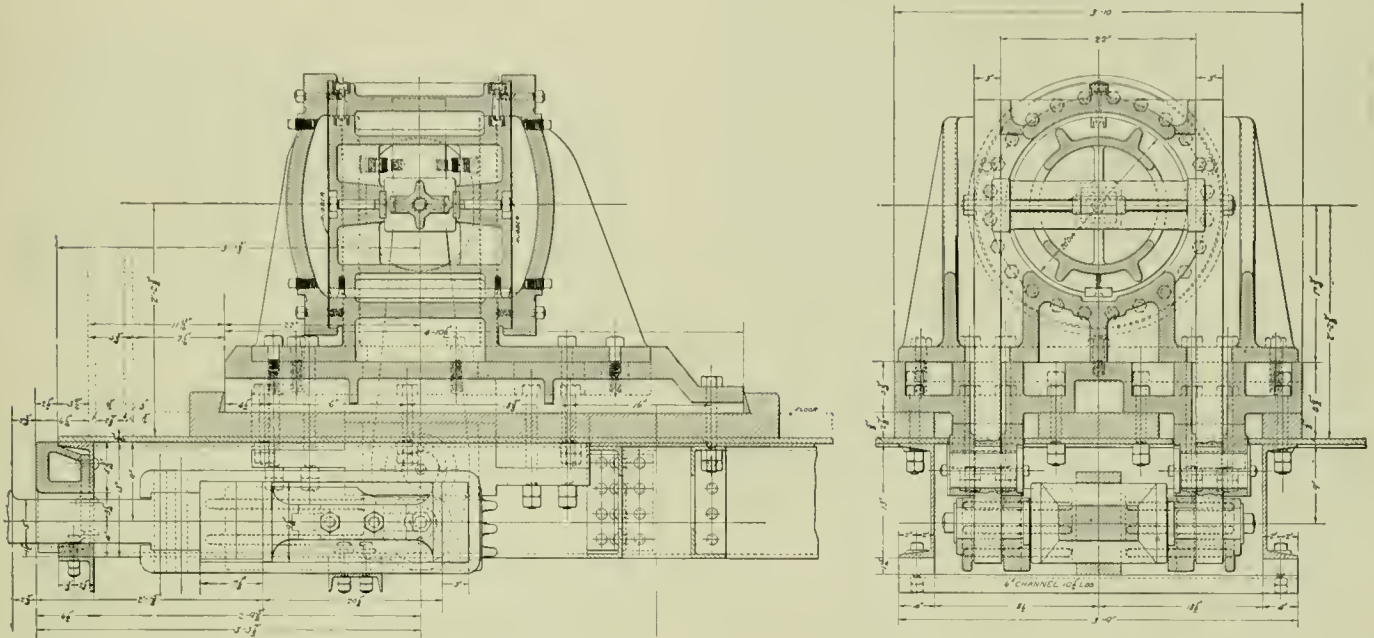

Dynamometer of 1,000,000 Lbs. Capacity; Santa Fe Dynamometer Car.

of 2 ft. from the floor. The length over end sills is 50 ft., and the extreme width is 10 ft. The working end of the car is 25 ft. in length, and contains the dynamometer, recording apparatus, switchboard, gage board, work benches, stove and desk. The rear half of the car contains four upper and lower berths, toilet room, closet and kitchen. The trucks are of the four-wheel arch bar type, with heavy elliptical springs and extra heavy arch bars. The wheels are 34 in. in diameter and have steel tires. The car is lighted by electricity from an axle lighting system, as will be explained later.

the main pins. A mixture of glycerine and alcohol is used in the liquid chambers. These latter are connected to the recording apparatus and gage board by $\frac{3}{4}$ -in. copper pipes. When the dynamometer is not in use the arms are brought to the center and held by four small jacks between the top of the arms and the cylinder casting. The dynamometer is so designed as to take and record safely a shock of 1,000,000 lbs. at the drawbar.

RECORDING APPARATUS.

The recording apparatus is placed just back of the dynamometer and the following records may be made on the chart:

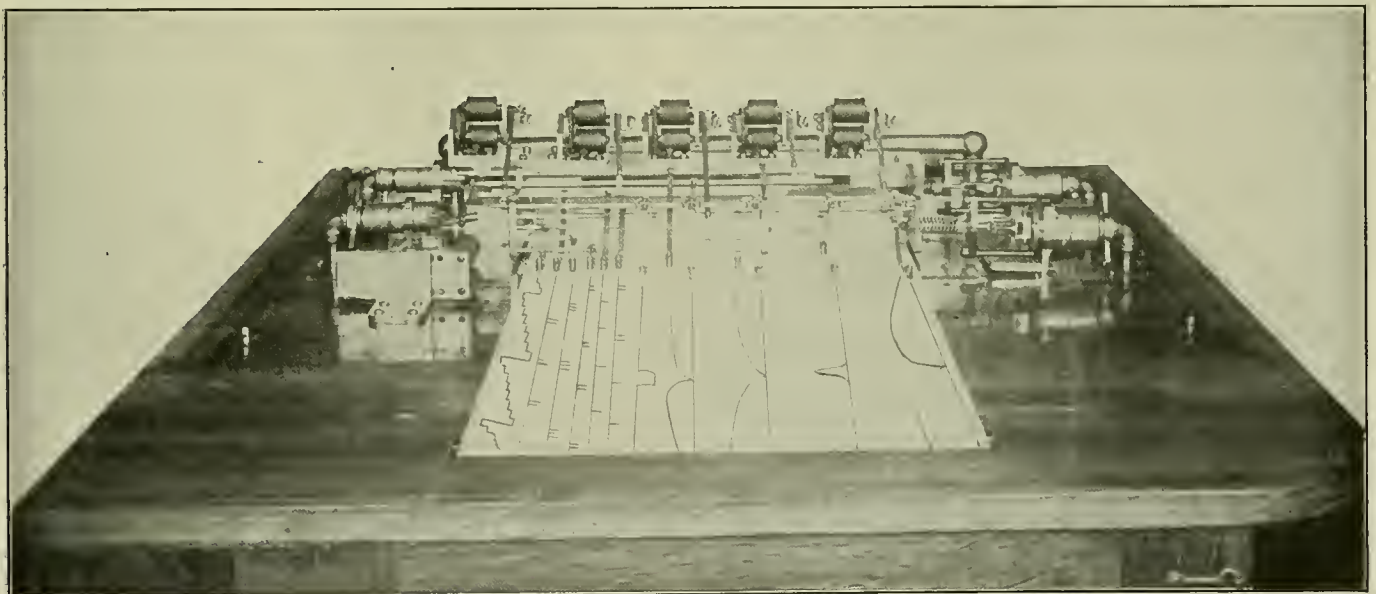

Recording Apparatus In Dynamometer Car Showing the Pens and Charts.

Drawbar pull; drawbar push; speed; time either by five seconds or half-seconds; position of mile posts and stations; throttle opening; reverse lever; boiler pressures; indicator cards; train line pressure; brake cylinder pressure, and coal or oil fired. The

train of bevel gears, which run in oil, by a universal joint. This auxiliary truck may be raised or lowered from within the car.

An electric motor is also provided for driving the recording apparatus. Three speeds are provided for the motor drive and three for the auxiliary truck drive, it being the intention to use the auxiliary truck drive in rating work and general engine tests, and the motor drive in special air brake and draft rigging tests. By means of two conveniently located levers and clutches it is



Gage Board in Dynamometer Car.

recording apparatus is mounted on a very heavy iron base plate through which a driving shaft passes from the auxiliary truck below. The auxiliary truck has two 22-in. wheels with 9-in. plain tires. It is connected to the main driving shaft through a

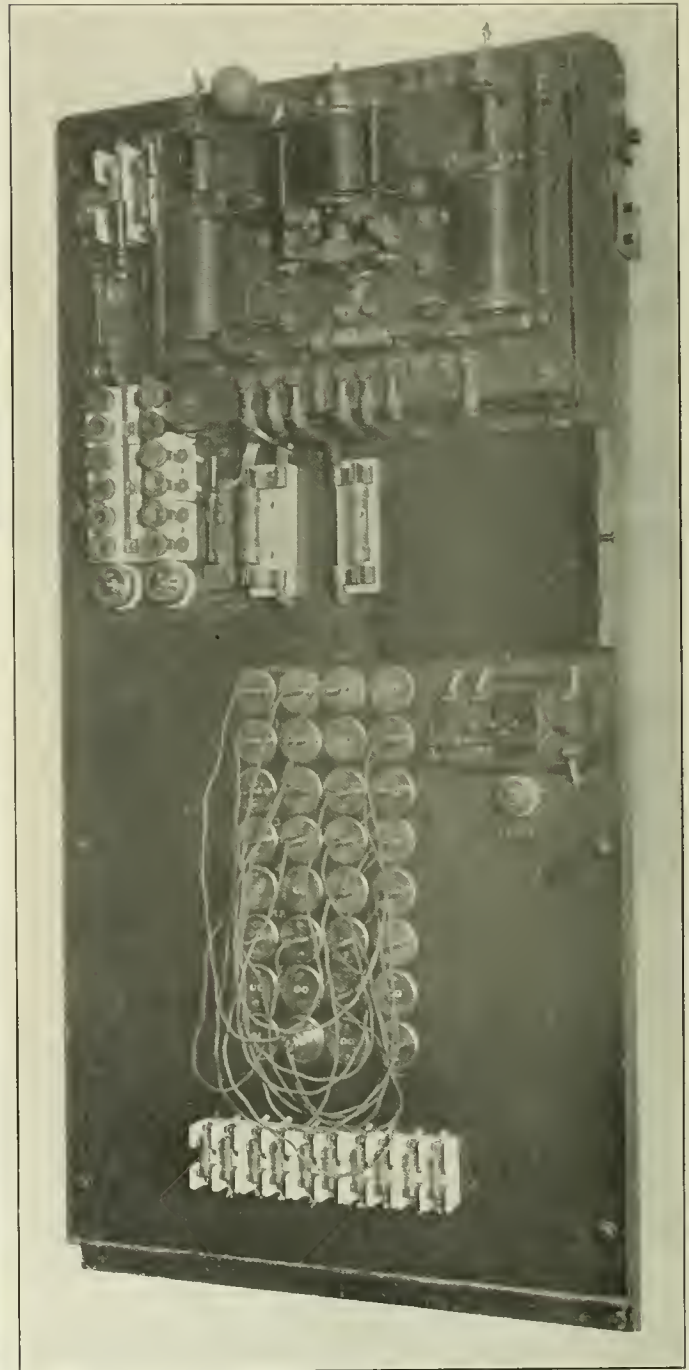

Switchboard in Dynamometer Car.

possible to quickly change from one drive or one speed to another. The drive is so connected that reversal of direction of the car movement does not reverse the direction of chart travel. The records are made on a chart 15 in. wide, which is drawn over the table between two gear-connected rollers by friction. Both originating roll and receiving roll are located at the back of the machine, and can be readily removed or put in place.

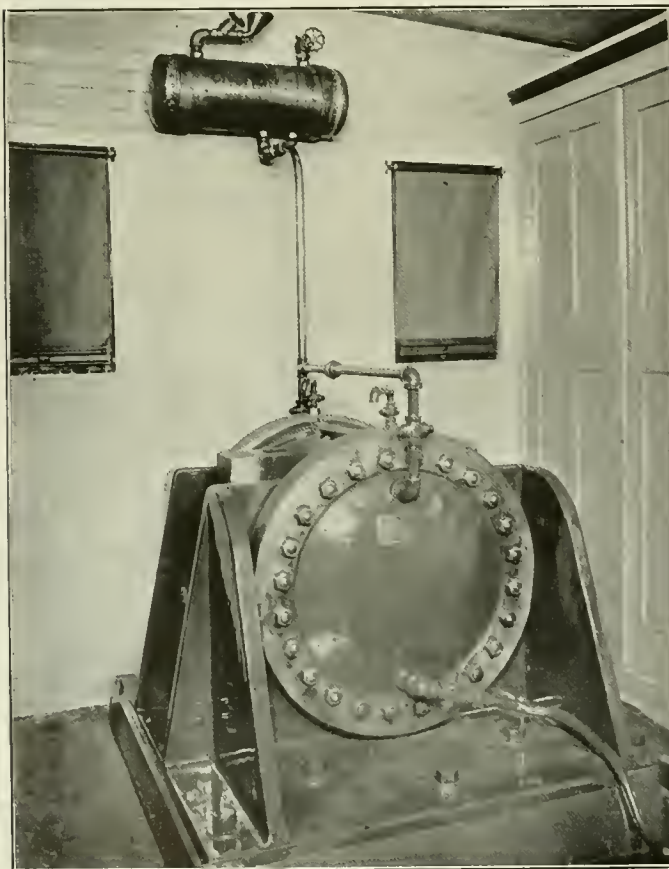

The Dynamometer.

All curves are drawn by pens attached to hollow aluminum rods running at right angles to the paper. All datum line pens are connected to a single cross bar at the front, their records being made an inch in front of those made by the recording pens. The pens are made of small brass cups with phosphor bronze troughs which carry a thread wick from the barrel to the point; they will draw a line moving sidewise as well as forward.

The pressures from the dynamometer are transmitted to standard outside spring Crosby indicators on one side of the recording table, it being the intention to put in different weights of indicator springs for the various classes of work. The curve of speed is obtained from a Boyer speed recorder located in the base of the recording apparatus and chain driven from the main shaft, it being so arranged that it may be driven at double its normal speed in freight service and at normal speed in passenger service, thus giving a large offset at low speeds when desired. The time record is drawn on one edge of the chart

cells, located beneath the car. These in turn are charged by means of a Bliss generator, driven from the rear truck of the car. The voltage used throughout is 32. The switchboard is so arranged with a series of multiple jacks that it is possible to put any voltage on any magnet, thus making the whole arrangement flexible and convenient. The total weight of the car is 91,000 lbs. The outside is finished in standard Pullman color, and the interior in French gray.

LUBRICATION AND SUPERHEATED STEAM

Oil for use with superheated steam is discussed in an article in a recent issue of *Revue Industrielle*, in which the author says that the flash point is an important point to be determined for such oils. As a general thing it may be taken that the flash point for oils used in connection with saturated steam should



Interior View of Dynamometer Car, Showing Recording and Other Apparatus.

by means of a pen connected to a small electric magnet, which in turn is operated from an electric clock. Records of one minute, five seconds, or one-half second may be obtained. The record of locations is made by a small electric magnet in connection with a push button running to the observation cupola. The cupola is provided with an electric searchlight for night work.

The records from the locomotive are also made by means of electric magnets similar to that used in the location record. Two pens connected to standard Crosby indicators on the side of the table give a continuous curve of air pressure in the train line and in the brake cylinder, or if desired, in the auxiliary or supplementary reservoirs.

The gage board contains the following apparatus: One standard clock; one Haushalter speed recorder, driven from the main truck; four air recording gages; four standard air gages; one gage for the dynamometer showing drawbar pull, two electric counters.

ELECTRICAL EQUIPMENT.

Electricity for the lighting of the car and the operation of all magnets and motors is obtained from a set of 16 storage battery

cells, located beneath the car. These in turn are charged by means of a Bliss generator, driven from the rear truck of the car. The voltage used throughout is 32. The switchboard is so arranged with a series of multiple jacks that it is possible to put any voltage on any magnet, thus making the whole arrangement flexible and convenient. The total weight of the car is 91,000 lbs. The outside is finished in standard Pullman color, and the interior in French gray.

Oil for use with superheated steam is discussed in an article in a recent issue of *Revue Industrielle*, in which the author says that the flash point is an important point to be determined for such oils. As a general thing it may be taken that the flash point for oils used in connection with saturated steam should

be at least 20 per cent. above, and in the case of superheated steam at least 50 per cent. above, the temperature of the steam. For a number of years compounded oils have been used for this purpose. That is to say, oils to which about 5 per cent. of animal oil has been added. The use of this addition is of doubtful advantage, and in any event, the percentage used should not be more than 5, because of the corrosion that is apt to be set up by the liberation of the acids. While the flash point may be taken in an open vessel, the use of the closed Pensky-Martens apparatus is recommended as preferable.

The acidity should not exceed an average of 0.3 per cent., calculated in sulphuric acid, for clear oils, and .15 per cent. for the dark oils. A practical test for the oil is suggested as follows: Let a few drops fall on the surface of a carefully polished plate of copper or brass, and set the plate aside for about eight days, taking the precaution to shield it from dust. If, at the end of that time, the oil takes on a clear green color, or distinctly shows a clear green precipitate, the conclusion may be safely reached that there is acid present in the oil and that it should be rejected.

SHOP KINKS

BY C. J. DRURY,

Master Mechanic, Eastern Railway of New Mexico, Amarillo, Tex.

FLUE SWEDGING MACHINE.

The flue swedging machine shown in Fig. 1 is made from an old brake cylinder with two $1\frac{1}{4}$ in. holes drilled in its sides $5\frac{1}{4}$

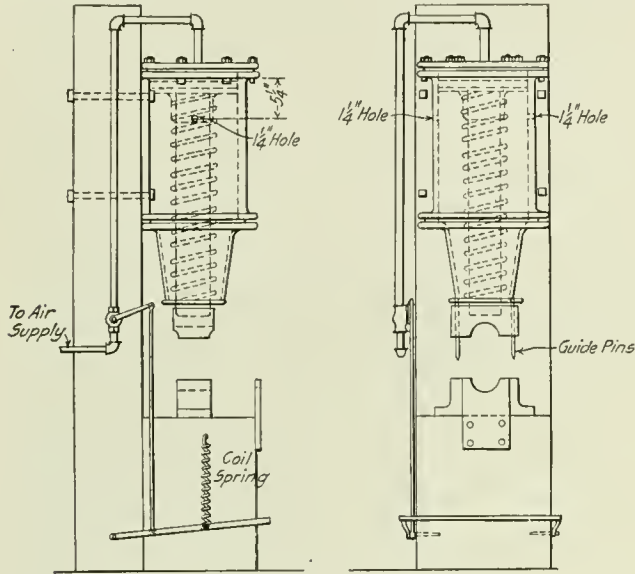

Fig. 1—Flue Swedging Machine.

in. below the top. The cylinder is fastened to a post as shown, and has a die fitted on the end of the piston rod. This die has

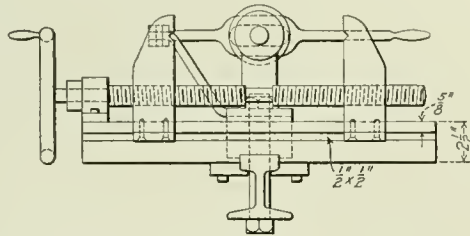

Fig. 4—End View of Bolt Centering Machine.

guide pins which fit in holes in the bottom die, thus keeping the dies in alignment. Air enters at the top of the cylinder and the supply is controlled by a foot lever which operates a valve. The machine will operate continuously while the air valve remains open, for, after the piston passes the exhaust holes, the pressure

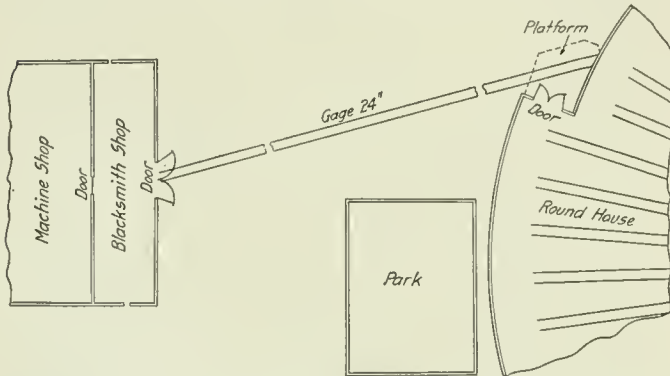

Fig. 2—Delivery Track Between Engine House and Machine Shop.

on it is relieved and the piston is forced back by the compressed spring. The machine can be made from scrap material for \$5.

ENGINE HOUSE TRUCKING SYSTEM.

The arrangement for carting the engine parts to be repaired from the engine house to the shops is shown in Figs. 2 and 3. A 24-in. gage track runs from a platform just inside the engine house door to the blacksmith and machine shops. The truck shown in Fig. 3 is used on this track. It has a platform 4 ft.

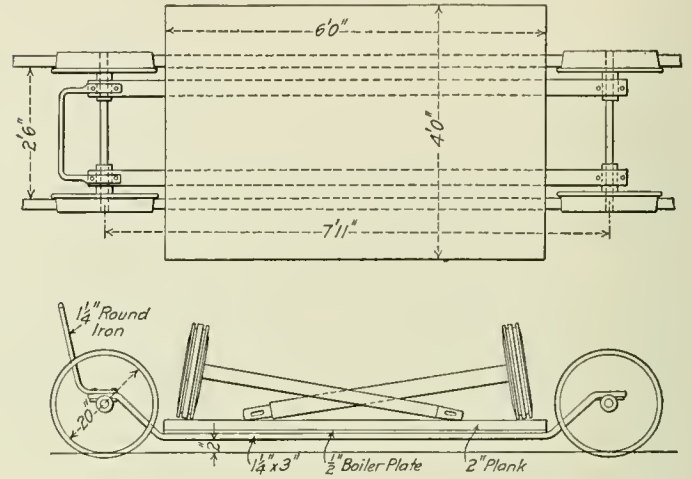

Fig. 3—Car Used for Handling Material Between Engine House and Shops.

wide by 6 ft. long, the top of which is only $5\frac{1}{4}$ in. above the rail, making it convenient for loading heavy material. The truck has a wheel base of 7 ft. 11 in. with 20-in. wheels, and the frame consists of two $1\frac{1}{4}$ in. x 3 in. iron bars connecting the two axles. A handle of $1\frac{1}{4}$ in. round iron is used to push the truck.

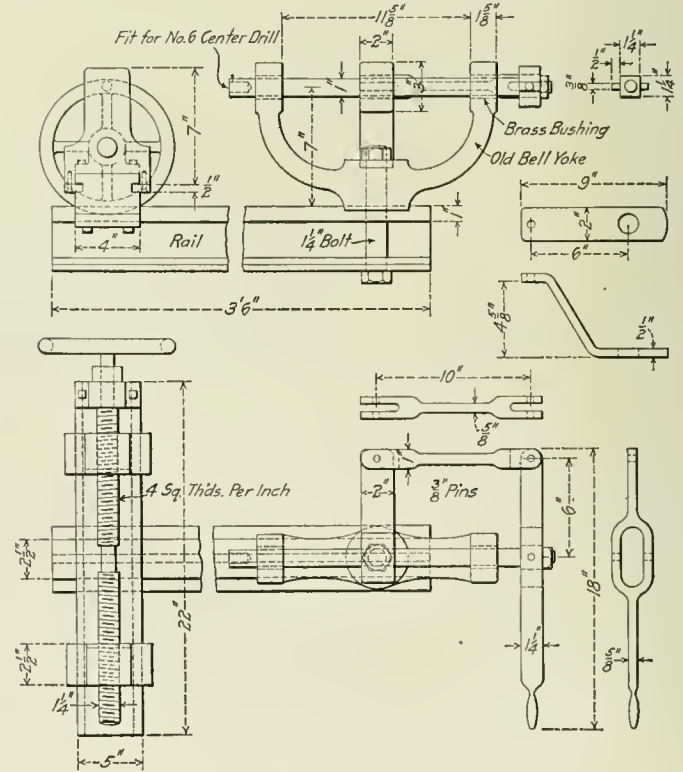

Fig. 4—Bolt Centering Machine.

BOLT CENTERING MACHINE.

In small shops that have no up-to-date machine for centering bolts, the device shown in Fig. 4 can be made and will give very satisfactory results. It consists of an old bell yoke fastened to a rail $3\frac{1}{2}$ ft. long, a transverse table for the chuck being at-

tached at the other end. The bell yoke is bolted to the rail by a 1 1/4-in. bolt and has a one inch spindle extending through the holes in the arms. This spindle has a 3 in. pulley fixed in the middle, and is given longitudinal motion by the system of levers shown, the drill being fitted in the end of the spindle as indicated in the illustration. The chucking table is made of a block 4 in. wide which is fastened across the end of the rail by four bolts. This block has slots which guide the two jaws that slide on its top. These jaws operate on a lead screw having right and left-hand square threads, which keeps them always at the same distance each side of the center. They are operated by a hand wheel, as shown. This arrangement can be easily made

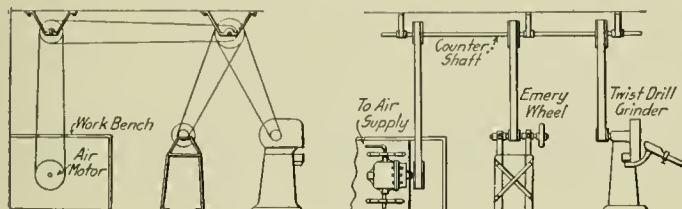

Fig. 5—Pneumatic Drive for Tool Room.

from scrap material at a cost of \$10, and will serve its purpose almost as well as any other bolt-centering machine.

PNEUMATIC DRIVE FOR TOOL ROOM.

In many shops the tool room is in such a location, especially at small plants, that it is inconvenient to reach it with the line

POWERFUL PACIFIC TYPE LOCOMOTIVE

A theoretical tractive effort 1,000 lbs. greater at 50 miles per hour than the average at that speed for other locomotives of the same type and of approximately the same weight, is a feature worthy of particular notice. This combined, with an ample boiler capacity to deliver its calculated cylinder power at that speed makes the design of the Pacific type locomotive built by the American Locomotive Company for the Frisco Lines deserving of careful study. A comparison of the tractive effort at various speeds, from starting up to 50 miles per hour, of this locomotive and the average of five other representative Pacific type locomotives of recent construction and about the same total weight is given in the following table:

| Speed, M. P. H. | Theoretical tractive efforts. (A. L. Co.'s formulæ.) | | Difference in tractive effort in favor of Frisco. | |
|-----------------|--|---|---|-----------|
| | St. Louis and San Francisco. | Average of 5 Pacifics of approximately same weight. | Pounds. | Per Cent. |
| Starting..... | 40,800 | 34,140 | 6,660 | 19.5 |
| 30..... | 24,760 | 22,670 | 2,090 | 9.2 |
| 35..... | 21,210 | 19,540 | 1,660 | 8.6 |
| 40..... | 18,560 | 17,110 | 1,450 | 8.4 |
| 45..... | 16,440 | 15,200 | 1,240 | 8.1 |
| 50..... | 14,660 | 13,650 | 1,010 | 7.4 |

These tractive efforts are calculated in accordance with the adopted practice of the builders which employs speed factors based on the piston speed corresponding to the speed in miles per hour. The average weight of the five locomotives is 255,500 lbs., as compared with 260,500 lbs. for the Frisco. The lightest weighed 9,000 lbs. less than the Frisco, and the heaviest 1,500 lbs.

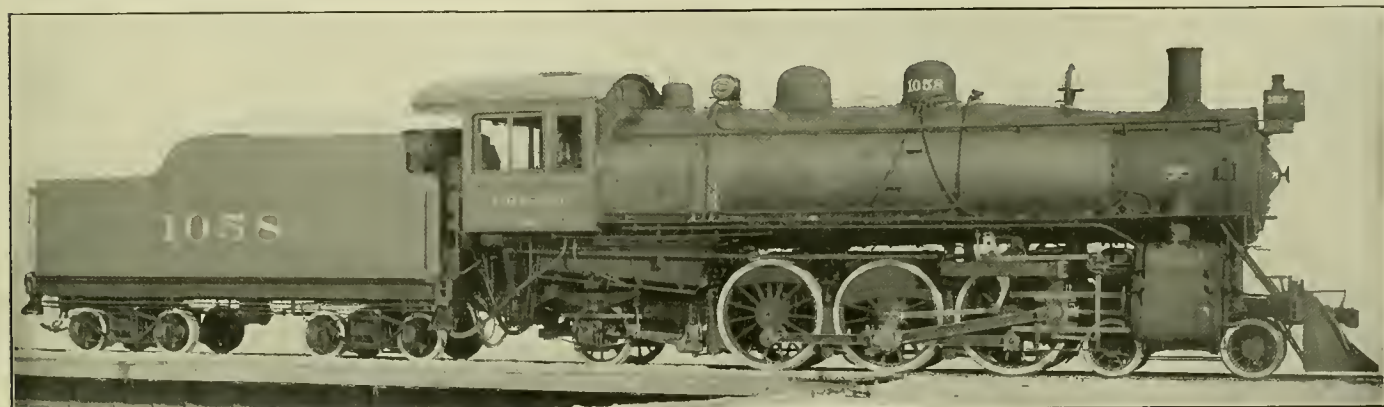

Pacific Type Superheater Locomotive of Exceptional Power at Moderate Speeds.

shaft from the shop engine. Such is the case in our shop, and it was found necessary to rig up an air motor drive, as shown in Fig. 5. The motor was boxed in so as to muffle the noise and keep out the dust. It will be noticed that it drives two emery wheels. The motor and the emery wheel stands were installed at a cost of about \$15 and the arrangement adds greatly to the efficiency of the tool room.

COIN OPERATED SPEED INDICATOR.—There has been designed in England an arrangement whereby a passenger on the train who is curious concerning the speed at which he is riding can, by inserting a coin and pressing a button, have his curiosity gratified. This idea was conceived by H. Weymouth Prance and consists of a speed indicator belted to the axle through the medium of a clutch. Normally the speed indicator is out of action, but when a coin is inserted in the machine, it releases a latch and permits the clutch to be engaged when the button is pressed. In this way the indicator is started through the medium of the belt, there being an automatic arrangement for taking up the slack and preventing slipping, and the speed of the train is shown on a dial in the car. When the button is released a spring disengages the clutch and it is locked in this position by the latch, requiring the weight of a coin to again release it.

more. Of the five, three use superheated steam. The tractive efforts given may therefore be considered conservative, as the speed factors used apply particularly to locomotives using saturated steam. From recent tests they appear to be somewhat low for locomotives equipped with fire tube superheaters.

With its 69-in. drivers, the Frisco locomotives would not seem to be particularly well adapted to some classes of modern fast passenger service in which speeds of 60 miles an hour and over obtain, but within the range of speeds covered in the table the comparison indicates a well balanced design, carefully worked out. With its large tractive effort at speeds of 40 and 45 miles per hour it would seem to be also well adapted to fast freight service on moderate grades.

Twenty of these engines have recently been delivered by the builders to the St. Louis & San Francisco, being built entirely to the railway company's specifications. There are included a number of new features first introduced into locomotive practice in this country by the American Locomotive Company, and which are being quite extensively adopted and specified by the various roads throughout the country. Among these will be noticed the outside steam pipes, the self-centering guide for the valve stem and the outside bearing radial truck with floating yoke spring guide and universal flexible spring supports.

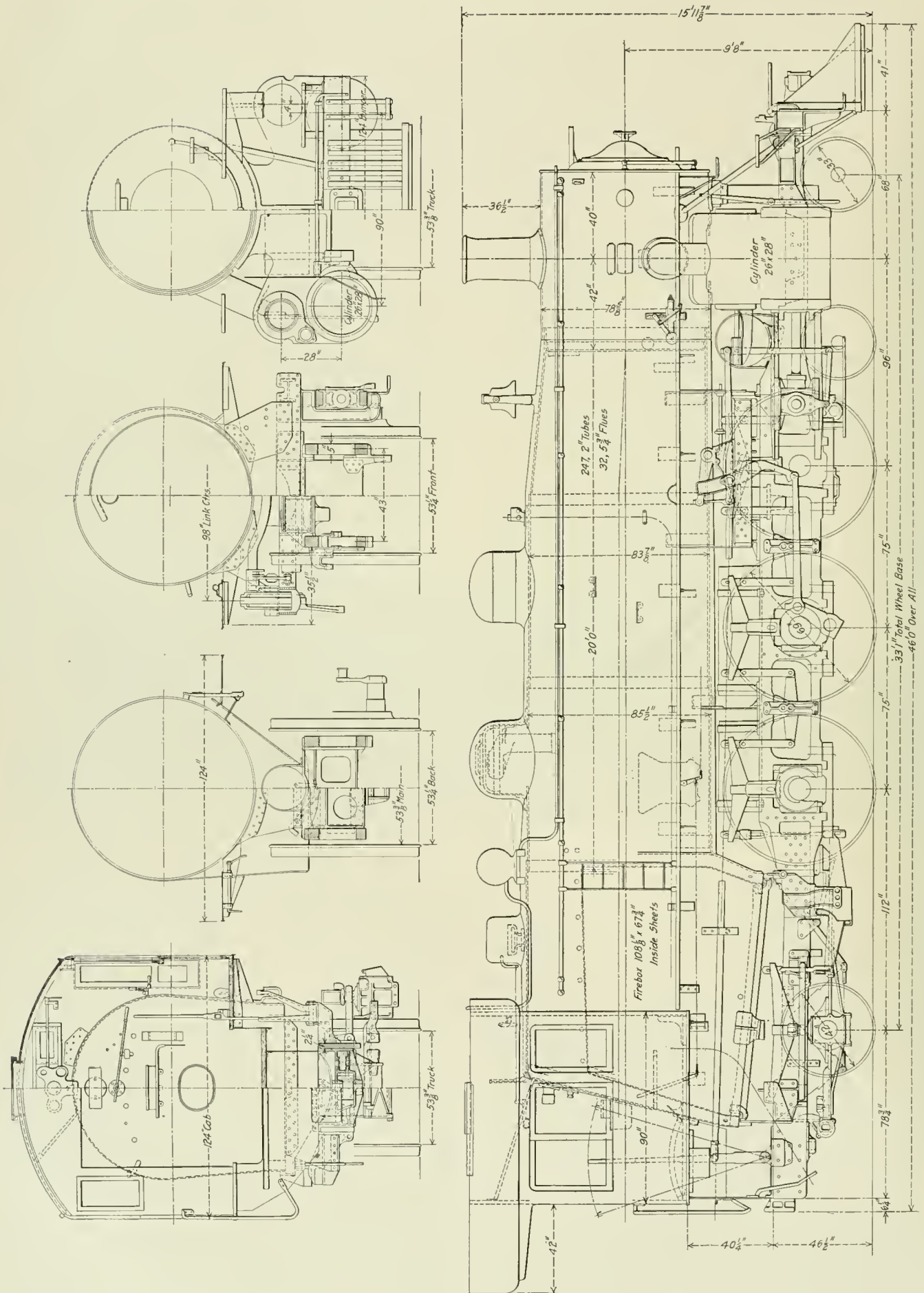

Pacific Type Locomotive for Heavy Moderate Speed Trains; St. Louis & San Francisco.

PAINT STOREROOM PRACTICE

BY O. P. WILKINS,

Foreman Painter, Norfolk & Western, Roanoke, Va.

It is generally conceded that to produce a thoroughly good and reliable paint it must be carefully ground and mixed. Realizing the importance of this last feature the Norfolk & Western installed some small machine-mixing cans, designed similar to the factory mixers at their Roanoke shops. The object was really two-fold; that of increasing the efficiency of the paint and to reduce the time lost by employees waiting to be served at the stock room counter. The old method of handling this

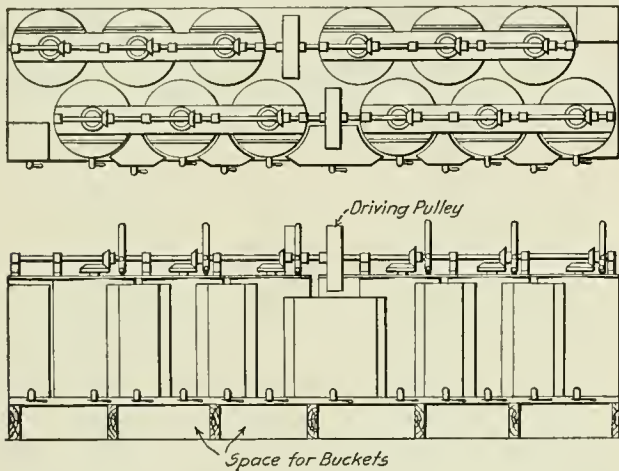

General Arrangement of Paint Mixing Tanks for Storeroom.

work was similar to that used in a large number of shops. All paints were mixed in pots, kegs or specially constructed cans with an ordinary spatula, and in most cases it was not mixed until the material was needed for the work at hand, and then it was done hurriedly on account of the work being performed on a piece-work basis. It was necessary for the men needing the material to wait at the counter, and if the job was of any size it would keep at least four men waiting, which would result in a loss of time ranging from 5 to 20 minutes for each man. This would not be so much for one gang, but in a shop where 30 to 40 men were employed on passenger car work, the time lost at the stock room counter was a serious question. The poor mixing was shown in some instances by the fact that a turpentine stain was frequently found at the top of the pot and the paste paint at the bottom. For the surfacers, truck color, floor color and roof paint a mixing can furnished by one of the varnish manufacturers was used. This can was provided with rod down through the center which held six blades and was operated with a handle on the outside of the can. This method of mixing was slow and uncertain.

The new method included 12 small mixing cans of about 25 gals. capacity each, which provides for the paints most frequently used on passenger car work. These mixers are motor-driven, connected by shaft, and can be operated separately or together. They are made of heavy sheet iron about $\frac{1}{8}$ in. thick, and are fitted with a slide spigot at the bottom of the mixer. The mixers are placed on a platform of sufficient height to allow a pail 12 in. high to clear the spigots. The space underneath the platform is utilized for the purpose of storing the various paint pots used for the different kinds of paint. Paints that are used almost every hour during the day, such as floor color, roof color, tuscan body color, truck color, baggage wall color, different kinds of surfacer, etc., are carried in the mixers and are always ready to be drawn off and passed over the counter to the workmen at short notice.

The stock room attendant and his two assistants are required, along with their other duties, to keep these mixing cans in good

condition and well filled with the proper materials. They report for duty 10 minutes in advance of the other workmen, in order to have everything in readiness, such as starting all the mixers, arranging the brushes, pots, etc., with the result that when the whistle blows everything is in shape to serve as called for, with the least possible delay. By simply throwing the electric switch, 12 of the most important paints are thoroughly agitated and are made ready for use. The brushes for the various kinds of paints are near the mixing cans, being within easy reach of the attendants. For example: an attendant will receive an order for four "kits" of surfacer to be used on one or more cars; he immediately goes to the surfacer can where he will find four pots under the platform; he opens the spigot directly in front of him, fills the pots with sufficient material for the job and with brushes for this particular material right at hand he passes it over the counter to the four men almost in less time than it requires to tell of the transaction.

With twelve of these mixing cans in use containing the paints that are used almost every hour it is plain to be seen that little or no time is lost in serving the materials, because all the mixing is done simultaneously, thoroughly and uniformly before the paint is called for at the counter. In the space between these 12 mixing cans are fitted specially designed cans to hold the different varnishes, oils, etc., that do not require mixing. These are also drawn off through slide spigots, and each can holds approximately 20 gals. The details are so thoroughly carried out that either of the attendants could go into the room at night without the aid of artificial light and serve any of the mixed paints without making a mistake, if necessity so required. The mixing apparatus is located in the center of the room and near the serving counter.

The same general scheme is worked out in the paint stock house where nothing but bulk materials are handled. In this building are three large mixers holding approximately 125 gals. each; they are used for mixing freight car and building paints. These mixers are located on a specially constructed table or

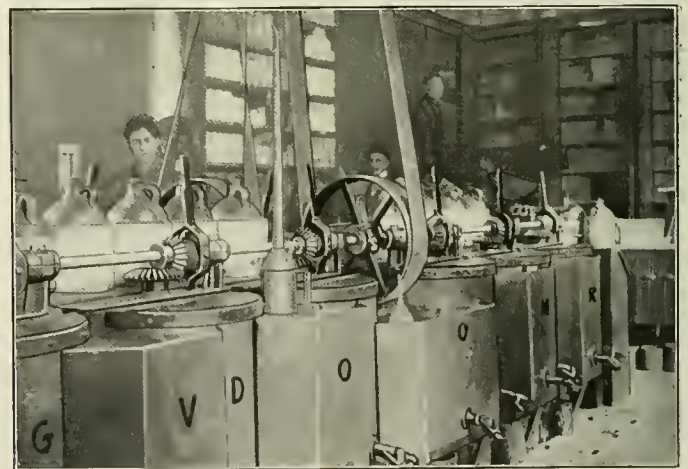

Paint Storeroom Equipped with Belt Driven Mixers.

platform of sufficient height to allow the mixed paint to run from the mixer to the barrel in which it is to be shipped. A chain hoist is used to lift a barrel of the semi-paste paint to the top of these mixers where it is placed on a specially constructed trestle; the head is partially removed, and the paste is allowed to run into the mixer. The different thinners, such as linseed oil, reducing oils, turpentines, etc., are piped to each of these mixers from the storage tanks in the cellar from which they are forced by an air pressure of 5 lbs. per sq. in.

It is believed that this new system more than paid for itself during the first year of service by the time saved at the stock room counter and by the saving in materials. The cost of the complete equipment, including the motor was not more than

\$450, and if it saved on an average ten minutes per man per day, 30 men at an average rate of 28 cents per hour, would effect a saving of \$1.40 per day, or \$420 in a year of 300 working days. This, however, does not take into consideration the saving in materials, the uniformity of the mixtures, or the high degree of proficiency, accomplished by machine mixing, each of which would add still more to the economy.

Another interesting feature in connection with this plant, and one worthy of special note, is that the cost of repairs during the entire five and one-half years' service has not exceeded \$2. The accompanying illustrations show the general outline of the mixers, but the plant should be seen in operation to be fully appreciated. The main brush trays are placed against the wall opposite the mixing cans which would be at the right hand side looking at the photograph. These trays are similar to the three small trays seen at the end of the table. The large mixers in the stock house are not shown, but they are like the other mixers, although of larger capacity. The results obtained from them are consistent with those obtained from the small machines.

ALL-STEEL BOX CARS.

The first large order for all-steel box cars has just been awarded by the Bessemer & Lake Erie to the Summers Steel Car Company, Pittsburgh, Pa. A sample car of this type, built by the Summers Company, has been in service for the past two years, and the 100 fifty-ton cars which have just been ordered will conform to the sample car as far as the construction is concerned, except that they will be 4 ft. longer and the truck side

them safely. Refrigerator cars, tank cars, and other cars of similar construction are often derailed, apparently because of their rigidity in connection with the rigid center bearing truck and rough track. The new truck has a flexibility which permits the car to travel over very irregular track without distorting the car body and at the same time prevents the hammer blows, due to transverse rocking, which are so injurious to the equipment, the lading and the track.

The inside dimensions of the new cars will be 40 ft. long, 9 ft. wide and 8 ft. high. The car has no center sills, the entire vertical load being carried on the side girders. The lower member of the side girder, or what corresponds to the side sill in an ordinary car, is a 5/16 in. pressed steel angle which is deepened near the center of the car. The lower half of the side sheet is a 3/16 in. plate and the upper half is 1/8 in. thick. The lower half of the end sheet is 1/4 in. thick and the upper half is 1/8 in. thick. The floor plates are 1/4 in. and are supported by 10 in. channels, which extend from side to side of the car. The side sheets are stiffened on the inside by 3 in. x 3/4 in. Z bars, weighing 6.7 lbs. per foot. The ends of the car are stiffened by the two horizontal pressed steel braces, the upper one of which covers the joint between the two halves of the end sheet.

The draft gear is attached to draft sills constructed of 3/8 in. plate pressed to a channel shape. Similar pressed members or diaphragms, but constructed of 1/4 in. plate, extend between the cross beams above the center of the truck and just back of it. A bottom cover plate 3/8 in. thick extends underneath the rear end of the draft sills and for a distance of about 4 ft. toward the center of the car. The roof sheets are of Carnegie copper steel, 1/8 in. thick. The carlines are on the outside, leaving a smooth



All-Steel Box Car Similar to Those Ordered by the Bessemer & Lake Erie, Although Not Quite as Long.

frames will be of the regular arch bar type, but equipped with the Summers balanced side bearing features, the same as on the sample car. This balanced side bearing feature is a new and radical development in car truck construction and bids fair to come into general use because of enabling a car body of rigid construction to traverse twisted and rough track without throwing the twist into the car body or without danger of derailment. The construction of all-steel box cars is so rigid that without a truck of this kind it will be practically impossible to operate

roof surface on the inside of the car. The construction is such that no rivets are driven through the roof plates to the inside of the car.

With this form of construction the car will weigh 43,000 lbs., or about 3,000 lbs. less than a steel underframe car of the same capacity and with the same inside dimensions. It is about 9 in. less in height at the eaves and the center of gravity is about 7 in. lower than for the steel underframe car. There are 12,000 lbs. more steel in the car and at the present prices of steel and lumber

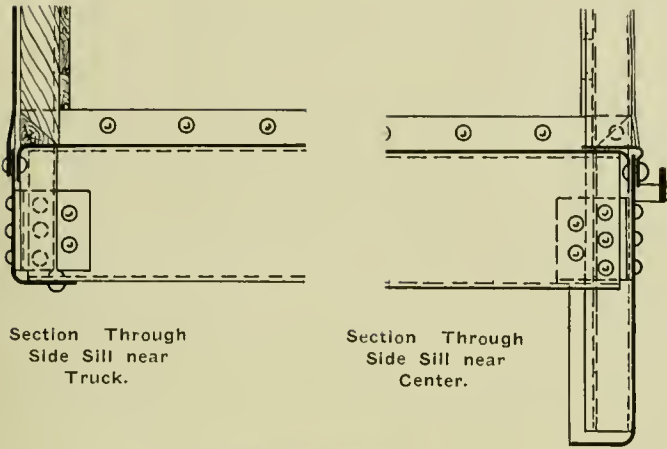

body to swing sideways at the bottom but does not allow the sides to sway at the top, with the attendant vertical hammering blows on the side bearings, springs and wheels.

A comparison of this truck and its performance with the standard or center-bearing truck will be interesting and instructive. The center-bearing truck, which at the present time is almost universally used, has one very grave disadvantage. The load supposedly carried on the center plate and evenly distributed to all the wheels, is, by reason of the transverse rocking of the car and the acceleration of this movement by the truck spring reaction and attendant track conditions, at times all carried on the wheels on one rail; not only is it thus all on half the wheels, but by reason of the every increasing load capacity of the cars and the attendant lifting of the center of gravity above the rails, the impact from the side oscillation may double or quadruple the rail reaction. When the impact occurs coincident with the wheel

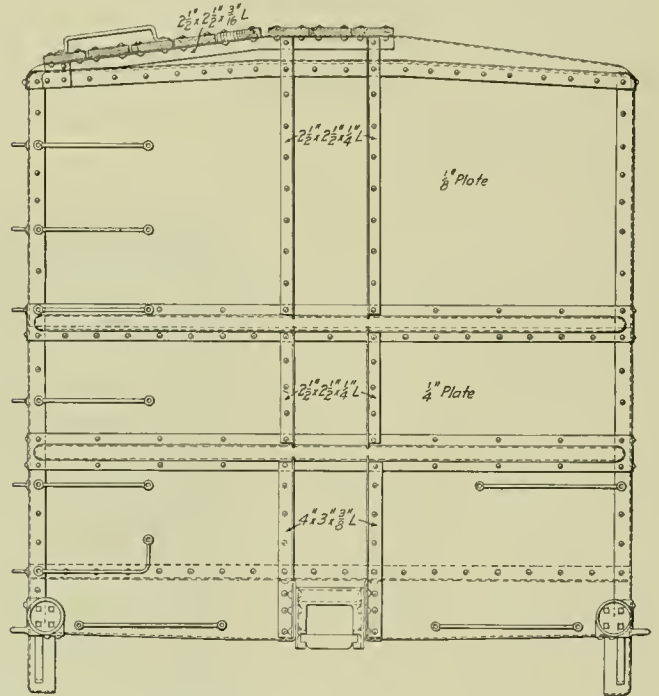
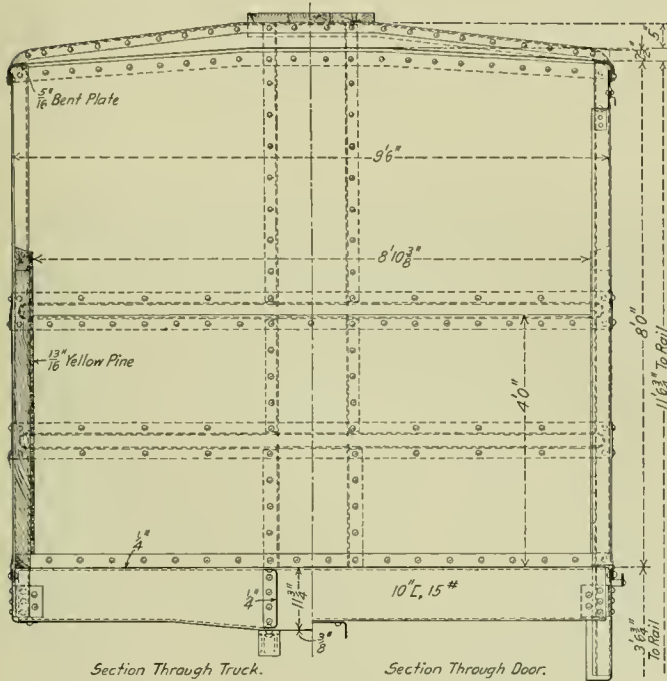

End View and Sections Through Summers All-Steel Box Car.

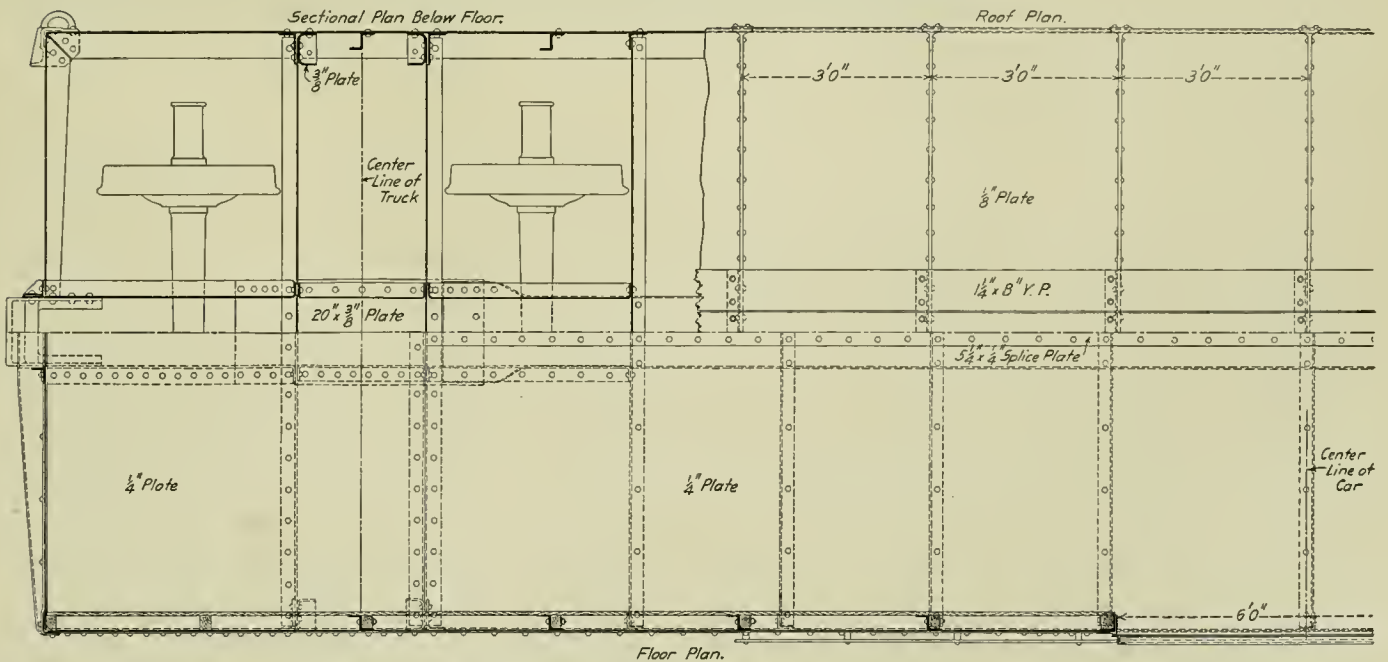

Partial Floor and Roof Plans for All-Steel Box Car; Bessemer & Lake Erie.

traversing a rough piece of track at high speed, a part of the stored energy due to train velocity is converted into vertical impact on the rail.

The new truck illustrated herewith carries the load on the inclined hangers *A*. Cast steel brackets *C* are fixed to the under-frame of the car body and cross bars *D* pierce the lower ends of hangers *A* and also fit in a notch in the under side of *C*, the load of the car body being carried through these members to the side bearing or rocker cap *E*, thence into the segmental rocker *F*, which is journaled in oil in the spring cap *G*, transmitting the load through the springs and truck side frame to the wheels. The brackets *C* hold the lower ends of hangers *A* at a fixed distance transversely, while the cradle member *H*, to which *E* is secured, holds their upper ends. When the car is moving slowly along the track, any vertical change in track alinement is taken care of by the rotation of the hangers *A* about their upper ends. With high train velocity the cradle *H* will move instead of the car body, the hangers *A* rotating about their lower ends, thus allowing the car body to move in a straight line, the vertical changes in track alinement being converted into horizontal movement by reason of the difference in inertia of the car body and the cradle. The cradle *H* is held in central position by its center plate *K* and the king pin *L*. The latter has a limited lateral movement at *M* and is returned to the central position by the springs *N*.

The king pin arrangement is clearly shown in the sections through the truck. The construction is of very generous proportions and indicates also that the parts that come into play in moving the truck along are located to advantage. The helical springs between the center pin and truck transom act to check and cushion the transverse swerve of the car body on curves or uneven track; these springs also come into action when the car is traveling at high speed, absorbing the lesser vibrations independently of car, the body and the truck proper. This type of side bearing truck makes it possible to carry the load distributed on all side bearings under any track conditions, and thus distributes the load equally to all the wheels. In a word the truck permits of a rigid car body being carried over the rough track, the wheels moving up and down or transversely without transmitting the motion to the car body.

STEAM WASTED AT POPS.—Recent tests made by Professor E. F. Miller on Crosby locomotive safety valves, which were described in detail in the September, 1911, issue of the *American Engineer*, showed that with a valve lift of only 0.05 in. the weight of steam discharged per minute, at 200 lbs. pressure, was as follows:

| | |
|--|----------|
| 3 in. muffled valve with flat seat having a square edge..... | 96 lbs. |
| 3 in. muffled valve with flat seat having a rounded edge..... | 107 lbs. |
| 3½ in. muffled valve with flat seat having a square edge..... | 114 lbs. |
| 3½ in. muffled valve with flat seat having a rounded edge..... | 127 lbs. |

This means that for every pound of steam about 1,200 B. t. u. were wasted, which, when considering that a pound of coal contains 14,000 B. t. u. and that about 60 per cent. of that is used in evaporating steam, and that coal costs about \$2.50 a ton, would mean a loss of from \$1.00 to \$1.35 an hour. Or, looking at it from another point of view, the fireman would be wasting from three to four times the amount of his wages during the time the pops were blowing. If the lift of the valve was 0.10 in. this cost would be just about double.

HINTS TO DRAFTSMEN*

BY WILLIAM FYFE TURNBULL

Many of the draftsman's drawbacks are due to peculiarities of personality. One of the most noticeable of these is the tendency to roam from place to place in search of so-called experience. Real seasoned ripe experience comes from staying in one place long enough to have had personal acquaintance with a great many jobs of different kinds, to have seen what mistakes were made and also what good points were made and how the designs stood up in service.

The draftsman has to contend with office and shop conditions which often require considerable haste in getting the work out. In such cases less time is allowed for thought and study of the design than is really necessary for accurate work, and unless the draftsman has trained himself to work well under high pressure something is almost sure to go wrong.

From one point of view a drawing is a communication with directions for doing work. In other words it is a graphic letter and like a good letter it should be readable, clearly understood and capable of only one interpretation. This may be violated in the first place by not making lines heavy enough and dis-

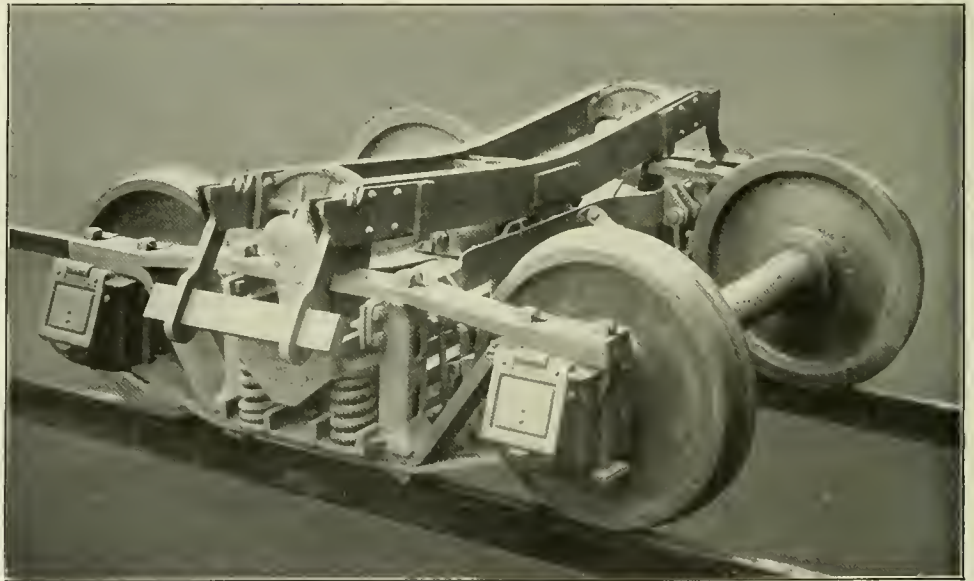

Summers Balanced Side Bearing Truck.

tinguishing lines of different importance. Another mistake is to make an elevation drawing which does not show sufficient detail to insure the clearance of all parts. An illustration of this was a locomotive erecting card on which the position of the reach rod had not been checked at the extreme points, and when erected the line of the rod in one position passed through an air reservoir, which of course had to be moved.

Another drawback is the showing of too few views and sections on a detail drawing. In one case a locomotive crosshead was to be copied and made stronger around the piston rod fit, having the increased dimension carried back to include the wrist pin collar. The original drawing showed a section near the wrist pin, and on this section the draftsman sketched in the increase in size desired. The foundry whose duty it is to follow a drawing and not to assume things, simply made the wrist pin collar higher and left the part around the piston rod as weak as before. There should have been an additional section shown farther up which would have involved considerable more drawing. A drawing cannot be made too plain, even at the cost of additional

*From an address before the American Society of Engineering Draftsmen at New York, February 15, 1912. Mr. Turnbull is with the American Locomotive Company, New York.

time and expense. A dollar in the drawing room has often saved ten in the shop.

From another point of view, a drawing is a description of work which must be made with regard to the strength of materials. This seems obvious, but how often it is forgotten. One cause of this forgetfulness is simple ignorance or the neglect to use the laws of mechanics. As an illustration of this fault a locomotive throttle lever was made in which the relative distances between the fulcrum, throttle rod and handle were such as to necessitate an excessive pull on the handle in order to open the throttle. A little consideration of the mechanical law of the lever would have prevented it. Another case was the attachment of a valve motion combining lever to a crosshead by a pin several inches high. The pin had been figured for shear only, and not for the additional bending due to the eccentric pull; consequently it broke in service. Numerous other such failures may be traced back to the draftsman and designer.

Many calculations must be based on the results of the action of parts in service, for in some instances the stresses are indeterminate mathematically; that is, elements enter in which cannot be measured, and in such cases one must familiarize himself with previous designs, seeking advice from designers familiar with those parts. A further difficulty comes from not considering abuses to which a part may be subjected. Think of the number of handles and lugs located at seemingly inaccessible places on machines, but which are used as steps when not designed for any such purpose. Safety would counsel that this should be considered, and that every structure or machine should be made as nearly fool proof as possible. One instance of this was a grate shaker shaft which was designed to withstand twisting moment due to the pull of one strong man. But at one time the grate became clogged with clinkers and the fireman was unable to shake it so the engineer came to help him out. Their combined pull instead of shaking the grate twisted off the shaft. These situations call for imaginative foresight and an intimate acquaintance with the rough treatment that a machine may receive.

Last of all a drawing is a description of work which must be made subject to the knowledge of shop-men and the action of machine tools. Draftsmen should have shop experience; they should know what dimensions are necessary to the shop-man and be familiar with the way the work is done. Drawings are frequently seen in which the dimensions given are not those which the mechanic uses in doing the work, and he is consequently compelled to lose time and run the risk of error by calculating the required dimensions for himself. An illustration of this is in giving the distance across the flats of a square shank instead of the diameter of the circumscribed circle, which of course the lathe hand must have in order to turn the piece before it can be shaped square. Again we often find that insufficient clearance is allowed for rivet heads and nuts when these are not shown in detail; bolt holes are also placed so close to a recessed corner that no room is allowed for the wrench. Pipes are often shown bent to impossibly small radii, and insufficient room is allowed in which to put the bend. An offset forging is sometimes seen with dimensions between the centers of the offset parts instead of between the outside flat sides which the smith must measure. Then, too, details are often shown which involve extra labor without any corresponding advantage, such as radii on milled surfaces smaller than the radius of the cutter and necessitating a shaping operation, or in other cases square corners on the outside of bent forgings where no advantage is to be gained. Small points like these involve unnecessary cost.

Following is the advice of a man who has been chief draftsman of a large locomotive works for many years: "Apply the established standards and data of your drawing room. Consult with the foreman of the pattern shop and with the foreman or other experts of construction departments, such as machine shops and boiler shops. Ask advice from more experienced draftsmen, especially from your immediate superior. Investigate the speci-

fications, requirements or restrictions which must govern the production of the part you are to work out. Conserve your time in the interests of those paying for it. Make a few notes that will aid in making you more proficient. Provide proper tools for quick and accurate work. Give your drawings sufficient checking for detection of errors and make corrections before submitting them to the attention of the inspectors. Make an honest endeavor to design so that work may be produced without unnecessary expense. Cease from copying another's design without proper consideration; stop guessing; learn the *what, how* and *why* of your business," and you will be a very successful draftsman and a joy to the engineer who oversees you.

ERECTING SHOP KINKS*

BY E. T. SPIDY,

Former Assistant to General Foreman, Canadian Pacific, West Toronto, Canada

JOURNAL BOX TRUCK.

The handling of journal boxes is a big problem at division points, and especially where they are required to be handled by one man. Fig. 1 shows a truck for conveniently and quickly handling driving boxes. To operate, the truck is run over the box, the handle is raised and the grab hooks are placed in the position shown, one fitting into the oil pocket on top of box while the other

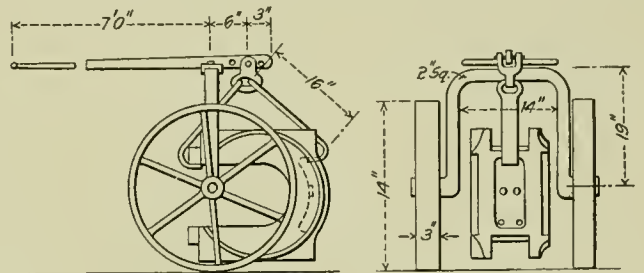

Fig. 1—Truck for Journal Boxes.

rests in the cellar fit at the bottom. When the handle is lowered the box is gripped and lifted from the ground, being held fast by its own weight. The link which carries the grab hook is adjustable on the handle. By placing it in the next hole farther from the support a smaller box may be lifted without excessive motion of the handle, likewise a greater leverage can be obtained for handling larger boxes by using the hole nearest the arch.

PORTABLE OIL BURNER FOR HEATING CYLINDERS.

A convenient arrangement for heating locomotive cylinders when applying bushings is shown in Fig. 2. It is fixed on a truck

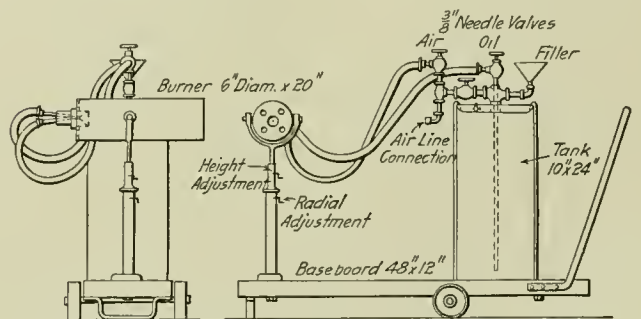

Fig. 2—Portable Oil Burner.

which is placed at the front of the engine between the front end beam and the cylinder, the burner being adjusted to the correct height and angle. It should point to the center of the cylinder about 4 in. from the end. A large sheet iron cone is placed in

*Entered in the *Railway Age Gazette* competition which closed September 15, 1911.

the cylinder, the back of the cone touching the back edge of cylinder while its point reaches near the front end. The flame is directed on the point of the cone which distributes it and heats the inside wall of the cylinder evenly. With the burner shown, a 22-in. cylinder can be heated ready for the bushing in 20 minutes. The details of the piping arrangement are enlarged in the illustration so as to show the construction more clearly. All the air pipe fittings are $\frac{3}{4}$ in. and the oil pipes are $\frac{3}{8}$ in. The idea of trucking the whole outfit was to save the time usually lost in getting and making hose connections. The possibilities of the various uses for a burner of this type are numerous. The same arrangement will fire up boilers for tests, or melt off babbitt from shoes or boxes, etc., thus effecting considerable savings.

TRUCKS FOR RODS OR AXLES.

A hand truck of the construction shown in Fig. 3 is a real time-saver in shops where the handling of driving or truck axles, main or side rods, or similar work, cannot be confined to cranes.

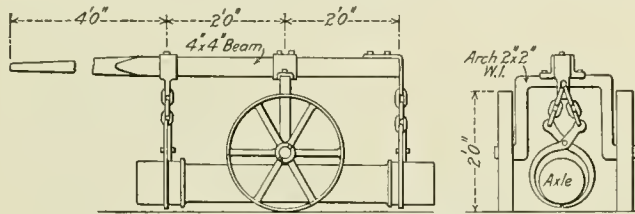

Fig. 3—Truck for Axles or Rods.

and it is much superior to the ordinary hand truck which is commonly used. In operation, it is run directly over the rod or axle, and when the handle is raised the far end is lowered, which allows the jaws of the grab hooks to close over the rod or axle. The handle is then lowered, raising one end of the axle and allowing the nearer pair of grab hooks to be placed over the other end of the axle. On bringing the handle to a horizontal position the axle or rod is lifted clear of the ground and is ready to be transported. The construction of the grab hooks is such that the weight of the carried body tends to tighten them, thus holding the object securely. The truck is of special value where this class of work has to be carried from the store house to the shops or engine house over more or less rough ground; it requires only one man to handle the

to carry it through the shop to where it is to be applied. It is undoubtedly a dangerous practice and unnecessary when such an arrangement as that shown in Fig. 4 can be made from the scrap material found in almost any shop. It consists essentially of three iron plates $\frac{1}{4}$ in. thick separated by pieces of 1 in. pipe and connected by $\frac{5}{8}$ in. bolts passing through the pipes. Pieces of angle iron are riveted to the top plate to serve as rests for the ladle, and both the operating valves are on one side behind the shield plate. The piping arrangement is such that only one connection is necessary to make it ready for use. A babbitt furnace of these dimensions will melt 20 lbs. of babbitt metal in less than 10 minutes.

ENCLOSED OBSERVATION PLATFORM

The observation cars for the Panama Limited of the Illinois Central, running between Chicago and New Orleans have a new feature called a sun parlor. Since these trains operate in daylight at both ends of the route, to make the observation platform available in the north during the winter season it was decided to have it enclosed. The next day, however, the temperature would permit it to be open, and therefore the large windows were arranged to drop out of sight, leaving practically an open observation platform.

The construction of the drop sash is shown in the illustration. A special steel frame capped with wood on the inside is used for the sill, being hinged to the inside finish so that when

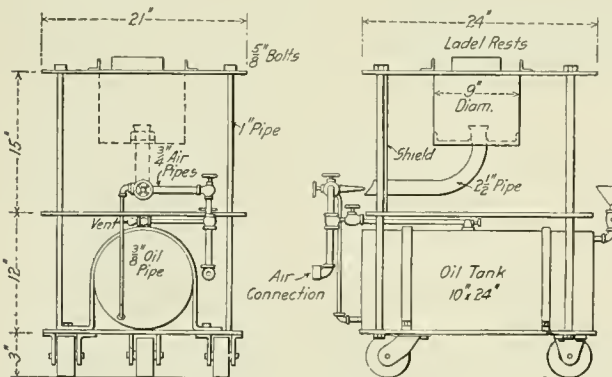
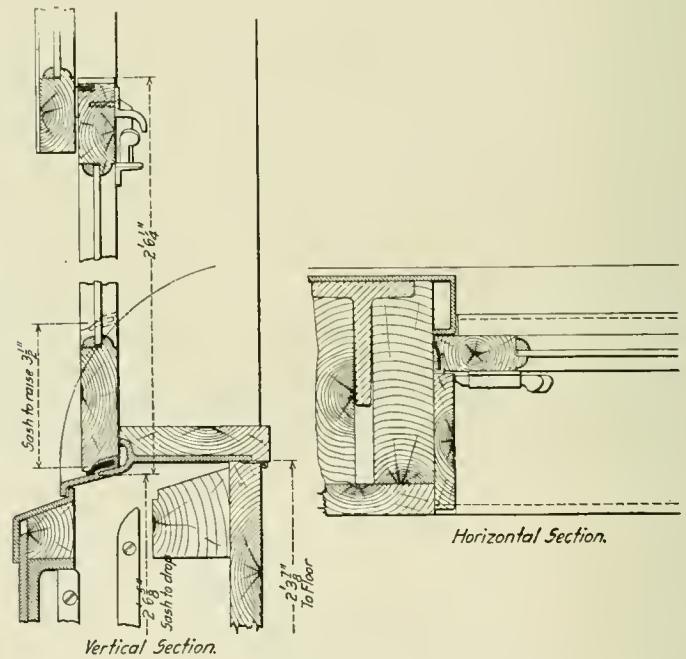

Fig. 4—Portable Oil Babbitt Furnace.

work instead of two or three. The handle is made of wood and the rest of the fittings are wrought iron, with the exception of the wheels, which are cast iron. The chain, the links of which are of 5-16 in. material, should be adjusted so that the bottom of the grab hooks will hang $2\frac{1}{2}$ in. from the ground when the handle is horizontal.

PORTABLE OIL BABBITT FURNACE.

A compact labor-saving device that is adapted to shops that have a variety of babbitting work and where it is inconvenient to take all such work to a stationary fire, is shown in Fig. 4. It is still customary in many shops to melt a ladle of babbitt and



Details of Drops in Illinois Central Observation Car.

the sash is raised about $3\frac{1}{2}$ in., it can be swung inward, permitting the sash to fall into the cavity below, and thus be completely covered when the window sill is again in place.

These cars were built by the Pullman Company, and are of composite construction, having a steel underframe and superstructure; the inside finish is of wood. They are 74 ft. in length over the end sills and have a large observation room with a seating capacity of 25 just ahead of the sun parlor; forward of this is a smoking room with a seating capacity for 20, which is enclosed, a side corridor forming a passage to the observation room. A toilet and a small buffet is provided in connection with the smoking room. The cars have total weight of 136,100 lbs. in working order and are equipped with axle light, using a Gould 40-volt, 3 k. w. generator and Edison batteries; also the vapor system of steam heating and Garland type C ventilators.

LOCOMOTIVE FEED WATER HEATER

BY GEORGE SHERWOOD HODGINS.

About five years ago D. Drummond, chief mechanical engineer of the London & South Western, devised and applied a method of heating the feed water* on locomotives before it entered the boiler. This arrangement proved so satisfactory and economical that its use has been extended on that road to cover practically

charged through an opening in the rear header to the ground, falling between the rails.

A duplex pump having steam cylinders 4 in. in diameter by 8½ in. stroke and water cylinders 3⅝ in. in diameter is driven by live steam from the boiler and draws its water supply from the hot well; it discharges through a pipe led forward underneath the boiler to the smokebox and through a check valve on the upper part of the front flue sheet. This pump is generally secured to the frames on the left side of the locomotive, although

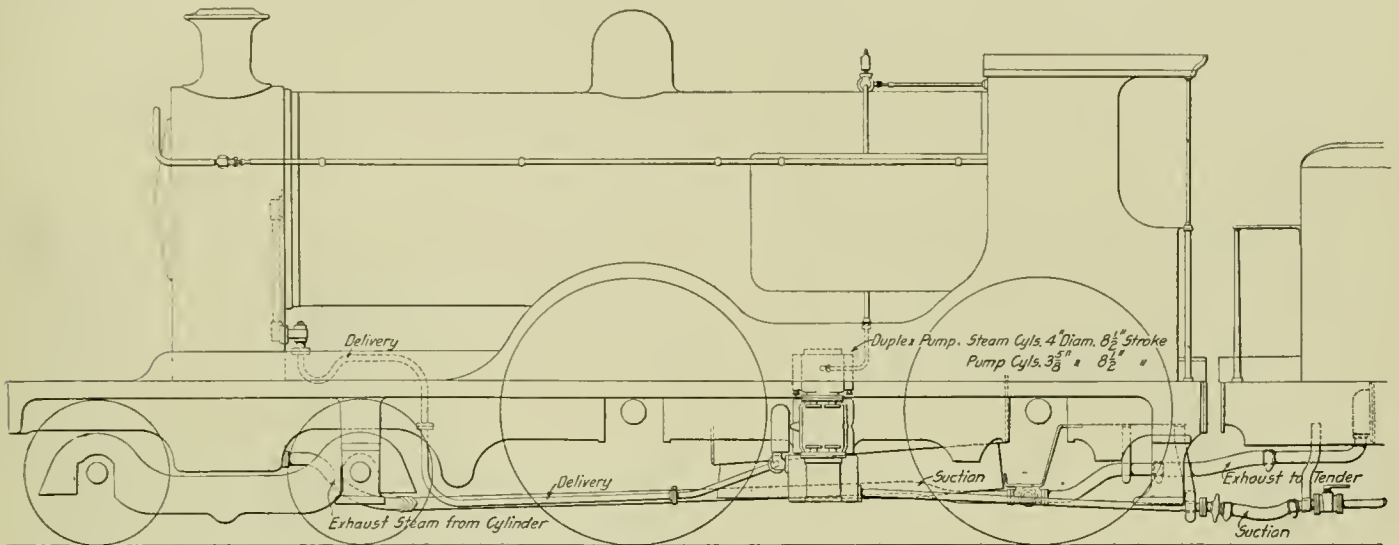

Arrangement of Feed Water Pump and Piping on the Locomotive.

all classes of locomotives, and it is stated that an average saving of about 13 per cent. is being obtained when compared with the use of feed water at the ordinary temperatures.

A well, or chamber, 2 ft. 2½ in. in width and about 18 in. deep, and extending the full length of the tender, is provided as a heating chamber, the source of heat being a small proportion of the exhaust steam from the cylinders and the exhaust steam

in some cases it is carried by a casting extending between the frames. On some locomotives two pumps are provided, and on others a regular injector drawing its supply directly from the tank is provided for an emergency. As may be seen in the illustration the hot well on the tender is water tight, being separated entirely from the tank, and obtains its supply through two 2-in. holes at the back end, while the pump suction is located at

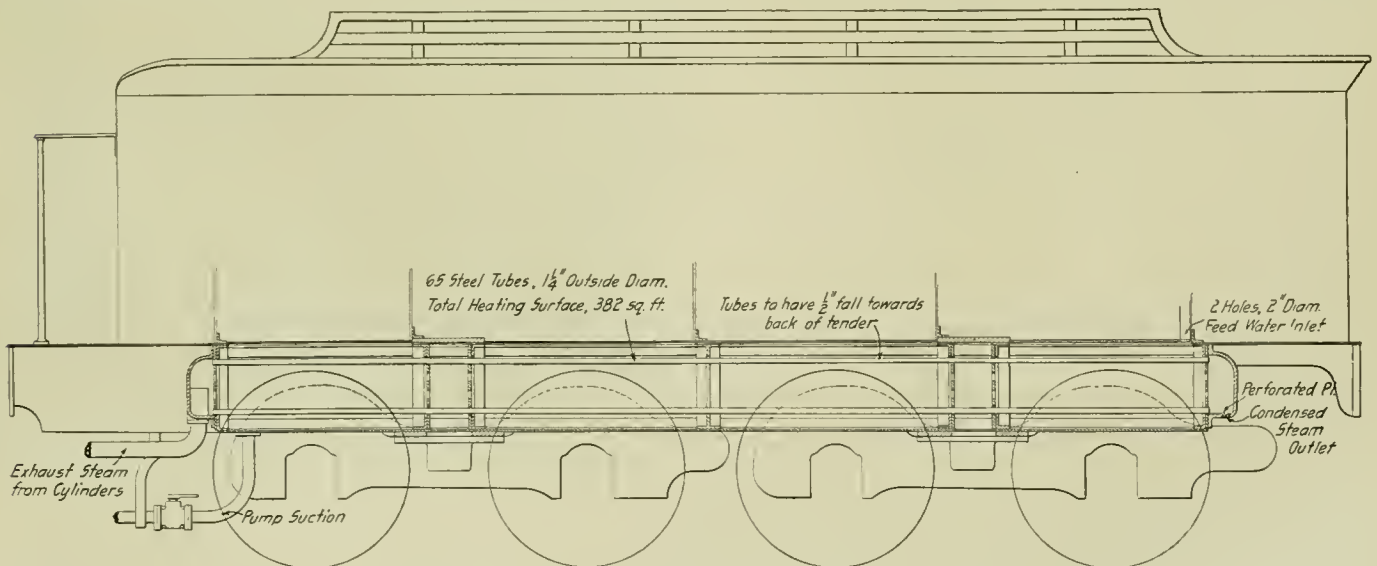

Longitudinal Section of Tender Showing the Hot Well.

from the duplex pump. In this well are sixty-five 1¼ in. tubes, 18 ft. in length, connecting two cast iron headers. These tubes are given a drop of ½ in. toward the back end and the steam entering the forward header gives up its heat to the feed water surrounding the tubes, is condensed and the condensation is dis-

posed at the front end. In this way there is comparatively little heat transferred to the main body of water in the tank and the water in the hot well is easily maintained at a temperature of about 200 deg., the heating surface in the tubes amounting to about 382 sq. ft.

It is a practice on the London & South Western to start the

*American Engineer & Railway Journal, May, 1907, page 184.

ump as soon as the locomotive is started, and to maintain the water level by governing the speed at which the pump is oper-

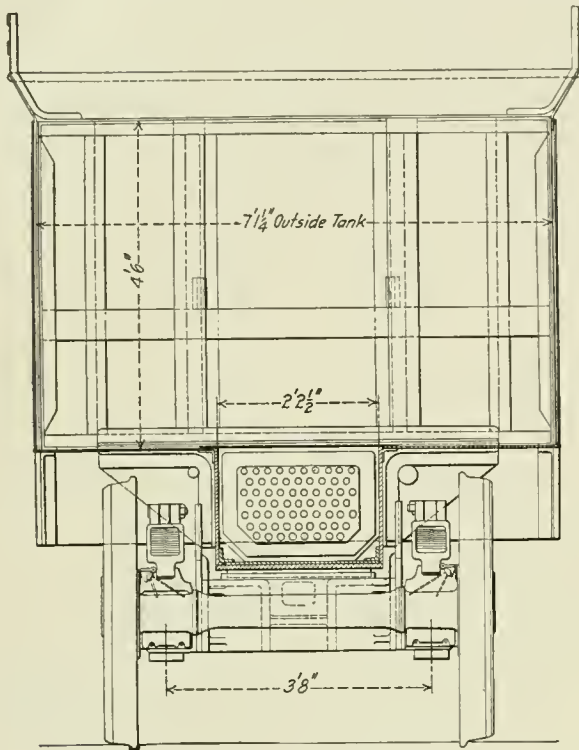

Section of Tender Fitted with Feed Water Heater.

ated, so that it works continuously and the supply of water to the boiler can be made to exactly equal the demand.

CASH VALUE OF EMPLOYEES.—In a statement issued to the employees of the road, President H. U. Mudge of the Chicago, Rock Island & Pacific, capitalizes each man earning \$83.33 a month, or \$1,000 a year, at \$25,000, because the man's wages or salary is the interest of 4 per cent. on \$25,000. He says a man earning that much is worth as much as a locomotive costs, but he adds: "You can make yourself worth more, while a locomotive cannot. You can direct your own energies, while a locomotive must be directed by a driver. It rests with you to raise your own capitalization to \$50,000, to \$100,000, or even to \$500,000. Therefore be careful about your food, treat your body decently, and, above all, feed your mind. You are working for a large corporation. In the nature of things it cannot know you very well personally, but it knows you by the work you turn out. It sets a real value on your work, higher than you think. Your value is measured by the quality and quantity of results you produce. Somebody knows your actual worth, appreciates your honest endeavors and has you in mind for better things. It is a business proposition. Each of us is capitalized."

TRAIN RESISTANCE.—A formula for train resistance is given by the Baldwin Locomotive Works as follows:

$$R = 1.8T + 100N.$$

Where R equals total resistance of train in pounds, T equals the weight of train in tons (both of these being exclusive of engine and tender) and N equals the number of cars in the train. This formula applies for a speed of 5 m. p. h. and for speeds greater than that, 2 per cent. of the result should be added for every mile per hour greater than 5 up to 30 m. p. h., beyond which speed the formula does not apply.

GERMAN VACATIONS.—It is proposed in Germany to change the end of the school year in different districts or states so that the vacation may begin at different seasons, and the summer travel on the railways be more evenly distributed.

INSPECTING SIDE BEARING MOTION

There is considerable uncertainty in regard to the action of several important details when a car truck is in motion, and careful observations of this action would be of material assistance to those who are endeavoring to improve these details. The movement of side bearings is a subject which is constantly under discussion, but on account of the difficulty of inspecting them when the car is traveling in regular service, very little is known as to their actual performance. The illustration shows a mirror arrangement which was devised by Edwin S. Wood & Co., Chicago, for observing the action of side bearings from the car window. The mirror is secured to the lower edge of the car side opposite the side bearing, and the angle is such that the image is reflected vertically and the motion of the truck with respect to the car body can be clearly seen. Various modifications of the

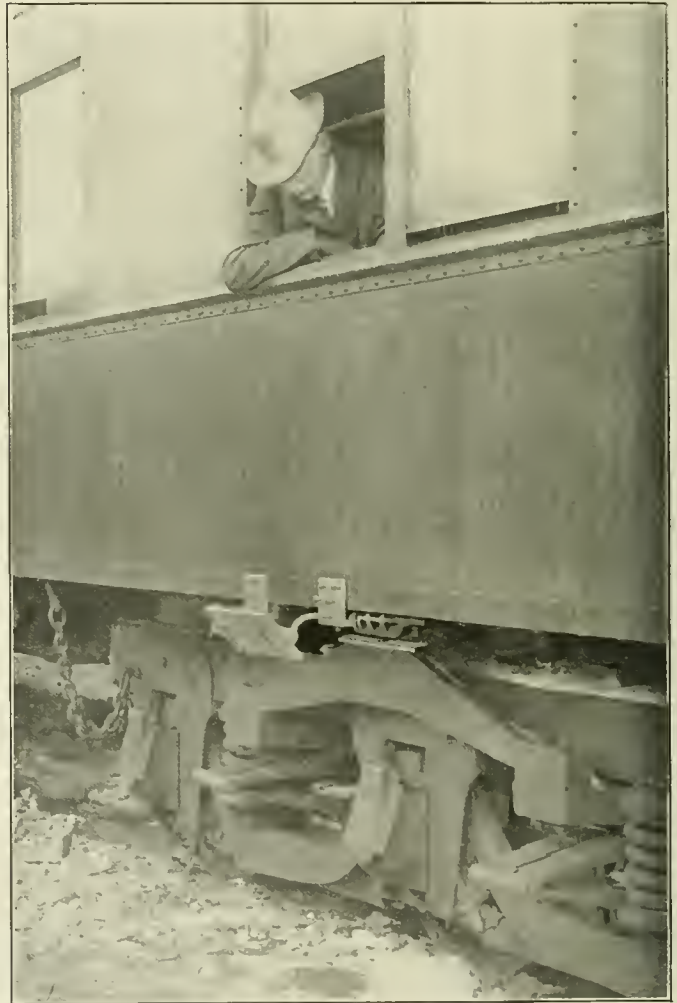

Mirror for Inspecting Side Bearing Motion.

same principle can be used for the purpose of observing the motion of the journal boxes, springs and equalizers, etc.

It is claimed by many that the friction of the center plate and side bearing is sufficient to hold the truck out of square after it has left a curve and entered a tangent. By a simple arrangement of the mirror this action could be readily inspected and some useful information could be derived from such a study. Here is a field for investigation which has not been properly cultivated, and with the assistance of the mirror it ought to be possible to obtain a number of valuable facts relating to truck motion and the action of truck details when moving rapidly, which should lead to important improvements.

FLANGE PRESS WORK IN RAILWAY SHOPS

An Analysis of the Economies Possible from the Efficient Operation of a Modern Flange Press in a Railway Shop for Both Locomotive and Steel Freight Car Work.

BY LEWIS D. FREEMAN.

Comparatively few roads appreciate the value of the hydraulic flange press as a cost reducing proposition and the object of this article is to point out the advantages of a properly equipped flange shop, such as would be suitable for the maintenance of upward of 500 locomotives and 15,000 steel cars. The flange shop herein described is supplying parts for 2,000 locomotives and approximately 90,000 cars, about one-third of which are of all-steel construction. Take a railway that buys 50 new locomotives that all go into service about the same time; after about five years of service, which is a fair average, the fireboxes will require renewal. This work will have to be done quickly to reduce the time that the locomotives are held out of service to a minimum.

Labor in making the repairs is the next most important factor. Hand flanging on the open fire is to be avoided as much as possible as it is expensive and unsatisfactory since the sheets cannot be kept hot long enough to flange but a small portion at a time, and the frequent heatings set up internal stresses in the sheets which cause cracks and other troubles; also it is practically impossible to flange a sheet by hand that will conform to the exact dimensions required. The cost of hand flanging is

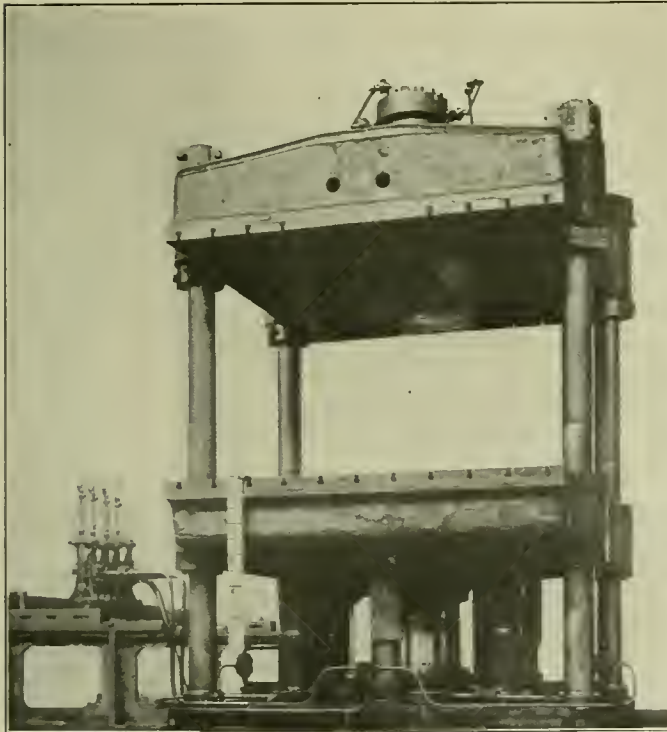

Fig. 1—Hydraulic Flange Press of 800 Tons Capacity.

almost prohibitive, it being, roughly, about nine times the cost of flanging on a modern hydraulic press. For example the cost of the renewal of 50 fireboxes and front flue sheets when done by hand and by the flanging press is as follows:

| | Hand. | Flange Press. |
|-----------------------------|------------|---------------|
| 50 Front flue sheets..... | \$400.00 | \$45.00 |
| 50 Back flue sheets..... | 675.00 | 75.00 |
| 50 Furnace door sheets..... | 675.00 | 75.00 |
| Total | \$1,750.00 | \$195.00 |

The net saving on this one job would be \$1,555, without taking into account the difference in time to perform the work by the two methods. One gang of five men can probably flange two front flue sheets per day while the same gang can flange but one back flue sheet or furnace door sheet. This does not compare very favorably with the hydraulic press where 30 back or front flue sheets is only a fair day's output after the formers have been set, with a crew of five men consisting of one press operator and

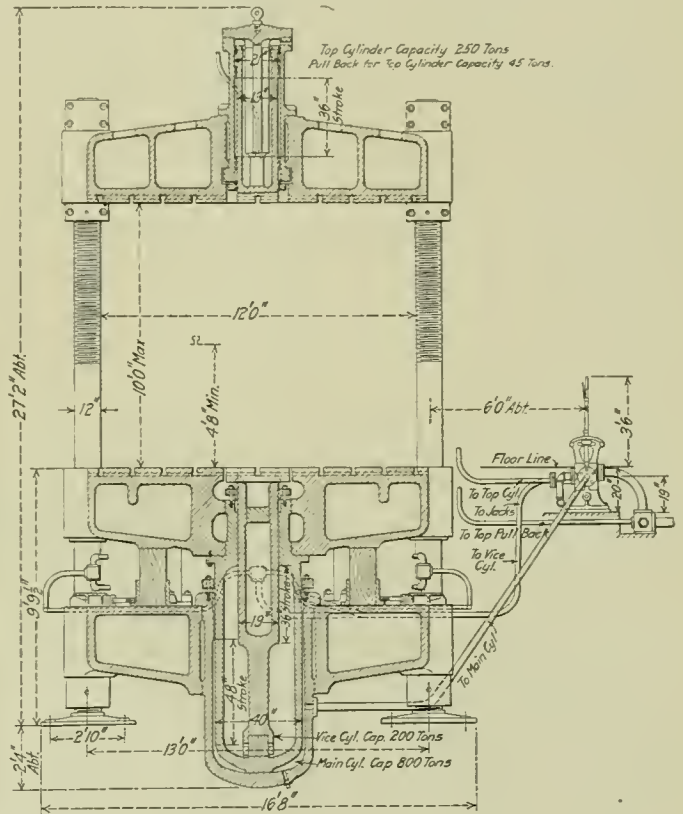

Fig. 2—Vertical Section Through Hydraulic Flange Press.

four laborers. It would not be a wise plan to flange more than 30 of any one kind of plates for stock, as too much money would be tied up in stock material and it would pay better to set up the formers oftener.

Assume that the road operates 1,500 locomotives with an average life of fireboxes of five years; this would mean the renewal of 300 fireboxes annually with a saving of \$9,330 per year over the hand method of flanging, as well as having the sheets exact duplicates of each other. By properly designed formers the sheets will fit the boilers more accurately, thus saving time in the fitting up process. In addition to the firebox work there are ash pan pockets over the wheels, sand box casings and smokebox fronts, which are a decided saving over the cast iron fronts, as the latter give trouble by cracking, especially during the winter months. The locomotive work just described will occupy about four working months' time, leaving the remaining eight working months for the manufacture of pressed steel car parts. Suppose 15,000 all-steel cars have been in service for a sufficient time to require frequent renewals of the more important parts to the

extent of \$10.80 per car per year which is only 10 per cent. of the \$108 which has been published as the average repair cost of all the freight cars in the United States. This would require the annual expenditure of \$162,000 for pressed steel repair parts if they were purchased from the various car manufacturers. This

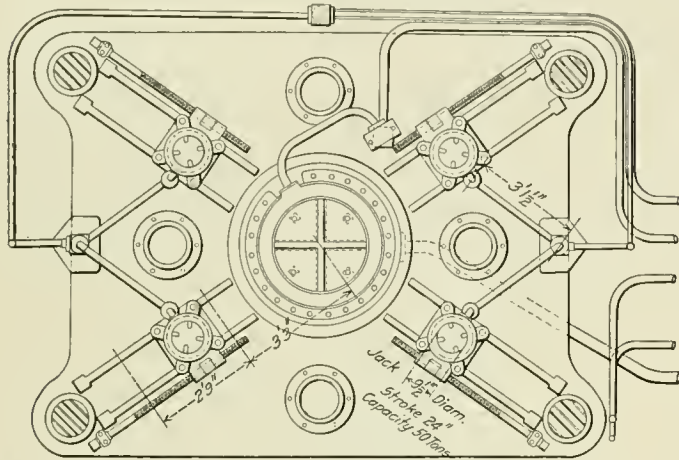

Fig. 3—Plan of Flange Press Showing the Four Auxiliary Plungers.

cost is at the rate of about 5 cents per pound for the parts ready for application to the cars. This same amount of material can be produced in the railway company's shop for about 2.5 cents per pound or at a saving of 50 per cent. or \$81,000 per year. However, as the cars grow older this repair cost will undoubtedly increase until the cost of maintenance becomes too great for economical operation. The investment necessary for a flange shop, as herein described, will be in the neighborhood of \$50,000

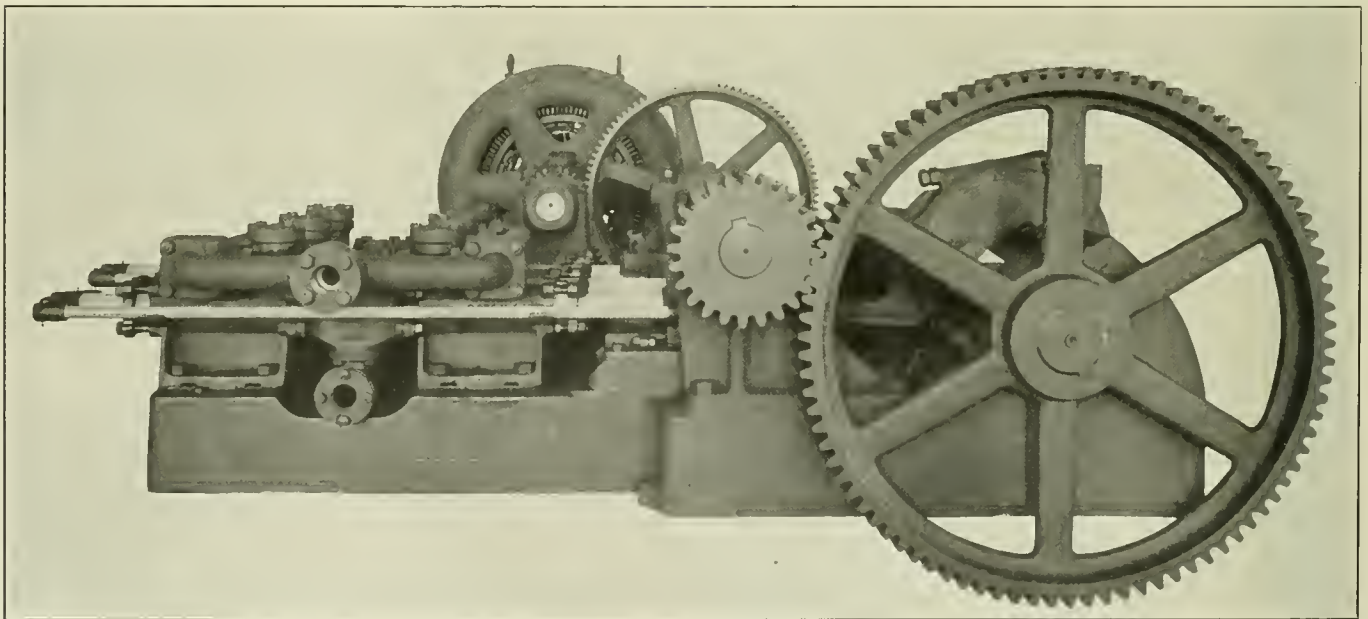

Fig. 4—Heavy Duty Pump for Hydraulic Flange Press.

and the operating expenses covering the interest on the investment, engineering expenses, labor and power for a ten hour day operating basis will be about \$24,000, which deducted from the gross saving on both car and locomotive work of \$89,330 will leave a net annual saving of \$65,330, which is well worth consideration.

DESCRIPTION OF THE PRESS.

A photograph of a 12 ft. x 15 ft. hydraulic flange press, designed and built by the Bethlehem Steel Company, is shown in Fig. 1. By referring to Fig. 2 which is a cross section through the vertical center of the press, it will be seen that there is a top

plunger 19 in. in diameter which works downward with a stroke of 36 in. and exerts a pressure of 250 tons; also a "pull back" which returns the plunger to its normal position. In the center of the lower platen is the 19 in. vise plunger which has a 36 in. stroke. No provision need be made for returning this plunger as it will fall of its own weight as soon as the pressure is released. The cylinder of this vise plunger, which is bolted to the lower or moving platen and serves as the plunger for the main platen, is 40 in. in diameter and has a stroke of 48 in. upward and exerts a pressure of 800 tons. In addition to these plungers there are four slots cut in the lower platen, as shown in Fig. 3, through which project four auxiliary plungers called jacks which operate independently of the other plungers. These jacks are 9½ in. in diameter and have a 24 in. stroke, with a capacity of 50 tons each. They are adjustable in a horizontal plane to the extent of 2 ft. 9 in., the closest distance to the center plunger being 3 ft. 3 in. All of the cylinders are outside packed having bronze flanges and bronze guide bushings, hemp packing being used. With this arrangement it is easy to repack the cylinders.

The top platen is adjustable to any height between 4 ft. 8 in. as a minimum and 10 ft. as a maximum above the moving platen; the most convenient setting has been found to be about 7 ft. 6 in. for most classes of work.

WATER SUPPLY.

The transmission of power by water is about the most economical method, having an efficiency of about 94 per cent. The water for operating this press is obtained from a large tank of clean water which is returned from the press cylinders after passing through them. The pump is shown in Fig. 4. It has three double acting 3¼ in. x 12 in. cylinders, and was made by the Chambersburg Engineering Company. This pump delivers 100 gals. per minute when running at 40 r. p. m. and is geared

direct to a 125 h. p. 500 volt d. c. motor running at 500 r. p. m. The water pressure is 1,500 lbs. per sq. in.

ACCUMULATOR.

In order to have a sufficient supply of water at the pressure of 1,500 lbs. per sq. in. two accumulators are connected in series by a 3 in. double extra strong pipe between the pumps and the press valves. Fig. 5 represents a cross section through one of the accumulators, which is a large vertical cylinder having a 12 in. plunger, which has outside packing flanges at the top. A large steel tank filled with sufficient scrap punchings to produce a pressure of 1,500 lbs. per sq. in. is supported on the plunger. A

by-pass valve is so arranged that when the accumulators reach their upward limit, which is 12 ft., the discharge from the pumps is turned from the accumulators into the supply well so as to save the water and to keep the pumps operating constantly.

HEATING FURNACE.

The output of such a hydraulic press outfit is limited to a certain extent by the capacity of the heating furnace used in connection with it. The coke furnaces have been replaced by

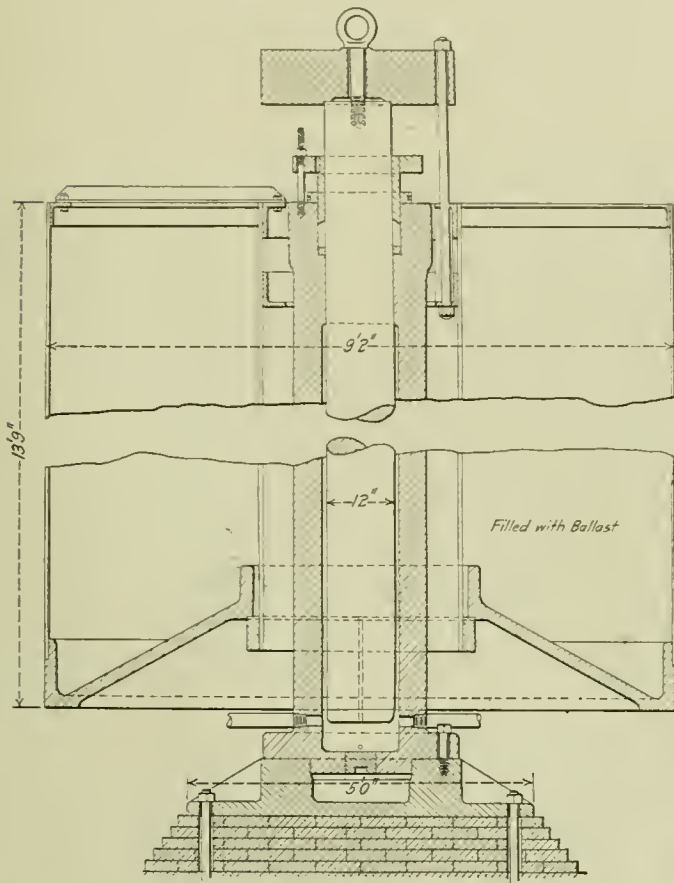

Fig. 5—Accumulator for Hydraulic Press.

the oil furnaces which give quicker heats and are less troublesome. There are no ashes and the oil takes up less room, as one gallon will produce 144,000 B. t. u. which is equivalent to 12 lbs. of coal.

Fig. 6 shows a Ferguson oil furnace made by the Railway Materials Company that is used in connection with the hydraulic press just described. This furnace has four burners with combustion chambers self contained so that the oil and air are vaporized in the burner and by an auxiliary air passage, sufficient air is admitted in this combustion chamber to provide for perfect combustion. The air is supplied by a belt-driven fan, the pressure being about 8 ozs. The oil is supplied from an underground tank at a pressure of about 8 lbs. per sq. in., these tanks being located in an oil house outside of the building and convenient to the tracks on which the oil car is brought in. Old car axles are placed in the furnace and act as rollers on which the material to be heated can be easily and quickly handled in and out.

OPERATION.

Following is an analysis of the most economical plan of operation in which the maximum output can be obtained for the money invested. Too many master mechanics either through ignorance or negligence do not realize the importance of the flange shop and do not give it the attention necessary for the

most economical operation; it should be placed in the hands of an expert capable of producing the best possible results.

Two plans of operation will be considered—the 10-hour day and the 23-hour day plans. The degree of efficiency in either case will depend on the ability of the operating officer. The 10-hour day plan produces less work per hour than the 23-hour day plan for the following reasons. The usual method is to pay the men on a day work basis for setting formers and taking care of the furnace and on a piece work for the actual flanging operations, which is satisfactory to both employer and men. When the shop is operated only ten hours per day the furnace is cold when the men report and has to be first filled with the material to be heated; three hours will be required to bring this material up to the proper flanging heat. If the furnace is filled with a large number of small or medium sized plates this material cannot be pressed before noon and the fire will have to be turned out until after 1 p. m. to prevent overheating; it will be about the middle of the afternoon before the furnace is free to be filled again with fresh material. This time it will only require about one hour for heating, as the furnace is already hot. This second furnace full will probably not be all flanged before 6 p. m. and the remainder of the material will have to be left in the furnace until the following day.

From the above statement it may be seen that three hours each day are lost in getting the furnace hot, thus reducing the efficiency of the whole hydraulic flange shop by 30 per cent., in addition to the time and oil necessary to reheat any material left in the furnace from the previous day. The second plan of operation is to run the press 23 hours per day, having two shifts of men, one shift working six days of ten hours and the other shift working five nights of 13 hours each. In this way the work can be so arranged that the day shift will come in at 7 a. m. and

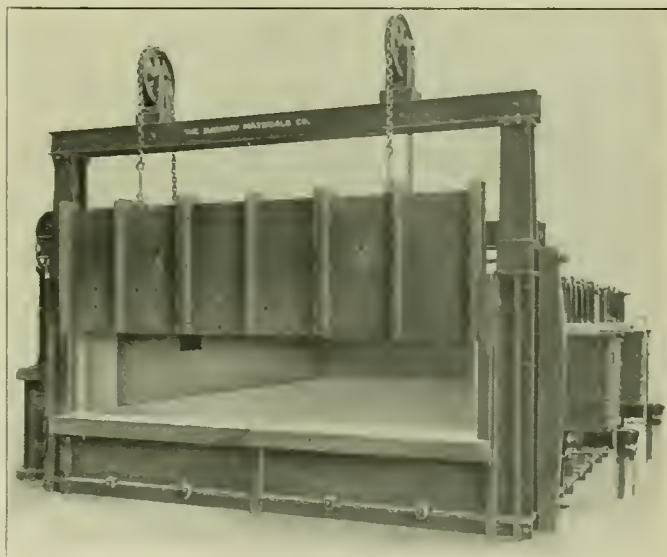

Fig. 6—Oil Furnace Used in Connection with Flange Press.

always have a furnace of hot material to begin the day's work, thus having time to empty the furnace before noon. It may now be filled up again with fresh material allowing the furnace to run during the noon hour and after 1 p. m. the second furnace charge will be ready for flanging and before 6 p. m. the second furnace full will have been worked up and the furnace will again be filled up for the night shift, which reports at 6 p. m. They can finish two full heats and have the furnace hot and filled with hot material for the day shift on the following day. From this it will be seen that the loss of three hours per day in getting the furnace hot is entirely eliminated and two shifts of men can produce four full heats in 23 hours, while one shift can only produce one and one half full heats per day of ten hours, the advantage being in keeping the furnace hot all the time.

POWERFUL HORIZONTAL BORING, DRILLING AND MILLING MACHINE

About a year ago the Lucas Machine Tool Company, Cleveland, Ohio, brought out a new design of horizontal boring, drilling and milling machine* which, by virtue of its range of operations, convenience of control, power and accuracy attracted much attention. The advantages of this tool appealed strongly to many railway shop superintendents, and largely on the basis of their suggestions, a larger, more powerful, and more rigid machine of the same general type has been designed, which it is believed will fulfill the requirements of the heavy, rapid work demanded by railway shops. The new machine has been designated as No. 33, while the former one is generally known throughout the trade as the No. 32.

Like the former design it may be fitted for use as a vertical milling machine, if required, and with this attachment it becomes very nearly a universal drilling, milling and boring machine.

the gear box. The arrangement is such that it is impossible to use the power movement when any feed is engaged or to engage any feed when the power movement is in use. The feed selecting levers are also interlocked and they are so arranged that one can be used at a time.

The spindle drive is of the internal gear face plate type for the slower speeds but for the faster ones the pinion is withdrawn from the internal gear and other gearing is engaged at the opposite end of the spindle sleeve, thus eliminating the necessity of running the pinion shaft at very high speeds. This change is made by the levers shown on the front of the spindle head near the top. These are interlocked and but one set of gears can be engaged at a time. The face plate may be removed to make place for lighter work when face milling cutters of small diameter are used.

The illustration shows that the matter of centralized control has been fully carried out and that it is possible for the workmen to reach any of the controlling levers from one position. The two small levers shown near the bottom of the feed box control sliding gears give 9 changes of speed, the back gears providing

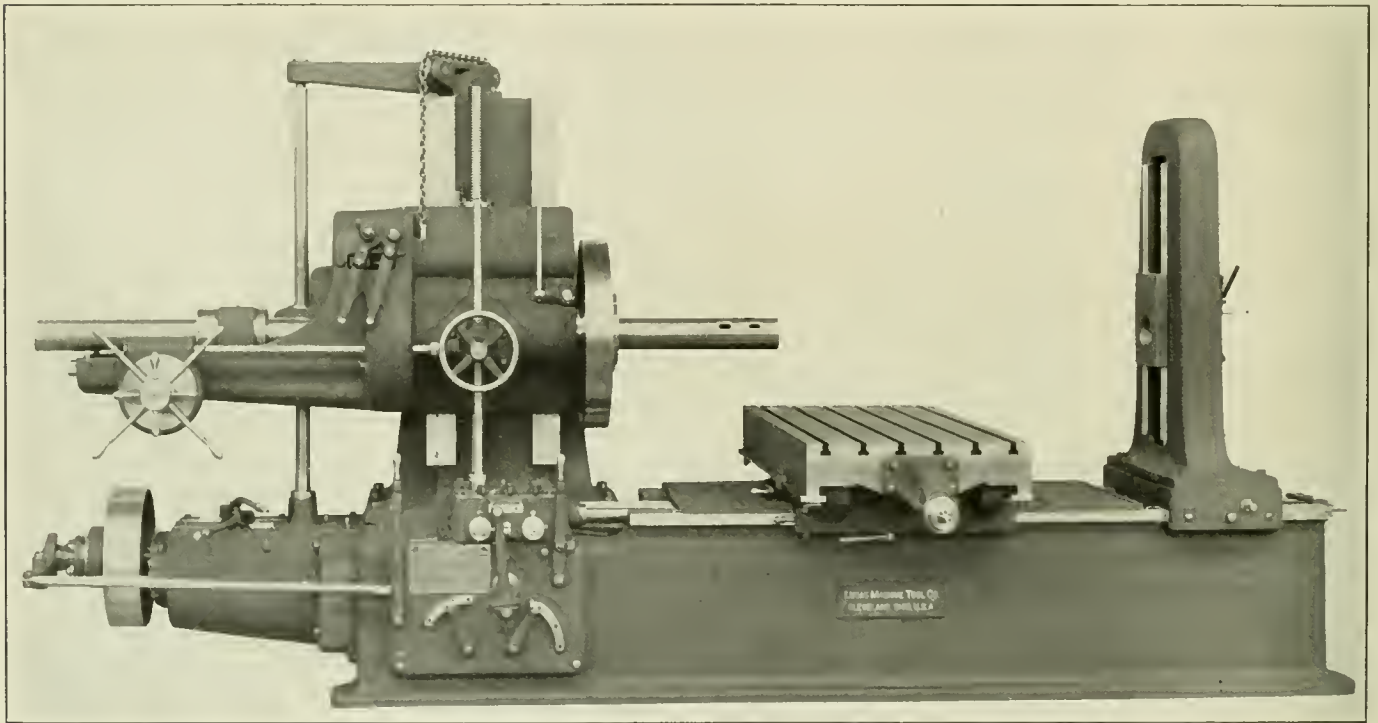

Horizontal Boring, Drilling and Milling Machine, Designed for Railway Shop Use.

It is especially suited for such work as boring, facing and drilling air pump cylinders, boring and facing driving boxes; boring cylinder bushings, drilling mud rings; machining steam pipes and exhaust nozzles; boring crossheads; boring rocker arms and link saddles; boring and milling (with gang cutters) cylinder castings; milling key seats, and facing packing glands and seats.

The principal feature in the arrangement of this machine is probably found in the quick return power movement to all parts having feeds. This is so arranged that no matter what feed is used a constant speed quick return can be obtained by simply moving the quick return lever to the reverse position. This is true no matter in which direction the feed is being given, and will give a rapid vertical movement to the head in either direction, or a cross movement to the platen, or longitudinal movement to the saddle, or longitudinal movement to the spindle, all by the use of the same lever, the part effected depending on the position of the interlocking feed selecting levers on the cover of

a total of 18 changes, ranging from .004 in. to .735 in. per revolution of the spindle. These speeds are applicable to the spindle, the spindle head and tail block, the saddle, and the platen and are at the same rate wherever applied. The selection of the part to be effected by the feed is obtained by means of the three small levers, the ends of which may be seen at the top of the feed box. The longer lever in front of the feed box is for reversing the feed and on either side of this are the hand adjustments for the saddle and the spindle head respectively, each having a micrometer dial which in the illustration makes them appear like small wheels. To the right of and projecting above the box is the feed and quick return lever which operates on any feed that may be in use and gives the quick return in either direction.

The longer lever located at the left of the feed box is the starting and stopping lever which controls a friction clutch at the end of the driving shaft. The primary drive, whether by belt or motor, is constant speed and the variations of spindle speed are given by a gear box with a range of from 5 to 150

*See *American Engineer & Railroad Journal*, April, 1911.

r. p. m., this being controlled by two levers setting in a horizontal plane shown near the driving pulley in the illustration. The round hand wheel on the head at the front is for slow spindle movement while the one with four long handles at the extreme left is for quick spindle hand movement. The two levers extending downward on the head control the interlocking back gears. On the platen is a hand adjustment with a micrometer dial and also an adjustable feed trip.

When the vertical milling attachment is applied, its spindle head is capable of being fed along the rail by power which, in combination with the other power feeds for the saddle and platen, gives the machine a wide range of usefulness for face milling. The crossrail required for this purpose is easily removed or applied, the same also holding true for the back rest.

near the center and drives through the shaft extending to the chain of gears which take the place of the driving pulley. One of these tools will be exhibited at Atlantic City during the convention next June.

ELECTRIC LOCOMOTIVE HOIST

An electric screw jack locomotive hoist for use in shops not provided with overhead cranes of sufficient size to lift locomotives, is being made by the Whiting Foundry Equipment Company, Harvey, Ill. These hoists are made in capacities from 100 to 200 tons, and will unwheel a locomotive complete in one-half hour from the time it is brought into the shop to the time

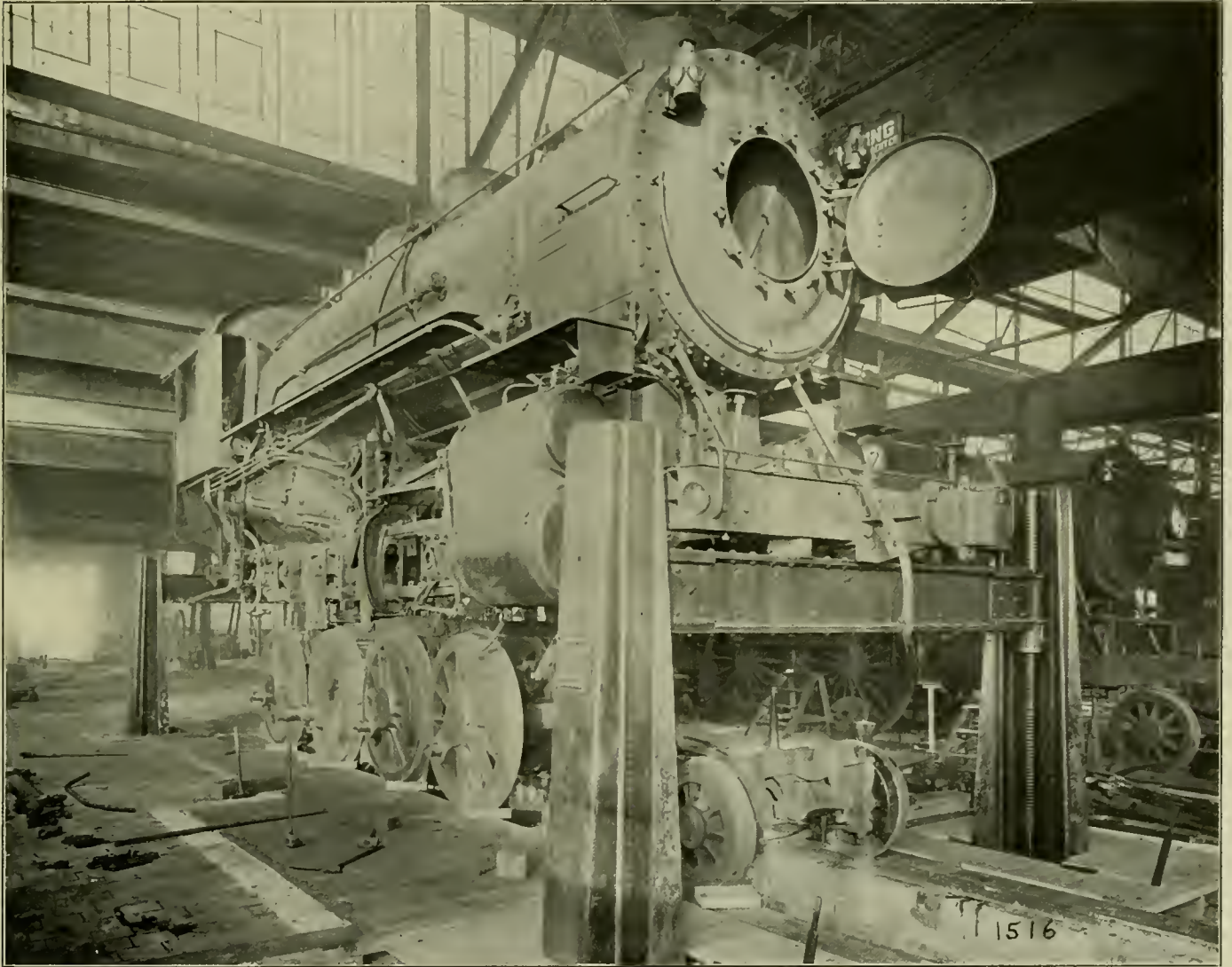

Electric Locomotive Hoist Wheeling a Large Consolidation Locomotive.

The power and rigidity of the machine are well indicated by its appearance and from the fact that it weighs about 18,000 lbs. without extra attachments. The spindle has a diameter of $4\frac{1}{2}$ in. and a total traverse of 60 in. The maximum distance from the face-plate to the outer support for the boring bar is 7 ft. and from the top of the platen to the center of the spindle it is $28\frac{1}{2}$ in. The platen measures 30 in. x 56 in. and has a 44 in. cross feed. The driving pulley on the belt driven machine is 20 in. in diameter and its face is suited for a $4\frac{1}{2}$ in. belt. It runs at 300 r. p. m. When the mill is motor driven, a 10 h. p. constant speed motor, running at about 1,000 to 1,200 r. p. m. is recommended. The motor is mounted on the rear of the bed

everything is cleared away and it is drawn out on shop trucks. The installation shown in the illustrations is in the shops of the Chicago & North Western at Boone, Ia.

The mechanism consists of two stationary screw jacks located on concrete foundations on either side of the stripping pit. At the opposite end of the pit are two similar jacks mounted on trucks operating on independent tracks parallel with the pit track, and providing sufficient travel to accommodate the different lengths of locomotives to be handled. A removable structural steel girder extends across the track, between each pair of jacks, one being located under the tail-bar and the other under the bumper beam of the locomotive. A motor which may be from 25 to 40 h. p.,

depending on the capacity and speed desired, is so connected to the jacks as to drive both simultaneously or each independently, as desired. The travel of the movable jacks is accomplished by a hand-operation device.

While a five-ton electric crane is shown handling the cross



Electric Locomotive Hoist When Not In Use.

bar in the illustration, this is not a necessary adjunct to the hoist and a trolley or jib crane could be used as well. In new shops, however, such a crane would no doubt be available.

PIPE THREADING AND NIPPLE MACHINE

A substantial, rigid machine, which will not only cut off and thread pipe, but will also without the use of a nipple chuck do the same with nipples, has been designed by the Loew Manufacturing Company, Cleveland, Ohio. This machine is of the pedestal type, and while having a revolving die head is claimed to possess all of the advantages of the barrel type machine. The revolving head has a self-locking and self-releasing feature which

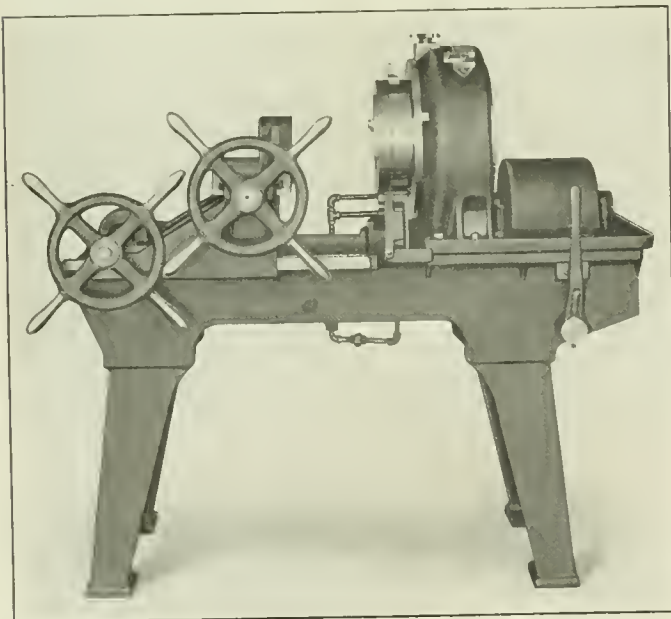

Loew Pipe Threading and Nipple Machine.

can be thrown into action easily. The cutting off tool is on the head and is fitted with a star wheel feed arrangement. It is so located as to be easily set to cut off the proper length, even when the largest size pipe within the capacity of the machine

is being handled. Two changes of speed, obtained by shifting gears, are provided, and no counter shaft is used. Tight and loose pulleys are provided on the belt-driven type.

HEADLIGHT WITH IMPROVED TURBINE.

The steam consumption of turbo-generators has been considerably reduced in Equipment E of the Pyle National Electric Headlight Company, Chicago, and the new generator here illustrated requires only about one-third as much steam for a given candle power hour as used in the older equipment. The turbo-generator operates on steam pressures ranging from 100 lbs. to the highest used in locomotive practice, and on superheated steam as well as saturated steam without any adjustment. The speed of the type E generator is only 2,400 revolutions per minute, and at that speed the efficiency is equal to that of turbines running at 4,000 to 5,000 revolutions.

The dynamo construction is based on the most recent im-

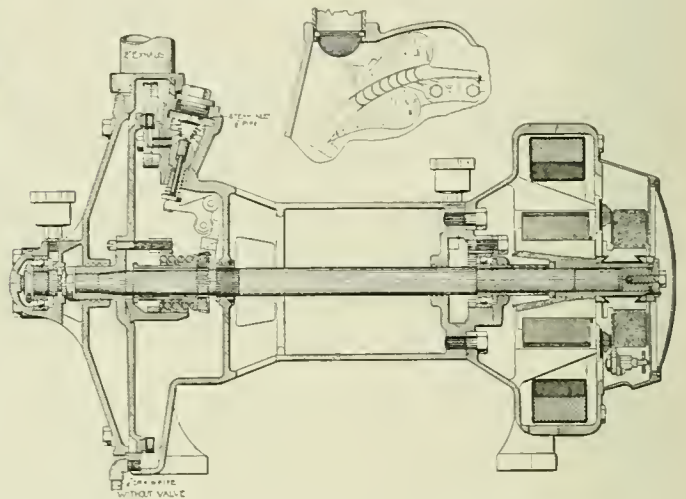

Improved Turbine for Pyle-National Electric Headlight.

provements, and the electrical balance is so perfect that no sparks should be seen at the brushes. The brush holders are fixed and the brushes may be taken out and replaced without changing the tension of the springs. The fields are compound wound to allow the burning of either the arc lamp or the carb lights independently. The armature on the new E equipment is interchangeable with all others made by the company. The bucket wheel of the turbine is made of steel and has only one row of buckets, but the steam passages outside the nozzles are arranged so that three impulses are delivered by the steam before it escapes. The governor is of the tension spring type, surrounding the main shaft and operating a balanced valve by means of levers. The tension of the spring is set for the desired speed of 2,400 revolutions before leaving the works.

GERMAN CHURCH PASSES.—The employees of the Baden State Railways, Germany, who are stationed at places where there is no church of their confession, are granted free passage on trains to the nearest station where there is such a church on Sundays and church holidays. Their wives and their children under 18 are to have the same privilege. Heretofore they were limited to twelve such journeys a year.

COAL SHIPMENTS.—The shipments of anthracite coal by the Philadelphia & Reading during the month of February were the heaviest in the history of the company, aggregating 784,000 tons. It is said that coal trains were despatched from the yard at Pottsville every half hour during the month.

GOLD'S IDEAL PRESSURE REGULATOR

Pressure regulators for car heating have in the past given considerable trouble, because of the sticking of the sliding valves and the unequal expansion of the double seated valves and their seat supports, making them unreliable and subject to frequent repairs, cleaning and adjusting. Moreover, they required regulating when there was a material drop in the boiler pressure, or an added demand on the steam supply. The Gold Car Heating & Lighting Company, New York, has developed a new regulator, known as Gold's Ideal pressure regulator, which does not possess these defects and regulates uniformly and practically automatically.

The following severe test of one of these regulators was recently made by Arthur M. Waitt, the following being an extract from his report: "The Gold Ideal regulator was applied to a standard passenger locomotive, which was then coupled to a train of five average sized modern passenger coaches. A steam gage was connected with the train supply pipe, from where it

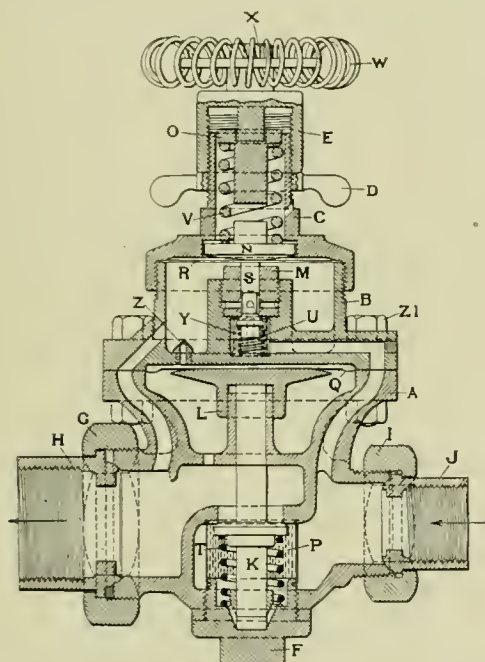

Gold's Ideal Pressure Regulator.

was attached to the regulator, and it constantly indicated the exact pressure maintained at that point. After coupling the steam hose between all the coaches steam was furnished to the train pipe, as far back as the rear of tender, by opening the regulator sufficiently to furnish a pressure of 30 lbs. on the train supply or outlet side of the regulator. With this setting steam was admitted first to the train pipe and radiating pipes of the coach next to the locomotive. After waiting several minutes until steam showed at the drip on this coach the steam was admitted to the train and radiating pipes of a second car, and it in turn was heated until steam showed at the drip. Next three more coaches were at once added to the train being heated. After allowing steam to be on the entire five cars for over five minutes the hose on the rear end of the rear coach was fully opened, allowing steam to blow freely from the train pipe. After allowing the rear hose to be open full for two minutes, the cars were all cut off at once by closing the cock on the front end of the first car. The next test was the severest possible one. The hose connection was broken between the tender and the first car and steam at full supply pressure was allowed to freely flow out from the tender hose.

"During all of the above changes in the demand on the locomotive steam supply, absolutely no readable variation could be noted on the train supply gage on the locomotive, from the 30

lbs. at which the regulator was set. The only noticeable movement in the gage hand was when the rear hose on the train, and the rear hose on the tender were opened full for steam to blow out. In these instances a slight unmeasurable vibration of the gage hand was produced, showing the rapid alternate slight opening and closing of the controlling valve in the regulator. As a final trial the regulator was set to furnish a pressure of 40 lbs., and the hose at the rear of the tender was left wide open. With this severe trial the supply pressure at the train supply side of the regulator was maintained absolutely steady. During the tests the locomotive boiler pressure varied between 200 and 205 lbs., but this variation produced no effect on the train supply pressure furnished."

This regulator consists primarily of two main parts: A small controlling valve and diaphragm in the upper half of the regulator, and a large main supply valve and diaphragm in the lower half. Its operation is as follows: By screwing down handle *W* until spring *V* is sufficiently compressed to allow the required and predetermined delivery pressure to be furnished at the outlet side of regulator (left hand side), the controlling valve *S* is opened. Steam at boiler pressure comes into the inlet side of the regulator (right hand side) and passes up through the small passage to the space under the bottom of the controlling valve and through the open valve to a small annular groove above the valve, and thence through a small connecting passage (shown in dotted lines) downward to the space above the large diaphragm *Q*. The pressure exerted on this diaphragm presses it downward, opening the main supply valve *K*, thereby admitting a flow of high pressure steam from the inlet to the outlet side of the regulator, the steam at the same time passing upward into a chamber under main diaphragm *Q*, and also upward through a small passage into the chamber under the controlling diaphragm *R*; it presses against these diaphragms until it just balances the pressure exerted on their upper sides. If the draft on the steam on the low pressure side of the regulator is increased, it tends to reduce the pressure there. This reduction of pressure is at once transmitted to the under side of the controlling diaphragm *R* and the fixed compression in the spring *V* at once causes this diaphragm to depress and the controlling valve is opened, thereby allowing high pressure steam to pass through this valve to the top of the main diaphragm *Q*, producing a further opening of the main supply valve and an immediate increase of the supply of high pressure steam directly to the low pressure side of the regulator. If for any reason the supply or boiler pressure is reduced, the resultant pressure on the outlet or train supply side of the regulator would be momentarily slightly reduced and the consequent pressure in the chamber under the controlling diaphragm *R* would be lessened and the controlling valve would at once open slightly, thereby in its turn causing the main supply valve to open farther and give the added volume and pressure from the boiler supply side necessary to keep the train supply side up to the predetermined pressure.

If, from any cause, the pressure on the train supply side of the regulator is increased, as might be produced by a reduction of the number of cars to be supplied with steam, the increased resultant pressure on the under side of the main diaphragm *Q* would at once cause the main valve to close and at the same time this increased pressure under the controlling diaphragm *R* would hold the controlling valve tightly closed until such time as the pressure on the train supply side of the regulator was reduced to a point below the predetermined train supply pressure. The controlling valve will always be closed when the train supply pressure reaches the predetermined amount, and will at once be opened automatically when it reduces below this amount. In case of any small leakage of steam through the controlling valve to the space above the large diaphragm, such leakage will pass through the small leakage plug opening at *Z* into the train supply side of the regulator, thereby causing no opening movement of the main supply valve.

ALL-GEARED SLIDING HEAD DRILL

A 26-in. drilling machine, guaranteed to drive a 2 in. high-speed twist drill at .041 in. feed per revolution of the spindle, or at the rate of 6½ in. per minute in cast iron, is shown in the accompanying illustration. A 1 in. high-speed twist drill can be driven at the rate of 13½ in. per minute in cast iron, and it is claimed by the makers, The Barnes Drill Company, Rockford, Ill., that it has the power of the ordinary 36-in. cone belt driven drill. It is, with the exception of the sliding head, designed along the same general lines as the all-gearred drills formerly built by this company.

There are eight geared speeds provided, and a similar number of geared feeds, all of which are controlled from the front of the machine. The feed for any position of the controlling levers is shown in plain figures on a plate, the ranges being from .005

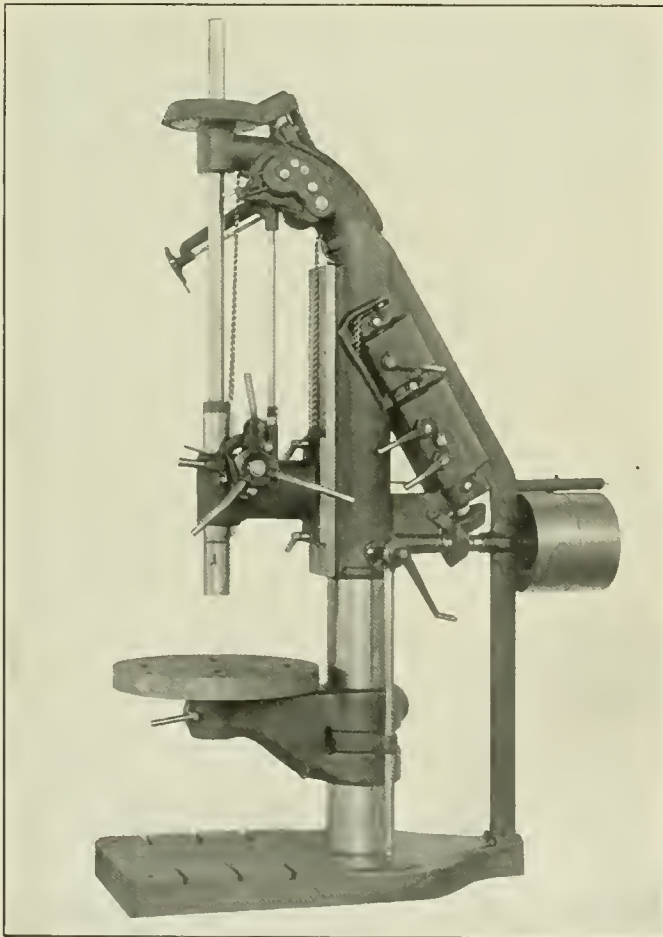

Barnes 26 in. Sliding Head, All-Geared Drill.

in. to .086 in. per revolution of the spindle. The spindle is 1 15/16 in. in diameter in the sleeve, and is double splined. The crown and pinion gears are of large diameter and have teeth of four pitch. Both the head and the sleeve are counterbalanced by weights hung in the column, the chains passing over roller bearing sheave wheels. Two quick acting clamp screws are provided for securing the head to the column face; it is raised and lowered by a crank pinion on the back of the machine, as shown in the illustration. A similar crank pinion with a threaded shaft is also suitable for some boring bar work and the feeds were selected with this in mind. Boring 8-in. holes is well within its capacity. Some of the general dimensions are as follows:

| | |
|--|---------|
| Distance from column to center of table..... | 13¼ in. |
| Diameter of column | 7½ in. |
| Diameter of table | 23 in. |

| | |
|--|-----------------|
| Vertical travel of table..... | 20 in. |
| Vertical travel of sliding head..... | 23 in. |
| Greatest distance from spindle to base..... | 54 in. |
| Greatest distance from spindle to table..... | 40 in. |
| Ratio of back gearing..... | 4 to 1 |
| Floor space required..... | 22 in. x 49 in. |
| Weight, net | 1,750 lbs. |

NEW MUFFLED POP VALVE

A locomotive pop valve, which has repeatedly shown its ability to open and close on a 2-lb. blow back, has recently been designed by the American Steam Gauge & Valve Manufacturing Company, Boston, Mass. It is claimed that by the method employed all chattering and fluttering of the valve has been eliminated and that the cushioning effect is practically perfect. Reference to the illustration will show the arrangement of the parts and the scheme of operation. It will be noticed that all adjustments are made from the extreme top of the valve, the blow back ring being part of the outer casing and adjustment for this purpose being accomplished through a hexagon nut by which the

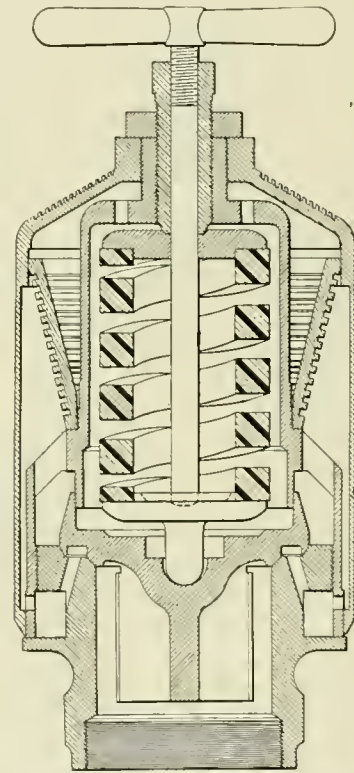

New Muffled Pop Safety Valve.

whole outer part is revolved and the outlet from the blow back chamber is enlarged or decreased as necessary. At the same place is a screw for setting the valve; but one nut lock is required for securing both adjustments. The very small number of parts required in this valve is a strong point in its favor.

The hydrostatic test plug is shown in place and permits of quickly and conveniently sealing the safety valves when it is desired to put the hydrostatic test on the boiler. This plug, of course, is removed when the locomotive is in service.

CHINESE WAGES.—The wages of the laborers of the Han-Yeh-Ping Iron & Coal Company, China, at the iron and coal mines are as follows: Miners, \$0.13 to \$0.15 per day; tippie coolies, \$0.05 to \$0.06 per day; loaders and pushers, \$0.05 to \$0.07 per day. The wages of laborers at the steel works are as follows: Rollers on mills, \$0.17 to \$0.35 per day; heaters on furnace and open hearth smelters, \$0.27 per day; helpers, \$0.17 to \$0.25 per day; blacksmiths, \$0.35 to \$0.50 per day.

GENERAL NEWS SECTION

The Missouri, Kansas & Texas is organizing safety committees in accordance with the plan which has been adopted by a number of railways recently.

The Chicago Great Western has issued the first number of a quarterly magazine devoted to the interests of employees and patrons, which is called *The Maize*.

The chairman of the house committee on interstate and foreign commerce has introduced in Congress a bill requiring the Interstate Commerce Commission to make physical valuation of all the railways in the country.

Judgments amounting to \$1,575 have been entered in the federal court against the Denver & Rio Grande for violations of the hours of service law, and judgments for violations of the safety appliance law against the Pere Marquette for \$1,500, and the Minneapolis & St. Louis for \$200.

The canal lock which opens the connection between Lake Erie and the new Erie large canal has been completed at a cost of \$1,250,000. It is located at Black Rock harbor, Buffalo, N. Y., and is the largest inland water lock in the world. The gates are of steel and will be operated by electricity.

The proposed meeting of representatives of the mechanical department crafts of the western railways for the purpose of organizing a federation, including employees of all the roads, which was to have been held at Kansas City on March 4, has been postponed, and it is now reported that the meeting will be held on April 15.

The report of the New York state commissioner of labor for the third quarter of 1911, gives the number of union laborers out of work in the state as 12,725, which is said to be less than at the corresponding time in any year since 1907. This number is 2.7 per cent. of the membership of the unions from which the reports were received.

The Supreme Court of the United States has decided that an employee in the car repair department of a railway is a fellow servant of employees in the operating department. This decision was in a suit against the Grand Trunk Junction Railway. The opinion is by Justice Holmes, who observes that if the fellow servant doctrine is unjust, Congress is the body to change it.

Verdicts against the Canadian Pacific for damages done in Maine in the year 1898 by forest fires set by sparks from locomotives, and which have just been made public, will aggregate \$139,400. The damages awarded are about 50 per cent. of the amounts claimed, and about twice as much as the railway asserted the damage to be. These were test cases representing perhaps half of the losses from the fires in question.

The number of fires on the property of the Pennsylvania Railroad system during 1911, as reported by an officer of the company, was 891, from which the loss was \$304,975. The measures taken by the company to prevent fires and to reduce the loss therefrom have been very successful, and there has been a steady increase year by year in the number of fires extinguished by employees. During the past year 43 fires were put out by the apparatus carried on yard locomotives.

The Michigan railway commission has prohibited the railways of the State from exceeding certain prescribed rates of speed during the winter at several points which the commission considers dangerous. The order also prohibits making up lost time. It is said to have been suggested by a report to the commission that on one night last week 250 broken rails were found in the tracks of the Michigan Central between Detroit and Chicago and 174 on the Pere Marquette between Detroit and Grand Rapids.

The constitutionality of an act passed by the Indiana legislature in 1909 authorizing the railway commission to investigate and regulate the condition and efficiency of locomotive headlights was upheld by Judge Carter of the Superior Court on March 2, in a decision on a demurrer of the state to a suit brought by the Vandalia to enjoin the commission from enforcing an order requiring the railways to equip their locomotives with headlights of at least 1,500 candle power. The court held that the commission has the authority to make such an order.

The *Santa Fe Employees' Magazine* publishes the record of an Atchison, Topeka & Santa Fe locomotive, No. 1443, that covered 269,899 miles, still carrying its original boiler tubes, between June 13, 1907, when it was received from the Baldwin Locomotive Works, and December 8, 1911, when it was received at the Topeka shops for heavy repairs, with a total outlay for repairs of less than \$2,000. The locomotive is an Atlantic type balanced compound passenger engine, and has been in service on the Middle, Southern Kansas and Oklahoma divisions.

The Joint Car Exchange Bureau at Denver on March 1 was amplified into a Joint Car Inspection and Interchange Bureau to handle the mechanical as well as the transportation inspection of cars interchanged at that point. William Hansen, who has been a traveling mechanical inspector for the Chicago, Burlington & Quincy, has been appointed manager of the bureau. The executive committee consists of J. A. Turtle, mechanical assistant superintendent of the Union Pacific; H. V. Vanbuskirk, superintendent of motive power of the Colorado & Southern, and W. A. Knerr, local freight agent of the Denver & Rio Grande.

The Illinois Central will establish 15 experimental farms along its lines in Mississippi and Louisiana to encourage agricultural development by inculcating the principles of correct farming. Each farm will consist of a 40-acre tract, to be worked by the owner under the supervision of instructors from the Agricultural College of Mississippi and the agricultural department of the University of Louisiana. Each of the tracts is to be centrally located so that the farmers of the district may reach it easily. The railway proposes to enter into contracts with the owners of the land guaranteeing them against loss.

The Permanent Manufacturers' Exhibit of Railway Supplies and Equipment was opened in the Karpen building, Chicago, March 16. As the name implies, this is to be a permanent exhibition for the purpose of bringing together devices, materials and specialties of interest to a visiting railway man so that he may conveniently and at a minimum amount of time inspect and compare the various devices in which he is especially interested. Chicago was chosen for the exhibit, because of its being the railway center of the country. The exhibition hall contains 26,000 sq. ft. of floor space, which is divided into booths of various sizes to meet the requirements of the exhibitors. Light and power is furnished for the manipulation of any working models.

General Manager J. B. Yohe, of the Pittsburgh and Lake Erie, in announcing a propaganda of safety for the employees of the road, has named the following as members of the general safety committee: L. H. Turner, superintendent of motive power, chairman; J. W. Riley, superintendent, vice-chairman; A. D. Brown, chief clerk to the general manager, secretary; J. A. Atwood, chief engineer; E. K. Connelly, purchasing agent; G. E. Shaw, general attorney, and Arthur Morgan, claim agent. Subcommittees are to be named, composed of men of the several departments. Their duties will be to minutely inquire into all accidents or losses of any kind, with a view of ascertaining the cause to prevent repetition. Economy in operation will also be looked after by the committeemen.

The Texas railway commission has received a most extraordinary petition signed by S. W. Steele, chairman of a general committee of blacksmiths, boilermakers, machinists, coppersmiths and carmen, protesting against an application of the Houston & Texas Central, which the committee believes is to be presented, for permission to issue bonds for the purpose of purchasing 50 or more locomotives. The craftsmen's petition makes no reference to the strike of mechanical department employees on the Harriman lines, but states that there are at present in Texas many idle mechanics seeking and needing employment, and that it would be more economical for the company to properly repair its present engines than to purchase new. The petition also states that the company is now employing unskilled non-residents instead of skilled mechanics, as formerly, and a much larger number than would be necessary if skilled mechanics were employed; and that the employment of non-resident labor entails on the company a greater expense than would be required to pay the skilled home labor for the same service.

The Bureau of Railway Economics, Washington, D. C., reports that there were substantial increases in the wages of railway employees during the fiscal year 1911. Reports filed with the Interstate Commerce Commission show that the total compensation to the employees of railways over 500 miles long was \$1,005,277,249. This sum was greater by \$41,868,822 than it would have been at the rates of pay in effect during 1910, and greater by \$69,297,678 than it would have been at the rates of pay in effect during 1909. Notwithstanding an increase of 2,108 in the miles of railway operated, there were fewer employees on the payrolls June 30, 1911, than on June 30, 1910, by 31,037, yet the total compensation paid to employees during 1911 was greater than that paid during 1910 by \$49,976,216. This is greater than the increase in the gross earnings of the railways by \$22,595,121. Net revenues fell off by \$40,988,539 during the same period in which compensation increased nearly fifty millions. The summary of revenues and expenses of the steam railways over fifty miles in length for the month of December, just issued by this bureau, shows that for the calendar year 1911 the total operating revenues were less than for the calendar year 1910 by \$27,698,780, and the net revenues less by \$22,286,784.

D. C. Buell, chief of the educational bureau of the Illinois Central, has issued a circular to employees announcing that the bureau is now in a position to assist employees in legal matters to a certain extent. It will endeavor to issue from time to time pamphlets for general distribution or to publish articles in the company's employees' magazine dealing with matters wherein experience has shown that for want of legal aid employees have been imposed upon so that they have suffered either financial loss or worry or unpleasantness, which could have been avoided had they known their legal rights. The circular states that it is the desire of the management to safeguard employees as much as possible and to make each employee feel that the company has a personal interest in his welfare and progress. The bureau has already afforded a means whereby employees may better inform themselves about their work, and is now taking steps to assist in

the prevention of accidents by means of explanatory lessons and later by means of moving pictures to illustrate right and wrong methods. The circular continues: "The first step that the bureau will take will be to explain the methods of loan sharks. While the rules of the company as regard garnisheeing, etc., stand as they have heretofore, nevertheless any employee of the company may feel free to write to the chief of the educational bureau regarding any complications that he may have gotten into, due to obtaining a salary loan from one of these money-lenders. The object of doing this is purely a friendly one, and the cases will, as far as possible, be handled in confidence. This offer of the educational bureau carries behind it the backing of all of the organization and talent of the company's law department."

RELIEF FUND OF THE PENNSYLVANIA

Nearly two and a half million dollars in benefits were distributed during the year 1911 to members of the Relief Funds of the Pennsylvania Railroad System, according to a report issued by the company. This brings the total distribution since the establishment of the funds some twenty-six years ago, up to \$33,008,804.89. Some idea of the extent of the work of these departments may be had from the fact that on the lines east of Pittsburgh and Erie during the month of December payments to the amount of \$139,127.73 were made. In benefits to the families of members who died \$54,898.22 were paid, while to members incapacitated for work the benefits amounted to \$84,229.51.

On the Pennsylvania Lines west of Pittsburgh the Relief Fund paid out a total of \$66,305.16 during the month of December, of which \$28,066.71 was for the families of members who died, and \$38,238.45 for members unable to work. The Long Island Railroad Company, a subsidiary of the Pennsylvania Railroad, established an Employees Mutual Relief Association in the same year that the Pennsylvania established its Employees' Relief Fund on the lines east of Pittsburgh. Since that time \$857,579.33 have been distributed in benefits to Long Island employees or their families. During the year 1911, the association distributed \$63,967.41 in benefits. Indicative of the popularity of the Relief Funds with the employees of the several companies is the fact that out of a total of 197,886 employees on December 31, 1911, 170,297, or 86 per cent., were members. On the Pennsylvania lines east of Pittsburgh the membership was 117,430 out of a total of 131,244 employees. The membership on the lines west was 46,343 out of 59,267, and on the Long Island, out of a total of 7,375 employees 6,524 were members.

MEETINGS AND CONVENTIONS

International Railway General Foremen's Association.—At the annual convention of the International Railway General Foremen's Association, to be held at the Hotel Sherman, Chicago, July 23-26, the following papers will be presented for discussion: How Can Shop Foremen Best Promote Efficiency? (A continuation of a paper presented at the 1910 convention) by

RAILROAD CLUB MEETINGS

| CLUB. | NEXT MEETING. | TITLE OF PAPER. | AUTHOR. | SECRETARY. | ADDRESS. |
|--------------------|---------------|--|-----------------------------|--------------------|-------------------------------------|
| Canadian | April 9 | Swedish Steels | A. R. Roy..... | Jas. Powell..... | Room 13, Windsor Hotel, Montreal. |
| New England..... | April 9 | Use of Highly Superheated Steam..... | G. E. Ryder..... | Geo. H. Frazier.. | 10 Oliver St., Boston, Mass. |
| New York..... | April 19 | The Chief Clerk..... | F. L. Morse..... | H. D. Vought.... | 95 Liberty St., New York. |
| Northern | | | | C. L. Kennedy.... | 401 Superior St., Duluth, Minn. |
| Pittsburgh | April 26 | Treatment and Properties of Tool Steel | W. E. Sullivan..... | J. B. Anderson... | Union Station, Pittsburgh, Pa. |
| Richmond | | | | F. O. Robinson... | C. & O. Ry., Richmond, Va. |
| S'th'n & S. West'n | May 16 | Cast Steel Tender Frames..... | | A. J. Merrill..... | 218 Grant Bldg., Atlanta, Ga. |
| St. Louis..... | April 12 | How an Engineering Contractor Would Run a Railroad..... | A. P. Greensfelder.. | B. W. Frauenthal | Union Station, St. Louis, Mo. |
| Western | April 16 | Boiler Failures and Water Treatment | M. C. B. A. A. Pownall..... | Jos. W. Taylor... | 390 Old Colony Bldg., Chicago, Ill. |
| | | Report of Committee on M. C. B. A. Rules of Interchange. | | | |

William G. Reyer (N. C. & St. L.); Shop Supervision and Local Conditions, by W. W. Scott (P. M.); Shop Specialization Work and Tools, by W. T. Gale (C. & N. W.); Roundhouse Efficiency, by W. Hall (C. & N. W.). Special papers will be presented on Reclaiming of Scrap, by C. H. Voges (C. C. C. & St. L.), and by C. Ogden (A. T. & S. F.); also on the Relation of Tests to Shop Efficiency, by J. S. Sheafe (I. C.), and L. A. North (I. C.).

Central Railroad Club.—Safety appliances and injury to employees was the subject of an interesting, illustrated talk given by W. O. Thompson at the March meeting. He drew attention to the fact that it is necessary in many cases to safeguard the workman against himself, and experience has shown that all possible danger points must have protection, even though it would naturally be considered that the danger was so evident as to prevent anyone overlooking it. Mr. Thompson drew quite largely for his discussion and illustrations from Mr. Bradshaw's book entitled, "Prevention of Railroad Accidents," and the photographs shown illustrated the installations of railings, guards, etc., in use on the New York Central Lines for protecting employees working near machinery in the shop and power house.

Richmond Railroad Club.—At the January meeting L. S. Randolph, professor of mechanical engineering, Virginia Polytechnic Institute, read a brief paper entitled, "The Relation of a Technical College to the Railroads." The author pointed out how methods of instruction had kept pace with the demand of the time and showed that the improvement in railway equipment, management and operation was paralleled by the improvement of the underlying ideas of instruction of a technical character. The old system of courses of instruction based on a rigid adherence to the opinions of those long dead and gone, which was intended more to train the memory than the reasoning powers, has long been abandoned by the more successful institutions and the development of courses for training the reasoning powers and adapted to specialization have been started and continued until practically trained men who are of immediate value in their chosen line are being turned out from the colleges and technical schools. The use that an engineering faculty of a modern technical institution can be to a railway management in solving some of the more elaborate problems, was mentioned and illustrated by Prof. Randolph and some of the more important questions of this character now awaiting solution were mentioned.

The following list gives names of secretaries, dates of next or regular meetings, and places of meeting of mechanical associations.

- AIR BRAKE ASSOCIATION.—F. M. Nellis, 53 State St., Boston, Mass. Convention, May 7-10, Richmond, Va.
- AMERICAN RAILWAY MASTER MECHANICS' ASSOC.—J. W. Taylor, Old Colony building, Chicago. Convention, June 17-19, Atlantic City, N. J.
- AMERICAN RAILWAY TOOL FOREMEN'S ASSOCIATION.—M. H. Bray, N. Y., N. H. & H., New Haven, Conn. Convention, July 9, Chicago.
- AMERICAN SOCIETY FOR TESTING MATERIALS.—Prof. E. Marburg, University of Pennsylvania, Philadelphia, Pa.
- AMERICAN SOCIETY OF MECHANICAL ENGINEERS.—Calvin W. Rice, 29 W. 39th St., New York.
- CAR FOREMEN'S ASSOCIATION OF CHICAGO.—Aaron Kline, 841 North 50th Court, Chicago; 2d Monday in month, Chicago.
- INTERNATIONAL RAILWAY FUEL ASSOCIATION.—D. B. Sebastian, La Salle St. Station, Chicago. Convention, May 22-25, Chicago.
- INTERNATIONAL RAILWAY GENERAL FOREMEN'S ASSOCIATION.—L. H. Bryan, Brown Marx building, Birmingham, Ala. Convention, July 23-26, 1912.
- INTERNATIONAL RAILROAD MASTER BLACKSMITHS' ASSOCIATION.—A. L. Woodworth, Lima, Ohio. Convention, August 15, Chicago.
- MASTER BOILER MAKERS' ASSOCIATION.—Harry D. Vought, 95 Liberty St., New York. Convention, May 14-17, Pittsburgh, Pa.
- MASTER CAR BUILDERS' ASSOCIATION.—J. W. Taylor, Old Colony building, Chicago. Convention, June 12-14, Atlantic City, N. J.
- MASTER CAR AND LOCOMOTIVE PAINTERS' ASSOC. OF U. S. AND CANADA.—A. P. Dane, B. & M., Reading, Mass. Convention, September 10-13, Denver, Col.
- RAILWAY STOREKEEPERS' ASSOCIATION.—J. P. Murphy, Box C, Collinwood, Ohio. Convention, May 20-22, Buffalo, N. Y.
- TRAVELING ENGINEERS' ASSOCIATION.—W. O. Thompson, N. Y. C. & H. R., East Buffalo, N. Y., August, 1912.

PERSONALS

GENERAL.

A. SHIELDS, general master mechanic of the Canadian Northern at Winnipeg, Man., has resigned.

J. McANANY has been appointed district master mechanic of the Canadian Pacific at Revelstoke, British Columbia.

JAMES WATSON has been appointed district master mechanic of the Canadian Pacific at Saskatoon, Saskatchewan.

R. B. KENDIG has been appointed chief mechanical engineer of the New York Central & Hudson River, with headquarters at New York.

S. J. FERO has been appointed master mechanic of the Great Northern, with office at Breckenridge, Minn., vice C. E. McLaughlin, promoted.

T. M. VICKERS has been appointed master mechanic of the Salt Lake division of the San Pedro, Los Angeles & Salt Lake, vice E. Neuhard, resigned.

B. E. OSGARD has been appointed master mechanic of the Lake district of the Great Northern, with office at Superior, Wis., vice T. E. Cannon, promoted.

J. B. KILPATRICK, superintendent of motive power of the First District of the Rock Island Lines at Davenport, Iowa, has transferred his office to Des Moines.

JOHN PONTIUS, road foreman of engines of the Pennsylvania Lines West at Columbus, Ohio, has been appointed general inspector of engines at Columbus.

GEORGE LANGTON has been appointed master mechanic of the Texas & Pacific, with office at Marshall, Tex., succeeding O. A. Clarke, transferred to Dallas, Tex.

C. S. WHITE has been appointed road foreman of engines of the Pennsylvania Lines West, with office at Columbus, Ohio, succeeding John Pontius, promoted.

S. J. DELANEY has been appointed assistant to the master mechanic of the Mohawk division of the New York Central & Hudson River, with office at West Albany, N. Y.

M. H. STRAUSS has been appointed master mechanic of the River division of the New York Central & Hudson River, with office at New Durham, N. J., succeeding G. H. Eck.

O. B. HAYES has been appointed assistant road foreman of engines of the Pittsburgh division of the Pittsburgh, Cincinnati, Chicago & St. Louis, with office at Steubenville, Ohio.

WILLIAM C. GARAGHTY, air brake inspector east of the Ohio river on the Baltimore & Ohio, has been appointed general road foreman of engines, with headquarters at Newark, Ohio.

W. J. CRANDALL has been appointed master mechanic of the Rochester division of the New York Central & Hudson River, with office at Rochester, N. Y., succeeding W. P. Carroll, promoted.

C. E. LAUGHLIN, master mechanic of the Great Northern at Breckenridge, Minn., has been appointed superintendent of the Dakota division, with headquarters at Grand Forks, North Dakota.

T. E. CANNON, master mechanic of the Lake district of the Great Northern at Superior, Wis., has been appointed general master mechanic of the Lake district, a new office, with headquarters at Superior.

W. R. LADD, assistant superintendent of the Oregon division of the Oregon-Washington Railroad & Navigation Company, in charge of mechanical matters, has been appointed master mechanic of the Albina shops, with office at Portland, Oregon.

W. P. CARROLL, master mechanic of the Rochester division of the New York Central & Hudson River, with office at Rochester, N. Y., has been appointed master mechanic of the Mohawk division, with office at West Albany, N. Y., succeeding S. J. Delaney.

GEORGE K. STEWART has been appointed master mechanic of the Missouri Pacific—Iron Mountain system, with office at Coffeyville, Kan. He was born August 5, 1869, at Ottawa, Kan., and received a common school education. In 1889 he began railway work as a machinist apprentice on the Atchison, Topeka & Santa Fe at Topeka, Kan., and in 1898 he went with the Missouri Pacific as a machinist, and has been with that company ever since. He was night engine house foreman at Coffeyville for two years, and was day engine house foreman for one year at the same place. He was transferred to Wichita, Kan., as division foreman in 1909, and held that position until March 4, 1912, when he was promoted to master mechanic of the Missouri Pacific—Iron Mountain system.



George K. Stewart.

A. R. AYERS, mechanical engineer of the Lake Shore & Michigan Southern, the Indiana Harbor Belt and the Chicago, Indiana & Southern at Cleveland, Ohio, has been appointed general mechanical engineer of all the New York Central Lines west of Buffalo, with office at Chicago, a new position. Mr. Ayers was graduated from Cornell University in 1900 as a mechanical engineer, and began railway work with the Lake Shore & Michigan Southern as a special apprentice in the same year, and he has been connected with the Lake Shore ever since. He was special inspector from 1903 to 1905, and in the latter year was made night engine house foreman at Elkhart, Ind. The next year he was made assistant general foreman of the Collinwood shops, and in 1907 was promoted to superintendent of shops at Elkhart. From January 1, 1908, to November 1 of the same year he was assistant superintendent of shops at Collinwood, and on the latter date was appointed assistant master mechanic, with office at Elkhart. He was appointed mechanical engineer of the Lake Shore, the Chicago, Indiana & Southern and the Indiana Harbor Belt, with office at Cleveland, Ohio, in 1910.



A. R. Ayers.

W. H. DRESSSEL, district foreman of the Northern division of the Oregon-Washington Railroad & Navigation Company, has

been appointed assistant superintendent of the Oregon division in charge of mechanical matters, at Portland, Oregon, succeeding W. R. Ladd.

W. J. EDDY has been appointed inspector of tools and machinery of the Rock Island Lines, with office at Chicago. Mr. Eddy was born in England, and previous to September, 1903, he was a machinist's apprentice and journeyman in the shops of the Choctaw, Oklahoma & Gulf at Shawnee, Okla. He was graduated from Purdue University with the degree of mechanical engineer in 1907, and in September of that year entered the service of the Erie Railroad as tool room inspector. While he was in that position the small tools were standardized and a classification and record of all shop equipment was made, as described in the Shop Section of the *Railway Age Gazette*, November 4, 1910, page 85. Mr. Eddy is also the originator of the shop standard practice system on that road, which was described in the January, 1912, issue of the *American Engineer*, page 15.

JOHN T. LUSCOMBE, whose appointment as master mechanic of the Cleveland, Cincinnati, Chicago & St. Louis, with office at Bellefontaine, Ohio, was announced in the March issue of the *American Engineer*, was born June 29, 1874, at Queenstown, Cork county, Ireland. He received a high school education at Belleville, Ont., and in 1891 he began railway work with the Grand Trunk at the same place. From 1891 to 1901 he served a number of roads as machinist. During this period he took a correspondence school course, and in May, 1901, he was made general foreman of the Baltimore & Ohio at Uhrichsville, Ohio, and was later transferred to Newark, Ohio, as machine shop foreman. In 1905 he went with the Chicago & Alton as machine shop foreman at Bloomington, Ill., and in September, 1907, became general foreman of the Toledo & Ohio Central at Bucyrus, Ohio. In March, 1908, he was promoted to master mechanic, which office he resigned to accept his present appointment. Mr. Luscombe's jurisdiction extends over the consolidated motive power department of the Cleveland-Indianapolis and Cincinnati-Sandusky divisions of the Big Four and the Cincinnati Northern Railroad.



John T. Luscombe.

F. J. ZERBEE, formerly master mechanic at Bellefontaine, Ohio, has been appointed superintendent in charge of federal and state inspection and safety appliances on locomotives and cars of the Cleveland-Indianapolis and the Cincinnati-Sandusky divisions of the Cleveland, Cincinnati, Chicago & St. Louis, and of the Cincinnati Northern, with headquarters at Indianapolis, Ind.

P. P. MIRTZ has been appointed mechanical engineer of the Lake Shore & Michigan Southern, the Chicago, Indiana & Southern, the Indiana Harbor Belt, the Lake Erie, Alliance & Wheeling, the Lake Erie & Western, the Dunkirk, Allegheny Valley & Pittsburgh, the Fort Wayne, Cincinnati & Louisville and the Northern Ohio, with office at Cleveland, Ohio, succeeding A. R. Ayers, promoted. Mr. Mirtz was born November 20, 1883, at Scranton, Pa., and was educated in the public schools at Scranton. He began railway work in 1901 with the Central Railroad of New Jersey as a mechanical draftsman, hav-

ing been for two years previous a draftsman apprentice with the American Locomotive Company. He became a mechanical draftsman for the New York, Chicago & St. Louis at Cleveland in 1903, and two years later went to the Erie at Meadville, Pa., where he had the same title. In 1906 he was appointed mechanical draftsman of the Lake Shore & Michigan Southern, was promoted to assistant chief draftsman at the Collinwood locomotive shops in 1907, and two years later was made chief draftsman at the Elkhart locomotive shops of the same company. In 1910 he was made assistant engineer of motive power at Cleveland, and he has recently been made mechanical engineer of the same road, as above noted.

F. W. KUHLE has been appointed road foreman of engines of the Charleston & Western Carolina.

J. J. McNEIL has been appointed supervisor of locomotive operation on the Mahoning division of the Erie.

W. J. FEE has been appointed road foreman of engines of the Grand Trunk, with headquarters at Lindsay, Ont.

E. ROBERTSON has been appointed road foreman of equipment of the Chicago, Rock Island & Pacific, vice C. W. Sheffer, resigned.

JOHN E. SENTMAN has been appointed acting road foreman of engines of the Philadelphia division of the Baltimore & Ohio, vice H. S. Peddicord, transferred.

CHARLES SNYDER has been appointed traveling engineer of the Elgin, Joliet & Eastern, with special duties pertaining to fuel economy and the operation of locomotives.

CAR DEPARTMENT.

L. E. CUNDIFF, car inspector of the Denver & Rio Grande at Cuchara Junction, Colo., has resigned.

W. H. PELLEY has been appointed coach shop foreman of the Trinity and Brazos Valley, with office at Teague, Texas.

SHOP.

W. S. LAMARS has been appointed bonus inspector of the Atchison, Topeka & Santa Fe at Newton, Kan.

J. H. DAVIS, blacksmith foreman of the Atchison, Topeka & Santa Fe at Albuquerque, N. M., has resigned.

J. H. JACKSON has been appointed locomotive foreman of the Canadian Pacific at Rogers Pass, British Columbia.

WILLIAM MASON has been appointed back shop foreman of the Atchison, Topeka & Santa Fe at Arkansas City, Ark.

W. J. COLEMAN has been appointed locomotive foreman of the Canadian Pacific at Calgary (West), Alberta, Canada.

JOHN T. COSGROVE has been appointed general engine house foreman of the Baltimore & Ohio at Benwood, W. Va.

J. A. CONEDGE has been appointed assistant boiler shop foreman of the Atchison, Topeka & Santa Fe at Albuquerque, N. M.

P. S. HOFFER, engine house foreman of the Atchison, Topeka & Santa Fe at Shopton, Iowa, has been transferred to Shawnee, Oak.

W. J. YINGLING has been appointed foreman of the Norfolk & Western, with office at Crewe, Va., vice A. S. Willard, transferred.

A. H. ASHER has been appointed night engine house foreman of the Denver & Rio Grande at Lelida, Colo., vice G. M. Cykler, resigned.

H. KAUFMAN has been appointed foreman of the Atchison, Topeka & Santa Fe at San Bernardino, Cal., vice C. H. Angle, resigned.

W. McPIERSON has been appointed locomotive foreman of the Canadian Pacific at Moose Jaw, Sask., Can., vice W. Jordan, resigned.

J. T. LEUDRUM, shop inspector of the Atchison, Topeka & Santa Fe at Albuquerque, N. M., has been transferred to Dodge City, Kan.

W. M. ROLOSON, general foreman of the Atchison, Topeka & Santa Fe at Shawnee, Oak., has been transferred to Fort Madison, Iowa.

F. LOZO has been appointed locomotive foreman of the Grand Trunk Pacific, at Fitzhugh, Alberta, vice F. E. Corrigan, transferred to Rivers, Man.

WILLIAM H. EDGEcombe has been appointed bonus supervisor of the Eastern Lines of the Atchison, Topeka & Santa Fe, vice Wm. L. Bean, resigned.

J. A. DOIG has been appointed locomotive foreman of the Canadian Pacific at Red Deer, Alberta, Canada, vice F. McFarlane, assigned to other duties.

A. S. WILLARD has been appointed general foreman of the Norfolk & Western, with office at Williamson, W. Va., vice D. G. Cunningham, resigned.

W. H. GRAVES has been appointed engine house foreman of the Chicago, Rock Island & Pacific, with office at Pratt, Kan., vice L. J. Miller, transferred.

L. J. MILLER has been appointed engine house foreman of the Chicago, Rock Island & Pacific, with office at Liberal, Kan., vice W. H. Graves, transferred.

J. H. WATSON, formerly district foreman of the Oregon-Washington Railroad & Navigation Company at La Grande, Ore., has been transferred to Seattle, Wash.

S. LA BELLE has been appointed acting general foreman of the Chicago, Rock Island & Pacific, with office at Eldon, Mo., vice H. Hamilton, assigned to other duties.

FRANK LEAVETTE has been appointed shop foreman of the Oregon-Washington Railroad & Navigation Company at La Grande, Oregon, succeeding Edward Thomas, promoted.

W. E. KEATING has been appointed boilermaker foreman of the Chicago, Rock Island & Pacific, with office at Argenta, Ark., vice L. E. Warren, assigned to other duties.

EDWARD THOMAS has been appointed division foreman of the Oregon-Washington Railroad & Navigation Company, with office at La Grande, Ore., succeeding J. H. Watson.

WILLIAM B. TAYLOR has been appointed car foreman of the Chicago, Rock Island & Pacific, with office at Liberal, Kan., vice John Fletcher, transferred to the St. Louis division.

J. FLETCHER has been appointed general foreman of the Chicago, Rock Island & Pacific, with office at Carrie avenue, St. Louis, Mo., in place of E. S. Butler, assigned to other duties.

C. J. HUMBERT, foreman of the blacksmith shop of the Trinity & Brazos Valley at Teague, Tex., has resigned to go with the International & Great Northern at Palestine, Tex., in a similar capacity.

PURCHASING AND STOREKEEPING.

C. M. SMITH, division storekeeper of the Atchison, Topeka & Santa Fe at Richmond, Cal., has resigned.

H. D. WEIR has been appointed storekeeper of the Atchison, Topeka & Santa Fe at Richmond, Cal., vice C. M. Smith.

C. M. ROUSE has been appointed storekeeper of the Atchison,

Topeka & Santa Fe at Gallup, N. M., vice J. A. Brackett, transferred to Winslow, Ariz.

OBITUARY

ROBERT PATTERSON, a number of years ago master mechanic of the Florence & Cripple Creek Railroad, died at his home in Denver, Colo., on March 10, at the age of 60 years.

JOSHUA B. BARNES, formerly superintendent of the locomotive and car department of the Wabash, with office at Springfield, Ill., died at Springfield on February 21. Mr. Barnes was born December 13, 1840, at Reservoir, Lincolnshire, Eng., and began railway work in 1856. Previous to 1861 he was master mechanic of the Dubuque, Marion & Western, now part of the Chicago, Milwaukee & St. Paul, and from 1861 to 1862 was machinist on the Pittsburgh, Fort Wayne & Chicago. In the latter year Mr. Barnes went with the Wabash, St. Louis & Pacific, and remained with that road and its successor, the Wabash, until his retirement in 1907. From 1862 to 1882 he was general foreman in the machinery department and was then for three years master mechanic; from 1885 to 1905, superintendent of motive power and machinery, and on July 1, 1905, his jurisdiction was extended over the car department, with the title of superintendent of the locomotive and car department, which title he retained until the time of his retirement several years ago.

R. F. McKenna, former president of the Master Car Builders' Association, and master car builder of the Delaware, Lackawanna & Western from March, 1904, to September, 1909, died on March 16 at Philadelphia, Pa., from the effects of a surgical operation. Mr. McKenna was born on November 14, 1868, at Scranton, Pa., and began railway work as an apprentice on the Delaware, Lackawanna & Western in 1884. In 1891 he was made chief draftsman in the car department. From 1892 to 1893 he was manager of the Buffalo Car Wheel Company. After that he returned to railway work as chief air brake instructor and foreman of the car shops of the Lackawanna at Scranton. In 1869 he was appointed general foreman of the Eastern division at Dover, N. J., where he remained until 1902, when he was appointed general foreman of the Scranton division. The following year he was made superintendent of car shops, and in March, 1904, he was appointed master car builder, from which position he resigned on September 1, 1909, because of the gradual failure of his health. Mr. McKenna's entire railway career had been with the Delaware, Lackawanna & Western. The first act of importance after his appointment as master car builder was to develop the organization and operation of the large car shops at Keyser Valley. He was president of the Central Railway Club at Buffalo in 1908. For a number of years, and until his death, he was chairman of the educational committee of the Railroad Department of the Y. M. C. A. Mr. McKenna's delightful personality, together with his high ideals and strong character, made for him a host of friends by whom he was held in the highest regard.



R. F. McKenna.

NEW SHOPS

ANN ARBOR.—Plans are being perfected for new car shops, a 40-stall engine house, machine, paint and repair shops and a smelting plant, which will cost approximately \$400,000 with the new trackage proposed, at Owosso, Mich.

ATCHISON, TOPEKA & SANTA FE.—It is reported that shops and an engine house will be built at Pueblo, Col.

BALTIMORE & OHIO.—The work on the general enlargement of the terminal facilities, at Garrett, Ind., will begin early in April. A new machine shop will be built at Mt. Claire, Md. A new engine house and turntable will be installed at Garrett, Ind., and the shops will be enlarged.

CANADIAN PACIFIC.—Contracts have been awarded for the construction of engine houses at Swift Current, Sask., and at Outlook, Regina and Wilkie.

CHICAGO, BURLINGTON & QUINCY.—It is reported that a new engine house and turntable will be constructed at Broken Bow, Neb.

DENVER & RIO GRANDE.—Announcement has been made that this company will spend about \$15,000,000 within the next two years for betterments and improvements, which will include the enlargement of the Denver, Col., shops.

DULUTH, SOUTH SHORE & ATLANTIC.—A new engine house will be built at Sault Ste. Marie, Mich.

ERIE.—Repair shops will be built at Randall, Ohio, during the coming summer.

ILLINOIS CENTRAL.—It is rumored that the repair shops at McComb City, Miss., and Water Valley will be removed to Jackson.

KANSAS CITY, MEXICO & ORIENT.—The Sweetwater, Tex., shops will be transferred to San Angelo.

LOUISVILLE & NASHVILLE.—New shops will be constructed at Winchester, Ky.

LAKE SHORE & MICHIGAN SOUTHERN.—It is reported that this road will build repair shops and two engine houses which will have a capacity of 15 locomotives at Air Line Junction, near Toledo, Ohio.

MISSOURI, KANSAS & TEXAS.—It is reported that some land has been purchased for a new engine house and shops at San Antonio, Tex.

NORFOLK & WESTERN.—The improvements to the erecting shop at Roanoke, Va., will probably be carried out during the coming summer.

NORTHERN PACIFIC.—It is reported that the South Tacoma repair shops will be removed to Auburn, Wash.

PENNSYLVANIA RAILROAD.—Plans are being prepared for an extension to the repair shops at Pitcairn, Pa.

SOUTHERN PACIFIC.—An engine house will be built at Beaumont, Tex. It is reported that work on a large car shop at Oswego, Ore., will soon be started.

TOLEDO & OHIO CENTRAL.—Two new buildings will be built at this company's shop at Bucyrus, Ohio, at a cost of \$30,000.

VIRGINIAN RAILWAY.—It is reported that additions will be made to the shops at Princeton, W. Va. Ten stalls will be added to the engine house; a 100-ft. addition will be made to the machine shop and a 12-stall stripping shop will be constructed.

WESTERN MARYLAND.—A new machine shop will be erected at Hagerstown, Pa. A 30-stall brick engine house will be erected at Cumberland, Md., and Hagerstown.

SUPPLY TRADE NOTES

Scully-Jones & Company, Chicago, have been made exclusive agents in Illinois, Indiana, Iowa and Wisconsin for Elco high-speed steel, made by Vickers Sons & Maxim, Sheffield, Eng.

C. W. Reinhardt, for the past 20 years chief draftsman of the *Engineering News*, New York, has resigned his position and opened a general drafting office at 120 Liberty street, New York.

Frederick Maley, formerly with the Baldwin Locomotive Works, Philadelphia, Pa., has been made superintendent of the oxy-acetylene department of the Alexander Milburn Company, Baltimore, Md.

The Lansing Company, Lansing, Mich., recently purchased the entire hoist building plant of the Butcher & Gage Company, Jackson, Mich., and in the future will manufacture the Wolverine hoists in Lansing.

Philip H. Ryan has resigned his position in the mechanical department of the New York Central & Hudson River to enter the railway department of the American Steam Gauge & Valve Manufacturing Company, Boston, Mass.

Martin Prehn, assistant eastern manager and associate editor of the *Railway & Engineering Review*, Chicago, has been made sales manager of the Revolute Machine Company, New York, manufacturers of blue printing machinery.

Jesse Lantz, vice-president of the Goodwin Car Company, New York, died March 20. Mr. Lantz was actively engaged in business at the time of his death and has been connected with the Goodwin Car Company for the last 10 or 12 years.

Willis L. Riley, formerly in charge of the freight car drafting department of the Union Pacific at Omaha, Neb., has been appointed mechanical engineer and assistant superintendent of the Moore Patent Car Company, St. Paul, Minn.

The Baldwin Locomotive Works has filed a notice for the proposed incorporation of the Chicago plant under the Pennsylvania laws. William L. Austin, Alba B. Johnson, Samuel M. Vauclain and William Burnham are named as the incorporators.

C. C. Owens, in the New York sales office of the Westinghouse Electric & Manufacturing Company, Pittsburgh, Pa., with special charge of the industrial and power division, has been made district manager of the Westinghouse company, with office in Detroit, Mich.

The reorganization committee of the Allis-Chalmers Company, Milwaukee, Wis., has given out its plans of reorganization. The preferred stock will be assessed 20 per cent., or \$3,210,000; the common stock, 10 per cent., or \$1,982,000, providing \$5,192,000 working capital.

Cornell S. Hawley, former president of the Consolidated Car Heating Company, Albany, N. Y., has been made president of the Laconia Car Company, Boston, Mass. Craig Colgate, William L. Putnam, Harold J. Coolidge and Robert T. Pine, 2nd, were elected to the board of directors.

The interest of E. A. Schumacher in the firms of Schumacher & Boye and Schumacher, Boye & Emmes, manufacturers of engine lathes, has been acquired by F. W. Boye, Jr., and W. T. Emmes, who have incorporated as the Boye & Emmes Machine Tool Company. The general office is at Cincinnati, Ohio.

W. D. Smith and Elmer J. Smith, of the Peter Smith Heater Company, Detroit, Mich., have purchased the Baker Heater Company of New York and have removed its offices and shops to 88 Isabella avenue, Detroit, Mich., where the business will be operated in connection with the Peter Smith Heater Company.

The U. S. Metal & Manufacturing Company, New York, has changed the name of its one-piece steel ladder for box cars, etc.,

from "Interstate" to "Safety." This change was made owing to the fact that after marketing a large number of ladders the company found that the name was similar to that of a ladder made by another company.

Dr. P. H. Conradson, chief chemist of the Galena Signal-Oil Company, Franklin, Pa., will, on April 10, 11, 12 and 13, deliver a series of lectures in the assembly room of the Permanent Manufacturers' Exhibit of Railway Supplies and Equipment, Karpen building, Chicago, on "The Lubrication of Steam Engines," dealing particularly with the use of high degree superheat in locomotive practice.

The Vulcan Engineering Sales Company has been organized and incorporated, with offices in the Fisher building, Chicago, and 30 Church street, New York. The company controls the entire product and will handle all sales of the Hanna Engineering Works of Chicago, Mumford Molding Machine Company of Plainfield, N. J., and Q M S Company of New York. Further factory arrangements are under way and the Vulcan company will own and manufacture a number of railway special tools and equipment for the shop and maintenance departments. The officers are H. K. Gilbert, president, formerly vice-president of the Buda Company—and P. W. Gates, secretary and treasurer, now president of Hanna Engineering Works, and formerly president of Gates Iron Works. E. H. Mumford, now vice-president and general manager of the Mumford Molding Machine Company, will continue in the same position and duties as heretofore, and William L. Laib, vice-president and secretary of the Hanna Engineering Works, will continue in his present position with that company.

T. R. Wyles, second vice-president of the Detroit Graphite Company, Chicago, was elected a director of the company at its recent annual meeting. Mr. Wyles has been connected with the Detroit Graphite Company since 1897, when he entered its employ as agent, and has been second vice-president since 1907. He was born in Prince Edward county, Ontario, January 14, 1872, and attended an English public school from 1879 to 1888. Until the fall of 1890 he was employed in various capacities in the coal business and tobacco business at Richmond, Va., and during the next year was private secretary to the president of the Lambert Pharmacy Company at St. Louis, Mo. From 1891 to 1896 he was a stenographer in the purchasing department of the American Refrigerator Transit Company at St. Louis, and from 1896 to 1897, contracting freight agent of the company at Chicago, which position he left to become connected with the Detroit Graphite Company.

The Bucyrus Company, South Milwaukee, Wis., has taken over the manufacture of the Atlantic type shovel, heretofore built by the American Locomotive Company, New York, and under a license from A. W. Robinson, the patentee, it is the expectation of the company to continue to build all of the sizes previously built, and to eventually have a complete line of Atlantic wire-rope shovels, in addition to a complete line of Bucyrus chain-type shovels. The Bucyrus company has transferred the manufacture of Vulcan shovels from Toledo, Ohio, to the new plant at Evansville, Ind. Norman B. Livermore & Co., San Francisco, Cal., will handle the steam shovels, wrecking cranes, pile drivers and ballast plows of the Bucyrus company in California, and the same products, with the addition of drag line excavators, in Nevada, Utah and Arizona. Arrangements have been made with the Yuba Construction Company, San Francisco, Cal. for the handling of the Bucyrus dredges on the Pacific coast and in Alaska. Smith & Wiggins, Mexico City, Mex., are agents for the Bucyrus company in Mexico. George B. Massey, for a number of years in charge of the New York office of the company, is now at South Milwaukee preparing for an extensive trip abroad in the interest of the company's foreign business.

CATALOGS

DUST GUARD.—The Virginia Equipment Company, Toledo, Ohio, has issued a folder describing the advantages of its journal box dust guard.

DERAILERS.—The Hobart-Allfree Company, Chicago, has issued catalog No. 113, describing and illustrating the Smyth and the Freeland derailers.

FIRE EXTINGUISHER.—The Pyrene Manufacturing Company, New York, has published a small illustrated folder describing and pointing out the advantages of Pyrene as a fire extinguisher.

BOILER TOOLS.—The J. Faessler Manufacturing Company, Moberly, Mo., has published an illustrated folder describing the Faessler, octagonal section expanders, roller expanders and flue cutting machines.

VALVES & FITTINGS.—The Crane Company, Chicago, has published a special railway catalog, No. 42-A, illustrating and briefly describing its line of valves, air-brake fittings, unions, union fittings, etc. The prices are included.

CULVERTS.—The Canton Culvert Company, Canton, Ohio, has published form No. 26 on its Acme Nestable Corrugated No-Co-Ro metal culverts. It is illustrated and gives descriptions and calls attention to the advantages of these culverts.

PACKING.—The Detroit Leather Specialty Company, Detroit, Mich., makers of the "Wear Well" leather packing, has issued a pamphlet entitled "Efficiency," which tells why the highest quality of leather packing should be used in air brake work.

OXYGEN AND HYDROGEN GENERATORS.—The International Oxygen Company, New York, has issued a 16-page pamphlet describing the I. O. C. system for producing pure oxygen and hydrogen. These gases are used in the oxy-hydrogen process of cutting and welding.

FLEXIBLE TRUCKS.—The McConway & Torley Company, Pittsburgh, Pa., has issued a pamphlet describing and illustrating the Buhop flexible truck. The design of the truck is made as simple as possible, and is such that it is flexible to vertical movements, but rigid to any twisting or angular horizontal movements.

SOUTHERN RAILWAY.—The land and industrial department of this company has published a 32-page, illustrated booklet on Kentucky, in which it describes the physical conditions, the climate, the resources and the products of this state. This booklet will be found very useful to the prospective home-seeker or investor, as it includes many definite facts on the various industries in Kentucky.

LOCOMOTIVE STOKERS.—Clement F. Street, Schenectady, N. Y., has issued publication No. 6 on the Street locomotive stoker, in which each function of this stoker is clearly and concisely described. Illustrations are given of each separate part, and also of the stoker applied to locomotives. Illustrations and the principal dimensions of five of the largest locomotives on which these stokers have been successfully used are given.

VALVES.—The Homestead Valve Manufacturing Company, Pittsburgh, Pa., has issued a 40-page catalog and price list of the Homestead valves. Straightway valves designed for pressures of 150 lbs. per sq. in. to 3,000 lbs. per sq. in.; three-way valves up to 1,500 lbs. per sq. in. capacity, and four-way valves up to 600 lbs. per sq. in. capacity are described and illustrated, the list prices being given for the various kinds and sizes.

TUBE CORROSION.—The National Tube Company, Pittsburgh, Pa., has published bulletin No. 4 containing an article entitled Corrosion of Boiler Tubes, by Rear Admiral John D. Ford, U. S. N. This is an abstract of an article from the Journal of the American Society of Naval Engineers of May, 1904. The

results of a number of tests are described and illustrations are included of tubes after they have been submitted to various tests.

TEXAS & PACIFIC.—The passenger department of this company has published the first number of its quarterly for 1912. This issue contains about 100 pages, is fully illustrated and gives detailed information on the productivity and fertility of the territory along the company's lines. Separate discussions are devoted to the different sections of the country, and valuable data are given on the numerous opportunities for both industrial and agricultural enterprises.

EQUIPMENT INSULATION.—The Union Fibre Company, Winona, Minn., has published a 110-page booklet telling of the evolution of the refrigerator car in the United States, tests of the heat and cold-resisting properties of refrigerator cars and some data on insulation of refrigerator cars, steel passenger cars, etc. A description is also included of a refrigerator car built by the Union company to show its ideas of insulation, air circulation, ventilation and drainage for such equipment.

AXLE CAR LIGHTING.—The United States Light & Heating Company, New York, has published three bulletins on the Bliss system of axle electric car lighting. Bulletin No. 207 is illustrated and gives detailed descriptions of this system. Bulletin No. 105 describes the National storage batteries for electric lighting of railway cars, which are used in connection with the Bliss system of axle car lighting. Bulletin No. 208 A is devoted to a list of spare parts for axle car lighting equipments.

BRAKE SHOES.—The Allen & Morrison Brake Shoe & Manufacturing Company, Chicago, has issued an illustrated catalog describing the advantages of the Acme steel-back, locomotive-driver brake shoe. The principal feature is the tire dressing obtained by hard metal inserts triangular in form and presenting an inclined shearing edge across the face of the shoe. A full report of tests of this shoe in various classes of service, with illustrations showing the comparative tire wear, is included in the catalog.

STEAM TABLES.—The Wheeler Condenser & Engineering Company, Carberet, N. J., has issued a 32-page pamphlet giving steam tables which are especially convenient for condenser work. Three tables give the properties of saturated steam from a 29.8 in. vacuum to atmospheric pressure; from 32 deg. F. to 212 deg. F., and from zero pounds (gage) to 200 lbs. (gage). Information is also presented concerning the use of the mercury barometer and the constant to be used for temperature and other corrections of the barometer.

TURBINE PUMPS.—The Lea Equipment Company, Wayne Junction, Philadelphia, Pa., has issued Bulletin K, describing its high-duty turbine pumps. The construction of this type of pump is much simpler than those of the reciprocating type, and it has been perfected so that its efficiency and reliability is established. They may be driven by motor, belt or the steam turbine, and occupy a comparatively small space per unit of capacity. A description of the design and materials used in construction is also included in the bulletin.

NICKEL STEEL.—In a paper on the heat treatment of nickel steel, written by W. Campbell and H. B. Allen and read before the American Society for Testing Materials, it was found that a steel with 3.15 per cent. nickel, 0.27 per cent. carbon, and 0.65 per cent. manganese, may be refined by heating to 750 degs. C., which is about 75 degs. lower than for an ordinary carbon steel. Hardening is complete when quenched from this temperature, but higher tensile strength was obtained by quenching around 900 degs. C. Overheating becomes marked above 1,200 degs. Tempering of bars quenched in water or oil gives very uniform increase in ductility and decreases in strength, the change varying very uniformly with the temperature of reheating, till at 650 degs. C. the properties are very nearly those of the original steel, having a slightly lower elastic limit and greater reduction in area.

AMERICAN ENGINEER

"THE RAILWAY MECHANICAL MONTHLY"

(Including the Railway Age Gazette "Shop Edition.")

PUBLISHED ON THE FIRST THURSDAY OF EVERY MONTH, BY THE
SIMMONS-BOARDMAN PUBLISHING COMPANY,
83 FULTON STREET, NEW YORK, N. Y.

CHICAGO: Plymouth Bldg. CLEVELAND: Citizen's Bldg.
LONDON: Queen Anne's Chambers, Westminster.

EDWARD A. SIMMONS, *President.* HENRY LEE, *Secretary.*
L. B. SHERMAN, *Vice-President.* A. E. HOOVEN, *Business Manager.*

The address of the company is the address of the officers.

ROY V. WRIGHT, *Editor.* R. E. THAYER, *Associate Editor.*
E. A. AVERILL, *Managing Editor.* WILLIAM FORSYTH, *Associate Editor.*
GEORGE L. FOWLER, *Associate Editor.*

Subscriptions, including the eight daily editions of the *Railway Age Gazette* published in June in connection with the annual conventions of the Master Car Builders' and American Railway Master Mechanics' associations, payable in advance and postage free:

United States, Canada and Mexico.....\$2.00 a year
Foreign Countries (excepting daily editions)..... 3.00 a year
Single Copy 20 cents

Entered at the Post Office at New York, N. Y., as mail matter of the second class.

VOLUME 86. MAY, 1912. NUMBER 5.

CONTENTS

| | |
|--|-----|
| EDITORIALS: | |
| M. M. & M. C. B. June Conventions..... | 217 |
| The Safety Competition..... | 217 |
| Mounting Air Brake Hose..... | 217 |
| The Convention Season..... | 217 |
| Steel Suburban Cars..... | 218 |
| Engine House and Shop Foremen..... | 218 |
| Burlington 2-10-2 Type Locomotive..... | 218 |
| Writing for Technical Journals..... | 218 |
| Superbeaters on Switch Engines..... | 218 |
| Engine House Problems..... | 219 |
| Poor Box Car Construction..... | 219 |
| Locomotive Costs on a Ton-Mile Basis..... | 219 |
| Convention Suggestions..... | 219 |
| New Books..... | 220 |
| ILLUSTRATED: | |
| Shop Kinks..... | 223 |
| Design of Formers for Hydraulic Press..... | 226 |
| Largest Non-Articulated Locomotive..... | 231 |
| All-Steel Electric Suburban Cars..... | 238 |
| Highly Superheated Steam..... | 244 |
| Engine House Kinks..... | 248 |
| Heavy Freight and Passenger Locomotives..... | 251 |
| Automobile Car..... | 253 |
| Portable Electric Motor..... | 256 |
| Hourly Fluctuation of Accidents..... | 257 |
| Journal Turning Lathe..... | 258 |
| Automatic Controller for Electric Motor..... | 259 |
| Driving Efficiency of Pulleys..... | 259 |
| New Type of Drill Socket..... | 260 |
| Shaper Knee Support..... | 260 |
| Everlasting Blow-Off Valve..... | 261 |
| Laying-out Keyways for Eccentrics..... | 261 |
| Accident Prevention..... | 262 |
| Christy Steel Box Car Door..... | 263 |
| MISCELLANEOUS: | |
| Engine House Organization and Operation..... | 221 |
| Prevention of Accidents..... | 230 |
| Reclaiming Lost Efficiency..... | 237 |
| Oxy-Acetylene Cutting and Welding..... | 256 |
| GENERAL NEWS SECTION: | |
| Notes..... | 265 |
| Meetings and Conventions..... | 266 |
| Personals..... | 268 |
| New Shops..... | 269 |
| Supply Trade Notes..... | 270 |
| Catalogs..... | 272 |

M. M. and M. C. B. June Conventions

The delightfully informal character of the entertainment features at the Atlantic City conventions, as outlined in the News Section, will undoubtedly be appreciated by the railway men and others who are looking forward to attending the conventions. With the substitution of the informal, but none the less enjoyable, features in place of the very formal affairs of previous years, it is hoped that more of the members will bring their wives and families with them. The way in which the cost of the entertainment features is to be divided among the three associations will obviate any possible criticism as to the railway members being entertained at the expense of the supply men.

The Safety Competition

The rapid developments in the safety campaign on the different railways during the past few months have created a widespread interest in this subject, and we hope that our readers will participate freely in the safety competition to close June 1, which was announced in our April issue. A most important part of the campaign must necessarily be to induce the employees to make proper use of the safeguards and to see that they are maintained in good condition and are not abused. A prize of \$25 will be awarded for the best article descriptive of safety devices which have been installed in railway shops, engine houses or repair yards, or of methods which may be used to awaken the employees to a full realization of their part in the safety campaigns. Articles not awarded a prize but accepted for publication will be paid for at our regular space rates.

Mounting Air Brake Hose

The *Railway Age Gazette* recently drew attention to the large percentage of air brake hose that fails, due to the puncture of the inner tube when forcing on the nipple by machine. The statement is made that some of the roads have discontinued the use of machines for this purpose and are having the work done by hand. A number of air operated machines for mounting air hose have been described in the *Railway Age Gazette* Shop Section at various times since the shop kink competitions were inaugurated. They can handle this class of work so much more rapidly than it can be done by hand that it would seem advisable to make a special effort to perfect such of the devices as may not have proved satisfactory, rather than to discard them entirely. The problem seems to be almost entirely one of keeping the hose and the nipple in proper alignment during the operation and this ought not to prove an insurmountable difficulty.

The Convention Season

The month of May will open the season for railway mechanical conventions. The Air Brake Association will hold its annual meeting at Richmond, Va., May 7-10, and the Master Boiler Makers' Association will meet at Pittsburgh, Pa., May 14-17. Two other conventions of associations which are closely allied to the mechanical department will also be held during the month. The Railway Storekeepers' Association will meet at Buffalo, N. Y., May 20-22, and the International Railway Fuel Association will meet in Chicago, May 22-25. Announcements of the principal subjects which will be discussed at each of these conventions will be found in the News Section. Three mechanical department associations will meet during June, all of them at Atlantic City, N. J. The Association of Railway Electrical Engineers will hold its semi-annual meeting June 11; the Master Car Builders' Association will meet June 12-14, and the American Railway Master Mechanics' Association, June 17-19. Two conventions will be held in Chicago

during July; the American Railway Tool Foremen's Association will meet July 9-11, and the International Railway General Foremen's Association, July 23-26. Both of the August conventions will also be held in Chicago. The International Railroad Master Blacksmiths' Association meets on August 15, and the Traveling Engineers' Association later in the month. The Master Car & Locomotive Painters' Association will hold its annual meeting at Denver, Colo., September 10-13.

Steel Suburban Cars

For high speed suburban service with comparatively frequent stops the dead weight of the rolling stock becomes an important factor, even more so than on steam operated trains where recent experience indicates that this feature of steel passenger car design will have to be given more serious consideration. On an electric suburban line of the character of the New York, Westchester & Boston, the provisions for safety and comfort approach those of steam railway operation, and the cars which have been designed for this service include features of construction which, possibly in a somewhat altered form, are worthy of consideration for heavier equipment. When a 70 ft. car seating 88 passengers, and of the evident strength of those on the Westchester, can be designed to weigh something under 90,000 lbs. (estimated to weigh 80,000 lbs.), its construction is worthy of careful study. The so-called "unit" side framing is a novelty, and of course is largely responsible for the success in weight saving. While these pressed shapes might be somewhat difficult to manufacture and handle for a larger car the ideas suggested by their use indicate a line of investigation which might result in a considerable saving in the weight of some of our present exceptionally heavy steel passenger cars.

Engine House and Shop Foremen

Many lessons may be learned about the proper condition of a locomotive leaving the shop by following it to the engine house. Engine house foremen almost universally severely, and in many cases justly, criticize the condition of locomotives which they receive after repairs have been made in the shop. This is generally, of course, aimed at small things, but it is just these small things which make so much difference in the engine house and which the shop so easily overlooks. On one road, noted for the efficiency of its organization, it has been found advisable to frequently promote engine house foremen of considerable experience to the shop staff, so that there will always be one or two thoroughly experienced engine house men among the shop officers. If the engine house foremen have had the proper amount of shop training previously, as should always be the case, they come back to the shop with a broader and more desirable viewpoint of locomotive repairs and the output of their shops will probably be much more free from criticism from the engine house viewpoint. Too frequently the shop and the engine house do not work in harmony, and a judicious interchange of officers of the two departments will very largely correct a trouble which in some cases is really serious.

Burlington 2-10-2 Type Locomotive

The five locomotives of the 2-10-2 type recently delivered to the Chicago, Burlington & Quincy by the Baldwin Locomotive Works, illustrated elsewhere in this issue, are of particular interest as marking the continued development of the simple non-articulated type permitted by the use of high degree superheated steam. These locomotives are very large and in fact seem to practically set the limit of weight for the non-articulated engine except in cases where wheel loads greater than 60,000 lbs. per axle are permitted. They are designed for a service which many people consider suited to the articulated type, and their performance will be watched with much interest. There

are two features which will probably be questioned in the minds of many motive power men in examining this design. One is the effect of this length of rigid wheel base and heavy wheel loads, not on the main tracks, but in the yards, and second, the advisability of putting this amount of power through two main crank pins, the latter being not so much on account of the direct pressure on the pins as the general effect of the necessarily heavy rods and counterbalancing. These features have evidently both been fully appreciated by the designers, and steps taken to properly care for them, but it will take actual service to positively settle the question. These locomotives are so large as to practically compel the use of an automatic stoker, if coal is to be burned, and the Barnum type of underfeed stoker which has been developed on the Burlington has been applied.

Writing for Technical Journals

One of the advantages of writing articles for technical papers is indicated by an incident which took place recently. In our March issue, page 123, Lewis D. Freeman described a 100-ton hydraulic press which could be utilized for light work by using two 14-in. auxiliary air cylinders in place of the hydraulic cylinders. A reader, noticing that the air pipes were so arranged that the air cylinders received air at the top only, and were therefore apparently used for pulling down or relieving the lower dies, suggested that Mr. Freeman's article was incorrect. We wrote to Mr. Freeman and here is his reply:

The air cylinders of the 100-ton hydraulic press as first designed were only used, as you state, to relieve the dies, but when writing the article I found that it would be an advantage to use the air independently for light work and to that end I am going to have the press so altered. However, I neglected to state in the article that air should be used on the top end of the cylinders to pull down the lower die, as the hydraulic pistons are packed so tight that the weight of the lower die is not always sufficient to lower the die.

In preparing an article for publication and explaining why certain things are done, or just how an operation is performed, weaknesses in the design are often developed, or possible improvements are suggested. The weakness of an argument often becomes apparent when the attempt is made to reduce it to writing. For these reasons the practice of writing for the technical papers develops and broadens a man in a way that it would be difficult to do otherwise.

Superheaters on Switch Engines

It has been quite generally considered that switching engines do not present an opportunity of obtaining any economy through the medium of superheated steam, but actual experience has shown that quite the contrary is the case. On one road two switching locomotives were equipped with Schmidt superheaters and put in service at a passenger terminal. The results have been a most pleasing surprise. The saving obtained in coal and water on a percentage basis is considerably greater than in the case of the road engines, and the power and quick response of the locomotive has been noticeably improved. There is also a considerable reduction in the smoke. It is somewhat difficult to explain the reason for these results, but it appears probable that because of the large proportion of time in which a switch engine is shut off, the cylinders cool down to so low a degree that the condensation of the saturated steam is very large. The amount of water frequently thrown from the stack is striking evidence of this. There is also considerable water drawn over through the dry pipe in many instances. The superheated steam largely overcomes this while, at the same time, the locomotives do not operate a sufficient distance to cause the loss which the full stroke would normally give with superheated steam. The throttle is not generally closed long enough at any one time to permit the superheater pipes to cool down enough to cause condensation in them, and while the temperature of the

steam at the cylinder is probably not as large as would be obtained after continuous service, it is still superheated sufficiently to, at least, greatly reduce the condensation loss. Whatever the explanation may be, the fact remains that a decided saving is obtained on these locomotives, not only in coal and water directly, but in the time lost in going after fresh supplies and by the more lively work performed. After looking carefully into the subject one large switching company has recently ordered superheaters for fifteen engines now being built.

Engine House Problems

The engine house is usually the critical point in the operation of a division, and as suggested by Mr. Cordeal, in an article elsewhere in this issue, it is more in need of systematic and effective organization than almost any other department. The wide variation in the size of engine houses and the conditions, even on one division, are such that it is difficult to outline an ideal scheme of organization which can be applied to all of them, and yet it must be admitted, after reading Mr. Cordeal's article, that he has been most successful in outlining an organization of this sort, which, in its general principles, may be universally applied. The trouble with many engine house organizations is that they are "one man" affairs and the foreman has to carry too much of the detail and wear out entirely too much shoe leather. With the organization suggested, and the records which are proposed, the foreman is enabled to take a broad view of the situation and direct his forces to the best possible advantage. Moreover, he will always be in a position to quickly and accurately advise his superiors as to the exact condition of the motive power and when it will be ready for service. The article on Engine House Organization in this issue, is the first of a series of three articles by the same author on engine house problems. The second article on Engine House Reports and Records will make definite recommendations as to exactly what records and reports should be kept to get the most efficient results. The third article will cover engine house facilities, taking up the question of the proper equipment for engine houses of various sizes. For instance traveling cranes, drop pits, jacks, machine equipment, tool rooms and special tools, boiler washing systems, and other small items will be considered, the present or absence of which influences the economic handling of engine houses to a greater or less extent.

Poor Box Car Construction

The *Railway Age Gazette* is publishing a series of articles on defective box cars and damaged freight, which promises to bring about important practical results in improving box car construction. Probably as much as \$10,000,000 a year is paid out by the railways of this country in settling freight claims for damage caused by defective equipment. A very large proportion of this is due to door fixtures which permit the cars to be pilfered from without breaking the seal, to poorly constructed sides and ends which permit grain and similar products to leak out, to side doors and roofs which allow moisture, dirt and cinders to enter and damage the freight, and to weak ends which allow the loads to shift and damage both the lading and the car. L. H. Turner, superintendent of motive power of the Pittsburgh & Lake Erie, in a letter to the *Railway Age Gazette*, said: "Our company pays out a large amount annually for loss and damage to freight, and I am free to say that 95 per cent. of the damage might be avoided by better loading of the freight in the cars, more careful handling of the cars by the trainmen and better constructed cars, which will not leak at the doors or the roof." That this condition exists is undoubtedly due to the fact that those in charge of drawing up the specifications for and purchasing the cars do not understand the seriousness of the situation. The defects are being described in detail in the *Gazette*, and remedies are suggested

in each case. Because of the interchangeability of the freight cars the recommendation is also made that the American Railway Association form a bureau whose duty it shall be to pass on new cars which are built, or on all cars which receive heavy repairs, and see that they are properly constructed from the standpoint of damage to the freight.

Locomotive Costs on a Ton-Mile Basis

On most roads the locomotive maintenance costs are based on locomotive mileage, and it is to the direct interest of the master mechanic, as well as other motive power officers, to have the tonnage per train at a minimum, and thus be able to present better unit cost figures. The division superintendent, on the contrary, is interested in obtaining a maximum tonnage, and thus two of the most important officers on a railway are working at cross purposes when there should be the greatest possible co-operation in their efforts. When on the engine mile basis, the master mechanic naturally makes every effort to have the tonnage rating of a locomotive reduced after it has made a reasonable mileage. Furthermore, the tendency will be to keep the locomotives out of the shop just as long as possible and to do as little work as possible on them at the engine house, attempting to force the superintendent to continue to operate them at reduced tonnage. This is not the best method for the railway, and the motive power officers should not be tempted to direct their efforts in this direction by a method of accounting. If, on the other hand, the cost of locomotive repairs is placed on the basis of ton-miles, the master mechanic and superintendent are working for the same ends, and the tendency will be for the master mechanic and all other motive power officers to direct their efforts toward keeping every locomotive on the road in 100 per cent. condition just as long as possible and to take it into the shop just as soon as it proves impracticable for the engine house to further maintain it at full hauling capacity. The master mechanic immediately becomes vitally interested in the ton-miles handled per hour on his division, and will use all the influence possible to see that full tonnage trains are operated at the highest practicable speed, and this of course produces the best net results for the company. The ton-mile costs also permit of very accurate information as to whether money should be put into new locomotives or into new shops to best increase the strength of the department.

Convention Suggestions

The average railway mechanical department association could make its work far more effective if the officers had a better understanding of their duties and spent more time in preparation for the conventions. The following suggestions, which are based on an observation of six of these conventions last year, may not be amiss. In some instances the president, and even the secretary of the association, arrived on the ground only a few hours before the convention was opened and the work of getting things into shape for the opening was left largely and almost entirely in the hands of the supply association. The officers seemed to have no clear idea when the convention was opened as to just how the meetings should be conducted, or what was to be accomplished, and an air of uncertainty hung over the first sessions of several of the conventions.

The officers should be on hand a day or two before the convention opens, and every move, not only for the opening session, but for the entire convention, should be carefully planned. Moreover, every association should start all of its meetings on the advertised time. It is pathetic to watch the officers hang around waiting for people to come into the convention hall when, if they actually got up on the platform and started the proceedings, the members would be only too glad to come in

and take their places. A little more decision and push on the part of the presiding officers would make some of the conventions from 25 to 100 per cent. more effective than they are now. The president has an entire year in which to prepare himself, and yet it is not unusual to find men holding this position who do not understand even the rudiments of parliamentary law. They are lost when it comes to stating or putting motions, and in spite of the fact that they are accustomed when working in the shop to make themselves heard above the noise of the machinery and pneumatic riveters, they seem to be afraid of their voices in the convention hall; in some cases it is difficult for even those in the front rows to understand what they are driving at. It is no easy matter oftentimes to conduct and direct the work of a convention, and those who are chosen for this work should realize that considerable study and preparation are necessary on their part in order to be able to perform their duties satisfactorily.

Another common abuse is that of having the committee reports read by the secretary or one of the officers, who has not had or has not taken time to look them over previously. Last year in several instances the whole import and value of reports was lost because the men who wrote them, and who were present at the meetings, would not or were not allowed to present them. The officers who were asked to read them could not read the writing freely, or it was expressed in terms which were foreign to them, and the effect of the reading was discouraging and practically spoiled the entire value and usefulness of the report. Committee chairmen should be notified that they are expected to present the reports, or if for any reason they cannot do so, it is up to them to have one of their committee members, who is properly qualified, do it for them. If no member of the committee can be present, or if an individual paper is prepared whose author cannot attend the convention, it should be forwarded to the officers of the association in plenty of time so that the one who is selected to read it can study it over carefully and be in a position to read it freely and intelligently.

In providing for the use of a hall or room in which to hold the convention, arrangements should be made so that all noise which may interfere with the proceedings will be eliminated while the meetings are in progress. Very few halls are satisfactory for the holding of railway conventions, and in some cases where satisfactory ones are provided the exhibitors or hotel attendants are not properly impressed with the idea that they must not under any circumstances make noises which will disturb the meeting. Last year at three of the conventions the exhibitors were responsible for creating noises and disturbances which seriously interfered with the progress of the meetings.

NEW BOOKS

The Mechanical World Pocket Diary and Year Book for 1912. Emmott & Co., Manchester, England. Cloth, 4 in. x 6 in., 263 pages. Price, 12 cents.

The twenty-fifth annual edition of this publication appears promptly, and with some improvement over previous issues. The section on steam turbines has been rewritten and extended considerably, with new illustrations. There are new sections dealing with roller bearings, helical springs and milling cutters, and a number of new tables. The book is more fully illustrated than formerly, and the whole work has been subject to a thorough revision.

Addresses to Engineering Students. Edited by Wadell & Harrington, consulting engineers. 480 pages, 6 in. x 9½ in. Bound in cloth. Published by Wadell & Harrington, Kansas City, Mo. Price \$1.

It is not infrequent that some of the very best thoughts and expressions of our foremost engineers and professors are contained in addresses delivered to student associations or classes. Even when such addresses are published they are usually given

such restricted circulation that their possible value is greatly reduced. Recognizing the importance of many of these addresses, Wadell & Harrington, consulting engineers, Kansas City, Mo., have collected material of this kind, so far as it was available, and have compiled it into a single volume. This has been done without thought of any pecuniary reward, and the book is being issued at cost price. Many of the addresses given are prefaced with editorial notes, telling who the writer was and for what special purpose the address was prepared. While this collection is intended largely for engineering students, particularly freshmen, it will also be found of interest to engineers in general, particularly those interested in educational work.

Proceedings of the Nineteenth Annual Convention of the International Blacksmiths' Association, held at Toledo, Ohio, August 15-17, 1911. 242 pages. Cloth. Illustrated. Published by the association, A. L. Woodworth, secretary, Lima, Ohio. Price, \$1.

The work of this association steadily improves in its quality and scope. Reports of the committees, while generally brief, were supplemented by excellent contributions from various members, and by the clearing up of debatable points during the discussion. The volume contains papers and reports on the following subjects: Drop forgings; frogs and crossings; special welding and threading steel; oxy-acetylene welding; tools and formers; properties of iron and steel in connection with their chemical composition; piece work; effect of heat and working on metals; the foreman and his men; flue welding; frame making and repairing; case hardening; spring making and repairs, and high speed steel. The proceedings also contain a list of members and the membership of the various committees which will report at the next convention.

Accident Prevention and Relief. By Ferd. C. Schwedtman and James A. Emery. 481 pages, 6 in. x 9 in., illustrated. Bound in half leather. Published by the National Association of Manufacturers, 30 Church street, New York.

The authors of this work were sent abroad by the National Association of Manufacturers to study and report on the prevailing systems for the compensation for and prevention of accidents in various foreign countries. They visited England, France, Germany, Austria, Hungary, Belgium, Switzerland and Italy, and at each place were given the fullest opportunity of making their investigation complete. The report deals especially with the systems in use in England and Germany, which were found to be the most advanced, and covers legislation, insurance, safety museums and societies, statistics, employers' liability, etc. Colored plates and charts are used very freely and the whole work of the authors and the associated committee is boiled down into very positive, clear-cut recommendations for action in this country. This book is beyond doubt the most business like and real practical publication available on this subject.

Prevention of Railroad Accidents. By Geo. Bradshaw. Published by Norman W. Henley Publishing Company, 132 Nassau street, New York. Bound in paper, 4½ in. x 6½ in. 173 pages. Illustrated. Price, 50 cents.

Possibly influenced by the activities of the Industrial Safety Association there seems to have been a recent revival of organized effort to prevent personal accidents in all departments of railways. Some of the companies are going to the extent of employing specialists in this line, whose efforts are producing most gratifying results. The author of this work, Mr. Bradshaw, has been employed on the New York Central & Hudson River for this purpose, and for a number of years has been constantly engaged in a study of railway accidents. The human element is the most important factor of the subject and he has therefore found it necessary to accomplish his results largely by the use of lectures and pamphlets. This book is composed principally of material prepared for this purpose, and is very thoroughly illustrated. In it are discussed accidents in all the different departments of a railway; the section devoted to shops is by no means the least important.

ENGINE HOUSE ORGANIZATION AND OPERATION

An Ideal, Practical and Simple Form of Organization Is Outlined, Which May Be Applied to Any Size Engine House.

BY ERNEST CORDEAL,

Acting Bonus Supervisor, Atchison, Topeka and Santa Fe, La Junta, Colo.

It is doubtful whether there is any one department on a railway which, while lending itself readily to effective organization and the production of satisfactory results by reason of systematic organization, is so greatly handicapped by its absence as the engine house. By reason of the complexity of the work to be handled and the importance of its being performed with the greatest possible expedition the necessity for an efficient, comprehensive, flexible organization is greater than in other departments. The efficiency of the engine house depends on its ability to handle and repair power in the least possible time consistent with the maximum quality of locomotive performance, and at the minimum expense. Engine house efficiency may be computed from the performance of locomotives handled on the basis of five definite items: (1) Cost of repairs; (2), cost of handling; (3), mileage between failures; (4), mileage between shoppings; (5), time of detention.

Only after the determination of the efficiency of each of these items can an equitable conclusion be reached as to the effectiveness of the organization. Low costs represent efficiency only in so far as they are correlated with a high standard of performance and low average time of detention.

High efficiency of performance as represented by large mileage between failures and between shoppings is the end chiefly to be desired, but there is no reason why such results should not be accomplished in conjunction with reasonable costs. The ends, therefore, which the engine house organization is expected to attain, are minimum costs of handling and repairs, elimination of engine failures, prolongation of periods between necessary shoppings, and minimization of time out of service due to repairs and handling. In order to accomplish these ends all movements of the locomotive from the time of its arrival at the engine house tracks until the time of its departure must be the subject of the most careful supervision.

It is to be feared that as a general rule the organization of engine house forces is of a very primitive form. The engine house foreman is often burdened with too much detail work to enable him to perfect and supervise a suitable organization, the result being an overworked man in charge of an inefficient force with a resultant poor locomotive performance and high cost. Again, the supervising force may be too large, giving each member an insufficient amount of work. Such a case will also result in inefficiency, owing to the high cost of supervision and general bad results emulating from the conflicting instructions which are bound to obtain in organizations where authority is divided between too many individuals.

There are four distinct classes of work in connection with the handling of locomotives: handling, machinery repairs, boiler repairs, and cleaning, and any organization to be effective should recognize these distinctions. The form of organization which is shown on the accompanying diagram should produce the highest possible efficiency.

To produce the best results the master mechanic should in no way interfere with the engine house foreman as far as the actual supervision of the department is concerned. All instructions which he may see fit to issue, all criticisms or suggestions which it is necessary or expedient to make, should be communicated directly to the engine house foreman, and never to assistant foremen or individual workmen. In this way only can the most effective organization be perfected and maintained.

Every time that a master mechanic or higher officer takes upon himself the duty of supervising details in an engine house he weakens his organization; he reduces the respect in which the authority of the foreman is held by his subordinates; he produces a complication in the handling of the work by creating a certain amount of uncertainty as to who is responsible for results, and in addition he wastes valuable time which should be spent in a study of division conditions as a whole.

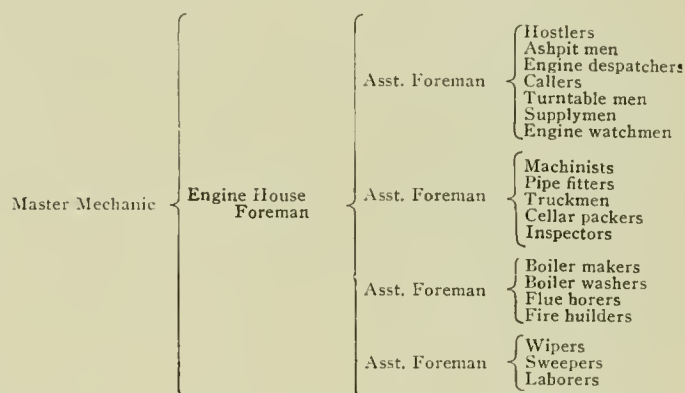

The engine house foreman should be supreme in his own province. He should be directly responsible to the master mechanic for the results obtained and should not be embarrassed by interference in the exercise of his exclusive supervision over the engine house as long as the efficiency of operation is satisfactory. If the proper results are not forthcoming, it is a clear indication that the wrong man has been selected for the place and he should be superseded by another man possessing the necessary qualifications.

What has been said of the master mechanic in his relation to the engine house foreman applies equally to the foreman in relation to his assistants. Each assistant, fitted by training for his particular position, should be responsible alone to the engine house foreman, and in turn the men under his supervision should report and receive their instructions directly from him. No workman should be under the supervision of two foremen at the same time, and no foreman should be required to look to more than one higher officer for his instructions.

As to the specific duties of each member of the suggested organization. The lines between the fields of responsibility should be clearly drawn and no foreman should be allowed to overstep those bounds by issuing instructions to men other than those directly assigned to his care. The engine house foreman should keep in close touch with the transportation department, so as to be informed at all times of the class of power that will be required and the time at which it must be delivered. He should, by a system of reports, understand fully at all times the power conditions at his station, so as to be able to furnish exact information as to what power is available for service. He should direct the movement of all locomotives while in his charge by issuing definite instructions to his assistants as to what work incoming locomotives will require, what time they should be set in the house, what time the repairs must be completed, and what time the engine must be fired and ready for service.

The assistant foreman in charge of hostlers should be responsible for the expeditious handling of power from the time

it arrives at the engine house tracks until it is turned over to the repair foreman, and should again resume authority as soon as repairs have been completed and the fire built. His prime object should be to see that no delays are incurred in knocking fires and supplying fuel, sand and water so that the maximum amount of time may be available for necessary repairs. When resuming charge of locomotives on which repairs have been completed, it is his duty to see that they are properly supplied for the coming trip and that they are in readiness at the appointed time.

The assistant foreman in charge of the mechanics should be responsible for the workmanship and despatch with which repairs to machinery are completed. He should be the judge as to the necessity for repairs reported by enginemen or inspectors, and on him should rest the responsibility for failures of power due to machinery parts.

The assistant foreman in charge of boiler makers, in addition to the supervision of boiler and firebox repairs, should also be entrusted with the washing of boilers and the building of fires. He should receive full information as to when engines are required for service so as to be able to have fires lighted at the last possible moment consistent with a fair margin of safety, in this way effecting fuel economy by not retaining engines under fire for long periods in advance of the time required.

The fourth assistant might properly be termed a labor boss, and the nature of his duties would hardly class him with the other assistant foremen. However, he should not be subordinated to any of the other assistants, but should report directly to the engine house foreman, thereby eliminating any possibility of a conflict of authority. His duties comprehend the cleaning of engines in such time and manner as not to interfere with the work of mechanics or boiler makers, the keeping of the engine house and adjacent yard clean and free from accumulations of scrap or rubbish and the furnishing of labor to handle material or assist in heavy repairs.

The suggested organization is a flexible one in that the principals evolved may be applied to engine houses of any class, regardless of the size of the force employed, by making minor changes in the duties of the assistant foremen or by adding additional sub-foremen where the force becomes too large to permit the four assistants to exercise sufficiently detailed control. In a small engine house where locomotives are merely turned, and the necessary minor repairs made to insure their arrival at the main division point, the assistant foremen should be simply working bosses, bearing the responsibility for the work performed in their particular division, and at the same time performing a part of the actual work. The first assistant foreman then becomes in intent a head hostler, the second a head machinist, the third a head boiler maker, and the fourth a head laborer. This arrangement should not in any way effect the form of organization, the duties and authority of each individual remaining the same in fact and only varying in degree. It may be that at points where a very small force is employed the engine house foreman will be able, without conflicting with his particular duties, to assume the responsibility of one or more of the assistant foremen.

At very large points where the volume of business to be handled precludes the possibility of the four assistants exercising the required amount of control over the force, sub-foremen, either working or otherwise, should be appointed with specific duties and report directly to the assistant foreman at the head of their department. A very good plan for the manipulation of a large force is to divide the workmen into small groups, each group being in charge of a working boss. The work of each group should be as nearly as possible on the same class of work and within as small a space radius as practical. It may be found advantageous to divide the machinists into two separate groups, one to take care of passenger and the other freight power, placing at the head of each gang a sub-foreman or working boss, who reports to the assistant foreman in charge of machine repairs. It will seldom if ever be found necessary to supply sub-foremen to

the departments under the first, third, and fourth assistant foremen as the force necessary under these divisions should not exceed that which can easily be handled by one man. However, in special cases where the number of engines handled in twenty-four hours is very large, it may be found advisable to provide the assistant foreman in charge of handling engines with a working boss at the ash pit or with a head hostler. The assistant in charge of boiler work at points where this work is heavy may require a boss boiler washer, or even one or more working boiler maker bosses. The principal need for additional supervision, however, will be found in the department handling machinery repairs.

The first efforts of the assistant foreman in charge of repairs should be directed toward a definite and logical placing of his force so as to attain the best possible results. The work should be specialized as much as possible; that is, certain men chosen for adaptness in a certain class of work should be assigned to that work, and only in case of absolute necessity should they be taken off for other jobs.

Specialization may be carried out to the extreme in a large engine house. There, after a careful study of the average amount of work to be handled, a certain gang of men may be permanently assigned to rod work, guides and pistons, drop pit, steam pipes, etc. By keeping these gangs at a minimum as to the number of men it should always be possible to keep each group on its own class of work. They, being thoroughly conversant with the work and having always at hand the special tools required, should be able to maintain a high efficiency of output, together with the best quality of workmanship. It must be taken into consideration of course that there is a more or less great variation in the proportions of each class of work which will be necessary on different days, but this difficulty may be easily overcome at large points by the employment of a floating gang. This gang should be composed of good all-around mechanics who are able to do any or all of the various classes of work and who will be available at all times for use on the class which at the time happens to be heavier than can be handled by the regularly assigned gang. At most engine houses a greater or less number of engines are given light shoppings and very effective use can be made of a floating gang by working them on shop engines while running repair work is not sufficiently heavy to require their helping out the regular gangs. The smaller engine houses will experience considerably more difficulty in specializing the work, yet it can be done to a certain extent and the greatest possible limit of such organization will net the best results.

One of the principal, if not the paramount advantage of the suggested form of organization is that it provides a means of speedily and satisfactorily filling any vacancy which may occur in any of the supervising positions. In case of the engine house foreman leaving the service, his place can immediately be filled by the promotion of the assistant foreman who has proved the most efficient, his place in turn being filled by the best working boss in that department. In the case of a temporary absence from duty of any foreman no confusion would arise, as the next man in line would simply assume charge for the time being.

Such a form of organization, entailing as it does a regular line of promotion open to any workman who is able to demonstrate his ability, will tend to promote efficient performance on the part of the entire force. Each workman will strive to attain a record which will insure his selection as a working boss. Each working boss will aspire to an assistant foreman's position, and each assistant will endeavor by the excellence of his work to obtain the next vacancy as engine house foreman.

Another point which must be given consideration is that of rates of pay. Men work primarily for the remuneration which they receive. If the wage is satisfactory in the position which they occupy, their energies are bent toward the attainment of a record for good service which will entitle them to further ad-

with which it is to be used. The two types of ends shown are used for different styles of air drills.

DRILL TWISTING DEVICE.

The device shown in Fig. 3 is used for twisting flat bars of steel, which are made into drills by casting a brass shank on the end of the bar, anchoring it by drilling two or three small holes in the end of the flat bar before it is twisted. One end of the bar fits in the slot in the end of the spindle and the other end rests in the slot in the angle which is bolted to the end of the device. A number of these slotted angles are provided for the different sizes of drills. They can easily be changed by remov-

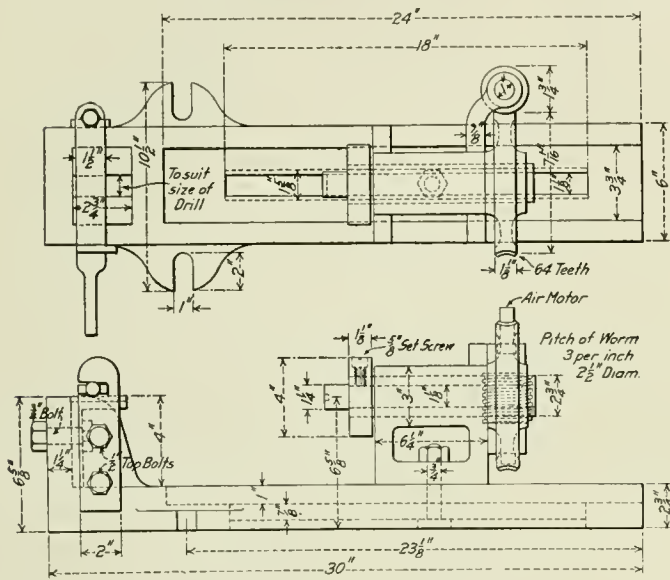

Fig. 3—Machine for Twisting Flat Drills.

ing the 3/4-in. bolt. The end of the flat bar is held rigidly in place by the clamp. After the brass shank has been cast on the twisted bar it is turned and ground to the proper taper, thus making a cheap and very serviceable drill.

Different lengths of bars may be twisted by adjusting the head-stock on the base of the machine. It is only necessary to loosen the nut of the 3/4 in. T-bolt, which holds it to the base. The spindle is also adjustable and is held in place in the revolving bearing by the 5/8 in. set screw and collar.

REBORING AIR PUMP GLANDS.

A device for accurately reboring air pump glands is shown in Fig. 4. The centering device, which fits in the head of the air pump cylinder, is fastened to the head by the cylinder head studs which fit in the 3/4 in. slotted holes. It is made from an old air pump head which has been planed to a width of 4 in.

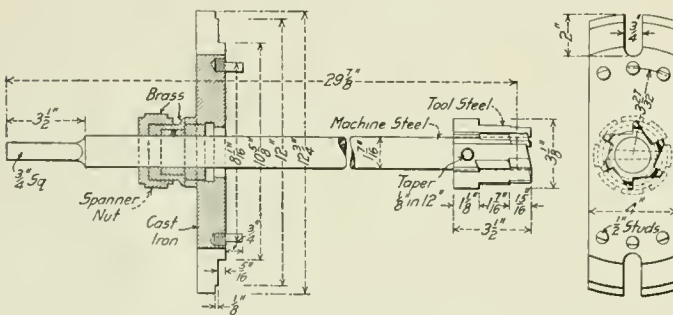

Fig. 4—Device for Reboring Air Pump Glands.

One-half inch studs are inserted in this centering piece, as shown, and they are then turned down to fit snugly into the pump cylinder. The cutter, which is made of tool steel, is

fastened to the 17/16 in. arbor by a 1/4 in. taper pin. Power for driving the device is furnished by an air motor.

PNEUMATIC HOLDER-ON.

An inexpensive holder-on for use in cramped quarters is shown in Fig. 5. These tools are made in several sizes to suit different classes of work. The steel box is threaded to take the head and the piston is of the type with leather packing, such as

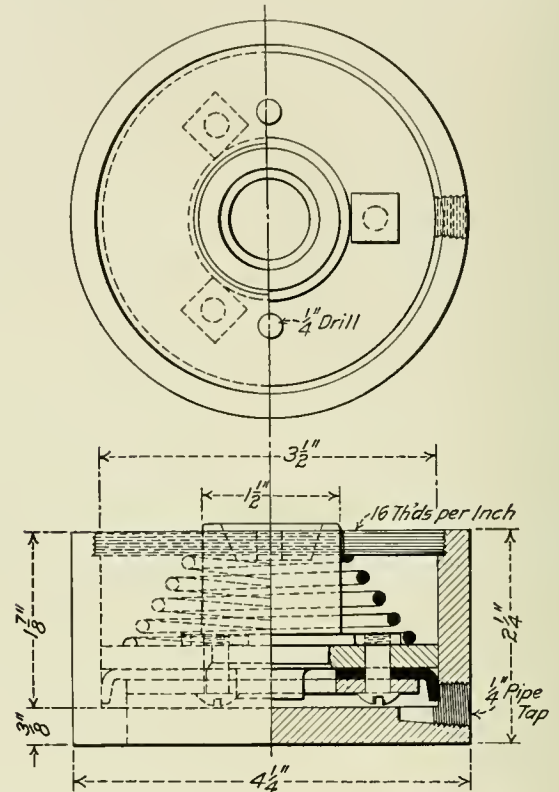

Fig. 5—Pneumatic Holder-on Used for Driving Rivets.

is ordinarily used in air cylinders. The piston is returned to its initial position when the air pressure is released by means of the coil spring. Compressed air enters underneath the piston through a 1/4 in. pipe, the connection for which is shown in the cross sectional view of the device.

CLAMP FOR HANDLING SMOKESTACKS.

A convenient and safe clamp or sling for handling smoke stacks in the erecting shop is shown in Fig. 6. The two parts of the band are made from 1/2 in. x 1 1/2 in. wrought iron bars. The

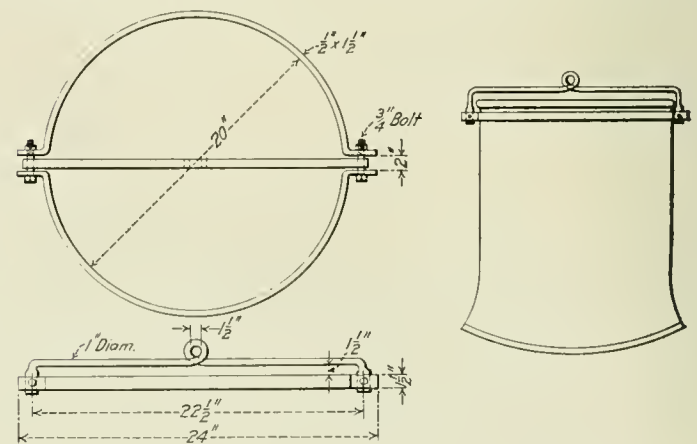

Fig. 6—Clamp or Sling for Handling Smoke Stacks.

hanger is made of 1 in. round iron with a 1 1/2 in. eye in the center, in which the crane hook fits. The ends of the hanger are

upset and flattened and connect to the clamp by $\frac{3}{4}$ in. bolts, as shown.

FLUE HOLE CUTTER.

The flue hole cutter shown in Fig. 7 is used on a drill press and has a record of cutting sixty 2 in. holes per hour in $\frac{1}{2}$ in. boiler plate, a Bickford radial drill being used. The shank is made of machine steel and has a socket, which is threaded to

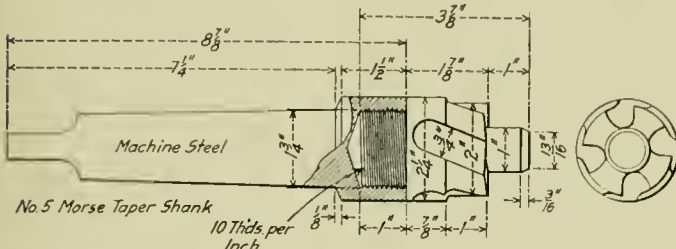

Fig. 7—Flue Hole Cutter.

receive the high speed steel cutter, as shown on the drawing. The cutter is guided and accurately centered by the 1 in. fit on the end, which fits in the 1 in. holes which have previously been drilled in the sheet. The bevel on the end of the fit assists it in entering the hole readily.

MOUNTING DRIVING WHEEL TIRES.

The device shown in Figs. 8 and 9 is convenient for handling driving wheel tires when mounting them on the wheel centers.

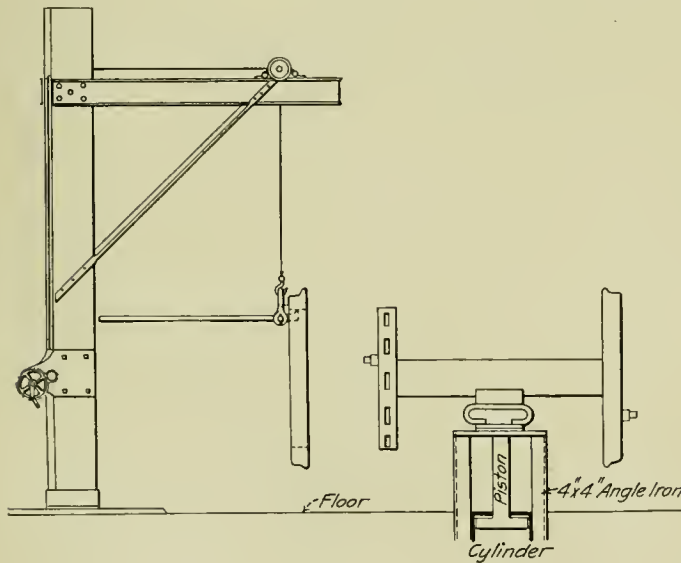

Fig. 8—Apparatus Used for Mounting Driving Wheel Tires

No chains are required, the tire being hung on the suspension point of the bar. In its normal position it holds the tire a little lower than the wheel center and the tire may, of course, be swung

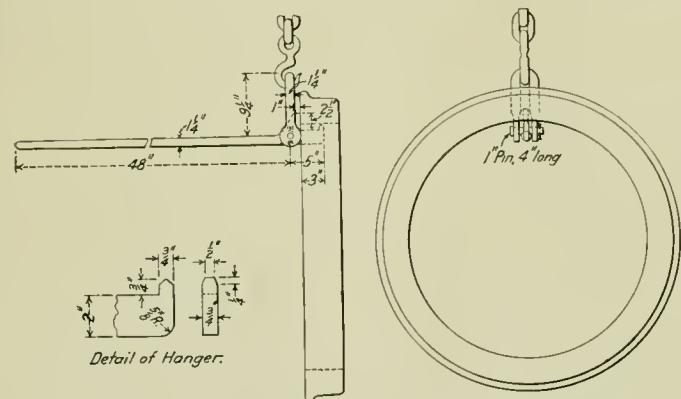

Fig. 9—Details of Hanger Used for Mounting Driving Wheel Tires.

away from the wheel center while it is being heated. In applying the heated tire to the center it can be adjusted to the proper height by bearing down on the end of the long bar. The details of the device are clearly shown in Fig. 9.

DRILLING TELL-TALE HOLES.

A simple and effective jig for drilling tell-tale holes in staybolts is shown in Fig. 10. It not only insures the hole being central, but saves many times its cost in broken drills, where the ends of the staybolts are not sheared square or have more or less irregular ends. The jig was designed by W. F. Black, the ap-

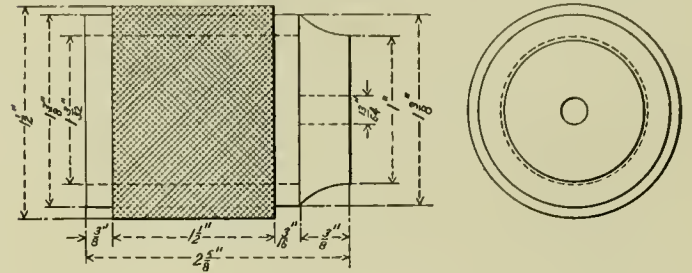

Fig. 10—Jig for Drilling Tell-Tale Holes in Staybolts.

prentice shop instructor, and has eliminated all troubles due to the tell-tale holes being drilled off center. It is made of case hardened machine steel and slips over the end of the bolt, the $\frac{13}{64}$ in. hole being used to guide the drill. This jig is made in several different sizes to suit the different diameters of staybolts.

PROTRACTOR FOR LOCATING ECCENTRIC KEYWAYS.

The protractor for locating eccentric keyways, which is shown in Fig. 11, is made of machine steel. The semi-circles which are cut on it represent the different sizes of axles that are used. The radial lines are cut one degree apart, as shown. In using the

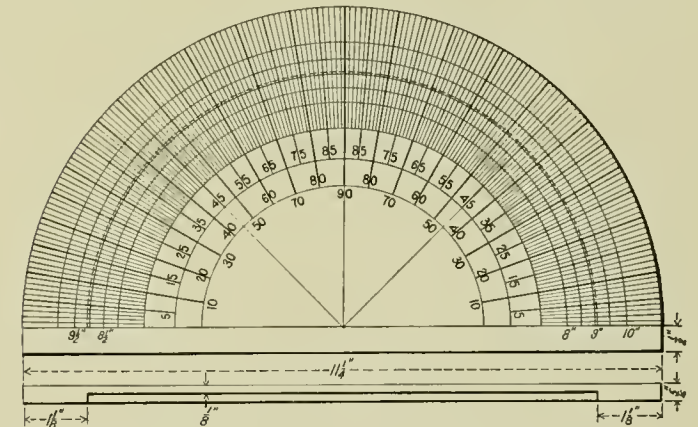

Fig. 11—Protractor for Locating Eccentric Keyways.

protractor lines are layed out on the axle corresponding with the centers of the crank pins. The dividers are then set to the required number of degrees and the center of the eccentric is laid off. Later a box square is used to strike the center line of the keyway. The weight of the protractor is reduced by cutting out the metal on the back, as shown.

LARGEST FERRYBOAT.—The Southern Pacific is building at its Oakland shipyards the largest ferryboat in the world, to be run across the Carquinez Straits between Port Costa and Benicia, Cal. The new boat will be known as the Contra Costa, and will be 433 ft. 4 in. long, by 116 ft. wide, with a tonnage of 3,800 tons. The Southern Pacific already has in service at this strait what is called the largest car ferry in the world, the Solano, built in 1879. The new vessel is only a little larger than the Solano, which carries 48 cars, of the length prevailing in 1879.

DESIGN OF FORMERS FOR HYDRAULIC PRESS

Outline of Methods Employed in Connection with the 800-Ton Press Described in the April Issue of the American Engineer.

BY LEWIS D. FREEMAN.

The problem of designing formers for a large hydraulic press is so extensive that only the general principles can be given here, together with a few illustrations of the different kinds of formers used to obtain certain results. To begin with the designer must have a thorough knowledge of the action of the press and the forces exerted; he should study each particular press and tabulate all the necessary information before proceeding with the design of the formers. In the present case the formers will be designed for the flanging press described in the April issue of the *American Engineer*, page 201. This press has the following capacities:

| | Capacity. | Stroke. |
|------------------------|--------------|-----------------|
| Top plunger | 250 tons | 36 in. downward |
| Vise plunger | 200 tons | 36 in. upward |
| Main platen | 800 tons | 48 in. upward |
| Jack plungers (4)..... | 50 tons each | 24 in. upward |

Strength of Formers.—Formers are usually made of cast iron and sometimes steel plates are used to reinforce the surfaces that are subjected to the most wear. The ultimate strength of good cast iron is about 20,000 lbs. per sq. in., and a factor of safety of at least 10 should be allowed in all parts of formers subjected to tension and shearing stresses, thus providing a safe working stress of 2,000 lbs. per sq. in. The working stress in parts subjected to compression only may be as high as 10,000 lbs. per sq. in. The strength of the formers depends on the maximum pressure that can be applied by the press and not on the pressure necessary to press the shape in the formers, as the whole power of the press is always exerted on the formers regardless of the pressure required to form any particular shape.

Styles of Formers.—There are two general styles of formers used on the standard hydraulic presses; those that are composed of two parts, called the male and female, and those that have three parts made up of a male, female and clamping parts. The former style is desirable where the parts to be pressed are simple and have no large flat surfaces or deep flanges to be kept free from wrinkles. Good judgment must be used by the designer in selecting the style of former best suited to the shape under consideration.

Allowance for Shrinkage.—It must be remembered when designing formers that the sheets to be pressed are hot and the shapes must be made larger than called for on the finished drawing to allow for the contraction when the plates cool after pressing. The coefficient of this shrinkage has been found to be 0.0078; that is, any plate that is heated to a flanging heat will expand in all directions 0.0078 times the original size. To simplify the calculations the given or finished dimensions must be multiplied by 1.0078, which is the equivalent of multiplying the given dimension by 0.0078 and adding the result to the dimension itself.

Weight of Formers.—While there is such a thing as making the formers too heavy, no effort should be made to cut down the weight to such an extent that the fiber stress will run above the figures given. It would be poor economy to cut a few hundred pounds off the weight of a large former only to have it fail on the first trial, resulting in a loss many times the amount saved, as well as the inconvenience caused by holding up the work.

Careless Handling.—Many well designed formers have been broken or damaged by not having the sheets hot enough, and if sheets are not placed on the formers while they are at a bright red heat they should be returned to the furnace and another heat taken. Flanging the sheets when cold causes them to crack and show other defects, and should be avoided.

Designing Formers.—No fixed or set rules can be laid down for the design of all formers, as the conditions vary with each particular case under consideration, and depends on the shape of the work to be pressed, and the size and capacity of the press. A uniform section should be laid out for each particular press, and if it proves satisfactory, after a fair trial, it should always be used on that press wherever possible, thus saving a large amount of work when designing new formers. The formers should be made of as nearly uniform thickness as possible to reduce the shrinkage strains in the castings. The proper application of the principles involved can best be illustrated by some examples of modern practice.

Standard Sections.—It has been found by experiment that the sections shown in Fig. 1 are suitable for use on a press where the maximum pressure exerted is 800 tons. The first section is suitable for sheets up to $\frac{3}{8}$ in. thick; the second section is

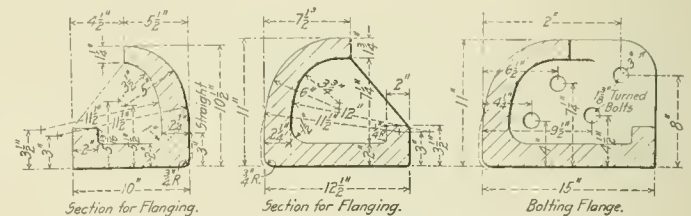

Fig. 1—Sections of Formers Suitable for 800-Ton Press.

suitable for sheets up to $\frac{7}{8}$ in. thick, and for heavier sheets a still heavier section should be developed. Where it is necessary to cut the female former at several places, the operation is greatly simplified by using a standard bolting section, as shown in Fig. 1. All corners should be rounded and liberal fillets allowed; also ribs should be placed where they are needed to further strengthen the different parts of the formers.

Ash Pan Wheel Pocket Formers.—It is often desired to press the ash pan wheel cover for the locomotive ash pan. Such a cover is shown in Fig. 2, and it will be seen that a three piece former must be used to insure smooth and flat flanges. The style of former is shown in Fig. 3. The press operator must manipu-

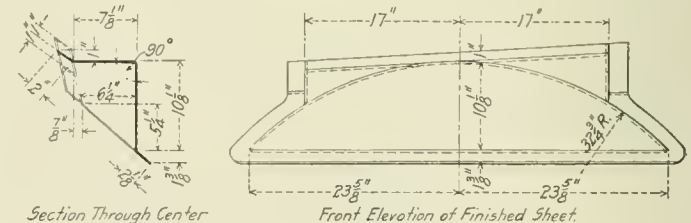

Fig. 2—Locomotive Ash Pan Wheel Cover.

late the press in such a manner as to allow the sheet to draw through between the female and clamping former, while the male former is forced through by the vise plunger on the press. It is impractical to attempt to finish such formers on a machine and the patterns must fit together to insure the formers being true when cast. The casting is usually done in dry sand which is rather slow. Some expert molders are now making such formers in green sand with good results. The pattern shop work may be greatly simplified by making the male former first and covering its working surfaces with old leather belting, which

In locomotive building plants it is customary to make many formers in sections so that liners may be applied to make different

the true circular form and the sheets pressed on such formers are usually found to give trouble after they have been placed in service. In railway shops it is more desirable to bolt up a set of formers for a particular class of locomotive, and as they will be used as long as the locomotives are in service it will pay to leave them bolted up ready for use on short notice. It will be an advantage to make use of the same patterns for making different sizes of formers where this can be done by adding extra finish to the smaller size patterns. Several different sizes can also be made by machining down old formers. In this way the work in the drawing office may be greatly reduced and formers of the same general design may be indicated on one drawing by making a table containing the various dimensions. To insure a careful fit of the heads in the boiler the former should be laid out as follows: Determine the correct diameter of the inside of the boiler at the flue sheet, and multiply this dimension by 1.0078, which will give the diameter of the flue sheet; now take 1/16 in. from the diameter to allow the head to be 3/16 in. smaller in circumference than the inside of the boiler; the result will give the diameter of the female former and it will be found that the flue sheet will be a neat fit in the boiler. To find the diameter of the male die subtract twice the thickness of the metal to be pressed plus 1/16 in. from the female former for clearance between the sheet and the former at all points. This will govern the exact outside size of the flue sheet.

Offset Firebox Sheets.—Another example of locomotive formers is shown in Fig. 5; this style of former is necessary to turn a 6 in. flange up all around the sheet. Lugs are cast on the clamping former in order to locate the sheet so that the proper amount of material may be left below the bend; after this operation the female former is brought into action, turning up the flange around the sheet. Until a short time ago the practice was to have the female former follow the contour of the sheet so that the flange would be turned up all around at the same time. With the advent of the offset sheet, however, it was found that when using this method the surplus metal was forced to the bend near the middle, with the result that the sheet was doubled over on itself and sometimes tore out the corner when the large amount of metal refused to pass through the formers at this

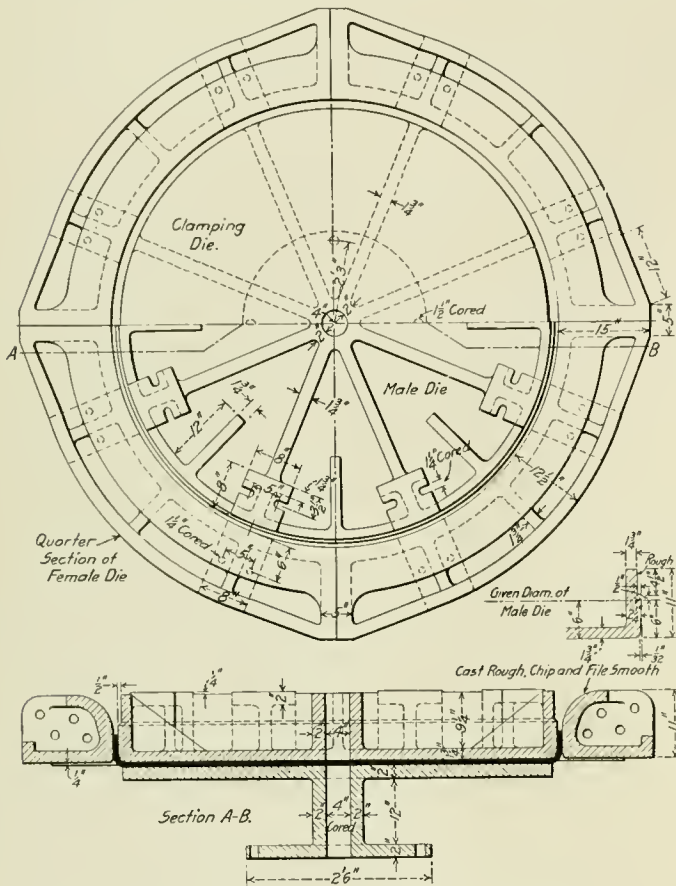

Fig. 4—Formers for Pressing Boiler Tube Sheets.

sizes, as the one size may never be used again. However, when liners are placed in circular formers they are distorted from

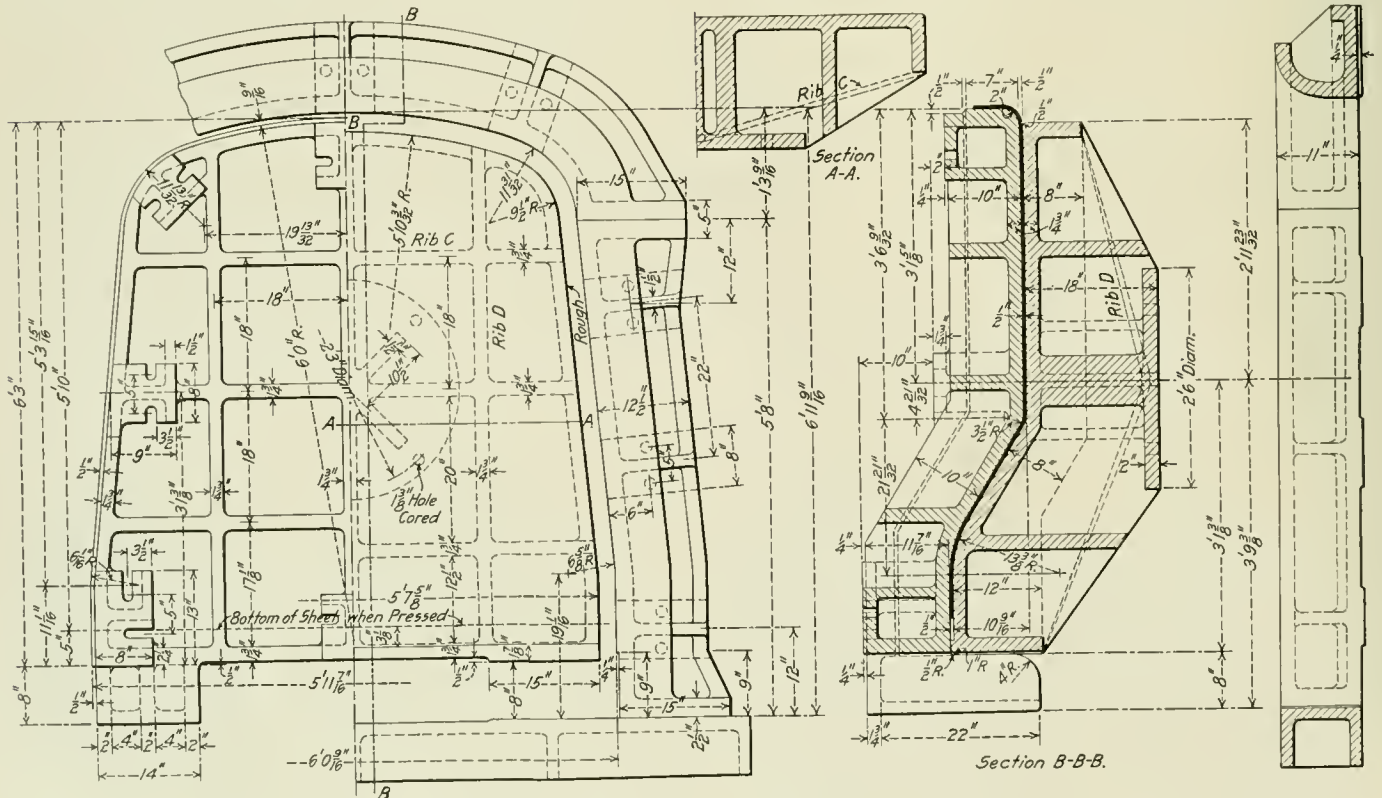

Fig. 5—Formers for Flanging and Forming Offset Firebox Sheets.

point. To overcome this difficulty the writer developed the straight line female former shown in Fig. 5, which will turn up the flange on the lowest part of the sheet first and allow the surplus metal to turn up along the ogee and escape at the highest point of the sheet which is pressed last, leaving a smooth and perfect flange. Guides are provided to hold the clamping former and the male former together when pressing the offset in the

kept on hand so that various combinations will be available. In all cases before sending the formers to the shops for use the blue prints should be marked with the proper length and style of supports to suit the strokes of the press under consideration. This matter should not be left for the shops to do, as it will delay the work.

Formers for Steel Cars.—An example of a steel car former

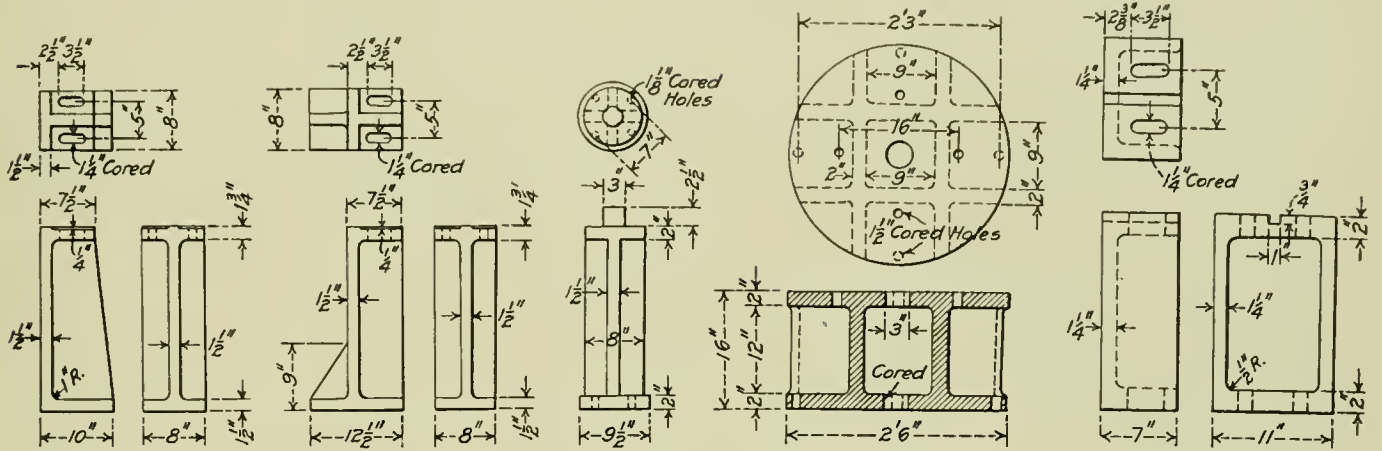

Fig. 6—Five Different Types of Supports for Formers.

sheet before flanging, as well as to form a guide for the female former and take the reaction against the crosstie in the back of the former when pressing the sheet.

Former Supports.—The designer must be well acquainted with the manner in which the formers must be supported to properly

used on this large press is shown in Fig. 7. It is intended to make two different lengths of side stakes for bracing the sides of steel hopper cars with high sides. This is a two piece former which is entirely suitable for such work. For making the longer stake a block is applied to the lower former, as indicated in the

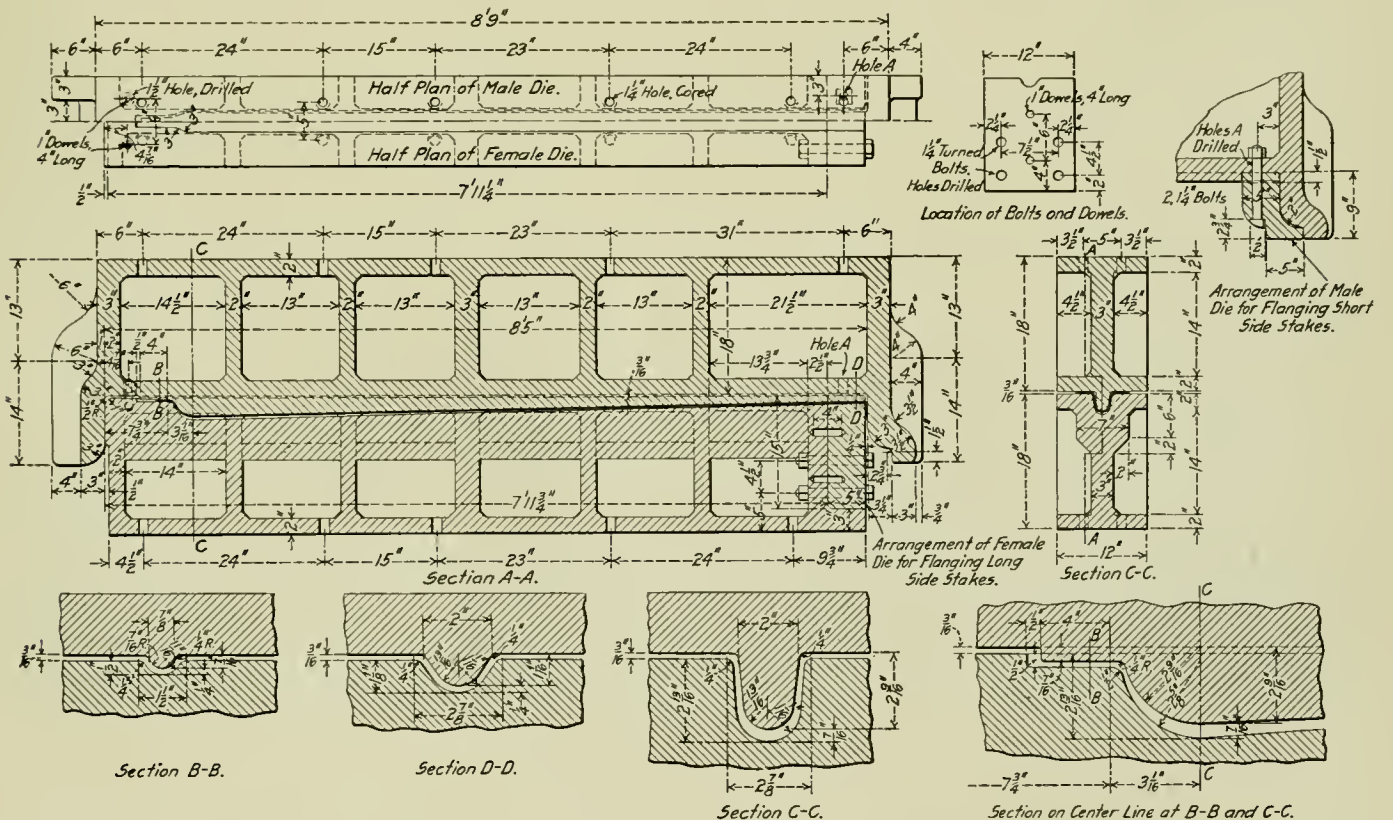

Fig. 7—Formers for Side Stakes of a Steel Hopper Car.

take the strains of flanging the sheets. A set of standard supports, such as shown in Fig. 6 should be made in various lengths. The first one will be found to be very economical, as the pads for the supports on the formers may be made to suit the standard supports. A sufficient number of these supports should be

drawing, and to make the shorter stake it is removed and another block is applied to the top former. In this way the shorter stake may be made on the same general former used for the longer one. Dowels are located on the lower former, so that the sheets may be centered quickly and not lose too much of

their heat. Great care must be exercised to provide the proper clearance in such places as at section C-C Fig. 6, so that the sheets may have sufficient clearance. The strongest kind of formers could be broken if this was not done, as the tongue on the former acts as the wedge, which with a load of 800 tons on the formers would certainly break something. Such formers when used on a large press should be set up in pairs so as to make two parts at one operation of the press, saving 50 per cent. of the power required to do the work separately.

Steel Freight Car Doors.—A three part former for pressing steel freight car doors is shown in Fig. 8. The operation of this former is the same as other three part formers already described. The lugs cast on to center the sheet are so arranged that both right and left hand doors may be made on the same former by

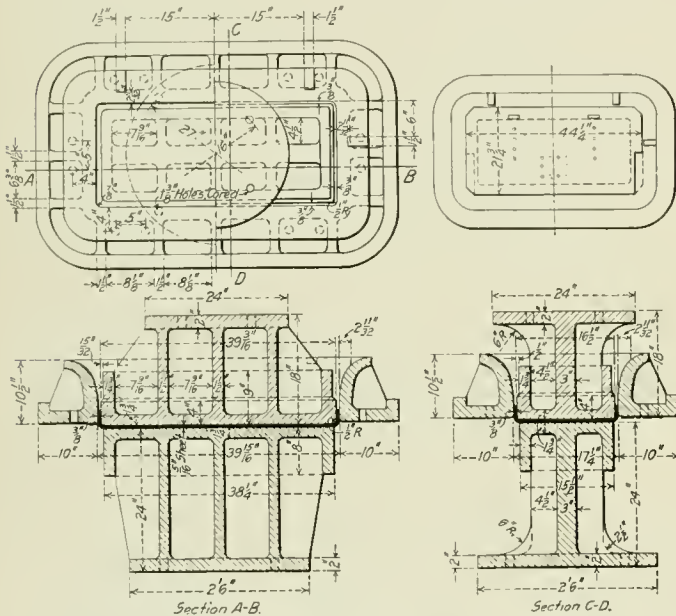

Fig. 8—Formers for Pressing Steel Doors.

reversing the blank sheet before pressing. In such simple work it is advisable to cut all holes and slots with a template while the plate is flat, as the work can be done much quicker than after the parts are pressed.

The Size of Stock Required.—The size of the blank stock required to form a certain piece should be estimated very closely by developing the sheet to some convenient scale and checking such development, so that the amount of material ordered may be kept down as low as possible. There is very little stretch in pressing sheets which are more than 1/8 in. thick, and no allowance should therefore be made for stretch. The formers should be so designed that the sheets will not be stretched and their thickness reduced. Very thin sheets have been known to stretch as much as 20 per cent., and the blank sheets could be made that much smaller, so as to finish to the required size. This cannot be done with thick sheets, and it is in no way desirable, as the strength of the parts are likewise reduced when the thickness of the metal is reduced.

RAILWAY STOCKHOLDERS.—The *New York Journal of Commerce* annual canvass of the number of stockholders of the principal large corporations in the United States this year covers 234 railway and industrial corporations, of which 91 are railways, with a capitalization of \$5,431,852,174. The number of stockholders of the railways is 389,571, the average holdings being 139 1/2 shares. This is an increase over 1910 of 29,275 in the total number of railway stockholders, which is approximately 8 per cent. The increase in railway capital is \$97,654,274, or roughly about 2 per cent.

PREVENTION OF ACCIDENTS

In a paper read before the Pittsburgh Foundrymen's Association, April 1, by W. H. Cameron, manager of the casualty department of the American Steel Foundries, Chicago, it was stated that from 30,000 to 35,000 wage earners in the United States die every year from accidents, and that in addition to these fatalities 2,000,000 men are seriously injured. To protect the employees from claims presented because of these accidents, \$22,000,000 is spent every year in liability insurance premiums. It has been estimated that not more than 25 per cent. of these premiums reach the sufferers from accidents. Up to seventeen months ago the American Steel Foundries followed the usual custom of protecting itself by carrying accident liability insurance; as it became apparent that the company could control to some extent, at least, the frequency of accidents among its employees, it was decided to conduct an effective safety campaign and that the company should carry its own liability insurance.

At first it was left to the master mechanic at each plant to supervise and recommend the making and installing of safeguards, but as these men were extremely busy and were so accustomed to existing conditions, it did not prove to be entirely satisfactory. Later three men were selected from three different departments of the plant and this committee made four whole day inspections each month. The men selected were not only old employees, but were familiar with all parts of the plant and were known to be conscientious and not afraid to report what they saw. They were paid their full wages while engaged in making the inspection and \$5 extra for each monthly report.

During the first month about 1,000 suggestions were received. These were submitted to the three foremen in charge of the departments from which the men were selected, and they acted as a jury in approving or disapproving them. The foremen inspected all of the conditions reported and very few of the suggestions were rejected. The report was then referred to the plant managers and after being passed on by them, the higher officers, feeling that the recommendations had been fully considered from the three different standpoints, accepted them. After a considerable number of safety appliances had been installed it was determined to appoint safety inspectors to devote all of their time and efforts to safety work. They report on everything from loose bricks in the building to slippery floors and stairways. Reports of serious accidents and their causes are discussed at the meetings of the foremen and the heads of the departments, and are treated as seriously as any regular work. The results of the safety committee's investigations are kept in the central office of the company, and this office keeps in constant touch with the safety inspectors. A safety inspector in a plant employing from 500 to 600 workmen will have ample time to investigate accidents as well as to visit injured workmen and to demonstrate to them that the company has an interest in their welfare and speedy recovery.

Cleanliness in and about the shops and yards cannot be too strongly urged, as it is an important factor in causing the men to be more cleanly about their work and in preventing accidents due to untidy conditions. Windows should be kept clean and the walls should be whitewashed regularly; unsuitable clothing should not be worn by men performing hazardous work. It is believed that the money expended for the protection of workmen will be amply returned in the form of better organization and will cause an actual saving in the accident expense accounts.

DRIVING WHEEL SPEEDS.—The Baldwin Locomotive Works has published the following as a simple method of figuring driving wheel speeds. To obtain revolutions per mile divide 1680 by the diameter of the driving wheel in feet. To obtain revolutions per minute multiply the speed in miles per hour by 28 and divide the product by the diameter of the driver in feet.

LARGEST NON-ARTICULATED LOCOMOTIVE

A Maximum Theoretical Tractive Effort of 71,500 lbs. Obtained With One Group of Drivers and Two Simple Cylinders Makes the New 2-10-2 Type on the Burlington of Particular Interest.

Five pairs of driving wheels have been considered as the largest practical number to be included in one group with a rigid frame, and when there is an average weight of over 60,000 lbs. for each pair, and cylinders are applied of such a size as to bring the factor of adhesion down to 4.22, it would seem as if the limit was practically reached for the non-articulated locomotive. Five engines fulfilling these conditions have recently been delivered to the Chicago, Burlington & Quincy by the Baldwin Locomotive Works. They are fitted with single leading and trailing trucks

Northern, there have been none built during the past 5 years, and the previous locomotives of this type were over 90,000 lbs. lighter than the present Burlington engines. Furthermore in the previous designs the trailer truck was applied more for its assistance in curving than to carry weight, and full advantage of the wheel arrangement could hardly be considered to have been taken, as is so completely done in the present case.

There is shown in the accompanying table two locomotives of the lighter 2-6-6-2 type and several of the latest examples of

| Road | C. B. & Q. | C. B. & Q. | N. Y. C. | Eric. | G. N. | C. & O. |
|---|------------|--------------|---------------|---------|---------|---------|
| Type | 2-10-2 | 2-6-6-2 | 2-6-6-2 | 2-8-2 | 2-8-2 | 2-8-2 |
| Total weight, lbs. | 378,700 | 361,650 | 354,000 | 320,600 | 287,000 | 315,000 |
| Weight on drivers, lbs. | 301,800 | 304,500 | 301,500 | 237,150 | 220,000 | 243,000 |
| Percentage on drivers | 79.7 | 84 | 85.2 | 74 | 76.5 | 77.1 |
| Average weight per driving axle, lbs. | 60,300 | 50,750 | 50,250 | 59,288 | 55,000 | 60,750 |
| Tractive effort, lbs. | 71,500 | 70,500 | 67,500 | 57,460 | 57,460 | 60,800 |
| Maximum I. H. P.* | 2,750 | 2,900 | 2,475 | 2,330 | 2,330 | 2,500 |
| Heating surface, total, sq. ft. | 5,161 | 5,090‡ | 4,393 | 4,155 | 4,720 | 4,051 |
| Superheater surface, sq. ft. | 970 | 464 | 966.3 | 843 | 871 | 845 |
| Equivalent heating surface, sq. ft. | 6,616 | 5,786 | 5,842.5 | 5,419.5 | 6,026.5 | 5,318.7 |
| Evaporation per sq. ft. of evaporating heating surface, lbs.‡ | 11.2 | 12 | 11.85 | 11.75 | 10.4 | 12.95 |
| Cylinders, diameter and stroke, in. | 30 x 32 | 23 & 35 x 32 | 21½ & 34 x 32 | 28 x 32 | 28 x 32 | 29 x 28 |
| Diameter of drivers, in. | 60 | 64 | 57 | 63 | 63 | 56 |

* Taken at 700 ft. per minute piston speed, tractive effort assumed to be .62 of the maximum.

† Steam consumption assumed to be 21 lbs. water per horsepower hour.

‡ Includes the feed water heater.

which together carry 76,900 lbs., making the total weight of the locomotive 378,700 lbs., of which nearly 80 per cent. is on drivers.

These locomotives were ordered after considerable experience with articulated locomotives of the 2-6-6-2 type* of practically the same power, as well as with Mikado and consolidation locomotives ranking with the largest of their type. It thus appears that for this service a simple locomotive of the non-articulated type fitted with a high degree superheater was considered prefer-

able to the articulated compound designs already in use on that road. These include engines fitted with superheaters, reheaters and feed water heaters, as well as an earlier design, which includes none of these appliances. Although the 2-10-2 type is not new, there being 160 in use on the Santa Fe and at least one on the Pittsburgh, Shawmut &

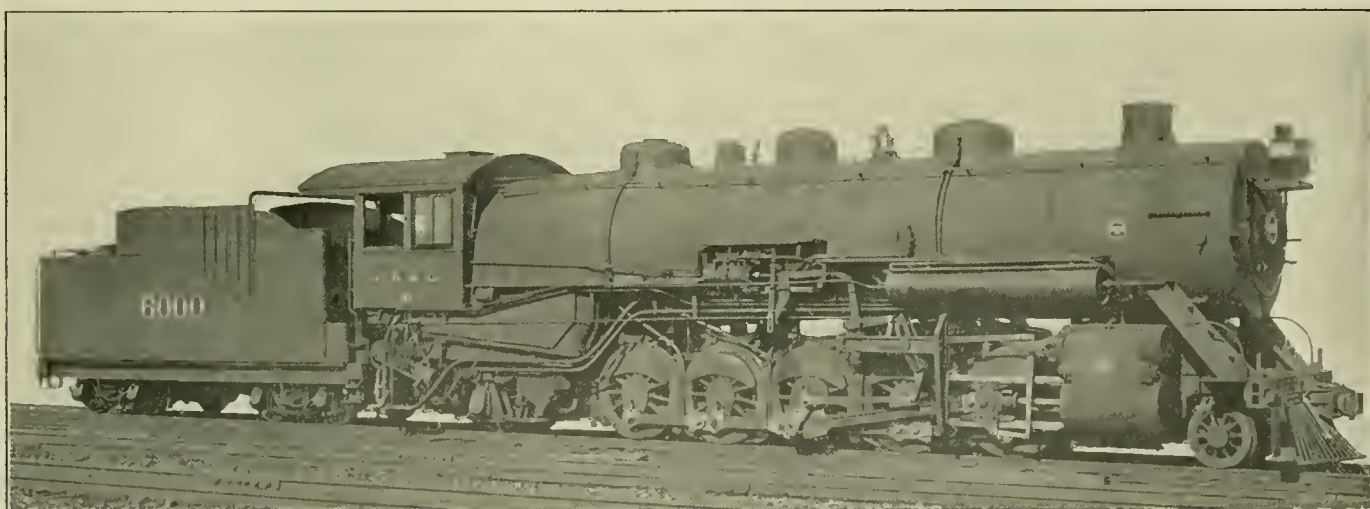

Most Powerful Non-Articulated Locomotive; Chicago, Burlington & Quincy.

able to the articulated compound designs already in use on that road. These include engines fitted with superheaters, reheaters and feed water heaters, as well as an earlier design, which includes none of these appliances.

Although the 2-10-2 type is not new, there being 160 in use on the Santa Fe and at least one on the Pittsburgh, Shawmut &

largest weight per driving axle now in service in this country. Figuring arbitrarily that the maximum indicated horsepower will be delivered with a piston speed of 700 ft. per minute, which in the case of the locomotives shown in the table varies from 22¼ miles per hour for the 57 in. driver to 25 miles per hour for the 64 in. wheel. It will be seen that the new Burlington engine is slightly less than the Mallet on the same road, but that it ex-

*See *American Engineer and Railroad Journal*, May, 1910, page 171.

Stoker.—This stoker is of the underfeed type employing screw conveyors of a constantly decreasing diameter toward the front end of the firebox, which are set in troughs just below the level of the grates. Above the conveyors in each trough are a series of inclined plates, adjustable for height and inclination. The clearance between the conveyor and the bottom of the trough can also be adjusted to secure the most satisfactory results. The conveyors are operated by a transverse worm shaft under the cab deck which is rotated by two small steam engines secured on the outside of the frames. There are four troughs and conveyors set 28 in. apart, and between them are the grate

is built in the combustion chamber and is extended up to a point 38 in. below the crown sheet. The inside of this wall is 16½ in. back of the tube sheet.

Because of the arrangement of the stoker it was not possible to use the usual plate support at the back end of the firebox and two vertical expansion links are employed. These are located 56 in. apart transversely, placing them outside of the frames, and the cast steel deck plate is extended out and fitted with heavy ribs to form a suitable support. At the top the links are pinned to a large casting fitting under the mud ring and on the back head of the boiler. At the front the mud ring

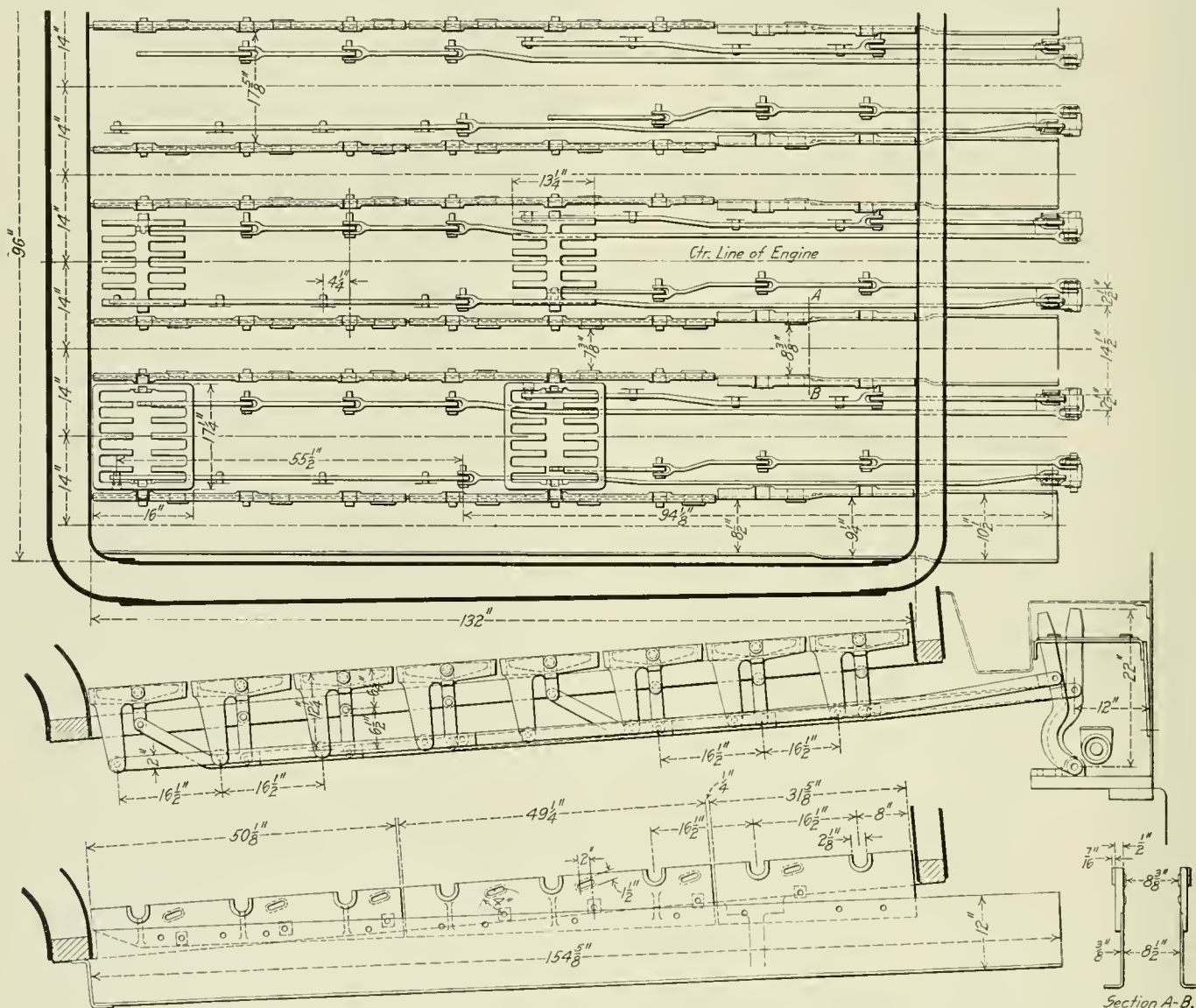

Grates and Operating Gear on the Burlington 2-10-2 Type Locomotives.

bars which are shown in detail in one of the illustrations. Each of the three sections of the grate are arranged to shake in two groups, and each grate bar is set in a rectangular frame which can be tilted through a wide angle for dumping the fire. Below each of the three sections of the grate is an independent ash pan having two hoppers. All of these hoppers are of the self-clearing type and are fitted with cast iron swinging doors.

A coal crusher driven by a 6 in. x 6 in. steam engine is located on the tender and delivers coal to a belt conveyor which transfers it to a transverse trough from which it is discharged into the longitudinal feed troughs. A Ryan-Johnson coal pusher is fitted in the coal space of the tender.

There is no arch in the firebox, but a brick wall 9 in. thick

is supported on the usual sliding shoes and from this point to the cylinder there are four plate supports.

Cylinders.—Cast iron cylinders, each including half the saddle in the customary manner, have been employed. Since the superheater has two separate headers, an equalizer pipe connecting the steam passages in the cylinders has been provided. The cylinder barrel walls are made unusually thick—2 in. because of their large diameter. Cast steel piston heads of the dished type fitted with cast iron bearing rings 6 in. in width, except at the bottom where they are widened to 8 in., are used. The 15 in. piston valves are of the double ported design similar to those employed by the same builders on the Nashville, Chattanooga

See American Engineer, March, 1912, page 141.

& St. Louis Pacific type locomotives. Circulating or drifting valves of the Sheedy type are provided and relief valves are tapped into the live steam passages. The guides for the valve stem crosshead are cast in one piece with the back steam-chest head. A Ragonet power reverse gear is employed.

Frames.—The frames are steel castings 6 in. wide with separate rear sections 4½ in. wide. Included in the castings at the proper points are thin webs for suitably attaching the frame braces. By this method the frame itself is not weakened by the numerous transverse bolt holes, and at the same time the braces have a better bearing and are more securely fastened. The construction and arrangement at the front pedestal and around the cylinders is particularly interesting. Separate front rails at the top and bottom are employed, but the bottom rail of

castings. At the top the rail is carried back well over the pedestal. This is one of the strongest and stiffest arrangements where separate double front rails are employed that has ever been illustrated in these columns.

Transverse frame braces are liberally employed and include a horizontal steel casting just back of the cylinders, which is bolted to the cylinder castings as well as the frames. Between the first and second pair of driving wheels the guide yoke acts as a frame brace and the valve gear bearer answers this purpose between the second and third pair. Just at the rear of the second pedestal is also a heavy cast steel ribbed brace in a vertical position secured to the 1½ in. webs forming part of the main frame castings. A similar brace is found in front of the fifth pedestal. Between the third and fourth and the fourth and

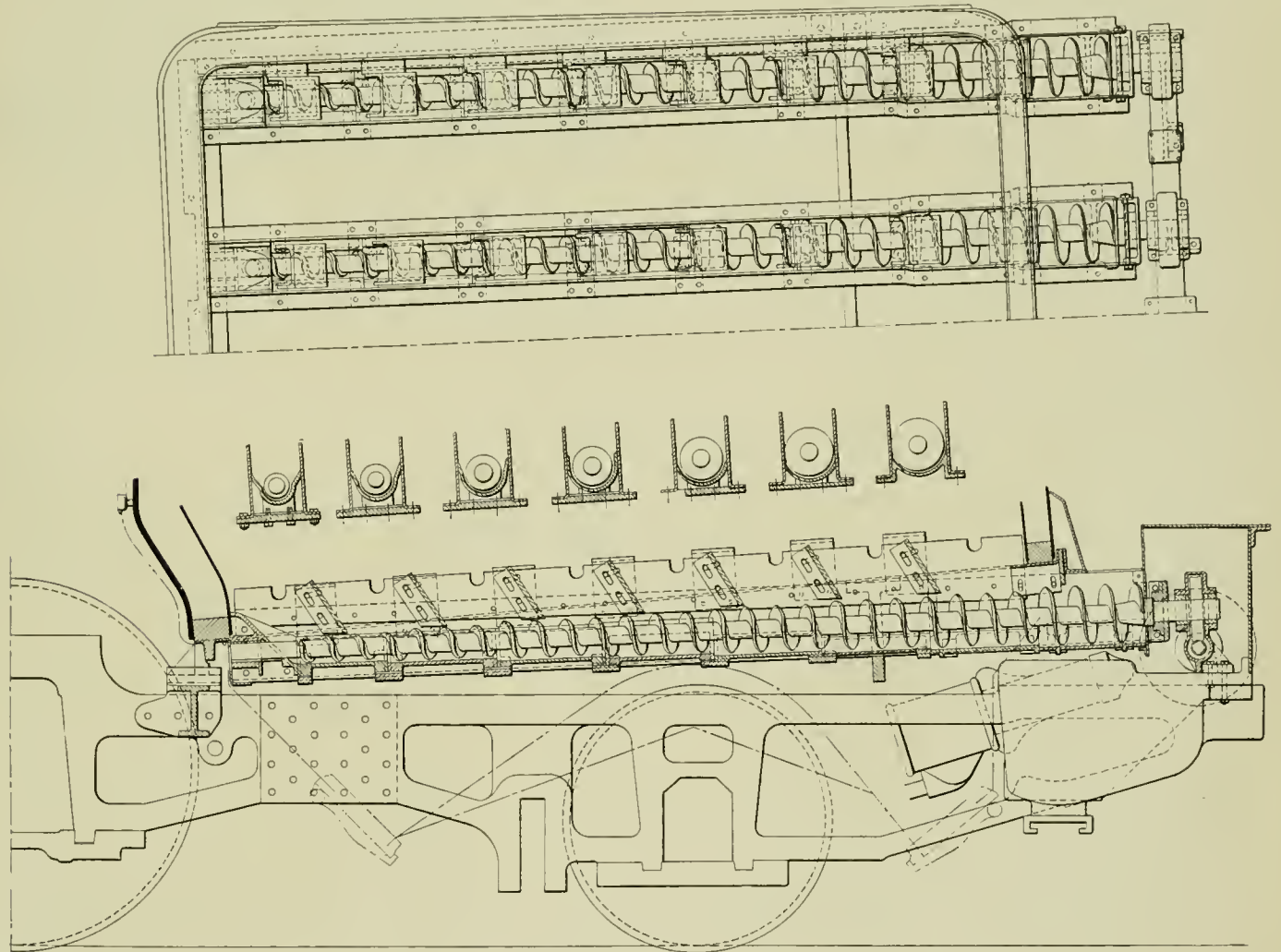

Barnum Underfeed Stoker Applied to Burlington 2-10-2 Type Locomotive.

the main frame is also carried forward underneath the cylinders for a distance of about 39 in. This extends below the lower front rail, which is of cast steel and arranged to accurately fit into the main frame back as far as the pedestal leg. The front rail includes a lip 2¼ in. thick extending down on the inside of the main frame for its full length, and also up the inside of the front pedestal leg nearly to the top. This inner lip has a stiffening web in the corner and also extends downward on the inside below the main frame, ending in a jaw which carries the bearing for the main brake shaft. Both of the front rails end just in front of the cylinders where they are bolted and keyed to a cast steel deck plate. There are 9 horizontal and 9 vertical bolts, as well as a large key securing the lower front rail and the main frame. Part of these bolts also connect to the cylinder

fifth drivers are heavy horizontal frame braces which also act as supports for the boiler braces. Shoes and wedges are of bronze and the pedestal binders are of cast steel lugged and bolted to the frames in the usual manner. Castle nuts are employed on these bolts.

Rods and Driving Wheels.—The main rods are of I section, but the side rods are rectangular in section. They offer no particular features of interest except the side rod stub ends at the second and fourth drivers. A detail of the construction at this point is shown in one of the illustrations, and it will be seen that the knuckle pins on the stub ends are surrounded by spherical bushings of case hardened steel, fitting in braces having a wedge adjustment. This arrangement was employed since the locomotives are designed to traverse 21 deg. curves and

| | |
|--|--------------------------------|
| <i>Ratios.</i> | |
| Weight on drivers ÷ tractive effort..... | 4.22 |
| Total weight ÷ tractive effort..... | 5.30 |
| Tractive effort × diam. drivers ÷ equivalent heating surface*..... | 647.00 |
| Tractive effort ÷ diam. drivers ÷ total heating surface..... | 830.00 |
| Total heating surface* ÷ grate area..... | 58.70 |
| Firebox heating surface ÷ equiv. heating surface*, per cent..... | 6.22 |
| Weight on drivers ÷ equiv. heating surface*..... | 58.60 |
| Total weight ÷ equiv. heating surface*..... | 73.40 |
| Volume both cylinders, cu. ft..... | 26.18 |
| Equivalent heating surface ÷ vol. cylinders..... | 253.00 |
| Grate area ÷ vol. cylinders..... | 3.36 |
| <i>Cylinders.</i> | |
| Kind..... | Simple |
| Diameter and stroke..... | 30 × 32 in. |
| <i>Valves.</i> | |
| Kind..... | Piston |
| Diameter..... | 15 in. |
| Lead..... | ¼ in. |
| <i>Wheels.</i> | |
| Driving, diameter over tires..... | 60 in. |
| Driving, thickness of tires..... | 4 in. |
| Driving journals, main, diameter and length..... | 12 × 12 in. |
| Driving journals, others, diameter and length..... | 11 × 12 in. |
| Engine truck wheels, diameter..... | 33 in. |
| Engine truck, journals..... | 6 × 10 in. |
| Trailing truck wheels, diameter..... | 42½ in. |
| Trailing truck, journals..... | 8 × 14 in. |
| <i>Boiler.</i> | |
| Style..... | Straight |
| Working pressure..... | 175 lbs. |
| Outside diameter of first ring..... | 88½ in. |
| Firebox, length and width..... | 132 × 96 in. |
| Firebox plates, thickness..... | ¾ & 5⁄8 in. |
| Firebox, water space..... | F—6 in.; S—4 to 6 in.; W—4 in. |
| Tubes, number and outside diameter..... | 285, 2¼ in. |
| Tubes, thickness..... | No. 11 B. W. G. |
| Flues, number and outside diameter..... | 30, 6 in. |
| Flues, thickness..... | No. 8 B. W. G. |
| Tubes, length..... | 22 ft. 7½ in. |
| Heating surface, tubes and flues..... | 4,841 sq. ft. |
| Heating surface, firebox..... | 320 sq. ft. |
| Heating surface, total..... | 5,161 sq. ft. |
| Superheater heating surface (steam side)..... | 970 sq. ft. |
| Heating surface, equivalent..... | 6,616 sq. ft. |
| Grate area..... | .88 sq. ft. |
| <i>Tender.</i> | |
| Tank..... | Water bottom |
| Frame..... | Steel |
| Wheels, diameter..... | 33 in. |
| Journals, diameter and length..... | 6 × 11 in. |
| Water capacity..... | 10,000 gals. |
| Coal capacity..... | 15 tons |

* Total heating surface plus 1.5 times the superheating surface.

RECLAIMING LOST EFFICIENCY

BY H. M. FITZ.

The question is asked daily: "Why does it cost more today for labor to produce a certain commodity than it did a year or two ago? At that time we could show a gain, now we show a loss." Have not the wages of many been increased on account of demands, without any regard for efficiency or reference to standards? Why not increase wages according to efficiency and standards, thereby decreasing the cost? There would be a mutual benefit to employees and employer; efficient production ceases when the employee loses confidence in the employer. To reclaim lost efficiency is different from anything else; we find it necessary first to regain the confidence of the employee.

Many of us wonder why so many premium, bonus or piece work systems fail. The real wonder is that more do not fail. Many well-founded projects—thoroughly studied plans or systems of merit—have suffered relapse, have sometimes been discontinued and thought to be a losing proposition on account of misapplication or lack of attention, especially to details. Man, himself, must have a little system of his own personal needs; the better his health, the greater his capacity should be for doing things.

I have in mind a large railway, employing thousands of men, which at one time maintained a betterment department for the express purpose of making and maintaining standards, effecting economies, supervising all efficiency work and helping, aiding and assisting in prescribing the best methods of procedure in the mechanical department; at the end of each year it showed a substantial financial saving which was effected through the efforts of the betterment organization. Its system was to the

company what a man's health is to himself: when your organization is tampered with, used for mere experimental purposes, or a little authority is unjustly exercised, or there is a lack of attention, it is bound to suffer the penalty of these faults, the same as a man does when his health is neglected.

In this particular instance, after standards were formulated and were being maintained in certain departments, and the efficiency had increased from 15 to 120 per cent. over that formerly attained, there arose all sorts of criticisms, complaints and fault-finding by other departments, who lived in constant fear of having their hair trimmed, and of being shown how to economize and to work more efficiently to earn their already high salaries. Little things of a detrimental nature were allowed to creep in, and these eventually had their effect.

There were criticisms from the store department that the mechanical department would no longer accept material that did not fill the requirements, with an added expense to make new and supposedly standard material serviceable. Substitution was its long suit. The store department received credit for carrying a small stock and few sizes. Presumably it was a very efficient department; 10 in. bolts were furnished where 5 in. ones were wanted; it was easy to cut them off and rethread them. A thousand and one similar cases had to be discontinued in order to reduce repair costs.

The transportation department complained that engines were not receiving proper care at terminals, which caused leaky flues or insufficient steam while on the road. This was attributed to the economical handling of these engines. On investigation it was found in nine out of ten cases that the engine was hauling far in excess of its tonnage, and that the crew was straining every joint to get it over the division, or the engine was mistreated by the crew by leaving the fire door open, or injecting too much cold water into the boiler at one time, or by the fireman not working in harmony with the engineer. The engineers' union decided to buck it, and started to complain about the repairs on the locomotives they ran, not from an economical standpoint, but from their own selfish point of view. Records are the silent witnesses, and show that more and better repair work was done under the betterment system than formerly.

The accounting department also came in, not being satisfied with what really and truly belonged to it, and became a destructive critic. Not even knowing the first principles of efficiency it undertook to dictate and did inject foreign and injurious rules, made rank decisions, and issued the most impractical instructions possible. These, and many more instances caused employees to lose faith in the company's intentions—not in the principles of efficiency, but in the way that true benefits were from time to time suppressed.

None of these departments gained anything, but have sustained a loss of thousands of dollars, as did also the company. We are asked, "Why not reclaim lost efficiency?" Part of it can be reclaimed, and the part that cannot, is wasted time. That is lost and no one feels it more keenly than those connected with the efficiency work. I share the belief of the winner of first prize on the subject "Reclaiming Scrap" in the March *American Engineer*, that with the proper supervision, serviceable material should never reach the scrap pile. Neither is there any excuse for a good efficiency system to reach the reclaiming stage.

REMARKABLE STEAM TURBINE.—A steam turbine that will carry a maximum load of 35,000 h. p. has recently been installed for the Brooklyn Rapid Transit Company.

WIRELESS TELEGRAPHY.—The Marconi Wireless Telegraphy Company, of England, has made a contract with British post office department for the construction of wireless stations at London, Alden, Bangalore, Pretoria and Singapore, which will be part of the system the British government contemplates extending around the world.

ALL-STEEL ELECTRIC SUBURBAN CARS

Used in Multiple Unit Service and Employing Pressed Shapes to a Greater Extent Than Has Ever Before Been Attempted in Passenger Equipment.

The New York, Westchester & Boston will soon put into operation its four track line running through the borough of the Bronx, New York City and Westchester county. This road has been built on a private right of way of the heaviest character of construction, is without grade crossings, and will be devoted almost exclusively to high speed heavy suburban traffic. The trains will all be of the multiple unit type and the cars are provided with full vestibuled platforms and diaphragms, and are arranged to give the same comfort, capacity and safety as the latest type of steel cars for steam operation. The construction of the car, however, is specially suited for multiple unit service and would not fulfill the requirements of ordinary steam operated trains.

tion these cars are of the type in which the side frame is designed to carry the whole load. Light center sills are included for directly transmitting the pulling and buffing shocks only, and even the weight of these is carried by the side framing.

Pressed steel shapes are liberally used throughout the car, and in the side framing particularly, full advantage has been taken of this form of construction to give the maximum strength with a minimum weight. The entire side framing of the car, from the side sill to the plate, forms the load-carrying girder. This is built up of 12 pressed steel units, each of which includes the facing of the main posts, diagonal braces on each side of the bottom and one-half of a Gothic arch on each side at the

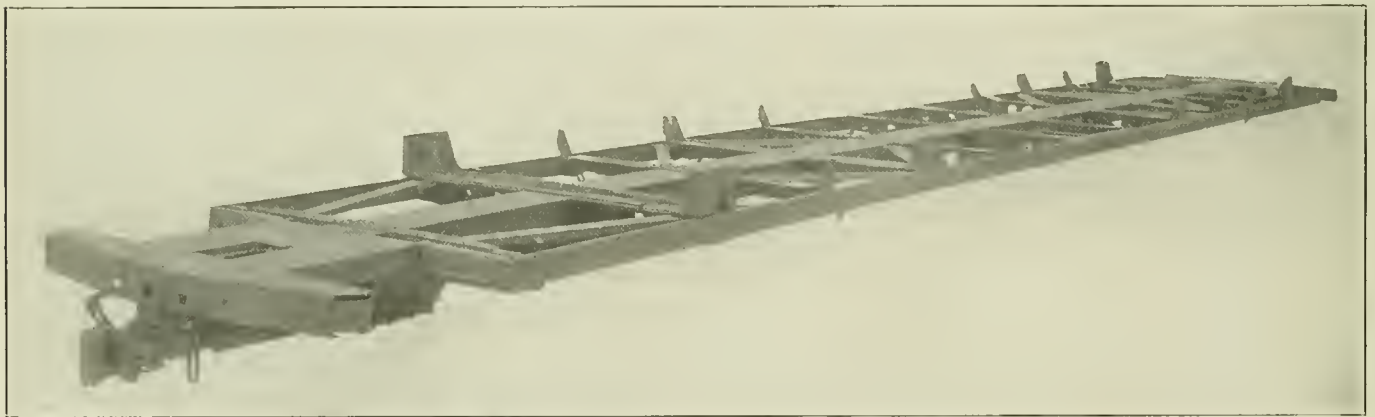

General View of Underframe of Steel Suburban Car; New York, Westchester & Boston.

Center side doors have been included since practically all of the station platforms are at the car floor level and all doors in the car are to be operated by a guard on the platform in a manner similar to that used in subway service.

There were 28 passenger cars and 2 combination coach and baggage cars in the initial order. They are 70 ft. long over the vestibule end sills and 9 ft. 7 $\frac{3}{4}$ in. wide over the main posts.

top of the post. These units are pressed and flanged in one piece from $\frac{1}{4}$ in. steel plate and are secured at the bottom to a 7 in., 12 $\frac{1}{4}$ lb. channel forming the side sill and the tension member of the side girder. At the top the units form a butt joint, reinforced at the back by a plate and welded on the face. These pressed units are reinforced by the main posts, which consist of a pair of pressed steel shapes of channel section and



All-Steel Suburban Electric Car in Which Pressed Steel Shapes are Liberally Used.

The height from the rail to the top of the roof is about 13 ft. 3 $\frac{1}{2}$ in. The passenger cars have a seating capacity of 78, while the combination car seats 54 passengers and include a baggage compartment 16 ft. 5 in. long. They were designed in the office of L. B. Stillwell, consulting electrical engineer of the road, and were built by the Pressed Steel Car Company.

As is generally believed to be advisable for multiple unit opera-

tion include the lower deck carlines. The posts are riveted to the facing throughout their length and are secured to the underframe by gussets connecting them to the cross bearers. The construction and arrangement at this point is clearly shown in one of the photographs. The joint between the pressed steel units at the top is stiffened and reinforced by intermediate lower deck carlines of pressed steel. It is readily apparent that a

structure of this type is exceptionally stiff and strong with a moderate weight.

At the center door the diagonal braces at the bottom are of course omitted and here there is an extra reinforcement on the inside of the side sill. At the point of connection with the bolsters it will be seen that the structure is somewhat heavier than at other points, although the members there are of the same general form. The lower deck plate is also of pressed steel suitably shaped for the best connection with the pressed steel carlines. It is continuous for the full length of the car.

The center sill in the underframe is formed of a pair of 8 in., 16 $\frac{1}{4}$ lb. channels, set 14 in. apart with flanges projecting outward, continuous for the full length of the car and have a cover

tween the center sill channels are also largely cut away in the web for lightness and to permit the passage of air, as will be explained later. The bolsters are of similar construction, but somewhat deeper and include a casting between the center sills instead of the pressed steel stiffeners used in other cases. The arrangement of the pressed steel knee, stiffening the connection to the side framing at the bolster, is clearly shown in the illustration.

The outside of the car below the windows is sheathed with $\frac{1}{16}$ in. American ingot iron plate secured and stiffened by a pressed steel belt rail and other pressed steel members arranged as shown in the illustrations. Above the window sills the steel framing forms the sheathing as well. The roof is also formed



Showing the Extent to Which Pressed Steel Shapes are Used in the Framing of the All-Steel Suburban Cars.

plate for the full length on the top only. The cross bearers are of $\frac{3}{16}$ in. pressed steel in the form of dished sections fitting between the longitudinal sills and one is placed at each of the posts, or there are eight between the bolsters. Tie plates pass above and below the center sill and for about two-thirds of the distance to the side sills on either side, to which the flanges of the dished section are riveted. The second cross bearer inside the bolsters is double and from its connection to the side sill there are pressed steel braces extending diagonally on both sides to the connection of the adjacent cross bearers with the center sill, where they are secured by gusset plates in the corners. The webs of all the cross bearers are largely cut away to permit the passage of conduits and piping. The sections be-

of $\frac{1}{16}$ in. ingot iron sheets about 2 ft. 8 in. wide and continuous from one side of the car to the other. They are lapped over the carlines and riveted and the joint is then welded by the oxy-acetylene process. Fixed deck sash and exhaust ventilators are provided. The floor is $\frac{1}{4}$ in. monolith laid on keystone corrugated sheets. On the under side, the floor is faced with $\frac{1}{4}$ in. Agasote heat insulation, and is covered with No. 24 galvanized sheet steel. On the inside, the roof and space below the windows between the side posts is lined with a $\frac{3}{4}$ in. layer of special insulating material made by Samuel Cabot, Inc., Boston, Mass. This is covered with fire proof burlap and the entire interior of the car is finished with a facing of Agasote. White enamel paint giving a maximum reflection of light is used on

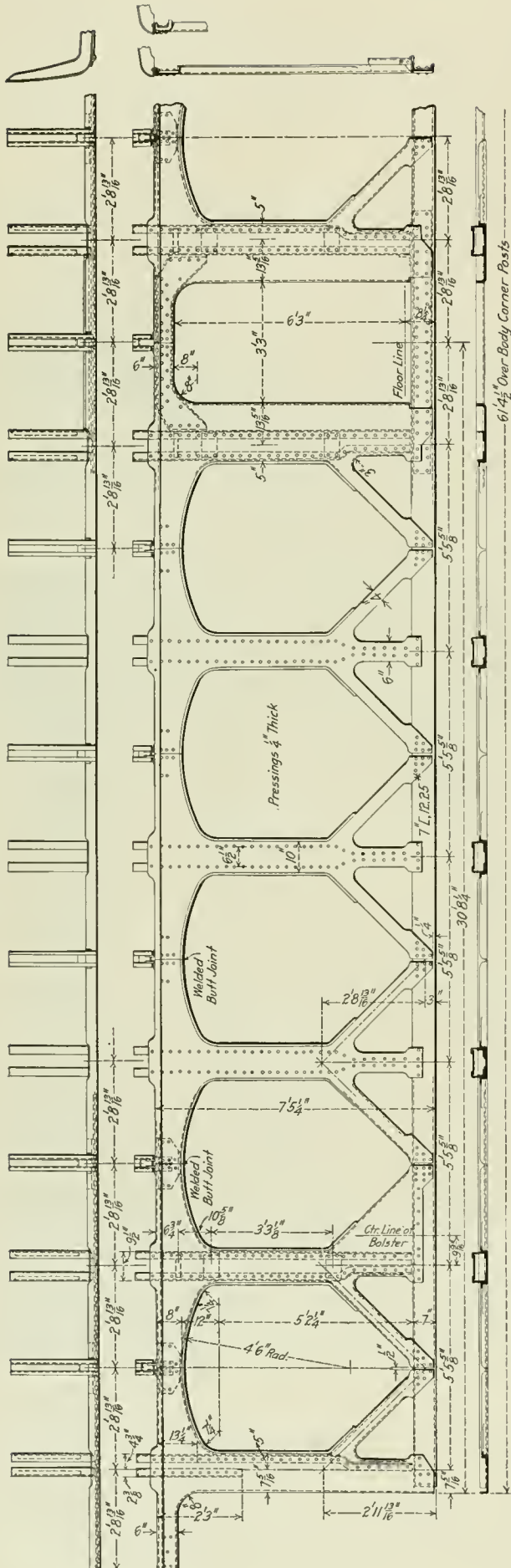

Elevation of Side Frame Showing Form of Pressed Steel Units.

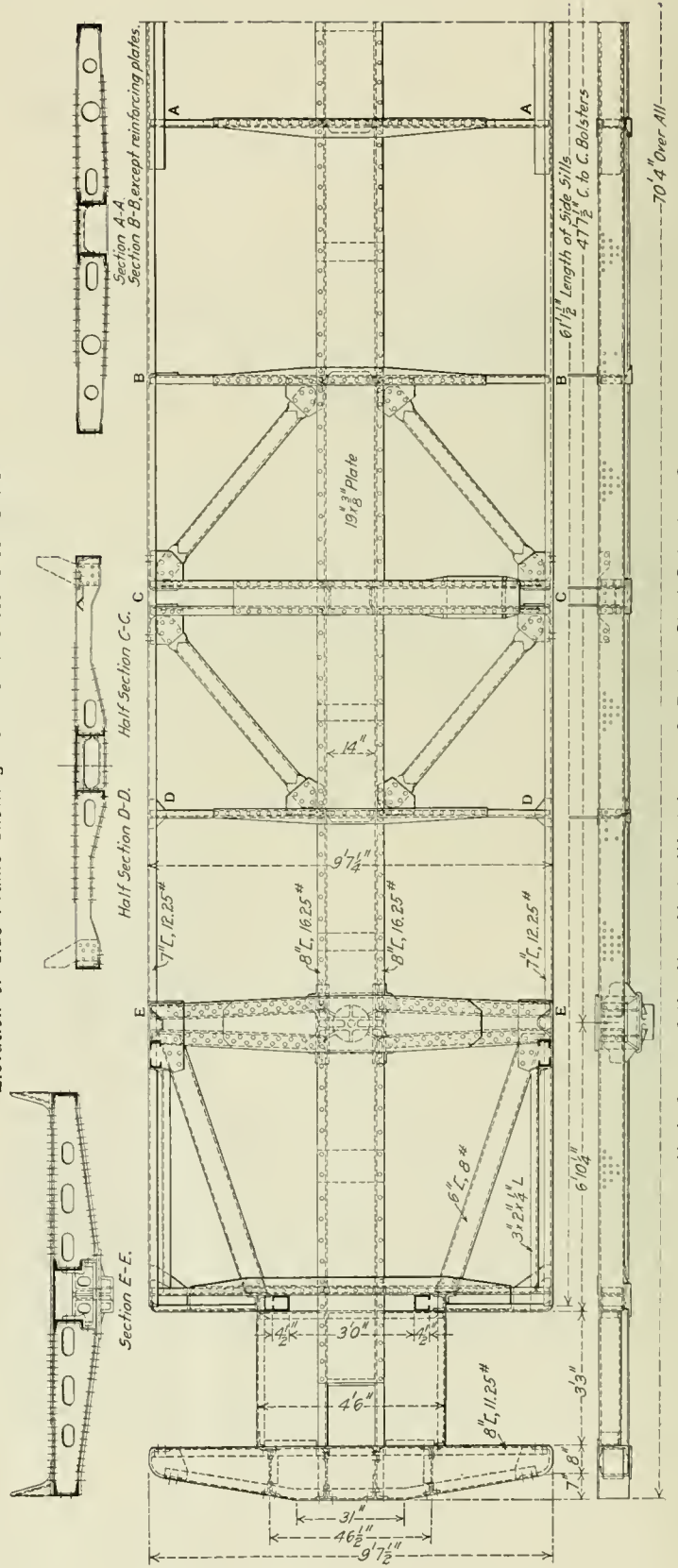

Underframe of the New York, Westchester & Boston Steel Suburban Car.

the head lining and dark green on the sides. On the exterior the cars are painted the standard New York, New Haven & Hartford coach color.

On account of the probability of occasionally operating these cars over sections of the New Haven which are not provided with elevated platforms, steps have been provided. They are covered with Edwards trap doors. The side and end doors are of the sliding type operated electro-pneumatically, the control being by means of switches in the vestibules. The door operating mechanism was furnished by the Consolidated Car Heating Company, who also provided the electric heaters mounted under the seats. The end framing of the car body and of the



Vestibule of All-Steel Suburban Car.

vestibule is of pressed steel members, and is faced with steel plates. In the end of the vestibule are two fixed circular windows 20 in. in diameter, and below the window on the right hand side in each vestibule are mounted the master controller and the engineer's brake valve, these being inclosed by a folding cab door when not in use. On the other side is an H. R. ratchet brake handle.

In the coupler and draft equipment these cars conform to the standard arrangement of the heavy steam railway passenger cars. The coupler of the Buhoup three-stem type, has the M. C. B. standard contour with 10 in. knuckle. It is attached through a pivot pin to a Forsyth friction draft gear consisting of 28 plates and having a capacity of 175,000 lbs. This is carried in a steel housing secured to the center sills just back of the body end sill. The buffer plate is backed up by a Forsyth buffing device consisting of two large helical springs and friction leaf springs with a capacity of 250,000 lbs., giving a total buffing capacity of 425,000 lbs. to the car.

Fifteen of the cars are equipped with nine Garland ventilators mounted on the sloping sides of the upper deck between the stationary deck windows. The remainder each have twelve ventilators furnished by the Gold Car Heating Company. Globe ventilators are used for the saloons in all cars.

Artificial lighting is furnished by forty-five 40-watt tungsten

lamps mounted on the lower deck and distributed so that a lamp is directly above each seat. These lamps are wired in multiple on a 110-volt circuit fed from a tap on the main transformer. There are also ten 10-watt tungsten lamps on a separate circuit connected to a 32-volt storage battery.

All of the present order of cars are equipped as motor cars and the weight complete is estimated at 120,000 lbs. A car of similar design equipped as a trailer and without center doors, but seating 88 passengers, would weigh approximately 80,000 lbs. Only one of the trucks is used for traction, and it carries two Westinghouse six-pole, single phase motors operated under forced draft ventilation and having an hourly rating of 175 h. p. These motors are sufficiently powerful to develop an acceleration of one mile per hour per second on a straight and level track. The other truck is very similar in design to the motor truck, but has smaller wheels and a different arrangement of brake rigging. The truck side frames in both cases are of the arch bar type with cast steel pedestals enclosing triple coil springs over the journal boxes. A heavy Z-bar is used for the top arch bar, while the inverted arch bar is a heavy angle securely riveted on the back of the top flange of the Z-bar over the journal boxes. The transoms are pressed steel channels and are attached to the side frames by large cast steel corner brackets. The bolster is of the pressed steel box type, 14 in. in width, and rests on quadruple elliptic springs, which in turn are carried by saddles suspended by swinging links hang-



Interior of All-Steel Suburban Car.

ing from pins in the cast steel corner brace between the transom and the side frame. The spring seats on each side are connected by the spring plank.

Each motor truck is fitted with eight brake shoes, two to each wheel. The purpose of this is to reduce the pressure per unit of shoe area and minimize the heating effect, as the regular schedule in which these cars will be used involve frequent station stops from high speeds. The brake rigging on the motor truck comprises a radius bar at the inner end of the truck frame to the center of which the rod from the cylinder is connected. From each end of this radius bar a rod extends toward the transom and is attached to the center of a short horizontal

floating lever located above the side frame. The inner end of this lever is fastened to the top of the live brake lever which carries the shoe bearing on the inside of one wheel. Below the shoe is a pair of rods straddling the wheel and connecting to the bottom of a dead lever hung from the truck end frame which carries the other shoe on this wheel. Means are provided for adjusting the length of these bottom connections as these shoes wear. From the outer end of the horizontal floating lever a rod connects to the outer end of a centrally pivoted lever of the same length in the same relative position on the other side of the transom. The inner end of this is fastened to the live brake lever of the other wheel, which in turn is connected to the dead lever in the same manner as before. The arrangement of levers on each side of the truck is the same, the two operating independently except for the single connection through the radius bar. A spring releasing gear is included on either side. The trailer truck brakes are of the inside type with a top beam connecting the two levers. The braking power on these trucks is considerably less than on the motor trucks, and four brake shoes are sufficient. No brake beams are used on either truck.

Present day operation of electric trains as exemplified on the New York, Westchester & Boston has made necessary the development of a brake apparatus of greater power and efficiency than that formerly used in steam or electric service, and

action automatic air brake would have to be supplemented by a number of additional functions, some of which could be supplied only by the addition of electric control to the pneumatic portion of the brake apparatus. Therefore the equipment as applied con-

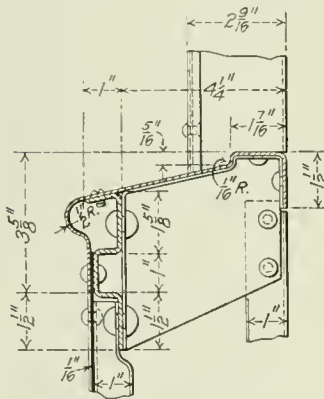

Sash Rest at Intermediate Post.

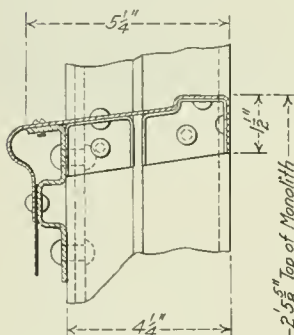

Sash Rest at Main Post.

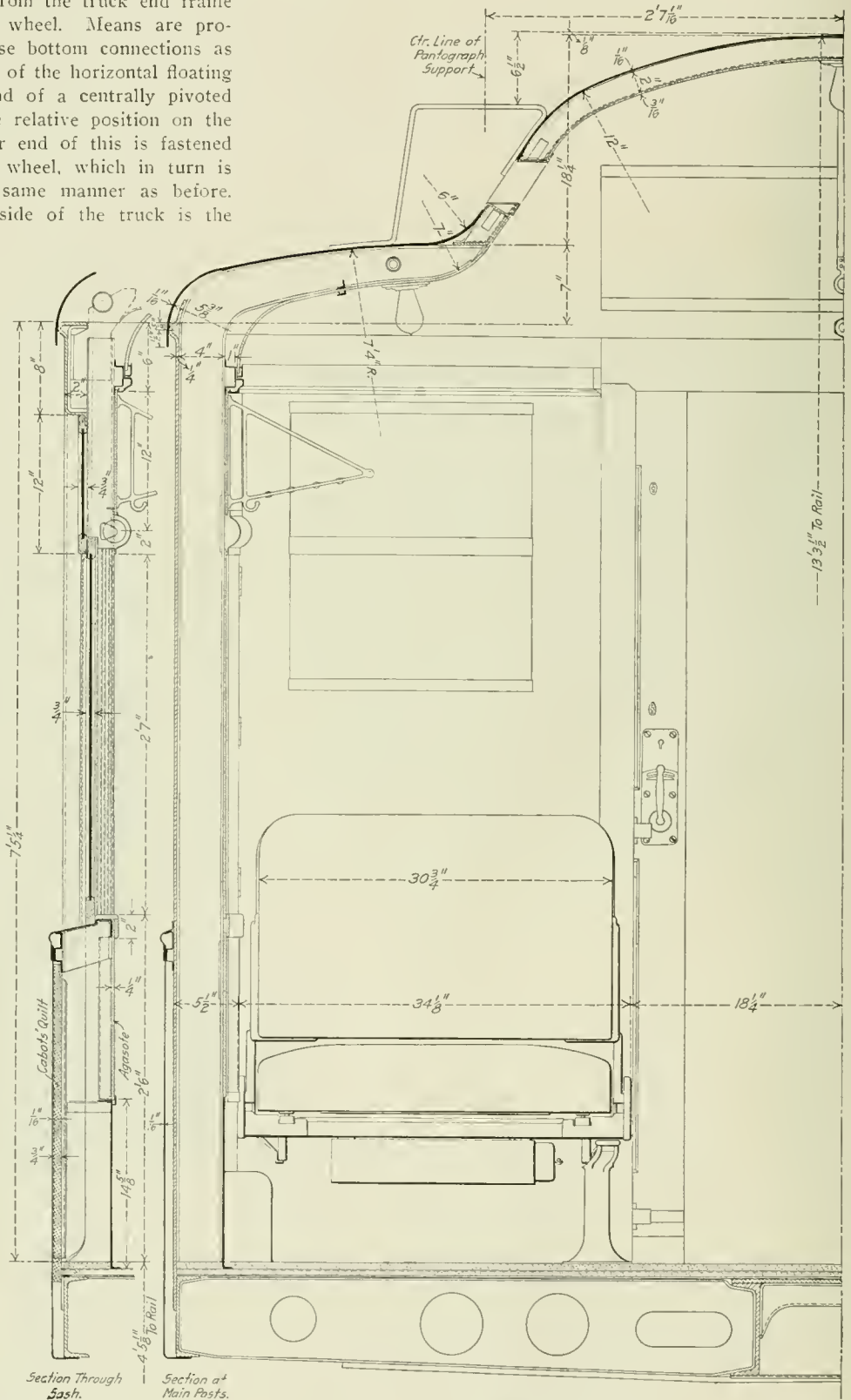

Cross Sections Showing Construction of Exterior and Interior Finish, All-Steel Suburban Car.

the brake equipment on these cars represents a radical departure from the customary practice. After carefully studying the conditions, it was evident to the Westinghouse Air Brake Company that the fundamental functions of the ordinary quick-

sists of a combination of the latest form of pneumatic service and emergency apparatus with electric control for either operation. While the electric control is used normally, the pneumatic is held in reserve without its efficiency being impaired.

Two brake cylinders, a supplementary reservoir, a control valve and the engineers' brake valve, in addition to the usual cut out cocks, complete the brake equipment which is designated as schedule A. M. C. E. One brake cylinder 14 x 12 in. is connected through suitable foundation brake gear to the motor truck, and the other cylinder 12 in. x 12 in. is connected to the trailer truck brakes. The operation of the brakes on the two trucks is entirely independent. With a brake pipe pressure of 70 lbs. the full service application will give a pres-

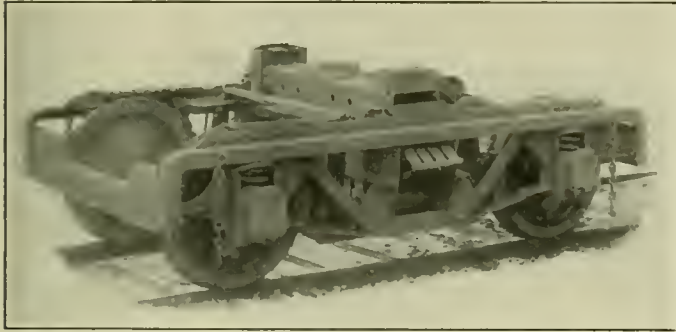

Trailing Truck; New York, Westchester & Boston Suburban Car.

sure of 50 lbs. in the cylinders. The emergency application, however, gives a pressure of from 90 to 100 lbs. in the cylinders, the connection being made directly to the main reservoir. A single control valve performs automatically all the functions of the triple valve, and in addition provides for maintaining the pressure in both brake cylinders constant against leakage. It is arranged to produce full emergency pressure at any time ir-

the armature and around the field coils by which the air cools every part of the motor.

The motors, transformer, pantograph trolleys, blower outfit, switch group and all electric equipment on each car has a total weight of 24,450 lbs. There are three running positions in either direction on the controller and three intermediate positions. At the former the motors are connected without resistance to three different taps on the transformer, making it possible to run the equipment continuously at any one of three speeds. With the intermediate positions, however, resistance is included in the circuit. The acceleration is controlled by an automatic relay and the unit switches will not close for the second or third running positions until the proper reduction in pressure is attained, even though the control handle be thrown immediately to the third position. Master controllers are provided with automatic release or "dead man's handle" for cutting off the current to the motors and automatically applying the brake in case the motorman's hand is removed from the control lever. An over-speed relay is provided to prevent the cars exceeding a speed of 57 miles per hour, which was determined as a suitable maximum speed for the service.

A motor generator set furnishes the current for operating the magnet valves of the switches and also for charging a 32-volt storage battery. In case the power goes off the line this storage battery takes up the work of the motor generator and supplies the current for the control apparatus, for the operation of the brakes, for the valve magnets and for the door operating devices as well as for the ten emergency lamps provided in the car.

Two pantograph trolleys are located on the roof above the center of each truck. These are raised and lowered by means

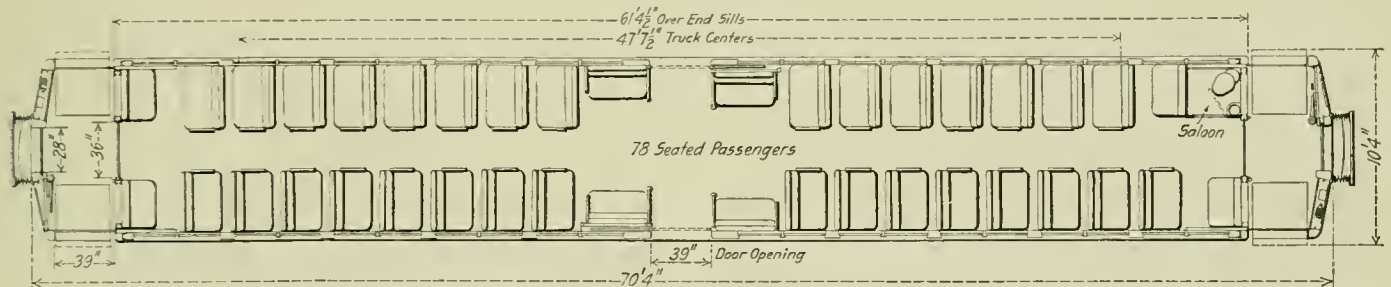

Plan of Center Side Door Steel Passenger Car; New York, Westchester & Boston.

respective of the pressure which may be in the brake cylinders. This control valve operates for either electric or pneumatic applications.

In the brake valve the portion controlling the pneumatic operation of the brakes is supplemented by the connections for the electric control of the system. A distinction between the two methods of application lies in the manner in which the brake pipe reduction is made. In the electric control the brake pipe reduction is made close to the cylinders by the service application magnet valve. In pneumatic operation, however, the brake reduction is made through the brake or engineer's valve only. The handle on this valve occupies the same position for either electric or pneumatic operation at any point, and in case the electric features should be rendered inoperative the pneumatic control will automatically come into use.

Air for forced ventilation of the motors and transformers is supplied by a motor driven blower attached under the car body. This draws its supply from openings in the side of the car to insure its being as free from dust as possible, and discharges into the center sill which for the distance from the blower to the motor truck is covered by a plate on the bottom and utilized as a duct to take the air to the motors. There is a bellows connection of heavy canvas connecting this duct with the opening in the motor casing. Passages are provided in

of air cylinders controlled by automatic valves operated by push buttons at the master controller. Either of the pantographs can be used to supply current to the car, and two are provided so that there will always be a spare trolley connection available.

GOOD ROADS.—The Department of Agriculture calculates that 300,000 miles of road must be improved before the public road system of the country will be of enough consequence to be appreciable. There are now but 190,476 miles of improved roads in this country, or 8.66 per cent. of the total mileage of all public roads, improved the unimproved. The French system of roads, long considered the best in the world, was bonded by Napoleon III for \$6,000,000, and something in the neighborhood of \$612,775,000 has already been spent on that system. In this country probably \$2,000,000,000 will have to be spent before a proper road system is developed. This, however, does not seem so large when it is divided among the states and spread over a period of ten or fifteen years. New York state has bonded itself for \$50,000,000, and \$5,000,000 a year is now being expended by that state. New York heads the list of states which have made progress. Georgia is second, and has built 4,344 miles of road in five years. That state employs 4,500 prisoners on the public roads.

HIGHLY SUPERHEATED STEAM*

BY GILBERT E. RYDER.

From the service results that have been obtained with superheaters on locomotives, it is conservative to place the saving effected in the fuel consumption under average working conditions at 25 per cent. This saving is so large that we are liable to overlook the significance of the fact that it really means an increased hauling capacity of $33\frac{1}{3}$ per cent. For example, assume that we are burning 6,000 lbs. of coal per hour in a saturated steam locomotive, and that this is the limit of the fireman's capacity. Assume also that the economy of the entire locomotive is such as to obtain one horse power hour with each 4 lbs. of coal. Under these conditions 1,500 horse power hours are being developed. Now suppose that the same locomotive is equipped with a superheater which permits the saving of 25 per cent. in fuel; that is, the consumption is 3 lbs. of coal per horse power hour, or 1,500 horse power hours with 4,500 lbs. of coal. But the capacity of the fireman was assumed to be 6,000 lbs. of coal per hour. In firing 6,000 lbs. of coal per hour with the superheater locomotive, 2,000 horse power hours are developed, an increase of 500 horse power hours, or $33\frac{1}{3}$ per cent. This increase of $33\frac{1}{3}$ per cent. in horse power hours means an equivalent increase in hauling capacity, which is the real thing of importance to the railway mechanical and operating departments, inasmuch as it means a decrease in the investment in power and a corresponding decrease in the operating costs to handle the same amount of traffic.

Dry or moderately superheated steam has been frequently tried, but with little economy compared with the remarkable results obtained with a high degree of superheat. The smoke box type is open to serious objection in that it obstructs the front end. Furthermore, in some designs there is a high cost of maintenance due to the corrosion of the pipes and their deterioration occasioned by the abrasive effect of the cinders. These mechanical defects have not been so instrumental in the abandonment of this type of superheater, however, as the small economies obtainable by the low degree of superheat which they produce.

The fire tube superheater, by the use of which the temperature of the steam entering the cylinders is from 600 to 650 deg., or a superheat of from 200 to 250 deg., has been almost universally adopted by railways using superheated steam, because of the largely increased efficiency of the locomotives using such high degrees of superheat. At present there are over 12,000 locomotives in the world equipped with fire tube superheaters furnishing highly superheated steam. Over 2,000 of these are in service in the United States.

The principal advantages secured through the use of highly superheated steam are occasioned by the increased volume of steam delivered per pound of water evaporated and the prevention of cylinder condensation. The economy which results from the use of the superheater is largely due to the reduction of what is known as the "missing quantity" or the difference between the actual steam passing through the engine and that which is shown by the indicator card. This quantity is largely due to the loss by condensation in the passages and in the cylinders.

Saturated steam has the same temperature and pressure as the water from which it is evaporated and with which it is in contact in the locomotive boiler, and for each pressure the steam has a certain constant temperature. At 170 lbs. boiler pressure, for example, the steam will always have a temperature of 375 deg. F. and a volume of 2.47 cu. ft. per pound. If more heat is added to the boiler it is transmitted to the water and is used in evaporating more water, but does not increase the steam temperature as long as the pressure remains the same. If heat is taken away from the saturated steam in doing work or by cooling, as in the steam passages of the cylinders, part of the steam condenses.

The amount of the steam condensed is almost proportional to the heat abstracted and this condensed steam, or water, is inert so far as the capacity for further work is concerned. The greatest loss from condensation occurs in the cylinders, for here the variation in temperature is widest and the large areas offer a favorable condition for the loss of heat or for condensation to take place.

Tests show that in Mallet compound locomotives without superheaters, the condensation in the receiver pipe runs up to over 20 per cent., while in simple saturated engines using a short cut-off it runs up to over 35 per cent. of the weight of steam admitted to the cylinders; that is, for every 100 lbs. of steam delivered to the cylinder only 65 lbs. are available for doing work. This loss, as stated above, can be overcome by the use of highly superheated steam, and means an average reduction of 35 per cent. in the amount of water used and of 25 per cent. in the amount of coal used per ton mile.

Let us now consider the qualities of superheated steam. When steam has left the boiler and passed into the superheater it is no longer in immediate contact with the water from which it was generated. If heat is now added to the steam in its passage through the superheater tubes and moisture is first evaporated and the additional heat is absorbed by the steam, so that on reaching the high pressure steam chest it has a temperature of about 200 deg. F. above that which it had when leaving the dry pipe, meaning that it reached the high pressure steam chest at

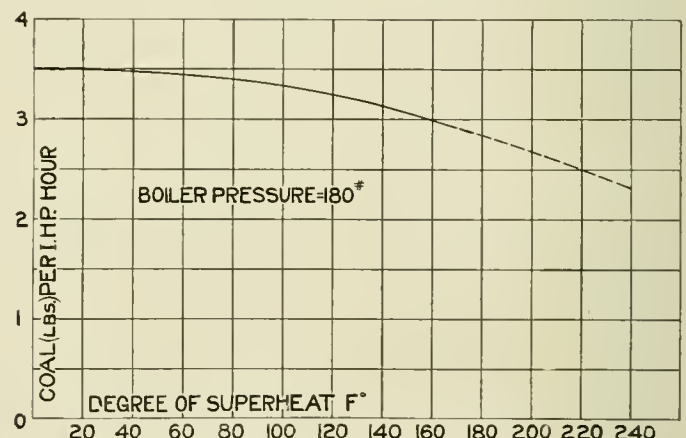

Fig. 1—Coal Used per Indicated Horse Power Hour for Different Degrees of Superheat.

an actual temperature of about 600 deg., instead of 390 and 400 deg., as would be the case with a saturated steam engine. The pressure of the superheated steam, however, is practically the same as in the boiler.

Superheated steam approaches the condition of a perfect gas. It has a larger volume per unit of weight than saturated steam, and like a gas, is a poor conductor of heat, giving up its heat to the cylinder walls and steam pipes less rapidly. Take a case of superheated steam at 170 lbs. pressure with 200 deg. F. superheat. It has a volume of 3.27 cu. ft. per pound, as against 2.47 cu. ft. per pound for saturated steam. Of course, when superheated steam passes from the superheater to the comparatively cold cylinder walls some of its superheat is given up to these walls and the passages traversed in reaching the cylinders, but the condition differs from that of saturated steam in that it does not condense until it has lost all of its superheat.

The curve in Fig. 1 shows the saving which is effected in the pounds of coal per indicated horse power hour for various degrees of superheat. It will be noted that from 0 to 160 deg. of superheat a saving of one-half pound of coal per indicated horse power hour was effected while this same saving was again effected in the next 60 deg. of superheat.

The effect of the superheater on the boiler is to increase its capacity from 25 to 35 per cent. in proportion to the decrease in

*Abstract of a paper presented before the Southern & Southwestern Railway Club, January 18, 1912.

the demands that are made on it. It has been shown that as the demand for power is increased the degree of superheat increases so that the demand on the boiler does not increase in proportion. It is, therefore, economical to force a superheater engine, while it is not economical to force a saturated boiler in the same way, and it is, many times, impossible to do so for any length of time. The fact has been proved that locomotives equipped with superheaters developing high degrees of superheat have at least 25 per cent. greater boiler capacity than the same size of engine without a superheater. As the engine is worked harder, the fire is forced, which means a higher fire box temperature and hotter gases in the superheater. This results in a higher temperature of the steam, and with this higher superheat we begin to get the greater efficiencies which are characteristic of the superheated steam locomotives when they are worked hard.

In engines operating in poor water districts where foamy water and fluctuations in water level would tend to increase the amount of water carried over from the boiler, it may readily be seen that a device which reduces the demand on the boiler, and which will in addition prevent the water from reaching the steam chest and cylinders, will greatly lengthen the life of the valves and pistons, prevent breakage of the cylinder heads from water pressure, and also lengthen the life of the boiler. Another feature which favors the boiler in the use of superheated steam is the comparatively low boiler pressure which may be carried. The size of the cylinders is not limited, as in the saturated steam engines, where the diameter of the cylinders must be limited in order to reduce condensation. Standard recommendations for boiler pressures to be used in connection with superheaters are 180 lbs. for freight engines and 200 lbs. for passenger engines. In bad water districts even lower boiler pressures may be used with correspondingly enlarged cylinders.

The requirements for an efficient and practicable fire tube

superheater may be summed up as follows: An integral header which is out of the way, in no way obstructing the front end or interfering with the maintenance of the boiler tubes, and so

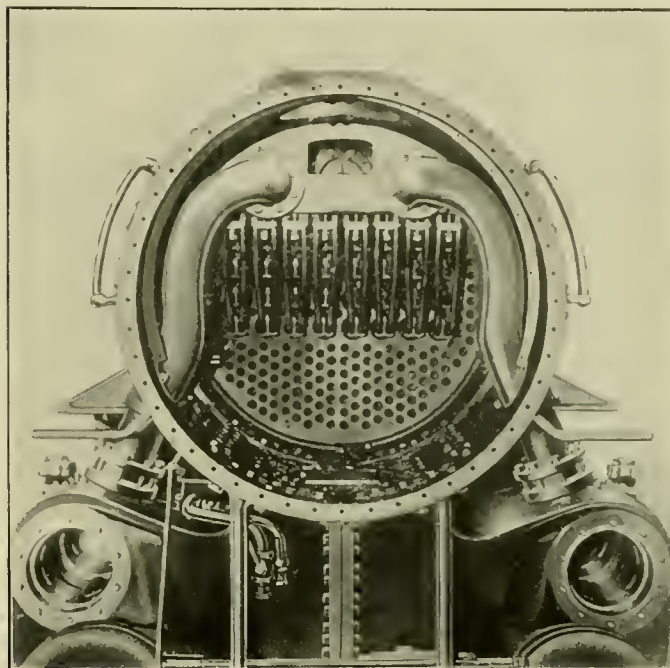

Fig. 3—Front End Arrangement with a Fire Tube Superheater and Outside Steam Pipes.

designed as to cause the least tendency toward wire drawing of the steam; the superheater pipes should be easily accessible and

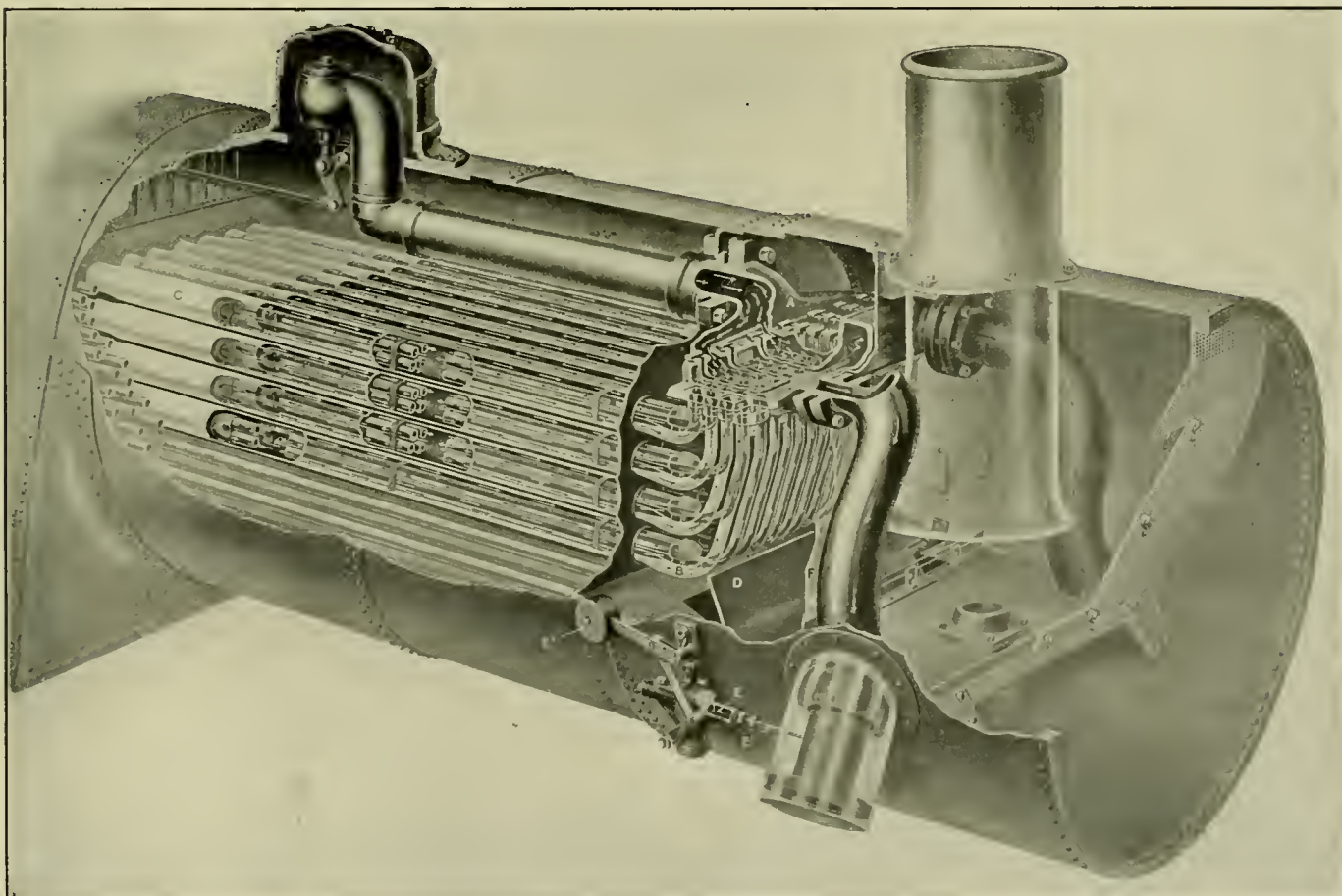

Fig. 2—Top Header Fire Tube Superheater.

removable, and so constructed that the unequal expansion caused by the difference in temperature as the steam passes through the tubes will be taken care of; the superheater flues should be located in the upper part of the boiler, where the tendency toward clogging is least and the temperature is highest. These points have been carefully provided for in a superheater which will be shown in the accompanying illustrations.

The superheater assembled, Fig. 2, consists of a header *A* supported on brackets in the smoke box and making a joint with the steam pipe in the same manner as the tee head used in the saturated engines. Attached to the header and in communication with it are the coils or units *B* made up of cold drawn seamless steel tubing and screwed into return bends. Each unit is located inside a large flue *C*, and extends to within about 2 ft. of the back flue sheet. The large boiler flues are set into the front and back flue sheets in very much the same manner as the ordinary small boiler tubes.

The tools which have been found to give satisfactory results in setting the large flues are a flue roller, consisting of five

tact with the superheater units. The deflecting plate *F* is in a vertical position, and this in connection with the horizontal partition, which extends from the deflecting plate to the front flue sheet and contains the damper, makes the complete enclosure for the header and the part of the superheater units which extend through the front flue sheet into the smoke box. The deflecting plate is made in parts to be easily removable. The operation of the superheater is as follows: When the throttle valve is open saturated steam passes through the dry pipe and into a portion of the superheater header designed to receive the saturated steam. From this portion of the header, which is in communication with one end of the superheater units, the steam passes downward through one tube of the unit, backward toward the back flue sheet, forward and backward again, and then forward and upward to the other side of the header designed to receive the superheated steam. From the header it then passes into the steam pipes, then into the steam chest and into the cylinders.

A detail view of the header casting through several sections

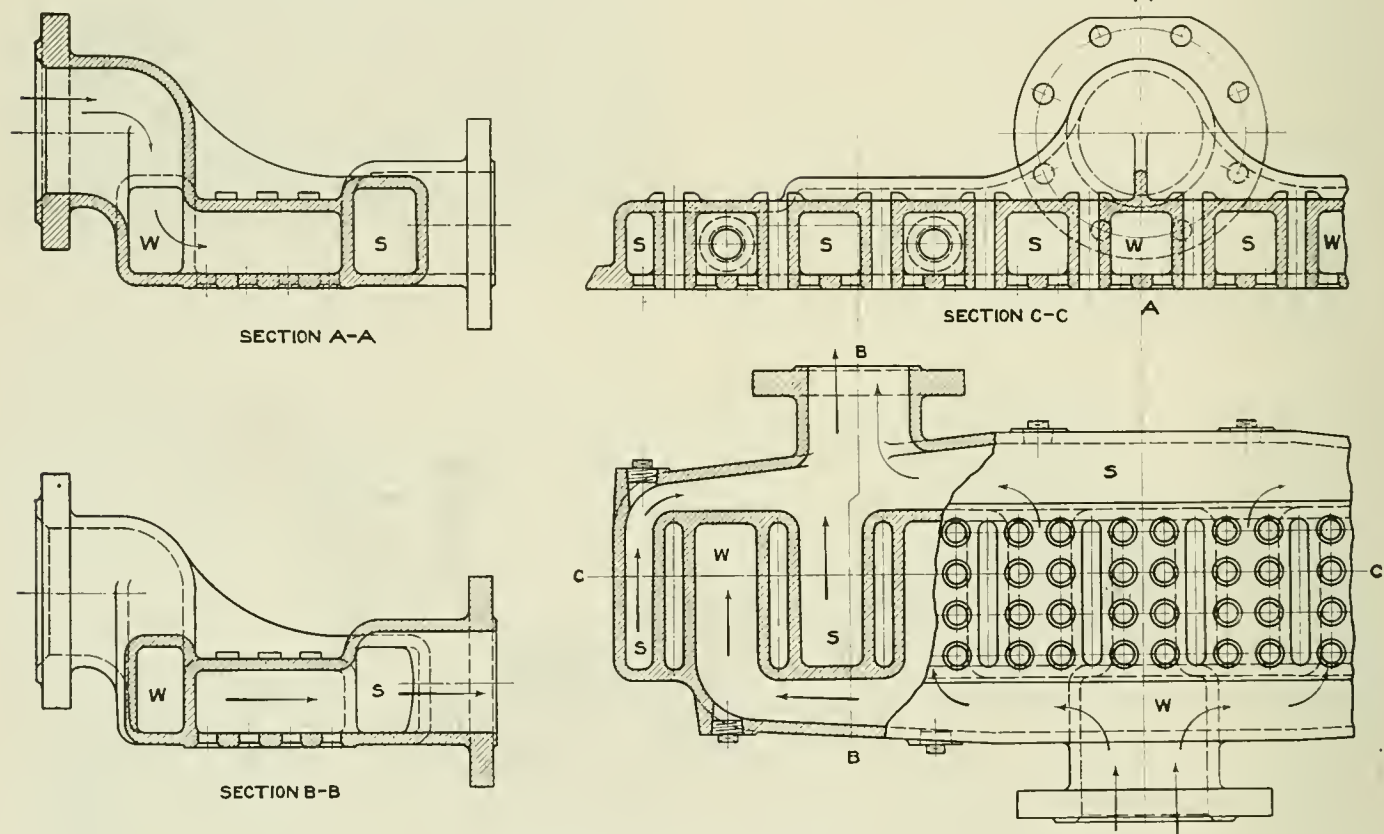

Fig. 4—Superheater Header Casting.

rollers, and a prosser or expander made up of twelve sections. The recommended method of setting the flues employs a copper ferrule in the fire box end; the rolling, prossering and beading of the flue on the fire box end; and the rolling and beading of the flue in the front end. In the introduction of the copper ferrule it is advisable to break the corner of the hole in the tube sheet on the outside of the sheet in order to remove any burr that may be left by the cutting tool, and also to remove the tendency of the sharp corner cutting into the flue. In beading the flues the beads should be carefully turned down against the sheet. In the maintenance of the flues, the prosser should be given preference.

The flow of gases through these tubes is controlled by a damper *D*, which is operated by the damper cylinders *E* located at the outside of the smoke box. The normal position of the damper is open when the locomotive throttle is open, thus allowing the gases to pass through the large tubes and come in con-

tact with the superheater units. The passageway marked *S* represents the superheated and that designated *W* the saturated steam passageways, which are in communication with the respective chambers marked *S* and *W* in the section *CC*. The units shown in Fig. 5 are held in place by a bolt which extends through slots in the header casting between the superheated steam and saturated steam chambers, and are prevented from turning by bosses or lugs located at the top facing of the header. The section through *BB* shows a section of one of the top steam pipe connections, and is similar in other respects to section *AA*. In the plan view of the lower side of the casting is also shown a part cut away to indicate the arrangement of the saturated and superheated steam chambers and the direction of the flow of the steam through their passages.

The ball connections of the units, Fig. 5, are each ground to fit the seats in the header casting and are clamped to the header. This clamp is supplemented by a ball ring fitting under the ball

of the tube in a manner that will provide for any irregularity that may occur in the hall heads or in the depth of the seat in the header. The return bends are of cast steel and are provided with lugs which rest against the inside of the large flues and keep the superheater units in the upper part of each flue.

The superheater tubes may be easily removed and replaced, and in doing this it is not necessary to take down the steam pipes.

they do not affect the steaming quality of the engine as in the case of steam pipe joints located inside the smoke box. Another advantage in their use is the absence of stress and heat interchanges in the cylinder saddle caused by the difference in temperature of the live steam and exhaust steam on opposite sides of the same wall. Outside steam pipes also offer a greater clearance in the lower part of the smoke box affording better oppor-

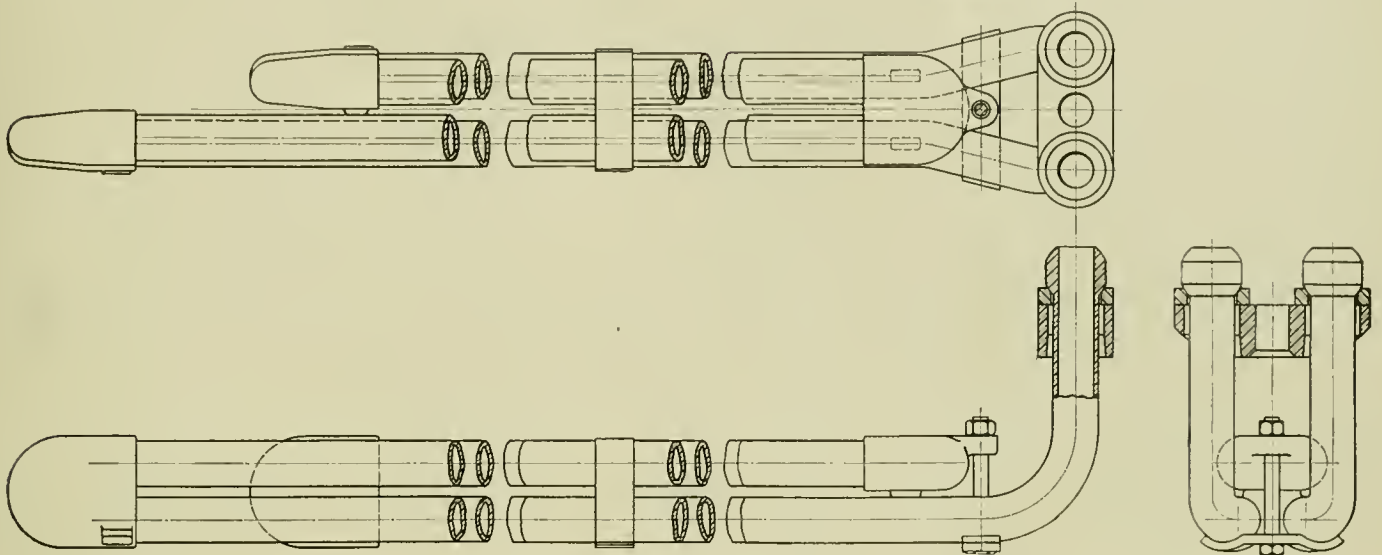

Fig. 5—One of the Superheater Units.

It is also possible to thoroughly inspect the front end, and do all necessary work on the boiler flues, boiler tubes and the front tube sheet seam, without the necessity of taking down the superheater header or the steam pipes. A hand hole opening is usually provided on the smoke box sides, through which inspection may be made of the entire front end of the superheater by the aid of a light, without taking down the front end netting or even opening the smoke box door.

The front end arrangement of the superheater applied in con-

tunity for drafting the engine, and making the operation of cleaning the front end very much simpler.

The introduction of the outside steam pipes also greatly simplifies the construction of the cylinder casting. It eliminates the steam passageway in the saddle, leaving only the exhaust passage. It also reduces the weight of the cylinder casting and simplifies the coring.

The joint rings between the steam pipes and the header, and the steam pipes and the cylinders should be made of cast iron;

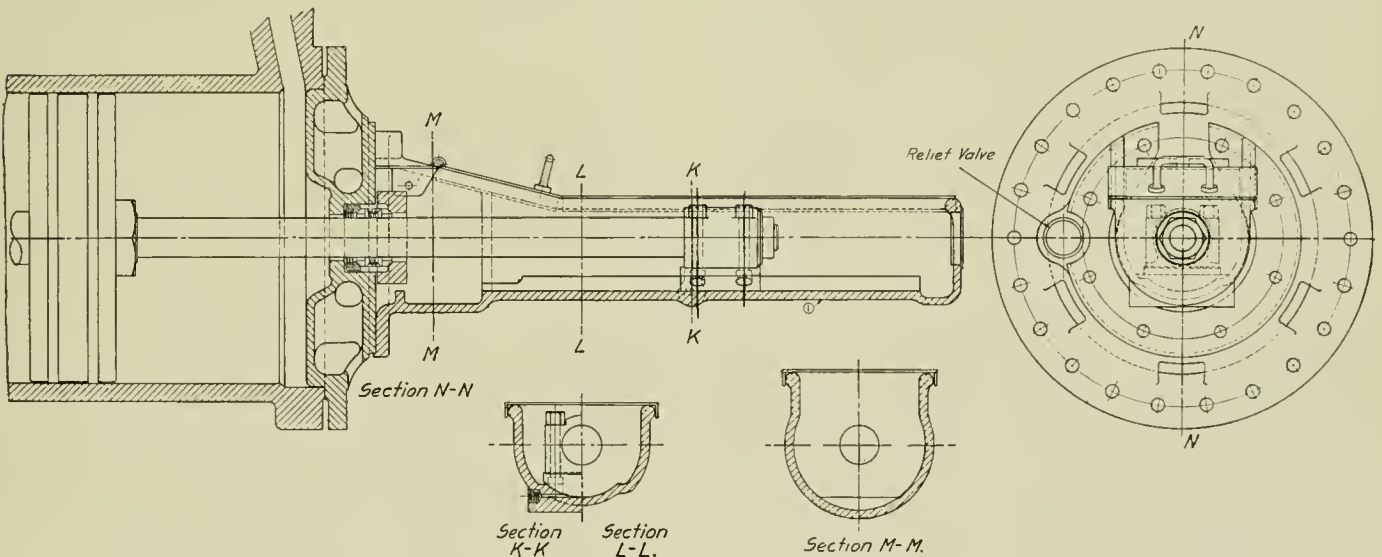

Fig. 6—Piston Rod Extension and Guide.

nection with the outside steam pipes is shown in Fig. 3. It clearly shows the convenience of the outside steam pipe arrangement, which is being applied quite generally to superheater locomotives. This arrangement places the two lower steam pipe joints outside the smoke box, making it easy to locate leaks in these joints, should any such occur; when these leaks do occur

brass rings will not stand the high temperature on account of disintegration. Piston valve rings and piston rings and bushings should be close grained cast iron, and too much attention cannot be given to the quality of material of these parts. The ordinary designs of piston rod packing have given satisfactory service, but the alloy used for the packing rings should have a higher melting

the wheel hub, allowing no shoulder for the steady rest jaws to rest on, a ring is provided about $\frac{1}{4}$ in. x $\frac{3}{4}$ in. in section. This is temporarily fastened on the wheel hub by three counter-sunk head screws. This machine has been found very serviceable and an entire set of pins on a consolidation locomotive can be gone over in 15 hours at a small cost when compared with the cost of renewal.

SMOKEBOX BLOWER CONNECTION.

A simple form of blower connection for raising steam when firing up locomotives in the engine house is shown in Fig. 4, which illustrates the details of a standard blower ell to be applied to all locomotives. The part *A* extends inside the smokebox and provides a union connection for the blower pipe to the stack. The flange part *B* is bolted to the smokebox from the outside. Two connections are provided for on the outside; the *D* end takes care of the steam line from the locomotive boiler, and the *C* connection may be connected to the steam blower hose in the engine house, and is used to raise steam when the fire is started. This *C* end has a coarse thread and when not in use is covered by the cap nut *E*, which has a handle and is chained to the flange *B*. The details of the handled nut connection that fits *C* upon removal of cap *E*, and to which the steam hose is attached, is also shown. This device has been used successfully where engines are fired up with crude oil and soft coal.

REFUSE AND CINDER CAR.

If the engine house and the surrounding yard are to be kept in good condition laborers must be constantly employed wheel-

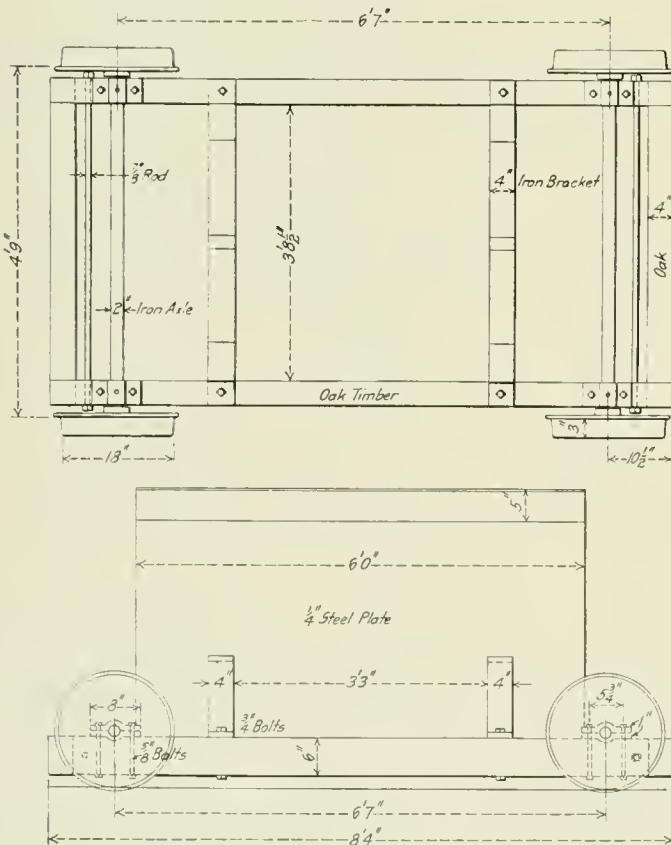

Fig. 5—Standard Gage Cinder Car for Shop and Yard Use.

ing out the cinders and sweepings. The car shown in Fig. 5 has been found very serviceable for such work. It is made of a heavy oak frame which is carried on two pairs of wheels of standard gage. The car is run into the house, or wherever needed about the yard, and dirt, cinders and refuse are thrown into it, saving the labor of loading up small wheel barrows and

wheeling the load to a dump car, usually a long distance away. When the bucket is full the car is pushed over the ash pit; the bucket is lifted from the car and by special mechanism of the ash pit pneumatic hoist it is carried over and the contents dumped into the cinder car. The bucket is made in two parts, hinged at the points *A*. The fastening of these two parts is such that they may be opened out by an attachment on the hoist when the bucket is over the cinder car. The capacity of the bucket being about a cubic yard, the dumping need only be done twice a day at the most, and usually only once.

MOLD FOR TINING CROSSHEAD SHOES.

The mold shown in Fig. 6 is used for tining crosshead shoes. It may be made of either cast or wrought iron and is divided

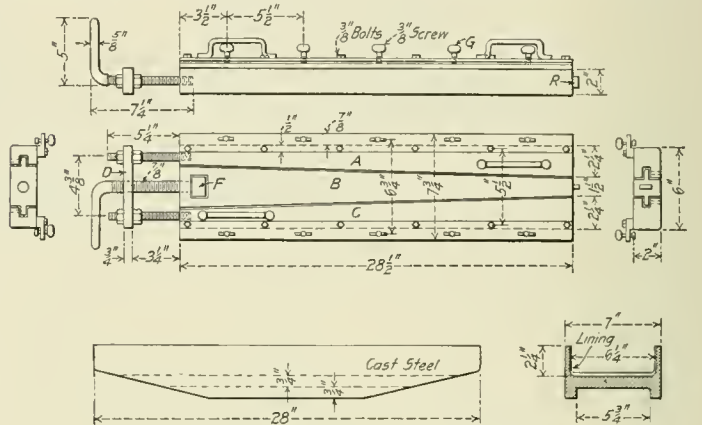
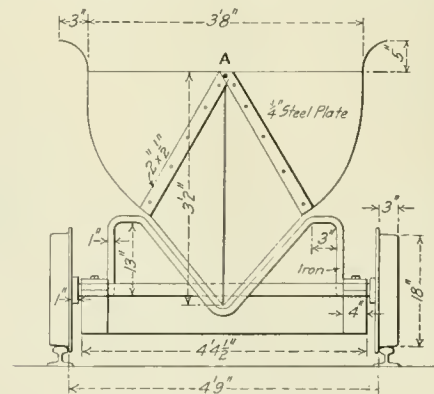

Fig. 6—Mold for Tining Crosshead Shoes.

into three parts, *A*, *B* and *C*. As will be noted in the end view, the part *B* slides in grooves in the parts *A* and *C*, and the various parts are held together by dowel pins located in *A* and *C*, which slide in grooves in the tongue of *B*. At the left hand end of the mold two studs are set in the parts *A* and *C*, which hold the guide bar *D* by lock nuts. A lead screw runs through this guide and is held to the part *B* by a collar *F*, which is free to turn. As this screw is turned *B* is moved in or out, as the case may be, and as it moves the outside blocks *A* and *C* are drawn in or out by the dowel pins. After the lining has been cast the mold can be easily removed.

The thickness of the babbitt metal is regulated by the thumb screws *G*, which rest on the sides of the crosshead shoe and



regulate the distance the mold extends into the shoe. Two handles are provided to facilitate carrying the molds. The crosshead shoe is held on the frame work shown in Fig. 7. It consists of a bar iron frame fastened to a $\frac{7}{8}$ in. plate, 25 in. long by 11 $\frac{1}{4}$ in. wide. This plate is pivoted at *H* on the end of a bench or table as shown in Fig. 8, and is held in a hori-

problem in the design of both classes of locomotives was, therefore, to provide a maximum capacity within the limitations of weight.

In the case of the Mikado locomotives a theoretical maximum cylinder horse power 36.3 per cent. greater than that of the present consolidations has been secured. At the same time the increase in total weight on driving wheels is only 26 per cent. Calculated on the same basis the Mikados provide a maximum capacity of 2,100 horse power and the consolidations only 1,543 horse power. The Mikados have a weight on drivers of 216,500 lbs., and the consolidations 171,600 lbs. The factor of adhesion

only difference being in the length of the smokebox. In the Mikado type the greater distance between the center of the cylinders and the forward driving wheels required an increase of 6 in. in the distance between the front tube sheet and the center of the cylinders, but in other respects they are practically identical.

Both designs embody the new features introduced by the builders within the past two years—viz., outside steam pipes, self-centering adjustable valve rod crosshead, self-centering guide for the piston rod extension and the improved outside bearing trailing truck.

One of the Mikado type locomotives is equipped with a Street

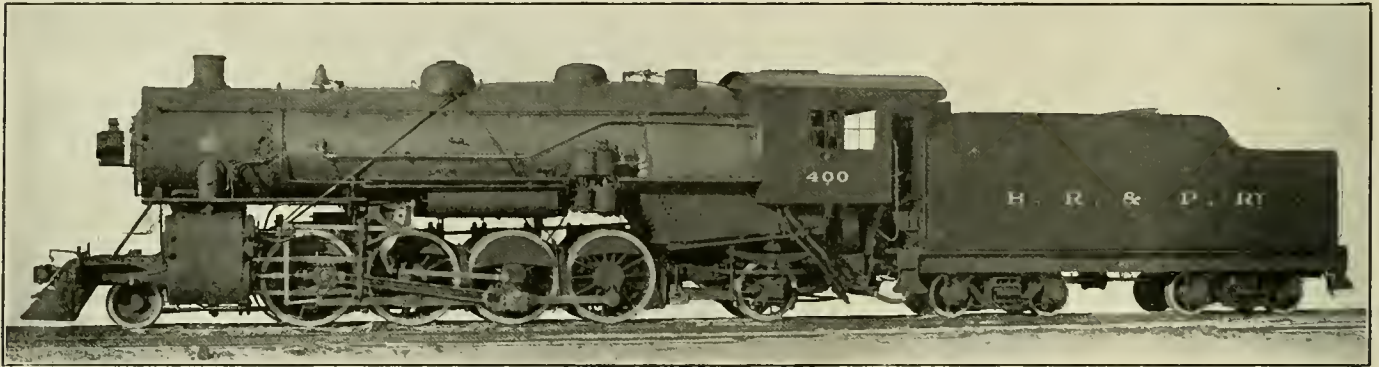

Powerful Mikado Locomotive for the Buffalo, Rochester & Pittsburgh.

provided in the Mikado design is, of course, a little less than in the case of the consolidations. Both, however, are well within the limits of good practice.

Conservatively estimated, it will require an evaporation per sq. ft. of heating surface per hour of not more than 12.4 lbs. of steam at 180 lbs. pressure to develop the maximum cylinder horse power of the Mikado, as compared with at least 14.6 lbs. at 210 lbs. pressure to give the maximum capacity of the consolidations. This comparison shows the much larger boiler capacity provided in the Mikado type, which is one of the most important advantages of this type of wheel arrangement.

mechanical stoker. The general dimensions, weights and ratios of the two types of locomotives are shown in the following table:

| <i>General Data.</i> | | | |
|--|---------------|---------------|--|
| Type | 4-6-2 | 2-8-2 | |
| Gage | 4 ft. 8½ in. | 4 ft. 8½ in. | |
| Service | Passenger | Freight | |
| Fuel | Bit. coal | Bit. coal | |
| Tractive effort | 36,312 lbs. | 51,133 lbs. | |
| Weight in working order..... | 258,000 lbs. | 273,500 lbs. | |
| Weight on drivers..... | 163,500 lbs. | 216,500 lbs. | |
| Weight of engine and tender in working order | 427,300 lbs. | 443,500 lbs. | |
| Wheel base, driving..... | 13 ft. | 16 ft. 6 in. | |
| Wheel base, total..... | 33 ft. 3 in. | 34 ft. 9 in. | |
| Wheel base, engine and tender..... | 65 ft. 11 in. | 67 ft. 4¾ in. | |



Locomotive Designed to Maintain 30 Miles Per Hour on a 1.5 Per Cent. Grade With a 400-Ton Train.

Likewise, in the design of the Pacific type, the increase in the total weight of engine as compared with the Atlantic is accompanied by a proportionate increase in cylinder capacity and a more than proportionate increase in boiler capacity. An evaporation of only 11.88 lbs. of steam at 200 lbs. pressure per sq. ft. of heating surface per hour will be required to develop the maximum theoretical horse power capacity of the Pacific, while in the case of the Atlantic type the boiler has to evaporate 13.6 lbs. of steam at 210 lbs. pressure per sq. ft. of heating surface per hour.

An extensive duplication of parts between the two classes of locomotives has been secured by care in working out the designs. The two boilers are practically identical in design, the

| <i>Ratios.</i> | | | |
|--|------------|----------|--|
| Weight on drivers ÷ tractive effort..... | 4.50 | 4.23 | |
| Total weight ÷ tractive effort..... | 7.09 | 5.31 | |
| Tractive effort x diam. drivers ÷ heating surface* | 594.00 | 680.00 | |
| Total heating surface ÷ grate area..... | 64.20 | 64.20 | |
| Firebox heating surface ÷ total heating surface, per cent..... | 6.60 | 6.60 | |
| Weight on drivers ÷ heating surface*.... | 34.30 | 45.40 | |
| Total weight ÷ heating surface*..... | 54.20 | 57.20 | |
| Volume both cylinders, cu. ft..... | 14.15 | 19.20 | |
| Heating surface* ÷ vol. cylinders..... | 338.00 | 250.00 | |
| Grate area ÷ vol. cylinders..... | 4.00 | 2.96 | |
| <i>Valves.</i> | | | |
| Kind | Piston | Piston | |
| Greatest travel | 6 in. | 6 in. | |
| Outside lap | 1 1/16 in. | 1 in. | |
| Inside clearance | 1/8 in. | 0 in. | |
| Lead | 1/4 in. | 3/16 in. | |

| Cylinders. | | |
|--|-----------------|-----------------|
| Kind | Simple | Simple |
| Diameter and stroke | 24½ x 26 in. | 26½ x 30 in. |
| Wheels. | | |
| Driving, diameter over tires | 73 in. | 63 in. |
| Driving, thickness of tires | 3½ in. | 3½ in. |
| Driving journals, diam. and length | 11 x 12 in. | 11 x 12 in. |
| Driving journals, others, diam. and length | 10 x 12 in. | 10 x 12 in. |
| Engine truck wheels, diameter | 33½ in. | 33½ in. |
| Engine truck journals | 6 x 12 in. | 6 x 12 in. |
| Trailing truck wheels, diameter | 43 in. | 43 in. |
| Trailing truck journals | 8 x 14 in. | 8 x 14 in. |
| Boiler. | | |
| Style | Ex. W. T. | Ex. W. T. |
| Working pressure | 200 lbs. | 180 lbs. |
| Outside diameter of first ring | 74 in. | 74 in. |
| Firebox, length and width | 108 x 75¼ in. | 108 x 75¼ in. |
| Firebox plates, thickness | ¾ and ¾ in. | ¾ and ¾ in. |
| Firebox, water space | 4½ in. | 4½ in. |
| Tubes, number and outside diameter | 240—2 in. | 240—2 in. |
| Flues, number and diameter | 32—5¾ in. | 32—5¾ in. |
| Tubes, thickness | No. 11 B. W. G. | No. 11 B. W. G. |
| Flues, thickness | No. 9 B. W. G. | No. 9 B. W. G. |
| Tubes, length | 20 ft. | 20 ft. |
| Heating surface, tubes and flue | 3,395 sq. ft. | 3,395 sq. ft. |
| Heating surface, firebox | 240 sq. ft. | 240 sq. ft. |
| Heating surface, total | 3,635 sq. ft. | 3,635 sq. ft. |
| Superheater heating surface | 757 sq. ft. | 757 sq. ft. |
| Grate area | 56.5 sq. ft. | 56.5 sq. ft. |
| Smokestack, diameter | 18 in. | 18 in. |
| Smokestack, height above rail | 14 ft. 10 in. | 14 ft. 7½ in. |
| Tender. | | |
| Tank | Water bottom | Water bottom |
| Wheels, diameter | 33 in. | 33 in. |
| Journals, diameter and length | 6 x 11 in. | 6 x 11 in. |
| Water capacity | 9,000 gals. | 9,000 gals. |
| Coal capacity | 14 tons | 14 tons |

*Equivalent heating surface equals total heating surface plus 1.5 times superheater surface.

AUTOMOBILE CAR

The automobile business in the Northwest has grown to such an extent that the Chicago, Milwaukee & St. Paul finds it necessary to build large numbers of special box cars for this trade. It is now constructing 470 fifty-foot automobile cars at the Milwaukee shops, with underframes and trucks designed for a car capacity of 80,000 lbs. The general plan and some of the principal details are here illustrated. In addition to the unusual length the car is very high, measuring 10 ft. 6¾ in. from the floor to the carline, thus providing a capacity of 4,675 cu. ft. The Bettendorf steel underframe is used, and is 50 ft. 10 in.

being only 3 ft. 7¼ in. from the top of the rail. This makes the height from the rail to the running board 14 ft. 10 in., and to the brake staff 15 ft. 4½ in. The side posts and braces are made of oak, 3 in. thick x 5 in. wide; the posts are reinforced on one side by 2½ in. x 2½ in. angles. The center posts at the ends are 4 in., 7½-lb. I-beams with 3 in. x 4 in. white oak pieces bolted to each side. The corner posts are double, and at one end are faced on the outside by 7 in., 9.75-lb., channels, to which the heavy hinges for the end doors are riveted. The end plate is faced with a 7 in. x ½ in. iron plate.

The special provisions for loading automobiles include doors

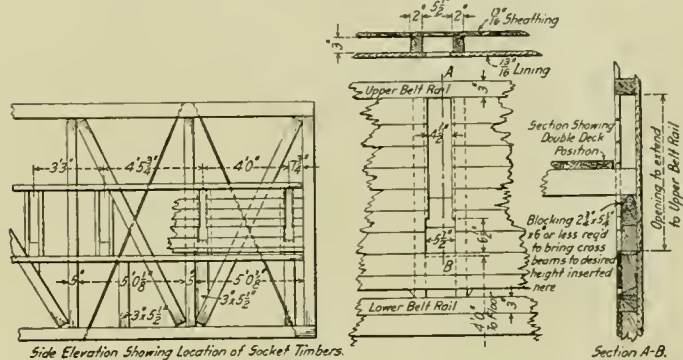

Arrangement of Double Deck Supports for Automobile Car.

at one end of which allow the full width of the car to be opened, wide doors at each side, and an adjustable double deck. These features have been worked out in an original manner, and are clearly shown in the detail drawings. Each end door is fitted with three large malleable iron strap hinges, with each butt secured to the channel post with 8 rivets. The doors are secured by a 1¾ in. x 6 in. bull bar, which swings on a pivot bolt fixed in one of the doors, the ends of the bar entering notches in the corner posts.

There are two doors on each side which provide a clear opening of 10 ft. when both are opened. One of them is 4 ft. 8¾ in. wide, and the other is 6 ft. 7½ in. wide. The wider

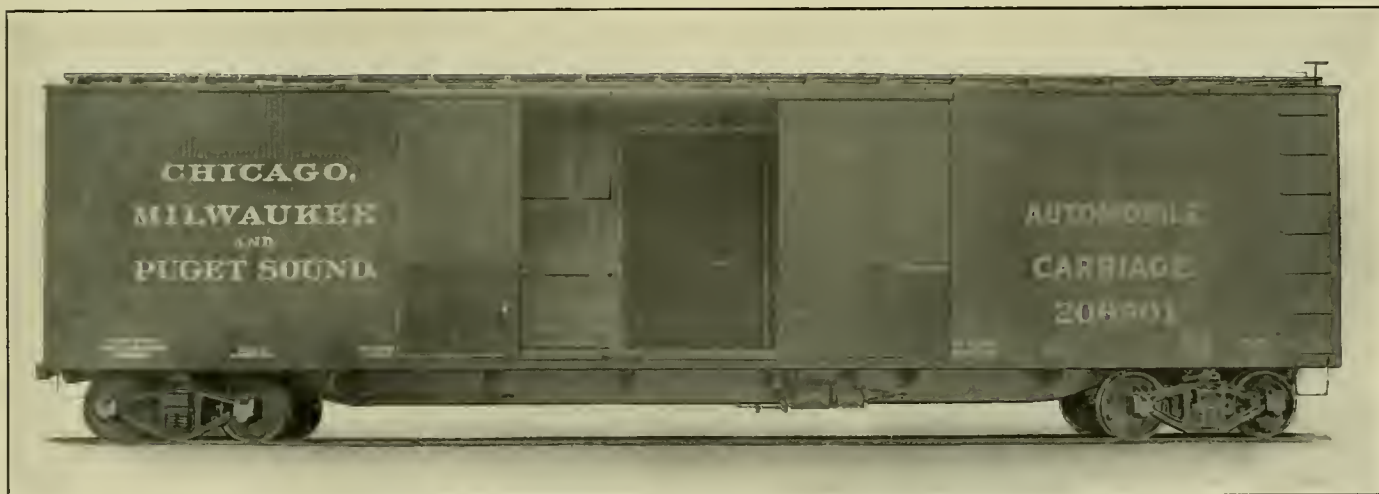

Automobile-Carriage Car; Chicago, Milwaukee & Puget Sound.

door covers the central opening as in ordinary box cars, and the narrow door is to the left in each case so that their centers are on a diagonal line with respect to the floor plan. The intermediate door post is made of oak, 3 in. thick x 4¾ in. wide, and is arranged to be made fast with the narrow door when the wide opening is not needed. The car is then equivalent to one with central side door openings 6 ft. wide on each side. This feature of securing the narrow doors with a substantial post

door covers the central opening as in ordinary box cars, and the narrow door is to the left in each case so that their centers are on a diagonal line with respect to the floor plan. The intermediate door post is made of oak, 3 in. thick x 4¾ in. wide, and is arranged to be made fast with the narrow door when the wide opening is not needed. The car is then equivalent to one with central side door openings 6 ft. wide on each side. This feature of securing the narrow doors with a substantial post

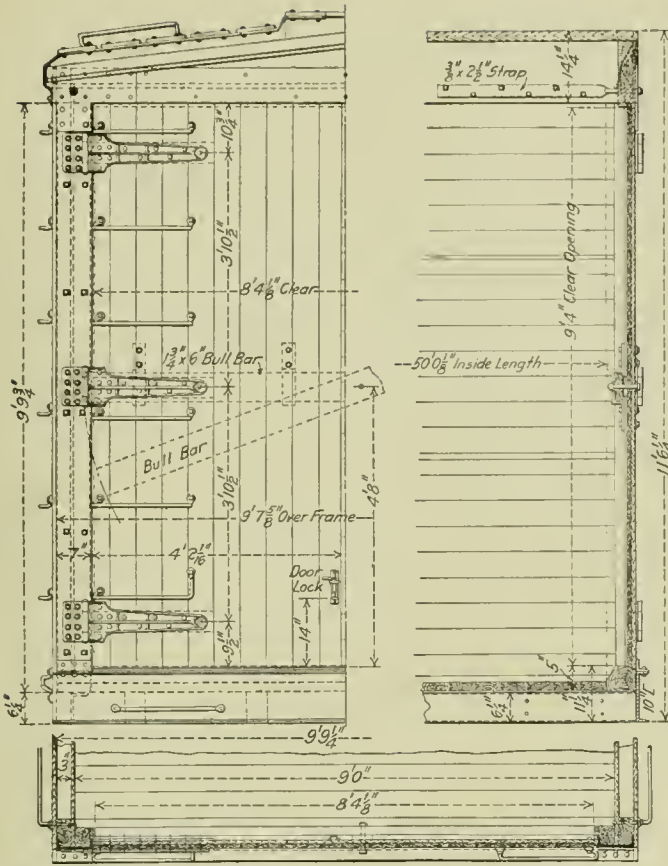

Construction of End Door on Automobile Car.

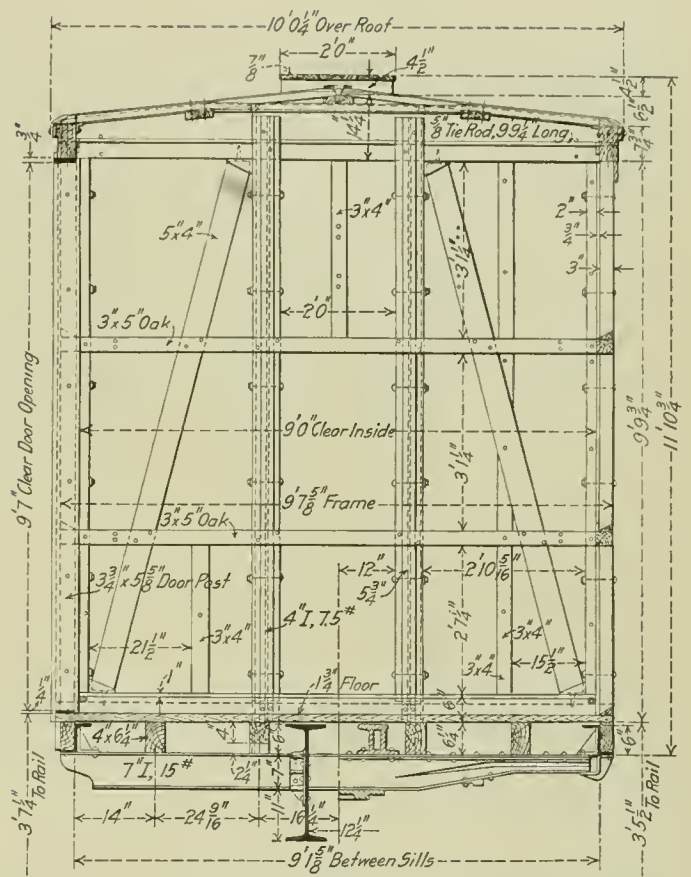

Cross-Section of Automobile Car.

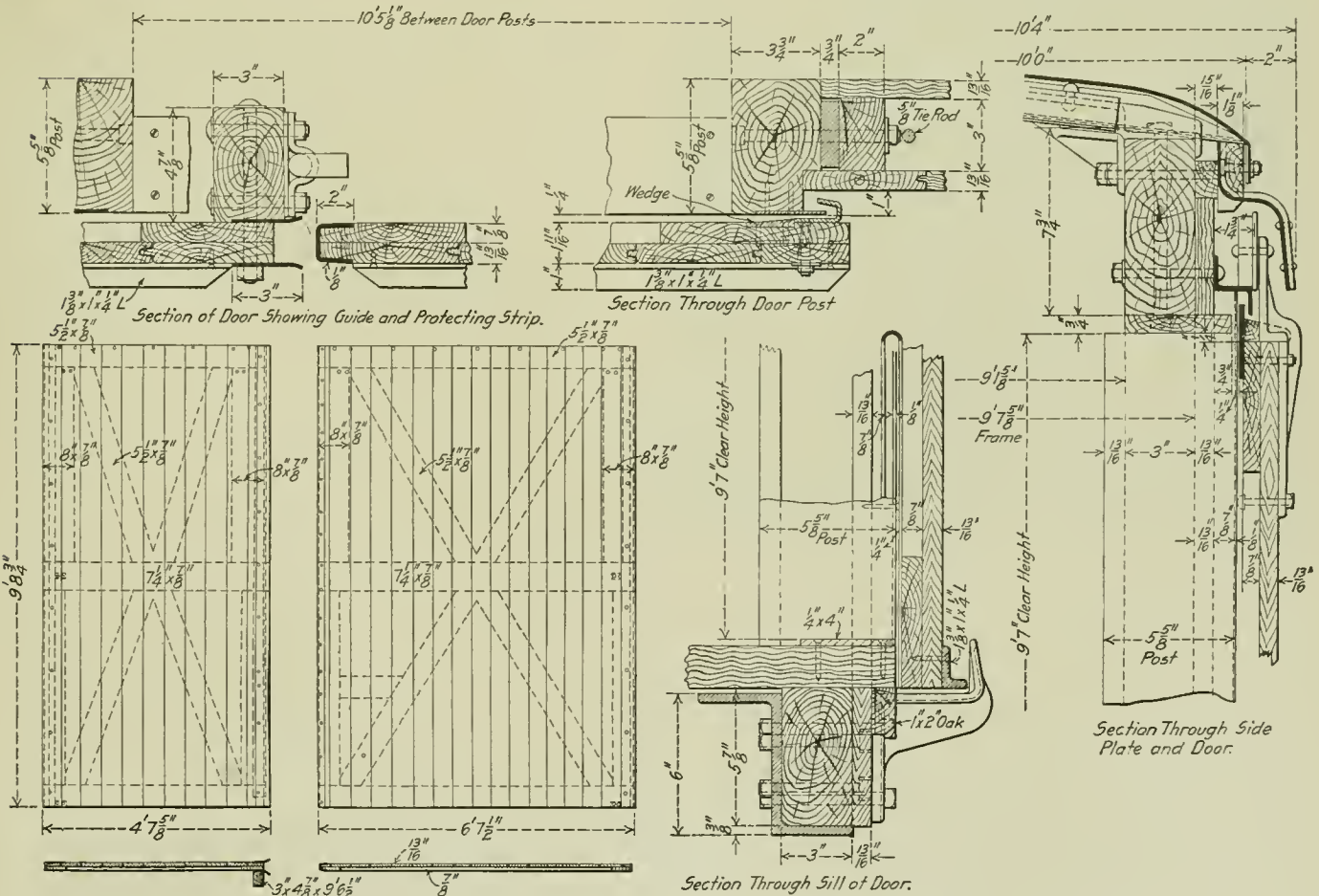

Side Doors of Automobile Car and Details of Their Construction.

fitted between the floor and side plate is patented. The detail drawing shows the narrow door bolted to the intermediate post; the edge of the door is fitted with $\frac{1}{8}$ in. protecting strips into which the edge of the wide door fits.

Provision is made for the installation of a temporary double deck, as shown in one of the illustrations, in order to load the car more nearly to its capacity and to the best advantage. The inside lining is nailed to furring strips which are specially arranged for the insertion of blocking to support the cross bearers for the temporary deck. The height of the deck may be regulated by the number of blocks which are placed in these pockets. The belt rail is supported by special posts directly below the blocking. The cars are fitted with the Bettendorf boltless trucks, the weight with these trucks being 46,800 lbs. Other fixtures include the Westinghouse air brakes, Hutchins' metallic roof and Security side door fixtures.

PORTABLE ELECTRIC MOTOR

In many shops, tools and devices operated by compressed air have become so numerous that it is practically impossible for the compressors to maintain the standard pressure, with the result that not only are the compressors themselves being operated very uneconomically, but the efficiency of the air riveting and chipping hammers and other air tools throughout the shop is greatly reduced. Most shops are provided with electric current, and there are many cases where electric power can be used in place of compressed air with equal ease, greater convenience and greater economy. If this transformation is made in a sufficient number of cases the efficiency of the compressors and

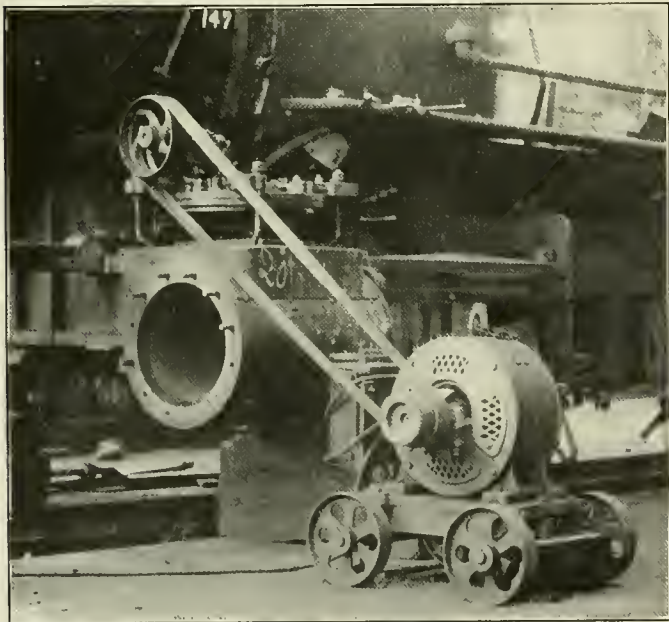

Portable Motor Belted to Valve Facing Machine.

other air tools will be greatly increased and the net result will be a decided saving.

As an illustration of one of the points wherein an electric motor can be used equally well, or better than an air motor, the accompanying photograph shows a valve seat facing machine in operation in the Macon shops of the Central of Georgia. The motor shown is of the direct current variable speed type, mounted on a small truck which also carries the controller. This motor is wheeled around the shop and is used for driving either the valve seat facing machine or the cylinder boring machine. This practice is also being followed in some other shops and has given good satisfaction.

OXY-ACETYLENE CUTTING AND WELDING*

BY J. A. WARFEL.

The highest temperature of the best solid fuel furnace is about 3,000 deg. Fahr. The oxy-hydrogen, which was the hottest of gas flames, is something less than 4,000 deg. Fahr. The oxy-acetylene flame gives a temperature of about 6,300 deg. Fahr., being more than double the hottest solid fuel heat known. Within the last few years a really satisfactory method has been developed for welding and cutting with the use of oxygen and acetylene gases by means of a blowpipe, simply because we are able to get a very high temperature, full control, and simple application, which are necessary for efficiency.

In order to relieve a welded piece of metal from internal strains due to welding, it is desirable not only to pre-heat the whole of the part when possible, but also to re-heat it after welding to a cherry red heat. This causes a molecular rearrangement to take place within the metal, which will bring about a distribution, if not an actual dispersion, of internal strains. In the case of cast iron this treatment is imperative where a repair is effected in a restrained member of the structure, and not only should pre-heating and re-heating (or annealing) be always employed, but the raising and lowering of the temperature in so doing should be slow, and the casting should be kept entirely free from air drafts, or other extraneous cooling effects. This treatment is less essential for steel, but it is always beneficial. Too much attention cannot be paid to this physical aspect of welding, and even when the process of fusion-welding is employed to fill up flaws in castings, it is desirable, when possible, to heat the whole structure before and after treatment.

The strength of the weld produced by the flame is almost invariably somewhat less than that of the original material. This may be due to the use of welding strips of inferior tensile strength or to those internal strains which have already been referred to. It is also undeniable that the structure of the material in the weld is less homogeneous than in other parts. This, however, is largely a matter of skill on the part of the individual welder. It is possible for a competent welder, at his discretion, to give a greater or less strength to the welded part.

Very often the question is raised as to whether or not iron and steel plate, when welded by the oxy-acetylene process, do not show a certain quantity of carbon formation in the weld, thereby rendering the material at the point of juncture somewhat brittle, thus having a deteriorating effect on the weld. To determine this point, one of our friends had a number of samples taken and plane sections were produced by cutting vertically through the weld. The samples were then ground and polished in the ordinary manner. One part was etched and treated in an alcoholic solution of picric and showed, according to microscopic photographs taken, that the distribution of the ferrite and pearlite was perfectly regular and even throughout the entire welded portion.

When overheating or burning has caused the metal to crystallize through to both sides of the weld, the fibrous structure of the metal may be so far destroyed, and the strength of the weld so impaired, as to make the weld worthless, and even annealing may fail to return the metal to its original condition.

Oxy-acetylene welding is a good thing, and to be made successful must be regarded as a trade, which can only be mastered by intelligent work and gradual development from simple to difficult jobs (and truly cannot be mastered within a few days, as we were sometimes led to believe by some over-zealous salesmen). Much depends on the intelligence and ability of the

*Abstract of a paper and discussion at the meeting of the Railway Club of Pittsburgh, Pa., January 26, 1912. Mr. Warfel is manager of the Pittsburgh, Pa., office of the Linde Air Products Company.

workman. A skilled welder will use a hammer freely as well as a blowpipe, more especially on a vertical or overhead weld in plates which are subsequently to be subjected to pressure strains. By the judicious use of hammering on the welded part at the right moment, the metal can always be made denser, with the result that the strength of the weld is increased.

The following suggestions are practical and necessary for success in welding:

Great care must be taken to remove scale and entirely clean the surface and edge of the metal where the welding is to be done. You must be careful to prepare the parts to be welded either by beveling deeply so as to enable the metal to be melted throughout the entire thickness of the plate or by cutting away sufficient metal to enable the blowpipe flame to penetrate to the under side of the plate, and thus insure that the added metal is welded-in throughout.

In the thicker sections of the plate the edges should be melted inwards for at least 25 per cent. of the thickness of the plate, while adding additional molten metal from the feeding wire. This is a secret of good welding which beginners invariably neglect.

When working on sections of material, the experienced welder displays his skill by raising the flame just at the moment when fusion has proceeded so far that complete welding is assured, and before the heat has advanced to a point where the material may be destroyed or pierced. Practice enables him to conduct this operation with great rapidity. It is especially important in thin work that the flame of the blowpipe should not be oxidizing, but rather decidedly reducing.

Light hammering in the case of wrought iron and steel is, when possible, always desirable while the metal is in a plastic condition. Never attempt to re-weld a cracked weld. Always cut or drill out a larger area than before, in order to remove all filling-in material; then re-weld, and insert a patch if required. Never neglect to pre-heat and afterwards anneal as much as possible. The importance of this treatment cannot be exaggerated, not only in dealing with cast iron, but in materials of all kinds. In the welding of ordinary iron, or mild steel plates, it is found that the best general results are obtained by employing as the welder feeder, soft Norway or Swedish iron wire, as free as possible from carbon.

In the welding of cast iron, rods of ferro-silicon are employed as feeders. Pure metallic copper is also sometimes employed as a feeder in the repair of complicated cracks in cast iron, with which it is found to make a satisfactory weld. As a general rule, it is also found advantageous to employ some welding flux, of which there are several varieties on the market. Copper to copper fusion welding is frequently employed, but chiefly on light work. Owing to the great heat conductivity of copper, local welding cannot be effected with the same economy as in the case of iron or steel. Aluminum is very successfully welded today by simply keeping out of the weld the film of aluminum oxide, which forms in the weld. It has been interesting to watch the rapid development of oxy-acetylene welding during the past two years, and the next two years will, without doubt, see a much more rapid development.

The paper was illustrated by lantern slides, showing methods of cutting and welding firebox side sheets and making other repairs to locomotive boilers. One illustration showed six cracks between staybolts on the inside sheet at the fire line. The time for doing the work included eight hours for the welder and three hours for the boiler maker, the total cost of labor and material being \$8.68. If these cracks had been plugged the cost would have been about \$18. Another example was that of a patch 32 in. x 60 in. welded in the side sheet of the firebox, where the time required was 17 hours for the welder and helper, at a total cost for labor and material of \$20.50. A crack 8 in. long on the inside of the smokebox was welded in 3½ hours at a total cost of \$4.

DISCUSSION.

In reply to a question in regard to pre-heating, Mr. Warfel said it was not necessary to pre-heat on side sheets, but it is a good plan to re-heat around the weld a short distance, after finishing the weld. L. A. Way explained the utility of the oxy-acetylene flame for cutting off heads of steel castings, and said, "We had in our foundry four high speed inserted teeth saws, and it took two men on day turn and two men on night turn to keep up with our work with these four saws. With the acetylene flame cutter one man working nine hours a day is able to keep up with the work. The flame will cut off a steel casting while a man is setting it up and getting it ready for the cold saw." Mr. Warfel explained that the proportion of oxygen should be 1½ cu. ft. to one cubic foot of acetylene. If too much oxygen is used it will oxidize the weld. Welding tubes into the back tube sheet of locomotives has been tried by two railway companies without success, and at the present time one of these companies is experimenting with the brazing of tubes. It is claimed that they do this successfully in France.

HOURLY FLUCTUATION OF ACCIDENTS*

The recent investigation reported in the Twelfth Biennial Report of the Bureau of Labor of the State of Minnesota shows that for the twenty-four hours there are four periods during the day at which the greatest number of accidents occurred. This is clearly shown on the accompanying diagram. The night hours, having much the fewer men at work, have by far the fewer accidents. There are, doubtless, more men at work in the early part of the night from seven to midnight than in the latter part from midnight to six. There seemed to be a highest point at the middle of the four periods, viz.: at 4 a. m., 10 a. m., 3 p. m. and 10 p. m.

The largest number of accidents are to be expected when the

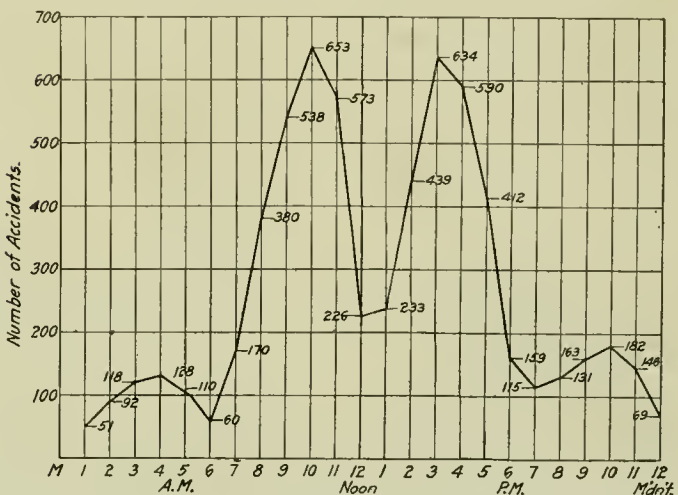

Hourly Curve of Industrial Accidents in the State of Minnesota During 1910.

first freshness which results from a rest from labor has been worn off and when the workers are doubtless at their highest speed of effectiveness and greatest nervous tension. The next highest number belong to a period a little later, when both physical and nervous powers have been let down by the fatigue of the day's work. Fatigue is doubtless responsible for a lowering of attention and probably a willingness to have the attention distracted from the work in hand. For illumination to secure effectiveness in the work areas, the factory of safety is rather a by-product. That is, illumination planned to stimulate and favor rapid production will be a little greater than that necessary for safety alone.

*Reported in the Journal of Industrial Safety.

JOURNAL TURNING LATHE

It is often necessary to refinish the journals on car axles when the wheels are not to be removed from the axles. With the more general introduction of the steel wheel in freight service this operation is becoming continually more frequent. A machine suitable for this purpose must of necessity be constructed

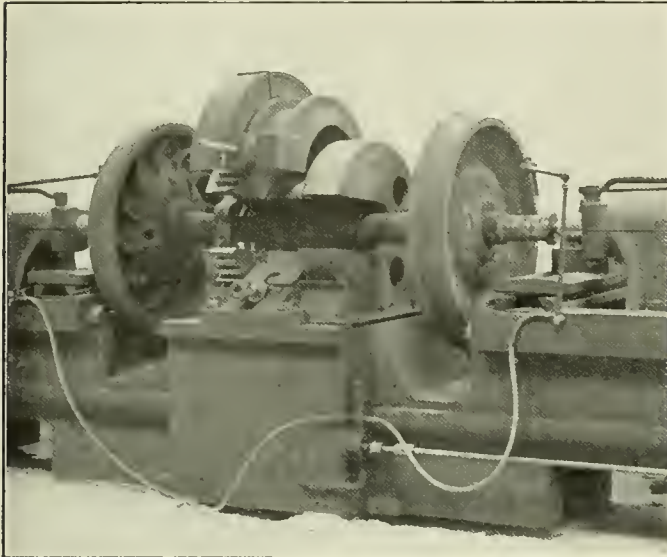

Journal Turning Lathe; Can Also be Used for Turning Axles.

to turn out accurate work since the cuts taken will be very light and perfect roundness is desirable. If the wheels are carried on the centers only, as is generally necessary where an old machine is adapted for this purpose, there is bound to be more or less

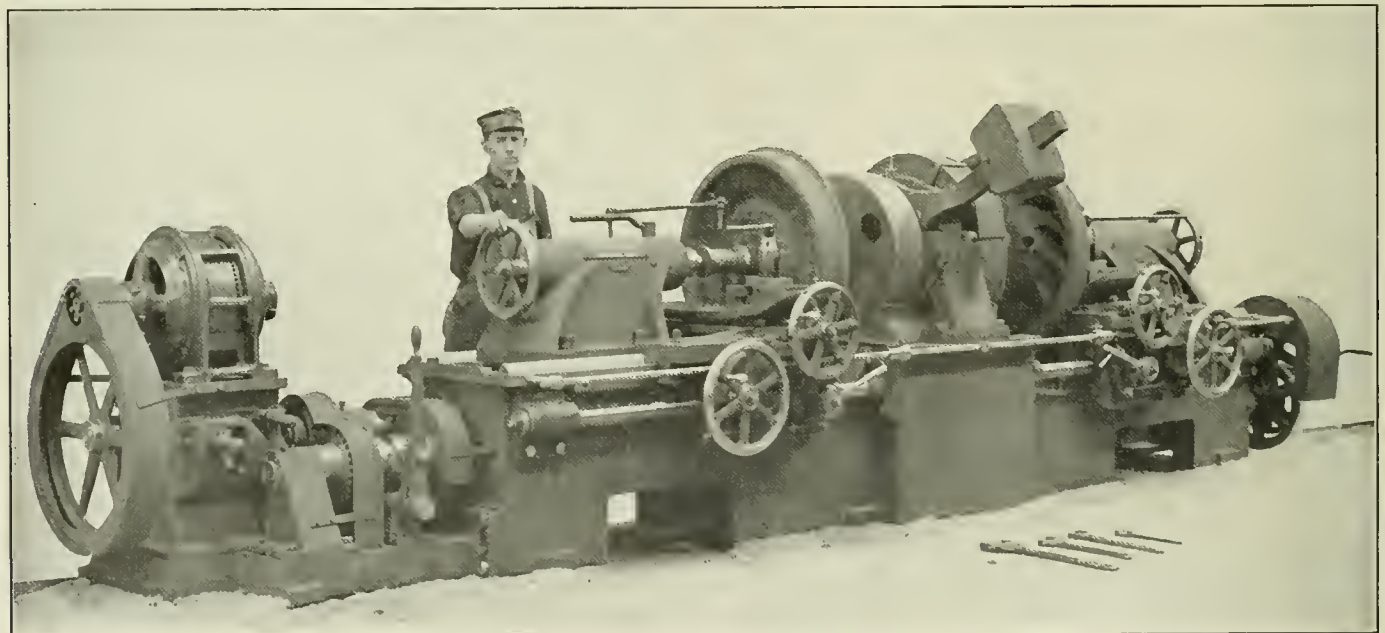

Motor Driven Journal Turning Lathe.

springing of the axle and lost motion at the centers which will be reflected in the quality of the work. Of course while some of the older designs of car wheel lathes were arranged and fairly well suited for journal turning, these machines are generally pretty well crowded with the work for which they are best adapted, and in fact the more modern tools of high capacity are not even arranged to permit journal turning.

Recognizing that a demand already exists which will become more insistent, the Niles-Bement-Pond Company has designed a machine especially for this purpose. It is arranged for center drive with a gap in the center head for putting in and taking out the axles, and is provided with suitable speeds and feeds for rapid, accurate turning and rolling of the journals. It has a capacity for axles carrying wheels up to 42 in. diameter on the tread. Both journals can be finished at the same time.

While journal turning will not require much power, the machine is designed throughout and is well suited for axle turning if a somewhat larger motor is provided. Arranged for both kinds of work, this machine could probably be kept busy in practically any shop where it would not be advisable to install it for journals alone.

In the arrangement of the driving mechanism, this machine is quite similar to a car wheel lathe, with the exception that the gap in the driving gear is not filled. There are two driving pinions provided, so arranged that when one is opposite the gap the other is in mesh and performs the work alone. The top bearing at the center is hinged at the front of the machine and provided with a counter weight. It is opened by simply loosening one nut on the clamping bolt, which is then swung out and frees the bearing, permitting the pair of wheels to be quickly handled. The driving dog is carried on an automatic adjustable driver plate, and is so constructed that it can be quickly applied and has a very powerful grip. The arrangement is such that there is no springing of the axle under the strain of the cut. The feed gears are supplied with a quick change arrangement using a sliding key and give all the necessary feeds for turning and burnishing.

The machine shown in the illustration is fitted with an alternating current, constant speed motor which makes necessary the group of gears shown between the motor and the bed of the machine. Where a variable speed, direct current motor can be used, this gearing will not be required. A 10 h. p. motor is suitable

for journal work only, but if the machine is also to be used for axle turning, a 25 h. p. motor should be used.

RAILWAY ACCIDENTS.—Out of 715 personal injuries on the Wheeling & Lake Erie during the year ending December 1, 1911, 414, or 58 per cent. were sustained in the car and locomotive shops and in engine houses.

AUTOMATIC CONTROLLER FOR ELECTRIC MOTOR

Convenience of control forms one of the principal characteristics of all modern machine tools and in the case of those which are driven by individual motors, the operation of the motor controller is in many cases more frequently necessary than is the use of adjusting levers, etc., forming part of the machine. The controller should therefore be within easy reach of the operator, simple in its operation and so located as to be safe from accidental change.

A controller which fulfills these conditions and possesses advantages of considerable importance for certain classes of machine tools is shown as applied to a Gould & Eberhardt motor driven shaper in the accompanying illustration. In this case the shaper is equipped with a 5 h. p. Reliance adjustable speed motor of the armature shifting type, giving a speed range of

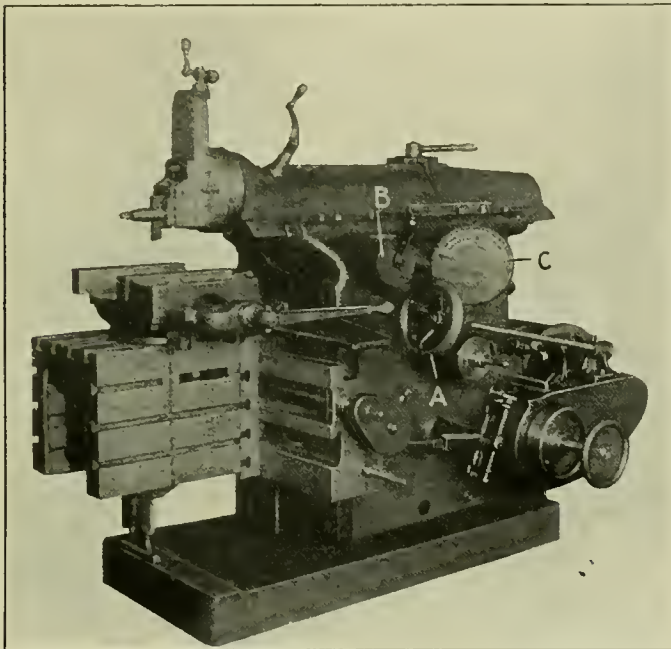

Shaper Fitted with an Automatic Controller.

300 to 1,500 r. p. m., which is controlled by the operation of the hand wheel *A* in the illustration. It is also equipped with Reliance speed dial *C*, which was fully illustrated and described in the March issue of the *American Engineer*.

A small drum switch *B* controls the starting and stopping of the motor, and also has a third point which puts into action a dynamic brake, making a brake clutch unnecessary on this machine. In addition to the operator's switch on the machine the controlling apparatus includes an accelerating unit which automatically accelerates or decelerates the motor, through the action of three, series wound, solenoid operated, switches which also act as current limit relays. This apparatus together with the line switch and fuses is mounted on a panel which can be secured to a post or frame near the machine.

When the operator's switch is thrown to a running position marked "Start," the current flows through the motor and all of the starting resistance in the accelerating switches, as well as through the solenoid of the first switch which is then connected in series. As the motor accelerates, the current drops, and when it reaches a pre-determined value, the first switch closes, automatically cutting out one-third of the resistance and throwing the solenoid of the second switch in series. When the current drops still further this switch goes out of action, cutting out still more resistance and putting the third solenoid

in the circuit. This in turn closes and the motor is directly on the line without resistance. When the switch is thrown to the "off" position the circuit is simply opened and the motor gradually comes to a stop after it has absorbed its stored rotative energy. If, however, the switch is thrown to the "brake" position, all of the resistance in the accelerating unit is put in series with the armature and quickly and smoothly brings the motor to rest, the accelerators acting as decelerating switches and cutting out the resistance step by step as the current generated by the motor decreases, due to its slowing down.

This controller is designed and manufactured by the Electric Controller & Manufacturing Company, Cleveland, Ohio, and while the one illustrated does not have the reverse position, other designs of the same general type are provided with apparatus for this purpose.

DRIVING EFFICIENCY OF PULLEYS

In a paper prepared by Prof. Sawdon* and presented before the National Association of Cotton Manufacturers, there is discussed at some length results obtained from an elaborate series of tests made by the author on the transmitting capacities of different pulleys in leather belt drives. The accompanying diagram and

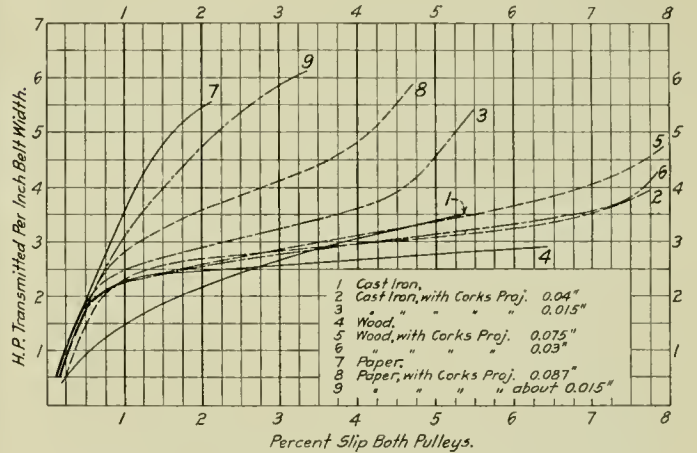

Relative Transmitting Capacity of Different Pulleys.

tables show the general results obtained from pulleys of three different materials, each with and without cork inserts of different sizes. These figures were obtained at a belt speed of 2,200 ft. per minute and an initial tension of 170 lbs. per square

TABLE 1.
HORSE POWER TRANSMITTED BY VARIOUS PULLEYS PER 1 IN. BELT WIDTH—
FROM TESTS.

| No. | Kind of pulley. | Slip.* | | | Comparative transmitting capacity at 2 per cent. slip. |
|-----|---|-----------|------------|-----------|--|
| | | 1 per ct. | 1½ per ct. | 2 per ct. | |
| 1. | Cast iron | 1.48 | 1.86 | 2.16 | 100.0 |
| 2. | Cast iron, with corks projecting .04 in. | 2.32 | 2.57 | 2.69 | 124.5 |
| 3. | Cast iron, with corks projecting .015 in. | 2.50 | 2.72 | 2.89 | 133.8 |
| 4. | Wood | 2.29 | 2.43 | 2.47 | 114.3 |
| 5. | Wood, with corks projecting .075 in. | 2.24 | 2.46 | 2.60 | 120.4 |
| 6. | Wood, with corks projecting .03 in. | 2.25 | 2.43 | 2.55 | 118.0 |
| 7. | Paper | 3.56 | 4.77 | 5.46 | 252.8 |
| 8. | Paper, with corks projecting .087 in. | 2.85 | 3.26 | 3.57 | 165.3 |
| 9. | Paper, with corks projecting (about) .015 in. | 3.12 | 4.00 | 4.72 | 218.5 |

inch of belt cross section. The belt was single ply, oak tanned leather, 5 in. in width. The pulleys were 24 in. in diameter, with 8-in. faces and without crowns. The tables give the horse

*Cornell University, Ithaca, N. Y.

power transmitted for different percentages of slip. The speed of the belt and its tension were kept constant, but the horse powers transmitted were varied, and the corresponding percentages of slip were recorded by the slip-meter.

Table 1 shows the horse power transmitted by the various pulleys per inch of belt width as obtained from the tests. The author states, however, that this table did not take into consideration the variations in the arc of contact, nor the greater stress occasioned on the tight side of the belt by the pulleys carrying the higher loads, which of course would reduce the life of the belt. He therefore prepared Table 2, which gives the relative trans-

TABLE 2.

CALCULATED HORSE POWER TRANSMITTING CAPACITY OF VARIOUS PULLEYS PER 1 IN. OF BELT WIDTH.

| No. | Kind of pulley. | Slip. | | | Comparative transmitting capacity at 2 per cent. slip. |
|-----|--|-----------|------------|-----------|--|
| | | 1 per ct. | 1½ per ct. | 2 per ct. | |
| 1. | Cast iron | 1.72 | 2.03 | 2.33 | 100.0 |
| 2. | Cast iron, with corks projecting .04 in. | 2.31 | 2.43 | 2.49 | 107.0 |
| 3. | Cast iron, with corks projecting .015 in. | 2.41 | 2.52 | 2.61 | 112.1 |
| 4. | Wood | 2.36 | 2.41 | 2.46 | 105.6 |
| 5. | Wood, with corks projecting .075 in. | 2.26 | 2.37 | 2.44 | 104.8 |
| 6. | Wood, with corks projecting .03 in. | 2.26 | 2.40 | 2.44 | 104.8 |
| 7. | Paper | 2.78 | 3.08 | 3.20 | 137.5 |
| 8. | Paper, with corks projecting .087 in. | 2.58 | 2.75 | 2.84 | 122.0 |
| 9. | Paper, with corks projecting (about) .015 in. | 2.60 | 2.95 | 3.10 | 133.2 |

*Increased distance traveled by the belt as compared to the face of the pulley expressed as a percentage. The creep is also included in these figures.

mitting capacities of the different pulleys when based on constant arcs of contact and constant belt tensions. These values do not represent actual observations from the tests, but were calculated by means of Nagle's formula using an arc of contact of 180 deg., and a maximum belt tension of 250 lbs. per sq. in. of cross section.

NEW TYPE OF DRILL SOCKET

A drill socket, differing in several particulars from any now on the market, is shown in the accompanying illustration. It is provided with a lip around the bottom with grooved extensions so arranged as to permit the insertion of a key for readily separating nested sockets. It also forms a reinforcement at the base

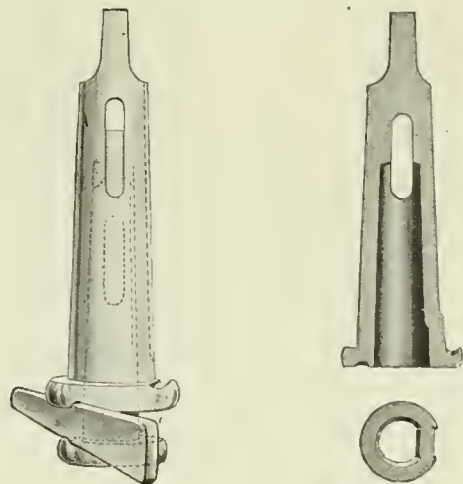

"Wear Ever" Drill Socket.

which greatly increases the strength and life of the socket. These sockets are made of special steel, heat treated, hardened and ground, and are in one piece. The socket has a flat key made integral with the socket on the inside and a similar keyway on the outside, both extending almost the entire length of the socket,

thus giving a positive drive and permitting the use of drills on which the tangs have been twisted off, requiring only that a flat be ground to fit the internal key. These sockets are, of course, made to conform to the standard Morse taper and will nest inside any other type of socket, and will also fit the spindle of any drill press. The "Wear Ever" socket, as it is called, is made by Scully-Jones & Company, Chicago, Ill.

SHAPER KNEE SUPPORT

A support for a swiveling knee has been designed and is being applied to 16 in., 18 in., 20 in., and 24 in. shapers, built by the Stockbridge Machine Company of Worcester, Mass. This support is of the same general type previously used by this company in connection with the standard type of box knee, but is arranged to permit the revolving of the knee, which operation is controlled by a worm and gear operated by the handle shown in the illustration. A graduated dial reading in degrees is provided on the front in connection with the knee support and permits an accurate setting for planing at any angle. If one

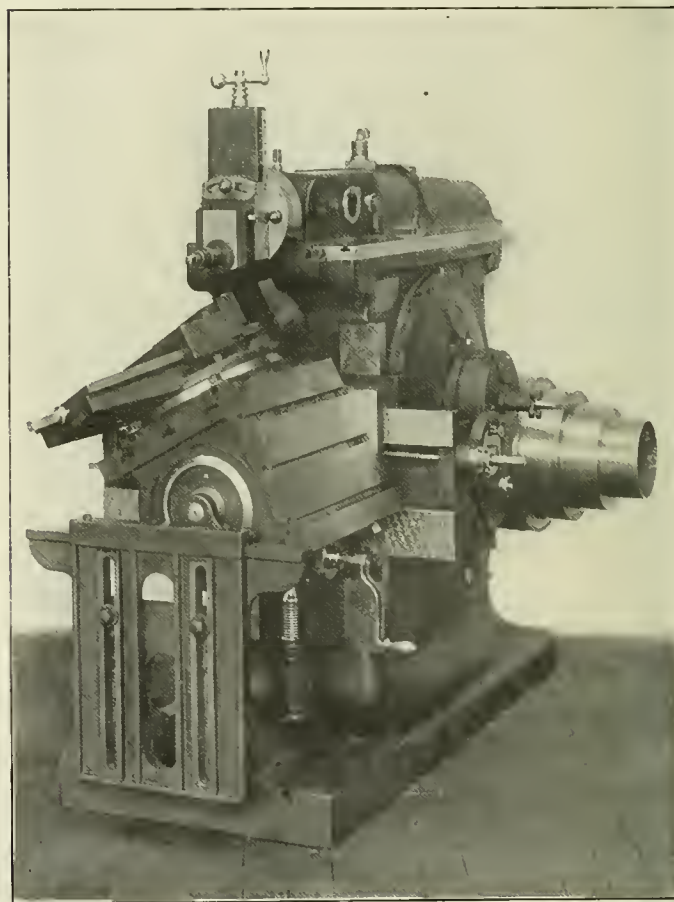

Support for Swiveling Shaper Knee.

side of the knee should also be provided with a tilting top with graduations, the shaper will be suited for planing compound angles of any character.

It is, of course, readily apparent that with the present practice of large shaper capacity, a knee support is practically indispensable, and while they are quite generally fitted on stationary knees, this is one of the first, if not the first, example where the same arrangement has been fitted with a swiveling type knee.

REINFORCED CONCRETE TELEGRAPH POLES.—The telegraph department of the New Zealand government is replacing wooden telegraph poles with reinforced concrete poles.

EVERLASTING BLOW-OFF VALVE

The Everlasting blow-off valve is designed for the severest conditions of blow-off service on locomotives, and differs from others now on the market in several important particulars. The boiler pressure is the only means used to keep it tight, and, as the valve disk never leaves the face of the valve, but is tightly pressed thereto, it is impossible for scale or sediment to get between them and thereby cause leakage, which is the common defect of blow-off valves. Another good point in this valve is the construction of the case, which is made in halves and bolted together. This is more expensive than the solid case used in most other valves, but the accessibility for repairs and inspection attained by this feature is a strong point of merit.

By unbolting the two bonnets the whole working mechanism of the valve can be taken out without the use of hand tools, and the faces may be re-surfaced in ten or fifteen minutes and made as good as new. The valve face is chilled and ground, and the disk is made of the very hardest nickel bronze, giving a remarkable wearing quality to these surfaces. This valve has no stuffing box, and it will be seen that the mechanism is arranged on very much closer centers than would be possible if the stuffing

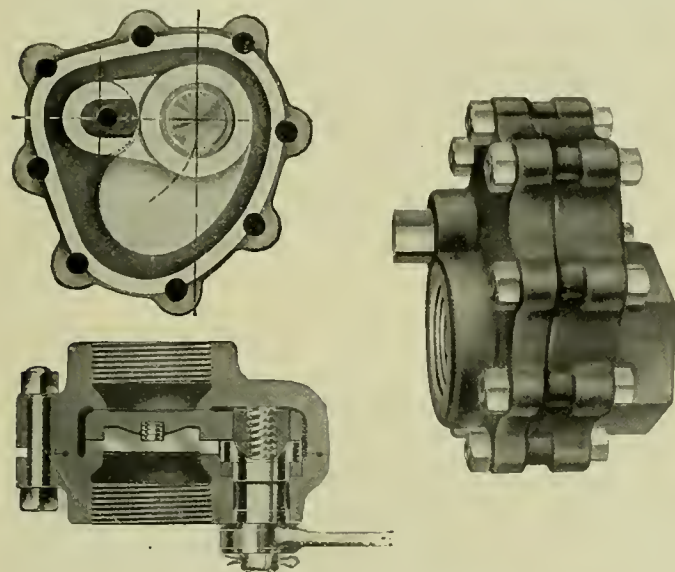

Everlasting Blow-off Valve.

box were used. A much smoother pull is thus secured, and this materially reduces the effort required to open and close the valve.

The inlet orifice is made tapered and slightly smaller than the opening in the valve face; that is, it is "choke bored." As these openings are eccentric and very close together, the greater part of the solid matter which is carried out with the blow-off enters the discharge pipe without impinging upon the valve face at all. This relieves the face from much of the wear it would otherwise have. By this means also there is obtained a syphoning action which cleans the valve at each operation. The valve is simple, compact, very strong and very rarely requires repairs. A large experience with these valves shows that they are practically self-grinding, as the disk revolves when being operated. The instructions state that the valves should be operated frequently, at least once a day, as this tends to keep them in good condition and is beneficial in helping to clean the boiler.

The 1½ in., 2 in., 2½ in. and 3 in. sizes will stand 150 lbs. hydrostatic pressure, and each valve is tested with 250 lbs. steam pressure before leaving the factory. The Central of Georgia has used the Everlasting valve as standard for three or four years. All engines on that line are equipped with four such valves, as the water in that region requires frequent blowing off. The same valve is used throughout the engine house at Macon, Ga., in connection with the hot water washing system,

and is found very satisfactory for this purpose. It has been used for some time with good results by the Chesapeake & Ohio, and all the new locomotives of the Chicago & North Western are equipped with it. The valve is made by the Scully Steel & Iron Company, Chicago.

LAYING OUT KEYWAYS FOR ECCENTRICS

BY CHARLES MARREL.

On locomotives fitted with the Stephenson valve gear the work of chipping the keyway in the axle after the valve is set has always been one of so great difficulty and inconvenience that it has stimulated the inventive faculties of many foremen and machinists, resulting in a number of methods, tools and machines to perform the operation in the shortest time and with the least labor. On the Chicago & North Western at the Clinton, Iowa, shops a method is in use which permits the laying off of the keyway on the axle before the wheels are under the engine. The eccentrics can be accurately fitted and secured before the locomotive is wheeled, and if the work is carefully done there will be no need for changing them when the valves are run over.

A face plate or a large piece of tin or sheet iron is used by the valve setter on which he draws the straight line *A*, which represents the line connecting the center of the axle and the center of the link block when the rocker arm is in a vertical position. On this horizontal line *A* a vertical line *D* is erected. From the intersection of these two lines, which is to represent the center of the axle, the circle *S* is described with

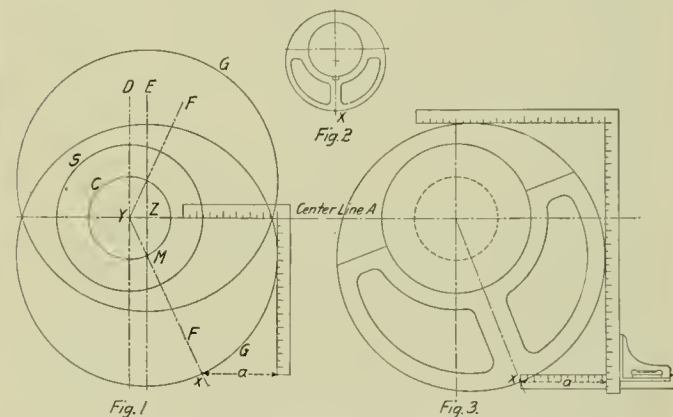

Laying Out Keyways for Eccentrics.

a radius equal to half the diameter of the axle at the point where the eccentric is to be placed. The circle *C* is then drawn with a radius equal to the throw of the eccentric. From the center point *Y* on the line *A*, the distance *YZ*, equal to the lap plus the lead (lead is subtracted if negative), is then laid off. This is of course only done in cases where the rocker arms are of equal length. If they are of different lengths this distance is proportioned to suit. From point *Z* the perpendicular line *E* is drawn. From the point *Y* line *F* is drawn passing through the intersection of the line *E* with the circle *C* (point *M*). With *M* as a center and a radius equal to that of the eccentric, circle *G* representing the outside of the eccentric is described. A 2 ft. square is then laid with its shorter end on the center line *A* and the other leg tangent to the circle *G*. The distance from the point *X* where the line *F* intersects circle *G* to the inner edge of the square is measured. Call this distance *a*.

The eccentric itself is next laid out, using a piece of wood inserted in the axle fit with pieces of tin on which to accurately lay out the centers of the axle and the eccentric. When this is done a line is carefully drawn through them and the point where this line intersects the circumference is prick-punched, this be-

ing point X . The eccentric is then placed on the axle and a combination square with a spirit level is set with its rule projecting a distance equal to the distance a plus the width of the plate of the carpenter's square which is to be used. A carpenter's square is then set over the eccentric and the combination square is adjusted to it, as is shown in Fig. 3. The wheels and axle are then so located that the crank pin is plumb and the eccentric is moved on the axle until the point X coincides with the end of the combination square when everything is level. The eccentric is then clamped and the keyway laid out or the amount of off-set determined. Experience has shown that where this method is carefully carried through there will be no need of changing the eccentric after the wheels are under the locomotive and the valves will properly tram so far as the amount of lap and lead is concerned.

ACCIDENT PREVENTION

The American Museum of Safety recently awarded the Pennsylvania Railroad a medal for being the industrial company that did the most for the protection of the lives and limbs of its workmen by means of safety devices for dangerous machines and processes, as was mentioned in the February issue of the *American Engineer*. This road, during the past year, has

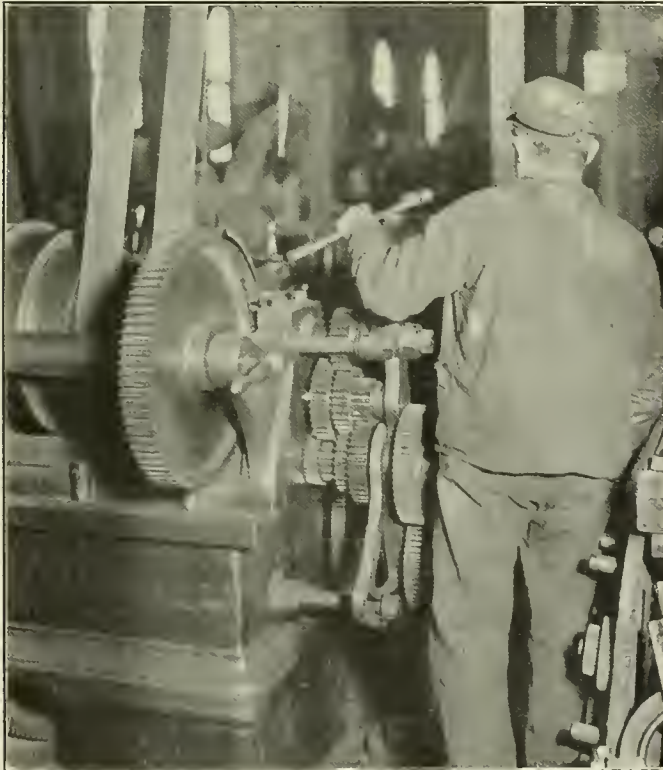

Fig. 1—Exposed Lathe Gears Liable to Cause an Accident.

reduced the accidents in its shops from 8.7 per 1,000 employees in a month to 3.5 per 1,000. These accidents include everything from a scratched finger to a fractured skull.

That many of the accidents were unnecessary and due to sheer carelessness was the belief of the Pennsylvania officials and in November, 1910, a vigorous campaign of education was begun among the employees. At that time experts were employed to show the company just how and what safety devices should be installed and the benefits derived from this work were so marked that frequent inspections have become the policy. The accompanying illustrations show some of the devices installed. Fig. 1 shows the unprotected gear wheels, at the end of a lathe. An employee passing by the running gears is liable to have his

clothing caught and in this way suffer an accident. Fig. 2 shows the gears fully encased. A door is placed on the end so that

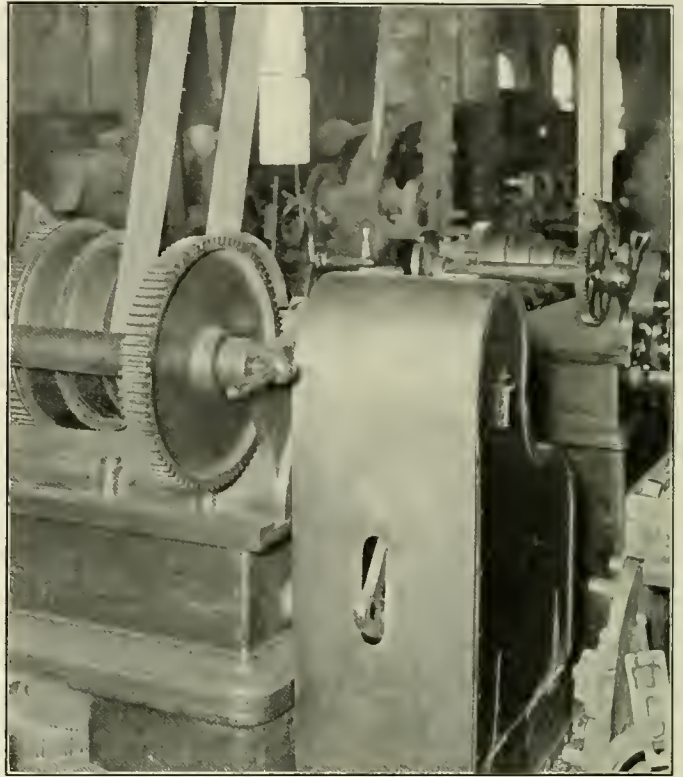

Fig. 2—Lathe Feed Gears Enclosed Insuring Absolute Protection.

the gears may be readily changed. Fig. 3 shows other safety devices as applied to the driving belts of a radial drill and the

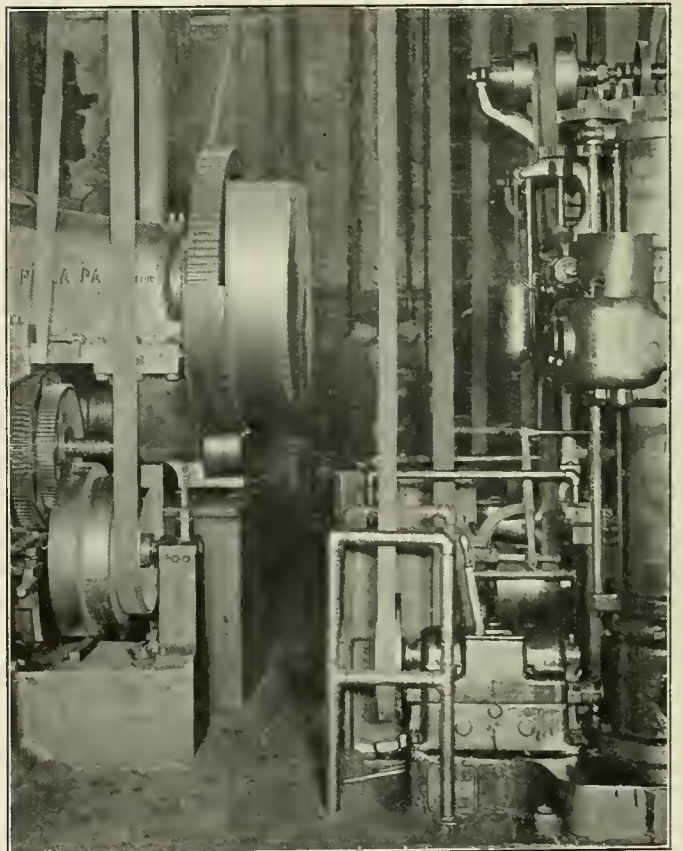

Fig. 3—Safety Appliances Applied to a Drill Press and Slotter.

driving gear of a large slotting machine, the belts being enclosed within a pipe railing and the gears being sufficiently covered by a sheet iron case. The following table shows the decrease in accidents throughout the year 1911:

| Month. | Number of shop employees. | Killed. | Serious injuries per 1,000 employees. |
|-----------|---------------------------|---------|---------------------------------------|
| 1911— | | | |
| January | 34,127 | 4 | 8.7 |
| February | 34,171 | 7 | 7.3 |
| March | 32,899 | 0 | 8.3 |
| April | 31,380 | 1 | 6.0 |
| May | 34,694 | 3 | 7.9 |
| June | 34,601 | 1 | 5.2 |
| July | 31,641 | 2 | 4.7 |
| August | 32,512 | 2 | 3.4 |
| September | 32,932 | 0 | 3.4 |
| October | 33,462 | 0 | 3.2 |
| November | 33,997 | 2 | 3.5 |

These results are said to have been accomplished on a most economical basis. The reports resulting from inspections contained in all 3,126 recommendations covering improvements or changes in 3,737 tools or machines, at an estimated cost of \$35,000, or an average of \$530 for each shop. At one shop for which 238 recommendations were made, 157 covered improvements made with practically no cost.

Shopmen themselves have the most at stake in the accidents and the organization of a shop safety committee of the rank and file has proved invaluable. As the road reports: "The prevention of industrial accidents depends largely on the care exercised by the individual workman. By serving on the safety committees they become interested in precautions and will instinctively avoid many of the common and preventable dangers." Inquiry develops that even laborers serve on these committees of protection.

A terminal division committee is composed of a locomotive inspector, a brakeman, baggage porter, track foreman, yard foreman, usher, and relief assistant trainmaster. A road and yard committee is composed of a passenger engine man, freight con-

ductor, inspector of car repairs, telegraph operator and a laborer. These are standing committees, the members of which are changed from time to time. The recommendations which they make are simple and cover a wide range of subjects.

There are now 33 committees, including 148 men, on the various divisions. The committees report monthly to the superintendent, who forwards the report to the general superintendent, who, in turn, reports to the general manager every three months.

CHRISTY STEEL BOX CAR DOOR

The Christy box car door, illustrated herewith, is a combined side door and grain door, is made entirely of steel and is fixed permanently to the car. It is a wide departure from ordinary practice used heretofore. The fixed grain doors which were formerly used were so expensive for maintenance that they were gradually abandoned and temporary doors substituted. Temporary doors are stolen and destroyed in such large numbers that the expense for them has also become a large item in the freight car repair account. The ordinary side door, when made of wood and with ordinary fixtures, has many defects; it frequently gets out of order and also causes a large expense for maintenance.

For these reasons, the permanent improved steel door here illustrated will be regarded with unusual interest. It has been used in regular service on the Rock Island for nearly two years. Sample doors have also been used experimentally on the Chicago & North Western and the Lake Shore & Michigan Southern, and fifty cars now building at Pullman for the Michigan Central will be equipped with it.

The door slides on the inside of the car and thus avoids the danger to passenger trains which sometimes occurs when the outside doors hang loose. It is well protected and is not liable

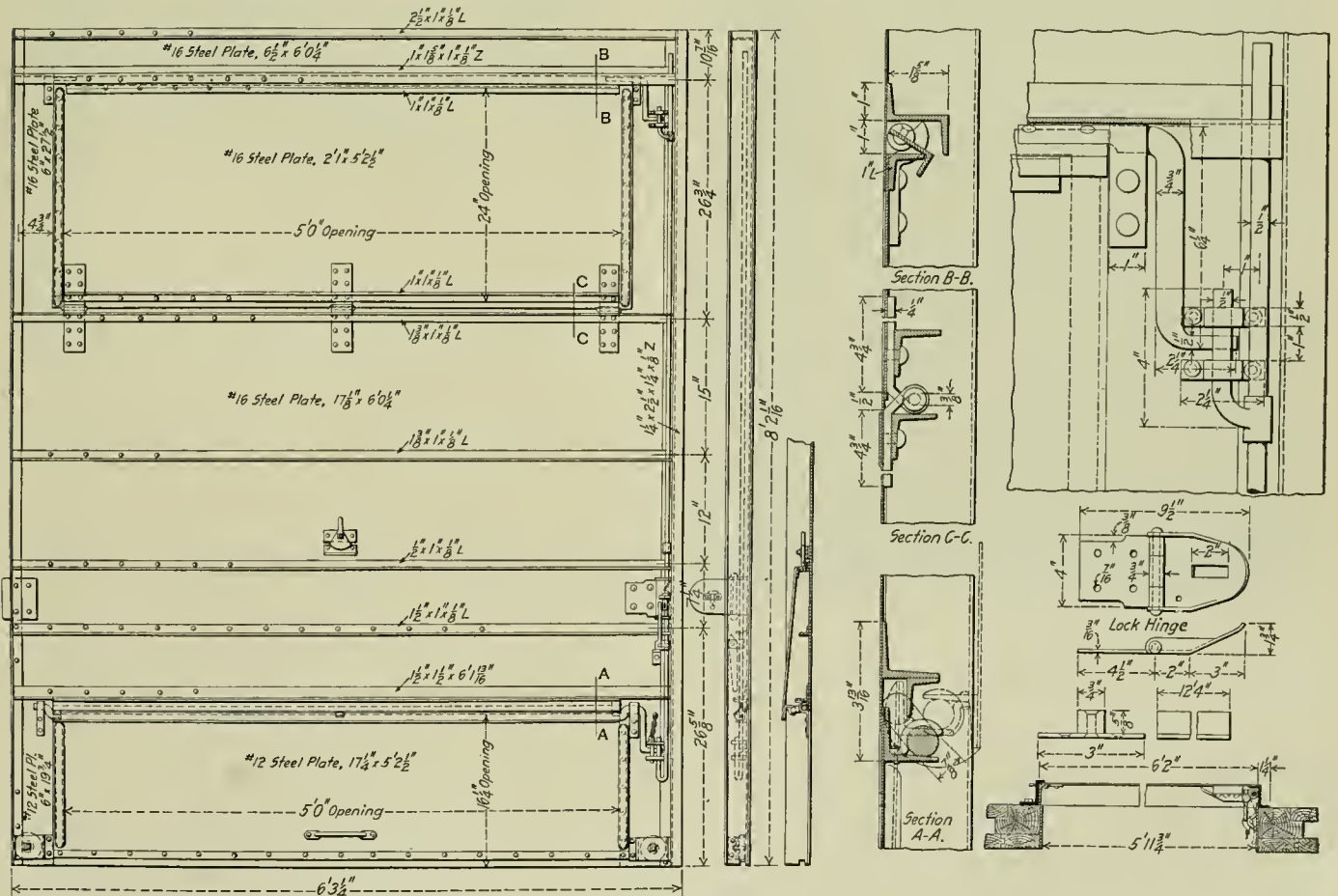

Details of Christy Steel Box Car Door.

to be injured by outside forces. The fixtures are so substantial and well arranged that they do not permit of pilfering, and the door is so tight that there is no loss from leakage of grain or damage from driving rain. It also has advantages in loading and unloading. A full car of grain can be completely unloaded and swept out in 28 minutes from the time the car is delivered at the elevator, while it often takes this long to open the doors and get the shovels ready for unloading.

The main door is made of No. 16 steel plate reinforced by angle irons of different sections and weights, as indicated on the drawing. In order to render the door satisfactory for the shipping of grain, coal or similar freight, it has two separate doors or ports, 60 in. wide, provided with simple and secure fastenings, permitting their easy and rapid operation. The upper door is 24 in. high and is hinged at its lower margin 5 in. above the grain line, and is large enough to admit the spouts used in loading grain and coal. The lower door, 16¼ in. wide, is hinged at its upper border and when opened permits the free discharge through it of all such freight as grain, coal, etc., without opening the main door. This lower door is likewise planned with special reference to the use of such power scoops or scrapers as are in general use at elevators and elsewhere for unloading grain, coal and similar substances from cars. When the smaller doors or ports are closed and fastened the main door, of course, acts as a rigid whole.

For freight which has to be passed through the main doorway,



Outside View of Christy Door Closed.

guards are provided to prevent packages from getting behind the door and thus preventing it from being opened. When the door is closed it completes the side wall of the car, making that part as strong as the other side walls, and all kinds of freight may be loaded against it, thus making available the entire cubic space of the car. The box car side doors now in use will not sustain any pressure from within; therefore, no freight of any kind can be loaded against them.

The photographic illustrations show the construction of the doors clearly. The upper one operates on plain strap hinges

which extend out sufficiently to make the door clear the adjacent angle irons. The sides are made tight by lapping over the half round molding which stiffens the side of the main door, and the top is made tight by the use of hinged angle irons, which are shown in section at *B-B*.

The lower door is hinged on a long ¾ in. round bar, which is offset so as to work like an eccentric and throw the door out and make it clear the adjacent angle irons. The section at *A-A* shows the angle iron on the top of the lower door overlapping an adjacent angle, which is secured to the stiffener of the



Interior View of Car Showing Christy Door Closed.

main door. In this way the top of the main door is made proof against the weather. The whole door rolls on a floor track made of ¾ in. square iron, and passes into the car where it is held in a pocket protected by six angle irons.

One of the illustrations shows the interior of the car with the door closed. When the door is closed both top and bottom auxiliary doors are fastened and sealed by a vertical rod which extends between the two doors and passes into sockets at the top and bottom of the door frame. A detail of this fixture is shown on the drawing. The other attachments which are connected with the sealing of the car are now being developed and can be better understood by an examination of the door with its fixtures in operation. This improved steel door, which combines the side door with the grain door in permanent form, was invented by H. A. Christy, 1447 Marquette building, Chicago.

OZONIZED AIR FOR SUBWAY VENTILATION.—The Central London Railway, England, which has for the past 11 years ventilated the subway on the exhaust system, has recently decided to install a continual influx system with fresh air treated with ozone to purify and improve its quality.

U. S. FOREIGN COMMERCE.—The statement of exports and imports made up by the Department of Commerce and Labor for the month of February shows increases over February, 1911, on both sides. The value of imports increased from \$121,694,000 to \$134,207,000; exports from \$173,304,000 to \$196,821,000.

GENERAL NEWS SECTION

The Western Weighing Association has issued a new form of triangular card which is to be placed on all foreign line cars where the actual light weight varies 500 lbs. or more from the stenciled tare.

All of the Master Car Builders' rules of interchange went into effect on May 1 without exception on all of the St. Louis terminal lines, following the adoption of a similar practice in Chicago on April 1.

A special train of mail cars, which arrived at Oakland, Cal., from the East over the Southern Pacific on April 5, delivered 350 tons of mail, the trains for several days having been detained by floods in Nebraska and east of there.

The lectures on First Aid to the Injured, given for the benefit of the employees of the Pennsylvania Railroad during the past year, numbered 270, and the attendance at these lectures aggregated 9,180 employees. Many local firemen and policemen also attended these classes.

George Sherwood Hodgins, who has been a frequent contributor to the *American Engineer*, has been engaged by the commissioners of the National Transcontinental Railway of Canada to make a special report concerning the shops and equipment of the various engine houses, terminal shops, etc., on that road.

At a meeting of the legislative committee of the four principal railway brotherhoods at San Antonio, Tex., on April 11, resolutions were passed protesting against the policy of the Mexican government in discriminating against American railway employees in an alleged effort to eliminate them from the service of the Mexican railways for the purpose of replacing them with Mexicans.

The stoppage of work in the anthracite coal mines was followed by the laying off of large numbers of trainmen on the Philadelphia & Reading. At the shops of the Erie at Hornell, N. Y., 700 of the 1,000 employees were laid off because of the expected diminution of the volume of coal traffic on the company's lines; and a similar suspension of work was ordered at the shops at Salamanca, N. Y., and Meadville, Pa.

In an article by Edward B. Phelps in the *American Underwriter* it is stated that the accidents to railway employees cost the railways 1.24 per cent. of their wages during the years 1908-1910. Mr. Phelps states further that a good fair estimate of the cost that the proposed bill before the U. S. Congress for the protection of interstate railway employees would inflict on the railway companies would be only 1.50 per cent. of the wages paid.

A meeting of the representatives of the machinists', blacksmiths', carmen's, boilermakers' and sheet metal workers' organizations on western railways was held recently at Kansas City, Kan., for the purpose of organizing a federation of shop employees of all railways west of the Mississippi river. The movement is an outgrowth of the organization of federations of the employees of the Illinois Central and the Harriman lines, which led to the shop strike last fall.

The twenty-third annual report of the Relief Department of the Chicago, Burlington & Quincy, for the year ending December 31, 1911, shows an expenditure during the year of \$621,165.34 in benefit orders to employees of the company. This was more than was received in contributions from members, and the company advanced \$38,262.76. Since the establishment of the fund in 1889 there has been paid in benefit orders to employees on account of sickness and accidents a total of \$8,240,184.67. The payments by the railway company have amounted to \$1,458,211.

Anatole Mallet, Paris, France; Dr. Carl Gustav Patrick De Laval, Stockholm, Sweden, and Dr. Rudolf Diesel, Munich, Germany, have been elected to honorary membership in the American Society of Mechanical Engineers. Anatole Mallet has been engaged in developing various mechanical problems since 1867, among which are steam engines with double expansion and the application of this system to locomotives. Dr. De Laval in his earlier years did important work in developing processes for the manufacture of steel, but is best known through his invention of the centrifugal cream separator and other apparatus for the use of dairies and the De Laval steam turbine. Dr. Diesel is widely known as the inventor of the Diesel engine.

B. A. Worthington, receiver of the Wheeling & Lake Erie, has established safety committees similar to those on the Chicago & North Western and other roads. A central, or advisory, committee is made up of H. T. Douglas, Jr., chief engineer, chairman; C. C. Needham, tax commissioner, vice-chairman; J. G. Code, superintendent; C. W. Coe, superintendent; J. E. O'Hearne, master mechanic; C. S. Morse, master car builder; J. F. Marshall, purchasing agent and C. H. Holmes, secretary to the receiver. Sub-committees meet every month and draw up recommendations which are presented to the central committee. Employees are requested to report any dangerous conditions to their superior officers or to any member of the sub-committees.

The simple Mallet locomotive which was recently built for the Pennsylvania Railroad by the American Locomotive Company, and illustrated in the March issue of the *American Engineer*, page 150, is reported to have made a splendid record run from Altoona to the mountain top on Saturday, March 30. A train of 1,125 tons was pushed up the mountain by the engine at an average speed of ten miles an hour. The total train resistance was figured at 1,898 tons, and the two H8 type (consolidation) engines at the front of the train pulled a trifle more than 700 tons. The Mallet used 6,000 gal. of water and 9,000 lbs. of coal, while the other engines used 4,500 gal. of water and 6,000 lbs. of coal. The mechanical stoker on the Mallet proved to be 90 per cent. efficient.

Two hundred and fifty delegates, representing the Brotherhood of Railway Car Men, the Brotherhood of Boilermakers and Helpers, the Brotherhood of Blacksmiths, the International Association of Sheet Metal Workers, and other shopmen's organizations, at a meeting at Kansas City on April 22, organized the "Federation of Federations," to represent the shop workmen employed on 47 lines west of the Mississippi river. The Federation claims 300,000 members. On the second day of their meeting they prepared and sent to President Taft a telegram notifying him that they had decided "to extend or to make preparation to extend" to all the railways in the West the strike on the Harriman Lines and the Illinois Central, which they started last year, "unless a settlement of an honorable character can be secured." They claim that their constituents are determined and that the other railways are assisting the Harriman Lines; and it is declared that boiler explosions are becoming more frequent. The president of the Federation of Federations is W. O. Horton, of St. Louis; vice-president, G. W. Pring, Des Moines; secretary, John Scott, San Francisco. The first of the eleven names signed to the telegram sent to President Taft is James W. Kline.

The Central Safety Committee of the Chicago & North Western reports that for the 15 months ending April 1, 1912, the number of passengers killed on that road, as compared with the preceding period of 15 months (ending December 31, 1910) fell off 57 per cent. The number of employees killed fell off

23 per cent., and of other persons 11 per cent. Injuries (not fatal) also showed marked diminutions. Other decreases for these two periods are as follows:

| | Per Cent. |
|---|-----------|
| 25 fewer trainmen killed | 53.2 |
| 1,790 " trainmen injured | 44.5 |
| 5 " switchmen killed | 26.3 |
| 132 " switchmen injured | 16.5 |
| 1 " stationmen killed | 25.0 |
| 120 " stationmen injured | 14.7 |
| 940 " trackmen injured | 42.7 |
| 120 " bridgemen injured | 29.8 |
| 5 " car repairers killed | 71.4 |
| 13 " car repairers injured | 3.5 |
| 1 " shop and engine house men killed | 14.3 |
| 214 " shop and engine house men injured | 13.2 |
| 1 " other employees killed | 7.7 |

There was an increase of 7 trackmen killed, 2 bridgemen killed, and 13 other employees injured.

The educational bureau of the Illinois Central has announced the company's plan for paying employees for useful ideas. It is a combination of the Pennsylvania Railroad's plan, with the added offer to recognize and pay for suggestions that are in use only locally. Each employee is offered the opportunity to present to the educational bureau for consideration any idea he may have thought out or worked out for promoting the interests of the company in any manner. Such ideas may be original in so far as the company is concerned, may be adoptions of plans that have been heard of or that may be in effect on some other railway, or may be descriptions of quick and economical ways and means of doing various kinds of work, which have been put into practice locally and which have proved that they were successful. The bureau calls attention to the wide field for suggestions. It may be a plan some foreman has for reclaiming scrap material or repairing tools, it may be a handy device some shop machinist has put into use, it may be a system some yard clerk has worked out, it may be a method some agent or conductor has for handling passengers or freight in a manner to win praise for the company. The advisory board of the educational bureau will pass on and judge all suggestions offered. Such suggestions as are deemed suitable for adoption will be properly recommended and presented to the management. If the management accepts a suggestion and puts it into effect, the advisory board will then decide on a fair and proper recompense to be made to the employee.

The Special Committee on the Relations of Railway Operation to Legislation has issued Bulletin 29, containing a full report of the conference committee, which co-operated with the post office department in formulating uniform specifications for steel postal cars. The most important change from the original specifications, was increasing the section moduli of the vertical end members from 35 to 65. Paragraph 29 referring to the floor was also changed to read as follows: "Sub-floor of postal cars to be of iron or steel plate, upper or wearing surface to be of matched wooden flooring, maple or rift-sawed yellow pine or fir, laid longitudinally; or a composition, preference being in the order named. If a composition is used, the wearing surface between the doors and the standing surface in front of letter tables and paper racks shall be of wood, cork or other suitable material. Proper insulation, including air space, should be provided between upper and lower courses. Floor strips for wood upper course should be bolted to sub-floor. Composition flooring may be

secured by corrugated, keystone, or equivalent style of plate or by wire fastening, anchored to sub-floor." The bulletin also contains specifications covering fixtures in mail cars, which were prepared by the post office department committee. The latter includes detailed descriptions of the distributing tables under letter cases, letter cases, racks for sacks and pouches, paper distributing tables and dumping tray, paper boxes in all mail cars, small cases for slips, portable bins for letter packages, gage for registered mail, order box, hoppers, lavatory, water tanks, wardrobe and mirror, wrecking tools, fire extinguishers, gas plate or steam cooker, cots, stools, deodorants and disinfectants, toilet paper, door fixtures, lighting, rakes for paper boxes, catcher arms, safety bars, cinder guards, safety rods, letter drops and movable stanchions. Both the specifications for the construction and for the fixtures have been referred to the second assistant postmaster general for approval.

MEETINGS AND CONVENTIONS

Railway Storekeepers' Association.—The annual convention of this association will be held at the Hotel Statler, Buffalo, N. Y., May 20-22. The committees will report on the following subjects: Recommended Practices; Piece Work; Scrap Classification; Accounting; Uniform Grading and Inspection of Lumber; Standard Grain Door; Apprenticeship; Stationery; and Standardization of Tinware. J. P. Murphy, secretary, Box C, Collinwood, Ohio.

International Railway Fuel Association.—The annual convention of this association will be held at the Hotel Sherman, Chicago, May 22-25. The program will include the following papers: Standard Locomotive Performance Sheet; The Use of Anthracite for Locomotive Fuel; Drafting of Locomotives; Proper Method of Firing Locomotives; Inspection of Fuel and a special paper by Dr. W. F. M. Goss, University of Illinois. D. B. Sebastian, secretary, La Salle street station, Chicago.

Air Brake Association.—The annual convention of this association will take place May 7-10 at the Hotel Jefferson, Richmond, Va. The subjects to be discussed are as follows: Recent Tests of Brake Shoes; The Cleaning Date; Westinghouse P. C. Equipment in Service; Report of the Committee on Air Hose Failures; the New York L. T. Equipment; Right-Angled Pipe Fittings in Air Brake Service; report of committee on Recommended Practice; the Westinghouse P. C. Equipment; Questions and Answers. F. M. Nellis, secretary, 53 State street, Boston, Mass.

M. M. and M. C. B. Conventions.—Following its usual custom, the Pennsylvania lines will provide a special train, to be known as the Master Car Builders' special, for the accommodation of delegates to the conventions of the American Railway Master Mechanics' Association, the Master Car Builders' Association and the Railway Supply Manufacturers' Association, to be held at Atlantic City, N. J., June 12-19. The train will leave Chicago at 3 p. m., Monday, June 10, and will arrive at Atlantic City at 2 p. m. on the following day. Summer tourist rates will be

RAILROAD CLUB MEETINGS

| CLUB. | NEXT MEETING. | TITLE OF PAPER. | AUTHOR. | SECRETARY. | ADDRESS. |
|-------------------------|---------------|--------------------------------------|---------------------------|-----------------------|-------------------------------------|
| Canadian | May 13 | Annual Meeting and Election | | Jas. Powell..... | Room 13, Windsor Hotel, Montreal. |
| Central | May 10 | Wireless Train Control..... | Frank Wyatt Prentice..... | H. D. Vought..... | 95 Liberty St., New York. |
| New England..... | May 13 | | | Geo. H. Frazier..... | 10 Oliver St., Boston, Mass. |
| New York..... | May 17 | Automatic Brake Slack Adjusters..... | W. H. Sauvage..... | H. D. Vought..... | 95 Liberty St., New York. |
| Northern | May 24 | | | C. L. Kennedy..... | 401 Superior St., Duluth, Minn. |
| Pittsburgh | May 18 | Vaudeville Entertainment | | J. B. Anderson..... | Union Station, Pittsburgh, Pa. |
| Richmond | | | | F. O. Robinson..... | C. & O. Ry., Richmond, Va. |
| S't'n & S. West'n | May 16 | Cast Steel Tender Frames..... | | A. J. Merrill..... | 218 Grant Bldg., Atlanta, Ga. |
| St. Louis..... | May 10 | The Local Freight Agent..... | R. O. Wells..... | B. W. Frauenthal..... | Union Station, St. Louis, Mo. |
| Western | May 21 | Annual Meeting | | Jos. W. Taylor..... | 390 Old Colony Bldg., Chicago, Ill. |

charged. Accommodations may now be reserved at the ticket office at 242 South Clark street, Chicago, and may be held until June 3

Master Boilermakers' Association.—The annual convention of this association will take place at the Fort Pitt Hotel, Pittsburgh, May 14 to 17. The subjects to be considered are: The Best Method of Applying and Caring for Flues; Steel vs. Iron Flues; Best Method of Staying the Front Portion of Crown Sheet on Radial Top Boilers; Advantages or Disadvantages of Fire Brick Arches and Arch Tubes; Circulation in Marine Return Tubular and Vertical Boilers; Advantages and Disadvantages of Oxy-Acetylene Process in Making Repairs to Boilers; Apprenticeship; Location of Feed Water Admission; When Is a Locomotive Boiler in Its Weakest Condition; Smoke Prevention and Spark Arrestors, and the Relation of Superheated Steam to the Upkeep of the Boilers. H. D. Vought, secretary, 95 Liberty street, New York.

ATLANTIC CITY CONVENTIONS

J. W. Taylor, secretary of the Master Mechanics' Association and the Master Car Builders' Association, has sent out to members a circular letter giving details regarding the entertainment features in connection with the conventions of these associations, which will be held in Atlantic City, June 12-19, inclusive. The announcement comes from Mr. Taylor this year rather than from the Railway Supply Manufacturers' Association, because, as Mr. Taylor's letter shows, the railway associations this year are contributing towards the expense of the entertainment features.

A charge of \$1 will be made for each badge issued to the members of the Master Car Builders' Association, in order to raise money with which to defray that association's portion of the expense, while no similar charge will be made for badges for the Master Mechanics' Association. The reason for this is that the Master Car Builders' Association, being an organization whose members represent the railways themselves, and whose expenses are paid by the railways, has no fund from which to meet this class of expenses, while the membership of the Master Mechanics' Association, being an individual affair of the members, and the money for its support being furnished by them, it can properly take the funds for this purpose from its treasury.

Mr. Taylor's letter is as follows:

At a meeting of the Joint Committee on Arrangements for the conventions in June, it was agreed that the expense connected with entertainments, procurement of badges, and such other details as are necessary in connection with the convention, should be borne by the three associations interested, viz.: Railway Supply Manufacturers' Association, Master Car Builders' Association and the American Railway Master Mechanics' Association on the following basis:

Music—Daily orchestra concerts on steel pier, Supplymen's Association. Informal dancing, one-third each. Incidental expenses in connection with informal dancing, 70 per cent. by Supplymen's Association, 30 per cent. by the other two associations. Musical entertainment, 70 per cent. by Supplymen's Association, 30 per cent. by the other two associations. Ball game, one-third each. Badges, cost to each association.

Inasmuch as these expenses are personal in character, being intended for entertainment purposes only, and not such as should be borne by the association, it has been decided, in order to provide a fund to meet them, that there be collected from each member at the time he registers and procures badges for himself, members of his family and guests, the sum of \$1 for each badge so procured, the fund thus obtained to be used under the direction of the Joint Committee on Arrangements in paying the above expenses.

The above arrangements for procurement of badges applies only to the Master Car Builders' Association, the Master Mechanics' Association badges being procured as formerly.

The free use of roller chairs has been dispensed with, but arrangements have been made with the Reed and Shill Chair Companies that coupon books will be provided as the following rates: Ten rides, \$2.50 each; 20 rides, \$5 each.

When the tickets are used, the book covers will be redeemed when presented to the chair companies, with a refund of 50 cents each on the ten-ride book and \$1 each on the twenty-ride book.

The following entertainment features have been provided:

Wednesday, June 12.

10:30 a. m.—Orchestra concert on Million-dollar Pier.

3:30 p. m.—Orchestra concert on Million-dollar Pier.

9:00 p. m.—Social gathering and informal dancing, Marlborough-Blenheim hotel.

Thursday, June 13.

10:30 a. m.—Orchestra concert on Million-dollar Pier.

3:30 p. m.—Orchestra concert on Million-dollar Pier.

9:30 p. m.—Informal dancing on Million-dollar Pier.

Friday, June 14.

10:30 a. m.—Orchestra concert on Million-dollar Pier.

3:30 p. m.—Orchestra concert on Million-dollar Pier.

9:00 p. m.—Musical program.

Saturday, June 15.

10:30 a. m.—Orchestra concert on Million-dollar Pier.

2:00 p. m.—Baseball; parade from Million-dollar Pier to street cars.

3:00 p. m.—Annual baseball game.

No scheduled entertainment in the evening.

Sunday, June 16.

No scheduled entertainment.

Monday, June 17.

10:30 a. m.—Orchestra concert on Million-dollar Pier.

3:30 p. m.—Orchestra concert on Million-dollar Pier.

9:00 p. m.—Informal dancing, Marlborough-Blenheim hotel.

Tuesday, June 18.

10:30 a. m.—Orchestra concert on Million-dollar Pier.

3:00 p. m.—Orchestra concert on Million-dollar Pier.

9:00 p. m.—Informal dancing on Million-dollar Pier.

The following list gives names of secretaries, dates of next or regular meetings, and places of meeting of mechanical associations.

AIR BRAKE ASSOCIATION.—F. M. Nellis, 53 State St., Boston, Mass. Convention, May 7-10, Hotel Jefferson, Richmond, Va.

AMERICAN RAILWAY MASTER MECHANICS' ASSOC.—J. W. Taylor, Old Colony building, Chicago. Convention, June 17-19, Atlantic City, N. J.

AMERICAN RAILWAY TOOL FOREMEN'S ASSOCIATION.—M. H. Bray, N. Y., N. H. & H., New Haven, Conn. Convention, July 9, Chicago.

AMERICAN SOCIETY FOR TESTING MATERIALS.—Prof. E. Marburg, University of Pennsylvania, Philadelphia, Pa.

AMERICAN SOCIETY OF MECHANICAL ENGINEERS.—Calvin W. Rice, 29 W. 39th St., New York. Spring meeting, May 28-31, Cleveland, Ohio.

CAR FOREMEN'S ASSOCIATION OF CHICAGO.—Aaron Kline, 841 North 50th Court, Chicago; 2d Monday in month, Chicago.

INTERNATIONAL RAILWAY FUEL ASSOCIATION.—D. B. Sebastian, La Salle St. Station, Chicago. Convention, May 22-25, Hotel Sherman, Chicago.

INTERNATIONAL RAILWAY GENERAL FOREMEN'S ASSOCIATION.—L. H. Bryan, Brown Maxx building, Birmingham, Ala. Convention at Chicago, July 23-26, 1912.

INTERNATIONAL RAILROAD MASTER BLACKSMITHS' ASSOCIATION.—A. L. Woodworth, Lima, Ohio. Convention, August 15, Chicago.

MASTER BOILER MAKERS' ASSOCIATION.—Harry D. Vought, 95 Liberty St., New York. Convention, May 14-17, Fort Pitt Hotel, Pittsburgh, Pa.

MASTER CAR BUILDERS' ASSOCIATION.—J. W. Taylor, Old Colony building, Chicago. Convention, June 12-14, Atlantic City, N. J.

MASTER CAR AND LOCOMOTIVE PAINTERS' ASSOC. OF U. S. AND CANADA.—A. P. Dane, B. & M., Reading, Mass. Convention, September 10-13, Denver, Col.

RAILWAY STOREKEEPERS' ASSOCIATION.—J. P. Murphy, Box C, Collinwood, Ohio. Convention, May 20-22, Statler Hotel, Buffalo, N. Y.

TRAVELING ENGINEERS' ASSOCIATION.—W. O. Thompson, N. Y. C. & H. R., East Buffalo, N. Y., August, 1912.

PERSONALS

GENERAL.

W. P. HAWKINS, fuel inspector of the Western Maryland, has resigned to go with the Missouri Pacific.

W. L. SCOTT has been appointed motive power inspector of the Pennsylvania Lines West of Pittsburgh, at Columbus, Ohio, vice C. S. White, promoted.

J. B. KAPP has been appointed assistant master mechanic of the Allegheny division of the Pennsylvania Railroad, with headquarters at Oil City, Pa.

W. J. HURLEY, formerly road foreman of engines of the New York Central, has been appointed chief examiner of firemen for promotion in the western district.

W. J. TOLLERTON, assistant general superintendent of motive power of the Rock Island Lines at Chicago, has had his official title changed to mechanical superintendent.

D. J. Sisson, formerly engine driver of the Empire State express on the New York Central, has been appointed chief examiner of firemen for promotion for the eastern district.

S. W. MULLINX, superintendent of motive power of the Rock Island Lines, second district, with office at Topeka, Kan., has had his official title changed to district mechanical superintendent.

J. B. KILPATRICK, superintendent of motive power of the Rock Island Lines, first district, with office at Davenport, Iowa, has had his official title changed to district mechanical superintendent.

C. M. TAYLOR, superintendent of motive power of the Rock Island Lines, third district, with office at El Reno, Oklahoma, has had his official title changed to that of district mechanical superintendent.

J. A. GIBSON, formerly master mechanic of the Cleveland, Cincinnati, Chicago & St. Louis at Urbana, Ill., has been appointed combustion engineer of the Illinois Traction System, with headquarters at Urbana.

H. H. HONAKER, master mechanic of the Frisco system, has been transferred from Birmingham, Ala., to Ft. Scott, Kan., where he will have charge of the mechanical work of the Northern division of that road.

J. E. FITZSIMONS, road foreman of engines of the Central Vermont of St. Albans, Vt., has been appointed acting superintendent of motive power and car department, with office at St. Albans, succeeding T. McHattie, resigned.

H. A. ENGLISH has been appointed locomotive inspector of the Canadian Northern, with office at Winnipeg, Man. He will supervise the examination of enginemen and report to the superintendent of rolling stock on matters pertaining to locomotive operation.

T. MCHATTIE, who recently resigned as superintendent of motive power and car department of the Central Vermont, has been appointed master mechanic of the Eastern division of the Grand Trunk, with office at Montreal, Que., succeeding J. Duguid, assigned to other duties.

W. L. ROBINSON, former special inspector of the mechanical department of the Baltimore & Ohio, has been made road foreman of engines of the Baltimore division, at Baltimore. Mr. Robinson is a graduate of Purdue University, and entered the service of the Baltimore & Ohio as a special shop apprentice. He afterwards became engine house foreman at Garrett, Ind., from which position he advanced to special inspector of the mechanical department. Upon the organization of the Baltimore & Ohio safety campaign, Mr. Robinson was appointed on the general committee representing the mechanical department, and through his in-

terest in the movement a number of important safety devices were adopted in the shops.

PEARL F. SMITH, chief draftsman of the Chicago, St. Paul, Minneapolis & Omaha, at St. Paul, Minn., has been appointed mechanical engineer, with office at St. Paul. Mr. Smith was born



Pearl F. Smith.

in 1878, and was graduated from the St. Paul high school in 1898. Four years later he went in the drawing room of the Northern Pacific and served on that road from 1902 to 1905 as tracer and draftsman. He then went with the Louisville & Nashville as draftsman and drawing room foreman. His service with this road extended from 1905 to 1907, when he resigned to go with the Chicago, St. Paul, Minneapolis & Omaha as chief draftsman, serving the later in that capacity until his recent appointment. Mr. Smith was a contributor to the *Rail-*

way Age Gazette Shop Section, having participated in the shop kink competition, which closed January 15, 1911.

V. C. RANDOLPH has been appointed master mechanic of the Erie, with office at Avon, N. Y. He was born on October 19, 1869, at Randolph, N. Y., and was educated in the common schools at Salamanca.

He began railway work in March, 1882, as a machinist apprentice on the New York, Lake Erie & Western, now the Erie, and after completing his apprenticeship he worked as a machinist until July, 1886, when he went to the Allegheny division as locomotive fireman, and was made an engineman in April, 1891. He remained in that position until July, 1902, and then became locomotive and air-brake instructor at the International Correspondence Schools of Scranton, Pa. In November, 1904, he returned to the service of

the Erie as general air-brake instructor, and was promoted in January, 1910, to supervisor of locomotive operation of the Allegheny and Bradford divisions, which position he held at the time of his recent appointment as master mechanic of the Rochester division of the same road.



V. C. Randolph.

CAR DEPARTMENT

W. GILLESPIE has been appointed master car builder of the Central Vermont, with office at St. Albans, Vt.

C. E. DUM has been appointed car foreman of the Denver & Rio Grande at Hoisington, Kan., vice A. L. Latham, resigned.

D. C. ROSS has been appointed master car builder of the Michigan Central, with office at Detroit, Mich., vice J. A. Chubb, deceased.

P. KASS, formerly of the Pullman Company, has been appointed general car foreman of the Fifty-first street yards of the Chicago, Rock Island & Pacific, vice C. Anderson, resigned.

O. J. PAGE has been appointed general car foreman of the Arkansas division of the Chicago, Rock Island & Pacific, with headquarters at Argenta, Ark., vice C. H. Westfall, resigned on account of ill health.

SHOP

J. D. LEWIS has been appointed gang foreman of the Denver & Rio Grande at Salida, Colo., vice T. A. Owen, resigned.

E. J. NEUNAN has been appointed foreman of the Norfolk & Western at East Radford, Va., vice T. L. Brown, transferred.

J. T. HEIDLER has been appointed general foreman of the Norfolk & Western at Bluefield, W. Va., vice J. W. Andrews, resigned.

R. L. BLACK has been appointed general foreman of the Norfolk & Western at Columbus, Ohio, vice J. T. Heidler, transferred.

P. E. BAUM has been appointed night engine house foreman of the Denver & Rio Grande at Salida, Colo., vice A. H. Asher, resigned.

H. F. JONES has been appointed foreman boilermaker of the Denver & Rio Grande at Salida, Colo., vice F. J. Gussenhoven, resigned.

T. L. BROWN has been appointed general foreman of the Norfolk & Western, with office at Kenova, W. Va., vice R. L. Black, transferred.

J. LYDDON, engine inspector of the Atchison, Topeka & Santa Fe, has been appointed engine house foreman of that road, at Barstow, Cal.

THOMAS MULVIHILL has been appointed foreman boilermaker of the Chicago, Rock Island & Pacific at Argenta, Ark., vice W. E. Keating.

W. E. ALLISON has been appointed night engine house foreman of the Norfolk & Western at West Roanoke, Va., vice T. H. Adams, transferred.

E. A. SWEeley has been appointed foreman of the engine house and car department of the Chicago, Rock Island & Pacific at Invergrove, Minn., vice F. Coates, assigned to other duties.

PURCHASING AND STOREKEEPING

A. M. DARLOW, mechanical engineer of the Buffalo & Susquehanna at Galeton, Pa., has been appointed also general storekeeper.

C. F. PARKER, purchasing agent of the Illinois Central, and vice-president of the St. Louis, Belleville & Southern, with office at Chicago, has been elected also vice-president of the Central of Georgia.

G. E. SMITH has been appointed purchasing agent of the Louisiana Railway & Navigation Company, with office at Shreveport, La., succeeding C. L. Vaughn, superintendent of transportation and purchasing agent, resigned to accept service with another company.

OBITUARY

J. F. SIMPSON, foreman of the tin and pipe shops of the Southern Railway at Coster, Tenn., died in the Lincoln Memorial hospital April 11. Mr. Simpson had been with the Southern Railway for 25 years, and was 67 years old at the time of his death.

NEW SHOPS

ANN ARBOR.—Additions will be made to the shops at Owosso, Mich.

ATCHISON, TOPEKA & SANTA FE COAST LINE.—A 25-stall engine house and trackage, water and drainage system will be constructed at Barstow, Cal., at a cost of approximately \$133,000, to replace the structures destroyed by fire June 23, 1911.

BALTIMORE & OHIO.—An electrical sub-station will be built at Mt. Clare, Baltimore, Md., to provide additional power required in the operation of shop machinery and in equalizing the distribution of electric current on the Baltimore Belt Line.

CANADIAN PACIFIC.—It is reported that \$600,000 will be spent in terminal facilities at Coquitlam, B. C., which will include an engine house, car repair shops, machine shops, etc., and 25 miles of track. An addition is to be made to the engine house at Brandon, Man.

CHICAGO, MILWAUKEE & PUGET SOUND.—It is reported that improvements will be made to the Tacoma, Wash., car shop, which will nearly double its capacity.

CHICAGO, MILWAUKEE & ST. PAUL.—An engine house will be built at Aberdeen, S. Dak., at an estimated cost of \$75,000.

ILLINOIS CENTRAL.—The repair shops at East St. Louis, which were recently burned, will be rebuilt at a cost of approximately \$75,000.

KANSAS CITY SOUTHERN.—It is reported that plans have been made for the erection of a six-stall engine house, a 90-ft. turntable, a machine shop, a coaling plant, and other buildings for this road at Watts, Okla.

NORFOLK SOUTHERN.—It is reported that a new repair shop will be built at West Munden, Va., near south Norfolk. The land has been purchased, and it is expected that the work will be started this coming summer.

NORFOLK & WESTERN.—It is reported that plans are prepared for the new shops at West Munden, Va. The estimated cost is \$500,000.

NORTHERN PACIFIC.—Contracts have been awarded for the construction of a new engine house and shop at Centralia, Wash.

SOUTHERN PACIFIC.—Plans are being prepared for larger car shops at Oswego, Oregon.

VIRGINIAN.—An officer writes that a contract has been given to the George B. Swift Company, Chicago, for building an erecting shop at Princeton, W. Va. The Roanoke Bridge Works has the contract for the steel work. The structure is to be 55 ft. high, 127 ft. 6 in. x 270 ft., and will be of steel and brick construction with gravel roof. The improvements will cost \$80,000, not including one 20-ton and one 200-ton crane, which have been ordered from the Niles-Bement-Pond Company. The same contractors have been given a contract to build an extension to the stripping shop, 70 ft. x 100 ft., to cost about \$12,000, to be used as a boiler shop. This building is to be of steel and brick construction, and will be equipped with a 30-ton crane. An additional contract has been given to the George B. Swift Company, for the foundations for a transfer table, 75 ft. x 410 ft., to cost about \$13,500, and to the Whitney Foundry & Equipment Company for the table.

WESTERN MARYLAND.—Contracts have been given to the Roberts & Schaefer Company, Chicago, for four large Holman locomotive coaling stations to be built at Hagerstown and at Cumberland, Md., at Rockwood, Pa., and at West Virginia Central Junction, W. Va. Two of the stations will be of 500 tons capacity, and are to be built to span and coal on four main-line tracks, having 24 ft. centers.

SUPPLY TRADE NOTES

The American Locomotive Company is making additions to its plant at Montreal, Can.

The Cambria Steel Company, Johnstown, Pa., has moved its Chicago office to 1860 McCormick building.

The Laconia Car Company, Boston, Mass., has moved its general offices from 141 Milk street to 60 Congress street.

L. R. Romeroy, consulting engineer, has moved his office from 30 Church street, New York, to 105 West Fortieth street.

The Lima Locomotive & Machinery Company, Lima, Ohio, will construct a two-story machine shop, 150 ft. x 350 ft.

The Harlan & Hollingsworth Corporation of Wilmington, Del., has awarded a contract for the erection of a large steel car shop.

The Railway Materials Company, Chicago, has moved its general office from the Old Colony building to the Railway Exchange.

Edgar Allen & Company, Limited, Chicago, steel manufacturers, has moved its office to larger quarters at 718-722 West Lake street.

The O'Malley-Bears Valve Company, Chicago, maker of the Multiple line of valves, has moved its general office to 333 Railway Exchange.

The Scullin-Gallagher Iron & Steel Company, St. Louis, Mo., has moved its New York office from 1 Wall street to the Grand Central Terminal.

R. L. Langtim has been appointed mechanical superintendent of the Western Railway Equipment Company, St. Louis, Mo., with office in that city.

H. M. Baxter, formerly with the Wolfe Brush Company, Pittsburgh, Pa., has been appointed manager of the railway department of the Kip Brush Company, New York City.

Herbert Wolff, mechanical engineer of the American Car & Foundry Company, New York, has been made assistant to Vice-President J. M. Buick, with office in St. Louis, Mo.

The Toledo Machine & Tool Company, Toledo, Ohio, has closed contracts for a three-story steel and brick building, 90 ft. x 115 ft., which will be added to its present plant.

C. E. Thomas has resigned his position as general foreman of water works of the Illinois Central, to go with the Central Material & Construction Company at Mt. Pulaski, Ill.

George F. Stalley, purchasing agent of the Browning Engineering Company, Cleveland, Ohio, has also been made advertising manager of that company; vice L. C. Pelott, resigned.

The railway sales department of John Lucas & Co., Philadelphia, Pa., manufacturers of paints, has moved its Chicago office from the Old Colony building to 945 Peoples Gas building.

Gardner Cornett, vice-president of the American Steam Gauge & Valve Manufacturing Company, Boston, Mass., and manager of the New York office, is to make a business trip through England.

The Chicago office of the Niles-Bement-Pond Company, New York, has been moved from the Commercial National Bank building to the McCormick building, 332 South Michigan avenue, Chicago.

The Pennsylvania Tank Car Company, Sharon, Pa., has awarded the contract for the erection of a building 250 ft. x 40 ft. When completed the company will have increased its capacity to five finished cars a day.

Milliard P. Osbourn, formerly assistant sales manager of the Westinghouse Electric & Manufacturing Company, at Boston, Mass., has become a member of the firm of Samuel W. Green & Company, Springfield, Mass.

Robert E. Frame, who has been connected with the American Car & Foundry Company, New York, for several years, has resigned to become connected with the Haskell & Barker Car Company, Michigan City, Ind.

The American Sheet & Tin Plate Company, Pittsburgh, Pa., having completed a series of service tests extending over several years, is now making all roofing terne plates exclusively from copper bearing open hearth steel.

William H. Winterrowd, formerly assistant engineer in the mechanical department of the Lake Shore & Michigan Southern, has been appointed mechanical engineer of the Damascus Brake Beam Company, Cleveland, Ohio.

The American Railway Supply Company, New York, has moved its general office from 24 Park Place, to its new factory building at 134-136 Charles street. The company has been located at the former address for 22 years.

John H. Long, for the past eight years sales engineer for the William Tod Company, Youngstown, Ohio, has resigned to take a similar position with the United Engineering & Foundry Company. His headquarters will be in Youngstown.

Nathan Owitz has been appointed manager of the Cincinnati, Ohio, office of the Wheeler Condenser & Engineering Company, Carteret, N. J. Mr. Owitz has been in the sales department in the home office of this company for the past six years.

The Ralston Steel Car Company, Columbus, Ohio, is making extensive improvements to its plant by enlarging the buildings and adding new machinery. When these improvements are completed the company will have a capacity of at least 40 cars a day.

J. W. Mack, secretary and treasurer of the Nathan Manufacturing Company, New York, died April 11, following an operation. Mr. Mack had been secretary and treasurer of the Nathan company ever since its organization in 1883, when it succeeded Nathan & Dreyfus.

R. A. Dugan, formerly assistant general manager of the Southern Railway, has gone to the Scullin-Gallagher Iron & Steel Company, St. Louis, Mo., to take charge of the sales department of its Chicago office. The exact location of this office has not yet been determined.

The plant of the Buffalo Foundry & Machine Company, Buffalo, N. Y., was damaged by fire to the extent of \$10,000 on April 11. The greatest damage was done to the roof, as the rest of the building was of practically fireproof construction. Work was only interrupted for four or five days.

Interests associated with the Nova Scotia Car Works, Halifax, N. S., have organized the Ontario & Western Car Company, Limited, with a capitalization of \$5,000,000, and have announced the intention of erecting immediately a modern car-building plant at Port Arthur, Ont., to employ about 1,000 men.

Benjamin Guggenheim, president and director of the International Steam Pump Company, the Blake & Knowles Steam Pump Works, Henry R. Worthington, the Laidlaw-Dunn-Gordon Company, and the Power & Mining Machinery Company, all of New York, was lost at sea in the wreck of the White Star steamship Titanic, April 15.

The Reed-Prentice Company, Worcester, Mass., has recently been incorporated with \$2,500,000 capital. This corporation is a merger of the following companies, all of Worcester: The F. E. Reed Company, manufacturer of lathes; the Prentice Brothers Company, manufacturer of geared head lathes and drills; the Reed Foundry Company, manufacturer of heavy ma-

chinery; the Reed & Curtis Machine Screw Company, manufacturer of machine screws and machine tools, and the Crompton Associates, manufacturers of heavy machinery and tools.

The Storrs Mica Company, Owego, N. Y., has taken the general agency for the railway trade of the Indestructible hose clamp, made by the Thompson Manufacturing Company, Newark, Ohio. These clamps are used on air brake, air signal, steam and water hose. Sales of this device will be in charge of Charles P. Storrs, manager of the railway department of the Storrs company.

At the annual stockholders' meeting of the Joseph Dixon Crucible Company, Jersey City, N. J., the retiring board of directors was unanimously re-elected and the following officers were elected for the ensuing year: President, George T. Smith; vice-president, W. H. Corbin; treasurer, George E. Long; secretary, Harry Dailey; assistant treasurer and assistant secretary, J. H. Schermerhorn.

The Greenfield Tap & Die Company, Greenfield, Mass., was organized in Boston on April 2 as a holding company. The capital of the company will consist of \$1,000,000 preferred stock and \$1,000,000 common stock. The company owns two-thirds of the stock of the Wiley & Russell Manufacturing Company, Greenfield, manufacturer of taps and dies, and a controlling interest in the Wells Brothers Company, Greenfield, also manufacturer of taps and dies, and expects soon to own the entire stock issue of the latter company.

The Pittsburgh Steel Foundry Company, Pittsburgh, Pa., has acquired all of the stock of the Pittsburgh Equipment Company, and the business of the latter company will hereafter be conducted under its name. The Pittsburgh Steel Foundry Company has increased its capital stock to \$1,000,000, and is enlarging its plant to provide better facilities for designing and manufacturing the line of cast steel equipment for freight car bodies and freight car trucks, which was developed by the Pittsburgh Equipment Company.

The Joliet Railway Supply Company, Joliet, Ill., announces that in addition to the Perry anti-friction side bearings it has made arrangements for the exclusive manufacture and sale of the improved Hartman anti-friction center plate. In addition to its works at Joliet, the company is now equipping and will operate a large plant at Fortieth street and Princeton avenue, Chicago, to which point it will remove its general office from Joliet and its Chicago office from the Fisher building, maintaining sales offices only at the Karpen building, Chicago, Mutual building, Richmond, Va., and Syndicate Trust building, St. Louis, Mo.

On March 28, the United States District Court for the district of New Jersey, in an opinion by Judge Cross, handed down its decision in a suit of the Westinghouse Air Brake Company, Pittsburgh, Pa., vs. the New York Air Brake Company, New York. The complainant alleged that patent No. 912,511, covering the K-triple valve, and patent No. 912,512, for a check valve, had been infringed by the defendant. The court decided in favor of the complainant as to the K-triple valve patent, but dismissed the complaint as to the other patent, it being evidently of minor importance and value, and the court holding it invalid.

Abram E. Smith, mechanical engineer of the Union Tank Line Company, New York, has been appointed assistant master car builder, with office at New York, succeeding Thomas Beaghen, Jr., promoted. Mr. Smith was born in Hereford, Eng., on February 2, 1879, and entered the service of the Union Tank Line Company on February 12, 1902, as a stenographer and draftsman. During the period from 1902 to 1907, he attended the evening classes at the Cooper Institute, and later was graduated from the Cooper Union School of Science. On May 1, 1907, he was made mechanical engineer of the Union Tank Line Company, which position he held until his recent promotion

The National Tube Company, Pittsburgh, Pa., which recently sold \$10,000,000 in bonds, will increase its capital stock from \$9,000,000 to \$13,000,000. This \$4,000,000 stock will be bought at par by the Federal Steel Company, New York, which is a subsidiary of the United States Steel Corporation, and which now owns all the outstanding stock of the tube company. The proceeds of the sale of the bonds and stock will be used to reimburse the United States Steel Corporation and subsidiary companies of the corporation for money borrowed from them to pay for actual outlays, for additions and extensions to the National Tube Company's plant, and for working capital. When this re-adjustment has been made the National Tube Company will have no floating debt.

Arthur M. Kittredge has resigned as president of the Barney & Smith Car Company, Dayton, Ohio. Probably no successor will be elected until the annual meeting in June. Mr. Kittredge entered the service of the Barney & Smith Car Company in 1884 as salesman, and was appointed assistant superintendent in 1886. He was superintendent from 1888 to 1900, when he was elected vice-president. This office he held until November, 1908, when he was chosen president to succeed Colonel J. D. Platt. Mr. Kittredge is widely known among railway officers and manufacturers of railway equipment and is considered an authority on matters of car construction. He remains a member of the board of directors of the Barney & Smith Company, being also a director of many industrial and financial institutions. Since the organization of the Railway Business Association Mr. Kittredge has been very actively identified with its work and is now one of its vice-presidents.

Thomas Beaghen, Jr., assistant master car builder of the Union Tank Line Company, New York, has been appointed master car builder, with office at New York, succeeding Charles M. Bloxham, who has retired on account of ill health. Mr. Beaghen was born on April 20, 1876, in Hancock, Delaware county, New York. After graduating from the Hancock high school and taking several special courses in mathematics, chemistry, etc., he graduated from the Pratt Institute of Technology. He also took a special course of mechanical engineering at Lehigh University. He then entered the mechanical department of the New York Central, and later was connected with the American Steel Foundries Company and the United States Metal & Manufacturing Company. Mr. Beaghen entered the service of the Union Tank Line Company on March 15, 1909, as inspector of materials, and was made assistant master car builder on June 1, 1910, which position he held at the time of his recent appointment as master car builder.

John Mather Wallis, assistant to the president of the Safety Car Heating & Lighting Company, New York, since 1909, died of heart disease at his home at East Orange, N. J., April 5. Mr. Wallis was born at New Orleans, La., December 10, 1853. After graduating from the Stevens Institute of Technology in 1876, he entered railway service in the Baltimore, Md., shops of the Northern Central. He was assistant road foreman of engines of the Northern Central and Baltimore & Potomac, November, 1879, to December, 1881; assistant engineer of tests of the Pennsylvania Railroad at Altoona, Pa., December 1, 1881, to June 1, 1882; superintendent of motive power of the Northern Central, June 1, 1882, to June 1, 1883; superintendent of motive power of the Philadelphia, Wilmington & Baltimore, June 1, 1883, to June 1, 1890; superintendent of motive power of the Pennsylvania Railroad division of the Pennsylvania Railroad, June 1, 1890, to October 26, 1896; general superintendent of the Philadelphia & Erie and the Northern Central, October 26, 1896, to January 1, 1899; general superintendent of the Pennsylvania Railroad division of the Pennsylvania Railroad, January 1, 1899, to 1903. In 1903 Mr. Wallis retired from railway service, and in 1909 he went to the Safety Car Heating & Lighting Company as assistant to the president.

CATALOGS

NUT TAPPING MACHINE.—The National Machinery Company, Tiffin, Ohio, has published a leaflet telling how its tapping machine will prevent the general breaking of taps.

DOOR FIXTURES.—The Railway Utility Company, Chicago, has issued a new booklet describing its line of automatic locks for freight car doors, double roller door hangers, and other door fixtures.

TOOL STEEL.—The Tool Steel Gear & Pinion Company, Cincinnati, Ohio, has issued a small illustrated booklet containing service records for gears and pinions in use on a number of electric railways.

WHEEL PRESSES.—The Watson-Stillman Company, New York, has published catalog No. 85, describing its hydro-pneumatic wheel presses. The catalog gives illustrations and detailed descriptions.

HYDRO RECORDERS.—Heriman Bacharach, Pittsburgh, Pa., has issued a series of pamphlets describing the various uses of hydro recorders. These instruments may be used for measuring draft, velocity, volume and pressure of air and water.

WATER FLOW METERS.—The General Electric Company, Schenectady, N. Y., has issued bulletin No. 4941, which contains a description of the G-E water flow meters, and supersedes the bulletins heretofore published on this subject.

MACHINE TOOLS.—The Betts Machine Company, Wilmington, Del., has recently issued catalog No. 1R, illustrating various heavy horizontal and vertical boring mills, slotters and planers that have been installed in various railway and locomotive shops.

CAR ROOFING.—The Hutchins Car Roofing Company, Detroit, Mich., has issued a new illustrated catalog describing and illustrating both by detail drawings and photographs, its various types of outside metal roofs, inside all-metal roof, and plastic car roofing.

HYDRAULIC BENDERS.—The Watson-Stillman Company, New York, has recently issued catalog No. 83, containing 64 pages and describing its hydraulic machines. Special mention is made of the hydraulic benders, which are used for bending rails, rods, pipes, automobile frames, shafts, etc.

ELECTRIC TOOLS.—The Chicago Pneumatic Tool Company, Chicago, has issued bulletins E 19, E 20, E 21 and E 23, describing its Universal electric drill for direct or alternating current, a new line of electric drills for heavy duty, the Duntley electric track drill, and air-cooled direct current drills.

RECORDING GAGE.—The Ashton Valve Company, Boston, Mass., has issued circular No. 50, describing its wheel press recording gage, duplex steam gage, triplex air gage, inspector's testing and proving outfit, locomotive gage cocks, train brake and signal cocks, test gages and pressure gage tester.

LIQUID FOR HYDRAULIC TOOLS.—The Watson-Stillman Company, New York, has issued Bulletin J, which describes a new liquid, called Jackohol, for hydraulic tools. It does not thicken, freeze, gum or change in chemical composition and protects the metal surfaces and packings with which it comes in contact.

EQUIPMENT AND SUPPLIES.—The Walter A. Zelnicker Supply Company, St. Louis, Mo., has published in a small booklet a list of its new and second-hand equipment and supplies, including locomotives, cars, contractors' supplies, track supplies, dredges, derricks, pumps, scales, engines, hoists, steam shovels, etc.

CAR VENTILATION.—The Railway Utility Company, Chicago, has issued a small folder describing the Utility car ventilator, which is operated by a jet action caused by a downward rush

of air between the body of the ventilator and an outer ring which siphons air from the interior of the car through an inner ring.

ELASTIC CORRUGATED TUBES.—O. N. Beck, 11 Queen Victoria street, London, E. C., has issued a catalog on the elastic corrugated tubes for expansion joints, heating and smoke tubes, superheaters, condensers, etc. These tubes have a uniform thickness throughout and will bend to a very small radius, and may be made to form most any connection.

MOTORS.—The General Electric Company, Schenectady, N. Y., has devoted bulletin No. 4915 to its type CVC, direct current motors of the commutating pole design. These motors embody certain improvements over those described in the company's previous bulletin on this subject. The bulletin amply illustrates and describes the motors and includes rating tables.

METALLIC HOSE JOINTS.—The Greenlaw Manufacturing Company, Boston, Mass., has issued catalog describing its flexible metallic joints. These joints will swing 50 deg. in any direction and are found to be especially useful for hose lines between cars and between the engine and tender; also for blower apparatus in engine houses. They are constructed for 200 lbs. pressure.

SCULLY BLUE BOOK.—The Scully Steel & Iron Company, Chicago, has recently issued its 1912 "Blue Book," which is a very complete catalog of its stock with the list prices. This book is intended to take the place of the monthly stock list recently issued by this company, and besides covering its products has tables and information which will be found valuable to its customers.

SMOKELESS CHIMNEYS.—The Furnace Gas Consumer Company, Matteawan, N. Y., has issued a 12-page pamphlet describing the furnace gas consumer, a device consisting of a bank of fire clay tubes installed in the space back of the bridge wall and underneath the boiler. It is claimed that these tubes become white hot, and in that condition they serve to complete the combustion of gases.

SMALL POLYPHASE MOTORS.—The General Electric Company, Schenectady, N. Y., has issued bulletin No. 4933, describing its small polyphase motors of riveted frame construction. These motors are for two and three-phase circuits and wound for 25, 40 and 60 cycles. They range from $\frac{3}{4}$ to 15 h. p. This bulletin describes both horizontal and vertical motors, and contains illustrations of various applications of the motors.

FILES.—The Vixen Tool Company, Philadelphia, Pa., has issued Bulletins A, B and C describing the Vixen files. These have deep semi-circular teeth, so formed that they will give off filings which resemble the turnings from a lathe or milling machine. The semi-circular tooth prevents clogging. Different types of files are clearly described and illustrated in these bulletins. Bulletin C is a report of tests made on this file by the Franklin Institute.

MACHINISTS' TABLES.—The Pratt & Whitney Company, Hartford, Conn., has issued a folding cardboard table which is of special value to machinists, and when folded is 7 in. x 15 in. The following tables are presented: U. S. standard screw threads; table of drilling speeds; metric standard screw threads; standard dimensions of wrought iron welded tubes; pitch or angular diameters of hand taps, and the A. S. M. E. standard for machine screws.

STEAM CHART.—The De Laval Steam Turbine Company, Trenton, N. J., has issued a Mollier diagram with a special scale that is used to facilitate the reading of the diagram. This scale has four sets of divisions by which the pounds of steam per horse power hour; the duty in million foot lbs. per thousand lbs. of steam; the velocity in feet per second, and the B. t. u.'s per lb. of fuel may be easily determined. Full directions are given on the back of the diagram for the use of the chart and the scale.

AMERICAN ENGINEER

"THE RAILWAY MECHANICAL MONTHLY"

(Including the Railway Age Gazette "Shop Edition.")

PUBLISHED ON THE FIRST THURSDAY OF EVERY MONTH, BY THE
SIMMONS-BOARDMAN PUBLISHING COMPANY,
83 FULTON STREET, NEW YORK, N. Y.

CHICAGO: Plymouth Bldg. CLEVELAND: Citizen's Bldg.
LONDON: Queen Anne's Chambers, Westminster.

EDWARD A. SIMMONS, *President.* HENRY LEE, *Secretary.*
L. B. SHERMAN, *Vice-President.* A. E. HOOVEN, *Business Manager.*

The address of the company is the address of the officers.

ROY V. WRIGHT, *Editor.* R. E. THAYER, *Associate Editor.*
E. A. AVERILL, *Managing Editor.* WILLIAM FORSYTH, *Associate Editor.*
GEORGE L. FOWLER, *Associate Editor.*

Subscriptions, including the eight daily editions of the *Railway Age Gazette* published in June in connection with the annual conventions of the Master Car Builders' and American Railway Master Mechanics' associations, payable in advance and postage free:

United States, Canada and Mexico.....\$2.00 a year
Foreign Countries (excepting daily editions)..... 3.00 a year
Single Copy 20 cents

Entered at the Post Office at New York, N. Y., as mail matter of the second class.

VOLUME 86. JUNE, 1912. NUMBER 6.

CONTENTS

EDITORIALS:

| | |
|-----------------------------------|-----|
| Our July Issue..... | 273 |
| The June Dailies..... | 273 |
| Reclaiming Scrap Material..... | 273 |
| The May Conventions..... | 273 |
| Shop Practice Competition..... | 274 |
| Absorbent Towels vs. Waste..... | 274 |
| The Brick Arch..... | 274 |
| Repairing Driving Boxes..... | 274 |
| Notes on the Fuel Convention..... | 275 |
| New Books..... | 275 |

ILLUSTRATED:

| | |
|--|-----|
| Repairing Locomotive Driving Boxes..... | 276 |
| Cylinder Head Carrier..... | 279 |
| Master Boiler Makers' Association..... | 280 |
| The Most Powerful Locomotives..... | 287 |
| International Railway Fuel Association..... | 290 |
| Paint Brush Storage..... | 307 |
| Spiral Staybolt..... | 308 |
| Tire Transfer Cart..... | 308 |
| Annual Meeting of Air Brake Association..... | 315 |
| Self Cleaning Ore Car..... | 319 |
| Glass Engine Numbers..... | 321 |
| Heavy Duty Lathe..... | 322 |
| Machine Tool Motor Applications..... | 322 |
| Boring with a Radial Drill..... | 323 |

MISCELLANEOUS:

| | |
|--|-----|
| Railway Storekeepers' Association..... | 309 |
| Three-Cylinder Simple Locomotive..... | 314 |
| Tests of Jacobs-Shupert Firebox..... | 323 |

GENERAL NEWS SECTION:

| | |
|-------------------------------|-----|
| Notes..... | 324 |
| Meetings and Conventions..... | 325 |
| Personals..... | 326 |
| New Shops..... | 328 |
| Supply Trade Notes..... | 328 |
| Catalogs..... | 330 |

Our July Issue

The four conventions reported in this issue were all so important, from the standpoint of *American Engineer* readers, that we have been compelled to devote a much larger part of the paper to them than was at first expected, and among other things a large number of shop kink and shop practice articles, which were intended for this issue, have had to be held over. To offset this a much larger portion of the July issue will be devoted to these subjects than has been customary.

The June Dailies

American Engineer readers will receive copies of the eight issues of the *Daily Railway Age Gazette*, which is published at Atlantic City, N. J., during the Master Car Builders' and Master Mechanics' conventions, June 12-19. The practice of the *American Engineer* has always been to publish abstracts of the proceedings of these conventions in its July and August issues, but this will be discontinued this year, because of the arrangement whereby its readers will receive a detailed account of the proceedings in the *Daily Railway Age Gazette*. Many of our readers will undoubtedly want to bind the dailies with the *American Engineer* at the end of the year, and our annual index will therefore include all of the articles in the *Daily Railway Age Gazette*, as well as the *American Engineer*.

Reclaiming Scrap Material

This problem came up at the annual meeting of the Railway Storekeepers' Association in two different forms. The committee on recommended practices advocated the installation of a special salvage department which would come under the direct control of the storekeeping, or supply department, and whose duty it would be to gather up all obsolete and scrap material, and arrange for reclaiming or selling it. E. J. McVeigh, a member of the committee, also read an extensive paper, in which he drew attention to the abuses which could be corrected if this matter was placed in the hands of a separate department, instead of being left to several departments, or individuals, no one of which was entirely responsible. J. H. Callaghan's paper on Line Inspection also touched on the improvements which could be made in the proper use of materials, and the reclaiming of scrap and second-hand material, by having an inspection team of officers make frequent trips over each division. Abstracts of both of these papers, and the discussions on them, will be found in another part of this issue.

The May Conventions

The conventions of the four associations, which met in May, and which are reported in this issue, were more than ordinarily successful, both as to attendance and the grade of the papers and the reports which were presented, and the way in which they were discussed. Three of the associations have decided upon the place of meeting for next year, two going to Chicago and one to St. Louis. It is rather significant that all four of the new presidents are from the middle west. H. A. Wahlert, the new president of the Air Brake Association, is with the Texas & Pacific; M. O'Connor, president of the Master Boiler Makers' Association, is with the Chicago & North Western at Missouri Valley, Ia.; J. R. Mulroy, president of the Railway Storekeepers' Association, is with the St. Louis & San Francisco at Springfield, Mo., and H. T. Bentley, president of the International Railway Fuel Association, is with the Chicago & North Western at Chicago. Of the 17 railway men who were elected as officers of these four associations, 14 come from the West and only three from the East. Usually the men selected for positions of this kind are from among those who are most active at the conventions, or who have attracted special attention because of the good work

they have done in the preparation of papers or reports. It is rather strange that more eastern men are not represented on the official boards of these associations.

Shop Practice Competition

A prize of \$25 will be awarded for the article, received before September 1, 1912, describing the best practice for repairing pistons, piston rods and crossheads. The description should cover both the renewal and repairs of the following parts: Piston heads, piston packing, piston rod, crosshead, crosshead shoes, wrist pin and glet and key, if the rod and crosshead are secured together in that manner. A time study of each operation, including a brief specification of the machine tool used and the feed and speed at which it is operated, will give the competitor considerable advantage in the decision. The article should be accompanied by a detailed account of the method used in transferring all the different parts from one place to another in the shop and with drawings or photographs showing any new kinks used in connection with the work. Mr. Spidy's article on the repairs to driving boxes in this issue will serve as a model for the kind of an article that should be submitted. Contributions which do not win a prize, if considered of sufficient value for publication, will be paid for at our regular space rates.

Absorbent Towels vs. Waste

Some interesting data concerning the use of absorbent towels for general wiping purposes, was brought out in a paper by W. O. Taylor, of the Galena Signal Oil Company at the Railway Storekeepers' convention at Buffalo, N. Y. This paper appears in abstract in another part of this issue. The oil is extracted from the towels, when they become soiled, by what is known as an emulsion machine, which is of the centrifugal type. On one road the oil thus extracted is sold to the signal department for the lubrication of switches, resulting in a saving of \$163.28 each month. This saving takes into account the cost of the towels, as well as the cost of cleaning them. It is expected that with fair usage the life of the towels will be about five or six months. Machines for reclaiming the oil from waste or packing are not in general use, although there would appear to be a good field for them on most roads. The New York Central & Hudson River uses such a machine at its East Buffalo, N. Y., car shop for cleaning journal box packing and soiled waste from the shops. It was described in the Shop Section of the *Railway Age Gazette*, August 5, 1910, page 236.

The Brick Arch

The brick arch committee of the Master Boiler Makers' Association is to be congratulated on the thorough, well-arranged and comprehensive report which it presented at the convention in Pittsburgh. The necessity for increased boiler capacity has done much, on many roads, to bring about a more general introduction of the brick arch, although the fuel savings, which are made possible by its use, are not to be overlooked, as indicated by the report and discussion which appear in abstract elsewhere in this issue. Like any other part of a locomotive, the best results can only be obtained when the arch is properly installed and taken care of. That the brick arch has not proved an entire success in the past has been not because it has not given good results in improving the combustion and preventing smoke, but because of difficulties in maintenance due to improper design and installation. The sectional arch which has been introduced within the past few years has overcome the difficulties which were experienced with the older types of arch, and has made it possible to secure the extremely favorable results which were reported at the meeting of the Boiler Makers' Association.

Repairing Driving Boxes

E. T. Spidy, assistant general foreman, Winnipeg shops, Canadian Pacific, is the winner of the \$25 prize in the competition on the methods of repairing driving boxes, which closed May first. Mr. Spidy's article will be found in another part of this issue. In awarding this prize, it is recognized that in some particulars Mr. Spidy's methods are probably not the best and the decision of the judges was based on the complete operation rather than the details. There is evidently a great diversity in ideas of the proper way of repairing driving boxes throughout the country, and it is to be hoped that the articles on this subject, published in this and succeeding issues, will draw attention to more rapid and less expensive ways of performing the ten or twelve necessary operations included in this work. The custom of putting driving boxes in a lye vat, boiling them for about three hours, and afterwards washing and wiping is very general. It has been found at several places that by turning a stream of warm water on the boxes and then wiping with waste, equally satisfactory results are obtained. This takes but about ten minutes per box.

Some roads tap the screw in plugs to hold the brasses. These require drilling before the brasses can be pressed out. A straight taper plug driven from the inside is equally good and does not require the box to be taken to a drill press. The practice of forming the outside of the crown brass by turning it in a lathe, and then transferring it to a shaper or slotter for finishing the corners, is quite general. This requires two settings and two machines. A better method seems to be to lay off the brass with a suitable instrument, and then shape or slot it complete at one setting. A draw-cut shaper fitted with a special appliance is used to advantage in some shops for doing this work. A number of roads are casting the crown brass in place in the box. Where suitably shaped and located dove-tailed grooves are cut and the box is heated sufficiently before pouring, this practice is proving most successful, and of course, from the standpoint of the shop, it is a satisfactory short cut which completely eliminates at least two operations. One company, at least, is using a removable brass held in place by a wedge. From an engine house viewpoint this construction has many advantages, but it makes more expensive work for the shop. Brass liners machined and fitted in the shoe and wedge channel of the box appear to be an unnecessary refinement. It is far better to groove the channel and cast the liner (in some cases made of hard babbitt) in place. There seems to be little doubt but a liner of some kind is a necessity unless bronze shoes and wedges are used.

Practice varies considerably in connection with the hub liner, which is sometimes found on the wheel center, sometimes on the driving box face, and sometimes on both. The best practice appears to be a liner on the driving box face which can be removed and replaced without dropping the wheels. Such liners are in use in a few places. Following this, the liner of hard babbitt cast on the face of the box, the edge of the recess being eccentric with the journal, seems to work very well if the proper quality of babbitt is used. This has the big advantage of not requiring machine work for facing, as the surface when cast against a steel form is sufficiently smooth. Brass is probably the most common material for this purpose, and is often fitted and secured in place with countersunk screws. A better practice, if brass is used, is to cast it in place. From the standpoint of repairs alone, babbitt is preferable, as no machine work is required either for removing or applying it. Furthermore babbitt can be easily melted anywhere, and the forms to cast it are simple.

After all, the shop generally has to accept what is given it to do, and it is probable that the greatest improvement to be made in most shops will be found in the relocation of the tools to give the proper sequence of operations and the fur-

nishing of convenient and ever ready handling appliances. That something along this line can be done in practically every shop, with a considerable reduction in the time of the complete series of operations, is a conclusion drawn from the contributions submitted.

Notes on the Fuel Convention

Papers and reports of a high character, an intelligent, active discussion and a general interest in the proceedings made the recent meeting of the International Railway Fuel association very successful. It is evident that this association has a real object for existing, and that the members propose to make it of as great value as possible both to themselves and the railways. While it is unfortunate that it was necessary for the president to call on members by name for expressions, this is doubtless an objection which will gradually be reduced as the association grows older. A number of members came fully prepared to speak on the subjects of interest to them, and it is to be hoped that this practice will grow more general. It will be necessary, however, for the committees to finish their work and allow the secretary to have the papers printed and sent to the members several weeks before the convention, if fully digested discussions are to be prepared. Some of the older associations should not be taken as a model in this respect.

Moving pictures to demonstrate the results of good and poor firing were unanimously voted a big success. Mr. Buell's paper and pictures were the most impressive features of the convention. Actual demonstration is, beyond doubt, the best method of teaching any form of physical activity and moving pictures which permit such a demonstration to be carefully studied and to be presented anywhere at any time, before any sized audience open wonderful possibilities for educational work. It is hard to understand how any fireman who has seen the picture demonstrating the amount of coal lost through an open safety valve, can fail to have this large pile of coal appear in his mind every time the pop opens. Or again, when he sees the difference between the amount of work performed by the good and poor fireman under the same conditions, how he can help but be anxious to learn and practice proper methods. Mr. Buell has developed a method which will probably take its place among the most important agencies for improvement and the Fuel Association is to be congratulated on having its meeting the theater of his first exposition.

Stimulated by Dr. Goss' experimental locomotive with 150 sq. ft. grate area and without a tender, some very fanciful arrangements were suggested. One member drew a picture of a train with a power house on wheels at the head, furnishing electric current to tractor cars located about ten cars apart throughout a train of any imaginary length. While wireless transmission between the source of power and the tractor cars was not mentioned by the speaker, it is probable that this was an oversight. The 6-ft. gage also bobbed up its head again in this connection. The members with good imaginations had a big advantage in the discussion of this subject, and it was unfortunate that the time did not permit all of them to get on record.

T. E. Adams, superintendent of motive power of the St. Louis Southwestern, received a long overdue public recognition and appreciation of the methods of firing he developed and has had in use for a number of years. He described his system in detail before several associations, but the full importance of his work does not seem to have been realized until recently. H. T. Bentley took this occasion to publicly thank Mr. Adams for what he had done and strongly recommended that all the members study the firing practice on the St. Louis Southwestern.

It came as a distinct surprise to most of the members present to discover that it was not infrequent for a locomotive to exert a greater horse power in producing draft than in producing tractive effort. Mr. MacFarland's paper on the subject of locomotive draft contained probably the most valuable information

on back pressure that has ever been presented. It was disappointing, however, that the paper did not include definite recommendations as to how to overcome the big losses shown by the tests. The author reported verbally that he was experimenting with induced draft by means of a fan in the front end to take the place of the exhaust pipe, and he had discovered that 50 horse power would be amply sufficient for very large locomotives. He hopes at the next meeting to give positive information as to the success of such an arrangement. The paper was also disappointing, in that there was no data presented as to the air openings in the ashpan, or the amount of vacuum at points other than the front end. Because of this, no opportunity was given to discover what effect the firebox end of the boiler might have had upon the results shown.

It appeared as if some of the railway supply companies had overlooked an excellent opportunity for the demonstration of their wares at this meeting. The exhibits were practically insignificant, although there was sufficient conveniently located space provided for them. The membership of this association is of the class that will well repay any of the supply companies having apparatus in any way connected with the saving of fuel, to go to considerable trouble to reach under such favorable conditions as existed at these meetings. Some firms saw their opportunity, and had exhibits, but they were far too few.

There is no doubt that unless every feature of locomotive and train operation having an effect on the consumption of fuel is known within a reasonable error, an accurate and reliable fuel performance sheet cannot be maintained. If the performance sheet is inaccurate, its value in the form of influence on the engine crews to make greater efforts or to compete one with the other, is practically lost. It would therefore seem, so far as this effect on the engine crew is concerned, that it is practically useless to attempt to maintain these records. As a basis for the proper coal distribution, and for a record of the fuel consumption in different classes of service, they probably have some value. As one member expressed it, "You can tell more about a fireman's work by the length of time it takes to clean the fire he brings in than you can by all the coal chute records it is possible to collect." In this connection it should not be overlooked that the mere knowledge of the presence of a record has a good moral effect, and aside from any other value, this might make a fuel performance sheet worth while.

NEW BOOKS

Treatise on Planers.—Practical information and suggestions for economically producing flat surfaces. 102 pages, 122 illustrations, 6 in. x 9 in. Bound in cloth. Published by the Cincinnati Planer Company, Cincinnati, Ohio. Price, 50 cents.

This volume has been prepared to aid those confronted with the sometimes perplexing problems of producing flat surfaces quickly and accurately. The subject has been treated in a clear and comprehensive manner, carefully avoiding any unnecessary discussion and presenting to apprentices and mechanics many points pertaining to the tools and fixtures used in connection with planer work. The book has been divided into eleven chapters. The first discusses what work should be planed, and included in this is a description of the various types of planers, one illustration being accompanied by a list giving the names of all the parts on a modern planing machine. In the next chapter the tools used are discussed at some length and illustrations are presented showing the proper shapes and manner of setting. Following this are chapters on methods of holding the work, special planer fixtures, samples of practical planer work, spiral, radius and arc planing, as well as the proper methods of taking care of the machine. A separate chapter is devoted to cutting and return speeds, and the volume is completed by a fully illustrated description of the proper way of setting up a new planer.

REPAIRING LOCOMOTIVE DRIVING BOXES

First Prize Article in the Shop Practice Competition. Detailed Description of the Methods Used at the Winnipeg Shops of the Canadian Pacific.

BY E. T. SPIDY.*

When a study is made for the purpose of obtaining the best results, both as to time and cost, in repairing driving boxes, it will be found that there are three fundamental features to be considered. 1. To reduce the time between operations to a minimum; i. e., to give to each man handling facilities and means of transportation independent of the regular shop cranes. 2. To arrange the machines and benches in the correct sequence of operations so that each man will be able to pick up the box with his crane from where it was placed by the last man; also that all the boxes may pass along a definite and direct route. 3. To adopt the most efficient methods of machine operation with the machinery available.

One of the illustrations shows a section of the Winnipeg shops of the Canadian Pacific. An auxiliary crane runway has been erected, extending down the whole length of the section devoted to driving box repairs. One rail is supported on the shop columns and the other on columns 22 ft. apart, made from old superheater flues. On this runway are three travelers, that handle all the work to and from the machines. The pipe columns are also utilized to support the light jib cranes used to lift the boxes from the floor to the bench and to the axles. Back of the benches is a track on which the wheels are placed when being fitted; behind this is a double track for wheel storage.

In describing the system of handling driving boxes in a shop like this one, it must be remembered that all the boxes do not receive identical treatment, because of their being of different

designs. For instance, all boxes do not have spring saddle pockets in the top, and thus do not have a pocket to be milled square (see operation No. 7). In such cases the box will pass straight up the line to the machine that is to operate on it. Boxes that do not require new crown brasses may require side liners, but

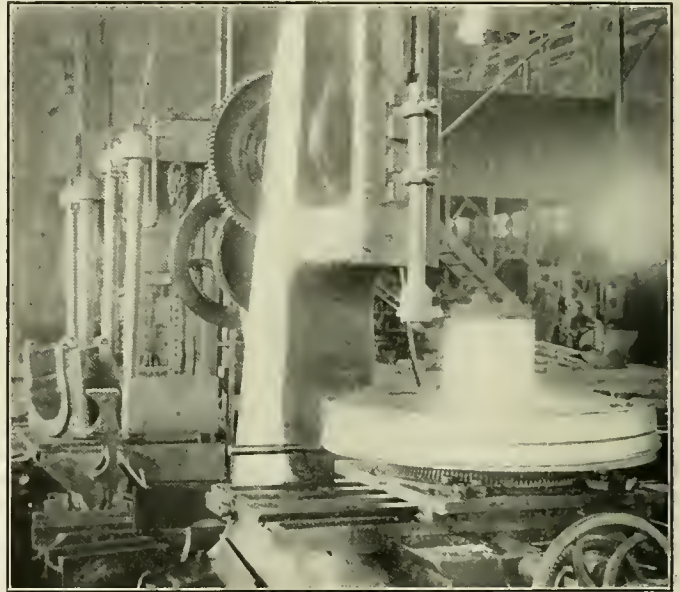

Slotting the Driving Box Brass.

they will all follow the general sequence and finish at the same place.

The detail description following is for the average type of driving box for a $9\frac{1}{2}$ in. journal, requiring complete repairs.

The locomotive is unwheeled by the 100-ton stationary overhead crane shown on left of the plan. It is lowered on trucks and the wheels are rolled back to the box cleaning platform where the driving boxes are removed from the axles.



General View of the Driving Box Section of the Winnipeg Shops.

Operation No. 1. Strip boxes from axles.—The cellar pins are driven out and the box, if not tight to the cellar, falls to the ground; if tight, it is driven out with a large hammer, or with a

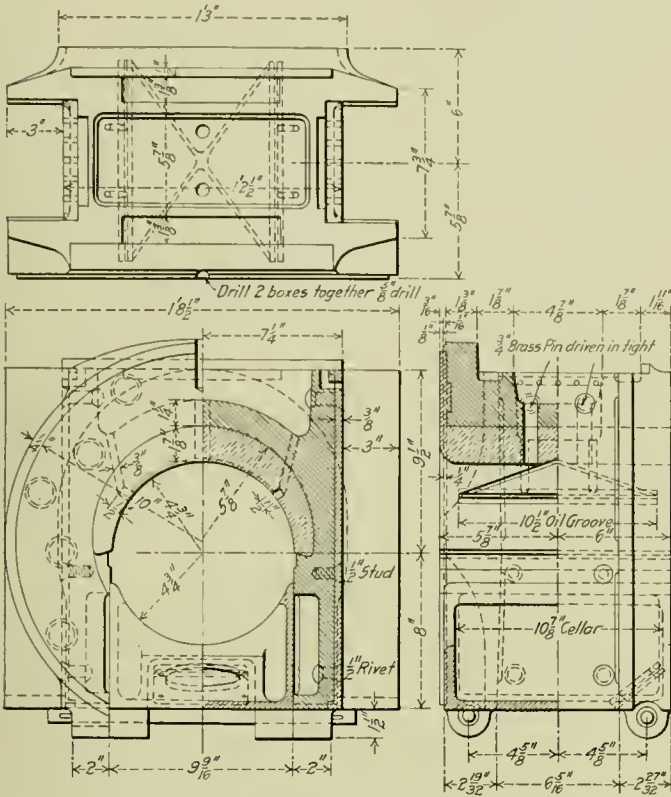

Driving Box on Which the Times Specified Were Obtained.

jack. No exact time can be given for this operation, as it varies from five minutes to an hour, according to the difficulty experi-

enced in removing the cellar. An average time for a box lubricated by oil would be about 10 minutes.

Operation No. 2. Clean box and cellar.—The boxes are then lifted with the small jib crane on the end post of the runway, to a cleaning platform that is about 30 in. high. Here they are cleaned by hand. A previous method of using a lye vat was discarded on account of the length of time required. The cleaned boxes are placed on the press side of the table, convenient to press operator. The average time for one helper to clean one driving box and cellar, would be 15 minutes for an oil lubricated box and 30 minutes for a grease lubricated box.

Operation No. 3. Strip crown brass and side liners.—The press used to remove crown brasses is of 50 tons capacity, and was made at the shops. Recently it was found necessary to add another press to keep up with the capacity of the rest of the machines. One press now does the stripping, and the other does the pressing in. An assistant to the press operator strips the side liners from the boxes after the removal of the crown brass. The detail operations are as follows:

| | |
|---|---------|
| Place the box in position to drive out the dowels..... | 3 min. |
| Drive out 2 dowel pins..... | 2 min. |
| Set up the box in the press, press out the brass and remove the box from the press..... | 5 min. |
| Cut off and drive out 8 rivets..... | 10 min. |
| Remove 4 screws and take off the liners..... | 5 min. |

Total time 25 min.

Operation No. 4. Slot the outside of a new crown brass to fit the box.—The slotter operator sets a special gage, shown in one of the illustrations, to the inside of the box. The three points are adjusted accurately and then the gage is inserted in a slot in the top of the clamping fixture, on the slotter, which is also illustrated. The brass is slotted direct to the gage. By slotting this fit the corners of the brasses are also accurately fitted and no further machining or fitting is necessary before they are pressed in the boxes. The machine used is an ordinary single head slotter. The tool bar is clearly shown in the photograph of this

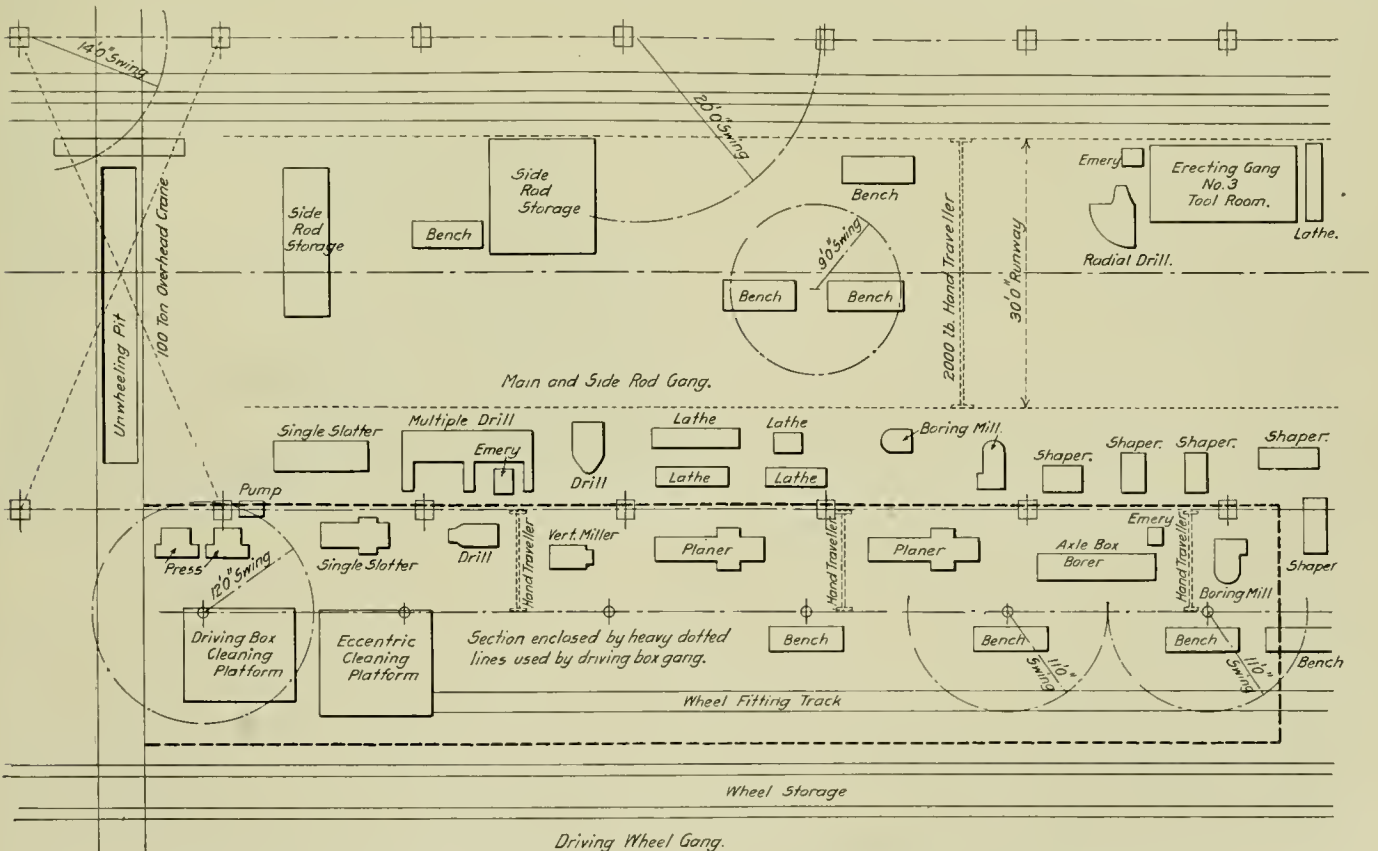

Section of the Winnipeg Shops Showing Arrangements for Driving Box Repairs; Canadian Pacific.

machine. A time study of the detail operations follows:

| | Depth of Cut. | Feed. | Strokes per Min. | Min. |
|---------------------------------|-------------------|----------|------------------|-----------|
| Set up and clamp the brass..... | | | | 8 |
| Set the gage to box size..... | | | | 2 |
| Set the tool..... | | | | 1 |
| Slot the box fit..... | $\frac{1}{8}$ in. | 1.32 in. | 32 | 24 |
| Gage and mark the corners..... | | | | 4 |
| Change the tool..... | | | | 1 |
| Slot the first corner..... | $\frac{1}{8}$ in. | 1.32 in. | 32 | 6 |
| Reset the tool..... | | | | 1 |
| Slot the second corner..... | $\frac{1}{8}$ in. | 1.32 in. | 32 | 6 |
| Remove from the machine..... | | | | 3 |
| Total time | | | | 56 |

Operation No. 5. Press in the crown brass.—The crown brass

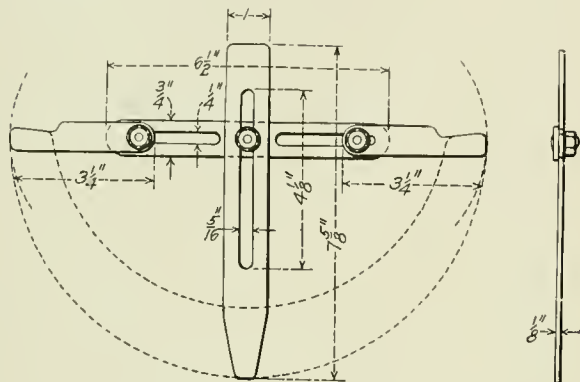

Gage for Slotting Crown Brasses.

is pressed in by the same men that do the stripping. The detail operations are as follows:

| | |
|---|----------------|
| Set up the box in the press..... | 3 min. |
| Place and press in the crown brass..... | 4 min. |
| Try in the cellar..... | 2 min. |
| Remove and clean the table..... | 3 min. |
| Total time | 12 min. |

Operation No. 6. Dowel and oil holes drilled.—From the press, the box is lifted by the hand traveler and placed on the table of a single spindle drilling machine, where it is drilled for the dowel and oil holes from the top outside, and the dowel pin holes are reamed from the inside. The detail operations are as follows:

| | Diam. Drill. | Feed. | R. P. M. | Min. |
|--|--------------------|-------------------|----------|-----------|
| Set up and clamp to the table..... | | | | 3 |
| Set the drill..... | | | | 1 |
| Drill two holes through the box and brass..... | $\frac{1}{16}$ in. | $\frac{1}{4}$ in. | 130 | 5 |
| Change the drill..... | | | | 1 |
| Drill four oil holes..... | $\frac{5}{16}$ in. | $\frac{1}{4}$ in. | 130 | 10 |
| Reverse the box on the table..... | | | | 3 |
| Change the tool and set the reamer..... | | | | 1 |
| Ream two dowel pin holes..... | | | | 7 |
| Remove the box from the machine..... | | | | 2 |
| Total time | | | | 33 |

Operation No. 7. Mill the spring saddle pockets and the end of the shoe and wedge fit for the side liners.—It is necessary, on certain classes of boxes, to mill the pocket seats in which the spring saddle fits in the top of the box. These pockets wear hollow and require squaring out when the saddle is repaired. The dimensions of the pocket are; length, $8\frac{3}{4}$ in.; width, $1\frac{3}{8}$ in., and depth, $\frac{5}{8}$ in. The detail of operations are as follows:

| | |
|------------------------------|----------------|
| Lift to the machine..... | 6 min. |
| Set the milling cutter..... | 2 min. |
| Mill two pockets square..... | 30 min. |
| Remove from the machine..... | 6 min. |
| Total time | 44 min. |

Certain classes of driving boxes, when equipped with new side liners, must be milled on each end of the shoe and wedge fit in order to allow the new liner to be applied. The average time required per box is 90 min.

Operation No. 8.—Dowel pins applied, new side liners fitted and riveted.—Brass dowel pins are driven in, and the side liners are fitted and applied. They are fastened to the box by four

rivets and two screws on each side. The detail operations are as follows:

| | |
|--|-----------------|
| Box in position, getting tools ready, etc..... | 10 min. |
| Drive in two dowel pins..... | 5 min. |
| Set the box ready to fit the side liners..... | 2 min. |
| Chip and fit two side liners..... | 30 min. |
| Lay off the liners for drilling..... | 9 min. |
| Rivet eight copper rivets (four on each side)..... | 25 min. |
| Tap the screw holes..... | 5 min. |
| Apply four screws, saw off and rivet over..... | 18 min. |
| Chip the oil clearance and file the burrs..... | 10 min. |
| Total time | 114 min. |

Operation No. 9. Plane the shoe and wedge fit.—This operation is performed on a high speed planer of a new design. Two machines are necessary to handle the work. The boxes are set on the table on a block that exactly fits the shoe and wedge channel. The detail operations are as follows:

| | Depth of Cut. | Feed. | Strokes per Min. | Min. |
|---|---------------|----------|------------------|-----------|
| Set the box on the table for first side..... | | | | 10 |
| Lay out the box from the center of the brass..... | | | | 5 |
| Set the tool..... | | | | 1 |
| Plane first side liner..... | 3.32 in. | 1.16 in. | 20 | 4 |
| Set for new cut..... | 3.32 in. | 1.16 in. | | 1 |
| Finish plane first side..... | 3.32 in. | 1.16 in. | | 4 |
| Turn the box over and reset..... | | | | 6 |
| Set the tool..... | | | | 1 |
| Plane second side liner..... | 3.32 in. | 1.16 in. | 20 | 4 |
| Set the cut..... | | | | 1 |
| Finish plane second side..... | 1.32 in. | 1.16 in. | 20 | 4 |
| Remove the box from the machine..... | | | | 2 |
| Total time | | | | 43 |

Operation No. 10. Bore and face the crown brass.—Although differing from the practice of many shops in this operation, boring

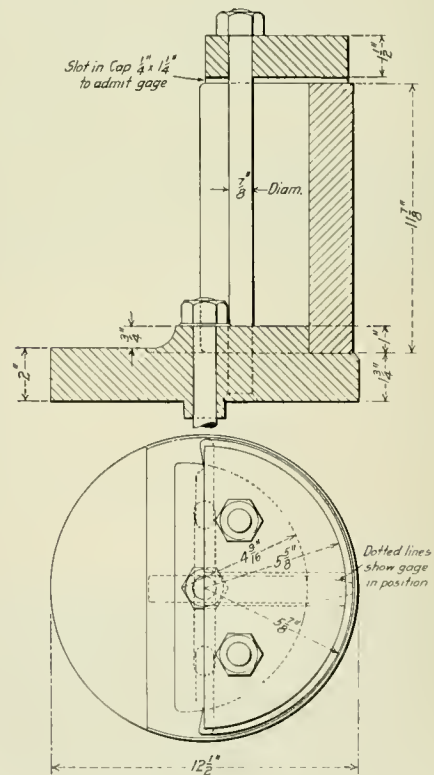

Clamp for Slotting the Box Fit on Crown Brasses.

and facing the boxes on a horizontal boring machine possesses advantages not common in other methods. Setting up is simple and requires no fixtures, other than a parallel block, which fits in the shoe and wedge channel; all other adjustments for the first box, vertical and horizontal, are obtained by the table adjusting screws. One of the illustrations gives a general view of the boring operation, and also shows the special caliper used in conjunction with it. This caliper is set from the ordinary calipers that gage the axle; with one point on the cutting tool, the other point calipers the brass in the same manner as with a

regular inside calipers. Another advantage of the boring bar is that all tools—roughing, finishing and facing, may be set at one time. The tool bar has slots at the correct positions for each tool.

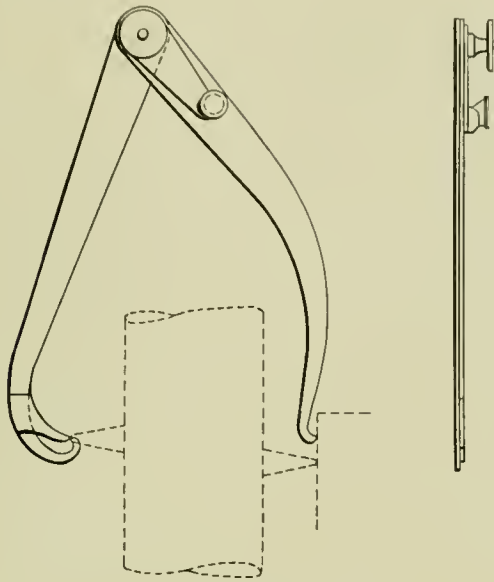

Caliper for Boring Driving Boxes.

For a new crown brass, the boring detail operations are as follows:

| | Depth of Cut. | Feed. | R. P. M. | Min. |
|--|-------------------|----------|----------|-----------|
| Set up and clamp the box..... | | | | 5 |
| Caliper the journal and set the special gage | | | | 3 |
| Set one tool..... | | | | 1 |
| Rough bore the brass..... | $\frac{1}{8}$ in. | 1 16 in. | 56 | 3 |
| Set three tools..... | | | | 3 |
| Bore the brass..... | 1 16 in. | 1 16 in. | | 3 |
| Finish boring tool following..... | 1 32 in. | 1 16 in. | 56 | 3 |
| Radius and face the end..... | | Hand | 56 | 5 |
| Remove from the table..... | | | | 2 |
| Total time | | | | 25 |

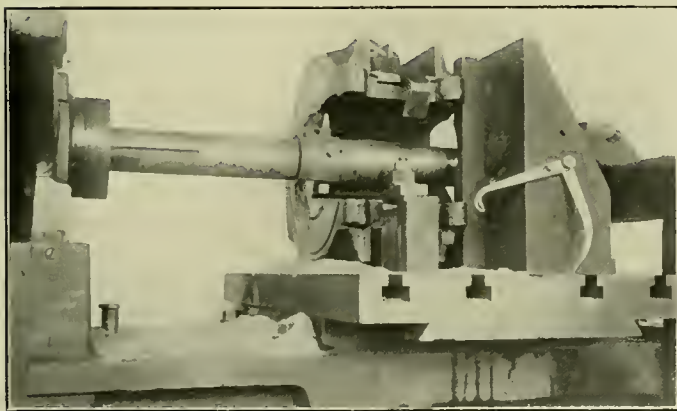

Boring a Driving Box on a Horizontal Boring Machine.

When a new crown brass is not required, the old one is rebored in the following times:

| | Depth of Cut. | Feed. | R. P. M. | Min. |
|------------------------------|---------------|----------|----------|-----------|
| Set up and clamp..... | | | | 5 |
| Set three tools..... | | | | 3 |
| Rebore the brass..... | 1 16 in. | 1 16 in. | 56 | 3 |
| Finish rebore following..... | 1 32 in. | | | 2 |
| Radius the brass..... | | | | 2 |
| Remove from the machine..... | | | | 2 |
| Total time | | | | 15 |

Operation No. 11. Fit to journal, cut the oil grooves, fit cellars, etc.—After boring, the boxes are fitted to the journal and the

oil grooves are cut with a pneumatic hammer. The cellar is then fitted and the pins are applied.

| | |
|--|-----------------|
| Fit one box to the axle..... | 120 min. |
| Cut the oil grooves in the box (includes filing up)..... | 25 min. |
| Fit the cellar and pins (includes grease springs)..... | 20 min. |
| Total time | 165 min. |

Operation No. 12. Remove and renew babbitt liner.—If the box requires a babbitt liner, it is stripped by the fitter before leaving the bench. This operation is not done before the engine widths are supplied, so that babbitt to the exact thickness required can be applied. Babbitt liners are not machined after pouring.

| | |
|--|----------------|
| Strip the babbitt liner..... | 20 min. |
| Set the mold (steel) and pour a new liner..... | 10 min. |
| Remove the mold and trim up..... | 10 min. |
| Total time | 40 min. |

Operation No. 13. Assemble on the axle.—When a babbitt liner is applied, the boxes are brought back to the wheels to which they belong and the cellars are filled with hard grease, and then jacked up into position under the axle and the pins are inserted. The box may be assembled complete in 25 minutes.

[Criticisms of these methods, operations or the times allowed are invited.—Editor.]

CYLINDER HEAD CARRIER.

BY F. H. HINKLEY.

The arrangement shown in the accompanying illustration has been found very convenient when removing front cylinder heads. The frame will fit in any ordinary two-wheel truck, the right hand end slipping through and hooking under a cross bar of the truck. The cylinder head is fastened to the upright *A* by

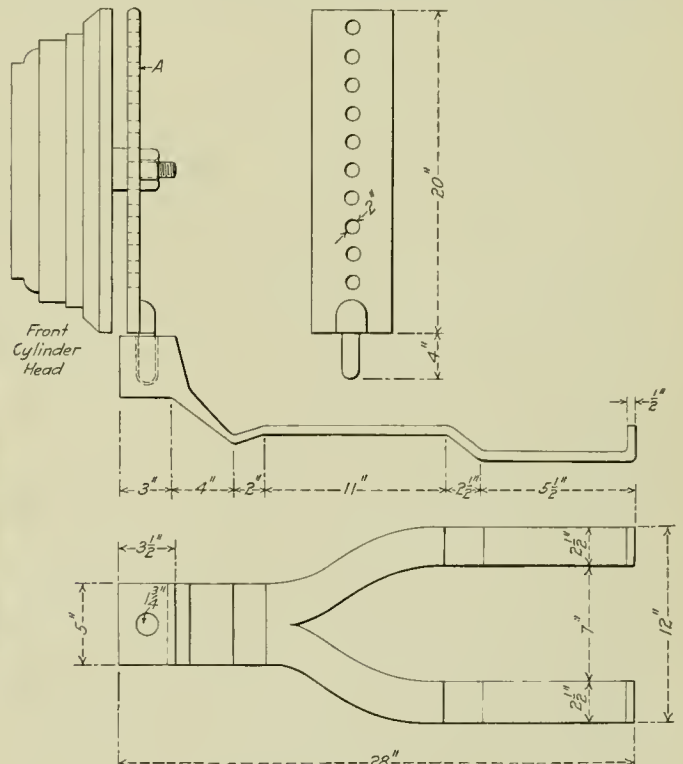

Cylinder Head Carrier.

the casing stud. There are numerous holes in the upright to accommodate most any engine. With this device cylinder heads may be easily removed and replaced, and can also be carried from one engine to another, without any unnecessary lifting.

CITY WATER CONSUMPTION.—During the year ending June 30, 1911, the city of Detroit, Mich., had an average water consumption of 180.4 gal. per inhabitant daily.

MASTER BOILER MAKERS' ASSOCIATION

Important Subjects Considered at the Annual Meeting Included Location of Feed Water Admission, Brick Arches, and Effect of Superheated Steam on Boiler Maintenance.

The sixth annual convention of the Master Boiler Makers' Association was held in Pittsburgh, Pa., May 14 to 17, George W. Bennett presiding. The opening session was given over to addresses of welcome and responses. L. H. Turner, superintendent of motive power of the Pittsburgh & Lake Erie, spoke on the responsibilities and duties of the boiler shop foreman. William McConway, of McConway & Torley, told of the transportation facilities in the early days of Pittsburgh. J. F. Deems believed that far more could be obtained from the men by kind treatment than in any other way. Most men respond to kindness, and if they do not, the best thing for the shop is to get rid of them.

The association now has a membership of 218, and there is a cash balance of \$391.77 in the treasury. Delegates were appointed to attend the meetings of the International Society for Testing Materials in New York in September and the Third National Conservation Congress at Kansas City, Mo., in September.

LOCATION OF FEED WATER ADMISSION.

A committee report was presented by D. G. Foley, chairman. The general practice followed in feeding locomotive boilers with water is to inject it through one of four different locations, i. e., at *A* on the front course of the barrel with individual checks on both sides; at *B* on the same course with duplex

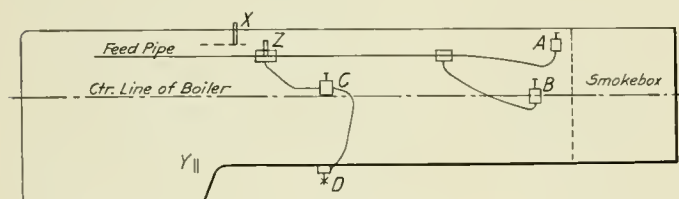

Location of Check Valves and Thermometers on Boiler Which Was Tested.

checks; and at *C*, as well as *D*, with individual checks located on the back head of the boiler, provided with internal pipes discharging the water near the front tube sheet.

The common practice is to have the feed water enter the boiler in a solid stream at a low temperature. The uneven temperature causes an undue contraction of the firebox sheets and bottom flues, causing leaky boilers, etc.

Some roads use a plate on the inside of the boiler to deflect the water up over the flues after it enters, thereby preventing the deposit of scale on the inside of the shell, between the shell and the flues. This shows some improvement, but still shortens the life of fireboxes and does not prevent engines from leaking.

Another device is the upturned elbow in the boiler check. An upturned elbow with a contracted nozzle has been found to be a simple and effective device for equalizing the temperature of the feed water, but as near as we can find out it only brings about a difference of 15 degrees between the temperature at the top and the bottom of the boiler.

A more recent device for delivering feed water to a locomotive is the Phillips check, which delivers the feed water in a solid stream in the steam space. A road having 14 consolidation engines equipped with the Phillips double boiler checks considers it an improvement all around over the old method of boiler feeding.

The Seddon boiler feed device, which was designed and

patented by C. W. Seddon, of the Duluth, Missabe & Northern, presents an entirely new idea. The feed water is discharged into the steam space in the shape of a spray; the small drops absorb the heat and fall to the surface of the water in the boiler at a uniform temperature. This method causes incrusting solids contained in the water to separate before they mingle with the boiler water, and these solids are collected in a sediment pan, thereby leaving the sheets and tubes free of scale. Another feature of the sediment pan is that the feed water is held in suspension before being allowed to mingle with water below, until it overflows the flange at the rear of the pan; this gives double assurance of the feed water getting heated to the same temperature as the water already contained in the boiler.

One road has 96 engines equipped with the Seddon boiler feed device and the records show gratifying results from its use; noteworthy is the 50 per cent. decrease in boiler maintenance, the increased life of fireboxes and flues, and the elimination of failures due to boiler troubles.

Enginemakers are often careless in the handling of injectors, not realizing the damage caused by the flow of cold water. Ninety per cent. of the boiler failures can be traced below the boiler checks. Our idea is to feed the water in the boiler just as high as we can and spread it as much as possible.

To determine the most desirable location for the admission, a 10 minutes' temperature test was conducted under three of the methods of feeding with the following results. The No. 9 Gresham injector was on full and the boiler pressure was 130 lbs

| Check Valve Open. | C | | | B | | | A | | |
|---|------|------|------|------|------|------|------|------|------|
| | X | Y | Z | X | Y | Z | X | Y | Z |
| Thermometer. | Deg. | Deg. | Deg. | Deg. | Deg. | Deg. | Deg. | Deg. | Deg. |
| Before injector was opened. | 374 | 352 | ... | 376 | 352 | ... | 375 | 352 | ... |
| At end of 10 min. of open injector | 377 | 274 | 171 | 376 | 328 | 172 | 376 | 334 | 174 |
| 3 min. after injector was closed | 376 | 268 | ... | 377 | 317 | ... | 376 | 346 | ... |
| Difference in temperature between time of opening injector and 3 min. after closing | ... | 84 | ... | ... | 35 | ... | ... | 6 | ... |
| Difference between thermometers Y and X before injector was opened | ... | 22 | ... | ... | 24 | ... | ... | 23 | ... |
| Difference between thermometers Y and X 3 min. after injector was closed | ... | 108 | ... | ... | 60 | ... | ... | 30 | ... |

| Min-utes. Test. | Feeding from bottom. | | Feeding from side. | | Feeding from top. | |
|-----------------|----------------------|------------|---------------------|------------|---------------------|------------|
| | Thermometer Bottom. | Temp. Top. | Thermometer Bottom. | Temp. Top. | Thermometer Bottom. | Temp. Top. |
| 1 | 255 | 347 | 196 | 347 | 222 | 346 |
| 2 | 256 | 346 | 197 | 342 | 220 | 345 |
| 3 | 258 | 334 | 199 | 335 | 220 | 343 |
| 4 | 258 | 313 | 203 | 322 | 219 | 342 |
| 5 | 255 | 295 | 206 | 313 | 219 | 339 |
| 6 | 252 | 281 | 210 | 307 | 219 | 339 |
| 7 | 247 | 270 | 213 | 303 | 219 | 339 |
| 8 | 244 | 262 | 216 | 302 | 219 | 340 |
| 9 | 242 | 258 | 218 | 301 | 219 | 338 |
| 10 | 239 | 252 | 219 | 301 | 220 | 334 |
| Drop | 16 | 95 | ... | 46 | 2 | 12 |
| Rise | ... | ... | 23 | ... | ... | ... |

The top thermometer was located at the water line, while the bottom one was connected about 18 in. above the foundation ring. It will be observed that the greatest temperature changes took place when feeding through the bottom of the barrel, because the bottom thermometer dropped 16 deg. F. and the top one dropped 95 deg. F. Feeding through the sides, the bottom thermometer rose 23 deg. F. and the top one dropped 46 deg. F. Feeding through the top the bottom thermometer dropped

2 deg. F. and the top one dropped 12 deg. F. The fourth method was not tested. It was not in question because it is generally conceded to be an undesirable location for engines operating in bad water districts, due to the internal pipes becoming full of scale, and they are also subject to breakage, causing damage to fireboxes.

Feeding with duplex checks through the top of the boiler was found the most desirable location, because of developing the least fluctuation in temperature around the firebox and tubes, and engines which gave considerable trouble leaking when fed from the bottom or sides of the barrel were almost free from it when fed from the top, under like conditions, and operating over the same section.

When the water was fed from the bottom the fireboxes, except the crown sheet, were necessarily renewed yearly, and since feeding from the top the same engines, on the same section of the road, operating the same trains and using the same water, have doubled that service, with a correspondingly less amount of firebox attention, and have still more service in their firebox plates. The tubes also have given better results in service, and their mileage has been increased 50 per cent. between renewals (when feeding from the top). Cleaning plugs are required close to the duplex check when it is applied to the top because of deposits of foreign matter over and between the tubes at the front tube sheet end, and if this is not kept clean the tubes will leak at the front tube sheet joint.

In our opinion feeding from the top, near the front tube sheet, is the most desirable location for locomotive boilers, because we find the mud and scale better distributed throughout the barrel of the boiler and less lime and magnesia deposits are found adhering to the pressure side of the firebox plates than when feeding from any other location, and this appears to be why better results are obtained.

Discussion.—The discussion centered about the use of the Phillips check and the Seddon method of injecting the water. The latter is such that the water is injected near the top and is thrown upward into the steam space in the form of a spray; there is a shield over the upper tubes. With this arrangement the water is heated to a high temperature at the front end of the boiler and deposits all of its impurities there, so that the mud does not get back into the water leg and accumulate on the mud ring. The immediate result of its use on one road was a great saving in the amount of boiler work that had to be done in the engine house, cutting down the number of boilermakers from 14 to 7, and at the same time making it possible to increase the tonnage ratings of the locomotives. It was also claimed that it had an effect on the number of broken staybolts, which have been reduced 35 per cent.

It was urged that the principle on which this method of feeding acts is the correct one and that any other that would throw the water up into the steam space and then hold it in suspension on the top of the main body of the water until it had become heated to the temperature of the steam would accomplish the same purpose.

The principal points where it shows an improvement is in the flue and side sheet leakages. Of course, where the water is not purified, the same total amount of scale is deposited in the boiler, but it is dropped where it does the least amount of harm. Investigations have shown that where the life of the side sheets was as low as nine months with the water injected in the usual manner, it rose to two years with the sheets still in good condition with the Seddon device. Some trouble had been experienced with it due to the accumulation of the scale in the form of sulphate of lime at the front end. In some cases it was found that the tubes were so embedded in this scale that they could not be cut out with the ordinary methods of cutting, when it came time for renewal. It was urged that this condition could have been avoided by a more thorough washing out and not allowing so much of the scale to form. But even then, the evils

of leaky tubes were very much less with the scale against the front tube sheet than they would have been had it been against the back sheet. As for the deposition of vegetable and organic matter, it does not make very much difference as to where it is deposited, as it may be easily washed out.

Where the accumulation of the scale at the front end has been allowed to become excessive, there has been some trouble with the leakage at the front ends of the tubes. Where the water is bad, the use of a surface blow-off is of great value in tending to keep the front end clean; the tubes should be removed before they get in the condition that has been described and before they are entirely blocked.

Another device used has a deflector over the dry pipe, and the water is fed into the steam space and allowed to flow down on it. This serves to thoroughly heat the water, but there is apt to be trouble by the scale forming a bridge or sheet over the tops of the tubes. This can, however, be easily removed by taking out the standpipe and getting inside the boiler to clean it out. This scale forms only on the two top rows of tubes and for about half way back.

On one road where the best results had been obtained there were 110 locomotives, of which 14 were fitted with the Phillips check and 96 with the Seddon's device.

It was frequently urged, throughout the discussion, that one of the best methods of securing good results from any method of feeding the water was to washout and blow off frequently. One case was cited where it was the practice to put four washout plugs in the bottom of the shell, two in the top and two in the front tube sheet. Washing out from the front end was considered to be the best method of cleansing the boiler. The automatic blow-off was also recommended, as it has a tendency to clear the boiler of scale and will have an effect at the upper portion where it is impossible to locate the washout plugs so as to be of any value. Cases were cited of engines on the same runs where the engineer in charge of one would make frequent use of the blow-off, with the result that there was little or no trouble from scale, while, in the case of the other, where the blow-off was not used, there was a great deal of scale and trouble with leaky tubes, with the consequent higher cost of boiler repairs.

The consensus of opinion of those who took part in this discussion was that the use of a method of water feeding that sent the water up into the steam space at the front end was of greatest value.

APPRENTICESHIP.

J. W. L. Hale, superintendent of apprentices of the Pennsylvania, gave an illustrated address on this subject. It did not refer specifically to boilermaker apprentices, but covered the general problem of apprenticeship. There are now 250 apprentices at the Altoona shops. This large number makes it possible to group them into classes and sections, thus securing better results than where the number of apprentices is so small that they cannot be thus grouped. Each apprentice receives four hours' of school instruction per week, divided into two periods of two hours each. This instruction is given during working hours and while the boy is under pay. A certain amount of home problem work is also required. The apprentices work in the shop with skilled mechanics. The monthly reports of the boys' school work, taken in conjunction with the regular records of the shop foremen, form a satisfactory and reliable basis upon which to place the boys to the best advantage in the shop. There was no discussion of this paper.

WEAKEST CONDITION OF BOILER.

The committee, of which J. T. Johnston was chairman, presented a short report, the conclusion of which was as follows: "In conclusion your committee wishes to state that in its opinion the elastic limit of the plates, braces, etc., used in the construction of a boiler, should be considered, rather than the ten-

side strength, in maintaining boilers in safe working condition." There was no discussion of this report.

SPARK ARRESTERS.

Thomas Lewis presented a report on spark arresters, in which he referred at some length to practical demonstrations in fuel economy which were made on the Lehigh Valley.

Discussion.—A few blueprints were presented showing the practice on some roads, but the recommendation of the committee that the front end, known as the Master Mechanics' standard, is about as good an arrangement as can be obtained, was concurred in. Attention was called to the excessively long front ends, that were the vogue a number of years ago, where the sides were provided with handholes, and the bottoms with chutes for the removal of the cinders; there was a great accumulation of cinders at the end of every run. It was found that when there was a failure to clean out at the end of a run, there was no greater accumulation at the end of the second or third run than at the end of the first. The smokebox simply filled up to a point where the draft could have the proper effect, and after that, to all intents and purposes, the front end became self-cleaning. With the arrangement recommended the diaphragm was carried down and in front of the exhaust pipes so that a strong current was created that carried the cinders to the front with sufficient force to break them up and make them small enough to pass through the netting.

In some cases the basket netting is in use. This, as its name indicates, is a netting in the form of a basket that sets down over the exhaust pipe and is free for the passage of cinders all of the way around. Where this is used there is a 10 in. opening in the firedoor. This is covered by a damper, and the single-shovel method of firing is used. As the fireman throws in a shovel of coal, he puts his foot on a lever that opens the damper, admitting air to the back end of the firebox and supplying sufficient to maintain complete combustion and thus avoid the formation of smoke. It was suggested that so large an opening would not only supply enough air to maintain complete combustion, but would admit such an excess as to greatly cool the fire and prevent obtaining the full heating value of the fuel.

With the diaphragm made in the form suggested there is no accumulation of cinders in the smokebox, and it is self-cleaning; whereas, where the diaphragm stopped back of the exhaust pipes the draft created was not sufficient to do the work of breaking up the cinders so that they could pass the netting.

As for the size of the mesh of netting that it is advisable to use, the practice of the engines running in the Adirondack region of New York state was cited. Here experiments had been made with nettings of three and four meshes to the inch, but the final size adopted was $2\frac{1}{2}$ meshes to the inch, using No. 11 wire. This arrangement seems to have almost put an end to the fires started by locomotives. Formerly the losses in the region amounted to hundreds of thousands of dollars every year, but last year they were not over \$10,000.

Some of the speakers advocated the use of a perforated steel plate instead of a wire netting, and stated that excellent results were being obtained by its use. The size of the perforations recommended was $\frac{3}{16}$ in. by $1\frac{5}{16}$ in.

Finally attention was called to the necessity of so arranging the diaphragm that the front end should be self cleaning. The cases of the old extension front were cited where it was necessary to make the whole of the smokebox air tight, for, if any air was admitted to the large body of cinders, it would cause them to burn, with the result that the ends frequently became red hot. With the self-cleaning front end such a thing as a hot smoke-box is unknown.

THE BRICK ARCH.

An abstract of the report of the committee on Advantages and Disadvantages of the Use of Arches and Arch Pipes, of which George Wagstaff was chairman, follows:

The committee endeavored to determine as accurately as possible what the advantages of the brick arches are and the true value of these advantages. It has also been the endeavor to determine definitely the disadvantages of the arch and arch pipes and, as far as possible, the actual cost to the railways of these disadvantages.

Under advantages are the following items: 1, Coal saving. 2, Smoke abatement. 3, Flue protection or reduction in roundhouse flue work. 4, Improvement of steaming qualities under demands for maximum power. 5, Reduction of engine failures from leaky flues and low steam. 6, Reduction in flue stoppage. 7, Reduction in honey-combing of flue sheets. 8, Beneficial effect of the arch tubes on circulation and evaporation. 9, Effect on the life of a set of flues.

Under "disadvantages" may be listed the following: A, Cost of maintenance of the brick. B, Cost of maintenance of arch pipes. C, Detrimental effect, if any, on fireboxes. D, Delays, if any, to the turning of power at the engine house due to the presence of the arch in the firebox.

Coal Saving.—The replies are almost unanimous in stating there is a coal-saving, the average of the percentages given being 11.9 per cent. This percentage virtually checks or verifies the result of a very comprehensive test recently made to determine the coal saving of the arch. The test was conducted by a committee made up of representatives from the Pennsylvania Railroad, the New York Central and the American Locomotive Company on a Mallet engine on the Pennsylvania division of the New York Central. The conclusions were to the effect that the brick arch under the conditions tested gave a fuel saving of 11 per cent. We also have information on other well conducted tests which would indicate a coal saving of 12 per cent., or more. The coal saving reported by the different members varies from a slight saving to 25 per cent. This might seem inconsistent but for the fact that the conditions under which these various percentages were obtained are evidently quite variable. The percentage of coal saving varies largely with different degrees of intensity of the work. For very light work the percentage will be slight. For very high rates of work, or rather high rates of combustion, the percentage should be high. Again, when the coal is of a low volatile nature the effect of the brick arch on coal saving will not be so great, but with high volatile coal there is much for a brick arch to do and under such conditions it will show a high percentage of fuel saving. The committee feels that 11.9 per cent. may be considered a fair figure for the average conditions.

Assuming a locomotive working 330 days in a year, running 100 miles per day and making on an average of 20 miles per ton of coal, the tons of coal consumed per year are 1,650 tons; 11.9 per cent. of 1,650 tons is 196 tons; money value at \$2 per ton, \$382.

Smoke Abatement.—The composite report shows favorably for the arch from a smoke abatement standpoint, the average being 40 per cent. This again depends on the nature of the coal used.

Effect on Flue Work and Percentage of Reduction of Frequency of Calking.—Thirty-five report reduction in flue troubles. Two find additional flue troubles, while three report no effect. The average percentage of reduction in frequency of calking is 40 per cent. Just what money value this would represent we are not able to determine, but it would no doubt be considerable.

Steaming Qualities Under Maximum Demand.—Forty-five replies say that arches make the engines more consistent steamers; one reply states, no effect. This would indicate that arches were of decided value. Just what the money value would be we cannot state. However, it indicates that by using brick arches better schedules can be maintained, a thing very important to the railways in competing for high class business. It may mean less double heading, a thing much to be desired. A very small reduction in the number of cases of double heading would pay

for much of the brick arch expense. It can mean more tons per train hauled and thus more ton-miles per ton of coal consumed.

Do Arches Tend to Reduce Engine Failures.—The vote on this item is 42 to 5, indicating that arches do reduce engine failures.

Do Arches Reduce Flue Stoppage.—The vote on this item is 37 to 10 favoring the arch.

Honey-Combing of Flue Sheets.—The vote on this is 29 to 9 in favor of the arch.

Effect of Arch Pipes on Boiler Efficiency, Circulation and Evaporation.—Replies indicate 23 favorable to and two neutral on these points. A previous report to the association shows a fraction over one per cent. gain of efficiency per arch per pipe. This gain would more than pay the arch pipe maintenance cost.

Effect on Life of Flues.—Thirty-two replies say life of flues is increased, two say the life is decreased and four say no effect.

As against the above advantage we have the possible disadvantages as follows:

Detrimental Effect on Life of Firebox.—Five claim that the arch with arch pipes prolongs the life of the box, 12 that the life of the firebox is shortened, while 14 report no effect, less than half reporting detrimental effects. A careful review indicates that the experience of those reporting detrimental effects is largely in connection with brick arches supported on studs. It would, therefore, indicate that the effect of the arch on the life of the firebox would depend on the style of the arch used. It would indicate that arches of the proper design supported on tubes have no bad effect on the life of the firebox. At any rate, we believe that we may safely draw the conclusion that the beneficial effect of the arch on the flues will at least offset any possible detrimental effect which the arch may have on the firebox.

Are Engines Held Longer at Terminals on Account of Arches.—The vote on this item is 29 to 12, indicating that less than 30 per cent. of the members reporting find that there is a delay to the turning of power due to brick arches. Several members report less delay to engines equipped with arches. It would seem that the style of the arch has some bearing on this point. One man reports that there is no delay if sectional arch is used. The majority of those reporting no delays are using the sectional arches. Your committee, therefore, feel justified in saying that the delay in the turning of power claimed by some, is not an unsurmountable disadvantage. There are good grounds for argument that in the majority of cases this belongs on the other side of the ledger, due to 40 per cent. reduction in roundhouse flue work.

Cost of Maintaining Arch Pipes.—The recapitulation shows an average of \$4.36 total to renew one arch pipe, and the average life of an arch pipe to be 14 months. With four tubes in an engine there would be an average renewal of one tube every three and one-half months. At a cost of \$4.36 each, the arch pipe cost per year in a box equipped with four tubes would be \$15.26. This, we believe, represents a fair average for the cost of maintaining arch pipes.

Cost of Maintenance of Brick Arches.—The replies gave us no line on the cost of maintenance of brick per 1,000 engine miles. We have data, however, showing that the average life of a set of brick in passenger service is 5,490 miles, in freight service 4,425 miles, and in switch 6,500 miles. Assuming 33,000 miles per year as the average for an engine, it would require about 6 arches per year for passenger engines, and about eight arches per year for freight engines. Not having replies on the cost of arches, we are obliged to make some assumptions. We know from other sources that the cost per 1,000 miles for arches in wide firebox locomotives will be between \$1 and \$3. These wide limits are necessary on account of the wide differences in conditions throughout the country. The condition of the water has a decided effect on the life of an arch; the qual-

ity of the coal also has a decided effect and the intensity or degree of severity of the service greatly affects the life of the arch. Assuming \$2 per 1,000 engine miles as a probable average and a mileage of 33,000 miles per year, we have for the cost of brick, \$66 per year per locomotive. Add to this the brick arch labor, given as an average of \$1.70 per month, we have \$20.40 for brick arch labor per locomotive per year; add to this the cost of maintenance of arch tubes which we found above to be \$15.26 per locomotive per year; and figuring the storekeepers' cost at 2½ per cent. as the average, we have a grand total of \$103.31 for the average cost for the yearly maintenance of brick arches and arch pipes in an average modern locomotive.

Compare this with the money value of the advantage of the brick arch, which we found to be on coal saving alone, at about \$392 per locomotive per year with the coal at \$2 per ton. Subtracting from these coal saving figures the total cost to maintain the arches, we have in districts where coal costs \$2 per ton a net saving of \$275 per locomotive per year.

To sum up, weighing the advantages against the disadvantages, it appears from the replies received that brick arches are giving a very good account of themselves on 26 of the 30 roads reported on.

Many roads have recently adopted the use of brick arches and superheaters, not so much from a desire to burn less coal, but in order to obtain more steam of a better quality, due to the necessity of having maximum sustained boiler power for a minimum of weight and operating expense.

The committee's recommendation, therefore, may be expressed as follows: The improvements in brick arch construction and the advancement in the art of boiler maintenance, including care of arch pipes, render the disadvantages of the use of arches so small in comparison with the advantages derived as to warrant the general use of brick arches in soft coal burning locomotives.

Discussion.—The consensus of opinion was that the arch was a good thing, though it was recognized by nearly every speaker that there were troubles, but whether they were inherent in the arch or not was not always clear. It was urged that contrary to the opinion sometimes held, the brick arch served to protect the side sheets from burning and was a promoter of circulation.

The question was asked as to what should be done in case the side sheet gave out so as to need patching and how the top seam of the patch could be kept from leaking. In reply it was urged, in the first place, that the sheet would not be likely to give out with a properly applied arch, but that if a patch was necessary it would be well to apply it with the oxy-acetylene method of welding, which would leave the sheet in first-class condition and not likely to leak.

It was assumed by all the speakers that the arch pipe was the proper method of supporting the arch, and it was said to be of great value as a promoter of circulation. It was in a position to take the water from the front portion of the boiler and carry it up to the back of the crown sheet, and the probabilities were that the circulation through the pipes was exceedingly rapid, and that the amount of water evaporated there was very great. The use of four supporting pipes and the sectional arch was strongly recommended. There was very little complaint of leakage of the pipes. The use of a bead was condemned and the general opinion was in favor of allowing the pipes to project through the sheet from ¾ in. to 1 in., and then bell them out so that there was no danger of pulling through. The main thing that was insisted on again and again was that the pipes should be kept clean. They should be frequently examined and a cleaner run through them where there is any danger of an accumulation of scale forming. Some members seemed to think that the arch would do very well in good water districts but that where the water was bad there would be no end of trouble. This was from men who were not using the arch and they were

met by statements from men who were in the worst of the bad water districts to the effect that they would work all right in any kind of water provided they were given the proper attention. They are used where the water will deposit $\frac{1}{4}$ in. of scale in three months.

The trouble with the bagging of the pipes on the bottom was brought prominently to the front. While there was no actual data given that could settle the matter, it was urged that one of the possible reasons for this trouble could be found in the thickness of the metal used. Most of the members were using steel pipes with a diameter of 3 in., and a thickness of metal of about $\frac{3}{16}$ in. In one case where such a tube had bagged and had to be taken out, and there was no other extra pipe at hand to replace it, a piece of tubing $\frac{1}{8}$ in. thick was used, and this had stood perfectly and had shown no signs of bagging. Another speaker argued that the trouble with bagging was irremediable because of the conditions under which the pipe had to work. It was covered and protected on the top by the brick, whereas on the bottom it was exposed to the hottest part of the fire. This caused such an expansion of the metal that it must of necessity bag. It was suggested that possibly the trouble may have come from the great rapidity of the circulation and that it was due in part to an abrasion of the metal. To remedy this it was suggested that it might be well to reduce the diameter of the pipe at the front end so as to limit the amount of water that could pass through. There was an immediate protest against this and the contrary course of enlarging the pipe was urged. The same trouble is experienced with the tubes of water-tube boilers. The thickness of the pipe was also considered to have an important bearing on the subject, and as better results have been obtained with side sheets of $\frac{3}{8}$ in. thickness than with those of $\frac{1}{2}$ in., so it was thought that the thinner pipe would be better than a thicker one.

The failure of the pipes is a serious matter in some places where they have to be renewed within a week of the date of their application. Sometimes they run for two and sometimes for three weeks. It was suggested that if the pipe could last one week it ought to last for two, or three, or more, if it had the proper care and attention. One thing was brought out very emphatically, and that was that the bagging of the pipes is not due to the accumulation of scale, for, in many cases, where the worst bagging has occurred, the pipes have been perfectly clean, and besides, there had not been time to collect any scale in the limited time in which they had been in place.

The theory that received the greatest amount of support was the one that there was a lack of water against the bottom of the pipe. Attention was called to the practice on some locomotives of using wide crowfeet for the braces of the front tube sheet. Sometimes these braces are set in so thickly that there is but little space left for the water to flow down into the water leg and thus reach the mouth of the pipes. It was considered desirable that these braces should be made as narrow as possible and set well to the front so as to allow ample water space and thus make it possible for the pipes to be kept filled at all times. Bagging evidently is not due to the water used, for it is as likely to occur with good as with bad water. The point where the maximum amount of bagging occurs is not well defined. It runs from the front tube sheet back to the back sheet, and may occur at any point, though one speaker said that his main difficulty had been found on a line with the back edge of the arch. Another had had his chief difficulty at the lower bend of the pipe. Straight pipes were considered to be more likely to give trouble than those with bends where there was a chance for expansion and contraction to adjust themselves. One point was insisted on, that while some districts were able to use the arch pipe, and some were not, it would be found that those where the pipes could not be used were where the water had a tendency to foam.

The type of arch used on the Lake Shore & Michigan South-

ern switch engines was described as one in which the standard sectional arch was carried back from the front tube sheet for a distance, and then there was an opening in it, and beyond the opening there were two bricks set against the back sheet so that there was practically an arch over the whole of the firebox with a hole through it for the passage of the products of combustion. Sometimes this construction is varied by the cutting away of the corners at the back and front ends. These arches are applied to switch engines for the purpose of abating smoke.

As for the saving effected in coal by the use of the arch, there was a unanimous agreement as to its efficiency. On the Lake Shore it is estimated that the saving amounts to from 8 to 10 per cent. of the coal that would be used in case the brick arch was discarded. On one road having 110 locomotives the estimate is that there is a saving of \$50,000 per year by the use of the brick arch.

The attitude of boilermakers towards the brick arch in the matter of repairs seems to have undergone a change during the past few years. The opposition to it formerly was due, in part, to the heat and the trouble that was involved for the men who had to go into the firebox to calk tubes while the engine was hot. With the long brick in use, it was frequently necessary to break down the arch to do the work. With the sectional arch now in use this is avoided and the center sections can be easily removed. It is never necessary to break down an arch, and only frequently is it necessary to break any of the small brick forming the sections. It has been found to be best to have regular brick men to attend to this work and not have the boilermaker touch the arch at all. The method of procedure is for the brick man to go into the firebox and remove as much of the arch as may be necessary. The boilermaker then does his work, and after he is through, the brick man goes back and replaces the arch. As for the time required for the boiler to cool sufficiently to enable the men to do this work, on one road where the passenger locomotives are dumped at the end of each trip, and the freight locomotives once in seven days, it is seldom more than 20 minutes or half an hour before the men can go into the firebox from the time the engines leave the cinder pit.

The brick arch is like all other parts of the locomotive. In order to get good and satisfactory results it must be properly applied, and then given good care while it is in service. It should be cleaned off and kept free from accumulations of cinders. The life of the arch is given in miles in the table in the report, but, in the discussion, it was stated that on one road the life ran about 30 days in passenger service, 42 in freight and 144 in switching. It was stated that brick arches cannot be used to any advantage on oil-burning locomotives.

The value of the brick arch as a smoke preventer was conceded, but in order that it may do its best work in this connection it is necessary that it should be properly installed and cared for.

As an aid to combustion it was agreed to be very valuable. In some cases where before it was used there was a great deal of difficulty with the fine particles of coal being carried out through the tubes before they had a chance to burn, and forming a sticky mass that obstructed the netting and the tubes, the whole trouble disappeared with the introduction of the arch. As for its influence on the side sheets, if there is any trouble there it should not be attributed to the arch and the hotter fire that it produces, but to the bad condition of the water that is used. There does not, however, seem to be much if any advantage to be gained from its use on locomotives having shallow fireboxes. It is true, too, that, if the arch is not properly applied, it will cause trouble with the sheets. In one case where the arch was carried up to a point rather close to the crown sheet, there was a great deal of trouble with the leakage of the longitudinal seam of the firebox. This disappeared when the top of the arch was dropped. It is true that the arch stores

a great deal of heat, and that if this heat is brought up against a seam there will probably be trouble, and it was for that reason that the recommendation was made to weld in patches instead of riveting them.

It was the opinion of the speakers that the arch and the pipes that support it was as safe as any other part of the boiler, if it was properly attended to and the pipes were kept clean.

The arch is an old institution, and its use is based on the proper principles for the production of the best rate of combustion of the coal, and it has come to stay. The reason why the old arches were so discredited is that they were often made of inferior material and were not made of a proper shape; now that the sectional arch has been introduced, these former troubles with the arch as an arch have disappeared, and with them the old arguments against its adoption.

SUPERHEATED STEAM AND BOILER MAINTENANCE.

A committee report on this subject was presented by T. W. Lowe, chairman. The fire tube type of superheater only was considered. The large holes in the front tube sheet are generally drilled about $\frac{1}{4}$ -in. larger in diameter than the body of the flue, the flue being swelled hot to fit that end before application, thus economizing on the labor attached to removals. The large holes in the back tube sheet are drilled smaller than the main flue, which is swedged several inches back, thus providing an abundance of water space at the firebox end, as well as ample material between the tubes, to prevent cracking of the interstices during the setting and maintaining of the flues. No copper ferrules are used to surround these large flues in the back tube sheets, and they are either welded in place or rolled to a joint by using four rollers in the tube expanders, then lapping and beading both ends of the flues with a suitable sized beading tool to take care of the thicker flue.

These large flues are handled in the shops under the same general methods that are followed with smaller flues; the safe ends are welded with a proportionately heavier roller tube welder, and the firebox end of the flue is swedged with a hydraulic push swedging machine or suitable top and bottom die. During six years' experience we have had no weld failures, and are practically free from leakage in service because of reasonable attention, such as stopping all leaks after the fire is drawn, whether reported leaking on arrival at the terminal or not, and, further, by blowing out all cinders with air.

The working steam pressure on superheated engines is generally 180 to 200 lbs., and on light power 160 lbs. The same size engines and boilers under the two former pressures, operating in good and bad water, have not yet shown any marked difference in the cost of boiler maintenance, and unless there is a saving in machinery expense with the low pressure there does not appear to be any good reason why the 200-lb. pressure engine is not better and more powerful than the 180-lb.

Superheating has not reduced the mileage run between washouts and, although the firebox space is found in better condition, we cannot accurately compare the quantity of scale and mud collected between washouts; yet we are satisfied there is a better all-round condition and decreased foaming of the boilers in service.

Competent authorities state that there is a saving in fuel averaging from 10 to 25 per cent. in favor of superheating, the fluctuations during the tests being due to conditions. This is accompanied with a corresponding decreased consumption of water, and a longer life for flues and firebox plates, but because of many other mechanical improvements, which are under experiment at the same time, no accurate statement can be given to show the advantage derived from each; notwithstanding all this there is sufficient proof that there is a much greater percentage of benefit derived from superheating on locomotives than has been attributed to any other known mechanical device introduced on locomotives for many years, and its relation to the upkeep of the locomotive boilers is such, that with ordinary

care in the application of the device and proper maintenance in service, the boiler is generally benefited.

During the severe frosty weather in northwestern Canada the superheater engines developed less flue and boiler failures compared to former saturated steam engines, which of itself is an economy not to be overlooked.

Discussion.—The discussion touched lightly on the relation of superheating to the upkeep of the boiler and centered almost entirely on the methods used in applying and replacing the tubes that are used for the superheater units. The major portion of this part of the discussion hinged about the large tubes that are used to carry the superheater units.

A representative of the Canadian Pacific stated that in all of the locomotives on the western section of that road, the superheater tubes are put in without using a copper ferrule in the back sheet. Other speakers advocated the use of the ferrule as a necessity in most cases, and statements were made to the effect that, in certain districts where the water was bad, it would be impossible to run the tubes without the copper ferrules. A practice that was warmly commended was that of the Chicago, Burlington & Quincy, where a very long ferrule is used. This ferrule has a length of about 1 in., and is first rolled into the sheet. Then the tubes are driven in and expanded and rolled out against the inwardly projecting portion of the ferrule inside of the sheet. The result is that, while the cost of the ferrules is more than for the shorter ones, there is very little difficulty experienced with leakages, due to bad treatment over the cinder pit. When the tube cools and shrinks, the ferrule on the inside of the sheet hugs it and maintains a tight joint, while the portion that is rolled in the sheet holds it tight. The result is that there is very little leaking of the tubes and a corresponding small amount of tube work to be done in the engine houses.

There was a decided difference of opinion as to whether the safe-ending of the tubes should be done at the front or back end. Those who favored the safe-ending at the back end claimed that it was the proper thing to do, because it put the new material that was in the tube at a point where the service was the most severe; while those who favored the front end claimed that a tube should not be used again if it was too thin to be used at the back sheet. Of course the tube would be thinner, and this difficulty was met by upsetting the end and bringing it back to its original thickness and then annealing it so that it would be practically a new tube so far as the rolling and expanding to which it might be subjected was concerned. In any event the back end of the tubes should be swaged down. This is recommended for two reasons. In the first place it gives more room between the tubes for the circulation of the water, and that very room makes better bridging possible. In putting these tubes in place it is well to use the expander and avoid the roller as much as possible. The expander should be a 12-section expander, and when the roller is used it should be of the 5-roller type, and not the 3-roller, as the arc between the rollers of the latter type is so great that the rolls are apt to push the metal on ahead of them and form corrugations.

Another method of putting in the large tubes that has been abandoned was to thread the holes in the sheet and the end of the tubes and screw them in. It was found that the tubes so treated would break off in the thread.

Where copper ferrules are used for the tubes they should be somewhat larger than those used for the small tubes, because of the greater stresses and pressure to which they are subjected.

A third method of safe-ending the tubes was suggested, and is in use. It is to make the first safe-end at the front and the second at the back, and then alternate until the tube is worn out. Still another argument presented for the safe-ending at the front was that it was well to have the weld as far from the fire as possible. Again, those favoring the back end, asked, why, if it was all right to have the old tube in the back sheet, it

would not be well to effect a still further saving and use old tubes for the safe-ends instead of buying new material? To this there was no reply.

A method of applying safe-ends was described. It consists of first swaging; then measuring the engine in which they are to be used; then welding the length, welding for the front end; then opening the front end to fit the holes. It was urged that in doing this work a standard system of tools be used. Where there are three sizes of beading tools, the Nos. 1, 2 and 3, the first being the smallest, and the last being that used for the large tubes, it is very bad practice to use the small tool on the large beads. The tool used should fit the bead, otherwise it will be cut, and bad results in the way of leakage will occur.

It was generally conceded that the life of the large tubes used for the superheater was longer than the small fire tubes of the boiler, and that this extra life frequently amounts to as much as two times or more between tube removals. Also that the life of tubes in superheater locomotives was longer than those of the ordinary locomotives. One reason assigned for this was that the superheater engines were frequently run with lower boiler pressures than engines of the same class using saturated steam. This because it is possible to use larger cylinders without incurring the disadvantages of cylinder condensation. Now it is well known that boiler repairs and troubles increase with the steam pressure, and this reduction of the working pressure with the superheater naturally causes a reduction in the amount of boiler repairs. It was agreed that the life of these tubes as well as that of the regular tubes of the boiler is more dependent on the water that is used than on any other one thing.

Finally it was brought out that the value of the use of the damper for the protection of the large tubes from the fire when the engine is drifting is dependent on the character of the road. On steep mountain divisions where there are long drifting distances the damper had best be retained. But, where the road is level or undulating and the drifting distances are short the damper can be removed without being in any way detrimental to the tubes, and this has been done in a number of cases.

CRACKING OF FLUE SHEET IN TOP FLANGE.

J. W. Kelly presented a paper on the Best Method of Staying the Front Portion of the Crown Sheet on Radial Top Boilers to Prevent Cracking of Flue Sheet in Top Flange. The practice of applying flexible stays to the crown sheet to afford relief to the flange of the back flue sheet and thus prevent the strain that has a tendency to permanently bend the sheet when rigidly connected, is now quite extensively followed by many of the rail-ways installing flexible or adjustable stays four rows back from flue sheet, while a few have made full crown sheet installations. The use of the adjustable or flexible crown stay allows a clear water and steam space unobstructed, other than by the diameter of the bolts, and thus presents a better condition to keep the crown sheet clean and free from accumulations of incrustations, as compared to other methods of staying.

The more rigidly the complete firebox is stayed, the greater is the liability of distortion. Rigid staying serves to restrict the relative movement of firebox plates under expansion, and the difference in the expansion of one plate over the other is the feature that demands great consideration.

In a paper on the same subject T. W. Lowe thought that 3 in. was about a proper radius for tube sheet flanges, and the edge of the tube holes should never be closer to the root of the flange than 4 in., so that when this condition exists, assisted by good treatment, the back tube sheets will be worn out in the body in advance of the top flange cracking circumferentially, regardless of what design of stays are applied at and near the front end of the crown sheet.

There are several forces which tend to produce these cracks, such as the boiler pressure tending to crush the flange; expan-

sion and contraction of the tube sheet body; a rigid crown sheet and side sheets united to the flange of the tube sheet by riveting, and secured to the outside shell with staybolts, thus preventing the tube sheet from altering its shape; and the surging of the water during the application of the air brakes.

We cannot get away from the boiler pressure tending to crush the flange.

Expansion and contraction of the tube sheet body. Considerable relief is assured when the method of maintaining tubes in the roundhouses is regulated to take more out of the tubes themselves, rather than developing severe stresses on the sheet, and further by not lowering the temperature of the boiler abnormally during washing out, or in handling at the terminals.

Referring to rigidity preventing the shape of the tube sheet altering. Where flexibility is adopted with the staying, the boiler pressure prevents the movement of the tube sheet in the direction it requires to go to prevent cracking, so that even flexibility with the staying, or design, does not remove the cause altogether, but helps to delay cracking.

Surging of the water in the boiler during the application of the air brake. A close examination around the pressure side of the top tube sheet flange discloses an innumerable number of incipient cracks, apart altogether from those developing over the tube holes; these appear to be related to the common star cracks which develop on the water space side of plates affected by bad water, and to those of us who frequently ride engines, and know the result of the air brake application whereby the water surges forward, the necessity for a mechanical device to retard the water should appeal, and particularly so when we know that the tube sheet flanges on passenger power with 20 ft. tubes are afflicted earlier and more severely than ordinary freight engines, with shorter tubes; this leads to the belief that the top flange suffers continuously from abnormal temperature, and a retarding device near the tube sheet would assist in keeping water at this location if there is sufficient carried in the boiler, and thus delay failures in the top flange of the back tube sheet, until the general condition demands the renewal of the sheet.

The next clause of this topic is Cause of Flue Holes in Back Flue Sheet Elongating and a Preventive for Same. My experience is that impure water is the cause of this defect developing, and until purification plants are installed to provide purer water, the only means whereby we can reduce the evil is by frequent renewal of the tubes, and preventing the staff destroying the tube holes in endeavoring to make scale or mud separate from the tubes, so as to be accessible to washing out, and I find where this is practiced the reamer will keep the tube holes in good condition.

OTHER BUSINESS.

The following officers were elected for the ensuing year: President, M. O'Connor, general foreman boiler maker, Chicago & North Western; first vice-president, T. W. Lowe, general boiler inspector, Canadian Pacific; second vice-president, James T. Johnston, assistant general boiler inspector, Santa Fe System; third vice-president, Andrew Green, general foreman boiler inspector, Big Four; fourth vice-president, Dan Lucas, general foreman boiler inspector, Chicago, Burlington & Quincy; fifth vice-president, John Tate, general foreman boiler maker, Chicago, Milwaukee & St. Paul; secretary, Harry D. Vought, New York; treasurer, Frank Gray, foreman boiler maker, Chicago & Alton. For members of the executive committee: B. T. Sarver, foreman boiler maker, Pennsylvania; A. Lucas, foreman boiler maker, Chicago, Milwaukee & St. Paul; W. H. Laughridge, general foreman boiler maker, Hocking Valley.

It was announced that Chicago had been chosen for the next place of meeting.

LOCOMOTIVE PRODUCTION.—The Borsig Locomotive Works, Berlin, Germany, had turned out 8,000 locomotives by last October. The number reached 7,000 in June, 1909, and 6,000 in November, 1906.

THE MOST POWERFUL LOCOMOTIVES

A Maximum Theoretical Tractive Effort of 138,000 lbs. Makes the Mallets for the Virginian of Unusual Interest Previous Designs Exceeded in Every Particular Except Weight.

Four locomotives with a tractive effort of 115,000 lbs. working compound, which is obtained with less than 60,000 lbs. average weight per driving axle, have just been built for the Virginian Railway by the American Locomotive Company. In every particular except weight the engines outclass all others. They were developed to meet particularly difficult conditions on this road and are expected to increase the train load on the Deepwater division from 3,340 tons to 4,230 tons. They will be used entirely in pusher service on a 14 mile grade.

This road has had an extensive experience with Mallet loco-

degs. For the first $2\frac{1}{2}$ miles, the grade is .5 per cent. At present, trains are usually operated over this grade with one Mallet of the lightest class at the head and two of the heavier locomotives as helpers. With this power, the maximum train over the mountain is 3,340 tons. This is approximately 500 tons less than the Mallet road engine can take over the remainder of the division.

As the road is single track and the volume of traffic is constantly increasing, it is essential to increase the maximum through tonnage and the locomotives here illustrated were developed to

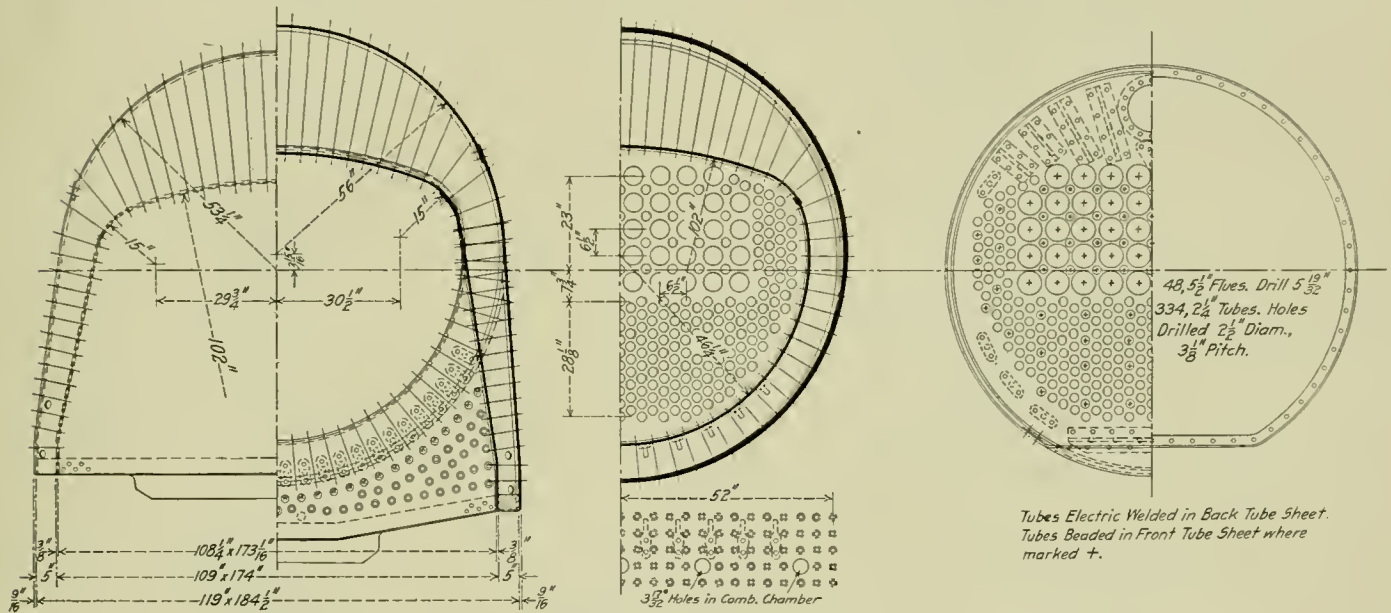

Sections of Boiler Showing Shape of the Water Legs and the Location of Superheater Flues.

motives, covering a period of about five and a half years. During this time a progressive series of classes of this type has been developed, each class being heavier and more powerful than the preceding one. The three classes now in service include four of the 2-6-6-0 type with a maximum tractive effort of 70,800 lbs. Eight of the same type have 92,000 lbs. maximum tractive effort

accomplish this without increasing the number of locomotives on each train. They will take the place of the Mallets now used as helpers which will be put into road service. With two of these locomotives as helpers and one of the class having 92,000 lbs. tractive effort at the head of the train, making a combined tractive effort of 332,000 lbs., it is expected that maximum trains

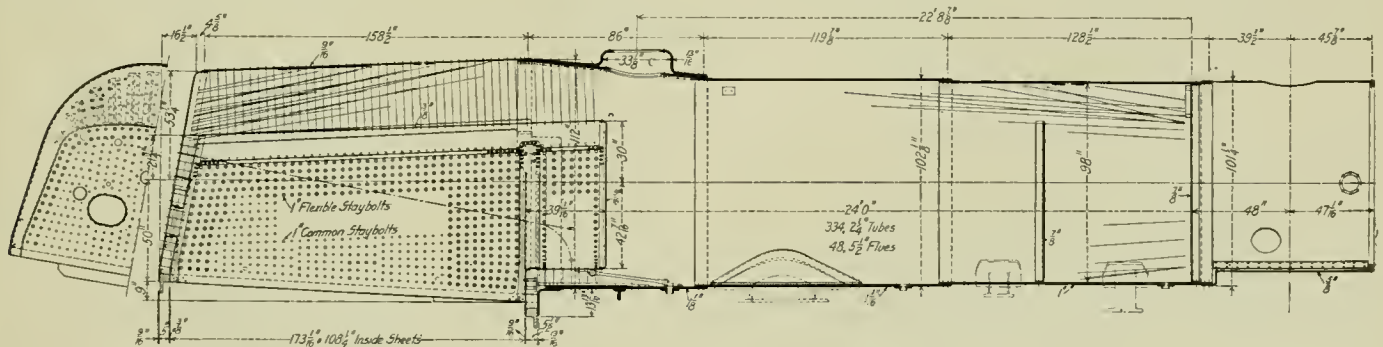

Sections of the Largest Locomotive Boiler; Virginian Railway.

and one of the 2-8-8-2 type has a tractive effort of 100,800 lbs. The crucial point on the entire road is that portion between Elmore and Clarks Gap, W. Va., on the Deepwater division, a distance of about 14 miles. The last 11 1/2 miles of this is on a 2.07 per cent. grade with maximum compensated curves of 12

of 4,230 tons over the Clarks Gap grade will be possible. The road engine, unaided, will take this train through to Princeton, the terminal of the division.

Apart from the great weight and power of the locomotive as a whole, the dimensions of some of the principal parts are im-

pressive as showing the extent to which all limits have been exceeded in its design.

| | |
|---|-----------------------|
| Outside diameter of boiler at front end..... | 100 in. |
| Outside diameter of largest ring..... | 112 in. |
| Tubes, number and diameter..... | 344 2 1/4 in. |
| Flues, number and diameter..... | 48-5 1/2 in. |
| Heating surface, total..... | 6,760 sq. ft. |
| Superheating surface (inside of tubes)..... | 1,310 sq. ft. |
| Firebox ring..... | 184 1/2 in. x 119 in. |
| Low pressure cylinders, diameter and stroke..... | 44 in. x 32 in. |
| High pressure cylinders, diameter and stroke..... | 28 in. x 32 in. |

As far as the running gear is concerned, the design throughout represents the builder's ordinary practice. Several new and interesting features are found in the boiler, introduced to satisfactorily solve the special and difficult problems involved. One of the most interesting is the arrangement of the fire brick arch employed. This consists of a combination of the Security brick arch with the Gaines arrangement of combustion chamber. With this the most complete deflection of the gases is secured, better combustion is obtained and the back end of the firebox is more fully utilized. Not only will the special advantages of each device be obtained, but, likewise, those that are common to both will be realized to a fuller degree. Although the firebox is unusually long, the grate area is only 99 sq. ft. This is less than that provided in a number of other big Mallets recently constructed. The grates are power operated, the Franklin Railway Supply Company's power grate shaking system being applied.* They are composed of six sections and the operating system is so arranged that any one section can be operated alone if desired.

Following the latest approved practice for this type of locomotive, the engines are equipped with superheaters. The superheater is of the fire tube, double loop type contained in 48 flues 5 1/2 in. diameter.

Vanadium steel was extensively used for those parts subjected to the greatest strain. The parts constructed of this material include the engine frames; crossheads; driving wheel tires; driving, front, trailing and tender truck springs; main driving axles, main crank pins, and piston spiders. The cylinders and valve chamber bushings are also constructed of vanadium cast iron.

| | |
|---|--------|
| Tractive effort x diam. drivers ÷ heating surface*..... | 738.00 |
| Total heating surface* ÷ grate area..... | 88.00 |
| Firebox heating surface ÷ total heating surface*, per cent..... | 4.69 |
| Weight on drivers ÷ total heating surface*..... | 54.90 |
| Total weight ÷ total heating surface*..... | 61.70 |
| Volume equivalent simple cylinders, cu. ft..... | 34.44 |
| Total heating surface* ÷ vol. cylinders..... | 254.00 |
| Grate area ÷ vol. cylinders..... | 2.89 |

Cylinders.
Diameter and stroke.....28 in. and 44 in. x 32 in.

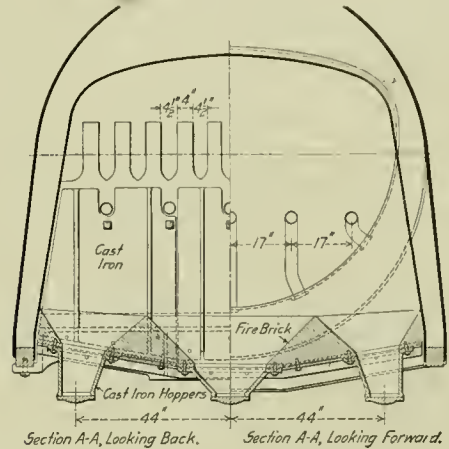

Section of Firebox Showing Mixing Fingers on Top of Fire Brick Wall.

| | |
|---------------|---------------------------|
| Kind..... | H. P.—Piston; L. P.—Slide |
| Diameter..... | 16 in. |

| | |
|--|--------------------|
| Wheels. | |
| Driving, diameter over tires..... | 56 in. |
| Driving journals, diameter and length..... | 11 in. x 13 in. |
| Engine truck wheels, diameter..... | 30 in. |
| Engine truck, journals..... | 6 1/2 in. x 13 in. |
| Trailing truck wheels, diameter..... | 30 in. |
| Trailing truck, journals..... | 6 1/2 in. x 13 in. |

| | |
|-------------------------------------|-------------------|
| Boiler. | |
| Style..... | Conical |
| Working pressure..... | 200 lbs. |
| Outside diameter of first ring..... | 100 in. |
| Firebox, length and width..... | 174 in. x 109 in. |

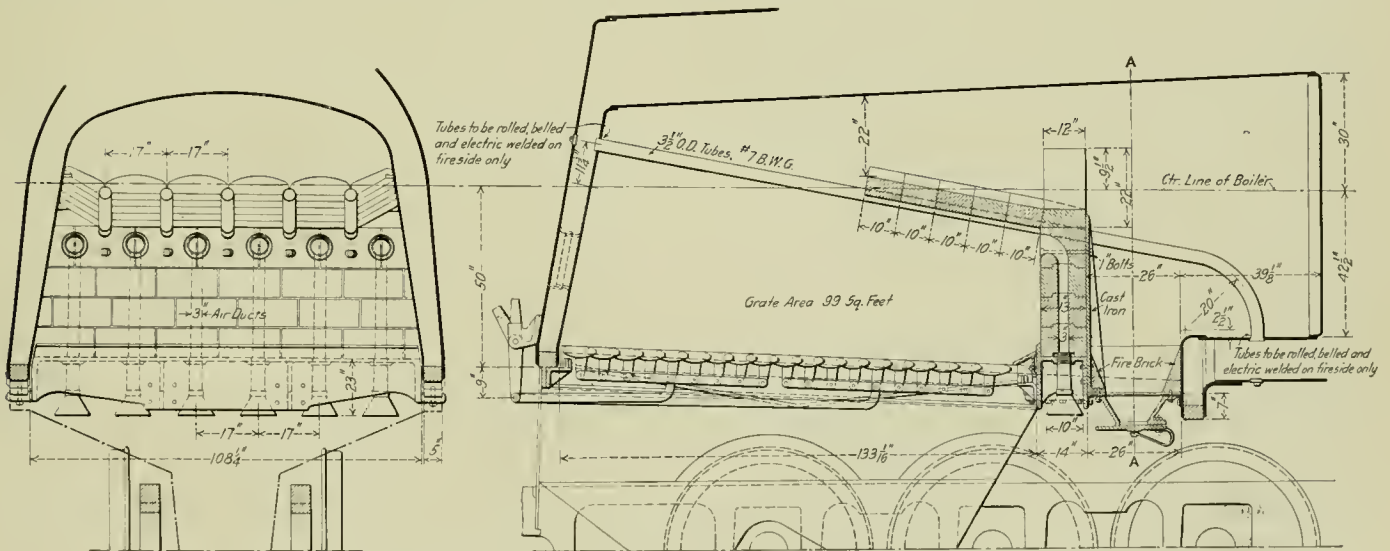

Firebox of Virginian Mallets Showing Combination of Gaines Fire Brick Wall with a Security Brick Arch.

The general dimensions, weights and ratios follow:

| | |
|---|--------------|
| General Data. | |
| Service..... | Pushing |
| Fuel..... | Bit. coal |
| Tractive effort, compound..... | 115,000 lbs. |
| Weight in working order (estimated)..... | 540,000 lbs. |
| Weight on drivers (estimated)..... | 479,200 lbs. |
| Weight of engine and tender in working order (estimated)..... | 752,000 lbs. |
| Wheel base, rigid..... | 15 ft. 6 in. |
| Wheel base, total..... | 57 ft. 4 in. |
| Ratios. | |
| Weight on drivers ÷ tractive effort..... | 4.16 |
| Total weight ÷ tractive effort..... | 4.69 |

| | |
|---|-------------------------------|
| Firebox, water space..... | F.—5 1/2 in.; S. and B.—5 in. |
| Tubes, number and outside diameter..... | 334-2 1/4 in. |
| Flues, number and outside diameter..... | 48-5 1/2 in. |
| Tubes, length..... | 24 ft. |
| Heating surface, tubes and flues..... | 6,350 sq. ft. |
| Heating surface, firebox..... | 410 sq. ft. |
| Heating surface, total..... | 6,760 sq. ft. |
| Superheater heating surface..... | 1,310 sq. ft. |
| Grate area..... | 99.2 sq. ft. |

| | |
|------------------------------------|----------------|
| Tender. | |
| Wheels, diameter..... | 33 in. |
| Journals, diameter and length..... | 6 in. x 11 in. |
| Water capacity..... | 12,000 gals. |
| Coal capacity..... | 15 tons |

*For detailed description see American Engineer & Railroad Journal, October, 1911, page 384.

*Equivalent heating surface equals 6,760 sq. ft. + (1.5 x 1,310 sq. ft.) = 8,720 sq. ft.

INTERNATIONAL RAILWAY FUEL ASSOCIATION

Comprehensive Reports and Interesting, Active Discussion
Made the Recent Annual Meeting of More Than Usual Value.

The fourth annual convention of the International Railway Fuel Association opened on May 22, 1912, at the Hotel Sherman, Chicago, with President T. Duff Smith (Grand Trunk Pacific) presiding.

After the invocation by Rev. Frederick E. Hopkins, the president delivered the opening address, using as his theme the necessity of co-operation to attain true economy. After discussing this subject from the railway standpoint as regards fuel and other supplies, he extended the same advice to the association, pointing out that in any new society, whose activities are of general interest to railway men, success for the first two or three years is assured by its newness. After reaching the point where the Fuel Association now finds itself, it is necessary to expend greater energy in all directions, if the possibilities of the idea which influenced the founders is to be developed to the fullest extent. He urged the co-operation of the members through committees, as well as individually.

Robert Quayle, superintendent of motive power and machinery, Chicago and North Western, pointed out the grave danger of permitting progress to extend to extravagance. This inclination is noticed in practically all things, and he directed his warning particularly to the danger of extravagance in the use of fuel. Much of this is easily possible to avoid, and he drew attention to many features that are not always given the prominence they deserve. It is first necessary to get good coal. There should be a carefully prepared specification, which should include the number of heat units required, on the basis of which all coal should be purchased. Inspection should be thorough and fair. He suggested the weighing of a certain percentage of the cars of railway coal regularly, in order to check the waybill weights. It is not at all infrequent to have a considerable amount of coal lost en route, either by leaking from the cars or through theft. Handling at the terminals should also be given close attention. Here, frequently, the greatest extravagance is discovered. In many cases a saving of from one to ten cents a ton is possible by improved methods of handling. He advised the members to persist in their efforts until they obtained the proper facilities. The speaker advised the use of shavings saturated with oil for starting fires, and strongly emphasized his recommendations for regular crews on regular engines, stating that this is the first essential to true economy. Grates should not be shaken more than is really necessary, which in most cases is very infrequent. He pointed out the extravagant methods of many enginemen in making station stops, and stated that, in his opinion, the air pump is one of the most extravagant parts of the locomotive. Education by leading, not forcing, was mentioned as being of primary importance. Large grate areas and the use of brick arches, which tend to greatly reduce the amount of smoke, were advocated.

Walter S. Bogle, president, Crescent Coal and Mining Co., addressed the meeting and advanced the coal operator's viewpoint of the railway fuel problem. He stated that there is a limit beyond which the coal operator cannot be expected to go in the expenditure of money for the preparation of railway fuel. At the present time, in general, the coal trade is not profitable, the average profit of all the coal operators east of the Rocky mountains being less than one-quarter of one per cent. on the money invested. Mr. Bogle said that the cost of coal to railways and other consumers is sure to increase, and mentioned several changes in conditions requiring it to do so. Among them were the safety appliance act, which has required the expenditure of over \$11,000,000 in the mines in the state of Illi-

nois during the past eighteen months; the indemnity law which is now costing the operators from 7 to 9 cents a ton of output, and the conservation law that will compel a more thorough removal of the coal from the mines. The present methods of mining are the cheapest but require the leaving of over 50 per cent. of the coal in the ground. The price of coal lands has increased over 300 per cent. during the last few years. This means, on a 5-ft. vein, an increase of about 3 cents per ton. The cost of labor has increased over 100 per cent. in fifteen years, and the higher wages are accompanied by a lower efficiency of labor.

Secretary and Treasurer's Report.—The report of the secretary-treasurer showed a membership of 406 at the opening of the convention, an increase of 39 for the year, and a balance of \$1,017.30 in the treasury.

FUEL AS A FACTOR IN LOCOMOTIVE CAPACITY.

Dr. W. F. M. Goss, dean and director of the College of Engineering, University of Illinois, read a paper on this subject, an abstract of which follows: The power developed by a steam locomotive is derived from the fuel it consumes. Other things being equal, the greater its rate of fuel consumption the greater will be its capacity. The weight of the modern locomotive cannot be greatly exceeded except at the expense of extensive improvements in track or through the adoption of an arrangement of wheels which will permit the load to be much more widely distributed than at present. As it is not likely that the demand for higher power will cease, the problem of supplying it is one of more than academic significance. It presents two possible lines of solution. One is through the better adaptation of fuel to the needs of locomotive service, and the other is through the better adaptation of the locomotive to the requirements of the fuel which it has to burn.

It is obvious that anything which will successfully promote the combustion of fuel in the firebox of a locomotive will operate to increase its power. Every pound of coal effectively burned represents a definite output in the form of power at the drawbar, and if through care in the choice and preparation of the fuel the rate of combustion can be materially increased, it is evident that the maximum capacity of a locomotive may be advanced. This fact is lost sight of when locomotives performing service, in which maintenance of schedule is a matter of great importance, are supplied with coal bad in its composition and which is a mixture of the finest dust with lumps of every possible size. Conditions of service which demand high power will justify unusual care in the selection of fuels. The coal used under such conditions should have a high thermal value, and it should be low in clinker and ash. It should be sized before it is put on the locomotive tender, and if necessary it should be washed and sized. One who looks upon sized coal in a car and then upon a carload of run-of-mine coal and considers that on the grate the combustion of coal can only proceed as air can pass through the bed and around the individual particles of coal, will easily understand the superior advantages offered by the sized fuel. A principal advantage of the briquetted fuel so much used in foreign railway practice is to be found in the fact that the briquettes are of uniform size. When the coal fired is made up of pieces of uniform size, it forms a bed on the grate in which the interstices between the pieces of coal are uniform and the admission of air over the entire area of the grate is finely divided and uniformly distributed streams. The result is that every part of the fire

is maintained in a condition of maximum efficiency; the temperature of the firebox will be higher than when mixtures of lumps and fine coal are fired; the rate of combustion will be greater, and, as a consequence, the capacity of the locomotives will be increased.

It is obvious that the power of a locomotive cannot be increased indefinitely merely through the proper selection of fuel, but the limits of its maximum performance may be materially extended. There are no objections to the general introduction of especially prepared fuel for locomotives excepting those of cost. The fuel bill of the railways is already an enormous one, and those who are responsible will always hesitate before permitting an increase in the purchase price per ton. But the ultimate cost, when measured in terms of service given, will be found in many cases justifiable. Under present practice, railways, in their desire for some increase in power, do not hesitate to increase the weight of their locomotives by giving them larger boilers, by raising their steam pressure, by the adoption of compound cylinders, and by the addition of superheaters. All of these are expensive measures, but they have been justified in practice by the results obtained. The more careful preparation of fuel is to be looked upon as a means to an end. It constitutes an embellishment in locomotive operation and is not different in purpose from embellishments in design. It will add to the expense, but will give a return in increased power which at the head of important trains may be greatly needed for the maintenance of service. I believe that a great opportunity, which as yet has been but little appreciated, lies awaiting the attention of the prophet who will proclaim the gospel of increased power of locomotives through the more careful selection of their fuels. The time is at hand when lump coal will be washed and sized, and when the fine coals will be washed and briquetted. These processes, excepting that of briquetting, are inexpensive and a demand for their employment will soon be forthcoming from the railways.

The alternative plan whereby the power of the locomotive may be increased, is that which provides for a development of its design along lines which will give it greater capacity to consume the indifferent fuels which under present practice are commonly supplied it. What changes need be made in present practice to provide a greater fuel-burning capacity? The first requisite in the development of such a design is a large grate. If a design could now be made which would permit the present maximum grate area to be doubled, several important results would at once be secured. First, while the total amount of fuel burned per unit of time might be materially increased, the rates of combustion per unit area need not be increased, they could even be reduced. The increase of power would be proportional to the increase in the total fuel burned, while the reduced rate of combustion would avoid the necessity for special care in the selection of fuel; would allow the use of fuels now normal to locomotive service; would operate greatly to reduce the loss of fuel in the form of sparks, and would prolong the period during which the locomotive could be kept in continuous operation. For example, when 6,000 lbs. of coal are burned per hour on a 60-ft. grate, the rate of combustion is 100 lbs. per foot of grate per hour, and the spark loss with many fuels represents fuel values which approach 10 per cent. of the coal fired. The collection of ash and clinker on the grate so much impedes the draft as to require a thorough cleaning of the fire after a run in passenger service of from 100 to 150 miles. A greater distance, if attempted, must generally be run at reduced power. With a large grate these conditions are all changed. The burning of 6,000 lbs. of coal on a 120-ft. grate would reduce the rate of combustion to 50 lbs. per foot of grate per hour, and the spark loss to 2 or 3 per cent., and would permit continuous operation for a passenger run of 300 miles between the cleaning of fires.

It is true that the larger grate would be at a disadvantage with

reference to losses of fuel on the grate at the end of the run, and in the larger amount required to cover the grate in the process of starting fires; but these would be entirely neutralized by the possibility of increased mileage between the starting of new fires. With the larger grate, only half as many new fires would need to be made per thousand miles run as were formerly required. While the same total amount of coal is burned in each case, it is evident that the 8 per cent. saving in spark losses would at once be made available as an 8 per cent. increase of power; also that among the possible variations in the method of taking advantage of the presence of the larger grate will be included the possibility of increasing the rate of combustion. For example, an increase in the total fuel consumed from 6,000 to 8,000 lbs. an hour, would increase the power capacity of the locomotive by 33 per cent., and would involve rates of combustion which, judged by present-day standards in locomotive service, would be accounted low. If the rate of combustion were forced to a total of 10,000 lbs., the increase of power would be 66 per cent., and the rate per unit area of grate would still be below the maximum now common in locomotive service. There is, therefore, much to be accomplished by increasing the grate area of a locomotive. If the output of power remains unchanged, it will permit lower rates of combustion, a reduction of spark loss, and the use of inferior grades of fuel. If, on the other hand, the rate of combustion per unit area of grate remains unchanged, the output of power may be increased in proportion to the increase in the area of the grate.

Locomotive grates having an area of 150 ft. or more would necessarily involve some new departures in locomotive design. As the width of such a grate could not greatly exceed 7 ft., its length would need to be from 20 to 25 ft. This may mean a complete abandonment of the existing type of locomotive boiler and the substitution therefor of some new type, but it does not necessarily imply such a change. It does mean, however, the adoption of an articulated form of locomotive which will admit of a space of 25 ft. or more between the two systems of wheels. It should be possible either to increase the spacing of the frames over this space or to drop the frames so low that the firebox and boiler with attachments may have an unobstructed area the full width of the track clearance for all heights 3 or 4 ft. above the rail.

In working out details, automatic stoking must be provided for. This can best be done by having the stokers feed transversely across the boiler from both sides of the firebox. The stokers themselves may be either of the chain belt or of the Roney type, or they may consist of any simple feeding mechanism, delivering to fixed inclined grates. They would be very short in the direction of the fuel movement, probably not more than 30 or 32 in. in length, and they would discharge on a flat dump grate running the whole length from front to rear of the firebox. The aggregate width of the individual stokers on each side would, of course, be from 20 to 25 ft., but they would be split up into as many different units as would best provide arrangement, the green coal would pass under the mud-ring for the construction of short arches over them. By such an of the boiler and under a short arch, where it would ignite. It would gradually be pushed forward toward the center of the firebox to the flat dump grate, where it would be met by fuel coming in from the other side. The inward movement of coal from both sides toward the center of the grate would, of course, proceed throughout the full length of the firebox, that is, for a distance which might be as great as 25 ft. The fact that the ignitions of the fuel would be under an arch would make the combustion nearly or quite smokeless, the mild draft would make the cinder losses small, while the low rate of combustion per unit area of grate, and the provisions for cleaning supplied by the stokers and dump grate, would permit continuous operation at full power for a very long period.

Narrow hoppers supplying these stokers would open up along the whole length of the firebox on both sides to the full width allowed by the track clearances. The operating mechanism of the stokers, which would be beneath them, would be allowed the same total width. An extension of these hoppers upward on both sides to the level of the top of the boiler or higher, would provide space for all the coal necessary for a run. No coal would be carried on the locomotive tender and none would need to be rehandled on the locomotive. It would all be loaded at once into an extension of the stoker hopper, and its weight would be added to the wheel loads of the locomotive.

In the discussions of the preceding paragraph, I have assumed that the general type of boiler employed would not be materially different from that now in service. Difficulties would, of course, appear in the construction and maintenance of a staybolt firebox 25 ft. in length, and whatever the outside form of the boiler might be, some special provision would need to be made in the working out of its construction. A demand for a firebox of such dimensions would doubtless call out various means for supplying it. There would probably be no difficulty in constructing a Jacobs-Shupert firebox of any desired length. The boiler would be so located on the frames of the locomotive that its back-end would be just in advance of the first of the rear system of driving wheels, and a foot-plate carrying all of the auxiliary machinery of the locomotive would extend rearward over the axles of these rear wheels and perhaps over the wheels themselves. A fire door, as usually placed, would supply the fireman an opportunity to inspect his fire, and guided by such inspection he would be able to so control the operation of the several stokers as to maintain uniform conditions throughout the length and breadth of the grate. The barrel end of the boiler would extend out over the forward system of wheels. So much for the arrangements involving a normal boiler. If it should be desired, an attempt could be made to work out the details of the design, using an entirely new form of boiler, such, for example, as a boiler of the water-tube type; but it is not likely that the adoption of any such new type would of itself simplify the general problem as herein outlined.

In conclusion, permit me to say that I appreciate thoroughly the danger of attempting within the limits of a few paragraphs to outline successfully a locomotive design that is entirely new. I appreciate also the many difficulties to be met in applying any such conception. I cannot even claim that I have yet given the matter such attention as will permit me to say that all difficulties are surmountable, but I am convinced that the general scheme is sufficiently promising to justify any study which is likely to be bestowed upon it. My purpose in presenting it is to place before the members of this association in as forceful a way as possible, the importance of larger grate areas in locomotive practice. If the capacity of locomotives is to increase in the future as it has in the recent past, and if locomotives are to be supplied with such grades of coal as are now commonly used in locomotive service, such a change will be found imperative.

Discussion.—A general agreement with the author's arguments in favor of better prepared fuel was evident, but there was considerable skepticism as to the feasibility of the practice under present conditions. The advocacy of larger grate areas on locomotives met with the approval of most of the speakers. One member suggested that it was not so much larger grates that are needed as larger firebox volumes.

H. B. MacFarland (Santa Fe) drew attention to the primary importance of boiler capacity in the locomotive, stating that, in a majority of cases, it was necessary to rate locomotives entirely on their boiler capacity. An opinion was expressed by W. E. Symons that the locomotive proposed was not far from present-day requirements. In that connection he drew attention to the design, recently patented by G. R. Henderson, hav-

ing three groups of drivers, one being under the tender. He also reminded the members of the proposal of the late E. H. Harriman to use a 6-ft. gage. This was advanced largely for the purpose of permitting the use of locomotives of greater capacity. A continental system for this gage had been outlined, and while the scheme was at present lying dormant, it was not entirely improbable that the requirements of the near future might again bring it to life.

C. A. Seley (Rock Island) stated that, although the suggested locomotive might seem radical, past history indicates that suggestions of this kind quickly become conservative and it should not be thrown aside on this account.

T. R. Cook (Pennsylvania) spoke briefly about locomotive stokers and their relation to increased locomotive capacity. Stokers handling a much larger amount of fuel than would be possible with hand firing are now in use and, taken in connection with other boiler capacity increasers, have put the present possible locomotive capacity considerably beyond anything considered feasible even a few years ago.

E. McAuliffe (Frisco) suggested that the permanent way would require considerable alteration if the larger locomotives were to be introduced. Even with the present Mallet locomotive it is frequently impossible to operate the locomotives efficiently because of the condition of the permanent way.

R. Emerson related his experience with burning soft coal on the large grate areas of locomotives designed to burn anthracite. Three difficulties appeared. The first is that the heat thrown off from the large fuel bed makes the fireman's work very difficult. Again, the amount of fuel to be put into the firebox is practically beyond the capacity of one man, and third the very thin fire which must be maintained in order to permit the air to pass through the fuel bed. He followed Dr. Goss' prophecy by suggesting an articulated locomotive in three parts. One group of drivers would carry the combustion section of the boiler, the second the evaporating section, and the third would be devoted to feed water heaters, etc. Another suggested development was the placing of a power house on wheels at the head of the train, which would generate electric current to be transmitted to the electric tractor cars scattered throughout the length of the train, possibly one for each ten cars. A fertile field for investigation was mentioned by the speaker in the use of powdered coal mixed with about 10 per cent. of oil. Such a combination gives great heat, and experiments had indicated its practicability.

LOCOMOTIVE FUEL PERFORMANCE SHEET.

Robert Collett, superintendent of locomotive fuel service of the St. Louis & San Francisco, presented a paper on this subject in which he described the locomotive fuel performance sheet used on the Frisco, and also summed up the replies to a circular letter which had been sent to the members of the association.

A little more than a year ago, the St. Louis & San Francisco decided to try out, on one division of 250 miles, an individual engine daily performance sheet. Formerly a monthly performance sheet had been kept, but this had been discontinued about three years previous, because the information was more or less inaccurate and reached those interested so late that it was not considered worth the expense of compilation.

It was the opinion of the general officer who originated the later plan, that if sufficiently close supervision could be given to all of the separate features, a correct daily record of each engine's performance could be obtained and that with this information, as well as a knowledge of what constituted good average performance in each class of service, a good idea could be obtained as to what each of the engines were doing and should do in the use of fuel. Accordingly, a daily performance sheet, such as shown herewith was started and sufficient time was spent on one division to get in thorough touch with all the

fuel station reports that it is not necessary for him to arbitrarily change the amount shown on the ticket in order to keep his balance somewhere nearly correct, but that the matter should be regulated with the party delivering the fuel to the locomotive. Likewise, it was found difficult to reconcile the average ticket furnished by the engineer with the amount of coal delivered to the engine as shown by scale weight, although the coal might be weighed immediately before being placed on the chute. The fact that this distribution requires such close supervision makes a daily record, in our opinion, desirable.

If performance sheet is kept, is it an individual engine record or engineer's record of fuel consumption? Replies indicate that one method is in use about as much as the other. Some members prefer both the engineer and engine record and are handling it in this way. Our opinion is that the engine record is preferable to the engineer's record, for the reason that we should have tickets to cover the individual trip. In freight service it sometimes happens that the engine will be handled by more than one crew in going over the division, and it is not possible to separate the fuel used by each crew; again, an engine may run over more than one division, handled by two separate crews, not taking any fuel at the intermediate terminal. Where engines are manned by regular crews, this report practically becomes an engineer's record also.

While the operation of the engine does have a great deal of bearing on the fuel consumption, the condition of the engine also is important and where it is necessary to rely to some extent on the engineer's estimate, as at chutes where a night force is not employed, the engine record, we believe, best serves the purpose. The waste due to the condition of the engine is apt to be as great as that due to improper operation, and it is necessary to have the engineman's co-operation in obtaining this information, both as to the condition of the engine and the amount of fuel used, while the waste due to improper handling or firing is more a matter of education through personal contact than through the medium of the performance sheet. The least skillful man is most likely to give a short ticket or cultivate the good will of the chute tender, to the engineer's advantage perhaps and to the discredit of another man who is really more economical in the use of fuel. Whereas, if it is an engine record, for each division, it reflects to a large extent the condition of the locomotives and is for, or against, the division mechanical officers. One division cannot be altogether checked against another division, but records of service tests on that division should also be used for comparison.

What is your opinion as to separating the fuel used at the terminal from that used on the trip? The opinion of those replying were almost equally divided, many objecting to the accounting necessary to separate the charges and taking the view that as it must necessarily all be charged to locomotive operation, nothing could be gained from the separation. A great many thought it unfair to charge crews with the fuel used at the terminal over which they had no control.

We do not attempt to separate the fuel used in firing up the engine from that used on the trip, but do undertake to give credit for the fuel used over and above the amount required to fire the engine up and which may be consumed by lack of facilities or other causes. This has been taken care of by a special terminal report, which has taken the place of a report formerly used to show the time engines were in terminal and the mechanical and transportation delays. This has been changed to include the time that engines are held under steam at terminal. All time in excess of three hours that the engine is fired up is shown as terminal delay and credit is given on the basis of a certain number of pounds per hour. This amount is deducted from the fuel used by all engines.

What methods are used to interest enginemen in economical performance? Class meetings are held on the different di-

visions, as often as convenient to interest the enginemen in fuel economy. They are not only attended by enginemen, but others who may care to attend, together with all of the officers that can be present. All points involved are discussed freely, suggestions and criticisms are invited, and division and system performances are gone over, so that all may be advised of the progress being made. Separate educational meetings are held with the firemen. While special effort is made to have the accounting as correct as possible, we depend more on personal contact than writing to the enginemen to obtain results. On divisions where the crews have regular engines, mimeograph forms are sent out at the close of each month, advising the engineer of the amount of coal consumed by him and the pounds per passenger car mile or the pounds per thousand gross ton-miles for freight trains and the average for all engines in that class of service. Information from the daily performance sheet is furnished the proper officers, who take the matter up personally with the crews. Crews are also complimented by letter for good performance where it comes under the personal observation of master mechanic or assistant superintendent locomotive fuel service; copies of these letters are frequently attached to the enginemen's personal record. Monthly bulletins are posted by the superintendents calling attention to what has been done on their respective divisions as shown by the division fuel statement, thus encouraging renewed effort.

Do you consider the extra expense of scales in mechanical chutes advisable? The majority of the replies indicated that scales are not in general use, about one-half favoring their use in connection with the fuel performance sheet, and several advising that experience with scales had proved unsatisfactory:

On our lines there are a number of mechanical chutes, only two of which are provided with scales; also several gravity chutes holding from 200 to 300 tons, with no means of measuring the coal delivered to each engine; a few pocket chutes which have been calibrated and stencilled in ton measurements; several locomotive cranes and at some points we shovel direct from the car to the engine tank. Our experience has been that the most accurate distribution is by using the billed car load weights as a guide, taking the fuel foreman's or hostler's estimate, and requiring them to observe the space in the tank. We find they become very familiar with the amount of coal that is required to fill a given space. All coal is weighed on our railway track scales after leaving the mines and special attention is given the feature of correct weights. Fuel oil tanks are provided with calibrating rods, stencilled in gallons. We do not use meters at our fuel oil stations. On a recent 30-day test of a Mallet locomotive, the hostler's estimates of coal taken from a mechanical chute at one end of the line and a fuel foreman's estimates at an intermediate pocket chute station, showed a difference of but 1.22 tons when compared with the amount recorded by the man making the test. This case is unusual, but serves to illustrate that a reasonably correct charge can be obtained.

In the opinion of the writer, scales are not necessary at terminal points, unless engines of foreign lines are to be coaled. Our observation leads to the belief that unless the person assigned to that duty has nothing to do but look after the scale, or if a large number of engines are handled, the weighing is apt to resolve itself into guess work, due to certain engines taking coal and the chute men not being at the scale at the time.

At intermediate coaling stations, if the chute is located at a pumping station where a night man is employed, or if there is enough work to justify the employment of two men to operate the chute, I believe the scale is desirable, as it does not represent any additional cost for operation and gives a better distribution than that made by relying upon the engineer's estimate.

We do not undertake to include an adjustment in the per-

formance sheet for the difference between coal chute measurements and the billed weights, but make a special effort to have the amounts shown tally as closely as possible with the fuel actually used. All concerned know that it is to their interest to have this shown; for if all the fuel used is not charged in any particular month, it will be reflected in the poor performance the following month when the error has been corrected.

The work on each division is under the direct supervision of the assistant superintendent locomotive fuel service, who formerly held the position of road foreman of equipment and who has practically the same duties, giving special attention, however, to the matter of fuel economy. The number of engines assigned ranges from 70 on the lightest to 130 on the heaviest division.

The handling of the performance sheet requires the services of one clerk for each division, and unless the division is a very heavy one, he can also handle the correspondence.

No extra expense is incurred in procuring data on tonnage, car miles, hours of service, etc., this being furnished on the report made up in the despatcher's office for the car accountant's records.

Too much emphasis cannot be given the matter of correct distribution. No greater mistake can be made than to assume, with the posting of a bulletin requiring correct fuel tickets to be made out or the installation of weighing or measuring methods, that the problem of distribution is solved. A little first hand experience will soon dispel this illusion. Nothing will cause an engineman to lose faith in a performance sheet more quickly than to find that some person handling the fuel report is changing tickets to suit his own convenience, while on the other hand, a sincere effort to give every one a square deal will meet with a very hearty response.

Some details which have had an influence in keeping up interest and also helped reduce the fuel bill, are as follows: Weekly reports submitted by the fuel inspectors on the condition of the flooring of coal cars placed for loading at the mines; a monthly report showing the diameter of the exhaust nozzles of each engine; a crusade on the overloading of engine tanks at coaling stations; waste at the coal chutes, and deck guards on engine tanks to prevent the coal wasting at the gangway.

Discussion.—The author's proposed forms drew but little favorable comment. There was a somewhat general criticism on the absence of any record of the performance of the engine crew. The advisability of attempting to maintain any record of this kind was questioned on the ground of its known inaccuracy due to the many indeterminate factors.

Several methods, using different forms than those proposed, were described by members, and particularly by G. M. Carpenter (N. C. & St. L.), who stated that the fuel department organization and methods as used on his road (234 locomotives) were very successful, although they possibly might not be as well suited for a larger road. The methods included the careful calibration of the coal space in the tender, and when a locomotive came in from its run the amount of coal left in the tender was recorded on the proper form. The amount then put on was recorded, and the crew starting out with the locomotive was charged with the total amount. From this would be deducted the amount remaining at the completion of the run. Daily reports were made and the fuel performance of the engineers and firemen were recorded as well as for the locomotive. Each coal chute had both a night and day foremen and the coal spaces in the chute were carefully calibrated. The foremen were responsible for the records.

Mr. McAuliffe drew attention to the items on the sheet used by Mr. Collett which showed the amount of time required for cleaning fires and stated that a very excellent check on the quality of the fireman's work can be obtained by a knowledge of the length of time it takes to clean the fire on his engine. He strongly advised the use of personal effort with the engine crew,

claiming it to be of much more importance in obtaining fuel economy than the use of any type of performance sheet.

R. Emerson advanced the opinion that unless the performance sheet can be accurate in every particular to at least within a few per cent. it is of no value. To do this so many factors must be taken into consideration that it would be very difficult to properly keep the records, and therefore performance sheets as now maintained, or as they can be maintained in the future, are useless. He described the system used on the Eastern Railway of France, this being the only one he knew that approached perfection. On this road all trains are scheduled and the same locomotives with the same crews are regularly employed. These conditions could not be duplicated in this country, and even the refinement there obtained would not be possible here.

Mr. Collett, in closing his paper, stated that he was not in favor of the calibrated fuel space in the tender recommended by Mr. Carpenter.

ANTHRACITE COAL FOR LOCOMOTIVE FUEL.

T. S. Lloyd presented a paper on this subject in which he recommended the use of anthracite coal on suburban, transfer and yard locomotives, in spite of its high cost, in order to abate the smoke nuisance and offset the movement for electrification.

Discussion.—Although it appears that the use of anthracite coal on locomotives, in general, is decreasing, as a means of reducing the smoke from yard and transfer engines and reducing the justice of the demand for electrification in urban districts, its value was generally recognized by the association. Several members testified to success in this direction. T. W. Brewer, for example, stated that the Lehigh Valley was using anthracite extensively and that all things considered, on yard engines, it was the cheapest fuel because of the absence of criticism from municipal governments on account of the smoke.

R. Emerson quoted from reliable statistics showing that five per cent. of the locomotives in the United States use anthracite coal and 5 per cent. use oil. The governing factor in the use of anthracite on road engines is whether the coal can be sold more profitably for domestic purposes. Anthracite in prepared sizes is sometimes used in passenger service for reasons other than economy. Special fireboxes are not required for burning anthracite on yard engines. As an alternative, coke has been suggested, but the difficulty of firing coke makes its use improbable. While briquettes are possibly a more suitable fuel than coke, the cost of briquetting is an objection which will probably delay its adoption. In emphasizing the importance of the reduction of smoke to avoid electrification he gave a brief outline of the cost of the latter and showed that no economy can be expected from electric operation.

PROPER METHODS OF FIRING LOCOMOTIVES.

D. C. Buell, chief of the educational bureau on the Union Pacific, Illinois Central, Yazoo and Mississippi Valley and Central of Georgia, presented an individual paper on the Proper Method of Firing Locomotives, in which he covered, more or less thoroughly, the entire field of fuel economy.

Is it not fair to assume that the reason we fail to get better results along the line of attempted fuel economy on railways is due to the fact that we have been working along the wrong lines? Is it too much to admit that our efforts are not based on sound principles, and that we need to discard the old and begin anew to work out this problem on basic principles, the following out of which must, from the nature of things, bring results?

Drastic measures seem to be necessary, and if statements in this paper appear harsh or radical it should be remembered that the object is not to criticize present practice, but to cause an awakening as to fundamentals—the better understanding of which will be necessary before any great improvement over present practice can be expected.

The army of combustion experts who are fighting for fuel economy center their attacks on the locomotive fireman. Books,

lectures, chemical demonstrations, road demonstrations, premiums, bonuses, and a thousand and one other things, are hurled at the fireman in a vain endeavor to make him burn the fuel more economically. Nevertheless the proper firing of a locomotive is an art known and practiced by but a small percentage of the locomotive firemen of today. The onslaught on the fireman has been so fierce, that in the smoke of battle many of those attacking this problem have entirely lost sight of the fundamentals which are beyond the control of the fireman, and consequently cannot be remedied by him. The proper training of the fireman to fire according to correct principles of combustion is but one of the steps leading to the solution of the problem of fuel economy on a railway.

Proper Grade of Fuel.—The officers of most roads have recognized the importance of a knowledge not only of the heat value per pound of the different grades of fuel available on their roads, but also of other properties of coal, such as whether it clinkers, how much ash it contains, its coking or caking properties, etc. Still another factor is determining what grade of a certain coal can be used most economically; that is, whether it is more economical to use mine-run, or the higher priced screened coal. The traffic department and the operating department must be consulted to make sure that, as far as possible, the interests of the company may be served well in the selection of the fuel to be used. The dependability of the mine in working steadily and turning out a uniform grade of fuel is also a factor. After the proper grade or grades have been determined they should be regularly used so that locomotives may be properly designed and drafted to burn the fuel furnished them economically; and so that the men can familiarize themselves with the proper handling of the class of fuel furnished to them.

Inspection.—Proper inspection of coal at the mines is just as essential as the inspection of locomotives or cars built for the company. Inspection should be made for both quality and weight.

Distribution.—The economic distribution of the fuel from the mine to the point used is one of the big items of fuel economy. I venture the assertion that on roads where this matter is not carefully handled, as much money is wasted through this channel as by improper firing. It is an operating matter pure and simple, and deserves a most careful study. A few years ago, J. G. Crawford, of the Burlington, worked out very complete statistics along this line and presented his results in a paper before the Western Railway Club.*

In this connection the direction of the volume of traffic must be considered, so that the company coal can tend to balance the tonnage instead of throwing it further out of balance. Other factors are the reduction of mileage of empty coal cars, the tonnage that can be hauled over ruling grades, etc.

As an example of what can be accomplished, it has been found economical on one of the transcontinental lines to haul a large quantity of company coal from mines in the far west to eastern terminals, and store it there for a time, the reason being that at certain seasons the traffic is almost entirely westbound. Then coal cars are needed east. These cars can be loaded at the mines, hauled east by power that otherwise would run light; the coal can be unloaded and stored and the cars released where wanted; all at an expense that is negligible compared to what it would cost to keep those eastern terminals supplied at a later season when the traffic was nearly balanced or heavier east-bound.

Coaling Stations.—There is an astounding variation in the cost of coaling locomotives. Cost may vary from two or three cents a ton at a modern link-belt station, to 25 or 30 cents a ton at some more primitively equipped plant. One road that I know of arranged with a company that makes a specialty of erecting coaling stations to finance the erection of a number of stations on its line. This road in a short time saved enough on the cost

of coaling engines to not only pay interest on the capital invested for them, but to pay the principal as well.

It is safe to say that a master mechanic or road foreman in territory where this item of cost has not been carefully supervised could save more money, save it more quickly and make the saving permanent, by reducing the cost of coaling engines than by a campaign among his firemen.

Waste at Terminals.—It is ridiculous to talk fuel economy to a fireman, when the road foremen, roundhouse foremen, or master mechanics will allow them to bring engines in from a trip with a ton or more too much of unburned fuel in the firebox—practically all of which is wasted when the fire is cleaned; and when, at this same terminal, hundreds of pounds more fuel are wasted keeping fires in engines that are allowed to pop off around the yard or in the engine house, or in rekindling fires. Such little economies (where they are economies) as the kindling of fires with oil and shavings make the fireman realize that coal is a valuable commodity, and set him thinking about how he can save some.

Condition of Locomotives.—There is nothing more discouraging to a good fireman than an engine that will not steam properly. But a poor steamer seems to have some hypnotic effect on a poor fireman or a new man that not only causes him to forget everything he has ever heard or known about the correct principles of firing, but suggests that he is no longer a fireman—merely a coal-heaver—and he acts on that suggestion. The average man, overtaken by the feeling that he has a good excuse for making a failure, fails with ease. The man to heed fuel economy talk is one who knows that the boiler plant of his locomotive is in good condition.

Stop Steam Leaks.—It is folly to delude ourselves into thinking that the fireman of today is stupid or weak-minded enough to listen with attention to either orders or pleading about economical firing when the engine he fires wastes more steam than he wastes coal. The waste of steam mentioned in this connection includes not only the steam that is wasted past piston and valve glands, packing rings, valve rings or seats, etc., but that steam which is wasted from poor valve setting, excessive engine friction, etc.

Accounting.—The accounting for fuel on most roads is a joke. There are but few, if any, of you in this room, connected with the motive power department of a railway who do not know of the pencil adjustments made every month at each coal chute to balance the tons of fuel charged against that point. This adjustment has become such a common-place affair that the engineers and firemen know of it. Then how can we command their respect if we talk about proper firing of an engine to produce fuel economy, when they know that we can't come within from 50 to 300 tons per month of balancing our fuel accounts at different coaling stations?

Common Sense Statistics.—How do you know whether or not a fireman is firing economically? What statistics have you to prove it? Our ideal is maximum work at the drawbar with a minimum number of heat units. Our performance sheets at the best show only inconclusive comparisons. Pounds of coal per thousand ton miles on a water level division and on a 2 per cent. are totally different propositions; and even comparing the same class of engines on the same run we fail miserably because we have no accurate method of checking the amount of coal issued to an engine, nor of knowing the amount left on the tank at the end of the run. Neither do we credit the fireman with the coal consumed while the engine is at the terminal.

On some roads every one of these items is receiving careful attention and good results are being accomplished. It is probably safe to say that on every road one or more of these items is the particular hobby of some officer and, therefore, is closely watched.

My object in calling attention to this matter has been to defend those hundreds and thousands of loyal men who are daily

*See *American Engineer*, April, 1908, page 124.

striving against staggering odds to get their firemen to fire locomotives properly. The reason that road foremen, master mechanics, fuel experts, combustion experts—call them what you may—have not been able to get permanent results has, to my mind, been due in most cases to the overwhelming odds they have had to work against.

Proper Firing.—The proper method of firing a locomotive is the logical method for all firemen to follow, for the simple reason that it is the easiest, the least laborious, and most satisfactory method. If an engine is fired properly there are fewer scoops of coal to be handled, little or no necessity for using the rake or slicebar, or of cleaning the fire; and the shaking of the grates is reduced to a minimum. In addition to this, an engine that is fired properly steams, unless there is something radically wrong with the engine, or the coal is devoid of heat units. But even in such a case proper firing produces the most steam possible under the conditions; and the fireman may safely feel that no one could have done better than he did under the circumstances.

In order to fire an engine properly the fireman need not necessarily know anything about the theory of combustion—he may have learned to apply the principles without knowing the reason for so doing. In fact many first-class firemen do not understand anything about these principles. There are, however, certain fundamental facts that should be borne in mind when endeavoring to explain to firemen the necessity of doing certain things to get proper results. To produce heat in a locomotive firebox three conditions are necessary—and only three: First, there must be a supply of fuel. Second, there must be a plentiful supply of air, and third, the air and the fuel must be brought together at a temperature at which they will burn.

Soft coal is composed of coke and gases. When a shovelful of this coal is thrown on a fire the gases are driven off by the heat, the coke remaining on the grates. Both the coke and the gases will burn, but before any burning can take place they must be supplied with air at what is called the igniting temperature. Air is made up of several gases, one of which is the particular thing required for burning the coke and the gases in coal. This burning will not take place until the fuel and the air are heated to a certain temperature, called the igniting point.

With the three conditions of fuel, air and proper temperature present, burning will always take place, but with any one of these three conditions lacking, burning absolutely will not take place. When burning does take place, the fuel disappears, with the exception of the ash and the dirt that were in the coal, and these remain on the grates. This disappearance of fuel is due to the fact that in the process of burning, a chemical change takes place by which the air and the fuel unite to form gases; these are drawn out through the flues into the front end, and from there pass out through the stack with the exhaust. During this changing process, the heat necessary for steam-producing purposes is evolved.

While there are many different kinds of fuel which may burn in many different ways, any one who thoroughly understands the basic principles set forth above can understand and explain most of the actions that take place in a locomotive firebox.

In describing the actual work of firing a locomotive, it is necessary to assume that the engine is properly drafted, and is in proper condition to burn economically the fuel furnished; and in the discussion which follows it is assumed that these conditions exist.

In starting out, the fireman should endeavor to have a light fire, a level fire, and a bright fire. These three conditions should always exist in the firebox. The thickness of the fire should be regulated by the class of fuel, the drafting of the engine, and the weight and schedule of the train. The fire must be light because the amount of air that can be supplied in a locomotive firebox is always limited.

If the fire is too light, the draft will pull such a large volume of cold air through it that the temperature of the gases will be

reduced below the igniting point, and proper burning will not take place. This condition can be ascertained by observing the fact that the steam pressure immediately falls under such conditions, and no smoke appears at the stack, even when fresh fuel is thrown on the fire. If the fire is too heavy, however, it is not so easy to recognize the condition, although proper results cannot be obtained with a thick fire. It is practically impossible to get sufficient air through a thick fire to properly burn the large volume of gases that are liberated from the fuel, and the result is, that when fresh fuel is thrown on the fire, although there is sufficient heat in the firebox to drive off the gases from this fuel, there is neither the proper igniting temperature present nor the requisite air supply to burn them. These gases, however, as soon as they are liberated from the coal, are pulled through the flues by the exhaust, and as the conditions in the firebox have not been such as to allow them to burn, and as these gases are the principal heat-producing part of the coal, it will readily be seen that a large amount of heat is wasted.

The fire must be level for the reason that in an engine properly drafted, there is an equal pull of air through the entire grate area; but, if the fire is banked at one place and low at another, the air, seeking the easiest channel for entrance, will for the most part pass through the place where the fire is light, very little air passing through the place where the fire is banked. This gives an unequal distribution of air to the fire, and creates the same effect on one part of the fire as though the draft were too light, and on the other part as though it were too heavy. This is further and better illustrated in cases where there is a hole in the fire. In such cases nearly all of the air passes through the hole, and very little through other parts of the fire, with the consequent result that the steam pressure immediately responds to this condition; and the pressure cannot be regained until the fire is leveled over, and the proper conditions for burning are once more obtained. A condition of this kind is very hard on the boiler, as well as on the steam pressure.

The fire must be bright, because it is absolutely necessary at all times to keep the temperature in the firebox up to the igniting point of the gases. Burning will absolutely not take place unattained in a locomotive is about 2,500 deg. Fahr.; the igniting temperature of the gases is about 1,800 deg., so that there is but comparatively little range between the maximum temperature that can be obtained, and the point at which the gases will not burn, due to the temperature in the firebox being below the igniting point of the gases. Burning will absolutely not take place unless this igniting temperature is present; and the three cardinal principles of the light fire, the level fire, and the bright fire, must be kept constantly in mind in order that the fuel can be properly burned.

With the fire in this condition, fresh fuel should be added in comparatively small amounts at regular intervals. The fresh fuel should be spread on the bright spots, and the fire door should be swung shut, or closed, after each scoopful of fuel is added.

There are two important reasons why fresh fuel should be added to the fire in comparatively small amounts. In the first place, opening the fire door to add fresh fuel allows a considerable quantity of cold air to enter the firebox, thus reducing the firebox temperature; and this fresh fuel must be "torn down" into its elementary constituents before burning commences, which absorbs considerably more heat. If it is desired to deaden a fire, it is covered over with a large quantity of fresh fuel; if fuel is added to the fire in large quantities it, in like manner, cools down the temperature of the firebox, perhaps below the burning point, with the result that although the temperature is lower than that at which the gases will commence to burn, nevertheless, a considerable amount of gas is driven off from the coal even at this lowered temperature. The result is that much of the heat possible to be obtained from these gases under normal conditions is lost because the gases are pulled through the flues and out of the stack, without having had an opportunity to burn. On

the other hand, had the coal been added in comparatively small quantities, the temperature would have been maintained at the burning point. The second important reason is that, with a large amount of fuel added to the fire at one time, such a large volume of gas is given off that even were the temperature of the firebox maintained at the burning point, it would be impossible to supply sufficient air to mix with these gases to properly burn them.

The fact that fresh fuel should be placed on the bright spots in the fire can readily be understood, because where the fire is brightest, the fuel is nearer to being consumed, and, consequently, fresh fuel is required at that point. The fact that the fire is not bright in some places in the box, indicates that there is a supply of fuel at those points that is not yet burning at the highest heat (in some cases this might indicate a hole or a clinker, but either of these will readily be detected) and that those points, therefore, do not require more fuel until the burning becomes further advanced. There is an old rule which says that "If a fireman takes care of the sides and the corners, the center will take care of itself." This, while not true in all cases, is well to remember.

As regards swinging, or closing, the fire door between each scoopful of coal, it can readily be seen that if this is not done, the firebox temperature will be reduced. Closing the door between each scoopful of coal gives an opportunity for the temperature to be maintained at the burning point.

With the engine in proper condition, it is an easy task to fire according to correct principles and get economical results; but, when engines are not in a condition that will permit firing them as just described, a much more difficult proposition confronts the fireman. The same general principles, however, hold true, although the fireman must use his practical experience and good judgment to get the best possible results under the conditions which exist.

Prevention of Smoke.—Some years ago the single scoop method of firing was advocated as a cure-all for smoke troubles. Experience has proved that with the modern large locomotive single scoop firing is not satisfactory in most cases, although there is seldom a time when more than three or four scoopfuls of fuel should be used for a fire. With a fire in the proper condition a fireman will produce but very little smoke if he carries a light fire, a level fire, and a bright fire, adding but three or four scoopfuls of coal to the fire at a time needed—spreading the coal over the bright spots and closing the door between scoops. This refers to unnecessary black smoke, and not to that smoke which will be formed at certain times and under certain circumstances, no matter what the condition of the engine is, or how careful the fireman may be.

In approaching stations, the summit of grades or other places where the engine will be shut off, the fire should be burned down sufficiently so that when the engine is shut off very little smoke will be produced if the blower is "cracked" slightly. In adding fuel to the fire while at stations, if the coal is placed along the sides of the firebox and in the corners, and a bright fire is left in the center of the box, most of the smoke will be consumed when the blower is opened a little way, and the fire will be spread by the exhaust when pulling out of the station.

Prevention of Clinkers.—Almost any fire can be clinkered by stirring it up with a hook so that green coal gets down on the grates. A fire can also be clinkered by shaking the grate so hard that green coal works its way down through the fire. With some classes of coal, heavy firing which causes banks to form in some portions of the fire will start a clinker. When a clinker has been formed in a firebox it can sometimes be broken up by shaking the grates with short, quick jerks, but as a general rule in order to get rid of it the fire must be cleaned. Trouble due to clinkered fires can be materially reduced by not shaking the grates so hard, not using the hook or slice-bar so often, and by careful firing to prevent the formation of banks in the fire.

Wetting Down Coal.—The first principle about wetting down coal is to use as little water as possible. Dusty coal should be sprinkled lightly so as to keep the dust out of the cab. Fine coal or slack should be wet just enough to hold it together after it is thrown into the firebox until it cakes or cokes; otherwise this fine coal will be pulled straight through the flues by the exhaust without having touched the fire or having an opportunity to burn.

Breaking Up Coal.—Coal should be broken to about the size of a man's fist before being fired. This allows it to be spread more evenly over the fire and also allows the coal to burn faster than it will when fired in big lumps.

Shaking the Grates.—With a fire that has a tendency to clinker the grates should be shaken with sharp quick jerks, but with a coal that does not clinker it is advisable to shake the grates easily so as not to disturb the fire any more than necessary. The grates should be shaken just enough to keep the fire clean. The question as to when the grates should be shaken depends upon the class of coal being used, and no general rule can be given covering this.

Popping.—It has been demonstrated that with the ordinary pop valves as much heat is wasted each minute the pop is open as is contained in from three to six ordinary scoopfuls of coal. There is absolutely no excuse for this wasteful practice.

Drumming.—Drumming can be stopped by closing the dampers, putting fresh coal on the fire, or making a hole in the fire. In other words, by changing the conditions so that the mixture of the air and the gases is changed from what it was while the drumming was being produced.

Systems of Firing.—A great many systems of firing have been advocated from time to time—single scoop firing, cross firing, banking and other methods. All that it is necessary to say concerning these different systems is that any system is good which follows the correct principles of combustion.

Firing Poor Steaming Engines.—There are a great many causes why an engine may not or will not steam. The one cause which is most frequently given, however, is the one that least often exists, namely, poor coal. Most of the cases of engine failure which are reported as due to poor coal are due to other causes, although there are many legitimate cases where the heat value in a certain tank of coal is not sufficient to make steam fast enough for the needs of the run. In such cases all that can be done is to fire according to correct principles so as to get the greatest possible amount of heat out of this poor coal. If an engine does not steam and the fireman is satisfied that he has done all he can do to build up and keep a proper fire in his engine, he should then examine the front end to see if there are any air leaks, the ash pan to see if it is full, the dampers to see that they are properly adjusted, the ash pan netting to see that it is not stopped up, the grates to see that they have not become clogged with clinkers and dirt. He should examine the flues to ascertain whether they have become honeycombed over or stopped up; and if none of these causes is present and there seems to be a good draft in the firebox and no leaking flues he should experiment with his fire, building it up heavier if he does not get much smoke at the stack, as he may be getting too much air through the fire; or letting it burn down lighter if large volumes of smoke appear at the stack, as the fire may be too heavy. If none of these things effect a remedy, there is probably something wrong with the engine or the manner in which it is being handled.

It is an easy matter to tell, as has just been done, how to properly fire a locomotive, but the problem of getting firemen to fire that way is a totally different matter.

Educating the Fireman.—So far as I know there are only three ways by which firemen can be brought to a realization of the importance of the subject and lined up so as to actually fire their engines properly, even when not under the eye of some one in authority. The first of these methods is by personal instruction and demonstration right on the deck of the engine during a

trip. The second is a combination of instruction by lectures, or otherwise, at the terminal and an accurate check of performance by an observer on the engine. Both of these methods are, comparatively speaking, expensive, and both require considerable time in which to accomplish any appreciable results.

The third method is by offering premiums or bonuses to enginemen and firemen for economy in the use of fuel. This method, however, is as a rule unsatisfactory on account of the lack of a proper system of accurately checking the results. The plan in practice seldom is fair and this causes dissatisfaction.

With all due respect to those advocating other methods I must say that my experience has been that such other methods accomplish only the minimum in the way of results. Their only recommendation is that they keep the subject alive and that in some cases they are so economical that if they do any good at all they more than pay for themselves. Classed in this latter category are combustion lectures, circulars and bulletins, instruction books, etc.

The ideal plan is to have a bright young engineer or an experienced fireman appointed as traveling fireman. Each traveling fireman should be able to handle successfully about a hundred engines, if not spread over too wide a territory. These men should not be assigned permanently to one particular territory, but should be moved from division to division or from district to district about once in 30 or 40 days so that they will be kept wide awake by the new surroundings and new problems they meet; and, in addition, so that they won't get calloused to improper local conditions, nor so well known to the engineers and firemen that familiarity will breed contempt for their instruction. These men should be more or less familiar with the principles of combustion, should be able to take the scoop away from the fireman at any time or place and fire the engine successfully, and should be able to explain, and in simple language, the principles they recommend and demonstrate. There are many such men in engine service on every one of our railways today.

With a crew of this kind reporting to the general road foreman of engines or to the superintendent of motive power of a road which is awake to the other conditions required to produce the ideal of fuel economy, such a crew of men should be able to pay a yearly dividend on the investment represented by their salary and expenses of from 500 to 1,000 per cent. or more.

The second plan that can be worked out successfully is through the agency of a first-class fuel man, who understands thoroughly the practical side of locomotive work, and in addition is well posted on the theory of combustion and the science of fuel economy. This man should be able to handle the problem on a road having not over 750 engines. He should be a good talker, should be equipped with statistics, charts, stereopticon and lantern slides, and perhaps with a very simple chemical outfit for demonstrating purposes, and, if he is right up to date, with moving pictures. He can be furnished with a car if extra equipment is available; or he can cut down his outfit and simply travel from roundhouse to roundhouse. He should have sufficient official standing to command the respect and co-operation of road foremen and master mechanics. Arrangement should be made so that all firemen would have to attend his talks at least once every 60 days.

This much alone, however, will not accomplish the desired results. He should have under him two or three bright apprentice boys equipped with a little pocket counter, a pail, and a small spring scale. He should keep these boys on the road all the time riding engines. The duties of these boys would be to count and keep record of the number of scoops of coal fired between stations. By means of the pail and scale and a little horse sense they could weigh four or five test scoops of coal to determine the average weight per scoop of coal fired. The boys' records should include the engine number, names of engineer and fireman, the kind of coal, number of cars in the train, the ton-

nage of the train and the weather conditions, and alongside the column showing station names and the number of scoops of coal fired, the time of leaving, arriving or passing the stations, including a record of the time the engine was standing at intermediate stations. The record should also show the number of times the engine popped off and approximately the number of minutes the pops were open; and, in addition, the number of times the grates were shaken, a record of the use of the rake or slice bar and memorandum of anything out of the ordinary regarding the condition of the engine or the method or running or firing it.

The fuel man, with these boys assisting him, is now in a position to have an accurate up-to-date check of actual performance to use in connection with his talks and demonstrations. From the very first the records that the boys obtain show up conditions that get both engineers and firemen interested. The data collected soon show that some men are going over the road and shoveling several tons less coal than other men, and the knowledge of proper methods gained from the lectures combined with a determination to do as well as the other fellow starts more men to firing according to correct principles.

The reason why both of these plans are successful is that both demonstrate to the fireman that the proper method of firing a locomotive is the easiest and least laborious method for him to follow. It seems impossible to make him believe this by talking alone, no matter what arguments you bring to bear.

When conditions do not permit either of these plans being put into effect and the premium or bonus plan is not considered practical, about all that remains to be done is to put as forceful a circular or instruction paper as can be written on the proper method of firing, letting master mechanics and road foremen follow the matter up as thoroughly as time will permit.

There are, of course, special cases where other methods may be worked out; for example, the moving pictures are to be used by the educational bureau on the Central of Georgia for the instruction of the colored firemen. It is also the intention of the Union Pacific Educational Bureau to put a plan into effect to break in the new firemen that are hired on the road as we now do men entering station service—the method would be a combination of class-room instruction and student trips on the road, both under the supervision of an experienced instructor. This method of breaking in will take no longer than the present method but should start the man in with proper ideas and correct habits instead of in the present hit or miss fashion.

An appendix to Mr. Buell's paper contained the instructions for firing with oil which have been issued by F. F. Gaines, superintendent of motive power of the Central of Georgia.

Mr. Buell's paper was illustrated with stereopticon views, including a large number of moving pictures which admirably brought out the effect of good and bad firing on the production of smoke. The presentation of these lantern views occupied a large part of Thursday afternoon's session. Some of the moving pictures represented two freight locomotives hauling a heavy train over quite a distance on a grade. Views were taken with the camera on a car ahead of the engines so as to show the engine from the front, and others were taken from a rear car to show the amount of smoke which is made by bad firing and to the annoyance of passengers in the observation car. Other moving pictures showed the firemen actually at work, one of them firing properly and the other producing lots of smoke by bad work.

Discussion.—The moving pictures used for demonstrating the proper method of firing to the firemen employed on the Central of Georgia were thrown on a screen for the benefit of the members. Mr. Buell explained the object of each film and the way in which it would be used. Films showing a complete firebox but without side sheets, so that the movement of the coal after it left the scoop could be observed, were shown. In these, a fireman was demonstrating the proper and improper method of handling the

scoop and the effect of each. Other films showed a good fireman working on a pusher engine and a poor fireman under the same conditions. All the bad practices of a fireman were demonstrated and the appearance of the stack and steam gage indicated their result. Another film showed two platforms by the side of a large locomotive which was popping. Coal was transferred from one platform to the other at the same rate it was being wasted through the safety valves. The size of the pile after five minutes was surprising. Other films showing a double header on a heavy grade were thrown on the screen. One locomotive had a good fireman and the other a poor one. The amount of smoke and the raising of the safety valve on closing the throttle for a flag clearly indicated the good results of proper methods.

General commendation of Mr. Buell's methods marked the statements of the members discussing the subject.

H. T. Bentley suggested that Mr. Buell's paper be printed and offered for sale. He would like to have sufficient copies so that all of those interested on his road could be furnished with one. As an instance of the result of the fireman's work he also mentioned the length of time it requires to clean fires. He had seen at one point as much as two hours needed to clean the fire of a locomotive and it frequently required over one hour. After discussing the subject with the fireman and closely following up the matter, it now required not over 20 minutes under the worst conditions. The work of the fireman frequently affects passenger traffic, the public not caring to travel on trains where there is excessive smoke. Mr. Bentley spoke strongly of the practice of shaking the grates, stating that it is not at all necessary. He explained that a study of the methods used by T. E. Adams on the St. Louis and South Western had taught him many things of importance about proper firing.

W. H. Averell (B. & O.) said that in connection with educational work among the firemen on his road he had appointed five supervisors of locomotive operation whose duties are to show all division officers, including operating as well as motive power, how they can assist in fuel economy. These men point out the methods of improvement and afterwards follow the matter up and see that their suggestions are being carried out. The division officers themselves authorize the changes. The methods used are, in general, the ordinary ones, and after one year's work along these lines it was found that there was a reduction of 12 per cent. in the cost of coal. Mr. Averell expressed the opinion that savings of this kind can usually be made by the regular organization, if their attention is properly drawn to the subject and the best methods are clearly placed before them.

F. W. Foltz (Mo. Pac.) reported on the operation of locomotives over a certain section of track used jointly by the Missouri Pacific and the St. Louis South Western. The same coal is furnished the locomotives of both roads, but on the former there were frequent engine failures, and a check in one case showed that over this section of the road the grates were shaken nineteen times and the ashpan was cleaned twice. Under the same conditions the locomotives of the latter road would go over the division without shaking grates or cleaning the ashpans. By careful attention and the use of Mr. Adams' methods of firing he had been able to cure the trouble and had also reduced the average time of fire cleaning from 47 minutes to 15 minutes. He spoke very highly of Mr. Adams and his method of firing. Other members who had studied the system used on the St. Louis South Western spoke strongly to the same effect.

LOCOMOTIVE DRAFTING AND ITS RELATION TO FUEL CONSUMPTION.

H. B. MacFarland, engineer of tests, Atchison, Topeka and Santa Fe, presented a lengthy and elaborate paper on this subject, an abstract of which follows:

The idea of drafting a locomotive for efficiency is seldom considered, or if considered at all, is only of a secondary consideration. The principal object is good steaming. The object of this paper is to present information showing results of our present method of drafting engines rather than to show slight variation

in results by slight changes in various pieces of apparatus relative to one another. A further object is to present information and data that will, in some great degree, obviate the troubles of our present system of drafting by throttling low pressure steam.

In order to determine the relative efficiency of the front end drafting arrangement of the various principal classes of locomotives in use on the Santa Fe, both passenger and freight, a number of tests were made and complete data bearing on the subject secured. The efficiency of the front end has been commonly defined as the ratio of draft in inches of water per pound of back pressure in the cylinders. Although a few scientific investigations have been made relative to the subject of locomotive drafting, any exhaustive study of the subject of back pressure in the cylinders produced by creating draft with the exhaust jet has been quite generally neglected.

The art of making an engine a good steamer, if it may properly be termed an art, consists largely in haphazard, cut-and-try methods. As an instance of the lack of uniformity in drafting arrangements it may be cited that for twenty locomotives of the same class, operating on the same district in similar service, and using oil as fuel, the diameter of the nozzle varied from $5\frac{7}{8}$ in. to $6\frac{1}{4}$ in., and yet all of these engines were considered good steamers. It may be further stated that these twenty locomotives were constructed by the same builders from the same designs and patterns and were supposedly alike in all respects.

The tests described were made on different divisions of the Santa Fe where conditions of operation are such that they represent the most severe demands made upon power, as well as power working under normal demands in average service. The data collected concerning the drafting arrangements typically represents the various methods employed for making an engine what is known as a "good steamer."

The simple adjustment of a petticoat pipe or diaphragm plate will often convert a poor steaming engine into a good steamer by causing an equalization of draft between the top and bottom flues, or the front and back portions of the firebox, or else will so change the action of the exhaust jet in the stack that a greater draft will be created. When an engine is once made to steam freely, no further consideration is given to front end adjustments regardless of the fact as to how uneconomical such an arrangement may prove as regards fuel consumption, water consumption, etc. The main consideration of those charged with locomotive operation is to get the engine in such shape that it will steam freely on the road and get its tonnage from terminal to terminal with least delay. And yet the theory of drafting by means of the exhaust jet is so uneconomical and productive of such great thermal losses and energy losses, due to back pressure on the cylinders, that any saving which could possibly be effected by minor adjustments within the smokebox would have but small bearing upon the total fuel cost.

The simplest and most effective way to increase the draft and produce a good steaming engine is to reduce the size of the exhaust nozzle. This reduction is accomplished by use of either a bushing or a bridge in the nozzle tip. Although this method of securing increased draft is easily understood by the men directly charged with getting the locomotive in operating condition, few realize the tremendous tax such an arrangement is upon the effective power of the engine.

The results of the tests show conclusively the price a locomotive pays in fuel and power, due to drafting with the exhaust jet. There is a general impression that some power is lost on account of back pressure, yet it is not recorded that this is any considerable per cent. of the power developed by the locomotive. The results of these investigations show that the potential energy lost, due to present method of drafting locomotives is very considerable, not only in actual amount but in percentage of total power of the locomotive.

The back pressure, due to any given sized nozzle, was found in these tests to be practically the same in the cylinders of a com-

pound locomotive as a simple locomotive, yet the power loss is much greater for the compound engine than for the simple engine, due to the greater area of the low pressure piston. This power

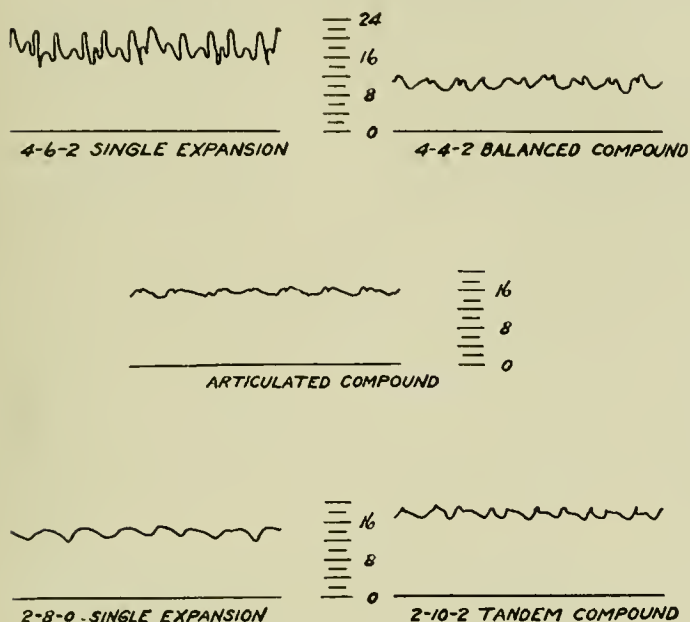

Fig. 1—Typical Exhaust or Back Pressure Cards.

loss is then in the ratio of the area of the low pressure piston of the compound engine to the area of the pistons on the simple engine, all other conditions being equal.

As this back pressure is acting against the piston, it can be computed as actual horsepower developed, but not utilized. When computed in this manner it is found to amount to from ten per cent. of the total available power of the engine at low speeds to over 50 per cent. of the total available power at high speeds. This condition holds true with both ordinary freight and passenger engines, but for Mallet engines the losses are much greater.

The locomotives tested, eighteen in all, were operating over the divisions to which they are regularly assigned. No special care was given to the selection of an engine, the object being only to secure an engine that would typically represent a certain class and type. An endeavor was also made to secure engines of the same type burning oil for fuel on one territory and coal for fuel on another territory, in order that the results secured might be comparable in so far as oil and coal-burning locomotives were concerned. Each engine was in regular service with its ordinary rated tonnage and was operated by its regular crew, no special instructions being given relative to its operation, so that results obtained would reflect those obtained under average operating conditions. A sufficient number of observations were made to cover completely all the varying conditions in speed on the grades over which the locomotive was operated.

Draft readings were taken at the side of the smokebox just ahead of the diaphragm plate. The draft gages used were of the usual "U" tube water column type, reading in inches of water. The back pressures in exhaust steam, due to the restrictions caused by the nozzle tip, were determined with an ordinary Crosby steam indicator using a 20-lb. spring. The pressure reading was taken in the exhaust cavity of the valve, the indicator being attached to a 1/2-in. pipe within the cavity. The pressure was determined within the exhaust cavity of the valve rather

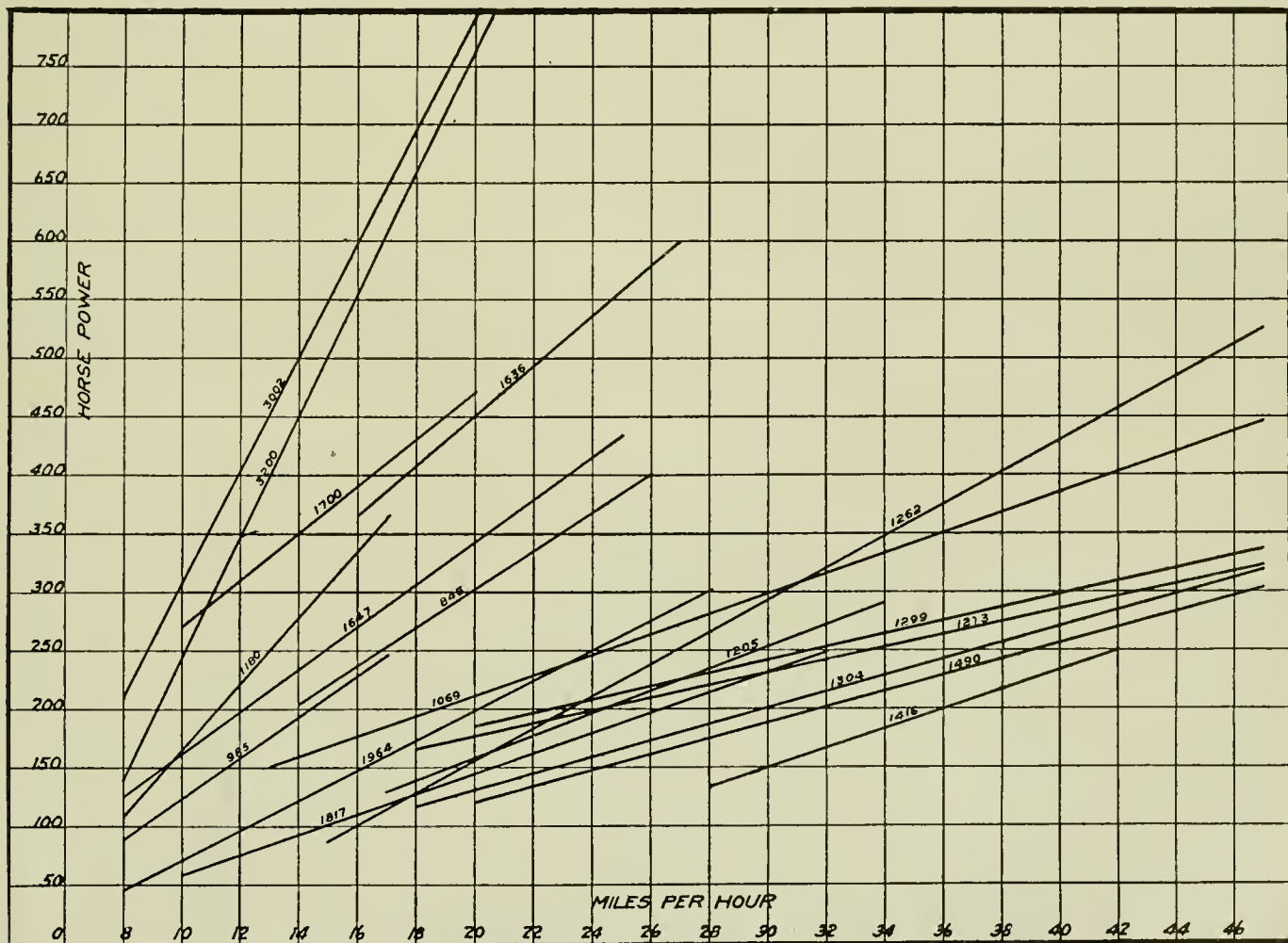

Fig. 2—Curves Showing Back Pressure Horse-Power at Speeds in Miles Per Hour.

than at the exhaust tip, in order that the pressure of the steam, which was acting directly against and retarding the action of the pistons, would be secured. Typical exhaust cards secured from both simple and compound locomotives under different conditions of operation are shown in Fig. 1.

[The results obtained in the tests of each of the eighteen representative locomotives, plotted on charts along with diagrams of smokebox arrangement, general characteristics of the classes of engines and a photograph of a representative locomotive of each class were included in the report but are not reproduced here.]

The wide variation in drafts and exhaust pressures between locomotives in passenger and freight service, as well as Mallet locomotives in heavy freight service, may be seen by reference to the general summary of results shown in Table 1, and must be

TABLE 1.—GENERAL SUMMARY OF RESULTS OF TESTS.
In Passenger Service:

| Engine. | Drafts. Aver. | Exhaust Pressure. | Back Pressure Horse Power at— | | | |
|---------|------------------|----------------------|-------------------------------|----------------|----------------|----------------|
| | | | 20 m. p. h. | 30 m. p. h. | 40 m. p. h. | 50 m. p. h. |
| 1299 | 9.7 | 12.6 | 185 | 240 | 295 | 350 |
| 1273 | 8.6 | 14.7 | 175 | 230 | 285 | 340 |
| 1262 | 9.3 | 11.4 | 140 | 290 | 440 | 590 |
| 1304 | 9.1 | 10.0 | 130 | 200 | 270 | 340 |
| 1205 | 11.5 | 16.2 | 155 | 250 | 345 | ... |
| 1416 | 11.6 | 9.2 | 75 | 155 | 235 | 315 |
| 1490 | 5.8 | 10.2 | 115 | 185 | 255 | 325 |

In Freight Service:

| Engine. | Drafts. Aver. | Exhaust Pressure. | Back Pressure Horse Power at— | | | |
|---------|------------------|----------------------|-------------------------------|----------------|----------------|----------------|
| | | | 10 m. p. h. | 15 m. p. h. | 20 m. p. h. | 25 m. p. h. |
| 1636 | 7.7 | 10.8 | 130 | 280 | 430 | 580 |
| 1647 | 6.5 | 10.4 | 160 | 250 | 340 | 430 |
| 843 | 7.2 | 12.5 | 150 | 225 | 300 | 375 |
| 1964 | 10.8 | 11.2 | 65 | 130 | 195 | 260 |
| 1817 | 5.5 | 7.3 | 65 | 105 | 145 | 185 |
| 985 | 10.6 | 13.5 | 120 | 210 | 300 | 390 |
| 1069 | 7.9 | 11.7 | 130 | 170 | 210 | 250 |
| 3002 | 10.3 | 16.5 | 300 | 550 | 800 | 1,050 |
| 3200 | 15.9 | 14.4 | 235 | 490 | 745 | 1,000 |
| 1700 | 11.3 | 11.2 | 290 | 385 | 480 | 575 |
| 1180 | 14.3 | 12.1 | 170 | 310 | 450 | 590 |

attributed to the peculiar conditions of operation, grade characteristics, and other purely local circumstances.

No specific analyses should be made of coal and oil-burning locomotives of similar type, owing to the fact that the oil-burning locomotive is generally operated or presents opportunity for operating at a much higher capacity than the coal-burning locomotive, due to the fact that the fuel used affords an opportunity for increased steam production.

A general study of the results shows that the back pressure remains practically constant at all speeds, indicating that the back pressure depends upon the volume of steam passing through the exhaust nozzle regardless of the speed of the locomotive. The draft, then, is dependent upon the intensity and velocity of the exhaust jet and not on the speed. Any increase in volume of steam passing through the exhaust nozzle in a

unit of time increases the intensity and velocity of the exhaust jet and causes a corresponding increase in draft.

Since the back pressure remains practically constant for any increase in speed, it necessarily follows that the back pressure horse power is the only variant and must increase in direct ratio to the speed. The back pressure horse power curve, then, is a straight line, and a formula may be developed for each class of locomotive which would enable one to compute the back pressure horse power for any given speed in miles per hour.

In order to get the general relation in back pressure horse power for the various locomotives tested, the back pressure horse power for each engine has been plotted on one general chart with reference to miles per hour and is shown in Fig. 2. (General dimensions of the locomotives are given in Table 2.)

A study of this chart will show the wide variation in loss due to back pressure between Mallet, freight, and passenger locomotives. As a general rule, it may be stated that the horse power loss, due to back pressure, at any given speed, is least for passenger and greatest for Mallet locomotives.

In order to get a comparison of back pressure horse power for all types of locomotives, curves have been plotted showing

TABLE 3.—CONSTANTS FOR BACK PRESSURE HORSE POWER PER MILE PER HOUR IN SPEED.

| Passenger Service: | | Heavy Freight Service: | | Fast Freight Service: | | Mallet Service: | |
|--------------------|---------------|------------------------|------------|-----------------------|---------------|-----------------|------------|
| 1270 & 1297* | B. P. H. P. = | 7.4 | x m. p. h. | 825 | B. P. H. P. = | 16.3 | x m. p. h. |
| 1270* & 1297* | B. P. H. P. = | 6.6 | x m. p. h. | 985 | B. P. H. P. = | 12.0 | x m. p. h. |
| 1200 | B. P. H. P. = | 5.4 | x m. p. h. | 900 & 1600 | B. P. H. P. = | 21.3 | x m. p. h. |
| 1226 | B. P. H. P. = | 9.3 | x m. p. h. | 1950 | B. P. H. P. = | 12.0 | x m. p. h. |
| 1400 | B. P. H. P. = | 6.4 | x m. p. h. | 1069 | B. P. H. P. = | 9.9 | x m. p. h. |
| 1485 | B. P. H. P. = | 6.9 | x m. p. h. | 1800 | B. P. H. P. = | 10.5 | x m. p. h. |
| 498 | B. P. H. P. = | 6.7 | x m. p. h. | 1180 | B. P. H. P. = | 27.0 | x m. p. h. |
| 500 | B. P. H. P. = | 7.2 | x m. p. h. | 1700 | B. P. H. P. = | 36.0 | x m. p. h. |
| 1309 | B. P. H. P. = | 10.0 | x m. p. h. | 3002 | B. P. H. P. = | 37.3 | x m. p. h. |
| | | | | 3200 | B. P. H. P. = | 35.3 | x m. p. h. |

*Bushed cylinders.

the back pressure horse power on a basis of cubic feet of piston displacement per minute. This chart (Fig. 3) is based on the cubic feet of piston displacement per minute of one cylinder only. On compound engines the low pressure cylinder value only was used. A study will show that the back pressure horse power for all of the locomotives tested follows the same general law. A general formula may then be developed to express the back pressure horse power loss for any given locomotive.

TABLE 2.—DIMENSIONS OF THE LOCOMOTIVES TESTED.

| Engine No. | Class. | Fuel. | Weight. Pounds. | Tractive effort. Pounds. | Kind. | Stack. Diam. | Nozzle. Diam. | Petti-coat pipe. | Over-draft. Inches. | Under-draft. Inches. | Working pressure. Pounds. | Total heating surface. Sq. ft. | Area of tubes. Sq. in. | Grate area. Sq. ft. |
|------------|-----------|-------|-----------------|--------------------------|----------------|--------------|---------------|------------------|---------------------|----------------------|---------------------------|--------------------------------|------------------------|---------------------|
| 1299 | 4-6-2 | Oil | 240,550 | 36,000 | Simple | 18 | 6 | 14 | 5 | 2 | 200 | 4,069 | 883 | 48.0 |
| 1273 | 4-6-2 | Oil | 234,600 | 36,000 | Simple | 17 1/2 | 5 3/4 | 0 | 0 | 0 | 210 | 4,243 | 883 | 49.5 |
| 1262 | 4-6-2 | Oil | 226,700 | 32,800 | Bal. Comp. | 15 1/2 | 5 1/2 | 14 | 6 | 1 | 220 | 3,595 | 938 | 53.5 |
| 1304 | 4-6-2 | Coal | 240,550 | 36,000 | Simple | 17 1/2 | 5 11/16 | 14 | 8 1/2 | 8 | 200 | 4,069 | 883 | 48.0 |
| 1205 | 4-6-2 | Coal | 216,100 | 33,600 | Simple | 16 | 5 1/2 | 14 | 6 | 6 1/2 | 220 | 3,595 | 938 | 53.5 |
| 1416 | 4-4-2 | Coal | 204,100 | 22,200 | Bal. Comp. | 15 1/2 | 5 1/2 | 11 | 15 | 2 | 220 | 3,206 | 883 | 49.5 |
| 1490 | 4-4-2 | Oil | 231,675 | 23,600 | Bal. Comp. | 15 | 5 5/8 | 14 | 7 | 1/2 | 220 | 3,673 | 883 | 48.0 |
| 1278 | 4-6-2 | Oil | 234,600 | 36,000 | Simple | 17 1/2 | 5 5/16 | 0 | 0 | 0 | 200 | 4,243 | 883 | 49.5 |
| 1276 | 4-6-2 | Oil | 234,600 | 36,000 | Simple | 17 1/2 | 6 | 0 | 0 | 0 | 210 | 4,243 | 883 | 49.5 |
| 498 | 4-6-0 | Oil | 181,900 | 31,800 | Simple | ... | 5 5/16 | ... | ... | ... | 210 | 3,112 | 851 | 50.5 |
| 500 | 4-6-0 | Oil | 181,900 | 31,800 | Simple | ... | 5 3/16 | ... | ... | ... | 200 | 3,112 | 851 | 50.5 |
| 1316 | 4-6-2 | Coal | 276,500 | 35,000 | Bal. Comp. | ... | 5 3/4 | ... | ... | ... | 210 | 4,131 | 1,160 | 57.6 |
| 1636 | 2-10-2 | Oil | 287,240 | 62,800 | Tandem Comp. | 17 3/4 | 5 7/8 | 14 | 6 | 2 | 225 | 4,796 | 1,265 | 58.5 |
| 1647 | 2-10-2 | Coal | 287,240 | 62,800 | Tandem Comp. | 19 | 5 3/4 | 13 | 15 | 3 1/2 | 225 | 4,796 | 1,265 | 58.5 |
| 843 | 2-8-0 | Coal | 199,250 | 43,200 | Tandem Comp. | 16 | 5 | 0 | 0 | 0 | 210 | 2,961 | 883 | 48.0 |
| 1964 | 2-8-0 | Oil | 212,400 | 49,500 | Simple | 17 1/2 | 5 3/4 | 12 | 9 | 10 | 180 | 3,750 | 883 | 47.3 |
| 1817 | 2-6-2 | Coal | 248,200 | 40,300 | Bal. Comp. | 17 | 5 1/4 | 12 | 13 1/2 | 8 1/2 | 225 | 4,020 | 1,106 | 53.7 |
| 985 | 2-10-2 | Oil | 276,960 | 60,470 | Simple | 17 1/2 | 6 | 14 | 13 | 1 | 225 | 5,616 | 1,265 | 58.5 |
| 1069 | 2-6-2 | Coal | 210,190 | 34,700 | Vauclain Comp. | 16 | 5 1/2 | 14 | 12 | 4 | 220 | 3,185 | 1,028 | 52.1 |
| 1962 | 2-8-0 | Oil | 212,400 | 49,500 | Simple | 17 1/2 | 5 3/4 | ... | ... | ... | 180 | 3,750 | 883 | 47.3 |
| 898 | 2-8-0 | Coal | 263,400 | 47,700 | Simple | 17 1/2 | 5 3/4 | ... | ... | ... | 160 | 6,186 | 1,852 | 58.5 |
| 901 | 2-10-2 | Coal | 306,950 | 62,800 | Tandem Comp. | 17 1/2 | 5 3/4 | ... | ... | ... | 225 | 6,807 | 1,265 | 58.5 |
| 917 | 2-10-2 | Oil | 292,140 | 62,800 | Tandem Comp. | 17 1/2 | 6 1/2 | ... | ... | ... | 225 | 4,796 | 1,265 | 58.5 |
| 923 | 2-10-2 | Coal | 287,240 | 62,800 | Tandem Comp. | 17 1/2 | 5 3/4 | ... | ... | ... | 225 | 4,796 | 1,265 | 58.5 |
| 3002 | 2-10-10-2 | Oil | 616,000 | 110,000 | Mallet Comp. | 17 1/2 | 6 1/2 | 16 | 6 | 3 | 200 | 7,233 | 883 | 47.3 |
| 3200 | 2-8-8-0 | Oil | 391,500 | 96,000 | Mallet Comp. | 17 1/2 | 6 | 14 1/2 | 9 | 3 | 225 | 8,419 | 1,253 | 70.4 |
| 1700 | 2-8-8-2 | Oil | 462,450 | 108,000 | Mallet Comp. | 20 1/2 | 7 | 16 | 9 | 3 | 225 | 8,419 | 1,253 | 70.4 |
| 1180 | 2-6-6-2 | Coal | 370,200 | 68,000 | Mallet Comp. | 17 1/2 | 5 7/8 | 14 | 8 | 6 | 220 | 6,191 | 951 | 54.0 |

B. P. H. P. = cubic feet piston displacement per minute times a constant. The constant is one-tenth for passenger and freight service, one-eighth for heavy freight service, and one-sixth for Mallet service.

This formula, when transferred from cubic feet piston displacement to miles per hour, gives a constant of value in considering any class of engines. The results for the different classes of engines tested are given in Table 3.

The efficiency of the drafting arrangement in the front end is generally expressed as the ratio of inches of draft to pounds of exhaust pressure. Table 4 has been prepared to show this

TABLE 4.—EFFICIENCY OF FRONT END.

Showing inches of draft per pound of back pressure with various conditions of draft.

| Engine No. | Condition with Draft | | |
|------------|----------------------|----------|----------|
| | Maximum. | Minimum. | Average. |
| 1299..... | 0.70 | 0.82 | 0.78 |
| 1270..... | 0.55 | 0.63 | 0.58 |
| 1226..... | 0.72 | 0.85 | 0.81 |
| 1297..... | 0.90 | 0.93 | 0.91 |
| 1200..... | 0.62 | 0.90 | 0.71 |
| 1400..... | 0.97 | 1.14 | 1.42 |
| 1480..... | 0.52 | 0.63 | 0.57 |
| 1636..... | 0.70 | 0.80 | 0.70 |
| 1647..... | 0.58 | 0.67 | 0.62 |
| 843..... | 0.56 | 0.57 | 0.58 |
| 1964..... | 0.97 | 1.40 | 0.93 |
| 1817..... | 0.70 | 1.00 | 0.73 |
| 985..... | 0.86 | 0.71 | 0.79 |

efficiency for the different engines. Maximum and minimum conditions refer to the maximum and minimum draft produced during the performance of the engine.

General charts have been prepared and are presented to show the relation between back pressure horse power, the indicated horse power and the drawbar horse power. The ob-

servations were taken from actual tests made on different types of locomotives, both in freight and passenger service, both coal and oil burners. These curves are plotted with horse power as ordinates, and miles per hour as abscissae.

The chart shown in Fig. 4, was prepared from data secured in the test of a single expansion Mikado type locomotive in

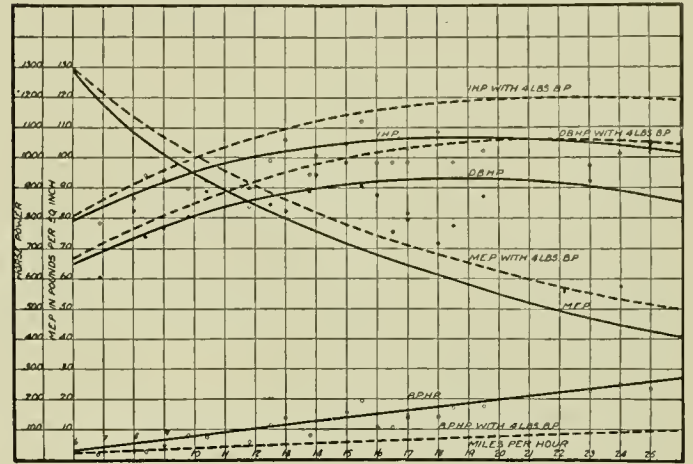
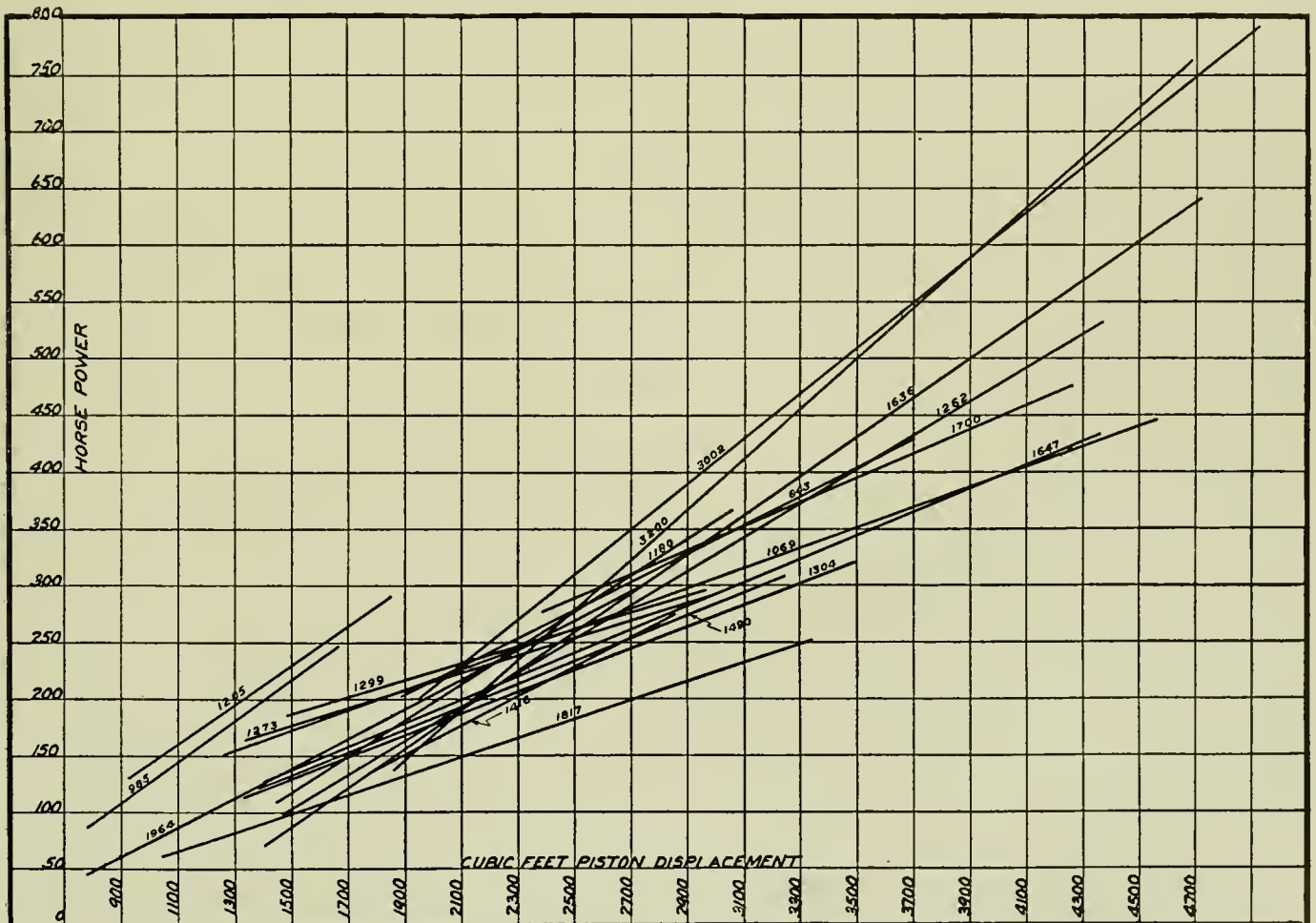

Fig. 4—Chart of Performance of Mikado Locomotive.

mountain service between La Junta and Trinidad, Colorado. The full lines show the back pressure horse power, indicated horse power, drawbar horse power and mean effective pressure.

Assuming an exhaust pressure of 4 lbs., the back pressure horse power is shown with a dotted line. The difference then,



Cubic feet of piston displacement is for one cylinder only. Low pressure cylinder used on compound locomotives.

Fig. 3—Curves Showing Back Pressure Horse-Power Per Cubic Foot of Piston Displacement.

between the dotted line and the full line curves, is the horse power to be gained, if the exhaust pressure could be reduced to 4 lbs. This reduction in back pressure would increase the mean effective pressure an equal amount. This increase is shown by a dotted line curve.

Since we have supposed that the mean effective pressure is increased, then the indicated horse power would increase to an amount equal to the gain in back pressure horse power. Then, assuming that the machine friction of the locomotive would not increase with the reduction of back pressure, we have with the

at 28 miles per hour, the indicated horse power would be 2,100, the drawbar horse power 1,500, and the back pressure horse power slightly above 200, which would mean that either greater speed could be obtained or, if this were not required, there would be a greater saving in fuel consumption.

The chart in Fig. 6, has been prepared from data secured in tests of a Pacific type coal-burning balanced compound passenger locomotive with cylinders 17½ in. x 29 in. x 28 in., and shows performance over heavy mountain grades with a train of 11 cars, or 644 tons. The back pressure on this engine was exceptionally high. At speeds ranging from 16 to 45 miles per hour, the back pressure horse power was 175 and 1,000 respectively. At a speed of 20 miles per hour the back pressure horse power was 220, the drawbar horse power 1,080, and the indicated horse power 1,400, or the back pressure horse power was 20.5 per cent. of the drawbar horse power and 15.9 per cent. of the indicated horse power. This locomotive attained maximum indicated horse power at a speed of 34 miles per hour. At this speed the back pressure horse power was 650, the drawbar horse power 1,200 and the indicated horse power 1,580, so that the back pressure horse power was about 55 per cent. of the drawbar horse power and about 41 per cent. of the indicated horse power.

It will be seen from a study of these charts that the back pressure horse power and drawbar horse power curves cross at a speed of 45 miles per hour and at a horse power of about 1,000. Assuming an average of 4 lbs. back pressure, the back pressure horse power curve has been plotted as a dotted line. The increased mean effective pressure, drawbar horse power and indicated horse power resulting from the reduction in back pressure are also shown by dotted lines. The increase in mean effective pressure, due to decrease in back pressure, is 10 lbs. at 20 miles per hour and 23 lbs. at 45 miles per hour. At the

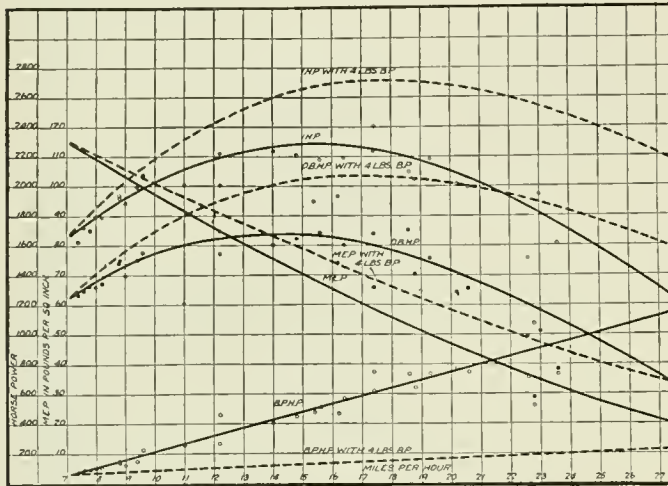

Fig. 5—Chart of Performance of Mallet Locomotive.

drawbar horse power an increase equal to the increase in indicated horse power. A dotted line also shows these results.

This locomotive, which is a coal burner, shows very favorable conditions of operation so that the actual gain is relatively low. The maximum speed shown is 26 miles per hour. The back pressure horse power at this speed is only 270, which is 32 per cent. of the drawbar horse power, and 26.5 per cent. of the indicated horse power. In comparison with conditions on other locomotives these figures are considerably below the average and indicate very favorable performance of this locomotive.

The chart presented in Fig. 5 has been prepared in similar manner to the preceding one and shows the performance of a locomotive of the Mallet type. This is an oil burner in heavy mountain service. A study of this chart will very readily show that the increased tractive horse power, due to the decrease in back pressure is very great. In this case the back pressure horse power and the drawbar horse power curves cross each other at a speed of 24.5 miles per hour, the power for drafting at this speed being equal to the effective work obtained at the drawbar. The maximum drawbar horse power is reached at a speed of 14 miles per hour, the back pressure horse power at this speed being 400, and the drawbar power 1,680.

If we assume a back pressure of 4 lbs. at a speed of 14 miles per hour, the drawbar horse power would be 1,960, and the back pressure horse power only 100, or the back pressure would then be 5.0 per cent. of the drawbar horse power instead of 24.0 per cent. The indicated and drawbar horse power decreases very rapidly at speeds above 14 miles per hour, and at a speed of 28 miles per hour the back pressure horse power and indicated horse power curves would come together at 1,200 and the drawbar horse power would be about 600, or 50 per cent. less than the back pressure horse power.

It can very readily be seen that the reason for the Mallet locomotive being a low speed engine is not due to machine friction, as has been frequently claimed, but to the amount of back pressure which is required to produce a draft. If the assumptions made were correct, with a back pressure of only 4 lbs.

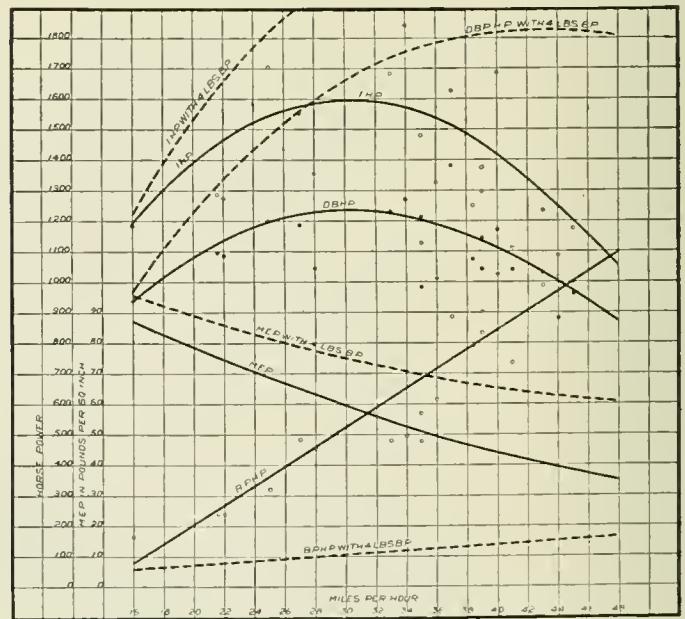

Fig. 6—Chart of Performance of Pacific Type Locomotive.

maximum indicated horse power, the possible increase in indicated horse power and drawbar horse power would be about 800.

This locomotive is of very recent build and its design is consistent with most modern practice for mountain passenger service. While it is giving satisfactory service, the great savings to be made in fuel consumption or the possible increase in speed by reduction in back pressure are readily apparent. With so high a back pressure it would be impossible for this engine to be efficient at any high rate of speed; in fact, it would be

impossible for the engine to maintain a high rate of speed with any considerable weight of train. At the speed of 45 miles per hour, where it should show its highest efficiency, it must give up an equal amount of power, to produce the required draft, as is delivered at the drawbar.

The calculation of the theoretical horse power required to draw the gases through the flues and front end of a locomotive is comparatively simple. The method employed in arriving at the data herein presented was as follows:

$$H. P. = \frac{PAV}{33,000}$$

P = Pressure per unit of area against which the gases were pulled.

A = Total area of the tubes.

V = Average velocity of the gases in feet per minute, calculated as follows:

$$V = \frac{CB}{60A} F.$$

C = Cubic feet of air necessary per pound of fuel.

B = Pounds of fuel burned per hour.

A = Area of flues in square feet.

F = Factor for increase in volume of gases due to increase of temperature from 60 deg. F. to 700 deg. F.; assuming conditions from 60 deg. F. to 700 deg. F., this value is 2.2.

In obtaining the values of C, calculation was based upon the analysis of the fuel and flue gases as obtained upon tests of both coal and oil burning locomotives.

The weight of air per pound of fuel burned was calculated as follows:

$$A = 3.032 \frac{N}{CO_2 \text{ plus } CO} C.$$

A = Weight of air supplied per pound of fuel.

N, CO, CO₂ = Percentage by volume of nitrogen, carbon monoxide, and carbon dioxide in the flue gases.

C = Proportional part by weight of carbon in the fuel.

Substituting actual figures in the above formulae, after reducing to unit of volume, gives a value of 185 cu. ft. of air per pound of coal burned.

Calculation by the same method for oil burners gives a value, in round numbers, of 200 cu. ft. of air per pound of fuel burned.

The following specific example will show the method:

ENGINE 923—COAL BURNER.

Run: La Junta to Trinidad.

Average fuel per hour = 4,415 lbs.

Draft in front end = 5.8 in. water.

Draft in front of tube sheet = 4.4 in. water.

Areas of flues = 1,265 sq. in., or 8.78 sq. ft.

$$V = \frac{185 \times 4,415}{60 \times 8.78} = 1,552 \times 2.2 = 3,415 \text{ ft. per minute.}$$

The power required to draw the gases through the flues alone will be

$$H. P. = \frac{(4.4 \times 0.0361) \times 1,265 \times 3,415}{33,000} = 20.8.$$

The horse power required to draw the gases through the flues under the diaphragm and through the netting equals 27.43.

The actual horse power utilized producing a draft in any given class of locomotive is taken as the horse power due to the back pressure in the cylinders. This back pressure horse power is not entirely chargeable to the production of draft because of the impossibility of operating non-condensing engines without at least 3 or 4 lbs. of back pressure. A greater part of the power thus expended, however, is used in producing draft alone.

The relation of horse power required for producing draft to the theoretical horse power required to draw gases through the flues and front end is shown in Table 5.

The above table is calculated from actual data secured in road tests of representative locomotives covering both freight and passenger, simple and compound, and coal and oil-burning engines. The figures given under the heading, "Calculated horse power required to draw the exhaust gases through the boiler," were obtained by the above method. The horse power of the steam jet for the various speeds in miles per hour was obtained from representative engines in actual service. The difference in these two values gives the excess in power directly chargeable to the exhaust jet. In the last column the values for

this excess power consumed are given in percentages of actual work done.

It will be seen that the efficiency of the steam jet, as a means of producing draft in a locomotive boiler, is extremely low from a power standpoint. The efficiency, based upon a mechanical standpoint, i. e., the simplicity and reliability of this form of apparatus, is not included in this statement. It will be seen from a study of the above figures that the loss in horse

TABLE 5.—RELATION BETWEEN POWER NECESSARY TO DRAW GASES THROUGH FLUES AND POWER EXPENDED IN LOCOMOTIVES AS DRAFTED.

| Engine Number. | Calculated H. P. required to draw exhaust gases through boiler. | Back pressure at | | Excess power in jet Per cent. of Required. | | |
|----------------|---|------------------|-------|--|-----|-------|
| | | M. P. H. | H. P. | H. P. | | |
| 923..... | Coal burner | 28 | 10 | 160 | 132 | 471 |
| | | | 15 | 275 | 247 | 882 |
| | | | 20 | 390 | 362 | 1,294 |
| | | | 25 | 500 | 572 | 2,041 |
| 917..... | Oil burner | 25 | 10 | 150 | 125 | 500 |
| | | | 15 | 300 | 275 | 1,100 |
| | | | 20 | 450 | 425 | 1,700 |
| | | | 25 | 600 | 575 | 2,300 |
| 1700..... | Oil burner | 65 | 10 | 290 | 225 | 346 |
| | | | 15 | 385 | 320 | 493 |
| | | | 20 | 480 | 415 | 639 |
| | | | 25 | 575 | 510 | 784 |
| 1301..... | Oil burner | 25 | 20 | 300 | 275 | 1,100 |
| | | | 30 | 500 | 475 | 1,900 |
| | | | 35 | 600 | 575 | 2,300 |

power, due to the throttling of the engine exhaust, is somewhat startling, amounting in many cases to several hundred horse power.

If other means could be provided to draw the necessary volume of gases through the boiler for the same rate of combustion possible with a steam jet, at an expenditure of power somewhere near the calculated power required to draw the gases through the boiler, a tremendous saving in power would be accomplished. The power thus saved could be utilized in useful work, either as increase in speed or as a direct saving in fuel consumption.

The argument is often advanced that it is not economical to run locomotives at high speeds on account of the great back pressure and the loss in efficiency. This is a very pertinent argument in view of the facts. In service it is shown conclusively that the maximum power is obtained at speeds less than those desired for present time schedules. With increase in speed there is a proportional loss in horse power due to back pressure. The result is that at some speed a locomotive will have its highest efficiency and that speed is generally lower than the speed at which the locomotive is required to do maximum duty.

Discussion.—As a verbal appendix to his paper, Mr. MacFarland explained an apparatus with which he is now experimenting for mechanically furnishing draft on locomotives. This requires the use in the front end, of a fan operated by steam engine or turbine. This arrangement had been successful in burning the maximum amount of coal required on some heavy locomotives and it had also been used successfully on an oil burner. He found that about 27 horsepower was required to operate the fan for maximum coal consumption on non-articulated locomotives. It was estimated that 50 horsepower would be required on Mallets. In pointing out the importance of reducing the back pressure horsepower, Mr. MacFarland stated that it is not at all uncommon to have a locomotive which could pull nine cars successfully, but in case ten cars were used on the train, a second locomotive was necessary and both would then operate inefficiently.

W. E. Symons strongly endorsed Mr. MacFarland's paper, but stated that in his opinion other features should also be included. Some of these were of equal or greater influence on the final economy of the locomotive. In connection with back pressure caused by restricted steam passages or inefficient valve gears, no change in the front end arrangement could correct the difficulty. Frequently the nozzle is reduced on account of conditions which

are present only near the end of the trip, or a very small proportion of the time that the locomotive is in operation. In studying the subject some years ago on the Santa Fe he designed and applied a variable exhaust nozzle. It gave splendid results when it was in operation but was so frequently out of order that it was eventually discarded. He mentioned also a design of variable nozzle which was interconnected with the reversing gear, but did not state what the final results had been with its use. In 1899 some tests on a southern railway had shown decided economies from the use of a variable nozzle. Mr. Symons remarked that frequently, in their efforts to save five or ten cents, motive power officers were stumbling over ten-dollar bills and that the whole subject of steam economy was deserving of considerably more study than it is being generally given. The proper design of a variable exhaust nozzle at a very minor outlay might give as great an increase in efficiency as a superheater. He suggested that, in the future, papers like the one presented by Mr. MacFarland should include more details. In this case, for instance, he would like to know the type of boiler in each test. Tests had shown that an ordinary boiler on a Mallet required 7 lbs. back pressure to properly draft it while a boiler which included a feed water heater on a similar size locomotive required 11 lbs. back pressure.

F. O. Bunnell (Rock Island) asked for information in connection with the front end arrangement of an oil burner as compared with coal-burning locomotives, stating that the nozzle was frequently smaller on the oil burner. Some tests he had made showed the temperature at the stack to be 200 deg. higher with oil than with coal fuel.

Robert Quayle (Chicago & North Western) was not in favor of the variable exhaust nozzle because of the difficulty in getting the enginemen to properly use it, and also on account of the frequency with which it got out of order. He regretted that no information was given in the paper as to the openings in the ashtrays which might vary considerably on different locomotives and be partially responsible for the back pressure shown.

R. Emerson pointed out the spasmodic method of locomotive improvement in this country, and, in contrast, stated that in England it took three years to build a new class of locomotive. One year was devoted to making the design, the second to the tests of two sample locomotives, and the third to the building of the order which would be duplicates of the test locomotives as finally decided upon. He believed independent valve gears are a necessity on the four-cylinder balanced compound locomotives.

Mr. MacFarland, in closing his paper, stated that the temperature in the front end of oil burners varied directly with the amount of soot on the flues. He had seen instances where the temperature in the front end was reduced 250 deg. in two minutes by sanding the flues. Each reduction of 25 deg. gives one per cent. increase in boiler efficiency. He objected to the use of variable exhaust nozzles because of the difficulty in getting the engineers to properly operate them.

INSPECTION OF FUEL FROM THE STANDPOINT OF THE PRODUCER AND THE CONSUMER.

J. E. Hitt presented the standpoint of the producer and strongly advised more rigid and careful inspection of railway fuel at the mines. He said it was hard to take seriously complaints received at long intervals from railways, which did not maintain inspectors, as they generally seemed so disinterested in the subject. He suggested that a coal miner be selected from each mine producing railway coal to act as an inspector. This man could represent all the railway companies purchasing from that mine.

The standpoint of the consumer was presented by Glen Warner, fuel inspector, C. H. & D. He also recommended more careful inspection and outlined the formation of an efficient fuel department so far as the inspector's duties were concerned. He stated that after acquainting himself with the traffic movement between the mines and the final destination, the inspector's place

should be on the road and that only an occasional visit to the mines was necessary. The greatest difficulty with poor coal comes through carelessness but he did not advise the use of a penalty system. Frequently the inspector should supervise the weighing of all cars and check up the way-bills.

Discussion.—More systematic, thorough and intelligent inspection was generally favored by both the coal operators and railways. While some of the recommendations of the authors did not meet with general approval, an improvement in the methods of inspection appeared to be strongly favored.

C. Scovell (Central Coal & Coke Co.) strongly favored the presence of the railway inspectors, stating that they were the operators' greatest protection. When there is a man present who has a knowledge of coal, the coal companies are relieved of many troubles in connection with straightening out complaints based on the reports of enginehouse foremen, coal chute men, etc., who generally are not very expert in judging coal. He admitted that the miners frequently get careless and the presence of an inspector tends to keep them watchful. As a further argument, he related instances where coal had been sent to a road which finally cost it more per car than the salary of an inspector for six months.

A new system of inspection that is giving satisfaction was described by T. Fawcett (C. P. R.). All coal is purchased on a specification based largely on the ash content. This is varied for the different mines, and the price paid is adjusted on this basis. There are two men at each mine, a sampler and an inspector. The sampler collects a 100 lb. sample from the chute as the coal is running in the car and the inspector separates this in the usual way and tests for the ash content. Twenty tests per day can be easily made and the cars are never delayed if the coal comes up to specifications.

STANDARD COAL ANALYSIS.

J. S. Sheafe (Ill. Cent.), as chairman of the committee on this subject, read a report in which the methods recommended by the American Chemical Society were stated to be the most suitable. If the association did not wish to adopt any standard at this time, the committee urged that the method actually used in any case, be specified. Some form of Baumé calorimeter was recommended. The committee was continued and asked to keep in touch with the other societies interested, making all efforts to secure a universal standard analysis.

OTHER BUSINESS.

It was voted that standing committees be appointed for the consideration of subjects of particular interest and importance to the members. It was suggested that these be fairly large and that the membership be changed in part at each meeting.

Standing committees on the following subjects were approved: Firing practice; fuel stations; distribution of information; constitution and by-laws.

Dr. W. F. M. Goss, dean and director of the College of Engineering, University of Illinois, was unanimously elected an honorary member of the association.

The following officers were elected for the ensuing year: President, H. T. Bentley, assistant superintendent motive power, C. & N. W.; first vice-president, R. Collett, superintendent locomotive fuel service, St. L. & S. F.; second vice-president, D. B. Sebastian, fuel agent, C. R. I. & P. Executive committee, two years, D. C. Buell, J. G. Crawford and R. Hibbit; one year, R. Emerson, W. H. Averell, and W. C. Cox. Chicago was practically the unanimous choice as the location of the next convention.

WIRELESS TELEGRAPH FOR AEROPLANES.—According to a press despatch from London, April 10, experiments made by the British army officers, in conjunction with the Marconi Wireless Telegraph Company, have resulted in sending messages both to and from an aeroplane flying in the air, at points several miles from the station on the ground.

PAINT BRUSH STORAGE

BY H. M. BAXTER,*

Proper storage for brush stock is a problem always before the master painter, and it is none the less his problem when a storekeeper has general charge of the brushes. Where proper storage conditions are not provided, their lack is brought to mind most forcibly and disagreeably, through the falling apart of the brushes, due either to the extremes of heat, dryness or dampness. If stored in too damp quarters, they will suffer just as much as though kept too near a steam pipe or in exceedingly dry air. This is due partly to the peculiar formation of the bristle itself, such hair being more or less porous—a succession of tiny cells, each overlapping the other—which give the bristle its strength and elasticity. In very damp air, these cells absorb the moisture, making the bristle floppy and unfit for use in oils, turpentine or spirits. This characteristic also renders it susceptible of a certain deception in weight, for a difference of 10 per cent. is not impossible between very dry stock and that which

the brush in its proper wrapping and allow to lay over night, when it will be sound as ever and ready for use.

The accompanying illustration shows a "humidor" or a system of storing brushes, which with slight variations has been installed and thoroughly tested by several large railway systems and found to be satisfactory and convenient in all details necessary for the preservation of brushes during storage. No general dimensions are given, and all drawings, notes and data have been carefully worked out to expedite construction for any given size. The number of shelves, sizes of compartments and over-all measurements must necessarily be based on available space, as well as quantity of stock to be cared for. Owing to its natural moisture-withstanding qualities, cyprus is undoubtedly the best wood to use in building a humidor, with sycamore and poplar as substitutes, though any sound wood will answer the purpose. From the viewpoint of economy alone, as well as promptness in obtaining material and effecting any later additions or repairs, it is best to use only standard sizes and supplies. All shelves and all the inside partitions (those between compartments) are cut away in the center and grooved (see the

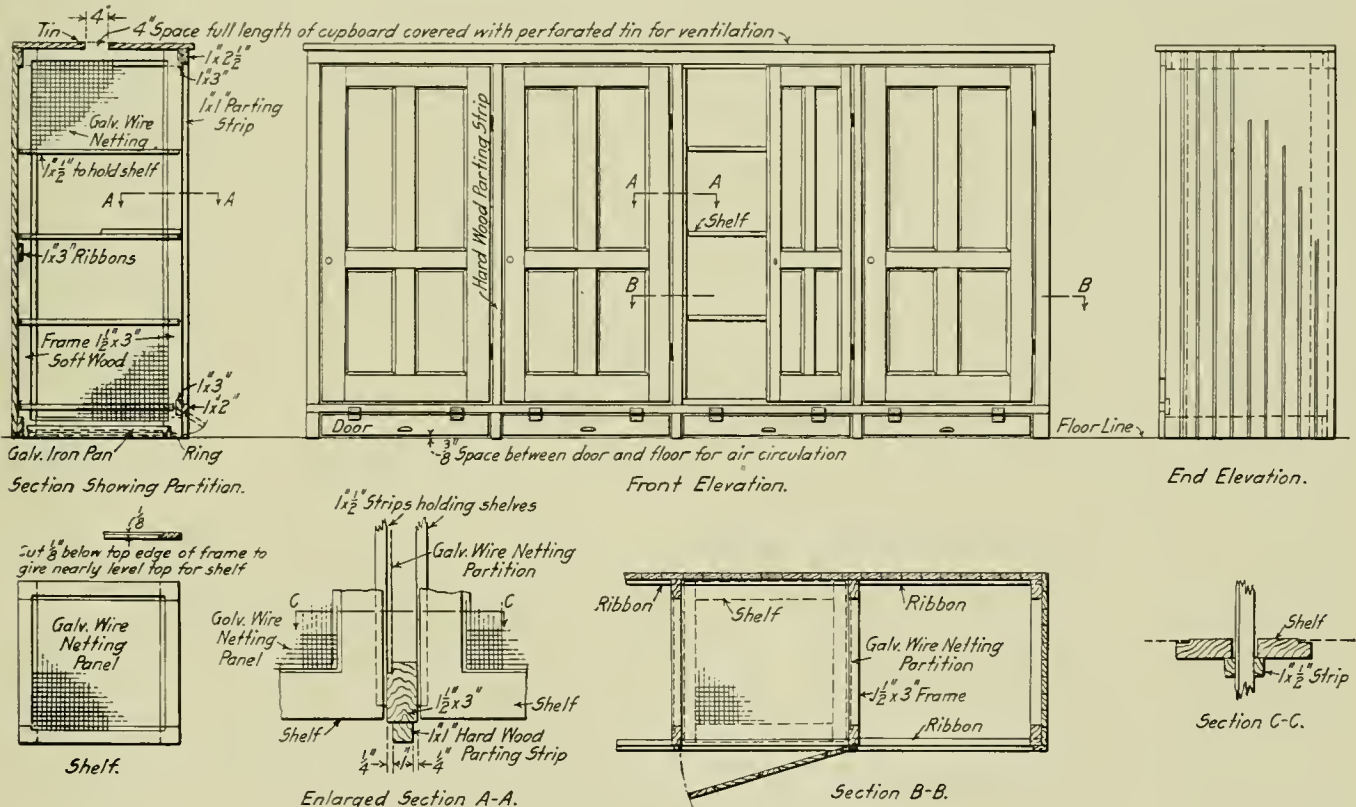

A Humidor or Closet for Storing Paint Brushes.

has been stored in damp places. The specifications for the weight should take this into consideration.

Further, the method of putting together the round and oval paint and varnish brushes is such as to cause serious trouble if they are kept in too dry air. They are made by driving a wedge-shaped handle through the center of the bristles, in such a manner as to bind them tightly against the ferrule, or encircling band of metal. While cement is used in the bound end of the bristle, the real holding power is in the tightly driven, wedge-shaped wooden handle, and any contraction of this handle, whether caused by dryness or other reasons, will eventually allow the brush to fall apart. In cases where the handles of such brushes have become loose, the remedy is simple and effective. Part the bristle in the center and pour half a teaspoonful of water (less if a small brush and a little more if very large) directly on the end of the wooden handle. Then allow the brush to season, with the bristle end up, for an hour or so; replace

sections A-A, B-B, C-C and the shelf in the drawing) so as to allow for the insertion of heavy wire netting. A 4-in. ventilating space runs along the top and is covered with perforated tin.

Under each section is a space for a galvanized iron pan, which is to be kept filled with water, and should be equipped with a ring for use when removing the pans to change the water. These spaces are fronted with loosely fitted hanging doors, with a 3/8-in. opening around the sides and bottom. With these air-supplying provisions, the ventilation is practically perfect, allowing a free circulation of air and preventing any accumulation of moisture. The doors may be paneled as shown in the drawings, or made to conform with the rest of the building, as desired, and may be provided with locks, if necessary, or simply fitted with springs to keep the doors always closed. A convenient addition for the storekeeper is a compartment built at one end having a solid top, shelves and partitions (no iron netting or perforated tin) and containing no water pan, so as

*Kip Brush Company, New York.

to permit the storage of wire brushes, which require absolute dryness, on account of rust. The supply of chamois skins, putty and scraping knives, sponges, feather dusters and the many other articles that always go with such stock, can also be stored in this compartment.

To aid the wood in resisting decay, and also to help the ventilation, the entire inside of the complete humidifier should be given a priming coat of $\frac{3}{4}$ linseed oil and $\frac{1}{4}$ dryer, followed, when thoroughly dry, by one coat of varnish. The exterior, of course, may be painted or finished in any way desired.

Moths eat only the extreme end of the bristle, known as the "flog end," as that is the softest portion, and as it is also the only part which spreads and smooths the paint and varnish, its removal naturally ruins the brush. To keep out the moths, it is wise to sprinkle a pinch of moth flake, or insert a strip of tar paper, in each box of brushes, before placing them in storage. However, moth flake should never be placed in boxes containing brushes which are set in pitch, as the action of the flake tends to soften the pitch and thereby allow the "knots" of bristle to fall out. Many floor brushes and counter dusters which have fallen apart are damaged by having come in contact with moth flake. Any oily or greasy substance produces the same effect on pitch, and in all cases where a brush is to be used in or around oil or grease, it should be made wire drawn, instead of set in pitch.

SPIRAL STAYBOLT

The staybolt shown in the accompanying illustration is designed to withstand the ever changing stresses it may receive in the fire-box of a locomotive boiler with a reduced possibility of fracture. In such service staybolts are subject to considerable repeated stresses, which materially affect the strength of the outside fibers of the bolts. With the staybolt in question this deteriorating

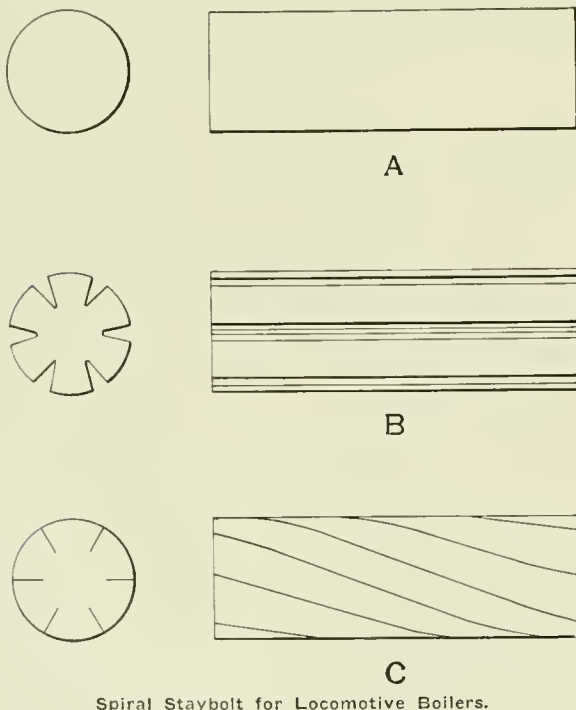

effect is considerably reduced on account of the slots which greatly increase the flexibility of the bolt.

The process of manufacture is as follows: The bar is heated and drawn through a specially constructed die in which are inserted six rotary splitting cutters, so arranged as not to actually cut the metal but merely displace the fibres as the bar is drawn through the die. When the bar leaves the die its cross section

is as shown at *B*; while it is still hot, it is passed through a set of closing rolls which bring it back to its original shape, completely closing the longitudinal incisions made by the splitting dies and finishing the bar as shown at *C*. The rod is twisted one revolution in 12 in. As the whole process is conducted at a heat considerably below the welding temperature, it will be seen that, whereas the bar has the appearance of an ordinary bar of staybolt iron—the faint lines of the incisions will be barely perceptible—yet as a matter of fact, in so far as stress considerations are concerned, it is composed of seven distinct members, similar to a wire rope, each having its own separate neutral axis. This operation does not detract from its ability to resist longitudinal elongation and experiments have shown in the majority of cases that the direct tensile resistance of the material is actually improved by this treatment. The splitting dies referred to do not extend the incisions beyond one-third the diameter of the bar.

Tests have shown that a piece of staybolt iron in its original form broke after 15,560 revolutions on a repeated stress testing machine, while the same material constructed as described failed at 114,120 revolutions. Both test pieces were 8 in. long and had a load of 4,000 lbs. which gave 7,018 lbs. per sq. in. fibre stress at the root of the thread. The eccentricity of vibration was $\frac{3}{16}$ in. and the machine was run at 84 r. p. m. This staybolt is made by the Patterson-Allen Engineering Company, New York.

TIRE TRANSFER CART

At the Clinton, Iowa, shops of the Chicago & North Western a three-wheel car has been designed for transferring driving-wheel tires with much greater safety and convenience than the customary method of placing them on a truck or rolling them by hand, especially in cases where the tires are stored in an upright position. The construction of the cart is clearly shown in

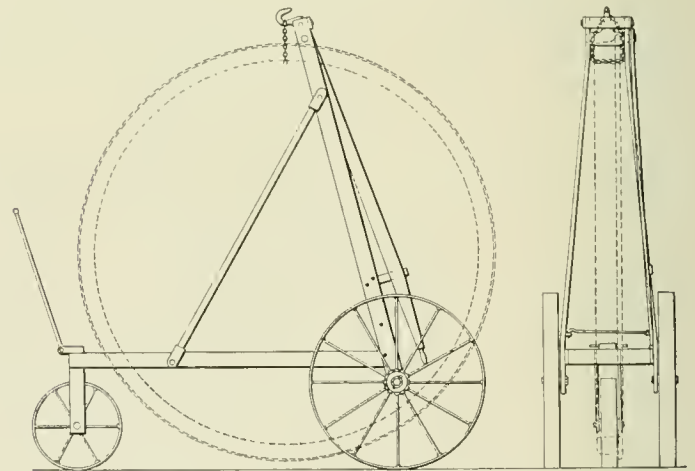

Cart for Transporting Driving Wheel Tires.

the illustration. The brace between the two large wheels is in the shape of a hook, which can be released when the tires are being rolled into place. The long handle hinged at the top has a short lever arm extending from its upper end with a hook from which the tire is suspended by a suitable length of chain. The handle is raised up and the chain looped around the tire with as little looseness as possible, so that when the handle is drawn down and latched the tire is lifted and supported clear of the ground. This cart has also been found convenient for handling front end rings. It was designed by H. Harrison, machinist at the Clinton shops.

CANADIAN COAL.—It has been estimated that there are about 30,000 square miles of coal lands in the Dominion of Canada which contain about 172,000,000,000 tons of coal.

RAILWAY STOREKEEPERS' ASSOCIATION

Ninth Annual Meeting. Abstracts of Reports and Discussions of Special Interest to the Mechanical Department.

The ninth annual convention of the Railway Storekeepers' Association was held at the Hotel Statler, Buffalo, N. Y., May 20-22. After an address of welcome by the mayor of Buffalo and remarks by J. A. Waterman, the past president, and by E. Chamberlain, of the New York Central Lines; W. F. Jones, general storekeeper of the New York Central & Hudson River, the president of the association, made an address. Special mention was made of the work of the committees, and particularly of the tinware committee, which had been in conference with similar committees of the Master Mechanics' and Master Car Builders' Associations for the purpose of standardizing tinware. It is believed that the action of this committee, if accepted, will result in the adoption of standards that will be of great benefit both to the railways and to the manufacturers. In fact, some roads are waiting for this report before ordering large amounts of tinware.

The membership of the association has been increased, the total number, according to the secretary's report, being 625. There were 210 members present at the convention.

RECLAIMING SCRAP MATERIAL.

The subject of railway salvage, or reclaiming scrap and the question of apprentices in the store department, were considered by the committee on recommended practices; H. C. Pearce, Southern Pacific, chairman. The latter subject was considered sufficiently covered in the paper presented by J. A. Waterman, of the Chicago, Burlington & Quincy, at the fifth annual convention. The former subject, however, was presented in detail and the substance of the report is as follows:

A separate salvage department was advocated, which should come under the direct control of the supply department. This new department should gather all obsolete and scrap material and arrange for its reclaiming or selling. It should be run according to a definite and well-planned system, so as to prevent any unnecessary handling. It was estimated that 10 per cent. of the total cost of the material could be saved. Three inspections should be made of the material before it was scrapped; the first by the workmen overhauling the equipment for repairs; the second by sufficiently trained men at the scrap piles, and the third as it is being loaded on the cars for shipment. It was claimed that considerable money is lost in rails and ties which could oftentimes be reclaimed by shortening the rails and by using the ties for secondary track and fence posts.

In addition to the report of the committee, E. J. McVeigh, Grand Trunk, who was also a member of the committee, read a paper on the subject, of which an abstract follows:

Today, and in the past, we have spent money each year on our scrap, and no matter how much, or how little, we spent, we considered it well spent. That is, it brought us a good return. What we want to consider is, should not we spend a little more and secure a much larger proportionate return.

We lose and waste through handling of oil in wooden barrels; by leaving perfectly good fittings on pipe sent to the scrap pile; loss of coal picks, oil cup covers, and many other things dropped from engines and cars, picked up by section men, and held by them instead of being sent in. The manufacturing in our own shops of many items of material that could be bought cheaper in the trade. The loss of air and steam heat hose and couplings through ignorance and carelessness. Putting into the scrap pile second hand material that might be used in place of new. The holding, by departments, of surplus material that should be sent in for redistribution. The putting into the scrap

pile of new material because we have no proper place for it. Stealing of brass scrap (there is generally more of this going on than we think). Throwing away barrel hoops, and very light steel metal. The abuse of oil cans, and other tinware by those using them. Keeping on hand material that has been purchased for a specific purpose, but owing to change of plans is not used for that purpose. Waste of stationery by clerks, and multiplicity of forms, letter heads, printed envelopes, etc. The purchase of cheap (first cost) material and use made of it. Improper use of fog signals and fuses by trainmen and others. Improper care of classification lamps, and train markers. The carrying in vans of excessive quantities of material. Destruction of wire cable owing to improper care and lubrication, and the attempt to use cables in places they are not designed for. Waste of cleaning soap, owing to its being too green, not cured properly.

These are a few of the items that occur to me off hand, and I have no doubt many more will come up in the minds of all good live storekeepers.

Fifty per cent. of all our loss and waste is the result of lack of education; the balance is due to pure "cussedness." This lack of education is not confined to any class or department. That we have, in many cases, insufficient storage facilities is due to lack of education on the part of our higher officers. They have not been educated to see the necessity for them. The abuse of oil cans and tinware, is due to pure cussedness on the part of those using them. The holding of valuable material by employees is due to lack of education or proper instructions. The loss of air and steam heat hose and couplings is a combination of the two evils mentioned.

You may note the item "new material put in the scrap pile because we have no other place to put it." By this is meant the short ends of iron bars, pieces of pipe, etc., that accumulate around our iron and pipe racks, and look so untidy, finally being put into the scrap some day when we have a good clean-up, ahead of the visit of the big fellows. There are few shop foremen, or storekeepers, who have not been bothered with this. Then there is the good second hand material that often finds its way into the scrap, just because there is no regular place for it, and it makes the place so untidy.

If we will examine our scrap piles at different shops, and observe what is put into them, and the men who put it there, we will realize how difficult, how impossible, it would be to properly control this in detail. To do this would cost us more than the material is worth, and we could not very well have proper facilities for this rescue at a dozen different places, so if we cannot control it at one end, or in the middle, we must make the effort at the other end. If this education and rescue work is to be done we must have some one to do it, and the facilities for doing it. And my idea is that at some central point, we should have this some one, and these facilities. These would consist of first, a man thoroughly familiar with railway material, and with knowledge of his road. He should have plenty of room, with a platform and sorting bins just a little too large for his work. He should have the tools necessary, and a few pieces of machinery, such as shears, bolt machines, pipe machines, rail saws, rail benders, etc., and in addition a storage building sufficiently large to hold material as rescued, or manufactured.

To such a place would be sent all of the scrap, second hand and surplus material on the system. It would be the business of the man in charge, with the assistance of other men of the supply department, to see that such material was sent there

promptly in carload lots; and here the real salvage work would be done. This would consist of the rescue from the scrap of all bolts that are worth cutting and rethreading. Also all short pieces of round iron that can be made into bolts. The cutting up of larger iron for the same purpose. Re-tapping of nuts that may be used again, cutting off the good ends of damaged pipe, and making it into nipples. The saving of rails with damaged ends. The cutting off of coupler pockets. The careful testing and selecting of coupler knuckles. Cutting up of scrap frogs and old tanks and boilers when considered advisable. The straightening and trimming of bar iron. Removal of good fittings from scrap pipe. The rescue from the scrap of all material that may be used without change, and many more things that will be noticed as the work proceeds.

Then there would be the final sorting of the actual scrap into the classes that would bring the best price in the market. This would be no small man's job, as the man doing it must not only know railway material from A to Z, but must study markets and keep in touch with their requirements, and while not doing the actual selling he must arrange his material to be sold to the best advantage. Finally this work should be done under the direction of the supply department. There is one item that needs special attention, and that is the air and steam heat hose and couplings. There is a good opportunity to effect a saving of from \$10,000 to \$30,000 in this item. Just how it can be done I know, because I have done it, and would be glad to tell anyone who has not done it.

As I have intimated this salvage question has been left too much in the hands of the different departments, and many individuals. What is everybody's business is nobody's business. Under the plan proposed this would be changed. The salvage man would hunt up the salvage, and see that it came in.

Discussion.—The discussion of this subject brought out the various methods and systems used in the gathering and reclaiming of scrap. H. E. Rouse, Chicago Great Western, spoke on the advantage of using the scrap classification as drawn up by this association, stating that his road received on an average \$1.38 more per ton by using this classification than by selling the scrap unclassified and as general scrap. The increased cost of operating this system was more than paid for by the additional material reclaimed.

The question of local or general scrap docks was discussed quite fully and the consensus of opinion seemed to be that as much reclaiming as possible should be done before the scrap is sent to the general scrap bins, and at these bins the scrap should be classified and carefully inspected for any usable material. Some roads, however, send all their general scrap to the general scrap bins and have it sorted and reclaimed there, but it was contended that the cost of hauling this usable material back and forth over the lines would be more than the money saved by the use of second hand material.

J. P. Murphy, Lake Shore, suggested that a definite set of plans be drawn up for handling the scrap for classification and reclamation, and suggested that all material should be painted and made to look as nearly as possible like new, for it had been his experience that such material would find much better usage at the hands of the shop men. Friendly competitions should also be carried on between different departments, to see which returns the least usable material.

C. A. Roth, of the Chicago, Burlington & Quincy, described the method used on that road. The mechanical department cooperates with the supply department and general reclaiming of the scrap is done at the shops and the remainder is taken to the scrap docks at Havelock, Neb. At this point a regular plant is laid out in a systematic manner, magnets being used for loading and unloading the scrap.

W. R. Schoop, of the Buffalo, Rochester & Pittsburgh, stated that his road had installed reclaiming rolls with which large savings are expected to be made. The scrap docks on that road

are arranged in the form of a circle, with the distributing bin in the center and classification bins radiating from that point.

In connection with this subject a query was sent in by one of the members asking whether the saving would justify using a \$50 or \$60 man for classifying a scrap pile of about 70 tons a month. It was decided that if the man was limited to this work alone the expense would not be justifiable, but it was questioned as to whether he could be kept busy enough on that job; if he was used on other work as well it would be worth while. However, a good man at the scrap pile is an absolute necessity, not only for the money he may save but for the moral effect he will have on the departments sending in scrap. For if these departments find that the scrap man is returning usable material they will be more careful about sending it in, especially, as is the case on some roads, where the general superintendent requires a report of the usable material returned to each department.

The committee on scrap classifications made a few changes in these classifications, which were found necessary on account of the increasing use of steel in railway work. However, no change was made in No. 1 wrought scrap, which is No. 66 on the storekeepers' classification and is defined as follows: "Clean wrought iron from railway equipment. Pieces measuring 4 in. long and over, exclusive of threads, may include rods and bolts $\frac{3}{8}$ in. in diameter, except track bolts; also drawbar yokes, bridge irons in bars or rods, heavy iron chain, links and pins; all to be free from riveted material." In assigning scrap to this classification it is practically impossible to determine whether the material is steel or wrought iron, and as a result the combination will be almost half and half, steel and iron. This is severely objected to by many of the scrap purchasers, and no doubt this classification will have to be changed.

OIL AND WASTE.

Papers were presented on this subject by W. O. Taylor, Galena Signal Oil Company; C. H. Tallman, New York Central & Hudson River, and E. C. Totten, of the same road. An abstract of Mr. Taylor's paper follows:

Present-day train service requires a light of greater candle power, and more reliability than is possible with common kerosene and the manufacturers have met this demand with a compounded oil, water white in color, 180 deg. fire test, 48 to 49 gravity, and 20 deg. below zero cold test, that has a candle power that meets all the requirements in those states where the law had heretofore forced an oil light from the service. The reduction of the number of headlight cases, reflectors, and chimneys furnished, where this oil is used, has contributed to a lessened expense for handling material.

The signal oil extensively used in railway service for light and signals, and mainly used in hand lanterns, has a fire test of 300 deg. Fahr., or more, a gravity 34 to 35 deg. Baume, cold test about 16 deg. above zero, color clear and light and is practically free from acids and alkalis. On account of its important service it should receive the greatest care, and its fine illuminating properties be guarded from the contamination of mixing with other oils, and from water and alkalis. This oil should never be stored in galvanized iron tanks or shipped in galvanized iron cans—for the reason that the animal oil in the compound acts on the zinc, dissolves it, and causes the signal oil to become green and rancid, utterly ruining it for the purpose for which it was made. Steel and iron tanks and heavy tin cans are the best containers. Before tin cans are used for signal oil, care should be taken to wash them free from all foreign substances, and particularly any of the acids used in soldering.

This oil should not be exposed to the extremes of heat or cold, for these conditions tend to a separation of the elements of which it is composed, and seriously affect its illuminating quality.

There should not be kept in storage more than a 30 to 60 days'

supply, and the storage tanks for holding this oil should be cleaned every six months, and in no case should they go longer than one year between cleanings.

Absorbent towels have been furnished workmen on a road as a substitute for waste for general wiping purposes. An "emulsion machine," which is of the centrifugal type, for extracting and filtering the oil removed from these towels was installed, with the following results:

"Extracted from dirty towels, 615 gal., value 8c. per gal., with a 15-in. emulsion machine.

| | |
|------------------------------|---------|
| Total | \$49.20 |
| Total cost to filter..... | 3.34 |
| Showing clear profit of..... | \$45.86 |

This oil was accumulated at this shop, from these dirty towels in about 65 days. This amount was shipped to the signal department, billing them 8c. per gal., and was used for lubricating switches."

Again quoting, "During the month of January, we washed 6,695 towels, at a cost of \$26.50, and furnished the entire division with same daily, and I believe that there was no complaint that anyone was short of towels and could not perform the same amount of work as they could with the waste, thereby showing a saving, of about 4,000 lbs. of colored waste, which we furnished previous to this, to the different points for the same wiping purposes. Taking these figures into consideration, we consider that we saved 24,000 lbs. of the colored waste in six months, value \$1,440, less the 6,695 towels at 4½ cents apiece, amounting to \$311.28, showing a saving in six months of \$1,138.72, or a monthly saving of \$189.78. Subtracting from this the cost of washing towels, \$26.20, leaves a net saving of \$163.28 per month. We figure that the life of one of these towels, under fair usage, to be about five to six months.

Valve, engine, coach and car oils are compounded from selected mineral and animal stock that is best adapted for the service required, with petroleum as the basic ingredient. The distinguishing characteristics of a valve oil are a high fire test, a high cold test, and lower gravity.

To the engine, coach and car oils there is added oxide of lead, and in such proportions with the other ingredients of these oils, as to make them best adapted for the service indicated by their trade names. The process of manufacture so thoroughly mixes the lead with the oils, that unless exposed to long periods of absolute rest, it will be held in suspension. The leading characteristics of these oils, is their adaptation to the varying climatic conditions.

Again referring to the results obtained from the use of the emulsion machine, which extracts the oil by centrifugal force, the same force being utilized for filtering the oil, it was said:

"We also have filtered, through this machine, car oil which is taken from dirty waste received chiefly from demolished cars.

| | |
|--|----------|
| 686 gallons, value 19c. per gallon, total..... | \$130.34 |
| Cost of filtering, one man at \$1.76..... | 5.54 |
| Cost of lubricating the machine..... | .94 |
| Total | 6.48 |

Showing a saving of.....\$123.86

"This covers about a 30 days' working of one machine, whenever we found time to reclaim this oil."

The information furnished has been confirmed by the writer's experience, and the centrifugal machine which extracts the oil from the waste, can be then used as a filter for the oil, and after the separation of the dirt and portions of waste unfit for further service, the oil can be used for resaturation of the good waste. Reclamation of journal box packing has been adopted by many roads with very satisfactory results.

Less expensive than the centrifugal machine, and very efficient, is the process of submerging or washing the waste in hot oil; in connection with this process suitable filtering or settling tanks should be installed and the dirty oil can be thoroughly cleansed and restored to service.

As illustrative of the possibilities of this system, here submitted, are figures covering a period of one year, and the first complete year after the system had been thoroughly installed.

All packing used on the system is prepared at three central points. Car oil is received in tank cars from the manufacturer, unloaded into the storage tanks in the basement of the oil station by gravity, thence raised by air pressure to a distributing tank located above the saturating tanks which are on the ground floor.

These tanks are connected in series of three or more, numbered, and are in communication with each other by means of a circulating pipe, and also carrier ways upon which rests a cylinder press operated by air pressure. The capacity of each of these tanks is 80 lbs of waste, and 90 gals. of oil.

After a saturation of 48 hours in tank number one, communication is made with any other tank in the series; to illustrate, tank number ten, and the movable press is rolled over tank number one, and 50 gals. of oil is pressed from this tank to tank number ten, leaving in tank number one, 80 lbs. of waste with 40 gals. of oil, or four pints to the pound, a total weight of 380 lbs. of prepared packing, or two barrels. This is shipped in tight barrels with removable heads, to the points where used, there dumped into a tank with screen and faucet, and as the oil flows by gravity to the well below the screen, it is drawn off and poured over the packing.

All journal box packing when removed from the boxes in shops, repair tracks, or along the road is supposed to be sent to the reclaiming plant, which is at the same station where new material is prepared. This old material is sorted over, heavy portions of dirt, coal, etc., shook out, metal picked out, and the short strands shaken out. It is then passed through the hot oil tank, where the action of the heat expands the oil, separating the strands of the waste. After 10 to 15 minutes in the hot oil tank it is in condition to be removed by forks and placed on the drainage screen which is independent of the hot oil tank and is not exposed to the heat, to guard against too rapid drainage. When drained sufficiently to approximate the proportions of 4 pints of oil to one of waste, this is mixed with new material in the proportion of 50 per cent. of each, and sent out to receive the same attention and use as new packing. The only charge for material is the new oil placed in the boiling tank.

The results for one year were interesting, and as compared with the previous year before this system was installed, very satisfactory.

| | |
|---|--------------|
| Old packing, dirt, etc., removed from freight cars..... | 262,548 lbs. |
| Reclaimed and returned to service..... | 171,227 lbs. |
| Babbitt metal recovered | 4,223 lbs. |
| Oil used in process..... | 499 gals. |
| Labor cost | \$759.72 |
| Cost per pound to reclaim material..... | .0037 cents |

As compared with the previous year, there was an increase of 3,392,430 miles, a decrease in total oil consumed of 3,783 gals., a decrease in waste used of 52 per cent., an increase in miles run per pint of oil from 424. to 474., a decrease in cost per 1,000 miles run from .0528 to .0475, and an increase in miles run per hot box from 49,666 to 50,805 miles.

The commercial term "waste" applies to a by-product of the manufacture of cotton and woolen textiles, and, without other designation, should only apply to straight products, which range in value from that of clear white, soft cotton, and long strand wool, to the poorer grades, coarser in texture, but retaining purity of stock. The blending of cotton and wool in the right proportions produces a "mixed waste," combining properties that gives it a value for journal box packing.

As distinctive characteristics of cotton waste, it excels in absorption and capillarity, and is best adapted for general wiping and cleaning purposes, and is used with a measure of success as journal box packing.

Wool waste excels in expansion or elasticity. The leading characteristic of the several "packings" is the claim for their

elasticity and resiliency. It has been the writer's experience that the superior service from a good grade of wool waste justifies its exclusive use for journal box packing.

There is an important possibility in the reclamation of waste that has been used for general locomotive and car cleaning, by the simple process of boiling. With the exception of waste that has been used for wiping paint, varnish, or like sticky surfaces, a large percentage can be reclaimed for further use and repeated cleanings. As evidence of this, data from one road is sufficient. Ninety-five per cent. of the total amount sent to the reclaiming plant was returned to service at a cost of .0099c. per pound. This expense would have been lessened had the attendant been constantly kept busy on this process, and the output increased without additional labor cost.

Mr. Tallman said, in part:

In connection with this subject the proper handling of grease should be considered. The quality of grease can be easily found if one follows this simple procedure:

Take a small piece of grease and work it between the thumb and fingers until it is slightly warmed, and if the grease cleans off readily, leaving a smooth, shiny surface, the quality is all right. If, however, it works into a soft, sticky mass, and pulls out in strings between the thumb and fingers, it is safe to assume that the quality is doubtful and it should be so reported.

Grease for either rods or journals should be protected from the elements and from dirt or other foreign accumulations. For this reason, barrels should be kept covered and all possibilities prevented of anything foreign becoming mixed with the grease.

The effect of water is very disastrous to the grease, as it not only saponifies it, but carries away the free alkali and other lubricating qualities, leaving nothing but a soft, sticky mass.

The object of the perforated plate in the driving box cellar is to provide the means of forming the vacuum necessary to deliver the grease to the journal and at the same time retain the grease to the greatest extent possible and still give sufficient for proper lubrication. It is of the greatest importance then that the perforated plate be in proper contact with the journal, otherwise the running temperature of the journal will be increased. If the increased temperature is excessive, we find that hard, blackened condition of the grease which has remained after the free alkali evaporates and the remaining substances have been subjected to extreme temperatures.

We can assist in overcoming excessive use of greases by protecting them in our oil houses and we can also enforce further economies through reclaiming grease removed from cellars when engines are undergoing repairs. The easiest and most successful method for reclaiming this grease is as follows:

Put 100 lbs. of old journal compound in a large kettle and melt it. Then add to this 50 lbs. of water and stir. Then take 3 lbs. of caustic (sal) soda, dissolve, and stir in thoroughly. Allow this mixture to boil slowly, skimming off the dirt and foreign matter which may rise to the top. Continue the boiling until the water has evaporated, then slowly stir in 7 lbs. of valve oil. This will give a grease equally as good as new stock.

Finally, I would urge a systematized effort in the protection of new grease, the reclaiming of old, and exerting our influence among the users both in the shops and engine houses for careful attention in the application and care of the device which applies it. We should see to it that our houses are equipped with a machine for properly preparing the grease, both in cakes and candles, and that close record is kept of all distribution. The value of a pound of grease is considerable, and if we are lax in protecting it against uses other than for which it is intended, we are not doing our full duty.

Mr. Totten in his paper on the subject took up the question of journal boxes, and said in part:

While hot boxes are, of course, sometimes caused by mechanical defects, I believe that fewer result from this cause

than is generally supposed. A journal nearly always begins to heat at the back end of the box, caused, no doubt, by the fact that at that point there is more weight, more dirt and less lubrication, and it has been noted that not enough attention is paid to truing up oil boxes and equalizers when cars are being overhauled. I would recommend, in this connection, instructions be issued to shop foremen that will insure as nearly as possible giving the equalizers a proper bearing.

I venture to say that 50 per cent. of all oil in journal boxes is wasted. Oil should never be poured into a box without first picking the waste and crowding it back against the wheel plate of the box twisted in the form of a rope. In considering the causes of hot boxes a great deal may be said about brasses. We have all heard a great deal of late about the electrotyping and copper spots on brasses. These are formed by the acid in the oil dissolving the copper in the brass. If for any reason the bearing gets warm, the heat draws copper and carbon to the bearing face, the journal takes up and deposits copper and carbon, which causes the copper spot and the journal becomes hot.

The following are common causes for hot boxes:

Dry and dirty packing.

Packing not touching the entire length of the journal.

Wedges working out of place.

Dust guards worn and improperly fitted, admitting dirt through the wheel plate.

Journal box lids improperly fitted and in some cases missing.

Excessive end wear on brasses, caused in many cases by improper location of the shoulder on the brass and often too much material cast in the shoulder on the brass and stop in the journal boxes.

Brasses not of proper shape; too large or too small for the journal.

Trucks out of square.

Axles slightly sprung out of a true line; principally caused by cars being derailed under load.

Journals worn concave and convex.

Wedges not fitting on the crown of brass properly, but riding on lugs of brass, causing the brass to bind and stopping the flow of oil bearings.

All second hand journals upon which new wheels are pressed should be given a lathe test, as the ordinary caliper and wheel gage test will not detect these defects in all cases.

A brass that has once run hot should be removed and relined. The practice of many roads is to give the brass a new soft metal face and apply it again. In such cases, it will run cool until the journal has worn through the babbitt face and then run hot again for the reason that, as far as the excessive degree of heat has penetrated the brass when it was first hot, the lead and zinc has been melted out. The brass is porous and the temperature uneven. A brass that has run hot may be relined and material enough added to bring it up to the standard weight at an average cost of eight cents per brass; where if the attempt is made to continue running the box with the same brass, in nine cases out of ten, the brass, worth about \$2.80, is ruined, trains delayed, and in many cases the journal cut.

In preparing sponge of oil and waste for journal boxes the following rules should be observed. Soak the waste in oil at least 48 hours before using. Keepers of oil and waste who issue packing to trainmen should pick the waste apart, before applying the oil. Drain off the surplus oil, allowing sufficient to remain in the waste so that by gently pressing with the hand, oil will flow. The first waste to be introduced into the journal box should be wrung moderately dry in the form of a rope and packed up tightly under the journal and against the wheel plate or back of box. This serves as a guard, excluding the dust from the outside as well as retaining the oil in the box. Then follow up with the waste out of the pail, so as to have it in a spongy condition under the journal.

In case of excessive end wear on brasses, great care should be taken in applying new brasses and in every case if there does not appear to be sufficient lateral motion between the end of the brass and the collar of the journal, the shoulder of the brass should be filed down to insure a perfect fit. Brasses are sometimes too light. Filled brasses are often weakened by drilling too large and too many holes in the crown of the brass for the purpose of holding the filling.

I also believe that many brasses that have just run warm and been removed are unnecessarily thrown away, through ignorance on account of the copper spot. I have experimented on this and found that by using a proper tool and planing off the copper spot, that the replaced brass can be worn out. It should also be remembered that the brass is for bearing. The soft metal face is to enable a journal to get a bearing quickly. I mention this from the fact that it seems to be the opinion of many of our car repairers, and in some cases others, that a brass is worn sufficiently to be removed when the babbit face only is worn. We have comparatively few hot boxes on our babbit or lead lining. In most cases the trouble begins when the lining has been worn through and bearing is on solid brass.

LINE INSPECTION.

A paper was presented on this subject by J. H. Callaghan, Canadian Pacific. An abstract follows:

Line inspection offers a big field for the heads of many important departments of a railway. Some lines have no less than 50 places where materials are carried, all of which come under the care of the various division storekeepers, and while these form a portion of the line inspection they do not afford anything like the field to work in which is offered by the line proper or such places as engine houses, car repair yards, bridge and building department shacks, construction yards, steamship, ferry and elevator terminals, freight and baggage sheds, etc., in fact, wherever company's material, whether new, second-hand or scrap, is apt to be found. These are the places where the general storekeeper with the inspection team can do a lot of very valuable work.

A good inspection team could be made up of the general manager, or an officer of equal rank; general master mechanic; master car builder, and the general storekeeper.

The general manager because he is in charge of all lines on which such inspections are made and decisions are arrived at on the ground. The general master mechanic because all division master mechanics are subject to his instructions. The master car builder for similar reasons, the various division car foremen being subservient to him, and the general storekeeper because he is the custodian of the company's materials, no matter where located.

On the eastern lines of the Canadian Pacific there are four general divisions with proper complements of officers, such as general superintendent, district and assistant superintendents, division car foreman, master mechanic, etc., and assistants, car and locomotive foreman in charge of supplies, in which capacity they report to the division storekeeper all matters pertaining to the upkeep and care of the stock, so that, in making an inspection over any of these divisions a number of these officers usually accompany the above mentioned inspection team.

During the inspection the general manager on the rear end of the train, notices sign boards not properly painted, station buildings in about the same condition, cattle guards, fencing wire, switch material ties, etc., not properly cared for, and speaks to the general superintendent of the division together with the superintendent in charge of the district as to these conditions and directs as to their proper disposition. The general master mechanic notices locomotives hauling regular trains where an engine of less capacity would answer the purpose and arranges at once with the division master mechanic for the proper disposition of this misplaced power. While in the engine houses and

machine shops he looks into the work of proper upkeep of machines, proper methods of general engine house practices and is constantly introducing shop kinks. The master car builder covers very much the same ground in his department.

There was a time and no doubt is yet, when officers in making inspections were frequently misinformed, when they had not the proper inspection team about; that is, they received a lot of unreliable and erroneous information simply because the information was given in such a manner that unless the officer was conversant with the details, he was liable to accept them as genuine.

The general storekeeper must satisfy the other members of the team that he is the right man in the right place, that he may be of valuable assistance to them in the various details of inspection as applies to their particular line, which in a general way is largely in common with his own, so that the assistance he renders may be mutually reciprocated. No better working inspection team is necessary for any purpose than the one with which I am connected. It is not directly with the stores department proper or material in the care of the department's employees at division or other points where the accumulations of new, second-hand or scrap materials may be found that the general storekeeper does his best work.

These latter accumulations are tabulated by the department's own men and proper record kept of them, in addition to which the department's inspectors are constantly on the line following them up, their work being mainly directed to the keeping down of surplus stock under the charge of the stores department. In visiting some section tool houses, car cleaners' shacks, etc., in unfrequented places some valuable finds are made. For example, on some of the smaller branch lines where they run a passenger train daily you may find a vacuum cleaner for the seats which is, of course, never used and the man in charge does not know what it is for, or you might find a hose for gasing cars where this operation would not be necessary once in years. Such finds are ordered shipped in to the divisional stores.

A feature of these inspection trips and one which tends to enhance their value is that meetings are held frequently of all the officers of the different grand divisions at which the inspection team aim to be present. The efforts made and results affected, particularly as applicable to the material question or work done by the general storekeeper are usually brought up at these meetings and detailed reports of such savings as have been made are usually illustrated in dollars and cents, and in reporting results of inspections in the way of saving purchases of material which are found to be unapplied at various places on your line. You cannot bring these facts home by simply describing, say 5 crossheads, 20 miles of No. 9 telegraph wire, to the same extent as you can if you say that during a certain period there has been picked up on your division material to the value of so many thousand dollars which your operating and other expenses have been credited with.

This is the sort of inspection which counts. Attach yourself to the proper team, be diplomatic and tactful, satisfy divisional officers that your efforts are intended to be helpful, earn their honest co-operation by dealing squarely with them, make clear that all material cleaned up by you is properly covered with the necessary credits resulting in reduction of cost in operating their district or division; establish this condition and you will add supporters to your good work every trip you make.

Discussion.—That line inspection is a necessity on all roads was conceded by all the members present. Various ways in which this inspection is now performed were described; some roads make two general inspections every year, while others make these inspections once a month.

While it would seem that a large road would be limited in the number of inspections possible to make, it was shown that on the Southern Pacific these inspections are made every month, although not by the general manager or by such high officers as

described in Mr. Callaghan's paper; they are represented by their subordinate or division officers. On this road a supply train made up of about eight cars runs as a special over each division every month. It is composed of supply cars and private cars to accommodate the superintendent, resident engineer, roadmaster, bridge and building engineers and master mechanic, together with the storekeeper. The train inspects every point and stops at each point as long as is necessary. This system has met with very good success, and it brings each local agent, foreman and operator in close touch with their superior officers on the division, and makes a much closer unit all the way through. The storekeeper becomes acquainted with different officers along the line, and this apparent support of the superintendent greatly aids him in controlling the stock to the best possible advantage. During this trip supplies are delivered and surplus stock picked up, together with any scrap that may be found along the line.

One storekeeper on a large system was ordered by his superior to spend two days in the office and four on the road. Mr. Murphy of the Lake Shore goes a little further with his inspection system and sends his men out visiting other roads, and he finds that they come back with renewed ambition and incentive and oftentimes with many valuable ideas.

In connection with the subject of surplus material, G. G. Allen, Chicago, Milwaukee & St. Paul, stated that the general or divisional storekeeper should keep as actively in touch with what is going on on the road or divisions as does the president or superintendent. In this way the storekeeper can be ready with supplies for any new work, or if a shop is transferred from one point to another can arrange to have his stock transferred with the least possible delay.

STANDARDIZATION OF GRAIN DOORS.

D. Kavanagh, chairman of this committee, reported that the committee had conferred with the committee of the General Superintendents' Association on reclamation as well as the standardization of grain doors, and with slight modifications had not found any reason to change the recommendations which were made in the previous report. It is still maintained that doors 20 in. wide by 7 ft. long are the most serviceable, and can be used in any freight car suitable for carrying grain having a standard width of door. It was agreed after conference with the committee of the General Superintendents' Association and with Mr. McNulty, the reclamation re-cooperage agent, that better results can be obtained from grain doors constructed with the two end cleats set out flush to the end of the door, instead of 6 in. back from the end as previously recommended. There is more nailing stock at the end of grain door, making it more substantial and less liable to be damaged in removing it from cars. For railways buying grain doors made of hard woods, it is not believed necessary to have a complete double door, i. e., a door made with a full double thickness of lumber all the way through, single thickness hard wood doors being equally as strong and serviceable as double doors made from soft wood, if all cracks are properly cleated.

Roads that can purchase hard wood doors to advantage, constructed as above described, will save approximately \$25,000 to \$30,000 a year where large quantities of these doors are required. In order to have the marking of grain doors uniform on all railways, it is recommended that on the inside the door should be properly stenciled with the initials of the railway in large letters, and also the name of the manufacturer of the grain door, this latter information for identification purposes. On the opposite side of the door, that is, the outside, should be stenciled also in plain large letters—"This Side Out—Return to A. B. & C. R. R."

HANDLING AND ACCOUNTING FOR MATERIAL AT CONTRACT SHOPS.

When equipment is to be repaired under a contract, care should be taken to see that the contract is practical. The ac-

counting, mechanical and supply departments should draw up the contract between them and it should be carefully studied by the accountants, inspectors and checkers assigned to the particular job. As the equipment is received at the shop it should be examined by the inspector with the assistance of the checker and his report should be made in duplicate, one for the contractor and one to be used in checking up new material as it is received. Definite prices should be agreed upon for any piece work done on the equipment and the price of the material, if any, furnished by the railway should also be fixed. It would be best to have all or none of the material purchased and furnished by the railway and still better for the contractor to furnish it all. When the railway company furnishes the material a complete store organization should be maintained by it at the contractors' shops. In this case all material should be double checked and the inspectors should watch for wasted material and scrap.

OTHER BUSINESS.

Among other papers presented was a report of the accounting committee, which requested more time in which to make a comprehensive report. The stationery committee, H. E. Rouse, Chicago Great Western, chairman, gave a report of progress and was continued for another year. This committee has done considerable hard work, and as the subject is such an extensive one it cannot be adequately handled in one year. A very able paper was also presented by H. C. Pearce, Southern Pacific, on increased efficiency in the supply department.

Concerning assembled shipments of material, the concensus of opinion seemed to be that for requisitions for five-car lots or under they should be shipped assembled, although no iron-clad rules could be laid down. Assembled shipments allow the work to be properly begun, limit the misapplication of material, limit the liability of stealing and save in the handling of the material.

The new officers were elected as follows: J. R. Mulroy, St. Louis & San Francisco, president; J. W. Gerber, Southern Railway, first vice-president; G. G. Allen, Chicago, Milwaukee & St. Paul, second vice-president; J. P. Murphy, Lake Shore & Michigan Southern, secretary and treasurer.

THREE-CYLINDER SIMPLE LOCOMOTIVES

Twenty Atlantic type locomotives recently built by the North British Locomotive Company for the North Eastern Railway of England are of the three cylinder simple type. Ten of them, built for saturated steam, have 15½ in. x 26 in. cylinders, and the remainder, equipped with Schmidt superheaters, have 16½ in. x 26 in. cylinders. They have been very successful in handling trains of from 300 to 500 tons behind the tender at average speeds of 53 miles per hour. They have 82 in. driving wheels and 27 sq. ft. of grate area. The total weight in working order is 153,400 lbs. Each of the three cylinders has its own piston valve operated by a Stephenson valve gear. The three cylinders and valve chambers are all in one casting and the valves for the two outside cylinders are located inside the frames about on the same horizontal line with the cylinder; while the center valve is in an inclined position over the center cylinder. All cylinders drive on the front pair of drivers, which has a cranked axle. The cranks are set at an angle of 120 deg. with each other. The steam pressure unfortunately is not given in the description of these locomotives in the *Engineer* (London), from which this information is taken.

ACCIDENTS.—A reduction of 29 per cent. in the number of accidents during 1911 as compared with the year 1910 is reported by the Illinois Central. In 1911 there were 269 accidents on the road as compared with 380 in 1910.

ANNUAL MEETING OF AIR BRAKE ASSOCIATION

Convention Report, Including Papers and Discussions on Hose Failures and on Wear of Shoes as Affected by Wheel Loads.

The nineteenth annual convention of the Air Brake Association was held at the Jefferson Hotel, Richmond, Va., May 7-10, W. P. Huntley, general foreman of the Chesapeake & Ohio at Ashland, Ky., presiding. Governor William Hodges Mann welcomed the convention to Richmond. Addresses were also made by W. H. Adams of the Board of Aldermen, T. M. Carrington of the Chamber of Commerce, and M. J. Capler, fourth vice-president of the Chesapeake & Ohio.

THE JOB BEHIND THE CLEANING DATE.

After the opening exercises a paper on The Job Behind the Cleaning Date, by C. P. McGinnis, was read by his successor on the Soo Line, H. A. Clark. It relates to the remarkable results accomplished by Mr. McGinnis, in the past two years, in improving the air brake service by careful inspection of the freight brake equipment, systematic testing and cleaning of triples and brake cylinders, and the providing of proper facilities for the purpose. This work has proved so important that representatives of other lines have gone to the Soo yards to inspect and study the methods used.

In the discussion the Pennsylvania method of testing the leakage of brake cylinders by gage and limiting the leakage to 5 lbs. per minute was generally commended; this practice is extending to other lines and its general adoption was strongly urged. It is difficult to comply with federal laws relating to air brakes and maintain 85 per cent. of the brakes on a train in good order without a well organized system of tests and inspection.

LIGHT AND LOADED AIR BRAKE EQUIPMENT.

W. V. Turner, of the Westinghouse Air Brake Company, gave an illustrated lecture on Recent Air Brake Developments. It dealt more particularly with the improved brake for light and loaded freight cars, and excited such unusual interest that this brake equipment will probably come into more general use.

Discussion.—C. C. Farmer described the successful operation of this system on the Bingham & Garfield in the copper region of Utah. Here 40 loaded cars weighing 3,040 tons are handled safely on a 16 mile grade, 3.2 per cent. maximum. The operation of the trains was one of the most difficult problems encountered by the air brake company. This equipment has also been applied to 500 cars on the Denver, North Western & Pacific, and there are a few in use on the Santa Fe, the Baltimore & Ohio, and the Southern Pacific. Representatives from these lines reported it working successfully and without any unusual difficulties. On account of its great advantage in increasing the percentage of brake power to the weight of the train it is expected that the use of this brake will extend to lines in level districts as well as on the heavy mountain grades, and it will be especially useful on 50-ton coal and ore cars.

AIR HOSE FAILURES.

Following is an abstract of a report on this subject which was made by a committee of which T. W. Dow was chairman.

The large increase in the number of air hose that blow off the fittings and burst, with the consequent serious detentions, and in some cases bad wrecks, has emphasized the fact that the subject is much more important than it has yet been considered. While there has always been more or less of these failures, the trouble has increased several fold during the last two or three years; on one of the large trunk line railways the matter became so serious during the summer of 1911 that a special soap-suds test of all air hose on all freight trains at all terminals was ordered, with a view of determining the exact con-

ditions. The result was most surprising, even to those who knew something of the trouble. Not only were an excessively large number of porous hose found and removed from its own cars, but an equally large number were removed from foreign cars as well. The cars of practically all railways were handled during the time of these tests, and none were found free from the defect; without doubt the trouble is not a local one, but general throughout the country.

Many suggestions as to the cause of these failures have been offered, but as yet no remedy has been found. To whatever cause the difficulty may be attributed, one thing is certain: the failures during the hot, dry summer weather are far in excess of those during the cold months, so far as the bursting and blowing off of the fittings is concerned.

At one time good Para rubber was largely used in the manufacture of air hose, but it is claimed that since the general introduction of the automobile, the greater part of this good rubber is used in tires, and that Mexican, or some other poorer substitute, has been used for hose. This is refuted by the manufacturers, and it is claimed that the low price paid for the air hose is responsible for the poor quality, and that there is plenty of Para rubber for all purposes, if it is desired.

Many failures of air hose can still be traced to the wrong practice of pulling the couplings apart instead of separating them by hand; while improved couplings may have to some extent reduced this trouble, much of it yet remains. Also, where some of the improved couplings have been struck and distorted, the force necessary to separate them seems to be about as great as with the old type. Could this practice be stopped, many failures would be eliminated, but good results cannot be obtained by a few roads stopping it and many others permitting it to be done. It must be by a general co-operation of all roads.

A great deal more trouble was experienced during the severe cold weather of the past winter with what are termed frozen or stiff hose than ever before; it would appear that this, too, was due, in some manner, to the make-up of the tubing; also to some extent to the moisture contained therein; many cases were encountered where the leakage was so great that both passenger and freight trains were stalled, the hose in some cases parting entirely.

There is no doubt but that pure Para rubber is but very little used in air hose, and it is known absolutely that the make-up of the rubber tubing is not as good as that of several years ago; yet, at the same time it is known that the manufacturers can furnish a hose that will stand the tests required by the Master Car Builders' Association. Further, it is not believed that such requirements are severe enough. It has been suggested that a higher tensile strength of the inner tube be required, and it is believed that this would make a decided improvement, as tests made with some of the present make, that have been but two or three months in service, developed numerous pin holes, which no doubt account for the large number of cases of burst and porous hose that are comparatively new.

Your committee is of the opinion that the only hope for improvement rests in a better quality of rubber tubing throughout; enough has been learned to lead the committee to think that such improvement cannot be obtained at the present price paid for the hose. It is admitted by manufacturers that the strength of air hose has, to some extent, been sacrificed in obtaining the friction required by the specification of the Master Car Builders' Association, inasmuch as a loosely woven duck has to be used; if a tighter woven duck could be used the

strength would be increased, although the friction might be decreased.

Every effort should be made to discourage the use of hose purchased only on specifications, as the manufacturers can furnish hose to meet said specifications without any regard to what life will be obtained from the material in service. On the other hand, better results will be obtained by securing the hose on a service basis, as can be easily arranged for.

Another recommendation has been made looking toward the advisability of making up a hose so that the pressure resistance can be materially increased by the use of a lighter weight duck and an increase in the number of ply. It has been suggested by an expert that a more homogeneous pressure resistance effect can be obtained with 8-ply and 8-oz. duck than with 4-ply and 10-oz. duck. Such a hose should be held together with a very high-class friction, and should be easily pliable at low temperature; i. e., zero or below. It is further believed that such a hose would give less trouble from pulling off the fittings on account of there being more canvass and less rubber under the hose bands.

The statement has been frequently made that it would be of little use for a few roads to purchase the best quality of air hose while the majority did not. There must, therefore, be some means devised to secure a hearty co-operation on the part of all, and it might even require a special ruling on the part of the Master Car Builders' Association to bring this about.

Whatever may be the outcome, the manufacturers will welcome the privilege of supplying a more serviceable grade of hose if the consumers are willing to pay the price. It is up to the consumers to outline reasonable requirements and to demand of the manufacturers hose to meet them.

Discussion.—Part of the discussion related to the hose blowing off of the nipple, but the principal interest was attached to the quality of the hose. In passenger service, with long cars and short cross-overs, there is such a large lateral movement of the car ends that the hose is pulled off, even with proper holders which provide for a free lateral movement. Some lines limit the service of passenger brake hose to six months, and it is then used in freight service; others make a longer limit and then scrap the hose entirely. They also test the hose on passenger engines with soap suds daily.

The northern lines still have trouble from rigid hose in very cold weather, and it is often necessary to remove hose from freight cars after six months' service in severe winter weather. The inferior quality of the rubber, especially that in the inner tube, was discussed at length, and it was generally admitted that the price usually paid was too low to secure rubber of good quality.

The M. C. B. specifications should be revised in several particulars, especially in requiring a high tensile strength for the rubber, so as to more effectually exclude poor rubber. Metallic coverings for air hose were approved by some, and by others it was even suggested that a complete metallic flexible coupling be used for passenger cars instead of rubber hose. Considering the short life of rubber and the expense for hose of good quality, it is possible that a metallic pipe union would prove economical in the end. Attention was directed to the importance of storing hose in a dry place where the temperature is not too high.

UNDESIRE QUICK ACTION OF FREIGHT TRIPLES.

J. W. Walker read a paper on this subject in which he analyzed the cause of the trouble known among trainmen as "kicker," "snapper" and "dynamiter," due to the emergency application when service stops only are desired. The numerous causes of the abnormal action of the triple, because the auxiliary reservoir pressure cannot reduce as fast as the brake pipe pressure falls, are listed on the chart below.

Weather conditions:

- Unequal expansion of different metals.
- Freezing of moisture.
- Gumming up of excess lubricant.

Lubricant:

- Too heavy.
- Too much used.

Feed valve:

- Sluggish.

Engineer's brake valve:

- Condition of—
 - Preliminary exhaust port too large.
 - Equalizing piston:
 - Dirty.
 - Gummed up.
 - Tight.
 - Conical end of piston stem filed off.
 - Removal of exhaust fitting.
 - Manipulation of—
 - Lap, allowing brake pipe leakage to apply brakes.
 - Open graduating valve.
 - Partial emergency position used for service.
 - Too light preliminary reduction.

Equalizing reservoir:

- Leaky.
- Volume reduced by water, etc.
- Too small.
- Choked passage between equalizing piston chamber and equalizing reservoir.

Brake pipe:

- Leaky.
- Long.

Conductor's valve:

- Attempted service application with.

Triple valve:

- Restricted service port in body or passage to brake cylinder.
- Restricted service port in slide valve.
- Dirty.
- Gummed up.
- Excessive friction of slide valve.
- Tight piston.
- Restricted feed groove.
- Piston makes tight seal on bush.
- Gum on piston level.
- Graduating valve spring catching in bush.
- Weak graduating spring combined with excessive friction.

Piston travel:

- Short.

Most of these causes can be removed if the brakes are properly maintained. The paper describes a device for locating triples which produce undesired quick action, the invention of C. L. Courson. It consists of an indicator placed between two hose couplers, so as to couple in the train line. When several of them are placed in a train line and brakes are applied, the needle on all the indicators will point in the direction from which the quick action started, and by a process of elimination the defective triples are located.

Discussion.—It was generally agreed that the use of dry graphite as a lubricant for the triple slide valve was the best remedy and has overcome most of the trouble so far as it relates to the triple itself. Air brake students are of the opinion that triples should be so improved that these difficulties will be removed and Mr. Turner, of the Westinghouse Company, said that that company had designed an improved triple which would not apply the emergency unless desired.

FRICION AND WEAR OF BRAKE SHOES AS AFFECTED BY THE WHEEL LOAD.

R. C. Augur, engineer of tests, American Brake Shoe & Foundry Company, read an elaborate report on this subject. The first part of the paper gave an interesting historical account of brake shoe tests and of brake tests. It showed the loss in efficiency by increased brake shoe pressure and included diagrams illustrating the present conditions in express passenger service. The author proposed a rational sliding scale for proportioning the braking power, the development of which is as follows:

The time has come when a sufficient mass of positive and usable data have been accumulated to enable us to say that the method used for so many years of proportioning braking power on passenger cars to 90 per cent. based on a brake cylinder pressure of 60 lbs. is no longer tenable and must become obsolete in the immediate future. Even though our methods have given good results in the past under other conditions, the situation today has so changed that practice must now be made to agree with known facts. If we wish to operate our passenger

trains with smoothness and safety we must adopt a rational sliding scale for proportioning the braking power.

Diagram 1 shows the amount of braking power required to make machine test stops from a speed of 60 miles per hour in a certain distance with different wheel loads. These curves will vary, of course, with different shoes, and had shoes of lower frictional qualities than plain cast iron or Diamond "S" been used, they would have been further to the right and have

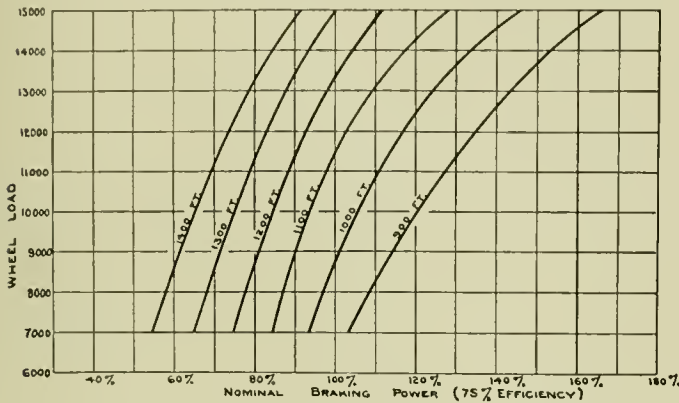

Fig. 1—Braking Power Required to Make Stops from 60 m. p. h. for Various Wheel Loads; Steel Tired Wheels.

shown the necessity of higher percentages of braking power for the same length of stop. The general character of the curves would have been the same, however. Similar curves for stops from a speed of 40 miles per hour might have been included, but they would not have brought out the facts any clearer as the angle of slope is essentially the same, although the distances in feet are less.

Diagram 2 shows the percentages of braking power which are necessary to insure essentially the same retarding force or length of stop with cars of different weights. To illustrate the way the diagram should be used we will assume that we have an eight-wheel coach weighing 69,000 lbs. By consulting the diagram we find that the braking power should be 110 per cent. If, on the other hand, we had an eight-wheel coach weighing 104,000 lbs., we find that the diagram calls for 146 per cent.



Fig. 2—Relative Braking Power Required for Cars of Different Weights to Produce the Same Retarding Force or Length of Stop.

braking power. By adopting a sliding scale such as this in proportioning braking power for passenger cars, stops will be shorter and smoother, while the danger of the wheels sliding under abnormal conditions will be decreased. These are features appreciated by the traveling public, and are also desirable from the viewpoint of the air brake and the transportation departments.

The results shown on Diagram 2 can be expressed very nearly by the following formula, the assumption being made that 90

per cent. is a satisfactory braking power for the light cars having a wheel load of 6,000 lbs.

$$\text{Percentage of Braking Power} = 90\% + \left\{ \frac{\text{Weight of car} - 6,000}{\text{No. of wheels} \times 100} \right\}$$

Stated in another form, this means that for every 100 lbs. increase in wheel load in excess of 6,000 lbs., an addition of 1 per cent. braking power should be made. In calculating braking power for baggage cars it is desirable to add 15 per cent. to the weight of the car for the load carried, and base the braking power on the assumed loaded weight.

In all of this discussion we have not referred to the acknowledged advantage of having the emergency braking power in excess of that used in service application. This difference is desirable on all weights of cars, but is of increasing importance with very heavy equipment. What we have desired to emphasize is that the braking power should be proportioned in accordance with the laws of brake shoe friction and that this calls for increasingly higher percentages of braking power as the car weights are increased.

While the subject of brake shoe friction is a vital one in connection with the design of car brakes, the rate of wear of brake shoes is one that is ever with us, as it affects operating costs. In the effort to obtain increased durability and consequently reduced costs, there has been a marked tendency on the part of many roads to use shoes of rather low frictional properties, not realizing that the saving is more apparent than real. On the other hand some of our largest systems appreciate the fact that brake shoes are used to do work, that other things besides durability are essential and that they are not applied simply as ornaments or to permit cars to be interchanged. If the work is done shoes will wear out and all that we should ask is that they render a good return for the investment. It is not the part of wisdom for a road to apply the latest improved brake mechanism and increase the braking power so that good stops can be made and then defeat what has been gained by selecting brake shoes solely because of their durability.

The whole subject of brake shoe wear is an interesting one which we shall not be able to more than touch on at this time. The rate of wear as well as the friction of the shoes is affected by several factors. As many of us have observed the same kind of shoes will often wear much longer on some cars than on others. This may be due to the frequency of the stops, the average running speed of the train, the weight of the car, or other factors.

The rate of wear for service tests is very generally calculated in pounds per thousand car miles. In machine tests it is usually expressed in pounds per 100,000,000 foot-pounds of work done, this expression being the one used by the M. C. B. committee in their reports. The rate depends mainly upon the following factors: Design of brake shoe; kind of wheel; initial speed; shoe pressure; wheel load.

In a general way it can be stated that any increase in speed or anything that increases the shoe pressure or rate at which work is done will increase both the actual amount of brake shoe metal worn off and the amount for doing a certain quantity of work.

The M. C. B. specification calls for the loss of metal per 100,000,000 foot-pounds of work not to exceed 0.8 lbs. for tests on a cast-iron wheel made at a constant speed of 20 miles per hour, application about one minute and release about three minutes with a shoe pressure of 2,808 lbs. On a steel-tired wheel, however, with stops from a speed of 65 miles per hour and a shoe pressure 12,000 lbs., the loss is specified not to exceed four pounds.

Some interesting data relative to the effect of conditions on brake shoe wear can be obtained from the M. C. B. report for 1910. Averaging results for all of the metal shoes we find that

on the Purdue machine the wear per 100,000,000 foot-pounds of work was as follows:

| | |
|--|-----------|
| Iron wheel, 20 miles, 2,808 lbs. pressure..... | 0.58 lbs. |
| Steel wheel, 20 miles, 2,808 lbs. pressure..... | 0.75 lbs. |
| Steel wheel, 65 miles, 12,000 lbs. pressure..... | 3.00 lbs. |

This shows, first, that when steel wheels are substituted for chilled wheels in freight service the rate of shoe wear will be increased, and second, that higher speeds and pressures greatly increase the rate of wear.

Turning now to the M. C. B. 1911 report, we find that tests were made on the same machine at a speed of 80 miles per hour with pressures ranging from 12,000 lbs. to 20,000 lbs. Averaging results, we find that the rate of wear under the various pressures was as follows:

| | |
|---------------------------|----------------|
| 12,000 lbs. pressure..... | 3.41 lbs. wear |
| 14,000 lbs. pressure..... | 3.48 lbs. wear |
| 16,000 lbs. pressure..... | 4.08 lbs. wear |
| 18,000 lbs. pressure..... | 5.00 lbs. wear |
| 20,000 lbs. pressure..... | 6.70 lbs. wear |

The general average was 4.53 lbs., or 50 per cent. more than tests made during the previous year at 65 miles speed, 12,000 lbs. pressure.

Numerous other instances might be cited to show the effect of increased speed and pressure upon the wear of the shoes, but one or two will be sufficient.

In the series of tests referred to in connection with the subject of friction it will be remembered that wheel loads were used which were approximately those for 60,000 lb., 90,000 lb. and 120,000-lb. cars with four-wheel trucks. Comparing wear for stops from 40 miles per hour with those from 60 miles per hour, we find that on the lightest car the rate of wear per 100,000,000 foot-pounds of work was practically the same, that for the medium weight car it was 12 per cent. more at the higher speed, while with the heaviest car it was 42 per cent. more. The work done in stopping from a speed of 60 miles is 2.25 times that in stopping from 40 miles. This means that the actual amount of metal worn off from the shoes on a 90,000-lb. car at a 60-mile stop is 2.5 times as much as from a 40-mile stop, while with a 120,000-lb. car it is 3.2 times as much.

Take another example from the same series of tests, stops being made from a speed of 60 miles per hour. A 60,000-lb. car braking at 90 per cent. had a shoe wear of 1.35 lbs. per 100,000,000 foot-pounds of work, while a 120,000-lb. car, braked at 125 per cent. and stopping in practically the same distance, had a rate of wear of 2.45 lbs., or 81 per cent. greater. The heavier car, however, weighed twice as much and required twice as much work to stop it; this means that on the heavier car the actual amount of shoe metal worn off was 3.6 times as much as on the lighter car.

In view of such facts is it any wonder that railways are finding that the expense for brake shoes for their heavy passenger cars is large and that there is need for shoes which will give good durability without the sacrifice of frictional properties?

The first essential in railway operation is safety, the second is economy. We have seen how in the struggle to retain safety the changing conditions have necessitated greatly increased brake shoe pressures, and that if the question of safety was given the attention it should have, many of our large roads would be obliged to use higher shoe pressures than they now are. While the brake shoe has been steadily improved and has been able to meet the changing conditions and stand up under the severely heavy modern requirements, it has been done at a marked increase in the rate of wear, even though considerable has been accomplished in the direction of increasing the brake shoe durability.

Personally I feel that we are going beyond shoe pressures which are good practice. It is self-evident that anything that will enable us to make the desired stops without such high pressures would be desirable inasmuch as lower pressures mean a greater coefficient of friction and a lower rate of wear.

At the present time one or two of our important roads are trying the experiment of clasp brakes. As this seems to be the most practical scheme for obtaining reasonable brake shoe pressures the results obtained will be watched with considerable interest by all of us.

Discussion.—The paper was discussed at length by S. W. Dudley of the Westinghouse Air Brake Company, who showed that while 90 per cent. of the brake power was applied to the shoe only 10 per cent. was realized in efficient work in stopping the train, and the principal loss was due to the brake shoe. The co-efficient of friction which is usually only 10 to 12 per cent. in passenger service, was the real measure of brake efficiency and some improvement should be made in the methods of brake shoe application to increase the efficiency.

W. L. Burton, of the Westinghouse Air Brake Company, then described verbally the clasp type of foundation brake gear for heavy passenger cars, and presented drawings of such gear as applied to four and six-wheel trucks on the Philadelphia & Reading. This gear has been in successful use on that road for about two years, and a service of 12,500 miles per brake shoe is obtained. The total leverage is 9 to 1, and as the usual load on the brake shoe is divided by two the wear is reduced and there is much less heating of shoes than where only one shoe is used per wheel.

W. V. Turner regarded these two papers—that of Mr. Augur and of Mr. Burton—as so important that the subject should be followed up, and it was decided to appoint a committee to further develop the proposed improvements, and report next year.

WESTINGHOUSE PC EQUIPMENT.

Thomas F. Lyons, of the Lake Shore & Michigan Southern, read an extensive paper on this subject in which he brought out the results obtained from the PC equipment in road service in the past few years, and explained in a general way the proper methods of train handling and the care and maintenance of the equipment. In closing he said:

“In conclusion it can be said that the PC equipment has fulfilled all the requirements laid down after the Toledo tests by the air brake supervisors of the New York Central Lines, and also that it does accomplish what was required by the railroad conference held in Pittsburgh in 1909.

“It is essential, however, that the truck and foundation brake gear be of such a design as to withstand the enormous pressure developed by the PC equipment. If this is done, it will only be necessary to state what stopping distance is required above 800 ft. at 60 m. p. h. in order to have it accomplished. As the matter now stands we cannot be sure whether the forces developed are being applied properly or not; that is to say, the trucks tilt, changing the weight on the wheels more or less, the springs are pulled down together, there is longer piston travel, and in various ways the forces are distributed in a detrimental manner. This, of course, largely defeats the object and may result in abnormal stresses in the train, flattening of wheels, etc.

“There can be no question but that the PC equipment will meet all the requirements of service braking and develop all the force required for emergency; but for these features to operate effectively, it is essential that it should have the proper foundation to work upon, and for this, it is not out of place to ask this association to put forth its best efforts to secure such truck and foundation gear design as will meet the requirements.”

Discussion.—The discussion related principally to the manner in which the engineers reduced pressure in applying the brake when the PM and PC brakes were mixed in a train. Much of the difficulty from the flat wheels was due to improper application, and in not carefully following the instructions for the use of these brake equipments.

PIPE AND PIPE FITTINGS.

P. 11. Donovan read a paper on this subject which related more particularly to the air brake piping on locomotives. It gave the results of an exhaustive investigation made by the Westinghouse Air Brake Company to determine the effect of elbows and pipe fittings on the service operation and quick action of the brake. It was shown that the ordinary data relating to air transmission in pipes does not apply to brake operation and is misleading if so applied. To secure proper brake action the pipes and fittings must be such as will insure a drop of pressure in the brake pipes at the rate of 8 lbs. per second. Following are the important conclusions which the author drew from the results of the experiments:

First, that the service operation of the brake is not seriously affected, either by size of pipe or number of elbows, whatever effect does occur being merely that due to volume and not resistance to movement.

Second, the question considered in this paper, therefore reduces to one of the effect of piping or elbows upon initiation and propagation of quick action.

Third, it is necessary to have a quick action valve or venting device located so near the brake valve and so near the following quick action device, as will insure the drop of pressure in the brake pipe at the rate of 8 lbs. per second, and that this rate occur while the quick action device is in release position.

Fourth, if the preceding conclusion is accomplished it is immaterial as far as quick action is concerned, whether the piping is long or short, or whether many or few elbows are employed.

Fifth, as it is important, however, that the time of transmission of quick action throughout the train be as short as possible, and as length of pipe adversely affects this by added volume and some slight resistance, and elbows by resistance and a slight increase in volume, it is desirable to keep both to a minimum.

Sixth, whenever the length of pipe, that is, volume of the brake pipe, can be reduced by the use of an elbow, it is preferable to use the elbow.

Seventh, that the deductions and rates made from experiments and experience in air transmission do not apply to a brake operation, and are misleading if employed in this connection, as here volume is the chief factor to be reckoned with, at least within the limit of present methods of installation.

Eighth, that with the conditions of long locomotives, double heading, the complexity of piping that goes with this, in combination with long trains, one quick action device per locomotive is not sufficient to insure the propagation of quick action; in other words, one quick action device per locomotive is not sufficient to secure the required drop of 8 lbs. per second on the first car.

Ninth, that a quick action device operated, by a fixed and invariable volume is preferable to one that is operated by a variable volume.

Tenth, that a quick action device governed entirely in its operation by rate of reduction is preferable to one whose operation is contingent upon, or varied by, the rate of reduction and resistance to movement.

Eleventh, that when triple valves are used, the rate of fall of brake pipe pressure must exceed 8 lbs. per second if the triple valves have been caused to assume or stop in service position before quick action reaches them.

Twelfth, that the volume, that is size, of auxiliary reservoir is a material factor in producing quick action with a triple valve, for the reason that the greater the volume the more extreme adverse conditions may be before quick action fails to take place.

Thirteenth, that to insure propagation of quick action in a long train, it is necessary (as near as we could determine for each 600 cu. in. of brake pipe volume, to suddenly open at least a 1/2 in. outlet to the atmosphere, it being understood that the quick action device is located about the center of this 600 cu. in. volume.

Fourteenth, that elbows and length of pipe, "per se," are not

the most important factors; that is to say, it will generally be found, when quick action fails, that it is due to other causes than these, for example, unnecessary restrictions in the piping, such as fins, use of unions with small passages, kinks in the hose, pipe screwed too far into tees or elbows, etc. Also any and all the circumstances and conditions mentioned in the previous conclusions; in other words, it would be a mistake to give consideration to elbows only as though their elimination would be a panacea for quick action failures.

To conclude, the writer would recommend that the foregoing conclusions be considered the real test for all locomotive brake installations, including piping, the type of locomotive and service conditions for which it is intended, determining the design that should be applied.

AN APPRECIATION.

The executive committee presented the following resolution relating to W. V. Turner, which was unanimously adopted:

"Resolved that as Mr. Walter V. Turner, chief engineer of the Westinghouse Air Brake Company, has devoted so much of his time and efforts towards the welfare and usefulness of this association, it is the sense of this association that a suitably engrossed resolution of appreciation be presented to Mr. Turner as a tangible recognition of our esteem and of his ability and genius."

In response Mr. Turner gave an interesting account of his career in connection with his work in developing air brake equipment.

OTHER BUSINESS.

Brief addresses were made by J. F. Walsh, general superintendent of motive power of the Chesapeake & Ohio, and J. E. New of the Norfolk Southern.

The following officers were elected: President, H. A. Wahlert, Texas & Pacific; first vice-president, W. J. Hatch, Canadian Pacific; second vice-president, L. H. Albers, New York Central; third vice-president, J. T. Slattery, Denver & Rio Grande; secretary, F. M. Nellis, Westinghouse Air Brake Company; and treasurer, Otto Best, Nathan Manufacturing Company. St. Louis was selected as the place of meeting for next year.

SELF-CLEARING ORE CAR

A self-clearing, quick-dumping ore car, built by the Pressed Steel Car Company, Pittsburgh, Pa., and specially designed for use in the ore trade in the northwest is shown in the illustrations. The primary object was to produce a self-clearing car which would discharge its entire lading between the rails, practically instantaneously on opening the doors, without leaving any ore inside the car, which would have to be removed by digging, shoveling or other laborious methods, as is almost invariably the case with the ordinary type of drop bottom ore car. The general dimensions and data for these cars are as follows:

| | |
|--|------------------|
| Length inside of the body..... | 18 ft. 1 3/4 in. |
| Width inside of the body..... | 8 ft. 6 1/2 in. |
| Width over side sheets..... | 8 ft. 7 in. |
| Length over ends..... | 22 ft. 0 1/2 in. |
| Height from rail to top of body..... | 9 ft. 6 in. |
| Distance from center to center of trucks..... | 14 ft. 8 in. |
| Length of drop door opening, at center, 5 ft. 7 1/2 in.; at sides..... | 8 ft. 0 1/2 in. |
| Width of drop door opening..... | 6 ft. 6 1/2 in. |
| Cubic capacity, level..... | 705 cu. ft. |
| Cubic capacity, level 10 ft. average heap..... | 834 cu. ft. |
| Weight of car body..... | 16,700 lbs. |
| Weight of trucks..... | 15,800 lbs. |
| Total dead weight..... | 32,500 lbs. |
| Ratio of lading to total weight of car when loaded..... | 77.2 per cent. |

These cars have the largest unobstructed door opening that it is practical to obtain. The hopper floor sheets have a slope of 50 deg., and the hopper side sheets 60 deg., insuring free and easy movement of the lading. Two doors, one hung from each

side of car, are operated by an adjustable self-locking safety device, which is positive in its action and will prevent the operator from being injured through carelessness or inexperience in operating the doors. The mechanism can be operated easily by one man and the time consumed in opening the doors, dropping the load and closing the doors again in actual service has been as low as one and one-quarter minutes. The doors are supported by cranks which turn over a dead center into a position of rest, so that no load is supported by the gears or by ratchet locks. To dump the cars the cranks are merely tipped over the dead center, after which the weight of the lading sends the doors down with a rush and sufficient shock to materially aid in detaching any of the lading which may tend to stick to the inside sheets.

The doors are connected to the cranks by heavy rods with screw adjustment, so that they may readily be maintained tight; there can be no stretch or give in these rods, as is the case with chain construction. This insures the doors remaining tight and close, and that there will be no leakage of ore in transit. Another advantage in this rod connection is that if the doors are frozen up in handling frozen ore, so that they will not drop by gravity, they can be forced down by these rods; this cannot be done with a chain connection.

The doors have been made stronger and are more heavily braced, than has been the practice in the past, to prevent distortion and damage from loading with steam shovels, under which hard usage it is difficult to keep the doors in good shape. The crank shafts at either end of the doors are equipped with segmental gears, connected by means of a rack gear along the side of the car, which insures perfect unison of action at each end of the door, both in opening and closing it; also does away with the use of chains, as applied to some of the earlier cars of this type. There is also an auxiliary latch which operates on the rack gear as an extra precaution to avoid accidental opening of the doors.

The general design of the car is in accordance with the best

for safely carrying 50 tons of ore and providing the necessary construction to make the car discharge its load freely. Material has been liberally used where necessary to insure the car

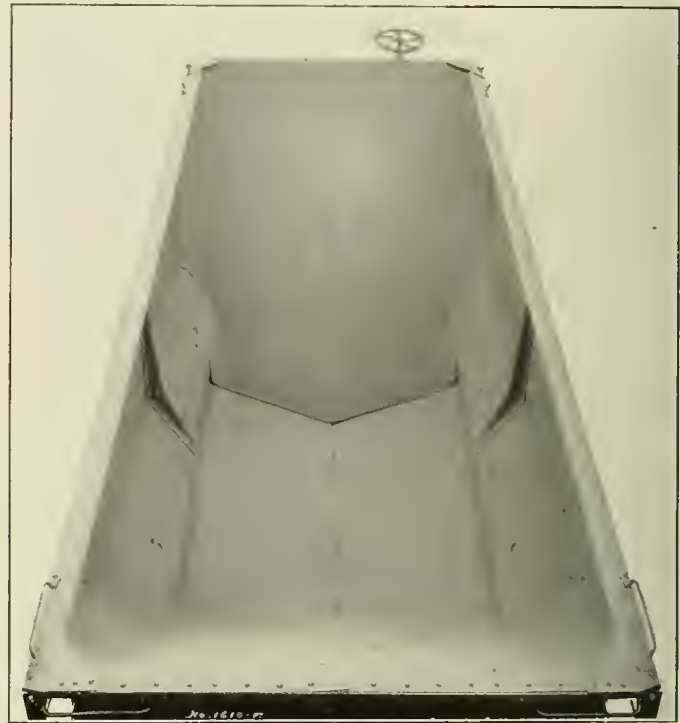

Interior of Self-Clearing Ore Car.

operating with a minimum cost for maintenance and operation. The trucks are of the arch bar type with $5\frac{1}{2}$ in. x 10 in. journals and have pressed steel bath tub type bolsters and pressed

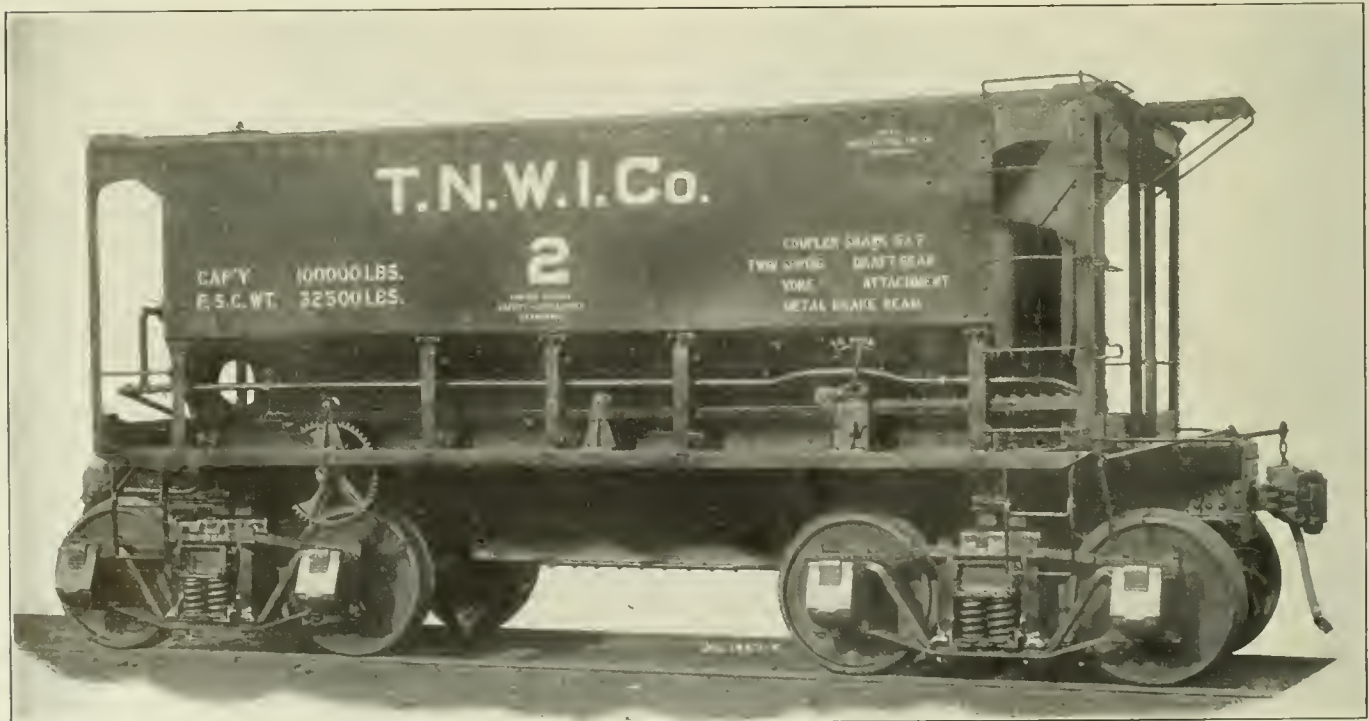

Steel Self-Clearing, Quick-Dumping Ore Car for the Northwest.

modern practice, every detail having been worked out with care to secure maximum strength and highest efficiency. The distribution of material is such as to give lowest possible weight

steel brake beams. Several hundred cars of this type have been in service on the Duluth & Iron Range, and the Duluth, Missabe & Northern for over a year, and have given satisfactory results.

TESTS OF JACOBS-SHUPERT FIREBOX.

A progress report of the comparative tests being made at Coatesville, Pa., between two boilers, one with a radial stay firebox, and the other with a Jacobs-Shupert firebox, has been made by Dr. W. F. M. Goss, under whose direction the work is being conducted. This report is as follows:

"The tests of Series A, have been entirely completed, with results which in general terms are set forth below.

The Boilers.—"Both boilers are identical in their general dimensions which are as follows:

| | |
|---|-----------------------|
| Outside diameter of shell of boiler at front end..... | 70 in. |
| Diameter of shell at throat..... | 83 $\frac{3}{8}$ in. |
| Number of 2 $\frac{3}{4}$ -in. tubes..... | 290 |
| Length of tubes..... | 18 ft. 2 in. |
| Inside length of firebox..... | 109 $\frac{3}{8}$ in. |
| Inside width of firebox..... | 76 $\frac{3}{8}$ in. |

"The purpose of the tests of Series A was to determine for each boiler the evaporation from the firebox and from the tubes separately. To make such a determination possible, the back-tube sheet was extended in all directions to the outside of the boiler, thus forming a diaphragm completely separating the water-space on the two sides of this tube-sheet. By this device each boiler was made in effect two boilers, the heating surface of one being all portions of the firebox, excepting the front tube-sheet, and the heating surface of the other being the tubes and tube-sheets.

"In carrying out the tests, each compartment was supplied with weighed water as though it were a separate boiler. The quality of the steam delivered from the firebox end and from the barrel end was determined independently, the purpose being to determine with the highest possible accuracy the heat delivered through the walls of the firebox and the heat delivered through the flues. The heating surface of the two boilers is as follows:

| | Radial-Stay Boiler. | Jacobs-Shupert Boiler. |
|--|------------------------|---------------------------|
| In the firebox..... | 179.2 sq. ft. | 201.9 sq. ft. |
| In the barrel..... | 2,805.1 sq. ft. | 2,806.5 sq. ft. |
| Total for both parts of the boiler.... | 2,984.3 sq. ft. | 3,008.4 sq. ft. |

Tests with Oil.—"A series of oil-fired tests have been run on each boiler. Three different rates of power have been employed in each series, the rate of fuel consumption ranging from 800 lbs. to 2,100 lbs. of oil per hour. The total water evaporated from both the firebox end and the tube end of the boilers has ranged from 10,000 to 24,000 lbs. per hour, the evaporation per pound of oil being approximately 16 lbs. in the tests of lowest power and 14 lbs. in those of highest power. In all tests a surprisingly large percentage of the total work was done by the firebox. This percentage was greatest when the rate of power was lowest. Speaking in general terms, at low rates of power from 45 to 50 per cent. of the total heat transmitted by the boiler is absorbed by the firebox. With increase of power the percentage falls, but the lowest value thus far obtained is approximately 34 per cent.

"As the heating surface of the firebox is a comparatively small fraction of the total heating surface of the boiler, it is evident that heat is transmitted from the firebox at rates which are extremely high. For example, results of a number of tests show the evaporation of more than 50 lbs. of water per square foot of firebox heating surface per hour, which rate of evaporation is equivalent to the development of more than 300 horse power to the firebox alone. In estimating the significance of these results, it should be remembered that in the experiments, the firebox virtually constituted a boiler by itself, that it had no more water about it than the normal locomotive firebox, and that it could not benefit by the circulation of water from the forward end of the boiler backward into the water legs. The fact that fireboxes subjected to such conditions could be worked at the rate of power stated, is suggestive of new possibilities in boiler design. The full development of these data will make of record facts with reference to the distribution of work between the firebox

and tubes of a modern locomotive boiler which have never before been determined.

"The experimental results have not yet been sufficiently studied to permit a final statement to be made concerning the relative performance of the radial-stay boiler and the Jacobs-Shupert boiler. It appears, however, that the absorption of heat by the Jacobs-Shupert firebox is somewhat in excess of that absorbed by the radial-stay firebox, and that taking the boilers as a whole, the Jacobs-Shupert boiler is slightly more efficient.

Tests with Coal.—"The oil-fired tests already described have been duplicated by a series of coal-fired tests. The results obtained, so far as they refer to the distribution of work between the firebox and the tubes, and to the relative performance of the radial-stay boiler and the Jacobs-Shupert boiler, are in entire agreement with those obtained from oil."

The tests for strength under low water conditions in which each boiler will be subjected to a progressive series of tests until the destruction or serious deformation of the firebox occurs, will take place at Coatesville, Pa., on June 20, 1912.

GLASS ENGINE NUMBERS

The gas in tunnels on the Northern Pacific is so corrosive that it soon destroys the painted numbers on locomotives and way cars, and on the Mountain division it is necessary to protect these numbers with glass. The illustration shows the method devised by A. M. Burt, superintendent of the division for doing this. On engine cabs the numbers are left as painted, and over them is bolted a wooden frame of 1 $\frac{1}{8}$ in. x 1 $\frac{3}{4}$ in. material of the proper length to take the required number of double



Locomotive Provided with Glass Numbers.

strength panes of glass, one pane for each number. The numbers are painted in white on the back of the glass, the balance being painted black. The glass is fastened to the frame by quarter round beading. The object of leaving the old numbers on the cab is to retain the complete engine number in case the glass becomes broken, although this seldom occurs. The service of these glass numbers is practically unlimited and the numbers are very easily kept clean and legible. The way cars on the Mountain division have the numbers treated in a similar manner.

A LONG SPAR.—A spar shipped recently from Sheldon, Mason county, Washington, on the Peninsular Railroad, measured 102 ft. in length and was carried on two 41-ft. platform cars, with another car of the same length between them. The spar was 6 ft. 6 in. in diameter at the butt and 3 ft. 6 in. at the smaller end, and it scaled 9,000 ft. of lumber.

HEAVY DUTY LATHE

A powerful lathe designed for turning heavy forgings and well suited for shops that forge their own driving axles and piston rods, has been designed by the Lodge and Shipley Machine Tool Company, Cincinnati, Ohio. It has clearance for a 15 in. diameter over the tool post and will swing $30\frac{1}{2}$ in. diameter over the bed. As shown in the illustration, it is fitted with a 30 h. p. direct current variable speed motor having a speed ratio of from 400 to 1,200 r. p. m. There are also two gear changes which, in connection with the motor, will give spindle speeds from 15.6 to 173 r. p. m. This gives a minimum cutting speed on a 15 in. diameter of 61 ft. per min., and a maximum on a 3 in. diameter of 136 ft. per min.

Very heavy parts and bearings of liberal area characterize the

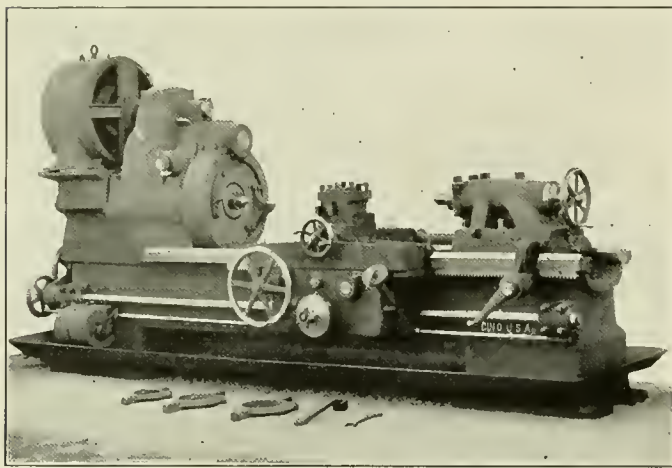

Powerful Lodge & Shipley Lathe for Forgings.

design of the head-stock and apron. All driving gears are of steel, hardened and heat treated. The lightest gear in the head has a 4 diametrical pitch. The front bearing of the spindle has a projected area of 60 sq. in., and the back bearing an area of 47 sq. in. The spindle is solid and runs against a hardened steel plug at its back end to take up the thrust. On the driving shaft are bearings on both sides of the gears in all cases and an oil circulation is provided for all driving gears and journals, as well as for the thrust bearing. The oil drains from the bearings to a reservoir cast in the bed and is pumped from there by a spiral geared pump to a reservoir at the top of the head, from which it flows by gravity to the various bearings. The machine will deliver, with a 30 horse-power motor, up to 19,500 lbs. pressure at an 8 in. diameter and 25,000 lbs. under the same conditions when the motor carries a 30 per cent. overload. This would ordinarily create a pressure of over 300 lbs. per sq. in. on the spindle bearing, but in this case the driving pinion is so placed that the pressure of the cut is opposed by it and the amount of pressure on the bearings is greatly reduced.

The rack pinion in the apron is of high carbon steel, is unusually large in diameter and has a wide face. In fact the smallest face of any gear in the apron is $1\frac{1}{2}$ in., and the smallest gear is $3\frac{1}{2}$ in. in diameter. The smallest diametral pitch is 5. The steel bevel gear on the feed rod has two keys diametrically opposed to each other. The feed rod is driven by a plain change gear and four changes of feed are provided. The motor control rod extends along the front of the bed and is operated by a handle near the top of the carriage.

In size, length of bearing and rigidity, the carriage is in keeping with the rest of the machine. It has 245 sq. in. total bearing area on the bed, and is gibbed front and rear, as well as under the inside V's. The tool block is steel and rests on a cast iron cross slide. It has one center slot to accommodate tools $1\frac{1}{4}$ in. x $2\frac{1}{2}$ in., and two open sides for tools of the same dimensions. The

cross slide has 168 sq. in. bearing surface on top of the carriage and the feed screw is placed as high as possible to resist the action of the cut. An oil trough is cast around the carriage, so arranged that the lubricant from the cutting tool will not flow to the sliding surfaces. This drains from its four corners into the drip pan under the bed. A substantial pump is provided, geared to the head-stock, which will deliver a $\frac{3}{4}$ in. stream of lubricant to the cutting tool at the rate of sixteen gallons per minute. A telescopic tubing, with proper stuffing boxes to take care of the longitudinal traverse of the carriage, is used instead of the usual flexible tubing.

The large steel oil pan under the bed is placed only far enough from the floor to permit a cast iron drip pan mounted on rollers to be run under it. The lubricant from the oil pan drains directly to this drip pan and is pumped from it to the cutting tool. The shipping weight of this machine with a 12 ft. bed, complete with 30 h. p. motor, is approximately 20,000 lbs.

MACHINE TOOL MOTOR APPLICATIONS

It is frequently desirable to apply an electric motor to a machine tool which is designed for, and has been operated, by a belt drive. For example: it is sometimes found necessary to operate the shafting for a whole group of machines a large proportion of the time in order to drive a single tool in the group, in which case it might be advisable to provide the tool with an individual drive. Again, the constant improvements being made in the vari-

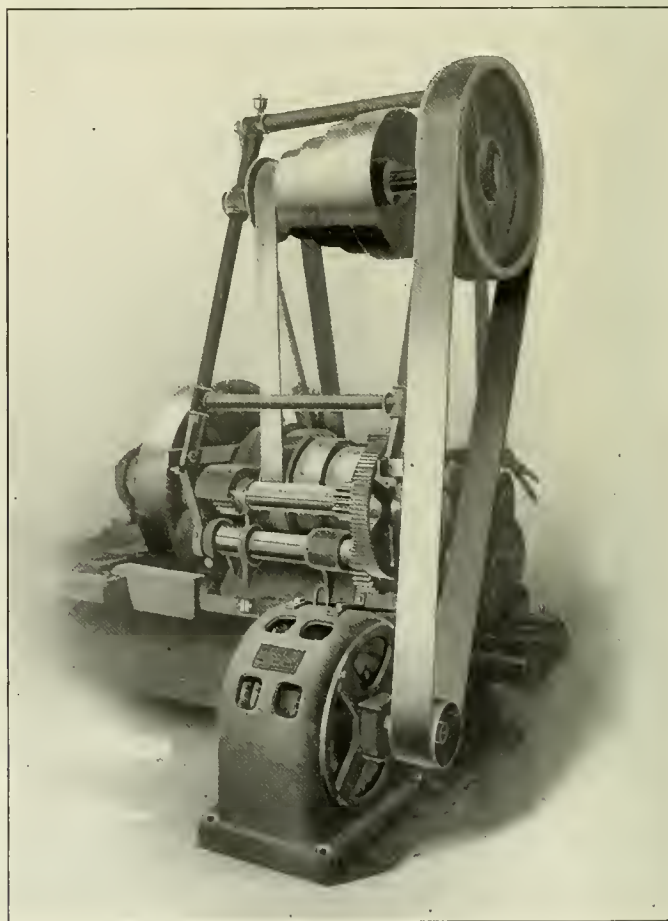

Motor Applied to a Belt Driven Lathe.

ous shops often make it necessary or advisable to so locate a machine as to make it inconvenient, or impossible, to drive it from shafting.

For use in such cases, the Burke Electric Company, Erie, Pa.,

is furnishing a framework and motor support which permits the direct application of a motor to the tools, allowing them to be operated in the same manner as if they were belted directly to the countershaft. If a variable speed motor can be applied, this arrangement also permits a decided increase in the range of speed changes on the tool.

In the accompanying illustrations are shown applications made by this company to a large lathe and to a shaper. It will be seen that the cone pulleys are retained. The motors are so located as to take up very little, if any, extra room and drive through belts to the pulleys on the countershaft, which gives the necessary

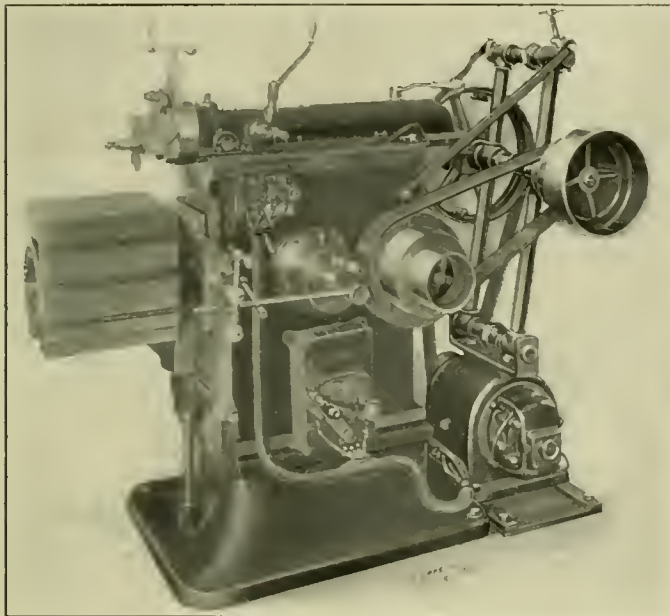

Burke Speed Changing Device Applied to a Shaper.

speed reduction. The shafts carrying the pulleys and the cones are carried by frames largely made up of pipe fittings, which are secured to the bed of the machine and so arranged as to permit a variation in the tension of the belts on the cones. This movement of the frame is obtained by a cam conveniently located, which can be locked at any point. In this way, a loose belt can be used for high speed operation and a tight belt for low speeds, and the shifting of the belt can be performed much easier and with less damage than if it was at a constant tension. It also permits the movement of the spindle or head by hand when setting work.

BORING WITH A RADIAL DRILL

In the shops of the American Tool Works Company, Cincinnati, Ohio, are a number of horizontal boring machines which are required to perform many operations of the greatest accuracy in boring. In a machine tool builder's plant of this character, there is of course a constant effort to obtain the greatest efficiency consistent with high quality of output, and in the detail studies of various operations it has developed that for certain classes of work the radial drill is far superior to a horizontal boring machine in the matter of time, and produces results of an equally high character. The machine used is a 6 ft. American radial drill of standard design.

As an illustration of the improvement obtained by the change, the work on the quick change gear box for a 16 in. lathe may be cited. When these boxes were bored on a horizontal boring machine it required 216 hours to finish 36 pieces. On the drill, by means of a suitable jig, the time is reduced to 45 hours for 36 pieces, a saving of 171 hours. Similarly, the work on the

aprons for 24 in. high duty lathes required 72 hours for a lot of 12 pieces in the horizontal boring machine, while the drill was able to do the work equally well in 24 hours, a saving of 48 hours.

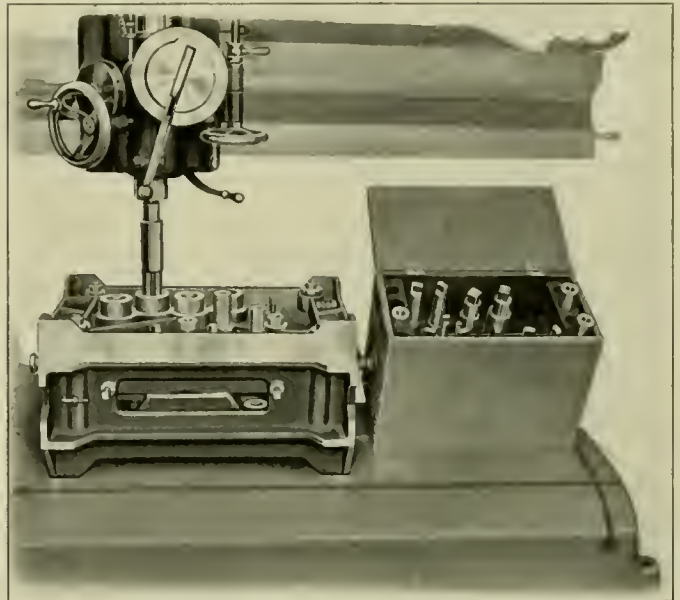

Boring a Lathe Apron on a Radial Drill.

The arrangement of the jigs for this operation is also shown in one of the illustrations.

It is appreciated, of course, that an equal saving would not be general and that there are many operations which can be satis-

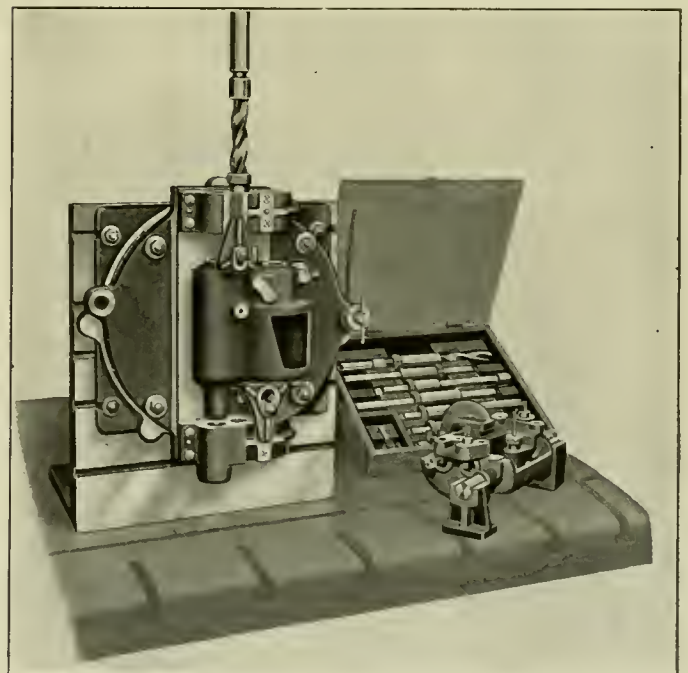

Boring a Speed Change Box on a Radial Drill.

factorily handled only on the horizontal boring machine. The instances given, however, illustrate typical examples which clearly indicate that there are some classes of work now being generally performed on boring machines for which a radial drill of suitable design and power is much better suited.

WIRELESS TELEPHONE.—Telephone conversation by means of wireless apparatus was, on May 17, transmitted a distance of over 160 miles, from Monte Marie, Italy, to Magdalena Island.

GENERAL NEWS SECTION

The University of Illinois announces that contracts will be let shortly for the new transportation building and the new locomotive testing laboratory.

Governor Foss, of Massachusetts, has signed a bill increasing the penalty from \$5,000 to \$10,000 to be imposed on a railway for the loss of life of an employee because of negligence.

The Chicago, Burlington & Quincy was fined \$300 in the federal court at Kansas City on May 3 for violation of the safety appliance law in running a train in its yards with less than 75 per cent. of the air brakes coupled.

The Brotherhood of Locomotive Engineers, in biennial session at Harrisburg, Pa., has voted that hereafter the convention shall be held only once in three years. Warren S. Stone was re-elected grand chief for a term of six years, by a large majority. The following were also elected: Assistant grand engineers, L. L. Griffing, Long Island, N. Y.; F. A. Burgess, Louisville; Ash Kennedy, Winnipeg.

The Massachusetts legislature has rejected the bill recommended by Governor Foss to provide for the merger of the Boston & Maine with the New Haven, and for the electrification and other improvements at Boston, the Senate rejecting it by a vote of 15 to 20. Governor Foss has told his friends that he will call an extra session of the legislature in July for the purpose of passing the bill.

Operation on the Rock Island lines on Friday, May 10, was affected by a variety of weather conditions. There was a snow storm near Calhan, Colo., and a dust storm driven by a 30-mile an hour wind at Gem, Kan., which piled sand so high in several cuts that it was necessary to send for a gang of workmen to clear the track. At about the same time there was a washout at Smith Center on the Nebraska division that cost the company \$6,000.

The anthracite coal miners in convention at Wilkesbarre last week adopted the report of their committee recommending an agreement with the operators. The plan, as presented by the operators, provides for fixed rates of wages, and the sliding scale, which has been in force during the past ten years, is abolished; but it is said that the new rates are enough higher than the old, so that the miners will be decidedly better off than with the sliding scale.

A committee of officers of the Harriman Lines is making a study of the safety committees which have been organized on various railways with the idea possibly of recommending the establishment of similar organizations on the Harriman Lines. The committee is composed of W. R. Scott, assistant general manager, Southern Pacific; M. J. Buckley, assistant general manager, Oregon-Washington Railroad and Navigation Company, and Charles Ware, assistant general manager, Union Pacific.

The Chicago Great Western has announced a "get-together" meeting to be held under the auspices of the enginehousemen, shopmen, track and bridgemen at Oelwein, Iowa, on June 8. Employees of other departments are invited, and any officers who may be present will be expected to take back seats and consider themselves, for the evening, as employees, and not as officials. Mrs. H. J. Slifer, wife of the general manager, will give a lecture on "A Trip Across the Isthmus of Panama," illustrated by about 200 stereopticon pictures.

The California Industrial Accident Board, in its first decision, holds that Harry Christ, an employee of the Pacific Telephone and Telegraph Company, who lost an eye while at work, is entitled to receive \$100 for medical and surgical expenses, full wages for time in hospital, 65 per cent. of his wages for the

following eight weeks, and 65 per cent. of his estimated loss in earning capacity thereafter for a maximum period of 15 years. The board finds that although the loss of an eye does not necessarily impair a man's earning capacity, it increases the difficulty of finding work.

The Chicago Association of Commerce Committee on Smoke Abatement and Electrification of Railway Terminals has 20 observers at work recording observations of 1,000 smoke stacks typical of the various plants consuming coal in Chicago. Observations at intervals of one minute for periods of a complete day will be taken by the observers who will record the classification of smoke as to density according to the Ringelmann chart and the exact percentage of density will be determined for each stack. Later a similar investigation is to be made of the locomotive smoke on each railway line of the city.

It is announced that the Southern Pacific is to follow the plan of giving publicity to accidents which has been in effect on the Union Pacific and other lines of the Harriman system for several years. Following an accident that is not of minor consequence the ranking officer of the division will convene a board composed of two disinterested persons not connected with the railway, and the division officers representing the operating, mechanical and engineering departments. The board will conduct a thorough investigation to fix the responsibility for the accident, and its findings will be given to the newspapers.

An International Safety Congress will be held in Milan, Italy, May 27-31. This congress, the first of its kind of international scope ever held, will be for the purpose of promoting a world wide movement for the conservation of human life in industry. The American Museum of Safety, New York, is making preparations to have the United States well represented. An American national committee has been selected by the museum to co-operate with the international body and to promote the American ideas and views at the congress. Dr. W. H. Tolman, director of the American Museum of Safety, James McCrea, president of the Pennsylvania, and other members of the committee will attend the congress. Among the papers which will be read at the congress are: The Safety Engineer on a Large Transportation System, by Dr. W. H. Tolman, and The Work of the Safety Committee of the United States Steel Corporation.

About 250 pensioned employees of the Southern Pacific attended the annual banquet at the Palace Hotel, San Francisco, on May 10. The banquet this year fell upon the forty-third anniversary of the driving of the last spike of the first trans continental railway in the United States, at Promontory, Utah. Approximately half of those now on the pension roll were factors in the construction of the system at that time, and it is the annual custom for the road to be built in reminiscence. Part of the entertainment was the exhibition of a complete set of 250 photographs taken during the construction period of the Central Pacific, and several of the higher officers of the road addressed the gathering. Since the inauguration of the pension system on the Southern Pacific, January 1, 1903, \$1,015,014 has been paid out in pensions. The system is absolutely voluntary on the part of the company, and 718 former employees have been awarded pensions in these nine years. On May 1 this year there were 477 pensioners on the rolls.

On May 27 the Supreme Court for the District of Columbia entered a final decree dissolving the injunction and dismissing the suit in the case that Peter H. Murphy brought against the Baltimore & Ohio for infringement of his car roof patents. The roofs were furnished by the Chicago-Cleveland Car Roofing Company, which protected the Baltimore & Ohio in defending the suit. This final decree was in accordance with the decision

of the Court of Appeals for the District of Columbia, which, on April 22 last, entirely reversed the previous decree of the lower court. The previous decree had held that the patents were valid and infringed upon, but the Court of Appeals wholly reversed it, and also, on May 14, denied Mr. Murphy's petition for a rehearing. On May 17 the Court of Appeals also overruled Mr. Murphy's opposition to granting the Baltimore & Ohio a large item of recoverable costs of the suit. There was also on April 29 a ruling of the Supreme Court of the United States that precluded any further appeal in such a suit. The Baltimore & Ohio was thus entirely sustained in the matter.

As a reward for faithful service the Missouri Pacific-Iron Mountain system has decided to issue annual passes to employees who have worked for the company 15 years or longer. The rules provide that for 15 years of continuous service an employee may receive an annual pass for himself over the division on which he is employed; for 20 years' continuous service, one for himself and wife over the division, and for 25 years' continuous service one for himself and wife over the entire Missouri Pacific-Iron Mountain system of nearly 7,300 miles. About 1,500 employees will receive these passes, including agents, conductors, engineers, brakemen, train baggagemen, switchmen, firemen, hostlers, telegraphers, bridge and building foremen and section foremen. R. W. Waters, a conductor on a suburban train running out of St. Louis, now in his 52d year of continuous employment, is the oldest man in point of service on the entire system. John Cook, and his son, C. W. Cook, both employed on the Central Kansas division as passenger engineers, under the 25 years of service ruling, are entitled to annual passes for themselves and wives.

The employees' compensation bill has passed the Senate at Washington by a vote of 64 to 15, but not until it had been vehemently opposed by a few senators. This bill was prepared with much care by a special commission and was recommended to Congress by President Taft. It provides that accidental disability or death of employees shall be subject to compensation, to be paid by the employer, and applies to all persons employed by railways engaged in interstate commerce. Numerous changes were proposed by senators, but the opposition was strong, and only a few amendments were accepted. One of the changes modifies the period during which children shall receive compensation; the age of 16, the ordinary limit, is to be extended, in the case of a daughter, to the age of 20, unless she marries before that age. The opposition to the bill seems to be based mainly on the claim that injustice will be done to railway employees who suffer serious injuries by fault of the employer and who, under present laws, may sue for heavy damages—much heavier than would be allowed under the proposed law. One of the objecting senators said that the officers of the labor unions, in endorsing the bill, have not fairly represented their constituents; but, on the other hand, some of the observers at Washington say that the opposition has come mainly from senators who, under the present law, make a good deal of money out of their work in prosecuting suits against the railways.

The Educational Bureau of the Union Pacific has issued a new instruction pamphlet, entitled "Safety First," containing several pages of "don'ts" for employees of the operating department, the observance of which would greatly reduce the number of accidents. Preceding the list of "don'ts" are several paragraphs devoted to observation of rules; the company expects employees to live up to the rules absolutely, and in all cases of doubt or uncertainty the safe course must be taken and no risks run. Some of the comments are as follows: "It is a common saying among railway men that if one lived up to the book of rules to the letter, he would never get over the road. This is true only in a degree, because the man who seems slow often accomplishes more, and as a rule works longer without causing accidents or injuries and does less damage to property than the man who is

always in a hurry and never does things exactly right. The company *does* want its rules lived up to. If there are rules that are found impracticable they can be changed and modified by a bulletin or special order, thus safeguarding all and hindering no one. The man who takes chances may be praised by a thoughtless official as long as he doesn't get into trouble, but the man who praised him while he kept out of trouble is the same man who will quickest discharge him when he takes the one chance too many or takes it too often. Employees are asked to make suggestions for additional "don'ts" or for photographs or moving pictures that could be taken to illustrate the right and wrong way of doing things, or to show more clearly what things not to do to avoid accidents.

FREIGHT RATE ON MATERIAL FOR REPAIRS OF CARS DAMAGED ON FOREIGN LINES.

Joseph W. Taylor, secretary of the Master Car Builders' Association, has issued to members the following circular concerning a proposed change in the M. C. B. rules:

Conference Ruling No. 333, of the Interstate Commerce Commission, reads as follows:

"333. Company Material.—Material for use in the repair of one of its cars was shipped by a carrier to the shop of a connecting line. Upon inquiry whether the material could move free of charge over both roads, it was held, That in cases of this kind company material may move without charge only over the line at whose expense the repair is made."

Inasmuch as present Rule 122 conflicts with this conference ruling, the Arbitration Committee suggests, and it will so recommend to the convention in June, that the first paragraph of Rule 122 be changed to read as follows:

"Rule 122. Companies shall promptly furnish to each other, upon requisition, and forward, freight charges from point of shipment to destination to follow, materials for repairs of their cars damaged upon foreign lines, excepting that the company having car in its possession at the time shall provide from its stock the following:

"Lumber, forgings, hardware stock, paint, hairfelt, piping, air-brake material and all M. C. B. standard material.

"Requisitions for such material shall specify that same is for repairs of cars, giving car number and initial of such car, together with pattern number or other data, to enable correct filing of requisition."

Under the ruling of the commission, material for repairs of foreign cars may be moved without charge over the line at whose expense the repairs are made, but the committee believes that less trouble and annoyance will be occasioned if the shipment is made on a freight rate from point of shipment to destination.

MEETINGS AND CONVENTIONS

Canadian Northern Club.—This is the name of a club which has been organized at Toronto by officers and employees of the Canadian Northern, the purpose being to promote both knowledge of railroading and better personal acquaintance and friendship. Meetings are to be held on the first Tuesday of each month. The president is A. J. Hills; secretary, R. Croasdell.

Western Railway Club.—The annual meeting of the Western Railway Club was held in the Karpen building, Chicago, on Tuesday evening, May 21. The membership of the club is now 1,437. The following were elected officers for the ensuing year: President, T. H. Goodnow, general superintendent, Armour Car Lines; first vice-president, H. H. LaRue, master car builder, Chicago, Rock Island & Pacific; second vice-president, W. B. Fall, superintendent, Mather Stock Car Company; secretary and treasurer, J. W. Taylor. The members were entertained with a musical program at the close of the meeting.

International Association for Testing Materials.—The sixth annual congress of the International Association for Testing Materials will be held in New York, September 2 to 7, 1912. Every effort will be made to accommodate the foreign delegates to this congress and the proceedings will be conducted in English, German and French, with the aid of competent interpreters. Several excursions have been arranged for, so that the visiting delegates will have a chance to visit places of interest in the eastern section of this country, special arrangements being made for those desiring to go as far west as the Illinois Steel Company's plant at Gary, Ind. Over 150 reports and papers will be presented during the convention.

National Association of Manufacturers.—The annual convention of the National Association of Manufacturers was recently held in New York City, with John Kirby, Jr., of Dayton, Ohio, president of the association, in the chair. In his opening remarks Mr. Kirby declared that the past year has witnessed the steady decline of labor unionism of the "Gompers type." The committee on interstate commerce and Federal incorporation in its report defends the Commerce Court. Although the court has not in all instances acted in perfect harmony with the Interstate Commerce Commission, it is not fair to assume that the court merits the criticism directed against it. The proposals for Federal incorporation laws have made little progress during the past year, and the manufacturers are urged to work for them in the interest of a sane regulation of industry. The prime function of our government should be to promote an attitude of sympathy and co-operation. W. J. H. Boetcker made an urgent plea for a strenuous campaign to further knowledge and skill in the various trades of our boys and girls. "Workers must be taught that we are not their natural opponents because we are their employers, but that there is a mutuality of interest that binds more strongly than the differences which may from time to time arise, and which are sometimes unavoidable. Motion pictures were given showing the cause, effect and remedy of various kinds of industrial accidents, a model factory fire drill and a lifeboat drill at sea. More than 1,000 employers and delegations of workmen attended this exhibition. Frank E. Law, vice-president of the Fidelity & Casualty Company, New York, gave an address on "Workmen's Compensation for Accidents."

The following list gives names of secretaries, dates of next or regular meetings, and places of meeting of mechanical associations.

- AIR BRAKE ASSOCIATION.**—F. M. Nellis, 53 State St., Boston, Mass. 1913 convention to be held at St. Louis, Mo.
- AMERICAN RAILWAY MASTER MECHANICS' ASSOC.**—J. W. Taylor, Old Colony building, Chicago. Convention, June 17-19, Atlantic City, N. J.
- AMERICAN RAILWAY TOOL FOREMEN'S ASSOCIATION.**—M. H. Bray, N. Y., N. H. & H., New Haven, Conn. Convention, July 9, Chicago.
- AMERICAN SOCIETY FOR TESTING MATERIALS.**—Prof. E. Marburg, University of Pennsylvania, Philadelphia, Pa.
- AMERICAN SOCIETY OF MECHANICAL ENGINEERS.**—Calvin W. Rice, 29 W. 39th St., New York.
- CAR FOREMEN'S ASSOCIATION OF CHICAGO.**—Aaron Kline, 841 North 50th Court, Chicago; 2d Monday in month, Chicago.
- INTERNATIONAL RAILWAY FUEL ASSOCIATION.**—D. B. Sebastian, La Salle St. Station, Chicago.
- INTERNATIONAL RAILWAY GENERAL FOREMEN'S ASSOCIATION.**—L. H. Bryan, Brown Marx building, Birmingham, Ala. Convention at Chicago, July 23-26, 1912.
- INTERNATIONAL RAILROAD MASTER BLACKSMITHS' ASSOCIATION.**—A. L. Woodworth, Lima, Ohio. Convention, August 15, Chicago.
- MASTER BOILER MAKERS' ASSOCIATION.**—Harry D. Vought, 95 Liberty St., New York.
- MASTER CAR BUILDERS' ASSOCIATION.**—J. W. Taylor, Old Colony building, Chicago. Convention, June 12-14, Atlantic City, N. J.
- MASTER CAR AND LOCOMOTIVE PAINTERS' ASSOC. OF U. S. AND CANADA.**—A. P. Dane, B. & M., Reading, Mass. Convention, September 10-13, Denver, Col.
- RAILWAY STOREKEEPERS' ASSOCIATION.**—J. P. Murphy, Box C, Collinwood, Ohio.
- TRAVELING ENGINEERS' ASSOCIATION.**—W. O. Thompson, N. Y. C. & H. R., East Buffalo, N. Y. Convention, August 27-30, Sherman Hotel, Chicago.

PERSONALS

GENERAL.

C. HOUSTON has been appointed master mechanic of the Nacozari Railroad, with office at Nacozari, Senora, Mex.

F. HONAKER, master mechanic of the St. Louis & San Francisco at Birmingham, Ala., has been transferred to Fort Scott, Kan.

H. W. CODDINGTON has been appointed engineer of tests of both the locomotive and car department of the Norfolk & Western.

F. T. PERRIS has been appointed manager of the fuel department of the Atchison, Topeka & Santa Fe Coast Lines, with office at Olinda, Cal.

F. C. RIPLEY has been appointed assistant manager of the fuel department of the Atchison, Topeka & Santa Fe Coast Lines, with office at Midoil, Cal.

B. A. BELAND, master mechanic of the St. Louis & San Francisco at Fort Scott, Kan., has been transferred to Birmingham, Ala., succeeding H. Honaker.

J. M. CHAFFEE has been appointed road foreman of engines on the Mohawk division of the New York Central & Hudson River, vice C. W. Stark, promoted.

E. R. WEBB, division master mechanic of the Michigan Central, at Michigan City, Ind., has been transferred to St. Thomas, Ont., succeeding Mr. Flynn, promoted.

T. J. BURNS, assistant to the superintendent of motive power of the Michigan Central, at Detroit, Mich., has been appointed assistant superintendent of motive power.

E. W. THOMAS has been appointed supervisor of apprentices of the Atchison, Topeka & Santa Fe, and the Atchison, Topeka & Santa Fe Coast Lines, with office at Topeka, Kan.

A. P. PRENDERGAST, superintendent of motive power of the Baltimore & Ohio Southwestern at Cincinnati, Ohio, has had his jurisdiction extended over the Cincinnati, Hamilton & Dayton.

J. A. HALEY has been appointed master mechanic of the Bellingham Bay & British Columbia, with office at Bellingham, Wash., succeeding M. Dailey, resigned to accept service with another company.

R. S. MOUNCE, assistant to the general foreman of the Erie at Cleveland, Ohio, has been transferred to the personal staff of William Schlafge, general mechanical superintendent at New York City.

F. W. TAYLOR, master mechanic of the Illinois Central at Mattoon, Ill., has been appointed master mechanic, with office at Waterloo, Iowa, in place of J. A. Bell, who succeeds Mr. Taylor at Mattoon.

E. D. BRONNER, who has been superintendent of motive power of the Michigan Central for the past 20 years, with office at Detroit, Mich., has been appointed general manager, vice R. H. L'Hommedieu.

W. H. CORBETT, road foreman of engines of the Michigan Central, at Jackson, Mich., has been promoted to the position of division master mechanic, at Michigan City, Ind., succeeding Mr. Webb, transferred.

C. W. STARK has been appointed supervisor of mechanical instructions and examination of enginemen for the eastern district of the New York Central & Hudson River, vice D. Cassin, assigned to other duties.

A. O. GARBER, general foreman of the Illinois Central at Paducah, Ky., has been appointed master mechanic, with office at

East St. Louis, Ill., succeeding W. H. Donley, given a leave of absence on account of illness.

WALTER H. FLYNN, division master mechanic of the Michigan Central at St. Thomas, Ont., has been appointed superintendent of motive power, with office at Detroit, Mich., succeeding E. D. Bronner, promoted to general manager.

S. F. HANCHOTT has been appointed road foreman of equipment on the Dakota division of the Rock Island Lines in connection with his other duties. His headquarters are located at Estherville, Iowa, and he succeeds F. Hopper, transferred.

H. H. HALE, formerly superintendent of the motive power and car department of the Cincinnati, Hamilton & Dayton at Cincinnati, has been appointed superintendent of the car department of that road and of the Baltimore & Ohio Southwestern.

M. J. DRURY, mechanical superintendent of the Northern district of the western lines of the Atchison, Topeka & Santa Fe, at La Junta, Colo., has been appointed superintendent of shops, with office at Topeka, Kan., succeeding John Purcell, promoted.

John Purcell has been appointed assistant to the vice-president in charge of operation of the Atchison, Topeka & Santa Fe system, with office at Chicago. Mr. Purcell began railway work in 1884 as an apprentice on the Santa Fe, and he has been with that road ever since. He was made gang foreman in 1887, and then filled various positions until he was appointed master mechanic at Argentine, Kan., about 1898 or 1899. He was later transferred as master mechanic to Shopton, Iowa, and in April, 1902, was promoted to superintendent of the Topeka shops, which office he held at the time of his recent promotion. In his present position Mr. Purcell will handle all mechanical department matters.



John Purcell.

F. HOPPER has been appointed road foreman of equipment of the Minnesota division of the Rock Island Lines, with office at Cedar Rapids, Iowa, vice C. F. Kilgore, assigned to other duties. Mr. Hopper will also cover the line between Vinton, Iowa, and Estherville.

W. I. ROWLAND, master mechanic of the Baltimore & Ohio at Grafton, W. Va., has been appointed assistant road foreman of engines of the Baltimore division, in charge of the engines of the Baltimore and Washington terminals, with headquarters at Baltimore, Md.

M. C. M. HATCH, formerly engineer of tests of the New York, New Haven & Hartford and the Boston & Maine, has been appointed superintendent of fuel service on the Delaware, Lackawanna & Western, with office at Scranton, Pa., and will have jurisdiction over all matters pertaining to fuel and fuel economies.

E. A. GILBERT, formerly western representative of W. H. Miner at Chicago, has been appointed general inspector of the motive power department of the Southern Pacific at San Francisco, Cal. He will have charge of all matters pertaining to rolling stock and shop practice.

JOHN HAIR, formerly superintendent of motive power of the Baltimore & Ohio Southwestern, at Cincinnati, Ohio, has been appointed safety inspector, and a member of the General Safety Committee, representing the mechanical department of the Baltimore & Ohio, with headquarters at Baltimore, Md., succeeding W. L. Robinson, promoted.

NELS OSGARD, whose appointment as master mechanic of the Great Northern, with office at Superior, Wis., was noted in the April issue of the *American Engineer*, was born May 26, 1869, in Norway. He received a common school education and began railway work with the St. Paul, Minneapolis & Manitoba, now the Great Northern, in October, 1887, at Minneapolis, Minn. He first worked in the engine house, taking care of ashpaus and as engine wiper, and he was subsequently call boy, boiler washer, boiler-maker, machinist, blacksmith and fireman. He became an engineer in November, 1896; in April, 1906, was promoted to traveling engineer, and except for about a year when he was road engineer again, he was a traveling engineer continuously until his present appointment. He was appointed traveling engineer of the Lake district in March, 1909, over which district he now has jurisdiction as master mechanic.

CAR DEPARTMENT

J. J. BURCH has been appointed division car inspector of the Norfolk & Western, vice J. R. Hayward, resigned.

SHOP

J. P. KELLY has been appointed acting locomotive foreman of the Canadian Pacific at Field, B. C.

W. J. RENIX, shop foreman of the Canadian Pacific at Brandon, Man., has been transferred to Moose Jaw, Sask.

B. E. SHONE has been appointed general foreman of the Depew, N. Y., shops of the New York Central & Hudson River.

T. S. BERTRAM has been appointed night foreman of the Canadian Pacific at Moose Jaw, Sask., having been transferred from Kenora, Ont.

R. MCPHERSON, shop foreman of the Canadian Pacific at Kenora, Ont., has been transferred to Brandon, Man., vice W. J. Renix, transferred.

A. PENTLAND, night foreman of the Canadian Pacific at Swift Current, Sask., has been transferred to Moose Jaw, Sask., vice T. S. Bertram, transferred.

W. C. MAYO, night locomotive foreman of the Canadian Pacific, at West Toronto, Ont., has been appointed locomotive foreman at Port McNicoll, Ont.

J. G. PARSONS has been appointed superintendent of shops of the New York Central & Hudson River, at Depew, N. Y., succeeding H. Wanamaker, transferred.

H. WANAMAKER, superintendent of shops of the New York Central & Hudson River, at Depew, N. Y., has been appointed superintendent of shops at West Albany, N. Y., succeeding L. H. Raymond, resigned.

W. J. HOSKIN, who recently resigned as master mechanic of the Chicago & Alton at Bloomington, Ill., has been appointed assistant master mechanic of the Paducah shops of the Illinois Central, with headquarters at Paducah, Ky.

OBITUARY

N. M. MAINE, general master mechanic of the Chicago, Milwaukee & Puget Sound, with office at Tacoma, Wash., died at Tacoma, on May 10.

NEW SHOPS

BALTIMORE & OHIO SOUTHWESTERN.—The contract has been awarded for the erection of two additions to the machine shop at Washington, Ind., to cost \$35,000, and improvements to the engine house which will cost \$25,000.

CANADIAN NORTHERN.—Repair shops and an engine house will be built at Port Mann, B. C., the Pacific terminus of this road. The cost of the construction and equipment is fixed at \$500,000.

CANADIAN PACIFIC.—A contract for the erection of new shops near Calgary, Alberta, which will cost about \$2,500,000, has been awarded to Westinghouse, Church, Kerr & Company, New York. A main locomotive shop, 305 ft. x 312 ft., will be built, and will include the erecting, machine, blacksmith and boiler shops. The coach repair and paint shop will be 146 ft. x 360 ft., and the planing mill will be 80 ft. x 300 ft. The pattern shop will be 30 ft. x 100 ft., and the freight car repair shop 230 ft. x 300 ft. The foundry building will be 80 ft. x 204 ft. Numerous other buildings and structures, including a store room, office building, oil house, etc., will be built. The erecting shop will be of the transverse type and will contain 35 bays. The general construction of the building will be of concrete, steel, brick, or hollow tile, depending upon conditions. J. G. Sullivan, chief engineer of the western lines of the Canadian Pacific, is in charge of the work.

CHICAGO, MILWAUKEE & ST. PAUL.—A new engine house and machine shop will be built at Perry, Iowa. A 30-stall engine house, a 50-ft. turntable and a mechanical coaling station will be built at a point between Manheim, Ill., and Bensonville, about 15 miles from Chicago.

CINCINNATI, HAMILTON & DAYTON.—New locomotive shops will be built at Elmwood Place, Cincinnati, Ohio.

COLORADO & SOUTHERN.—Plans are being made for the construction of an engine house and shops at Hartville, Wyo.

EL PASO & SOUTHWESTERN.—Bids for an engine house, station and freight house, to be built at Tucson, Ariz., are asked for not later than June 20.

ILLINOIS TERMINAL RAILROAD.—The car shops which were destroyed by fire on May 3 at Alton, Ill., will be rebuilt and re-equipped.

LOUISVILLE & NASHVILLE.—A large pumping station will be built at DeCoursey, Ky.

MICHIGAN CENTRAL.—A new engine house and shop buildings will be erected at Detroit, Mich.

NORFOLK & WESTERN.—Contracts have been awarded for the new shops at Columbus, Ohio. The buildings will be of brick and steel construction, and will include a 25-stall engine house; a 52 ft. x 139 ft. machine shop, with an annex of 35 ft. x 64 ft., for store and office buildings.

PENNSYLVANIA.—A new engine house, costing \$200,000, will be erected at Indianapolis, Ind.

PERE MARQUETTE.—Receivers Walters and Blair have made application in the Federal Court at Detroit, Michigan, for permission to issue \$2,000,000 receivers' certificates to build new stations, engine houses, coaling plants and extensions of the yards at Toledo, Ohio, and Port Huron, Mich.

SAN ANTONIO, ROCKPORT & MEXICAN.—Land has been acquired at Lockport, Tex., for an engine house, car shops and other terminal facilities. This road was incorporated last September, and will build from San Antonio, Tex., through Crowther and Rockport to Harbor Island. The work will later be extended to Tampico, Mex., and the City of Mexico.

WESTERN MARYLAND.—The erection of a new engine house and shops at Millersville, Md., has been started.

SUPPLY TRADE NOTES

The Union Draft Gear Company, Chicago, has moved its main offices to 1162 McCormick building.

The Adams & Westlake Company, Chicago, has moved its Philadelphia office to 2218 Ontario street.

The Automatic Ventilator Company, New York, has moved its main offices from 120 Liberty street to 2 Rector street.

The Ashton Valve Company, Boston, Mass., has moved its Chicago office from 166 West Lake street to 174 North Market street.

It is reported that the Canadian Car & Foundry Company of Montreal, Can., will build a car plant costing \$1,500,000 at Fort William, Ont.

A. E. Davis has been appointed general manager of the Davis Boring Tool Company, of St. Louis. This company manufactures expansion boring tools.

The Pyle-National Electric Headlight Company, Chicago, has moved its offices from the McCormick building to 1000 Karpen building, 500 South Michigan avenue.

Ferdinand Schlesinger, of Milwaukee, Wis., and associates have purchased a tract of 415 acres at Hammond, Ind., with the purpose of building a large steel plant.

The Sherwin-Williams Company, Chicago, has moved its office from the Steger building to the eleventh floor of the Peoples Gas building, Michigan avenue and Adams street.

The Roberts & Schaefer Company, Chicago, has moved its general offices from the Old Colony building to the McCormick building, Van Buren street and Michigan boulevard.

The Chicago-Cleveland Car Roofing Company has moved its New York office to room 368, 50 Church street. Arthur S. Lewis has been added to the staff as eastern representative.

Hildreth & Company, New York, consulting and inspecting engineers have moved their main office from the Whitehall building, New York, to the Mills building, 15 Broad street.

The plant of the American Steel Foundries at East St. Louis, Ill., began regular operation on June 1. This plant has large orders for car material and will run at almost full capacity.

William Sellers & Co., Inc., Philadelphia, Pa., have purchased 46 acres of land at Folsom, Pa., on the Baltimore & Ohio, as a site for plant extension. This property is located 10 miles from Philadelphia.

J. M. Monroe, foreman of locomotive repairs of the Southern Railway shops at Columbia, S. C., has resigned that position and has gone to the Hunt-Spiller Manufacturing Corporation, Boston, as a representative.

The Kennicott Company, Chicago Heights, Ill., is erecting as an addition to its car shops a brick building 70 ft. x 323 ft., and is installing two new electric traveling cranes, orders for which were recently placed.

J. E. Fries has been made Pacific coast engineer of the Crocker-Wheeler Company, Ampere, N. J., with office at San Francisco, Cal. This company on April 1 opened an office in the Title Insurance building, Los Angeles, Cal.

The Baldwin Locomotive Works, Philadelphia, Pa., is making rapid progress with the construction of the various additions to its plant at Eddystone, Pa. The new erecting shop, which will be one of the largest of its kind, is rapidly approaching completion, and various other important improvements are under way. The operating force of the company is being steadily increased.

F. D. Reemer, who has been assistant purchasing agent of the American Car & Foundry Company, New York, has been ap-

pointed purchasing agent of the Haskell & Barker Car Company, Michigan City, Ind., with office in that city.

Edward E. Wright has been appointed manager of the central sales district for the McKeen Motor Car Company, Omaha, Neb., and will have charge of the new office which has been established by the company in the Marquette building, Chicago.

W. S. Quigley, until recently vice-president and general manager of the Rockwell Furnace Company, New York, has resigned that position to become vice-president of the new Quigley Furnace & Foundry Company, 50 Church street, New York.

Howard K. Porter, a southern representative of the Lorain Steel Company, Philadelphia, Pa., has been made manager of the southern railway department of the U. S. Metal & Manufacturing Company, New York, with office in Candler building, Atlanta, Ga.

A. H. Ehrenhaft, previously connected with the Hanna Engineering Works, has joined the sales force of the Vulcan Engineering Sales Company, Chicago. Mr. Ehrenhaft's special field will be that of riveters, and he will be located in the Hudson-Terminal building, New York.

The Kip Brush Company, New York, has made Wood, Bowers & Company, St. Louis, Mo., its southern representative. The Kip company recently organized a special railway department under the charge of Harry M. Baxter, formerly in charge of production and sales for the Wolfe Brush Company.

J. F. MacEnulty, formerly general manager of the Western Steel Car & Foundry Company, has been appointed general sales manager of the Western Steel Car & Foundry Company

and of the Pressed Steel Car Company, a newly created position, with office at New York. He was born in Pittsburgh, Pa., January 10, 1879, and in 1899 he entered the service of the Pressed Steel Car Company at Pittsburgh as inspector, and later became foreman of the truck and bolster department, chief inspector and engineer of construction. He was then transferred to New York as sales agent, and about six years ago went to Chicago as general superintendent of the Western Steel Car & Foundry Company. In 1909 he was made gen-



J. F. MacEnulty.

eral manager, which position he now leaves to take charge of the sales department in New York.

At the recent annual meeting of the Cement Products Exhibition Company, Edward M. Hagar, president of the Universal Portland Cement Company, Chicago, was elected president. It was decided to hold the sixth annual Chicago cement show in the Coliseum, January 16-23, 1913, but to hold no shows in New York and Kansas City, Mo.

J. E. Buckingham has been appointed superintendent of motor and refrigerator equipment of Wells Fargo & Company with headquarters at New York City. He will have general supervision of the mechanical department with respect to the construction and maintenance of motor and garage equipment, and refrigerator and ventilator cars.

George Price, formerly with the Tidewater Building Company, will represent the Flintkote Manufacturing Company and J.

A. & W. Bird & Company, Boston, Mass., in the New York district in their line of building specialties, which cover roofing, water proof sheathing, water proofing compounds, Rex wall board, cold water bands, Ripoline enamels, etc. The New York office is located at 66 Beaver street.

W. H. Winterrowd, who, as reported in the May issue of the *American Engineer*, has been appointed mechanical engineer of the Damascus Brake Beam Company, Cleveland, Ohio, was born



William H. Winterrowd.

April 2, 1884, at Hope, Ind. He received an elementary education in the public schools at Shelbyville, Ind., and was graduated from Purdue University in 1907. In 1905, during his university training, he served as a blacksmith helper on the Lake Erie & Western at Lima, Ohio, and in 1906 served as car and air brake repair man on the Pittsburgh, Cincinnati, Chicago & St. Louis at Dennison, Ohio. In the latter part of the same year he engaged in locomotive test work on the Big-Four at Indianapolis, Ind. On graduating Mr. Winterrowd entered the

service of the Lake Shore & Michigan Southern as special apprentice, serving in that capacity until 1908, when he was made engine house foreman of the Lake Erie, Alliance & Wheeling, at Alliance, Ohio. In 1909 he was made night engine house foreman on the Lake Shore & Michigan Southern, at Youngstown, Ohio, and in 1910 was transferred to Cleveland, Ohio, in the same capacity. Later in the same year he was promoted to assistant to the mechanical engineer on the Lake Shore & Michigan Southern, which position he held until his recent appointment as mechanical engineer of the Damascus Brake Beam Company and Railway Supply Company, at Cleveland, Ohio.

The court of appeals of the District of Columbia on April 22 rendered a decision in the suit of Peter H. Murphy against the Baltimore & Ohio for infringement of the Murphy outside metal car roofs patents in roofs furnished by the Chicago-Cleveland Car Roofing Company, reversing the decision of the Supreme Court of the District of Columbia rendered on November 27, 1911, which held that the patents had been infringed.

At the stockholders' meeting of the Kelly Reamer Company, Cleveland, Ohio, the following were elected directors of the company: William E. Kelly, W. A. Calhoon, H. J. Maxwell, O. H. P. Davis, E. B. Jessop, George Bauer and Thomas A. Torrance. The following officers were also elected: William E. Kelly, president and general manager; W. A. Calhoon, vice-president; H. J. Maxwell, secretary, and O. H. P. Davis, treasurer.

Charles J. Symington, general sales agent of the T. H. Symington Company, Baltimore, Md., with office at Chicago, has been made vice-president in charge of sales, with office in New York, and Thomas C. de Rosset, sales agent of the Symington company, has been made manager of eastern sales of that company, with headquarters in Baltimore, succeeding John F. Symington, resigned to go to Hambleton & Company, Baltimore, a banking firm.

James Rawle, president of the J. G. Brill Car Company, Philadelphia, Pa., died at his home at Bryn Mawr, May 1, at the age of 70. Mr. Rawle was graduated from the University of Pennsylvania in 1861 as a civil engineer. In 1872 he became a

partner with John G. Brill and George M. Brill in the manufacture of street railway cars. In 1887, when the firm was incorporated as the J. G. Brill Company, Mr. Rawle took charge of the finances.

The various steel companies of the Lake Superior Corporation, Sault Ste Marie, Ont., have been combined into the Algoma Steel Corporation, in accordance with its plans for the consolidation of the various subsidiary companies in natural groups. The companies to be included in the consolidation are the Algoma Steel Company, Sault Ste Marie; the Lake Superior Iron & Steel Company, Montreal, Que.; the Lake Superior Power Company; the Fiborn Limestone Company; the Cannerton Coal & Coke Company, and the Algoma Iron Works, Ltd.

The Vulcan Engineering Sales Company, Fisher building, Chicago, has been organized by the Hanna Engineering Works, Chicago, the Mumford Molding Machine Company, Plainfield, N. J., and the Q M S Company, Plainfield, N. J., for the purpose of handling the sales and distribution of the goods made by these companies. The same engineering organizations of the different companies will continue as before, only under the name of the Vulcan Engineering Sales Company. The principal officers are J. K. Gilbert, president, and Philetus W. Gates, secretary-treasurer. The New York office of this company is located in the Hudson-Terminal building.

The Southwark Foundry & Machine Company, Philadelphia, Pa., manufacturer of turbine engines, has been sold. The new board of directors consists of Alba B. Johnson, Samuel B. Vauclain, Holstein De Haven Bright, John P. Sykes, Reeves K. Johnson, Alba B. Johnson, Jr., Jacques L. Vauclain and Andrew C. Vauclain. The new officers are as follows: President, Holstein De Haven Bright; vice-president and treasurer, James H. Maloney, and secretary, Alfred C. Maule. Alba B. Johnson, president of the Baldwin Locomotive Works, Philadelphia, Pa., said that this was an individual enterprise and that the Southwark company would have no connection with the Baldwin Locomotive Works.

CATALOGS

BEARING METAL.—The Damascus Brass Company, Pittsburgh, Pa., has issued a 24-page pamphlet describing its various bearing metals.

RADIAL DRILLS.—The Fostick Machine Tool Company, Cincinnati, Ohio, has issued a circular illustrating its 4-ft. and 5-ft. National radial drills.

UNIONS.—The National Tube Company has issued bulletin No. 9, which describes some tests made on the Kewanee unions. The sizes tested were from $\frac{1}{2}$ in. to 2 in.

BALL BEARINGS.—The Hess Bright Mfg. Company, Philadelphia, Pa., has issued a 32-page pamphlet describing the application of ball bearings to woodworking machinery.

ANTI-FRICTION METAL.—The Magnolia Metal Company, New York, has issued pamphlets in English, Spanish and Portuguese, giving full directions for the pouring of its anti-friction metal.

HEATER CARS.—The Alcohol Heating & Lighting Company, Chicago, has issued an illustrated booklet, describing its combined alcohol heater and refrigerator cars for the handling of perishable freight.

SPECIAL I-BEAMS.—The Carnegie Steel Company, Pittsburgh, Pa., has published a 12-page booklet giving the physical properties of I-beam sections which are supplementary to the American standard sections.

UNIONS.—The National Tube Company, Pittsburgh, Pa., has devoted bulletin No. 9 to the results of tests of Kewanee unions.

The bulletin also describes the construction of these unions and points out their advantages.

NUT LOCKS.—The Boss Nut Lock Company, Chicago, has issued a 16-page pamphlet describing the different types of boss nuts, explaining how these nuts lock and giving the general sizes and prices of the square and hexagon types.

ELECTRIC HOISTS.—The General Electric Company, Schenectady, N. Y., has issued bulletin No. 4939, which describes the electric hoists manufactured by that company. This bulletin supersedes the previous bulletin on the same subject.

PUMPS.—The Ingersoll-Rand Company, New York, has published bulletin No. 7004 on Cameron steam pumps, which is illustrated and describes in detail the construction and operation of these pumps. Prices and dimension tables are also included.

GRINDING WHEELS.—In the April issue of the bulletin called Grits and Grinds, issued by the Norton Grinding Company, Worcester, Mass., the question of balancing grinding wheels is discussed in detail. Both the running and standing balance is considered.

TEST METERS.—The General Electric Company, Schenectady, N. Y., has published bulletin 4942 on Thomson direct current test meters, type C B-4. This bulletin is illustrated, gives detailed descriptions and supersedes the company's previous bulletin on this subject.

INDUCTION MOTORS.—The Crocker Wheeler Company, Ampere, N. J., has issued Bulletin No. 141, illustrating and describing certain interesting details in the construction of their form R induction type motor, designed for operating from 25 cycle, poly-phase, a. c. circuits.

GRATES.—The Shear-Klean Grate Company, Chicago, has published a small booklet on Shear-Klean grates, in which their many advantages are pointed out and in which their construction is briefly and concisely described. It is claimed that these grates save both coal and labor.

ELECTRIC LAMPS.—The General Electric Company, Schenectady, N. Y., has issued bulletin No. 4947, describing the Edison-Mazda and Gem lamps for railway service. The bulletin contains illustrations showing cars lighted by these two types of lamps compared with the old carbon filament lamps.

HYDRAULIC JACKS.—Richard Dudgeon, New York, manufacturer of hydraulic jacks, has published a small illustrated booklet entitled The History of the Hydraulic Jack. It gives a brief history of the development of hydraulic jacks, a detailed description of their construction, and a number of points on their care and upkeep.

PNEUMATIC TOOLS.—The Independent Pneumatic Tool Company, Chicago, has issued a new catalog, No. 9, 118 pages, relating to the Thor pneumatic tools, including air drills; reaming, tapping and wood boring machines; grinders, riveters and chipping, calking and beading hammers. It also includes pneumatic staybolt drivers, hoists, motors and tube expanders. All these are illustrated by excellent drawings of the complete tools and general views showing their application in building and repairing locomotives and cars. There are complete catalogs of repair parts which are each illustrated and numbered. The Corliss valve motion used in the drills and one-piece riveting hammers, and the valve mechanism in chipping and calking hammers are claimed to be the latest and most scientific improvements in air tools. Since the last catalog was published a number of improvements have been made in these tools, the most important of which is the adoption of roller bearings and a one-piece connecting rod in all drills. The tabular specifications for Thor air tools include, in addition to general dimensions, the weight, the amount of air required for driving in cubic feet per minute, speed and capacity.

AMERICAN ENGINEER

"THE RAILWAY MECHANICAL MONTHLY"

(Including the Railway Age Gazette "Shop Edition.")

PUBLISHED ON THE FIRST THURSDAY OF EVERY MONTH, BY THE
SIMMONS-BOARDMAN PUBLISHING COMPANY,
83 FULTON STREET, NEW YORK, N. Y.

CHICAGO: Plymouth Bldg. CLEVELAND: Citizen's Bldg.
LONDON: Queen Anne's Chambers, Westminster.

EDWARD A. SIMMONS, *President.* HENRY LEE, *Secretary.*
L. B. SHERMAN, *Vice-President.* A. E. HOOVEN, *Business Manager.*

The address of the company is the address of the officers.

ROY V. WRIGHT, *Editor.* R. E. THAYER, *Associate Editor.*
E. A. AVERILL, *Managing Editor.* WILLIAM FORSYTH, *Associate Editor.*
GEORGE L. FOWLER, *Associate Editor.*

Subscriptions, including the eight daily editions of the *Railway Age Gazette* published in June in connection with the annual conventions of the Master Car Builders' and American Railway Master Mechanics' associations, payable in advance and postage free:

United States, Canada and Mexico.....\$2.00 a year
Foreign Countries (excepting daily editions)..... 3.00 a year
Single Copy 20 cents

Entered at the Post Office at New York, N. Y., as mail matter of the second class.

VOLUME 86.

JULY, 1912.

NUMBER 7.

CONTENTS

EDITORIALS:

| | |
|---------------------------------------|-----|
| Recent Competitions | 331 |
| Tool Foremen's Convention | 331 |
| Making Piston Packing..... | 331 |
| Maintaining Mallet Locomotives..... | 331 |
| Engine House Reports and Records..... | 332 |
| Criticisms of Shop Practice..... | 332 |
| General Foremen's Association | 332 |
| Repairing Boiler Tubes | 332 |
| Defective Freight Cars | 333 |
| Canadian Pacific Mallet | 333 |

COMMUNICATIONS:

| | |
|---|-----|
| Formers for Hydraulic Press | 334 |
| Repairing Locomotive Driving Boxes..... | 334 |

ILLUSTRATED:

| | |
|---|-----|
| Maintaining Mallet Locomotives | 335 |
| Shop Kinks, Pennsylvania, Tyrone, Pa..... | 338 |
| Engine House Reports and Records..... | 339 |
| Shop Kinks, Grand Trunk, Battle Creek, Mich..... | 343 |
| Simple Mallet for High Speed..... | 347 |
| Central of New Jersey Ice Car..... | 353 |
| Ash Pan for Narrow Firebox..... | 356 |
| An Ideal Boiler Tube Department..... | 357 |
| Car Shop Kinks | 361 |
| Articulated Electric Locomotives with Eight Motors..... | 363 |
| Locomotive Boiler Low Water Tests..... | 366 |
| Repairing Driving Boxes..... | 369 |
| Pacific Type Locomotive with Gaines Firebox..... | 372 |
| Double Drill with Independent Leads..... | 373 |
| Rolled Steel Truck Side Frames..... | 375 |
| Automatic Feed for Bolt Header..... | 376 |
| Rochester Horizontal Boring Mill..... | 376 |
| A Dining Car Without Vestibules..... | 378 |
| Variable Lead Attachment on Walschaert Valve Gear..... | 379 |
| All-Steel Pilot | 380 |

MISCELLANEOUS:

| | |
|---------------------------------------|-----|
| Efficiency of Railway Employees..... | 355 |
| Cutting Speed on Planers..... | 366 |
| Gas-Electric Cars for the Frisco..... | 379 |

GENERAL NEWS SECTION:

| | |
|--------------------------------|-----|
| Notes | 381 |
| Meetings and Conventions | 382 |
| Personals | 382 |
| New Shops | 384 |
| Supply Trade Notes | 385 |
| Catalogs | 386 |

Recent Competitions

The safety competition, which closed June first, was well supported by our readers. The judges have not yet decided upon the winner, but the decision will be ready in time for publication in our August issue. It is also expected that the announcement of the winners in the shop kink competition, which closed some time ago, will be made at that time. The delay in making this latter decision has been due to the very large number of kinks which were submitted, and the uniformly high quality of the contributions.

Tool Foremen's Convention

The American Railway Tool Foremen's Association will hold its fourth annual convention in Chicago, July 9. Although this organization is quite young its conventions have been fairly well attended and the meetings have been interesting and well conducted, although they have suffered somewhat because of the poorly adapted quarters in which they have been held. This year the convention will meet in the Hotel Sherman, which is much better suited for it. The reports will cover the standardization of steel for small tools, the design and tempering of milling cutters, the care of shop tools, checking systems, and the treating of steel in electric furnaces.

Making Piston Packing

Not the least important feature that will be considered in connection with the shop practice competition on repairing pistons, piston rods and crossheads, which closes September 1, will be the methods employed and the results obtained in the manufacture of piston packing. This is one of the most important jobs in a shop and one on which some shops have made surprising reductions in cost and time by a careful study of the whole operation and by the selection of machine tools best suited for the work. Competitors for the prize of \$25 offered in this competition, announced in the June issue, will greatly improve their chances of winning, by giving detailed time studies of the work on each part. Photographs or drawings, or both, are of great assistance in articles of this kind and should accompany the contribution whenever possible.

Maintaining Mallet Locomotives

Properly maintaining articulated locomotives of moderately large size in regular road service has not proved very difficult on the Pennsylvania division of the New York Central. Twenty-six of these engines have been in service for over a year, and at the present time are all in a 100 per cent. condition. How this is done is fully explained in an article in this issue wherein it will be discovered that the secret of success is more a matter of methods and organization than it is of equipment. As a matter of fact, no new equipment of any kind has been required at the terminals for use especially on the Mallets. At one end of the division there is not even a roundhouse which will admit one of these locomotives and allow the doors to be closed. There seem to be two or possibly three features in the methods employed at Corning and Jersey Shore that are chiefly responsible for the results. First, the locomotives are inspected minutely, making sure that every possible defect is discovered. Second, the system of checking the work insures all adjustments and repairs being properly and promptly made. Third, a traveling engineer is assigned to these 26 locomotives operating on a division about 100 miles in length. While these three features go a long way towards assuring proper maintenance, they would not be altogether successful except in cases where the locomotives were properly designed for the work they are to do. In this case 25 of the engines were built after a most thorough and exhaustive test and trial of a single experimental

locomotive. All the unsatisfactory features of design or construction were discovered on this locomotive instead of showing up on each one of a large order, as is quite frequently the case.

Engine House Reports and Records

The second of a series of articles on engine house organization and operation, by Ernest Cordeal, appears elsewhere in this issue, and suggests certain forms and records which should be used in order to secure the best results in improved engine house efficiency. To be effective such forms should be simple and as few in number as possible. Any forms which are at all complicated, either in their arrangement or in the method of handling them, will surely give trouble and cannot be expected to give satisfactory results. Then, too, duplication of work in checking up and filing the records and of making out the reports should be avoided. Charles Maier, engine house foreman of the West Jersey & Seashore, directed attention to this phase of the problem in an article on Systemized Clerical Work in the Engine House, in the Shop Section of the *Railway Age Gazette* of October 6, 1911. In studying over Mr. Cordeal's suggestions it might be well, also, to refer to the simple and effective methods which were devised by H. B. Brown, master mechanic of the Illinois Central at Memphis, Tenn. These were described in the article on Efficient Engine House Methods, by J. S. Sheafe in the Shop Section of the *Railway Age Gazette* of November 3, 1911. Mr. Cordeal's next article will deal with engine house facilities.

Criticisms of Shop Practice

In each issue of this journal there are a number of articles on shop practice. It will be readily understood that it is impossible for the editors to be conversant with every detail of the latest practice in the various shops throughout the country, and that they are to a considerable extent dependent on the readers for information on these features. We are anxious, of course, to publish the most improved methods, and are constantly endeavoring to obtain contributions or suggestions. The articles that are published are believed to be in advance of the general practice at least, but whether they are the best methods, it is often impossible to determine unless the readers who are acquainted with more improved methods than those described will give us the benefit of their knowledge. We welcome critical discussions of any article published in this journal, and urge all the readers to draw our attention to any practice, kink or arrangement they believe to be better than those published. We are now running a series of separate articles on methods of repairing driving boxes. These are all susceptible of criticism. In fact, Mr. Le Compte has accepted our invitation and his criticism of Mr. Spidy's methods appears in this issue. Mr. Westbrook's article also has a number of features that are open to criticism and discussion. We will be glad to hear from you.

General Foremen's Association

The International Railway General Foremen's Association, which is to hold its annual meeting at Chicago the latter part of this month, has been gaining steadily in strength and influence during the past two years. It occupies an important field and there is no reason why, if its members take a proper interest and back up the efforts of the officers—and it appears that they intend to do so—it should not be of equal importance with the Traveling Engineers' Association. The Master Mechanics' Association would do well to co-operate closely with these two organizations—one representing the operation of the locomotive and the other its care and maintenance in the shops and engine houses. The Master Mechanics' Association can only find time to investigate the larger and more

general problems of the mechanical department, but it should be in intimate touch with the special, and none the less important, questions which confront the traveling engineers and the shop and engine house foremen. By a closer co-operation between the three organizations the work of each could be planned to supplement that of the others. There is no question but that the Traveling Engineers' Association is worthy of this confidence; it is one of the strongest and best conducted mechanical department organizations. The General Foremen's Association is younger and has had a hard time in finding its feet and getting a broad view of its work and its possibilities. Last year it made a distinct step forward and if it lives up to the standard which was set for it by those who planned the work for the coming convention it will follow closely on the heels of the Traveling Engineers' Association. Mr. Bentley, the past president of the Master Mechanics' Association, referred to the desirability of a closer co-operation with the General Foremen's Association in his presidential address and it is understood that the matter has been referred to the executive committee of that association for action.

Repairing Boiler Tubes

Mr. Pomeroy presents in an article in this issue, an arrangement for repairing boiler tubes which he is willing to guarantee will give a cost of not over 3 cents per tube from engine to engine, in shops where at least 400 tubes per day are repaired. The cost in some cases will probably be somewhat less. He accomplishes this result by selecting machines of high capacity, and so locates them that the work is continuous and without useless movement on the part of the workmen. In no case is it necessary for the tube to be reversed, nor does any man have to take more than a step or two from his position in order to obtain a tube or to deliver it to the next man. It will be noted that no allowance is made for testing the tubes after they are safe ended, and the author claims that this procedure has been found to be practically needless where a modern roller type of welder is employed. The poor welds are so infrequent that it is claimed, it will pay better to remove the occasional bad tube than to test all the tubes. There may be some difference of opinion on this point, but there is no doubt but what the modern welder is a very decided improvement and gives very much better results than most of those now in use. It is quite possible that the quality of the tube and of the safe end may have considerable effect on a decision of whether it is worth while testing or not.

It will be noted that Mr. Pomeroy has very ingeniously arranged his tube department so that the regular shop crane can be used, but at the same time the work in this department is not dependent on it, and any delay in the crane service will not effect the work in the tube department. The type of car developed on the Canadian Pacific for carrying tubes has been selected by the author, because of its very evident advantage in permitting the cars to be tiered one on top of the other, for storage. This scheme not only saves shop floor space, but makes it more convenient for handling the tubes. Superheater flues are generally about 5½ in. in diameter for the greater portion of their length, and are narrowed down to about 4½ in. at one end. It is possible to safe end the smaller or firebox end of these flues once or twice, but a point is soon reached when the neck comes too close to the superheater element, and it will be necessary to extend the larger end of the flue. For this work, Mr. Pomeroy has selected a welder capable of adjustment and use on any diameter up to 6 in., permitting the safe end to be applied to either end of the superheater flue. Since there are a comparatively small number of these large flues, he has arranged a separate group of tools for this work, which it is expected will be intermittently used. On roads where there are few superheater engines, and even these few extra machines do not seem to be ad-

visible this work can be done on the regular welder if a type is specified that is capable of sufficient adjustment.

There is no doubt but what the safe ending of boiler tubes is costing altogether too much in many shops, and that the cost can be brought within a reasonable figure by a simple rearrangement of the machines to make the work more convenient. In others, it may require the installation of one or two new tools of higher capacity. Very frequently a new cleaner will greatly increase the output and proportionally decrease the cost. Mr. Pomeroy has pointed out what he considers is the best way, and if any one can improve upon it, we will be very glad to describe his methods.

Defective Freight Cars

The report of the Committee on Overhead Inspection of Box Cars, which was presented at the recent meeting of the Master Car Builders' Association, clearly indicates, from the reception which it received, that railway officers generally are awakening to the necessity of improving the condition of the freight equipment. The committee felt that there were two ways by which the problem could be approached—to concentrate the responsibility for losses, due to defective car bodies, in such a manner as to provide an automatic incentive for the use of better cars, and to establish standard requirements for the inspection of car bodies. These are good suggestions, but the trouble is so deep seated that more radical measures will undoubtedly be necessary if a permanent improvement is to be made. In the first place the design and construction of a large portion of the box cars now in service is such that radical changes must be made before it will be possible to maintain and keep the equipment in good condition, as far as protecting the lading from the elements and pilfering is concerned. That this condition exists cannot be entirely charged against the mechanical department, for in most cases the officers of that department were strictly limited as to the amount of money that could be expended for new equipment, and were not allowed to use such designs or specialties as they believed would give the best results.

Even if the design and structure of the car is above criticism it must be watched closely to keep it in good condition. This cannot be done if the car department forces are cut down and disorganized with every fluctuation in business. The work must be done systematically and thoroughly. While at first thought this may appear to be the most expensive method, it is really the cheapest. In commenting upon this phase of the question at the recent meeting of the Master Car Builders' Association, M. K. Barnum said: "I have spent a great deal of time in the last ten or twelve years figuring on who was making their car repairs the cheapest, but have seldom been asked who was keeping their cars in the best condition. The road in the West that is the very lowest in the cost of its car repairs is also above all others in the way its cars are maintained. A great deal of the trouble starts with the buying of new cars. The question of side doors has been raised here. We all know the difference between a first class door and one that is not first class is only a matter of a dollar or two a car, but it means \$2,000 for 2,000 cars, and so the cheap, flimsy door is generally preferred."

Canadian Pacific Mallet

Grouping the four cylinders of a Mallet locomotive at the center of the wheel base permits a decided simplification of the steam pipe arrangement with a considerable reduction in the number of ball and sliding connections. This is well demonstrated by the simple Mallet, designed and built by the Canadian Pacific, which is described by Mr. Evans in this issue. This locomotive bears the distinction of being the first simple articulated locomotive to be put in serv-

ice in this country and has been designed for comparatively high speeds. The four cylinder simple type was selected instead of the compound arrangement, because of the losses in comparative steam economy given by a compound when operated at high speeds. In addition to the simple cylinders, this locomotive presents a number of other new and interesting features. The adoption of a long drawbar with a radial buffer followed the experience with the customary pin connection on a similar locomotive built about two years ago. It takes but a moment's thought to recognize the advantage of this construction when there is as great a distance between the drivers of the two groups as there is in this case. Arranging the pins with a wedge face will permit taking up any wear that may occur on the buffers. This should be slight, as the buffers have large surfaces and are in full contact at all times. This design of buffer and drawbar connection would seem to be suitable for application between the engine and tender of any locomotive, particularly one having a very long overhang.

The design of spring supported quadrant boiler bearing and centering device is practically a duplicate of the one applied on the first locomotive, and its unaltered form is evidence of satisfactory service. This arrangement is particularly flexible and permits practically any desired resistance to the movement of the front group of wheels at any point in its travel, by a change in the angle of the bearing plate or wedge on which the quadrant operates, and also by altering the amount of weight carried on the friction-bearing plates. In the arrangement shown, at the beginning of the movement, there is a horizontal resistance of about 2,300 lbs. from the rolling resistance, and about 2,500 lbs. from the friction surfaces. In the first $3\frac{1}{4}$ in. deviation from the mid position, the rolling resistance increases rapidly up to about 3,700 lbs., while the frictional resistance decreases to 1,800 lbs., the combination of the two increasing from 4,800 lbs. to 5,500 lbs. At this point the inclination of the wedge changes from one in six to one in fourteen. This reduces the rolling resistance and the combined resistance for the horizontal movement is then practically constant at 3,500 lbs. If any tendency of the front truck to nose or sway occurs, it is easy to see that a greater inclination to the first section of the wedge will tend to overcome it, and a short trial will permit the selection of the proper arrangement to give the best results.

Eight equal exhausts coming in two groups of four each that may have any relation to each other from being simultaneous to being exactly spaced, offers a problem of exhaust pipe design and front end arrangement that is new. The experiments made in arriving at a solution of this question are briefly explained by Mr. Evans. It will be seen that a design of variable exhaust nozzle gave satisfactory results, but was finally discarded in favor of an ordinary single nozzle.

This same problem was also presented on the very large simple Mallet that was put in service on the Pennsylvania last spring. Various shapes and types of nozzles were tried, and finally the most satisfactory arrangement was a nozzle with a single tip of peculiar shape, being somewhat longer from front to back than across the center. It thus appears that the double nozzle did not give satisfactory results in either case.

It is interesting to note that the feed water heater used on the first engine has been discarded and that the boiler is practically of the standard arrangement. The same tendency is quite evident throughout the country, and it would appear that feed water heaters forming the front section of the boiler barrel have not proved the success anticipated. This appears to be due very largely to the difficulty caused by the pitting of the tubes in the heater. Among the other interesting features of this design, the type of power reverse gear developed on this road should not be overlooked. This offers all of the advantages of the screw reverse gear, and is operated by steam or air.

COMMUNICATIONS

FORMERS FOR HYDRAULIC PRESS

BALTIMORE, Md., May 3, 1912.

TO THE EDITOR OF THE AMERICAN ENGINEER:

Referring to the article on the Design of Formers for Hydraulic Press on page 226 of the May issue of the *American Engineer*, I would like to call your attention to a slight error in the clamping die shown in Fig. 4, page 228. The section *AB* does not show

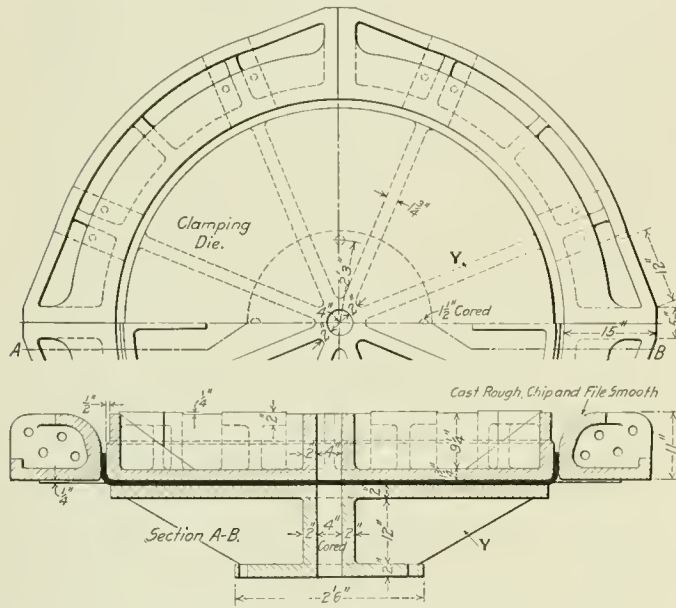

Formers for Pressing Boiler Tube Sheets.

the ribs that are indicated in the plan view by the dotted lines. They should be as shown herewith. The line *Y* in the elevation representing the corresponding rib *Y* in the plan view. The ribs are $1\frac{3}{4}$ in. thick and run from the extreme diameter of the clamping die to the base, making a substantial support.

LEWIS D. FREEMAN.

REPAIRING LOCOMOTIVE DRIVING BOXES

BALTIMORE, Md., June 22, 1912.

TO THE EDITOR OF THE AMERICAN ENGINEER:

In response to your invitation for criticisms of the methods of repairing driving boxes as given by E. T. Spidy in the June issue of the *American Engineer*, I wish to submit the following:

While the time required in handling the driving boxes is remarkable in some operations, yet the inaccuracies that result from the methods employed must, in several cases, be of such a character that the erecting shop will be required to spend much time and labor to make the locomotive tram, to say nothing of the end-play of the boxes that must vary from 1-32 in. to 3-16 in. due to the uneven wear on the flanges in the shoe and wedge space. All driving boxes should caliper the same on both flanges when tested for end-play. This condition would be impossible if the methods reported are employed. If the driving boxes are set in an absolutely level position when the hot metal is applied for end-play, the running of the metal to form the liner is not regular, nor can it be made absolutely so, even if the box is heated. Therefore, all other conditions being favorable to this operation, a true surface cannot be obtained without facing the box. Very few boxes wear the same on both flanges of the shoe and wedge space. The wear on the flanges is largely caused by rounding curves and the greater wear is

caused while engines are going ahead. This readily explains why some flanges are thicker than others, especially so where they are planed for vibration or oscillation. Therefore this condition would only add to the inaccuracy of the method given for pouring liners.

The seat of the saddle in the top of the boxes should also be square with the end face. This will avoid chafing of the frames and give a true bearing for the springs. The operation of slotting the crown brasses for box size is an ancient operation, as is shown by the time required to perform it. Allowing all the time specified in the time study, starting with the gaging and marking the corners and including removing from the machine, 35 minutes is required for performing this operation. It can be performed in 25 minutes on a lathe with the largest size brass measuring 13 in. by 13 in., and I have even seen these bearings turned in much less time on a vertical boring mill.

From the sketch of the gage I am unable to understand how the corners of the brass, after being slotted, will accurately fit the driving box and have an even bearing along the edges. This gage has fingers that can be adjusted in or out and apparently at a radius from the bolt used in clamping them, but it is lacking the necessary range to meet the many varied angles of these corners, as the different builders as well as different machine operators do not use the same degree or angle at this point. A slot in the fingers of the gage as shown can be used to suit the different diameters of the box, but the base on which the fingers rest should be sufficiently wide to permit a slot long enough to adjust the side fingers at any desired angle. They should be clamped together, when properly set, with a bolt, using wing nuts, thereby doing away with the wrench which is necessary to tighten up the gage as securely as will be required.

The drilling of dowel and oil holes can be best performed on a horizontal boring mill. A chuck mounted on a plate having ball bearings can be made at a small cost and will save the clamping and unclamping necessary on a drill press. The time required in turning the box over to ream from the inside is saved, as the chuck can be made to stop at any angle and ream exactly true from the inside after the holes are drilled. By utilizing such a chuck the drilling will be much handier and time will be saved.

As I have before stated, the flanges should caliper the same from the hub face, and as the wear is not the same on both flanges on the inside, all driving boxes should be faced while mounted on double knees, having a flange to clamp to the table of the boring mill and another at right angles trued off at the same height to extend beneath the flange of the box.* This should be high enough so that when boxes are placed on it, the flanges will rest on the right angle section of the knee and not on the back of the box. The box can be held firmly in place by set screws extending through the knee. This method will give an accurate surface from which to work. The driving box should then be planed in the shoe and wedge space with the face toward the knee mounted squarely upon planer. This will make the shoe and wedge space square with the face. The box should also be bored with the face against parallel strips. If the above method is carried out carefully the box will be bored absolutely central and by proving it will be found that on both the face as well as the back of the box, the exact center of the shoe and wedge space will be the center of the bearing. I thoroughly believe that the above method is the only accurate one and I know from experience that the method given by Mr. Spidy is very inaccurate. By moving the box back $\frac{1}{4}$ in. from the boring bar on the mill after boring the crown and extending the tool a little, a light cut may be taken, extending 1 in. back from the edge of the brass, which will only require a few minutes and will save the erecting shop about 20 minutes in chipping clearance.

JOHN V. LE COMPTE.

Foreman, Mt. Clare Shops, Baltimore & Ohio.

*See *American Engineer*, March, 1912, page 127.

MAINTAINING MALLET LOCOMOTIVES

New York Central & Hudson River Practice. Careful Inspection Followed by Immediate Attention to All Adjustments and Repairs Is of Vital Importance.

Twenty-six locomotives of the 2-6-6-2 type are in regular road service on the Pennsylvania division of the New York Central & Hudson River between Corning, N. Y., and Jersey Shore, Pa. This division includes some fairly difficult grades, as is shown in Fig. 1, and has numerous curves. The freight trains are operated at an average speed of 15 miles an hour, and up to about one year ago it required 60 large consolidation locomotives, with a tractive effort of 45,700 lbs. each, to move 1,000 loaded cars over the division in 24 hours; 29 of these were used as pushers on the heavier grades. When it became evident some time ago that the increasing traffic would soon necessitate either double tracking or the operation of heavier trains at the same speed, consideration was given to the possibility of using an articulated type of locomotive.

One engine of the 2-6-6-2 type was purchased and careful tests were made with it in comparison with two different designs of consolidation locomotives.* These tests extended over a period of two and a half months, and resulted in the purchase

and a pressure reducing valve in the high pressure cylinder saddle, with a separate exhaust when the locomotives are operating simple.

On the test, the Mallet locomotive handled 3,461 tons behind the tender at 15 miles per hour and 3,734 tons at 12½ miles per hour. After one year's continuous service all of the locomotives are handling an equal tonnage at speeds as good as or better than those obtained in the test. They are doing this easily and to the complete satisfaction of all concerned. The fuel and water consumption is practically the same as was obtained on the tests which required .084 lbs. of coal per ton-mile at 15 miles per hour. This was practically 40 per cent. less than was required by either of the consolidation locomotives at the same speed.

This continued excellent service of all of these locomotives indicates that they were properly designed for the conditions, that they were well built, and, most of all, that they are being properly taken care of at the terminals. Even with the first two

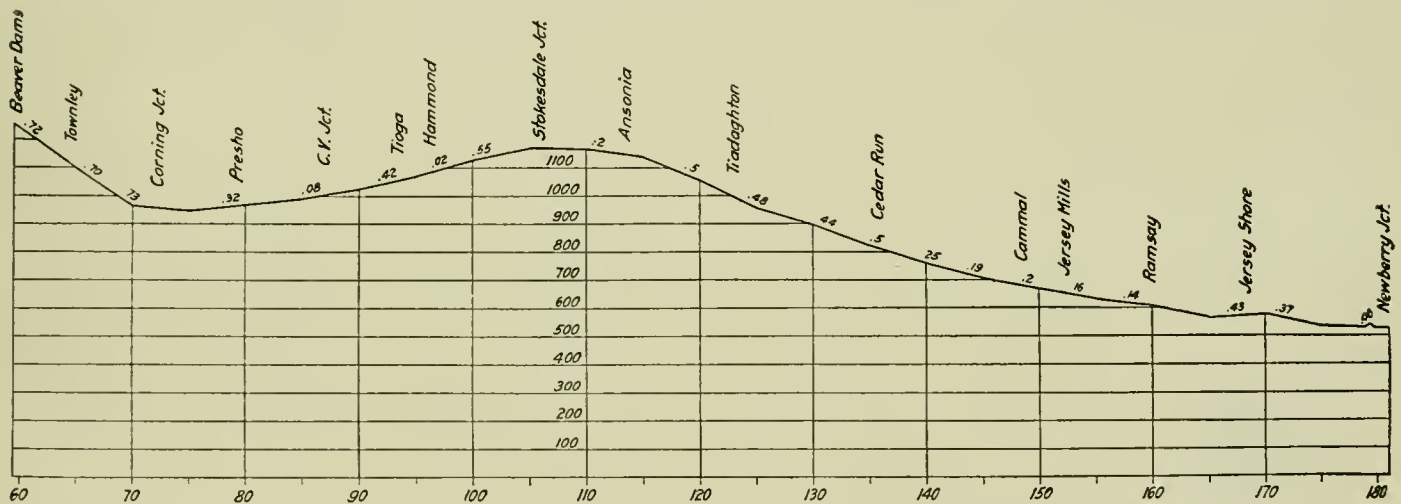

Fig. 1—Profile of Pennsylvania Division of the New York Central & Hudson River Between Jersey Shore and Corning.

of 25 more Mallet locomotives of the same design as the one tested. These locomotives are of the 2-6-6-2 type, and were built by the American Locomotive Company. They are fitted with Schmidt superheaters which have 966.3 sq. ft. of heating surface. The cylinders are 21½ in. and 34 in. x 32 in.; the steam pressure is 200 lbs., and the drivers are 57 in. in diameter. The locomotive has a total weight of 354,000 lbs., of which 301,500 lbs. are on drivers. The tractive effort is 67,500 lbs. working compound and 81,000 lbs. working simple. The rigid wheel base is 10 ft.; the total driving wheel base is 30 ft. 8½ in., and the total wheel base of the engine and tender is 75 ft. 8 in. There are 235 2¼ in. and 36 5½ in. tubes 22 ft. in length, which give a heating surface of 2,468 sq. ft. The total heating surface of the boiler is 3,293 sq. ft., and grate area is 56.5 sq. ft. All the locomotives are fitted with Security brick arches. The boiler is of the straight top type, having a radial stay firebox, and measures 83¾ in. diameter at the front end. The high pressure cylinders have piston valves, while the low pressure cylinders are fitted with slide valves. The Mellin system of compounding is employed, having an intercepting

conditions beyond criticism, without proper attention to maintenance the present satisfactory results would not be obtained.

The secret of the success in the maintenance of these locomotives, as well as all the others running into the same terminal, lies in the extreme care taken in inspection and the immediate attention given to all adjustments and repairs. No locomotive is allowed to leave the terminal at either end with any work left undone which has been reported by the engineer or the inspectors, if it will, even in the slightest degree, effect the operation of the engine. The result is that after a year's service every one of the locomotives is practically as good as new, and is performing work every day equal to that done by the original engine under the special conditions surrounding the test runs.

A new locomotive terminal* was placed in operation during the year 1910 at Corning, N. Y. This included a new engine house of the standard New York Central design, having normally 92 ft. interior space between walls and including five pits in a drop pit section which is 115 ft. between walls. In these long pits the Mallet locomotives can be easily housed, but

*For full report of the tests and description of the Mallet locomotive, see *American Engineer & Railroad Journal*, December, 1911, page 471.

*For fully illustrated description, see *American Engineer & Railroad Journal*, December, 1911, page 461.

in the shorter ones it is only by practically blocking the passage at both ends that they can be taken inside the doors. There is an excellent machine shop with a tool equipment sufficient for running or light general repairs. At Avis (Jersey Shore), however, the engine house has but few of the 92 ft. pits, and it is practically impossible to completely house the locomotives at this point. New construction will soon be undertaken here which will give an ample number of pits of sufficient length to easily accommodate the Mallets. The Avis repair shops are located near the engine house, and provide ample facilities for

coal chute by its regular crew. It is then taken in charge by the hostler who fills the tender with coal and water, and the sand box with sand, and sees that the fire and the water level are in proper condition before leaving it. The engineer on his way to the engine house stops at the office of the inspectors and dictates to the clerk in charge a memorandum of any repairs or adjustments that he considers necessary. This work is entered by the clerk on forms M.P. 344 and 345 (Figs. 2 and 3) which are bound in book form. Each separate subject is given a separate item and after being entered, they are read

Form M. P. 344 N. R. 5824



Condition of Locomotives at end of trip, and of Air Brake Equipment before leaving terminal.

Date _____ 19____

| Loco. No. | SAFETY VALVE | | AIR PRESSURE | | * CONDITION OF | | | SIGNATURE OF ENGINEMAN | AIR BRAKE EQUIPMENT INSPECTED BY ME AND FOUND IN GOOD CONDITION BEFORE LOCOMOTIVE LEFT THIS TERMINAL (To be signed by A. B. Insp.) | |
|---|---------------|---------------|----------------|-----------------|----------------|------|-------------|------------------------|--|-------------------|
| | Lifts at Lbs. | Seats at Lbs. | Reservoir Lbs. | Train Line Lbs. | INJECTORS | | Gauge Cocks | | | Glass Water Gauge |
| | | | | | Right | Left | | | | |
| | | | | | | | | | | |
| | | | | | | | | | | |
| * IF CONDITION IS NOT O. K. THE DEFECTS MUST BE SPECIFIED IN BOOK, FORM M. P. 345 | | | | | | | | | | |

Fig. 2—Form for Reporting Condition of Safety Valves, Air Brakes, Injectors, Gages, etc.

all classes of repairs. An 85 ft. electrically operated turntable at both points is of sufficient size to easily turn these locomotives. There is no special equipment of any nature provided for the Mallets at either end of the division, nor are there special men assigned to work on them. They are treated in every way the same as any other locomotive that comes to the terminal.

A traveling engineer is assigned to this power and spends a large proportion of his time on the road riding the Mallet

over and personally signed by the engineman, who then proceeds to the engine dispatcher's office, "signs in," obtains his mail and is relieved. The fireman accompanies the engineman, and any work he has to report is included with that of the latter.

When the inspection pit is cleared, the chief inspector boards the locomotive at the coal chute and brings it to the inspection pit. Four men then proceed to examine it. One inspector in the pit examines all of the running gear that is visible, or can

Form M. P. 345 N. R. 5925



Condition of Locomotives at end of Trip.

Date _____ 19____

| Loco. No. | The Locomotive is in good condition, with following exceptions (To be signed by ENGINEMAN & INSPECTOR) | Disposition of each item of work Reported 1. Repaired 2. Work not Necessary 3. Held over | No. of forms M. P. 347 Issued for each Loco. |
|-----------|---|---|--|
| | | | |
| | | | |
| | | | |

Fig. 3—Form for Reporting Condition of Engine at End of Trip.

locomotives. This practice undoubtedly has a decided bearing on their successful operation. One traveling engineer to 26 locomotives on a division about 100 miles in length is undoubtedly an efficient arrangement and will have considerable effect on train operation. A traveling fireman is assigned to all of the locomotives on the division, and the Mallets obtain simply their proportion of his attention. All of the locomotives have regularly assigned enginemen and firemen.

On coming in from a trip, the locomotive is brought to the

be reached from that point; another on the ground outside examines all parts of the running gear, frames, cylinders, boiler and its attachments that are accessible from this point. He carefully notes the condition of the brick arch, flues, grates, etc. A third inspector carefully examines all parts of the air brake system. The fourth inspector is a helper who fills all grease cups and headlights, applies new bell cords, puts soda ash in the tank, etc. These inspectors are provided with wrenches and hand tools, and take care of all repairs which

can be made without delay, such as tightening loose nuts, applying cotter keys, putting on new brake shoes, packing tender journal boxes, draining air reservoirs, taking up the slack of brake cylinder push rods, etc. This work requires from 30 to 45 minutes for a Mallet locomotive under ordinary conditions, and not infrequently as much as 50 minutes or an hour are used. Upon its completion, each inspector reports to the desk, examines the engineer's report, and dictates to the clerk any other work he has found necessary. This is entered below the engineer's report and is signed by the inspector.

A hostler then takes the locomotive from the inspection pit to the cinder pit, where the fire is cleaned, the outside of the boiler and the running gear washed down with a hose; the engine is then taken to the house. At Corning, the fires on all Mallet locomotives are dumped, while at Avis they are usually only cleaned. This is done because of the rule in force that requires all boiler tubes to be blown with air, and the brick arch to be cleaned off at the end of each round trip.

Items on forms M.P. 344 and 345 are transferred by the clerk to form M.P. 347 (Figs. 4 and 5). A separate slip is made out for each item, and these are numbered consecutively for each locomotive and the number is entered in the last column of M.P. 345. These slips are sent to the engine house and placed on the foreman's desk. As soon as the locomotive comes in its number is entered on the blackboard near the foreman's desk opposite the proper pit number. The work slips are then placed in pigeon holes corresponding to the pit number on which the locomotive is standing. Those for the attention of the boiler maker, air brake gang, cab work, etc., are placed in separate pigeon holes under these headings.

From here the engine house foreman distributes the work to the machinists, giving each a slip corresponding to the job that he is to perform. After the repair or adjustment is made, the slip is signed by the workman and returned to the foreman's desk. If, for any reason, such as lack of material, lack of time or the necessity for a decision from higher authority, it is impossible for the workman to perform a comparatively unimportant piece of work, he fills in the space on the back of the card, giving the proper reason in full. This is approved

| | | | |
|--|----------------------------|-------------------------------------|------------|
|  | | (G. M. P. Co. 8101). Form M. P. 347 | |
| LOCOMOTIVE WORK CARD. No. _____ | | | |
| Eng. No. _____ | Eng'r _____ or Insp. _____ | Place and Date _____ | |
| _____ _____ _____ _____ | | | |
| Above Work Performed by _____ | | | Date _____ |

Fig. 4—Face of Locomotive Work Report.

by the foremen and placed in a separate pigeon hole for all unfinished work. The cards for completed work are returned to the inspector's office each day, where they are checked off against the items on M.P. 344 and 345, and filed under the engine number in a special cabinet.

There has been nothing of any importance that can be noted as giving special trouble on the Mallet locomotives. The ball joints on the receiver pipe require slight adjustment about once a month and a renewal of packing on an average of about once in three months. Some difficulty was found with the sand pipe leading to the front group of wheels, as it was originally applied. This, however, has been overcome by the substitution

of metallic hose for the slip joint arrangement previously used. The intercepting valve chamber requires opening on an average of once in every three or four months for the purpose of cleaning and lubricating. It was found that this valve had a tendency to stick, somewhat like an air brake triple valve, at about these intervals. It is easily accessible, and this work is easily and quickly performed. No trouble has been given by the cutting of the packing either on the valve stem or the piston rod by the superheated steam since the application of the style of packing now in use. It is seldom that a report is made of valve or piston packing blowing. Although no flange lubri-

| REMARKS—Why Not Done | Foreman | Date |
|----------------------|---------|------|
| | | |
| | | |
| | | |
| | | |
| | | |
| | | |
| | | |
| | | |
| | | |
| | | |

Fig. 5—Back of Locomotive Work Report.

cators are used on the drivers, they show no sharp flanges after over 30,000 miles service. Indications are that the tires will give a mileage close to 50,000 before they require turning. Grease driving box lubrication is employed and hot boxes are very infrequent. No trouble at all is given by leaky flues, although the water is not specially good. Before the application of the brick arch on this division, leaky flues were frequent and troublesome, and it is believed that the arch is largely responsible for their great infrequency at the present time. The arch is run down solid against the throat sheet.

One of the Mallet locomotives is fitted with a Street stoker; it has been in regular service for a year, and is operating with great reliability. It has been found necessary to increase the size and weight of some of the parts, but no engine failures have been assigned to the failure of the stoker.

There are a number of two cylinder Richmond compounds in use out of the Avis terminal, which gives the workmen at this point a familiarity with the Mellin system of compounding that is of some advantage in the maintenance of this feature of the Mallots.

LINEN IN DINING CARS.—Some figures showing the amount of work involved in caring for the linen used on the dining cars of a large railway system have been compiled by the Southern Pacific. An average of 315,000 pieces of linen are laundered each month in this department, including 100,000 napkins, 100,000 dish towels, and 40,000 table cloths, and each piece is carefully looked over by inspectors to detect tears or signs of wear. At the commissary department at Oakland, Cal., there is maintained a linen repair room where thousands of napkins, table cloths, dish towels and cooks' and waiters' aprons are kept in perfect condition. Fourteen electrically-operated sewing machines are kept running steadily eight hours a day and six days a week. With these machines it is said that a hole in a piece of table linen can be darned so well that it is sometimes impossible to detect the stitches from the original weave. Each piece of linen as it is brought in from a trip is counted and careful count and inspection are continued until it is returned. In employing women for this work preference is given to dependent relatives of employees who have been injured or killed

SHOP KINKS

The following shop kinks or devices are in use at the Tyrone, Pa., shops of the Pennsylvania Railroad.

TIRE TRUCK.

The truck shown in Fig. 1 is used for carrying tires to and from the storage yard. It is made of $\frac{3}{4}$ in. x $1\frac{3}{4}$ in. bar iron. The wheels are $13\frac{1}{2}$ in. in diameter and are spaced far enough apart to give sufficient stability and to allow the tires to set securely on the $4\frac{1}{2}$ in. steps shown on the side view of the truck.

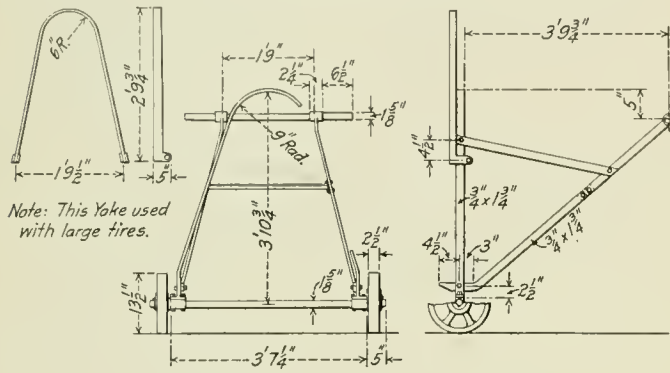

Fig. 1—Truck for Carrying Tires.

The truck was first built for handling small tires and proved so successful that a yoke was added, as shown, to accommodate the larger ones. When the handle is pressed downward the tire slopes back enough so that it will not be jarred off.

SAND DRYER.

The steam coil shown in Fig. 2 has been in continuous service for three years, drying about 12 tons of sand per day. It is made up of 24 sections of $1\frac{1}{4}$ in. pipe. The bottom section contains four slides or covers, which are removed when it is de-

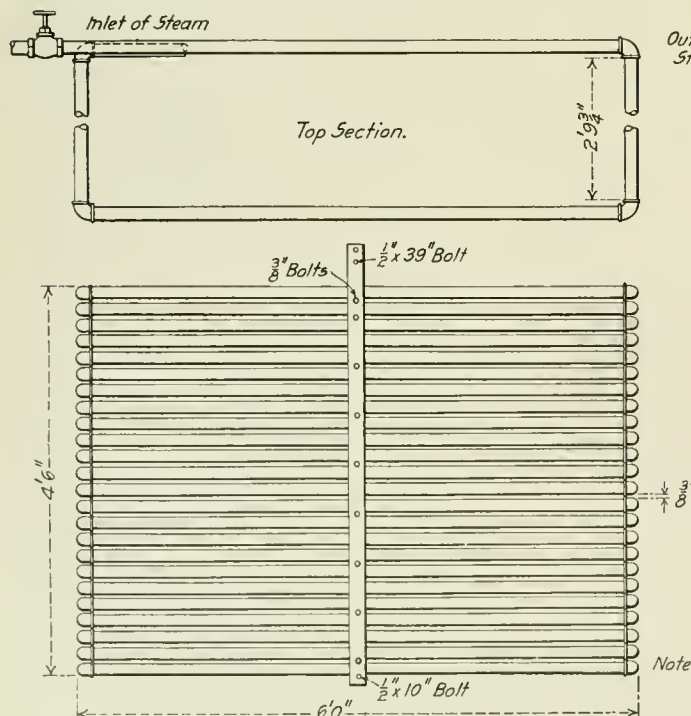

Fig. 2—Steam Coil for Drying Sand.

sired to clean the coil. It is located below the sand bin, and two chutes, 2 ft. in diameter, conduct the green sand from the bin to the coil. The pipes have not rusted since they were installed three years ago and seem to be in good condition.

IRON BOX FOR DIRTY WASTE.

The box shown in Fig. 3 is used as a receptacle for dirty waste. Its chief point of merit is that the cover is always closed, except when the waste is either being put in or removed from

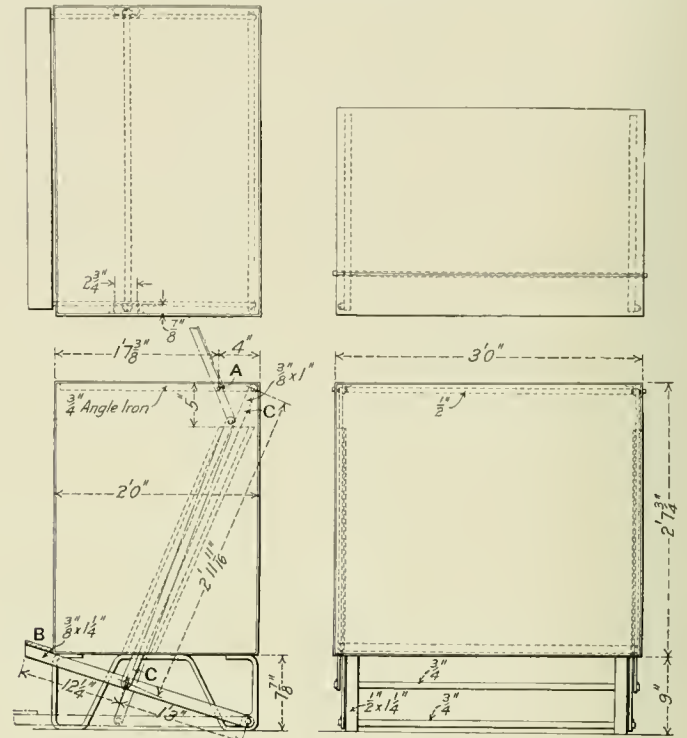
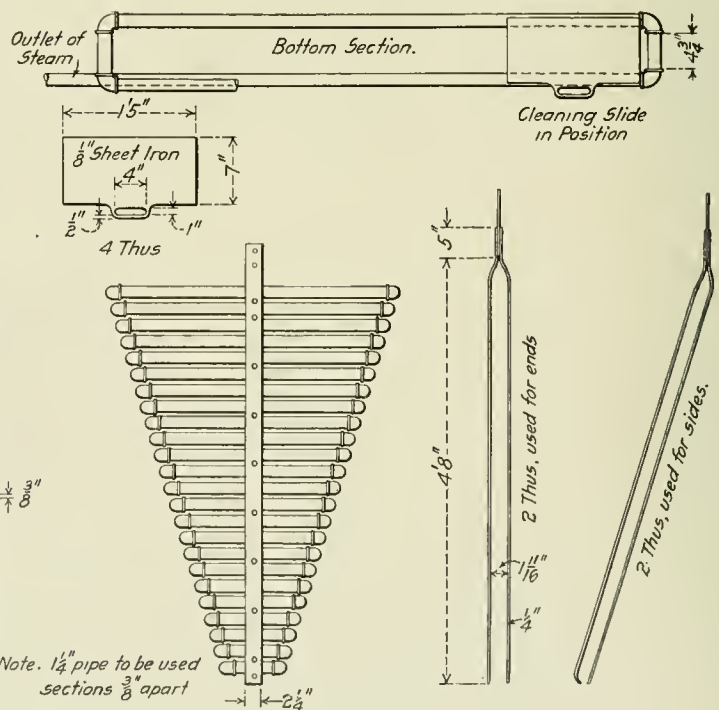

Fig. 3—Iron Box for Soiled Waste.

the box. The cover is swung on the pin A, and is opened by pressing on the treadle B, which is connected to the cover by the $\frac{3}{8}$ in. x 1 in. bar C. The dot and dash lines show the posi-



tion of the cover, bar and treadle when the cover is raised. The weight of the cover is sufficient to close it down when the foot is removed from the treadle B. As will be seen, the bar is enclosed in a pocket which allows it to operate easily.

ENGINE HOUSE REPORTS AND RECORDS

Must Be Few in Number, Brief, Accurate and Comprehensive and Must Be Designed for Use in Permanent Files Which Can Easily Be Referred to.

BY ERNEST CORDEAL,
Atchison, Topeka & Santa Fe, La Junta, Colo.

Next in importance to effective organization in promoting efficiency in the engine houses comes accurate, concise and immediate reports and records to indicate the work which is to be, or has been done. After a satisfactory organization has been perfected the next step is to provide its members with a simple, yet complete means of conveying the necessary information and instructions to govern the movement of the men and to insure the furnishing of such data as will be necessary to maintain the requisite records.

The suggestion of such forms, few in number and entailing the minimum of clerical labor, as are necessary to cover the various operations at engine houses is the purpose of this article. These forms, eight in number, may be designated by the

quate nor convenient. Probably the most prevalent method of handling engineers' work reports is to have, in the office of the engine house foreman, a book in which the engineer is expected, after the completion of his trip, to enter the items of work which he considers it necessary for the repair force to do before the engine is again called into service. Too often an examination of work report books of this nature reveals the fact that their pages contain essays by individual engineers on the subject of the general run-down condition of the particular engine they happen to be running, but are peculiarly devoid of any definite information as to what parts should be repaired or renewed. Other reports consist of minutely detailed accounts of the work which, in the engineer's opinion, should be done and in some cases also contain definite instructions as to how the work should be performed.

A work report of this kind must be read over by the foreman, or more generally by his clerk, who culls out such points as he considers necessary for the preparation of work slips to be distributed to the workmen. In so doing it is more than likely that the elaborately written report, giving details as to the performance of the engine and specific instructions as to the method of making repairs, will receive but slight consideration, only a few of the most important points being transmitted to the men performing the actual work. In this way really important matters, which are to an extent covered up by the verbosity of the reportee, may be entirely overlooked, giving the engineer cause for his complaint with regard to work reported and not done.

The form suggested as an engineer's work report is illustrated in Fig. 1. This form should be made up on sheets of convenient size to be carried in the pocket; say, 4 in. x 7 in., and bound into books with pliable covers, each sheet being perforated so as to be easily removed as used. The idea is that the engineer should carry one of these books with him on the road and should enter therein the defects which develop during the actual operation of the engine. This removes the possibility of items being forgotten, which is a thing of not unusual occurrence where the report is not made until the end of the trip. Another advantage is that on the arrival at a terminal the report is complete and it is only necessary for the engineer or fireman to drop it at the foreman's office instead of spending a considerable amount of time which rightfully belongs to them in thinking over and recording the weak points on the engine.

The report is made in such form as to insure the greatest brevity consistent, furnishing as it does the name of the defective part and the location and nature of the defect, which is all the information needed by the mechanic who is to make the repairs. The work on the machinery and the boiler is separated so as to minimize the efforts of repair foreman in segregating the items under each head.

Inspectors' Work Report.—After the arrival of an engine at the inspection pit or in the engine house, it should be thoroughly looked over by a competent mechanic for the purpose of detecting any defects which may have escaped the notice of the engineer. Before making a report the inspector should carefully peruse the engineer's work report to avoid any duplicate reporting of work, after which he should fill out a form as shown in Fig. 2, which is substantially the same as that used by engineers and is merely a supplement thereto. These two work reports furnish the information necessary for the engine house foreman

| ENGINEERS' WORK REPORT | | |
|------------------------|-------|-----------------|
| Engine Number _____ | | |
| Station _____ | | Date _____ |
| MACHINERY | | |
| Part. | Side. | Work Necessary. |
| | | |
| | | |
| | | |
| BOILER. | | |
| Part. | Side. | Work Necessary. |
| | | |
| | | |
| | | |
| _____ Engineer. | | |

Fig. 1—Engineers' Work Report.

following heads: Engineers' work report; inspectors' work report; hostlers' report of engines handled; foremen's report of work done; daily line-up; daily report of engines handled; monthly report of engines handled; monthly inspection report. These few reports, it is believed, will fill the general need, furnishing all the information that is necessary without duplication.

Engineers' Work Report.—We hear constant complaint from engine house foremen to the effect that engineers do not properly report work. As constantly, the engineers contend that work which they report is not done. Both contentions are no doubt true to a great extent, and there is little doubt that the responsibility for this condition lies in the fact that the forms used for the reporting of work, in the majority of cases, are neither ade-

to make an estimate of the length of time that will be necessary to complete the repairs and make the engine ready for service. They also furnish to the repair foremen the data which they require in assigning workmen to the various repairs. The use of these forms in expediting repairs and as a permanent record will be discussed later in relation with the other forms suggested.

Hostlers' Report of Engines Handled.—The form illustrated in Fig. 3 is for the use of the head hostler in conveying information as to engine movement to the engine house foreman, and should be handled as a daily record. As to size and binding, the recommendations for the engineer's work report might be advantageously followed in this case. As soon as an engine is turned over by the engineer to the engine house force the engine number and exact time of the transaction is recorded in columns 1 and 2. When the engine has been properly supplied, the fire knocked, and it has been placed in the engine house, the time is recorded in column 3, which indicates its passing from the hands of the hostling force to those of the repair foremen. When the

The work of each shift should furnish a complete report on this form, that is, the movement of all engines handled by the shift should be entered on one form which at the end of the working day is turned in to the engine house foreman's office.

| INSPECTORS' WORK REPORT | | |
|--------------------------------|-------|-----------------|
| Engine Number _____ | | |
| Station _____ | | Date _____ |
| MACHINERY. | | |
| Part | Side. | Work Necessary. |
| | | |
| | | |
| | | |
| | | |
| BOILER. | | |
| Part. | Side. | Work Necessary. |
| | | |
| | | |
| | | |
| | | |
| _____ | | Inspector. |

Fig. 2—Inspectors' Work Report.

engine is again under steam with repairs complete, the time is entered in column 4, this representing the time when the responsibility for the engine's movement is again shifted from the repair foremen to the hostling force. After the necessary work of fueling, sanding and watering has been performed, and the engine is turned over to the crew, column 5 is filled in, indicating the end of responsibility for the engine house force.

The sixth column is to be entered from the "line-up," and represents the time at which the engine must be turned over to the road crew to insure ample time for them to proceed from the engine house tracks to the train. The seventh and eight columns are for the purpose of recording delays to outgoing engines for which the engine house force is responsible, the former giving the duration of such delay and the latter furnishing the explanations. Under an effective organization these two final columns will, as a general rule, be superfluous, but even at the best managed engine house delays, seemingly almost unavoidable, will occur at rare intervals.

| HOSTLER'S REPORT OF ENGINES HANDLED | | | | | | | |
|--|----------------|----------------|-------------|-----------------|--------------|---------------|--------|
| Station _____ | | | | Date _____ | | | |
| Engine Number. | Time Received. | Time in House. | Time Ready. | Time Delivered. | Time Wanted. | Delayed. | Cause. |
| | | | | | | | |
| | | | | | | | |
| | | | | | | | |
| | | | | | | | |
| | | | | | | | |
| | | | | | | | |
| | | | | | | | |
| | | | | | | | |
| _____ | | | | | | Head Hostler. | Shift. |

Fig. 3—Hostler's Report of Engines Handled.

It will be understood, of course, that all columns will not be filled out on a single report for each of the engine numbers given, as in a large number of cases engines which are handled in on one shift will not be handled out until the following shift.

| FOREMAN'S WORK REPORT | | | |
|------------------------------|-------|----------------|------------|
| Engine Number _____ | | | |
| Station _____ | | Date _____ | |
| Time Received _____ | | | |
| Time Ready _____ | | | |
| Part. | Side. | Work Done | Man Number |
| | | | |
| | | | |
| | | | |
| | | | |
| | | | |
| WORK REPORTED AND NOT DONE | | | |
| Part. | Side. | Work Not Done. | Reason. |
| | | | |
| | | | |
| | | | |
| _____ | | | Foreman. |

Fig. 4—Foreman's Work Report.

It will be seen then that these forms, if intelligently handled, will constitute a continuous record of locomotive movements from shift to shift and from day to day.

Foreman's Work Report.—The form shown in Fig. 4 is for the

use of repair foremen in recording the actual work performed in the progress of repairs, and further to indicate the reported work which was not done and the reason for its neglect. A book of these forms, similar in size and make-up to the engineers' work report, should be constantly in the pocket of each repair foreman. Immediately on a locomotive being placed in his hands by the hostlers he should enter the engine number,

allowing the work to be shown in the "not done" section of his report, makes himself responsible for the ability of the part in question to make another trip over the road without danger.

Daily Line-Up.—The purpose of this form, as illustrated in Fig. 5, is to furnish to the interested parties the fullest information possible as to the engines which will be required for service during the day and the time at which they must be ready. The line-up should be made in the engine house foreman's office before the beginning of the working day, so as to be in the hands of the various foremen when work is commenced. The necessary information as to the time of delayed trains, and also as to the requirements for extra power must be obtained from the chief dispatcher.

It will be well understood, by anyone conversant with engine house operations, that any such line-up as this issued to cover a 24-hour period must be subject to revisions at any time in order to take care of unexpected demands for power or unpredicted delays to regular trains; it will be found necessary to

DAILY LINE-UP

Station _____ Date _____

| Engine Number. | Train Number. | Time. | Repairs Complete. | Engine Ready. | Remarks. |
|----------------|---------------|-------|-------------------|---------------|----------|
| | | | | | |
| | | | | | |
| | | | | | |
| | | | | | |
| | | | | | |
| | | | | | |
| | | | | | |
| | | | | | |
| | | | | | |
| | | | | | |

_____ Engine House Foreman.

Fig. 5—Form for Report of Daily Line-Up.

date and time received, which should correspond with the time shown in column 3 of the hostlers' report. As the work progresses the various operations should be entered, together with the number of the mechanic assigned to the job. After the repairs have been completed the time should be entered in the proper place and the report may then be checked against the

LINE-UP CHANGE SLIP

Station _____ Date _____

Time Issued _____

Add to } Line-Up as Follows.
Change }

| Engine Number | Train Number | Time | Repairs Complete | Engine Ready | Remarks. |
|---------------|--------------|------|------------------|--------------|----------|
| | | | | | |
| | | | | | |
| | | | | | |
| | | | | | |

_____ Engine House Foreman.

Fig. 5a—Line-Up Change Slip.

work reports to determine the operations which were not performed.

It frequently occurs that work reported by engineers or inspectors is found to be unnecessary, in which case the proper notation will be made under the caption "Reason." Other work, not of vital consequence, it may be found expedient to defer until a subsequent trip, and in this case, the repair foreman, by

DAILY REPORT OF ENGINES HANDLED

Station _____ Date _____

| Engine Number. | Ar-rived. | Re-ceived. | Repairs Completed. | Ordered For. | Ready. | De-parted. | De-layed. | Detention. | |
|----------------|-----------|------------|--------------------|--------------|--------|------------|-----------|------------|-----|
| | | | | | | | | MD. | TD. |
| | | | | | | | | | |
| | | | | | | | | | |
| | | | | | | | | | |
| | | | | | | | | | |
| | | | | | | | | | |

Total Engines Out _____

Detention Mechanical Department _____

Detention Transportation Department _____

Delays _____

Fig. 6—Daily Report of Engines Handled

provide for such emergencies by the use of a line-up change slip (Fig. 5a), which should be issued immediately on receipt of information to advise all parties that a change of plans will be necessary. On some roads it is necessary for the mechanical department to furnish the transportation department with a line-up report showing what engines are available for service and at what time they will be ready. The preparation of this statement is a matter of little difficulty where reliable work reports are furnished, and a form similar to Fig. 5, but giving only engine numbers and time ready, could be advantageously used.

Daily Report of Engines Handled.—As a vehicle of information to officers and as a permanent record for the supplying of the necessary data to complete certain general reports, it is important that a daily statement should be issued covering the history of locomotives, while in charge of the engine house force. In Fig. 6 is illustrated a form which it is believed compiles the needed information in the most concise form possible.

This report shows the time of arrival of trains at the ter-

through the hands of the engine house foremen to those of the repair foremen as their guide in performing the necessary work. In order to avoid the necessity of making these reports in duplicate to supply the necessary information to foremen in charge of machinery and boiler repairs, and also to protect the reports from loss, destruction, or partial obliteration, it will be found advisable to provide small boxes on the wall of the engine house immediately in front of each pit in which the reports may be placed which refer to the engine occupying the stall. The reports should be placed in the boxes immediately upon arrival of the engine in the house. This plan obviates the necessity of making work orders for each individual operation to be performed, as the foreman has simply to consult the report and assign workmen to the various jobs. The workmen will have easy access to the reports in case of dispute or uncertainty as to the work required.

The foreman's report of work performed should also be deposited in this box, so as to be available to both machinery and boiler foremen, who may use the same form, thereby concentrating all information for each engine on one blank. After the completion of repairs the three reports should be collected and filed in the engine house foreman's office under engine number and in date sequence. A cabinet, containing pigeon holes corresponding in number to the assigned power, will be found the best method of filing these reports. It is constantly necessary to refer back to work reports for preceding trips and the suggested forms and system of filing provide a means of accomplishing this with the minimum of effort.

The hostlers reports of engines handled must of necessity remain in the possession of the head hostler during his shift and be turned in to the foreman's office only at the end of that period, where they should be filed in date order, forming a consecutive history of engine movements through the engine house.

The daily line-up together with the line-up change slips provide the engine house foreman with a method of issuing the pertinent instructions to his subordinates as to power requirements. This form should be made in manifold, so as to provide copies for each of the repair foremen, for the head hostler, and also a file copy to be retained in the office, which after the end of the day is filed in date order as a permanent record.

The three remaining reports, "The Daily Report of Engines Handled," "Monthly Engine House Report," and "Monthly Inspection Report," are primarily for the information of the master mechanic and higher mechanical department officers. They are simply compiled from detail reports furnished by foremen and inspectors, which work is performed by the clerical force.

It is of course realized that the forms suggested may not provide a means of furnishing all of the data which may be required of the engine house, the quantity and subject of such information being a matter of local preference. Any or all of the forms may, however, without change of principle be adapted to the requirements on any division or system, where either more or less information than that provided for is required, by simply contracting or extending their scope. It is believed that the system suggested will insure the greatest accuracy coupled with effectiveness and simplicity.

RAILWAY WAGES.—The Bureau of Railway Economics, having made a study of the railway conditions in the United States and the principal countries of Europe, states that the average daily compensation of railway employees of all classes for the year 1910 was \$2.23 in the United States; \$1.05 in the United Kingdom; 81 cents in Prussia-Hesse, excluding the supplementary allowance negligibly affecting the average, and 89 cents in Austria. The lowest paid railway employee in the United States receives a greater compensation than those on any railway of France and more than some of the higher grade of employees with responsible duties.

SHOP KINKS

BY M. H. WESTBROOK,
Grand Trunk, Battle Creek, Mich.

MACHINING TIRE RETAINING RINGS.

The machining of retaining rings is a large item on roads that use them, and there are several different methods for doing the work; the one described herewith is the simplest and most satisfactory of any yet tried by the writer. Four holes are drilled

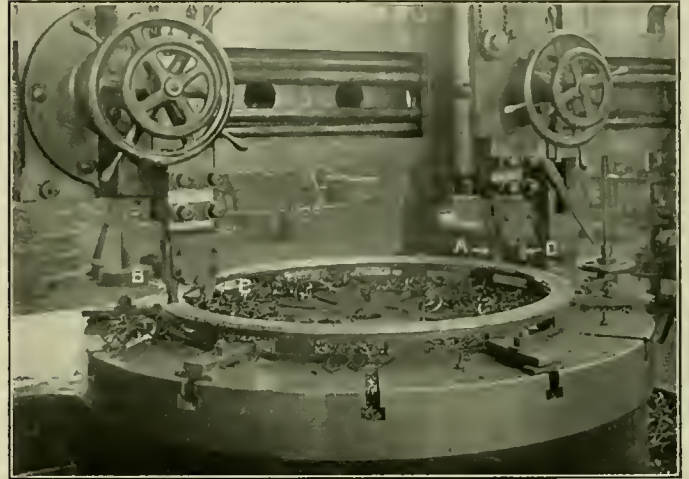

Fig. 1—Machining Tire Retaining Rings.

and tapped in each ring at points that are spotted for rivet holes. The ring is then attached to the jig shown in Fig. 1 by cap screws set in from the underside of the jig, the screws, of course, not being long enough to extend through the ring. The jig is

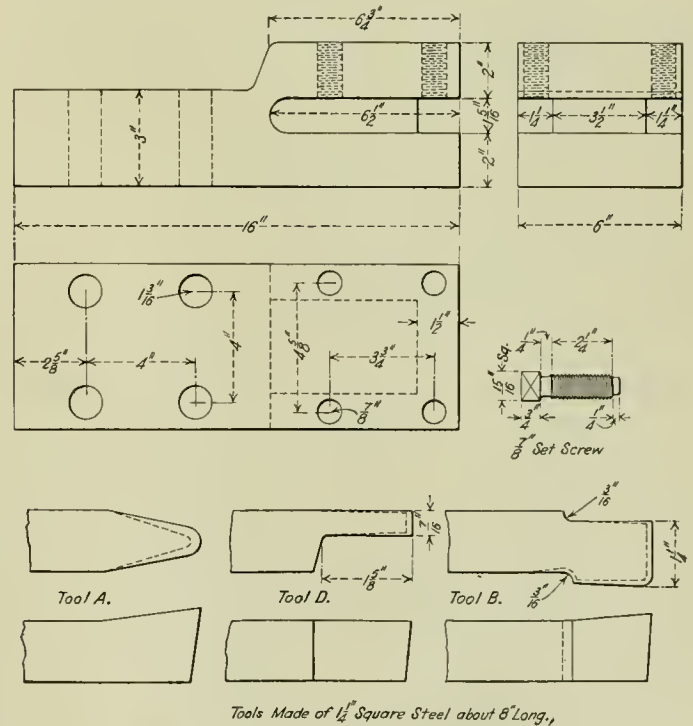

Fig. 2—Tools Used for Machining Retaining Rings.

then centered and clamped to the table of a two-head boring mill. The finished retaining ring is shown in Fig. 3.

There are two tools fixed in each tool holder, which are shown in detail in Fig. 2. The tool *A* is set in the right hand head, and is used to finish the face of the ring in one cut. The tools *B* and

C (Fig. 1) are set in the left-hand head to turn the outside and inside diameters respectively. These tools are spaced in the holder to give the required width of ring, and are started immediately after the tool A has begun to cut. The tool B is so shaped that it may be used to round over the under-corner of

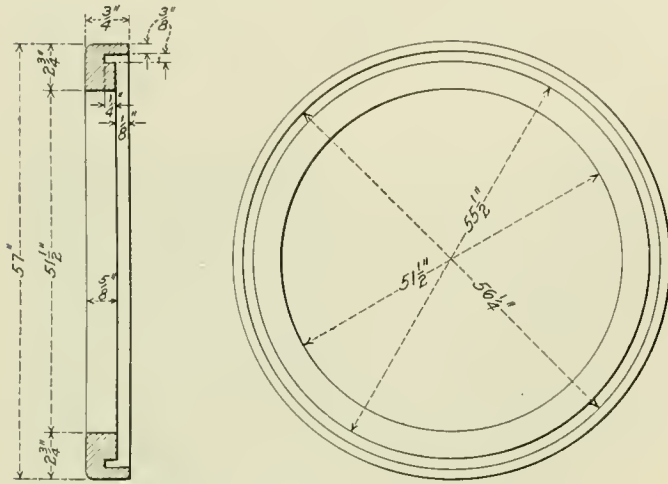

Fig. 3—Finished Tire Retaining Ring.

the ring after the diameter has been turned, in this way eliminating the necessity of setting a separate tool for that purpose. It is not necessary to turn over the corner on the inside of the ring. The tool D is used to form the groove in the ring after it has been faced off by the tool A. As the tool A approaches the

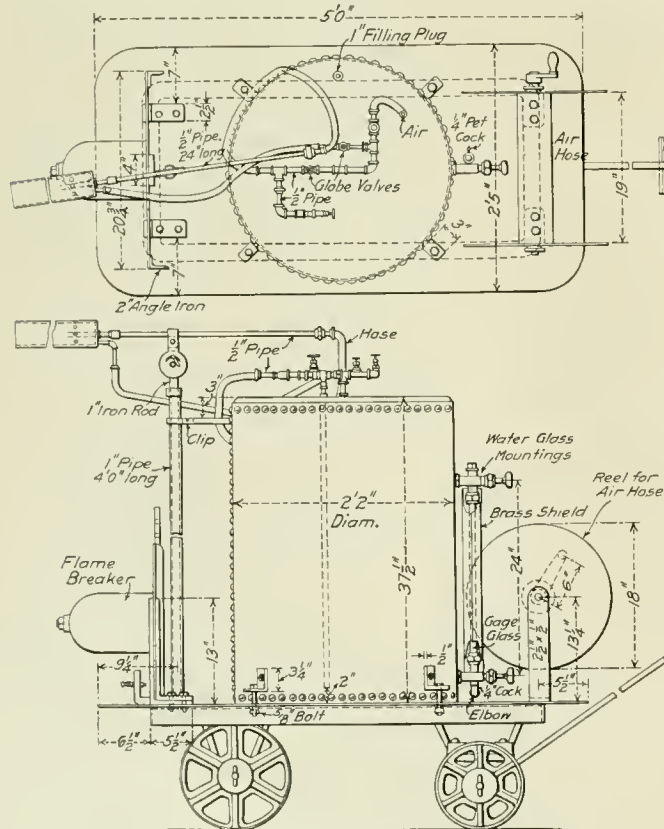

Fig. 4—Portable Oil Tank and Torch.

outside of the ring it is raised so as to give the additional 1/8 in. thickness at the outside, stops being used to insure the correct measurements. The outside face of the ring is not finished. This method has reduced the time of finishing these rings by 50 per cent. over the old method. A duplicate set of tools are

kept ready to replace any of the others, and wooden patterns of them are made so that all tools may be made alike and be maintained to the proper shape. The tool holders were forged from an old tire and are shown in detail in Fig. 2, together with the shape of the tools.

PORTABLE OIL TORCH FOR TESTING.

A complete heating arrangement for testing fireboxes and locomotive boilers is shown in Figs. 4 and 5. Although there have been other portable oil burners described in your columns, none have been quite as fully equipped as this one. It is provided with a reel for the air hose, and has a gage glass to show the amount of oil in the tank. The glass is graduated into fractions of gallons, so that the amount of oil used during a test may easily be ascertained. There is an adjustable rod at the rear end of the truck which holds the burner in position. A flame breaker or spreader is also carried on the truck so that it will always be at hand when needed. It is placed directly in front of the burner, and is used to diffuse the flame, and thereby spread the heat to

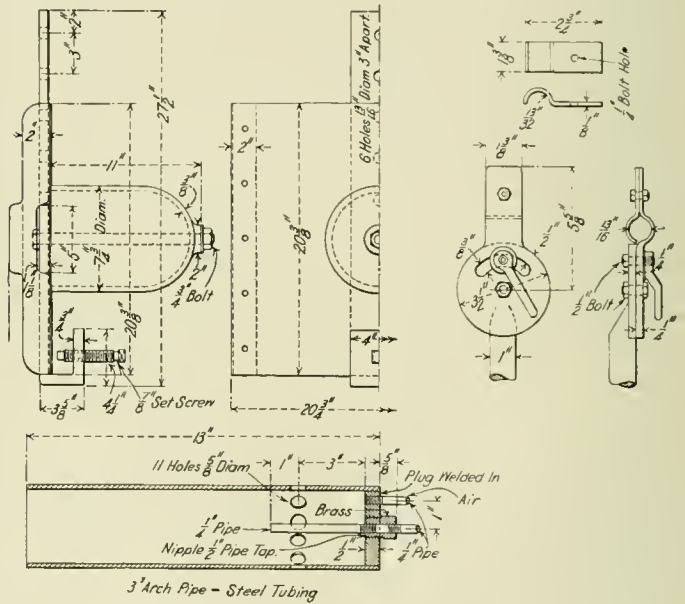

Fig. 5—Details of Flame Spreader and Torch.

all parts of the firebox. The construction is entirely of steel and iron, which makes a fireproof and durable combination.

The tank is held to the sheet iron floor of the truck by four 5/8 in. bolts, which pass through lugs on the side of the tank, so that they may be readily removed if it is desired to remove the tank from the truck. When the burner is not in use the air hose is neatly reeled, making the complete apparatus ready for immediate transfer to any part of the shop. The construction is clearly shown in the illustrations, Fig. 5 giving the details of the burner, the flame spreader and the arrangement for clamping the burner in position. This burner was devised by A. G. McClellan, master mechanic of the Chicago & Alton, at Bloomington, Ill.

TIRE CHUCK FOR BORING MILL.

A chuck that will grip all classes of tires on the outside tread while they are being bored on the inside is shown in Fig. 6. Four of these chucks are bolted at equal distances around the table of the boring mill, and after they have been once centered and located for the different sizes of tires, two 5/8 in. holes, not shown on the drawing, are bored through them into the table. Steel dowel pins are then placed in the holes made in the chuck so that it may be easily relocated thereafter. The jaw B is provided with the saw-teeth to insure a firm grip on the tire. One side is made with a radius to suit the largest driving tire, and the other to suit the largest diameter of the small tires. It has been found that this will provide a solid grip for all the differ-

ent sizes. The jaw is actuated by a hardened steel cam C, which rotates in the chuck, the bottom bearing being held in a hardened steel bushing. The cam is turned by a single ended box wrench and the top of the chuck is indexed to indicate the amount the jaw has been pushed in; by having each of the four indicators read the same it is assured that the tire is true with respect to the outside diameter. This is of special importance, for the tires are seldom received from the makers with the inside diameter bored true to the outside one, and by thus truing them at the beginning considerable metal is saved and less machine work is required on turning the tread after the wheels have been mounted.

When the chucks are located by the dowel pins they are clamped to the T-slots of the table by bolts fitting in the slots A, which are countersink so that the nuts will clear the tire. When centering, the jaws B should be set to the average throw

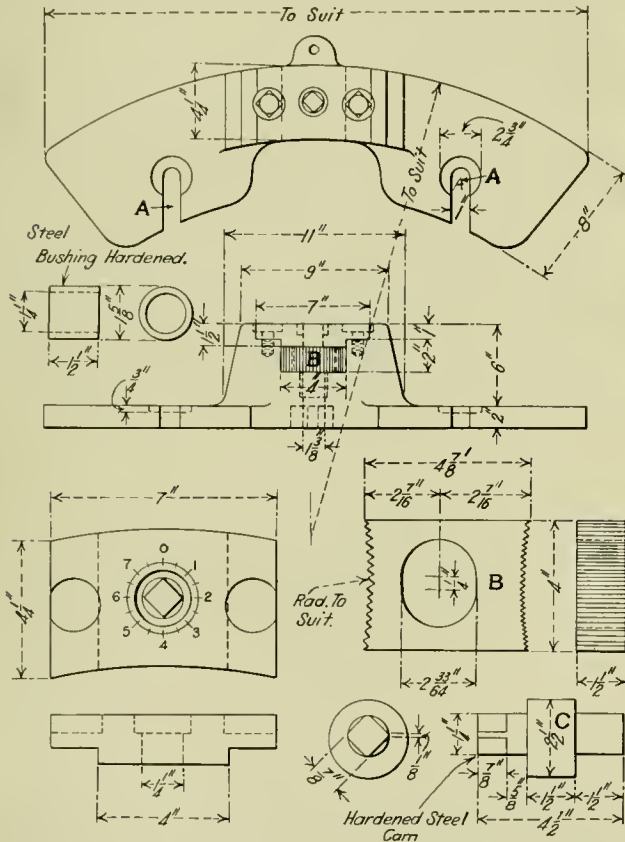

Fig. 6—Chuck for Holding Tires.

by the cam C, which would be at No. 2 in the indicator. It has been found that these jaws will hold the tire rigid enough for any cut when the indicator is anywhere between 0 and 4. With the jaws indexed, as described, it takes a very short time to center the tire; the operation is done in about two revolutions of the table. They also show how much variation, if any, there is between the tires of a set. For instance, if one tire was trued up with all the indicators at No. 1, and another with the indicators at No. 3 it will mean that one is 1/8 in. smaller in diameter than the other. This is a valuable check, and is made at the proper time. The chucks described herewith have been used for five years in a modern 20-pit shop, and are still giving splendid results. Care must be exercised when making the cams to have them all of the same throw. In the present instance each cam has a 1/8 in. throw, which will allow for a variation in the diameter of the tire, and so far the limit of the chucks has not been reached with American tires.

PNEUMATIC CLAMPS.

The two small air cylinders, or jacks as they might be called, shown in Fig. 7, are used for clamping guide bars to the table

of a grinding machine. They operate on the long arm of levers which are fulcrumed on posts that are free to slide in the T-slots of the table. The arrangement is easily adjusted, being much quicker than the ordinary methods, and with a pressure of 100 lbs. the jacks will hold the bars sufficiently firm for grinding. The cylinders are 4 1/2 in. in diameter, and the pistons have a

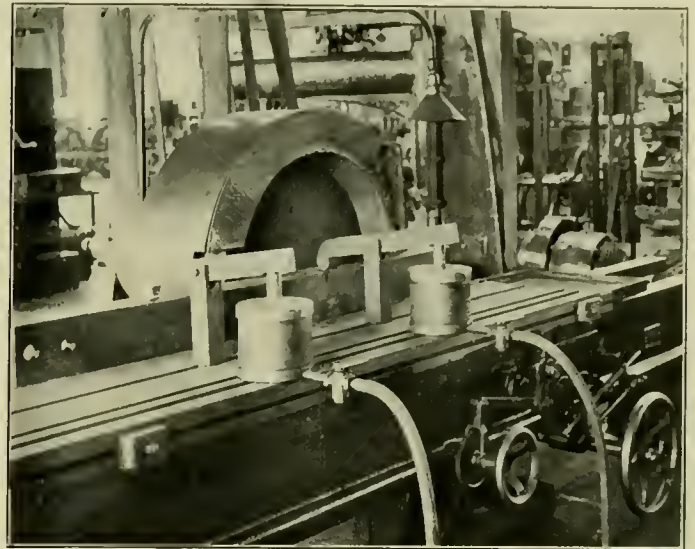

Fig. 7—Air Cylinders Used for Clamping Guide Bars to Grinding Machine.

stroke of 4 1/2 in. They are similar in construction to the air cylinders shown in Fig. 10. If the available shop air pressure is less than 100 lbs. the cylinders can be made larger, or the length of the arms of the lever may be made to give the necessary clamping force on the guide bar.

MOLD FOR CASTING HUB LINERS.

A successful and inexpensive method of casting hub liners on driving wheels where no holes have been drilled in the hubs is

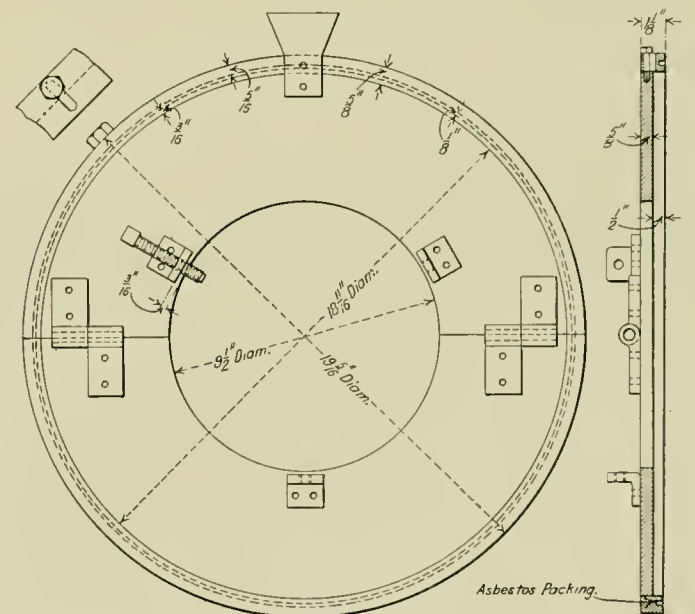

Fig. 8—Mold for Casting Hub Liners.

shown in Figs. 8 and 9. The mold is made of cast iron and is hinged in the middle. It is held to the axle by three set screws in lugs which are spaced equi-distant about the axle. The thickness of the liner is regulated by an adjustable ring on the circumference of the mold. This ring is held in place by four cap

screws located at equal distances around the mold, although only one is shown in the drawing. A groove in the ring is filled with asbestos packing, which provides a tight joint and prevents the metal from escaping. A hopper is provided at the top through which the metal is poured. With this arrangement it is unnecessary to machine or face off the liner after it has been

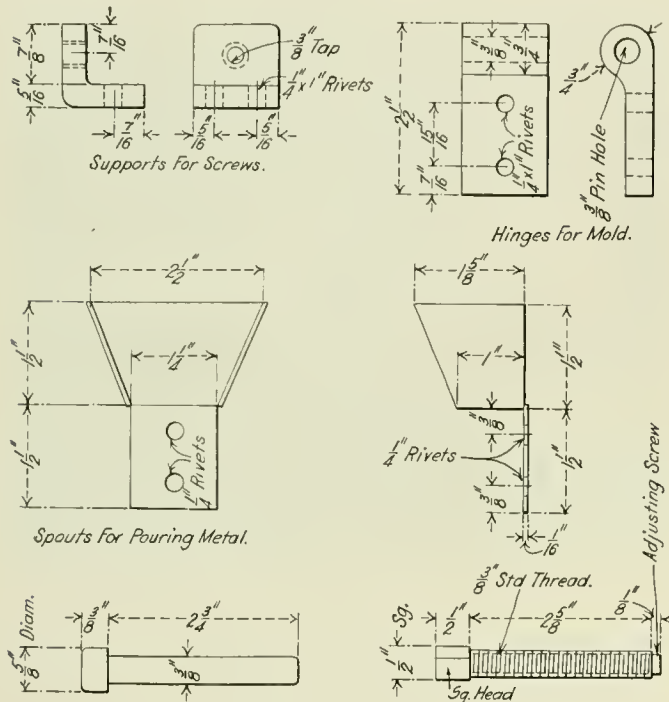

Fig. 9—Details of Hub Liner Mold.

cast. With a good grade of babbitt, engines have run 180,000 miles with only 1/8 in. of lateral wear.

ATTACHMENT FOR NUT FACING MACHINE.

It was found that with the ordinary nut facing machine it took as much time to stop the machine and remove the nut as it did to face the nut. To reduce the time for this operation the device shown in Figs. 10 and 11 was installed. It consists of an

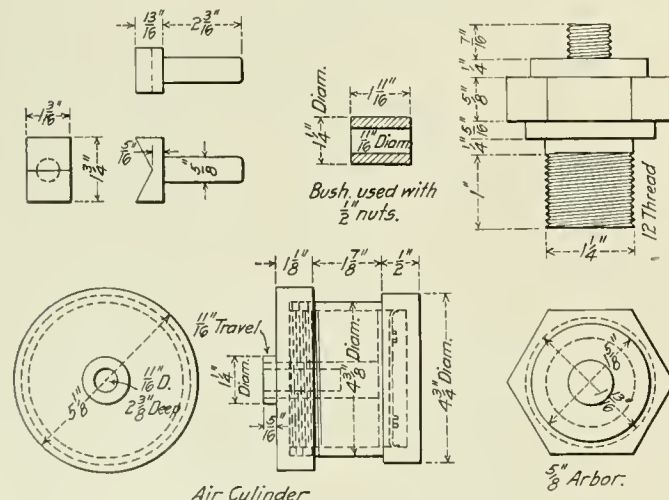

Fig. 10—Air Cylinder for Nut Removing Device on Nut Facing Machine.

air cylinder with a V-block fitting in the end of the piston rod. After the nut has been faced the machine is immediately reversed and the air is applied. The block will be forced against the nut and will keep it from rotating, unscrewing it from the arbor. A boy will soon become expert in handling the machine and will almost double the output.

A bushing regulates the height of the V-block above the end of the piston rod, so that it will just come in contact with the nut and not bring any pressure to bear on the arbor. For a 1/2 in. nut a bushing 1 11/16 in. high is required and for larger nuts correspondingly shorter bushings will be necessary. These bushings are stamped and kept in the tool room with the special nut arbors. The tool used in facing the nut can be ground so as to be used in countersinking the hole on the underside of the nut

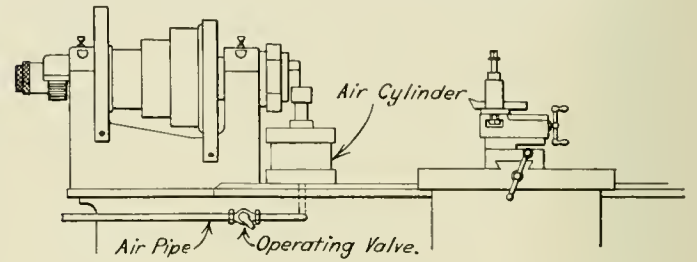

Fig. 11—Nut Removing Device for Nut Facing Machine.

about the length of the first thread. This will remove any burr that is made while facing and allow the nut to be easily applied.

SPRING CHUCK FOR FACING METALLIC PACKING.

The application of an air-spring chuck to a lathe is shown in Fig. 12. This chuck is used for facing metallic packing, steam pipe rings, or anything of that nature. The main body of the chuck is 3 3/4 in. in diameter, and has a 1/2 in. hole for applying or removing it from the lathe spindle. It is about 3 3/4 in. long, the outer portion being split in four sections, as shown, which allows it to be expanded to grip the inside of the work to be faced. The chuck is expanded by the cap A, which screws on

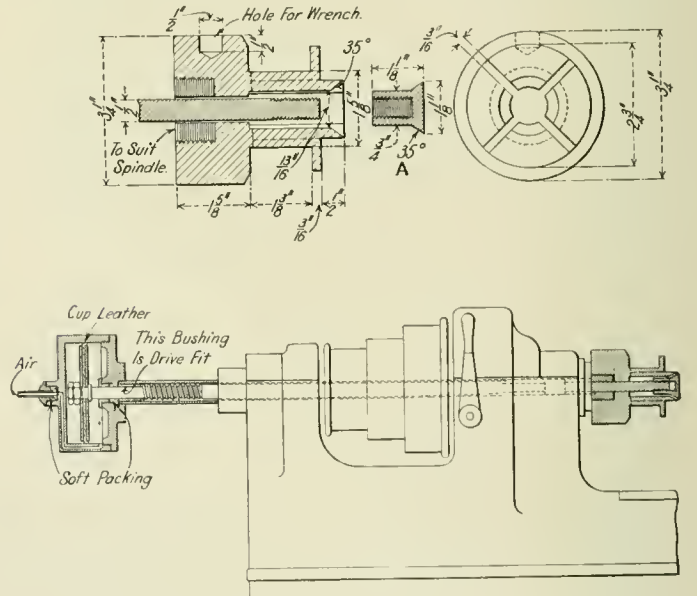

Fig. 12—Spring Chuck for Metallic Packing.

the end of the rod, extending through the spindle from the air cylinder, and fits in the conical surfaces on the inside of the split section of the chuck. After the packing ring has been placed on the chuck, the air is applied and the cap A forces the split sections out, gripping the ring. Different size chucks have to be used for each different diameter of ring to be faced, but where there are a large number of packing rings of the same diameter to be finished, the time saved by this method is very appreciable. When the air is exhausted from the cylinder the spring forces the cone plug out of the chuck, thus releasing the grip on the ring.

LIVE STOCK CLAIMS.—A western road paid \$49 a day last year, for the settlement of live stock killed on the right of way.

their axes meet at a point 2 in. below the top of the stack. With this, the usual difficulty of filling one side of the stack only was encountered, and, although various forms and diameters of stacks were tried, both with draft pipes and inside extensions, it was not an entirely satisfactory arrangement. Square nozzles of various sizes were tried with results similar to the circular type.

Double nozzles were finally abandoned and a single, variable

back pressure in the exhaust was about 25 per cent. greater than with double nozzles.

The nozzle finally adopted for use is of the ordinary single type, 5½ in. in diameter, there being apparently no great advantage in the variable types, as the engine now steams freely and there is no danger of excessive back pressure by the careless use of the variable feature.

The exhausts from the front and back engines are brought

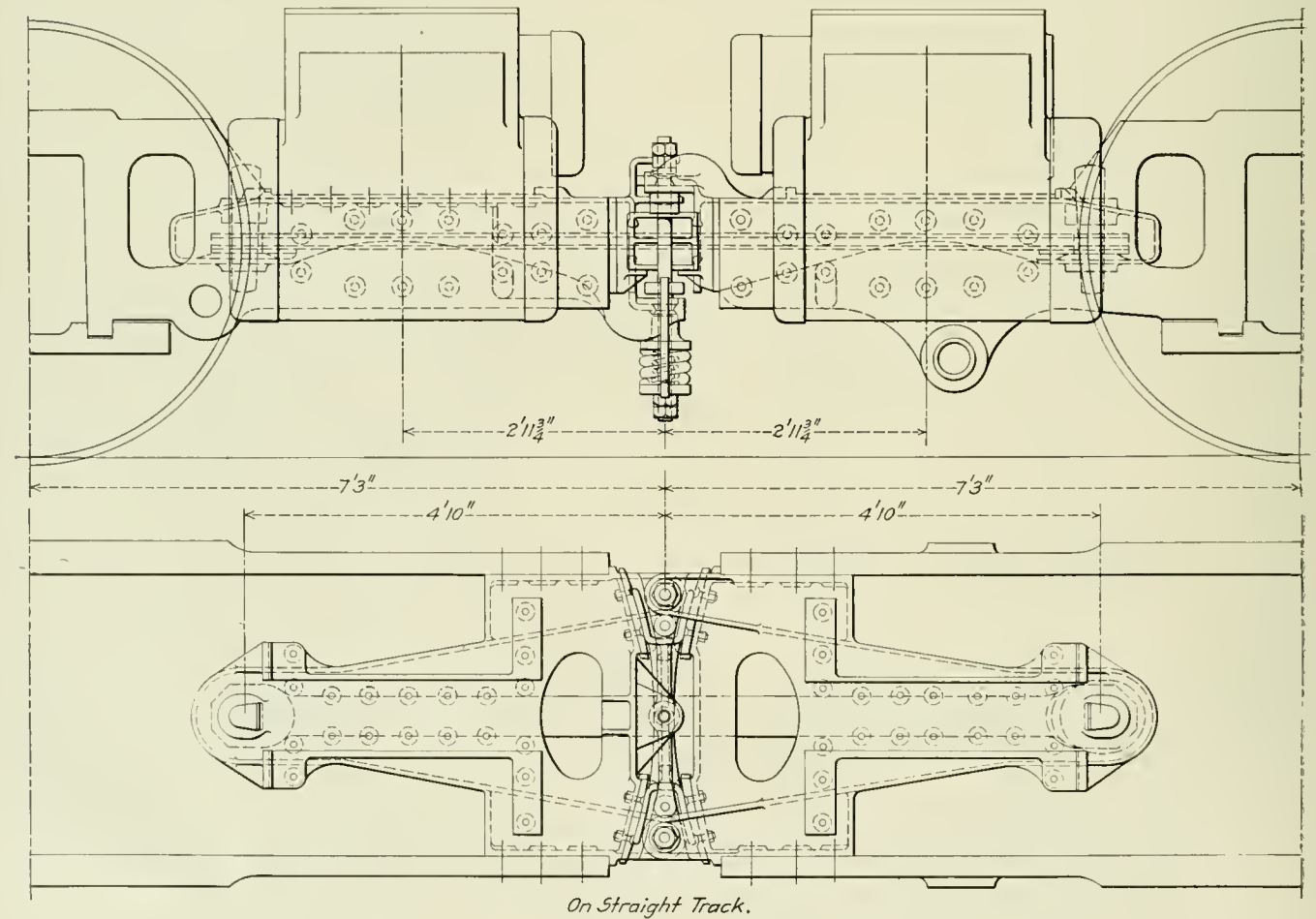
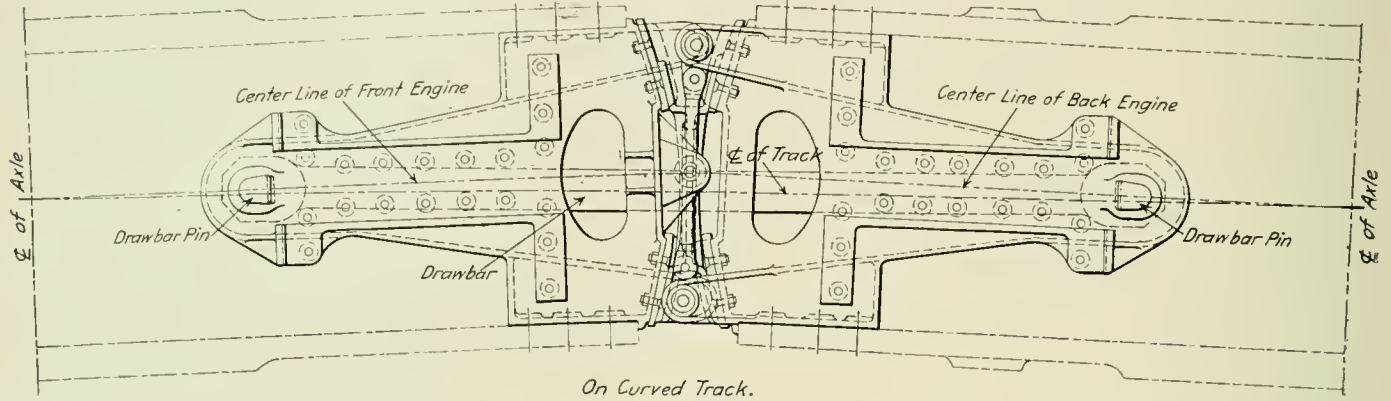

Type of Articulated Connection Employing a Long Drawbar; Canadian Pacific Mallet.

nozzle, with a minimum area equivalent to the area of a 6 in. circle, was substituted. This made an immediate improvement and was used on the engine after it went into regular service. The engineer could change the area of the tip when the engine was working by means of a lever in the cab connecting to an expanding bar in the nozzle casting. With skilful handling the

together in a cast steel header with two inlets and a single outlet. This header is bolted solidly to the boiler barrel and the 7-in. exhaust pipe from the back cylinders extends from it to the exhaust connection on top of the cylinder. The exhaust pipe from the front engine connects to the header and cylinders by spring loaded ball rings, arranged both for

swiveling and sliding, as there is considerable movement at this point. Although both exhausts are brought together in the same header they do not combine, as there is a vertical dividing wall carried forward through the 10-in. wrought iron pipe, forming the front section of the exhaust pipe, and well up in the exhaust stand. The exhausts finally combine at a point just below the exhaust nozzle.

The superheater is of the fire tube type developed on the

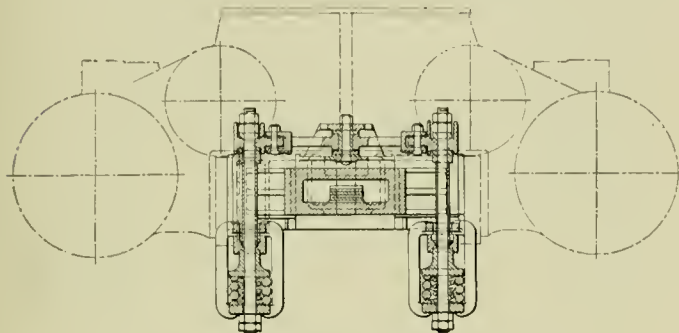

Section of the Articulated Connection.

Canadian Pacific with separate saturated and superheated steam headers. Two steam pipes 4 7/8 in. inside diameter, one on either side of the boiler, lead back to the cylinders; the pipe on the left side is rigidly fastened to the boiler and connects to the back pair of cylinders. The right-hand pipe delivers steam to the front pair of cylinders connecting to a steam header by means of a packet joint, bolted over each steam chest. Practically the only movement at this joint is a swiveling of about 5 deg., so that the use of an expansion sleeve is not required. There are, therefore, only one packed and two sliding ball ring joints in the whole steam and

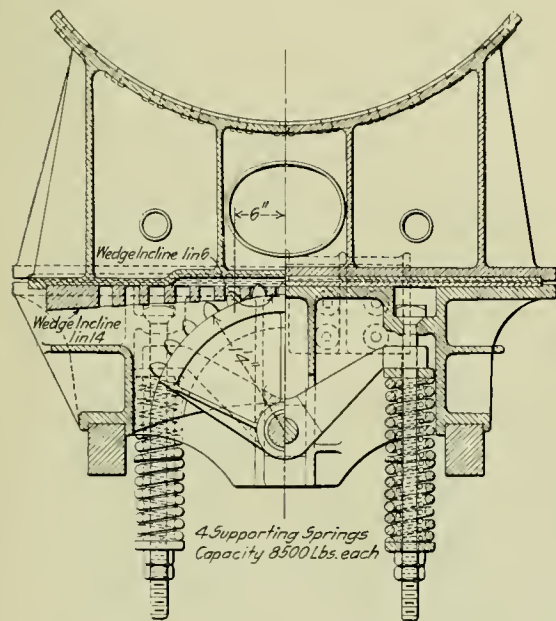

Forward Boiler Bearing and Centering Device; Canadian Pacific Mallet Locomotive.

exhaust pipe system, as against five packed joints on the usual design of Mallets.

Frames.—The main frames are of cast steel 4 1/2 in. wide, without splices, and the cylinders are bolted to slabbed extensions which are 3 in. wide by 15 in. deep. The front set of frames are thoroughly cross-braced by the front bumper, main boiler bearing, guide yoke and the cylinders, also by a filler underneath the cylinders, utilized as a connection between the front and back engines, the arrangement of which will be described later. The back set of frames are braced

by the cylinders and filler, expansion plate and the back foot-plate.

On the experimental compound Mallet a pivot connection was used to connect the front and back engines, but, as the distance between the center pair of drivers is necessarily long on these engines, it was found that flange wear quickly developed on the wheels on either side of the cylinders. This will best be understood by reference to the diagram illustrating the present connection between the two engines, from which it will be seen that the pivot pin on the experimental compound engine is a considerable distance outside the center line of the track when the engine is traversing a curve and that, if the distance between the middle wheels is increased, a point will quickly be reached where the flange pressure would cause danger of derailment. On subsequent engines this difficulty was overcome by substituting the radial bumper shown in the illustration and a drawbar, the pins of which are located so as to straighten out the line of pull on curves and prevent excessive flange wear. The broad surfaces of the bumper blocks are manganese steel and wear very slowly. Slack can be taken up by driving in the pins, one side of which is wedge-shaped and acts like a connecting or side rod key.

When curving, the action of the wedge block is to assume a position with its center line directly over the center of the drawbar, the faces of the bumper castings on each frame remaining in contact over its entire surface. The purpose of the horizontal cross bolt is to prevent any tendency of either engine to move sideways independently of the other. Each end of the cross bolt is, therefore, fastened by a vertical pin to lugs cast on the bumper casting of the back engine, while the center connection is made to a similar lug and pin on the front engine bumper.

The weight of the boiler on the front engine is carried on

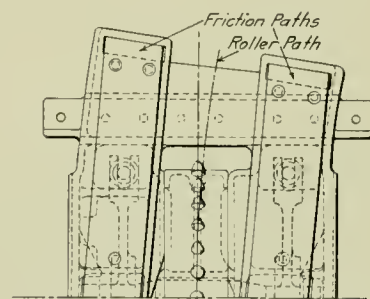
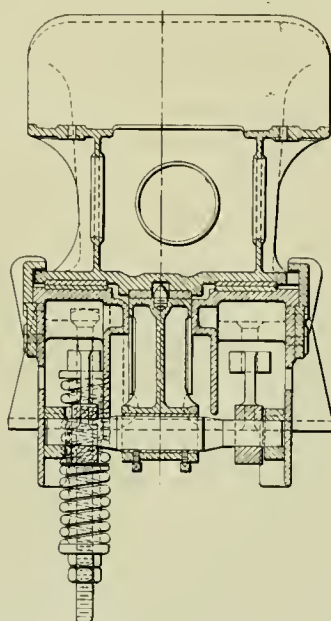

a single support, located 19 in. ahead of the middle pair of drivers and of practically the same design as used on the experimental engine.* The top casting, bolted to the boiler barrel, rests on the lower casting, bolted to the engine frame, and is free to move sideways across it as the engine enters a curve. The weight of the boiler and attachments, resting on the front engine, is 45,800 lbs., 14,000 lbs. of which is carried by a fan-shaped roller, supported by two equalizers carried on four sets of helical springs, suspended by bolts from the lower casting.

*See *American Engineer and Railroad Journal*, March, 1910, page 84.

The remainder of the weight, 31,800 lbs., is supported on four friction surfaces and the total guiding power of the front engine is, therefore, the sum of the rolling and frictional resistances. The total resistance may be entirely changed by the use of greater or less inclination on the roller blocks, which are carried in pockets in the upper casting. The roller pivot pin is guided in the vertical direction by grooves in the lower casting which allow it to rise and fall with the springs, but prevent its movement sideways no matter what the position of the top casting into which the roller teeth mesh, may be. The roller path on the upper casting consists of two steel blocks 28 in. long with a 1 in 6 incline, extending 6 in. on either side of the center and 1 in 14 incline on the remaining 22 in.

With this device the total resistance, when the boiler stands centrally with the frames, is about 5,000 lbs.; 2,375 lbs. rolling resistance from the 1 in 6 incline and 2,500 lbs. from the friction surfaces. As the boiler moves sideways through the first 3.3 in. the rolling resistance increases, due to the greater weight transferred to the roller by the deflection of the supporting springs, and the frictional resistance decreases. Any further roller movement is on the 1 in 14 incline, the resistance starting at 1,750 lbs. and increasing slightly as the deflection of the supporting springs increases. When straightening out after leaving a curve, the inclines exert a force to bring the boiler back to midposition. The object of the steeper incline at the center is to provide sufficient resistance to prevent a side swing of the boiler when running fast on straight track.

Boiler.—The boiler is of the radial stay type to which, in accordance with experience gained from other boilers of similar type, a system of cross-stays has been added above the firebox. There are nine cross-stays 2 in. in diameter secured by pin connections to T braces riveted to the roof sheet. The stays cross the firebox at a point about 6 in. above the crown sheet. Other features of the boiler design are the large radii on the firebox corners. The outside rows of staybolts are placed at a considerable distance from the

edges of the sheets with the object of allowing greater flexibility and preventing breakage of the end rows.

The ashpan applied is of a type adopted after extensive experience with practically all forms of self-clearing pans

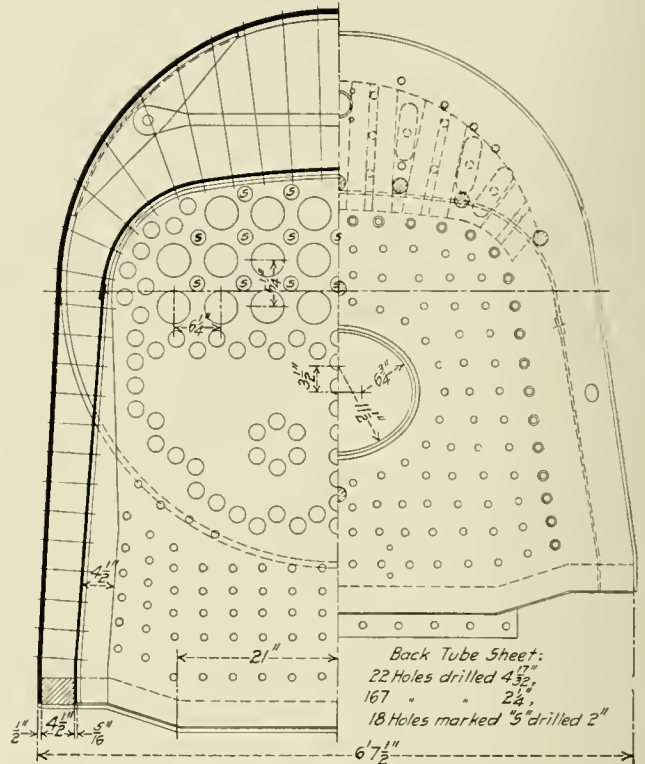

End Elevation and Section of Firebox; Canadian Pacific Mallet.

under all conditions of climate and service. There are two hoppers with inclined swinging doors operated by levers from the side of the engine. The doors are of malleable iron

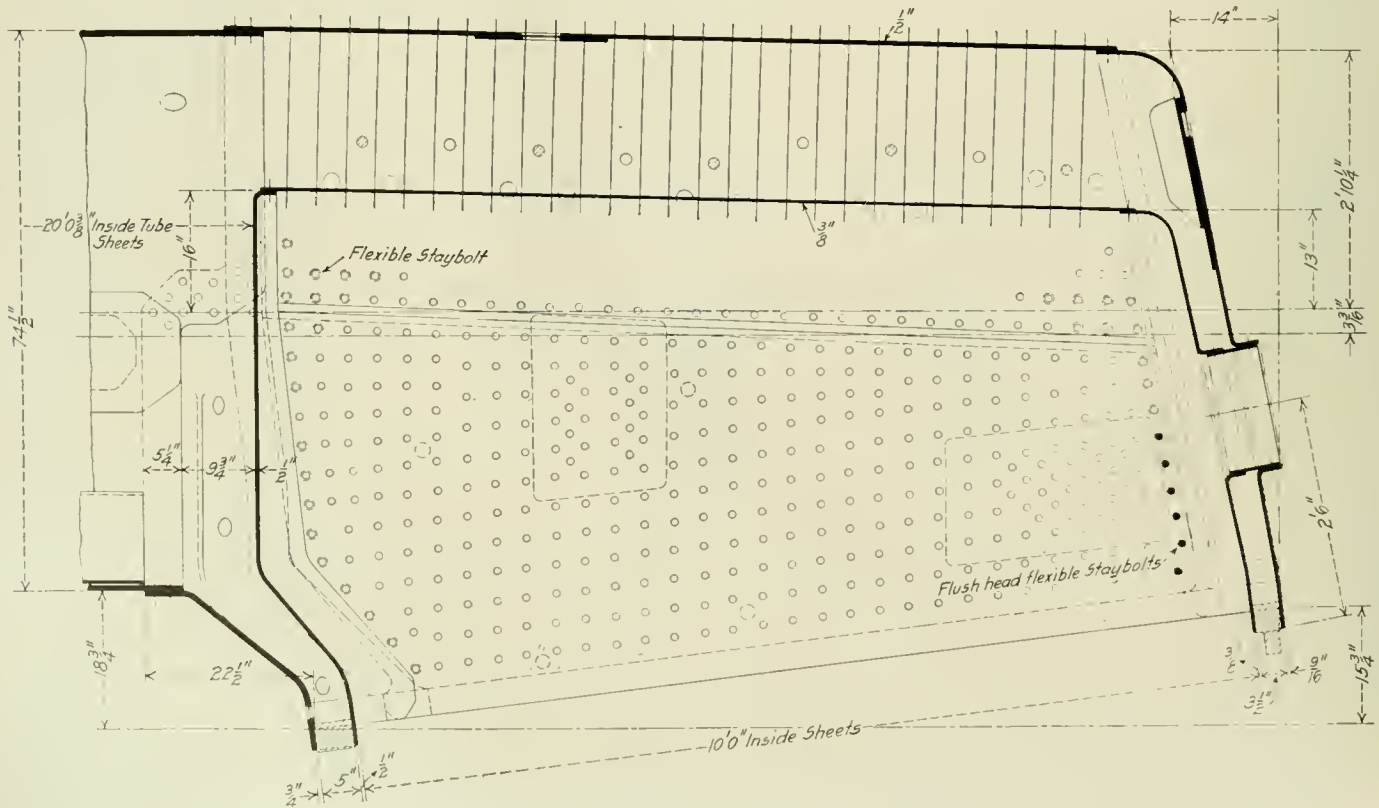

Section of the Firebox on the Canadian Pacific Simple Mallet.

with cavities in which steam may be turned to thaw them free in cold weather. Sufficient air space is provided by the usual system of openings under the firebox ring, protected by deflector plates, to prevent the dropping of live coals or sparks.

The general dimensions, weight and ratios follow:

General Data.

| | |
|--|---------------|
| Gage | 4 ft. 8½ in. |
| Service | Freight |
| Fuel | Bit. coal |
| Tractive effort | 57,500 lbs. |
| Weight in working order | 262,000 lbs. |
| Weight on drivers | 262,000 lbs. |
| Weight of engine and tender in working order | 395,000 lbs. |
| Wheel base, rigid | 10 ft. 4 in. |
| Wheel base, total | 35 ft. 2 in. |
| Wheel base, engine and tender | 60 ft. 9½ in. |

Ratios.

| | |
|--|--------|
| Weight on drivers ÷ tractive effort | 4.55 |
| Total weight ÷ tractive effort | 4.55 |
| Tractive effort × diam. drivers ÷ heating surface* | 884.00 |
| Total heating surface* ÷ grate area | 64.00 |
| Firebox heating surface ÷ total heating surface*, per cent. | 4.90 |
| Weight on drivers ÷ total heating surface* | 69.50 |
| Total weight ÷ total heating surface | 69.50 |
| Volume both cylinders, cu. ft. | 19.00 |
| Total heating surface* ÷ vol. cylinders | 198.00 |
| Grate area ÷ vol. cylinders | 3.10 |

Cylinders.

| | |
|---------------------------|-----------------|
| Kind | Simple |
| Number | 4 |
| Diameter and stroke | 20 in. x 26 in. |

Valves.

| | |
|------------------------|----------|
| Kind | Piston |
| Diameter | 11 in. |
| Greatest travel | 6½ in. |
| Outside lap | 1 in. |
| Inside clearance | 1/16 in. |
| Lead | ¼ in. |

Wheels.

| | |
|---|-------------|
| Driving, diameter over tires | 58 in. |
| Driving journals, main, diameter and length | 9½ x 12 in. |
| Driving journals, others, diameter and length | 9 x 12 in. |

Boiler.

| | |
|--|---|
| Style | Wagon top |
| Working pressure | 200 lbs. |
| Firebox, length and width | 120 x 70¾ in. |
| Firebox plates, thickness | T., ½ in.; B., 7/16 in.; S. & C., 3/8 in. |
| Firebox, water space | S., 4½ in.; F., 5 in.; B., 3½ in. |
| Tubes, number and outside diameter | 167—2¼ in.; 18—2 in. |
| Flues, number and outside diameter | 22—5¼ in. |
| Tubes, length | 20 ft. ¾ in. |
| Heating surface, tubes | 2,765 sq. ft. |
| Heating surface, firebox | 185 sq. ft. |

*Equivalent heating surface = 2,949 sq. ft. + (1.5 × 548 sq. ft.) = 3,771 sq. ft.

| | |
|-----------------------------------|---------------|
| Heating surface, total | 2,949 sq. ft. |
| Superheater heating surface | 548 sq. ft. |
| Grate area | 59 sq. ft. |

Tender.

| | |
|-------------------------------------|--------------------------|
| Tank | Semi water bottom |
| Frame | 13 in. & 10 in. channels |
| Wheels, diameter | 36¼ in. |
| Journals, diameter and length | 5½ x 10 in. |
| Water capacity | 5,900 gals. |
| Coal capacity | 12 tons |

CENTRAL OF NEW JERSEY ICE CAR

Ice must be carried in well insulated cars that are securely braced to withstand the impacts due to the shifting of the load. A load of ice is more liable to shift than almost any other commodity and the car must have a strong end construction. The floor must be made water proof to prevent water from leaking through and rusting or rotting the underframe. Two hundred and fifty cars in which these requirements have been carefully considered have recently been delivered to the Central Railroad of New Jersey by the Standard Steel Car Company, Pittsburgh, Pa. They were designed jointly by the engineers of the railway company and the builders.

The car is 38 ft. 4 in. long over the striking plates and has a capacity of 80,000 lbs. The inside is 36 ft. long x 8½ ft. wide x 8 ft. high, providing a space for about 140,000 lbs. of ice, but it is impractical to load such a car to its full cubical capacity and only about 80,000 lbs. can be loaded conveniently. The construction of the body of the car is clearly shown in the accompanying drawings. There are two belt rails, 3 in. x 4 in., extending along the sides of the car and two 4 in. x 4 in. rails at the ends of the car. The end corner posts and the two intermediate end posts are 4 in. I-beams, with fillers of yellow pine. The intermediate posts and braces along the sides of the car are 3 in. x 5 in. yellow pine, while the door posts are of white oak.

The details of the side door, which is provided with the Unoit car seal, are clearly shown. It has three layers of hair felt and two air spaces, one 7/8 in. and the other 2 1/16 in. thick for insulation. The sides and ends of the car have yellow pine lining grooved and tongued; it is 1¼ in. thick at the sides and 1¾ in. thick at the ends. One layer of hair insulation is placed on both sides of the air space which is 3 in. wide at the sides and 4¼ in.



Ice Car of 80,000 lbs. Capacity; Central Railroad of New Jersey.

wide at the ends. The roof consists of two layers of yellow pine boards 13/16 in. thick; there is also a ceiling of 13/16 in. lining boards which is covered by a layer of hair insulation fastened to the underside of the carlines.

One half of the cars are provided with the Hutchins improved plastic roofing while the other half has the Lehon Company's roof. This special roofing is placed between the two layers of boards.

The junction of the floor with the sides and ends of the car is water-proofed by a zinc angle, 0.4 in. thick. The flooring of yellow pine is ship lapped and is 2 3/8 in. thick. On the underside of the floor a three-ply water-proofing paper is placed over the stringers and center sills to protect the underframe from any moisture that may permeate through the floor. Four air seal drip cups of a special design shown in one of the illustrations are used to drain the car.

The center sills are I-beams 24 in. deep at the center and tapering to 13 7/16 in. at the ends. Two needle beams extend across the car 4 ft. 5 in. each side of the center, while three 6-in. channels serve as cross-bearers. The end sills are 12-in. channels with their flanges turned inward. The side sills are also made of 12-in. channels with the flanges turned inward and with a 4 in. wooden sill on the outside supported on angle irons.

The striking plate is of special construction, being designed by G. W. Rink, mechanical engineer on the Central Railroad of New Jersey. Its special feature is the coupler carrier, which is so

designed that when one surface is worn by the coupler yoke it can be inverted or renewed, providing a new surface for wear and prolonging the life of the plate.

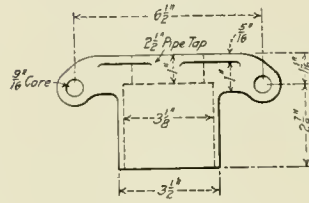
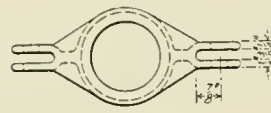

Drip Cup Support.

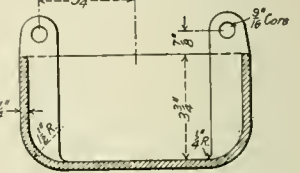
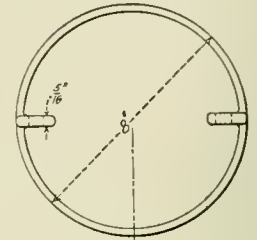

Drip Cup.

Drip Cup for Ice Car.

Four different kinds of draft rigging have been applied as follows: The Farlow-Westinghouse on 50 cars; the Farlow-Gould on 50; the Farlow-Session on 50 and the Miner friction,

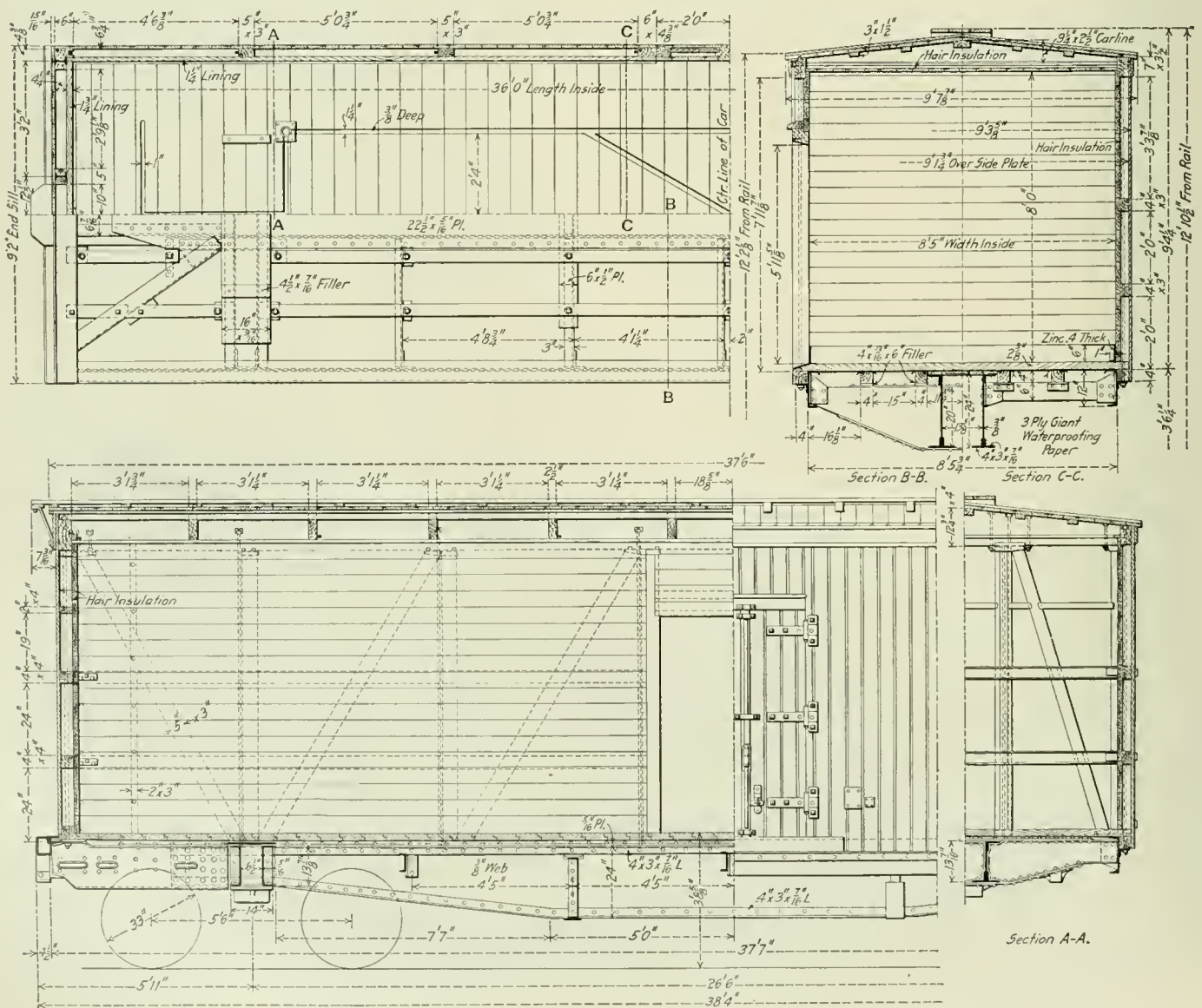

Plan and Elevations of an 80,000 lb. Capacity Ice Car; Central Railroad of New Jersey.

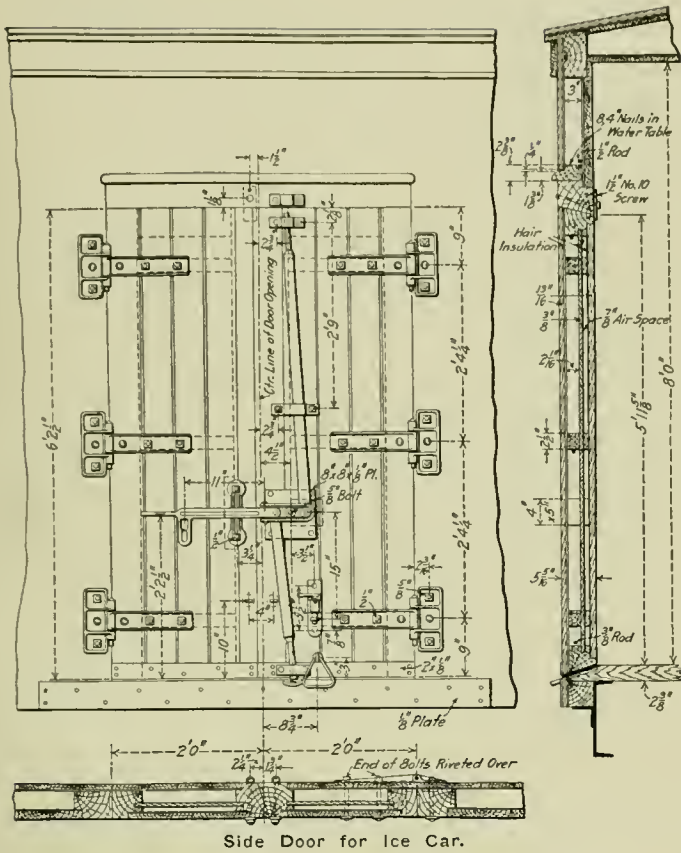

class A-7, on 100 cars, the idea being to test out these different types of draft gear in this particular service. The trucks are of the cast steel side frame type made by the American Steel Foundries and the truck bolsters are also made of cast steel. The truck frames are provided with removable wearing plates at the opening for the bolster. The wheels are 33 in. in diameter and

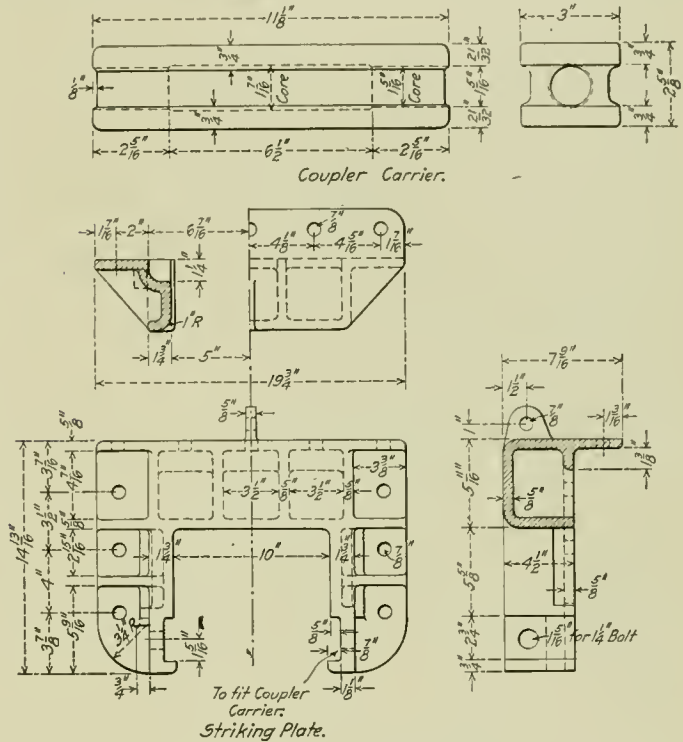

weigh 675 lbs. The underframe and the trucks are designed for 88,000 lbs. capacity each, in addition to the light weight of the car body. This provides a leeway of 8,000 lbs. on the rated capacity of the car.

EFFICIENCY OF RAILWAY EMPLOYEES

W. W. Finley, president of the Southern Railway, presented a paper on "The Interest of Railway Employees in Greater Efficiency of Operation" before the Richmond Railroad Club, April 4, 1912, in which he brought home the part which each individual employee plays in the development and earnings of a railway. He used the term "efficiency of operation" in its broad sense, including all branches of railway work and not restricting it to what is commonly known as the operating department. The following is taken from the paper:

"The formulation of plans for obtaining greater efficiency of operation is the duty of those of us who are charged with railway management, but each of us can contribute to the success of such plans by making his individual service efficient. All that is necessary is that the individual employee shall know his duty and do it to the best of his ability. He should not only endeavor to perform his specific duties as effectively as possible, but he should seek at all times to co-operate intelligently and helpfully with all other employees in his own department and in other departments. I do not mean by this that he should seek to thrust his aid on others. If he does he will probably make a nuisance of himself, and if he spends his time attending to the business of others he is in danger of neglecting his own duties. There are, however, many opportunities for helpful co-operation and effective teamwork.

"The highest efficiency of management consists in securing safety and efficiency of service by so conducting operations that expenditures will bear a fair and reasonable relation to the

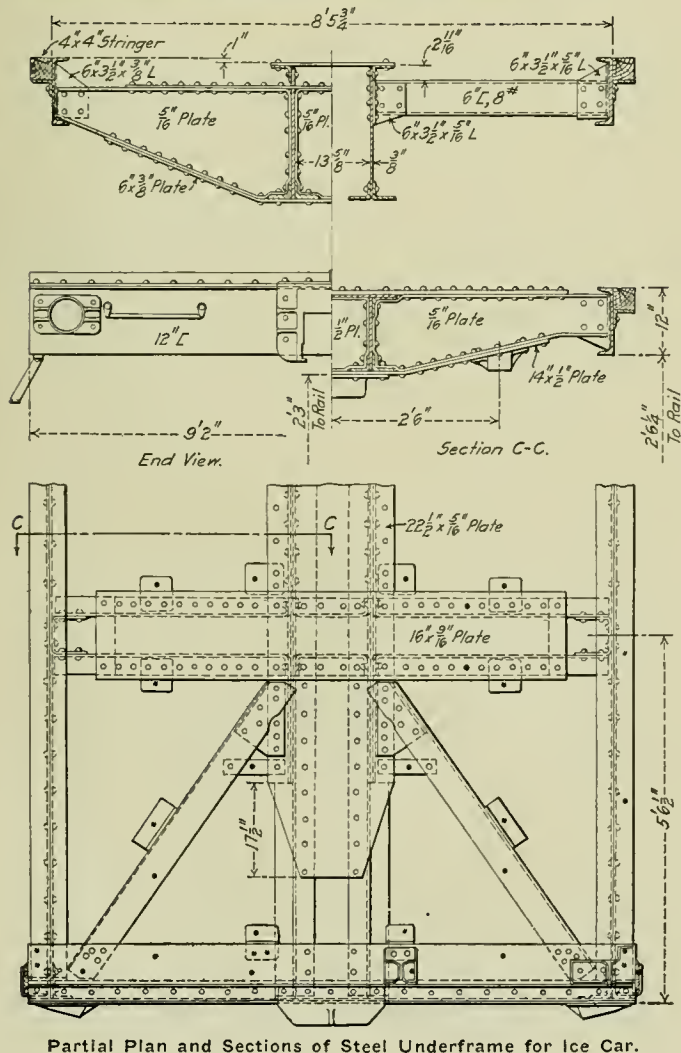

revenues of the company. Therefore, in the maintenance of the property and in conducting its operations otherwise, the factor of consistent economy should be ever in mind. The intelligent ordering and use of materials in roadway maintenance; the effective use of materials in shop and other operations; careful watch on storehouse supplies; close attention to fuel consumption; close check on and the proper use of stationery and other station supplies—these are only some of the things tending to greater efficiency.

"A phase of the general problem of greater efficiency with which the employees of the operating department are chiefly concerned and falling within the category of personal injuries—which places so heavy a burden on the railways of today—is the prevention of accidents. Some railway accidents are unavoidable by any human means. Others are due to the carelessness or recklessness of passengers, trespassers, or others not in the employ of the companies, and their prevention is often beyond the power of the employees. Still there are other accidents that are clearly preventable.

"A recent writer on this subject has said that 'every prevent-

ASH PAN FOR NARROW FIREBOX

BY P. F. SMITH,

Mechanical Engineer; Chicago, St. Paul, Minneapolis & Omaha; St. Paul, Minn.

The three-hopper ash pan shown in the accompanying illustration was designed to comply with the federal law, and has performed excellent service on eight-wheel engines, and may be used on any type of engine with a narrow firebox and deep water legs. The castings are so designed that they may be used on all engines of this type, as the different lengths of grates are taken care of by the slope of the ends of the ash pans. The arrangement consists of three slides connected to each other by links of 2 in. x 1/2 in. iron. They operate on cast iron guides, cored out for steam heat, to keep the slides from freezing in cold weather, but in the experience of the past three years steam heat has not been found necessary. The slides themselves are made of 3/8 in. cast iron, and are machined on the ends where they slide in the guides.

Between the slides are the castings, so designed as to deflect

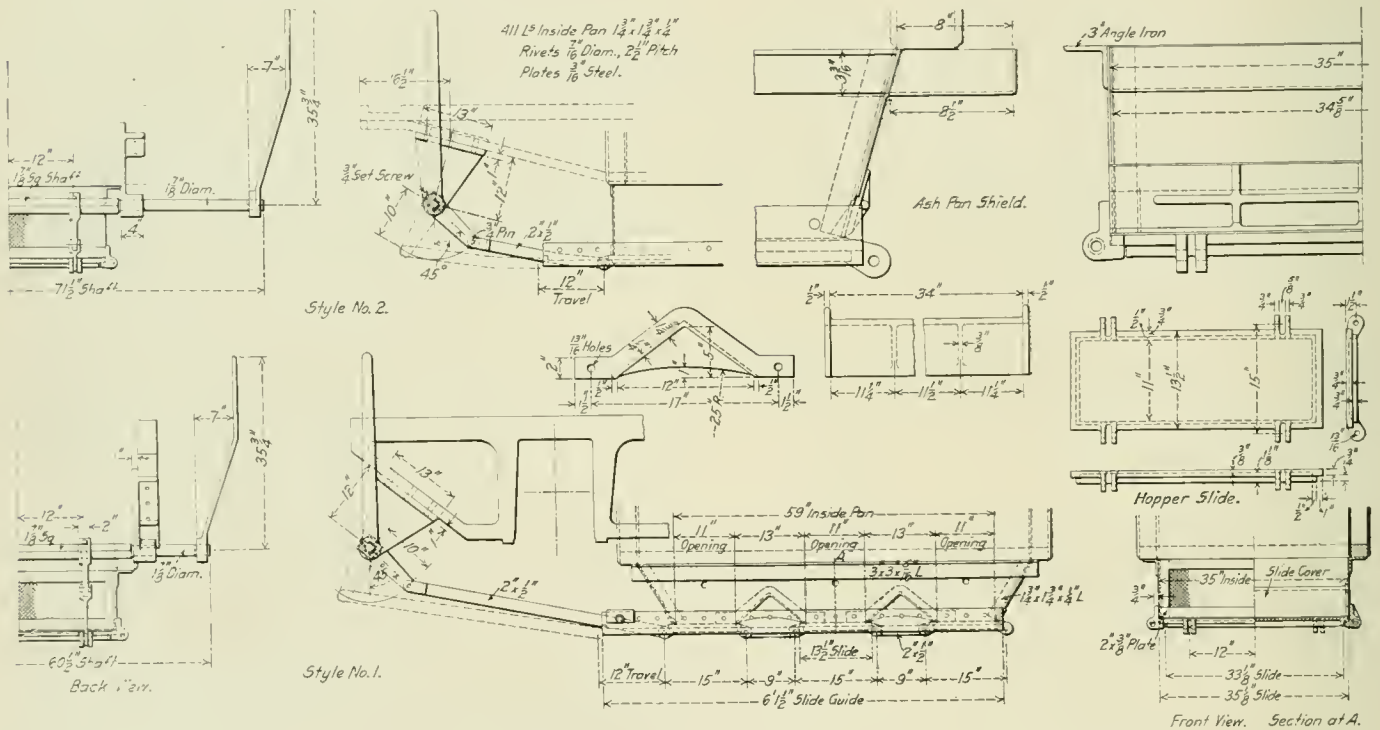

Three-Hopper Ash Pan for Narrow Fireboxes.

able accident is due to some failure or insufficiency of material, method, or man.' Materials and methods are largely in the control of the management, but shortcomings of the human element can be corrected only by the men themselves, and back of failures which, on their surface, may seem to be attributable to materials or methods, there may be faults of men. This is manifestly the case where an accident results from a defect in material which it was the duty of some one to detect and report, and we all know that the effectiveness of methods is largely dependent upon the attitude toward them of the men by whom they must be carried out.

"The absolute elimination of preventable accidents should be an end for which railway managers and employees should strive for two reasons; first, because it is our primary duty to the public to safeguard the lives and property entrusted to us for carriage; and, second, because of the large hole which payments on account of personal injuries and loss and damage make in the fund in which, as we have seen, owners and employees are alike interested."

the ashes on to the slides. All the parts used in the pan are drilled by means of jigs, and without considering the first cost of the patterns one of these pans can be made for \$20. The cost of maintenance is not greater than the old style pans, and the only breakage that has occurred on 150 engines that have been equipped with them has been due to obstructions between the rails. When these pans were first tried out a perforated plate was used for the ends, but it was found that this became blocked up by frost and snow in cold weather, and for this reason the ends were replaced with tank steel shields, which are used both in summer and winter.

Economy.—It was recently suggested by an officer of the Rock Island Lines that the length of the ordinary pin used in pinning papers together could be shortened 1/16 in. On the face of it this seems to be a very small matter, but it was found that 921,000 pins could be saved per year, which would save the company \$81. This is along the line of the campaign on this road for each employee to save a nickel a day.

AN IDEAL BOILER TUBE DEPARTMENT

Arrangement of Modern Equipment to Handle 450 Tubes a Day, at a Labor Cost Not to Exceed Three Cents Per Tube, from Engine to Engine.

BY L. R. POMEROY.

An extensive investigation of the methods employed in the repairing of locomotive boiler tubes by the various railway shops reveals the fact that in many cases the same attention has not been given to standardizing the tube repair operations that has been devoted to providing modern tools and efficient organization for machine shop operations.

In shops where but ten to fifteen locomotives per month are given heavy repairs, the number of tubes required to be handled daily is so small that the ordinary box flue-rattler, more or less antique in pattern, is sufficient to keep up with the demand, but it is by no means efficient and gives a high labor cost per tube cleaned. When the shop is of a size that requires the handling

of 400 or more tubes a day, the question of giving the tube department adequate consideration is of decided importance. This number of tubes is beyond the capacity of the home-made box-rattlers or cleaners under average water conditions.

It is quite a surprise to find, even in the larger shops, how little effort has been made towards providing the best apparatus suited to the purposes and arranging the sequence of operations so as to reduce the cost for each tube to an economical, or rational figure. Data on costs show that the extreme usually varies from five to eight cents per tube, from the engine in the erecting shop, through the tube department and back to the engine. With modern apparatus and some attention given to the

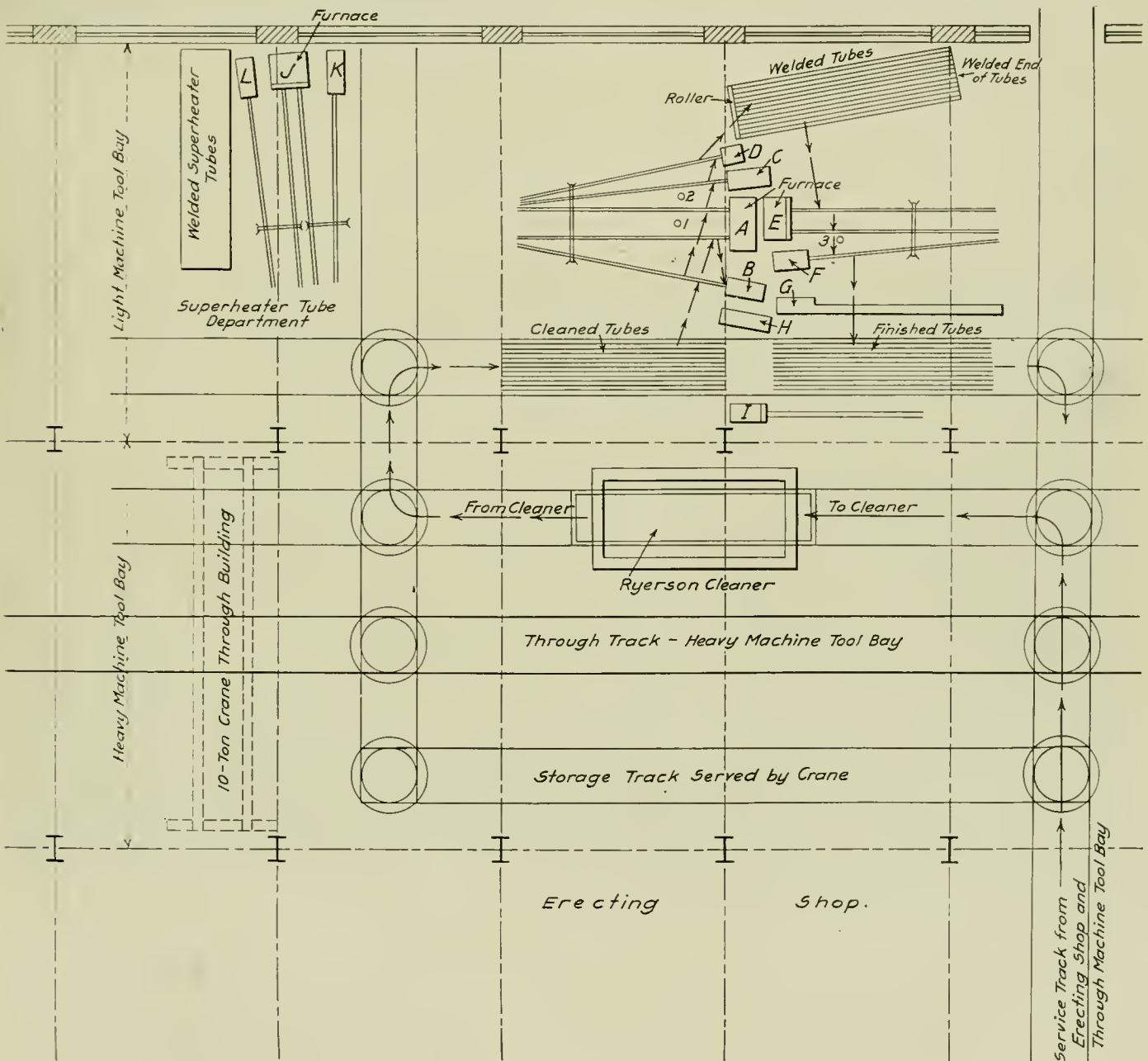

Fig. 1—General Arrangement of a Boiler Tube Repair Department Designed to Give a Labor Cost of Not to Exceed Three Cents a Tube.

arrangement of the tools, these costs need not run over three cents a tube where 400 to 500 tubes are handled daily. In fact, one reputable concern manufacturing well known appliances for this work does not hesitate to guarantee this figure with the proper tools and arrangement.

The following study is intended to outline a flue department, where these results may be easily obtained. This arrangement is only typical, and can be modified to suit other conditions if the apparatus and sequence of the operations is practically preserved.

The general arrangement of the apparatus and the track connections is shown in Fig. 1. This is based on the prevailing type of shop, where the erecting shop and boiler department are under the same roof and where the machine shop is placed alongside the erecting shop. This plan is suited to either a transverse or longitudinal track arrangement in the erecting shop. The figures, 1, 2 and 3, on Fig. 1, show the stations of the workmen performing the consecutive operations. The letters designate the machines as follows:

- A.—Welding furnace, preferably of the oil type.
- B.—Hot-saw and expander provided with safe-end magazine, where the safe-ends are automatically delivered.
- C.—Improved welder. Made adjustable to handle tubes from 1½ in. to 6½ in. in diameter.
- D.—Tube swedger.
- E.—Second oil furnace.
- F.—Hot-saw and expander.
- G.—Tube tester. (A large number of roads are doing away with the testing of tubes as they have found that the weld, made by means of the modern roller type machine is so uniformly satisfactory that it is safe to omit the test, although it has been found that where the welding has been done by pneumatic hammers the percentage of poor welds is so large as to make the use of a flue tester necessary.)
- H.—Rack for storage of safe-ends.

handled per day is so small, it may be advisable, or economical, to use one machine in the manner described, rather than to have a separate machine for swedging. It is, however, obvious that should the number of tubes to be handled warrant a second machine, the operations would be accelerated, especially as one heat could be obviated.)

The method of procedure is as follows: As the tubes are withdrawn from the boiler, in the erecting shop, they are placed

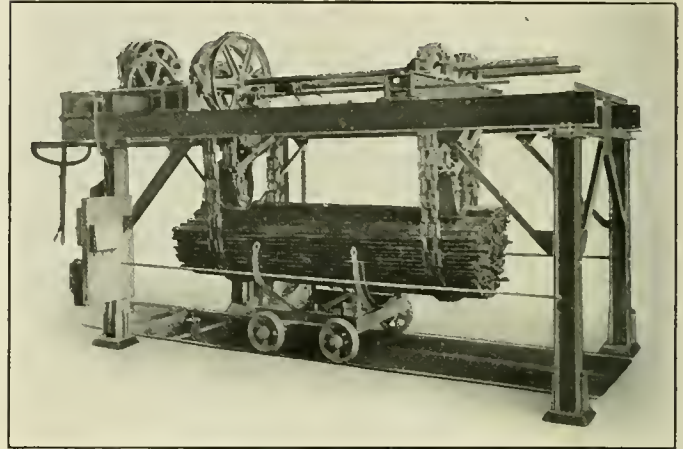

Fig. 3—Ryerson Overhead Type Flue Cleaner.

on a flue carrier or car, Fig. 5, conveniently located at the front end of the locomotive, as represented in Fig. 2. When the carrier is loaded it is picked up by the crane, carried to the boiler shop, and set down on the cross service track, which is



Fig. 2—Removing Tubes from the Boiler and Loading on the Flue Car in the Erecting Shop.

- I.—Safe-end machine for cutting and scarfing tubes.
- J.—Furnace for heating superheater flues.
- K.—Cut-off saw and expander for superheater flues.
- L.—Welder and swedger, designed for flues from 2 in. to 6½ in. in diameter. (This machine should be adapted for welding the 4½ in. safe-ends on the small end or full size 5½ in. on the opposite end of the superheater flue. After the required amount of flues are safe-ended and welded, the adjustment can be changed to perform the operation of swedging and the flues again put through the machine and swedged. This involves another heat, but as the number of superheater flues to be

usually located between the erecting and the boiler shops. Such a service track at this point is quite common to both the longitudinal and transverse types of shop. The tube car is pushed along this track, in the direction of the arrows, to the track on which the tube cleaner (Fig. 3) is located and then in the cleaner. The tubes, comprising a complete set, are first lifted from the car by the suspending chains as shown in Fig. 4. The car is pushed clear of the machine and the tubes are lowered

in the pit and cleaned. The same chains that raise and lower the tubes in the pit perform the rolling action for cleaning.

After being cleaned, the tubes are raised from the pit, the tube car is pushed under them and they are lowered on it. The car is then pushed in the direction indicated by the arrows to the station marked "Cleaned tubes."

Man No. 1 takes a tube from the pile on the car, and without turning inserts the firebox end in the furnace *A*. When heated the scored or damaged end is cut off by the saw of machine *B*. The tube is then placed in the clamps and on the mandrel alongside the saw on this machine where it is expanded and placed on a safe-end. The machine is provided with a magazine from which the safe-ends are automatically fed down in place at the side of the expander. The work so far has required but one heat. The tube, with safe-end attached, is then returned by the same man to the furnace *A* for a welding heat. When heated, man



Fig. 4—Removing or Loading Flues at the Cleaner.

No. 2 takes it from the furnace and welds it on the weider *C*, after which, with the same heat, he swedges the end on machine *D* to accommodate the copper ferule. It is then delivered to the rack marked "Welded tubes."

Man No. 3 takes the tube from the welded pile and heats the smokebox end in furnace *E*. It will be noted that he does not have to turn the tube end for end. After heating, it is cut to length and the end is expanded on the machine *F*; when finished it is placed on the pile marked "finished tubes." This pile, or rack, is on a flue car, and when the set is complete, the car is pushed back, either to the erecting shop or to the storage track.

In this layout, two thoughts have been kept in mind. First, to keep clear of the through track in the heavy machine-tool bay, which it is very desirable to keep free and clear from end to

end of the shop; and second, the tube manipulations are not dependant upon the crane service in the heavy machine-tool bay, and therefore are not affected by any delays incident to the crane being in use when it may be greatly desired for lifting and handling tubes. Yet it is possible to use this crane as an

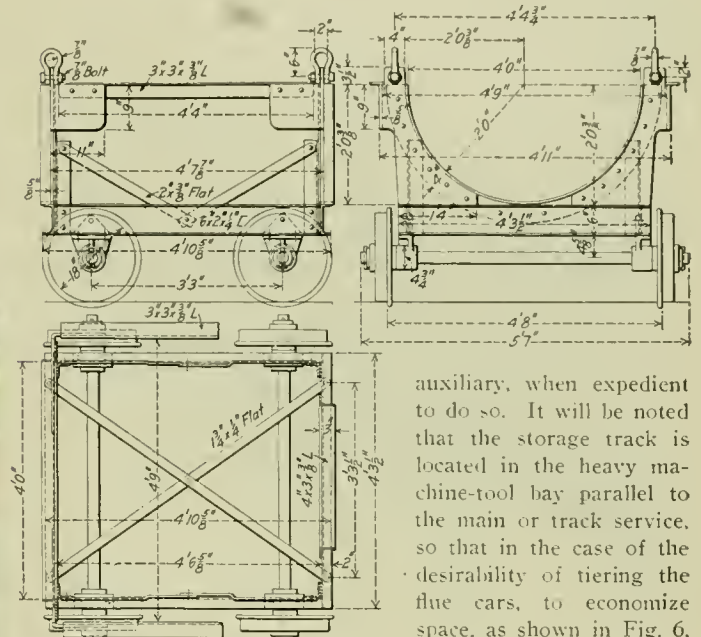

Fig. 5—Details of a Flue Car Arranged for Tying; Canadian Pacific.

auxiliary, when expedient to do so. It will be noted that the storage track is located in the heavy machine-tool bay parallel to the main or track service, so that in the case of the desirability of tiering the flue cars, to economize space, as shown in Fig. 6, the crane can be utilized, but it is obvious that dependance on the crane

for the simple purpose of storage manipulation will not entail any delay in the tube operations.

The overhead type of flue cleaner mentioned above is shown in Fig. 3. The capacity of this machine is 500 2-in. tubes up to 24 ft. long. This machine raises and lowers the tubes in the

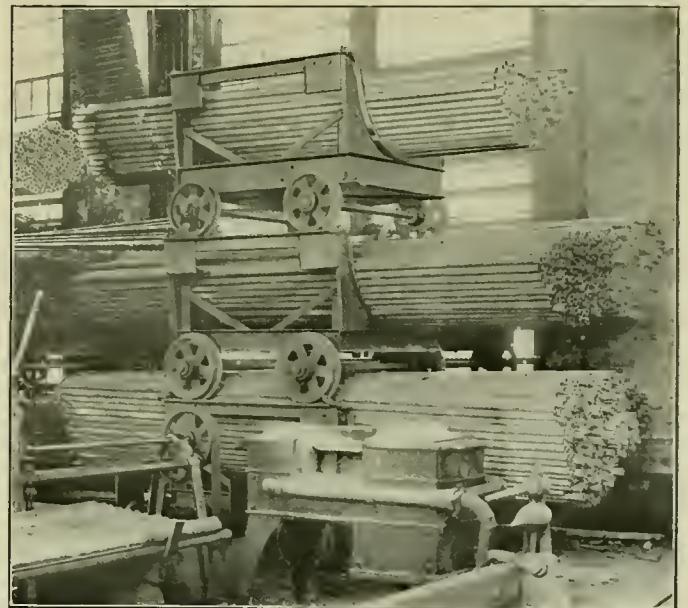

Fig. 6—Method of Tiering Flue Cars on Storage Tracks, Each Car Holds One Complete Set of Tubes.

pit by its own power and may be loaded and started in less than eight minutes and unloaded in the same length of time. It will clean 500 tubes in the same time that the ordinary tube rattler or tumbler-barrel will take to clean one load of approximately 120 tubes and with much less consumption of power. It consists

of an overhead, structural steel, framework of heavy construction, supported by four columns. Four steel sprocket wheels, provided with suitable driving gear, are mounted on this and wide face, case-hardened driving chains pass over them and under a steel idler pulley, and form two loops or slings of equal length, which extend in the pit beneath the framework and support the tubes. By driving the sprockets, the chains cause the

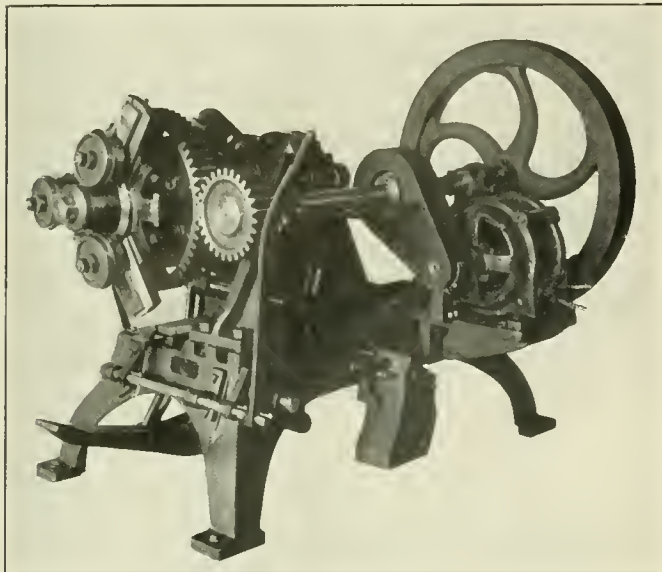

Fig. 7—Hartz Motor Driven Welder with Gear Guard Removed.

tubes to roll over and over on themselves in the cradle formed by the loops. The pair of sprockets carrying the rear chain is mounted on a traverse or bridge, which has a movement to and from the driving end of the machine. The main shaft carrying the sprockets is splined so that by turning the screws, which operate the traverse, the position of the rear sprockets may be changed and the distances between the two slings modified to

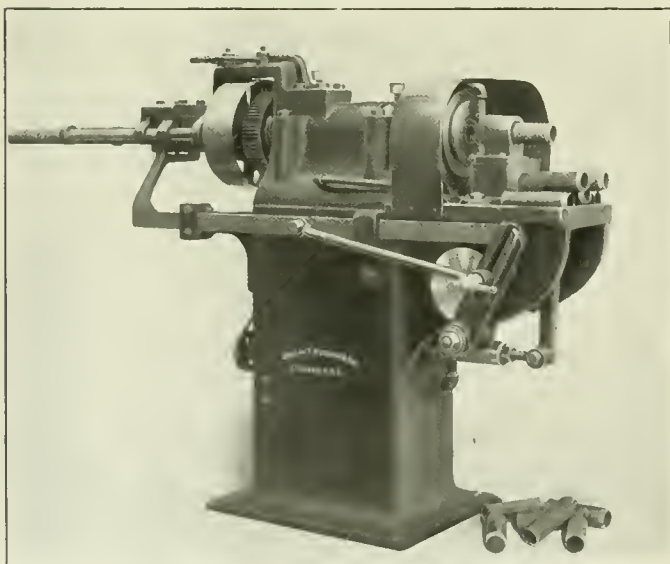

Fig. 8—McGrath Safe End Machine.

suit the length of the tubes being handled. The power of the machine is utilized for changing the position of the traverse carriage.

This machine is also made in another form called pit drive type which has no overhead framework. All the framework necessary for the handling and cleaning of the tubes is integral with the pit itself, and below the floor line of the shop. With

this type some form of crane or hoist has to be provided to lift the tubes in and out of the pit. The sling chains used for lifting from the car are loosened and remain around the tubes in a recess provided, while the tubes are being cleaned. The operation of cleaning is performed in the same way as that described for the overhead type and either will clean sufficient tubes to give the output assumed for this ideal shop.

The type of flue car in use at the Angus shops of the Canadian Pacific, which is suited for tiering, one on top of the other for storage purposes, is shown in Figs. 2, 5 and 6. The type of car shown in Fig. 3 is the general form used where it is not deemed necessary to tier the cars.

The form of flue welding machine, selected for this shop, is shown in Fig. 7. The machine is designed to do the complete welding in three operations, and operates on the roller principle. In its latest form it has a range for tubes from 1½ in. to 6½ in.

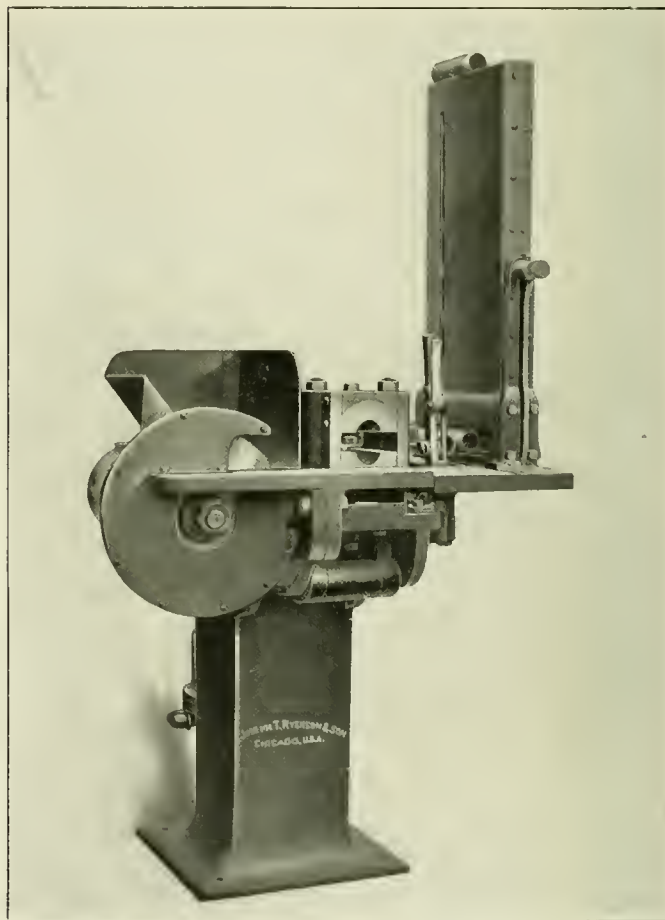

Fig. 9—Hot Saw and Expander with Safe End Magazine.

The adjustment of the rolls is such that a smooth weld, true to gage and practically invisible, is assured. The attachments for the cutting-off, swedging, spreading and scarfing operations can be applied, but owing to the capacity of the machine it is mainly used for welding. In the handling of superheater flues these various attachments may be used to advantage, as the time to change the machine for the different operations is not a serious disadvantage, owing to the small number of flues to be handled a day.

The safe-end cutting-off machine assumed is shown in Fig. 8. This is designed to automatically and correctly cut off to length, scarf and finish safe-ends in any length up to 12 in. and is so arranged that either stock or scrap tubing can be utilized. In general it resembles the ordinary screw machine in that it consists of a substantial base, and means are provided for supporting the tube to be cut. The tube is automatically fed through

a chuck, arranged with proper cutters to perform the operations for any degree of scarf or bevel.

If the customary method of cutting safe-ends on a hollow spindle turret lathe or a pipe machine is followed it will not be possible to attain the price of three cents per tube which the arrangement and apparatus under discussion will give.

A Ryerson combination hot saw and tube expander forms a very vital part of the suggested equipment. This machine (Fig. 9) is arranged to perform three operations; namely, cutting, expanding, and picking up the safe-end. A suitable groove is provided for holding the safe-end, to enable it to be driven on to the end of the tube as described above. There is also a magazine for holding the supply of safe-ends which will automatically permit one to roll in the groove after the one in place has been removed. The saw is supported on a mandrel on the left side of the stand as the operator faces it. It operates at high speed and requires but a fraction of a second to cut off the end of the heated tube. A metal chute is provided for removing the hot fag end. The saw is protected by a hood and is only exposed at the point where the cutting is done. The tube clamping device consists of a lower stationary jaw and an upper jaw mounted on a lever which, in turn, is connected with a pneumatic cylinder. A horizontal cylinder is located directly back of the tube clamp, and the end of the piston rod is provided with a taper mandrel extending between the jaws of the clamp. The operating lever is so connected with the valves controlling the two cylinders that when it is brought forward the clamp jaws close, holding the heated tube in place while the expanding mandrel is forced in the end of the tube.

CAR SHOP KINKS*

BY C. C. LEECH.

TONGS FOR HANDLING CAR AXLES.

The axle tongs shown in Fig. 1 is made from 5/8-in. bar iron forged to the shape shown. The parts that grip the axle are 1 1/4 in. wide and are so shaped that when they are

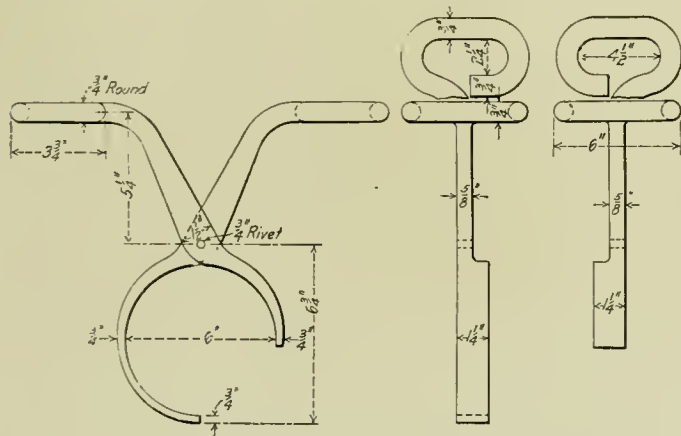

Fig. 1—Tongs for Handling Axles.

in the form of a perfect circle there is an opening of a little less than 90 degs. This insures a positive grip on the axle.

AXLE CENTER FACING JIG.

A burr or rough edge is raised at the center on the ends of nearly all car axles because of the frequent swinging on the lathe center when they are being trued or fitted. This rough edge is objectionable as it sometimes catches the packing in the journal box and displaces it, oftentimes causing the axle to run hot. It is not convenient to change the tools in the axle lathe and move the tool post and carriage around to

*These kinks are taken from Mr. Leech's contribution to the *Railway Age Gazette* September 15, 1911, shop kink competition.

enable this burr to be faced off, so the jig shown in Figs. 2, 3 and 4 was made to do this quickly by hand, either before or after the axle is mounted.

Fig. 2 shows the device clamped to the axle. It consists of

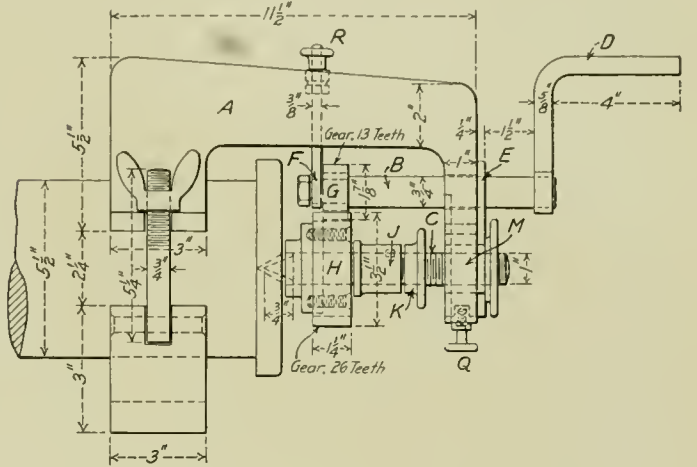

Fig. 2—Machine for Facing Axle Center Holes.

the frame *A*, the driving shaft *B* and the spindle *C*. The frame is rigidly clamped to the axle, as shown in Fig. 3. The driving shaft *B* is turned by the handle *D* and runs in the

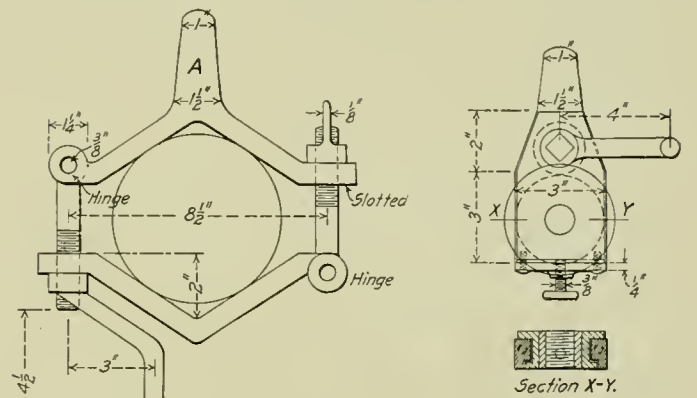

Fig. 3—Clamp and End View of Axle Center Facing Jig.

bearings *E* and *F*. The spindle *C* is driven by the gear *G*, which meshes with the gear *H*. The latter has a broad face and slides freely on the spindle. An end milling cutter is fastened on

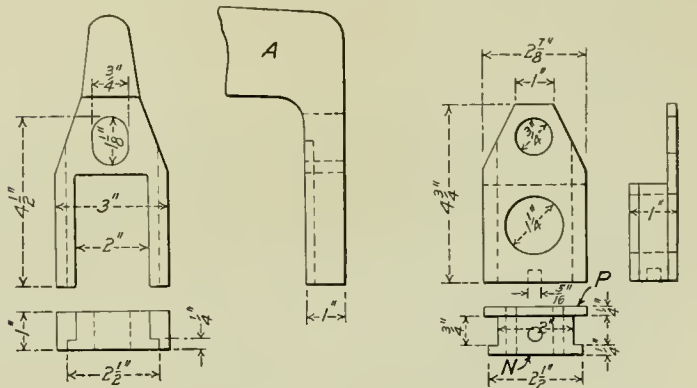

Fig. 4—Details of Spindle Support Block.

the end of this gear, being held to it by screws. The spindle *C* is threaded back of the bushing *J*, and through the nuts *K* and *M*; it is held into the axle center by nut *M*. The nut *K*

forces the bushing *J* against the gear, pushing the milling cutter against the axle, and thus faces off the burr.

The end of the frame *A* is shown in Fig. 4. It is forked to receive the block *N*, which may be adjusted up or down by the screw *Q* (Fig. 2). It will be noticed that the hole in *A* through which the shaft *B* passes is elongated to allow for this adjustment. The other end of the spindle is adjusted by the arrangement at *R*.

GAGE FOR WHEEL FIT AND JOURNAL LIMITS.

The gage shown in Fig. 5 is made of steel and is used for measuring the diameter of the car journals. It consists of the part *A* and the sliding part *B*, which has a set screw and key for locking it fast at any of the lines *C*. A pin *D* keeps the

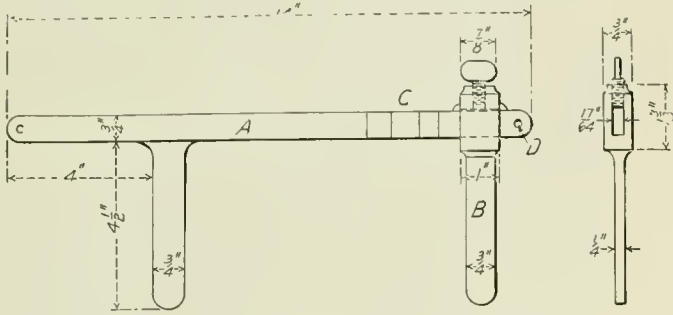

Fig. 5—Gage for Axle Diameter Limits.

part *B* from slipping off the end. The extension of part *A* at the left serves as a handle. When an axle is dismantled at the wheel press it can be quickly ascertained whether it is below the prescribed limits by trying the gage which has been set to the limit line for the axle which is to be inspected.

WHEEL BORING MILL ATTACHMENT.

Nearly all the flanges of cast iron car wheels are more or less warped, and in order to make a pair of wheels tram properly the high sides of the flanges should be diagonally opposite when the wheels are pressed on the axle. To find this spot quickly and accurately the attachment shown in Fig. 6 was made. The parts are of forged iron and may be made to suit the boring mill. The bracket *A* is bolted to the column of the machine and carries the arm *B*, which is free

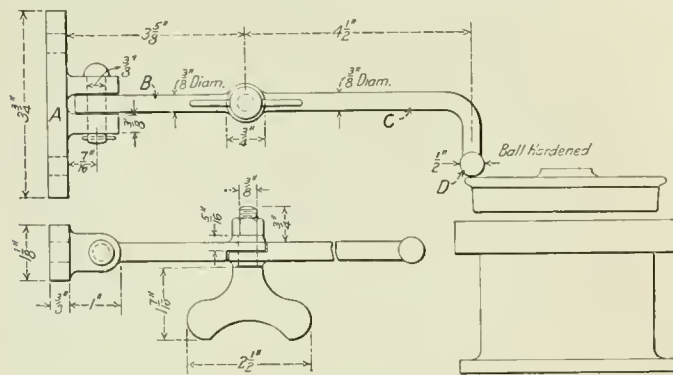

Fig. 6—Device for Testing Warped Car Wheels.

to move in a horizontal direction. The arm *C*, which moves in a vertical direction, is secured to this by a thumb screw and nut. After the boring mill is started the operator pushes down the arm *C* until the hardened ball *D* just touches the highest point on the wheel flange. He marks it with chalk, also noting the amount that the flange runs out. He is then able to pair the wheels that run out about the same amount and mount them to correct the defect. He is also able to quickly detect any wheels that should be condemned. The two movements of the arm prevent the ball end from being caught on a rough spot and being bent.

ADJUSTABLE FLANGE GAGE FOR CAR WHEELS.

When new or old cast iron or steel wheels are paired for mounting, it is desirable and necessary to have very little variation in the flange thickness, in order that the wheels after being mounted on the axle will run properly over the rails and frogs. The adjustable gage shown in Fig. 7 is made of hardened tool steel. The part *B* slides freely on part *A* and allows the gaging joint *E* to go up against the outside of the wheel flange, the gage fitting down over the flange, part *D* being on the in-

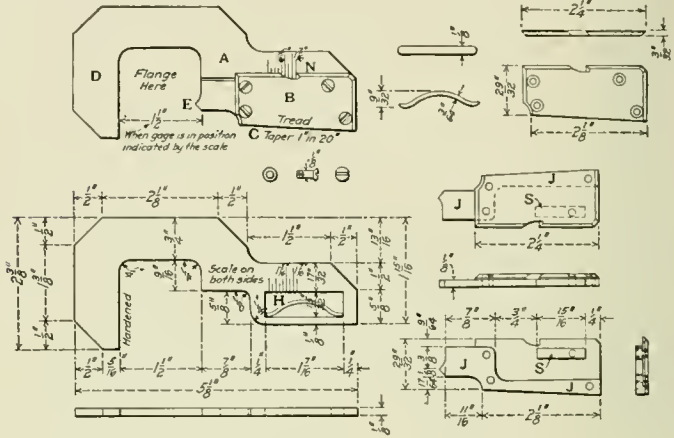

Fig. 7—Gage for Measuring Flange Thickness.

side. The index point at *N* shows the thickness of the flange as indicated by the scale, which is stamped on both sides of the part *A*. The lower edge of *B* is made the same taper as the wheel tread and rests on it when the flange is measured. Detail parts are shown in the illustration. The piece *B* has a small strip *S* riveted to it, which acts as a stop. The small spring *H* which is located in *A* also bears on *S* and holds the part *B* firmly to *A*. On the lower side of *B* is fastened the part *J* which has the gaging point *E*.

HOOKS FOR LIFTING CAR WHEELS.

The device shown in Fig. 8 is used to lift car wheels to the table of a boring mill. Its design is clearly shown in the illustration. There are two adjustable arms having U-shaped ends which are bent so as to hook over the flange of the car wheel.

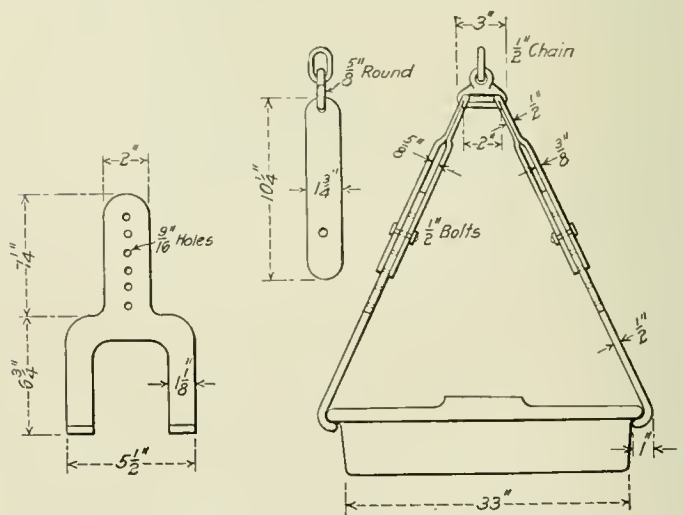

Fig. 8—Hooks for Lifting Car Wheels.

The U-shaped pieces fit in the upper part of the arm, as shown, and adjustment is provided by the six holes. The upper end of the arm is held in a clevis which has a ring for the hoisting hook. The adjustment allows for handling of wheels of varying diameters.

TIRE GAGE.

A tire gage is shown in Fig. 9. It is made of tool steel $\frac{1}{4}$ in. thick, and consists of the body *A*, which is in one piece with the part *D*, and the movable arm which slides up and down on *D*, and is held in position by the screw and key *E*. A slot is cut in the arm to allow the crosshead *B* to be moved over the lowest joint in the tire tread. The gaging screw *C* is then set down till it bears on the tread of the tire. The amount that the screw extends below the arm is subtracted from the distance

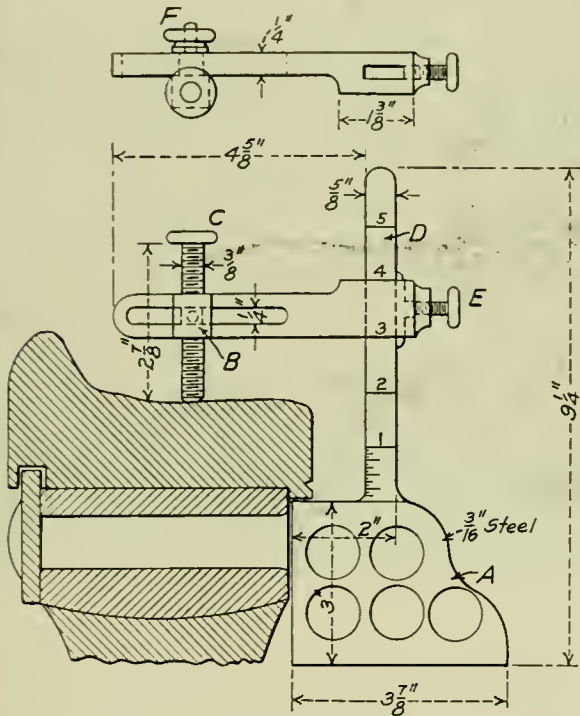

Fig. 9—Tire Gage.

that the arm is from the zero line, which in this case is 3 in., to give the tire thickness. Care must be exercised to allow for the shoulder on the tire. The method of applying the gage is shown on the sketch. The part *D* is graduated its full length, as shown on the first inch. One turn of the screw *C* raises or

lowers the screw $\frac{1}{16}$ in. In order to get a square bearing for the gage against the wheel rim care should be exercised to clean off the paint, so that there are no lumps. Holes are drilled through *A* to lighten the gage.

ARTICULATED ELECTRIC LOCOMOTIVES WITH EIGHT MOTORS

In each order of electric locomotives built for the New York, New Haven & Hartford during the past two or three years, there have been incorporated new features of design, but in the thirty-nine heavy service locomotives now under construction by the Baldwin-Westinghouse companies no new features have been introduced, but all the arrangements that have proved to be best in everyday road service of the previous locomotives have been combined. The most noticeable feature is one that was applied experimentally to a single locomotive over a year ago and consists of the use of eight motors for four pairs of drivers. These are arranged in four units of two motors, each pair having practically one casing and both driving on the same quill. The articulated type of running gear, consisting of two trucks, each having two pairs of drivers and a pony truck, connected by a drawbar at the center and so arranged that no forces are transmitted through the cab underframe, has again been used.

Experience has shown that the eight-motor arrangement is a desirable one for the following reasons: Peripheral speed is a limiting feature in railway motor design and with two small motors it is possible to use a rotative speed approximately twice that of an equivalent large motor. Each motor thus has about one-half the number of poles of practically the same size required by an equivalent large motor. Therefore there is no increase in the number of parts, such as field coils, armature coils, brush holders, etc., in the two small motors over what would be required for an equivalent large motor. Furthermore, there is considerable saving in weight and space due not only to each of the motors being one-half as large in diameter, but also because each motor exerts about one-half the torque and a single gear can be used on the quill in place of the two gears previously found necessary. This allows the motor to be made longer and in a more economical design. The motor armatures used on these locomotives are interchangeable with those used on the other motor cars of the New York, New

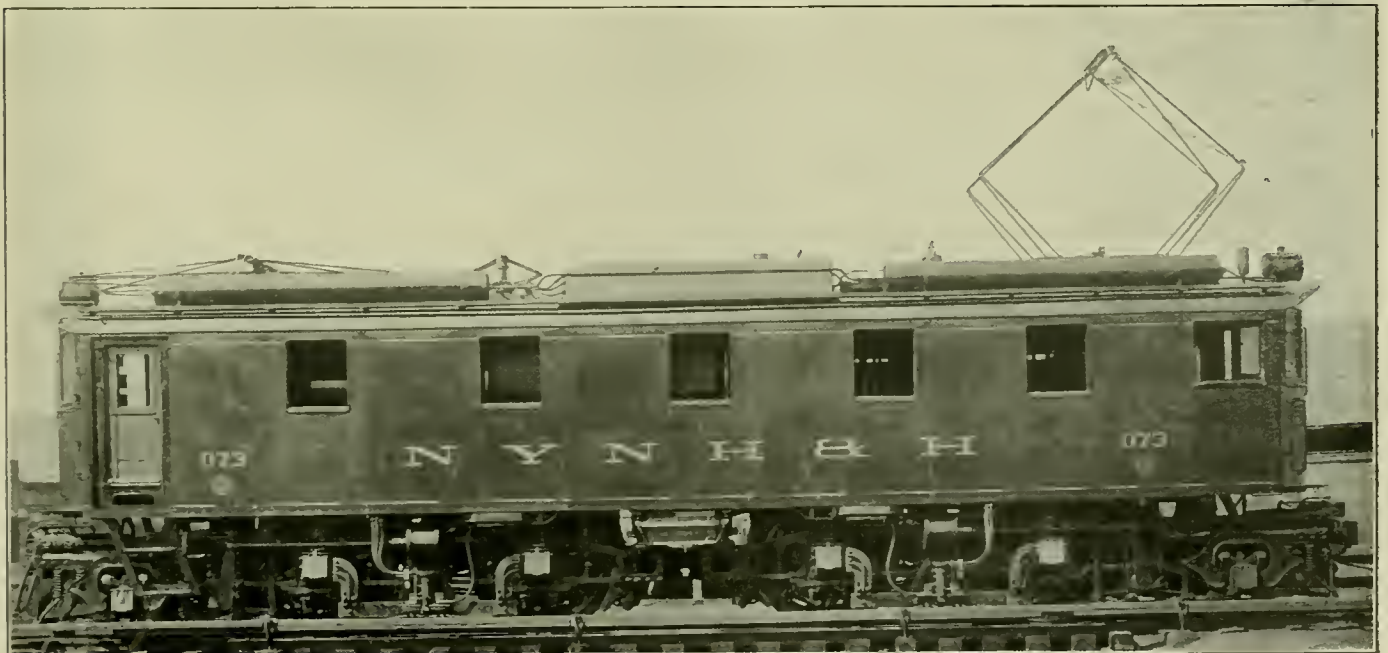

Eight-Motor Type of Electric Passenger Locomotive for the New York, New Haven & Hartford.

Haven & Hartford and the New York, Westchester & Boston. Outside of the twin motor application, these electric locomotives are very similar to those built by the same companies for the Boston & Maine for use in the Hoosac tunnel.* Each pair of motors is bolted to the truck frame over each pair of driving axles and as part of the bottom of their casing there are two axle

quills and the driving wheels is effected through helical springs mounted between the driver spokes and projecting arms provided on each end of the quill. In this way the dead weight of the motors and quill are carried by springs and the wheels have sufficient clearance and freedom to follow irregularities in the track.

Each motor has a capacity of 170 horsepower, hourly rating,

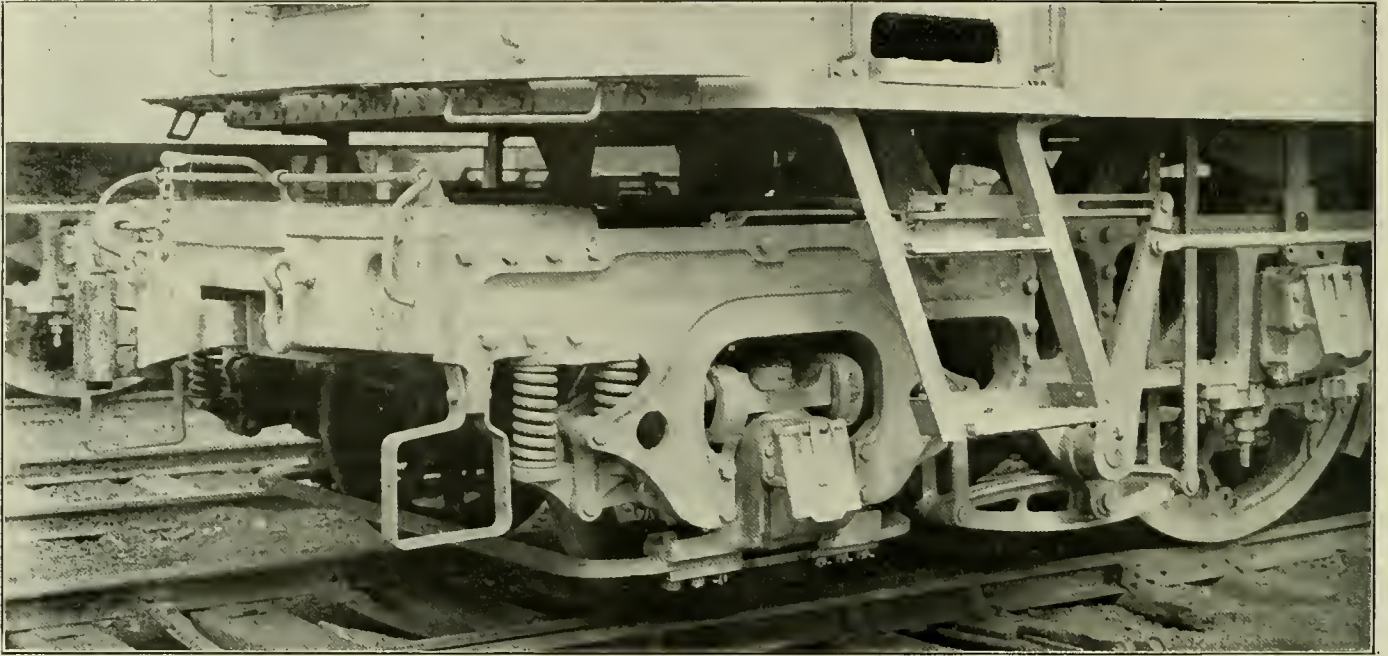

Construction of Electric Locomotive Trucks at the Outer End.

bearings which carry a quill concentric with and surrounding the axles. The inner diameter of the quill is three inches larger than the diameter of the axles. A single gear is secured to one end of the quill and the two pinions keyed to the ends of the armature shafts mesh with it. The connection between the

*See *American Engineer and Railroad Journal*, November, 1911, page 446.

and three of the locomotives are arranged for operation on either alternating or direct current, while the remaining thirty-six are for alternating current only. Each pair of motors is connected permanently in series, and when the locomotive is operating with alternating current the four pairs are connected in multiple. When direct current is being used, however, ar-

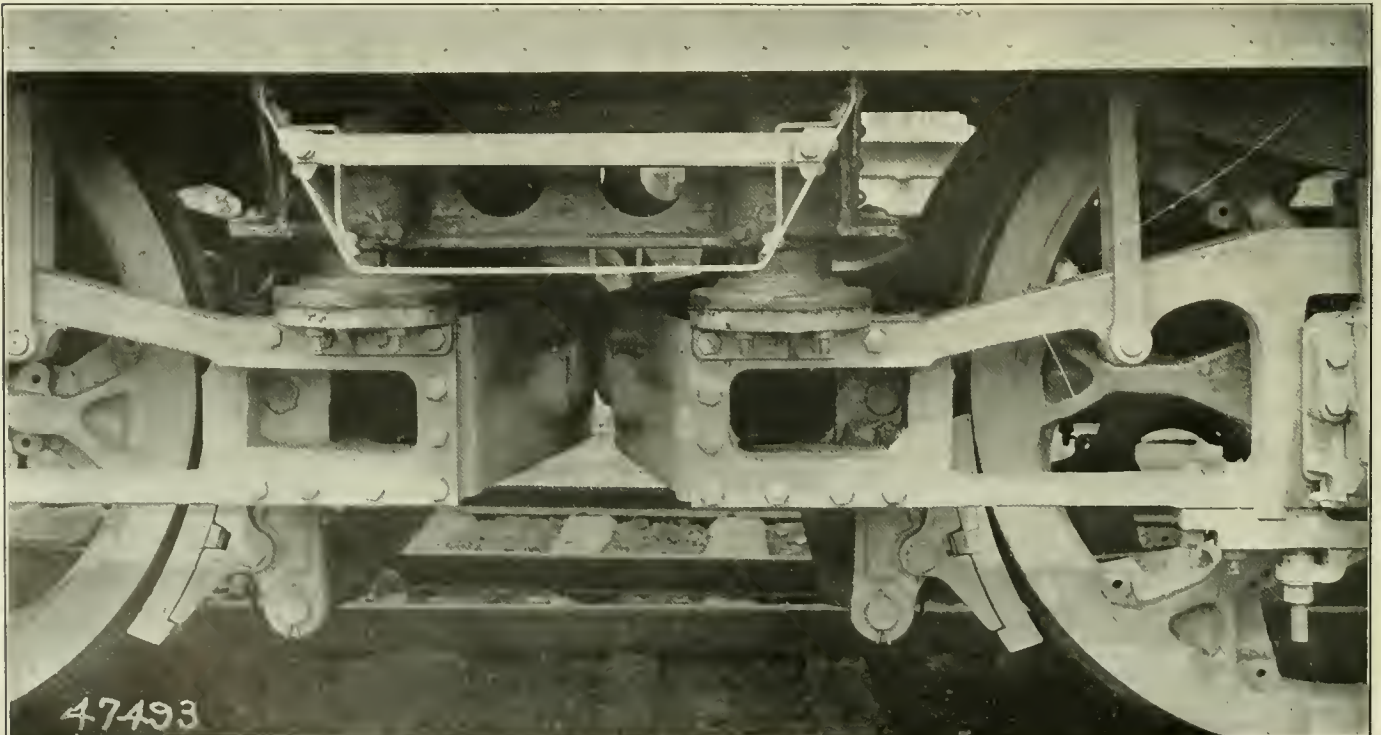

Articulated Connection and Cab Supports of Electric Locomotive.

rangements are made so that two pairs can be connected in series as well. The construction is suited for 11,000 volt, 25 cycle, single phase, alternating current, or 650 volts direct current. The locomotives arranged for alternating current only are intended primarily for fast freight service, and are designed to handle a train of 1,500 tons at 35 miles per hour. They are

Spring buffers are provided at this point, and the drawbar has a slotted hole in one end so that all buffing shocks are taken directly by the buffer and the drawbar is never placed in compression.

A radial type drawbar arranged to receive a housing for a Westinghouse friction gear is mounted on either end of each truck. This is provided with a centering device. The pony trucks are of the Rushton type, with outside journals. The

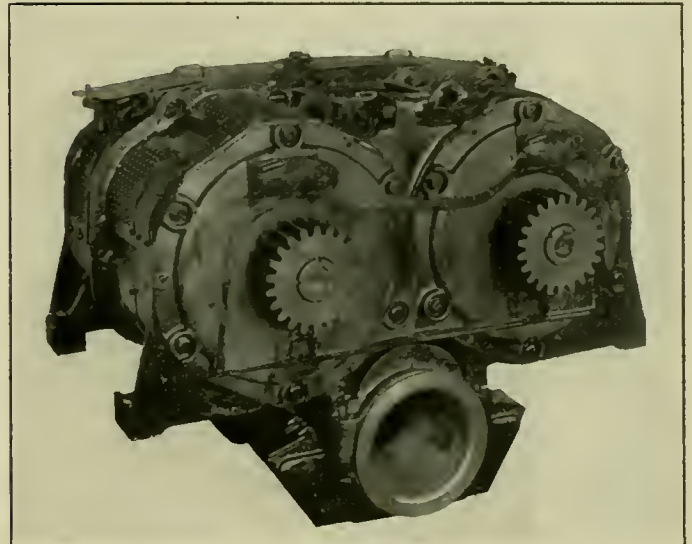
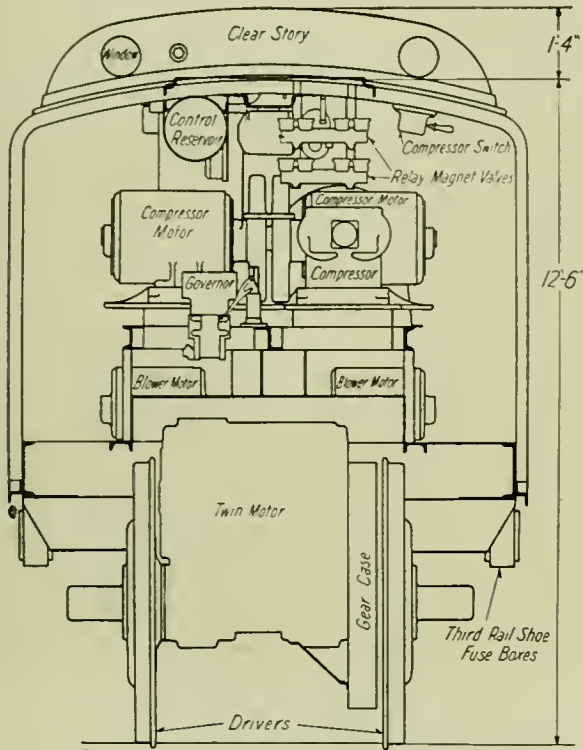

View of Pinion End of the Twin Motor Units.

Transverse Section of Twin Motor Type of Electric Locomotive.

equalization scheme provides a four point support for the whole locomotive.

expected to deliver a maximum tractive effort of 40,000 lbs. The remaining three are for fast freight and heavy passenger service, and are designed to handle a trailing load of 800 tons at a maximum speed of 45 miles an hour.

Each group of two pairs of drivers and pony truck has cast steel frames of the bar type equipped with regulation shoes and

The cab underframe is composed of two 12-in. channel side sills and two trussed center sills. It covers the whole locomotive, and the cab is built of steel plate on a Z-bar frame. The cab is supported at four points on each truck, the two at the center being 84 in. apart transversely, while the two at the ends are about 34 in. apart. The weight of the cab and the equipment carried is transferred to the truck through coil springs and the spring pocket plungers are allowed to slide on the bearing secured to the truck frame. This construction is clearly

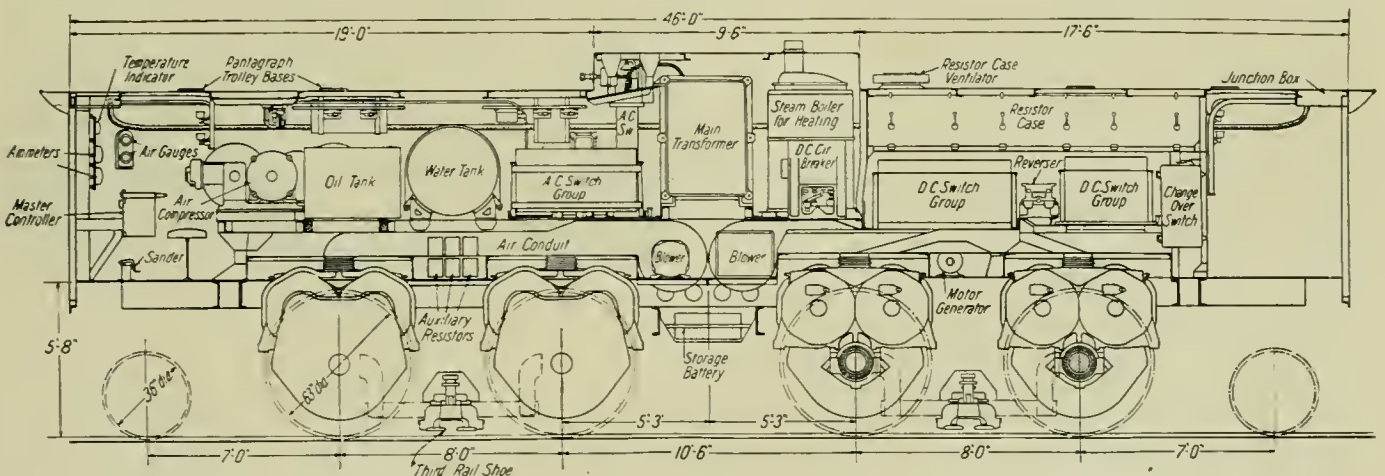

Section of A. C.—D. C. Locomotive Showing Location of Apparatus in the Cab.

wedges. These are located outside the drivers and are connected by heavy steel castings at either end, and a built up steel structure acting as a center plate support and frame brace is secured across the frames between the drivers. The tractive effort is transmitted from truck to truck by means of a drawbar arranged to leave a half-inch maximum clearance between the bumper plates of the trucks when all the slack is taken up.

shown in the view of the articulated connection. The center pins carry no weight, and are employed simply to hold the cab in its position. One of them is allowed sufficient longitudinal movement to prevent any of the pulling or buffing stresses from passing through the cab underframe.

When operating on alternating current, the energy passes through an oil circuit breaker, through the primary of the main

transformer and then to the ground. A number of taps, provided on the secondary winding of the main transformer, are connected through preventive coils, by means of pneumatically operated switches, to the motor circuits. There are twelve voltage steps on the transformer, of which nine are for running points. The pneumatically operated switches are assembled in one group located close to the transformer. The reversal of the direction of rotation of the motors is effected by two pneumatically operated drum type reversers, each of which is so connected as to control two pairs of motors. There are two blowers located in the center of the cab directly under the main transformer. These are each driven by an a.c.-d.c. motor, and draw the air from the outside of the locomotive, discharging it through the main transformer, motors and resistors. There are two motor-driven air compressors, each having a capacity of 50 cu. ft. of free air per minute, provided for the operation of the air brake and control equipment. An oil burning steam heater plant capable of supplying 800 lbs. of steam per hour is installed on the passenger locomotives.

The thirty-six alternating current locomotives have the following general dimensions:

| | |
|--|---------------|
| Length between coupler faces | 50 ft. |
| Maximum width | 10 ft. 3 in. |
| Maximum height over cab | 13 ft. 10 in. |
| Rigid wheel base | 8 ft. |
| Total wheel base | 40 ft. 6 in. |
| Driving wheel diameter | 63 ft. |
| Driving journals | 7 x 13 in. |
| Truck wheels diameter | 36 in. |
| Truck journals | 6 x 12 in. |
| Weight on driving wheels (a.c.-d.c. locomotive)..... | 182,000 lbs. |
| Weight, total (a.c.-d.c. locomotive)..... | 240,000 lbs. |

CUTTING SPEED ON PLANERS.

A method of obtaining an equivalent planer speed to cover any combination of cutting and return speeds, and give the average for the full cycle, has been developed by L. R. Pomeroy, consulting engineer, New York. This will be found useful in connection with detailed studies of machine tool operation, particularly time studies.

Let C = cutting speed in feet per min.
 R = return speed in feet per min.
 E = equivalent cutting speed in feet per min.

$$E = C \div 1 + \frac{C}{R}$$

$$= \frac{C \times R}{C + R}$$

For example, if C = 40 ft. per min., and R = 100 ft. per min.

$$E = \frac{40 \times 100}{40 + 100} = 28.6 \text{ ft. per min.}$$

If the work is 12 in. wide and 10 ft. long and a feed of 1/8 in. can be taken, the time for cutting will be

$$\frac{8 \cdot 12 \times 10}{28.6} = 33.6 \text{ min.}$$

the equation being

$$\frac{(\text{Cut per in.}) \times (\text{width in inches}) \times (\text{length in feet}) \times (C + R)}{C \times R}$$

Overrun can be included as a percentage of the length of cut.

By using the ratio of the cutting to the return speed the equivalent cutting speed is obtained even more simply.

| | |
|-------------------|----------------|
| Ratio 1 to 1..... | E equals 1/2 C |
| Ratio 1 to 2..... | E equals 2/3 C |
| Ratio 1 to 3..... | E equals 3/4 C |
| Ratio 1 to 4..... | E equals 4/5 C |
| Ratio 1 to 5..... | E equals 5/6 C |

ORE TRAFFIC.—The Bessemer & Lake Erie in the month of May hauled from Lake Erie to the mills of the Pittsburgh district 23,584 cars of ore—1,115,000 tons. This is 62,000 tons more than was ever before carried over the line in a single month.

LOCOMOTIVE BOILER LOW WATER TESTS

As a culmination of the extensive series of comparative locomotive boiler tests that have been under way at Coatesville, Pa., during the past five months, the two boilers were subjected to a trial for determining the effect of low water. This test took place on June 20 at Coatesville and resulted in the giving way of the crown sheet of the radial stay boiler when the water had fallen 14 1/4 in. below the crown sheet level, while the Jacobs-Shupert boiler gave no signs of failure or distress after 55 minutes and when the water level was more than 25 in. below the top of the crown sheet. The impossibility of obtaining sufficient steam from the water remaining in the boiler to maintain a pressure of more than 50 pounds and give the required draft, forced the closing of the test.

These tests were outlined by and have been conducted under



Radial Stay Boiler Just as the Crown Sheet Gave Away.

the direction of Dr. W. F. M. Goss, and have very fully covered the comparative results for efficiency, capacity, water circulation and strength of the two boilers, which were identical in construction with the exception that one was fitted with a Jacobs-Shupert firebox, while the other had a normal radial stay firebox.

In preparation for this test, both boilers were placed on the cinder dump of the Lukens Iron & Steel Company, at a point sufficiently far away from houses and other buildings to prevent accident in case of the complete rupture of the boilers. This dump is located in a valley and the adjacent hillside offered a splendid position for the spectators. A grandstand was built about 2,500 ft. from the nearest boiler and here the invited guests had an excellent view of the proceedings. A bomb-proof consisting of a firebox turned on its side was located about 250

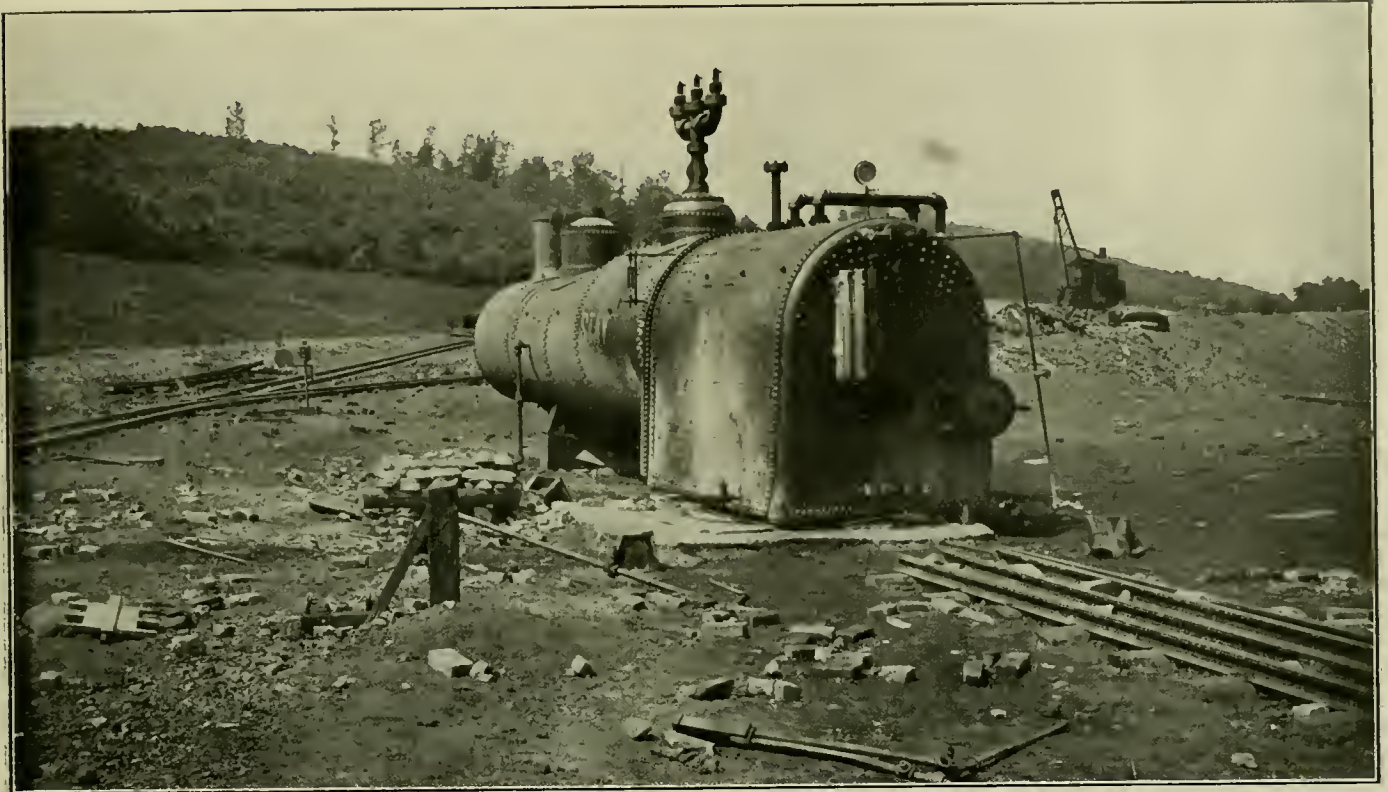

Radial Stay Boiler After the Low Water Test.

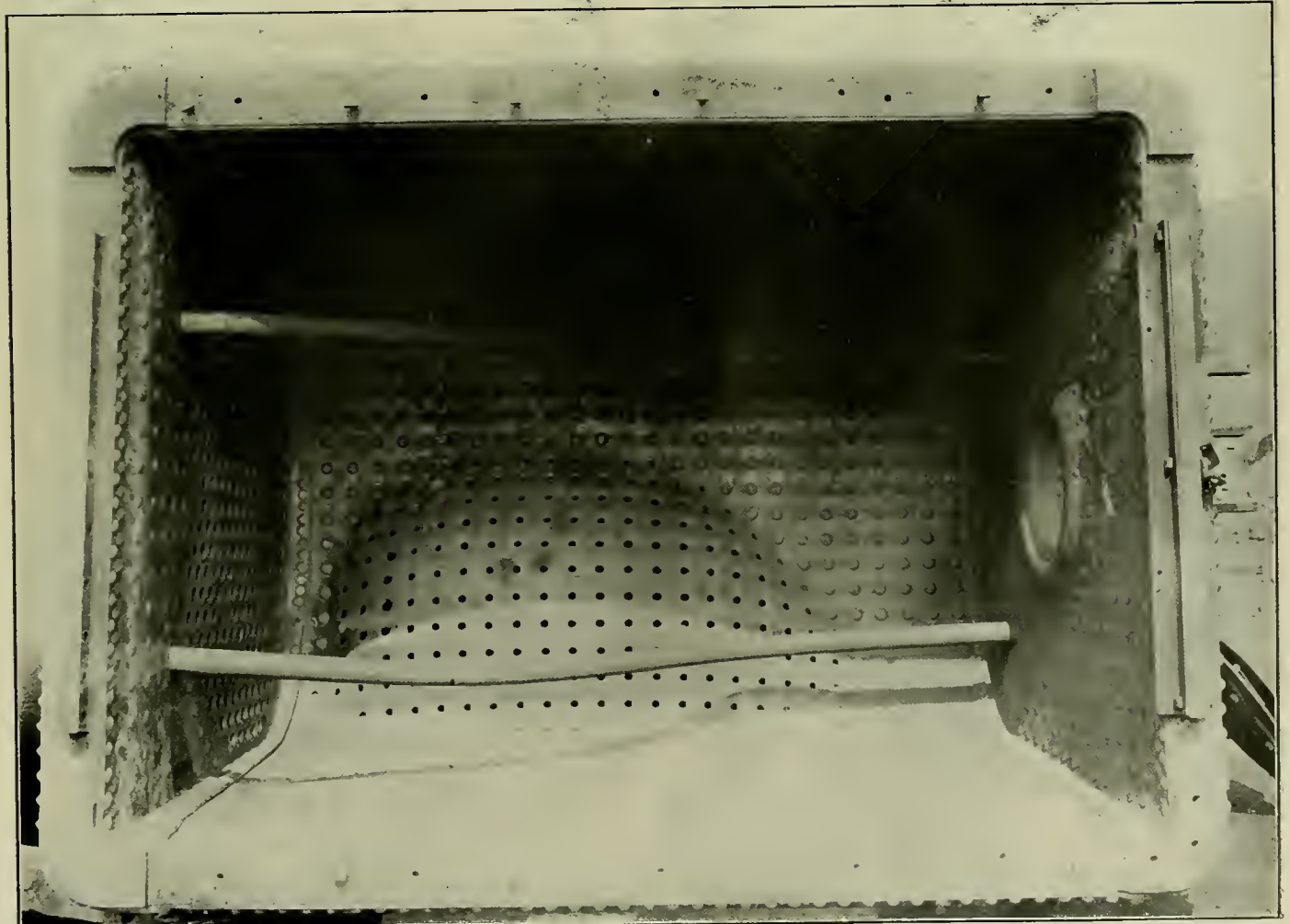

Interior of the Radial Stay Firebox After the Low Water Test.

ft. from the boilers, and from this point the oil fuel, feed water pump and draft were controlled. Here also were mounted telescopes through which the reading of the steam gage and the water level gages were made. Telephonic communication between the bomb proof and the grandstand was arranged and an announcer at the latter point gave continuous information on the progress of the test. In addition, a large water level and steam pressure indicator mounted near the bomb proof showed the height of the water level and the amount of steam pressure in the boilers at all times.

The Jacobs-Shupert boiler was tested first. At the beginning of the test the water level stood 6 in. above the crown sheet and the steam pressure was 225 lbs. The feed water supply was then shut off and part of the steam generated was used for draft, the remainder being blown out through the three large pop valves set to close, one at 225 lbs. and the others slightly higher. The water level continued to fall and at the end of ten minutes the top of the crown sheet was bare. The steam pressure remained at about 225 lbs. The water level began to fall quite rapidly and after it had reached a point about 10 in. below the crown sheet, it was evident from the appearance of the steam emerging from the pop valves that superheating was taking place. Gradually one safety valve after another seated and when the level had reached a point about 18 or 20 in. below the crown sheet, the steam pressure fell enough to permit all

stack. Finally, when the pressure had dropped to 50 lbs., about 55 minutes after the test began, it was necessary to discontinue it for lack of steam pressure, due to the small amount of water remaining in the boiler. Reference to the illustrations will show the condition of the firebox at the completion of the test and it will be seen that there is no visible distortion of the plates, although it is very evident that they were highly heated. The



Interior of the Jacobs-Shupert Firebox After the Low Water Test.

brick arch tubes were in no way disturbed nor do they show any signs of leakage, although practically half their length was above the water level at the end of the test.

While the test of the Jacobs-Shupert boiler was going on, the radial stay boiler was being prepared and the test on it was immediately started. It was subjected to exactly the same conditions and, after an interval of about 10 minutes, it was announced that the crown sheet was bare. The pressure at this time was from 225 to 230 lbs. When the water level had reached a point about 6 in. below the crown sheet some leakage appeared around the staybolts in the outer sheet, and the joint between the throat sheet and shell developed a leak. These, however, were all comparatively small. The pressure was maintained and the water level continued to fall until it had reached a point 14¼ in. below the crown sheet, which occurred about 23 minutes after the test had begun, when an explosion took place which lifted the boiler and threw a shower of brick, piping, timbers, etc., over a space of about 50 ft. in every direction. The boiler was displaced from its foundation and thrown about 18 in. to one side as is shown in one of the illustrations. Examination showed that the crown sheet had given way in a sag but that it had not split or cracked. It was found that 72 hammer headed stay bolts, 81 button headed stays and 21 T-bar bolts had pulled out. The damage was largely on the right side, beginning at about the second row of T-bars and extending back 14 rows.



Back End of the Jacobs-Shupert Firebox After the Test.

the safety valves to close. It continued to fall quite rapidly until the level had reached a point 25 in. below the crown sheet, which was the limit to which the water level gages read, when it had dropped to 190 lbs. The test was continued, however, but the rapidly falling pressure reduced the blast and the combustion became more and more incomplete. This was clearly indicated by the large amount of black smoke pouring from the

REPAIRING DRIVING BOXES*

BY M. H. WESTBROOK.

The writer has noted over 50 different variations of the necessary 10 or 12 operations for completing each driving box of a locomotive, and gives below what is judged to be the best methods so far observed. As there are necessarily a far greater number of boxes repaired than new ones made, the discussion

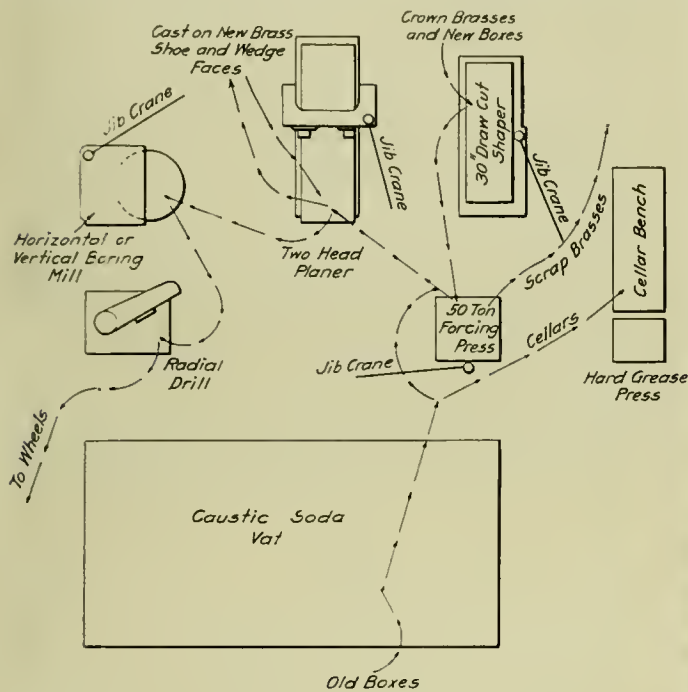

Fig. 1—Arrangement of Tools in Driving Box Section of Shop.

is largely confined to the repairing operations, with only an occasional reference to new boxes.

The size and character of the shop and the nature of its equipment must, to a large degree, enter into the method of doing this class of work, and will also be a factor in deciding

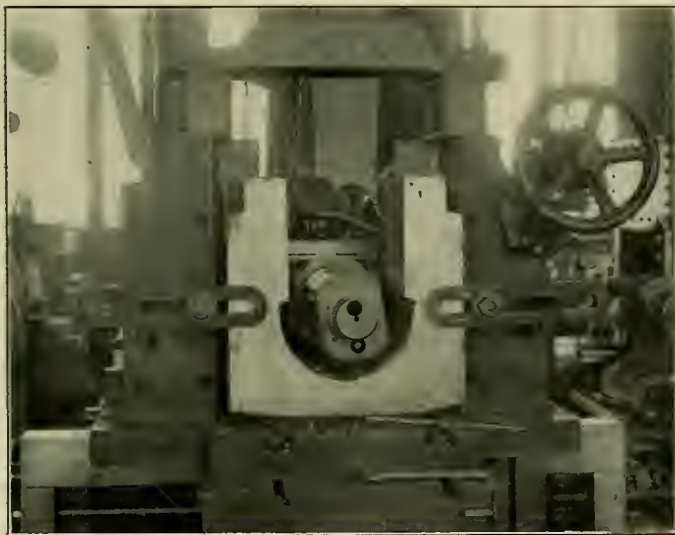

Fig. 2—Machining the Crown of New Boxes on a Draw Cut Shaper.

whether certain machinery should be installed or not. The methods described are suited for a shop operating 15 or more pits, and the arrangement of tools in Fig. 1 is suggested as the best to get the most efficient results.

Facing New Boxes.—This operation should be performed on

*Entered in the shop practice competition which closed May 1, 1912.

a heavy double-head planer, setting the boxes up in two rows. This method is preferable to milling, because steel boxes are frequently so full of sand, that the work is very destructive to the milling cutters, which are not as easily made or resharpened as planer tools. The castings should not have more metal left on them than can be removed in one cut, and ordinarily this operation on a set of six steel boxes should be completed in less than four hours.

Machining the Crown of New Boxes.—An excellent method of machining the crown of new boxes is by using a Morton draw-cut locomotive shaper, as shown in Fig. 2. This process ordinarily takes about one hour per box (12 in. brass) after the fixture is set up. The usual way of doing the work on a slotter will require a considerably longer time.

Machining the Brass.—What is believed to be the quickest and most economical method of machining the crown brass is shown in Fig. 3. This is on the same machine as shown in Fig. 2. The brasses are cast to the proper length and should require no machining on the ends, although this is being done in many shops. The time taken for machining the brass ready



Fig. 3—Finishing a Crown Brass on a Draw Cut Shaper.

to press in the box is 45 minutes for an average every-day performance.

Pressing in the Brass.—The method of pressing the crown brass in the box, using a Lucas 50-ton forcing press is shown in Fig. 4. New brasses are forced in new boxes in a very few minutes at a pressure of about 25 tons.

The practice recommended when forcing the brasses in old boxes is as follows: A standard cellar for each class of box should be kept at the press and used as a gage so that in forcing in the brass the proper pressure will be used to spring the legs back to their original position. This practically brings the shoe and wedge faces parallel to each other, and permits the minimum amount of planing. It also insures the cellars being maintained to a standard size. Instances have been observed where brasses were pressed or cast in regardless of this feature, and either the cellars were refitted to suit, or the boxes were machined to fit the cellars. In some cases the whole set would have cellars of different sizes.

In taking data from 500 boxes it was found that to press in the brass and spring the box back to its original shape, the

pressures ranged from 17 to 28 tons. Using these pressures has resulted in no trouble whatever, owing to variation of pressure fits. The operator on the shaper soon becomes expert in making the proper allowance for springing the legs back, if he calipers the box first to ascertain the amount the legs have closed in at the points. The operation of pressing in the brass to meet these requirements averages 25 minutes. Only occasionally do they

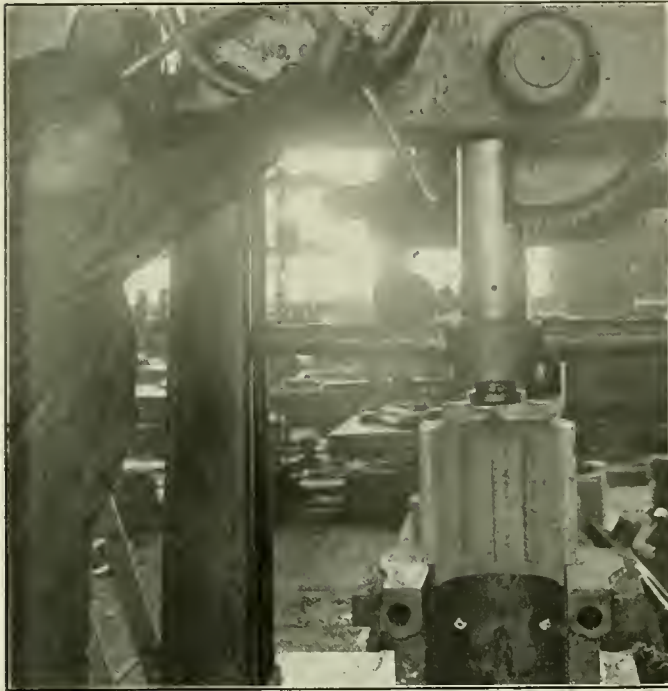

Fig. 4—Pressing in the Brass.

have to be removed and filed before pressing all the way down. Some roads make a practice of pouring in the crown brasses, and the writer will leave the advocates of that method to speak for themselves. It has been praised highly by some and condemned by others as unsatisfactory.

Shoe and Wedge Channels.—Some shops are using a brass liner fitted in and covering the whole channel, which has to be machined on its three outside surfaces and also on six end

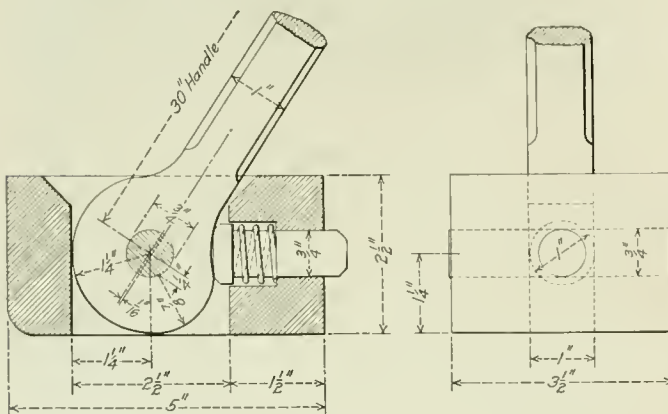

Fig. 5—Holder-On for Rivets in the Flanges of a Driving Box.

thrust strips. After the liners are fitted to the previously machined surfaces in the box they are drilled and riveted on the sides and fastened by six or more countersunk bolts. This method seems to be altogether too involved and expensive and takes up an unnecessary amount of time. When this or a similar practice requiring riveting on the flanges is standard, Fig. 5 shows a holder-on for the rivets that will be found to be very convenient.

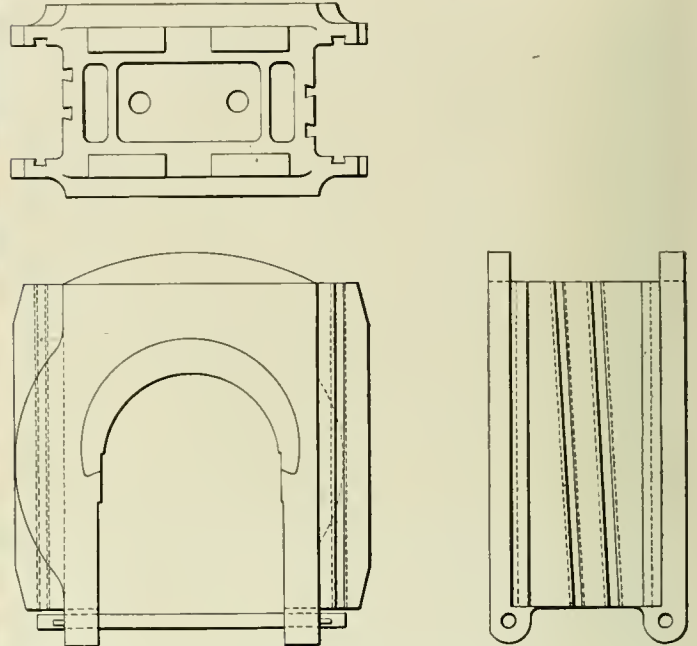

Fig. 6—Driving Box Prepared for Pouring Brass Liners in Shoe and Wedge Channels.

where brass is not used and the continual vertical movement caused by running over rough roadbeds, cause a bad scoring on both the box and shoe and wedge faces. Cases have been seen where these faces were so badly scored that it was possible to almost lay a little finger in the cavities which had corresponding projections on the opposite face. This, of course, prevents a proper adjustment of the wedges with its consequent effect on the efficiency or length of time in service of the locomotive. On the other hand, engines have come into the shops for repairs with a record of 60,000 or 70,000 miles, having brass

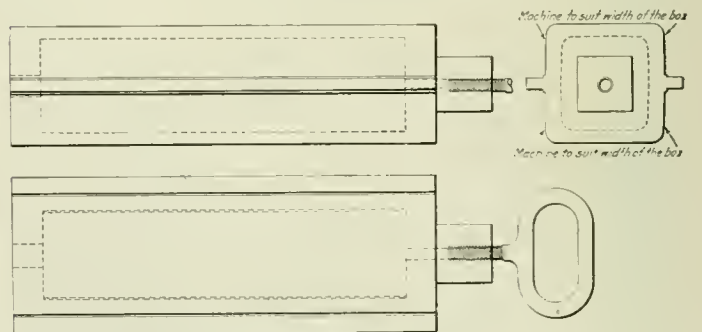

Fig. 7—Cast Iron Forms for Pouring Shoe and Wedge Liners.

faces on the boxes that were perfectly smooth and not worn over 3/64 in. from the time they first went into service.

A method of lining these faces is shown in Fig. 6. Boxes that have previously been fitted with lines, held in place by rivets and screws, should be planed out as shown. Two dovetailed grooves are planed slightly diagonal in the bottom of the channel and experience has also shown that the grooves on the sides prevent the brass from shrinking away while cooling. By doing this it is only necessary to slightly heat the boxes before pouring the lines. The operation of planing out old boxes to

receive the brass requires about one hour per box. Cast iron forms (Fig. 7) are held on the boxes by clamps which are placed on end on a plate for pouring. These forms should be machined as smoothly as possible and be given a slight taper inward. An allowance of 1/16 in. on each face is ample for finishing to size. After the metal is ready, one man and a

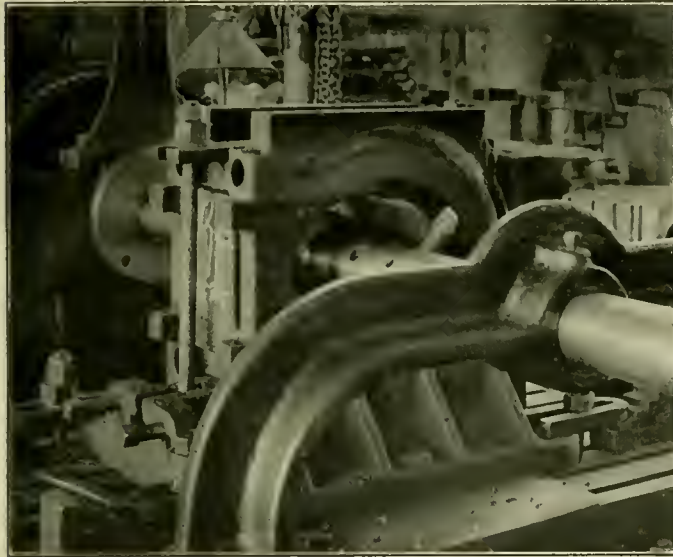

Fig. 8—Boring the Brass on the Jig Shown in Fig. 9.

helper can pour a set of six of the largest boxes and have them all ready for the planer in less than one hour. This is less time than one slipper could be fitted to a box. There seems to be no good reason for the brass extending up the sides of the channel, and in repairing boxes that have not already had shoes extending up the sides, it seems best to pour the brass on the

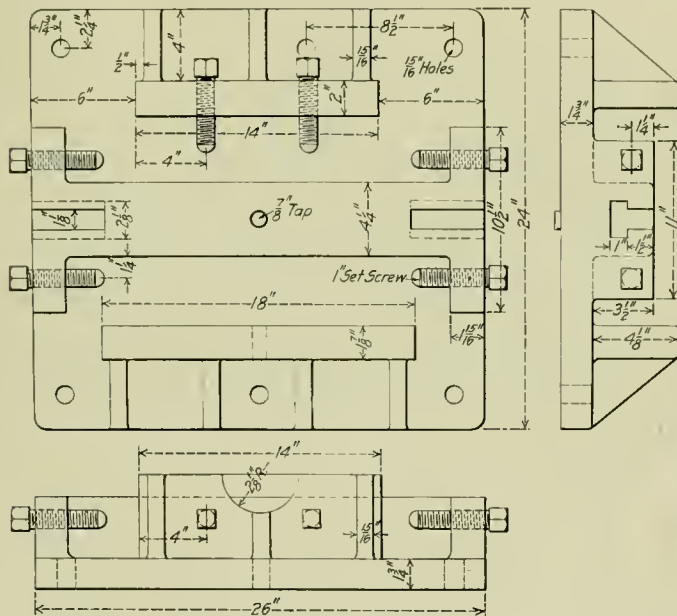

Fig. 9—Jig Used on Horizontal Boring Machine When Boring the Crown Brass.

shoe and wedge faces only, the box of course first having the two dovetailed grooves planed in the faces.

Boring the Brass.—A good method of boring, using the jig in Fig. 9, is shown in Fig. 8. Two tools are arranged so that as soon as one leaves the brass the other starts to cut, enabling the box to be bored in one setting in most cases. The boxes are planed central and the shoe face always rests on the jig,

thus ensuring every box being bored alike; only the first one needs to be laid off. There is not much to offer in support of this being a better method than machining on a vertical boring mill. The time occupied by either machine is about the same, from 20 to 40 minutes, depending on whether the cellar is to be bored out at the same time or not.

Hub Liners.—Where brass or babbitt hub faces are used on the driving wheels, very little lateral wear takes place on the driving box. It seems to the writer, after a period of obser-

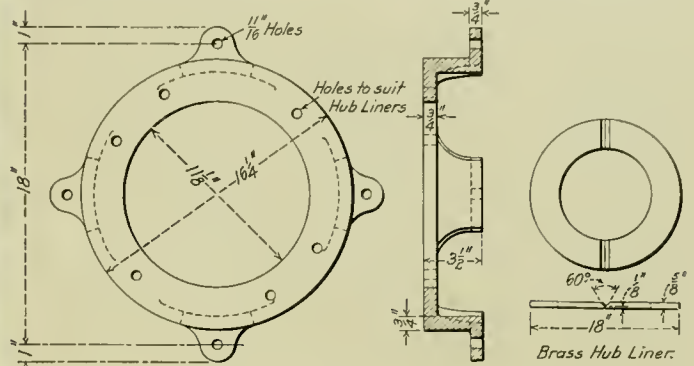

Fig. 10—Hub Liner for Driving Wheels and Jig for Machining It.

vation exceeding eight years, to be much better to face the wheels instead of the driving boxes. Two methods of taking up the lateral wear are given below as being the best in the judgment of the author.

Fig. 10 shows a brass hub liner and a jig for machining it. The liner is cast with the weakening groove as shown, and after being faced and turned to the required measurements, is broken in two halves by being thrown on a block of wood. These halves are then clamped on the wheel and the holes drilled in the wheel face to correspond with the countersunk holes already drilled in the hub liner and used to hold it while being faced on the jig. The holes on the wheel are drilled slightly larger at the bottom by a wobble drill, and copper or brass



Fig. 11—Pouring Babbitt Hub Liners.

rivets or plugs are driven into the wheel and riveted over to fill the countersunk holes in the hub liner. This method is much quicker than tapping the holes in the wheels and is quite as effective.

The other method, that seems to the writer to be better, is illustrated in Fig. 11, which shows two boys pouring hard babbitt faces on the wheels, using an adjustable molding jig that can be set for any desired thickness of liner. The boys shown have poured a set of six wheels, including the time for melting the babbitt, in four hours, the proper thickness of the

liner having first been given them. To use this method good hard babbitt must be employed and the wheel center should have a dovetailed counterbore about $\frac{1}{2}$ in. deep cut in it. A heavy locomotive having a mileage of over 100,000 miles shows less than $\frac{1}{8}$ in. lateral wear, and the only failures noted with this method have invariably been when a soft or poor quality of babbitt has been used. The writer's experience has been with oil lubrication and the effect of grease on liners of this kind has not been considered.

Fitting the Boxes.—There is much diversity of opinion regarding the fitting of the boxes to the journals. Some shops bore the brass $\frac{1}{32}$ in. larger than the journal and put it up in that condition. Others carefully file and scrape the brass to a perfect bearing. All journals that have become worn either out of round, out of center or taper $\frac{1}{32}$ in. or more should be turned. They should be tested in the lathe while revolving on their centers, as many journals are found to be perfectly round and parallel with calipers, but when put in the lathe they run considerably out of true. If this is done and the boxes are bored to a good fit for the journals, slightly easing off the

PACIFIC TYPE LOCOMOTIVE WITH GAINES FIREBOX

In the February, 1912, issue of the *American Engineer*, F. F. Gaines, superintendent of motive power of the Central of Georgia, discussed at some length the theories of flame action in a locomotive firebox which led to the design of the Gaines firebox. The constructional features were also illustrated in the same article and a comparative test was reported showing a decided economy in favor of this design. The 2-8-0 type locomotive on which these tests were made has been in regular service for over three years, giving no trouble from leaky tubes or steam failure, and has continued to give the fuel saving it demonstrated on the test.

This experience has led to the application of the same type of firebox to six Pacific type locomotives recently delivered to the Central of Georgia by the Baldwin Locomotive Works. These are moderately heavy, having 23 in. x 28 in. cylinders, 69 in. drivers and 180 lbs. steam pressure. They are essentially

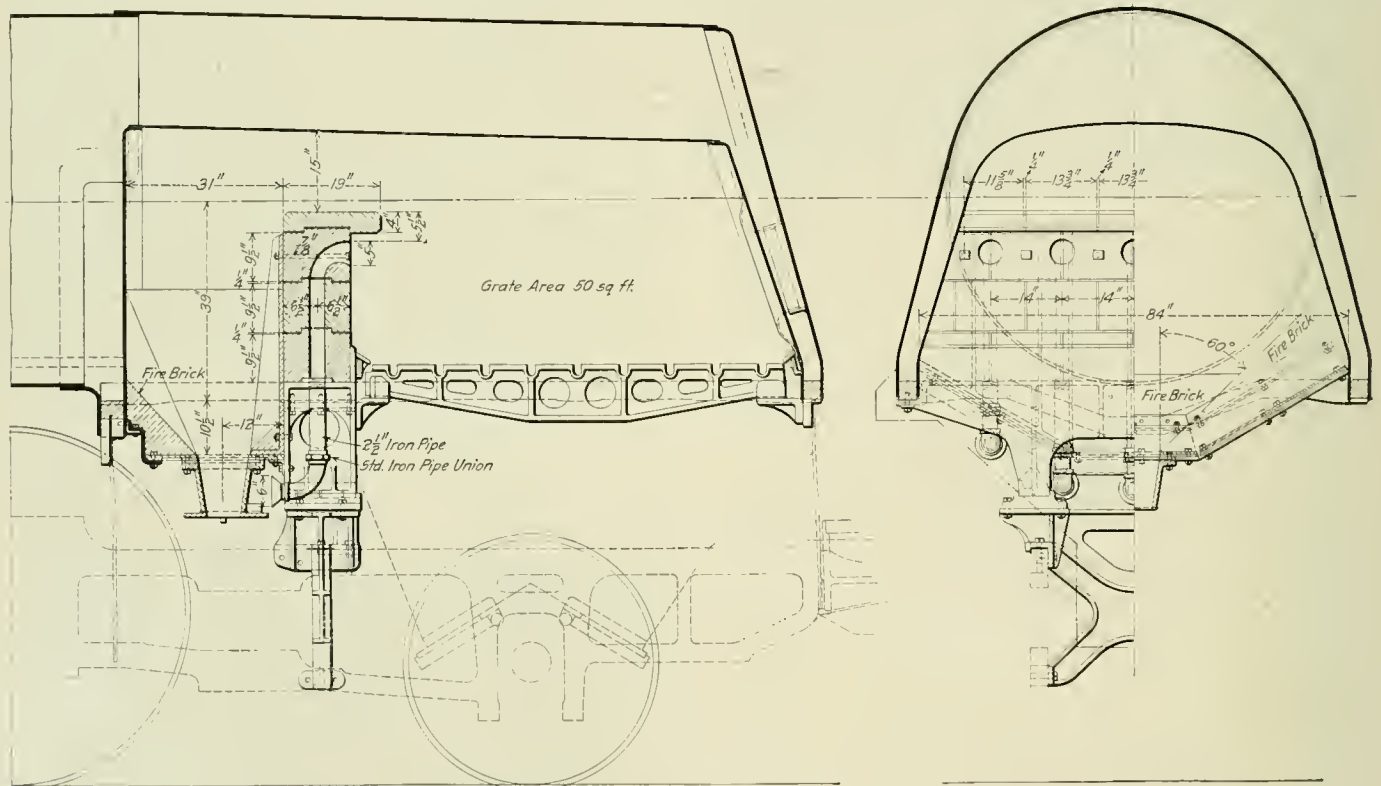

Sections Through Gaines Firebox on 4-6-2 Type Locomotive; Central of Georgia.

sides with a file only, there is no need of scraping or filing to a fit. This operation need not take more than 30 minutes per box.

[Criticisms of any of the operations or suggestions in this article will be welcomed.—Editor.]

ACCIDENT RECORD.—The Pennsylvania Lines west of Pittsburgh carried, during the calendar year ending December 31, 1911, 32,558,337 passengers, who traveled 1,138,329,577 miles; and not one was killed in any train accident. The Vandalia Railroad, which is a part of this system, has maintained a similar record for five years, and during that time has recorded only 46 passengers injured in train accidents, this number including every case requiring medical or surgical attention, however trivial. The Grand Rapids & Indiana reports a similar freedom from fatal accidents to passengers for five years. It is expected that these records will be beaten next year.

modern in every detail, being equipped with Schmidt superheaters, outside steam pipes, front extension of piston rod, etc., but present few features of novelty outside of the firebox construction.

One of the illustrations shows the sections through the firebox and it will be seen that the level of the grates is somewhat above the bottom of the barrel of the boiler. This permits an unusually large and deep ash pan. While the area inside the mud ring is 77 sq. ft., the actual grate area is but 50 sq. ft., giving practically 50 per cent. greater volume in the firebox than would be provided by the ordinary grate at the same level. It will also be noted that with this arrangement it would have been possible, with very slight changes in the boiler, to have placed a fourth driver under the firebox, if such construction had been desirable. A comparison of the ratios, as shown in the table below, will indicate, based on the actual grate area, that this locomotive is about the average practice for proportions of weight, heating

surface, etc. When the increased efficiency of the firebox heating surface, in addition to its proportionally larger amount, is considered, there seems to be but little question but what these locomotives will have a very large average evaporation per sq. ft. of total heating surface. The short stroke, superheated steam, double ported piston valves and highly efficient heating surface will probably make it possible for them to deliver a larger proportion of the rated tractive effort at high speeds than any other locomotive of the same weight now in service.

In constructional features, the design follows the most approved practice. Frame bracing has been very fully provided by cast steel braces secured to both rails of the frame at three different points between the cylinders and the firebox. The frames are of open hearth steel with single front rails cast integral with the main sections. The back sections are separate and designed to accommodate the Hodges type of trailing truck. Both injectors are on the right side feeding through a double check valve. The dome is flanged from a single piece of steel plate and is noticeable on account of its size, being 33 in. in diameter and 24 in. high. Flexible staybolts are liberally used in the water legs. Two 16 in. circular fire doors are provided and the O'Connor door flange has been applied. Forged and rolled steel wheels are used under the tender and for the front engine truck.

The general dimensions, weights and ratios are given in the following table:

General Data.

| | |
|--|--------------|
| Gage | 4 ft. 8½ in. |
| Service | Passenger |
| Fuel | Bit. coal |
| Tractive effort | 32,800 lbs. |
| Weight in working order | 222,300 lbs. |
| Weight on drivers | 134,850 lbs. |
| Weight on leading truck | 43,150 lbs. |
| Weight on trailing truck | 44,300 lbs. |
| Weight of engine and tender in working order | 360,000 lbs. |
| Wheel base, driving | 12 ft. |

| | |
|------------------------------------|---------------------------|
| Trailing truck wheels, diameter | 48 in. |
| Trailing truck journals | 4 x 14 in. |
| <i>Cylinders.</i> | |
| Kind | Simple |
| Diameter and stroke | 23 x 28 in. |
| <i>Valves.</i> | |
| Kind | Double ported piston |
| Diameter | 12 in. |
| <i>Boiler.</i> | |
| Style | Straight |
| Working pressure | 180 lbs. |
| Outside diameter of first ring | 70 in. |
| Firebox, length and width | 132 x 84 in. |
| Firebox plates, thickness | ¾ and ½ in. |
| Firebox, water space | F. 4½ in.; S. & B.—3½ in. |
| Tubes, number and outside diameter | 194—2 in. |
| Tubes, thickness | No. 12, B. W. G. |
| Flues, number and size | 28—5½ in. |
| Flues, thickness | No. 9, B. W. G. |
| Tubes, length | 18 ft. |
| Heating surface, tubes | 2,526 sq. ft. |
| Heating surface, firebox | 163 sq. ft. |
| Heating surface, total | 2,689 sq. ft. |
| Superheater heating surface | 605 sq. ft. |
| Grate area | 50 sq. ft. |
| <i>Tender.</i> | |
| Tank | Water bottom |
| Frame | 12 in. 40-lb. channels |
| Wheels, diameter | 33 in. |
| Journals, diameter and length | 5½ x 10 in. |
| Water capacity | 7,500 gals. |
| Coal capacity | 13 tons |

DOUBLE DRILL WITH INDEPENDENT HEADS

A powerful, simply arranged, double-headed drill, designed primarily for work on mud rings and flue sheets, is shown in the accompanying illustration. This machine is suitable for a general line of heavy work as well as the specialties to which it is particularly fitted, and is arranged so that each of the two

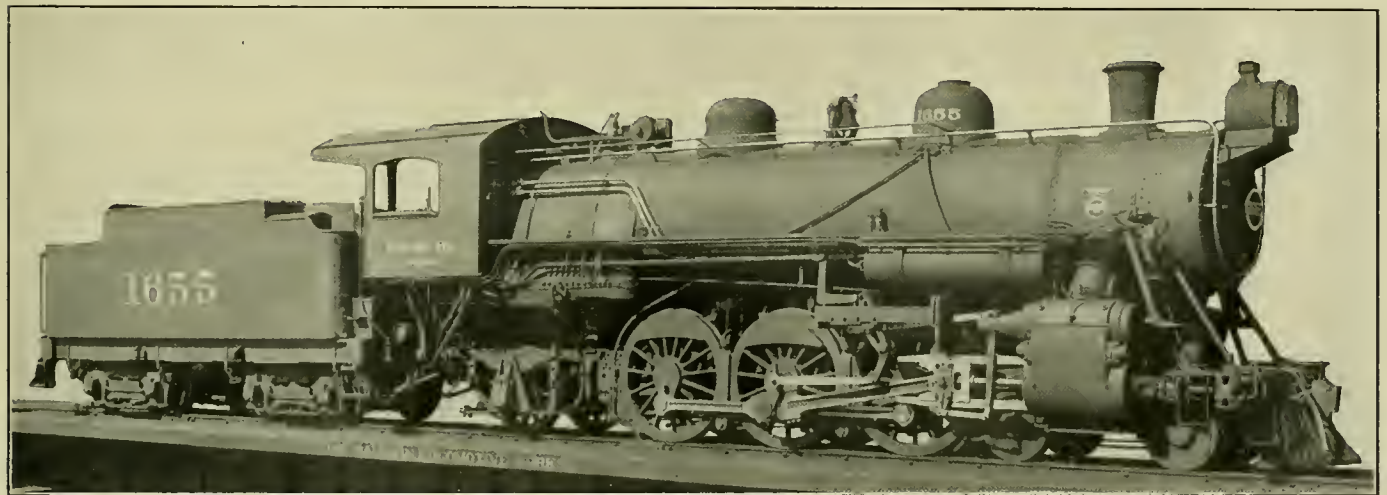

Pacific Type Locomotive with Gaines Firebox, Schmidt Superheater and Double Ported Piston Valves.

| | |
|-------------------------------|---------------|
| Wheel base, total | 31 ft. 6 in. |
| Wheel base, engine and tender | 63 ft. 9½ in. |

Ratios.

| | |
|---|--------|
| Weight on drivers ÷ tractive effort | 4.12 |
| Total weight ÷ tractive effort | 6.78 |
| Tractive effort × diam. drivers ÷ heating surface* | 631.00 |
| Total heating surface* ÷ grate area | 71.90 |
| Firebox heating surface ÷ total heating surface*, per cent. | 4.55 |
| Weight on drivers ÷ total heating surface* | 37.50 |
| Total weight ÷ total heating surface* | 62.00 |
| Volume both cylinders, cu. ft. | 13.46 |
| Total heating surface* ÷ vol. cylinders | 266.00 |
| Grate area ÷ vol. cylinders | 3.72 |

Wheels.

| | |
|---------------------------------------|-------------|
| Driving, diameter over tires | 69 in. |
| Driving, thickness of tires | 3½ in. |
| Driving journals, diameter and length | 10 x 12 in. |
| Engine truck wheels, diameter | 33½ in. |
| Engine truck journals | 6 x 12 in. |

*Equivalent heating surface equals 2,689 sq. ft + (1.5 × 605 sq. ft.) = 3,597 sq. ft.

heads is an independent and self-contained unit, permitting maximum flexibility in operation and allowing the correct feeds and speeds to be used on each spindle independently. The heads have an in and out adjustment of 8 in. on the knee which, in connection with the 24 in. adjustment of the table in the same direction, makes it possible to cover a large area with one setting.

As will be seen in the end view of the machine, the saddles carrying the heads and motors are of massive design and are carried by a very heavy cross-rail. By mounting the motors in the manner shown, the drive is greatly simplified. On the armature shaft is a rawhide pinion meshing with a coarse pitch spur gear which drives through a single pair of bevel gears made of forged steel with planed teeth, carefully heat treated and hardened. From this point the drive to the spindle is through spur

gears. Each spindle has an individual clutch allowing it to be stopped and started at will without stopping the motor.

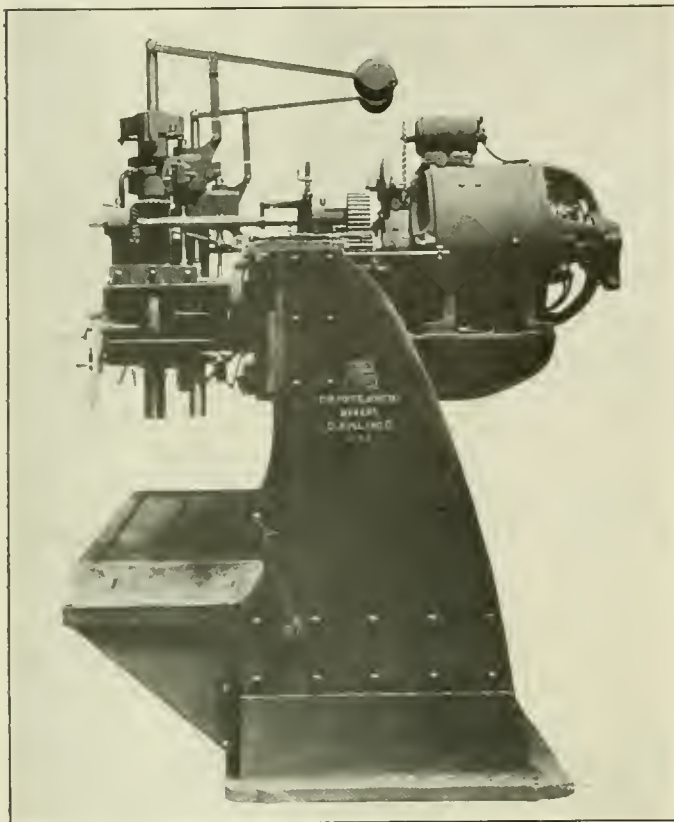

End View of Mud Ring and Flue Sheet Drill.

The motors are 7½ h. p. of the armature shifting type, manufactured by the Reliance Electric & Engineering Company, of

Cleveland, Ohio. They give a speed range of from 200 to 1600 revolutions without the use of gearing. The shifting of the armature is accomplished by a small motor mounted on the large motor and connected to the shifting mechanism through sprockets and a chain.

A quick change gear device, controlled by a lever within easy reach of the operator, gives the three feed changes. Each spindle is provided with an individual oil pump having its own tank, allowing it to be operated independently and insuring delivery of the cutting compound to the drill under all circumstances. The power feeds are provided with an automatic stop as well as the usual hand knock-off and clutch. Ball thrust bearings are used in connection with the spindles and feed worms.

Guess work in setting the speed of the motor to give the best results for each piece of work is avoided by the application of a Reliance speed dial on each head. This dial has two scales on its face; the upper one is graduated to show cutting speeds in feet per minute, and the lower one gives the various sizes of drills. The dial is first set for the cutting speed desired, and the speed of the motor is then adjusted until the pointer is opposite the size of the drill to be used. The stopping and starting of the motor is controlled by automatic starters operated by push buttons.

When working on mud rings, the brackets supporting the table are removed and special mud ring chucks are placed on the table, which is run back between the housings. These brackets are doweled in position, allowing them to be readily removed and replaced.

Some of the more important dimensions of this tool, which is built by the Foote-Burt Company, Cleveland, Ohio, are given in the following table:

| | |
|--|-----------------------|
| Clear width between housings..... | 14 ft. 4 in. |
| Maximum distance from spindle to top of table..... | 21½ in. |
| Length of power feed..... | 12 in. |
| Maximum distance center to center of spindles..... | 10 ft. |
| Minimum distance center to center of spindles..... | 18 in. |
| Working surface of the table..... | 24 in. x 14 ft. 4 in. |
| Spindle speeds | 37 to 347 |
| Diameter of spindle in sleeve..... | 2¼ in. |
| Weight of machine | 28,000 lbs. |

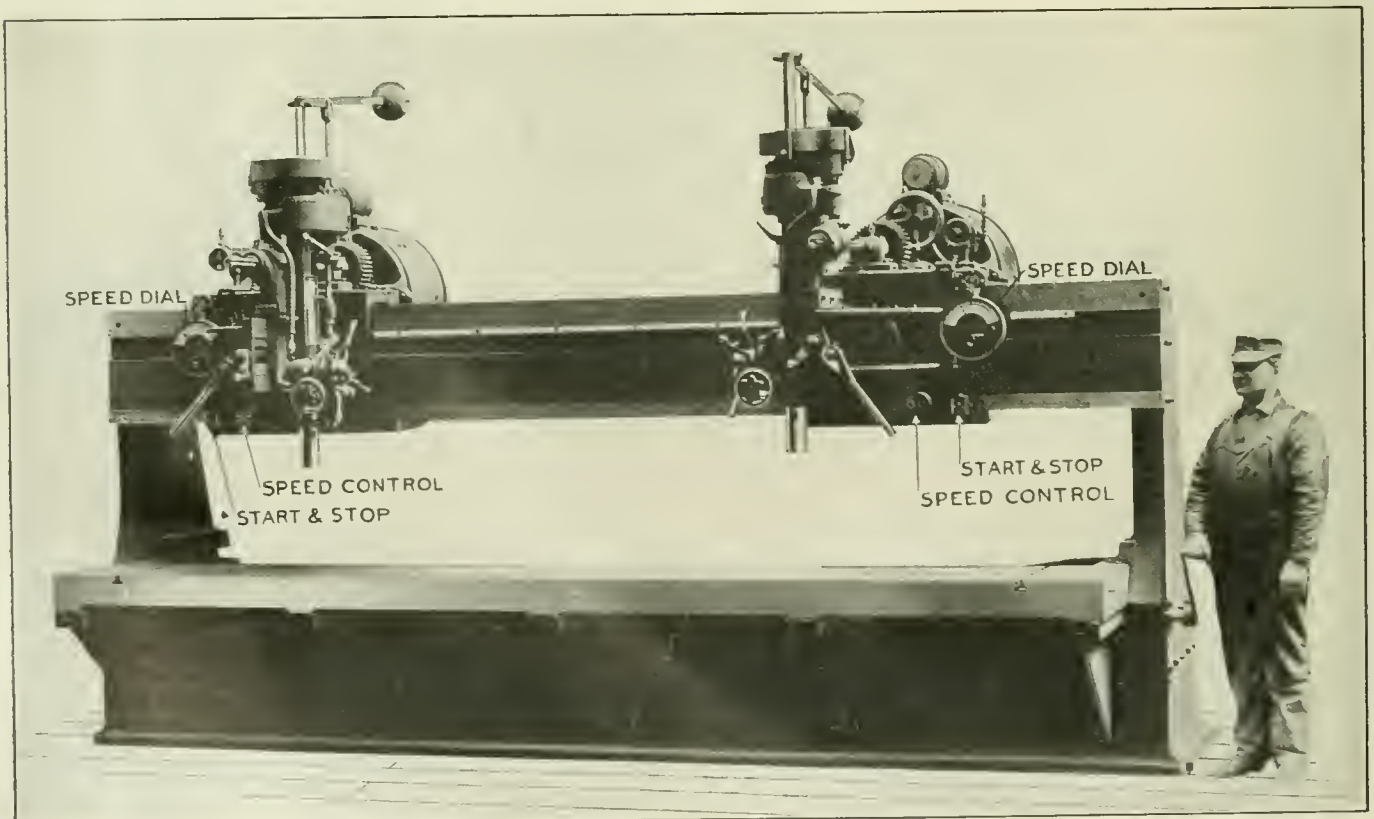

Mud Ring and Flue Sheet Drill with Independent Motor Driven Heads.

straightened and the rivets that sheared were re-driven. It was then bolted to the columns of the hydraulic press through the journal box holes and a side load was applied at the center of the column guides, approaching as nearly as possible the loads that would occur in practice, due to the side thrust from the bolster. The frame began to take a permanent set in a side-wise direction at a load of 115,000 lbs. and with a load of 167,000 lbs. the set became quite noticeable, approximating $5\frac{1}{8}$ in. The load was gradually increased until it reached 232,500 lbs.,

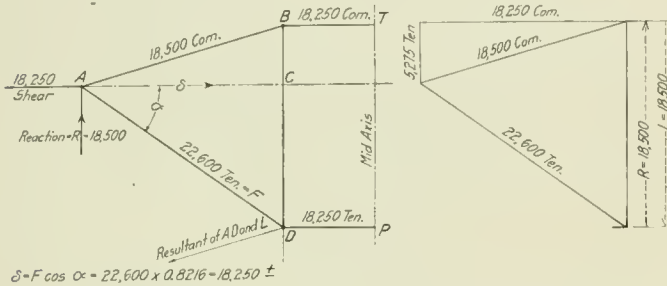

Stress Diagram of Murphy Truck Side Frame.

at which point the frame was badly bent and the permanent deflection was found to be $17\frac{1}{8}$ in. The plate on the compression member between the two column guides was displaced and all of the connections were strained.

These frames are claimed to be stronger, lighter and much cheaper than cast steel, being considered immune from crystallization due to shocks and vibrations. They are designed to conform to all the M. C. B. requirements. Any design of brake hanger may be used with them.

AUTOMATIC FEED FOR BOLT HEADER

In many cases the output of a bolt header depends entirely on the ability of the operator to withstand the fatigue of continued rapid movement. Even with a helper it is not always possible for a man to develop the full capacity of the machine because of his physical limitations. This difficulty has been largely overcome by an automatic feed for bolt or rivet headers that has been designed by the National Machinery Company, Tiffin, Ohio.

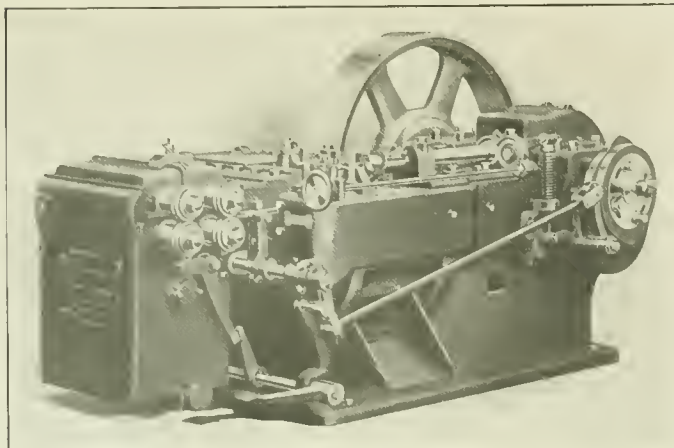

Bolt Header Fitted with Automatic Feed Rolls.

With this attachment long rods in mill lengths, taken on the initial heat or reheated in special long furnaces, are started in the feed rolls by the operator and are advanced automatically, the blank sheared and headed and a finished bolt or rivet ejected at each revolution of the machine. This attachment is suited for work on any type of single blow work, i. e., a bolt or rivet head formed by one blow of the machine. The feed rolls are

chilled castings and water jacketed, insuring the minimum wear on the feeding surface and a steady uniform feed.

On the machine to which this automatic feed is applied a new type of stock gage is employed. This is designed not only to allow rapid and accurate adjustment while the machine is in operation, but also to eliminate all spring and secure uniformity in the quality of the product. An increase in output of from 50 to 100 per cent. has been obtained in shops where this type of automatic machine has been substituted for the hand feed type.

ROCHESTER HORIZONTAL BORING MILL

A new machine of unusual interest and embodying many original and novel features has recently been designed by the Rochester Boring Machine Company, of Rochester, N. Y. Although this machine comes within the general classification of a boring mill, a more accurate name would be, a boring, milling, drilling and tapping machine, since it is arranged to perform all of these functions proficiently, accurately and conveniently. It can also be used for splining, oil grooving and thread cutting. While this may seem to be a very wide range of work for one machine, reference to the illustration will show that the design is without complication. On the contrary it is marked by extreme simplicity when its size and range of work are taken in consideration. Possibly the most striking feature is the centralized control that permits every change of feed, speed or traverse in every direction, as well as the starting, stopping and reversing, to be made from a position of the operator which allows

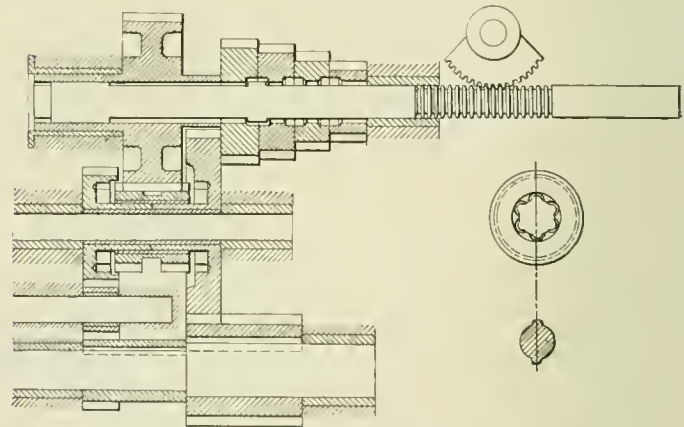

Arrangement of Gearing for Feed Changes and Reverse.

him to closely observe the work of the cutter at the same time. The arrangement in the head will not allow two conflicting levers to be engaged at the same time.

All the driving and feeding mechanism is centralized in the saddle or head, insuring maximum efficiency of power by the elimination of many shafts, joints and gears. The aim throughout the machine has been to make the drive as direct as possible, so that the power is used for doing work and not for overcoming the friction of the machine itself. When the machine is motor driven, the power is applied direct to the vertical driving shaft and when belt driven it is applied through bevel gears from a horizontal shaft. A clutch for starting and stopping is provided in the main driving pulley of the belt driven type.

One feature in particular that has made possible the centralized control and simple design, is the ingenious method employed for feeding the spindle. This is arranged on a screw feed principle, providing a continuous feed for any length of spindle and applied concentric with it, between its two main bearings, thereby doing away with the heavy overhanging strongback at the end of the saddle generally required by the rack and pinion feed. One of the illustrations shows a sectional view which per-

mits the details of this construction to be understood. It will be noticed that the spindle has its own independent bearings at the extreme ends of the saddle, giving a very rigid support. A spindle sleeve on which the driving gears are mounted also has

the spindle. The spindle sleeve *B* has gear teeth cut in one end which mesh with the three pinions *G*, mounted on studs that form part of the differential feed driving gear *D*. Through the double internal gear *F* and three pinions *G*, which mesh in the

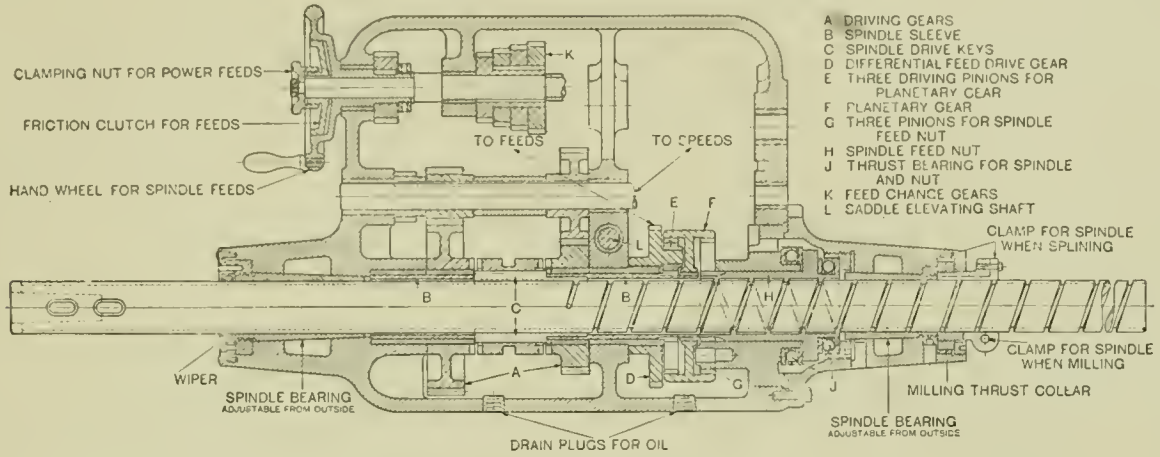

Section of the Saddle Showing the Driving and Feeding Mechanism on the Spindle.

its bearings in the casing, and clearance is provided between the sleeve and saddle, avoiding any possibility of transmitting vibration to the work. The spindle is rotated by the long spline keys fitted in the driving sleeve and engaging the double splines in

saddle feed nut, *H*, the latter is rotated at the same speed and in the same direction as the spindle as long as the feed driving gear *D* remains stationary, which is the case when the feeds are disengaged. When the feed is applied and the driving gear *D*

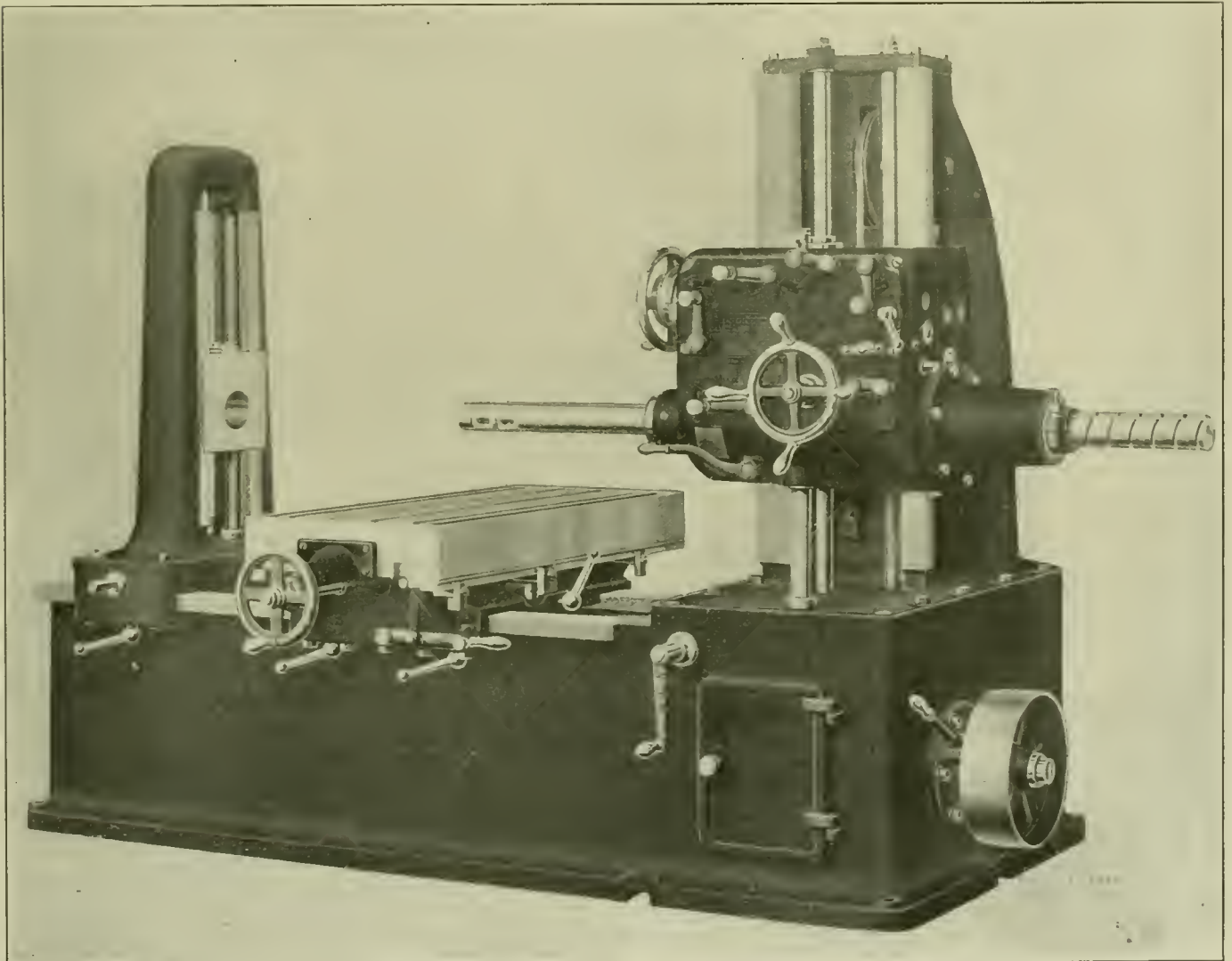

Horizontal Boring, Drilling, Milling and Tapping Machine.

rotates, the speed of the feed nut *II* will be different from that of the spindle in either *D* direction, and at a speed in proportion to the movement of *D*, thus giving a feed to the spindle. The feed nut comes in contact with the sides of the thread on the spindle only, and the end thrust in either direction is taken on ball bearings of large diameter. End thrust when milling is taken direct on the saddle through bronze bearings, which do not come in use when boring. Positive planetary gearing is arranged for controlling the movement of the spindle from the hand wheel, which permits its adjustment either at rest or when running.

All feeds before being applied to the different parts are transmitted through a friction clutch, and since all feeds are taken from the shaft that rotates the spindle, they are in direct ratio to the revolutions of the spindle.

A feed reverse mechanism is provided at the source of the power for the feed, permitting it to be quickly reversed when desired without stopping the machine. The moving parts at this point are running at a good speed and with a light load. This arrangement eliminates all keys, tumblers and bevel gears, and the drive is applied at the periphery of the gear instead of at the center.

One of the illustrations shows the sectional view of the main driving clutches located in the saddle between the column ways.

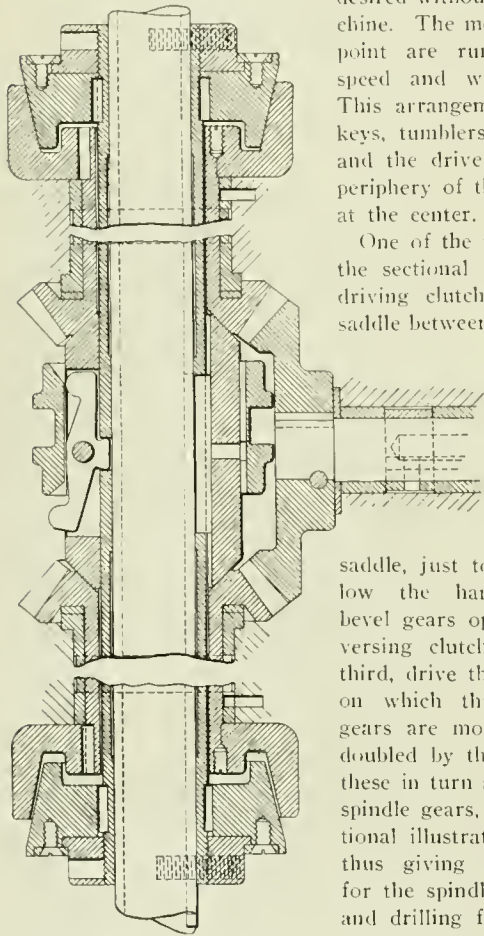

The operating lever for starting, stopping and reversing the machine is conveniently located at the front of the saddle, just to the left and below the hand wheel. Two bevel gears operated by the reversing clutch and engaging a third, drive the first speed shaft on which three speed change gears are mounted. These are doubled by the back gears, and these in turn are doubled by the spindle gears, shown in the sectional illustration of the saddle, thus giving 12 speed changes for the spindle. Sixteen boring and drilling feeds are provided, and also sixteen milling feeds for the saddle and the table.

Power rapid traverse at constant speed and independent of the feeds is provided for the spindle, saddle, table and carriage, and automatic limit stops are arranged for movements in all directions in addition to adjustable stops for the feeds of the table.

Driving Clutch on Rochester Boring Machine.

All gearing in the saddle is enclosed and runs in oil. A pump lifts the lubricant to a reservoir at the top of the saddle from which it is distributed by pipes to the different bearings, the overflow running over the gears. The operation of this system is entirely automatic.

The feeds and traverses in the saddle are transmitted to the table by the vertical shaft from the bottom of the saddle connecting through bevel gears to a horizontal shaft in the bed. At the table, the feed is distributed either to the cross feed of the table or to elevate the saddle and outer support. While the power feed for lateral motion of the table is not included, it can be supplied when specified. All screws giving movement to the table are located between the ways in the center of the resistance, so that all tendency of swiveling or cramping action is avoided. The nuts on the screws for the various traverses are made in two parts to provide for taking up wear and back-lash, and all nuts rotating on screws have bearings independent from the shaft on which they operate.

When the machine is used for splining, the spindle gear clutch is brought to a neutral position disengaging the spindle driving gears and a key is inserted in the milling clamp collar at one end of the saddle. The milling clamp collar is secured to the spindle by a friction band tightened by a thumb screw on the outside of the bonnet, and the key engages one of the spline ways in the spindle. The power rapid traverse is then employed for driving the spindle in and out, but without rotating it. Spiral oil groove cutting of different pitches can also be obtained with this machine by using the power rapid traverse for traveling the spindle, and at the same time engaging one of the spindle speeds, thereby rotating it at the same time. By combining the direct and back gears for the feeds, and the 12 speed changes of the spindle, different pitches of oil grooves or threads can be cut. When cutting spiral oil grooves the clamping collar used for splining is disengaged. These machines are now being built in two sizes, one with a 3 in. spindle, and one with a 3½ in. spindle.

A DINING CAR WITHOUT VESTIBULES

By omitting the platform and vestibule at each end of the car, the Pennsylvania Railroad, in its latest equipment of this type, has been able to increase the seating capacity of dining cars by six, making it possible to serve thirty-six people at one time. The cars are all-steel, of the standard Pennsylvania cantilever type, and measure 83 ft. in length over-all. They weigh 147,500 lbs. It will be noticed in the plan that side doors are provided at each end of the car for convenience in stocking the steward's and kitchen departments. No steps or trap doors have been installed and these doors are not to be used for entrance or exit. Reference to the floor plan will show that the pantry and serving arrangements have been carefully studied to facilitate the work of the waiters as much as possible. The result of this arrangement is shown by a recent demonstration when in one of these cars 108 people were served in three hours with no rushing or crowding. The pantry is separated from the main body of the car by a sliding door, and electric fans with liberal ventilator equipment in the kitchen, prevent all odors from gaining access to the dining section. The car has the usual design of six-wheel trucks used on all of the heavier Pennsylvania steel equipment. These are placed at 56 ft. 3 in. centers.

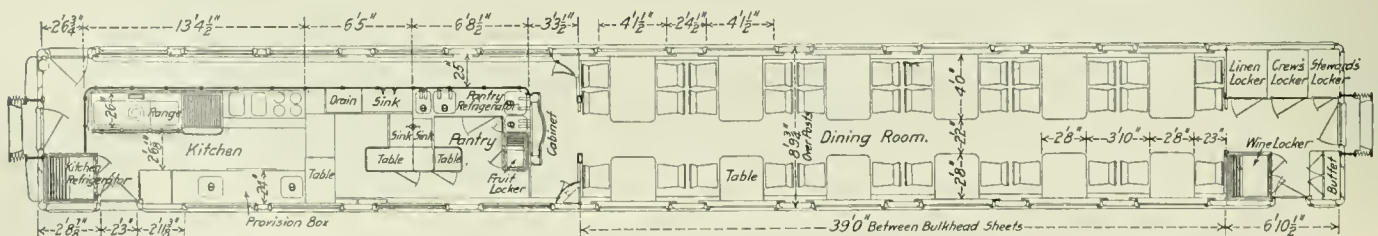

Plan of a New Pennsylvania Car that Seats 36 Persons.

VARIABLE LEAD ATTACHMENT ON WALSCHAERT VALVE GEAR*

In certain classes of service the variable lead given by the Stephenson valve gear permits the locomotive to accelerate more rapidly and to better adjust itself to different operating conditions, than is possible with the Walschaert valve gear, giving a constant lead at all points of cut-off.

To overcome this difficulty, William L. Davis, roundhouse foreman of the Santa Fe in Chicago, has designed and patented a construction which automatically gives, with a regular Walschaert valve gear, a lead varying in amount with the point of cut-off, giving valve events practically duplicating those obtained with a Stephenson valve gear. In addition to providing a vari-

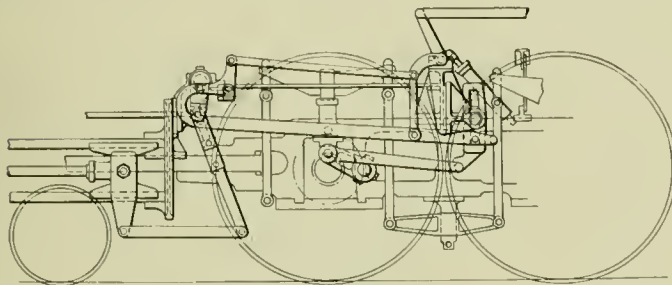

Davis Variable Lead Attachment.

able lead, this construction also permits a convenient adjustment of the amount of the lead.

Since the amount of lead with the Walschaert valve gear depends on the relation of the distance from the valve stem connection on the combination lever to the connection with the radius rod, and from the latter to the union link, it will be seen that if the ratios of these two distances can be changed the lead will be altered in the same proportion. To do this, Mr. Davis' construction provides a block, sliding in guides in the combination lever, to which the front end of the radius rod is connected. This block is supported by a link carried from a bell crank fulcrumed on the cross east-

*See also *American Engineer & Railroad Journal*, December, 1911, page 499.

ing that supports this part of the valve gear. The upwardly projecting arm of this bell crank is connected, by a long rod, to the arm on the lift shaft that carries the hanger to the radius rod.

As will be seen by reference to the drawing, the arm on the lift shaft is so proportioned that as it is drawn upward the connection to the bell crank will move forward. This, in turn, will lower the link, carrying the block in the combination lever, and thus increase the distance between the connection of the radius rod and the valve stem, and increase the lead. The reverse action of course takes place as the lift shaft is dropped down and the cut-off increased.

On a locomotive fitted with a regular Walschaert valve gear, it was found that the cut-off in full gear was 21 in. After the Davis attachment was applied the cut-off was 23½ in., the lead at running position being the same. A year's trial has proved the practicability of the construction and the fears that there would be excessive wear on the sliding blocks in the combination lever have proved unfounded. These blocks have a maximum travel of 1¼ in., and have practically no movement except as the point of cut-off is changed.

GAS-ELECTRIC CARS FOR THE FRISCO.

The St. Louis, Brownsville & Mexico, one of the lines of the Frisco system, has ordered two gas-electric motor cars of the GE-70-B-11 type from the General Electric Company, Schenectady, N. Y. These cars will be built with side entrances for the passengers and a rear door for the use of the conductor when the cars are coupled to trailers. The Frisco system will now have 17 of these cars running on regular schedules over its lines operating between the following points: Brownsville, Tex., and Mission; Orange and Newton; Madill, Okla., and Ardmore; Westville and Muskogee, Lawton, Okla., and Quanah, Tex.; Eunice, La., and Crowley; Dallas, Tex., and Sherman; Enid, Okla., and Bailey; Salem, Mo., and Cuba; Bolivar and Chadwick. The cars are capable of running about 60 m. p. h. on a level stretch and will average 25 to 35 m. p. h. schedule speed with stops two to three miles apart.

The new cars are 70 ft. 5 in. long and are divided into four compartments, one for passengers, which is 33 ft. long; a smok-

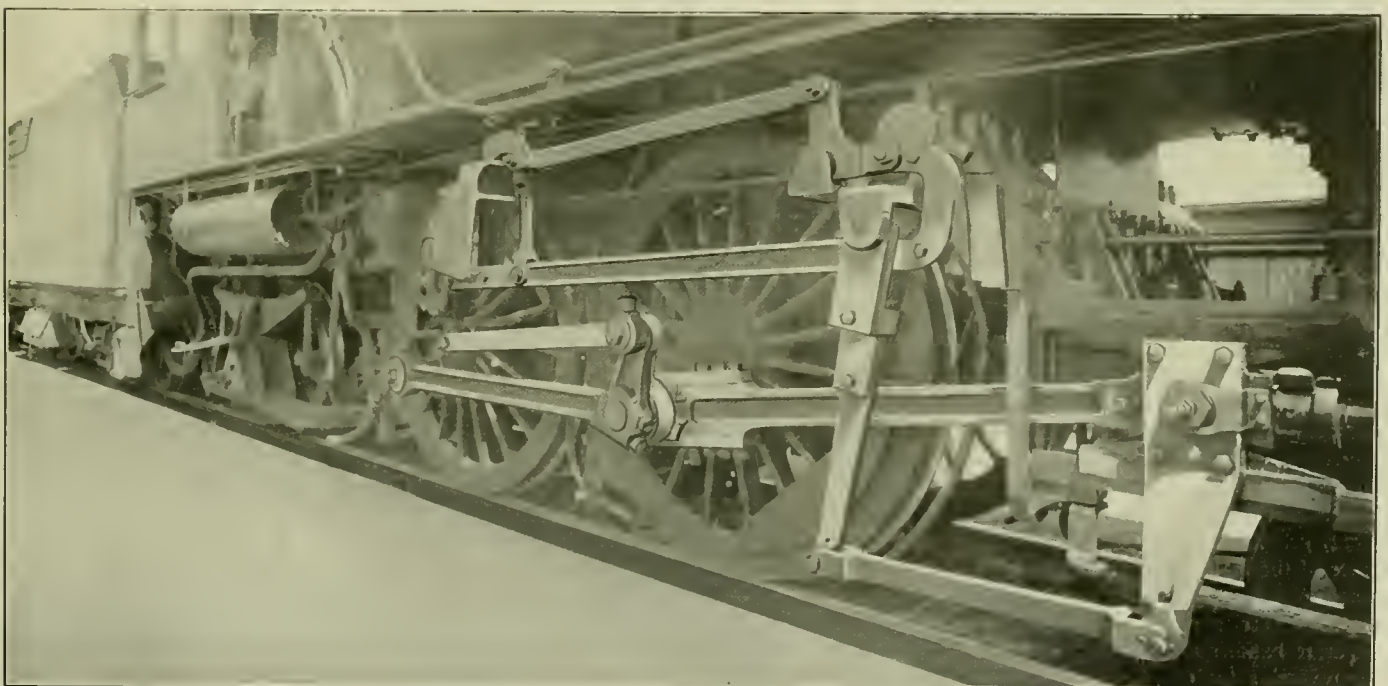

Davis Variable Lead Attachment Applied to a Balanced Compound 4-4-2 Type Locomotive.

ing compartment, 10 ft. long; a baggage compartment, 11 ft. long and the engine room, 12 ft. long. Each car has a seating capacity for 92 passengers, each seat accommodating 3 persons, and the net weight of the car is approximately 50 tons. It is of all-steel construction, except the interior finish, which is of mahogany and composite board. The frame is made up of steel I-beams and channels, with steel plates for the outside sheathing. The under floor is made of wood, having sheet iron on the lower side. A heavy felt lining is inserted between the wood and the iron. The sides of the car are also insulated with felt. The steel roof and the rear of the car are of the turtle back design. The seats are covered with friezette plush in the passenger compartment and genuine Spanish leather in the smoking room. The entire car is lighted with electricity.

The engine is an 8-cylinder, 4-cycle gas engine of the I' type and is direct connected to a 600-volt generator, which is designed to meet the special conditions of this service. The engine is started by compressed air taken from the main reservoirs of the

The trucks are of the swing bolster type, having elliptic and coil springs. The bearings, wedges and the contour of the wheels conform to the M. C. B. standards. The brake equipment includes the hand and the combined straight and automatic air brakes. A hot water heater, coal fired, is used for heating the car and to prevent the freezing of the engine circulating water

ALL-STEEL PILOT

BY ARTHUR J. BELAND.

Duluth & Iron Range, Two Harbors, Minn.

Owing to the scarcity of suitable timber a demand has arisen for all-steel beams and pilots for locomotives; the accompanying illustration shows a steel pilot that is made from scrap material and a steel bumper built up of structural shapes. The bumper is made up of two 10-in. channels 109 in. long extending across the top and bottom, being connected by two 5 1/2-in. side

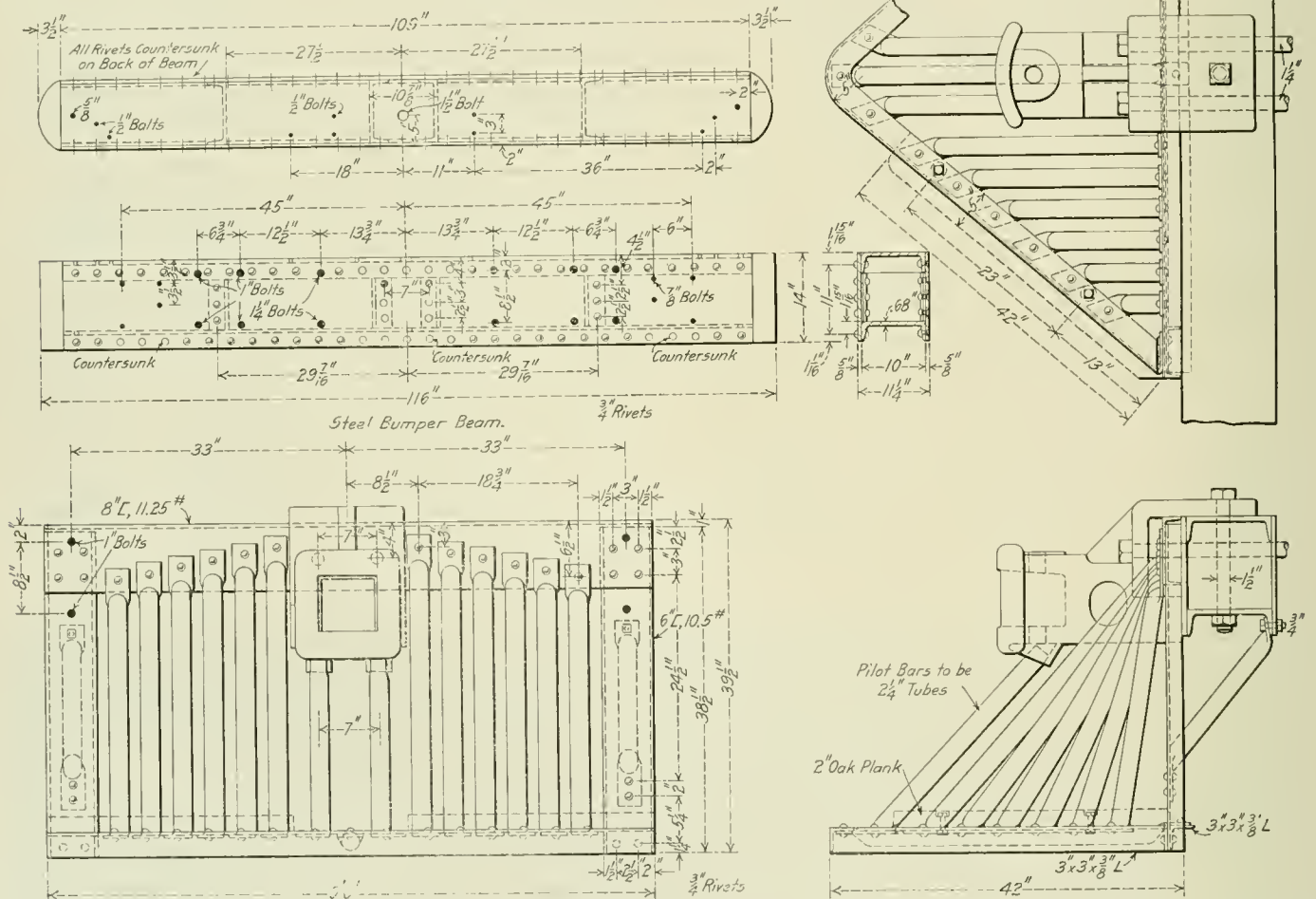

All-Steel Pilot and Bumper.

air brake system. The main air compressor is driven from the crank shaft of the main engine and is fitted with an automatic governor which maintains a constant pressure. An auxiliary two-cylinder, 4-cycle engine operates a single cylinder air compressor and the lighting generator. This set is used for supplying the initial charge for starting the main engine. Two railway motors of the GE-205-600 volt, box frame, oil lubricated, commutating pole type having 100 h. p. capacity, are mounted on the axles of the forward truck. The voltage of these motors is governed by varying the strength of the generator field and they are placed in series or parallel by means of a special controller. Separate handles are also provided for throttling the engine and for reversing the car, the latter being accomplished by changing the motor connections in the usual manner, without stopping the engine. All the handles are in easy reach of the operator.

plates 14 in. wide. The side plates are further strengthened by 4 pieces of 10-in. channel 7 7/8 in. long, riveted in a vertical position between the two sides. The rivets on the inside of the bumper are countersunk to provide a smooth surface for the connection to the frame and front foot plate.

The frame of the pilot may be made of bar iron or steel, and the bars are of scrap locomotive boiler tubes. The tubes are heated and the ends flattened and bent to fit the pilot frame to which they are secured by rivets. By using these scrap tubes, of which there is always a large supply in the scrap yard, an all-steel pilot may be made at a cost of not much greater than that of a wooden pilot. The end posts are made of 6 in. channels to which are riveted the 3 in. x 3 in. x 3/8 in. angles that form the bottom frame. The 2 in. oak plank indicated by the dotted lines show how the step may be applied.

GENERAL NEWS SECTION

The names of 21 employees were added to the pension roll of the Rock Island Lines during the month of May, increasing the total number of pensioners to 134.

The educational bureau of the Union Pacific is planning a series of motion picture exhibitions showing correct and incorrect ways in which employees do things in different branches of the service. The pictures will be accompanied by explanatory lectures to be delivered before meetings of employees at division points all over the system.

The Chicago, Milwaukee & St. Paul, and two of its employees have been indicted in connection with the collision at Odessa, Minn., last winter. The railway company and L. Gillic, conductor of the passenger train, which was struck by the following section, were indicted on a charge of manslaughter in the second degree. Robert Law, the flagman, was indicted for violation of the company's rules.

The Elgin, Joliet & Eastern Railway has had safety committees actively at work since January, 1911, and in these 16 months the local committees have sent to headquarters over 1,200 suggestions for the promotion of safety; and all but about 75 of these have proved useful. This information appears in the last accident bulletin of the Indianapolis State Railroad Commission, which has recommended that all of the roads of the state establish safety committees, and which is making inquiries to see what the roads are doing. The Elgin, Joliet & Eastern uses stereopticon pictures and other up-to-date means of informing employees concerning every-day dangers. Bulletins are issued giving notice of important discoveries and conclusions. Cases have been found where men injured but slightly had made no report to the medical officer, with unfortunate results—in one case loss of life.

Safety committees have been organized on the New York Central Lines west of Buffalo under the supervision of Vice-president A. H. Smith. A general safety committee includes the assistants to the vice-president, the general manager of the Lake Shore, the general manager of the Big Four, the general manager of the Michigan Central, the general superintendent of the Indiana Harbor Belt, the general claims attorney and the general safety agent. As previously announced, George H. Bradshaw, assistant to the claims attorney of the New York Central & Hudson River, has been appointed general safety agent, with headquarters at Chicago, and will be secretary of the general committee. In addition, a central safety committee has been appointed for each line, including the assistant general manager, general superintendent, assistant chief engineer, superintendent of motive power, signal engineer, mechanical engineer, inspector of freight transportation and chief claim agent. Division safety committees have also been appointed and shop committees will be appointed at the larger shops. The central division and shop committees will meet at least once a month.

The Chicago & Western Indiana and the Belt Railway of Chicago have recently organized safety committees, following the plan that has been put into effect on many other roads, but with a slightly different method of organization. The safety committee plan was explained at a mass meeting of the employees by officers of the company and the members of the central safety committee were nominated and elected directly by the employees. The central safety committee consists of the following: C. G. Austin, general attorney, chairman; E. H. Lee, chief engineer; R. W. Stevens, superintendent; F. E. Jacob, signal engineer; E. L. Pollock, purchasing agent; G. M. Grimes, claim agent, and L. M. Betts, car accountant, who is

secretary of the committee. The plan also includes five district committees, also elected directly by the employees, except that the chairmen were appointed by the central committee, and they comprise a division committee. The lines of the Western Indiana and of the Belt were divided into five districts, and the district committees were elected by ballot by members of the various crafts, according to a plan which insured that the different crafts would be properly represented on the committees. The district and the division committees will hold meetings once a month and make recommendations to the central committee which will also meet once a month following the meeting of the other committees. An attractive button is being prepared to be worn by members of the committee. It will be in the form of the company's trade mark, and will contain the motto "Safety Always First."

WAGES AND EARNINGS ON THE PENNSYLVANIA

While the strike vote was being taken by the eastern engineers, the Pennsylvania distributed among employees in train service on its Lines East a statement as to wages and earnings from which the following is extracted:

In 1890 for every dollar earned, the Pennsylvania Railroad paid to its employees 44.8 cents; in 1911, 51.7 cents. In 1890 the average annual earnings of the employees were \$570.37; in 1911, \$800.29. The employees, therefore, today are receiving 39 per cent. more than in 1890, and 15.4 per cent. more on every dollar earned than in 1890. In 1911 the enginemen received 16 per cent. more on every dollar of gross earnings than they did in 1890. The average annual earnings of all P. R. R. enginemen in 1890 were \$1,114.71; in 1911, \$1,546.34, an increase of 39 per cent. In addition to this, many of these enginemen earned wages as firemen. In 1890 the same enginemen on full time basis earned \$1,130.54, while on the same basis in 1911 the average was \$1,741.42, an increase of 54 per cent. Excluding the Pennsylvania Railroad, the increase asked for by the enginemen amounts to 20.2 per cent. for all lines interested, whereas its effect on the P. R. R. alone would be 11.8 per cent. increase, evidencing the fact that its own enginemen are now receiving nearly 8.5 per cent. more than the average wage paid enginemen on the other roads interested.

The Pennsylvania Railroad stockholder in 1890 received a dividend of 5.5 per cent. on the face value of his stock; in 1911 he received 6 per cent.; therefore, the stockholder who bought his stock in 1890 at the average market price of \$51.50 per share and continued to own his stock and allotments in addition to cash dividends would have received on his investment an average yearly return for the period 1890 to 1911 of 5.4 per cent., or practically no increase. It is apparent, therefore, that the stockholders have not profited with employees in the growth of the company. In the 1908 depression they sustained a reduction of over 14 per cent. in their dividends, while the wages of employees, then at the highest figure, remained unchanged, and in 1910 were further increased. Out of every dollar received by the company in 1890, 68.5 cents had to be spent for operation; in 1911, 78 cents. This increase in the cost of operation was due to advance in wages, increased taxation, increased cost of material and necessary items in operation and to meet legislative and public demands. Based on the 1911 operations of the company, if the 11.8 per cent. increase asked for by the P. R. R. enginemen were granted to all employees, it would entirely wipe out the surplus, necessitating the curtailing of improvements and reducing the dividends paid stockholders, and leaving the company no margin of surplus to protect its financial credit.

MEETINGS AND CONVENTIONS

International Railway Congress.—The permanent commission of the International Railway Congress, which will hold its next meeting at Berlin, Germany, in 1915, has, on the recommendation of the American members of the commission, designated the following as the American reporters on the subjects mentioned:

| <i>First Section.</i> | |
|--|--|
| SUBJECTS. | REPORTERS. |
| I. Method of construction of readbed and track, etc. | II. U. Mudge, President, Rock Island Lines. |
| II. Study of maintenance and supervision of track. | Epes Randolph, President, Southern Pacific in Mexico. |
| III. Special steels. | W. C. Cushing, C. E. M. of W., Pennsylvania Lines. |
| IV. Reinforced concrete. | C. H. Carlidge, Bridge Engr., C. B. & O. |
| <i>Second Section.</i> | |
| VII. Passenger equipment. | R. F. Bush, President, Missouri Pacific Ry. |
| VIII. Electric traction. | Horace G. Burt, Chief Engr., Chicago Committee of Investigation on Electrification of Railway Terminals. |
| <i>Third Section.</i> | |
| IX. Passenger terminals. | F. A. Delano, Receiver, Wabash Railroad. |
| X. Freight terminals. | W. S. Kinnear, President, Kansas City Terminal Co. |
| <i>Fourth Section.</i> | |
| XIII. The relation of cost of service to rates. | Fairfax Harrison, President, C. I. & L. |
| XV. Interchange of equipment and demurrage charges. | Arthur Hale, General Agent, American Railway Association. |
| XVI. Workmen's dwellings. | A. F. Banks, President, E. J. & E. |
| <i>Fifth Section.</i> | |
| XIX. Special types of traction units for branch lines. | H. B. Spencer, Vice-President, Southern Ry. |

The American members of the permanent commission of the Congress are the following: W. F. Allen, general secretary, American Railway Association; E. P. Ripley, president, A. T. & S. F.; Theodore N. Ely, Bryn Mawr, Pa.; Fairfax Harrison, president, C. I. & L.; Charles M. Hays (deceased), president, Grand Trunk; Franklin K. Lane, Interstate Commerce Commission; L. F. Loree, president, C. & O.; Stuyvesant Fish, 52 Wall street, New York; W. W. Finley, president, Southern Railway.

The following list gives names of secretaries, dates of next or regular meetings, and places of meeting of mechanical associations.

- AIR BRAKE ASSOCIATION.—F. M. Nellis, 53 State St., Boston, Mass. 1913 convention to be held at St. Louis, Mo.
- AMERICAN RAILWAY MASTER MECHANICS' ASSOC.—J. W. Taylor, Old Colony building, Chicago.
- AMERICAN RAILWAY TOOL FOREMEN'S ASSOCIATION.—M. H. Bray, N. Y., N. H. & H., New Haven, Conn. Convention, Sherman Hotel, Chicago, July 9.
- AMERICAN SOCIETY FOR TESTING MATERIALS.—Prof. E. Marburg, University of Pennsylvania, Philadelphia, Pa.
- AMERICAN SOCIETY OF MECHANICAL ENGINEERS.—Calvin W. Rice, 29 W. 39th St., New York.
- CAR FOREMEN'S ASSOCIATION OF CHICAGO.—Aaron Kline, 841 North 50th Court, Chicago; 2d Monday in month, Chicago.
- INTERNATIONAL RAILWAY FUEL ASSOCIATION.—D. B. Sebastian, La Salle St. Station, Chicago.
- INTERNATIONAL RAILWAY GENERAL FOREMEN'S ASSOCIATION.—L. H. Bryan, Brown Mayx building, Birmingham, Ala. Convention at Sherman Hotel, Chicago, July 23-26, 1912.
- INTERNATIONAL RAILROAD MASTER BLACKSMITHS' ASSOCIATION.—A. L. Woodworth, Lima, Ohio. Convention, August 20, Chicago.
- MASTER BOILER MAKERS' ASSOCIATION.—Harry D. Vought, 95 Liberty St., New York.
- MASTER CAR BUILDERS' ASSOCIATION.—J. W. Taylor, Old Colony building, Chicago.
- MASTER CAR AND LOCOMOTIVE PAINTERS' ASSOC. OF U. S. AND CANADA.—A. P. Dane, B. & M., Reading, Mass. Convention, September 10-13, Albany Hotel, Denver, Col.
- RAILWAY STOREKEEPERS' ASSOCIATION.—J. P. Murphy, Box C, Collinwood, Ohio.
- TRAVELING ENGINEERS' ASSOCIATION.—W. O. Thompson, N. Y. C. & H. R., East Buffalo, N. Y. Convention, August 27-30, Sherman Hotel, Chicago.

PERSONALS

GENERAL.

GLENN WARNER has been appointed fuel inspector of the Pere Marquette, with office at Detroit, Mich.

J. F. GOODRICH has been appointed assistant superintendent of the Arizona Eastern, with office at Phoenix, Ariz.

J. J. CAREY has been appointed master mechanic of the Baltimore & Ohio Southwestern at Washington, Ind., succeeding C. A. Gill.

W. L. DAVIS, formerly apprentice instructor of the Atchison, Topeka & Santa Fe, at Topeka, Kan., is now night enginehouse foreman at 18th street, Chicago.

PETER MCQUAID, engine house foreman of the Prince Edward Island Railway, has been appointed master mechanic, with office at Charlottetown, Prince Edward Island.

T. J. BURNS, whose appointment as assistant superintendent of motive power of the Michigan Central, with office at Detroit, Mich., was announced in the *June American Engineer*,



T. J. Burns.

was born July 24, 1869, at Hillsdale, Mich. He is a graduate of the Bay City, Mich., high school and of Assumption College at Sandwich, Ont., and he took a post-graduate course at Grand Seminaire, Montreal, Que. He began railway work with the Michigan Central at Bay City, Mich., and after working one year in the track department he entered the locomotive and car department. In 1902 he was made chief clerk of the locomotive department at Jackson, Mich., and three years later was transferred to Detroit as chief clerk of

the locomotive and car department. He was appointed assistant to the superintendent of motive power in 1909, which title he held until his recent promotion to assistant superintendent of motive power.

J. E. TIERNEY has been appointed master mechanic of the Louisiana & Arkansas, with office at Stamps, Ark., succeeding A. J. Wade, resigned on account of ill health.

J. P. McMURRAY has been appointed master mechanic of the Rio Grande division of the Atchison, Topeka & Santa Fe, with headquarters at Albuquerque, N. M., vice L. A. Mattimore.

HENRY W. JACOBS, assistant superintendent of motive power of the Atchison, Topeka & Santa Fe system, with office at Topeka, Kan., has resigned, and will devote his time to private affairs.

J. R. GOULD, superintendent of motive power of the Virginia general division of the Chesapeake & Ohio, has been appointed general superintendent of motive power, vice J. F. Walsh, resigned.

J. C. MORRISON, road foreman of the Chicago, Burlington & Quincy at Lincoln, Neb., has been appointed master mechanic of the Omaha division, with office at Omaha, Neb., succeeding A. N. Willsie, who has been appointed chairman of the company's fuel committee at Chicago.

JAMES F. WALSH, general superintendent of motive power of the Chesapeake & Ohio, with office at Richmond, Va., has retired from the active duties of that office. He may continue with the road in a consulting capacity.

Mr. Walsh was born in March, 1857, at Cleveland, Ohio, and began railway work in 1871, on the Cleveland, Columbus, Cincinnati & Indianapolis, now a part of the Cleveland, Cincinnati, Chicago & St. Louis. From 1871 to 1892 he was consecutively apprentice, locomotive fireman, locomotive engineer, and shop foreman. Mr. Walsh left railway work in 1892 to become mechanical expert for the Galera Oil Company, but returned to the railway service ten years later as superintendent



J. F. Walsh.

of motive power on the Chesapeake & Ohio. He held the position until May, 1910, when he was promoted to general superintendent of motive power. An important work which has been carried on during the past few years under Mr. Walsh's direction was the introduction of the Mountain type, Mikado and Mallet locomotives, which have received frequent mention in our columns.

SAMUEL GARVER THOMSON has been appointed superintendent of motive power and rolling equipment, of the Philadelphia & Reading, with headquarters at Reading, Pa. Mr. Thomson was

born on November 19, 1875, at Cumberland, Md., and was graduated from the Lawrenceville school in 1894, and from Princeton University in 1898. In October of the same year he began railway work on the Pennsylvania Railroad as special apprentice at the Altoona, Pa., shops, and he completed his apprenticeship in 1902. The following year he was general foreman of the Bedford shops at State Line, and in November, 1904, he was assistant master mechanic of the Harrisburg shops. Mr. Thomson was appointed assistant engineer of motive



S. G. Thomson.

power of the Buffalo & Allegheny Valley division, now the Northern division, with headquarters at Buffalo, in February, 1906, and in April, 1908, was transferred in the same capacity to the office of the assistant to the general manager at Philadelphia, Pa., of the same road. He went to the Philadelphia & Reading as assistant engineer of motive power on November 15, 1909, and in January, 1912, was made acting superintendent of motive power and rolling equipment of the same company, which position he held at the time of his recent appointment as superintendent of motive power and rolling equipment, as above noted.

CHARLES A. GILL, master mechanic of the Baltimore & Ohio Southwestern, at Washington, Ind., has been transferred to the Cincinnati, Hamilton & Dayton at Cincinnati, Ohio, succeeding W. G. Rose.

W. G. ROSE, master mechanic of the Cincinnati, Hamilton & Dayton, at Cincinnati, Ohio, has been appointed master mechanic of the Moorefield shops, near Minneapolis, succeeding W. C. Steers, resigned.

FRANK RUSCH, district master mechanic of the Chicago, Milwaukee & Puget Sound at Tacoma, Wash., has been appointed acting general master mechanic, with office at Tacoma, succeeding N. M. Maine, deceased.

J. R. SEXTON, master mechanic of the Missouri division of the Atchison, Topeka & Santa Fe, has been promoted to mechanical superintendent of the Northern district of the Western lines, with headquarters at La Junta, Col.

M. J. DRURY, mechanical superintendent of the Northern division of the Western lines of the Atchison, Topeka & Santa Fe, has been appointed superintendent of shops, with office at

Topeka, Kan. He was born May 24, 1849, at Berkenhead, Eng., and came to this country with his parents when he was three years old, and received a common school education at Parkersburg, W. Va. In 1886 he entered a contract shop as a machinist apprentice, and in 1870 began railway work with the Baltimore & Ohio at Grafton, W. Va., with which company he remained for ten years, working at Grafton and Newark, Ohio, and at Chicago. He then went to the Missouri, Kansas & Texas as a machinist at



M. J. Drury.

Parsons, Kan., and was later gang foreman. In 1887 he went with the Lake Shore & Michigan Southern at Elkhart, Ind., as a machinist, and the next year went to the Denver & Rio Grande as night foreman. On February 1, 1889, he went with the Atchison, Topeka & Santa Fe, with which road he has been ever since. He was consecutively machinist, gang foreman, general foreman, first at La Junta, Colo., and later at Arkansas City, Kan., and division foreman of the Oklahoma division at Arkansas City. He was appointed master mechanic at Winslow, Ariz., in October, 1902, and was transferred with the same title to Raton, N. Mex., in May, 1906. On November 1, 1906, he was appointed mechanical superintendent of the Western lines, with headquarters at La Junta, from which position he was recently promoted to superintendent of shops.

E. H. RAQUET, chief chemist of the New York, New Haven & Hartford, at New Haven, Conn., has been appointed engineer of tests of the New York, New Haven & Hartford, the Boston & Maine, and the Central New England, with office at Boston, Mass., vice M. C. M. Hatch, resigned.

F. L. CARSON has been appointed master mechanic of the Chicago Great Western at Des Moines, Iowa, vice A. J. Isaacs. Mr. Carson was formerly connected with the Atchison, Topeka & Santa Fe, the Gulf, Colorado & Santa Fe, El Paso & Southwestern, Mexican Central and the National Lines of Mexico, and comes to his new position from San Antonio, Tex.

SHOP

H. A. KESWICH, shop foreman of the Canadian Pacific at Kamloops, B. C., has resigned.

R. R. NEILD, general foreman of the Canadian Pacific at the Winnipeg shops, has resigned.

J. H. JACKSON has been appointed locomotive foreman of the Canadian Pacific at Rogers Pass, B. C.

ELMER BLINN, apprentice instructor of the Atchison, Topeka & Santa Fe, at La Junta, Col., has been transferred to Topeka, Kan.

H. W. HINMAN, apprentice instructor of the Atchison, Topeka & Santa Fe, has been transferred to Topeka, Kan., from Clovis, N. M.

A. STURROCK has been appointed acting locomotive foreman of the Canadian Pacific at Ft. William, Ont., vice J. McArthur, who is seriously ill.

C. P. LYLE has been appointed division foreman of the St. Louis & San Francisco at Hugo, Okla., vice J. L. Harvey, transferred to Fort Worth, Tex.

D. G. McDONALD has been appointed acting locomotive foreman of the Canadian Pacific at Red Deer, Alberta, vice J. A. Doig, assigned to other duties.

OBITUARY

W. K. HIGH, formerly master mechanic of the Cleveland, Cincinnati, Chicago & St. Louis, with office at Mattoon, Ill., died at Mattoon on June 22. Mr. High was placed on the pension roll of the company last November.

DAVID HOLTZ, formerly for over 30 years master of machinery of the Western Maryland, died on May 30, at Baltimore, Md. Mr. Holtz was born on November 15, 1842, at Baltimore, and began railway work in 1856. He was consecutively messenger boy, clerk, apprentice in machine shops and draftsman on the Baltimore & Ohio, and then for 15 months he was assistant engineer in the United States Navy. The following eight years he was chief draftsman of the Baltimore & Ohio, and for one year from September, 1873, was superintendent of rolling stock of the New York, Lake Erie & Western. In 1874 he returned to the Baltimore & Ohio as draftsman, and in November, 1876, was appointed master of machinery on the Western Maryland, from which position he resigned in June, 1907.

NEW R. R. Y. M. C. A.—The Railroad Young Men's Christian Association at Forty-ninth street and Madison avenue, New York City, adjacent to the Grand Central Terminal, whose beautiful building at that point was given to the association by the late Cornelius Vanderbilt, is to have a large new building, three blocks north and one block east of its present location; and the \$500,000 necessary for the purpose has already been subscribed. The land at the new location is given by the New York Central & Hudson River. It is bounded on the east by Park avenue, on the south by Forty-ninth street and on the north by Fiftieth street; and its depth west from Park avenue is 67 ft. The new building will be six stories high and will have about 70,000 sq. ft. of floor space. It will be the most elaborate institution of the kind in the country, and probably in the world, and will have 250 sleeping rooms. The walls will be of white brick trimmed with white granite. Park avenue, running north and south above the track of the approach to the Grand Central Terminal and extending southward through the center of the yard to the station building at Forty-fifth street, will be one of the most beautiful streets in the city. It is understood that members of the Vanderbilt family are large subscribers to the building fund.

NEW SHOPS

BOSTON & MAINE.—The \$3,000,000 shops at North Billerica, Mass., have progressed to a point where the contract for the concrete piling and capping has been let. The ten shop buildings will cover about 150 acres. Bids are being prepared for the new machine tools.

CHICAGO, ST. PAUL, MINNEAPOLIS & OMAHA.—The contract for the construction of an engine house at Minneapolis, Minn., has been awarded. The cost is estimated at \$150,000.

CHICAGO & NORTH WESTERN.—It is reported that a 60-stall engine house and machine shop will be built at Green Bay, Wis.

CLEVELAND, CINCINNATI, CHICAGO & ST. LOUIS.—It is reported that the Indianapolis, Ind., yards will be enlarged and that \$175,000 will be spent in erecting additional shop buildings at Beech Grove.

ELGIN, JOLIET & EASTERN.—Bids have been received for a two-story locomotive shop, 149 ft. x 440 ft., at Joliet, Ind.

GEORGIA, FLORIDA & ALABAMA.—The engine house, machine and other shops that were destroyed by fire at Bainbridge, Ga., May 1, will be rebuilt as soon as possible at an approximate cost of \$50,000.

MICHIGAN CENTRAL.—Work will be started at once on the construction of a large engine house and machine shop at Kalamazoo, Mich.

MICHIGAN CENTRAL.—New car shops will be built in Bay City, Michigan.

MISSOURI, KANSAS & TEXAS.—Contracts have been awarded for grading and filling at East Waco, Texas, preliminary to erecting an engine house and other terminal improvements, which will cost approximately \$300,000.

NORFOLK & WESTERN.—Contracts have been let for an engine house, machine shop, store and other buildings to be built at Norfolk, Va., at a cost of \$100,000.

PENNSYLVANIA.—A new machine shop will be built at Cleveland, Ohio, on the Lake front near West Boulevard. The building will be 65 ft. wide by 70 ft. long and one story high. It will be of steel and concrete construction.

TEXAS & PACIFIC.—The yards at Westwego, Texas, will be reconstructed and an engine house and the shops will be rebuilt.

UNION PACIFIC.—Extensive improvements are being made in the Denver, Colo., shops, which were formerly leased by the Pullman Company, so that they will be able to handle general locomotive repair work for the Colorado division, thus saving the cost of sending locomotives a long distance to other shops. It is planned to have the improvements in operation early in July, including a 10-pit machine shop, and a locomotive blacksmith and boiler shop with a capacity for making heavy and general repairs to about fifteen engines a month. About \$90,000 has been expended on modern motor-driven tools arranged for group motor drive. A new modern power house equipped with water tube boilers, filters and coal and ash-handling machinery is also to be built at this point.

WABASH.—Plans for new shops at Decatur, Ill., are being considered. They will cost approximately \$750,000.

WAGES ON THE PENNSYLVANIA.—The Pennsylvania Railroad System in the past 25 years has paid in wages \$2,220,034,753, or double the amount of the national debt. The system has 11,503 miles of line, 25,236 miles of track, and about 185,000 employees.

SUPPLY TRADE NOTES

The Watson-Stillman Company, New York, will soon open a branch office in Philadelphia, Pa.

The Western Electric Company has opened a branch office and a large warehouse at Houston, Tex. The sales agent is H. P. Hess.

Frank J. Kent, patent and trade mark lawyer, has removed his office to the Metropolitan Bank building, 271 Broadway, New York.

The Pittsburgh Testing Laboratory, Pittsburgh, Pa., has opened a branch office at 204 White building, Seattle, Wash., in charge of C. A. Perkins, district manager.

A bill asking the foreclosure of the property of the Allis-Chalmers Company, Milwaukee, Wis., in Chicago, has been filed in the United States district court, by the Continental & Commercial National Bank.

R. A. Dugan, in charge of the sales department of the Chicago office of the Scullin-Gallagher Iron & Steel Company, St. Louis, Mo., has been made district manager, with office at 1049-50 McCormick building, Chicago.

Robert M. Smith has been appointed sales manager of Burton W. Mudge & Company, of Chicago. Mr. Smith was previously in New York in charge of the eastern territory of the railway department of a supply concern.

J. T. Georgeson, formerly with the machinery department of Joseph T. Ryerson & Son, Chicago, has joined the sales organization of the Vulcan Engineering Sales Company, Chicago, dealing especially with the Q. M. S. Company's products.

J. E. Chisholm has opened an office at 355 Old Colony building, Chicago, and will handle railway specialties. Mr. Chisholm has been sales manager of the Chicago Steel Car Company for the past three years, and was formerly mechanical superintendent of the Chicago Great Western.

W. A. Austin, for a number of years in the engineering department of the Baldwin Locomotive Works, Philadelphia, Pa., with office in that city, has resigned that position to go to the Lima Locomotive & Machine Company, Lima, Ohio, as chief mechanical engineer, with office at Lima.

The Lima Locomotive & Machine Company, Lima, Ohio, has sold to New York bankers, first mortgage, 6 per cent., 20-year sinking fund bonds to the amount of \$2,000,000, the proceeds to be used for the construction of additional buildings, the purchase of machinery and for working capital.

The H. W. Johns-Manville Company, New York, has moved its Winnipeg, Man., offices to 92 Arthur street. This is a six-story and basement building, 50 ft. wide and 100 ft. deep, and will be occupied throughout by the company's offices and storerooms. The office force will be increased.

John S. Quist, formerly in the locomotive department of the Union Pacific, has become associated with the M. M. Rogers Company, of Chicago, maker of the Rogers improved indestructible journal packing. Mr. Quist will have charge both of the manufacturing and sales departments, and his office will be at the factory, 6422 Stony Island avenue.

The American Mason Safety Tread Company, Boston, Mass., has purchased from the Quincy, Manchester, Sargent Company, Chicago, all patents, machinery, selling rights, etc., connected with the Stanwood steel car steps and treads. The Stanwood step has been used by street, elevated and steam railways for a number of years. It is composed of a number of thin strips of steel, crimped so as to form corrugation which, when the strips are assembled, produce a series of hexagonal openings.

H. M. Estabrook was elected president of the Barney & Smith Car Company, at the annual meeting held at Dayton, Ohio, June 4. He was born in Cambridge City, Ind., in 1864, and received his education in the public schools, graduating from the Terre Haute High School in the class of 1883. He then went to Oswego, N. Y., to study stenography, and soon after became stenographer in the motive power department of the New York, West Shore & Buffalo, now the West Shore, under R. H. Soule and James M. Boone. In August, 1885, he went to Dayton, Ohio, as stenographer for the Barney & Smith Car Company. After filling various positions he was made general assistant to the superintendent, and was appointed assistant superintendent in December, 1897. In January, 1900, he was appointed superintendent, and in June, 1905, he was elected a member of the board of directors, and was also elected second vice-president and general superintendent. On November 10, 1908, he was elected vice-president and general superintendent, and now becomes president of the company. Arthur J. Stevens, who was also elected first vice-president and general manager, has been in charge of the lumber department of that company for the last four years, having been appointed manager April 1, 1908. On October 21, 1909, Mr. Stevens was appointed manager of purchases and transportation, which included the purchase of all materials and lumber and transportation, including all inbound and outbound shipments; and in June of the following year he was elected to the board of directors and also second vice-president. Mr. Stevens was born on May 23, 1871, at Dayton, Ohio. He received his early education in the public schools and at Cooper Seminary in Dayton, which was founded about the year 1834 by Eliam E. Barney, the founder of the Barney & Smith Car Company. After finishing his course at the seminary he took a college course at Denison University, at Granville, Ohio, and after leaving college he entered the lumber business. He entered the service of the Barney & Smith Car Company as assistant lumber buyer on December 26, 1897; later when he was appointed manager he succeeded his father, James H. Stevens, who retired after a continuous service with the car company of over 46 years. In March, 1905, the company having bought large timber interests, including a saw-mill and railway in southern Georgia, there was organized



H. M. Estabrook.

ice with the car company of over 46 years. In March, 1905, the company having bought large timber interests, including a saw-mill and railway in southern Georgia, there was organized



A. J. Stevens.

ice with the car company of over 46 years. In March, 1905, the company having bought large timber interests, including a saw-mill and railway in southern Georgia, there was organized

the Milltown Lumber Company, Milltown, Ga., and the Milltown Air Line Railroad, of both of which companies Mr Stevens was elected president, which offices he now holds. Mr. Stevens was a grandson of Ansel E. Stevens, who was with the car company in its earliest years, having entered its service in 1852. He was associated with the elder Mr. Barney in the early days of the company, and continued in its service until 1882. Mr. Stevens' grandmother, Mrs. Ansel E. Stevens, was a sister of E. E. Barney, founder of the car company, and his father, J. H. Stevens, and his grandfather, A. E. Stevens, have given to the car company an aggregate service of over 90 years, having had complete charge of its very extensive lumber interests since the founding of the company. Under the direction of Mr. Stevens, the car company has become an importer direct of fancy woods from all parts of the world. The following officers were also elected at the annual meeting: Second vice-president and treasurer, J. F. Kiefaber; secretary and assistant treasurer, E. A. Oblinger; assistant secretary, E. H. Sines; and directors, Walter St. J. Jones, J. Rawson, John L. Lincoln and John M. Wright, Cincinnati, and Eugene J. Barney, E. Frank Platt, H. M. Estabrook, A. J. Stevens and J. F. Kiefaber, Dayton.

The Cincinnati Locomotive & Car Works has been incorporated in Ohio with a capitalization of \$25,000, to make and repair locomotives, cars, machinery and general railway equipment at Cincinnati. The incorporators are John Glenn, of Ludlow, Ohio, and William Edwards and Daniel Goldstein, of Cincinnati. The plant will soon be moved to Covington, Ky.

Major Eli H. Janney, inventor of the Janney car coupler, died at his home in Alexandria, Va., June 17, in his eightieth year. Major Janney was a field quartermaster on the staff of General Robert E. Lee in the civil war. The contour lines of the Janney coupler were adopted by the Master Car Builders' Association, and thus are now the well-known "M. C. B. standard," used everywhere throughout the United States.

The Eastern Car Company, recently incorporated with a capitalization of \$2,500,000 as a subsidiary of the Nova Scotia Steel & Coal Company, advises that its intention is to erect a modern steel freight car plant at New Glasgow, N. S., with a capacity of 25 cars a day. Plans are now being prepared, and it is expected that the work will be commenced within two weeks. From 800 to 1,000 men will be employed. The plant will be located immediately adjoining the mills of the Nova Scotia Steel & Coal Company.

The M-C-B Company has been organized under the laws of Illinois to make and deal in railway supplies, with the following officers and stockholders: President, Walter E. Marvel; vice-president, Frank A. Buckley; secretary and treasurer, Erle C. Cowgill. Mr. Marvel was for several years manager of the St. Louis branch of the Buda Company, Chicago, and later western sales manager of the Detroit Seamless Steel Tubes Company, Detroit, Mich. Mr. Cowgill was assistant to President Markham of the Illinois Central. Mr. Buckley is western superintendent of the Armspear Company, New York, and the Central Railway Signal Company of Pittsburgh. The new company derives its name from the first letters of the surnames of its officers and stockholders. The Chicago offices will be located in the McCormick building. The M-C-B Company, in addition to making several of its own patented devices, has secured the exclusive sole rights in western territory from some of the foremost manufacturers of the following lines: Miscellaneous cars for traction lines; snow plows, flangers, sweepers and ice diggers for steam and electric lines; pneumatic tools for railway shop work; track and bonding drills, tool grinders, cattle guards, jacks, handmade chains, locomotive water gages, track tools, anti-rail creepers, portable kerosene lights, etc. The Russell Car & Snow Plow Company, Ridgway, Pa., has appointed the M-C-B Company its exclusive agent in western territory.

CATALOGS

RADIAL DRILLS.—The Fostick Machine Tool Company, Cincinnati, Ohio, has issued two folders describing their 4 ft. and 5 ft. National radial drills. A brief description and specifications are included in these folders.

AIR COMPRESSORS.—The Chicago Pneumatic Tool Company, Chicago, has issued a pamphlet, form No. 90, illustrating and describing its single and duplex compressors, which may be driven by steam, belt or electricity.

WATER TUBE BOILERS.—Egbert R. Morrison, Sharon, Pa., has published a pamphlet on Morrison Water Tube Boilers, containing diagrams, brief descriptions and reasons why these boilers are safe, economical and efficient.

SHAFT HANGERS.—The Hess-Bright Manufacturing Company, Philadelphia, Pa., has issued a 32-page catalog describing its ball-bearing hangers. Illustrations are included showing the various types of hangers, and accompanying tables give their general dimensions.

VOLT-AMMETER.—The General Electric Company, Schenectady, N. Y., has issued bulletin No. 4880 describing its type S-2 signal volt-ammeter. This instrument is used for testing direct single current apparatus and is arranged for six combinations, giving three volt and three current ranges.

BRAKE BEAMS.—The Damascus Brake Beam Company, Cleveland, Ohio, has issued a 78-page illustrated catalog, including drawings and photographs of, and descriptive data and specifications regarding, the Waycott Special, Anglrod and Damascus brake beams, the Brascott freight car ladder and miscellaneous appliances.

OIL FILTRATION.—S. F. Bowser & Co., Ft. Wayne, Ind., have published an illustrated booklet entitled Oil Filtration and Circulating Systems. This booklet contains detailed descriptions of these systems amplified by diagrams. Accessories are also illustrated and described. The booklet ends with 17 advantages of these systems.

ALCOHOL HEATER CARS.—The Alcohol Heating & Lighting Company, Chicago, has issued a pamphlet describing and illustrating the use of alcohol heaters in warming freight cars carrying perishable freight. The burners are provided with automatic control and each car has a capacity for 24 gals. of alcohol, which will keep one burner going continuously for eight 24-hour days.

ELECTRIC RAILWAY SYSTEMS.—The General Electric Company, Schenectady, N. Y., has recently issued bulletin No. 4950, which describes the Washington, Baltimore & Annapolis 1,200 volt d. c. electric railway. Illustrations are given of the various installations and wiring diagrams used on this road; data concerning the operating expenses and power production are also given.

STEEL VALVES AND FITTINGS.—The Nelson Valve Company, Philadelphia, Pa., has issued catalog S describing the Nelson steel valves and fittings. Illustrations are given showing various operations in the process of manufacture, as well as the different types and sizes of valves, with an accompanying price list. This company handles all kinds of valves and fittings and the catalog includes the general sizes up to that for 24 in. pipe.

GRAPHITE.—The Joseph Dixon Crucible Company, Jersey City, N. J., has issued a 40-page booklet entitled Graphite Products for the Railroad, giving illustrations and descriptions of methods of using Dixon graphite products in maintenance of equipment work. This is the second edition of the book brought up to date to correspond with certain changes that have been made in standard practice and several new products that have been added to the line.

AMERICAN ENGINEER

"THE RAILWAY MECHANICAL MONTHLY"

(Including the Railway Age Gazette "Shop Edition.")

PUBLISHED ON THE FIRST THURSDAY OF EVERY MONTH, BY THE
SIMMONS-BOARDMAN PUBLISHING COMPANY,
83 FULTON STREET, NEW YORK, N. Y.

CHICAGO: Plymouth Bldg. CLEVELAND: Citizen's Bldg.
LONDON: Queen Anne's Chambers, Westminster.

EDWARD A. SIMMONS, *President.* HENRY LEE, *Secretary.*
L. B. SHERMAN, *Vice-President.* A. E. HOOVEN, *Business Manager.*

The address of the company is the address of the officers.

ROY V. WRIGHT, *Editor.* R. E. THAYER, *Associate Editor.*
E. A. AVERILL, *Managing Editor.* WILLIAM FORSYTH, *Associate Editor.*
GEORGE L. FOWLER, *Associate Editor.*

Subscriptions, including the eight daily editions of the *Railway Age Gazette* published in June in connection with the annual conventions of the Master Car Builders' and American Railway Master Mechanics' associations, payable in advance and postage free:

United States, Canada and Mexico.....\$2.00 a year
Foreign Countries (excepting daily editions)..... 3.00 a year
Single Copy 20 cents

Entered at the Post Office at New York, N. Y., as mail matter of the second class.

VOLUME 86. AUGUST, 1912. NUMBER 8.

CONTENTS

EDITORIALS:

| | |
|--------------------------------------|-----|
| Prize for Shop Kink Competition..... | 387 |
| Result of Safety Competition..... | 387 |
| Win a Prize of \$25..... | 387 |
| Maintenance of Boiler Tubes..... | 387 |
| Mallet for Yard Service..... | 387 |
| Brick Arches and Hard Coal..... | 388 |
| General Foremen's Association..... | 388 |
| Tool Foremen's Convention..... | 389 |
| New Books..... | 389 |

ILLUSTRATED:

| | |
|---|-----|
| Heavy Hard Coal Burning Pacifics..... | 391 |
| Care of Locomotive Boiler Tubes..... | 414 |
| Counter Sinking Reamers..... | 417 |
| Filing and Indexing of Tracings..... | 418 |
| Mallet for Yard Service..... | 420 |
| Railway Tool Foremen's Association..... | 422 |
| Repairing Driving Boxes..... | 429 |
| Emergency Wheel Guard..... | 431 |
| Band Saw Safe Guards..... | 431 |
| New Headlight and Car Numbers..... | 432 |
| Barco Flexible Joints..... | 432 |
| Cold Metal Saw as a Rotary Planer..... | 433 |
| Staybolt Drilling Machine..... | 433 |
| Aspirator for Coach Cleaning..... | 434 |

MISCELLANEOUS:

| | |
|--|-----|
| Railway General Foremen's Association..... | 396 |
|--|-----|

GENERAL NEWS SECTION:

| | |
|-------------------------------|-----|
| Notes..... | 435 |
| Meetings and Conventions..... | 436 |
| Personals..... | 436 |
| New Shops..... | 438 |
| Supply Trade Notes..... | 438 |
| Catalogs..... | 440 |

Prizes for Shop Kink Competitors

It is with profuse apologies that the judges have handed us the decision in the Shop Kink competition, which closed March 15. The delay was due to the exceptionally large number of kinks which were submitted by the 15 contributors. J. C. Brekenfeld, of the St. Louis & San Francisco, at Springfield, Mo., was awarded the first prize of \$50, and R. S. Mounce, formerly assistant to the general foreman of the Erie Railroad, at Cleveland, Ohio, was awarded the second prize of \$25.

Result of the Safety Competition

The first prize in the Safety, or Accident Prevention, competition, which closed June 1, has been awarded to W. T. Gale, shop demonstrator of the Chicago & North Western shops at Chicago. The article will be published at an early date. Friends of Mr. Gale will also be delighted to know that he was elected chairman of the executive committee of the International Railway General Foremen's Association, which has just held its annual convention at Chicago. The several other contributions to the competition have been accepted.

Win a Prize of Twenty-Five Dollars

As a basis of the second shop practice competition, the winner of which will receive a prize of twenty-five dollars, we have selected the subject of repairs to piston heads, piston rods and crossheads. This was announced in both the June and July issues, and the competition closes on September 1. On reading this, you will still have sufficient time to prepare the article and have it reach us before the closing date. We do not desire a finished composition, simply give the necessary facts in connection with your method of making piston packing, machining piston heads, machining or grinding piston rods and machining crosshead bodies and gibs, furnishing photographs or drawings, or both, and including information on the time required for each operation.

Maintenance of Boiler Tubes

Last month L. R. Pomeroy told how the boiler tubes could be handled through the shop at a minimum of time and expense. An ideal arrangement of tools was suggested, and the best types of machines for the purpose were described. The article on the Care of Locomotive Boiler Tubes by Mr. Hedeman in this issue, supplements Mr. Pomeroy's article and considers the best materials to be used for the tubes, safe-ends and ferrules, and also tells how the flues should be renewed, applied and maintained. We hope that our readers may secure much benefit from these articles. It is possible that you may be able to suggest improvements in some of the details. If so, we shall be delighted to have you write and tell us about them, for the subject is such an important one that we should like to get the most advanced and best practice placed thoroughly on record before leaving it.

Mallets for Yard Service

When the very long and heavy trains that are being handled over the road by the modern freight locomotives arrive at the classification yard, it is generally necessary to divide them in several sections to permit the yard locomotives to push them over the hump. At some points practically all of these trains are completely reclassified and the organization and arrangement is such that there is no necessity for stopping after the train is once started over the hump. In these cases a locomotive capable of handling a long train as it is brought in the yard will greatly facilitate the work and therefore the train movement in general. Such a locomotive has recently been delivered to the St. Louis, Iron Mountain & Southern, being the first

instance of the purchase of a Mallet locomotive strictly for yard service. In studying this design the question arises as to the advisability of the application of engine and trailer trucks to locomotives for yard service. The average weight per axle is less than 50,000 lbs. and would be but little over 54,000 lbs. if the two trucks had not been applied. This would not seem to be sufficient increase to forbid the obtaining of from 8,000 to 10,000 lbs. more tractive effort from the same boiler. Since this locomotive will be started and stopped frequently, a semi-automatic starting valve has been applied which admits live steam to the receiver pipe on opening the throttle and automatically closes the communication when the receiver pressure reaches its normal point. Arrangement is also made in this construction to permit the opening of this valve at the will of the engineer, but at the same time it forbids the obtaining of a pressure in the receiver pipe greater than that which has been previously determined to be suitable. In other words, it is impossible to get full boiler pressure in the low pressure cylinders.

**Brick Arches
and
Hard Coal**

One of the anthracite burning passenger locomotives just received by the Delaware, Lackawanna & Western, is fitted with a sectional brick arch carried on the usual arch tubes. This is probably the first instance of a brick arch of this type being fitted to an anthracite burning locomotive and its service will be watched with much interest. In the earlier Wooten fireboxes, which included a combustion chamber, there was a brick wall erected at the back of the combustion chamber proper. In this case, however, the firebox does not include a combustion chamber and the arch extends diagonally upward and backward from the flue sheet in the same manner as in a soft coal firebox. At various times attention has been drawn in these columns to the value of an arch considered as a baffle wall only. It is for partly this purpose that the arch has been applied in this case. It is not expected that it will very greatly improve combustion, but that it will improve the efficiency of the firebox heating surface and increase the capacity of the boiler proportionally. When an arch is installed, the back of the crown sheet and the upper back corners of the side sheets, as well as the door sheet, are permitted to transmit as much heat as the other parts of the firebox, which is not the case without the arch. Since the heating surface at this point is practically eight times as valuable as in the flues, the importance of using it to the best advantage is evident. At the same time the improved circulation given by the installation of the arch tubes and the protection of the boiler tube ends by the arch are features that influenced the decision to apply one in this case.

**General
Foremen's
Association**

At last, under an aggressive leader, surrounded and backed up by several hand workers who have been acuated by a strong belief in its possibilities, the International Railway General Foremen's Association has demonstrated by the work of the past year, and especially by the convention which was held in Chicago last week, that it is to be a strong, effective organization in a class with the Traveling Engineer's Association, and close on the foot steps of the two larger mechanical department organizations. Mechanical department officers are asked to carefully examine the report of the proceedings in this issue with a view to seeing whether it will not be to their best interests to affiliate with it. The association has unfortunately been badly handicapped by its name. Its function, as its present leaders see it, is to study and make recommendations concerning shop and engine house equipment organization, operation and practices—things that mechanical department officers generally are vitally interested

in, and to which the two leading mechanical department associations are in position to devote very little time and attention.

Because of its name—General Foremen's Association—many of the master mechanics, shop superintendents, etc., have apparently felt it beneath their dignity to join, and possibly, with some justification, for until recently those in authority in the association did not seem to have a very big, or a very broad conception, of its work. However, that time seems to have passed. It was undoubtedly no passing thought, but rather a deep conviction of the value of this association, which made H. T. Bentley, president of the Master Mechanics' Association, mention the advisability of having it assist the large association, in his presidential address last June. And, by the way, did you ever hear of a superintendent of motive power or mechanical engineer who held aloof from the Master Mechanics' Association because its name was such that he might belittle himself by joining it?

Several things made the recent convention a memorable one: In the first place W. L. Park, vice-president and general manager of the Illinois Central, who during the past year has so successfully guided his way through a most serious difficulty involving the shop employee, made an address in which he spoke frankly and to the point on the labor problem. In his opinion too much managerial caution has been displayed in the past in dealing with this question and the time has come when it must be met frankly and openly. He did not advocate sweeping the labor organizations out of existence, but rather that they might choose wise leaders, who had the real interests of the men at heart. Things have got to be adjusted on the basis of the Golden Rule and the best interests of both the railways and the men are the same. Neither can suffer without effecting the other. The men in charge of the shops and engine houses are the ones who come into intimate contact with the men, and can do much, if they have a proper appreciation of the possibilities, to get them to see and feel this.

Another thing occurred at the convention which is significant, and that is that the association, after considerable discussion of two important subjects, made positive recommendations—in the first case to the effect that at least 30 days' advance notice of the conditions of all parts of locomotives which were to be shopped should be given to the shop authorities, in order that they might be properly prepared to handle the repairs expeditiously and efficiently; in the second case that shops of 15 pits or over should improve their supervision by the employment of shop demonstrators. It is the duty of such demonstrators to see that the men are properly instructed in operating the machines, or otherwise handling the work, in order to secure the most efficient results. The foremen are too busy with their other duties to give the attention which is necessary to these details.

This year the members were furnished with advance copies of the papers, and the papers themselves were of a much higher grade than those presented at previous conventions. Not a minute was wasted in the discussions. Mr. Pickard in his blunt, direct way, saw to it that the members took part promptly and there was a business-like atmosphere, which was somewhat lacking in previous years. The papers were all good and were all well discussed, although three of them may possibly be considered of more importance than the others, because of the more important information which was brought out in the discussions. The first of these, presented by C. L. Dickert of the Central of Georgia, was really an appendix to the paper on How Can Shop Foremen Best Promote Efficiency, presented by Mr. Reyer. Mr. Dickert's paper, however, dwelt entirely with the idea of furnishing advance information on the engines to be shopped and outlined the way in which this is done on the Central of Georgia. It was as a result of the discussion on W. W. Scott's paper on Supervision, that it was decided to recommend the use of shop demonstrators. The next paper

which attracted considerable attention was that on Roundhouse Efficiency, by William Hall, and so much did the members appreciate the good things developed in the discussion that they asked that a report on engine house work be presented next year. As may be seen the other papers all brought out good discussions and valuable information, and this is particularly true of the one on Reclaiming Scrap Material.

President Pickard deserves a great deal of credit for the success of this year's convention. He objected strongly to his re-election, but the call was so forcible that he submitted, and almost before the convention had closed had several committees organized for next year's work; and to the men who have been honored with these assignments devolves a heavy responsibility to make the reports for next year so thoroughly to the point and so practical that the standards of the association will be placed on a still higher level. And at the same time it is up to the mechanical officers generally—no matter what their titles are—to lend their support. It is not true that at least 75 per cent. of the criticism against the railways in the recent scientific management discussion, which attracted attention far and wide, was directed against the shop operations? Can the superintendents of motive power and master mechanics afford to ignore the one association which is making a business of trying to improve shop and engine house efficiency?

Tool Foremen's Convention An absence of hesitancy in giving their experiences or opinions on the subjects brought up for discussion has been a marked feature of the conventions of the Railway Tool Foremen's Association. While there were no long prepared talks at any time during the sessions of the last convention, which lasted from three and a half to four hours each, there was no delay or difficulty in getting the members to speak. Everyone seemed to have either information or pertinent inquiry ready for the first opportunity to speak. It is just this spirit that makes associations of this sort of real value and its presence among the tool foremen is one of the strongest arguments in favor of the continued usefulness of the society. While the field covered by the activities of this body is comparatively narrow, it is of sufficient importance to justify the railway companies in permitting their employees to spend the three or four days required each year at the convention, if the members are serious in their efforts to obtain the greatest possible benefit. That they are in this case, cannot be doubted by anyone who attended the recent convention.

Because of the comparatively narrow field, some difficulty is being encountered, even now, in obtaining subjects that have not already been discussed at previous meetings. There would seem to be no objection to again bringing up a subject after an interval of two or three years. In fact there are a number of subjects of interest to this body that are of sufficient importance to justify a standing committee to report each year. The state of the art in connection with tools is advancing at practically the same rate as other mechanical features and this association should aim to keep its members informed on the very latest and most advanced practice. The appointment of standing committees, who will work, is probably the best way of doing this.

It has also been suggested that at each meeting an acknowledged expert on some feature of direct interest to the tool room foreman, be invited to deliver an address. This is a splendid suggestion and it is to be hoped that the executive committee will take it under consideration and next year will arrange to have a talk on the manufacture of tool steel, design of small cutting tools, portable electric tools or some similar subject. Such a talk would preferably be illustrated.

The absence of printed advance copies of the various papers made it difficult for the president to keep the discussion perti-

nent to the subject and in some cases important suggestions in the papers themselves received no discussion at all. It is recognized that a young association of this kind of comparatively small membership, is restricted in its financial expenditure, and that advance copies of the various papers may be beyond its resources. The dues are at present as high as they should be and there seems to be no way of increasing the income except to resort to the plea for more advertising in the proceedings, which is objectionable for several sound reasons. However, it would seem that some way could be discovered of arranging for the issuing of printed advance copies of the papers without calling on the members individually for greater support. A properly prepared plea to the various railway companies, or possibly to the heads of the motive power departments, for a small contribution to assist in increasing the value of this association would probably meet with a ready response. While this suggestion might be looked on unfavorably at first thought, it is beyond doubt much preferable to approaching a supply company for a similar contribution in the guise of an advertisement.

The spirit that prompted the attempt to have the association make positive and definite recommendations on certain features is to be commended, but in this connection, it should be remembered that the value of any recommendation generally depends on the amount of study and discussion that has preceded its adoption. Furthermore, no recommendation of any association should be made without previously informing all the members that the subject is to be brought up for final decision, at a certain time, thus permitting them to express their arguments for or against it, by letter if need be. Preferably such recommendations should only be made by a vote in which each member has a voice—in other words, by letter ballot. There are a number of features on which the knowledge of the tool foremen is necessary for decision, and recommendations from this association on these points would be gladly accepted and the association, as a duty to itself and the railway companies, should formulate such decisions, but, only as is stated above, after thorough investigation and discussion.

NEW BOOKS

Methods of Analyzing Coal and Coke.—Technical paper No. 8. Written by Frederick M. Stanton and Arno C. Fieldner. Published by the Bureau of Mines, Washington, D. C.

This paper describes the methods used at the laboratories of the Bureau of Mines for analyzing coal and coke and determining the heat value of these fuels. The original methods which were recommended by the American Chemical Society, together with such modifications and changes as have been deemed advisable, are included in the paper. Copies may be obtained by writing to the director of the Bureau of Mines, Washington, D. C.

Walschaert Locomotive Valve Gear. By W. W. Wood, air brake inspector. Published by the Norman W. Henley Publishing Company, 132 Nassau street, New York. 5 in. x 7½ in. 245 pages. 50 illustrations. Bound in cloth. Price, \$1.50.

This book is the third edition, revised and enlarged, and is divided into five divisions, the first four dealing with the analysis, design and erection, advantages, and questions and answers relating to the setting of the Walschaert valve gear. The fifth division is given over to the setting of the Walschaert gear and a discussion of other modern radial valve gears, including the Hobart-Allfree, the Baker-Pilliöd and the improved Baker-Pilliöd. This division also includes questions and answers on breakdowns. The history of the Walschaert valve gear is considered and the development of the gear is carried forward in a very simple manner, so that it may be readily understood by the elementary student, as well as those more familiar with the gear. In the design of the gears both the Reuleaux and Zeuner diagrams are con-

sidered. The book will be found valuable by the designers of valve motions as well as by the mechanics who handle this class of work in locomotive shops.

The Effect of Cold Weather on Train Resistance and Tonnage Rating. By Edward C. Schmidt and F. W. Marquis. 24 pages, 13 illustrations. 6 in. x 9 in. Bound in paper. Published by the Engineering Experiment Station, University of Illinois, Urbana, Ill. Bulletin No. 59. Sent free on request.

This bulletin presents the results of tests which were made to determine the increase in resistance of freight trains in cold weather over that which prevails in summer. It shows how great this difference may be in some cases. The tests also show that freight trains must run a considerable distance from their starting point before the minimum resistance is reached. In cold weather this distance may be as much as twelve or fifteen miles. The bulletin presents, in addition, a summary of the practice of American railways in reducing tonnage ratings during cold weather.

Electrical Injuries - Causes, Prevention and Treatment. By Chas. A. Lauffer, A.M., M.D. 77 pages, 4 in. x 6½ in. Bound in cloth. Published by John Wiley & Son, New York. Price 50c.

Injuries of all kinds from electrical circuits are discussed in a clear, simple manner and the proper procedure for first aid in each case is given. The various cases are treated in a logical manner, beginning with an understandable explanation of the effect of the electric shock or flash, followed by an explanation of the object of the treatment, and by a detailed description of the proper method of treating. Instructions are included on the proper way of removing a man who is still in contact with a live circuit, on artificial respiration, first aid treatment for burns, etc. The book is intended for practical men, and the author has consistently maintained this viewpoint. A series of questions at the back of the book will be found useful for preparing examinations on this subject.

The Coal Trade. By Frederick E. Seward, Editor, *Coal Trade Journal*, 20 Vesey street, New York. Price \$2.

The 1912 Coal Trade is the thirty-ninth annual handbook covering statistics and conditions in the coal trade. It is a handbook that is essential to those interested in the coal business, and is of value to railway men whose roads carry any considerable amount of coal. A good history of the trade, not only for the whole country, but for the important individual sections of the country in which coal is produced or marketed, is given, and the handbook also includes a great number of short studies on various subjects connected with coal which are very useful as references. The book might be compared to a newspaper almanac, devoted, however, entirely to one subject. The value of such a handbook is affected very much by the kind of index which accompanies it. The index of *The Coal Trade* seems to have been prepared conscientiously and fairly fully.

Cylinder Performance of Reciprocating Engines. By J. Paul Clayton, assistant in the mechanical engineering department of the Engineering Experimental Station of the University of Illinois, Urbana, Ill. Published by the University of Illinois, Urbana, Ill., as Bulletin No. 58.

For many years the only accurate method of ascertaining the steam consumption of an engine has been to measure or weigh in some manner the water used. It has been discovered, however, that the quality of the steam present in the cylinder at cut-off controls the form of the expansion curve of the indicator diagram in a perfectly definite way. From this fact there has been developed a method of computing the steam consumption of an engine from the indicator diagram alone to within 4 per cent. of the actual consumption as measured by test. There has also been developed a method of obtaining the volumetric clearance of a cylinder using steam, gas, air, or ammonia to a degree of accuracy almost as great as the method of filling the clearance

space with a known weight of liquid. The bulletin contains an exposition of the methods employed in obtaining the steam consumption and clearance, and also methods of detecting leakage from the indicator diagram with the engine in regular operation.

Electric Traction for Railway Trains. By Edward P. Burch, consulting engineer. Cloth, 583 pages, 6 in. x 9 in., illustrated. Published by the McGraw-Hill Book Company, New York. Price \$5.

There has been a demand for a book of this sort in the railway engineering field, both for the technical student and the practicing engineer. The book is not presented in the nature of a popular treatise on the subject, but with the desire to satisfy the wants of the engineer. The first chapter is devoted to a résumé of the history and the present status of electric traction, including tables presenting the general data of roads using electricity in America and Europe. The second chapter concerns the characteristics of modern steam locomotives, giving operating data and diagrams of some of the most recent power. The next two chapters consider the advantages of electric traction and the various systems available, citing the various railways using these systems. The following chapters consider the arrangement and design of the trains and locomotives in detail, giving technical descriptions of the direct current, the three-phase and the single phase locomotives. The way in which power of different kinds may be transmitted and developed at the power plant is considered. Tables are given with operation cost data and information about the equipment for different roads. Throughout the book references are made to articles in the standard engineering journals.

Dynamics of Machinery. By Gaetano Larva, S. B., C. E. and M. E., Professor Emeritus, Massachusetts Institute of Technology. 6 in. x 9 in.; 246 pages; 137 illustrations. John Wiley & Sons, New York. Price, \$2.50 net.

The book is in the form of a text book for students, and is a collection of the more important notes previously used in the course on dynamics of machines given by the author to the senior students of the Massachusetts Institute of Technology. It also contains additional data to make the work more complete. The first chapter describes the different types of dynamometers which are included in the above course. The remainder of the book, however, has for its chief object the methods of dealing with the inertia forces that arise in various kinds of machinery, especially in cases where high speeds are employed. Chapter II contains a theoretical discussion on the moments and products of inertia, and includes practical illustrative examples. Chapter III contains a discussion on the action of the reciprocating parts of a steam and gas engine, and describes the manner in which the formulae are obtained, as well as their use in actual problems. The subject of flywheels, their fluctuations in speed during a revolution and the stresses set up in their rims due to centrifugal force is carefully considered. Diagrams are worked out for the rotative effect of different types of engines. This chapter also discusses the subject of the balancing of revolving masses, giving in detail the problems met with in different types of locomotives. The calculation of stresses in locomotive driving rods is also presented in a theoretical but concise manner. Chapter IV contains a theoretical discussion on the pendulum and flywheel governors, in which the methods used by German scientists have been considered. Chapter V considers the action of bodies moving at a high rotative speed, theoretical treatment being given the moving axis of the symmetrical top, which leads directly to the consideration of the gyroscope. Appendixes cover the discussion of the principal axes and moments of inertia, the deduction of formulae for governor oscillation and the critical velocity of shafting. The book is intended primarily for the use of students, both in and out of school, and is of value to engineers who are doing this class of work.

HEAVY HARD COAL BURNING PACIFICS

The Lackawanna Has Received Seven Powerful Passenger Locomotives That Include a Number of Interesting Features of Construction.

A total weight of 284,000 lbs., and a maximum tractive effort of 40,800 lbs. make the new hard coal burning Pacific type locomotives recently built for the Delaware, Lackawanna & Western by the American Locomotive Company, among the largest and most powerful of this type. They are fitted with Wooten fireboxes for burning hard coal and a brick arch has been experimentally applied to one locomotive. The design throughout is characterized by refinements in details developed with a view of reducing the cost of maintenance. One prominent feature of this kind is the main driving boxes, which are 11 in. x 21 in. Thrust collars have also been fitted to the axles of the engine truck, bearing against the inside of the journal boxes, which will tend to reduce the wear on the wheel hubs and boxes. The front extension of the piston rod, outside steam pipes and screw reverse gear are other features of design which assist in reducing the cost of maintenance and improving operation.

These locomotives have been designed to handle a 460-ton train at a sustained speed of 30 miles an hour on a 1.6 per cent. grade. With the 10-wheel locomotive now in service be-

so far taken to overcome the tendency of the increased horizontal forces set up in the modern powerful locomotive to produce rapid wear and the accumulation of lost motion in the driving journals, resulting in the necessity of frequently renewing bearings. Main driving boxes of this design have been applied to two Pacific type locomotives on the New York Central & Hudson River. From their service thus far, the results have been very satisfactory.

Heretofore, driving boxes have generally been designed with reference only to the weight they support. The size has, therefore, been in direct proportion to the load borne by each journal. This method has not made proper provision for the longitudinal forces, particularly in the case of the large modern locomotive. In the big locomotive of today, the transverse spacing from center to center of the cylinders has necessarily been increased. At the same time, the distances between the frame centers have been decreased to obtain as long a driving box as possible within the limitation of the spacing between hubs imposed by the 4 ft. 8½ in. standard gage. As a result, the horizontal forces have increased in greater proportion than

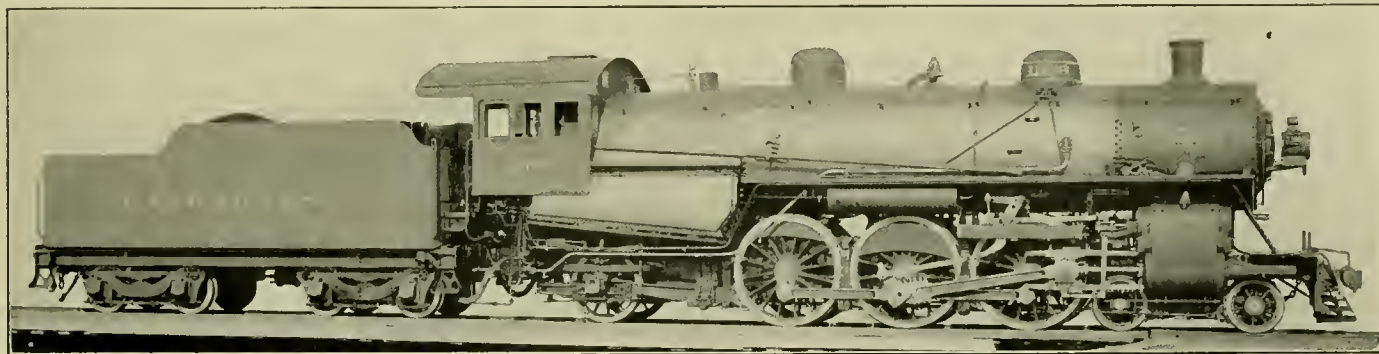

Hard Coal Burning Pacific Type Locomotive for the Delaware, Lackawanna & Western.

tween New York and Elmira, a six-car passenger train weighing 325 tons is the limit for one locomotive. It is frequently necessary to run seven cars, and helpers are then required through the mountainous districts. The new locomotives are intended to handle 8 cars on the present schedule, and inasmuch as this rating is made on the basis of saturated steam, it is believed that with the reserve boiler capacity secured with the use of highly superheated steam, the locomotives will actually be able to handle nine cars, or 530 tons, over the division without assistance. The ten-wheelers now in use have total weight of 217,000 lbs., a tractive effort of 34,860 lbs., 69 in. wheels, 215 lbs. boiler pressure and 22½ in. x 26 in. cylinders.

This is another instance in which the modern big locomotive has been resorted to in order to save the expense of double heading in a difficult passenger service which has outgrown the capacity of a lighter class of conventional design. The locomotives are the embodiment of the builder's best ideas in the design and construction of locomotives of their class.

In one of the illustrations is shown the details of the long main driving boxes which also include the use of shoes and wedges over 50 per cent. wider than has been customary. In spite of the extreme length, the arrangement is such that the spring load is equally distributed to all portions of the box and the frames and spring rigging are retained in their normal positions. This device would seem to be the most effective step

the load borne on the journals. Consequently, while the vertical pressure per square inch of bearing surface due to weight has been maintained fairly constant, the horizontal forces have been increased. This tends to result in the rapid accumulation of lost motion, causing pounding and requiring a renewal of the driving box bearings after much less mileage than theretofore.

Previous efforts to solve the problem have consisted chiefly in increasing the width of the shoes and wedges by making the legs of the pedestals wider than the body of the frame. The disadvantage of this method has been that the increase in the length of the box was possible only by resorting to a lop-sided construction, and experience has shown that it results in the uneven wear of the bearing and conical wear on the journals.

In the device under discussion, the normal width of the frames at the main pedestals is increased by means of auxiliary pedestals on the inside of the frames, combined to form a continuous cross-brace. The width of the shoe and wedge fit is increased by an amount equal to the width of the supplementary pedestal, or that portion of the shoe and wedge bearing formed at each end of the cross-brace which is inside of the frame. The spring load is transferred equally to the center of the box, without disturbing the spring rigging from its normal position in the center of the frames, by the combination spring saddle extending across the engine. Spring seats are

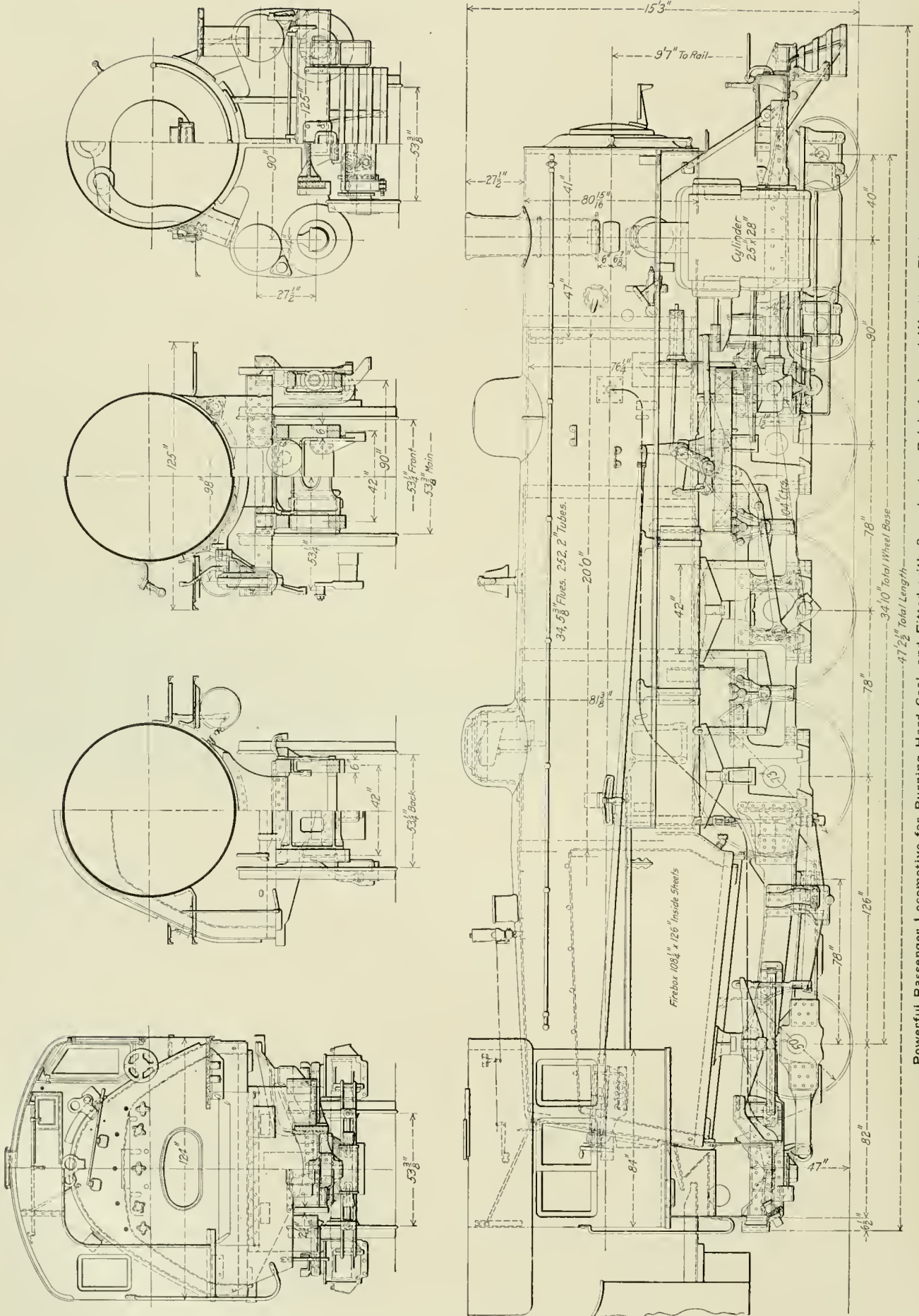

Powerful Passenger Locomotive for Burning Hard Coal, and Fitted with Superheater, Brick Arch and Wootten Firebox.

a design of the Walschaert valve gear arranged to give a variable lead. With this arrangement a maximum cut-off in starting is provided with the proper amount of lead at the ordinary running cut-off. This gives a satisfactory steam distribution for high duty service. This practice has been used by the builders in a number of recent designs. The favorable results for starting in full forward gear are, however, obtained at the expense of distortion of the valve events in back motion. For this reason, the practice is suitable for passenger and fast freight locomotives, but not for slow freight or switching locomotives. In the arrangement here employed the eccentric crank is given an angle of advance of less than 90 deg. It thus lags behind its correct position for constant lead and the link is not in its central position when the crank pin is on the center. With the eccentric crank so set, the lead increases from full forward to full back gear.

A new arrangement of flexible connections between engine and tender for the steam and air pipes, furnished by the Franklin Railway Supply Company has also been applied to

| | |
|---|---------------|
| Weight on drivers | 179,500 lbs. |
| Weight of engine and tender in working order..... | 443,600 lbs. |
| Wheel base, driving | 13 ft. |
| Wheel base, total | 34 ft. 10 in. |
| Wheel base, engine and tender..... | 69 ft. |

Ratios.

| | |
|--|--------|
| Weight on drivers ÷ tractive effort..... | 4.39 |
| Total weight ÷ tractive effort..... | 6.96 |
| Tractive effort × diam. drivers ÷ equivalent heating surface*..... | 592.00 |

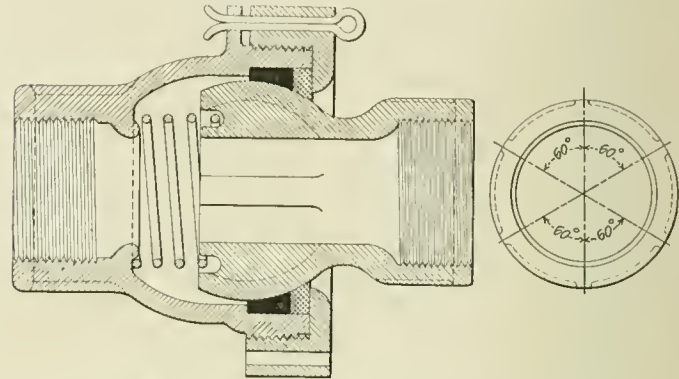

Franklin Ball Joint Used on Steam and Air Pipes Between Engine and Tender.

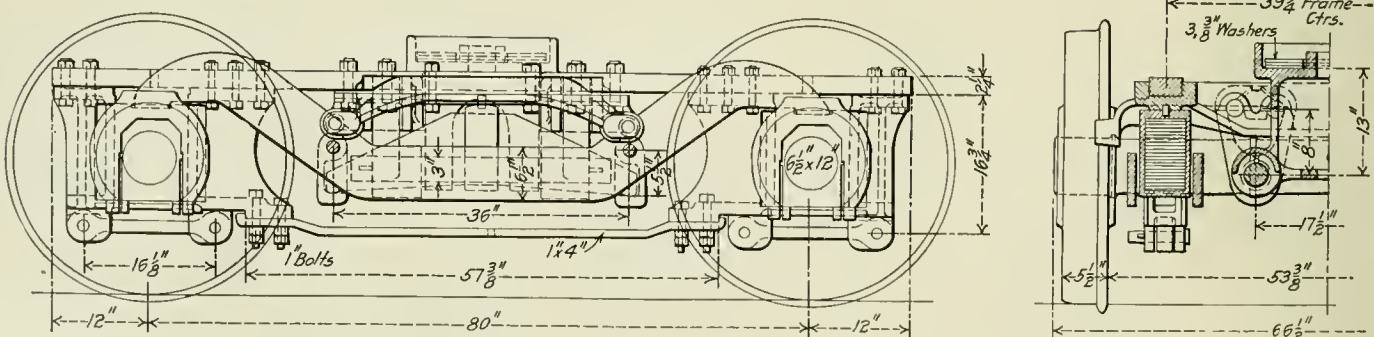
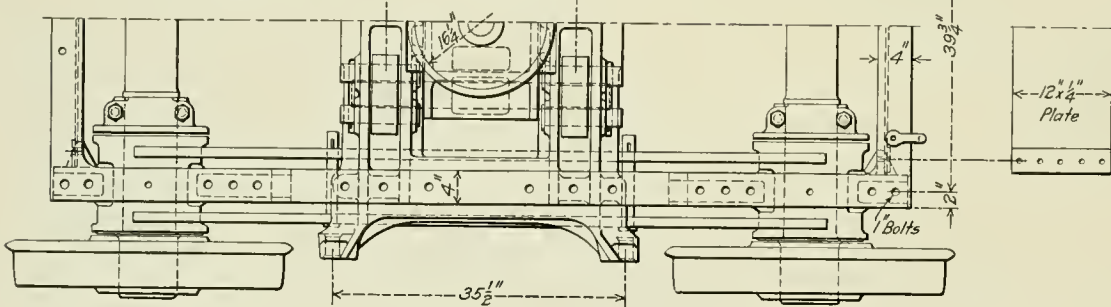
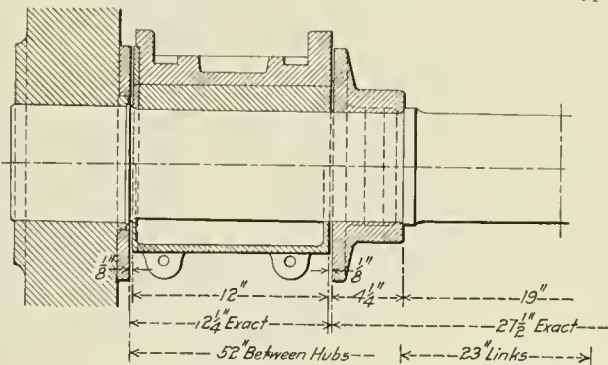

Engine Truck with Collar on the Axle Inside of the Journal Box; Lackawanna 4-6-2 Type Locomotive.

these engines. It employs a system of ball joints. Vanadium steel is used in the frames.

The general dimensions, weights and ratios are given in the following table:

General Data.

| | |
|-------------------------------|-----------------|
| Gage | 4 ft. 8 1/2 in. |
| Service | Passenger |
| Fuel | Anth. coal |
| Tractive effort | 40,800 lbs. |
| Weight in working order | 284,000 lbs. |

| | |
|---|--------|
| Total equivalent heating surface* ÷ grate area..... | 53.20 |
| Firebox heating surface ÷ total equivalent heating surface*, per cent. | 4.74 |
| Weight on drivers ÷ total equivalent heating surface*..... | 35.50 |
| Total weight ÷ total equivalent heating surface*..... | 56.10 |
| Volume of both cylinders, cu. ft..... | 15.90 |
| Total equivalent heating surface* ÷ vol. cylinders..... | 317.00 |
| Grate area ÷ vol. cylinders..... | 5.94 |

Valves.

| | |
|-----------------------|-----------|
| Kind | Piston |
| Diameter | 14 in. |
| Greatest travel | 6 1/2 in. |

| | |
|-------------------------|-----------|
| Outside lap | 1 1/8 in. |
| Inside clearance | 3/16 in. |
| Lead in full gear | 0 in. |

Cylinders.

| | |
|---------------------------|-------------|
| Kind | Simple |
| Diameter and stroke | 25 x 28 in. |

Wheels.

| | |
|---|-----------------|
| Driving, diameter over tires | 73 in. |
| Driving, thickness of tires | 3 1/2 in. |
| Driving journals, main, diameter and length | 11 x 21 in. |
| Driving journals, others, diameter and length | 10 1/2 x 13 in. |
| Engine truck wheels, diameter | 33 in. |

| | |
|-------------------------------------|--------------|
| Grate area | 94.8 sq. ft. |
| Smokestack, diameter | 16 in. |
| Smokestack, height above rail | 15 ft. 3 in. |

Tender.

| | |
|-------------------------------------|-----------------------------------|
| Tank | Water bottom |
| Frame | Steel, 15 in. and 10 in. channels |
| Wheels, diameter | 36 in. |
| Journals, diameter and length | 6 x 11 in. |
| Water capacity | 8,000 gals. |
| Coal capacity | 14 tons |

*Equivalent heating surface equals 3,818 sq. ft. + (1.5 x 821 sq. ft.) = 5,050 sq. ft.

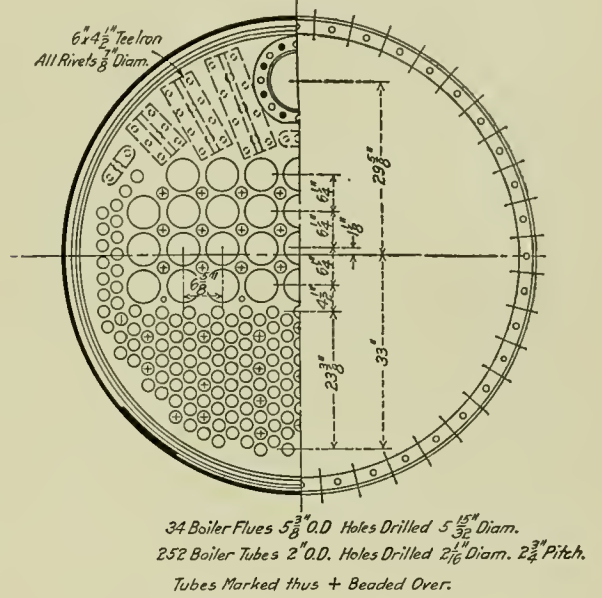
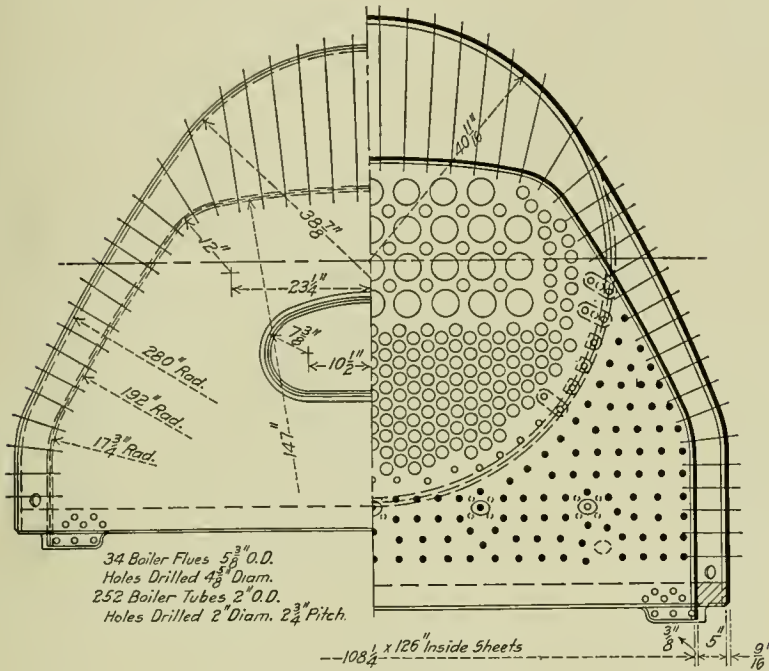

Sections of the Wooten Firebox on the Lackawanna 4-6-2 Type Locomotives.

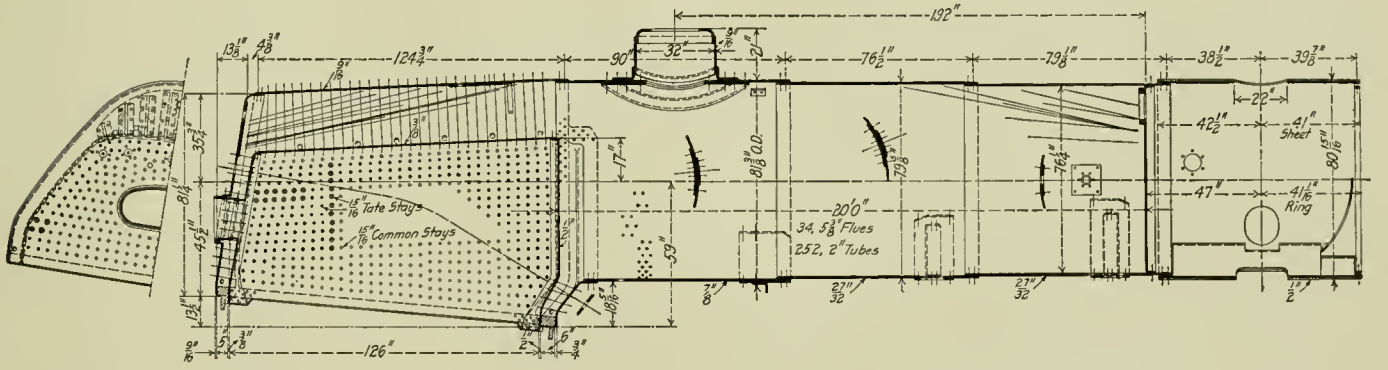

Large Boiler and Firebox Arranged to Burn Anthracite Coal; Lackawanna 4-6-2 Type Locomotives.

| | |
|---------------------------------------|----------------|
| Engine truck, journals | 6 1/2 x 12 in. |
| Trailing truck wheels, diameter | 50 in. |
| Trailing truck, journals | 9 x 14 in. |

Boiler.

| | |
|--|---------------------------|
| Style | Straight top Wooten. |
| Working pressure | 200 lbs. |
| Outside diameter of first ring | 78 in. |
| Firebox, length and width | 126 x 108 1/4 in. |
| Firebox plates, thickness | 3/8 & 1/2 in. |
| Firebox, water space | F., 6 in.; S. & B., 5 in. |
| Tubes, number and outside diameter | 252—2 in. |
| Tubes, thickness | No. 11, B. W. G. |
| Flues, number and diameter | 34—5 3/8 in. |
| Flues, thickness | No. 9, B. W. G. |
| Tubes, length | 20 ft. |
| Heating surface, tubes | 3,579 sq. ft. |
| Heating surface, firebox | 239 sq. ft. |
| Heating surface, total | 3,818 sq. ft. |
| Superheater heating surface | 821 sq. ft. |

STEPLESS TROLLEY CAR.—The Brooklyn Rapid Transit Company, Brooklyn, N. Y., is trying on its surface street railways a "stepless car." All passengers board the car at a center side entrance. This opening is 6 ft. 6 in. wide. It provides an entrance aisle 33 in. wide and two aisles for exit 21 in. wide on either side. The center platform, which passengers reach upon entering, is only 14 in. above the top of the running rail. The conductor is seated at the entrance in charge of a fare-recording device. After paying fare the passenger may step into the car toward either end. Both passengers and conductor signal the motorman to stop the car by pressing an electric push button. The signal for starting consists of small electric lamps placed in front of the motorman which are lighted only by the closing of all the doors. The conductor can stop the car quickly by operating a special valve within his reach. A similar car is also used in New York City.

RAILWAY GENERAL FOREMEN'S ASSOCIATION

W. L. Park, Vice-President of the Illinois Central, Speaks
Frankly on the Labor Problem. Splendid Papers, Well Discussed.

The eighth annual convention of the International Railway General Foremen's Association was held at the Hotel Sherman, Chicago, July 23-26. F. C. Pickard, master mechanic of the Pere Marquette at Saginaw, Mich., presided. The convention was opened with a prayer by Rev. Annesley Thomas Young, after which an address of welcome was made by Maclay Hoyne, first assistant corporation counsel of Chicago. W. W. Scott, shop superintendent of the Pere Marquette at Saginaw, Mich., responded to Mr. Hoyne. The secretary-treasurer's report showed a membership of 135 and a balance in the treasury of \$835.06.

PRESIDENT PICKARD'S ADDRESS.

After commenting on the splendid work done by the committees during the year and on the growing importance of the work of the association, President Pickard said in part:

A suggestion was made at the last convention that the executive committee confer with the executive committee of the Master Mechanics' Association, with regard to having certain matters referred to this association that the larger one is unable to handle because of the pressure of other more important matters. President Bentley of the Master Mechanics' Association has taken a keen interest in this association, and was quick to grasp the suggestion, and made considerable mention of it in his address at the June convention.

The introduction of superheat on locomotives has given a good account of itself in both freight and passenger service. Careful study should be made by the general foremen as to maintenance of engines so equipped, especially in the first year of their service. Economies in shop practice mean a reduction of cost and increased output. They involve the proper location of machine tools and also of the buildings, so that unnecessary handling of material will not be necessary; a great deal of time is lost in this way. I would suggest that visits be made to other shops by yourself and your subordinates to see what the other fellow is doing.

Staff meetings should be held weekly in the office of the general foreman, shop superintendent or master mechanic, to talk over the work of the past week and to plan the work for the coming week. You may have figured on seven engines and only turned out six. The reason for the failure should be located. First ask the gang foreman who has charge of the pit where the trouble occurred and as to the cause—whether it was on account of the boiler work, blacksmith work, or shortage of material. In this way you will be able to place the responsibility and trace it direct to the department where the failure occurred. It may be that the force is not equally divided, that it may need building up, or it may be a lack of machine production. When you take a matter of this kind up always be sure to determine the real cause of the trouble.

Specialization of mechanics and shop laborers is an important factor and worthy of a great deal of consideration. Special grouping of machine tools should be studied to avoid unnecessary transferring and handling of parts through the shop. Several hundred experts may gather in convention and tell of a great number of ways of doing a certain piece of work. You can figure that 95 per cent. of these are wrong. We, as an association, must decide which is the best.

ADDRESS BY W. L. PARK.

W. L. Park, vice-president and general manager of the Illinois Central, made the following address at the Wednesday afternoon session:

In my opinion, the paramount problem confronting the mechanical foremen of our American railways today is the effect of socialism on the working forces.

In recent years we have lost much of the *esprit de corps* which formerly characterized our shop labor. There is not to be found anywhere, as obtained a few years back, that firm control of the employees, so essential to the proper conduct of large industrial undertakings. While there has been, perhaps, improvement in contract shops in general efficiency, it can be attributed more to new machinery and methods than to increased efficiency of labor. The inability of the railway shops to increase their efficiency in the same ratio was brought out quite prominently in the recent discussion of Harrington Emerson's scientific management, used by Mr. Brandeis to defeat, for his clients, the railways in their request for increased rates in the hearing before the Interstate Commerce Commission.

Of course the shop foremen and railway men generally knew the impracticability of the Emerson-Brandeis theories. At the same time it appealed to the people who were unable to differentiate between the factory that could close down indefinitely if threatened with labor troubles, with hardly a ripple on our industrial activities, and the railway, which is compelled by its charter to operate daily. The public was not well enough informed to distinguish between theory and practice, consequently the sentiment was molded against the railways, and their case was lost. When the government attempted to make scientific management effective in its own shops it was met with difficulties which were not insurmountable, but which seemingly appalled them, and they laid down ignominiously.

We all know that railway shops can be run more economically if certain facilities are provided and the control thereof turned back to the managers. Railways, from dire necessity, practice economy and have done so for years. You probably all remember the story of the examination of the fireman for promotion to an engineer on a railway making strenuous efforts to economize, among other supplies, in the use of oil. The fireman was asked what action he would take as an engineer if he was suddenly confronted with an approaching headlight on the same track. He thought the matter over seriously, and, brightening up as the answer came to him, said: "I would grab the oil can and the tallow pot and jump off."

Another story of at least a quarter of a century of antiquity is that of the manager who found along the track in the weeds a railway spike, rusty and bent. Carrying it to the section foreman, he proceeded to give him a lecture on economy. The foreman took the spike, looked it over carefully, and said: "I have had a man looking for that spike for two days. Where in hell did you find it?"

As you gentlemen know, the greatest difficulty in operating a railway shop as you would like to operate it is the present attitude of the labor element. Organized ostensibly to benefit their members, the unions have recently become subservant to the service of certain individuals of strong socialistic tendency, who, to not only insure their salaries, but certain perquisites and emoluments, constantly instill insubordination, dissension and dissatisfaction into the rank and file, which in turn breeds indifference, bickering and strife.

Our railways, because of their magnitude, are particularly vulnerable. One foreman may have absolute control of his particular shop, treat his men fairly, and obtain a reasonable amount of work. He is, nevertheless, affected by shop methods and adverse conditions existing in some remote locality, which upset

his best calculations and cause his men to be overcome with imaginary grievances. It behooves us all to make a most careful survey of the situation and get together to apply the remedy.

There has been too much managerial caution in this country for the good of the railways. We have temporized too long with socialism, syndicalism and other pernicious isms. When organized labor attempts to dictate who shall be employed, regardless of capability, and who shall be foreman, regardless of all qualifications other than seniority or unionism, it is digging a pitfall into which it or its employers must eventually disappear. When the organizations again realize that they are to man the railways, and the managers must be left to manage them, they can begin to really better their condition. No business can prosper saturated with disloyalty and steeped in incompetency, bred by labor restricting fanatics and socialistic agitators.

The railways can perhaps stand more of it than ordinary business, but there comes a breaking point, and it is with a breath of relief that many a foreman has stretched forth his arms and said, "Thank God, I am boss again," as the strike line filed out of the gate. He had been ignored, mistreated and humiliated. He was not turning out the work he was capable of doing. He saw on every hand waste of time and material—an unnecessary waste, an ungodly and unjustifiable waste of his employer's property, powerless through the tyranny of the organization to prevent it, and when the thing broke he felt the shackles fall from his arms. He knew trouble was ahead, but he welcomed it as a relief from an intolerant condition, repugnant to every right-thinking and honorable man.

What is the trouble? Is it with the bosses or with the rank and file, or with both? Railways which treat their men liberally with pensions for old age, modern hospital departments, good working conditions and the highest wages are frequently the ones to suffer first.

Let us attempt to analyze the problem. We are all cast in the same mold. In this country we are assured under the constitution equality of birth. Our best statesmen, business men and industrial captains have been self-made men. The same opportunities exist today as have heretofore existed. There is no boy in this wide land endowed with health and average intelligence who cannot make a place for himself far above the working classes, if he chooses. He must be loyal, industrious and studious. All these attributes are seemingly treated with contempt by the modern shop labor organizations. Instead of examples to emulate and advice to rise in his chosen profession, the young apprentice is instilled with disloyalty and insubordination, constantly told to do as little work as possible, to deceive his foreman, and that his employers are grasping capitalists seeking his undoing. He is told that the shop foreman wears a brass collar, that he obtained his preferment through favoritism, and that he is a nonentity anyhow—the shop committee dictate to him where he should head in. He listens to socialistic talks, and is advised to keep away from the night schools, so that his time is occupied in poolrooms and other questionable amusements.

He must be indeed strong if he can fight shy of all these harmful and pernicious influences and rise above his fellow-shopmen. If he does, he has the mettle and stuff in him of which men are made. A good father or a good mother leads him onto the goal, past the temptations of the shiftless and envious, aided by a foreman who has had the same experiences and who is quick to note the material available, until finally he emerges into his estate, one of a thousand who successfully pass the insidious temptations surrounding him.

I can remember when it was not considered treason to his fellow-workmen to be loyal to his employer. I know of a time when an employee on the railway could do something for which he was not paid without fear of ridicule or a lodge fine. It is entirely within my recollection when a foreman was looked up to for advice, and his word was the law of the shop. He did not require a walking delegate or a shop committee to dictate to him how far he could go, and where he should stop. Only a

few years ago employees who asked for the dismissal of a foreman invited disaster to themselves.

Are the foremen less competent today? I think not. They have been made in a hardier mold. They may, from necessity, be more diplomatic. They may gum-shoe through the shops to avoid trouble. They must be more ingenious, more tactful, and more resourceful, to meet the present conditions. Their responsibilities are greater, as are all of the responsibilities of the railway man of today, as compared with a few years ago.

How long can present conditions obtain? Can a master mechanic or foreman fear his employees and their power and influence with those in authority and render efficient service? Does he not lose in self-respect when he lets some shiftless agitator tell him who shall do certain work and who shall not; when he is compelled to use as a gang boss, by reason of seniority, a man he knows to be incompetent and disloyal; when he is compelled to not see spoiled work, misused tools or time-killers? If his energy, ability and desire for increased responsibility is to be circumscribed by carelessness, disloyalty and ingratitude, is he not apt to degenerate and lose heart?

It is the crime of our industrial life that such conditions obtain, and they do obtain to a greater or less extent in every railway shop in this country, and they are not getting better—on the contrary, they are getting worse. The men are dissatisfied, they are not prosperous, they are full of unrest. They are assessed unmercifully to remedy some far-fetched grievance of which perhaps they have no knowledge. The wives and children suffer, and they are taught by the professional fixer of their wrongs to strike, as the serpent, at the hand that feeds them. The effect of deception, violence and brutality is always a boomerang, but it is deplored that the innocent must suffer while the guilty are, for a time at least, seemingly prosperous.

Not all of the organizations are conducted in this way. Those that are not are making real progress. They have wise leaders who are conservative. They advise and compel their members to keep contracts. They go to the very extreme before breaking with their employers, and seldom does such an event occur; consequently, they are respected. They do not attempt to interfere with the management of the property, therefore they do not become *persona non grata* with their superiors.

The metal crafts must throw off this yoke of ignorant and corrupt leadership. They are intelligent men. They certainly can be deceived only a part of the time—not all of the time. Let them make an impartial and searching investigation of their affairs and compare them with other organizations working for the same people. Select men who are trustworthy and intelligent to conduct their affairs on the same lines. Make an effort to uplift their organization to the plane of intelligent, reasonable and conservative employees. Concede to the managers an interest in their affairs, instead of imaginary hostility. Give the foreman credit for knowing his business. He should be unrestricted by lodge affiliation—he cannot serve two masters. Remember that there was only one perfect man, and he was crucified two thousand years ago. Give and take. Let the indolent, improvident and unskilled take their proper places in the scale of humanity. Give every man and boy a helping hand, and a good wish that he may become foreman, master mechanic, superintendent of machinery or manager, and help him get there.

The employees should take pride in the railway and resent any interference with its rights, and contend always that it shall have a square deal and living rates. It will then be in a position to give a square deal and good wages. We should all work zealously to bring about such a condition of affairs. We all know what is essential for the good of the employees, the railway and ourselves. This cannot be accomplished with the mailed fist; it must be done by placing before the men the true facts, obtaining their confidence by fair, impartial treatment, giving them less cause for grievance committees. The shop foreman should be a walking delegate for the men under him.

Labor must be taught how to throw off the yoke of autocratic

and arbitrary leadership. The professional labor leader should be relegated to the scrap heap, and only the intelligent, conservative and diplomatic members of the organizations elected to such responsible positions. The tenure of office should be dependent upon the maintenance of harmonious relations with the employer. Those who are contentious and arrogant should be considered unsafe; those who misrepresent facts, deceive their membership and practice dishonorable methods should be gotten rid of absolutely.

The organizations should confine themselves to controllable units. If there are momentous questions involving the possible loss of position and the savings of a lifetime, the membership—and not the irresponsible officers—should decide the matter.

There should be calm debate and most careful consideration of every phase of the controversy. The voting power should be secret and sacred, free from intimidation or official influence. There should be a free expression of ideas and brotherly consideration for those of different views. The minority is quite frequently in the right.

When a contract or agreement is made it should be sacred; no flimsy pretext gotten up to serve a temporary purpose should be permitted to break it. The commercial world is founded upon credit. He who breaks his word is ostracized. It must be so between employee and employers.

The general foremen have a greater power to bring about right conditions than any other influence. They are generally from the ranks. They are in constant touch with the managers, and close to the rank and file. Their knowledge of the right and the wrong is born of years of experience and carries conviction. The time is opportune to commence this work. The men are sick of the mistakes of their leaders; they are tired of unsuccessful strife, and ready to do business on business principles.

The Cleveland Federation of Labor recently adopted resolutions to bring about more friendly relations with employers. Labor will find no great difficulty in reaching common ground and harmonious relations everywhere, if they are disposed to apply the Golden Rule literally to their efforts.

MR. DE VOY'S ADDRESS.

James F. De Voy, assistant superintendent motive power of the Chicago, Milwaukee & St. Paul, addressed the association at the afternoon session of the first day. Among other things he spoke of the importance of such organizations as the General Foremen's Association in determining the proper methods of doing work and suggested that they were far more capable of doing such things than state and other commissions. He said that a great deal of trouble had been caused on his road during the past winter because of hot boxes on locomotives. All the mechanical officers were called together and the question of the proper method of finishing a driving box journal was discussed. Some maintained that it should be done one way, while others thought it should be done another way. It is up to the association to determine which is the right way of performing various shop operations. Mr. De Voy had heard different organizations criticised as to the amount of good they had done, and as to whether it paid the railways to send representatives to the meetings. It does pay! He said: "If you will return and tell your people the way that things should be done, if you will fairly instruct the men that have to do the work, you will not have any trouble with the labor organizations. You ought to be able to judge, if you are a general foreman, what time it takes to line up a set of shoes, wedges or guides or anything of that kind; you ought to know whether a man gets a fair wage; and if he gets a fair wage your province in the matter is to see that he delivers to your superiors value received for just what he gets and not to abuse him when he does it."

HOW FOREMEN CAN BEST PROMOTE EFFICIENCY.

W. G. Reyer, general foreman locomotive department, Nashville, Chattanooga & St. Louis, Nashville, Tenn., read a paper

on the above subject, of which the following is an abstract:

A shop with only five pits should be handled by one foreman, who should have charge of both the machine and the erecting shops. In a shop of this size the gang bosses who have charge of the copper shop, paint shop, tank shop, air brake department, and toolroom should be expected to work. In a shop with 10 pits there should be a foreman of the machine shop and a foreman of the erecting shop and two gang bosses; also a foreman boiler maker, blacksmith foreman, air brake foreman, carpenter foreman, paint foreman, copper shop foreman and truck builder foreman. In this size shop foremen should not be expected to work, but to follow up the work and also the men closely. In a shop with 15 pits there should be a general foreman and an assistant, with demonstrators in the machine shop. Also one gang boss to every five pits in the erecting shop, and one gang boss for all pits to look after the steam pipes, dry pipes, cab work, pops, whistles, and hand railing; the other departments should have the same supervision as a 10-pit shop, except for the boiler shop, and the foreman of that shop should have an assistant. In a shop with 20 pits, or over, there should be a shop superintendent and a general foreman over the erecting shop, machine shop and other departments.

The general foreman or shop superintendent should show the men that his word and his way of doing things mark him as a man of firm character and good judgment, one who says what he means and means what he says. This kind of a man is bound to be respected. When you gain the confidence and respect of your men they will put forth their best efforts. An organization is not up to a good standard if the head of any department cannot be spared away for a reasonable length of time, and the department keep up its work the same as if he was present. Every position of any importance should have a man who at a moment's notice will be able to fill it, if it is vacated.

Men should be paid according to their individual merits. Some men are naturally quick, both to grasp an idea and to do the work, and will push the work with energy. Others will work all day and accomplish very little. Some men can do only one class of work, others are all around mechanics. My plan is to advance a man as he progresses and broadens. I believe in paying the best established wages to the hustler and thinker. We have made it a practice to hire handy men, whose general appearance and manner of speech show they are capable of learning. I tell them what I will start them at and also that it is "up to you to make good, and get your wages raised." The workmen and the company both gain by the step rate of pay. The workman gains because he knows he has to accomplish something and pushes at every opportunity to advance his work. He begins to study out plans to shorten the operations and thinks ahead. He soon finds that if he exercises his mind a little he will accomplish more with less labor.

Plan of Organization.—[Mr. Reyer's intention in going so thoroughly into the details of the work at the Nashville shops was not because he considers it an ideal plan for other shops to follow in detail, but rather to show the extent to which the specialization of work may be carried with good results. The conditions at Nashville are peculiar and the details of the plan of organization are made to suit them, and would not be applicable to the same extent elsewhere. What he intended to force home was the importance of the general principle of highly specialized work which will give good results in any shop, although the details will have to be worked out to suit the local conditions.—Editor.] We have a general foreman and an assistant, four gang bosses, a machine shop foreman and an assistant, tool room foreman, boiler shop foreman and an assistant, two inspectors, and foremen of the following departments: Copper shop, blacksmith shop, engine painters, engine carpenters, truck builders, airbrake and air switch foremen. In the engine house we have a foreman and an assistant, also a night foreman. It has been the practice of the road to ad-

vance its men and it gives good results, for they will strive to show their ability to hold more important positions.

A man in charge should be firm and positive, not too familiar with his men, and yet let them know that he is approachable at any time if the circumstances call for his time and attention. Let the men know that your time is taken up by company matters, and that only when the case cannot be handled by your assistant will you interfere. If it can be handled by a gang boss or a foreman, refer it to them for adjustment. If you want to have the best condition and smoothest running shop let everything come up through its proper channel, and if you find any man taking advantage of you discharge him.

We keep a record of each man's time and the engine or job on which he works, and can at a moment's notice estimate what any part of a locomotive is costing. We do all work by either shop or job numbers, and find that it works satisfactorily. All stock work is done by shop numbers. The department that originates the work stamps a ticket with a lot number, describing what is to be manufactured; all sub-requisitions bear the same number and are sent to any department that may be required to furnish material or labor to complete the work. Each department records the weight, kind of material, and hours it took to do the work. When the work is completed the tickets are placed on file and collected by messenger and delivered to the superintendent's office. We have regular reports made out by the traveling engineer containing advance information relative to repairs necessary to engines to be shopped at a future date. When engines come from branch lines we ask for a report and send out copies of it to the different foremen.

Our method of testing steam pipes, nozzles, nigger heads, steam chests, joints and front and back cylinder heads is to fill the boiler and apply hydraulic pressure at 110 lbs. This will show whether the work is properly done. We use 1/16-in. wire-woven asbestos under the nozzles with excellent results. This does away with spotting down these parts and saves labor.

After the locomotives are overhauled they are tried out by a special engineer, who also makes an inspection of the engine and reports in writing any defects he finds. When these are repaired it is sent out on the road, and the engineer runs it until he can report it O. K. for service. Whatever work he reports is handled by the erecting shop. It is then turned over to the roundhouse, after which all repairs are made at that place. In the roundhouse are two day inspectors and one night inspector. The day inspector's work is divided as follows: One man inspects the tank trucks, drawbars, wedges, spring rigging and has charge of the men who do this work. The other inspector looks after the inspection of rods, guides, crossheads, link motion, frames, and all braces, binders, shoes and wedges and reports any defects to the engine house foreman. We also have special men to look after and make repairs to the netting, front-end rigging and ash pans. Another special man examines all axles, crank pins, piston rods and side and main rods; besides this he has charge of re-turning all driving wheels, engine truck wheels, tank truck wheels, and coach wheels.

We try, as nearly as we can, to run our passenger and freight engines 100,000 miles. The switch engines we try to run from 40,000 to 60,000 miles. The superintendent's office gets reports from the traveling engineer as to the general condition of engines. Where the general foreman can get a report on any engine that is to be shopped and has a large enough force and machines for stock work, this information is of great service and should naturally shorten the time the engine is in the erecting shop. To illustrate: Suppose any engine needs a new firebox, cylinders, cab, driving boxes, shoes and wedges, tires, crank pins, rod brasses, or tank frames. If this information is in the general foreman's hands 30 days before the engine is sent to him he could advise the different departments that a certain engine would be shopped in 30 days and would require certain repairs,

and to see that the parts required were ready for the engine.

The work in the erecting and the machine shop should be specialized. If this is done the output will be increased from 25 to 30 per cent. over the shop that does not specialize. Again, a part of the erecting shop should be reserved for repairing and assembling the work. In our shops we have twelve working pits and always try to reserve sufficient floor space and handle the work as follows:

Handling spring and brake rigging requires about 8 ft. x 15 ft. This work is done by one handy man and a helper. They inspect all parts and send such as need repairs first to the blacksmith shop. The smith work when finished is returned, laid off, and drilled and when the engine is ready these men apply the brake rigging. They also look after and keep up stock for shipment on the road.

Handling steam pipes, dry pipes and exhaust pipes requires about 8 ft. x 25 ft. This work is handled by three handy men and three helpers. They remove all pipes and the crane then transfers them to the part of the shop reserved for this work. Here they are inspected and ground. If any new pipes are required it is reported to the gang foreman, who orders them from the foundry, stating just when they are wanted.

Rocker arms, rocker boxes, tumbling shafts and boxes require about 6 ft. x 12 ft. This work is looked after by a handy man, who examines all parts and sends them to the different departments for repairs. After the parts are repaired, he gets them ready for application, but he does not apply any work. We use a brass bushing in our rocker boxes. This is cast in halves, sweat together, then turned and bored to fit the box and arm. We apply two set screws to hold it in position. This brass has a collar on the end to take up lost motion.

Steam chests, valves, valve rings, valve strips, and valve yokes require about 6 ft. x 8 ft. This work is looked after by one machinist and one apprentice. Together they face the valves, apply the steam chests and see that the necessary repair parts are kept in stock.

Pistons, crossheads, and cylinder rings require about 8 ft. x 15 ft. This is looked after by one machinist and one handy man. They examine all crosshead guides, piston heads, and piston rods for cracks. The work is sent to the machine shop with the working instructions. They also lay off key ways for new piston rods and fit the keys; if new piston heads are required they see that they are properly prepared. They also get all the cylinder rings and cut them.

Quadrant and reverse lever work requires about 4 ft. x 12 ft. It is handled by a machinist who removes, overhauls, and applies these parts.

The shoes and wedges are looked after by one machinist and one apprentice. They examine all shoes and wedges and fit up new ones, or true up the old ones when they are used over. They also square the engine and lay out the work. We have one machinist who files pedestal jaws and looks after the binder and binder bolts.

The cab fittings and pops require about 4 ft. x 6 ft. space. This work is handled by one machinist and one apprentice. They remove these parts and send them to the brass lathe to be overhauled; when the engine is ready they reapply them. They also see that gage cocks are in good condition, that the steam gage and connections are O. K., set the pops, and see that all steam leaks are stopped.

We have one machinist and one apprentice on lining guides. They examine the guides, and, if worn, send them to the guide grinder to be ground, and apply back cylinder heads or lay off new ones when required. They have no floor space reserved for this work.

We have handy men for drilling and cutting holes in boilers. Also two machinists and two apprentices to apply links, eccentrics, eccentric straps and set the valves. They examine all eccentrics and straps; if new eccentrics are required they re-

move the old ones and send the new ones (which they keep in stock) to the machine shop.

The link work is overhauled on the machine shop side, and requires about 6 ft. x 15 ft. It is done by one machinist and one apprentice. After the links are removed from the engine they are sent to the link bench, where a machinist examines them for cracks and overhauls them. We use brass bushings and have a special reamer to ream out holes after the bushings are applied. We grind all pins after they are case hardened. By this method we get an accurate fit.

Our rod work is handled on the machine shop side, and requires about 12 ft. x 15 ft. This work is handled by two machinists and one apprentice and three colored helpers. They do up all the rod work.

The driving box work is handled on the machine shop side and requires about 6 ft. x 8 ft. It is looked after by one machinist who examines and applies all brasses, gets the lateral for the boxes, and applies all brasses for stock boxes.

In the machine shop are special machines to do the following work: One lathe handles all piston rods. The operator examines old rods for cracks. One lathe takes care of all piston and valve stem glands, makes all new work that is required, and grinds all glands. This lathe also takes care of spark caps. Another man at a lathe turns all valve stem and piston rod packing and bores out to suit the engines. He keeps a book record of the size of all the valve stems and piston rods, so that the proper packing can be sent to any point if the engine number is given. This takes about one-half of his time and he is assigned other work to fill out the time. One lathe takes care of the air pump work and pops. We have two lathes to handle crosshead pins, knuckle joint pins, valve yokes, and solid rod bushings. Two lathes do all the link work. Three lathes are used for brass parts. We manufacture all injector repair parts and repair parts for pops, all gage cocks, cylinder cocks, checks and throttles. One boring mill, and sometimes two are used on driving boxes and rocker boxes. One planer is used on new driving boxes, and at times the operator has a chance to do other work. There is one planer for valves and valve strips; one shaper for rods and rod brasses; one draw-cut shaper fits all driving brasses and does other work, as well; guide grinders are provided for grinding all guides, and a miller for milling all shoes, wedges, and crosshead gibs.

We have a delivery gang of colored helpers. They handle material from the erecting shop to any department and return it when it is ready. We also have a special repair gang that looks after all machinery and the manufacture of all shop appliances. Our special men have the necessary tools issued to them by the company, a careful check being kept on them so that they cannot be stolen. We issue to each man ten checks. This allows him to draw this number of tools from the toolroom. All checks are numbered and each man's name is registered in a book with the number of his check. All tools must be in the toolroom at the end of each day's work. If necessary to keep them out, they must have the approval of the gang boss. If tools are not returned in a reasonable time, the toolroom foreman sends the check with the name of the tool to the general foreman.

Before we made specialists of our men we had a messenger and telephone service, but the present plan is to equip each man with the tools and wrenches suitable for the job assigned to him, and this cuts down the number of trips to the toolroom. If he needs anything from the toolroom, he sends a helper for it.

Discussion.—In studying Mr. Reyer's paper it must be kept in mind that the Nashville shops are non-union, that colored helpers are available, that the shop is not exceptionally large, that the men are paid on a day-rate basis, and last, but not least, that it is very much overcrowded and that it would be desirable to assign much more space to the various classes of

work. The purpose of the paper was not to recommend the practices as ideal for conditions as generally met with, but to show the value of highly specialized work. A number of questions were asked and some criticisms were made, which would not have occurred but for a misunderstanding on the part of the members as to the purpose of the paper. These will be passed over in reporting the discussion.

C. L. Dickert (Cen. of Ga.) suggested that the amount of supervision for a shop with a given number of pits would depend on the output per pit per month. In other words two shops of 10 pits each might differ so greatly as to output per month that one would require very much more supervision than another. He also said: "The question of handy men is one that depends on local conditions. We are not allowed handy men except on drill press work and bolt cutters. I think Mr. Reyer has too many gang foremen for the number of pits. We have 22 working pits and only two gang foremen. The assistant general foreman has jurisdiction over the boiler shop, machine shop, blacksmith shop and copper shop, and we get along very nicely."

L. A. North (Ill. Cen.) did not believe in making a working gang foreman out of any gang foreman. If he takes care of his men he has all he can do without working, although he should not be afraid to help the job along. If a man supervises his men and looks after the material, he has about all he can do. Mr. Reyer replied that in the very small shop he thought the gang foremen should work part of the time.

W. Smith (C. & N. W.):—Mr. Reyer does not speak of the method of stripping engines. One of the most important things that a general foreman has to contend with is the arranging of the material that is stripped from the engines in order that it will not be lost or overlooked. It puts the shop to great expense if things are not where they can be found when needed. His method of tool checks is good, but I think there are other methods that are as satisfactory. A rotary rack in the tool room with the different checks and numbers kept on it is a good scheme, because there are times when the men will take the checks home with them and forget to bring them back. With the rotary rack in the tool room, the man in charge can look after the checks. It works very successfully in some shops. The method of specializing work, and having special tools for the special gangs, is good, and all shops should follow this method. The men should be provided with suitable shelves or drawers in which to keep the special tools. The general foreman should always be willing to have special tools made, for they will promote efficiency to a great extent in any shop.

William Hall (C. & N. W.):—The gang boss has enough to do without working himself. I agree with Mr. Reyer that there should be ample supervision. Ample supervision, but not too much of it. I also agree with him that an organization is not up to the standard when the head man cannot be spared to attend a convention. It shows poor organization when the head of it, or the man next to it, cannot be spared for a reasonable length of time.

W. Smith:—How does Mr. Reyer manage to take care of delinquent gangs? One gang is apt to get behind another, and thus effect the output of the shop.

W. Reyer:—Replying to the criticism about the number of gang bosses, we use more than might be justifiable at other places because of the special labor conditions at Nashville. We do not have a regular shop schedule for turning out engines, but accomplish the same purpose by going over matters thoroughly at our weekly meetings. We have not enough floor space. Our shop should be twice as large as it is to handle the work as well as I should like to. At one time we were cramped and crowded and got far behind with our output; we closed three of the working pits and used the floor space to assemble the work with marked improvement. We have no store house. Mr. Smith spoke about making provision for the

gangs that got behind with their work. We have a gang that looks after dead engines in the enginehouse. This gang I can move or transfer to any department which needs help.

President Pickard:—It has been brought out very plainly that there are a lot of conditions in the different localities that will enable one shop to do the work more economically than another shop in another portion of the country. Different members of the mechanical department have been called before commissions that do not know anything about shop practices. They act as judges for us, and the comparisons are not fair, from the fact that the classification of one road's engines may be different from another road.

It was suggested that the Canadian Pacific had made considerable progress in getting a fair basis of comparison of one shop with another, and the executive committee was asked to see if it could have some one from that road at the convention next year to tell about it.

ADVANCE INFORMATION ABOUT ENGINES TO BE SHOPPED.

C. L. Dickert, assistant master mechanic, Central of Georgia, Macon, Ga., read a paper on the above subject, of which the following is an abstract:

It is absolutely necessary that the erecting, machine, and boiler shop foremen should know as far in advance as possible when a certain class engine is to be shopped, in order to make the repairs promptly. The foremen should also know whether it is in need of new cylinders, frames, tires, firebox, flues, or any heavy repairs that are not generally given an engine shopped for general repairs. It will not only facilitate the handling of such repairs, but will enable them to carry a minimum of material in stock.

We have a method that enables me to know the condition of all power at all times. A form is worked up each month, showing the condition of each engine; when it is expected to be shopped; the class of repairs it is to receive; the condition and life of the firebox, boiler, and flues; the condition of frames, cylinders, machinery, cistern, and tank trucks; tire wear and thickness, and the general condition of the engine—whether good, fair, or bad. In going over this form each month with the master mechanic, we select the engines that are to be shopped within thirty days. These are submitted to the superintendent of motive power for approval. This is a great help to the shop foremen in making preparations to handle engines when they are shopped. If the foreman has no knowledge that a certain class engine is to be shopped until it is run in the shop on the stripping pit, how is he to know, until an inspection is made, whether or not he will have to arrange for new cylinders, frames, or any part that requires renewing. After this inspection (which takes time) he has to hustle to get in his order to the different departments; then he may find there are no cylinders on hand. If he had known thirty days before that they would be needed, he would have looked over his stock and made sure that he either had the material on hand or that it had been ordered. In going over this form each month, I know exactly what engines will need new tires when shopped; I look over the stock and see what I have on hand and order new ones accordingly.

Discussion:—A lengthy discussion followed the reading of this report, the more important points brought out being as follows:

G. H. Logan (C. & N. W.):—We make out a shop list from the condition of power report, showing all engines that will need shopping within 50 days.

L. A. North (Ill. Cen.):—I think the method mentioned in the first paragraph is good for small shops. With a 25 pit shop we find it necessary to carry plenty of stock on hand, such as cylinders, tires and other material which is likely to be needed. Once a month I make it a point to talk over with the general foreman of the engine house what engines are

likely to be shopped, and as a general rule there are from seven to ten dead engines, of which we have had advance notice, giving us ample time to get the material that may be required for them.

W. F. Fowler (Nor. Pac.):—We make out a report about 30 days before an engine goes to the shop; it shows everything that is necessary to be overhauled.

T. J. Mullen (L. E. & W.):—We have what we call a power meeting every few months. A report is drawn up which shows when each engine on each division should be shopped, and the class of repairs that each engine should receive.

H. G. Dimmitt (C. M. & St. P.):—We have a system a great deal like the ones that have been outlined. The monthly form shows the condition of all parts of the engine; from that we can tell about when each engine will need to be shopped and what material will be necessary. But one of the disadvantages of our report is the inaccuracy on the part of the enginehouse foremen who supply the information. For instance, they may think that certain cylinders will need renewing, when the shop inspection will show that such is not the case; we can not work up material on these reports on that account. We have orders to get together with the general enginehouse foremen each month and all conditions of the engines are discussed, and the master mechanic decides which ones are to go to the shop; it is up to the general foreman to line up the material for them.

Question:—What in your opinion would be an ideal way of handling the advance report?

Answer:—I think it should be handled from the master mechanic's office, all of the general enginehouse foremen to report to him. He should go over their reports carefully and also add any information that he may receive from his assistants, and possibly consult with the general foreman as to what he could handle in the shop. In that way he can tell how many engines it will be possible to put through the shop, and what classes of repairs can be handled to the best advantage.

G. H. Logan:—We have what we call an X and O sheet. It is a large sheet and all parts of the locomotive are listed on it. They are filled in by the division master mechanics when engines are sent to headquarters for repairs, or by the enginehouse foreman when they are sent to division headquarters. In listing the engines on the power report the master mechanic states when each engine will need repairs and then furnishes the X and O sheet. Any part that needs new material is marked X; where repairs solely are needed it is marked O. In this way we get a good idea of what work will have to be done in the shop. The X and O sheet includes all parts of the boiler, engine and tender.

W. Smith:—If the advance information is not correct a report of this kind is of no value. In some places the way the advance information is prepared is a sort of a joke; it is done by the enginehouse clerk or the master mechanic's clerk, or some one who has not a proper understanding of the condition of the power.

L. A. North:—The X and O sheet appeals to me, if for no other reason than that it checks the work and we can see where the money is spent. If the work done was checked against the X and O sheet which was sent in and the man who made it out was notified of the differences, I think there would be more correct information sent in from the outside points.

C. B. Hitch (C. & O.):—I think the card system is a very good one. We have such a system, and no report is made on an engine unless something unusual appears. If an engine in the enginehouse develops a cracked cylinder, and the enginehouse foreman thinks it will need a new one, it is reported to the general foreman's office and noted on the proper card for reference. The boilermaker foreman tests the boiler and if he thinks it needs flue sheets or sides, he immediately reports it. If the engine leaves the division and goes to another division, the card is mailed to the master mechanic of the other division. When

an engine is shopped, we immediately know whether there are to be any unusual repairs.

G. H. Logan:—On our road the advance information as to the condition of the engines is furnished by the road foreman of engines. It is one of his duties to ride all engines, and when an engine is found needing repairs to immediately make a report to the master mechanic of the nature of such repairs. On the North Western we get more of our information from the road foremen of engines than from any other source.

R. B. Van Wormer (Atlantic Coast Line):—The Waycross, Ga., shop makes all the heavy repairs to locomotives over several divisions and outlying points. The method used of securing advance information is the result of extensive experiments. When an engine is still in service, and immediately after it is authorized to be shopped for general repairs, a report giving the details of all necessary repairs is received from the master mechanic in charge of the division on which the engine operates. This includes a similar statement from the enginehouse or general foreman directly in charge of the engine, and frequently one from the engineer. This report when received at the general repair shop is used as the basis for another report or bulletin which may also include a notice of the standardization of any part, an examination of a device which has been applied for test purposes, etc. Copies are distributed to all foremen, who thus know the nature of the repairs required before the engine is received and can prepare parts to replace those removed. The advantages are greater than was anticipated. In addition to facilitating rapid repairs it familiarizes all concerned with the individual characteristics of each engine, the service resulting from the previous repairs which were made, and it also has a tendency to make more thorough inspections at outlying points, both before and after shopping the engine. The outlying points feel that the general repairs to be given the engine will be based more or less on their inspection and upon the return of the repaired locomotive will examine and criticize it accordingly. The back shop in turn may find some defect which was not discovered and reported, and at the same time it has the advantage of knowing of defects of invisible or inaccessible parts, such as leaky dry pipes, cracked mud rings, etc., without having to test for them. It also realizes its workmanship is subjected to close inspection by the outlying points. Frequently these reports show parts which were placed in good conditions shortly before the engine was shopped, and therefore need no attention. As the reports are kept on file it also enables the different departments to follow their work and see its condition when the engine is next shopped.

C. L. Dickert:—We have a foreman's meeting once a week when we line up the material, consider the engines to be shopped and look over the stock and see that we have enough material on hand. If not, we order it. The boiler shop foremen keeps a personal record of all fireboxes and boilers, and keeps in touch with their condition on all engines on the division. We have an X and O sheet that is furnished by the division master mechanic 30 days in advance of the engine. In reply to a question as to the accuracy of the advance information, Mr. Dickert said: "There are a few cases of work reported that it is not really necessary to do, and in other cases you will find work that is not reported."

G. H. Logan:—I move that it be the unanimous recommendation of this convention that advance information of 30 or 60 days is an absolute necessity for the making of proper repairs to engines on arrival in shops. The motion was carried.

SHOP SUPERVISION.

A paper on this subject was presented by W. W. Scott, shop superintendent, Pere Marquette, Saginaw, Mich., of which the following is an abstract:

It is safe to maintain that results gained in shops where the output is up to the maximum must be accomplished through perfect organization of the forces and frequent interchange of

information bearing upon subjects that will best serve the purpose of enlightening each unit of the organization as to how the work is progressing. The engines to be shopped should be listed thirty or sixty days in advance of shopping. The necessary material can be arranged for, thereby making rush requisitions on the store department unnecessary. It keeps the department foreman keyed up to the highest point, so that his department will not have to explain a delay. It also gives the store department sufficient time to order and receive material. As soon as the engines arrive over the shop pit they should be stripped and all parts cleaned and taken promptly to the department where they are to be repaired. We consider under our conditions that 50 per cent. of the shop engines should be stripped with all wheels out, and 50 per cent. should be wheeled with the material being applied. By maintaining this ratio the machine side, boiler shop, blacksmith shop, and other shops will have the work evenly balanced.

All work should be specialized. But in order that the mechanics may be kept interested in the work and that they be not allowed to get into a rut, I advocate a change of workmen from one job to another every six months. In this way you will soon have a shop full of high-grade men, who can be used in any emergency.

It is a wise plan to allow your foreman to visit different shops with a view of noting how the other fellow is doing the work. I care not how small the shop may be, you will always find something which makes your visit worth while. It is also a good plan for the general foreman to put the work directly up to department foremen and not try to carry the full burden on his own shoulders. Make each foreman personally responsible for the efficiency of his department.

The general foreman must insist on absolute loyalty from his subordinates if he expects to maintain his organization, and he must be loyal and fair. The general foreman who allows a feeling of distrust of his judgment, or who wilfully misrepresents facts in order to increase his shop output will soon find that it may work once, "but never again."

Local conditions greatly determine the possibilities of shop efficiency. Your shop output may be at the mercy of a storekeeper who is not of a progressive and agreeable nature, and who takes particular delight in withholding information relative to material that you ought to know about. It stifles the ambition of any general foreman to be misled on a material proposition, and leads to a rapid decline of efficiency in shop management.

Labor conditions also have a direct influence for good or evil results. The lack of intelligent interpretation of work agreements with the attendant petty annoyances and discord engendered by reason of misguided leadership is known to have caused a falling off in shop output of fully 10 per cent.

It has always been a sound doctrine that when two broad-minded persons cannot fully agree on a declaration of principles, a fair and full discussion will have a tendency to eradicate any and all fractional issues, and establish a middle ground broad enough for both to stand upon without crowding. The reverse condition exists when one or the other is narrow. The general foreman must be broad enough at least to point out and carry the issue with his superior officer or with those who may be under his supervision. The broadening process can be accomplished by many methods, but the most successful, in my opinion, is through the process of study. Be a student of human nature and apply the knowledge gleaned from that source, with the information offered you in our mechanical publications, and you will be surprised to know what a high degree of efficiency you will attain in shop supervision.

Discussion:—A lengthy discussion followed the reading of Mr. Scott's paper. A number of speakers outlined the form of organization at the shops with which they were connected, giving some idea of their size and capacity. Reference was made in

one case to a shop demonstrator and that part of the discussion which is reproduced relates largely to the possibilities of such demonstrators.

L. A. North (Ill. Cen.):—We have recently installed machine shop demonstrators and it is a paying proposition. I am only sorry we did not go into it sooner. The foreman found that his time was so taken up with other matters that he had little time to look after details and facilities for increasing the output, and this has been turned over to the shop demonstrators.

T. J. Mullen (L. E. & W.):—I believe, as Mr. North says, that a demonstrator is a paying proposition. It takes the detail off of the other foremen and the demonstrator can instruct the men as to just how the work is to be done.

C. L. Dickert (Cen. of Ga.):—I do not agree with Mr. Scott on changing the men about every six months. If a man is not familiar with the class of work that he is put on it takes him from four to six months to get thoroughly on to it, and why change him after he gets accustomed to it?

R. B. Van Wormer (A. C. L.):—Our theory is, as far as possible, to cover each job by a man who can be responsible at all times for each operation. In case anything occurs that is not as we should like it, we know just where to look for the responsible party.

E. F. Fay (Ill. Cen.):—I find, in getting more closely in touch with the problem of shop supervision throughout the country, that it is not the general practice, as I thought it to be, to manufacture the various items of locomotive equipment used at the smaller outlying points at the general shop. Some roads make this a practice. It seems to me that it would be economy to manufacture the various items at the one central point. From past experience it seems to me that a shop demonstrator nowadays is almost a necessity, not only to relieve the burden that is imposed upon the machine shop foreman, but also to obtain from each individual a maximum output for a maximum effort. It requires a diplomat to be a good shop demonstrator—a man who can approach another man from any angle and get him to put forth his best efforts. I believe that the shop demonstrator has come to stay in the larger shops. I believe in supervision—lots of supervision. Of course, it can be carried to extremes the same as anything else, but ordinarily there is a tendency toward too little supervision.

J. S. Sheafe (Ill. Cen.):—Referring to Mr. Scott's suggestion as to a change of work every six months. It is impossible to get the best efficiency out of any organization unless you have the interest of the men. If they are given a chance to work on the various jobs in the shop they will appreciate it and will be stimulated to greater efforts. Referring to the tool room—at Burnside, we have our tool steel kept in the storehouse, a long distance from the tool room; a half hour is consumed by the machinists in getting the stock and returning the unused portion. I believe that a supply of tool steel should be kept in the tool room and under the direct supervision of the foreman. I have also noticed many good tools ruined by improper treating in the blacksmith shop. It seems unfair to take a piece of work that the tool room is proud of to the blacksmith and have him treat it. I think this should be done under the jurisdiction of the tool foreman, as he is more familiar with the uses to which the tool will be put.

W. T. Gale (C. & N. W.):—The duty of the demonstrator of the Chicago & North Western shops in Chicago is to assist any and every foreman in every department, in any manner, shape or form that he possibly can to expedite the work. It is his duty to look out for all the weak points. The foreman in a shop where they are rushing work as we try to rush it and get results, applies himself to the immediate necessities of his position, and in the hurry and bustle necessary at times may overlook essential details. The demonstrator is supposed to be looking for these and to strengthen shop organization. He has complete supervision over the work of the machines, as well as the manner in which the men perform the work in the various de-

partments. He is supposed to be a practical machinist, a man who has gone through the shop, and who has held the position of foreman of one or all of the departments. He must be somewhat of a diplomat and must approach the men in different ways and make suggestions pertaining to the results they are trying to achieve. It is his duty to show them the manner in which they can get better results. At the North Western shops he has supervision over the apprentice schedule and has the direct welfare of the apprentices at heart. He is sent out from time to time to visit other shops and pick up ideas and present them to the management. He is supposed to note the condition of various machines and to make suggestions pertaining to machinery that has not the proper capacity or has become obsolete. He makes suggestions from time to time as to the handling of the men, placing and grouping of the machinery, etc.

G. H. Logan:—Mr. Gale was my successor as demonstrator. I think primarily the demonstrator was installed to get from each machine and each man a maximum output. My first duty was among the men on the machine side. I was to stay by the men and bring the output up to the capacity of the machine, as well to break in new men on the machines.

W. Smith (C. & N. W.):—The Santa Fe has inspectors who relieve the gang foremen and erecting foremen from following up any work. They see that it is properly put up and that the engines are right before they are fired up to make their trial trip. It seems to me it is a good thing to check up all power work before it has a chance to go out on the road and fail.

W. W. Scott:—I would like to ask Mr. North how he uses two or three different demonstrators?

L. A. North:—It was something entirely new to us when they were installed six months ago, and we went at it rather gradually. The demonstrators report to the foremen they are working under and are subject to their orders. The results we got when we put a demonstrator in the bolt gang were surprising. We had a fairly capable man in charge, but in looking over the situation we found that it was about as weak a place as we had in the shop on account of having apprentice boys in it, and the foreman was often absent checking off the work on the pit side; in five days we could notice such a decided improvement that we decided to put on as many demonstrators in the shop as we would be allowed to. We have three demonstrators on the machine side, and one on the erecting side who is now looking after the safety appliances on locomotives to see that they comply with the law. On the machine side one is working in the rod gang and on the new milling machines we have installed there. One is working in another gang and the third one is a general demonstrator going around wherever the machine side foreman sees fit to place him.

H. G. Dimmitt (C. M. & St. P.):—I visited one of the smaller shops of the Soo, and the foreman of the wheel shop told me that they had had a shop demonstrator in the shop for about a year, whose work had been to cut down the cost on all the different operations. The wheels, for instance, as they were pulled off, instead of being handled by hand are simply rolled on to a hoist that automatically lifts the wheel and sends it outside. Everything moves forward without any confusion, and a system of trolleys and devices cuts the cost very low and enables a few men to do a great deal of work. They assign the demonstrator to some particular operation and let him work at it until he gets it working as efficiently as is possible.

The following resolution relating to shop demonstration was passed at the closing season of the convention. Resolved, that we, the International Railway General Foremen's Association, in convention assembled July 26, 1912, after due consideration and discussion, do favor the adoption of a shop demonstrator in all locomotive repair shops consisting of fifteen or more engine pits.

ROUNDHOUSE EFFICIENCY.

William Hall, general machine shop foreman, Chicago & North Western, Escanaba, Mich., read a paper on this subject of which the following is an abstract:

The eyes of the railway world are centered on the problem of reducing the time locomotives are out of service from various causes, or in other words, time elapsing between the arrival of locomotives at terminals, and the time they are ready for service again. At large terminals, but more especially at points where the power is limited, much depends on the quick despatching of locomotives. This quick despatching calls for the hearty and responsive co-operation and concerted action of all parties concerned—including roundhouse foreman, road foreman of engines, engineers, hostlers, and heads of other departments.

The roundhouse foreman should be closely identified with the transportation department, so as to get all the information he can as to the time of departure of the power. He should be capable of looking and planning ahead, watching the company's business as he would his own, and should have the support of his superiors, a good organization, a sufficient amount of help, and last, but not least, a good supply of facilities to enable him to cope with the situation under all conditions, without which all his own efforts, far sightedness and energy will not count for much; but on the other hand, if the man at the helm has all these facilities at his command, but does not use good judgment, is not quick in thought and action, he is a failure and does not make for efficiency.

The road foreman of engines can help quite materially in bringing the efficiency of the roundhouse to a high standard by educating the engineers and firemen under his supervision in making out their reports accurately, leaving the fires in good condition, etc.

It is essential to the maintenance of the efficiency of the roundhouse that it be a clean, light and comfortable place for the men to work in; efficiency is dependent on a man's willingness as well as his ability, and willingness is influenced by his surroundings. I have seen roundhouses so dark, so poorly heated and ventilated, that the men could not do efficient work, and but for their loyalty to the company would not have remained at their posts. Such conditions as these handicap the most efficient of men.

Engines should also be kept clean, for many a failure from fractured frames, fractured rods, loose eccentrics, etc., would have been avoided had these defects not been covered up with dirt and grease; and right here I wish to say that we can learn not a little from our friends in Europe. Their engine houses are kept clean, light and airy, and their locomotives are kept clean, and the railway companies consider it money well spent. Defects can be more readily seen, men will do more work, and it has a good moral effect on the men in general. The cleanliness of the power also acts as a good advertisement, as the public takes a delight in looking at and commenting on a good clean-looking locomotive.

The efficiency of the roundhouse is not based entirely on the quick despatching of locomotives, but also on the number of miles each locomotive will make without a failure being recorded against it, and the best method of promoting this kind of efficiency is to do good work in the roundhouse.

Every engine house should have its own equipment of modern tools, entirely separate and distinct from the back shop—the two should be segregated. In fact, it would be far better if they were far removed from each other, as then the roundhouse would not be depending upon the back shop for support. If any branch of railway service needs and should have good tools it is the roundhouse. Engine houses at division points should have an engine lathe, a small lathe for brass work, a drill press, a small planer and an emery wheel, and such other tools as will tend to facilitate the work, the number and size to be governed by the size of the house; also a sufficient number of men to insure prompt service. To promote roundhouse efficiency considerable attention should be paid to shop kinks—taking advantage of every device that will facilitate operations and decrease the cost, such as air hoists, small portable cranes, benches, etc.

The next essential thing in the promotion of efficiency is a good organization, without which it is useless to look for efficiency. The work, as far as practicable, should be specialized, as more will be accomplished by this method. The men become more proficient along their different lines and will use their ingenuity in devising little devices and kinks to help themselves along. If thought advisable the men could be changed around at intervals, which might stimulate their interest in the work. Another aid to roundhouse efficiency is a hot-water plant for washing out purposes and refilling boilers after washing out, thus avoiding undue strains and stresses; much time is also saved, especially in cases of emergency. One or more good drop pits at suitable places in the house should be a part of the equipment for removing engine truck wheels, tender wheels, and, if necessary, driving wheels.

The coal chutes, water tanks and sand towers should be in close proximity to each other, and should be so arranged that in the despatching of engines there will be no reverse movements. It is essential to roundhouse efficiency that a sufficient number of hostlers be on hand, so that immediately an engine arrives it can be handled without delay and delivered to the house, when the foreman having his work slips arranged can line up his men and get an early start on the needed repairs, and by keeping in constant touch with the transportation department can advise them when they can reasonably expect certain power; they in turn can reciprocate by furnishing the roundhouse foreman advance information relative to breakdowns, etc., thus giving him an opportunity to make the necessary preparations. The inspectors should be alert and on the job at once, losing no time in making their inspections before anyone else has had a chance to do anything, as fractures will be more readily found.

A fair supply of staple articles should be kept in stock so that no delays may ensue while parts are sent for from headquarters. I believe that a long step in the direction of efficiency would be taken if all work was inspected after its completion, for then the careless man would be detected and failures from carelessness would be eliminated.

Discussion.—This paper received a most thorough discussion, the more important parts of which are reproduced herewith.

W. F. Fowler (Nor. Pac.):—As applied to roundhouses the term efficiency is a broad one and must be viewed from many sides; the principal objects to be sought after are, maintaining power at a reasonable cost with minimum delays from failures on the road and maximum time available for service on the road. Low costs represent efficiency only when accompanied with high mileage per engine failure and a high average mileage per engine per month, and high mileage between general repairs. To accomplish these results requires a high degree of organization. A modern locomotive represents an investment of from \$15,000 to \$20,000, and its earning capacity is variously estimated at from \$25 to \$100 per day. If by judicious management the roundhouse organization can keep the engines in service twenty-nine days in every thirty, instead of twenty-five, a service has been effected which will result in handling the same business with less engines. In other words, the earning capacity of each engine has been increased and this in turn would justify a slightly greater expenditure to accomplish these results.

To accomplish satisfactory results the first and most essential factor is a sound and flexible organization and the most important thing in securing it is proper and adequate supervision. The roundhouse foreman should have a staff of assistants such as to prevent his being over-burdened by detail work. On the other hand too much supervision results in loss on account of increased cost and the tendency of men to overlap their authority when their time is not fully occupied.

The roundhouse foreman must be supreme in his field and to him should go all criticisms and suggestions, he in turn to issue them to his different assistants, or to the men direct, as the case may be. The practice of master mechanics or higher officers interfering with the roundhouse foreman's authority is

an exceedingly pernicious one and leads to a weakening of the foreman's authority, and sooner or later is bound to create a certain feeling of disrespect of his position which will react on the whole organization and will result in a divided responsibility that is one of the worst enemies of a good organization.

The secret of a perfect organization in a roundhouse, as well as in any other department, is to have all branches of the work so covered that some one man is responsible for every different job. When this feeling of responsibility has been clearly defined and each man has been made to understand exactly what his duties are the first steps for a good organization have been laid.

The roundhouse foreman must keep in close touch with the transportation department and be fully conversant with the requirements in the way of power and the approximate time it will be required for service. It is equally as important to know when each engine is expected to arrive and to know promptly on arrival the character and amount of work which will be required to place it in proper condition to go out again. The assistant foremen in charge of the workmen must keep in close touch with the condition of the power and by frequent consultations with their chief plan their work so that proper repairs can be made in the most convenient manner. Too much time is lost in many places by failure to plan ahead. An engine which requires some heavy machine work should be placed as near the shop as possible, while an engine which possibly requires only a visit from the wipers and inspectors can better be placed in the stalls farthest from the working center.

Our modern boiler-washing plants have shown what close attention to details can produce in the way of efficiency, and they are a further daily evidence of the truth that a saving properly effected in one department usually results in a saving in others closely allied to it, for we have found that with reduced cost of doing the work has also come increased time the engines are available for work, increased life of staybolts and flues and a great reduction in the possibilities for failures from boiler troubles.

Under the head of specialization should come not only specialization in assignment of work to various men, but also specialization in the methods and manner of doing various jobs. Proper incentives should be offered to each and every one to make suggestions in the line of improvements, and not only should all such suggestions receive due consideration but also full credit should be given to the originator of the idea or suggestion. Too much cannot be said about this important factor in building up a strong organization and getting the very best results. The gang boss, assistant foreman, general foreman, or master mechanic, who is not broad enough to give his men credit for any idea or suggestion made by them cannot hope or expect to long hold the respect of his men. As a rule the facilities and tools available at an ordinary terminal are not always the best and if an organization can be developed where each man is planning and scheming to overcome inherent weaknesses in equipment or facilities by simple effective means a vast stride in the direction of higher efficiency will result.

The salaries paid foremen and assistant foremen should be enough greater than those of their subordinates to make the position one to be sought after and enable the road to secure the highest grade of service. You cannot expect to get the best possible results from a roundhouse foreman when some of the skilled workmen, who only put in nine hours regular service each day with practically no responsibility, get nearly as much, if not more, pay than he does. If the foreman is not worth more money as an organizer and supervisor of work, then he should be changed and a competent man put in his place.

Another important matter bearing on roundhouse efficiency is the facilities provided for the personal comfort of the men. Proper methods of ventilation, sewage system, heating and lighting are of the utmost importance. It is hard even when

paying extra high salaries to secure and keep good men when working conditions are unpleasant. Neatness is absolutely necessary and the man who will not be neat and clean, orderly and careful as regards his surroundings will not exercise these same qualities to any marked degree in his work.

W. W. Scott (Pere Marquette):—As soon as the engines are brought in the inspector goes over them and makes out a report, which is coupled with the report of the enginemen. The clerk copies it and places it on a clip which is located on a post at each pit. When the work is completed it is signed by the workman who does it and the report is turned in and kept on file for thirty days. In case of an accident we can refer to our files and see just what the condition of the engine was when it arrived at the terminal. It also checks up engine failures. We have also installed a large board, known as the O. K. board, and when an engine arrives it is the duty of the hostler to place its number, the time of arrival and the pit number on the board. There are spaces opposite the engine numbers for each class of work and as the work is completed an O. K. mark is placed in the proper place. If the roundhouse foreman wants to know the status of any particular engine he simply refers to the board which shows it at a glance. We make it a practice in case any defect is found in the work that might lead to an engine failure, to allow the inspector a little bonus of an hour's time, or something of that kind, which is usually left to the discretion of the roundhouse foreman.

E. F. Fay (Ill. Cent.):—A roundhouse organization of the utmost flexibility, reporting to one head is absolutely essential. A matter not touched on in the report, but which should receive consideration, is the delays between the time an engine arrives at the terminal and the time it is housed. At the places where I have worked, almost without exception the principal delays have been between the storage track and the engine house. A first-class roundhouse foreman, and a sufficient number of assistants reporting directly to him to cover all the branches of the work, is a requisite. I believe there should be one foreman who should exercise jurisdiction over the coal chutes, cinder pit and the watering and sanding of the engines and to also have charge of the hostlers.

We find particularly in the western country that there is ordinarily insufficient roundhouse supervision to carry on the work as it should be carried on. A good organization for a large roundhouse handling from 75 to 80 engines is a foreman, an assistant foreman in charge of running repairs, and an assistant in charge of the dead work. The work in the roundhouse should be specialized, and that on passenger engines may be done very advantageously by one or two, or possibly more, machinists being assigned directly to it, and being held responsible for it.

There is one thing I have never seen satisfactorily worked out. We all have traveling engineers who are supposed to ride a certain number of engines daily and make reports as to their condition; we depend on them more than we do the regular enginemen to keep us in touch with locomotive conditions. The engineers make out their work reports, frequently omitting some of the essentials that should be taken care of, but the traveling engineer's report invariably covers these matters. If we have not time to take care of all the work reported by the traveling engineer on his incoming trip, it is arranged so that the work will be taken care of the next time the engine comes in and in such cases it may be forgotten until we have a failure on the road. That is one of the things that I have never seen successfully worked out, although I understand they have a very good system on the Lake Shore.

In most roundhouses we have what is known as a daily transfer between the day roundhouse foreman and the night man, and vice versa. The master mechanic or the general foreman, or whoever may be in charge at that point, should be conversant with the details of these transfers, and a copy of this turn-over should be sent to him daily. This could be arranged

by having the roundhouse foreman use a loose sheet with a carbon on the page of the transfer book, sending the original to the master mechanic and leaving the carbon copy on the book for the use of the on-coming foreman. This transfer should cover anything unusual which may have occurred and also any failures of which the foreman might be cognizant. Enginemen should be instructed to detail any unusual delays that they have encountered on the road, due either to engine or cars, though not considered engine failures; this will keep the roundhouse foreman posted as to operating conditions. This roundhouse turnover should be in the nature of a log book and all of the extraordinary happenings should appear and should be made a matter of permanent record.

Coaling engines with a coaling crane has been adversely criticised. There are places where coaling cranes have been used advantageously, and one of the largest railway systems in this country uses it exclusively for coaling engines, and coal is being handled at a cost of 2½ cents per ton. There are very few mechanical devices that are handling coal at less than 2 cents a ton, and considering the amount of money invested, they are not making any showing over the crane at that figure. The following plan is used on the Southern Pacific: A trestle is provided that will hold ten or twelve, or as many cars as are considered necessary. The coal is dumped from cars on this trestle. A section man in one hour and 30 minutes will dump 16 cars. The coaling crane is on the trestle and coals engines directly from the receiving dock below; it also loads cars for other places, cleans the cinder pit which is parallel and adjacent to the coaling dock, and fills the night coal bunkers, which are arranged on one side with a sufficient capacity for night requirements. The crane operator is paid \$100 a month, and he has a helper at about \$65. One hour a day of the section man's time is charged to dumping the cars. There is seldom a delay for coal because of a crane being out of commission, as ordinarily a second crane is provided. The engine makes one stop for coaling, sanding, watering and ash pan cleaning.

It is an excellent suggestion to have the engine board show all the various items of work on each engine. That ought to be worked out everywhere so the roundhouse foreman or any one else, would know the condition of the power by glancing at the board.

The bonus, mentioned by Mr. Scott, is a new idea to me except for covering rod fractures. I agree with Mr. Hall that the roundhouse work should be segregated from that of the back shop. Make the roundhouse foreman responsible for the roundhouse and give him the finished material to put up and let him take care of it. A great many of us who are operating repair shops and roundhouses that are close together realize how dependent the roundhouse foreman becomes on the back shop, and how when anything is missing he feels that he cannot wait a few minutes longer until repairs can be made, but must rob the back shop. It tends to reduce the efficiency of the back shop and decrease its output.

In a great many places it is the practice to have a clerk in the roundhouse office, frequently termed an engine despatcher; he answers the telephone and looks after the roundhouse reports and the reports incident to periodical inspection, roundhouse correspondence, keeps the boiler washing record, relieves the roundhouse foreman of a great deal of clerical work, and gives him more time to devote to the supervision of roundhouse repairs. I believe we would find almost invariably that the expense of such a clerk in the roundhouse is covered by the increased efficiency of the roundhouse organization. It should not be necessary for a roundhouse foreman to sit at his desk to exceed thirty minutes a day.

Our enginemen furnish a work report. We have an outside inspector whose duty it is to replace missing nuts and cotters and to adjust the rod wedges; also to report any defects he may

discover. We also have an inside inspector who goes under the engine, and a cab inspector who looks after the cab inspection and the condition of the bell ringer. We have a federal safety appliance inspector who looks after the condition of the grab-irons, height of couplers and brake cylinder piston travel.

G. H. Logan (C. & N. W.):—We have one engine inspector who inspects* the machinery and details during the day and one at night. The staybolt inspection is made by a boiler-maker who has been assigned as an inspector to comply with the requirements of the federal boiler inspection law. He must be present at all hydrostatic tests, make subsequent internal inspection, set the pops on all engines out of the shop and make the quarterly gage and pop tests on such engines as come in on which this inspection is due. At night this work is taken care of by a boilermaker and a machinist, who jointly fill out boiler form No. 1 and the quarterly cab card. As far as possible all tests and inspections are made during the day by the regular inspector.

L. A. North (Ill. Cen.):—Engines should be kept clean. It renders a fracture or crack, or anything that may cause an engine failure, more noticeable, and has a tendency to create a much more favorable impression on the traveling public. I think a wiping gang is just as important to good roundhouse management as good machinists.

E. F. Fay:—We have a special man who adjusts all the wedges and sees that all the eccentrics and set screws are in place and properly tightened.

R. B. Van Wormer (A. C. L.):—In my opinion it is very necessary to maintain a stock of repair parts in the roundhouse that can be utilized on engines coming in with worn parts requiring repairs. If the parts removed are then repaired they can be returned to the stock and the stock maintained at all times, thus facilitating the more rapid handling of the locomotives in the engine house. The engine on its way to the turntable should have the ask pan cleaned and cool water and sand supplied as quickly as possible in order that as much time as possible may be devoted to the repair work. It takes about seven minutes from the time the engine reaches the clinker pit until it is on the center of the turntable at Wayercross. One man has charge of the coaling of engines, as well as the unloading of the coal, the clinker pit and the sanding of the engines, although he is not in direct charge of the hostler. Speaking about the co-operation between the back shop and the roundhouse foreman, I think it will be found that if the engine house will maintain a supply of repair parts and keep a full line of everything that it is believed will be required from time to time, it will be practically independent of the back shop.

T. J. Mullen (L. E. & W.):—We use the same system of reporting work that the Lake Shore does. When an engine arrives at the terminal the engineer comes into the roundhouse after inspection of the engine and makes a report to the clerk who copies it in a work report book. He then copies each item on a separate slip that shows which clerk handled the report, the engineer's name, the engine number, the date and the work necessary to be done. We have a number of little file boxes, one for the machinist foreman, one for the boiler foreman, one for the tin and pipe man, one marked "unfinished work"; also one for the back shop so that in case an engine goes to the back shop the slips in it may be handed to the erecting shop foreman. When each item of work has been completed the man who handles it O. K.'s the slip. If the foreman in looking over the slips before he distributes them sees something that he thinks is unnecessary, he inspects it himself. If he decides it is not necessary he marks on the back of the slip "O. K. for service," and places it in the unfinished box. Sometime later he catches it when he has more time to do the work. In case the men cannot finish the work that has been assigned to them before they stop work for the day they

hand the slip back to the day foreman and they are put in the unfinished box, and the night foreman distributes them just as if the engine came in at that time. After the work has been completed the slips are filed in a case under the proper engine number and are kept there for 30 days, after which the clerk ties them up in a bundle and puts the engine number on the outside. In case the engine should have a failure, all the master mechanic or traveling engineer, or roundhouse foreman has to do is to refer to the case and see who worked last on the part that failed. The master mechanic and his clerk come down to the office of the roundhouse about once a week and take the slips out of the case and check them up with the report book to see whether any of them are missing. The inspector makes his report in the same way as the engineer does, or, if the master mechanic should see any defect, he reports it, and it is put on the book and a slip made out with his name on the back showing who reported the work. The best feature of the system is that the master mechanic or clerk checking over the slips once a week has a strong tendency to make everybody turn in his slip. In case a slip is not turned in, we hold the roundhouse foreman responsible for it.

Thos. Zinken (C. H. & D.):—I am advocating that the roundhouse foreman should have off at least two Sundays a month. It is an exceptionally hard task to be a roundhouse foreman now-a-days because of the federal requirements, and he is deserving of this consideration.

H. G. Dimmitt (C. M. & St. P.):—We do not work independent of the back shop, but have certain machines in that shop that do nothing but roundhouse work; it is up to the roundhouse foreman to say what work he wants done on these machines, and if necessary to advise the machine shop foreman that he needs more machines. The assistant roundhouse foreman has direct supervision over the boiler washers. We still hold the enginemen for a thorough inspection of their own engines. They have, however, been relieved of the inspection of passenger engines, except running inspection. On the arrival of the engine at the terminal it is inspected by one inspector who has to do with the safety appliances, another on machinery, and a third, the head boilermaker, who looks after the draft appliances, ash pans and the condition of the boiler. The interior of the boiler is inspected by the head boiler washer. The reports made out by the engineer, and also by the inspector are filed in the roundhouse office for 30 days, and after that they are filed in the master mechanic's office.

W. Smith (C. & N. W.):—One important thing that we have got to consider is terminal delays. They are very expensive and amount to hundreds of dollars at large terminals; it is a matter which can be sifted down the same as engine failures, or anything else. There is always a reason, and when a failure or a terminal delay occurs it should be investigated thoroughly. As an example, most of our engines are equipped with air operated fire doors, and we have had a few failures from the broken air pipe. It was found that it was caused by the engine washers when they inserted the nozzle of the hose in the back head, and after several delays of this kind we inaugurated a system of having these pipes inspected, and delays from that source have been done away with. Another thing that should be carefully checked is the matter of failures and the placing of responsibility. Most every engine failure can be traced to negligence on the part of somebody.

Portable tool boxes for the different wrenches and tools are great time savers and promote the efficiency of the roundhouse greatly. Another point is having the material on hand that is to be used in making repairs, such as gage cocks, lost motion shims for drawbars, tire shims, etc. Repairs can thus be made without any delay. Another thing is the monthly inspections that should be made in the roundhouse.

Some of the roads go very extensively into this. The Pennsylvania and the Lake Shore are the foremost; on our road we examine cylinder packing monthly on freight engines, and on passenger engines twice a month. On superheater engines this is especially important, and I think a great many failures are eliminated by this precaution. I understand some roads anneal drawbars periodically. We examine the drawbars and drawbar pins monthly, but do not anneal them. We have the built-up piston heads and it is essential that they be inspected regularly so that failures may be eliminated as far as possible.

C. M. Newman (A. C. L.):—We have a book report of the arrival of all engines, showing the time of the engine's arrival, the time it is ready for service, and also a record of the time that each engine is coaled, the time that the crew is called, and the time that the crew reports. This helps in determining the dead time of the engines and also any overtime that might develop from some failure of the engine after it has been furnished to the transportation department. We also keep a log book. Anything out of the ordinary, or any changes are noted in it. The engineer's work report is deposited in the cab of the engine and is removed and taken to the roundhouse foreman's office and each item is copied on a separate slip. The inspector also makes report of any work he finds. These slips are turned over to the roundhouse foreman who distributes them among the men he wishes to do the work. After the repairs have been completed the slips are signed by the men who do the work and turned back to the assistant foreman, and they are held as records.

J. W. Anderson (C. & N. W.):—We ran 36 days without an engine failure on our division. We were all proud of it, and it was due not only to the organization, but to every man in the shop. Everybody watched the failure sheet, which is posted every morning, closely and did everything possible to prevent failure. Our engine inspector does not do any work on the engines. We found if we depended on him to do such work the inspection was slighted. We make monthly cylinder packing inspection on freight engines, and on passenger twice a month. We have not had any failures on account of cylinder packing or valve rings for I think five months, since we inaugurated the system. I have always felt that there were engine failures and man failures, and we find that the man failures exceed the engine failures.

We use blow-off cocks to a great extent on account of bad water. There is one on each side at the corner of the mud-ring, and the engineers will open them as high as 200 times in going 150 miles, just enough to blow out the small amount of mud that collects. It is a wonderful improvement and helps out with the boiler washing. After the water is let out one of us generally happens around to see the amount of soft mud that has collected, and if there is much of it we report it to the master mechanic and he gets after the engineer and fireman to see why they did not properly blow it out.

The air pumps are changed on passenger power every six months regardless of whether there is anything reported on them or not. Both pumps are taken to the repair department and overhauled.

MR. GOSSETT'S ADDRESS.

W. J. Tollerton, mechanical superintendent of the Rock Island Lines, was to have made an address at the Thursday afternoon session, but was unexpectedly detained and C. E. Gossett, general master mechanic of the Minneapolis & St. Louis, was asked to take his place. Among other things he said:

No doubt a great many of you think that you are underpaid; that you do not get money enough for what you really do. That is perhaps true in many cases, but the only way to get more money is to succeed at what you are doing and

demand then from your superiors an increased responsibility, which brings accordingly increased compensation.

We are today confronted with a labor situation that this country never knew before. What are we going to do with it? Labor conditions vary with the locality. Therefore it is up to each general foreman to cope with the situation at his particular point. There is no ironclad rule to be laid down that will govern the handling of labor today. We have got to meet it as it exists in the various localities.

We have monthly mechanical meetings. My office door is open once a month to the master mechanics, general foremen, roundhouse foremen, road foremen, shop foremen and any one else that may care to be present, and it is surprising to see how these meetings are growing. Engineers, firemen, fire knockers, sweepers, everybody, is welcome to them. Twice a week our master mechanics require their foremen to meet them at the storekeeper's office. They go through the entire store stock and analyze all of the material on hand.

I would like also to call your attention to the apprentice situation. This is really more serious to us, when we take it home, than the labor situation. What are we going to do in a few more years for machinists? In employing apprentices we should absolutely insist on selecting our material from our home shop town. Get an engineer's boy, a machinist's boy, a foreman's boy, somebody that has got something back of him so that he can live in comfortable circumstances while he is learning the machinist's trade. On top of that, he should have a mother's care. A boy between the ages of sixteen and nineteen is not able to go out and cope with this world as it is today. If they do get out and get away from home they get before the machinists' organization. They are told how little to do, how little a machine will get out and still keep the general foreman and the shop foreman satisfied. They are not told how to get the maximum output of the machine. Therefore we should select our apprentices from material we know something about, and not only give them a proper training, but keep them in their home environment and under their mother's care.

SHOP SPECIALIZATION.

W. T. Gale, demonstrator, Chicago & North Western, read a paper on this subject, of which the following is an abstract:

I would refer to one of the largest railway repair shops in the western country, located in Chicago. It was erected in 1873, and consequently cannot be considered up to date along structural lines. It has twenty-four pits, one being equipped with a stationary hoisting engine for wheeling engines. There is no modern overhead traveling crane for the conveyance of heavy material. The erecting shop is of the transverse type with the machine shop on the opposite side. In 1906, with the addition of a few necessary tools to complete the equipment, and with an additional wing added to the machine side of the shop, the reorganization was begun. The plan was to complete one section, or gang, at a time in order not to delay or impede the progress of the regular output of the shop. The rod gang was the first to be arranged. It was located in the center at one side of the shop, and grouped around and in front of it, at convenient positions, were the necessary machines for the work, such as drill presses, slotting and planing machines, boring mills, shapers, lathes, millers, hydraulic press, bolt machines, etc. Wall bracketed overhead swinging air lifts were erected over the rod benches at regular intervals between each operator's station. A traveling roller bearing circular overhead lift was erected between the rod horse benches and the machines, with which the rods could be passed from bench to bench, from one end of the gang to the other in a very few moments, or, when necessary, fed to the various machines, as occasion required.

This work having been rearranged satisfactorily, the driving box and cellar work was taken up and treated in a somewhat

similar manner. Drill presses, planers, shapers, lathes, boring mills, hydraulic press, babbitting furnace, jigs, and other necessary machines and appliances, were all grouped together, forming one complete homogeneous system for handling the work correctly and expeditiously.

The same arrangement was made in connection with the link motion work, pistons and piston rods, valves, etc. Special men were selected according to their various qualifications and placed on machines doing a special class of work, such as planing or milling main and side rods, shaping, turning and boring rod brasses; planing, boring and slotting driving boxes; turning, fitting, grinding, milling and fitting up pistons and piston rods, etc. Drill presses were placed in suitable positions opposite to and near erecting shop gangs that had work of this kind; gang lathes were run by apprentices; Gisholt and bolt machines were placed adjacent to erecting gangs. All heavy machinery, such as wheel lathes, hydraulic press, quartering machines, large planers, slotters, radial drill press, etc., were alined near the center of the shop.

On the erecting side of the shop was placed a series of overhead traveling hand-power air hoists parallel to the length of the shop and in front of the engines. Over the rear end of the engines and also parallel to the length of the shop was placed a series of overhead traveling hand-power circular air hoists, and these hoists were used in lifting front ends, driving rods, pistons, driving boxes, etc. Special men were then selected, as on the machine side, and placed on special work; they were given special tools, such as air hammers, drills, taps, valve-setting motors and cylinder boring tools, etc., and were considered as specialists for work in all erecting shop gangs. They were subject to the call of the gang foremen, as required, and were directly under the orders of the erecting shop foreman. Their work consisted in taking care of all operations that heavy and general repairs call for in the locomotive repair shop. About sixty men were placed in this way, doing special work assigned to them, and that kind only.

As a still further improvement, and in order to facilitate the repair shop work as fast as it consistently could be done, all shop orders or requisition work that had formerly been done in the back shop, was transferred to another shop, which had been prepared for it. Here the same order was maintained pertaining to the specialization of men, work, and tools. This department, being supplied with a large number of special tools, jigs, etc., it became necessary to take special care of them, which was done in the following manner: A series of special cupboards were arranged with shelves placed in them. The cupboards and shelves were lettered and numbered; wooden boards 14 in. x 2 in. thick with recesses cut in them for holding box tools, special drills, forming tools, reamers, taps, dies, etc., were placed in the cupboards in numerical order. The various machines, being numbered and lettered to correspond to the boards, a chart was arranged with the letters and numbers, which showed at a glance the location and kind of tools wanted for the particular kind of work and machine. This saved many unnecessary steps and considerable time in getting tools and starting on the work.

This same general plan of specializing was installed in all the shops under the motive power department, and it has been generally conceded by representative motive power executives who have visited and studied the system at these shops, to be an exceedingly efficient and economical method of facilitating the output. This plan of specialization having been in operation for several years, seems to justify its continuance, and has in many cases been adopted by other roads with considerable success.

There is small demand for the jack-of-all-trades. It is the expert who is accomplishing the big things, and it is the expert who is getting the reward for his knowledge and ability. It is the specialist who gets special results.

Discussion.—The subject was discussed at some length and the important points brought out are as follows:

L. A. North (Ill. Cen.):—We are interested in manufacturing material to the best advantage. For instance, suppose a planer will take two complete sets of shoes and wedges. If it is filled up and both heads set to work they can be much more economically handled than if only the one set, which might be needed at the time, was furnished. This is only one of a number of items which might be treated in the same way.

G. H. Logan (C. & N. W.):—I think we are all in accord with Mr. Gale's idea of shop specialization—the concentration or assembling of certain parts of the engines to be repaired in one particular place or in collective groups and having special men to take care of these special parts. We know that it goes for an increased output, but I think specialization should be coupled with a time schedule for repairing the locomotives. All engines passing through the shops for repairs should have a specified time allotted to them for the different classes of repairs. The workmen in the various departments should have a knowledge of the date that every engine is to leave the shop. In this way the work will move along in proper rotation. It also eliminates a good deal of controversy that is apt to arise between the different gang bosses or foremen of departments. For instance, if I had an engine that I wanted some particular part for and the work was up to where I needed it, naturally I would get after the machine shop foreman if the work were in his department; but if some other gang foreman had an engine which left the shop a day before my engine and he was at work on the parts for that particular engine, I really would have no kick coming. Of course, to arrive at the proper amount of time to allot the respective classes of repairs is quite a proposition. If it takes you 200 hours on a general repair engine, establish a 200-hour schedule and see how nicely it works out. I think it would be only a question of time before the time would be cut down 50 hours or better. I can remember working in the gang for the North Western when we used to have 200 hours for a general repair engine. I believe the time now is cut down to 113 hours and things move along very smoothly.

W. Smith (C. & N. W.):—I have known of remarkable results having been obtained by rearranging machines with regard to trucking and light. The question of light is a very important matter to be considered, and the output of many back-number shops could be greatly increased by such rearrangements.

C. L. Dickert (Cen. of Ga.):—Specializing work is carried as far as practicable at our shops. In my opinion, this means of handling work is the most effective, as the men become more efficient in one class of work than you could possibly expect on general work. They know, when an engine is shopped, that they will be held responsible for the work regularly assigned to them, and they will anticipate their wants and get up such stock as they think they will need in order to keep ahead. They have all the tools necessary to do the work assigned to them, and keep their tools in good condition. They also pride themselves in getting up handy and time-saving kinks that they would not think of otherwise. I find the special men will exert themselves to have their work finished when needed, so as not to be behind. If their work is not promptly delivered to them when an engine is stripped they make a kick. They soon become familiar with the standards and working prints of their line of work, and when information is wanted and questions asked about it are in position to furnish it. Where the work is specialized it gives the foreman more time to look after things in a general way and not have to follow up every little detail.

As a general rule, the men are not in favor of specializing the work, but after they are on the job they seem to take more interest than they do on roustabout work. I have tried handling the work both ways and find we accomplish 25 per cent. more by specializing. In the erecting shop we have special men on squaring engines; special men on valve setting; one man on guides, valve seats, steam chests, and cylinders; two on cab work, including cocks, throttle levers, reverse levers, whistles, safety valves and water glasses. Another looks after steam and exhaust pipes, throttle boxes, dry pipes and front ends; one on cylinder cocks and rigging, bells, tank hose and fittings. In the machine shop we have a man who does the fitting up of driving boxes; one man who attends to valves, yokes, pistons, rockers and arms. We have a special rod gang, link gang, gang foreman of turret group, a brass group and a wheel group. By having a head to each class of work you have only one man to deal with directly, where if one man was on the job today and another man tomorrow it would be a hard matter to keep up with the work. When an engine is stripped the distributing gang knows just where the parts belong and delivers them to their respective departments, and the same gang is used to place the work at the engines when finished.

The first of each week the erecting foreman makes out a list of engines, giving a copy to all department heads and special men, showing which engines are to be given preference and placing them on the list in the order in which they are to be turned out. If any department, or special man, sees where he cannot finish by the time set he notifies the erecting foreman, who investigates the trouble.

R. V. Van Wormer (A. C. L.):—Within the last two years we materially increased the output, principally by specializing the work; in some cases we moved machines to new locations better suited to the conditions and the work. Most of our tools are independent motor-driven, with a few small group drives. We also standardize different parts of our locomotives and carry a fair supply of these parts ready to replace worn parts as the engines come in for repairs.

W. G. Reyer (N. C. & St. L.):—We do our tempering in the toolroom with a gas furnace, getting better results than when it was done by the blacksmith.

W. T. Gale:—We have the tools grouped for driving-box work. The boxes are brought over from the vat after they are cleaned and are placed in the gang, where the brasses are taken out and the liner stripped. The drill presses and the planer and shaper for the brasses are all adjacent to each other. We have a series of overhead cranes for passing from one machine to the other.

THE RECLAIMING OF SCRAP.

Three papers were presented on this subject by different members of the association; abstracts of these follow:

Mr. Hall's Paper.—William Hall, general machine shop foreman of the Chicago and North Western at Escanaba, Mich., said: That there is a great deal of money to be made or saved from the scrap piles is without question. In the first place, a practical man who is familiar with the different parts of both locomotives and cars should be in charge of the scrap bins, a man capable of using good judgment as to what should or should not be consigned to the scrap pile, and who will pay strict attention to the proper sorting and classification of the scrap. To reduce the cost of handling this class of material to a minimum it must be handled in a scientific manner and in such quantities as would justify the cost of a reclaiming plant. Such plants are now in operation on a number of roads.

The first and great mistake is in allowing good, usable material to get into the scrap, for if it can be taken from the scrap pile and made as good as new it should have been used up in the first place. If, from any cause whatever, through a change in

class of power, etc., good, usable material should accumulate, it should be returned to headquarters as such and not as scrap, thereby saving the cost of extra handling. A reclaiming plant should be established at all division headquarters with a sufficient force to handle it economically, and would prove to be a paying investment; the plant to be in proportion to the size of the division and the amount of business done, thus avoiding shipping to headquarters.

The Chicago and North Western has gone into the reclaiming of material on a large scale and in various ways. At the Chicago shops we have a reclaiming shed 24 ft. x 176 ft, which contains the following tools: One steam hammer, one bulldozer, one double shear, one large single shear, three machines for removing nuts from bolts, one 25-lb. spring hammer and one Bradley hammer. This shed was built from lumber reclaimed from old torn-down cars, and the tools were removed from the blacksmith shop to make room for more modern ones. All the reclaiming is not done in this shed, however, as a large quantity is handled in the blacksmith shop and the machine shop. In the reclaiming shed all usable bar iron is straightened and cut up for bolts, etc., and the scrap is sent to the blacksmith shop, cut up, heated in a large furnace and then hammered into slabs, and they in turn are converted into axles.

At the Winona, Minn., shops we have a reclaiming shed 30 ft. x 100 ft., containing one small drill press, one triple head bolt cutter, one combined shears and punch, an emery wheel, one steam hammer, two ordinary blacksmith fires, one long fire, a screw press, vises and a straightening plate. This shed is manned by a foreman, two blacksmiths, two helpers, one bolt cutter, two laborers and a boy.

At several points on the system we have plants for the reclaiming of old waste taken from the journal boxes of both locomotives and cars. It is renovated and soaked in oil for a certain length of time and then allowed to drain, and is ready for use again; any waste having babbitt adhering is burned and the babbitt saved. Old car sills are used for flooring in round-houses and other buildings, or wherever they can be used to good advantage. Old driving box grease is melted in a steamer; the foreign substances settle to the bottom and the grease is then used for rod lubrication with good results. Old boiler lagging is ground up in a home-made machine and used over again. Valves, nuts, bolts, washers, spikes and old car springs are reclaimed. When old cars are torn down all good siding, lining and other parts are used for patching or for building purposes, and the scrap wood is used for firing up locomotives; the iron parts are used over again to a great extent. I think I am perfectly safe in saying that a saving of \$1,000 a month is made on material that was formerly burned up. During the year 1911 a saving of \$50,000 was made on old bolts alone, and the saving on nuts, track spikes and brake lever pins in the same period was in the neighborhood of \$26,000.

During the month of October, 1911, a total saving of \$12,881.36 was made; November, \$9,989.86; December, \$8,655.31; January, 1912, \$8,192.16. These figures represent the saving on reclaimed material for the entire system. Following are a few samples of reclaimed material at our Winona shops:

DECEMBER, 1911.

Amount reclaimed, \$1,282.57; scrap value, \$270.59; labor, \$286.92; total saving, \$725.06.

11,781 bolts recut—Labor \$57.14, scrap value \$64.27; reclaim value, \$280.51; total saving, \$159.10.

4,440 nuts retapped—Labor \$32.61, scrap value \$24.41; reclaim value, \$133.55; total saving, \$76.53.

Twelve car doors, \$24—Labor and material, \$16.79; total saving, \$7.21.

JANUARY, 1912.

Amount reclaimed, \$808.75; scrap value, \$203.63; labor, \$218.15; total saving, \$386.95.

7,730 bolts recut—Labor \$50.21; scrap value \$59; reclaim value, \$183.98; total saving, \$73.78.

3,128 nuts retapped—Labor \$17.32, scrap value \$22.70; reclaim value, \$60.46; total saving, \$20.44.

Ten car doors, \$20—Labor and material, \$12.87; saving, \$7.13.

FEBRUARY, 1912.

Amount reclaimed, \$1,500.33; scrap value, \$231.02; labor, \$262.74; total saving, \$1,006.57.

15,500 bolts recut—Labor \$71.16, scrap value \$86.71; reclaim value, \$438.10; total saving, \$280.23.

2,220 nuts retapped—Labor \$27.75, scrap value \$11.50; reclaim value, \$98.61; total saving, \$50.36.

Twelve car doors, \$24—Labor and material, \$18.73; saving, \$5.27.

The foundry is another source of revenue for reclaimed material. All scrap car brasses which have not had the babbitt worn through and are not defective are put into a melting out furnace and cleaned of all foreign substances; they are then tinned and rebabbitted. This saves the melting up of the scrap material, making of new shells and boring them. During the year 1911 a saving of about 50 per cent. was effected.

All cinders and clinkers, ashes and slag from coal and oil furnaces are cracked into small pieces and washed in a revolving washing machine. All sweepings from the foundry are also put through this washing machine. It is so arranged that the dirt is carried away by water and the brass remains in the washer. These washings are then used in making new car brasses. The babbitt melted out of scrap car brasses is poured into ingots and allowed to accumulate in lots of about 50 or 60 ingots; from these sample drillings are taken and analyzed. The proper metals are then added to bring this up to a standard metal and it is used instead of new material. A large saving is effected by this practice. Scrap copper from batteries, scrap copper wire and scrap headlight reflectors are all melted up and used in the manufacture of brass. Brass borings containing babbitt, steel or iron are run through a magnetic separator and used in the manufacture of brass also. Driving box brasses, rod brasses, etc., are melted and used again for making similar brasses. Locomotive bells are remelted and recast into bells. Scrap red and yellow brass, such as is found in injector parts, globe valves, etc., is melted and used in the manufacture of red and yellow brass.

Mr. Voges' Paper.—C. H. Voges, general foreman of the Big Four at Bellefontaine, Ohio, said: It would pay any company, where a large quantity of wrought iron scrap accumulates, to install a furnace and a large steam hammer to forge the material into billets so it can afterward be drawn out, as this is much cheaper than purchasing it from outside points. We have to keep a large amount of cast iron and brass castings on hand to protect ourselves and outside points. It would pay any large railway to install a foundry for both cast iron and brass. It would cut the amount of stock on hand to a minimum.

We have a large bin in which we keep all scrap brass. This is divided into six equal parts and has six separate covers. There is a long rod 1 in. in diameter that extends the full length of the bin and a bracket on each end holds it in place, while a padlock is placed on one end to hold it and keep it from being opened. Each part has a sign on the cover which designates what kind of scrap it contains. No. 1 contains phosphor bronze, which includes half-moon brasses, rod brasses and driving box side liners. No. 2 contains engine brass, which includes small parts such as gage cocks and stems, cylinder cocks, valves and engine truck brasses. No. 3 contains car brasses, No. 4 phosphor bronze turnings, No. 5 engine brass turnings and No. 6 sheet copper and pipes.

When an engine is being stripped for repairs the gang foreman in charge has all the worn and broken parts thrown in the center of the track at the rear of the engine and the shop laborer remove it to its proper place, the foreman giving the engine credit for the amount of scrap. All hexagon nuts are taken to the tapping machine and the operator retaps them and they are taken to the storeroom, where they are given out free of charge. Old piston rods, bolts of all sizes, old driving axles, car axles and crank pins are taken to the smith shop, where they are used to make different kinds of forgings. The tin and copper smith foreman, who is in charge of such material as globe valves, jackets, and copper and iron pipes with fittings, inspects

it when it is removed from an engine, and, if it is found to be worn or broken, he gives the engine credit and throws it in the scrap if it cannot be repaired.

The following is not considered as scrap material. All good wool waste that is removed from our engine truck cellars, trailer cellars and driving box cellars is sent to the oil room and the engine is given credit for the amount turned in. We pick up all old waste around the plant which has been charged out and take it to our waste cleaning plant, where it is boiled, and, after it is cleaned, it is given out free of charge. We use this on freight tenders and freight cars and also supply different points on the division. This waste boiling plant was started on October 10, 1911, and we can clean daily on the average about 160 lbs. We have cleaned up to the present time 1,900 lbs. of cotton waste and 1,800 lbs. of wool waste. The attendant is a 15¼-cent laborer, and he spends about 1½ hours a day in looking after the plant. The dirty waste which has lots of sand and grease in it we send to outside points to be used in firing up engines. We use our journal grease and rod grease in the same way that the wool waste is used.

Mr. Ogden's Paper.—T. H. Ogden, general foreman, Atchison, Topeka & Santa Fe, Las Vegas, N. M., also read a paper on reclaiming scrap, of which the following is an abstract:

A considerable amount of care must be exercised to prevent serviceable material from finding its way into the scrap bin at small terminal points. Our system is to not allow any serviceable material to get into the scrap bin. We have a place provided in the shops where any such material, which is picked up by roundhouse sweepers, or in the yard by the yard cleaners, may be put, and workmen are instructed to use this material as long as it lasts before calling on the storehouse for new material. We also have platforms near our shop entrances, where such engine material as is serviceable, or has been repaired, is placed, and workmen draw from this platform such material as they can use. Any material that can be repaired by blacksmiths, or otherwise, is also placed on this platform and is used if possible before drawing new material from the storehouse. A platform is also placed near the entrance of the blacksmith shop, where all pieces of iron of serviceable length are placed. This iron must be used before going to the iron rack at the storehouse, and the storehouse is the last resort.

Again, surplus material fit for service will accumulate at division points, and this should be turned back to the storehouse and credit furnished. In this case a working memorandum should be furnished covering reclaimed material and complete instructions for accounting for all such material which may be returned to stock. For instance, it may be required that all serviceable material may be returned to stock until needed. This action affords a record on the stock books for any available material for use and very often enables the redistribution of such material, avoiding the purchase of new parts.

When foremen order new material they should show on the requisition when serviceable parts are to be displaced, and this would permit a closer check of the material that usually finds its way into the scrap bins when it should be reclaimed at once when removed.

Discussion:—The discussion of this subject was alive and brought out many valuable points.

C. L. Dickert (Cen. of Ga.):—In the car department we have a platform with fifteen scrap bins, each labeled for the kind of scrap to be deposited therein; also an assorting platform, the whole spanned by a gantry crane. Everything in the way of scrap and second-hand material collected in the shop and repair yards is unloaded on the assorting platform, where a competent white man with a corps of negro laborers assort the good material. All freight car forgings that are not broken are placed on a platform near the smith shop to be straightened, reshaped and re-applied to cars undergoing repairs. The bolts are sorted in sizes; all of the

longer ones are straightened and re-threaded, the broken ones being cut off for shorter bolts. The nuts are collected and sent to the nut tapper to be retapped, and, with the re-threaded bolts and cut and cast washers, are placed in the sub-stores in the car department to be issued for repairs without charge. Our arch bar and coupler yoke scrap is straightened under an air machine, sheared and run through a splitting shear on our reclaiming rolls. It is then rolled into sizes to make ¾-in. and 1-in. draft bolts at a cost of about 85 cents per 100 lbs. This, of course, includes the value of the scrap with a liberal shop percentage for maintenance added to the labor. The reclaimed iron is made into bolts on shop orders issued from the store department and the store is billed with the labor cost of producing the bolts plus the cost of reclaiming the scrap. On the output of this machine alone the difference in the price of reclaimed iron and the price of merchant bar iron amounts to several thousand dollars annually. Our good bar stock, salvage from wrecked or burned cars, is not handled that way, but is cut into lengths for bolts, brake staffs and other purposes that we can utilize it for.

To handle scrap and second-hand material properly, equipment other than a crane and magnet are necessary. We have a small power hammer for straightening bolts and other material, and a furnace for heating brake beams that we straighten with the heads and fulcrums intact on a home-made machine. We have also a hydraulic shear that we use largely for shearing yokes from couplers, a rivet furnace, a pneumatic riveter for riveting yokes on couplers, and last, but not least, a heavy alligator shear.

In the machine and erecting departments we do not have as much material that can be reclaimed or utilized for other purposes as in car shop, yet a considerable saving can be effected in many ways. Our scrap crown and side rod brasses are broken into small pieces under a steam hammer and melted in an oil furnace. With this we cast our hub liners on wheels and driving boxes. The broken tap shanks, worn out reamers that cannot be annealed and reworked, and, in fact, any other carbon tool steel scrap that is large enough, is made into chisels, calking tools and center punches for machinists and boiler makers. In the last six months our tool dresser has made by actual count 318 hand chisels at odd times. Our smaller sizes of high speed steel for tool holders are made from scrap ends that break off of wheel, lathe and planer tools, and even the triangular pieces that are cut off the end of wheel lathe tools to give the proper clearance is saved and drawn out into 5-16-in. and ¾-in. square sizes.

The dope in cellars when engines are brought in for repairs is all saved and sent to oil house to be worked over, and is issued to freight crews to be used in the lubrication of freight car journals. All of the cotton waste used on passenger cars and in the wash yard for wiping cars is saved and sent to the roundhouse to be used again in cleaning the machinery of locomotives. It is then used for firing up purposes.

In the boiler shops, scrap wagon tops, fireboxes, etc., are utilized for frog plates. Our company requires a plate 1 in. x 24 in. x 84 in. under a No. 9½ frog. The cost of this plate is about \$10.35, plus freight charges. We get for our scrap boiler plate \$11 per gross ton. On this item we make a large saving, taking the cutting up and straightening into consideration. We also utilize scrap boiler plate for transfer plates, and the thin material is used largely for tail shims, fire hoes, eccentric stud keys, center and truck hanger pin keys.

Pieces of burst lengths of air hose are cut and spliced for use on work equipment, tanks, etc., with a considerable saving. For instance, a new air hose costs \$.86 and weighs 1¾ lbs. When sold for scrap we get \$4.75 per 100 lbs., which

would be about 57 old hose. These 57 hose will make, when cut and spliced, 28 good hose at an additional cost of \$.45 for labor and \$1.40 for nipples, clamps, etc. This \$1.85 added to the scrap value, \$4.75, makes \$6.60. Twenty-eight new air hose at \$.86 each would cost \$24.08.

The driving journal compound is taken from the cellars when the engines come in for repairs, or cakes have to be renewed, and is carried to the oil house. There it is pressed into strips and used as a liner beneath the regular cake that has been partially consumed, and this, while it does not result in a direct saving in dollars and cents to the company, reduces the journal grease consumption, and, as future contracts are based on past consumption, it really is a saving to the company. All old files used in the shop that are not worn too bad are recut with a blast of sand and steam. A 16-in. square B file costs \$.44, and when recut is restored to about 50 per cent. of its original efficiency.

J. S. Sheafe (Ill. Cen.):—This work on the Illinois Central comes under the test department. Our net saving for the month of June amounted to \$11,456. This is all a saving that previous to 1907 went to waste. We have a centrifugal oil machine for reclaiming of oil and waste; also a two-high, home-made reclaiming rolling mill. We reline journal bearings and splice air hose. The latter we use on camp cars, construction cars, locomotives and cabooses, and they give good service. We make brake shoe pins from $\frac{3}{4}$ in. square and rod iron. I think it is a good idea to hammer down axle iron for follower plates. We reclaim paint scums and steps by boiling down with raw oil in a large kettle and adding red oxide of iron to bring to the proper shade. We reinforce 1-beam brake beams, making them 25 per cent. stronger than the same beams when new. We are saving all car roofs and use them for patching outbuildings and in other ways.

G. N. Logan (C. & N. W.):—In connection with the reclaiming of scrap, such supervision is necessary as will insure usable material not finding its way into the scrap pile. As much credit is due to keeping usable material from the scrap pile as in reclaiming scrap material.

R. B. Van Wormer (A. C. L.):—We save the different scrap sheets of the proper thickness and make washers from them. Practically all the bolts that are used in the freight car repair yard at Waycross are obtained from old bolts that are cut off and threaded, and sometimes reheated.

W. W. Scott (Pere Marquette):—We furnish follower plates for the whole system, forging them from old axles. We are slabbing all our scrap material and making rods out of it; as much of the heavy stuff as we can use is made of the scrap material.

W. G. Reyer (N. C. & St. L.):—We take the grease from the driving-box cellars after they have been dropped. The top scum next to the perforated plate is cut off and placed in a box, which is removed to the oil house. We have a press there and have no trouble about dirt getting in the grease, as we are careful in handling it.

C. M. Newman (A. C. L.):—We cut old flues into three-foot lengths, heat them in an oil furnace and make washers of them on a washer punch. All our tank steel from 1-16 in. to $\frac{1}{4}$ in. is cut up and made into washers. We split the old arch bars and reduce them for various purposes.

L. A. Reece (C. R. I. & P.):—We used to throw all the grease away that came from the hot boxes. Now a man saves it until he gets 50 lbs. and then takes it to the press and forms it for the grease cup.

Thos. Zinken (C. H. & D.):—We take the dirty grease from the driving boxes, put it in a vat and boil it with steam heat. We cannot sufficiently remelt this over fire heat without burning it, but you can boil it with steam heat for days if necessary. Add a sufficient amount of water to soften the grease and, after softening, add tallow and potash and it will prove as good as new.

Wm. Hall:—In treating the old driving-box grease we use a large can with another can containing the grease inside of it and add a certain amount of water to the grease. A steam jet is then allowed to discharge in the outer can. The chips settle to the bottom and the grease rises to the top. We dump it into wood buckets after it is melted sufficiently and let it cool off, but before doing this we add a little tallow. We sent a sample to the chemist and he said it was practically the same as it was in the original state, and we now use it in our rod cups. Reclaiming asbestos lagging was another problem, and I want to give *Railway Shop Kinks* credit for my first investigation. There was a little machine described in it with a revolving brake wheel. I tried that but was not very successful, owing to the kind of asbestos. It was so hard that the wheel would not cut it very well. I then built a roll of iron, drilled holes into it and put steel pegs in them. We put a pulley on the end of the roll and run it from the line shaft. A box was built around the roll and the asbestos was fed into it by a screw, the teeth on the roll pulling the asbestos through grooves in the frame. It comes out as fine as flour. Then we mix it up with lime and water and apply it again.

THE RELATION OF TESTS TO SHOP EFFICIENCY.

J. S. Sheafe, engineer of tests of the Illinois Central, Chicago, presented a paper on this subject, of which the following is an abstract:

A man cannot do good work if he is constantly wrangling with his associates. Let us go a step further and assume a case where there is no ill feeling, but the minor departments of a railway feel sufficient unto themselves. Rather than the speedy communication possible, where co-operation exists, letters through the various red tape channels are necessary and time is lost. This means burdensome work and wasted stationery. The item of stationery on the Illinois Central amounts to \$641,000 a year. It is safe to assume that a large per cent. of this is used unnecessarily.

Let us do what is to be done and do it expeditiously. As an illustration: The steel used for eccentric set screws was giving trouble. It would not machine properly and was delaying the work. Inside of one hour after the gang foreman had called the attention of the general foreman to the difficulty, a request was on the way to the purchasing agent for samples of hex steel suitable for machining and case hardening. From the samples submitted tests were made resulting in the selection of a steel much superior to anything before used. While it is the business of the engineer of tests to locate trouble, it is safe to assume that without co-operation in this case only the merest chance would have brought it to his attention. Had this co-operation been lacking and the matter been reported through the regular channels, it is questionable how much time would have elapsed before the trouble was cleared. In the meantime the general foreman would have been working with a steel unsuited to his needs. The labor item in making these set screws was cut 50 per cent. This does not consider the wear and tear on the tools used in finishing. Whenever a material is wrong no time should be lost in correcting it. As a matter of information a splendid process of case hardening for set screws is hydrocarbonated bone black packed around the work in a box and heated over night, about 14 hours.

A general foreman has no time to write letters, or worry over matters of faulty material or construction. The output of his shop, in quantity and quality of work, is of vital importance to the railway's operation and means that he is helping the road vastly more by directing his subordinates and generally overseeing each bit of work, than he would be by carrying a worrying load that belongs on other shoulders. He should be relieved of this, and on many roads this is being realized by the management.

There is another phase of the possibilities of co-operation.

Assume that we are to try out some articles, such as drills, taps or tool steel. This work can all be done in the test department and with accurate results, but with wasted energy. The work done in testing should be saved. The general foreman and the engineer of tests, by working together, can make the test practically without cost.

Discussion.—The discussion on this paper related largely to the method of conducting practical tests in the shop, a representative of the test department working in conjunction with the shop foremen.

ELECTION OF OFFICERS.

F. C. Pickard, master mechanic of the Pere Marquette, Saginaw, Mich., was re-elected president by acclamation. The other officers who were elected are: First vice-president, W. W. Scott, shop superintendent, Pere Marquette, Saginaw, Mich.; second vice-president, T. F. Griffin, general foreman, Big-Four, Indianapolis, Ind.; third vice-president, L. A. North, general foreman, Illinois Central, Burnside shops, Chicago; fourth vice-president, W. Smith, roundhouse foreman, Chicago & North Western, Boone, Iowa; secretary-treasurer, William Hall, machine shop foreman, Chicago & North Western, Escanaba, Mich.; chairman of executive committee, W. T. Gale, demonstrator, Chicago & North Western, Chicago, Ill.; members of executive committee, C. L. Dickert, assistant master mechanic, Central of Georgia, Macon, Ga.; J. S. Sheafe, engineer of tests, Illinois Central, Chicago; W. G. Reyer, general foreman locomotive department, Nashville, Chattanooga & St. Louis, Nashville, Tenn.; and G. H. Logan, general foreman, Chicago & North Western, Missouri Valley, Iowa.

OTHER BUSINESS.

A unanimous rising vote of thanks and appreciation for his many years of faithful and efficient service was extended to the retiring secretary, Luther H. Bryan.

The convention adjourned Friday noon in order to take advantage of an invitation extended to the members by W. L. Park, vice-president and general manager of the Illinois Central, to visit the shops at Burnside. A special train was provided and a large party spent a couple of hours at the plant. The features that were most generally commented on were the arrangement of the equipment, as well as the uniformly neat and clean appearance of the shop; the large and workman-like force in spite of the fact that a strike is still supposed to be on; the work of the large press in the boiler shop, which was engaged in pressing out flue sheets; and the extensive equipment for reclaiming scrap material.

With characteristic vigor the president appointed the following committees to report next year:

Maintenance of Superheater Locomotives, P. C. Linck, general foreman, C. & E. I., Danville, Ill., chairman; J. W. Anderson, general foreman, C. & N. W., Boone, Ia.; T. J. Mullin, general foreman, L. E. & W., Lima, Ohio.

Engine House Efficiency, W. Smith, foreman, C. & N. W., Boone, Ia., chairman; Thos. Zinken, general foreman, C. H. & D., Indianapolis, Ind.; W. F. Fowler, engine house foreman, Nor. Pac., Billings, Mont., and H. G. Dimmitt, C. M. & St. P., Minneapolis, Minn.

Shop Schedules, L. A. North, general foreman, Ill. Cen., Chicago, Ill., chairman; Henry Gardner, New York Central & Hudson River, New York; and George C. Bingham, C. & N. W., Winona, Minn.

A committee will also be appointed on Apprenticeship.

CHICAGO FREIGHT TRAFFIC.—A report of the Chicago Association of Commerce concerning smoke abatement showed that the heaviest traffic entering or leaving Chicago was over the Chicago & Western Indiana, between Forty-seventh and Forty-ninth streets. During one week in January 425,000 tons of freight were moved over this section.

TIRE MANDREL

It is the custom on some roads, whenever tires need turning, to remove them in the engine house, apply a second hand set if it is necessary to get the engine out immediately and to then return the removed tires on a mandrel. In cases where there is no wheel lathe in connection with or near the engine house the tires are shipped to a central shop and there turned in quantities. A supply of tires of various sizes, machined and ready for use, is maintained at the various engine houses.

At the Clinton shops of the Chicago & North Western a mandrel has been designed for holding the tires while being turned, which was proved to be a decided time saver. The custom formerly was to shrink the tires on a temporary mandrel. This method was not only expensive, but required considerable time. At other shops the tires are held by set screws or wedges, but this method will not permit of the heavy cuts frequently necessary.

The mandrel shown in the illustration is clamped to the face-

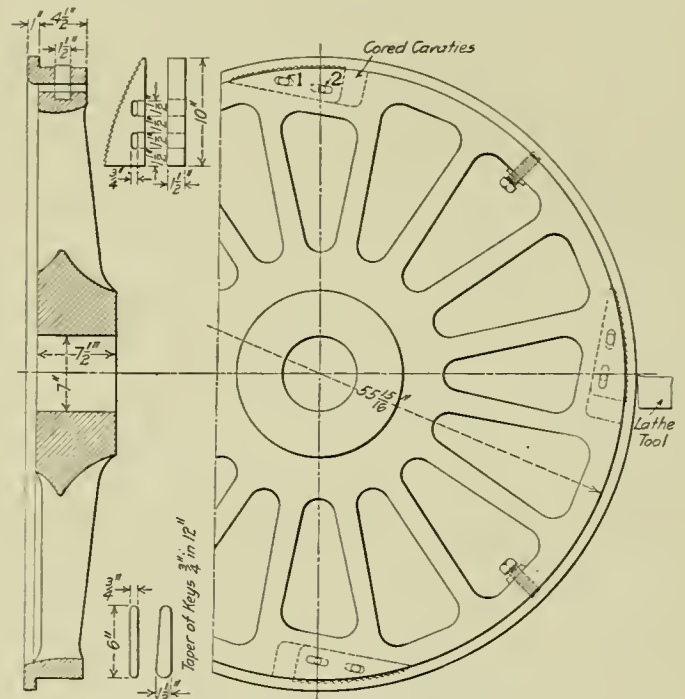

Mandrel for Turning 56 in. Tires.

plate of the wheel lathe and has a lip against which the face of the tire is held. The four 1 in. set screws are used to hold and center the tire, after which the dogs are forced up by inserting the tapered keys in the keyways, and driving them tight. It will be seen that the wedges are arranged on an incline so that they tend to continually grip tighter as the cut is being taken, and thus to hold the tire securely while being turned, the set screws meanwhile acting as a support midway between the wedges. When the tire is to be removed the tapered keys are taken from slots 1 and placed in slots 2, which permits them to draw the wedges back to their seats and in this manner release the tire.

Mandrels of sizes to suit different diameters of wheel centers are of course required, and they are frequently made from old driving wheel centers, although it is more satisfactory to have a special pattern for this purpose. Tires can be placed on the mandrel and be ready for turning in less than 15 minutes, which is much less time than would be required for shrinking them on the wheel centers. This mandrel was designed by Charles Markel, foreman of the Chicago & North Western shops, Clinton, Iowa.

CARE OF LOCOMOTIVE BOILER TUBES

Specifications for Tubes, Safe-Ends and Ferrules, and Rules for Renewal, Application and Maintenance of Flues.

BY WALTER R. HEDEMAN.

One of the most important, as well as expensive, items in connection with keeping a locomotive in good working order is the maintenance of the boiler tubes in the highest state of efficiency. To keep down the cost and at the same time maintain the efficiency, it is necessary that methods be standardized for all flue work in the different shops and engine houses. This, of course, must apply to both labor and material. Under the heading of labor it is obvious that instructions must be issued to insure uniform methods and tools being used. As regards material, the best obtainable will be found to be ultimately the cheapest, and only that which conforms to standard specifications should be accepted.

The labor cost of removing, safe-ending, and applying a boiler tube is about 15 cents per tube. This includes all operations with 380 $2\frac{3}{4}$ in. tubes it will amount to \$96.90, per locomotive. Operations, such as cutting off, welding, expanding, shouldering, testing, scarfing, setting copper ferrules, etc. The material cost will be about as follows: A new safe-end 6 in. long is worth 5.5 cents, a copper ferrule 2.5 cents, the supervision on labor is 2.25 cents per flue, and storehouse and overhead charges .25 cents per flue, making a total cost for labor and material for the renewal of one flue of 25.5 cents. On a modern locomotive

The thickness of copper ferrules used varies with different roads; some foreign roads use a ferrule .049 in. thick; the Pennsylvania Railroad uses .075 in.; the Baltimore & Ohio, .09 in., and the Baldwin Locomotive Works .065 in. A ferrule $\frac{1}{2}$ in. long should be used with 2 in., $2\frac{3}{4}$ in., and $2\frac{1}{2}$ in. tubes. Specifications for copper ferrules for boiler tubes should include the following: All material should be inspected and tested on its arrival at destination. Ferrules must be made seamless of annealed copper. They must be 99 $\frac{1}{2}$ per cent. pure copper, free from flaws and other defects. Sizes will be ordered by their outside diameters—all sizes to be cut straight, without beads. Material, to be rejected, should vary more than $\frac{1}{32}$ in. either way in length, $\frac{1}{64}$ in. either way in aver-

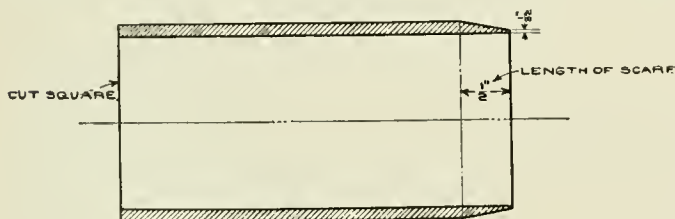

Fig. 1—Detail of Safe-End.

age diameter, .002 in. either way in thickness, and should be brittle, or show defects in working.

In addition to the above tests the right should be reserved to make a repetition of any tests to insure that only material meeting all the requirements set forth in the specification be accepted, and all material not up to any one or all of the requirements should be rejected. Material used for tests, additional to those specified, should be paid for if the entire lot of material is accepted; if the entire lot of material is rejected, the additional test material should not be paid for. Samples representing rejected material should be retained in the test bureau not longer than two weeks from the date of the test. If, at the end of that period, the sellers have not given shipping direc-

tions, the material represented will be returned to them at their own risk, they paying the freight both ways, in either case.

Tubes 2 in., $2\frac{3}{4}$ in., and $2\frac{1}{2}$ in. in diameter should be .125 in. thick, and the safe-ends should be .135 in. thick. The specifications for tubes and safe-ends should include the following: This material should usually be tested and inspected at destination by the railway test bureau. It may, however, be inspected and tested at the manufacturer's works, if the railway so desires, in which case the manufacturer will furnish all the necessary assistance and apparatus for making the inspections

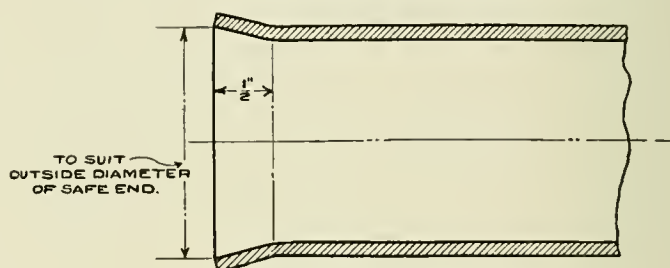

Fig. 2—Flue Flared for Safe-End.

and tests free of cost. In either case the decision of the engineer of tests, as to the acceptance or rejection of the material, shall be final. All tubes and safe-ends should be carefully examined and must have a smooth surface, free from laminations, cracks, blisters, pitting and imperfect welds; they must be free from bends, kinks, etc., and must conform to the size designated in the order; they must be truly circular in section, uniform in thickness throughout, and conform to the thickness and weights specified. All iron and steel locomotive tubes must be lap welded, or seamless; safe-ends must be of seamless steel.

All tubes and safe-ends which are not round, or show a variation in diameter of more than $\frac{1}{64}$ in., or whose mean diameter is more than .020 in. of the size ordered, should be rejected. Safe-ends should be ordered in 4 in., 6 in., or 8 in. lengths, to be scarfed at one end on the outside at an angle of about 15 deg. with the center line of the tube, and for a distance of $\frac{9}{16}$ in. from the end of the tube, and be not more than $\frac{1}{32}$ in. thick at the edge of the scarf, the opposite end to be cut square. All cutting and scarfing must be done with sharp tools to avoid pulling or unnecessarily straining the metal, and must be in a plane at right angles with the center line of the tube. Tubes and safe-ends must be within .010 in. of the normal gage specified. Welded tubes should have an allowance variation of .015 in. at the weld greater than the normal gage.

All tubes and safe-ends showing defects during the process of placing in the boiler should be rejected. All material, before leaving the manufacturer's, must be subjected to a hydrostatic pressure of 1,000 lbs. per sq. in. for seamless tubes, and 750 lbs. per sq. in. for welded tubes. If 20 per cent. or more of the pieces tested fail to meet any of the requirements, the whole shipment will be rejected.

The following rules adopted by one of the largest railways in the United States are the result of years of experience and of the findings of a special committee appointed to investigate the subject. Tubes applied and maintained in accordance with

these rules should have a life of 40,000 miles on superheater engines, and from 55,000 to 60,000 miles on non-superheater engines. The idea was to present the rules in simple language, accompanied by numerous sketches for the information and guidance of the shop men.

RULES FOR RENEWAL, APPLICATION AND MAINTENANCE OF FLUES IN LOCOMOTIVE BOILERS.

Removal of Flues.—When renewing fireboxes, the flues must be cut off inside the inside faces of both the front and back

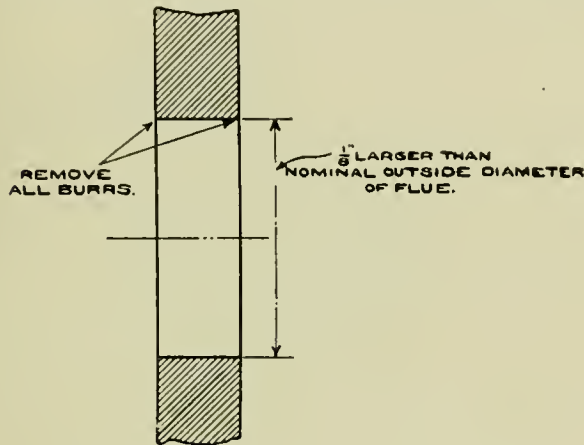

Fig. 3—Preparation of Holes in Front Flue Sheet.

flue sheets, using a pneumatic flue cutting-off machine of approved design. When renewing a partial or complete set of flues, the dry pipe not being removed, the flues must be cut off at the front end, preferably with a pneumatic flue cutting-off machine, and the beads at the back flue sheet should be cut off with a thin flat chisel, and the flues be backed out through their own holes in the front flue sheet, if possible. If not, through a flue hole enlarged $\frac{1}{8}$ in. in diameter, located near the center of the front flue sheet.

Safe-Ends.—Safe-ends must be .135 in. thick, in lengths of 4 in., 6 in., and 8 in., of seamless steel tubing, and in accordance with the specifications. One end of the safe-end must be

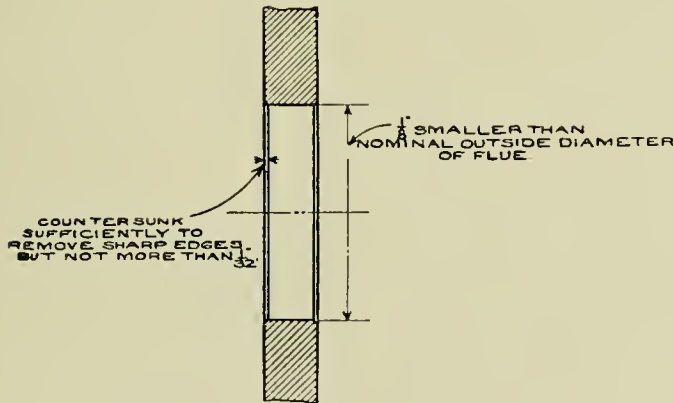

Fig. 4—Preparation of Holes in Back Flue Sheet.

scarfed for a distance of $\frac{1}{2}$ in., being tapered to $\frac{1}{32}$ in. in thickness at the end of the scarfing and cut square on the opposite end by the manufacturer, as per Fig. 1. A 4 in. safe-end must be used on all new flues, and when these flues require repairs a second 4 in. safe-end should be applied. The next time they require repairs the safe-end portion may be cut off and longer safe-ends, 6 in. or 8 in. should be used in their places, the object being to reduce the number of welds in the flues.

Preparing Flues.—The firebox end of the flues should be heated and enlarged. Fig. 2 for the entrance of the scarfed

safe-end, this being done by ramming on a standard tapered horn. The safe-end should be placed in the end of the flue end, both should be heated to a white heat, drawn out quickly and be welded on a flue welding machine, care being taken to see that the weld is smoothly made. Not more than six welds should show in any one flue. When this point has been reached, the flues may be used again by cutting off the welded portion and applying new safe-ends and using in boilers requiring shorter flues. This may be continued as long as the body portion remains strong enough for use. New flues should be pur-

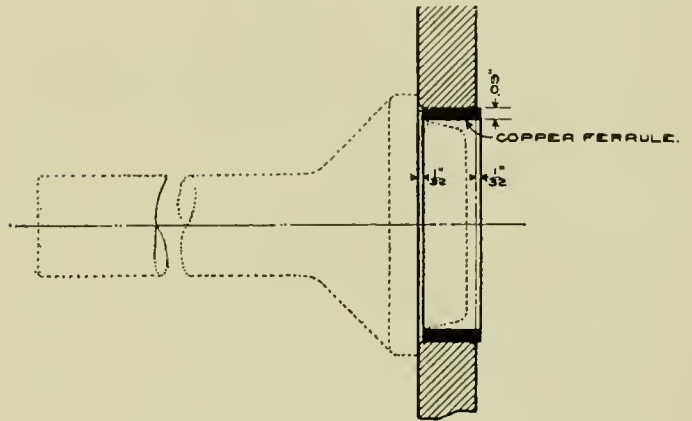

Fig. 5—Setting of Copper Ferrule in Back Flue Sheet.

chased and used whenever possible in the boilers requiring the longest flues.

When measuring over the tube sheets to find the necessary length of the flues, a sufficient number of measurements should be taken to insure getting them of an average length. They should be $\frac{7}{16}$ in. longer than the distance over the tube sheets, $\frac{3}{16}$ in. of this to be at the firebox end and $\frac{1}{4}$ in. at the smokebox end. The flues must be cut accurately to the lengths furnished by the boiler maker foreman.

In purchasing new flues it must be kept in mind that a 4 in. safe-end is to be applied, and flues should be purchased 3 in. shorter than the actual distance over the tube sheets. Before

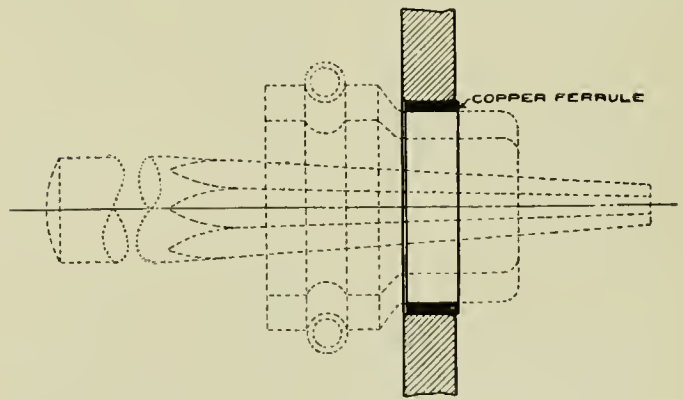

Fig. 6—Tightening Copper Ferrule in Back Flue Sheet.

placing the flues in boilers, care must be taken to see that the ends are perfectly clean and smooth, all burrs and scale being removed, preferably by filing.

Front Flue Sheets.—The smokebox end of the flues should be expanded to a size $\frac{1}{32}$ in. less in diameter than the hole in the front flue sheet; all new front flue sheets must have flue holes $\frac{1}{8}$ in. larger than the nominal outside diameter of the flue (Fig. 3) to permit quick removal of the flue.

Back Flue Sheets.—The holes in the new back flue sheets must be drilled to a size $\frac{1}{8}$ in. smaller than the nominal outside diameter of the flue, and both the inside and the outside edges

of the hole through the sheet should be countersunk sufficient to remove the sharp edges, but not more than $1/32$ in., as shown in Fig. 4. When the flue holes become $1/32$ in. out of round, they must be reamed with a straight reamer. Copper ferrules must be used only on the firebox end of the flue.

Setting of Copper Ferrules.—The outside diameter of the ferrule should be of a size to tightly fit the hole in the back flue sheet, being set in position by the ferrule setting tool shown in Fig. 5. The shoulder on the tool must seat against the face of the flue sheet to insure the ferrule being properly located $1/32$

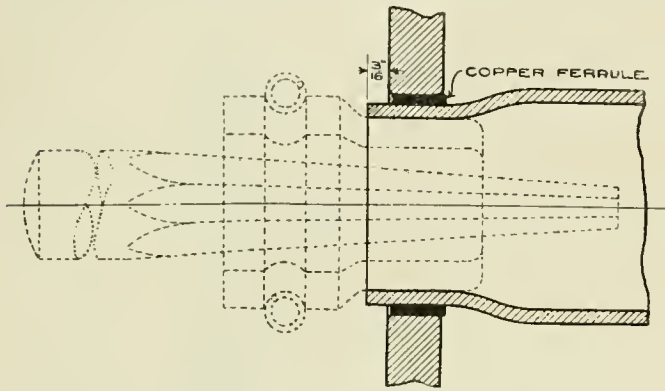

Fig. 7—Tightening Flues in Back Flue Sheet With Straight Sectional Expander.

in. inside of the flue sheet face; after this the ferrule must be tightened in the hole by using the straight sectional expander shown in Fig. 6. When placing the flue in the boiler particular care should be taken to avoid injuring or displacing the copper ferrules.

Setting Flues (Back End).—The flues must be tightened in the back flue sheet with a straight sectional expander, as shown in Fig. 7, after which, they must be flared, using a standard flaring tool, Fig. 8, and then expanded with standard sectional expander, as shown in Fig. 9. A long stroke riveting hammer must be used with each of the above tools, the expander pin or mandrel to be driven into the expander until the flue is solid

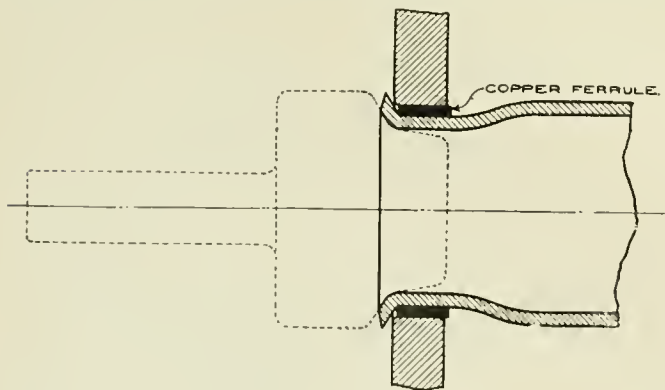

Fig. 8—Flaring End of Flue at Firebox Sheet With Standard Flaring Tool.

against the sheet, then slacked off and the expander turned slightly in the flue and driven in again; this should be done at least three times, or until the flue is properly set and evenly expanded all the way around.

The flues should be beaded as shown in Fig. 10, using standard beading tools. In using a short stroke riveting hammer, care should be taken to see that nothing enters between the bead and the flue sheet. The expanding, flaring, and beading should be done along the lines indicated in Fig. 11, from *A* to *A*, *B* to *B*, *C* to *C*, and *D* to *D*, after which, work should begin at the center of the sheet and work around in a circle until the outer flues are finished.

For flue maintenance in engine houses, the straight sectional expander, Fig. 7, and beading tool only should be used.

Maintaining Standard Tools.—All beading tools must be checked at least once every 30 days by the boiler maker foreman, or some person designated by the master mechanic, to see that they conform accurately to the standard gages. Beading tools not conforming to the gages should be sent to the main shop of each division for repairs, and after being made standard to gage, must be returned to the point from which they were received. Beading tools must not be repaired at any outlying points. After the tools have been checked, a report must

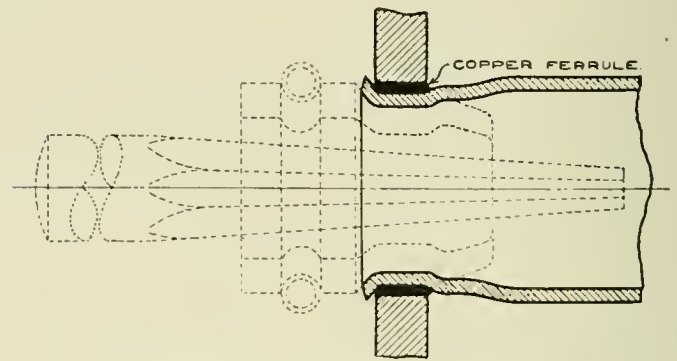

Fig. 9—Standard Sectional Expander for Prossering Flues in Firebox Flue Sheet.

be made to the master mechanic showing their condition, where inspected, and the number of tools returned for repairs.

Sectional Expanders.—Sectional expanders should be cut into eight segments for all tools, except those for superheater flues, and the standard tapered pin or mandrel used with the expanders should have eight sides. The expanders must be maintained by the same method of inspection and checking with gages as the beading tools.

Standard Gages.—Standard gages for beading tools, mandrels and expanders should be available by making application to the mechanical engineer.

Setting Flues (Front End).—Flues in the front flue sheet

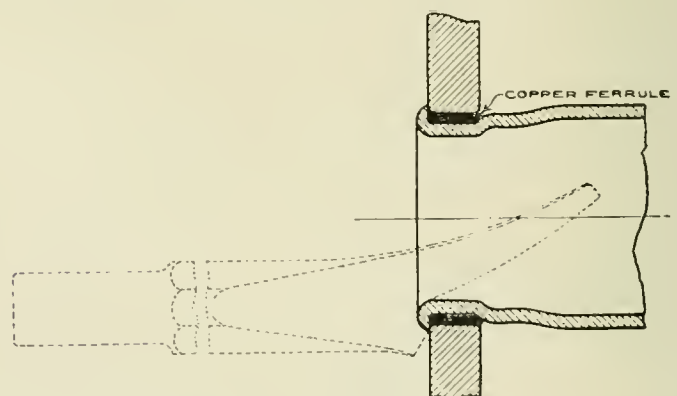

Fig. 10—Beading Flues in Firebox Flue Sheet.

should be tightened, using an approved design of roller tube expander as shown in Fig. 12. No flues should be beaded at the front end.

Care of Flues in Engine Houses.—When flues are reported leaking and the boiler is under pressure, use a straight sectional expander, as shown in Fig. 7, and expand a sufficient number of flues to insure a tight job. Beading tools should be used only when necessary to set the bead back against the flue sheet.

If the entire set of flues is to be worked over, it should be done when the boiler is empty after being washed, and when the sheets are cooled off. The firebox ends of the flues must first be cleaned out thoroughly, and the standard sectional ex-

pander, Fig. 9, should be used for tightening the flues, and the standard beading tools should be used to set the beads tightly against the flue sheet, if necessary. The firebox ends of the flues in service must be expanded with the standard sectional expander, Fig. 9, at intervals of not over 15 days; this being regulated by the service. Flue leaks in the firebox must be stopped by the sectional expander, and not with a roller expander or beading tool. Roller expanders should be used only for tightening the flues in the front flue sheet. The proper height of the beads on the flues must be maintained by using

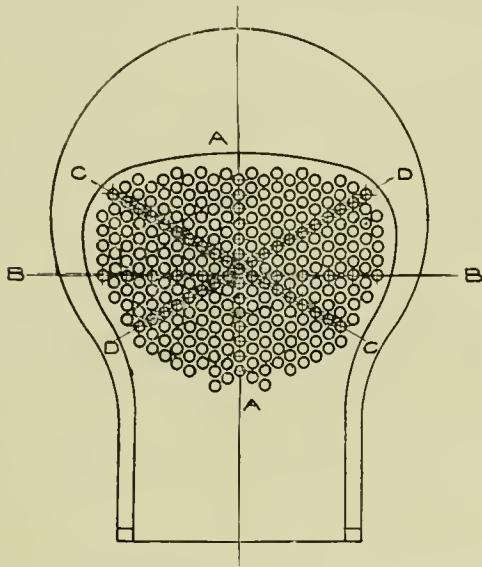

Fig. 11—Order of Working in Setting Tubes in Back Flue Sheet.

only standard beading tools for both new and maintenance work.

Building Fires.—In building new fires a slow one should be started, with the blower turned on just enough to produce sufficient draft to ignite the fuel. The furnace doors should be kept closed and the steam pressure should not be forced. After 100 lbs. steam pressure has been obtained, the blower should be shut off. Care should be taken to see that the fire is well distributed over the grate surface, particularly near the flue

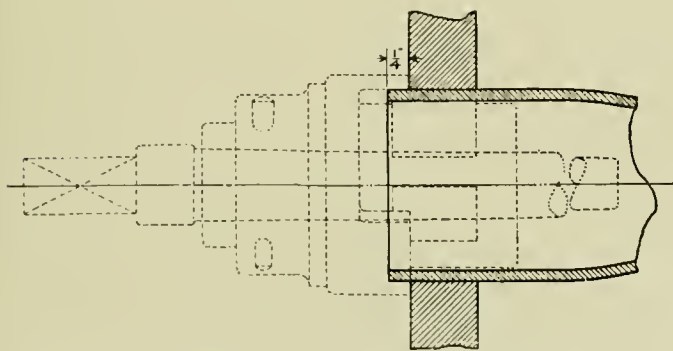

Fig. 12—Front Flue Sheet Roller Expander.

sheet. Whenever possible, warm water should be used for washing out and filling boilers.

Cleaning of Boilers.—When the flues are removed from the boiler, it should be thoroughly cleaned and all scale, mud and sediment removed from the shell, firebox, crown sheets and stays, where possible, and a thorough examination made both inside and outside, to detect any cracks in the sheets.

Resetting Flues in Firebox.—When a locomotive arrives at an engine house with the flues leaking so badly at the firebox end that it must be taken out of service, the boiler must be

drained, after which the firebox ends of the flues must be reset with the sectional expander.

PREVENTION OF LEAKING FLUES.

In order to reduce the flue leakages to a minimum the following practices must be followed: When fires are being cleaned or drawn the blower should be used only sufficiently to prevent smoke emitting from the fire door.

Banking of Fires.—All fires must be banked at the flue sheet except in fireboxes having the front grates bricked off, in which case the fire should be banked over the adjoining grates.

Use of Injectors in Engine Houses and Yards.—Unless absolutely necessary injectors should not be used while the fires are being cleaned, also when no fire is in the fireboxes, and while locomotives are being moved under their own steam in the engine yards without first brightening up the fire.

Care of Flues on the Road.—The boiler should be fed regularly while the engine is using steam, and the supply of water must be so regulated that it will keep the water level in the boiler as uniform as possible. The fire should be kept bright and even at all times when the engine is in service, a good bright fire next to the flue sheet being very essential. The grate shaker should be used at regular intervals, and the clinker hook should be used only when absolutely necessary. Engine crews should be instructed and required to bring engines to the ash pit with light fires, and with sufficient steam pressure and water in the boiler to permit of quick handling and removal or cleaning of fires by hostlers.

COUNTERSINKING REAMERS

The reamer shown in the accompanying illustration is used to countersink holes in boiler patches for the patch bolt head and insures the countersunk hole in the patch being true to the hole in the boiler shell. A pilot bar *A* is screwed into the hole in the boiler shell and provides a true center for the reamer.

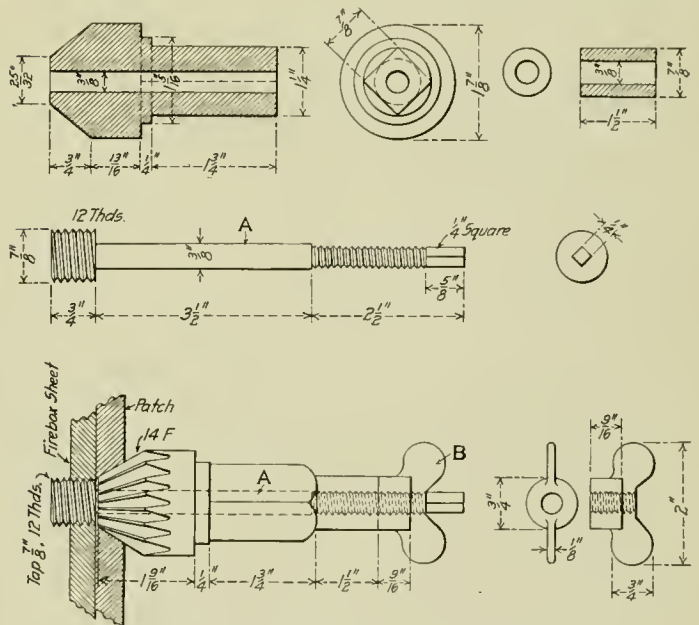

Reamer for Countersinking Patch Bolt Holes.

The reamer is turned by an ordinary wrench fitting over the square part of the shank and is forced into the hole by the thumb screw *B*. A few turns of the reamer will make a first class countersunk hole. We are indebted for this information to Charles Markel, foreman of the Chicago & North Western shops at Clinton, Iowa.

FILING AND INDEXING OF TRACINGS

Methods Used on the Erie, as Well as the Practices Followed in Issuing Blue Prints to the Shops.

BY E. G. CHENOWETH,
Mechanical Engineer, Erie Railroad, Meadville, Pa.

Although the question of the proper filing and indexing of tracings has been given a great deal of thought it would take an expert equipment man to locate some of the standard drawings in many drawing rooms. This is not due, perhaps, to not being properly filed, but more to the conditions under which they are filed. The different methods and ideas of different persons in applying titles are found to be a great cause of filing drawings covering the same details under different heads. The selection of proper titles can be accomplished in most cases by appointing one man, whose business it is to assign all titles; this, however, is only temporary and cannot be relied upon to extend over a period of time which would materially better the files as a whole to a very great extent. Another method, which the writer believes preferable in its continual influence to better the files, is to have the card index printed with a standard list and all the details will then be indexed in the same way, as far as the printed index cards cover the file.

It is appreciated, however, that this only covers standard equipment and does not properly care for odd drawings, foreign to the standard equipment. It was found advisable before the titles are printed on the tracings to submit to the chief draftsman, or his assistant, a form filled out giving the drawing number assigned, with the title of the drawing. This form, illustrated in Fig. 1, assists greatly in obtaining uniform and correct titles.

The card index system is believed to be the best method of properly indexing drawings. Four general heads for the filing

| ERIE RAILROAD COMPANY. | | |
|---|----------|--------------------------|
| APPLICATION FORM FOR CARD NUMBERS | | |
| ATTACH THIS FORM TO TRACING. LOCATION AND DESCRIPTION TO BE FILLED IN BY DRAFTSMAN. TITLE WILL BE APPROVED AND CARD NUMBER ISSUED BY CHIEF DRAFTSMAN. | | |
| CARD NO. | LOCATION | DESCRIPTION |
| | | |
| | | |
| | | |
| | | |
| APPROVED: | | |
| _____ DRAFTSMAN | | _____ CHIEF DRAFTSMAN |

Fig. 1—Drawing Titles Must Be Approved When the Card Number is Issued.

of drawings have been used and found to work out satisfactorily in a railway mechanical department drawing room, i. e., locomotive, car, improvement, tool and machinery.

The locomotive index should include not only the locomotives and tenders, but also all appliances or specialties connected therewith, as well as locomotive cranes. The above classification should be sub-divided into classes and under the classes, should be headings covering the detail parts.

The car index covers all cars, which can be readily sub-divided into passenger and freight, and under each would be gasolene, motor and electric cars.

The improvement index should cover yard layouts, build-

ings, turntables, transfer tables, coal elevators and power plants, including boilers, engines, pumps and generators.

The tool and machinery index comes last, perhaps because what is left over is classified under this head, and it is a fact that in most drafting rooms, where there is a doubt, the drawing is generally classified under tools. This classification should include the tools and machines in the shops, also shafting, hangers and belting, small hand tools and special devices in the machine, boiler and blacksmith shops and all details directly connected therewith.

A rule has been in effect for some years in the office of which the writer is in charge, to make all details for different

| STANDARD SIZES OF TRACINGS | | | WHERE USED | SERIES | GEN. DRG. |
|----------------------------|-----------|---------------|------------|--------|-----------|
| 8 1/2" x 11" | 17" x 33" | 25 1/2" x 33" | 1 1/2" | 1" | 1" |
| 11" x 17" | 17" x 44" | 25 1/2" x 44" | | | |
| 17" x 22" | 17" x 55" | 25 1/2" x 55" | | | |

| SPECIAL TRACINGS | | |
|--|-------------------------------|---|
| LETTERING DIAGRAMS..... | 8 1/2" x 22" AND 8 1/2" x 33" | EQUIPMENT BOOK PRINTS SIZE 27" x 38" |
| SIDE RODS..... | 11" x 34" | |
| HEAD-LINING DIAGRAMS FLOOR PLANS..... | 11" x 42" AND 11" x 34" | |

| BOOK TRACINGS | | |
|------------------|----------------|-------------|
| AXLES | SHOES & WEDGES | TOOLS |
| GLASSWARE | PISTONS | PISTON RODS |
| ROD BRASSES | ROD BUSHINGS | SPRINGS |
| TINWARE | GAUGES | FIRE BRICK |
| WHEELS | | |
| CRANK PINS | MAIN RODS | PISTONS |
| STRESS DIAGRAMS | DRIVING WHEELS | STEAM PIPES |
| SMOKEBOX ARR'GS. | | |

| RELEASED | DATE | CHANGE |
|----------|------|--------|
| | | |

| ERIE R.R. | | |
|--|---------------|-----------|
| STANDARD PRACTICE FOR MAKING UP TRACINGS | | |
| CORRECT: | MEADVILLE PA. | APPROVED: |
| MECH. ENGR. | 10-18-1910 | 13183 |
| | | 1-6-6 |

Fig. 2—Standard Instructions for Making Tracings.

classes of equipment on the same size tracings, leaving ample margin at the left hand edge for binding. This is not only very convenient for making up blue print books of certain parts, but it also naturally follows that these details will be filed either in the same section, or in the same size section in the tracing filing case, which assists greatly in locating the tracings.

This can be carried out nicely for drawings covering locomotive and car standard details. Some books of this kind which have been found to be of great assistance to the shops and whose titles appear on covers are: axles for cars and tenders, brake details, crank pins, fire brick, gages, glassware, journal bearings, knuckle pins, pistons, piston rods, rod brasses, shoes and wedges, smith shop dies, special devices, springs, tinware, tools, and car and tender wheels. Other details which can be readily made on standard tracings for books are: side rods, main rods, driving wheels, smokebox arrangements and steam pipes.

Each shop getting one of these books is charged up with it. The cover should be of a loose leaf design so that in case one or more of the prints become obsolete, or are reissued, the correct print can be filed in the cover and the superseded one removed and destroyed, or returned to the office from which it was issued.

Instructions giving the standard practice for making tracings are issued to the drawing room for the guidance of the drafts-

men. These instructions are embodied in a standard drawing as illustrated in Fig. 2.

All printed notes appearing on tracings should be made of the same kind and size letters. Small capital letters were made standard, inasmuch as it was found that all the draftsmen could more readily make them uniform than any other style of lettering. The type for the titles is also made standard and is printed with a hand printing press.

The reissuing of tracings is in a great many instances not given the thought and attention which it deserves, and sometimes through carelessness or oversight proper reissue notes

*Form 842-4-12-131

ERIE RAILROAD COMPANY

FORM FOR REISSUED CARDS

NOTE—When tracings are reissued, or changed without reissue, one of these forms must be promptly filled out and filed.

Card No. _____ Location _____ Issue _____

Title _____

Change _____

Date _____ 191_____ Draftsman _____

Fig. 3—Form Used in Drawing Room when Tracings are Revised.

are not placed on the tracings. Some notes should merely state what change was made; others should also give the reasons why it was made; while still others should tell what disposition should be made of the material in stock of the original design. It may call for special instructions in regard to finishing or altering the old material, so that it need not be scrapped. While this information or instructions can be given in a circular letter, it must be conceded that a circular letter seldom gets into the shop to the man who uses the blue print, and moreover it is not considered as permanent as a blue print.

When necessary to reissue a tracing it is advisable to have a form, as per Fig. 3, filled out by the draftsman and given

which are readily separated and may have holes punched for filing, if desired, as shown in Fig. 4. On the upper card request is made for specifications, blue prints or standard practice cards and is sent to the mechanical officers' office, from which

* Form 3212-7, '09-1,000.

ERIE RAILROAD COMPANY

_____ 19____

GEN'L MECH'L SUPT.
MEADVILLE, PA.

Dear Sir:—Will you kindly furnish this office
*Specifications,
Blue Prints, Numbers,
Stan. Pract. Cds.*

Yours truly,

○ _____

ERIE RAILROAD COMPANY

Meadville, Pa., _____ 19____

Dear Sir:—In compliance with your request of _____
*Specifications,
Blue Prints, Numbers,
Stan. Pract. Cds.*

Kindly acknowledge receipt of prints by returning invoices properly signed and dated.

Yours truly

○ _____
Gen'l Mech'l Supt.

Fig. 4—Forms Used in Connection with the Requesting and Supplying of Material from the Mechanical Engineer's Office.

they are issued. In furnishing the prints the lower part of the card is returned with them, making it practically unnecessary to do any letter writing. Attention is directed to the fact that the card is already addressed to the mechanical officer, on

| | | | |
|-------------|--|--|---|
| (A) CARD | (B) | (C) | DATE: |
| ISSUED | INVOICE OF CARD | RECEIPT FOR CARD | This Card, bearing numbers as hereon stated, has been received and will be taken care of as per instructions. |
| | TO _____ | TO _____ | |
| | ACCOUNT OF _____ | ACCOUNT OF _____ | |
| | <p>DETACH THIS INVOICE</p> <p>AND KEEP IT ON YOUR FILE FOR REFERENCE.</p> <p>INSTRUCTIONS:</p> <p>1st.—Compare the numbers of Card and Print attached with the numbers hereon.</p> <p>2d.—Detach the "Invoice of Card" and place the same on file in your office for future reference.</p> <p>3d.—Properly enter the "Invoice of Card" in your records, that you may be prepared to give an account of the same at any time.</p> <p>4th.—Properly sign and date the "Receipt for Card" and mail the same under cover of envelope to the Mechanical Engineer of the Erie Railroad.</p> <p>5th.—Keep the Card, bearing numbers as hereon stated, on file and in good order, as same will be referred to, by number, by officials of the Erie Railroad, and same may be recalled by the Mechanical Engineer.</p> <p>NOTE:—The "Receipt for Card" when signed, dated and returned to the Mechanical Engineer of the Erie Railroad, is placed on file in this office and held as evidence that you have received the Card and are holding and caring for same, as per above instructions.</p> | <p>RETURN THIS RECEIPT</p> <p>TO THE MECHANICAL ENGINEER OF THE ERIE RAILROAD.</p> <p>INSTRUCTIONS:</p> <p>1st.—Compare the numbers of Card and Print attached with the numbers hereon.</p> <p>2d.—Detach the "Invoice of Card" and place the same on file in your office for future reference.</p> <p>3d.—Properly enter the "Invoice of Card" in your records, that you may be prepared to give an account of the same at any time.</p> <p>4th.—Properly sign and date the "Receipt for Card" and mail the same under cover of envelope to the Mechanical Engineer of the Erie Railroad.</p> <p>5th.—Keep the Card, bearing numbers as hereon stated, on file and in good order, as same will be referred to, by number, by officials of the Erie Railroad, and same may be recalled by the Mechanical Engineer.</p> <p>NOTE:—This "Receipt for Card" when signed, dated and returned to the Mechanical Engineer of the Erie Railroad, is placed on file in this office and held as evidence that you have received the Card and are holding and caring for same, as per above instructions.</p> | |
| | <p>ERIE RAILROAD CO.</p> <p>OFFICE OF MECHANICAL ENGINEER, MEADVILLE, PA.</p> <p>ISSUED _____</p> <p style="font-size: x-small;">**Form 882-11-11-10M</p> <p style="text-align: right; font-size: x-small;">MECHANICAL ENGINEER.</p> | <p>ERIE RAILROAD CO.</p> <p>OFFICE OF MECHANICAL ENGINEER, MEADVILLE, PA.</p> <p>ISSUED _____</p> <p style="text-align: right; font-size: x-small;">MECHANICAL ENGINEER.</p> | |

Fig. 5—Cards Used for Keeping Track of Blue Prints, etc., Issued to the Shops.

to the chief draftsman, who in turn holds it until blue prints from the revised tracing are sent out and the old prints destroyed.

Forms used in requesting and sending out blue prints have also been developed and have been found to work very successfully. There forms are made in the shape of two filing cards

which the request is made, and therefore the card need not be sent in an envelope.

Several systems are in vogue by means of which a proper check can be made against the shops to ascertain if certain prints and issues have been received. In keeping check on blue prints sent out, invoice cards as shown in Fig. 5 have been found to

work successfully. The card is self explanatory and, therefore need not be described in detail. The small stub end of card marked *A* is detached and held in the office issuing the prints until the part of the card marked *C* is returned properly signed; it is then destroyed, as it has performed its function. The part marked *B* is retained for file by the shop officer who received the blue print. The part of the card marked *C*, when returned properly signed and dated, is filed numerically in a drawer set aside for the particular shop or station.

MALLET FOR YARD SERVICE

The Baldwin Locomotive Works has recently completed for the St. Louis, Iron Mountain & Southern, a locomotive of the 2-8-8-2 type, which will be used in hump yard service. This is an interesting application of the Mallet type to special service conditions, which in the present case requires a locomotive capable of developing large tractive effort at slow speeds for comparatively short periods of time. When using steam the engine will usually operate at long cut-offs, and the large amount of weight carried on the driving wheels can thus be utilized to the best advantage. The tractive effort developed, when operating compound, is 94,500 lbs.

The locomotive has a separable boiler, with a feedwater heater in the front section. The feedwater enters the heater on

single expansion and subsequently change to compound. The starting valve is placed in a 3-in. pipe connecting the high pressure steam pipes with the receiver pipe. When the throttle valve is first opened, live steam passes through this pipe direct to the low pressure cylinders. As soon as pressure in the receiver pipe builds up, the starting valve closes, cutting off communication between the live steam supply and the low pressure cylinders, and the locomotive then works compound.

One of the illustrations shows this valve in section. The opening at the left connects to the high pressure steam pipe, and the one at the bottom to the receiver pipe. The communication between them is through the medium of eight triangular shaped ports in the 3 in. bushing surrounding one end of the differential piston valve. From the same chamber in which the receiver pipe connection is made is a $\frac{3}{8}$ in. passage communicating to the small valve marked *A*. Alongside this is another small valve that closes the passage from the back of the chamber in which the large end of the differential piston operates, to a pipe leading to the cab. A $\frac{3}{8}$ in. cross connection is also made from the chamber above the seat of valve *A* to this passage. The pipe leading to the cab carries at its upper end a suitable valve to permit steam pressure to either be admitted or released.

In operation the valve works as follows: As the throttle is opened the live steam passes through the triangular ports to the chamber and the receiver pipe. As this becomes filled



Superheater Mallet for Hump Yard Service.

the bottom center line and leaves it on the top center, thus circulating through the entire depth of the heater. The rear, or evaporating section of the boiler, contains a Schmidt superheater, with 36 elements. The dome has a diameter of 33 in., and a height of $15\frac{3}{4}$ in. It is of pressed steel, made in one piece, and its center is 56 in. back of the front tube sheet. The superheater head is placed in an intermediate chamber 66 in. long, located between the evaporating section of the boiler and the feed-water heater. The live steam pipes pass out through the sides of this chamber, and then extend back to the high pressure steam chests. Here the distribution is controlled by inside admission piston valves, 15 in. in diameter and of the built-up type. The valves are set with a lead of $\frac{3}{16}$ in.

The high pressure exhaust passes out through the back of the cylinder casting and enters a cavity formed in the cylinder saddle. This cavity contains a seat for the ball joint at the back end of the receiver pipe. The center line of the ball joint coincides with the center of the articulated frame connection, thus requiring only one such joint in the pipe. The steam is conveyed direct to the low pressure cylinders without being passed through a reheater. The low pressure distribution is also controlled by 15 in. piston valves.

As this locomotive is intended for service in which frequent starting and stopping are required, a semi-automatic starting valve has been applied, enabling the locomotive to start as a

and the pressure increases, the valve in the cab being closed against steam pressure, valve *A* is lifted from its seat and the pressure is communicated through the cross passage to the back of the large end of the differential piston. This forces this piston forward against the spring, gradually closing the triangular ports until a balance is obtained between the two pressures. This will be in the same ratio as the areas of the two heads of the differential piston.

As soon as the high pressure cylinder begins to exhaust, the pressure in the chamber builds up and the valve continues to close until it entirely cuts off the passage and the locomotive is then operating in compound. If it is desired to close the valve before it automatically closes itself, steam pressure is admitted in the cab. This pressure passes through the pipe and lifting the small valve communicates directly to the large piston and forces it forward. At the same time, this pressure through another passage comes on top of valve *A* and closes it. On the other hand if it is desired to admit live steam to the receiver pipe while the locomotive is in operation the valve in the cab is opened. This relieves all pressure from the top of valve *A*, permitting it to raise and allowing the spring of the differential piston to push it backward, opening the ports until a balance is obtained. When the locomotive is in normal compound operation, pressure is maintained in the pipe leading to the cab.

The high pressure cylinder saddle is cast steel, made in two pieces. The upper piece is comparatively small and is riveted to the boiler shell while the lower piece is extended back of the cylinders, and to this extension, the rear frames are bolted, while the cylinders are secured directly to the saddle, which thus constitutes part of the frame system. The frames and cylinders are keyed to the saddle by vertical keys, which are arranged in pairs and are driven in parallel keyways with their tapered faces in contact. The arrangement at the low pressure cylinders is generally similar, except that the saddle is made in one piece and carries no superimposed weight.

There are three bearers on the front frames of this locomotive. Normally, the entire weight is transferred through the rear bearer, as the middle bearer has 1/4 in. clearance between the upper and lower sections, and the front bearer 1 in. clearance. The middle bearer carries the centering spring, and is placed under the feed-water heater. The upper casting is riveted to the boiler shell. In the case of the front and back

| | |
|--|--------|
| Total weight ÷ total equivalent heating surface* | 74.10 |
| Volume equivalent simple cylinders, cu. ft. | 29.30 |
| Total equivalent heating surface* ÷ vol. cylinders | 200.00 |
| Grate area ÷ vol. cylinders | 2.87 |

Cylinders.

| | |
|---------------------|------------------|
| Kind | Compound |
| Diameter and stroke | 26 & 40 x 32 in. |

Valves.

| | |
|----------|----------|
| Kind | Piston |
| Diameter | 1.5 in. |
| Lead | 3/16 in. |

Wheels.

| | |
|---|-------------|
| Driving, diameter over tires | 55 in. |
| Driving, thickness of tires | 3 1/2 in. |
| Driving journals, main, diameter and length | 11 x 12 in. |
| Driving journals, others, diameter and length | 10 x 12 in. |
| Engine truck wheels, diameter | 30 in. |
| Engine truck, journals | 6 x 10 in. |
| Trailing truck wheels, diameter | 30 in. |
| Trailing truck, journals | 6 x 10 in. |

Boiler.

| | |
|--------------------------------|--------------|
| Style | Straight |
| Working pressure | 200 lbs. |
| Outside diameter of first ring | 84 in. |
| Firebox, length and width | 126 x 96 in. |

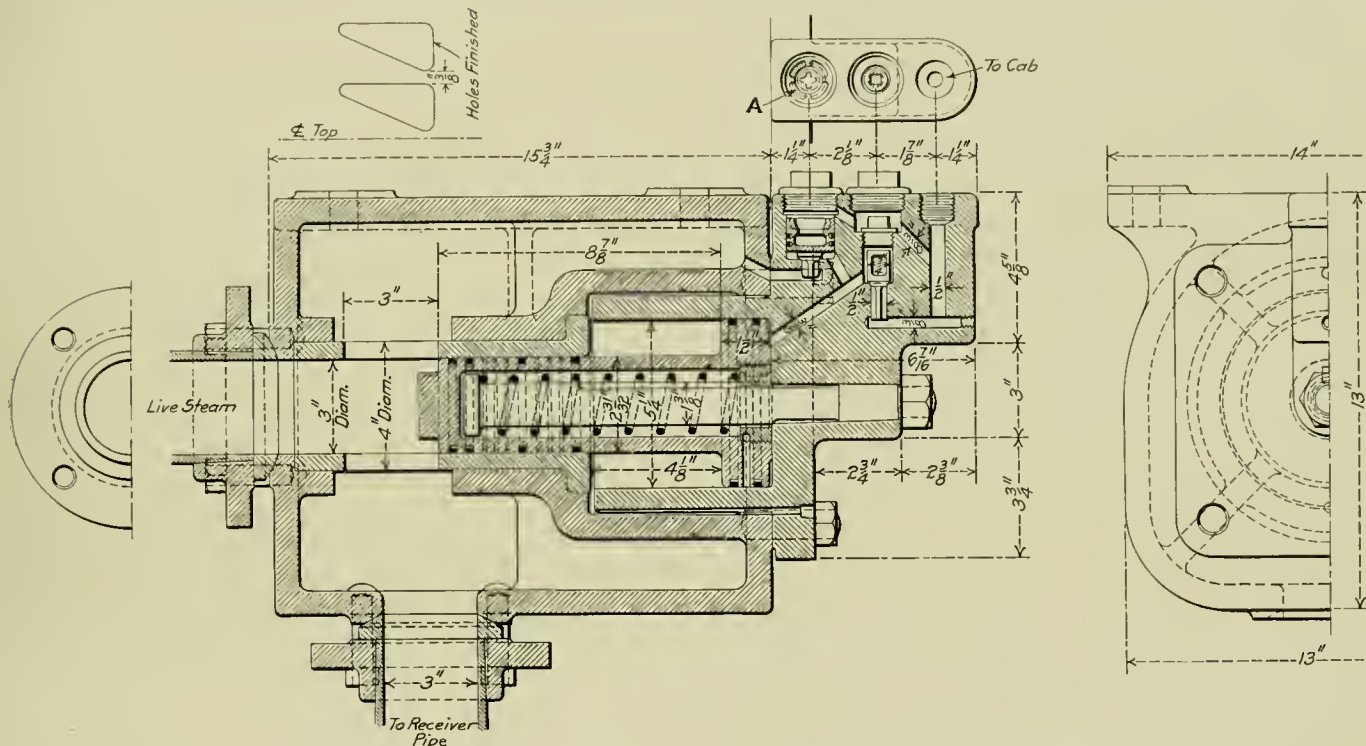

Baldwin Semi-Automatic Starting Valve for Compound Locomotives.

bearers, which are placed under the forward and intermediate smoke boxes respectively, the upper castings are bolted in place. The casting for the back bearer has a spark ejector passage cored in it, so that the smokebox may be readily cleaned of the cinders.

The tender is built with a cast steel frame, and has a tank of 8,000 gals. capacity. The general dimensions, weights and ratios of the locomotive are given in the following table:

| | |
|--|------------------|
| <i>General Data.</i> | |
| Gage | 4 ft. 8 1/2 in. |
| Service | Yard |
| Fuel | Bit. coal |
| Tractive effort | 94,500 lbs. |
| Weight in working order | 435,000 lbs. |
| Weight on drivers | 395,000 lbs. |
| Weight on leading truck | 20,000 lbs. |
| Weight on trailing truck | 20,000 lbs. |
| Weight of engine and tender in working order | 590,000 lbs. |
| Wheel base, driving | 15 ft. |
| Wheel base, total | 56 ft. 7 in. |
| Wheel base, engine and tender | 85 ft. 2 1/4 in. |
| <i>Ratios.</i> | |
| Weight on drivers ÷ tractive effort | 4.17 |
| Total weight ÷ tractive effort | 4.60 |
| Tractive effort × diam. drivers ÷ equivalent heating surface* | 885.00 |
| Total equivalent heating surface* ÷ grate area | 70.00 |
| Firebox heating surface ÷ total equivalent heating surface*, per cent. | 4.31 |
| Weight on drivers ÷ total equivalent heating surface* | 67.50 |

| | |
|------------------------------------|---------------|
| Firebox plates, thickness | 3/8 & 5/8 in. |
| Firebox, water space | 1.5 in. |
| Tubes, number and outside diameter | 260-2 1/4 in. |
| Tubes, thickness | .125 in. |
| Flues, number and diameter | 36-5 1/2 in. |
| Flues, thickness | No. 9, W. G. |
| Tubes, length | .21 ft. |
| Heating surface, tubes | 4,281 sq. ft. |
| Heating surface, firebox | 252 sq. ft. |
| Heating surface, total | 4,533 sq. ft. |
| Heating surface, feed water heater | 1,230 sq. ft. |
| Superheater heating surface | 890 sq. ft. |
| Grate area | 84 sq. ft. |

Tender.

| | |
|-------------------------------|----------------|
| Wheels, diameter | 33 in. |
| Journals, diameter and length | 5 1/2 x 10 in. |
| Water capacity | 8,000 gals. |
| Coal capacity | 14 tons |

*Equivalent heating surface equals 4,533 + (1.5 × 890) = 5,868 sq. ft.

NEW JERSEY SHIP CANAL.—A contract has been let for the survey of the route of the proposed ship canal across the state of New Jersey from the Delaware river, at Bordentown, to Raritan bay, at South Amboy. An expenditure of \$500,000 has been granted by the legislature of New Jersey to purchase the right-of-way, with the expectation that the federal government will dig the canal.

RAILWAY TOOL FOREMEN'S ASSOCIATION

Papers on Milling Cutters and Reamers; Standardization of Steel for Small Tools; Care of Shop Tools; Checking Systems and Electric Furnaces Formed the Basis of Discussion at the Fourth Annual Convention.

President E. J. McKernan, tool supervisor of the Santa Fe, called the fourth annual convention of the American Railway Tool Foremen's Association to order at the Hotel Sherman, Chicago, Ill., on July 9, 1912, about fifty members being present. After prayer by Rev. O. M. Canard of the Normal Park Presbyterian Church, Robert Quayle, superintendent of motive power of the Chicago & North Western, delivered the opening address.

MR. QUAYLE'S ADDRESS.

Mr. Quayle, in commenting on the motto of the association—Higher Efficiency in Railway Tool Service—said in part: Today the efficient man, who is also an executive, is the one who knows what Tom, Jack and Harry are doing. If he does not know that, he is not efficient. The word efficiency not only applies to tools, but in a larger and more comprehensive sense it also applies to men. We talk about shop efficiency, but we are not talking very much about man efficiency, and after all, it is the man that moves the tools. It is the brain of the man that conceives the idea to make the tools. It is the need of the tool that has come into man's brain, and then the man works out the ideas in his head to accomplish what he is looking for. The man is higher than the tool that he makes. We sometimes give credit to the tools, but back of the machine there is the brain and the man who fitted, and adjusted, and changed, and perfected it. How seldom we give credit to the man. It is the thing that we see before us to which we give the credit, and the man often is forgotten.

If you have men working for you and they do something worth while, or something better today than they did yesterday, a word of encouragement makes them bigger and better men tomorrow, and your chances are enhanced because of that kindly word of encouragement. He grows and you grow because he does. You profit by the work he does.

You sometimes think that in this day and generation opportunities have gone by. Get that out of your heads. Opportunities are more numerous today than they ever were. There is more need of invention today than there ever was. Every new invention creates new thoughts. We get in touch with the bigger things of life, and the larger, more intricate machinery. Let us get familiar with the biggest things on earth in our line and the best things in our line and study them out, and do not think that opportunities have gone by. When you cannot find an opportunity, just make one. You are big enough to make opportunities and have things coming your way.

If this association is good for anything, let it be good for eliminating cost by the standardizing of tools and methods. See that your standards will not only be a standard of the local shop, but for the entire system.

MILLING CUTTERS AND REAMERS.

A. R. Davis (Cent. of Ga., Macon, Ga.) presented the following paper on this subject:

I will consider the topic from the standpoint of cutting efficiency, and the cost of keeping the tools in working condition. We have all been bound to old tradition as to milling cutters and their formation, giving them many flutes of a given form, either with a 12 flute and 40 deg. cutter for the smaller diameters and 12 flute and 50 deg. for the larger diameters and also using arbors entirely too small for the work. For the past three years I have been gradually decreasing the number of flutes, and increasing the total angle of the fluting cutter, with excellent results. After reading Mr. DeLeeuw's article on Milling Cutters and Their Efficiency, presented before the American Society of

Mechanical Engineers last year, I proceeded to follow his recommendations as to the number of flutes and their form with results that have exceeded my expectations.

A section of Mr. DeLeeuw's article on the formation of the flutes and their number is as follows: "The $3\frac{1}{2}$ in. diameter cutters are made with nine and the $4\frac{1}{2}$ in. diameter with ten flutes which correspond to about $1\frac{1}{4}$ in. spacing; the point of the tooth has a face of one thirty-second of an inch, and the back of the tooth forms an angle of 45 deg. with the radial line.

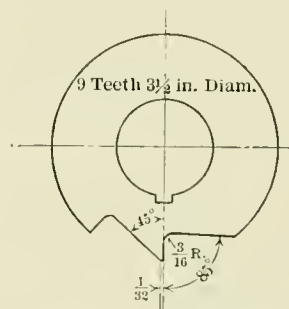

Fig. 1—Formation for Nine Flute Cutter.

The chip space is approximately four times as great as in the usual standard cutter of the present time, and is formed with a $3/16$ in. radius at the bottom." These cutters are shown in Figs. 1 and 2.

In using cutters of this form for a year we have not had a single one break in service, and have removed as high as three cubic feet of stock (machine steel) with a 4 in. diameter, $4\frac{1}{2}$ in. face cutter with one grinding. Though not directly connected with the foregoing, attention should be called to the fact that present practice calls for arbors which are too small. In the

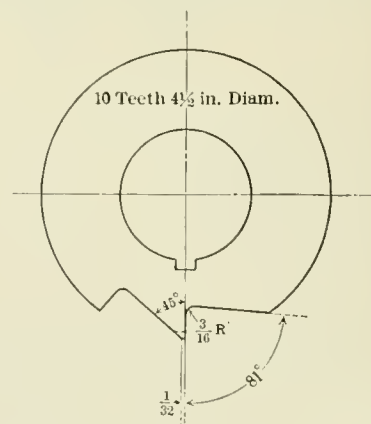

Fig. 2—Formation for Ten Flute Cutter.

cutters mentioned, the $3\frac{1}{2}$ in. is made with $1\frac{1}{2}$ in. and $1\frac{3}{4}$ in. arbors, the $4\frac{1}{2}$ in. cutter with $1\frac{3}{4}$ in. and 2 in. arbors.

Since adopting our present standard cutters, I have made a number varying from 3 in. to 6 in. in diameter, and have made the spacing as large as $1\frac{5}{8}$ in. on some $6\frac{1}{4}$ in. diameter cutters, with good results. We mill these cutters with a spiral of 12 deg. angle, and in pairs of rights and lefts to reduce the end thrust on the spindle as much as possible. These cutters are nicked one inch pitch, with a 75 deg. nick, and a $1/16$ in. radius

at the bottom. This nick has eccentric relief, giving ample clearance to prevent dragging the stock.

The table below gives the number of teeth for the various diameters of cutters and end mills, and my experience indicates that a spacing of from 1 1/4 in. to 1 1/2 in. will give the best results.

| FOR CUTTERS. | | | | |
|--------------------|------------------------|--------|----------|----------|
| Diam. | Arbor. | Teeth. | Degrees. | Radius. |
| 2 1/2 in. | 1 in. | 8 | 90 | 3/16 in. |
| 3 in. to 3 1/2 in. | 1 1/4 in. to 1 1/2 in. | 9 | 85 | 3/16 in. |
| 4 in. to 4 1/2 in. | 1 3/4 in. to 2 in. | 10 | 81 | 3/16 in. |
| 4 1/2 in. to 5 in. | 2 in. to 2 1/2 in. | 11 | 78 | 1/4 in. |
| 5 in. to 6 in. | 2 1/2 in. to 3 in. | 12 | 75 | 1/4 in. |

| FOR END MILLS. | | | |
|----------------|--------|----------|----------|
| Diam. | Teeth. | Degrees. | Radius. |
| 1 in. | 4 | 105 | 1/16 in. |
| 1 1/4 in. | 5 | 105 | 1/16 in. |
| 1 1/2 in. | 6 | 90 | 1/8 in. |
| 2 in. | 8 | 90 | 1/8 in. |

End mills up to 1 5/8 in. require a second cut to relieve the back of the teeth and prevent excessive depth of flute. The back is milled at an angle of 45 deg. to the cutting edge. Figs. 3, 4, 5

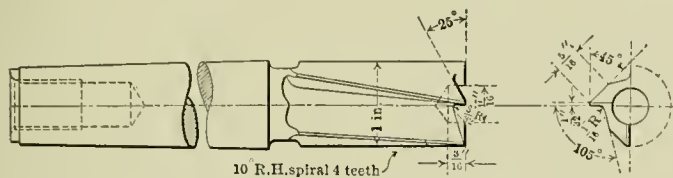

Fig. 3—New Design of End Mill with Four Teeth.

and 6 show the end view of these mills. These cutters will have a greater depth of flute and can be ground oftener and quicker than the old style. The cutter enters the work without excessive chatter and gives a smooth finish. It will not leave revolution marks to as great an extent as a cutter with more flutes. The wide spacing allows more chip room and permits heavier feeds. A ammeter on a motor driven miller shows about 25 to 30 per

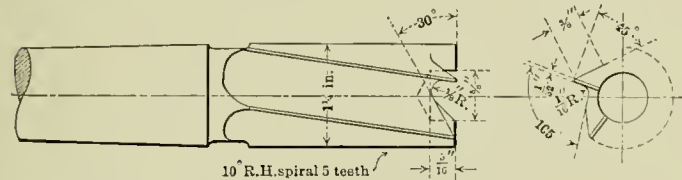

Fig. 4—New Design of End Mill with Five Teeth.

cent. lower power consumption in favor of the coarse flute. The four and five flute end mills cut freely and permit of very coarse feeds, and do not break from choking as does the usual end mill.

The helical cutter gives a fine finish, will not make revolution marks, and does not spring the arbor. The power consumption is very low. On a 60 in. vertical miller used on rod work we

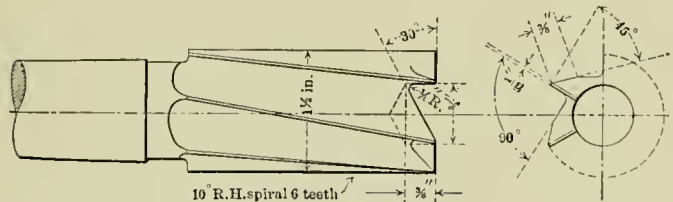

Fig. 5—New Design of End Mill with Six Teeth.

have used a helical cutter, the spiral made to throw the thrust up thus taking the weight of the spindle off the bearings.

The following, from Mr. DeLeeuw's paper, gives a description of the helical cutter: "These cutters consist of a cylindrical body, with two or three screw threads wound around them, the threads being of a section indicated in Fig. 7. The helical is wound around the body with an angle of 69 deg. with the axis. The diameter is 3 1/2 in. and the lead of the helix 4 1/2 in. They are made in two styles, either single, or as interlocking right and

left hand cutters. They are given a rake of 15 deg. and clearance of 5 deg. when used for steel, and with a rake of 8 deg. and clearance of 7 deg. when used on cast iron."

The helical cutters I made were given slight changes in the lead and were of diameters from 2 1/2 in. to 4 1/4 in., but we maintained the same rake and clearance recommended. The results were good.

All of our fluting cutters are given an angle of 12 deg. on one side and the necessary additional angle for the other. They are given an 1/8 in. throw eccentric relief. Cutters 2 1/2 in. in diameter have a 1 in. arbor and 8 teeth for end mills and reamers.

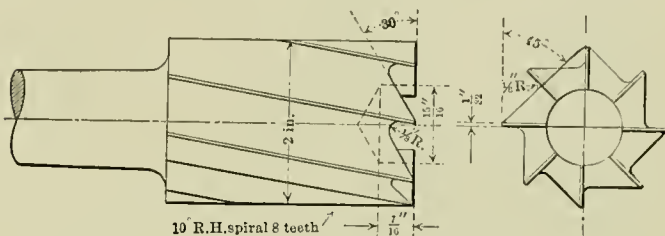

Fig. 6—New Design of End Mill with Eight Teeth.

Cutters 3 in. in diameter have a 1 1/4 in. arbor and 10 teeth for the milling cutters.

I have not made a thorough test as to the advantage of different angles of spiral in relation to power consumption and finish of work. After trying from 8 deg. to 20 deg. angle of spiral, 12 deg. was selected as the best angle. This may be changed after a more complete test. Each form of cutter is a problem in itself as to diameter, number of flutes and amount of relief.

Reamers are of such a variety of styles and are used for such a variety of work, that I will not deal with any but those most generally used. The 1/16 in. taper per foot hand reamer is the one most used in railway shops, and is also the most abused, running at high speed without oil, and being driven into the work and pulled loose with a jerk and is even run backwards occa-

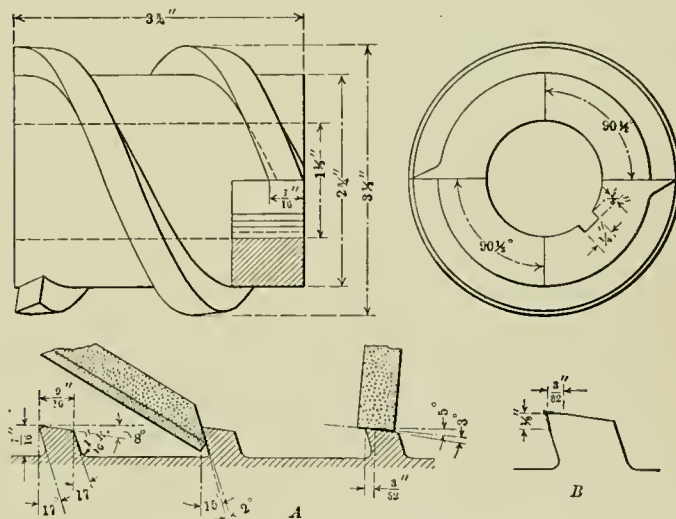

Fig. 7—New Design of Helical Cutter.

sionally. A reamer to give satisfaction must be tough enough to stand this abuse and maintain a cutting edge under the most trying conditions; it must not choke in the flutes and must cut with the minimum power consumption.

With these points in view we have made a number of tests during the past year that included sixteen styles of reamers of four different flute formations. In the preliminary tests we tried a number of different angles of spirals ranging from 5 to 12 deg. and selected 8 deg. as consuming the least power. A list of reamers used in the final test and their form is given in the table. We used three sizes of each form and reamed 1/2 in. from

the holes to get as nearly as possible a uniform load on the motor. The tests were made on machinery steel, part being through a 4½ in. section and part with three 1½ in. plates. We selected 1⅛ in., and 1 5/32 in. and 1-3 1/16 as the average size of bolts used on an engine.

| No. Flutes. | Form of Flute. | Power Ratio. |
|-------------|--------------------|-----------------|
| 10..... | Stg. flute..... | 100 per cent. |
| 10..... | Stg. nicked..... | 98.46 per cent. |
| 10..... | Spiral 8 deg..... | 96.63 per cent. |
| 10..... | Spiral nicked..... | 95.34 per cent. |
| 8..... | Stg. flute..... | 92.30 per cent. |
| 8..... | Stg. nicked..... | 86.15 per cent. |
| 8..... | 8 deg. spiral..... | 71.92 per cent. |
| 8..... | Spiral nicked..... | 70 per cent. |
| 6..... | Stg. flute..... | 66.92 per cent. |
| 6..... | Stg. nicked..... | 62.29 per cent. |
| 6..... | 8 deg. spiral..... | 48.84 per cent. |
| 6..... | Spiral nicked..... | 47.24 per cent. |
| 5..... | Stg. flute..... | 48 per cent. |
| 5..... | Stg. nicked..... | 43.96 per cent. |
| 5..... | 8 deg. spiral..... | 43 per cent. |
| 5..... | Spiral nicked..... | 39.23 per cent. |

The strength of all forms of reamers was tested by driving the reamer in a reamed hole ¾ in. and measuring the load on an 18 in. lever. The result was:

| | | |
|---------------|-------------------|------------------|
| 10 flute..... | Load 500 lbs..... | Did not cut. |
| 8 flute..... | Load 500 lbs..... | Did not cut. |
| 6 flute..... | Load 410 lbs..... | Started cutting. |
| 5 flute..... | Load 380 lbs..... | Started cutting. |

As to holding a cutting edge, I could not detect any decided advantage of any one form in the test, but since the five and six flute reamer has been used in the shop the amount of grinding on reamers has decreased. I attribute part of this to the fact



Fig. 8—New Five, Six and Eight Flute Reamers.

that in hand reaming, the reamers are not jerked backwards on account of the reamer pulling easier when driven in the work. End views of the five, six and eight flute reamers are given in Fig. 8. The formation is much stronger than the drawing indicates.

In testing rose reamers, the power required for the different flute formations was much the same as in the taper reamers as in shown below:

| | |
|------------------------------------|-----------------|
| 8 flute rose reamer..... | 100 per cent. |
| 6 flute rose reamer..... | 63.22 per cent. |
| 3 flute spiral, 30 deg. angle..... | 56.45 per cent. |

The ten and eight-flute taper reamers and the eight-flute rose reamers choked in reaming and had to be cleaned frequently. All reamers were run at as high a speed and as coarse a feed as consistent for carbon steel.

The large reamers in use in the railway shops on rod and motion work can be divided into two classes, the shell and the inserted blade. I consider solid reamers over 3 in. diameter obsolete on account of the risk in tempering. We make all rod and motion reamers of 3 in. in diameter and over with inserted blades of high speed steel in a machine steel body, making the blades either ¾ in. or 7/16 in. thick, nicking them 1 in. pitch. The blades protrude 3/16 in. and have a groove milled at the face of the blade for chip room; the back is milled with a 45 deg. angle. The spacing is from 1¼ in. to 1½ in. This makes a cheap reamer that gives no trouble and is easily renewed when below size. The smaller reamers with sharp tapers are made with 8 deg. angle of spiral left hand, nicked and with taper shanks. The large shell reamer has an advantage over the inserted blade in that it may be cut spiral and reduce the power required.

My experience is that the coarse flute in the milling cutter will give as good a finish as a fine flute cutter, that the coarse flute reamer, except the five straight flute reamer, will give a good finish, and that the coarse flute will cut a shoulder out of a hole

faster and thus require less reaming. Also that the spiral and nick are a decided advantage and great power savers.

In tempering cutters and reamers we use the barium chloride furnace for high speed steel and the lead pot for carbon steel. In hardening high speed tools of large sizes we preheat slowly from three to five hours, bringing the heat up to about 1,800 deg. F. and then immerse in the barium and bring the heat up to 2,175 deg. F. and immerse in oil. We then draw in oil to 500 deg. F. and allow them to cool in the air. For carbon reamers we preheat in the muffle furnace to 1,000 deg. F., then immerse in the lead pot bringing the reamer to 1,435 deg. F. (100 to 110 points carbon) dip in water, and draw in oil to 460 deg. F. Do not draw too fast.

Discussion.—J. A. Shaw (Central of N. J., Elizabethport, N. J.): We are making all milling cutters from Rex A. A. steel. The flutes are milled in 6 in. to 10 in. cutters about ⅝ in. deep and 1⅜ in. pitch with a 40 deg. spiral. They are made in pairs, right and left on one arbor. By doing this the thrust on the spindle is counteracted. We omit the notches for chip breakers on these cutters. In tempering, we heat in a furnace with a very slow heat at the start, then increase it until they are brought to a sweating heat. They are then placed in a cold air blast of about 75 pounds pressure, allowing the blast to play on all parts of the cutting edges at the same time until they are cold. We are having success with this way of tempering and have not lost a single cutter. They are from two to three times as efficient as any cutters we can buy, or make with any other process we have tried.

In reply to a question, Mr. Davis explained that a feed of about .025 in. per revolution was about the maximum in machinery steel. He also stated that the shell reamer had an advantage over the inserted blade, but that he believed in large sizes the inserted blade is the cheaper reamer of the two to manufacture.

Mr. Martin (Big Four, Beech Grove, Ind.): I am strongly in favor of the spiral cutter. We turn our shell. For instance, if the shell of the reamer was 9 in. in diameter and 22 in. long, we mill a slot around the shell and insert square pegs in it. That style of reamer has given us excellent service.

E. F. Eaton (B. & O., Mt. Clare, Baltimore, Md.): I do not agree with the gentleman in regard to the spiral peg cutter. It is a very bad cutter to grind. I have tried several with poor results. The solid inserted blade is better.

Mr. Martin: If the spiral peg cutter has not a uniform lead it will leave marks on the work. After we insert the pegs, we send it to the milling machine and mill a perfect spiral. It is somewhat difficult to grind, but we catch about two teeth at a time and get good results.

Mr. Eaton: I tried to cut them so that the grinder would take two or three teeth at a time. The grinding blade would catch in between the teeth, and I considered it dangerous unless the machine is especially adapted for grinding and the head has a spiral feed. I intended to build a machine for the purpose, but we had such bad luck with the cutters breaking that we gave them up altogether.

G. W. Smith (C. & O., Huntington, W. Va.): We never make the peg cutters, but purchase them. We use an 8 in. cutter on rod work with success. The pegs break out occasionally, but we have not had much trouble about grinding. We have had experience with the solid cutter that was not altogether satisfactory. We purchased the steel and when it came to tempering we followed the instructions given by the manufacturers. They did not show any signs of cracks after the tempering but later cracks developed both ways, lengthwise and around the cutter. The makers of the steel sent an expert to show us how to temper and we had very good success with the cutters he tempered.

Mr. Eaton: We use the inserted cutter for diameters over 6 in. or 7 in. Under that we use the solid cutter.

H. C. Wilson (Southern, Spencer, N. C.): On a pair of 8 in. diameter 18 in. long blade cutters, I used ½ in. x 1 in. Mushet steel, inserted deep and held with copper plugs. They gave good

results. We also made an 8 in cutter, about 6 in. face, from an old driving axle. It was case hardened with bone at a temperature of about 1,000 deg. for 10 hours and has never been ground. I am getting good results with old axles and piston rod steel. Of course we use coarse teeth and leave plenty of backing. We are milling side rods with the cutter and we are going to make more like it.

Member:—We had some experience along that line that was not satisfactory. It was found that the case hardened soft steel cutters on a large mill would have the teeth driven back in the soft material. We case hardened for about 10 hours.

Mr. Elkart (M. K. & T., Denison, Tex.): About a year ago we had half a dozen engines on which the seats of the throttles had to be changed. The seat was too flat. We decided to make the tool for this work of soft steel and then case-harden it. We made about 8 cutting edges on an 8 in. diameter cutter. It did the job nicely. Of course, there was already a seat established but the angles was changed.

Mr. Sheehan (N. & W., Roanoke, Va.): We purchased some inserted blade cutters. They were 3½ in. wide high speed steel blades and soft steel bodies. Six of these cutters on an arbor as a gang cutter were put to work and we used them only a short time, when it was found that the strain was so great that it imbedded the pin holding the blades in place in the body and we destroyed two sets of cutters inside of a week. I then ordered a number of pieces of side rod steel from the smith shop. In making the slots and blades we kept away from square corners as much as possible. We drew the temper of the blades up to 500 or 600 deg. and obtained good results. The blades were put in with a driven fit and we caulked them in place. We channel many of our rods 1½ in. deep and take a feed of 3 in. a minute. For slabbing work there does not seem to be any limit to their capacity.

Mr. Briggs (D. & H., Carbondale, Pa.): In tempering high speed steel the blacksmith often gets near the melting point. I would like to know what the experience of the members is in connection with the use of so high a temperature. Formerly we ordered our steel for the cutters ¼ in. large and removed all the scale. Later we ordered high speed Mushet steel annealed to the size of the cutter. We have had some trouble getting good results. I would also like to learn what the experience has been in hardening steel without removing the scale.

Mr. Martin: I think that it depends largely on the brand of steel that you are using. Some high speed steels you must almost melt to get them hard enough to do the work, while other steels will harden at a remarkably low heat. As to using a piece of steel without removing the scale, I do not believe in it. It always pays to remove the outside of any steel that you are using, no matter what kind. Another important matter to consider is the trying to make something that the company can buy cheaper. There are so many things that we can make at a profit that we cannot afford to make anything that can be purchased cheaper. For instance, we started to make Davis boring bar tools and found we could not compete with the factory. We only made one outfit of tools. It is our duty to watch these things closely.

THE STANDARDIZING OF CARBON TOOL STEEL.

Henry Otto (Santa Fe, Topeka, Kan.), chairman of the committee, submitted an individual report from which the following extracts are taken: On account of the many varieties of steel in the market it is rather difficult for tool foremen to secure the proper steels that are needed to meet their requirements. My idea of overcoming this would be to standardize the grades of steel and designate them in a manner that would indicate the per cent. of carbon contained in each. About four classes will meet all the requirements for tools used in railway shops. The four grades would be as follows:

| | |
|--------------|---|
| Grade 1..... | from 0.65 per cent. to 0.75 per cent. carbon. |
| Grade 2..... | from 0.75 per cent. to 0.85 per cent. carbon. |
| Grade 3..... | from 0.85 per cent. to 0.95 per cent. carbon. |
| Grade 4..... | from 0.95 per cent. to 1.05 per cent. carbon. |

One of the greatest benefits to be derived from this classification is in the maintenance of the tools, as it will enable us to heat them more accurately for forging and tempering. If the workmen are not familiar with the per cent. of carbon contained in the steel, it is impossible for them to heat the steel with any uniformity, and as a consequence the steel deteriorates. With the grades recommended we should heat and harden the steel at the following temperatures:

| FOR FORGING. | |
|--------------|---------------|
| Grade 1..... | 1,750 deg. F. |
| Grade 2..... | 1,700 deg. F. |
| Grade 3..... | 1,650 deg. F. |
| Grade 4..... | 1,600 deg. F. |

| FOR HARDENING. | |
|----------------|---------------|
| Grade 1..... | 1,480 deg. F. |
| Grade 2..... | 1,475 deg. F. |
| Grade 3..... | 1,455 deg. F. |
| Grade 4..... | 1,450 deg. F. |

FOR ANNEALING.
All grades should be heated from 1,250 to 1,300 deg. F.

The temper of all grades should be drawn to suit the character of the work to be performed.

I would suggest that the first grade of steel be adopted for use in making pick points, wrenches, pinch bars, crowbars, etc. The second grade to make blacksmith tools, boilermaker tools, track tools, hammers, sledges, cold chisels, chisel bars, etc. The third grade to make general machine shop tools, counterbores, milling cutters, punching tools, rivet sets, shear blades, machine drills, etc. The fourth grade to make taps, dies, reamers, small machine shop tools, brass tools, etc.

W. J. Eddy, inspector of tools and machinery, Rock Island Lines, also a member of the committee, recommended that tool steel for making taps and reamers should contain from ninety-five point to 110 point of carbon; punches and dies should contain .85 per cent to 1.00 per cent; rivet snaps should contain .65 per cent. to .80 per cent. He doubted whether tools having shanks used in connection with air hammers should be in the same class as shear blades. Shear blades should contain .90 per cent. to 1.00 per cent. carbon, and rivet snaps should not contain as much carbon.

C. A. Cook, tool room foreman, Chicago, Indianapolis & Louisville, at LaFayette, Ind., another member of the committee, did not think it would be at all practical to use one standard of steel for the making of all tools but did believe it could be covered by two carbon numbers. First, for the reamers, taps, drills, and thread cutting tools, about ninety to one hundred point carbon gives the best results, but for rivet snaps and all tools with shanks to be used in air tools, also punches, dies, and shear blades, where they are subject to the shock, the steel should be of a lower point carbon, say about seventy-five.

A. Sterner, tool room foreman of the Rock Island, at Chicago, also a member of the committee, suggested that the tools be divided in three classes: (1) *Tool room tools*, (2) *Boiler shop tools*, (3) *Blacksmith shop tools*.

The first includes such tools as taps, reamers, drills, milling cutters, threading dies, punches, forming tools, shear blades, etc. The second and third classes include rivet snaps, beading tools, flue cutters, calking tools, prosser expanders, expanding pins, forging dies, etc.

The tools in the first class are all cutting tools, while tools in the second and third are subjected to vibration and heavy pressure strains. For the first class we have been specifying what is termed by the steel makers "Special Grade," giving the purpose for which the bar is to be used. For the second and third classes, we have been ordering the "Extra Grade," except for beading tools and forging dies. Beading tool steel is ordered special and forging dies are made of ordinary steel.

The best system I have seen for identifying the kind of steel is to paint the bars, selecting a different color for each grade and one for annealed steel. A strip of color is painted down the complete length of the bar. When the steel is annealed, two strips are used, one showing the grade and the other that it is

annealed. With this system no matter how small the piece may be, the grade will be known to those accustomed to handling the steel.

Discussion—A. B. Davis: I think 95 point carbon steel is too high for boiler punches. We use about 75 or 80 point and get good results. A boiler punch is a tool that gets considerable shock, and it would nick much quicker if made of high carbon steel. We have four grades of tool steel for use in the tool room, and order to the steel company's specifications. As the steel comes in we paint the bars a different color for every grade and when a workman needs steel for a certain job we tell him to get a white, or blue, or red bar; in that way we have eliminated the possibility of using the wrong steel. We tried to make one kind of steel do, and it was a big mistake. We have a different color for high speed steel. If it is not marked plainly, expensive mistakes will sometimes be made.

August Meitz (Pere Marquette, at Grand Rapids, Mich.): I believe that 90 point carbon is too high for punches. They should be made of as low carbon as is possible to handle. There is not so much danger of breaking the punches by punching through the material, but we find that we break 90 per cent. of the punches by stripping.

J. Martin: Has anyone ever tried to change the construction of the die to prevent the closing up of the material as the punch goes down. A die that is straight on top will close a great deal more than if it crowned on top. I believe if any of you have trouble with breaking the punches as they leave the hole, this will greatly reduce it.

A. M. Roberts: I have been using 35 point carbon vanadium alloy steel for punches for the boiler shop, car and general work, and have had punches good for as many as 30,000 holes, while others break on the third hole. These will be hardened at the same time, and made from the same bar. I believe the fault lies in the stripping or dragging unevenly. If it does not strike the stripper section squarely, it will cause a side pull on the punch which will break it. I think the carbon specified by Mr. Otto is all right, but I would rather see it start down at about 50 point carbon. It seems to me that 65 point carbon is too high for some kinds of work.

A. B. Davis: I had a little trouble with rivet snaps. We broke quite a number of those purchased and started making them ourselves. We bought some vanadium bar stock and made the snaps on the turret lathe with fairly good success. We then made some drop dies and drop forged the snaps, and got better results. We did not lower the prices as much as I hoped to, but we did increase the life of the snap. Of late we have been making snaps of tire steel. I was rather skeptical as to results when I first made them, but have to admit that they are a success. We are getting about 10 or 15 per cent. less efficiency with the tire steel than with the vanadium, but they are a good deal cheaper and we are better off on the net cost. However, it is hardly out of the experimental stage yet.

J. H. Arbuckle (G. C. & S. F., Cleburne, Tex.): Through a mistake I once made some punches of high speed steel and did not have very good results; but for dies for boiler shop work high speed steel gives very good service.

E. R. Purchase (Boston & Albany, Springfield, Mass.): I made some high speed steel punches from $\frac{3}{4}$ in. up and had good results, but on smaller dies they broke off. I think carbon steel is better for the smaller sizes and high speed for larger sizes.

A. M. Roberts: We use quite a bit of high speed steel for punches and our trouble has been that while the steel seems to last fairly well, it becomes rough on the sides and causes the breakage of the punch.

B. Henrikson (Chicago & North Western, Chicago): For a number of years we have dated all tools and stamped the maker of the steel and the percentage of carbon on each. I found it convenient to know how long a tool had been in service and

also, when it gets in the scrap, we can pick out the exact kind of steel we want.

O. H. Dallman (Pennsylvania Lines, Chicago): We can use a piece of steel for the purpose for which it was specified by looking it up in the catalog, but I think it would be a good idea for the steel companies to also show the percentage of carbon in their catalog. It would be a great advantage in handling the carbon steel and also in the hardening of self-hardening steel.

TEMPERING OF TOOL STEEL IN AN ELECTRIC FURNACE.

B. Henrikson, tool room foreman of the Chicago & Northwestern at Chicago, presented a paper on this subject, part of which is given below: All metals in the shops are now-a-days being worked at a speed undreamed of in the days of carbon tool steel. Much of this advance is due to the advent of the use of the rarer metals, such as vanadium, nickel, chromium and tungsten, but even their presence would be of no practical importance without the proper heat treatment of the metal after it has been manufactured. This change from the use of the old time carbon steel to the present day special steels is working a revolution in the methods which were formerly in vogue for tempering carbon steels. Temperatures are demanded which cannot be successfully attained in the ordinary forge without danger of altering the composition of the steel.

The best results so far obtained in a furnace requiring fuel have been brought about in the following manner. The tool to be tempered is placed in some sort of a receptacle and all the space around it is filled with finely divided charcoal. Then the receptacle is sealed up, so as to be impervious to gas or air, and is placed in the furnace. The temperature is brought to that required to give the tool the desired degree of hardness (about 2,100 deg. F.), and this temperature is maintained until the heat has had a chance to penetrate entirely through the whole mass. This requires about two hours. The receptacle is then removed from the furnace and the tool taken out and plunged into an oil bath. The charcoal does not adhere to the steel. By this method an excellent job is obtained. An even heating of the steel prevents spring, giving accuracy. By packing in charcoal and sealing, exposure to air, gas or fuel is prevented and consequently the chemical composition is not altered.

The nearest approach to the results obtained in the above manner is obtained by the use of the electric furnace, which itself supplies the place of the sealed receptacle and as it requires no blast or fuel to obtain a high temperature, the danger of altering the chemical composition is obviated. The highest desired temperature can be obtained and by varying the strength of the electric current, any desired degree of heat can be obtained and maintained constant.

There are two distinct types of electric furnaces. One type is so constructed that it forms an open vessel in which is placed a substance which becomes a liquid at the hardening temperatures. The substance generally used consists of barium chloride and potassium chloride mixed in the proper proportion, this proportion depending upon the metal to be hardened and the temperatures desired. For very high temperatures, only pure barium chloride is used. In some shops for temperatures below 700 deg. C. (1,292 deg. F.) pure sodium nitrate is used and sometimes a mixture of sodium nitrate with potassium chloride. The author's experience does not cover the use of nitrates. In practice, it has been found that one objection to the use of this method is that the tongs, used in removing the tools from the bath, decompose and tiny particles of iron collect on the cutting edges and when plunged, these particles become so hard that they can be removed only by grinding. Often it is impossible to grind them off without injuring the tool. Aside from this trouble, very good results are obtained in this furnace. The outer walls of the furnace are never hot, so there is no danger from fire and the cooling bath may be placed close to the

furnace thus reducing to a minimum the time between removing and plunging.

The other type of furnace does not make use of a heating bath, but consists of a box-like structure which may be closed so as to exclude the outside air. The heat is generated by the resistance of carbon resistors located in the side walls of the furnace. The current strength and thus the temperature of the furnace is varied by altering the area of contact of these resistors. The greater the current which is allowed to flow, the higher is the temperature obtained. It is generally found that if the furnace is entirely closed, a reducing action takes place, so a door is provided for the admission of outside air until the action is neutral. Care must be taken in using this furnace, that too much air is not allowed to enter, for then oxidation takes place and the steel will scale.

The electric furnace has a distinct advantage over any kind of a furnace making use of a blast, as in the latter case it is next to impossible to maintain the temperature constant in all parts, and the tool to be hardened will become hotter on one side than on the other and will be sprung out of true. With the electric furnace no draft is required and as a purely soaking action takes place the tool is evenly heated.

Discussion—There was practically no discussion on this paper.

CARE OF SHOP TOOLS.

On account of the illness of J. W. Pike, chairman of the committee on this subject, no report was presented. Several of the members, however, briefly discussed it as follows:

Discussion—A. R. Davis: For beading tools we turn up the shank from the bar stock on the turret lathe and have a die which practically leaves no other machine work to be done. I use lead altogether in hardening. We are using vanadium steel, $\frac{7}{8}$ -in. octagon. Usually we make a dozen at a time and bring them up to 1,200 or 1,500 deg. in a muffle furnace; they are then heated up to 1,435 deg.—we have brought a few to 1,450—and dipped in water. Afterwards we put them in a basket and draw in oil to 490 deg. They are hardened all over and drawn to an even temper. Our beading tool trouble is a thing of the past. In the last nine months I believe we have made but one order of beading tools for the system. I can not give the actual number of flues each will bead but the first I tempered were used eighty days for all flues in the back shop without injuring them. It is a twenty-three pit shop.

J. Martin: We make beading tools in a forging machine, but previous to sending them to the machine we draw them down on a Bradley hammer. I am not in favor of trying to make a beading tool in one blow, as I think it will injure the steel. Hammering steel properly will refine it. We make them in one blow on the forging machine, after they have been drawn out and shaped up on the hammer. About the number of flues from one dressing of a beading tool. If we get 1,000 we are satisfied. I have tried all tempers, and I would rather stay on the safe side and have a tool to repair than to have it break. The greatest trouble we had with breakage was at the shank. We changed our stock from $\frac{7}{8}$ in. to $\frac{3}{4}$ in., and gave particular attention to see that bead of the tool was in the center of the stock.

O. H. Dallman: We had a lot of trouble with beading tools in breaking the shanks and tongues, and overcome it by getting an alloy steel. One of these on a thorough test beaded 3,600 flues before the size to the gage was gone. We allow $\frac{1}{64}$ in. wear.

A. Meitz: We use $\frac{13}{16}$ -in. steel. We did use $\frac{7}{8}$ in. but changed to $\frac{13}{16}$ in. and find that it makes the best shank.

Other members reported both $\frac{3}{4}$ in. and $\frac{13}{16}$ -in. octagon steel to be satisfactory for this purpose.

O. H. Dallman: In forming the tools up in one blow, I would like to know if Mr. Davis makes them sideways or endways. Stock $\frac{3}{4}$ in. in diameter will not carry enough if you do not upset it.

A. R. Davis: We form them endwise in a die.

C. A. Sheffer (Illinois Central): We tried many different kinds of drills for opening up the holes of rusted staybolts, and even had a number of flat drills made. They worked very well but were expensive. I attempted to obtain some high-speed bar or tool steel about $\frac{5}{32}$ in. square, but was not able to get it. A small piece of steel of this size ground down on the four sides to a point, makes a very good drill for opening up these holes, with the exception of staybolts that are riveted over so that the hole is closed. I also took the matter up with one of the companies that makes special drills for tell-tale holes. These drills are made of flat twist high-speed steel, the material used having a concave surface on each side. They made me a number with a flute straight edge, and I believe they are superior to anything in the twist drill line for this purpose.

B. Henrikson: We had trouble in drilling the tell-tale holes, which we make $\frac{3}{16}$ in. in diameter. I got up a kink for doing the work which includes an injector that squirts water in the hole. When the machine is started the water blows the chips out. A man can drill 60 or 70 staybolts an hour. In opening up, I find the carbon drill is about as good as any.

E. R. Purchase: I made some staybolt taps with a 45 deg. rose reamer on the end, and find that they make a good hole. You get the hole and the tap follows pretty straight.

Member: I notice the manufacturers are making a four fluted staybolt tap. In our shop we have received them without specifying, and when we put them in use we could not get the bolts to follow the tap. The five fluted tap gives no trouble.

H. Otto: The five fluted taps are the best. You should have a bucket of compound, and when you tap from the outside, use four or five taps in rotation.

J. J. Sheehan: I make a motion that we recommend, as a standard, boiler studs of $\frac{3}{4}$ -in. taper per foot, 12 thread, the form of the thread to be U. S. standard, and that it receive the endorsement of the Tool Foremen's Association.

The matter was laid over for one year to be disposed of at the next meeting.

CHECKING SYSTEM FOR SMALL TOOLS.

Committee: J. T. Fuhrman (Great Northern, St. Paul, Minn.), Alfred Peterson (Colorado & Southern, Denver, Colo.), G. Mitchell (Erie, Galion, O.), H. E. Blackburn (Erie, Dunmore, Pa.) and J. B. Hastey (Santa Fe, San Bernardino, Cal.).

The committee made the following recommendations:

Have the toolrooms centrally located, well lighted, and equipped with racks large enough to hold a sufficient number of tools to meet the daily requirements. Enough cupboards should be furnished to hold templates, standard gages, and a small amount of tools for stock, also files, punches and dies, taps, drills, expanders and repair parts for pneumatic drills and hammers, etc., to replace broken and worn tools.

Every tool should be stamped with its size or name. Have a rack for drills, one for reamers, one for taps, etc. Place the heavy tools at the bottom, and the light ones on the top shelves.

Keep the tools most in use close to the window. Have a stamped brass plate fastened to the shelf showing the size or number of the tool placed there. The tool room, for its use only, should have checks to signify the tools under repairs, or to be replaced. There should be a tool or a check of some kind in every place where a tool is kept.

All the men have shop numbers and the same number should be used on his tool checks; the man when first employed should give his name and check number to the tool room attendant, who makes a record of it and furnishes six tool checks. The office furnishes the toolroom attendant with a list of all the names and their clock number at the end of every month. The list is hung up over the check board, which holds six checks of each number on the time clock in the shop. If there are any changes made the attendant will change the checks.

When a man gets a tool from the tool room he gives a check

for every tool he receives, and the check is put in the place where the tool is kept.

All tools out on tool checks should be returned to the toolroom every night before the hour of closing. Where tool checks remain in the toolrooms over Sunday, the general foreman should be notified and the men to whom the checks belong should be required to give an explanation of why they did not return the tools. A clearance card properly signed should be presented to the toolroom for tools damaged or broken before the tool check will be returned to the workman. At the close of each week the clearance cards should be given to the general foreman.

No machinist, boilermaker, handyman, or apprentice should be allowed to keep any tools whatever in a private place. Such practice is always bound to end by having a large number of tools locked up out of service.

No tools should be loaned outside of the shop beyond the check system, except by a written order from the superintendent, or his assistant. A record should be kept by the tool foreman of every tool loaned and it should be signed by the man who received the tool. The order is kept as a check and is returned to the office when the tool is returned.

No man should receive his time upon quitting without having a clearance card signed by the toolroom foreman.

Generally speaking boys and helpers are employed as toolroom attendants. The idea is to have the boy get acquainted with the tools. It may be all right for the boy, but it is bad for the tools. It takes some time to get acquainted in a large toolroom, and a boy generally wants a change before he really gets familiar with the tools. The attendant should be a man well acquainted with all tools, and should know when a tool is to be repaired or sharpened, and there should be enough help for giving out tools at rush hours in the morning and evening, and the spare time of the extra men should be used in cleaning shelves and tools.

Discussion—Several members described the systems in use in their shops which, in general, were practically the same as the committee recommended. The use of apprentice boys, however, for passing out tools at the windows is very common. There was also some disagreement with the recommendations of the committee as follows:

J. Martin: It is important to know what it costs to carry tools back and forth. In the case of some small tools that cost 50 or 60 cents, the time wasted after they are carried back and forth several times may amount to more than the tool did in the first place. I think it is almost impossible to insist on the men carrying the tools back to the toolroom each night in a large shop. They would have to stop work much earlier in order to get the tools in. I am in favor of giving the men outfits, especially those that are on special classes of work. Each of these men should have a tool box large enough to hold his outfit. We are mounting these on hand trucks. The stud man has his air motor; he could not work 15 minutes without it and he uses it continually. He has taps that he uses frequently, his air hose and, in fact, everything he needs. The box is numbered and he is furnished with a key to lock it. We have a list of the tools in it and frequently inspect them. I find that a man will take much better care of these tools than if he was dependent on the toolroom for them. The idea may be applied to all classes of work. We have men who do not come to the toolroom once a week. If a machinist has to come to the toolroom, his helper has to wait until he returns. Probably there are three or four at the window when he gets there, and sometimes, after he has waited he does not get what he came for. In a large shop where there are 1,000 or 1,200 men working, you can never pass the checking room that you do not see one or two men, often many more. These men are losing time and it is a dead loss; in some cases it exceeds the first cost of the tool. I do not mean that a man is supplied with everything

that he is ever expected to use. He is supplied with the tools he uses mostly. For instance, the stud man—the sizes of studs in a boiler do not have a very wide range and he has a set of the general sizes only. He is supplied with the tools he uses mostly. We have a number of such special tool boxes and I feel that it pays to have them.

A. M. Roberts: This scheme puts too many tools out of use. It would be like making a special engineer for a certain engine and that nobody else could run it. In the shop we have 600 or 700 men; it takes a great many motors, and I think too many tools would be tied up and out of service. We try to keep the motors constantly in service. When they are not in use they are worthless, just the same as a locomotive when it is not running. It is constant service that gives the returns. When a man is through with a motor he immediately returns it to the toolroom, and it is there for somebody else to take out.

C. A. Sheffer: I believe the value of this scheme depends on local conditions, or the distance the toolroom is situated from the work. In some cases an outfit would be a good thing. I would like to know what a standard outfit would include.

E. J. McKernan: We have a standard outfit—it is listed in duplicate on cards. The man who receives the tools has a record, and a copy is left in the toolroom. If he draws more than his required outfit it appears on the card. When he quits he takes his supply to the toolroom and unless he can check off all the tools on the list he will not receive his time.

H. Otto: The outfit given a man depends on what line of work he is doing. A floor man gets three or four files, three chisels, a flat chisel and a monkey wrench; these tools are marked on a card, and he signs it himself. He also gets any extra tools they are marked on the card, and when he quits his tools are returned.

A motion made by A. M. Roberts and seconded by H. Otto, that the association recommend the use of six checks to be carried by the men, was amended by A. R. Davis to read as follows: The American Railway Tool Foremen's Association approves of a checking system that includes the following features: A set of six checks shall be furnished. The man shall carry his checks. Lost checks cannot be replaced without an order from the superintendent or general foreman. Broken or lost tools shall be accounted for to the foreman or general foreman before the checks will be released. A value shall be placed on checks. A man must have a tool clearance before receiving his time. Checks cannot be loaned.

This motion, as amended, was carried.

Honorary Membership—W. H. Bray, former vice-president, president and secretary-treasurer of the association, who has resigned from railway service, was unanimously elected an honorary member.

Election of Officers—The following officers were elected for the next year: President, J. Martin (C. C. & St. L., Beech Grove, Ind.); first vice-president, A. M. Roberts (B. & L. E., Greenville, Pa.); second vice-president, August Meitz (Pere Marquette, Grand Rapids, Mich.); third vice-president, M. B. Roderick (Erie, Hornell, N. Y.); secretary-treasurer, A. R. Davis (Cent. of Ga., Macon, Ga.); executive committee, O. H. Dallman, C. A. Shaffer, A. Sterner, J. J. Sheehan and E. R. Purchase.

The report of the secretary-treasurer showed a balance of \$60.22 and a total membership of 68.

WATER FAMINE AT THE ISTHMUS.—A water famine occurred in parts of the Canal Zone in May, owing to prolonged dry weather. Cristobal was supplied from the Gatun system by loading barges with water, towing them to Cristobal, and pumping the water from them into the mains. West Culebra, Bas Obispo and intervening places were partly supplied from the Chagres River.

the pneumatic press shown in Fig. 4. This press has a 20-in. cylinder, and a pressure of 120 lbs. per sq. in. is used. A swinging jib crane transfers the box to a drill press where the plug

is laid in a level position on the floor and this torch is blocked just above the spaces where the hub faces are to be poured. After heating, a mold is applied as shown in Figs. 6 and 7, and the brass mixture, made of 400 lbs. of scrap brass, 50 lbs. of copper, 6 lbs. of lead, 3 lbs. of tin and 10 lbs. of zinc, is poured. After the hub face is cool, a mold is clamped at either

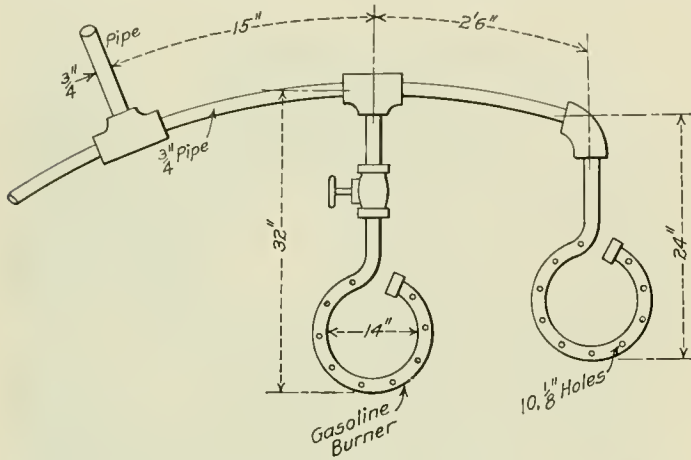

Fig. 5—Apparatus for Preheating When Pouring Brass Hub Faces.

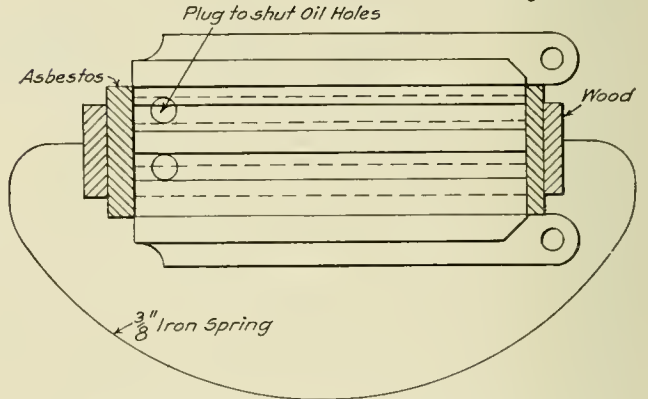
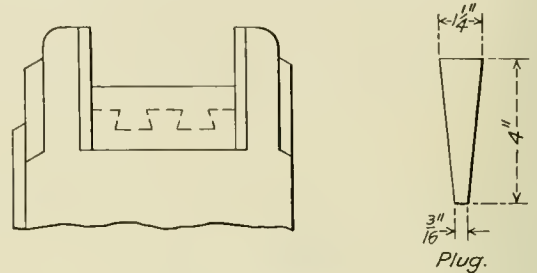

Fig. 8—Molds for Pouring Shoe and Wedge Liners.

end of the shoe and wedge faces as shown in Figs. 7 and 8, and the liners are poured from the same material. In Fig. 7 the method of arranging the plugs for coring the oil holes is clearly shown.

After again being transferred to the machine shop, the box is clamped to the planer as shown in Fig. 9 and the shoe and

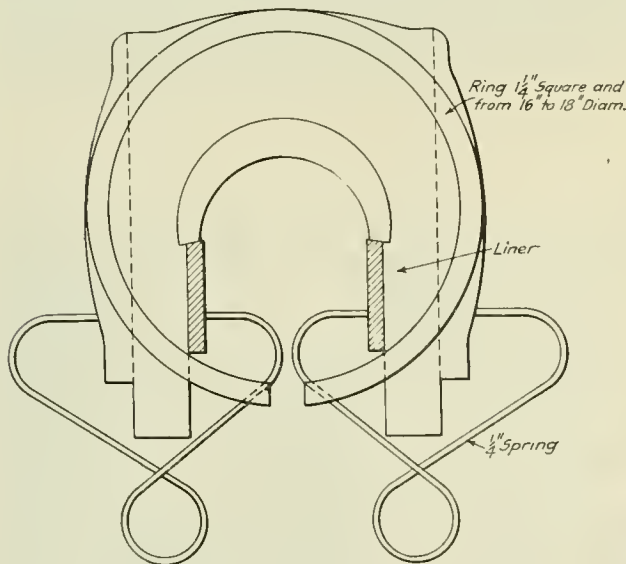

Fig. 6—Mold for Pouring Hub Faces.

holes are drilled and reamed. Tapered brass plugs of the proper length are driven from the inside and riveted.

The box is next transferred to the foundry by a hand truck

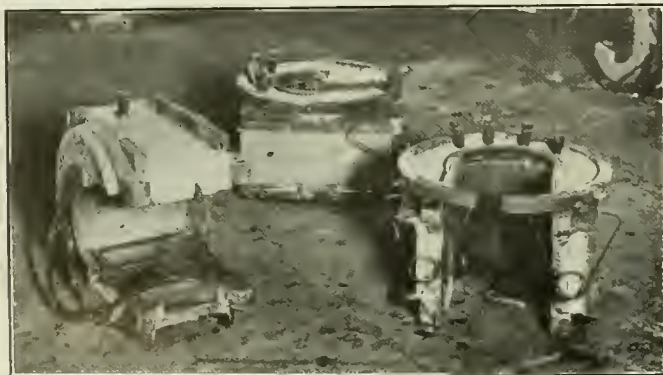

Fig. 7—Boxes After Hub Face and Shoe and Wedge Liners Have Been Poured.

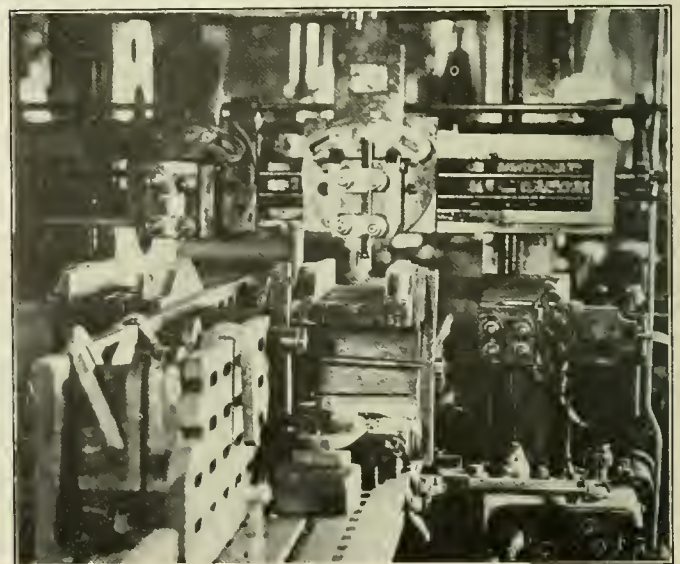

Fig. 9—Boxes Clamped on the Planer.

and the new brass shoe and wedge liners and hub facing are applied. In preparing the boxes for pouring, four are heated at a time, using the gasolene torch shown in Fig. 5. The boxes are

wedge faces are machined to size, after which it is put on the boring mill and bored for the journal fit. While still on the boring mill, the hub face is machined to the proper thickness. In the erecting shop it is fitted to the axle by scraping and spotting. The oil grooves on the shoe and wedge face are chipped and the cellar is fitted to the box.

In the following table are given the times required for the different operations.

| OPERATION. | MACHINE. | TIME PER PIECE. |
|--|----------------------------|-----------------|
| Cleaning | Lye vat | 25 min. |
| Inspecting | | 5 min. |
| Pressing out brass | Pneumatic press | 10 min. |
| Remove hub face | Boring mill | 45 min. |
| Remove shoe and wedge facing | Planer | 30 min. |
| Caliper for brass | | 1 min. |
| Turn new brass | Lathe | 15 min. |
| Slot corners of brass | Shaper | 10 min. |
| Mill oil grooves | Milling machine | 10 min. |
| Press in brass | Pneumatic press | 15 min. |
| Drill all oil and plug holes | Drill press | 45 min. |
| Apply plugs | Hand | 5 min. |
| Heat and pour hub face and shoe and wedge liners | | 12 min. |
| Plane shoe and wedge fit | Planer | 65 min. |
| Caliper and set boring tool | | 5 min. |
| Bore the brass | Vertical boring mill | 25 min. |
| Face hub liner | Vertical boring mill | 20 min. |
| Fit box to axle | Hand | 30 min. |
| Fit and pack cellar | Hand | 15 min. |

EMERY WHEEL GUARD

BY E. L. DUDLEY,
Baltimore & Ohio, Baltimore Md.

The emery wheel guard illustrated is simple to make and apply, and is effective. Fig. 1 shows a side view of an emery wheel, such as is used to grind small castings. *A* is a cast iron guard, and usually covers more of the back of the wheel than is shown here. *B* is the guard which is to be described. The material used is 1/16 in. glass and 1/8 in. galvanized iron. First cut out the two upper covers and the middle *C* of a piece of 1/16 in. iron, as shown in Fig. 2; also punch the rivet holes in the upper edge. Slit the two lower corners and flange the ends and sides over, as shown in Fig. 3. Solder over the two corners where the iron laps. Two of these parts should be made.

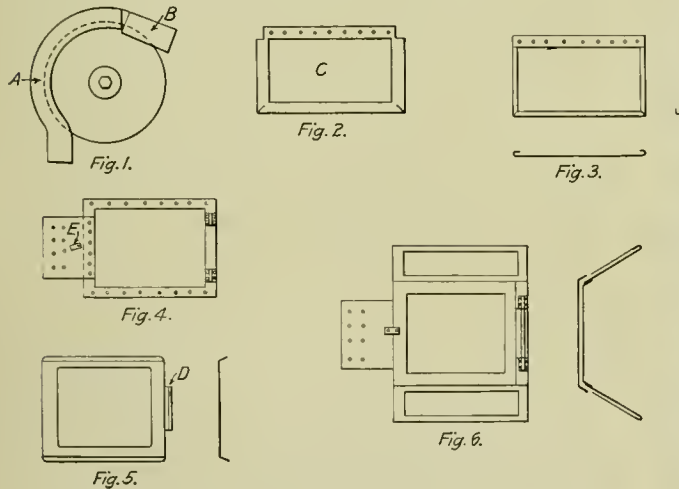

Glass Guard for Emery Wheel.

Next cut a piece of galvanized iron, as shown in Fig. 4, and make two hinges out of the same material and rivet on; also rivet a piece of 1/8 in. iron at the left side and punch the holes in this plate and on the edges of the frame. A door of the same material is then made, as shown in Fig. 5, and is fitted on the part shown in Fig. 4. It is held in position by a piece of wire which goes through *D*, and the hinges on Fig. 4. The other edge of the door is held by the button *E*.

The next step is to assemble the guard. Two pieces similar to the one shown in Fig. 3 are riveted to Fig. 4 on the top and bottom sides. The piece extending to the left in Fig. 4 is riveted to cast iron guard *A*, shown in Fig. 1.

The guard assembled is shown in Fig. 6. Having cut the glass the proper sizes, the lid or door is lifted, and the glass is applied to the sides and the top. The lid laps over the sides, so that the glass for the sides cannot be applied without raising the lid. The advantage of such a guard is that all flying

particles are stopped, thus eliminating the necessity of wearing goggles, and at the same time the work can be plainly seen. The glass can be easily taken out and cleaned, and when broken can be readily renewed. The guard is easily made, and may be applied to larger wheels, if desired.

BAND SAW SAFEGUARDS

Possibilities of serious accidents with band saws are very great, even though used with considerable care and skill. A saw which it is believed is safeguarded sufficiently to prevent any possible personal injury to the operator is shown in the accompanying illustration. The entire lower part of the machine is enclosed in a steel casing, and the upper wheel is encased with a wire netting and steel guard. The use of netting permits a circulation of air to keep the saw cool. It is hinged to the casing so that it may be swung aside and the saw removed when desired. A hollow split tube covers the saw from the upper wheel nearly to the work table, so that there is no danger to the operator when he leans forward to watch his lines. Similarly, at the back where the saw ascends it is shielded in such a way that the elbow cannot be caught when large circular shapes are being worked in curves around the blade. It will be noticed that the use of



Safeguards on a Band Saw.

netting for enclosing the upper wheel also has the advantage of not obstructing the light. There is a slot provided in the netting to permit the adjustment of the bearing of the wheel, if necessary. This guard bears the endorsement of the Industrial Safety Association, to whom we are indebted for the photograph.

ENGLISH TRAFFIC.—On account of the recent strikes in England the majority of railways did not start on their regular summer schedules until the middle of July.

NEW HEADLIGHT AND CAR NUMBERS

The accompanying drawing shows the design of lettering which has been adopted for headlights on the western lines of the Canadian Pacific. They are also used on time cards, and it is expected that they will be put on engine cabs, and possibly later on box cars.

They were designed by George Bury, vice-president, with the

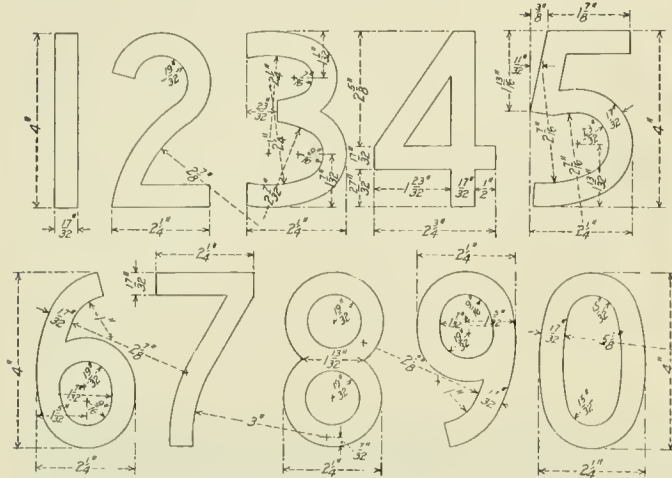

Headlight Numbers Used on the Canadian Pacific.

idea of making them so distinct that it would be impossible to mistake them. In many designs of figures in common use the "3", the "6" and the "8" may often be mistaken for one another. This is largely because the loops on the 3's and 6's are long, and it will be noted that this feature particularly has been eliminated

engine numbers and the trouble resulting from misreading car numbers make it worth while to try to improve the legibility of the figures.

BARCO FLEXIBLE JOINTS.

Experience with the Barco flexible joint shows that it is well adapted to a number of the requirements of railway service where flexible connections are required, and it is now exten-

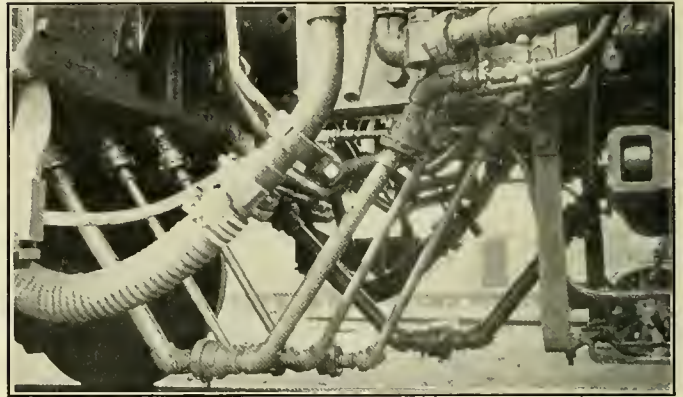

Barco Flexible Joints on Pipes Between Engine and Tender; Chicago & North Western.

sively used as a substitute for rubber hose, especially for the pipe connections between the engine and tender. This joint consists of three metallic parts and two composition gaskets which surround the ball and prevent it from coming in contact with other metallic parts; that is, the cap and casing. The vulcanized gaskets provide a firm resisting seat somewhat softer than the

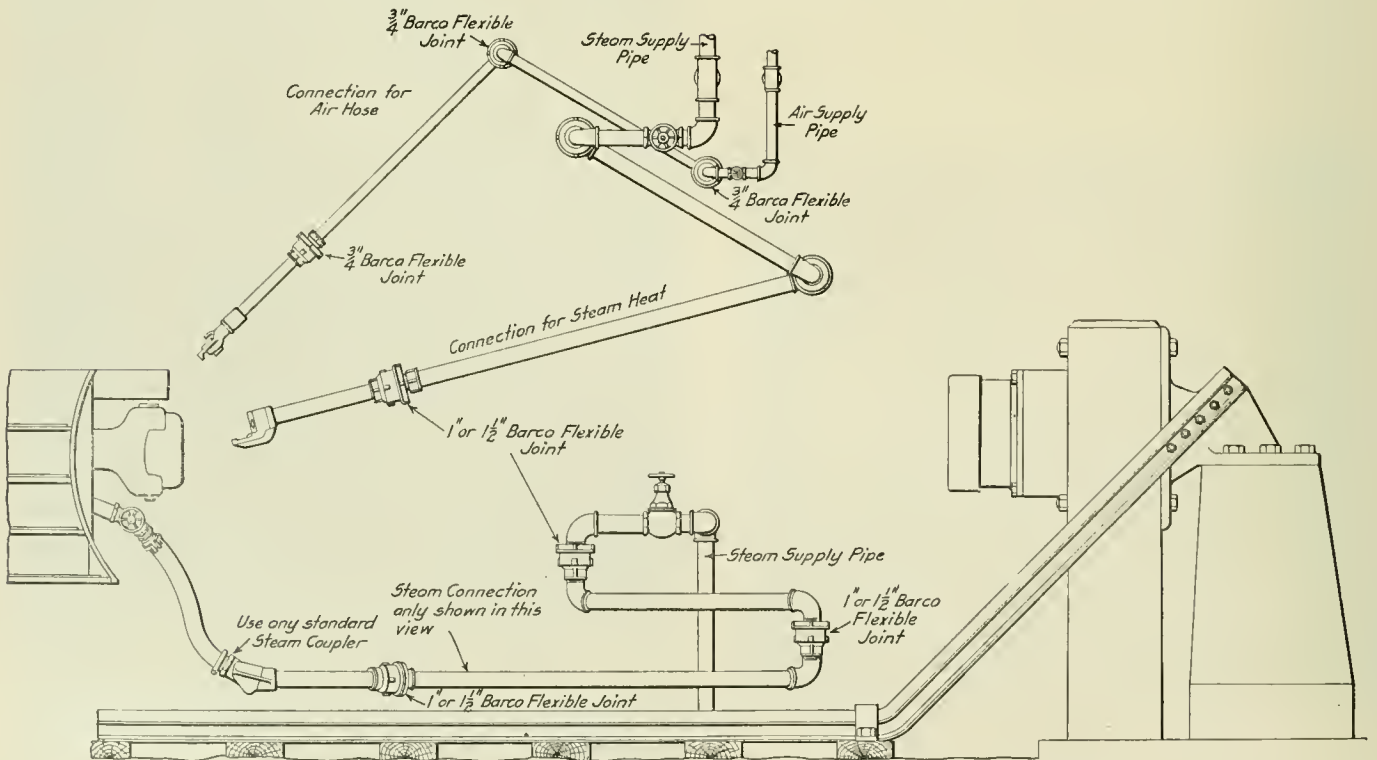

Application of Barco Flexible Joints to Steam Heat and Air Connections at Terminals.

in the accompanying figures. The difference between the "5" and the "6" has also been noticeably increased.

Figures on locomotives and cars have to be read hurriedly in all kinds of light, and the accidents sometimes due to misreading

metal ball but hard enough to keep their shape without disintegration.

The success of this joint is largely due to the peculiar qualities of the composition gasket, as it has sufficient softness to

secure a tight joint and has self-lubricating qualities which insure easy movement with minimum wear. These gaskets are reversible, and thus insure a double wearing surface, and are easily renewable at a small cost. The outer ring of the coupling is split and provided with a set screw so that it becomes adjustable, and slight wear can be taken up in this way.

While many of the Barco joints are made of brass, it is found that when made of a good quality of malleable iron they are entirely satisfactory; they are sufficiently strong and rust-proof, and considerably cheaper than when made of brass. This reduction in the cost of the joint makes it possible to use it in places where the higher cost of brass joints might be prohibitive.

The illustrations show some of the recent applications of this joint. The photographic view shows its use between engine and tender on locomotives recently placed in service on the Chicago & North Western. The large pipe connection is for air to the main train pipe. One of the smaller ones is to the tender brakes and the other for the signal line. The drawing shows the application of the joint for steam heat and air at terminal stations. Here there are several swivel joints with radius pipes which allow considerable flexibility and adjustment. A piping system of this kind is also economical for ash pits, where steam hose is used up very rapidly; it also has a useful application for engine houses, where a steam connection is used for blowing the fire. These flexible joints are made by The Barco Brass and Joint Company, Chicago.

COLD METAL SAW AS A ROTARY PLANER

In shops where a considerable amount of structural material, such as I-beams and channels for tender and car underframes, have to be cut to length, an efficient cold metal saw has been found useful. In most railway shops, however, this machine will not be kept at work all the time, and by the arrangement shown in the illustration its efficiency may be decidedly increased by also using it as a rotary planing machine.

It is readily apparent that a machine that is suited to use inserted saw teeth will be equally suited for work where the teeth are on the side of the holder instead of on the circumference. Therefore, by simply substituting a rotary cutter head for the saw blade, a cold metal saw of this type becomes an efficient rotary planing machine or surface miller. It is then

available for facing the ends of large steel castings and similar work. The capacity of the machine shown in the illustration, which is built by the Newton Machine Tool Works, Philadelphia, Pa., is indicated by the fact that it is capable of removing 1 1/4 cu. in. of metal per horsepower per minute when sawing with a kerf only 9/16 in. in width. It is also capable of cutting off a 15-in. I-beam in two minutes.

STAYBOLT DRILLING MACHINE

Drilling tell-tale holes in staybolts has become a formidable operation in many of the larger shops. While it is sometimes performed after the staybolts are in place in the boiler, it seems to be considered better practice to drill them before their appli-

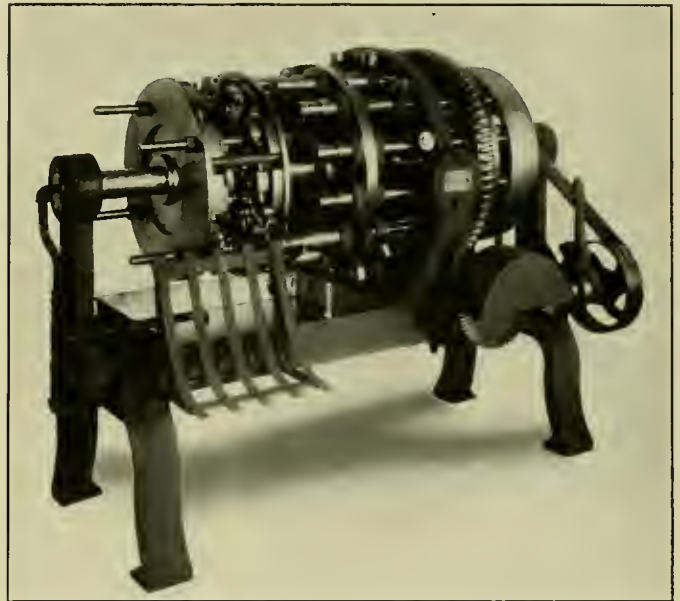

Semi-Automatic Machine for Drilling Staybolts.

cation. To drill each one separately is expensive unless it can be performed at the same time some other operation on the bolt is under way. This plan is generally not feasible, and a semi-automatic machine has been designed which will permit

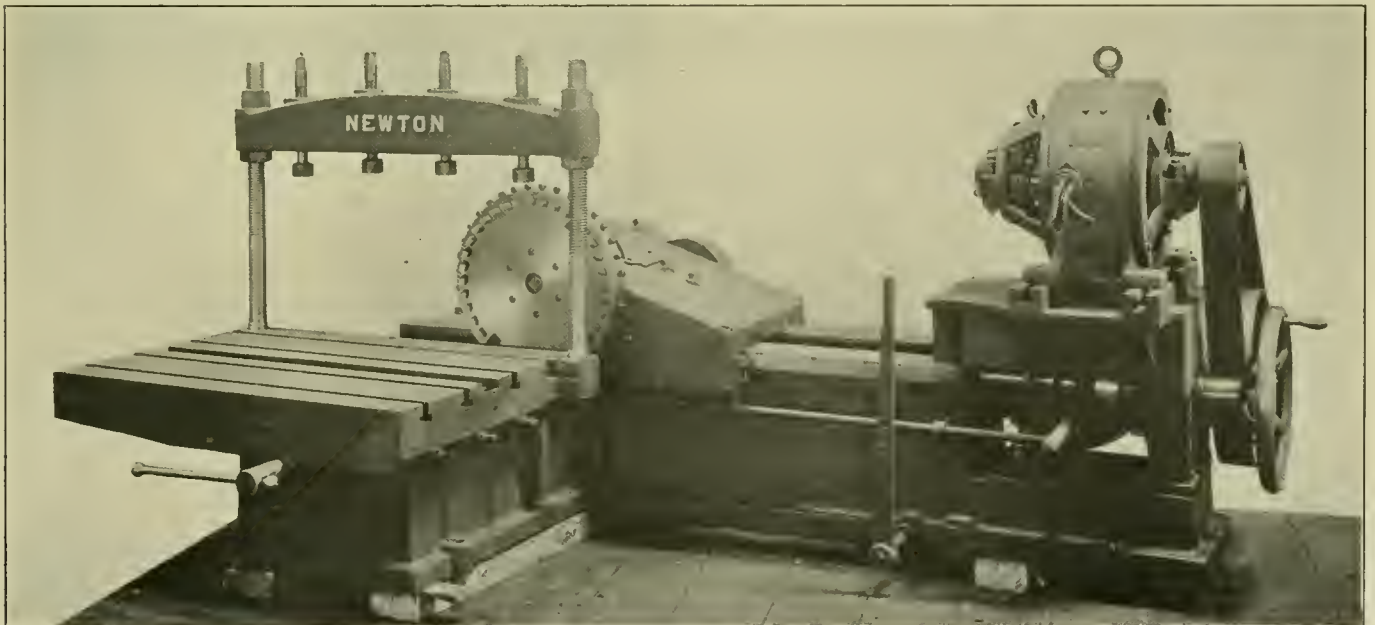

Newton Cold Metal Saw Used as a Rotary Planer.

rapid work with the attention of only an apprentice boy or helper after the machine is once adjusted.

This machine has been designed by the Richmond Staybolt Drilling Machine Manufacturing Company, of Richmond, Va., and carries 12 spindles for drilling. These spindles will drill any depth of hole up to $27\frac{3}{8}$ in., and can be arranged to use drills between $\frac{3}{16}$ in. and $\frac{1}{4}$ in. in diameter. The chucks for holding the drills are carried on one-inch steel spindles that are driven by steel gears which are three inches in diameter with a one-inch face. These 12 small gears mesh with a large 12-in. cast iron gear secured to a shaft driven by a pulley or motor. All of these gears are enclosed in a casing that forms part of the framework which carries the drill spindles and chucks. The outside of this casing is a worm gear, and the whole casing is slowly revolved when in operation. On the drill spindles are sleeves or bushings carrying the drill heads. There is an offset shoulder on these sleeves which carries a hardened steel roller. A cast iron ring, fastened to the bed of the machine, encircles the group of spindles. This ring is formed as a cam on its face and the rollers on the sleeve are held in contact with it by two springs. As the nest of spindles is revolved this cam gives the proper feed to the drills and is arranged to withdraw the drill at the completion of a revolution. There are also two offsets or reliefs which allow the drills to be withdrawn to clear cuttings at intermediate points.

Mounted on the same shaft with the nest of gears is a cage which carries the apparatus for gripping the bolts. Each bolt has a separate grip composed of a malleable casting with a steel case-hardened jaw which is adjustable to take any size bolt from $\frac{15}{16}$ in. to $1\frac{1}{4}$ in. in diameter. These grips are opened and closed automatically by a cam, and the jaws are cushioned to prevent rigidity.

In operation, the staybolt is simply dropped in its grip, and is then automatically clamped as the cage slowly revolves. The drill head then comes forward, and at the completion of the revolution the staybolt is drilled, the drill is withdrawn, the clamp opens, and the bolt drops clear of the machine without further attention.

A rotary force pump takes the drilling fluid from a retainer under the machine and forces it through a passage in the main shaft which is connected to a cavity in the die plate hub, from which it is conveyed by a small pipe to a discharge at each drill. There is a small air pipe arranged to clear any shavings or chips from the grips immediately after the bolt is released.

AN ASPIRATOR FOR COACH CLEANING

BY FRANCIS P. MANN.*

A new apparatus for cleaning railway cars is being furnished to a number of railways on the Continent by Julius Pintsch of Berlin. It operates in much the same manner as the usual vacuum cleaners as regards the operation of cleaning, but is a small portable device connected to the steam heating pipe on a locomotive. It is arranged to be quickly applied and removed, and can be easily stored either aboard the train or at the coach yard or station.

This apparatus is known as a steam aspirator designed on the Koster system and creates a suction through the long hose by means of a steam ejector. In the accompanying illustration it is shown applied to the front end of a small locomotive. The ejector, which is arranged to be readily fitted to the steam hose connection, has a condensing pot below it for collecting the condensed steam. The larger tank to the right is the dust collecting vessel and to the bottom of this is connected about 50 ft. of hose with the suction head for cleaning at the end. Before starting the cleaning, the dust collector is partially filled with

water and when the steam is turned on a partial vacuum is formed and the dust-laden air passing through the hose is cleaned by the water in the collector and reaches the aspirator in a purified condition. This air partially condenses the steam and the tank retains the condensation. Such steam as is not condensed is exhausted through the vertical pipe from the top of this tank.

After the operation has been carried on for some time the dust collecting tank becomes filled with a thin mud, and a discharge plug is provided by which it can be easily cleaned and fresh water again introduced. All parts of the apparatus are so arranged as to be easily taken apart and cleaned. The suction head is made in different shapes, according to the kind of cleaning to be done, and the best results are found to be obtained when the hose from the suction head, for a distance of about 15 ft., is of a smaller cross section than the remainder. Some

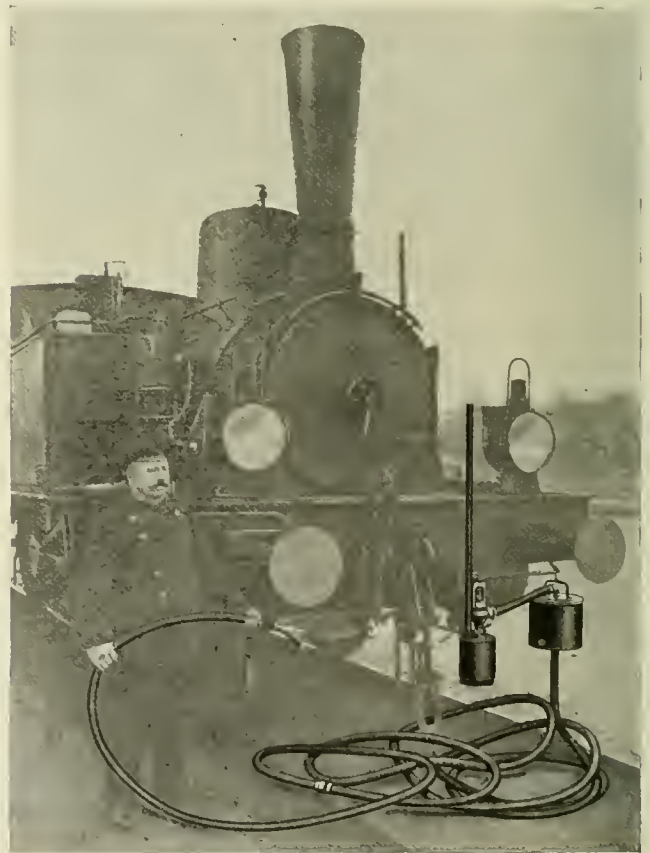

Aspirator for Coach Cleaning.

of the suction heads are provided with small pipes so arranged that the incoming air acts as a jet and stirs up the dust and dirt in upholstery, etc. It is stated by the manufacturers that although neither the condensing pot nor the collector are absolutely necessary for the success of the apparatus, they have been applied and their use is recommended for sanitary reasons.

BRITISH COAL EXPORTS.—In the five months ending May 31, this year, the export of coal from the United Kingdom was 20,416,679 tons, as compared with 26,255,066 tons and 23,898,792 tons in the corresponding periods of 1911 and 1910 respectively. The following were the principal shipments in the first five months of the last three years:

| Country. | 1912. Tons. | 1911. Tons. | 1910. Tons. |
|-----------------|----------------|----------------|----------------|
| Sweden | 1,030,269 | 1,353,327 | 1,337,047 |
| Germany | 2,379,271 | 3,489,983 | 3,347,541 |
| France | 3,415,107 | 4,473,896 | 3,890,391 |
| Spain | 1,258,864 | 1,384,012 | 1,121,132 |
| Italy | 3,159,856 | 3,750,576 | 3,464,850 |
| Egypt | 997,948 | 1,288,357 | 1,067,012 |
| Argentina | 1,082,730 | 1,433,502 | 1,172,544 |

*12 Boulevard Arago, Paris.

GENERAL NEWS SECTION

At a recent meeting of the Board of Pensions of the Rock Island Lines over \$550, monthly pensions, were awarded.

Safety committees have been organized by General Manager Henry Miller, of the Wabash, which will have duties similar to those of the committees on other roads.

The sinking of a coal mine at Dunmore, Pa., on the night of June 25 damaged the building and contents of the Erie repair shops to the extent of \$16,500. No person was in the building when the settling occurred.

E. L. Copeland, secretary and treasurer of the Atchison, Topeka & Santa Fe, has organized the Santa Fe Historical Society, and will endeavor to obtain records from every division and collect all interesting facts connected with the early history of the railway.

A steel freight car ladder that meets the requirements of the Interstate Commerce Commission safety appliances is being tested by the Pennsylvania Railroad. It is made of pressed steel, it is light and can be easily removed from the car by taking out three or four bolts which hold it.

The eight-hour day that has been in vogue in the locomotive shops of the Atchison, Topeka & Santa Fe at Topeka, Kan., has been abolished, and the shops are now working on a nine-hour basis. The passenger car shops are working eight and nine hours and the freight car shops ten hours.

The recent action of the Pennsylvania Railroad in prohibiting the sale of liquor on its trains in the state of Pennsylvania is said to mean that soon liquor will not be sold on the trains between New York and Chicago. It is expected that other railroads in the state will adopt the same practice.

A complete file of the proceedings of the American Railway Master Mechanics' Association, and a collection of miscellaneous volumes of interest to the Department of Railway Engineering, has been presented to the library of the University of Illinois by Jacob Johann, of Springfield, Ill., who has for many years been identified with the Illinois Central.

John Mitchell was sentenced to nine months' imprisonment for contempt of court in connection with the Bucks Stove & Range Company case in the district court at Washington, July 23. Mr. Mitchell is vice-president of the American Federation of Labor, and an appeal to this sentence was taken, as in the cases of Samuel Gompers, the president of the Federation, and Frank Morrison, the secretary.

Sid Paul, locomotive engineer on the Pecos division of the Atchison, Topeka & Santa Fe, has been commended on his fuel performance in freight service. Mr. Paul made 1,852 miles on an average consumption of 12.81 lbs. of coal per 100-ton miles, as compared with the district average of 13.77 lbs. It is figured that during the eight months, from September to May, inclusive, Mr. Paul has saved \$206.66 in this way.

The University of Illinois has published in bulletin form the address by C. A. Seley on the Conference Committee Methods in Handling Railway Legislation on Mechanical Matters; an address by H. M. Bylesby on Organization in Engineering, and an address by C. F. Loweth on Personal Efficiency, which are numbered 25, 27 and 28, respectively. These addresses were delivered to the College of Engineering in the early part of this year.

In furtherance of a plan of fuel economy, the Wabash has placed inspectors at the different mines from which the company receives its coal, and fuel service supervisors in each of the nine operating districts into which the system is divided. These supervisors will instruct firemen in the best methods of firing, and

investigation will be made of the various grades of coal and their use in locomotives of different types. Lectures on fuel economy will be given at stated periods at the various division headquarters.

A "Safety Rally" will be held September 14 at Kansas City, Mo., by the railways entering that place. Eight thousand employees will be invited with the members of their families. The program will include addresses by railway officials on the causes of accidents, and moving pictures will be shown, illustrating the careless and safe methods of performing the various duties of railway employees. W. B. Spaulding, claims attorney of the St. Louis & San Francisco, will have charge of the moving pictures, and addresses will be made by Gardiner Lathrop, general solicitor of the Atchison, Topeka & Santa Fe; J. D. M. Hamilton, claims attorney of the Atchison, Topeka & Santa Fe, and R. C. Richards, general claims agent of the Chicago & Northwestern.

The Denver & Rio Grande put into effect July 1 a safety organization which consists of a central safety committee, division committees and shop committees. Their aim is to correct all conditions, customs and practices that are dangerous. E. N. Clark, general attorney of the road, is chairman of the general safety committee, which is further made up of the superintendent of motive power, general superintendent of the Colorado lines, general superintendent of the Utah lines, chief engineer, chief surgeon, claim agent and inspector of transportation. The shop safety committees will include the master mechanic, as chairman; a representative of the store department, a boiler maker, a machinist, a blacksmith and a car department representative. The central committee will have continuous service, but members of the division and shop committees will be appointed for a term of six months. All members of the committees will be supplied with a neat button indicating their capacity.

The Department of Industrial Research of the University of Pittsburgh, Pittsburgh, Pa., was provided with funds by a Pittsburgh business man in the fall of 1911, with which to make a thorough investigation of the smoke nuisance. A staff of experts have been giving considerable time to this investigation, making studies of the effect of smoke and soot on the atmosphere, weather, plant life, buildings, public health, the economic damage done by smoke and soot, and the mechanical devices for preventing or abating smoke. With the experience obtained from these studies the department announces that the members of its staff are prepared to lecture on the following phases of the smoke problem: The Smoke Nuisance (a general presentation of the main phases of the subject); Smoke and the Public Health; Smoke and the Cost of Living; Smoke and Plant Life; Methods and Means of Smoke Abatement; The Effect of Smoke on Buildings and Building Materials; the Psychology of Smoke; and the Smoke Nuisance and the Housekeeper. All correspondence should be directed to Dr. R. C. Benner, department of industrial research, University of Pittsburgh, Pittsburgh, Pa.

A bill has been passed by the House of Representatives creating the Department of Labor, the head of which will be a member of the President's cabinet. The purpose of the department is to guard and promote the welfare of the wage-earners and to improve their working conditions and opportunities. It is expected, however, that there will be some opposition to the bill in the Senate, partly on the ground that there is no reason to suppose that such a department would do more favorable work in connection with labor matters than the present Department of Commerce and Labor is doing. The House bill, concerning a commission of nine members, not less than three of whom are to be employers and three representatives of organized labor, to

inquire into the condition of labor in the principal industries of the country, has been favorably decided upon by the Senate Labor Committee.

MEETINGS AND CONVENTIONS

Master Blacksmiths' Association.—The twentieth annual convention of the International Railroad Master Blacksmiths' Association will be held at Hotel Sherman, Chicago, August 20-22, inclusive. The subjects to be considered are as follows: What Has the Association Accomplished During its Twenty Years of Existence; Flue Welding; Carbon and High Speed Steel; Drop Forgings; Frogs and Crossings; Case Hardening; Forging Machines, Dies and Formers; Spring Making and Repairing; Locomotive Frame Making and Repairing; Piece Work and Other Methods of Having Work Done; Shop Kinks; Oxy-Acetylene Process for Welding and Cutting of Metals, and Heat Treatment of Metal. In addition to this, the president has issued a request to all members of the association to present subjects that they are definitely interested in and will be of interest to the association.

Master Painters' Association.—The forty-third annual convention of the Master Car & Locomotive Painters' Association of the United States and Canada will be held in the Albany hotel at Denver, Col., September 10-13, inclusive. Among the subjects to be considered are: The Finish of Vestibule Ends; the Essentials of a Protective Paint Making Oil; Interior Car Renovators; the Most Economical Method of Removing Paint from Locomotive Jackets; Passenger Car Concrete Floors; Care of Steel Passenger Car Roofs; Standard Paint Material for Railway Equipment; Exterior Passenger Car Painting; the Present Day Foreman Painter; the Treatment of Ash, Oak or Mahogany Natural Finish; Relative Cost of Maintenance Between Steel and Wooden Passenger Cars, and the Painting of Wooden Freight Car Roofs. Arrangements have been made for a special train which will leave over the Rock Island Lines from Chicago to Denver, by way of Colorado Springs, on Saturday, September 7, at 10:30 p. m. The train will arrive in Colorado Springs early Monday morning, so that the day may be spent on sight seeing, and will leave at 7 p. m., arriving at Denver about 10 p. m.

The following list gives names of secretaries, dates of next or regular meetings, and places of meeting of mechanical associations.

- AIR BRAKE ASSOCIATION.—F. M. Nellis, 53 State St., Boston, Mass. 1913 convention to be held at St. Louis, Mo.
- AMERICAN RAILWAY MASTER MECHANICS' ASSOC.—J. W. Taylor, Old Colony building, Chicago.
- AMERICAN RAILWAY TOOL FOREMEN'S ASSOCIATION.—A. R. Davis, Central of Georgia, Macon, Ga.
- AMERICAN SOCIETY FOR TESTING MATERIALS.—Prof. E. Matburg, University of Pennsylvania, Philadelphia, Pa.
- AMERICAN SOCIETY OF MECHANICAL ENGINEERS.—Calvin W. Rice, 29 W. 39th St., New York.
- CAR FOREMEN'S ASSOCIATION OF CHICAGO.—Aaron Kline, 841 North 50th Court, Chicago; 2d Monday in month, Chicago.
- INTERNATIONAL RAILWAY FUEL ASSOCIATION.—C. G. Hall, McCormick building, Chicago.
- INTERNATIONAL RAILWAY GENERAL FOREMEN'S ASSOCIATION.—William Hall, Chicago & North Western, Escanaba, Mich.
- INTERNATIONAL RAILROAD MASTER BLACKSMITHS' ASSOCIATION.—A. L. Woodworth, Lima, Ohio. Convention, August 20, Sherman Hotel, Chicago.
- MASTER BOILER MAKERS' ASSOCIATION.—Harry D. Vought, 95 Liberty St., New York.
- MASTER CAR BUILDERS' ASSOCIATION.—J. W. Taylor, Old Colony building, Chicago.
- MASTER CAR AND LOCOMOTIVE PAINTERS' ASSOC. OF U. S. AND CANADA.—A. P. Dane, B. & M., Reading, Mass. Convention, September 10-13, Albany Hotel, Denver, Col.
- RAILWAY STOREKEEPERS' ASSOCIATION.—J. P. Murphy, Box C, Collinwood, Ohio.
- TRAVELING ENGINEERS' ASSOCIATION.—W. O. Thompson, N. Y. C. & H. R., East Buffalo, N. Y. Convention, August 27-30, Sherman Hotel, Chicago.

PERSONALS

GENERAL.

H. E. PENDLETON, road foreman of engines of the Atchison, Topeka & Santa Fe at Belen, N. Mex., has resigned.

T. F. SULLIVAN, division master mechanic of the San Antonio & Aransas Pass, with office at Yoakum, Tex., has resigned.

W. D. JOHNSTON, division master mechanic of the International & Great Northern, with office at Palestine, Tex., has resigned.

J. E. SENTMAN has been appointed road foreman of engines of the Baltimore & Ohio, in charge of the locomotives between Philadelphia and Baltimore, Md.

H. OSBORNE has been appointed assistant superintendent of motive power of the Canadian Pacific, with offices at Montreal, Que., succeeding L. R. Johnson.

J. F. McDONOUGH, master mechanic of the Atchison, Topeka & Santa Fe at Newton, Kan., has been transferred to Shopton, Iowa, succeeding J. R. Sexton, promoted.

I. WELLMAN, road foreman of engines of the Atchison, Topeka & Santa Fe at Argentina, Kan., has been appointed master mechanic, with office at Newton, Kan.

J. R. SEXTON has been promoted to mechanical superintendent of the Northern district of the Western lines of the Atchison, Topeka & Santa Fe, with office at La Junta, Col.

JOHN C. BRENNAN has been appointed road foreman of engines on the Adirondack division of the New York Central & Hudson River, vice N. J. Graves, assigned to other duties.

L. R. JOHNSON, assistant superintendent of motive power, eastern lines, of the Canadian Pacific at Montreal, Que., has been appointed general superintendent of the Angus shops district.

A. L. CREW has been appointed road foreman of engines of the Los Angeles division of the Atchison, Topeka & Santa Fe, with headquarters at San Bernardino, Cal., vice Walter Reed, retired.

J. D. YOUNG, general foreman of the Missouri Pacific, at Atchison, Kan., has been appointed master mechanic of the Omaha division, with office at Falls City, Neb., succeeding W. G. Seibert.

W. G. SEIBERT, master mechanic of the Omaha division of the Missouri Pacific, at Fall City, Neb., has been appointed master mechanic of the Colorado division, with office at Hoisington, Kan.

FRANK ZELENY, assistant to the superintendent of shops of the Chicago, Burlington & Quincy at Aurora, Ill., has been appointed engineer of tests, with office at Aurora, succeeding William A. Derby, deceased.

W. C. SMITH, master mechanic of the Missouri Pacific-St. Louis, Iron Mountain & Southern, with office at Kansas City, has been appointed general master mechanic of the Western district, with office at Kansas City.

T. RUMNEY, who is assistant second vice-president of the Rock Island Lines at Chicago, has also been appointed assistant vice-president in charge of mechanical matters of the St. Paul & Kansas City Short Line.

E. F. STROEH, master mechanic, Colorado division of the Missouri Pacific at Hoisington, Kan., has been appointed master mechanic of the Kansas City Terminal division, with office at Kansas City, Mo., succeeding W. C. Smith, promoted.

D. W. CUNNINGHAM, assistant superintendent of machinery of the Southern district of the Missouri Pacific, Iron Mountain & Southern, with office at Little Rock, Ark., has had his title changed to general master mechanic; his duties, however, will be the same as heretofore.

J. R. SEXTON, master mechanic of the Missouri division and the Shopton shops of the Atchison, Topeka & Santa Fe at Shopton, Iowa, has been appointed mechanical superintendent of the Western lines, Northern district, with office at La Junta, Colo., succeeding M. J. Drury, promoted.

J. P. McMURRAY, who has been appointed master mechanic of the Rio Grande division of the Atchison, Topeka & Santa Fe, with office at Albuquerque, N. Mex., as announced in the July *American Engineer*, was born August 21, 1858. He began railway work as a wiper for the Atchison, Topeka & Santa Fe at Pueblo, Colo., in October, 1877, and has been with that road ever since. He was made locomotive fireman at Pueblo in 1878, and three years later was made locomotive engineer on the Rio Grande division at San Marcial. In January, 1903, he was promoted to road foreman of engines on the Rio Grande division and the Third district of the New Mexico division. He subsequently held the same position on the Western division, the River division and the Colorado division, and was promoted to master mechanic on May 15, 1912.



J. P. McMurray.

J. B. KILPATRICK, district mechanical superintendent of the Chicago, Rock Island & Pacific at Des Moines, Iowa, has been also appointed mechanical superintendent of the St. Paul & Kansas City Short Line, the position of superintendent of motive power of that road having been abolished.

W. L. TRACY, assistant superintendent of machinery of the Western district of the Missouri Pacific-St. Louis, Iron Mountain & Southern, with office at Kansas City, Mo., has been appointed general master mechanic of the Eastern district, with office at St. Louis, Mo. The office of assistant superintendent of machinery has been abolished, and the duties of these officers will be assumed by the general master mechanic.

R. J. TURNBULL, acting superintendent of machinery of the eastern district of the Missouri Pacific-St. Louis, Iron Mountain & Southern, with office at St. Louis, has been appointed mechanical superintendent of the entire Missouri Pacific-St. Louis, Iron Mountain & Southern, with office at St. Louis. The office of superintendent of machinery has been abolished and the duties heretofore performed by that officer have been assumed by the mechanical superintendent.

PURCHASING AND STOREKEEPING.

C. J. ROGERS, acting purchasing agent of the White Pass & Yukon Route at Vancouver, B. C., has been appointed purchasing agent, with office at Vancouver.

J. A. STRUBEL, assistant to the receivers of the Detroit, To-

ledo & Ironton at Detroit, Mich., has been appointed assistant to the receiver and purchasing agent, with office at Detroit.

BERTON ALLEN AIKENS has been appointed purchasing agent of the Michigan Central, with office at Detroit, Mich. Mr. Aikens was born August 25, 1869, at Hartford, Vt., and he received a public school education. He began railway work on April 1, 1889, with the Central Vermont Railroad. On April 1, 1899, he became a clerk in the office of the purchasing agent of the Rutland Railroad, was subsequently chief clerk in that office, then assistant storekeeper, and on February 1, 1905, was promoted to purchasing agent, which office he resigned on July 1 to become purchasing agent of the Michigan Central, and, effective July 11, to become also general tie agent of that road, the Lake Shore & Michigan



B. A. Aikens.

Southern; the Lake Erie & Western; the Lake Erie, Alliance & Wheeling; the Cleveland, Cincinnati, Chicago & St. Louis; the Peoria & Eastern, the Cincinnati Northern; the Toledo & Ohio Central; the Zanesville & Western, and the Chicago, Indiana & Southern.

SHOP

E. W. TUCKER, pipe shop foreman of the Atchison, Topeka & Santa Fe at Colvis, N. Mex., has resigned.

THOMAS MULVIHILL has been appointed boiler foreman of the Chicago, Rock Island & Pacific at Argenta, Ark.

J. TANGNEY has been appointed foreman of the locomotive and car department at Inver Grove, Minn., vice E. A. Sweeley, resigned.

G. L. HEGBERG has been appointed night engine house foreman of the Chicago, Rock Island & Pacific at Argenta, Ark., vice C. A. Welch.

T. A. MERRIFIELD has been appointed boiler foreman of the Atchison, Topeka & Santa Fe at Las Vegas, Nev., vice W. J. Doerfler, resigned.

H. C. CURTAIN, night engine house foreman of the Atchison, Topeka & Santa Fe at Needles, Cal., has been appointed day engine house foreman at Barstow.

J. C. BEVELLE, apprentice instructor of the Atchison, Topeka & Santa Fe at Topeka, Kan., has resigned to go with the El Paso & Southwestern, at El Paso, Tex., as tool foreman.

W. H. GABLE has been appointed assistant engine house foreman of the Minneapolis, St. Paul & Sault Ste. Marie at North Fond du Lac, Wis., vice C. A. Bauers, transferred.

E. ZIMMER, former engine house foreman of the Minneapolis, St. Paul & Sault Ste. Marie, has been transferred to North Fond du Lac, Wis., vice L. Colburn, resigned.

C. A. BAUERS, former assistant engine house foreman of the Minneapolis, St. Paul & Sault Ste. Marie, has been appointed engine house foreman at Stevens Point, Wis., vice E. Zimmer, transferred.

NEW SHOPS

CANADIAN PACIFIC.—The town of Trenton, Ont., has given this road a free site for an engine house and station, on the condition that Trenton is made a division point.

CENTRAL VERMONT.—The repair shops at St. Albans, Vt., will be enlarged.

CHICAGO, PEORIA & ST. LOUIS.—The shops at Jacksonville, Ill., will be removed to Springfield by October 1.

CLEVELAND, CINCINNATI, CHICAGO & ST. LOUIS.—A new five-stall engine house will be built at Carey, Ohio; a 10-stall engine house at Hillsboro, Ill., and a 10-stall brick engine house at Terre Haute, Ind.

GEORGIA SOUTHERN & FLORIDA.—A drop pit shop will be built at Macon, Ga., for locomotive repairs.

GRAND TRUNK.—It is reported that large locomotive shops will be built at Brockville, Ont.

ILLINOIS CENTRAL.—The contracts for the new engine terminal at Centralia, Ill., have been awarded. They include a 48-stall engine house, an erecting shop, power house, machine shop, car repair shop, mechanical coaling station, three cinder pits, an inspection pit and two water tanks. The contract for building construction has been awarded to T. S. Leake & Company, Chicago.

LAKE ERIE & WESTERN.—Improvements will be made in the shops at Rankin, Ill., and additional power equipment will be installed.

MISSOURI, OKLAHOMA & GULF.—It is reported that \$400,000 will be spent on new shops of steel, brick and concrete construction at Muskogee, Okla. They will include a machine, repair and boiler shop, transfer table and engine house.

NEW YORK, ONTARIO & WESTERN.—The car shops at Middletown, N. Y., were destroyed by fire July 3. The estimated loss is \$250,000. They will be rebuilt.

NORFOLK & WESTERN.—It is reported that a 25-stall engine house will be built at Crewe, Va., at a cost of about \$50,000.

NORTHERN PACIFIC.—It is reported that a car wheel shop will be erected at Missoula, Mont.

PERE MARQUETTE.—A contract has been awarded to Hauser-Owen-Ames Company, Grand Rapids, Mich., for a 16-stall engine house at Ludington, Mich., that will cost approximately \$50,000. The contract for the 12-stall engine house at Port Huron, Mich., has been awarded to Rabbit & Sons, Toledo, Ohio, to cost approximately \$40,000. The contract for the coaling station at Saginaw, Mich., has been awarded to the Fairbanks, Morse & Company, Chicago, the approximate cost being \$50,000.

VIRGINIAN.—It is reported that contracts have been let for an eight-stall addition to the engine house at Roanoke, Va., and Victoria.

WABASH RAILROAD.—The contract for a complete engine terminal at Detroit, Mich., to cost \$100,000, has been awarded to C. W. Gindele & Company, Chicago.

WESTERN PACIFIC.—The work that was suspended on the shops at Sacramento, Cal., will be resumed and the shops will soon be completed.

TELEGRAPH SERVICE RECORD.—According to an officer of the Western Union Telegraph Company, the *Titanic* tragedy produced the greatest volume of telegraphic communication of any single event in history. The day the *Carpathia* reached New York, Western Union wires handled 715,000 words (of press matter) compared with a previous high record for a single day of 433,000.

SUPPLY TRADE NOTES

Isaac Block, president of the Hyman-Michaels Company, Chicago, died July 10.

The Chicago Steel Car Company has moved its general offices from Chicago to its plant at Harvey, Ill.

The Jerguson Manufacturing Company, Boston, has moved its general office from 221 Columbus avenue to 10 Post Office Square.

The Davenport Locomotive Works, Davenport, Iowa, has opened an office in the First National Bank building, Cincinnati, Ohio.

Harry N. Turner has been made eastern railway representative of the Kay & Ess Company, Dayton, Ohio, succeeding D. L. Paulus, who died at his home in Atlantic City, N. J., June 20.

The Railway Motor Car Company, Marion, Ind., has been incorporated with W. P. Worth, J. D. Worth, H. B. Shore, G. R. Stewart and Eben H. Wolcott, as directors. The capital stock is \$200,000.

The Brownell Company, Dayton, Ohio, maker of automatic and throttling engines, boilers, feed water heaters, etc., has opened a branch office in the Oliver building, Pittsburgh, Pa., in charge of B. S. Rederer.

F. T. Heffelfinger has been elected vice-president of the American Arch Company, New York, succeeding C. B. Moore, who has resigned to go to the Jacobs-Shupert United States Firebox Company, Coatesville, Pa.

The new plant of the Canadian Steel Foundries, at Longue Pointe, Que., is ready for operation. This concern is a subsidiary of the Canadian Car & Foundry Company, and it is the largest producer of steel castings in Canada.

E. P. Williams, purchasing agent of the Baldwin Locomotive Works, Philadelphia, Pa., has been appointed assistant to the vice-president. Mr. Williams held his former position for 25 years and will be succeeded by John Lindauer, Jr.

The Warner & Swasey Company, Cleveland, Ohio, has petitioned to increase its capital stock from \$500,000 to \$1,000,000. The company contemplates the construction of an additional building on the east side of its present structures.

W. H. Davis, formerly with the Scully Steel & Iron Company, Chicago, has gone with the Jos. T. Ryerson & Son, Chicago, with office in New York. Mr. Davis will be especially interested in the machinery sales department.

F. H. Stevens, a member of the executive committee of the American Locomotive Company, New York, has been elected director of the United States Cast Iron Pipe & Foundry Company, Burlington, N. J., succeeding John A. Hayes.

Templeton, Kenly & Company, Ltd., Chicago, have moved their Chicago offices and shops from 1335 Sloan street to their new plant at 1016-1024 South Central avenue. A switch from the Baltimore & Ohio Chicago Terminal connects with this plant.

The Vulcan Engineering Sales Company, Chicago, has taken the selling agency for the line of structural and plate working machinery, such as punchers, shears, rolls, bulldozers, etc., manufactured by the Rock River Machine Company, of Janesville, Wis.

W. L. Allison, of the Franklin Railway Supply Company, New York, with office at Detroit, Mich., has been made general Western sales manager of the American Arch Company, New York, with office in the McCormick building, Chicago. Mr. Allison will represent both companies.

Louis E. Carlton, president of the Heywood Brothers & Wakefield Company, Wakefield, Mass., died at his home in

Gardner, Mass., July 4, at the age of 50. Mr. Carlton was also president of the First National Bank of Gardner, and was a delegate to the National Republican Convention in 1908.

The U. S. Metal & Manufacturing Company, New York, will no longer act as agent for axles made by the Carbon Steel Company, Pittsburgh, Pa. On July 1 the company took over the account of the Pollak Steel Company, Cincinnati, Ohio, manufacturer of heat-treated traction axles, tender and driving axles, crank pins, side and driving rods, equalizers, etc.

The Westinghouse Electric & Manufacturing Company, Pittsburgh, Pa.; the Equitable Trust Company, New York; the Stone & Webster Corporation, Boston, Mass., and William Morris Imbrie & Company, New York, have formed a syndicate to purchase the controlling interest in the Electric Properties Company, New York, from the Westinghouse Machine Company, Pittsburgh, Pa.

The following companies, which are controlled by the same interests, have moved their general offices to the new Vanadium building, Forbes and Meyran avenues, Pittsburgh, Pa.: The American Vanadium Company; the Vanadium Sales Company of America; the Flannery Bolt Company; the Vanadium Metals Company; the J. Rogers Flannery & Company, and the Keystone Nut Lock Manufacturing Company.

John Gill, a former superintendent of motive power of the Chicago, Indianapolis & Louisville, has been appointed manager of the Permanent Manufacturers' Exhibit of Railway Supplies and Equipment, in the Karpen building, Chicago. Mr. Gill is thoroughly conversant with the mechanical department of railways, having worked his way from a machinist apprentice to superintendent of motive power, as above stated.

The National Steel Car Company, Ltd., Hamilton, Ont., has been organized with a capital of \$6,000,000, and will erect a car building plant on a 50-acre site on the water front east of Hamilton, where the company will make wooden and steel freight cars. The capacity of the plant for the present will be 30 cars a day, which will later be increased. The officials of the company are as follows: President, Sir John Gibson, lieutenant-governor of Ontario; vice-president and general manager, Basil Magor, of New York; assistant secretary, treasurer and purchasing agent, Adolph Butze. The directors are Sir John Gibson, William Southam, and J. J. Scott, all of Hamilton; Sir H. Pellatt, of Toronto, Ont.; W. G. Ross, Mortimer Davis and C. H. Cahon, all of Montreal; William Barclay Parsons, W. Kirkpatrick Brice, Murray H. Coggeshall and Basil Magor, all of New York. The company has placed contracts for its steel work, and all contracts are being let for completion not later than November of this year. The main plant will be 900 ft. x 200 ft. The general offices will be at Montreal, Que.

The Lima Locomotive & Machine Company, Lima, Ohio, has been reorganized as the Lima Locomotive Corporation. The new corporation has sold to Redmond & Company, New York, the entire issue of \$2,000,000 first mortgage 20-year sinking fund gold bonds, callable at 110, on any interest date, the proceeds of which will be used for the erection of additional buildings, purchase of equipment and for working capital. The new plant will provide employment for 4,000 men. For many years the old company made only geared locomotives, but during the past ten years it has steadily increased its output of locomotives of all classes until further extensions have become necessary. The new corporation owns 43 acres of land at Lima, Ohio, on which there is a modern plant, having a capacity of 400 engines per year. This capacity will be increased to 900 or 1,000 locomotives a year. The net earnings for the past seven years, after deducting for depreciation, have averaged two and a third times the interest on the new bonds. The directors are: A. L. White, Ira P. Carnes, W. T. Agerter, O. J. Thomen, George L. Wall and Merle Middleton, who is chairman of the board. The com-

pany will be under the management of the same official staff as heretofore with the officers as follows: President, A. L. White; vice-president, George L. Wall; secretary and treasurer, W. T. Agerter.

Gilbert H. Pearsall, secretary of Joseph T. Ryerson & Son, Chicago, has been made a vice-president of the Jacobs-Shupert United States Firebox Company, Coatesville, Pa., and Charles

Brearley Moore, vice-president of the American Arch Company, New York, has resigned that position to become a vice-president of the Jacobs-Shupert Company. Mr. Pearsall will be in charge of the New York office of the Jacobs-Shupert company. He still retains his position as secretary of the Ryerson company, with which concern he has been connected since May, 1901. Since January 1, 1905, he has been in general charge of the sales of that company. In 1887 Mr. Pearsall entered the service of the Erie, with office at Owego, N. Y.

From 1891 to 1897 he was chief rate clerk of the Chicago, Burlington & Quincy, and from 1897 to 1899 he was chief clerk in the traffic manager's office of the Indiana, Illinois & Iowa, now a part of the New York Central Lines. From 1899 and 1901 he was city freight agent and freight agent of the Delaware, Lackawanna & Western. In May, 1901, he resigned his

position with that road to go to the Ryerson company. Mr. Moore will have charge of the western sales department of the Jacobs-Shupert company, with office in Chicago. He was born in McComb, Ill., in 1874, and received his primary education in the public schools, graduating in 1891 from the Kewanee, Ill., high school. In 1895 he was graduated from the Lake Forest University and then went to the Northwestern University law school from which he was graduated in 1898. In 1900 he organized the Columbia Boiler



G. H. Pearsall.



C. B. Moore.

Company to make house heating apparatus and boilers. In 1902 he organized the American Locomotive Equipment Company, of which he was general manager and a director until 1911, when he was made president of the company. Mr. Moore shared in the organization of the American Arch Company in 1910 and was made vice-president and a director of that company. In 1911 he organized the Boss Nutt Company, Chicago, of which he is now a director. Mr. Moore has invented and developed a number of locomotive devices, of which his brick arch is the best known.

CATALOGS

CAR APPLIANCES.—The Wine Railway Appliance Company, Toledo, Ohio, has issued a brief catalog describing their steel car ladders and freight car ventilators.

SNOW FLANGER.—The Railway Appliance Company, Chicago, has issued an 8-page pamphlet illustrating their various types of snow flangers as applied to locomotives in service.

FORGED STEEL VALVES.—The Patterson-Allen Engineering Company, New York, has published a folder describing their forged steel valves, giving the price list and table of dimensions for the various sizes.

KEROSENE GAS ENGINES.—The Wisconsin Engine Company, Corliss, Wis., has published a leaflet giving a general description of its kerosene gas engines. This company builds these engines of from 50 to 200 h. p. capacity.

WIRE GLASS.—The Pennsylvania Wire Glass Company, Philadelphia, Pa., has issued a catalog describing their cobweb wire glass, its uses and advantages in building construction. Fire tests that have been made on this glass are also included.

TURBINES.—The Kerr Turbine Company, Wellsville, N. Y., has published bulletin No. 24 on the Economy steam turbine for belt drive. This bulletin illustrates installations and describes the construction of these turbines and points out their advantages.

ROOFING.—The Barrett Manufacturing Company, New York, has issued a catalog entitled A Mile of Barrett Specification Roofs, which apply to the installation at the Bush terminals in Brooklyn. The total roof area of these buildings is 3,100,000 sq. ft., or more than 70 acres, which is covered with the Barrett specification type roofs.

TRANSFORMERS.—The Crocker-Wheeler Company, Ampere, N. J., has issued bulletin No. 151, which describes and illustrates the Remek distributing transformers. Various processes in manufacture are illustrated and the detailed construction is explained. One of the special advantages of the Remek type of transformer is in the low average core loss.

SMALL MOTORS.—The General Electric Company, Schenectady, N. Y., has issued bulletin No. 4963, which describes small motors ranging in size from 1/50 to 1/4 h. p. wound for either direct or alternating current. The illustrations show the completed motors and various processes used in manufacture, together with structural details and typical installations.

CHAINS.—The Jones & Laughlin Steel Company, Pittsburgh, Pa., has issued a clearly illustrated leather bound catalog describing their various types of chains and hooks, together with a brief description of their manufacture and maintenance. Tables are also given of tests and weights of the various grades of their chains. Special chains and attachments are also illustrated.

OXY-ACETYLENE WELDING AND CUTTING.—The Alexander Milburn Company, Baltimore, Md., has issued a well illustrated catalog of 23 pages describing the work that may be done with their welding and cutting apparatus. The acetylene generator and oxy-acetylene torch are also described and illustrated. A price list of their various outfits and stock list is included in a separate folder.

DRAFT GEARS.—The Forsyth Bros. Company, Chicago, have issued a 24-page pamphlet entitled the "Modern Connections Between Drawbars and Draft Gears," in which they quote from the proceedings of the M. C. B. association concerning drawbar side clearance. Various illustrations are included which show graphically the faults of a restricted side clearance, and their improved radial yoke which tends to decrease side clearance restrictions.

PNEUMATIC HAMMER-DRILL.—The Ingersoll Rand Company, New York City, has issued form No. 4021, which describes the new type BCR-43 Jackhammer. This machine is a new development of the hand hammer drills and is designed to operate with either steam or air. It is automatically rotated, being equipped with the butterfly valve, a simple piece of steel oscillating on a central trunnion actuated by the unbalanced pressure on the wings. The drill has a cylinder 2 1/4 in. in diameter and a 2 in. stroke.

ELECTRIC LOCOMOTIVES.—The Westinghouse Electric & Manufacturing Company, East Pittsburgh, Pa., has published a 64-page catalog entitled Baldwin-Westinghouse Electric Locomotives. It is quite complete, and includes various illustrations showing the different types of electric locomotives and many of their details. A brief history is given of the modern railway motor, with illustrations of the improved details in design. The unit switch control system is discussed, as is the design of cabs, underframes, trucks, wheels, journals, special equipment, etc. A few pages are devoted to data concerning the selection of electric locomotives, their operation on curved track and train resistance.

FUEL ECONOMIZER.—The Green Fuel Economizer Company, Matteawan, N. Y., has issued catalog No. 142, which contains 104 pages and gives data that would be of service to power plant engineers. The function of the economizer is discussed and the amount of heat that has been saved in specific cases is also given. Various installations are illustrated, as are charts describing their efficiency. The details of this economizer are also illustrated and described and specification dimensions are given for the different sizes of economizers. A steam table from zero to 350 lbs. absolute pressure is included.

SUPERHEATERS.—The Locomotive Superheater Company, New York, has issued a 28-page catalog which gives a brief history of locomotive superheaters, together with the advantages that are now obtained by their use. Several examples of installations that have given increased hauling power with a decrease in the fuel consumption are noted, and various illustrations are given which clearly describe the various parts of the superheater, as well as the operation of the various types. A statement of the number of superheaters ordered to June 1, 1912, accompanies this catalog and shows that there are 4,505 superheaters in service and under construction.

THROTTLE VALVE.—The Watson-Stillman Company, New York, has issued catalog No. 86, which describes the Chambers throttle valve. The feature of this valve is that it is opened by turning the valve rod instead of pulling it in the ordinary way. It does away with the necessity of numerous levers in the throttle pipe, and is operated by rotating a crank. Among the claims presented for this valve are, the increased room in the dome for inspection, decreased liability of failure on account of there being a less number of parts, that steam may be taken from a higher point in the dome, the ease of operating, and the ease of regulating the opening of the valve.

VANADIUM STEEL.—The American Vanadium Company, Pittsburgh, Pa., has issued an 80-page catalog, which is clearly illustrated and contains data and information that will be acceptable to engineers using this class of steel. A brief historical account precedes a more technical discussion of this steel. The effect of Vanadium in steel is spoken of, together with its strength, hardness and heat treatment, the latter including several illustrations of metallurgical photographs. The various types of Vanadium steel from A to K are described and their chemical contents given, together with their physical properties. Nickel chrome Vanadium steel and carbon Vanadium tool steel are next considered, as are the various methods of manufacture. The catalog closes with a discussion of the use of Vanadium in cast iron and the various applications of all the types of Vanadium steel. It is quite complete and would be a valuable book for one's library.

AMERICAN ENGINEER

"THE RAILWAY MECHANICAL MONTHLY"

(Including the Railway Age Gazette "Shop Edition.")

PUBLISHED ON THE FIRST THURSDAY OF EVERY MONTH, BY THE
SIMMONS-BOARDMAN PUBLISHING COMPANY,
83 FULTON STREET, NEW YORK, N. Y.

CHICAGO: Plymouth Bldg. CLEVELAND: Citizen's Bldg.
LONDON: Queen Anne's Chambers, Westminster.

EDWARD A. SIMMONS, *President.* HENRY LEE, *Secretary.*
L. B. SHERMAN, *Vice-President.* A. E. HOOVEN, *Business Manager.*

The address of the company is the address of the officers.

ROY V. WRIGHT, *Editor.* R. E. THAYER, *Associate Editor.*
E. A. AVERILL, *Managing Editor.* WILLIAM FORSYTH, *Associate Editor.*
GEORGE L. FOWLER, *Associate Editor.*

Subscriptions, including the eight daily editions of the *Railway Age Gazette* published in June in connection with the annual conventions of the Master Car Builders' and American Railway Master Mechanics' associations, payable in advance and postage free:

United States, Canada and Mexico.....\$2.00 a year
Foreign Countries (excepting daily editions)..... 3.00 a year
Single Copy 20 cents

Entered at the Post Office at New York, N. Y., as mail matter of the second class.

VOLUME 86. SEPTEMBER, 1912. NUMBER 9.

CONTENTS

EDITORIALS:

| | |
|--------------------------------------|-----|
| Ten Dollars for a Letter..... | 441 |
| Clean and Neat Shops..... | 441 |
| Master Blacksmiths' Convention..... | 441 |
| Engine House Equipment..... | 442 |
| Traveling Engineers' Convention..... | 442 |
| New Books..... | 442 |

COMMUNICATIONS:

| | |
|------------------------------|-----|
| Repairing Driving Boxes..... | 443 |
|------------------------------|-----|

MISCELLANEOUS:

| | |
|--|-----|
| Engine House Equipment and Facilities..... | 455 |
|--|-----|

ILLUSTRATED:

| | |
|---|-----|
| Master Blacksmiths' Association..... | 444 |
| Pneumatic Hammer for Smith Shop..... | 454 |
| Goodwin Duplex Water Glass..... | 458 |
| Tender Wheel Lubricator..... | 459 |
| Mikados for the Lackawanna..... | 459 |
| A Novel Design of Sling Stay..... | 462 |
| Traveling Engineers' Association..... | 463 |
| Solid End Main Rod..... | 478 |
| Link Grinding Machine..... | 481 |
| Shop Safe Guards..... | 482 |
| Boiler Tube Testing Machine..... | 484 |
| Locomotive Blowoff Valve..... | 485 |
| Sectional Tube Expander..... | 485 |
| Automatic Temperature Regulator..... | 486 |
| Coupler Yoke Shearing and Riveting Press..... | 486 |
| Combination Pattern Makers' Grinder..... | 487 |
| Attachments for Tool Room Lathes..... | 487 |
| Radial Engine and Tender Buffer..... | 489 |
| Forging Flat Wrenches..... | 489 |

GENERAL NEWS SECTION:

| | |
|-------------------------------|-----|
| Notes..... | 490 |
| Meetings and Conventions..... | 492 |
| Personals..... | 492 |
| New Shops..... | 495 |
| Supply Trade Notes..... | 496 |
| Catalogs..... | 498 |

Ten Dollars for a Letter

In the July number of the *American Engineer* was an article on An Ideal Boiler Tube Department by L. R. Pomeroy, which showed an arrangement of equipment for handling 450 boiler tubes in one day at a labor cost of not more than three cents a tube, from engine to engine. In the August issue of this journal Walter R. Hedeman had an article on Care of Locomotive Boiler Tubes, in which he told how the tubes should be applied, maintained and renewed. The two articles thus covered the subject thoroughly. Did you find anything in these articles that has helped you to get better results? Are you using methods or tools superior to those described? Can you suggest better ways of performing the various operations? Are there other phases of the question which should have been considered? If so, write and tell us of your ideas, methods or experiences. For the best letter on any phase of this subject received before September 26, 1912, we will mail a check for \$10. Such other letters as may be accepted for publication will be paid for at our regular space rates.

Clean and Neat Shops

H. T. Bentley, assistant superintendent of motive power and machinery of the Chicago & North Western, brought out an excellent point in his address to the master blacksmiths at their recent convention. The point was to "keep the shops neat, clean and tidy, having a place for everything and keeping everything in its place." Most every foreman can realize the wisdom of these words, for what one of us but cannot do much better work if things are not scattered around carelessly and the general appearance of the shop is neat and orderly? Confusion about the shop will wear on the men's nerves, greatly interfering with their productiveness. When men say they cannot keep a blacksmith shop clean they do not fully understand the meaning of the term. While it may not be possible to go through the shops without soiling one's hands, things need not be untidy. The scrap iron can be kept in a certain place, and facilities for carting the scrap away from the forges and the hammers should be sufficient to keep the shop picked up. One laborer giving all of his time to this work would so increase the output of the workmen that his wages would be more than paid for. Foremen in railway shop departments other than the blacksmith shop would also do well to keep this matter constantly in mind.

Master Blacksmiths' Convention

The International Railway Master Blacksmiths' convention, held in Chicago, August 20-23, clearly demonstrated the value of an association made up of shop foremen. The men were enthusiastic and eager to learn of the experiences of their fellow members. The discussions at all times were lively and in many cases protracted. The president, F. F. Hoeffle, is to be congratulated upon the way in which he presided over the meetings. He was careful to see that every member had a chance to discuss each subject, and in many cases restricted the members from speaking twice on the same subject until the other members had been heard from. While the subjects were along the same lines as those considered at previous conventions, there was something new presented in practically all of them. Many of the members make investigations of their own during the year, so as to be able to talk intelligently at the conventions and give the members the benefit of their research. This feature, of course, is ideal in any convention, and each master blacksmith should continue along this line. At the present time there are special fields in the heat treatment of metals, the handling of vanadium steel in both frames and springs, and the comparatively new processes of welding, which need to be investigated. One of the best subjects considered this year was that of shop kinks. A comparison of the different ways of doing the same operation, even though the facilities at different shops are very

different, cannot help but suggest better and improved methods to the members interested in the work that is under discussion.

As H. T. Bentley said in his address, any convention that tends to bring its members together in the interests of their employers is one that should be encouraged. This association may certainly be included in that category, and the superior officers of the master blacksmiths may rest assured that their companies will benefit by having the members attend the convention, provided, of course, that these members conscientiously attend the meetings. The meetings this year were well attended, although the punctuality was not all that might have been desired.

Engine House Equipment

Mr. Cordeal's third article on efficient engine house operation appears in this issue. The first article, which considered the best type of engine house organization, was published in the May number, page 221, and the second one, on engine house reports and records, appeared in the July issue, page 339. The question of providing additional facilities, which is covered in the third article, must be treated as a cold-blooded business proposition, but to do this properly it is of vital importance that the right point of view be selected. For instance, the repairing and maintaining of locomotives is not the real business of a railway, but is incidental to the conducting of transportation, from which the revenue is derived. It is, therefore, necessary to study the question from an operating point of view, rather than that of the mechanical department. Really both viewpoints should be the same, but unfortunately too many mechanical department officers do not appreciate this as fully as they should, and strive to reduce the expenses of their department, regardless of its effect on the road as a whole. There is also the danger of erring too far on the other side as suggested by Mr. Cordeal. Each engine house must be considered by itself, for what may be good in one case would be all wrong in another. For instance, two trunk lines each have a division in the same territory on which the conditions are quite similar. One road pools its engines and uses one-third the number of locomotives to handle the same business as does the other road. Manifestly the engine house facilities on the first road must be more complete and elaborate than those on the second road, which has very much more time in which to clean and repair the locomotives and return them to service. The important thing, therefore, is to get the engines back into service as soon as they can be used, even though the mechanical department costs may be considerably increased thereby.

Traveling Engineers' Convention

The twentieth annual convention of the Traveling Engineers' Association, held in Chicago last week, fully upheld the reputation of previous meetings in attendance, interest and value. There were 492 members registered, and the total attendance, including supplymen, ladies and guests, was over 1200. Two long sessions each day were hardly sufficient to give all who desired to speak an opportunity to be heard. During the sessions there were seldom less than 200 in the meeting room, and frequently double this number. At no time was there any lagging in the interest, and often the president had to decide the claims of four or five members who wished the privilege of the floor. The time for adjournment, rather than a lack of speakers, determined the closing of a subject in nearly every case.

A spirit of this kind—and the Traveling Engineers' Association is noted in this respect—can hardly help but produce real, tangible, beneficial returns to the members who are fortunate enough to be present, as well as to railway companies that were farsighted enough to send their employees. With very few exceptions all of the more progressive railways were represented;

in one case by 23 men, in another by 19, and in many cases by from 10 to 15 men. The subjects considered were all of primary importance, and if there was any way of determining the improvement in such matters as fuel economy, train braking, feed water treatment, etc., that will result from the knowledge gained at these meetings, there is little doubt but that every railway would order every traveling engineer on its lines, that could be spared, to attend the next convention—and that they would be amply repaid.

The 1912 convention was particularly fortunate in the selection of the men who were invited to deliver addresses and profited by four valuable papers that were not listed on the program. These were by S. O. Dunn, editor of the *Railway Age Gazette*, who clearly pointed out the opportunities of the traveling engineer in improving the efficiency of labor; J. M. Daly, general superintendent of transportation of the Illinois Central, who explained the best practices of tonnage rating; H. T. Bentley, assistant superintendent of motive power of the Chicago & North Western, who pointed out the duties of the members in the safety campaign, smokeless firing, and in co-operation; and B. A. Worthington, president of the Chicago & Alton, who indicated the duty of all to neutralize the misleading socialistic ideas that are being adopted by the thoughtless or ignorant. A liberal extract of each of these addresses will be found elsewhere in this issue.

The traveling engineer, more than any other officer, links the mechanical and the operating departments together, and in the discussions the subjects were often, very properly, considered more from the operating than the strictly mechanical point of view. The discussion on the braking of long trains was an example of this. The consideration of this report occupied two full sessions and was practically all confined to the effect of different methods of handling the engineer's brake valve on the long passenger and freight trains that are now being operated, and the interest in the latest apparatus was centered in its effect on the train. It is quite evident that the progress in mechanical devices for railways is advancing more rapidly than the training of men to properly handle them, and it is encouraging to see this association show a strong tendency to give its greater efforts in this direction.

The desire of the members to obtain the maximum amount of information in the time allowed was indicated by the number of representatives of supply companies who were given the privilege of the floor and requested to answer questions. In this way expert advice of great value was very frequently obtained.

NEW BOOKS

Methods of Analyzing Coal and Coke.—Technical paper No. 8. Written by Frederick M. Stanton and Arno C. Fieldner. Published by the Bureau of Mines, Washington, D. C.

This paper describes the methods used at the laboratories of the Bureau of Mines for analyzing coal and coke and determining the heat value of these fuels. The original methods which were recommended by the American Chemical Society, together with such modifications and changes as have been deemed advisable, are included in the paper. Copies may be obtained by writing to the director of the Bureau of Mines, Washington, D. C.

Railroad Operating Costs. By Suffern & Son. Bound in cloth, 144 pages, 8 in. x 10½ in. Published by Suffern & Son, New York. Price \$2.

To those who are compelled to use the statistics of railways, it has been evident that the matter published in the annual report of the Interstate Commerce Commission left much to be desired. The reports furnished by the railways, however, include vastly more than is given general circulation, and about a year ago Suffern & Son, accountants, New York, published the first edition

of "Railroad Operating Costs," in which was included much statistical matter that had not previously been available. This book met with so much success that a second edition is now being issued. This includes later reports, covers a greater number of railway systems, and has been extended and amplified in other directions. For example, the subject of maintenance of equipment is now treated in four chapters instead of one, as in the first volume. There is also an entirely new chapter on fuel costs, which contains much original information on this highly important subject. The volume has been arranged to include the operations of the year 1911.

The Modern Locomotive. By C. Edgar Allen. 175 pages, 4 1/2 in. x 6 1/2 in. Flexible cloth. University Press, Cambridge, England; for sale by G. P. Putnam's Sons, New York. Price 40 cents.

The treatment of the modern locomotive in this little volume is confined almost entirely to European practice, and it relates largely to locomotive performance rather than to its design and construction. The author has succeeded in presenting an interesting and authoritative account of locomotive performance, although it is necessarily limited and concise. It is not intended for the specialist, but rather for that numerous class which has some knowledge of mechanics and science, and finds the locomotive an interesting machine. To such readers the work is admirably adapted. After a brief account of the development of the British locomotive, considerable space is devoted to combustion, steam generation, superheating, compounding, boiler improvements and the utilization of steam. There is an excellent chapter on counter-balancing and stability, and one on performance and speed. Though the price of the volume is only 40 cents, it contains more information on the locomotive than many of the popular treatises published in this country which are larger and cost several times as much.

Ferney's Catechism of the Locomotive. Part II, Third edition, revised and enlarged. By George L. Fowler, consulting mechanical engineer. Bound in cloth, 6 in. x 9 in., 287 pages, 195 illustrations. Published by the Simmons-Boardman Publishing Company. Distributed by the McGraw-Hill Book Company, 239 West 39th street, New York. Price \$3.

In Part I of the third revised edition there will be found a general description of the construction and methods of operation of the locomotive. In that section the machine is regarded from a purely physical standpoint and scientific discussions of the observed phenomena have been avoided. In Part II, which is now ready for distribution, the more technical features have been collected, and here will be found the discussions of the reasons for the observed phenomena. This volume aims to show the reader in simple language, and to avoid as far as possible mathematical calculations, why locomotives are built as they are and the principles of their operation. While much of the text is a discussion of principles and remains unchanged from the first edition, the later experiments and more thorough knowledge, together with the introduction of the improved apparatus, has required the addition of much entirely original matter. In this volume will be found a discussion of the principles and their application, of the expansive action of steam, the movement of the piston and rods, the design of locomotive boilers and of all types of valve gear, the resistance of trains, the proportions of locomotives, etc. All of these discussions are in the simplest of language, the value of brevity being fully appreciated by the author.

Valves, Valve Gears and Valve Designs. By Franklin DeR. Fuiman, M. E., professor of machine design at the Stevens Institute of Technology, Hoboken, N. J. 152 illustrations. Cloth, 8 in. x 10 in., 130 pages. Price, \$3.50.

A paragraph in the preface indicates that this book is a small edition published privately by the author with the expectation of printing later a more complete treatise in better form.

It is a collection of notes for use in the class room, arranged to fit in with the general course in mechanical engineering at Stevens Institute. This feature is too strongly emphasized to make the book a satisfactory one for the general use of young engineers. As a guide to the student in designing valves and laying out valve gear, it may be regarded as a good general treatment in compact shape, orderly arranged and well indexed. The section relating to piston valves and the Walschaert valve gear as used on the locomotives is too brief to make the book of value in the locomotive drafting room. The most useful portion in this respect is the condensed arrangement of the Auchinclos' method of design of the Stephenson link motion. The illustrations are uneven and often crude, and the technique of the drawing is poor. The student should have set before him the best examples of good technique in mechanical drawing, if he would obtain proper ideas in regard to correct appearance as well as correct proportion in machine design. In another edition this feature of the book should have considerable improvement, with the use of uniform sections and lettering, and a higher standard for the general finish of the drawings.

REPAIRING DRIVING BOXES

WINNIPEG, Man., July 22, 1912.

TO THE EDITOR OF THE AMERICAN ENGINEER:

Replying to Mr. LeCompte's criticism on our methods of repairing driving boxes, I do not consider the methods described by him as any more accurate than our own. The only essential difference is that while we make our boxes standard to the original back face, Mr. LeCompte makes them standard to the inside of the shoe and wedge flange. The trouble of engines failing to tram is unknown to us as each box is standard and the wheel centers are standardized at each shop.

The accuracy of our method will be clearly seen from the following outline: The back face of the box (the inside surface that has no wear) is used in setting up for planing. Lines are scribed on the box equi-distant from the center line, and to these, by means of a "U" shaped gage the shoe and wedge channels are planed. In boring, the box is set on a parallel strip on one shoe and wedge face, with the original unworn side of the box clamped to an angle plate at right angles to the table. This assures the box being bored true with the back, as well as parallel with the face of the shoe and wedge channels.

In connection with the claimed inaccuracy in our method of applying the babbitt end play liner: I do not claim that we get a face as close-grained and perfect as a machined face, but the face is practically flat and is square with the inside flanges of the shoe and wedge fit. We place the box in a vertical position and then adjust the jig-plate until the distance between its face and the box corresponds to the thickness of babbitt required. The jig plate is exactly 1 in. thick, and by adding 1 in. to the required dimension we can caliper from the shoe and wedge fit to the outside face of the plate, also from the face of the plate to the back face of the box. We have not found 5 per cent. of our boxes in which the difference (in comparing these measurements) amounted to 1/32 in. Comparing the foregoing with Mr. LeCompte's methods which require the liner to be faced, I do not think this extra operation is warranted. In the majority of shops, where the liner is faced it is done during the boring operation.

E. T. SPIDY.

[In response to the invitation for criticisms of the methods described by E. T. Spidy in his prize winning article on Repairs to Driving Boxes, published in the June issue, John V. LeCompte, foreman, Mt. Clair shops, Baltimore & Ohio, submitted a criticism which was published on page 334 of the July issue. In answer to this we have received the above letter from Mr. Spidy.—EDITOR.]

MASTER BLACKSMITHS' ASSOCIATION

Program Included Papers on High Speed Steel,
Case Hardening, Dies and Formers, and Shop Kinks.

The twentieth annual convention of the International Railroad Master Blacksmiths' Association was held in the Hotel Sherman, Chicago, Ill., August 20-22. F. F. Hoeffle, of the Louisville & Nashville, presided. Geo. W. Kelley, of the Central Railroad of New Jersey, an ex-president of the association, made the opening prayer. Leon Hornstein, assistant corporation counsel of Chicago, welcomed the Association in behalf of Mayor Harrison.

The secretary-treasurer's report showed a total membership of 337 and a cash balance of \$362.66 on August 1, 1912.

PRESIDENT HOEFFLE'S ADDRESS

The president made special mention of the work of the committees and spoke, in part, as follows: The opportunity for the members to take part in the convention exercises gives them a valuable educational experience and enables each to measure himself alongside of others of his craft. We are not here as individuals, but as representatives of the railways for the purpose of devising ways and means of making improvements and advancements in our field. The best minds in the world today are men who make individual efforts to improve their efficiency by constantly studying and reading good literature bearing on their work. We should constantly improve ourselves for it is important that the master blacksmith should be able to handle with credit any work that he may be called upon to do. To become expert, we must learn to realize these conditions and to qualify ourselves to meet them. Great changes have taken place in the blacksmith department by the introduction of improved methods and devices which have greatly reduced the cost of making forgings. It is necessary for the master smith to keep pace with these new mechanical and operative conditions.

There is no place in the industrial work shop, where more hard work, closer calculation and keener insight are required than in the forge and blacksmith shop. There is no class of men who watch the work more closely in the operation of their departments than the master blacksmith, in order to insure the safety of the public which depends on its thoroughness. As improved ideas are brought forth, we must accept them and when necessary, shake off the old methods and habits.

H. T. BENTLEY'S ADDRESS

H. T. Bentley, assistant superintendent of motor power and machinery of the Chicago & North Western, said in part: The blacksmith shop is one of the most important parts of a railway shop plant for when it falls down it ties up the other departments. On a recent trip to England one thing that greatly impressed me was a drop forge shop. It contained about fifty hammers, and there was not anything from a watch spring to an anchor, but what they made under the drop forge, and the work was magnificent. After it came from the drop forge nothing more was required to finish it. The trouble with us is that we leave too much stock for the machinist to take off. They say: "When we finish it, it is done."

Everybody who is working for a railway is working for the purpose of helping it pay dividends and keep the public satisfied. It would not keep you or me five minutes unless we were earning money for the company. It could not afford to do so. Therefore, every man should try to reduce the cost of the various operations that are performed by him. I believe if you will look into the question of drop forgings it will enable you to make some strides in reducing costs.

I have been through a number of blacksmith shops and many of them look untidy. The foreman will say: "You cannot keep a clean blacksmith shop." A blacksmith shop has no more need

to be dirty and filthy than any other place around a locomotive plant. I have been in a blacksmith shop where I could eat my dinner off of the floor, it was so clean. Tidiness is something we ought to practice. Have a place for everything and put it in its place. When a visitor comes in, he does not have time to see how many forgings you are making but the clean shop makes a favorable impression.

The hydraulic forging machine has impressed me favorably and I think there is a great field for it.

FLUE WELDING

J. P. Kane (B. & O., Newark, Ohio): Flue welding should be done in the blacksmith shop. In our shop the flues are cleaned by a rattler 28 ft. long, running at 15 r. p. m., which will clean 200 flues in two hours when water and small pieces of iron are used to loosen the scale. The flues are then dumped near a cutting-off machine, on which the first cut is made at an angle of 45 degs. Afterwards they are placed near a crude oil furnace of our own designs having 3 heating holes. A good welding heat is obtained in 48 seconds and the flues are expanded and the safe-ends welded and shouldered in one heat. Both operations are performed by one man on a machine having a shoulder attachment, at the rate of 40 flues per hour. The flues are then cut to length and expanded for the front end of the boiler on an especially constructed machine which performs the work quickly. Each flue is tested under 400 lbs. per sq. in. hydrostatic pressure. By doing so the number of flues removed from the boiler after the pressure has been put on is about one-fifth of one per cent.

Discussion—J. Masser (C. N. O. & T. P., Ludlow, Ky.):—We welded 60 superheater flues in 7 hours on a hard swedge with a blacksmith and 2 helpers using a coke furnace for the heating. I believe that a blacksmith should do the work, not a boilermaker.

G. H. Judy (Pittsburgh, Pa.):—In the past the blacksmith has been doing the flue welding but the man who puts them in the boiler ought to be responsible.

F. F. Hoeffle (L. & N., Louisville, Tenn.):—On our road the flue welding is done in the boiler shop, but recently a 5½ in. superheater tube was brought to the smith shop for welding. This we did on a 4 in. forging machine with perfect success.

G. W. Kelly (C. R. R. of N. J., Elizabethport, N. J.):—We use a handy man for welding flues but he was carefully instructed how to do the work by a mechanic, as are all the other handy men we use on machines.

A. McDougal (B. & A., Milo, Me.):—We use a hammer for welding flues and work the flue back and forth so that the metal on both sides of the weld will be thoroughly hammered; by doing this we have no trouble of breakage just back of the weld.

CARBON AND HIGH SPEED STEELS

F. Kopenhoefer (C. N. O. & T. P., Ferguson, Ky.):—For high speed steel the weight of the hammer and the force of the blows should be varied for the size of tool to be forged. As this steel is more dense than carbon steel it should never be worked at too low a heat and should frequently be reheated, keeping it as near a bright red as possible. When the tool is forged, and while it is still red hot, it may be easily ground on a dry emery wheel. It should then be reheated to a red heat and be allowed to cool in a dry place to eliminate all forging strains. The tool should then be heated slowly to a good red heat and the point to a good sweating heat. Then plunge in oil or harden in air. One essential is a clean fire, and the blast should not touch the steel while heating it to harden.

All carbon steel tools should be hardened as uniformly and at

as low a temperature as possible. It is better for a tool to be hardened at too low a heat than to be so brittle and hard that it has to be softened by tempering. Do not heat to a distinct line for hardening; also avoid dipping to a distinct line on tools not to be hardened all over, such as reamers, drills, taps, etc. All tools whether made on an anvil or by machine should be free from scratch marks, as they are starting points for cracks or breaks when hardening.

W. J. Coward (Erie, Kent, Ohio):—We use compressed air and oil for hardening and believe that the best results may be obtained by strictly following the makers' directions. For lathe and planer tools the air seems to be best. When annealing high speed steel we heat it to a bright red and cover it over with charcoal and give soft coal in a fire—and leave it to cool.

W. F. Stanton (J. A. Fay & Egan Company, Cincinnati, O.):—We use the best grade of carbon steel for reamers, rose bits, milling cutters, lathes, tools, planer tools, matcher bits, dovetail bits, router bits, and planer knives. Carbon steel should be heated in a clean fire, and kept above the tyre iron, as the steel coming in contact with the air will burn, making it unfit for use. After the tools have been forged we re-heat them and let them cool off before hardening. Treating carbon steel tools in this manner relieves the strain, and, when hardened, they are less liable to crack.

In hardening carbon steel for woodworking machines, all the pieces are cooled off in oil, and drawn to a certain color depending on the shape and the kind of work they are to be used for. We find the lead bath the best for fine-edge cutting tools. In annealing we use charcoal, mica, burnt bone, and iron turnings packed in air tight boxes and heat in an oven and leave to cool slowly. Too much annealing is worse than not enough. Steel that is over-annealed opens the pores and makes the grain coarse, and if not worked over again will show hard and soft spots on hardening.

The method of hardening high speed steel depends entirely on the purpose for which it is used, but it should be remembered that any tool that is to be subjected to a high heat while working can be properly hardened in one way only, and that is by heating it to a white or sweating heat, or from 2150 deg. to 2200 deg. F., and cooling as rapidly as possible by dipping that part of the tool which is to be hardened into some good thin oil. Lathe and planer tools for all general purposes should be preheated slowly to a bright cherry red, bringing the point rapidly to a white or sweating heat, and then plunge into a tank of fish or cottonseed oil, keeping them in motion until cool. For tools that are to be used in cutting cast iron or anything containing sand or scale, better results will be obtained by cooling in a solution of kerosene in which has been dissolved about 10 per cent. of cyanide of potassium, and 10 per cent. of common salt. Where tools of this kind have been forged to shape, it is good practice to re-heat the tool to a bright cherry red after forging and allow it to cool slowly in a box of sand or lime, after which re-heat and harden in the regular way.

For general purposes a semi-muffle furnace burning gas is the most desirable for treating high speed steel. When large quantities are being hardened continually, the barium chloride furnace is the best to use as it protects the steel from coming in direct contact with the blast, thus eliminating danger of oxidization. In placing tools in barium they should be first preheated to about 1300 deg. F. to eliminate the shock occasioned by subjecting the cold metal to the intense heat suddenly.

Discussion—C. Watson (Ill. Steel Co., Chicago, Ill.):—An instrument, such as a pyrometer, should be used to determine the temperature when tempering steel. We take a sample of every bar of steel and get its critical point. This is recorded and all tools made from the bar are given the proper treatment. We find the only proper way to draw the temper of a tool again is in an oil bath. We have tried lead and everything else, but find oil gives the best results. We have a table of temperatures indicating the degs. Fahr. the oil bath should be kept at to temper to a blue or

a straw. With this arrangement any irregular shaped piece can be tempered uniformly, if left in the oil long enough. When judging temperatures with the naked eye there will be a variation of 200 or 300 degs., which makes it impossible to give the steel the proper treatment. At the South works we rolled a lot of manganese rails and the hardness of the web was so great we could not drill a 3/16 in. hole. We tried to burn it through with oxy-acetylene and electricity, and we got steel punches and tried them but it was not until we had given the punches a proper heat treatment that we could do anything, and then we punched 2,000 holes in the rails with four punches.

H. Timmons (Am. Loco. Co., Richmond, Va.):—When tempering long articles, such as taps and reamers, they will probably be bent, if there are hard and soft parts. Care should be taken to heat and cool the tools uniformly.

T. E. Williams (C. & N. W., Chicago, Ill.):—If the ingot from which a tool is made was hammered before it was thoroughly heated, it would cause the tool to bend while being tempered.

C. F. Hinkens (Westinghouse Air Brake Co., Wilmerding, Pa.):—Where pyrometers are used they should be set level and plumb, for if they are not they will be liable to vary as much as 100 deg.

George Hutton (N. Y. C. W., Albany, N. Y.):—Assuming that taps are made of carbon steel, there is not a factory that can make 12 taps and guarantee that they will come out straight. You get them in the annealed bar and machine them. Some want to put them in a furnace right off, but if they are preheated properly, they will be more liable to come out straight. If a pyrometer is placed in a furnace that is not muffled it will not register the correct temperature of the material being heated on account of the variation due to drafts. In my experience taps and reamers of high speed steel are much easier heat treated than the carbon steel tools. With carbon steel there is danger of not getting them hot enough, and the high speed steel has much less chance of being destroyed in the treating than carbon steel.

C. W. Schafer (C. of Ga., Macon, Ga.):—A pyrometer may be checked with common salt which melts at about 1,465 deg. F. If any foreign element sticks to a tap or reamer while it is being cooled, so that the cooling material does not reach the tool, the spot it covers is liable to be soft. The best way to heat a tap or reamer is in an electric furnace.

DROP FORGINGS

H. E. Gamble (P. R. R., Altoona, Pa.):—The dies on the drop forging machines must be designed so that the work may be readily lifted from them after each blow of the hammer. Also there should be enough, but not too much, metal to completely fill the die. With these suggestions followed the dies will give good service. Sometimes the dies will last until re-dressing wears them out, and again they will not last nearly as long. This is sometimes attributed to the operator not having his material properly heated, his dies not lined up, or the work not of the proper size. In our shop we use carbon, vanadium, Bessemer and crucible steels; in some cases we case-harden the faces, while in others we heat from 1,480 deg. to 1,500 deg. F., cooling the face and drawing it to 900 deg. F. We do not harden the tongue of the die. Be sure that the work is properly heated and strike as few blows as possible with the hammer; the first blow does the most work.

John Cunningham (Union High School, Grand Rapids, Mich.):—Oil furnaces are almost universally used for heating, but in some cases large coal furnaces of the reverberatory type are used with a steam blast, the object being to prevent oxidation of the metal. The steam blast has also been used in oil furnaces with success. Concerning the materials and life of drop forging dies, *Machinery* tells us that forged blocks of open hearth steel should be used for this work, as the cast steel blocks are liable

requirements. With the dies shown in Fig. 1, we can turn out 4,000 ends in 9 hours on a 1½-in. forging machine. It requires one heat and two blows to make each end. The header used for the second blow is provided with a projection that almost punches a hole through the end. With this it is estimated that 350 ft. of 1 in. round iron is saved a day. When heading the second end, the first one is placed on a button which holds the iron in line, so that when bending it no twisting is necessary. After the ends are formed they are trimmed, when necessary, and punched on a hammer fitted up for that purpose, a shear

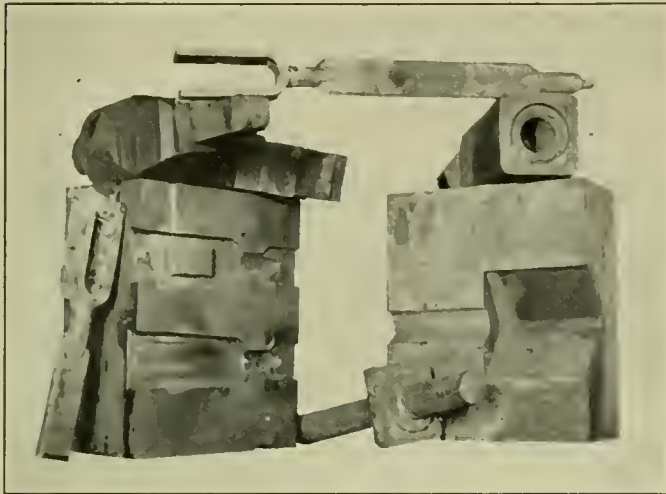

Fig. 3—Dies for Traller Spring Hanger and Traller Hanger; Chicago & North Western.

blade being placed in the top hammer holder and a punch in the header holder. Six thousand ends can be trimmed and punched in 9 hours. They are bent cold on a power punch, which makes a bend at every stroke of the machine. The dies are made of carbon steel and 60,000 grab irons have been made on one set of dies without dressing. The headers are made of piston rod steel which is hardened about like carbon steel. They require dressing quite often.

G. Creedon (B. & A., West Springfield, Mass.) :—Dies used on a 4-in. forging machine for making grease plugs for side rods are shown in Fig. 2. The plugs are made from 1¼-in.

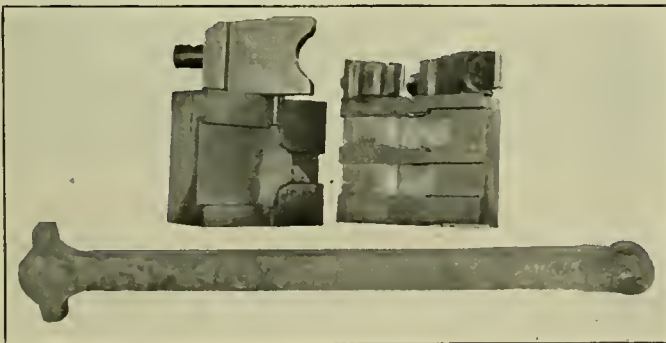

Fig. 4—Dies for Forming Back Section of Side Rod; Chicago & North Western.

square iron and the three operations are made with one heat. The first stroke upsets the rod, the second punches it and the third cuts it off to the required length. The plugs have proved very satisfactory and do not rattle off.

T. E. Williams (C. & N. W., Chicago, Ill.) :—Dies for our large machines are nearly all made of cast iron. Those subjected to severe wear have steel inserts hammered from old driving axles. The small dies are nearly all made of cast steel, with tool steel inserts put in where necessary. We made 140

equalizers for way-cars from common bar iron 2 in. x 3 in., bending them on a bulldozer and upsetting them on a forging machine, for a total cost of \$110. If these were hammered from old axles, bent and finished at a fire, the cost would have been at least \$700. Allowing \$150 for material and labor on the dies, this leaves a saving of \$440.

Fig. 3 shows a front trailer spring hanger made on a 6-in. Ajax forging machine. This seems to be a very small forging for such a large machine, but as it requires about 14 ins. of plunger travel to make the weld, it cannot be made on a small machine. It costs about \$4.75 apiece to make them by hand; we are now making them on the machine for 85 cents each. The second forging in Fig. 3 is a trailer hanger. This piece is 3 ins. round with an 8 in. x 8 in. x 1¼ in. collar which is upset in two strokes in a single groove die. To make this by hand, it would have to be forged from the solid rod.

Fig. 4 shows the dies and plungers for making the back section of a locomotive side rod. We have several of these side rods in service, and some of them have come to the blacksmith shop to be straightened after having been badly twisted up in a wreck; they showed no fracture, proving that they were well made. Fig. 5 illustrates the dies and plunger used for forming the forked end of a main rod.

George W. Kelly (C. R. R. of N. J., Elizabethport, N. J.) :—We have a 5-in. universal Ajax machine, driven through gears by a 40 h. p. motor, and a 3½-in. machine equipped with the automatic control made by the Monitor Controller Company. The machine is started by simply pushing a button attached

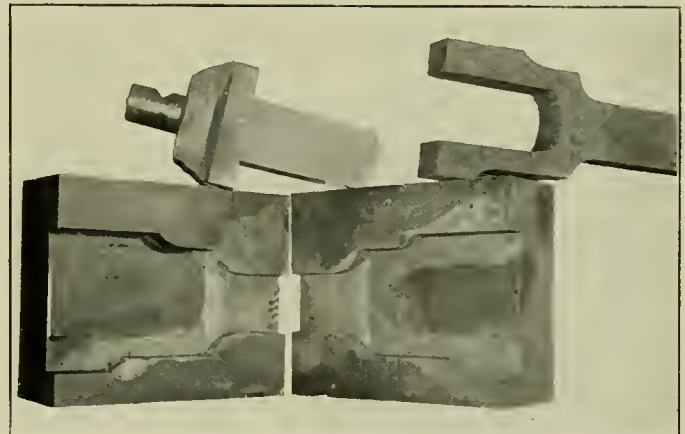

Fig. 5—Dies for Forming Forked End of Main Rod; Chicago & North Western.

near the clutch of the locking lever. This energizes a series of relays in the controller box on the wall, which are so adjusted that the current fed to the motor will not overload the circuit and damage the motor. The system is so regulated that the machine will ordinarily attain full speed in about six seconds from the time the button is pushed. It is stopped by pushing another button. This system saves time for the operator, as there are no belts to shift, no switches to pull, and no rheostat to fool with. There is a saving of electricity, as the machine will more likely be stopped when not working; a saving in the life of the motor and perhaps in the wrecking of the machine. The machine may be "inched" along as readily as before and the system on the whole has proved satisfactory.

A. W. McCaslin (P. & L. E., Pittsburgh, Pa.) :—A collection of forgings that are made in the Pittsburgh & Lake Erie shops are shown in Fig. 6.

SPRING MAKING

H. D. Wright (C. C. C. & St. L., Beech Grove, Ind.) :—When repairing springs measure them up and see that you have the same amount of steel in pounds and in inches as when the

spring was new, and if not, add plates until you get it. By using our rules and scales a little more, we can save many a dollar that is thrown away in the scrap. I have made a test on a spring plate to find out its condition after twenty times resetting and tempering. The plate was $\frac{3}{8}$ in. x $3\frac{1}{2}$ in. x $22\frac{1}{2}$ in., and weighed 8 lbs. $8\frac{1}{2}$ ozs. After being set and tempered once, it had lost $\frac{1}{2}$ oz., making the plate weigh 8 lbs. 8 ozs. After twenty times setting and tempering it had lost 1 lb. $8\frac{1}{2}$ ozs., making the plate weigh 7 lbs., a reduction of 18 per cent. The analysis of the steel before and after treating is given in the following table:

| | Before. | After. |
|------------------|-----------------|-----------------|
| Phosphorus | 0.05 per cent. | 0.05 per cent. |
| Sulphur | 0.033 per cent. | 0.038 per cent. |
| Manganese | 0.26 per cent. | 0.23 per cent. |
| Carbon | 0.55 per cent. | 0.50 per cent. |

This shows a difference that has not improved the material any. In treating vanadium spring steel, heat it to about 1400 degs. F. and set just the same as any other steel; then dip in oil

foreman should know the degree of heat at which the different lots of steel should be worked to the best advantage, and the amount of flashing required to bring the steel to the proper temper; each test piece should be given a pressure test, so as to determine the load the spring will carry. A spring plant should be so laid out that there will be no backward movement of the work.

John Holl (C. C. C. & St. L., Delaware, Ohio):—I have noticed that the spring leaves that were dipped in cold oil will not give as good service as those dipped in warm oil.

O. D. Vawter (Wabash, Moberly, Mo.):—When handling repaired springs we use as much of the old material as possible and if the set is all right with the exception of a few broken plates we simply add new plates without resetting the spring. We allow the first and second plates to stand off 5-16 in. to $\frac{1}{2}$ in. and give the plates a gradual taper to the top.

J. Carruthers (D. M. & N., Proctor, Minn.):—We have re-

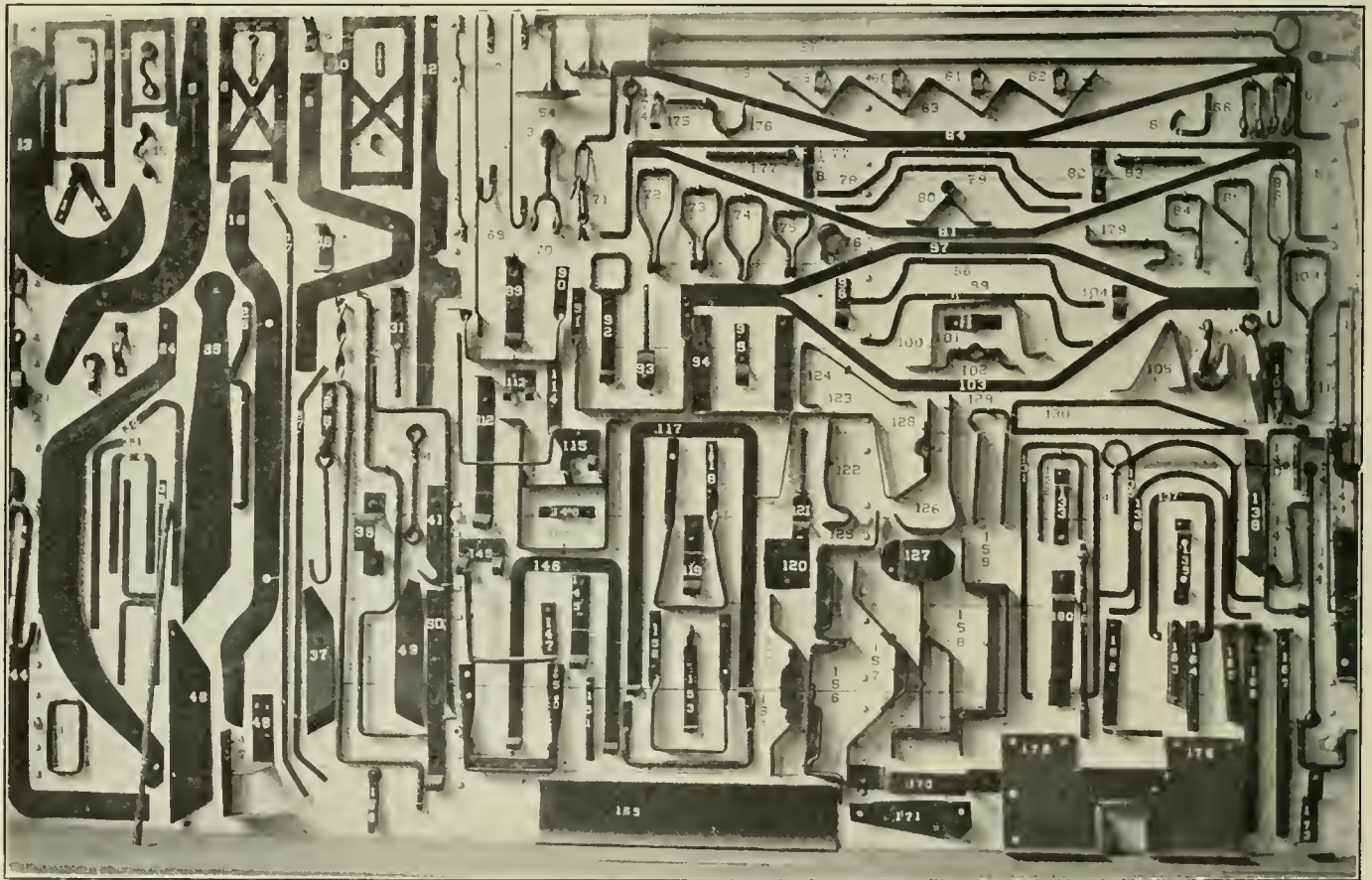

Fig. 6—Examples of Forgings Made at the Pittsburgh & Lake Erie Shops at McKees Rocks, Pa.

and let it stay until cold, then draw back until the scales shed freely—a little more freely than they do on ordinary carbon steel.

G. P. White (P. M., Saginaw, Mich.):—There should be one main spring plant for the system located at the same point as the general storehouse. All springs should be handled through the store department for the following reasons:

First, we all have some difficulty in keeping the stock of steel on hand for making repairs. If the responsibility of keeping all points supplied with springs fell on the store department, it would make more of an effort to keep the material for repairs on hand.

Second, the cost of repairs would be kept more accurately as the springs would all be repaired on monthly store orders.

Nothing but the best of steel should go into a spring, as the life of the locomotive depends a great deal on the springs. The

cently applied some vanadium steel spring to our engines as an experiment. I straightened out one of the plates a number of times in an air press the same as I would any other and it lost 1-16 in. of its set. A $\frac{3}{4}$ -in. block was then placed in the center of the plate and the plate was bent that much beyond its straightened position and it was found that it lost $\frac{1}{8}$ in. of its set. We treated this steel the same as we did the ordinary spring steel.

FRAME REPAIRING

Geo. Hutton (N. Y. C. & H. R., West Albany, N. Y.):—We have changed the frame from a spliced front end to a solid frame throughout on some of our engines, forging the solid front ends from scrap with oil welds in most every case with good results. The welded portion is always made larger than the section of the frame. On new engines the frames come from

the manufacturer properly annealed and in my opinion we should not anneal the pedestals and braces every time the engine is shipped. Some recommend annealing other parts of the frame after an oil weld has been made, so as to relieve the strain. I believe this does the frame more harm than good. Experts have tested frames that have run 3 years without annealing and have found no change in the structure of the material. The frame, if properly annealed, will stay in that condition as long as the life of the engine, except, perhaps, when it has had numerous welds. In that case the whole frame should be annealed in a furnace large enough to handle it.

F. Norris (Sheffield Car Works, Three Rivers, Mich.)—The thermit process is the best for repairing frames while they are in place on the engine, as the welds are made with steel and can be made stronger than ordinary welds by making the section larger than the frame itself. When repairing the frames in the smith shop too great care cannot be taken to see that the frame is not overheated. Whenever possible the welding should be done under the steam hammer and the frame hit as hard as practicable. It requires more force to weld steel than iron on account of its being harder and the light blows will not affect much more than the surface.

C. V. Landrum (N. C. & St. L., Nashville, Tenn.)—A successful method of repairing frames that are broken in the bottom rail close to the jaw is shown in Fig. 7. We cut the rail

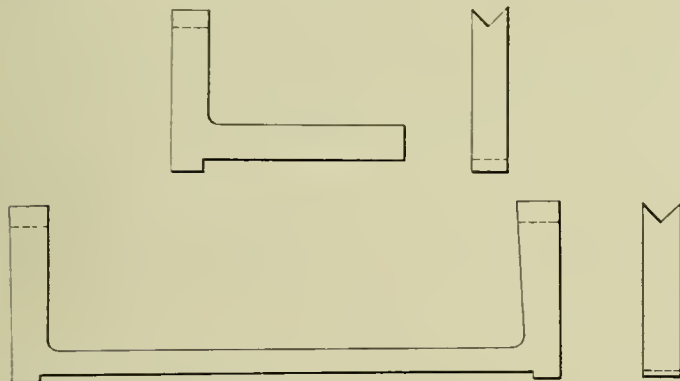

Fig. 7—Method of Repairing Frame Breaks in the Lower Bar Near Pedestal.

about 10 in. or 12 in. from the jaw and cut the jaw about 4 or 5 in. above the rail and weld with oil. If the bottom rail is broken near both jaws we weld in a piece connecting the two pedestals.

J. W. Smith (I. C., Paducah, Ky.)—I have never made new frames complete, but have made half of them and use old driving axles with good results. We weld the frames with thermit. I believe that cast steel frames after they are made ought to be annealed in a suitable furnace and be allowed to cool off slowly with the furnace.

F. F. Hoeffle (L. & N., Louisville, Ky.)—I have had considerable experience in welding frames with oil and thermit and am a clean cut thermit man. The only objection to this type of weld is that it leaves the frame bulky at the joint. We have made 24 of these welds during the past year, and they have all been successful.

O. D. Vawter (Wabash, Moberly, Mo.)—In making an oil weld on a 4 in. steel or iron frame, we spread the frame and build a furnace around it. A depression is rammed in on each side of the frame while at a welding heat, with round pein rams and wedges that are heated in the same furnace are welded in on each side of the frame. An oil burner is used on each side, unless the break is under the firebox. In that case a machinist cuts a V-shape piece out on each side of frame and the weld is made the same as on an anvil. On large 6 in. cast steel frames we use several small wedges and weld the same as on the anvil. I find

one wedge on each side cannot be rammed hard enough to weld the center of frame.

S. Uren (Sacramento, Cal.)—A rapid change in temperature has as much to do with frame breakage as anything else. In the Sacramento valley an engine starts out with the temperature at perhaps 50, 60 or 75 deg.; it goes 75 miles and gets into snow banks. The lower braces dragging through the snow are contracted while the upper portion of the frame, next to the boiler, is expanded.

H. D. Wright (C. C. C & St. L., Beech Grove, Ind.)—I have found that the cast steel frame gives trouble where the risers are placed when casting. The question has been asked time and time again: "Why doesn't the frame break in the smaller section?" The reason is that the frame was not churned as it should have been while it was being cast. The smaller section cools before the larger sections, and as it contracts pulls the material in from the larger section. On an order of frames I recommended that a riser be placed at every large part on the frame, at the top of the legs and down through the front sections where there is a large body, and that the inspector make special efforts to see that the frame was well churned while it was being cast. We got 50 engines with those frames, and when they went through the shop they were perfect.

HEAT TREATMENT OF METALS

J. F. Keller, of Purdue University, showed on an emery wheel how the different kinds of steels could be determined by the sparks. He described to some extent the change in molecular structure of steel undergoing heat treatment and the benefit derived from such treatment. He also quoted from the 1911 proceedings of the American Society for Testing Materials as to the proper methods of heat treating various steels, stating that section 14 under the heading of Practice Recommended for Annealing Miscellaneous, Rolled and Forged Carbon Steel Objects would especially appeal to the master blacksmiths. This section is headed as follows: "14: Special annealing to remove the effect of rolling or otherwise working the object in the cold or at any unduly low temperature, and states that for steel containing less than 0.15 per cent. carbon the object should be heated to about 1,652 deg. F., and cooled with a slowness which should increase with the thickness, i. e., the least dimensions of the piece. Great brittleness may be caused by annealing very low carbon steels in the neighborhood of 1,292 deg. F., after they have been subject to cold working.

T. J. McSweeney (B. & O., Baltimore, Md.)—In treating self-hardening steel we have found it best to follow the instructions of the manufacturer. To anneal it we pack the pieces or parts in a box with the bone that we have used for case-hardening, and heat until red, then allow it to cool in the box. In treating beading tools we cool the tool off in oil and then bring it to a cherry red and quench in oil. In treating carbon steel, such as shear blades, etc., where the blades are 36 in. long and over, it is quite difficult to keep them straight in treating and tempering. With 2 in. x 8 in. x 36 in. blades, heat to 1,200 and 1,400 deg. F.; then put into a tank of flowing water for 30 seconds, and then into a tank of oil and leave to cool off.

F. F. Hoeffle (L. & N., Louisville, Ky.)—An axle should be allowed to cool after final forging before it is given any heat treatment, for the reason that in the process of forging there is liable to be an unequalized condition of the metal, such as hard spots on the surface and internal strains. Tire steel used for blacksmiths' tools, such as flatters, fullers and swedges, will not stand the treatment that a good carbon steel tool will, and by the time it has been cut and hammered down to the proper size it will have cost considerable.

R. Maronde (Ill. Steel Co., Chicago, Ill.)—The accompanying table gives a portion of the results of tests made by the Illinois Steel Company on three link chains of 3/4 in. material to compare the effects of various methods of the heat treatment. Three

tests were made of each of the following methods and the average results are given in the table:

| Method of Annealing. | Per Cent. Elongation. | Ultimate strength. Lbs. per sq. in. |
|--|-----------------------|-------------------------------------|
| Heated in a forge fire to 1,000 deg. F. and buried in ashes for 2 days | 23 | 32,600 |
| Heated in a forge fire to 1,000 deg. F. and cooled in air. | 23 | 32,530 |
| Heated in a coke furnace to 1,500 deg. F. and quenched in tempering oil and then reheated to 1,100 deg. F. and cooled in air | 23 | 32,800 |
| Heated in a wood fire to 1,000 deg. F. and buried in ashes for 2 days | 25.2 | 31,566 |
| Heated in a wood fire to 1,000 deg. F. and cooled in air. | 17 | 29,600 |
| Old chain that had been in use for about six months without annealing | 12 | 31,733 |
| New chain made of dredge iron. | 30 | 31,666 |

Geo. F. Hinkens (Westinghouse, Air Brake Co., Wilmerding, Pa.):—Our company has specifications covering the heat treatment for all forgings subject to stresses. With proper heat treatment we can get a high elastic limit with ductility, especially with vanadium steel.

PIECE WORK

T. F. Keane (Ramapo Iron Works, Hillburn, N. Y.):—There are many things to be said concerning the advantages of piece work over day labor. With piece work a man's ability is accurately known. The men will not only apply all their skill in

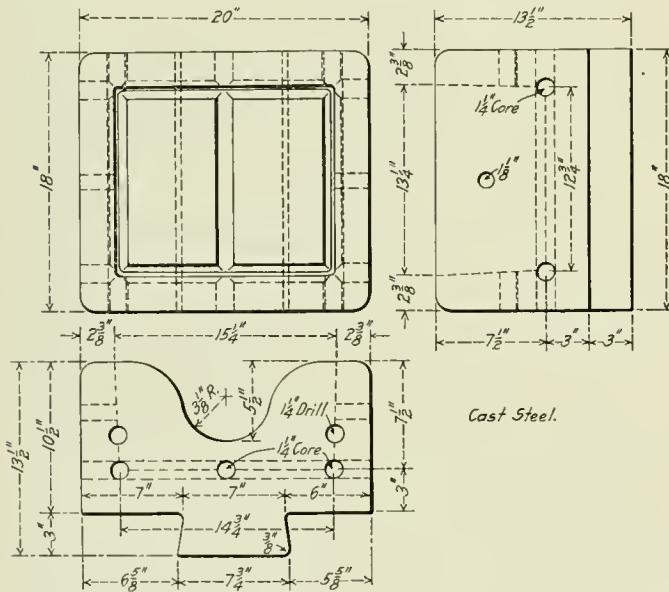

Fig. 8—Foundation Die for 4,000 lb. Steam Hammer; Central of New Jersey.

doing the work, but they will improve their output and learn better and more efficient methods of handling their tools, so that they may work them up to greater capacity. Always give the same kind of work to the same man, as men constantly doing the same work will increase their output and turn out better work. Cutting piece work prices shows great ignorance and inexperience on the part of a piece-rate man. It is a sign when some men make more money on their piece work that they are taking an interest in their work and that they are hustling and working more efficiently. If their work is done properly they deserve all the money they can make. The chances are if another man was put at the same work he would not be able to make as much.

The man should understand that the price set on a piece of work is satisfactory to the employer, provided, of course, that it had been set properly in the first place, and that what the employer wants is production. It pays to treat the men with consideration and investigate their complaints if they make any. And it may be necessary at times to raise a price to take care of certain unforeseen conditions. There are hundreds of little things to consider. If everything is given the proper attention there is no reason why the straight piece work system should

not be looked upon with favor by the employee, who through it will make more money.

SHOP KINKS

G. W. Kelly (C. R. R. of N. J., Elizabethport, N. J.):—A foundation die used on a 4,000 lb. steam hammer is shown in Fig. 8. It is a steel casting which is keyed to the base of the

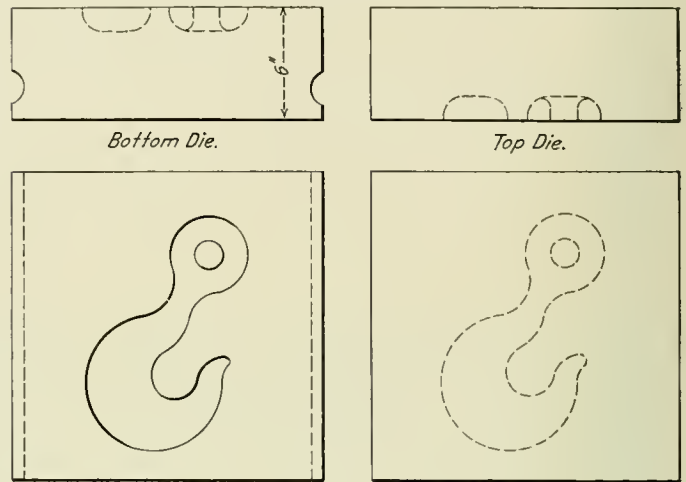

Fig. 9—Hammer Dies for Making Hooks; Central of New Jersey.

hammer, and is hollowed out and holds smaller dies 5 to 5 1/2 in. thick, for making link hangers, valve rod ends, hooks, etc., where the number to be made would not warrant the making of

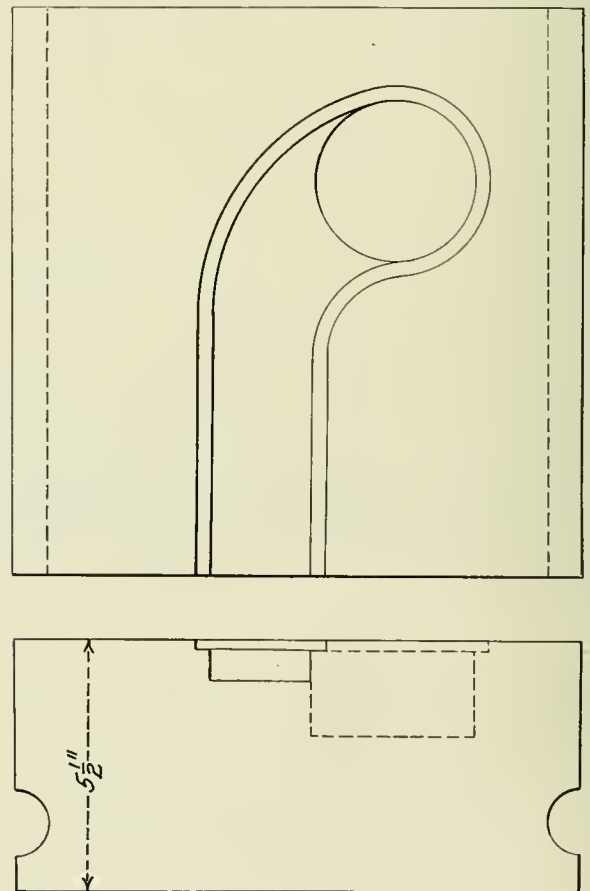

Fig. 10—Hammer Dies for Making Valve Rod Ends; Central of New Jersey.

larger dies. This is a convenient arrangement, the blocks being easily handled and simple to make. Should the impressions be too rough after they have been cast heat them before they are

mild steel rods 18 in. long. These were bent on the anvil in the shape of a coil spring. I was not a bit careful as to how hard I hit them, as I wanted to break them if I could. There were 3 fractures in the $\frac{5}{8}$ in. piece, and one in the $\frac{3}{8}$ in. piece which were due to the carelessness on the part of the welder and not on account of the system. Two pieces of 2 in. x 2 in. mild steel were welded together, and after being brought up to a high heat it was drawn down to one-fourth of its original size. A slight fracture was found on one corner. I then tried bending it back and forth, but I could not break it. I am convinced that a weld can be made on 2 in. material, but it is necessary that a good operator should do the work. The oxy-acetylene welding is used in our shop on light stock, such as $\frac{3}{16}$ in. plates, making welds from 6 in. to 8 ft. in length.

SHOP EFFICIENCY

J. T. McSweeney (B. & O., Baltimore, Md.):—Every foreman is trying to have harmony with discipline among the men in his shop. No shop can attain high efficiency unless harmony does exist. You should have as much light in the shop as you can. Keep the windows clean and if possible have the walls white-washed every year. Do not let the finished material lay on the floor. Put it on the outside in a pile. Also have a place to receive the material to be repaired. Do not bring it into the shop until you are ready to repair it. In this way, you will have no accidents on account of not having room for the men to work, and will be able to do more work to the man than if they are hemmed in by a lot of material. It is up to the foreman to be the leader in the organization as well as the organizer. The best results are obtained by careful analysis of the special conditions and requirements. See that a broad view of all subjects is taken. Don't issue any orders unless you intend to live up to them, and don't issue too many. Be always on the lookout for improvements that will reduce the cost of making the material. One of the best things to increase the shop efficiency is to have the machinery kept in good repair. There is nothing worse to look at in a shop and nothing that lowers the efficiency more, than neglected machines or tools, or steam pipes and air pipes leaking.

OTHER BUSINESS

During the convention addresses were made by C. W. Cross, superintendent of apprentices of the New York Central Lines, Chicago, and T. H. Curtis, formerly superintendent of machinery of the Louisville & Nashville, and now on the Committee of Investigation of Smoke Abatement and Electrification of Railway Terminals in Chicago. T. F. Keane of the Ramapo Iron Works also read a paper on Frogs and Crossing, and many members spoke on the benefits derived from the association during its 20 years of existence. The convention was in session a day longer than expected, on account of the amount of business.

The following officers were elected for the ensuing year: J. T. McSweeney, Baltimore & Ohio, Baltimore, Md., president; H. E. Gamble, Pennsylvania Railroad, Altoona, Pa., first vice-president; T. F. Buckley, Delaware, Lackawanna & Western, Scranton, Pa., second vice-president, and A. L. Woodworth, Cincinnati, Hamilton & Dayton, Lima, Ohio, secretary and treasurer. It was the sense of the association that the convention be held on the Atlantic sea coast next year, either at Richmond, Va., or Philadelphia, Pa.

JOINTED CARS ON THE BOSTON ELEVATED.—The Boston Elevated Railway is building for its street surface lines a "jointed coach"; that is to say, a street car made in two parts, or two cars fastened permanently together, with a covering or hood at the middle, the entrance for passengers being at the middle. The car will have the capacity of an ordinary car about 50 ft. long, while at the same time it can be run around curves at street corners, where a straight 50 ft. car could not conveniently be run.

PNEUMATIC HAMMER FOR SMITH SHOP

BY SAM LEWIS

Foreman Blacksmith, Grand Trunk Pacific, Rivers, Manitoba

The pneumatic hammer shown in the accompanying illustration has proved very efficient in a blacksmith shop that is not equipped with modern appliances. It may be made from scrap material usually found about locomotive shops; the yoke was made from an engine drawbar, the cylinder from an old axle, and the base block from a center casting taken from an old locomotive. It was designed originally to make brake shoe keys, but may be used for various other purposes, and is heavy enough to weld $1\frac{1}{2}$ in. round iron. The stroke of the hammer is $6\frac{1}{2}$ in., and the ordinary shop air pressure of 70 lbs. per sq. in. is used. The valve arrangement is especially ingenious, being made to produce the heaviest blow possible. The end of the valve rod is forked and slotted as shown, the idea being to maintain a maximum valve opening as long as possible. The hammer is operated by a treadle which is connected to the main valve and the force of the

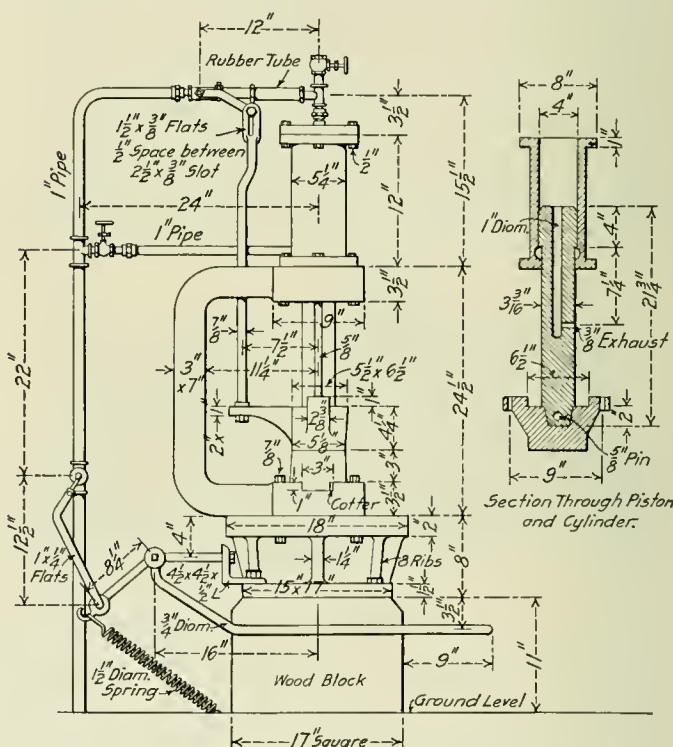

Air Hammer for Light Smith Shop Work.

blow can be easily regulated by this treadle. Pipes connect to both ends of the cylinder. The piston is raised by the air pressure acting on the small annular space on the underside of the piston. The pressure is always applied to this end of the piston, while the main valve is open, but the resultant lifting force is only sufficient to raise the piston and does not materially detract from the downward force of the hammer. The exhaust is accomplished, as shown in the illustration, through the 1 in. hole in the piston and the $\frac{3}{8}$ in. outlet. The bottom of the yoke is fastened to the base casting by four $\frac{7}{8}$ in. bolts, and the anvil block is held to the yoke by a wedge. The cost of making this hammer is very small, and with it from 600 to 700 brake shoe keys can be made in ten hours. Credit should also be given to L. Lozo, locomotive foreman of the Grand Trunk Pacific at Fitzhugh, Alberta, for the design of this machine.

GERMAN EXPRESS TRAINS.—The fastest train in Germany is the so called "D-Zug20," between Berlin and Hamburg, which maintains an average speed of 55.2 miles an hour.

ENGINE HOUSE EQUIPMENT AND FACILITIES

Suggestions as to Some of the More Important Tools and Appliances, and of the Principles Which Should Govern Their Selection.

BY ERNEST CORDEAL,
Bonus Supervisor, Atchison, Topeka & Santa Fe, La Junta, Col.

Under the head of engine house facilities are to be considered the tools, machines and appliances which are, or may be, employed to facilitate the handling and repairing of engines in service. Facilities should not, as is often the case, be given an exaggerated value in their effect upon the total efficiency of operation. Adequate facilities do not insure efficient operation, and lack of them does not imply inefficient performance. The best of tools and appliances in the hands of a poorly organized, incompetently directed force are simply an added expense in the form of excessive overhead charges. Scarcity of machines or tools, or the antiquity of their design, will be only a more or less serious handicap to an engine house otherwise efficient. Any shop may be over equipped as easily as under equipped, and the results on a cost basis are apt to be more serious in the former than in the latter case.

It should be acknowledged, then, that organization is the prime factor and that adequate modern equipment, while a great aid in minimizing costs and limiting time of detentions, is only an item of secondary moment. Only after the force has been properly organized and comprehensive reports and records have been provided to furnish accurate data as to performance is it possible or profitable to make an intelligent study as to requirements. Any attempt to provide modern tool equipment for an engine house at which efficient organization is lacking would in all probability result in over equipment and increased costs, while the same result may obtain should the modernizing of a well organized plant be undertaken without careful figuring as to the first cost, depreciation and utility of the facilities to be introduced.

There is a tendency on the part of engine house foremen and master mechanics to lay undue stress on the matter of facilities. A lack of equipment is probably the most common excuse advanced to explain inefficient operation and high repair costs, while in truth this feature is probably the least prevalent cause of unsatisfactory conditions. It is not the intention to convey the impression that up-to-date equipment is an undesirable adjunct to the engine house, but it is absolutely essential that careful, intelligent study should precede the ordering of expensive machines and tools to insure a fair return on the investment. As a concrete example of insufficient consideration of the needs in the purchase and installation of expensive appliances might be cited the case of traveling cranes in some comparatively small engine house where the service obtained would not pay the interest on the money invested, and where by the exercise of competent planning and supervision the work could be performed at a slightly increased labor cost in equal or less time without the crane. Before recommending the amount and quality of equipment to be supplied to any engine house a thorough investigation should be made to determine definitely the following points:

- (1) Cost of the appliance and depreciation rate.
- (2) Quantity of work to be handled.
- (3) Possibility of making the repairs in question at other engine houses.
- (4) Cost of operations performed by the appliance.
- (5) Cost of operations without the appliance.
- (6) Value of possible time saving.

Under the first head should come a consideration of all the machines on the market designed for the performance of the

work in question. This investigation should cover the first cost, durability, capacity and adaptability of the machine. After definite conclusions have been reached as to what may be expected of the various types of machines available, the second item, that of quality of work which may be handled, should be introduced and a careful estimate made as to the proportion of time which it will be profitably possible to keep the machine in use. The possibility of so arranging the performance of certain classes of repairs as to centralize the work at one point on a division should be carefully considered. For example, it may be found that a drop pit at one terminal will be able to handle all of the driving wheel work for the division and that a little foresight will enable all the power to be handled in such a way as to allow for the necessary detention at that point when repairs of this nature are necessary. It would then be obviously unnecessary to place drop pits at both ends of the division, and the one which was installed might be made more efficient by allowing for its construction a part of the cost of the second pit.

When the quantity of work of a certain class which will be performed is known, together with the output capacity of the various available machines, it is a matter of simple calculation to determine which appliance will effect the best results. The machine which guarantees the lowest piece cost will not prove the most economic unless the quantity of work is such as to permit almost continuous operation, and it is therefore necessary to base cost figures on the output of a certain period, preferably a year, rather than on the direct cost of labor and machine charge per piece. In computing estimated costs the items which must be given consideration are: labor, power, depreciation of machine, and interest on money invested. Any appliance which fails to show a lower piece cost, when figured on this basis, than that obtained with the old facilities, is an item of extravagance which should not be considered.

Another item which should not be overlooked is that of the possibility of reducing the time of detention; in other words, increasing the time locomotives are in actual revenue earning service. A saving in time on the performance of a particular item of repairs does not necessarily imply that an equal amount of time is added to the actual time in service of the locomotive; in fact, on the contrary, as a general rule, the repairs can, under competent supervision, be completed in less time than that allowed for rest to the engine crews and for washing boilers and otherwise preparing for the return trip. Any time saved which can not be utilized by the engine in actual service is valueless and should therefore receive no consideration in estimates covering improved facilities.

A number of specific items which may be classed as engine house facilities will be taken up in detail to illustrate the method which should be employed to determine their economy and some suggestions will also be made as to what equipment is necessary under various conditions.

CRANES.

The employment of traveling cranes in engine houses to facilitate the handling of material from one place to another, or in lifting heavy parts to place, may in general be considered as uneconomic, except as applied to very large points. Let us assume that the point under consideration has a thirty stall

house handling on an average sixty engines a day. A careful study will probably determine that a labor gang of ten men at a rate of \$1.50 a day could handle all of the material and provide help for handling all the heavy repair parts. Conceding that the crane, if installed, would take the place of these ten laborers, the next step is to determine whether or not the crane could be purchased, the necessary supporting structure erected, and the power, repairs and operators furnished at a less yearly cost than that of the original labor gang. In the case cited it would be necessary to show a yearly cost of \$4,500, allowing 300 working days to the year. Estimating that the yearly cost of operation for the crane, including wages of operators, cost of power and cost of repairs, amounted to \$1,500, it would then be necessary to determine whether the crane could be purchased and installed at a cost which would provide for interest and depreciation. It will be noted that the difference between the cost of operation of the crane and the cost of labor to perform a like amount of work leaves a yearly sum of \$3,000. Making an allowance of eight per cent. for interest and depreciation, it will be seen that this surplus would render economical the installation of a crane at a cost of less than \$37,500.

Crane service in the engine house can not be considered as a time saving feature, for, although it is true that parts may be transferred from one place to another, or can be raised to position in considerably less time, the actual saving on any one job will be more than swallowed up by delays on other work due to the fact that the crane can perform but one operation at a time, and that the time wasted by mechanics in waiting for crane service will be much greater than where a labor gang is provided. A labor gang has the advantage of being susceptible of division into the number of units composing it, for the simultaneous performance of a variety of small jobs and concentration into one force in case of need, while the crane can only perform one operation at a time regardless of the amount of power required. An additional advantage of the labor gang over the crane is that in times when the work is not sufficient to require the whole gang, or the entire time of the gang, a part of the members or a part of the time may be utilized on other classes of work, while in the case of the crane standing idle, or only working at a part of its capacity, the overhead charge to be borne by foregoing and subsequent operations would be accruing.

DROP PITS.

One of several methods may be employed for removing a pair of driving wheels. If a crane of sufficient capacity is available the simplest method is to merely lift the engine off of the wheels. A locomotive hoist accomplishes the same result in a considerably increased time; or at a great expense of time and labor the engine may be jacked up until the wheels can be rolled out. The drop pit, however, presents advantages for engine house use over any of the methods mentioned. The pit when properly erected should be as permanent as the engine house itself, and the charges for repairs will be negligible. When equipped with a proper jack for lowering and raising the wheels the operation, when only one pair of wheels are to be removed, should consume less time than any of the other methods with the possible exception of the crane. The consideration of cranes of high capacity for engine house use is obviously out of place as the higher cost and small range of utility would prohibit their installation.

The hoist or drop table may be used to advantage in a very large engine house where it is a common practice to remove two or more pairs of drivers and where the volume of work of this nature warrants the expenditure of the comparatively large amount of money entailed in their purchase and installation. For the ordinary engine house, however, the drop pit serves all purposes to the best advantage and insures the lowest unit costs. As has previously been mentioned, it is not necessary that every engine house be equipped with a drop pit, as

with proper supervision as to conditions, it is perfectly practical to so handle locomotives that work requiring the dropping of wheels may be performed at one main point for each division. When drop pits are to be installed, or old ones remodeled, the actual work should be preceded by a careful study of the amount of work to be handled to determine the number of engine pits which it will be necessary to use for this class of work. The dimensions of pits should be made to provide for all of the variations in types of power in actual service or in prospect, so as to avoid frequent remodeling or inconvenience in performing work on engines with exceptionally high drivers or an unusually short wheel base. Pits should be constructed with a view to permanency, reinforced concrete being probably the best material for the purpose. The provisions for draining should be given special attention to insure a clean, dry pit under all conditions.

Nothing is as destructive to drop pit jacks as being allowed to stand in a pit partially filled with water, nor is anything so discouraging and distasteful to workmen as being required to work in a slimy, evil-smelling, unsanitary hole. The jack carriage should be made as wide and with as long a wheel base as possible to insure the greatest protection from tipping and also to facilitate its easy movement under load. The jack head should be constructed to give ample support for the wheels to avoid any danger of their slipping off and falling into the pit. The best type of jack for drop pit use is a subject of considerable difference of opinion, some mechanics holding that the hydraulic type, although very much slower and requiring more physical effort for its operation, is better adapted to the purpose on account of the steadiness of movement which minimizes the liability of accident. The air jack, however, while considerably cheaper as to first cost and maintenance, and many times faster in operation, if carefully constructed and so arranged as to provide for raising and lowering by means of a valve placed so as not to require the operator to stand in the pit, will prove a far more satisfactory machine for the purpose.

The question is often asked, when drop pit improvements are suggested, as to how much can be economically expended on this facility, presupposing that redesign will effect a certain saving in time and labor per pair of wheels dropped. Let us suppose that with the old equipment a mechanic and helper, with rates per hour of forty and twenty cents respectively, are able to remove and replace a pair of wheels, considering only such time as influenced by the pit facilities, in four hours, which represents a labor cost of \$2.40. Assuming, then, that improvements can be made which would reduce the time of removing and replacing the wheels to two hours at a labor cost of \$1.20, it is still necessary to determine the average number of wheels which it will be necessary to drop. Let us say that from past records it is found that an average of one pair of wheels are handled each day. By reducing the labor cost by \$1.20 per pair this amount of work would provide a fund of \$438 per year to pay the interest and depreciation on the new equipment. Assuming the rates of the two combined at 8 per cent., it will be seen that an expenditure under \$5,475 would be justified in making improvements which would insure the decrease in time. The feature of time detention should also be considered when drop pit improvements are contemplated, as with effective equipment work on driving wheels and boxes may be done within the time ordinarily allowed for handling and rest of crews, and it becomes unnecessary to hold engines out of service, as is often necessary on account of inadequacy of facilities.

Before leaving the subject of drop pits it might be well to say a word as to the provision of small pits for the purpose of handling engine truck wheels. The common practice of jacking up the engine, removing and replacing the pilot, and tearing apart the truck frame to renew a pair of engine truck wheels, or their boxes, is by no means an efficient operation, and a comparatively small amount of this work would warrant the

consideration of one or more small pits for handling these wheels.

JACKS.

It is doubtful whether there is any one item under the general head of facilities which deserves more close attention than that of jacks for raising engines. Poor jacks, or jacks of insufficient power, are the cause of much wasted time. Another large item of time waste is often engendered by the careless method of handling which leads to the impression that the supply is insufficient when in reality the number of jacks is ample for all needs, provided they can be found and are in proper condition for use when desired. Every engine house should be equipped with jacks of sufficient capacity to raise without difficulty the heaviest class of engine on the division, the number of such jacks required at any point being easily determined from a study of the class and quantity of repairs to be handled. Hesitancy is often exhibited by engine house foremen and master mechanics in the ordering of new jacks for the reason that the best articles in this line are very expensive; however, the initial cost of good jacks will be insignificant when compared with the saving in cost of operations which they are able to effect.

Cases have often come under observation in which two or more men have spent from three to five hours in trying to raise an engine with poor jacks or jacks of insufficient capacity, when the operation might have been performed in one-half hour or less with the proper facilities. An item of equal or perhaps greater moment than the supplying of jacks of proper number and capacity is the care of such equipment when furnished. These machines are in need of almost constant attention in order that they may be kept in the best of condition. A certain man, fully conversant with the work, should be assigned the duty of making the necessary repairs, and he should be held responsible for their condition. A platform centrally located should be provided on which all jacks should be kept when not in use, and definite instructions should be issued insuring their return to this place as soon as operations requiring their use are completed. It is safe to say that six or eight good jacks, which should be a sufficient number to handle the work at any engine house of average size handling, say, fifty to sixty engines a day, would pay for themselves and their care many times over during a year by the amount of time saved on the various operations.

MACHINE EQUIPMENT.

The engine house requirements as to machine equipment will vary greatly with the class of work to be handled and the proximity to the shops. The engine house which is located at a point where no back shop is in operation must be provided with a sufficient number and variety of machines to take care of all the machining operations which will ordinarily arise. As a rule, such engine houses are of minor importance; that is, they are located at intermediate points between division terminals where shops are provided, and the work they are required to perform is therefore only the lightest of running repairs. It is not economic to provide such engine houses with expensive up-to-date machines, as their use would be intermittent and a large part of the time they would stand idle. A few old machines, which have served their term of usefulness in a shop, when carefully repaired, will serve all purposes, and will allow for a minimum cost of performing operations, as the hourly machine charge will be very low, although the labor charge will, of course, be slightly higher than with a new machine.

A small engine lathe, shaper, drill press and single head bolt cutter, with possibly a small planer, will generally furnish the necessary equipment for such points. The original cost of this equipment when supplied from the discard of large shops will be very small indeed, and if the machines are put in good repair before installation and are kept in good condition by periodical overhauling, they will handle the ordinary run of work at a minimum cost.

The engine house which is located at a shop point is the one which deserves the most careful investigation as to machine equipment. It is too often the case that an engine house so located as to be within a few hundred feet of a back shop is provided with no machines whatever, making it necessary for every job, no matter how small, to be taken to the machine shop. This system presents many disadvantages, both to the engine house and to the shop management. The machine shop foreman has constant occasion for complaint in that his regular shop work is delayed and his plans interfered with on account of the necessity of giving engine house work preference, which often entails the removal of a piece of work from a machine in order to substitute a rush job. The machine operator loses a very considerable amount of time in making trips to the engine house to obtain measurements. The engine house mechanic wastes a far greater amount of time in taking his work to the machine shop and waiting for it, or running back and forth at frequent intervals. The simple operation of fitting a bolt will require the machine operator to make two or more trips to the engine house, consuming more time in making the trips than in turning the bolt. The drilling of a hole in a clamp or bracket, which requires but a few seconds, will entail a trip consuming several minutes.

A little study will show conclusively that a few simple machines centrally placed in the engine house, manned by one or more all-around operators, will effect a saving in time of repair men, will relieve the machine foreman of much aggravation, and will provide a means of rendering the engine house more or less independent of the shop, which is at all times desirable. Such equipment should only provide for the performance of those operations which are of frequent occurrence, and should not be expected to take care of work requiring heavy machining, as this can be accomplished by the regular shop machines at less cost. A small engine lathe for fitting bolts and pins, turning piston and valve stem packing and other miscellaneous small parts; a small drill press and bolt cutter to handle the innumerable operations of this nature; and a small planer or good sized shaper for reducing rod brasses or eccentrics, planing keys, liners, shoes and wedges, crosshead gibs and other small parts would, as a rule, be a sufficient equipment for the ordinary engine house, although it will occasionally prove expedient to install a small high speed boring mill for boring rod brasses, eccentric straps, rocker boxes, etc. When considering the machine equipment of engine houses it should be borne in mind that the actual time consumed, or the cost of the various items, will not be as low as for the same operations performed in the machine shop, the great advantage gained being in the time saved by eliminating the trips between shops.

TOOL ROOMS.

The tool room is as necessary an adjunct to the engine house as it is to the shop, and should be as fully equipped and efficiently handled. The best of tools are of doubtful advantage unless properly cared for and easily available. The engine house tool room should contain a supply of all of the regular and special tools needed for the performance of the various operations included in running repairs, and should be in charge of a man, or men, who are competent to make the repairs necessary to keep them in the best of condition.

There are certain tools, of course, which it is necessary for each mechanic to have with him at all times, such as a hammer, chisels and monkey wrenches, and these tools should be kept by the workmen. Then there are the regular tools such as sledges, bars, wrenches for various parts, small jacks, motors, air hammers, etc., which are in demand at all times, but not sufficiently so to require their being furnished to each individual workman. These tools should be kept in the tool room where they may be obtained with as little trouble and loss of time as though they were kept in the cupboards of the workmen,

as is often the practice. Keeping these tools in a tool room provides for their proper care and prevents their loss or destruction, as it also insures the minimum necessary number of each article.

It has been observed that in the average engine house a large part, even to a majority, of the time of the mechanics is consumed, not in the actual work, but in getting together the necessary tools and materials for its performance. In many cases each mechanic is provided with a helper regardless of the class of work to which he is assigned, the reason being given that the low rate man may save the time of the mechanic by making the necessary trips to the tool room, store house or shop. A much more economical plan would be to employ tool runners who, under the direction of the repair foreman, would do the necessary running about for an entire gang of men.

BOILER WASHING.

Perhaps the most important of comparatively recent inventions for facilitating the handling of engines is the hot water boiler washing system. The advantages of this system have been so widely advertised and its adoption has been so universal that extended comment would seem unnecessary. Under the old cold water system the operation of washing a boiler was one which could not be rushed for fear of damage to the firebox and boiler; engines were frequently held from their regular runs or let go out dirty. With a properly constructed hot water system, cooling down is unnecessary, the actual draining, washing and filling processes consume but a few moments, and there is no danger of damage to the sheets. The system has the triple advantage of saving time and therefore reducing the cost of the operation of washing, insures the minimum time out of service for the locomotive, prolongs the life of sheets, staybolts and flues, and thereby reduces the cost of boiler repairs and the frequency of boiler troubles.

SIGNALS.

In very few engine houses has the importance of a signaling system been recognized. The engine house foreman, one of the busiest of men, spends a large part of his time hunting for his various under-foremen. If you have ever tried to find a particular man in a busy engine house you will realize just what a proposition this is. Some one is constantly wanted, the hostler to move an engine, the inspector, the boiler foreman, anyone of the various gang bosses, and the common method is to inquire and hunt until they are located. A simple and inexpensive method of alleviating this condition, thereby saving much valuable time and many miles of walking, is to install a small air whistle in the foreman's office. A code of signals can be arranged so to attract the attention of the person required.

The system of signaling may be carried still further by providing a line of electric push buttons connecting each stall of the engine house with the tool room or foreman's office. This system, together with the employment of tool and material runners, will save a great deal of the time of high rate mechanics, as when they are in need of a tool from the tool room or material from the store house or the assistance of the labor gang, they may make their wants known without leaving their work.

The suggestions which have been made do not in any degree cover the ground embraced under the head of engine house facilities, nor has there been any attempt to point out just what the best equipment would be for any particular engine house. The whole object has been merely to place the subject in such form as to emphasize to engine house foremen and master mechanics the importance of making a thorough study of conditions to determine what can and should be done to assist in the handling of engines, and to assist them, if possible, in figuring the savings which may be expected from improved facilities so that these things may be placed before the officers who make the appropriations in such light as to insure their approval.

GOODWIN DUPLEX WATER GLASS

A high pressure water glass arranged so that both members of the locomotive crew can see the water level from any point in the cab without the use of mirrors, has been applied to the Pacific type locomotives recently built for the San Pedro, Los Angeles & Salt Lake. This water glass was designed and is being manufactured at the Los Angeles shops of the Southern Pacific. It has a number of advantages in addition to its range

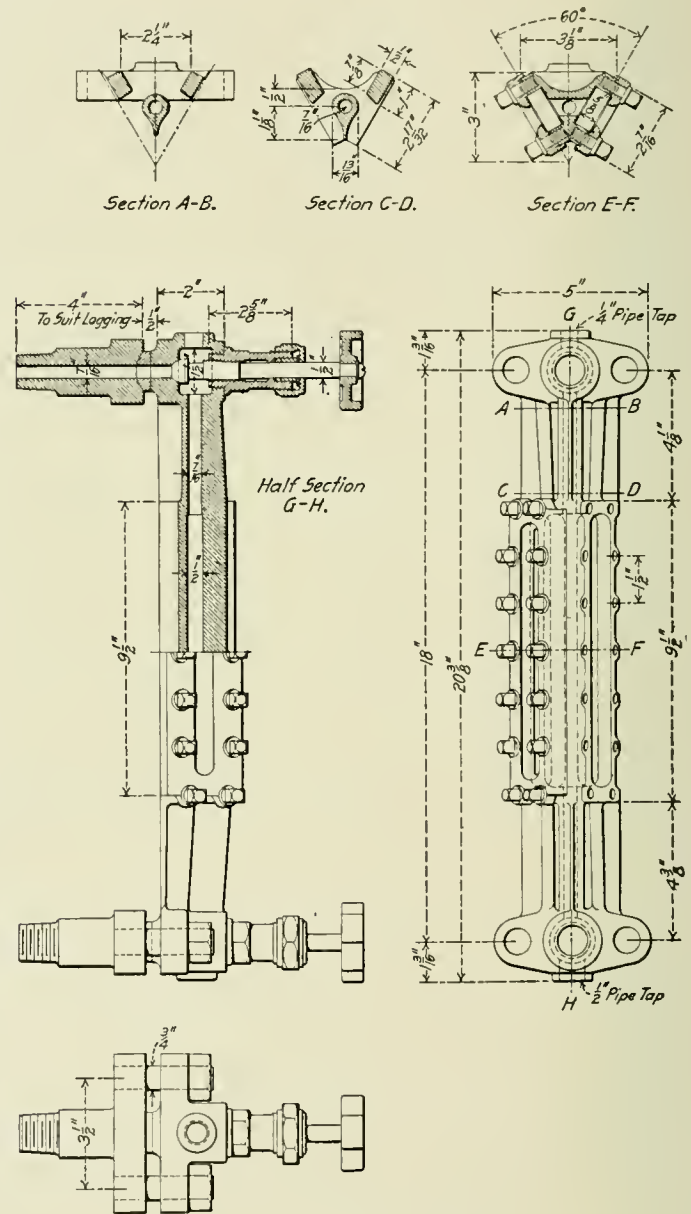

Goodwin Duplex Water Glass.

of visibility. Plain glass, 5/8 in. in thickness, is secured in place in the same manner that the reflex glass usually is. The connection to the boiler fittings is made with ground joints, each end of the frame holding the glass being secured by two studs, eliminating the necessity of using any gaskets or nipples. A special ball washer is provided for the joint which can be easily ground in place. The material throughout, except the small studs, is of brass.

AROUND THE WORLD IN THIRTY-NINE DAYS.—E. J. Scott and J. A. Allen, of Phoenix, Ariz., claim they have encircled the globe in 39 days, which is about 19 hours less than the time made by the Paris reporter last year.

TENDER WHEEL LUBRICATOR

Some of the pusher locomotives on the Buffalo & Susquehanna operate over a switch-back in which there are five leads. The conditions at this point are such that the engines normally make about seven hundred engine miles to one hundred train miles. This service causes excessive flange and rail wear, the former being particularly noticeable on the pusher engine, and especially on the tender wheels. John W. Clark, the roadmaster, suggested experimenting with water lubrication and the arrangement shown in the accompanying illustration was applied. It consists simply of a 3/8-in. pipe tapped into the rear

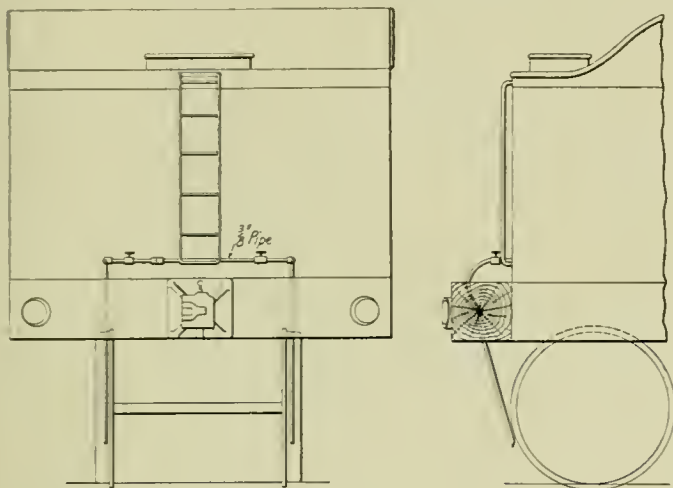

Water Lubrication for Tender Wheel Tires When Operating Over Sharp Curves.

of the tender tank and carried down to a point about 8 in. above the rail near the tire of the rear tender wheels. Valves permit adjustment to allow the proper amount of water to play on the flanges and tire of the wheel. The improvement in both flange and rail wear, as well as the reduction in the tendency of derailment was immediately noticeable and the scheme is considered a success.

It has been found impossible to use it during the winter months, but at that time there is sufficient snow and rain on the rail to reduce the friction. It is used when the locomotives are backing up, as well as going ahead, and has caused no trouble from slipping of the drivers. When going ahead it

MIKADOS FOR THE LACKAWANNA

In addition to the seven large hard coal-burning Pacific type locomotives, illustrated on page 391 of the August issue of this journal, the Delaware, Lackawanna & Western is also putting in service 15 locomotives of the 2-8-2 type, built by the American Locomotive Company. These are to be used in both fast and slow freight service between Buffalo and Elmira, N. Y., the object being to operate larger train units. At the present time consolidation locomotives having 26-in. x 30-in. cylinders and a maximum tractive effort of 24,400 lbs. are used in slow freight service in this district, and locomotives of the 2-6-0 type with a maximum tractive effort of 29,480 lbs. are generally employed for fast freight trains. The new Mikados have 28-in. x 30-in. cylinders, 63-in. wheels, and a tractive effort of 57,000 lbs. They are fitted with very large high degree superheaters.

Compared with other locomotives of the same type that have been recently illustrated in these columns, the new Lackawanna engines stand among the leaders in weight and capacity. While they are exceeded slightly in total weight by at least three other recent designs, and in tractive effort by four other designs, there is but one other group of Mikado engines that exceeds them in evaporative heating surface, and since they were not fitted with superheaters the Lackawanna locomotives in regard to boiler power, judged from a basis of equivalent heating surface, are the most powerful of their type. The boiler is of the straight top type and measures 88 in. outside diameter at the first ring and 89 7/8 in. at the largest diameter. The accompanying table will permit a comparison with three other boilers of Mikado type locomotives. The most striking feature evident from this comparison is the size of the superheater that has

GENERAL DIMENSIONS OF BOILERS FOR RECENTLY BUILT MIKADO LOCOMOTIVES.

| Road | D.,L.&W. | C. & O. | Erie. | C.,R.I.&P. |
|---------------------------------------|----------|-----------|-----------|------------|
| Type of boiler | Str. | W. T. | Str. | Str. |
| Outside diameter at first ring, in.. | 88 | 83 3/4 | 84 | 86 |
| Outside diameter at throat sheet, in. | 89 7/8 | 96 | 87 3/4 | 89 1/2 |
| Number and diameter of tubes, in. | 304-2 | 238-2 1/4 | 232-2 1/4 | 238-2 1/4 |
| Number and diameter of flues, in. | 43-5 3/8 | 40-5 1/2 | 36-5 1/2 | 36-5 1/4 |
| Length of tubes, ft..... | 21 | 19 | 21 | 21 |
| Steam pressure, lbs..... | 180 | 170 | 170 | 180 |
| Heating surface, firebox, sq. ft.... | 261.3 | 311.2 | 219 | 260 |
| Heating surface, tubes, sq. ft.... | 4,592.8 | 3,740 | 3,936 | 4,004 |
| Heating surface, total, sq. ft.... | 4,854.1 | 4,051.2 | 4,155 | 4,264 |
| Heating surf., superheater, sq. ft. | 1,065 | 845 | 843 | 848 |
| Heating surface, equivalent, sq. ft. | 6,451.6 | 5,318.7 | 5,420 | 5,536 |
| Grate area, sq. ft..... | 63.1 | 66.7 | 70 | 63 |
| Evap. H. S. ÷ superheater H. S. | 4.56 | 4.79 | 4.93 | 5.03 |
| Evap. H. S. ÷ grate area..... | 76.9 | 60.7 | 59.4 | 61.5 |

been applied. Although 2 in. tubes have been used, which give the very large evaporative heating surface, still the superheater

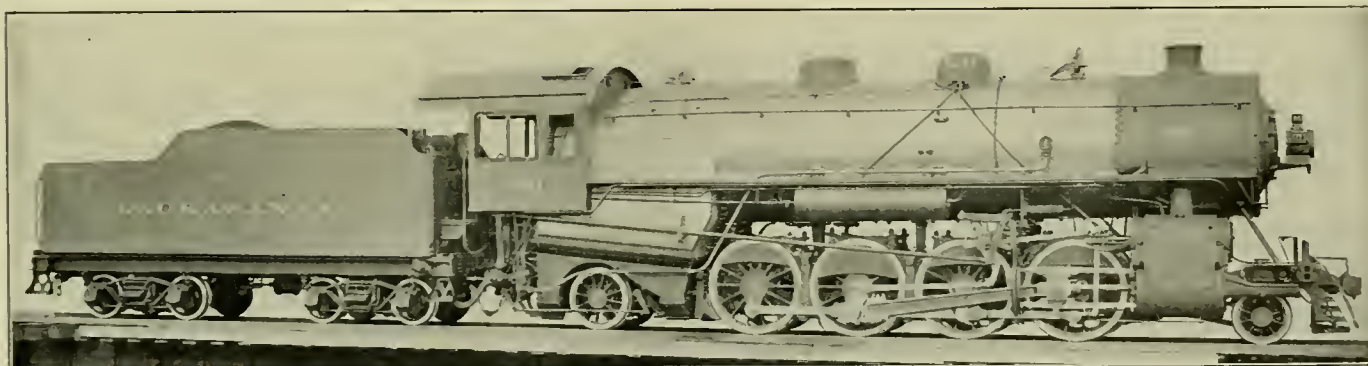

Mikado Locomotive Designed to Haul Heavier Freight Trains Between Buffalo and Elmira on the Lackawanna.

washes the sand from the rails and reduces the resistance of the train.

ELECTRIC LINE IN AUSTRALIA.—The electrification of the suburban lines of Melbourne, Victoria, will include 300 miles of single track.

is even relatively larger and has one square foot of heating surface to every 4.56 sq. ft. of evaporative heating surface. This is about 5 per cent. less than the same ratio on the Chesapeake & Ohio, 7 1/2 per cent. less than on the Erie, and 9.4 per cent. less than on the Rock Island. The superheater is composed of 43 elements arranged in four rows of nine each and one top

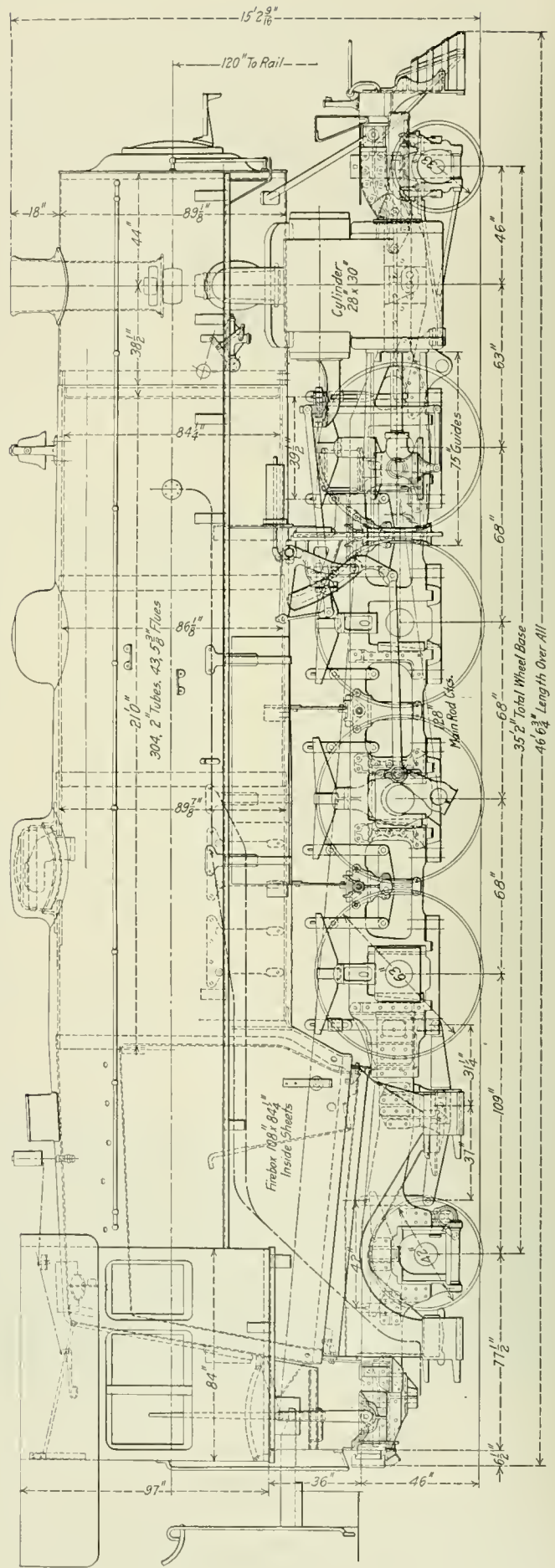
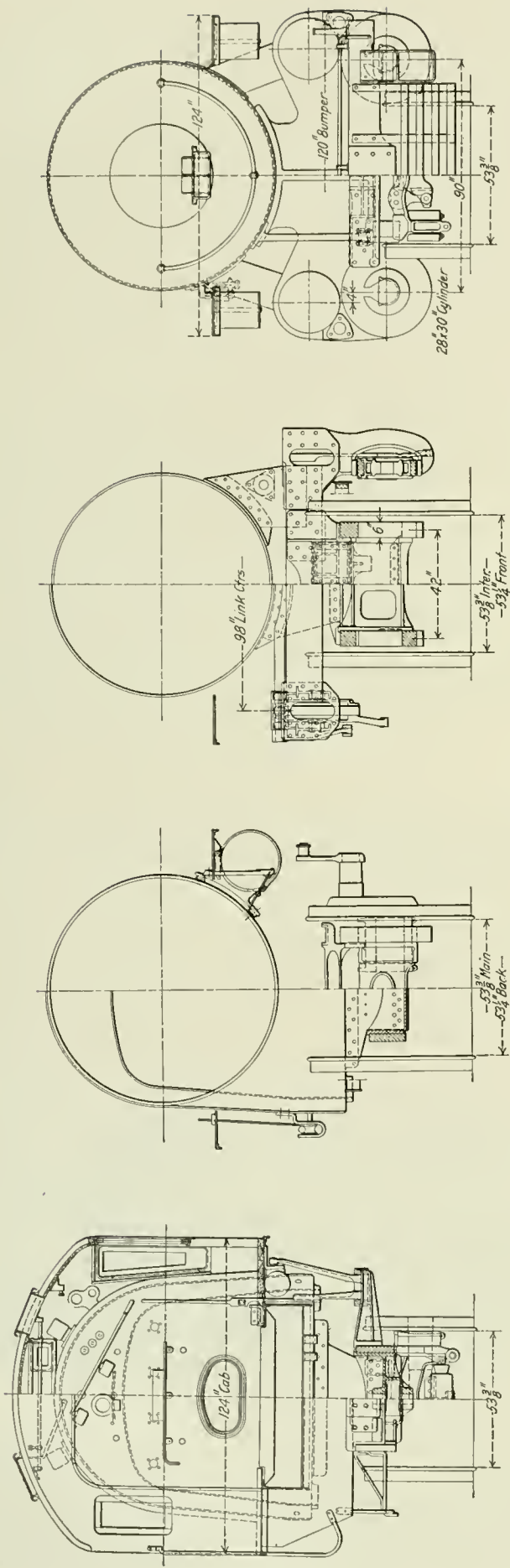

Mikado Locomotive for Use in Fast and Slow Freight Service on the Delaware, Lackawanna & Western.

row of seven, as is shown in the accompanying boiler illustration. This gives a surface, figured on the inside of the tubes, and not including the area of the header, of 1,065 sq. ft., making it the largest superheater ever applied to a non-articulated locomotive. The grate area of 63 sq. ft. is practically the same as is shown on the Rock Island design, but the ratio of grate area to evaporative heating surface is very much larger.

In construction, the boiler presents no novelties. Tate flexible staybolts have been freely used and the firebox is fitted with a Security brick arch carried on four water tubes. The dome is built up of three parts, there being a 1/2-in. sheet ring con-

of driving box is meeting with general approval, and that it has now been adopted for 82 locomotives, either built or under construction. The self-centering guide for the extended piston rod and the self-centering arrangement for the valve stem guide have been applied to the Mikado as well as the Pacific type. The piston valve is 16 in. in diameter and has a 7-in. travel, the steam entering through the outside pipe at the top of the steam chest. It will be noted that the ordinary type of reverse lever is used and that the reach rod is placed very low, connecting to a downwardly extending arm on the lift shaft. The same design of six hopper ash pan* applied to the Mountain and Mikado

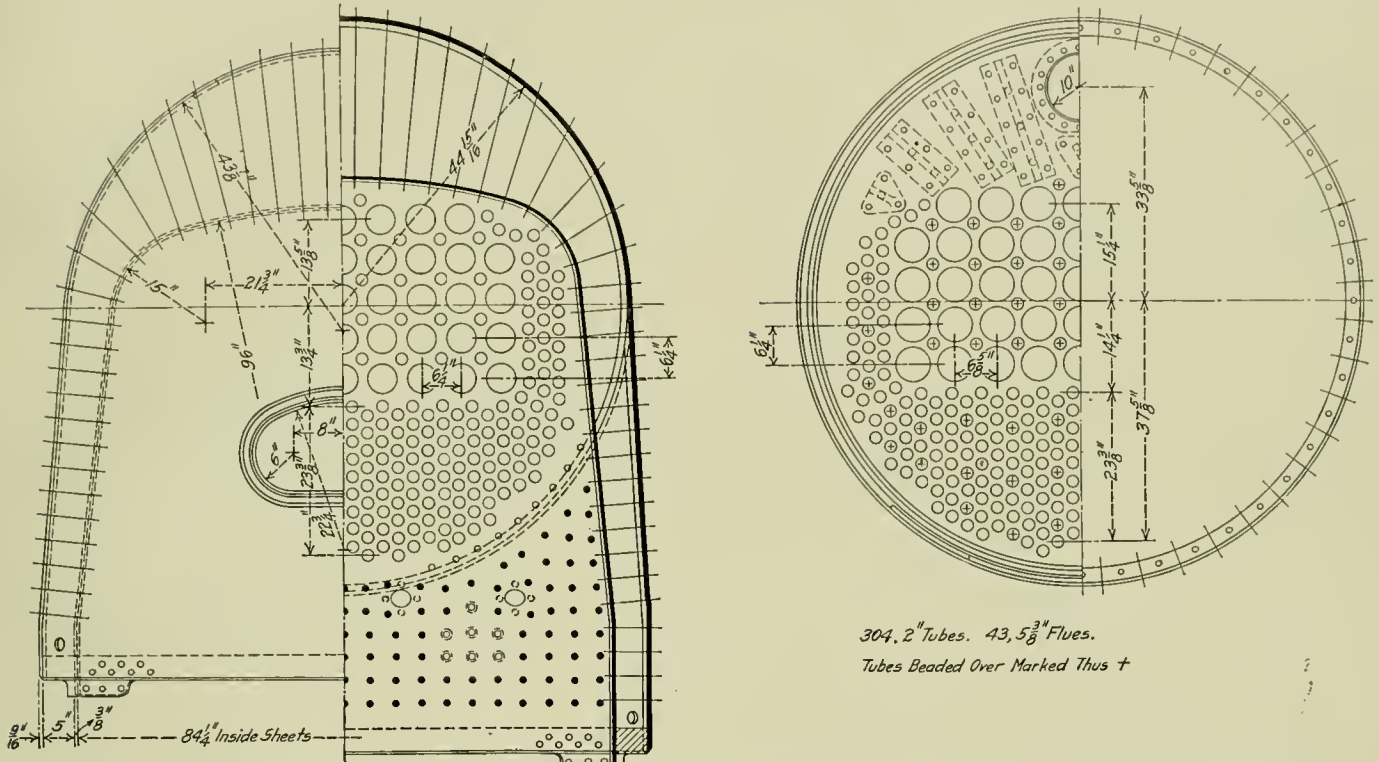

Arrangement of the Firebox Sheets and Boiler and Superheater Tubes on Mikado Locomotives for the Lackawanna.

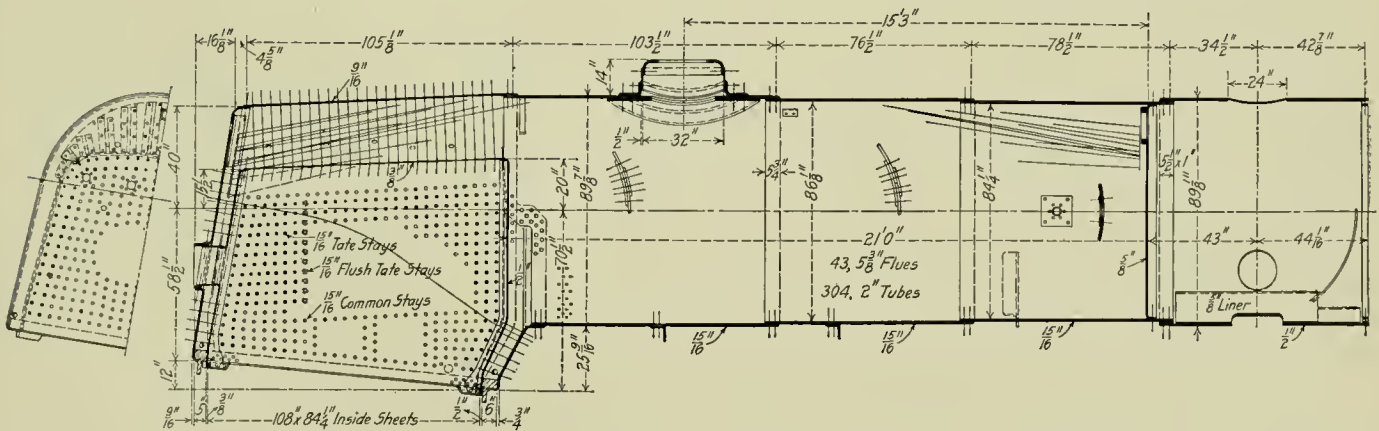

Boiler of New Mikado Locomotive for the Delaware, Lackawanna & Western.

necting the two flanged 1 in. sections. The smoke stack has a very long interior extension, bringing its lower edge but one foot above the top of the exhaust nozzle.

In the construction of the running gear the latest approved practices of the builders have been followed in many particulars. It will be noticed that the same type of long main driving box which was used on the Pacific type above mentioned, and was illustrated and described in detail in the August issue of this journal, page 393, has also been applied to these locomotives. It is stated by the American Locomotive Company that this type

locomotives built for the Chesapeake & Ohio Railroad has been specified on these engines.

The general dimensions, weights and ratios are shown in the following table:

General Data.

| | |
|-------------------------|-----------------|
| Gage | 4 ft. 8 1/2 in. |
| Service | Freight |
| Fuel | Anthracite coal |
| Traction effort | 57,000 lbs. |
| Weight in working order | 312,000 lbs. |
| Weight on drivers | 236,500 lbs. |

*See American Engineer & Railroad Journal, October, 1911, page 384.

| | |
|---|--------------|
| Weight of engine and tender in working order..... | 471,700 lbs. |
| Wheel base, driving..... | 17 ft. |
| Wheel base, total..... | 35 ft. 5 in. |
| Wheel base, engine and tender..... | 67 ft. 7 in. |

Ratios.

| | |
|---|--------|
| Weight on drivers ÷ tractive effort..... | 4.15 |
| Total weight ÷ tractive effort..... | 5.47 |
| Tractive effort × diam. drivers ÷ equiv. heating surface*..... | 556.60 |
| Total equiv. heating surface* ÷ grate area..... | 102.40 |
| Firebox heating surface ÷ total equiv. heating surface*, per cent.... | 5.40 |
| Weight on drivers ÷ total equiv. heating surface*..... | 36.60 |
| Total weight ÷ total equiv. heating surface*..... | 48.50 |
| Volume of both cylinders, cu. ft..... | 21.40 |
| Total equiv. heating surface* ÷ vol. cylinders..... | 301.40 |
| Grate area ÷ vol. cylinders..... | 2.94 |

Cylinders.

| | |
|--------------------------|-----------------|
| Kind..... | Simple |
| Diameter and stroke..... | 28 in. x 30 in. |

Pistons.

| | |
|-----------------------|------------|
| Kind..... | Piston |
| Diameter..... | 16 in. |
| Greatest travel..... | 7 in. |
| Outside lap..... | 1 3/16 in. |
| Inside clearance..... | 0 in. |
| Lead..... | 1/8 in. |

Wheels.

| | |
|--|---------------------|
| Driving, diameter over tires..... | 63 in. |
| Driving, thickness of tires..... | 3 1/2 in. |
| Driving journals, main, diameter and length..... | 11 in. x 21 in. |
| Driving journals, others, diameter and length..... | 10 1/2 in. x 13 in. |
| Engine truck wheels, diameter..... | 33 in. |

| | |
|------------------------------------|--------------|
| Smokestack, diameter..... | 18 in. |
| Smokestack, height above rail..... | 182 9/16 in. |

Tender.

| | |
|------------------------------------|---|
| Frame..... | 13 in. chan. center and 10 in. chan. side sills |
| Wheels, diameter..... | 33 in. |
| Journals, diameter and length..... | 6 in. x 11 in. |
| Water capacity..... | 8,000 gals. |
| Coal capacity..... | 14 tons |

*Equivalent heating surface equals 4,854.1 sq. ft. + (1.5 × 1,065 sq. ft.) = 6,451.6.

A NOVEL DESIGN OF SLING STAY

BY GEORGE SHERWOOD HODGINS.

The boiler sling stays on the London & South Western express and tank engines are simple in construction and strong. On the roof sheet of the boiler, over the flue sheet, an old form of U-rail is riveted, and to this, at regular intervals, are pinned the crow's feet. The pin used is sharpened at one end and has a hinged key at the pointed end. This enables it to be pushed into place easily, and when in position the hinged key automatically locks it.

The stay itself drops through a hole in the crow's foot, and

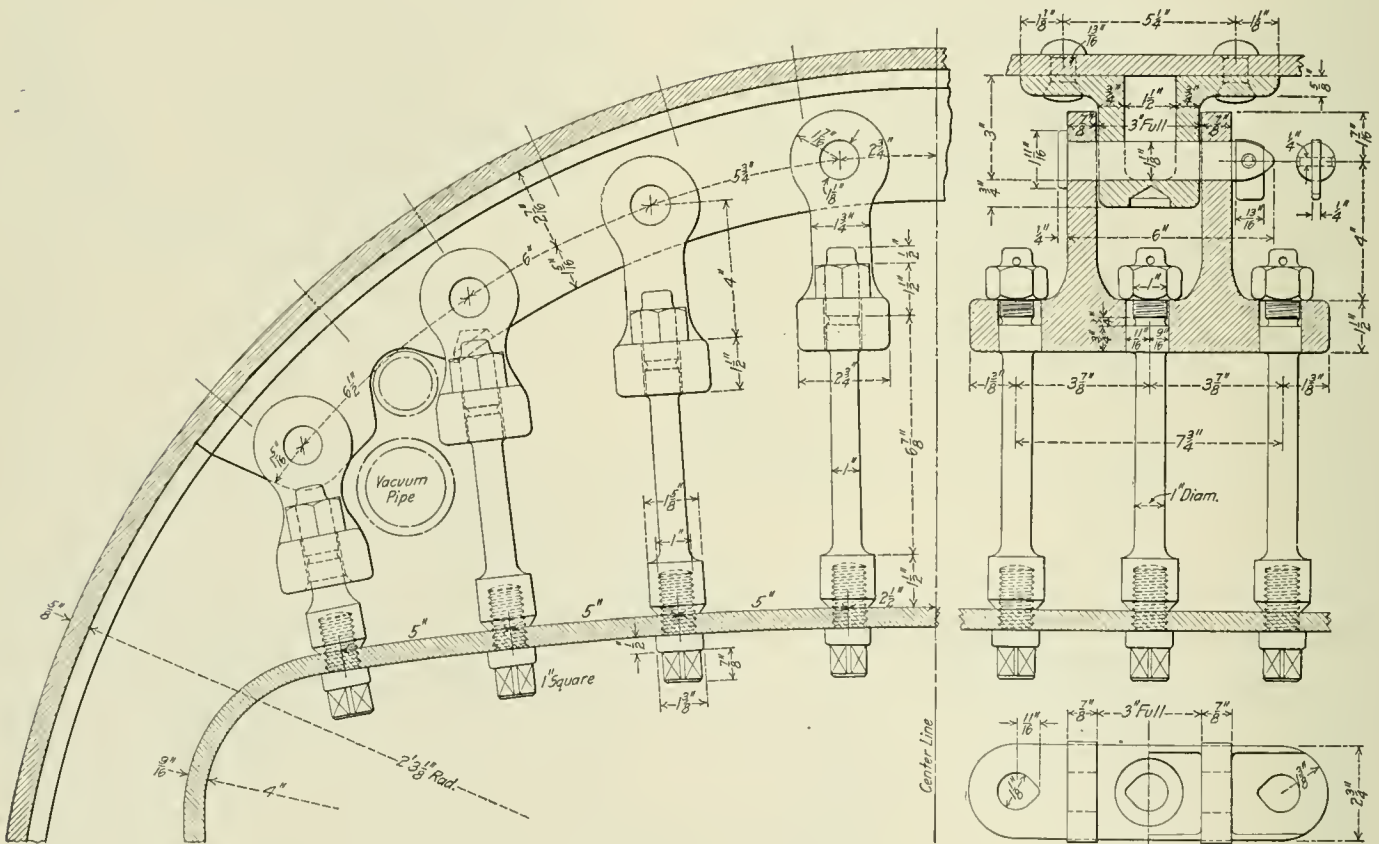

Type of Sling Stay Used on the London & South Western.

| | |
|--------------------------------------|----------------|
| Engine truck journals..... | 6 in. x 12 in. |
| Trailing truck wheels, diameter..... | 42 in. |
| Trailing truck journals..... | 9 in. x 14 in. |

Boiler.

| | |
|---|--------------------------|
| Style..... | Straight |
| Working pressure..... | 180 lbs. |
| Outside diameter of first ring..... | 88 in. |
| Firebox, length and width..... | 108 in. x 84 1/4 in. |
| Firebox plates, thickness..... | 3/8 in. and 1/2 in. |
| Firebox, water space..... | F-6 in.; S. and B.-5 in. |
| Tubes, number and outside diameter..... | 304-2 in. |
| Flues, number and outside diameter..... | 43-5 3/8 in. |
| Tubes, thickness and material..... | No. 11, B. W. G. Iron |
| Flues, thickness..... | No. 9, B. W. G. |
| Tubes, length..... | 21 ft. |
| Heating surface, tubes and flues..... | 4,592.8 sq. ft. |
| Heating surface, firebox..... | 261.3 sq. ft. |
| Heating surface, total..... | 4,859.1 sq. ft. |
| Superheater heating surface..... | 1,065 sq. ft. |
| Grate area..... | 63.1 sq. ft. |

is secured in place by a nut with a split key above. The "neck" of the stay has a pin on one side which fits into a recess in the crow's foot, and this enables the nut to be put on above, and the tap bolt entered from below. This arrangement subsequently prevents the stay from turning or slackening in any way. The crown sheet stay is practically a tap bolt which screws through the crown sheet and up into the enlarged socket at the lower end of the stay.

The whole arrangement is such that the stay is always tight in the crown sheet, and any vertical movement of the flue sheet tends to lift the nut on the crow's foot and provide the necessary "give and take" for the expansion and contraction of the firebox.

TRAVELING ENGINEERS' ASSOCIATION

The Twentieth Annual Convention Maintained the High Standard of the Previous Meetings of This Body.

The twentieth annual convention of the Traveling Engineers' Association was opened by President W. C. Hayes, superintendent of locomotive operation of the Erie, at the Hotel Sherman, Chicago, on August 27. There were about 375 members and guests present. After prayer by Dr. Kennedy Marshall, S. O. Dunn, editor of the *Railway Age Gazette*, was called on for the opening address.

ADDRESS OF S. O. DUNN

Mr. Dunn spoke forcefully of the necessity for greater efficiency of railway operation, particularly in connection with the work of the employees. After drawing attention to the continual decrease in the net earnings, due principally to the increase in operating expenses and taxes, he pointed out that although government regulation had been partially responsible, the main cause of the recent increases in operating expenses had been the advances in the wages of railway employees. He then continued as follows:

"All who are connected with railways agree that it is the duty of state and national governments, in regulating and taxing them, not to make or keep their rates so low as to impair reasonable gross and net earnings. A majority of those connected with railways think that the tendency of the regulating authorities is to make and keep rates and gross earnings too low. But net earnings depend not only on how much gross earnings are, but also on how much operating expenses are; and employees are not unanimous in believing that it is to their interest and is their duty to do all that they can to further the efficiency in operation, which is necessary to enable the roads, while paying reasonable wages, to keep operating expenses as low as practicable.

"All who work for railways and receive from them salaries and wages are employees. The president, the general manager, the superintendent, the traveling engineer are just as much employees as the engineman, the switchman, or the track laborer. But ordinarily we divide those on railway payrolls into the officer class and the employee class. Now, you and all other officers recognize the fact that it is to your interest to increase efficiency just as much as you can. It needs no argument to convince the traveling engineer that it is advantageous to so do his work that the number of tons moved one mile by each engine crew, by each engine and by each pound of coal shall be the greatest practicable. To accomplish this is what you are employed for, is what you are here for. But among employees, that is, among those who work for what are called "wages," as distinguished from what are called "salaries," there is a quite general opinion, not perhaps often explicitly put into words, but often very explicitly manifested in acts, that they have nothing to gain and something to lose by heartily co-operating with the railway managements in efforts to increase the efficiency of operation to the utmost. I need not detail any of the various manifestations. You are familiar with them, because you are on the firing line all the time, laboring to get the greatest efficiency from the most important and distinctive part of railway equipment and those who handle it. This feeling is one that pervades a large part of labor in all lines of industry. The employees are apt to say—if not in words at least in attitude and acts—that the company will, of course, gain by getting as much and as good work as possible from each man. They are apt to say that the individual officer will also gain; by this means the traveling engineer may get promoted to master mechanic or assistant superintendent, and thence to higher positions. But

the effect on the employees, they are apt to contend, will be, not to increase their wages or reduce their hours of work, but to make necessary fewer men, and, thereby, throw some out of employment.

"As to promotion, the history of our railways and the biographies of their present officers show that the avenues leading up to the very highest offices always have been open to every employee. The managements are no more disposed to close that door on anyone now than they ever were. They know that the best way to get capable officers is to let the process of natural selection work itself out among all of the 1,700,000 employees. Today, as in the past, every hard-working and competent employee has a fair chance of being advanced for individual efficiency, even to the highest positions.

"Aside from the matter of promotion, is it not to the interest of all railway employees that the railways should be as economically and efficiently operated as is reasonably practicable? Is it not to the interest of all workmen that all industrial processes should be as efficiently and economically performed as is reasonably practicable? We will all agree that it is undesirable, in the pursuit of industrial efficiency, to so speed men up or to require them to work such long hours that their health will be impaired, or that they will be denied the time and opportunity for reading, for the pleasures of home and social intercourse, and for the performance of their duties as citizens of a democratic country. But, conceding this, is it not to the interest of all employees to work to the *healthy* limit of their capacity and to co-operate with their employers in developing and adopting every method and device that will increase their individual and collective efficiency?

"The answer given by many employees is, in substance, no. The machinist says, in effect, that if each machinist does all he can there will not be enough places for all machinists. The engineman says, in effect, that if he moves as many ton miles per hour as he can there will not be enough employment for all enginemen. If it be true that if all those employed in each craft do all they can there will not be employment for all members of each craft, it must follow that if all the employed workers in the country do all they can there will not be enough employment for all who want to work. This, of course, involves the assumption that at any given time there is only a certain amount of work to be done, and that unless it is equitably divided among all there will be some who can get nothing to do. I read not long since in the official publication of one of the largest railway brotherhoods an article opposing the use of methods, devices and equipment adapted to increase the amount of work done by each shop employee and the number of ton miles of freight handled by each train crew on the express ground that these things tend to cause unemployment.

"Now, if it could be shown that the use of methods and machinery that enabled each worker to turn out a larger product, whether that product were corn or manufactures, or ton miles, did tend to injure the workers as a class, either by increasing unemployment or in any other way, we all ought to oppose the use of such methods or machinery. Industry exists for men, not men for industry; and whatever in any industry is injurious to those employed in it should not be tolerated unless it can be clearly shown that the compensating benefits it confers on the employees and on society as a whole exceed the harm that it causes. But is it true that increased industrial efficiency does tend in any way to injure working men, except in very exceptional, temporary and isolated cases? What do men

work for? Not for money, but for the things that money buys—food, shelter, raiment, and so on. And what must be the effect of limiting the amount of work that men do? Obviously, it must be to limit the total amount of things that are produced and that can be consumed. What, on the other hand, must be the effect of increasing industrial efficiency? Obviously, it must be to increase the amount of the things that are produced and that can be consumed. Does increased production and the possible increased consumption that results from it do harm?

"If it were true that the greater the amount of work done by each person who was employed the more unemployment there would be and the worse off the working classes would be, we would find the least unemployment and the highest state of welfare among the workers in those countries where the individual efficiency of labor is the least. On the contrary, it is in countries where the individual efficiency of labor is the greatest that we find the least unemployment and the highest state of welfare among those who work with their hands. The industrial efficiency of a nation is made up of all the individual efficiencies of all its people; and you cannot get the greatest national industrial efficiency if you limit the individual efficiencies. On the contrary, that way lies national and individual industrial and commercial disaster and penury.

"If you go among the employees of railways or any other class of working men and present this argument you may be answered that the demonstration is conclusive that an increase of production accomplished by an increase in the quality and quantity of work done by each employee would be beneficial to all if the increased product were equitably divided, but that the trouble would be that the increased product would not be equitably divided—that the lion's share, or all of it, would be appropriated by the capitalist class. But the question of the division of the product is a question of distribution, not one of production. Limiting what is produced merely limits the amount that there is to be divided, and clearly brings no nearer the 'social justice' which cries out for an equitable system of distribution. The workers are able now, and always will be able to get just as equitable a division of a large product as of a small product. Therefore, it is to their interest, while seeking by every lawful and honest means to get a fair division of what is produced, to also exert themselves to the healthy limit of their capacity to make the amount produced as great as practicable. A fairer distribution of golden eggs will never be produced by killing the goose that lays them.

"There is another aspect of this matter as it relates especially to railways and their employees which is not often considered. The fact is recognized that the public authorities should deal fairly with railways and with their employees in regulating the railways. The fact is also recognized that the railway is a public service corporation and that, therefore, its owners and you and its other officers owe high and peculiar duties to the public. But, as I have already said, the engine-man, the switchman and the track laborer are just as much, and no more, employees of the railways as are its president, its general manager and its traveling engineer. Therefore, every employee of a railway, merely because he is an employee of a railway, also owes high and peculiar duties to the public which are similar to and supplement yours. One of the duties of the officers is to endeavor to operate the properties as economically and as safely as practicable in order that the transportation sold to the public shall be as cheap and safe as practicable. But you cannot do your work satisfactorily and effectively unless you are given the earnest and hearty co-operation of your subordinates; and it is, therefore, the duty of every railway employee to give to the officers, and, through them, to the company, and, through it, to the public, the best service that he can. For employees individually or

collectively to seek to interfere with the development of railway efficiency to the very highest point is, therefore, unfair, not merely to their superior officers and to the company, but to the public, for, in the long run, the effect must be to increase the cost and impair the quality of the transportation rendered to the public. The employees have a right to demand good wages. They have a right to demand the adoption of methods and appliances that will protect them while they are at work. But they have no more right than the owners and officers of the railways by any act of omission or commission to hinder the most economical and efficient operation.

"The education of the railways regarding their duties to their employees and the public has progressed rapidly in recent years. Doubtless by constant efforts on the part of those who appreciate the rightful position of the railway in industry and commerce the public will also be educated to a better understanding of its duty to the railways and their employees, and, by similar means, the employees will be educated to a better understanding of their duty to themselves, to the railways and to the public. While, therefore, we cannot reasonably hope that the employees, the railways and the public will ever exactly appreciate and fully perform their duties to each other, we can at least reasonably hope for and expect changes in their attitudes and relations all around which will be mutually and greatly beneficial to them all."

PRESIDENT HAYES' ADDRESS

"No greater problem confronts any local officer upon any division of the railways in this country today than that which rests on your shoulders. The greatest operating problem of the times is yours. It is your duty to make locomotives haul every ton of freight one mile at the lowest possible cost for repairs, fuel, lubricating materials, tools, and other supplies. On this factor the cost of performing every operation that enters into plans of any magnitude on any railway in this country is founded.

"It will thus be seen that the chief factor in securing results in locomotive operation is the ability on the part of the supervising officer in charge of this work, first, to so train himself that he will be able to impart such instruction to engineers and firemen in regard to this problem that they will see clearly just how, where and when the different savings can be made; second, to follow up systematically all educational lines by practical demonstration, and to keep engine crews fully alive to the subject; third, to stimulate their interest by periodical class meetings in which new phases of the subject may be discussed—in other words to point the way in every conceivable way in order that the operation of locomotives may be made not only economical, but attractive; fourth, to arouse on the part of the engineers and firemen friendly competition in regard to the result of their individual performance of which proper detailed record should be kept; and lastly, to teach all engineers that there is a language which the locomotive speaks and which every engineer, worthy of the name, readily understands, for every piece of apparatus about the locomotive has its voice of contentment, or wail of protest. Hence, the ability to understand and appreciate that language fully, cuts a large figure in economical locomotive operation.

"These principles properly worked out are the only positive way to improve the service rendered. Keeping diligently at it so that results will flow in a progressive and permanent way, remembering at this time one thing which in itself is quite important; namely, that this city, as well as many others, is expending considerable time and money in developing anti-black smoke ordinances, it is more than ever important that greater care and skill than ever be practiced in the operation of locomotives so as to minimize the amount of black smoke. As a guide to better the firing of locomotives the skilful engineer and fireman can do much toward the prevention of black

smoke. But the price of a clean stack is constant vigilance on their part in order to keep themselves free from complaint or from violation of the law. Therefore recommendation is now made that the question of proper elimination of black smoke, as far as locomotives are concerned, be taken up by this convention, with a view to finding a solution to that vexing problem. With the agitation that is now going forward on the part of many states and municipalities throughout the country, the time is not far distant when black smoke will be a disturbing factor which will have to be met and mastered, principally, I may say, by the efforts of the members of this association.

"When it is considered that every member of this association is a self-educated man—practically speaking—who has to wrest whatever success may be secured in improved operation of locomotives by making a study of the best methods that may be employed, and then also making a study of a sure method to best impart that information to others, so that it may be reflected in the service performed, it can readily be seen that the task which each traveling engineer has set be-

what opposes him, no matter what obstacles confront him."

"This might be paraphrased as follows, so as to have direct application: 'Give me the man who is always on time, whose resourcefulness can always be depended upon, whose chief aim is not always manufacturing an excuse for a failure, who spends more time seeking a remedy for some trouble than hunting an excuse for not being able to do things, and I will show you a successful officer or locomotive engineer, as the case may be, whose standing is pointed to with pride, and the result of whose work in locomotive operation is economy exemplified.' He is always at the head of the list, and his record is such that it furnishes to others a splendid example for emulation."

CHEMICALLY TREATED WATER AND INCREASED LOCOMOTIVE EFFICIENCY

The report of this committee consisted of conclusions drawn from the replies to a series of 23 questions submitted to the members. To a request for a description of the type of system

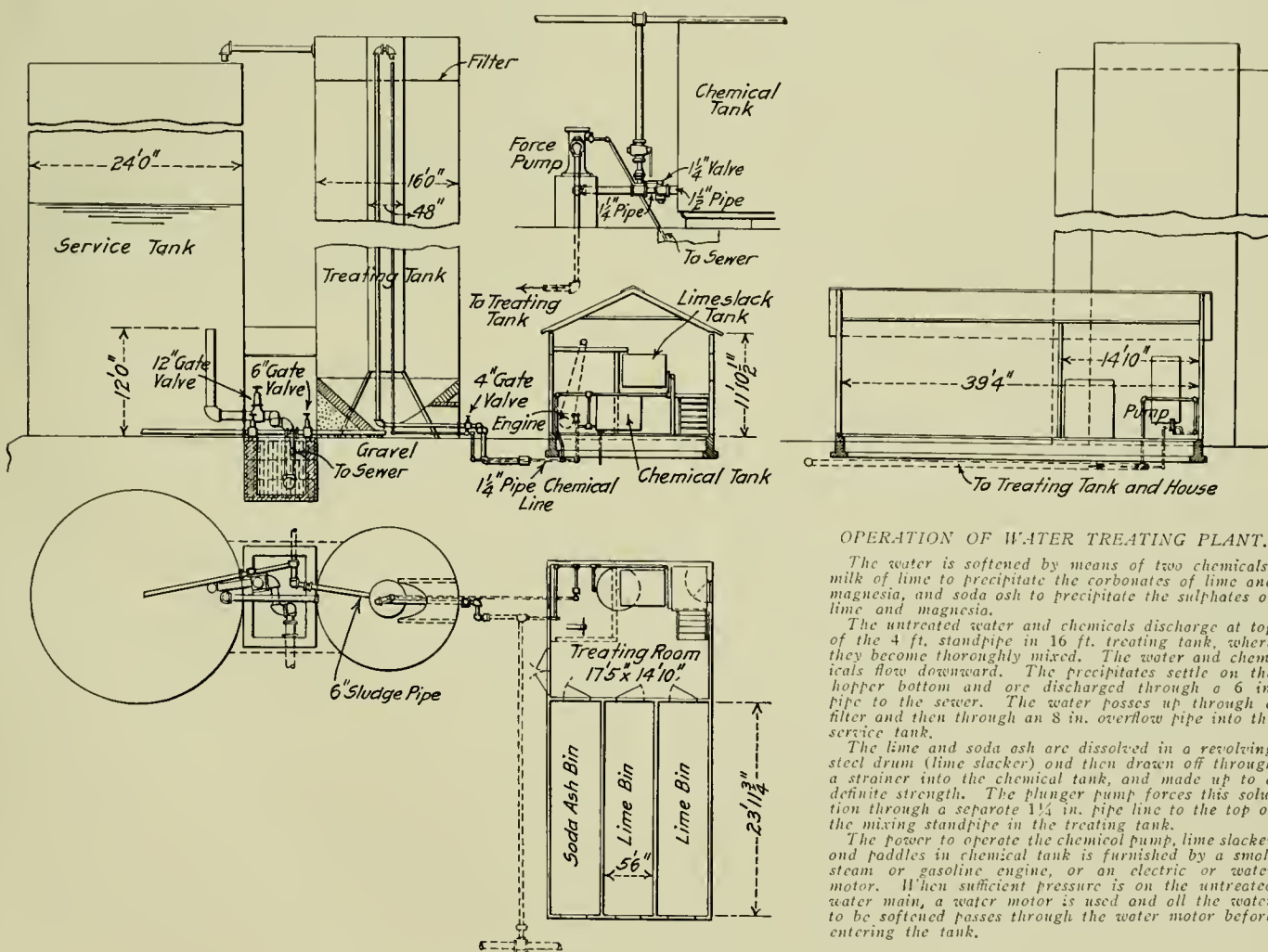

OPERATION OF WATER TREATING PLANT.

The water is softened by means of two chemicals: milk of lime to precipitate the carbonates of lime and magnesia, and soda ash to precipitate the sulphates of lime and magnesia.

The untreated water and chemicals discharge at top of the 4 ft. standpipe in 16 ft. treating tank, where they become thoroughly mixed. The water and chemicals flow downward. The precipitates settle on the hopper bottom and are discharged through a 6 in. pipe to the sewer. The water passes up through a filter and then through an 8 in. overflow pipe into the service tank.

The lime and soda ash are dissolved in a revolving steel drum (lime slacker) and then drawn off through a strainer into the chemical tank, and made up to a definite strength. The plunger pump forces this solution through a separate 3/4 in. pipe line to the top of the mixing standpipe in the treating tank.

The power to operate the chemical pump, lime slacker and paddles in chemical tank is furnished by a small steam or gasoline engine, or an electric or water motor. When sufficient pressure is on the untreated water main, a water motor is used and all the water to be softened passes through the water motor before entering the tank.

General Arrangement of Powers Water Treating Plant as Used on the Santa Fe.

fore him is not by any means a sinecure, but one involving large responsibilities, requiring a high type of man with a keen knowledge of the situation, in order that he may measure up to the duties of the position. In fact, he must be after the fashion of the man Kipling had in mind when he penned the following words, 'Give me the man who can hold on when others let go; who pushes ahead when others turn back; who stiffens up when others weaken; who advances when others retreat; who knows no such word as "can't" or "give up"; and I will show you a man who will win in the end no matter

used for treating feed water, but one road submitted its blue prints. These showed the construction and arrangement of the Powers water treating plant in use on the Santa Fe.

The committee reports that the use of soda ash in the tank in the proportion of about 1 lb. per 1,000 gal., the use of caustic soda in smaller proportions, and also the water treating plants, have all met with success so far as scale formation is concerned. In connection with the graphite, luminator and crude oil treatments, the committee has no information of any beneficial results having been obtained.

But one complete report was submitted in reply to the request for the cost of treating feed water. This was from the Santa Fe. The accompanying table gives the average costs for the different divisions:

COST OF TREATING WATER ON THE SANTA FE.

| Station. | Grains of Incrustants. | | Lbs. incrusts. removed. | per 1,000 gals. | Cost per 1,000 gals. | Total lbs. incrusts. removed. |
|--------------------------|------------------------|--------------|-------------------------|-----------------|----------------------|-------------------------------|
| | Before treat. | After treat. | | | | |
| Illinois Div. | 29.2 | 3.6 | 25.6 | 3.65 | .0313 | 972,193 |
| Missouri Div. | 25.7 | 4.4 | 21.3 | 3.04 | .0210 | 470,463 |
| Kansas City Div. | 20.7 | 4.8 | 15.9 | 2.27 | .0230 | 595,491 |
| Eastern Div. | 28.4 | 1.0 | 24.4 | 3.48 | .0282 | 1,073,922 |
| Middle Div. | 36.9 | 4.3 | 32.6 | 4.65 | .0444 | 1,100,651 |
| Oklahoma Div. | 34.3 | 4.3 | 30.0 | 4.28 | .0319 | 808,954 |
| All Eastern Lines..... | 30.8 | 4.2 | 26.6 | 3.80 | .0298 | 5,021,674 |
| Western Div. | 33.8 | 2.9 | 30.9 | 4.41 | .0425 | 654,506 |
| Arkansas River Div. | 52.4 | 3.6 | 48.8 | 6.97 | .0553 | 1,596,271 |
| Colorado Div. | 47.8 | 3.5 | 44.3 | 6.32 | .0231 | 894,667 |
| New Mexico Div. | 42.9 | 4.3 | 38.6 | 5.51 | .0186 | 1,006,544 |
| Rio Grande Div. | 24.3 | 4.1 | 20.2 | 2.88 | .0311 | 648,573 |
| Pan Handle Div. | 42.4 | 3.3 | 39.1 | 5.58 | .0432 | 427,695 |
| Plains Div. | 31.4 | 4.2 | 27.2 | 3.88 | .0182 | 41,853 |
| Pecos Div. | 39.2 | 3.8 | 35.4 | 5.05 | .0611 | 956,886 |
| All Western Lines..... | 38.9 | 3.7 | 35.2 | 5.02 | .0375 | 6,226,995 |
| A. T. & S. F. Proper.. | 34.9 | 3.9 | 31.0 | 4.42 | .0336 | 11,248,669 |
| Albuquerque Div. | 34.1 | 4.2 | 29.9 | 4.27 | .0393 | 1,152,635 |
| Arizona Div. | 25.0 | 3.2 | 21.8 | 3.11 | .0257 | 1,271,690 |
| Los Angeles Div. | 23.6 | 2.5 | 21.1 | 3.01 | .0274 | 1,042,723 |
| Valley Div. | 22.6 | 2.9 | 19.7 | 2.81 | .0261 | 171,916 |
| Coast Lines | 26.3 | 3.2 | 23.1 | 3.30 | .0297 | 3,638,964 |
| A. T. & S. F. System— | | | | | | |
| 1911 | 30.6 | 3.5 | 27.1 | 3.87 | .0324 | 14,887,633 |
| 1910 | 31.6 | 3.6 | 28.0 | 4.00 | .0318 | 15,284,164 |
| 1909 | 35.4 | 3.7 | 31.7 | 4.52 | .0332 | 13,063,320 |
| 1908 | 35.8 | 3.9 | 31.9 | 4.55 | .0346 | 11,102,859 |
| 1907 | 32.6 | 4.3 | 28.3 | 4.03 | .0355 | 9,579,772 |
| 1906 | 35.0 | 4.1 | 30.9 | 4.41 | .0361 | 7,906,233 |

The conclusions from the answers to the questions in connection with the mileage of flues and fireboxes before and after treatment of feed water show that an increase in mileage of from 78 per cent. to 150 per cent. is being obtained where the water is handled in treating plants. Equally good results followed the use of anti-scale chemicals in the tenders. Following is the report of the Santa Fe on this feature:

"Since the adoption of our water treating system the mileage of fireboxes and flues has been doubled and trebled. One of the best examples is the Los Angeles division. In the latter part of 1905, eight large Pacific type oil-burning, passenger locomotives went in service on that division, and up to December, 1907, each of these locomotives had received a new firebox, six of them had received three sets of flues, and the other two, two sets; the average mileage of all fireboxes was 66,064, the lowest 62,452, and the highest 81,608. The average mileage per set of flues during this period was 25,167. There are mountain grades on which helpers are used. The work performed by these engines is heavy fast passenger service, and a very large part of the division is 1 per cent. grade. Shortly after these engines received new fireboxes, or in the latter part of 1907 and the beginning of 1908, a number of water treating plants were installed and three other plants were installed in 1910, consequently some of the locomotives made considerable mileage with the second firebox before the installation of the water treating plants was completed. There are no serious defects in those boxes yet, and they have up to January of this year given an average service of 168,589 miles, and are still going; the flues have given an average service of over 44,000 miles, an increase in flue mileage of 78½ per cent.

"The accompanying diagram shows the flue performance of all classes of boilers on the Los Angeles division for the last eight years, which includes the performance of the eight passenger locomotives previously referred to. You will note a constant improvement, notwithstanding the increased work demanded of the locomotives; this improvement seems to keep pace with the improvement in the condition of the feed water.

"We use treated water to prevent incrustation, and give credit

for the prevention of incrustation and improvement in the performance of our fireboxes and flues to the system of treating water. We use an anti-foaming treatment to prevent foaming, both with our treated water and in territories where the water is not treated, which does the work very satisfactorily, eliminating all of the troubles due to a foaming boiler, reducing the cost of fuel and lubrication, and enabling us to handle tonnage that it would be impossible to handle otherwise. In territories where the water is not bad enough to warrant the installation of treating plants, but does give trouble with foaming, we find that anti-foaming preparations have a favorable effect in preventing incrustation as well. It is but just and fair to a water treatment that counteracts or prevents foaming, to give it credit for

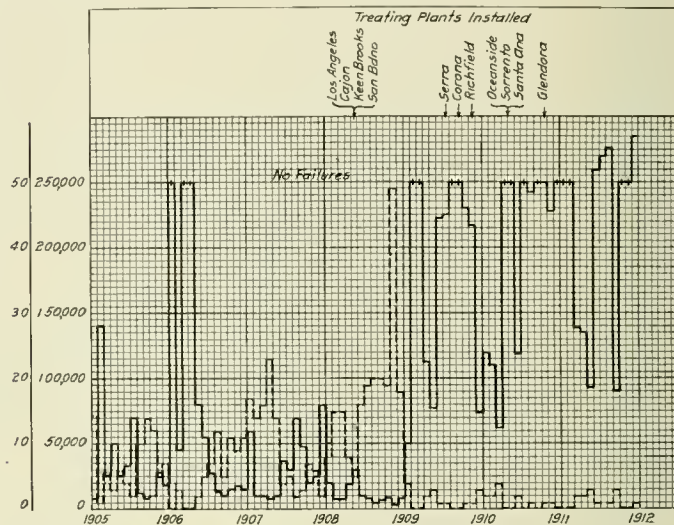

Solid Line Shows Number of Engine Miles per Flue Leaking Failure and Dotted Line the Number of Such Failures on the Los Angeles Division of the Santa Fe for the Past 7 Years.

adding to the life of the firebox and flues, on the theory that when it prevents foaming it keeps the water in a more dense condition, so that it absorbs more readily the heat that is passing through them, and by so doing prevents their overheating and consequent damage."

Other conclusions reached by the committee were that treated water increases the tendency to foam; that anti-foaming chemicals are successful; that treated water does not increase the mileage between washouts; that the efficiency of the locomotive is increased by the use of treated water, especially if used in connection with an anti-foaming treatment; that the increased foaming of waters treated for scale increases the cost of maintenance of the locomotive; that blow-off cocks should be freely applied and used, that their operation should be convenient and that the frequent use of blow-off cocks for short intervals is better than longer openings at long intervals. The committee stated that soda ash is beneficial in waters where the encrusting solids are heavy and the alkali salts light.

Committee:—F. McArdle, chairman; George Austin, W. S. Reid, W. H. Wallace, Wm. Daze, W. D. Cooper and T. F. Lyons

DISCUSSION.

The discussion was confined principally to the treatment of water by chemicals introduced in the locomotive tanks, or direct to the boiler. Some trouble was reported with the use of soda ash in superheater locomotives causing a deposit on the inside of the small superheater tubes. A. M. Bickel stated that the use of soda ash on these locomotives had been discontinued on the Lake Shore & Michigan Southern. F. P. Roesch (El Paso & Southwestern) explained that unless the blow-off cocks were opened frequently or an anti-foaming compound was used, soda ash would cause a deposit of scale in the superheater. He

had found it difficult to get the enginemen to use the blow-off cocks as frequently as desirable, but had had excellent results from the use of an anti-foaming compound. Other members testified to the success of the anti-foaming compound, but all agreed that the proper use of the blow-off cocks would have a decided effect on a foaming condition, and even where the compound was used blowing down should not be neglected.

The cost of the treatment in the tender appears to be from three to ten cents a thousand gallons, depending on the quality of the water. The anti-foaming treatment costs from one and one-half to two cents a thousand gallons.

Replying to a question Wm. Daze (Santa Fe) explained that bottom blows were used instead of surface blows to overcome a foaming condition, because the chemicals causing the foaming settle to the lowest point. This is especially true where a compound is added to overcome the foaming. One member reported that the enginemen on his division had found castor oil to be effective in reducing foaming.

The mileage between washouts is increased where the water is treated at wayside tanks, and decreased when chemicals are introduced in the locomotive tank. Frequent blowing down in the latter case will tend to increase the time between the washouts. Blow-off cocks should not be used when the injector is working.

One member reported on an experiment with settling tanks to remove the sediment in dirty waters. The results were a complete failure, although the equipment was extensive and most carefully designed. It was reported, however, that the Santa Fe is now building some tanks for this purpose.

The discussion as a whole indicated the complete success of treating feed waters by the introduction of compounds direct to the tender tank, if blow-off cocks are applied and used. This applies to both scaling and foaming waters.

RELATION OF MECHANICAL APPLIANCES TO FUEL ECONOMY

The only object in burning fuel is to obtain from it the stored-up energy and utilize this energy to produce motion. This being the case, any device or mechanical appliance that will enable us to obtain more energy from a given amount of fuel, or to utilize, by converting into work, a greater part of the energy contained, must be classed as a distinct factor in the fuel problem. The percentage of economy, due to any mechanical device, can be calculated by the increased amount of work obtained from a given quantity of fuel; and as work in this instance means motion, the time element must enter in the problem. Therefore, to get the true measure of economy for any mechanical device, the work must be measured, not in train or engine miles, but in ton miles per hour. The relation of any mechanical appliance to fuel economy would, therefore, be in proportion to the decrease in fuel consumption per mile in hauling the same tonnage at the same speed; to the increase in speed with the same tonnage on an equal amount of fuel per mile; or to the increased tonnage hauled at the same speed on the same consumption of fuel per mile run.

Viewing the proposition from this standpoint, there is no question but that of all mechanical appliances the high degree superheater stands pre-eminently at the head. The most comprehensive and carefully conducted tests carried out in this country, with a view to obtaining definite data bearing on the fuel economy due to the use of superheat were made by the New York Central, in connection with the Pennsylvania Railroad in 1910.* The final results of these tests are shown in the following table, in which it is seen that the saving in fuel due to superheat (allowing 2.3 per cent. as due to improved circulation of the arch tubes) was equal to 26 per cent., while the total saving due to the installation of a brick arch and a superheater was equal to 33.3 per cent. This test also shows

that the application of the brick arch resulted in a net saving in fuel of 7.3 per cent.

A series of tests, conducted by the chairman, covering a period of several months, showed that the increase in fuel economy is proportionate to the increase in tonnage, which proves the theory that the efficiency of a superheater locomotive is proportionate to the increase in superheat, and the degree of superheat depends on the rate of combustion; the

| DRY COAL PER DYNAMOMETER H. P. HOUR. | | | | |
|--------------------------------------|------------------------------|--------------|--------------------------------|--|
| Speeds. | Saturated Steam, No Arch. | Superheater. | Superheater and Brick Arch. | |
| 12.5 | 4.67 | 3.15 | 2.90 | |
| 15.0 | 4.75 | 3.56 | 3.25 | |
| 17.7 | 4.69 | 3.40 | 3.27 | |
| Average | 4.70 | 3.37 | 3.14 | |
| Relative Coal Consumption... | 100 | 71.7 | 66.7 | |

rate of combustion being necessarily higher when handling an increased tonnage at the same rate of speed. The final results checked very closely with the results found on the New York Central and the Pennsylvania.

Undoubtedly, next in order, as a mechanical appliance affecting fuel economy, is the brick arch, although the feed water heater runs it a close race and in some instances precedes it. The value of the brick arch as a fuel economizer is due (where arch tubes are used to support it) to the increased heating surface of these tubes, and to the better utilization of the firebox heating surface.

No better illustration of the method by which the application of the brick arch utilizes the full firebox area to the best advantage can be given than that shown in the article contributed to the February, 1912, number of the *American Engineer*, by F. F. Gaines, superintendent of motive power of the Central of Georgia, from which the table on the following page showing the results of several tests is taken.

It will be noticed that by a change in firebox construction and the substitution of a vertical hollow wall, an even greater fuel economy is effected, and there is no question but that if this type of firebox was used in connection with a high degree superheater, a greater per cent. of the energy now unavoidably lost in the present type of locomotive would be conserved.

The economical value of the brick arch depends on the type of boiler, the relation between the firebox heating surface and the tube heating surface, the nature of the fuel and character of the service, and it is due to the failure to take into consideration the above essentials that so many widely varying results are obtained, and so many different opinions find credence for and against the value of the arch. Facts are stubborn things, however, and as repeatedly verified tests can be taken as facts, we can safely assert that in the majority of the present-day locomotives the intelligent application of a correct brick arch will result in an economy of fuel ranging from 5 to 15 per cent.

Among other mechanical appliances tending toward fuel economy, the feed water heater must not be overlooked. Prominent among the successful types are the Buck-Jacobs, as used on the Santa Fe, and the Gaines, used on the Central of Georgia. Personal observations, made by the chairman, as to the efficiency of the former, proved that the temperature of the feed water was increased 75 deg. This multiplied by the number of pounds of water heated will give the saving in heat units, and this product divided by the number of heat units obtained in the firebox from each ton of fuel would represent the fuel saving. No absolute data on this particular subject is available, however, but various estimates have placed the feed water heater, where the temperature is raised 50 deg., or more, as being equal to from 8 to 12 per cent. in fuel economy.

While the mechanical stoker has a bright future ahead of it,

*See *American Engineer & Railroad Journal*, December, 1911, page 470.

and will unquestionably, when perfected, be applied to such locomotives as consume an amount of fuel beyond the physical capacity of the fireman to handle, yet as a fuel economizer *per se*, the committee is not prepared to go on record with any definite statements. Although many tests have indicated that an economy in the amount of fuel per ton mile per hour has frequently been obtained with the different types of stokers, yet other tests have shown contrary results, thereby still leaving the question of economy in pounds of coal somewhat in doubt, but when calculated on the basis of cost per pound of coal, the balance is in favor of the mechanical stoker, as tests have proved that by means of this appliance a cheaper grade of fuel can be handled successfully. The committee is prepared to go on record, however, to the effect that on large engines, which tax the ability of the fireman to the utmost, the application of a successful mechanical stoker will result not only in an increased efficiency of the locomotive, but also in a measure of fuel economy after the enginemen become sufficiently familiar with it to handle it intelligently.

There are several other mechanical devices, such as mechanically operated fire-doors, grate-shakers, coal-passers, etc., that have a direct bearing on the fuel problem, but in the absence of any authoritative data on the efficiency of any of these

ture, however. The fact that there is a smaller quantity of steam being exhausted and that it escapes at a higher velocity would evidently demand a smaller nozzle.

Superheaters on switch engines is a late development that attracted considerable interest. Members that have had experience with such locomotives reported them to be surprisingly successful. One speaker reported a saving of 50 per cent. in fuel and an increase of one-third in the amount of work performed. On the Lake Shore & Michigan Southern the dampers in the front end have been removed from superheater switching engines with no apparent disadvantage.

Stokers.—Clement F. Street was called on and briefly reviewed the development of locomotive stokers during the past year. He stated that the stoker was now positively out of the experimental stage and was as reliable as any piece of machinery could be. There are now 175 Street stokers in service or on order. The greatest development of the past year has been the appreciation of the necessity for regular attention and inspection of stokers at the terminals. This feature is now fully understood and every stoker is inspected and lubricated before the locomotive goes out on its run, with the result of a practical elimination of stoker failures on the road.

| Engine Number. | Train Number. | Date. | Actual Time Consumed. | Stops. | | Pounds coal consumed. | | | Pounds water evaporated. | | Miles run to one ton of coal. | Tons coal used in excess, based on Engine 1014 as unit of comparison. | Relative efficiency based on coal consumption per mile. |
|----------------|---------------|---------|-----------------------|---------|----------------|-----------------------|----------------------|----------|--------------------------|--------------------|-------------------------------|---|---|
| | | | | Number. | Time Consumed. | Total. | Per 1,000 ton miles. | Per hour | Total | Per pound of coal. | | | |
| *1014 | Extra | 1/13/11 | 6 hr. 34 m. | 6 | 1 hr. 4 m. | 11,950 | 93 | 1,820 | 96,800 | 8.10 | 16.74 | | |
| | 2/36 | 1/14/11 | 6 hr. 42 m. | 8 | 1 hr. 33 m. | 13,350 | 104 | 1,991 | 109,000 | 8.16 | 14.98 | | |
| 1014 | 3/37 | 1/16/11 | 6 hr. 12 m. | 7 | 49 m. | 12,450 | 97 | 2,008 | 105,750 | 8.49 | 16.08 | | |
| | 1/36 | 1/17/11 | 6 hr. 39 m. | 7 | 1 hr. 12 m. | 14,250 | 111 | 2,143 | 109,800 | 7.71 | 14.04 | | |
| | | | 26 hr. 7 m. | . | 4 hr. 38 m. | 52,000 | 101 | 1,991 | 421,350 | 8.10 | 15.38 | | 100.00 |
| †1012 | Extra | 1/18/11 | 7 hr. 12 m. | 5 | 57 m. | 20,400 | 159 | 2,833 | 121,458 | 5.95 | 9.80 | | |
| | 1/36 | 1/19/11 | 8 hr. 4 m. | 5 | 1 hr. 16 m. | 21,900 | 170 | 2,715 | 124,887 | 5.70 | 9.13 | | |
| 1012 | Extra | 1/20/11 | 6 hr. 43 m. | 5 | 45 m. | 19,087 | 148 | 2,841 | 113,095 | 5.93 | 10.48 | | |
| | 2/36 | 1/21/11 | 7 hr. 20 m. | 8 | 1 hr. 43 m. | 22,500 | 175 | 3,068 | 121,883 | 5.42 | 8.89 | | |
| | | | 29 hr. 17 m. | — | 4 hr. 41 m. | 83,887 | 163 | 2,865 | 481,323 | 5.74 | 9.54 | 15.94 | 61.96 |
| §1716 | Extra | 1/23/11 | 8 hr. | 9 | 2 hr. 33 m. | 15,000 | 117 | 1,875 | 110,400 | 7.36 | 13.33 | | |
| | 1/36 | 1/24/11 | 7 hr. 24 m. | 10 | 1 hr. 41 m. | 16,500 | 128 | 2,230 | 120,000 | 7.27 | 11.43 | | |
| 1716 | Extra | 1/25/11 | 6 hr. 50 m. | 9 | 1 hr. 20 m. | 13,800 | 107 | 2,080 | 102,801 | 7.45 | 14.49 | | |
| | 1/36 | 1/26/11 | 7 hr. 28 m. | 12 | 1 hr. 42 m. | 15,600 | 121 | 2,089 | 117,166 | 7.51 | 12.82 | | |
| | | | 29 hr. 42 m. | — | 7 hr. 16 m. | 60,900 | 118 | 2,050 | 450,367 | 7.39 | 13.14 | 4.45 | 85.58 |

*Engine 1014—21 in. x 32 in. Cooke consolidation—with new firebox and combustion chamber, with hollow brick wall and provision for mixing hot air with burning gases. Total heating surface, 2,987.33 sq. ft.

†Engine 1012—Same class engine as 1014, but with original boiler unchanged, and brick arch. Total heating surface, 3,022.29 sq. ft.

§Engine 1716—22 in. x 30 in. Baldwin consolidation—brick arch. Total heating surface, 3,230 sq. ft.

Analysis of fuel: Moisture, 1.39 per cent.; volatile combustible matter, 30.56 per cent.; fixed carbon, 55.11 per cent.; ash, 12.94 per cent.; sulphur, 1.5 per cent. B.t.u. per lb. dry coal (Mahler Atwater calorimeter), 13,179; B.t.u. per lb. actual coal, 12,996.

appliances in this respect, the committee would prefer to have the relative economies of them brought out in the discussion on the floor.

Committee:—F. P. Roesch, chairman; Dan Daley, F. R. Scott, Y. S. Merriman, D. J. Madden, G. E. Spangler and G. M. Carpenter.

DISCUSSION.

Superheaters.—The subject of superheaters was first placed before the meeting for discussion and the remarks of the members indicated that the service of superheater locomotives is so uniformly successful as to offer very few features for discussion. Such test results as were quoted showed the reported figures to be correct and the comment of the speakers showed that no difficulties of any importance have developed. There was some question as to the proper size of nozzle to use on a superheater locomotive that had been converted from a saturated steam locomotive. It was finally explained by a representative of the Locomotive Superheater Company that if the size of the cylinders had not been increased, the nozzle would have to be decreased. There is no set rule on this fea-

Mr. Street stated that there were no test figures available as to fuel economy, but that he hoped to have complete tests in the near future. He explained, however, that present service indicated that the amount of coal per engine mile and per ton mile would be decidedly increased, but that the amount per ton mile per hour would be less. Stoker locomotives are worked to their greatest capacity all the time and handle larger trains at higher speeds. There was no discussion.

Brick Arches.—The president called on Le Grand Parish, president of the American Arch Company, for a report of the progress in the use of arches during the past year. Mr. Parish stated that 85 per cent. of the new locomotives are fitted with brick arches. In 1907 but 25 per cent. had arches. He said that the most important recent development toward improved combustion was the use of the combustion chamber, particularly the design developed by F. F. Gaines, superintendent of motive power of the Central of Georgia. As an instance of what can be expected in this direction he said that the very large Mallet locomotives for the Virginian, which have a tractive effort of 115,000 lbs., were estimated to require 9,000 lbs. of coal an hour to give their full power. It was found,

however, that, principally on account of the application of the Gaines combustion chamber, they consumed but 7,500 lbs. of coal an hour at full power.

Mr. Parish stated that the tests by Dr. Goss at Coatesville showed an increase of 8 per cent. in the amount of water evaporated per pound of semi-anthracite coal and of 12 per cent. with bituminous coal.

Replying to a question, the speaker explained that the quality of the fuel would determine whether the arch should be tight to the flue sheet or not. In 85 per cent. of the applications it is set away from the sheet from 5 to 6 in. The openings are larger at the corners than at the center.

The value of the circulation in the arch tubes was explained to vary in relation with the distance from the upper end of the tube to the surface of the water. It is now the practice to place the back end of the tubes close to the crown sheet.

MR. WORTHINGTON'S ADDRESS

B. A. Worthington president of the Chicago & Alton, accepted an invitation to address the convention, and spoke, in part, as follows:

There is no position in the railway service where more effective work can be done than in the position of traveling engineer, and no position that can bring about more economy than from the head end of a train. Very much good can be done on the part of traveling engineers, especially by instructing firemen to properly perform their duties, as the average fireman can save his wages every trip over the road through proper fuel economy.

Much good can be done by instructing the engineers to use careful judgment in starting trains, and in forcing them to speed, and in moving them between stations with as small consumption of fuel as is consistent with necessary speed and time requirements. Also in instructing the engineers in the proper use of the steam in the cylinders. Boiler feeding is quite as important for fuel economy as the right use of steam. While engineers should maintain a nearly steady steam pressure, they should permit liberal variations of the water level within safe limits to save fuel.

Firemen should be instructed that the blowing of pop valves wastes usually about a shovelful of coal per minute, or a lump of coal as large as a lemon every second, and that the avoidance of popping will save considerable of their energy and at the same time save dollars for the company.

Another thing comes to my mind suggestive of how the traveling engineers can do much good, not only for themselves, but for the benefit of their fellow workmen. As is well known, there is prevailing among the laboring classes generally throughout the country a spirit of unrest manifesting itself through strikes of the various crafts and demands for higher compensation, until the employers have reached a stage where they find themselves unable to grant further concessions and maintain the solvency of their properties. Yet labor in all lines of service has never been better paid, and the working conditions have never been less arduous in this country than they are at the present time.

In your daily association with men in the service, think of the influence for good which you might exercise if you would but make the effort. Half of the troubles of these men come through ignorance—ignorance which is fostered by various societies and by labor leaders who are supported and aided by newspapers through the dissemination of socialistic literature. In fact, there seems to be a yellow fever of literature prepared for the spread of incorrect information, which is misleading to the men who have not the chance or opportunity to get at the facts to enable them to take a broader view of things. Soon the men who fall under the baneful influence become unable to distinguish between the right and the wrong. Naturally, they develop a morbid thirst for sensational printed matter, and the more they read the less they learn.

Men in your position who are able to look on both sides of

the problem, should speak out plainly and do everything possible that will work as an antidote to these dangerous influences. What I am pleading for is the wider, nobler, unpaid-for service which conservative men are able to render to society, simply by being thoughtful and helping other men to think, thereby exploding wild and impracticable theories and bringing them out to the test of reason, obstinately opposing all rash experiments.

We should not forget that the existence of many of our fellowmen is along dark, confused and bitter lines. Some are groaning under the burden of want, partly because of their own idleness or incapacity, or partly because they are following the socialistic doctrine that they are entitled to a life of ease and pleasure at the expense of somebody else; some because of the greed and injustice of other men; and some because of the lack of proper guidance and of good counsel and human sympathy.

The question naturally arises to each and every one of us as to how best to meet this situation. Manifestly, if we take a negative position no good will be accomplished. Our influence, to be felt, must be positive and along unmistakable lines. All reactionary sentiment and false standards should be rebuked by those of us who are able to explain the fallacy of such dangerous doctrines. There is a loftier position than merely to stand high in the world, which can be attained by stooping to help your fellowman to a higher moral plane; by fearlessly pointing out the pathway of truth, purity and righteousness, which will certainly result in the greatest good to the greatest number, and what we need today is a larger number of men who will not hesitate to stand for the right and declare in unmistakable terms their honest convictions against the evils that are present on all sides, and the wild theories that are being exploited among the laboring classes today, causing so much socialistic unrest and labor trouble.

It should be remembered that decay begins in discord, which is simply a loss of balance in an organism because one part of the system gets more than its share of sustenance and the other part too little, and if the process is continued, destruction is inevitable.

The traveling engineers could do much good by conservative action, in softening and ameliorating unavoidable inequalities of life which have existed since the world began, and by striving to change the feeling of jealous hatred against the more fortunate ones into a feeling of generous fortitude and hospitality, endeavoring to keep the relations between man and man and between class and class in a healthy condition for the benefit of society as a whole.

If the traveling engineers of the country will work along these lines, much good can be accomplished, and their splendid services in this way will tend to offset the socialistic sentiment which seems to promise to men of limited understanding a life of ease and comfort through legislative enactment and through the coercive forces of union labor, regardless of the industry, frugality and merit of the individual.

HANDLING LONG TRAINS WITH MODERN AIR BRAKE EQUIPMENT

The control of slack in passenger and freight trains is an important factor in successful handling; in freight trains this item is affected by so many variable conditions that a hard and fast rule for its control is impossible. The slack action is affected more by unequal braking power than by any other single item, and it has been very aptly said by W. V. Turner, in a paper before the Western Railway Club, that "the operation of the brake is according to fixed laws and conditions over which the engineer, of all men, has the least control," and still it is on the engineer that the responsibility rests for the proper handling of trains. With all these variable conditions to be met, his success fundamentally depends upon the use of proper judgment, the ability to grasp and analyze conditions as they arise, and to select the general rule of operation of the brake that will cover the situation with the least shock and danger.

To make the handling of long trains successful it will be necessary to have the co-operation of both the transportation and mechanical departments, the former interested in the make-up of trains and the latter in the maintenance of equipment. When shorter trains were general and comparatively light power was used, the make-up of a train was not given special consideration, nor was it essential that it should be, but when you consider that in the ordinary 100-car train there is over fifty feet of slack, the energy stored in a moving loaded train (especially when concentrated at any one point) is terrific.

To give some idea of the effect of unequal braking power in a long loaded train, we call attention to tests made on the Chesapeake & Ohio. The train consisted of a Mikado engine, dynamometer car, wooden underframe coach, one hundred loaded steel cars and a caboose. The gross weight, exclusive of engine, was 6,592 tons. The train was moving at a speed of twelve miles an hour on level, straight track, with the steam pressure on the engine down to eighty pounds. The engine was equipped with two No. 5 New York pumps and "LT" equipment. The brake pipe pressure had gradually fallen from seventy to sixty pounds, when one of the triples near the head end went to quick action, but quick action did not carry through the entire train, as the brake pipe recording gage on the caboose showed a seven-pound service reduction. A buff was recorded on the dynamometer car of 830,000 lbs. and the drawhead was driven up and the Farlow attachment stops sheared off on the fifty-ninth car. The quick action probably carried close to the fifty-ninth car, causing the head end of the train to stop and the slack running up in the rear portion caused the shock.

On another run with a Mikado engine ascending a .3 per cent. grade with eighty-five fifty-ton steel cars, 6,025 gross tons, and being pushed by a helper, the train was moving at a speed of eleven miles an hour, when the air hose burst on the fourth head car, causing a buff of 610,000 lbs. on the dynamometer car and breaking down the drawhead and draft sills on the twenty-first car from the leading engine.

The same condition is true, only in a lesser degree, when the slack is run in rapidly with a heavy service application of the brakes, and it is of the greatest importance that the equipment be kept in the best possible condition, the adjustment of piston travel uniform, the brake cylinder leakage kept to the minimum, and that the enginemen be instructed as to the proper methods of handling.

With the improved equipment that has been put in service recently, the success of handling the long train depends chiefly on how the equipment is operated. By long trains we mean eighty-five cars or over. We would in no case recommend that more than a seven to ten-pound initial reduction be made, and as far as possible that that reduction be allowed to stop the train. When within fifty to seventy-five feet of the stop another reduction should be made, so that the brake pipe will be exhausting when the train comes to a stop. The latter reduction is made to keep the slack bunched and to leave the train in a good position for starting. When a stop can be contemplated far enough in advance, the throttle should be closed gradually, and the train allowed to drift before an application is made, so as to allow the slack to assume its normal position and bunch slowly, for in the case of the large engines the internal resistance will very readily bunch the slack when the engine is shut off. In every case where the train consists of loads on the head end and empties on the rear the application should be begun before the engine is shut off, keeping the train stretched as far as possible, otherwise when the brakes take hold on the rear, the slack will run out rapidly, due to the excess braking power concentrated on the rear, with a tendency to part the train.

In all air brake operation the chief factor is the time element, and this governs either when applying or releasing the brakes. The ideal method of controlling the slack in long trains would be to cause the serial operation of the brake on each car rapidly

enough to make each car do its braking and at the same time equalize the retarding force of each car, but as a rule with a long train the stop is completed before the brakes on the rear of the train are effectively set, and while the time element is reduced by the introduction of the quick service triple, it is still an ever-present factor and one which both the air brake companies are trying to overcome by the use of the electro-pneumatic and load-and-empty brakes, which are in process of development.

When releasing the brakes, the time factor becomes of greater moment so far as the serial operation of the brake is concerned, and where an effort is made to start long, heavy trains before the release of the rear brakes the danger of parting is as great as when stopping trains. After coupling up at water or coaling stations, or after a full service application has been made, we recommend that the enginemen be instructed to place the brake valve handle in full release position not longer than fifteen seconds and then return it to running position, and that no effort be made to start the train until one minute has elapsed with fifty cars or less, and with trains of over fifty cars two minutes additional be allowed for every twenty-five cars over fifty. For instance, three minutes should be allowed for seventy-five and five minutes for one hundred cars. This is to be independent of the pump capacity, for the length of time required to release the brakes depends on the time required to build the pressure up on the rear of the train, which is entirely controlled by the frictional resistance of the brake pipe. When releasing the brakes in all cases we recommend the "kick-off" to release such brakes on the head end as may have re-applied.

The successful handling of freight trains depends on the condition of draft rigging, piston travel, brake cylinder and brake pipe leakage, all of which is dependent on the thoroughness of terminal inspection.

Yard test plants should be installed at all terminals, brakes put in serviceable condition, and brake pipe leakage determined before the engine couples to the train. The amount of brake pipe leakage permissible is determined by the length of the train, but it must be remembered that brake pipe leakage is beyond the control of the engineman, and on the amount of leakage depends to a great extent his ability to handle the train successfully. The maximum amount of leakage determined on by a certain large system, that is operating long trains successfully, is as follows: Eight pounds for trains not to exceed twenty-five cars, seven pounds for trains up to fifty cars, six pounds for trains up to 75 cars, and five pounds for all trains over 75 cars.

The make-up of trains is determined largely by local conditions, such as yard facilities, classification, character of lading and types of cars; however, upon the make-up of the train also depends the ability of the engineman to successfully handle it to avoid break-in-two shocks and shifting of lading. While it is considered impractical to alternate loads and empties, some effort should be made to equalize the braking power of long trains as affected by loads and empties or light and heavy loads, such as coal and merchandise. This can be done to some extent by distributing the lights and the loads in cuts throughout the train, rather than by placing the loads ahead and empties behind, as is the common yard practice. One of the most prolific causes of break-in-twos is the improper handling of cars on hump yards and failure to make thorough inspection to determine the condition of the cars after they have been humped.

Where engines are equipped with large pumps, there has been some doubt as to the ability to stop long trains by the use of the conductor's valve, or where the break-in-two occurs near the rear, and several cases are known where the train proceeded for a considerable distance after breaking in two without any appreciable fall in pressure shown by the gage on the engine; while this is possible where the train has not been charged up, several tests which were conducted on a 100-car train show that by opening the conductor's valve all brakes could be set; the feed valve would release the first ten to fifteen brakes and keep them re-

leased, the remainder of the brakes would remain applied, these tests being conducted with the brake valve handle in running position. Where the train is properly charged, a break-in-two would stop the train; therefore the enginemen should be impressed with the fact that when handling long trains with engines of large pump capacity they should not attempt to start until all auxiliaries have had time to charge. It requires from fourteen to twenty minutes to charge the one hundredth car from zero to seventy pounds. We do not mean to imply that it is necessary to stand still that length of time, but sufficient time should elapse after coupling up, when the engine has been detached for long periods, to give the auxiliaries time to charge up sufficiently, so in case of a break-in-two the brakes would set. It has been the experience of the committee that where trains break in two, proceed and leave the rear section, it usually occurs at water tanks or where the engine has been detached from the train for a considerable length of time and an effort is made to start without waiting for time to recharge. The conductor should be instructed that when necessary to stop the train from the rear, the conductor's valve should be opened wide, without the usual effort to make a service application.

A few general instructions should be given to enginemen, which, together with the use of good judgment, will practically eliminate break-in-twos. Care should be used not to run the slack in or out too rapidly; the heavier the engine and the longer the train the more care and time should be used. No accurate stops should be attempted; where the engine has to be spotted, such as at water tanks and coaling stations, it should be detached from the train. A light initial reduction should be made and that allowed to stop the train, except that when within fifty to seventy-five feet of the stop another reduction should be made so that the brake pipe will be exhausting when the stop is completed, this to leave the train in a favorable position to start. Straight air should not be used to make stops or to handle trains except when releasing brakes, and then only to assist "K" triples in preventing slack from running out.

When beginning an application, the speed of the train should be taken into consideration. It must be remembered that the retarding force of any given cylinder pressure increases as the speed decreases. When handling long trains on grades, such application should be made as necessary to control the speed of the train, care being taken to prevent overheating of the tires.

On long grades where upward of seventy-five cars are handled and where the character of the grade will permit, it will be found of advantage to turn up about 75 per cent. of the retainers on the head end of the train. This will have a tendency to keep slack from running in and out each time an application and release are made, and this is especially so where light loads or empties are being handled on the rear.

With trains of over seventy-five cars, the brakes should not be released after the speed has reduced below fifteen miles an hour.

When backing long trains, where possible to do so, they should be allowed to drift to a stop; otherwise steam should be used with the locomotive brake released to keep the slack from running out too rapidly.

Handling Passenger Trains.—With the introduction of heavy steel passenger equipment came the introduction of the double "PM" equipment, the "LN" and "J," a little later the "PC," and now the electro-pneumatic brake is being pushed for passenger service.

The double "PM" equipment consists of two separate sets of brakes on each car, a brake for each truck, and has proved more or less unsatisfactory, due to the increase in the volume to be taken care of and the attendant liability of stuck brakes unless the greatest amount of care is used. In ordinary passenger train handling with double "PM" equipment it is necessary that very close attention be given to the condition of triple valves, especially as to the tightness of the packing ring; otherwise unless heavy reductions are continually made, trouble will be experi-

enced with the brake sticking. In instructions to enginemen we recommend that they make no reductions of less than fifteen pounds, the reduction being split, the initial reduction to be six pounds, so as to gradually bunch the slack in the train, that to be followed with a nine or ten-pound reduction before releasing. The brake valve handle should be kept in full release position with over eight cars for at least five seconds. Unless the enginemen will follow these instructions there will be more or less trouble experienced with the "PM" equipment, due to burned-up brakes or slid flat wheels, the explanation being that the heavy load remaining on the slide valves of each triple valve where the pressure is reduced to but a few pounds below standard, coupled with the slow rise in brake pipe pressure requires that the triple valve piston packing rings be a good fit to insure release. It must be understood that if the speed of a train is slow the heavy reduction, if made while moving, will have about the same effect as quick action. A light reduction should be made to stop the train, and after being stopped the brake pipe pressure should be further reduced, so as to insure release.

With either the "LN," "J" or "PC" equipments the best results are obtained by splitting up the reductions, for in long passenger trains the slack action can be made very uncomfortable for passengers. We recommend that in each case the preliminary reduction be from six to eight pounds, and after a short interval the necessary reductions be made to stop the train. It must be remembered, however, that the brakes with these equipments are positive and severe, and care should be taken at slow speeds to prevent wheel sliding. With the "PC" equipment it is necessary to make a seven or eight-pound reduction of brake pipe pressure before the brake applies, the high differential being used so that slight variations in brake pipe pressure, such as would be caused by a sluggish feed valve, will not cause an undesired application.

On account of the large volume of air required for heavy passenger trains, and the various devices on engines operated by air, it is imperative that passenger engines be equipped with two pumps, and they should not have a main reservoir capacity of less than 50,000 cu. in.

Committee: W. F. Walsh, chairman, E. F. Wentworth, W. V. Turner, C. W. Wheeler, H. A. English, and H. A. Flynn.

DISCUSSION.

This subject aroused the most discussion of any of the reports presented at the meeting. It appeared that the trouble with rough stops on long passenger trains and damage to the cars in long freight trains, due to poor handling of the brakes, was quite general, and that there was considerable doubt in the minds of many members as to the proper methods to overcome it. W. V. Turner, of the Westinghouse Air Brake Company, opened the discussion with a very clear and complete explanation of the proper proceeding in braking long trains, and during the two sessions given up to a discussion of this subject, he was called on frequently for further suggestions to suit special cases. It was made clear by Mr. Turner that it was impossible to make rules that would fit all cases. The engineman's judgment must be depended on, as he is the only one who can know the exact conditions. He should be taught to give the time element careful consideration in every case, and should be instructed in principles rather than being given rules to follow.

T. F. Lyons (Lake Shore & Michigan Southern) stated that most of the flat wheels could be avoided by a more careful manipulation of the brakes, which usually means a longer time allowed in making the stop. The success of the two-application method depended on how much the speed was reduced with the first application. If the speed was not reduced to about 20 miles an hour, the second application would not give a smooth stop. He also strongly advocated the cultivating of judgment rather than the teaching of rules. Several other members spoke of the multiple application method not being successful, but it appeared that either the conditions were not normal or that the

speed was not reduced sufficiently, as explained by Mr. Lyons.

The fact that the loaded and empty cars in freight trains are not equally distributed throughout the train was held by some members to be responsible for many bad order cars. This make-up of train was strongly recommended by some speakers, but later in the discussion the fact was made clear that if the tonnage could be increased by grouping the loads ahead, this factor would be of more value than the improved braking qualities. The thing to be done is to learn to handle the trains as they are and not as the engineman would like them to be.

A light application of the brakes before the throttle is closed was reported as being successful, as it permitted the slack to adjust itself without shocks. Here again it appeared that the make-up of the train and the character of the brake equipment would be the determining factor as to the advisability of this practice.

The fact that much damage to cars that is blamed to poor handling of the brakes is really due to rough handling in the yards was mentioned by Mr. Roesch. Damage to cars resulting from treatment in the yards very frequently will not make itself evident until the train is many miles away, when a stop or slow-down that is practically perfect will give the shock needed to release the damaged drawbar. This is especially so with wooden cars when mixed with all-steel equipment.

In connection with handling long passenger trains, Mr. Turner explained that a reduction of not over ten pounds should be made if the speed of the train is less than thirty miles an hour. He explained that different make-ups of train, i. e., how many loaded baggage or mail cars there were at the head end of the train and how many passenger cars and sleepers back of them; the condition of the rail, the speed of the train, the grade and curve conditions, were all factors to be taken into consideration in determining the proper method of stopping long passenger trains. A retarding force of not over $1\frac{1}{2}$ per cent. per second should not be exceeded. Unless everything in connection with the brakes on the train is in good condition it is impossible to make a perfect stop in any case. The electro-pneumatic brake is now being developed to overcome some of these troubles.

The use of the conductors' valve for service application of the brakes was strongly condemned; this valve is for emergency only.

F. B. Farmer, of the Westinghouse Air Brake Company, advised the use of braking methods, suited to the worst conditions, at all times. The so-called split reduction had been found successful in some cases.

In the opinion of one member, rough stops are sometimes due to the fact that the brakes on the locomotive do not release as quickly as do those on the cars.

The uniformity of smooth stops with long passenger trains on the New York Central Lines, which was mentioned by Mr. Turner, was explained by Mr. Kenny, a locomotive engineer on that system, as being entirely due to the attention given the matter by the enginemen. No set rules are followed, and the so-called running test, which consists of a light application, soon after the train is started, is depended on for information as to how to handle the brakes in making a stop.

TRAIN TONNAGE

J. M. Daly, general superintendent of transportation of the Illinois Central, presented a paper on Train Tonnage, of which the following is an abstract:

Admitting that the roads require economy from your department, the next move is to carefully analyze the factors that create train resistance and determine what is necessary to obtain increased efficiency in the loading of trains. To do this, it is necessary to briefly review the methods used in loading trains.

Records show that in 1870 the carrying capacity of freight cars was about 24,000 lbs.; today it is 100,000 lbs., an increase of over 400 per cent. In 1870 the average weight of a car was 16,000 lbs., or 40 per cent. of its capacity, whereas today, a 100,000 lb. capacity car weighs only 40,000 lbs. or 40 per cent. of its

capacity. In 1870 the record shows that trains were made up on the basis of a given number of loaded cars, and if empty cars were in a train they were rated at two empties equal to one load. Later on this was modified and three empties were considered equal to two loads. This was a reasonably accurate basis due to the uniform capacity and loading of cars moved in tonnage trains, but with the adoption of the large capacity cars, the car basis had to be abandoned and the gross ton basis adopted.

About 1895, with the introduction of the large 50-ton capacity coal car, the Hocking Valley found it impracticable to load engines on the basis of the number of cars, as trains with 50-ton capacity cars invariably stalled. This condition necessitated a change, and the gross ton basis was adopted. Immediately on the adoption of the gross ton basis, it was found that an engine rated at 2,100 gross tons when hauling 30-ton capacity cars, gross weight per car 50 tons, had its maximum load with 42 cars or 2,100 tons, whereas the same engine could run away with 30 cars of 70 tons each, although the gross weight of both trains was the same; hence it then became necessary to equate the tonnage of cars due to the gross weight of each.

About this time D. F. Crawford, general superintendent of motive power of the Pennsylvania Lines, devised his plan to make an arbitrary car allowance to meet the variation in gross weight of cars. This plan is to test engines with a train made up of all light empty cars and another test of the heaviest loaded cars; then divide the difference in the gross tons hauled by the difference in the number of cars hauled, then allow the result as an arbitrary to each car in addition to its actual weight.

In 1900 we made a test on the Ontario & Western with a full tonnage train of cars averaging 55 gross tons, and the engine had no trouble in hauling it over the grade, whereas with 70 gross ton cars it stalled. This required an investigation, and it was a conductor that solved the problem for us by showing that the heavy cars depressed the rails at the joints and made an increased up-hill pull, or, as he stated, it made waves in the track at the rail joints, due to light rail, poor ballast and surface. I cite this instance merely to show that the building of large capacity cars of itself would increase the expense of transportation, unless additional money was spent for the heavier rail and better roadbed, points which the public does not give proper consideration.

Mr. Cheeney, of the Chicago, Milwaukee & St. Paul, has devised the plan of loading engines on the basis of pounds of tractive power used, instead of gross tonnage, which is a very accurate basis. For example, on a .25 per cent grade if a 72-ton car requires eight lbs. per ton of tractive power, he figures it at $8 \times 72 = 576$ lbs., and would, in building up the train, use the 576 lbs. instead of 72 tons, and when the total pounds of tractive power used on all cars is equal to the tractive effort of the engine it has its full tonnage, or 100 per cent. The objection to this plan is the amount of time required in busy yards to compute the tonnage. This, however, can be overcome by reducing the pounds of tractive effort used per car to the ton unit and using a computing machine properly adjusted.

The most important feature in connection with the problem is to see that trains are properly loaded under any plan adopted. My experience leads me to believe that the work of the mechanical engineer, the traveling engineer and other officers in determining the resistance per ton of car and other factors previously stated, is the easy part of it. The difficulty is in having the terminal forces build up the trains properly with the assigned tonnage.

The ideal method to increase the train load is to equate the tonnage of cars, then arrange for the switching department to properly build up the train, and, when ready, have the yard clerk check the track, go to the office, pull the bills, foot the tonnage on the train resistance computer, notify the yard what tonnage to add to or take off, have the bills ready for the conductor when he calls, and avoid delaying the departure of the train,

which will save in overtime and fuel and often permit another train to pull in on the track cleared. After the departure of the train, the yard clerk should enter on his daily tonnage report the train number, number of cars hauled, the rating of engine and the equated tons hauled. A copy of this report should be sent to the superintendent or train master at the close of each day, in order that he may investigate at the time the cause of failure to properly load the individual train, instead of investigating the matter 30, 60 or even 90 days later, when the terminal is not in position to make an accurate explanation.

The 16-hour service law has materially affected the handling of tonnage, and frequently when trains are given their assigned tonnage not equated, and it happens to be largely in light capacity cars, it results in dragging over the road and very frequently in the train being tied up on the line on account of the 16-hour law, thereby creating considerable expense instead of resulting in a saving.

This condition can be largely overcome through the equated basis of loading engines, as under that plan the drawbar pull of all trains is equalized so that it is impracticable to have one train exert 40,000 lbs. of tractive power, as compared with another train with the same tonnage exerting only 32,000 or 34,000 lbs. By loading the trains with a uniform drawbar pull, the engines should be able to handle all trains within the time allowance.

Another factor which has been given considerable thought and on which a large number of tests have been made by some roads is the weather or temperature factor. Tests have been made of the resistance of different weights of cars at 30 deg. above and at different stages from that down to 20 deg. below zero, but personally I do not consider them as of much importance in practical operation for several reasons. The temperature may be 20 above zero with a drifting wind which is carrying snow into the cuts, making it much more difficult to operate than if the temperature was zero and calm. Again, the temperature at the initial terminal point may be 20 above and calm, whereas 50 miles out in the direction the train will move, it is snowing, drifting and down to zero. Again, at certain terminal points where they are fortunate enough to be located on an elevation where they get the benefit of down-grade or momentum in leaving the terminal, an engine can haul 300 or 400 tons more in cold weather than if the terminal was located in a sag where there was a slight grade leaving the terminal, for the reason that the lubricant congeals when trains stand a few hours in the yard waiting for movement, and creates considerable resistance on the journals in starting. Therefore, I feel that the question of loading engines in extreme cold and stormy weather is one which must be left largely to the discretion and good judgment of the men on the ground.

Another factor in connection with the rating of engines which should receive consideration is making some slight allowance for trains moving on busy track, where there are a large number of superior class trains, in order that the train may cross over on double track or take sidings and get out with despatch, instead of being obliged to frequently double out, thereby delaying the passenger trains. In other words, an engine with 40,000 lbs. tractive effort on a .25 per cent. grade on one division may be able to handle regularly 3,000 gross tons, whereas on another division where they have heavy traffic, it would be economy to reduce this tonnage to possibly 2,800 tons on account of the number of trains to be met, so that the physical conditions on the individual division or train district must be considered in the rating of the power. An arbitrary set of figures will not apply successfully at all points.

After having the conductors and engineers thoroughly convince me in actual practice that four 15-ton cars used more tractive power and pulled much harder than one 60-ton car, although the gross weight in each instance was the same, and having gone into the matter carefully, I was convinced that the load-

ing of trains on the tonnage basis would not be a success until such time as a device could be perfected which would simplify the mathematical complications, and I devoted much of my time in perfecting an automatic computing machine that would reduce the gross weight of each car to the tractive effort weight. In other words, a machine that would add the resistance of the car in lieu of the weight of the car. For example: If a 20-ton car is equivalent to 27 tons as to resistance, the machine instead of adding 20 would add 27, and if a 70-ton car meant only 60 tons in resistance, the machine when adding a 70-ton car would add 60 or 61 tons. With such a machine, a train of 80 or 90 cars can be computed and the drawbar pull determined by an ordinary yard clerk in less than 4 minutes.

In my judgment more money is lost in overloading the power than in underloading it, and the only safe and economical method for obtaining 100 per cent. efficiency is in using the equated basis.

INTERESTING ENGINEMEN IN THE ECONOMICAL USE OF FUEL AND LUBRICANTS

We are told that fuel used for locomotives in the United States alone, in 1911, amounted to about 132,000,000 tons, at a cost of approximately \$240,000,000. At least 10 per cent. of this did not come under the control of the engineers and firemen although, as a rule, it is charged to their performance, and it is not uncommon for enginemen to feel that a great deal of the fuel charged to them is used or wasted in other ways. If in any way fuel wasted before reaching the engine tank can be saved (although it costs nearly as much to save it as it is worth), it should be done, if for no other purpose than to show the enginemen that every reasonable effort is being made to give them credit for what they are able to do. No more fuel should be used in making engines ready for a trip than is necessary, and if extra fuel is used, by reason of lack of terminal facilities or engines ordered before they are needed, it should be charged to terminal consumption.

We wish to emphasize the necessity of a correct disbursement of fuel to each engine and the importance of the engineer familiarizing himself with the amount of fuel used during the trip. We have found it a good plan, where the chutes are equipped with scales or means for accurately measuring the coal, to occasionally meet the engines on their arrival at the coaling station and after the engineer has given his ticket for the amount he thinks necessary to fill the tank, advise him of the exact amount of coal delivered. By doing this the enginemen will very soon become familiar with what a given space in the tank will hold. Under present-day practices enginemen are not apt to be as familiar with this feature as in former times, when coal was delivered from pocket chutes or from buckets or buggies.

One railway has adopted the plan of posting bulletins at the terminals showing the tons of coal unloaded during the month, as per billed weights at the various coaling stations, and the percentage of this amount as represented by the engineer's estimate on their fuel tickets, also the fuel foreman's estimate. The result of this is that the engineers' estimates are now getting very close to the actual amount of coal received, whereas, formerly, they did not represent more than 60 per cent. of that amount.

The traveling engineer should be familiar with the various grades of coal. If it can be done, it is a good plan to visit the mines with the fuel agent or other purchasing officer. It is also a good plan to check weigh coal occasionally for their own information, to know how it compares with the billed weights. The traveling engineer should also use his efforts to have the coal properly prepared before being placed on the tender.

One of the best ways to interest the enginemen in what can be accomplished in the use of fuel and secure their co-operation is to make test trips in various classes of service similar to

those shown below, which are records of actual trips made. The scoops of coal are counted with a tally counter, unless the coal can be accurately measured otherwise. In making such tests, frequently the water used is noted, the distance run between water tank stops and the amount of lubricants used, or any other data that may be considered advisable.

FUEL PERFORMANCE.

Through freight, engine 1283, Springfield to Newburg, distance 119 miles.

| | |
|-------------------------------|---------------|
| Gross ton miles handled..... | 130,401 |
| Total time on road..... | 7 hr. 40 min. |
| Delay | 2 hr. 30 min. |
| Coal used | 7 tons |
| Coal per 1,000 ton miles..... | 108 lbs. |

No coal taken at Sleeper. Water taken only one place on division.
Per cent. rating, 101.

Through passenger, engine 1111, train 106, Fort Scott to Kansas City.

| | |
|---------------------------|---------------|
| Total running time | 2 hr. 45 min. |
| Total delay | 8 min. |
| Number of stops..... | 4 |
| Cars in train..... | 8 |
| Total car miles..... | 800 |
| Fuel oil consumed..... | 708 gal. |
| Gallons per car mile..... | 885 |

The injector never worked at more than 50 per cent. maximum capacity.

Through passenger, engine 1051, train No. 4, Springfield to Newburg.

| | |
|-------------------------------|---------------|
| Total running time | 3 hr. 13 min. |
| Total delay | 10 min. |
| Total car miles..... | 840 |
| Amount of water used..... | 8,000 gal. |
| Scoops of coal used..... | 401 |
| Average weight per scoop..... | 16 lbs. |
| Amount of coal consumed..... | 6,416 lbs. |
| Pounds per car mile..... | 7.63 lbs. |

Engine held at Newburg from 5:20 p. m. to 2:00 a. m., and made ready on 46 shovels of coal. 53 square feet grate area.

Considerable publicity is given these records. They are frequently shown on the enginemen's bulletin book or copies are sent to the employees' magazine. Where the performance is especially good, the superintendent of the division or other officer commends the enginemen, a copy of the letter and performance being attached to their personal record files. We should give the men all the credit that is due them. They have to take the blame whether they like it or not whenever the performance is not good.

Another method in use on certain divisions is to send out a mimeograph form at the end of the month to each engineer, showing car miles or gross ton miles handled by him during the month, the total amount of fuel used and pounds of coal or gallons of fuel oil per car mile, per thousand gross ton miles and the average of all engines in similar service, with such comment as the traveling engineer may see fit to make.

In submitting this question to a number of engineers and firemen, their reply almost invariably is: "Give us regular engines; do the work on them, and let us know what we are doing in the use of fuel and lubricants." These items are not under the control of the traveling engineer, but are mentioned to show the arguments he has to combat. On many roads, certain conditions will not permit of assigning regular engines, and it is no doubt possible to maintain engines in pooled service in as good condition as in regular service, but it is rarely ever done, and it is therefore difficult to excite the same interest in both cases.

Without doubt the condition of the engine has more bearing than any other one item, and the traveling engineer should use his best efforts to have the engines maintained in the best possible condition. They should be made to steam with as large exhaust nozzles as consistent, it being understood that all other draft arrangements are properly adjusted before contracting the nozzle, but by all means they should steam freely. It is almost impossible to get a fireman interested in fuel economy on an engine that does not steam well. A periodical inspection should be made of draft appliances and a correct record of all measurements and sizes of nozzles maintained, in order that en-

gines of the same class will have uniform exhaust openings, which will permit the fireman to carry the same depth of fire in each engine of the same class.

Cab arrangements should be made convenient and comfortable; injectors of proper size and so maintained that they can be skillfully operated; valves not only square but well balanced, so that the engine can be worked in a short cut-off when necessary and still lubricate properly a throttle that will remain in any desired position; proper distance between the fire-door and the coal gate; fire-doors at a proper height from the deck; deck guards if necessary, so that the fireman will not have to be continually raking coal in to prevent it wasting from the gangway. Grates, flues, steam pipes and all draft appliances should be kept in first-class condition and the ash-pan provided with ample openings for air admission.

An electric flash light torch is a valuable aid to the traveling engineer, if he wishes to make an occasional personal inspection of draft appliances without opening the front end door, or for noting the condition of flues and grates. This is especially useful where fire-tube superheaters are in use, due to the fact that the ordinary torch test is insufficient, as the return bends are some distance from the flue-sheet and cannot be seen with the illumination furnished from an oil torch and also from the fact that they may be almost entirely clogged and still have sufficient draft to draw in the flame.

Engineers' work reports should be closely followed up, for if certain men are careless in making their reports, others will become discouraged, feeling that their efforts in properly locating and reporting defects are not appreciated, and while all engineers realize the importance of it, some of them are apt to become a little careless in reporting worn cylinder packing, leaky steam chests, worn choke plugs, pockets in the oil pipes, or valve motion in such condition that it will cause the valves to be worked in an 8 to 10-in. cut-off when a 5 to 6-in. cut-off will do the work.

Many men do not realize that they are using a little more fuel and supplies that are necessary, not because they are indifferent, but because their attention has not been called to the fact that it is possible to do better. In riding with the engine crews the traveling engineer should encourage the efforts of the engineer and fireman in handling the train with as little fuel as possible consistent with maintenance of the schedule. In doing this, if circumstances will permit, explanation can be made to the enginemen as to what a relatively small saving by each crew per trip will mean in decreased operating expense on the entire division for one month. Encourage them to make similar tests when you are not with them. A very good illustration is to have them experiment to see just what kind of a run can be made by working the injector at minimum capacity, or nearly so. Show them how to figure ton miles and car miles and ask them to come to you if the work reported on the engines is not promptly done or to advise you in regard to other items that need attention, in order to save fuel, and show them you appreciate it by having such matters looked after. Ask the engineer to handle the engine so as to assist the fireman in every way in keeping a clean fire. Nothing will cause the fireman to lose heart more than to have a fire spoiled by an engine slipping leaving a terminal, after he has been very careful in getting it properly prepared.

The most successful engineer will tell you that he attributes much of his success to knowing the condition of the fire at all times, as well as the physical condition of the fireman and in having the fireman confident in his ability to keep the engine hot, encouraging him to make a study of keeping a clean fire at all times, rather than in trying to keep the engine at the popping point every minute, regardless of what may happen to the fire in so doing and causing the engine to steam hard on the last part of the road with resultant waste of fuel.

Close attention should be given to see that the engines leave

the terminal with clean fires. The education of fire builders and engine watchmen is as necessary as that of the new firemen.

It is a good plan to keep a record of the condition of fires as they come into the terminals and the time required for cleaning them. Firemen who succeed in bringing in a good fire for a certain period—say 30 days—can be commended, while the firemen that do not bring in good fires should have their attention called to it and be asked for an explanation.

In the selection of men who are to become firemen, the traveling engineer should play an important part. He should see that the right material is selected. The men should make student trips not only with the best firemen, but with men who are known to be of a good disposition; have a talk with the student, if possible, before he goes to work and let him have an idea of the amount of fuel he will be required to handle and the importance of economy in its use to avoid extra labor to himself and needless expense to his employer. Encourage his confidence and help him to select proper reading matter on combustion and the locomotive.

Progressive examinations are in use on a number of roads, and this, in the opinion of the committee, is one of the very best means of interesting the firemen. This should, we believe, be rigidly followed up on every road.

General meetings for enginemen and all other employees whose duties may in any way affect the use of fuel are productive of good results. The attendance of the officers has a helpful influence. The meetings should be arranged for in advance and subjects announced and the men asked to give their opinions. Many suggestions will be offered, and, if they are practical, they should be tried out.

On one road, mechanical clubs have recently been formed; officers are elected and committees appointed from among the engineers and firemen, the traveling engineer usually being the president or a member of one of the committees. Subjects are arranged for in advance, a question box is provided and questions or suggestions are deposited therein and thrashed out at the meetings. Charts and blue-prints are provided, showing proper and improper methods of firing, drafting; also on lubrication and other matters of interest.

In the use of lubricants, a first-class terminal organization is necessary for the systematic care of the cellars. We believe each engineer should be furnished with his own hand oilers and supply cans, so that he will be credited with his savings. The oil should be charged to engineers and not engines, and the schedule should be sufficiently liberal to prevent issuing extra oil as much as possible.

On the road mentioned, where the traveling engineers are supervising the fuel performance sheets, soon after the records were started a number of enginemen advanced the idea that a more liberal supply of lubricants would save fuel, and an experiment was tried on one division. Although the schedule was considered quite liberal at that time, each engineer was given an extra supply of cylinder oil to start with and all concerned were advised that it was not the intention to save lubricants at the expense of fuel. The fuel and oil performances were both closely checked for a month, at the end of which time it was decided that there would be nothing gained by a change in the oil schedule previously in effect.

We believe it is practical in some cases to ask engineers to make tests of the amount of oil required in the various classes of service and to have the cylinder heads or valve covers removed for their information at the end of the trips or test.

While it is possible to run pooled engines with the same amount of oil as regular engines, generally speaking we believe engines with regular crews will be better lubricated than pooled engines on the same amount of oil. With regular engines, the engineer knows just how the cups are feeding and how all bearings are running. In pooled service, he will not know this or whether the lubricator was entirely fed out when the engine

came in, and the valves and cylinders dry. On this account he will probably feed the lubricator a little too fast to start with than on a regular engine. Also, not knowing how the engine will steam or do its work, he is more apt to fill the boiler a little too full when starting out than with a regular engine. Unless he drains the lubricator, he will not get the oil saved on easy trips. Pooled engines usually do not get over the road as well as regular engines. Again, if the oil goes out of sight in the gage glass, the engineer will probably adjust the feed to run to the end of the trip, regardless of the effect on the fuel consumption.

No test figures are at hand to show the effect of insufficient lubrication. The statement has been made before this association that not less than 12 to 15 per cent. in tractive effort is lost when lubrication is insufficient.

We believe it is a good plan to let the men know about what the fuel and lubricants cost and what the company, with their help, is trying to accomplish. What will awaken interest will maintain it, and this can only be accomplished by continually keeping after it. New ideas will continually present themselves and the enginemen will contribute many good suggestions.

Committee:—Robert Collett, chairman; J. F. Meredith, D. L. Eubank, L. Redford, W. H. Donohue, J. S. Lemley and C. F. Schraag.

DISCUSSION.

While the systems used for checking the fuel and oil consumption on a number of railways were clearly explained, there appeared to be little that is new or particularly successful in the records themselves. A number of speakers reviewed the possible points at which savings could be made, but it appeared that personal efforts, arguments and demonstrations were the most successful methods for accomplishing results.

The importance of full and active co-operation of the enginemen was mentioned by D. J. Madden (Eric). He had found that by assisting the enginemen in getting the locomotives in first-class condition and stopping steam leaks, particularly in the cab, etc., they would be more receptive of suggestions for saving fuel. The same feature applies in connection with an active defense of the engineman whenever he is right in an argument with the train master or other officer. If the enginemen are satisfied with their surroundings and know that the traveling engineer is their champion, his instructions in fuel economy will be much more faithfully carried out.

Several speakers advocated the concentration of effort on coal saving rather than on oil. One member stated that the same attention which would result in the saving of one cent's worth of oil would save two dollars' worth of coal.

A. G. Kinyon pointed out the desirability of more careful training of the fireman before he is put to work, and the advisability of greater supervision of his work at the start. He compared the methods of training machinists' apprentices and firemen. He also made a plea for greater supervision of enginemen as well, and stated that a traveling engineer should not have over thirty crews under his charge.

F. C. Wayer (Southern) said he had found a device for automatically registering the amount of time the safety valves are open to be of decided value in saving the considerable loss of coal through this channel. When the device was first applied it was found that the pops were open 300 minutes on each trip. This had now been reduced to an average of 30 minutes. The careful attention to features of this kind, together with demonstrations and instructions, had resulted in a saving of 6 per cent. of the fuel on his road last year. Among other things a careful watch of the fires brought to the ash pit had been most helpful in checking the firemen's work.

In closing the paper, Robt. Collett (Frisco) stated that not infrequently it was necessary to educate the higher officer in fuel economy, as well as the firemen, in order to have the necessary full cooperation all along the line.

INSPECTION OF LOCOMOTIVES

The committee is of the opinion that no money expended by the railways will return a larger dividend than that paid the enginemen for the short time it requires to make a careful terminal inspection and report. It is further of the opinion that there should be no one more capable of making this inspection than the enginemen, and therefore advocates a careful and general inspection by the enginemen, and asks their full support in taking care of the expensive and heavy power we are now handling.

The engineman should make close observation of the operation of the engine while on the road, in order to determine defects that cannot be so well located while the engine is at rest. On arrival at the terminal he should begin at the front of the engine and inspect the condition of the parts as follows: Condition of the smoke-box front to see that the door is properly secured and that no loose nuts exist about the front end. The condition of the cellars and bolts as far as he can see, all parts of the valve gear, guide bolts, frames, springs and rigging, ash pan slides, tender trucks, condition of couplers and operating mechanism, condition of truck and driving wheel flanges, note temperature of bearings, examine rods for loose bushings and nuts, cross-heads, driver and tender brake shoes and rigging. The engineman should report whether or not the engine throws fire dangerously and any defects, such as valves out, cylinder packing or valve blowing, engine steaming badly, injectors not working, pop valves out of order, flues or any part of the firebox leaking, grates out of order, any defect in the air brake equipment, rods or boxes pounding, and such other defects as would usually come under his observation while operating the engine. If there should be any pounds or blows that he has been unable to locate while on the road, a careful terminal test should be made.

Enginemen should be conversant with the safety appliance and federal inspection laws, and report any defects that would constitute a violation. Such reports as "engine pounding" or "blowing" or "steaming badly," should be discouraged. Careful checking of the work reports and the assistance of the roundhouse foremen will greatly assist in the education of new men.

We should bear in mind the importance of having men in charge of engines who are well posted on their construction and competent to handle them in the best possible manner. And in order to encourage them to reach this point of efficiency, we should be as exacting as circumstances will permit in requiring the men to be well qualified before promoting them, and after they are promoted require them to give intelligent and careful attention to the engines in their charge and hold them responsible for failure to report any defects they have had an opportunity to find by using reasonable care.

Committee:—H. F. Henson, chairman; G. C. Jones, J. C. Petty, W. H. Dellert, J. B. Hurley, R. H. Fish, M. J. Keating and G. S. Tillman.

DISCUSSION.

It seemed to be the consensus of opinion that the engineer should make as complete work reports as possible, and in any case they should cover all features that would not be evident when the locomotive was standing. These would include blows, knocks, pounds, stuck wedges, valves out, hot bearings, etc. Some roads require enginemen to report everything without going under the locomotive. In other cases, on some passenger runs, the engineman is not even given an opportunity to make an outside inspection at the terminal.

The difference between the work reports by enginemen on regular and pooled engines was alluded to and started a discussion on this much debated subject. It was clearly shown, however, that the pooled locomotives were an absolute necessity in many cases, and if the engineman will do his duty as he should he will report as carefully on a pooled locomotive as on one regularly assigned to him.

The fact that the work reported by enginemen is frequently not performed was given as one cause for the incomplete reports.

One railway has introduced a system of records showing the work not reported by the enginemen, which was discovered by the inspectors. A copy of this goes to the master mechanic, the superintendent and the enginemen each week.

ADDRESS BY H. T. BENTLEY

The splendid work that has been accomplished by this association has been noted not only by the mechanical officers, but by the operating officers of the country. I believe I am safe in saying that there is no association in the United States that is so sincere, so energetic and so progressive as the Traveling Engineers' Association.

The road foreman of engines has a hard row to hoe. You start a man out and say, "Get results." It is a pretty hard job, and often takes two or three years before the man really knows what he is going to do and how he is going to do it. My idea is that as soon as a road foreman is appointed, if there is a convention of this kind in session, the best thing we can do for him and the company is to insist that he attend it and mix with the old timers—men who have been through the mill, men who know what to do and how to do it. It is a whole lot better to be able to get information from some fellow that knows something about it than to go digging around for three or four months and not get anywhere.

A new road foreman of engines is very apt to get discouraged. There is no question but that it is discouraging when a man works and does not get anywhere; but a little encouragement, a pat on the back from the man in charge, makes the man feel a whole lot better. A little encouragement is one of the finest things to bring about good results.

One of the worst things that the railways have to contend with at the present time, is the rough handling of trains, particularly passenger trains. I believe that there is a great opportunity, with very little effort on your part, to so improve the passenger service of this country that it will be the talk of the country and the talk of the traveling public.

There is another thing that will improve the service, and that is for you to preach and practice the safety habit. You have heard of the safety committees being appointed on all the prominent roads and some of the smaller ones; the results which they have obtained are remarkable. The fact that accidents have occurred in our shops which could have been prevented by these safety committees seems plain. We are all prone to take chances, and you ought to do all you possibly can to stop any chance taking by your men. The papers are altogether too glad to tell of two or three hurt here, and two or three killed there, simply because a man was taking a chance. If you want to improve the service of the American railways, preach and practice the safety habit. It will pay everybody concerned, and particularly the company for whom you are working, in the satisfaction that comes from the reduced loss of life and injuries.

There is another way in which the service can be improved, and that is in the emission of smoke. The engineer and the firemen are jointly responsible for excessive emission of smoke. The fireman, of course, is handling the coal, and he can do more as to the emission of smoke probably than the engineer, but the engineer by co-operation can reduce it so that it is not a nuisance.

The superheater engine has been in service long enough for us to know what it will do and how it will do it, and about how it compares with the saturated steam engine. The success of the superheater engines has been made by the efforts of the traveling engineers and the men who are operating them. When the engines first came out we had a number on the Chicago & North Western, and had so much trouble with them that we felt we had a white elephant on our hands; but by putting it up to the traveling engineers and the men who were operating the engines, as well as to the roundhouse to do their share, we found that the superheater engine was practically as easy to maintain

as the saturated steam engine, and very much better results could be obtained by improved train service, decrease in the cost of fuel and other things that you know all about. I want to thank the traveling engineers and the men under them who responded to their instructions, for the success of the super-heater engine.

Where you are getting records you ought to try to have them just as accurate as you can—coal, oil or anything else that pertains to your work—because an inaccurate record is a laughing stock to the men you are talking to. I have seen records which showed that a number of men had been operating certain engines with an average coal consumption of so much; and the officers have been inclined to pat the fellows on the back who were above the average and condemn the men who were below. We found that coal reports of that character were not right, because we had no way of knowing but that the lowest man was altogether too high. Working on that theory, we made some tests on the Galena division, and found that the engine crews were burning very much more coal than was really necessary to perform the service which was required of them on most of the runs; after a number of simple but careful tests we set a standard of coal consumption for certain trains which was very much below the average of our reports. Since then we have been endeavoring, not only on the one division but on all divisions, to bring the men up so that we can say that they are burning about the amount of coal that we think they are justified in burning, and no more.

The same thing applies to oil. There is no reason why on our oil reports we should not set a standard and say that that is the standard for that trip, and not make an oil report with averages and say any man above the average is all right. Speaking about oil, you will often see an engineer on a local train get down with his oil can and oil around nearly every time it stops—every fifteen or twenty miles. I was on a train the other day that ran 158 miles without a stop and wondered how he got over the road without oiling. If that man can run 158 miles without oiling, there is no reason why a man on a 60-mile run has to get down every few miles and oil.

One of your best friends is the roundhouse foreman. He can either make or mar your opportunities; that is, he can help you to good results that you can not get by yourself. The road foreman of engines and the roundhouse foreman should be very close together. Your interests are identical and you should co-operate fully.

—The American Railway Master Mechanics' Association should co-operate with such an organization as this. The work that you gentlemen are doing is so great and so good and we think so much of it, that I believe that the Master Mechanics' Association should call on you as an association to do some of the things that they have not time to do, and I know you would carry the burden nobly and help them out. The same offer was made by the General Foremen's association at a meeting I attended last year, and they volunteered to take up any subject that the Master Mechanics' Association felt that they could not handle, and dig into it and present a report to the Master Mechanics' association showing what they had found. I believe that there is a possibility of the Master Mechanics' Association helping you out and your helping them out in some things that they are not able to handle themselves, and I just simply throw it out as a suggestion that possibly you might volunteer, if you think proper, to undertake some such action.

ADVANTAGES AND DISADVANTAGES OF LEAD

BY J. F. JENNINGS.

It is impossible to give a fixed rule for the amount of lead to be given an engine, as what would be suitable for one type would not do at all for another because of the difference in clearance, cylinders, volume, cut-off, etc. The only practical way to determine the best lead is by the use of the indicator,

which will show whether or not the engine has the proper valve setting.

ADVANTAGES OF LEAD.

It gives pre-admission of steam, or steam is admitted into the cylinder before the piston has reached the end of the stroke, thus furnishing a cushion for the piston and reciprocating parts.

It gives a wider opening of the steam ports when steam is admitted, insuring as nearly as possible full boiler pressure at the beginning of the stroke and also gives an increased port opening after the crank pin has passed the center, by keeping the port open longer.

Lead permits of an earlier cut-off in the stroke, and consequently a longer expansion of the steam. An increase of one-eighth of an inch in lead would reduce the cut-off a total of one inch on one side of the locomotive; but it must be remembered that an increase of lead hastens every other operation of the valve.

During the exhaust the walls of the cylinder and the piston have had a chance to cool to a certain extent and the pre-admission of steam or lead insures the reheating of these parts at an earlier moment than would be the case without lead.

DISADVANTAGES OF LEAD.

When the crank pin is at or near the dead center, any pressure against the piston will have no effect in turning the wheel, and if the engine has lead it will actually tend to work against the cylinder on the other side of the locomotive, which is at its mid-stroke; especially is this true for locomotives used in slow service with hard pulls. This may be overcome to a certain degree by setting the valve blind in back gear in order to help the forward gear. By doing this, the lead is made almost constant for full and mid-gear.

We all know that when running at full speed, if we shut off the throttle and drift, we notice no ill effects from pounding; in fact, the engine sometimes runs better, due to the lack of pounding which occurred when it was working steam. This would seem to indicate that at high speeds the cushion of steam provided by lead is not at all necessary to arrest the motion of the reciprocating parts.

On locomotives with Walschaert valve gear the lead is constant for all cut-offs. This is a disadvantage for the following reason: The clearance volume to be filled with steam before the beginning of each stroke is the same and the amount of time for filling this space decreases as the speed increases. This shows that the amount of lead which would do for a slow speed would not give the best results for a high speed; therefore a constant lead is not desirable.

Again, suppose an engine with Walschaert gear and constant lead to be working with the lever in the corner and the piston nearing the end of the stroke; in this position the piston is traveling slowly while the valve is traveling fast. Due to the lead given the valve, the piston has an inch and a half or 2 in. yet to go when a large amount of steam is admitted into the cylinder. All lost motion of the worn parts will be taken up suddenly and a pound will result. It would seem from this that a negative lead would be an advantage because steam would not be admitted to the cylinder until the piston was in a position to use it to good advantage in the actual work of turning the wheels.

With the modern engine equipped with piston valves the exhaust lap is undoubtedly a move in the direction of economy. You can thereby cushion the reciprocating parts and fill the cylinder clearance by compression and to a certain extent maintain cylinder temperature by compression. Then when the crank has passed the center, let admission take place, or, as one writer said, "What we want is prompt admission, not pre-admission."

These few reasons for and against lead, would appear to indicate that there is not so much loss or not so much gain by

having early or late admission of steam and that the lead or absence of lead necessary for a locomotive should be determined which will give the best results, this of course varying with different types of locomotives, with the service in which they are used, and with the physical characteristics of the road.

DISCUSSION.

W. E. Symons opened the discussion on this subject by warning the members against attempting to decide on the correct amount of lead regardless of the local conditions. Each class of locomotive and each class of service may require radically different treatment in this respect. He illustrated his meaning by an instance in his experience where an increase in the lead of some passenger locomotives, which experience with other locomotives on the division seemed to indicate was the proper move to improve their operation, proved to be radically wrong, and it was only when they were given a negative lead that they could be operated satisfactorily. This was due to the fact that the locomotives had a very short main rod, short link radius and a rocker with the longer arm on top. In reply to a question, Mr. Symons explained that, as a general proposition, a reduction of steam pressure would not require an increase in the lead if the locomotive remained in the same service.

R. F. Darby, mechanical engineer of the Pilliod Company, drew attention to the necessity of considering the difference between variable and constant lead valve gears in deciding the proper lead to use. With the former the difficulty is generally to avoid too much lead at the shorter cut-off, while with the latter care must be taken not to get too small a port opening with a short cut-off, which means that the proper liberal lead must be maintained. On the request of a member, Mr. Darby explained the difference between lead and pre-admission as follows: Lead is the amount of valve opening when the engine is on dead center. Pre-admission is the distance of the piston from the end of the stroke when the valve starts to open.

Mr. Darby was requested to explain the Baker valve gear, and confined his remarks to possible break-downs and the proper procedure in each case. It seems that with this type of gear any break between the return crank and the bell crank would not put that side of the locomotive entirely out of commission since the valve movement that could be obtained from the combination lever would still be available and would give a port opening equal to the amount of lead. Any break, however, between the valve or cross-head and the bell crank would require the blocking of the valve.

In closing the discussion, Mr. Jennings stated that in his opinion, the only way to determine whether the full or part throttle opening is better is by the use of an indicator.

OTHER BUSINESS

Report on Master Mechanics' Association.—F. C. Thayer, the delegate of the association to the 1912 convention of the American Railway Master Mechanics' Association, read a report in which he briefly outlined the reports and papers presented, the trend of the discussions and the actions taken.

Reports of Secretary and Treasurer.—The secretary's report briefly reviewed the history of the association which has grown from 14 members in 1892 and 53 in 1893 to 882 at the opening of this convention. During the twenty years there have been 153 subjects acted on and in over 90 per cent. of the cases the recommendations were adopted. The treasurer's report showed a balance of \$2,884.66.

Subjects for 1913.—The committee on subjects recommended three committee reports and three individual papers to be considered at the next convention. The committee reports were: Uniform instructions to enginemen on the handling of superheater locomotives. Credit due the operating department for power utilization and train movement that reduces the consumption of fuel per ton mile. The care of locomotive brake equipment on the road and at terminals; also methods of locating and report-

ing defects. The individual papers were: Advantages obtained with the brick arch in locomotive service. What can we do to eliminate the black smoke evil on locomotives burning bituminous coal? Scientific tonnage rating.

Election of Officers.—The following officers and members of the executive committee were elected: President, W. H. Corbett, Michigan Central, Jackson, Mich.; first vice-president, F. P. Roesch, El Paso & Southwestern, Douglas, Ariz.; second vice-president, Robert Collett, Frisco, St. Louis, Mo.; third vice-president, J. C. Petty, Nashville, Chattanooga & St. Louis, Nashville, Tenn.; treasurer, C. B. Conger, Wm. Sellers & Co.; secretary, W. O. Thompson, N. Y. C. & H. R., East Buffalo, N. Y. Executive committee: W. C. Hayes, Erie; H. F. Hensen, Norfolk & Western; Martin Whalen, Cleveland, Cincinnati, Chicago & St. Louis; J. W. Hardy, Rock Island; F. C. Thayer, Southern; and V. C. Randolph, Erie.

Next Meeting.—In the ballot for the location of the 1913 convention, the three cities receiving the highest number of votes were as follows: Chicago, New York and St. Louis. The executive committee will select the place of meeting from these three. There appeared to be a very strong sentiment among the members in favor of again meeting in Chicago.

SOLID END MAIN ROD

BY C. D. ASHMORE,

General Foreman, Chicago & North Western, Clinton, Iowa.

A type of main rod that has no straps or bolts has been developed at the Clinton, Iowa, shops of the Chicago & North Western. This design, after eighteen months' service, has demonstrated its success and has proved decidedly economical in cost of repairs and renewals, as well as convenient and cheap in running repairs.

This style of rod is forged in the usual manner, and after being milled and having the ends planed to the proper thickness, the openings in both ends are laid out by templets and four

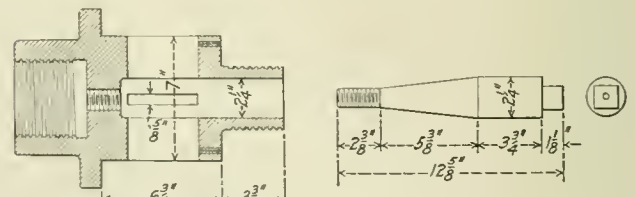
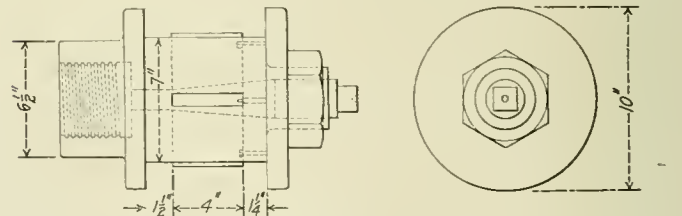

Mandrel for Turning Main Rod Brass.

Jig for Turning the Outside of the Main Brasses.

$1\frac{1}{2}$ in. holes are drilled in the corners. The rods are then taken to the slotter and the center pieces are cut out, and the openings are machined to fit the templet. Careful records have shown that the first cost of labor on the rod itself is considerably less than on the strap, or open type of rod.

The parts that fit into the opening in the back end of the rod are all made to jigs and templets, and are interchangeable. There are six of these pieces, which are shown both separately and assembled, in the accompanying illustrations. Nos. 1, 2, 3 and 6 are cast steel, while 4 and 5 are brass. The shoe marked 1 has flanges $1\frac{1}{4}$ in. deep, which hold in place and retain any

shims that may be required. Wedge 2 has one face tapered to an angle of $1\frac{1}{2}$ in. in 12 in. This wedge is the same width as the shoe, and has a $2\frac{1}{2}$ in. hole drilled through it near the bottom. There is also a $1\frac{3}{32}$ in. hole drilled through the center from top to bottom. A brass plug is pressed in the large opening and is drilled and tapered for a $1\frac{1}{8}$ in. adjusting bolt. The cast steel and filler block 3 has $\frac{1}{2}$ in. flanges top and bottom and is milled or bored out on its inner face to leave a $\frac{1}{2}$ in. should-

wedge adjusting bolt and slipping the wedge out sidewise, which permits the removal of block 1 and the application of a liner. If it is necessary to renew the brasses, filler block 3 is slipped backward and the enlarged opening in the rod permits them to be removed. The brasses can then be slipped out sidewise, the same applying to the filler block 6 after the brasses have been removed.

At the front end of the rod the construction is even more simple, consisting of two round turned brasses, one filler block and a wedge, the construction and arrangement of which are clearly shown in the illustrations. It will be noted that a set screw is provided for holding the wedge in place. The brasses are not provided with shoulders, since there is no opportunity for their slipping out sidewise when in service. They, however, have the round bearing surface on either side which prevents any vertical movement.

Special jigs have been developed for manufacturing the various part of this rod at the Clinton shops. After the two filler blocks 3 and 6 have been finished on their outside surfaces, they are placed in a cast iron frame as shown in one of the illustrations. Four set screws with steel dogs hold them in place. The jig is then clamped to the table of the boring mill and the special boring tool, also shown in the illustration, is used, which finishes their interior circular surfaces and flanges to exact size. A limit gage assures the accuracy of this work.

For finishing the brasses, the process consists of shaping the two adjoining edges, sweating the halves together, facing them, and boring out for the pin fit, if they are to be applied

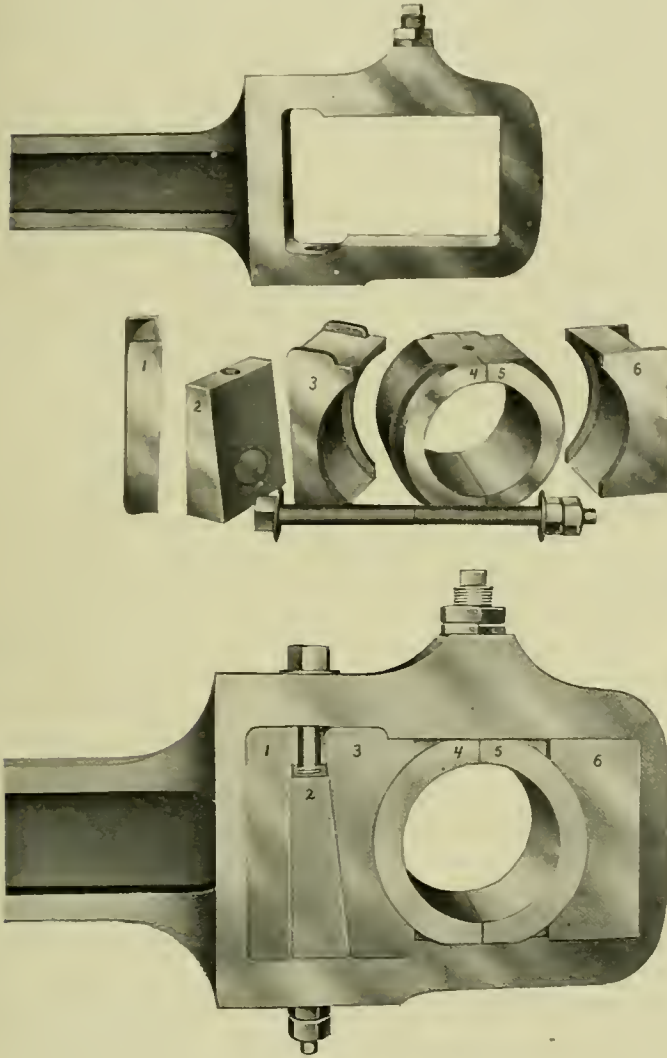

Back End of Main Rod Showing Parts Dismantled and Assembled.

der on each side for retaining the brass. The two brasses are duplicates and are sweated together and turned on the outside by means of templets to fit between the flanges of the filler block. They are then faced off top and bottom to a sliding fit in the rod opening. The filler block 6 is the same as 3 on the inner face, but has no flanges on the top and bottom. It, however, includes $1\frac{1}{4}$ in. flanges on each side at the back, which hold it in place and retain the shims.

It will be noted that there is but one drilled hole in this construction, that being for the wedge adjusting bolt. As this is not subject to appreciable wear, it appears that the only parts needing renewal will be the brasses. These, being jig made, can be finished complete with the exception of the bore for the pin fit and retained in stock. It will be noted that even though the brass is loose top and bottom it will not work up and down in the rod opening on account of its round surface in contact with the retaining or filler blocks.

For repairs in the engine house, this back end can be dismantled in 10 minutes, the process consisting of removing the

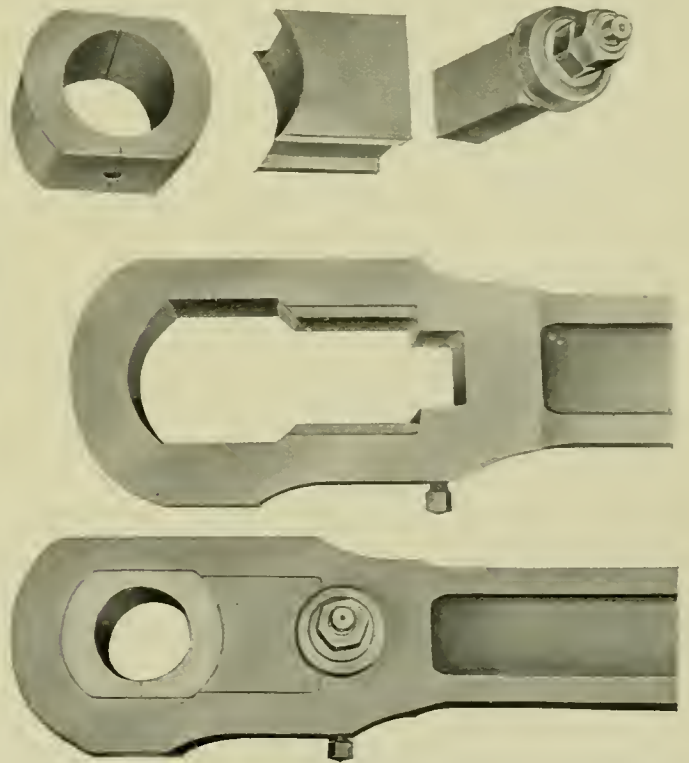

Front End of Main Rod Showing Parts Assembled and Separately.

immediately and the size can be obtained. They are placed on the mandrel, shown in one of the illustrations, which is attached to the lathe spindle, and are accurately centered by four adjustable jaws forced out by a tapered pin in the center. They are then clamped in place and turned on the outside, the same limit gage used for the filling blocks being employed to insure an accurate fit at the flanges. Standard calipers are also provided for giving the proper diameters.

Careful records have shown that the first cost of this rod complete is \$25 less than the strap, or open end rod. In re-

pairs, if the old brass is simply closed and rebored, it will cost but 79 cents for labor to put the rod in condition for service. If new brasses are required for both ends, the total cost for labor and material of this rod will be \$1.74, as compared with \$6.38 for the strap and bolt rod, the details of these costs being shown in the tables below.

For the purpose of estimating the saving this type of rod

| | | |
|---------------------------------|---------------|---------------|
| Fitting front end brass..... | .70 | |
| Closing and reboring brass..... | .79 | |
| Total | \$1.74 | \$1.74 |

Strap Rod.

| | | |
|--|---------------|-------------|
| Stripping back end..... | \$0.30 | |
| Closing brasses, babbitt and replating strap fit..... | 1.35 | |
| Hand fitting brasses to strap (half hour)..... | .19 | |
| Closing strap, refitting, reaming bolt holes, etc. (6 hrs.)..... | 2.37 | |
| Fitting three new bolts (1 hr.)..... | .20 | |
| Cost three new bolts, 24 lbs. at 3c..... | .72 | |
| Fitting front end brass (3 hrs.)..... | 1.25 | |
| Total | \$6.38 | 6.38 |

Difference

Comparative cost of material:

Solid End Rod.

| | | |
|-----------------------------------|----------------|----------------|
| New brass, back end, 114 lbs..... | \$12.70 | |
| Labor..... | .59 | |
| New brass, front end, 37 lbs..... | 4.12 | |
| Labor..... | .39 | |
| Total | \$17.80 | \$17.80 |

Strap Rod.

| | | |
|-----------------------------------|----------------|--------------|
| New brass, back end, 150 lbs..... | \$16.71 | |
| Labor..... | 1.56 | |
| New brass, front end, 53 lbs..... | 5.90 | |
| Labor..... | 1.37 | |
| Total | \$25.54 | 25.54 |

Difference

Comparative roundhouse saving:

Solid End Rod.

| | | |
|-----------------------------------|---------------|---------------|
| Refit back end brass to pin..... | \$0.90 | |
| Refit front end brass to pin..... | .59 | |
| Reline back end wedge..... | .10 | |
| Total | \$1.59 | \$1.59 |

Strap Rod.

| | | |
|-----------------------------------|---------------|-------------|
| Refit back end brass to pin..... | \$1.42 | |
| Refit front end brass to pin..... | .59 | |
| Reline back end wedge..... | .40 | |
| Total | \$2.41 | 2.41 |

Difference

The patents on this design of main rod are controlled by the Locomotive Improvement Company, Clinton, Ia.

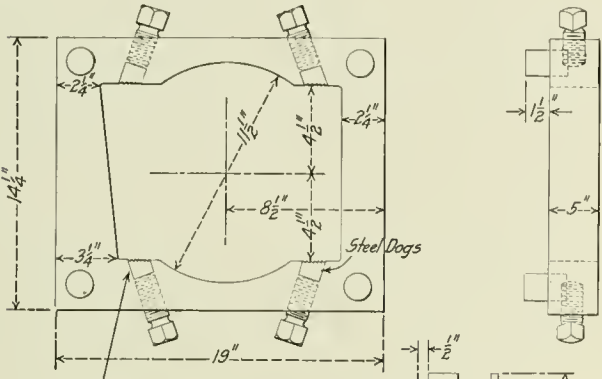

Jig to Hold Retaining Block While Boring.

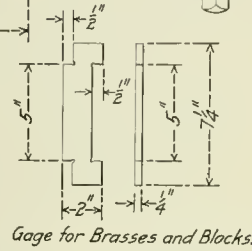

Gage for Brasses and Blocks.

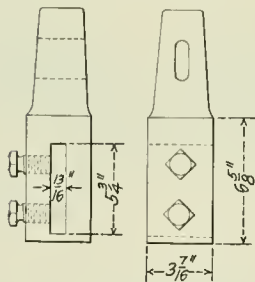

Tool to Bore Retaining Blocks.

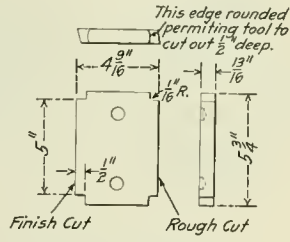

Finish Cut Rough Cut

Jig for Finishing the Inner Faces of the Filling Blocks.

will give as compared with the strap end rod, both for repairs and renewals, the following data based on the costs at the Clinton shops are impressive:

Comparative cost of labor:

Solid End Rod.

| | |
|-----------------------------------|--------|
| Dismantling rod (10 minutes)..... | \$0.05 |
| Closing brasses | .20 |

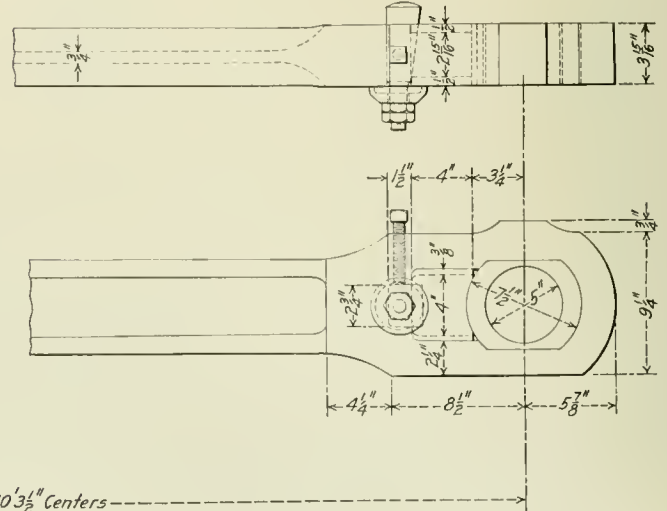
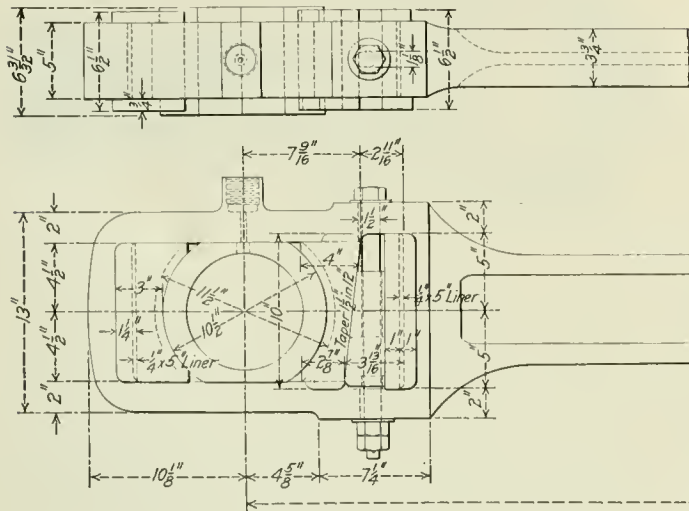

Solid End Main Developed at the Clinton Shops of the Chicago & North Western.

ACCIDENTS ON THE UNION PACIFIC-SOUTHERN PACIFIC SYSTEM. --Julius Kruttschnitt, director of maintenance and operation of the Union Pacific and the Southern Pacific, states that for four years not a passenger on the Southern Pacific lost his life through collision or derailment. During this period 157,000,000 passengers were carried an average distance of 42 miles. The Union Pacific in approximately the same period of time had but a single accident which resulted in the death of a passenger. These records are attributed to the automatic block signal system, on which \$5,000,000 has been spent during the past five years.

LINK GRINDING MACHINE

A number of years ago, F. H. Dersch, foreman of the Chicago & North Western repairs shops at Dubuque, Iowa, designed a simple link grinding machine, which has been used for ten or twelve years without repairs. It consists of two bars *C C*, which are pivoted at their ends and can be set at any angle with each other by adjusting the micrometer screws *B B*. Attached to these bars, *C C*, either by sliding blocks *A A*, or riding on them with rollers, there is a frame *D* to which the link to be ground is bolted. Set with its center in a vertical plane above the pivotal point *F* of the two bars is an emery wheel, which can be raised or lowered in a line with the center *F*. The method

and kept always against the pins *G G'*, then the path of the point *H*, will be the arc of a circle. And that circle will be the one passing through *G H G'*. If the straight edges be moved to the position *H' J'*, *H' K'*, the point *H'* will still be on the arc of the circle, because the angle at *H* is constant and the points *G G'*, being fixed, measures a constant length of arc. It is also evident that if a straight edge were laid along the points *L* and *H*, and was held at *L*, the center of the arc *G' H G*, the point *H* on the straight edge being constrained to move along the arc *G' H G*, that every point on the straight edge would describe the arc of a circle.

The link grinding machine works upon the same principle; but, instead of moving the straight edges over the points *G G'*, the

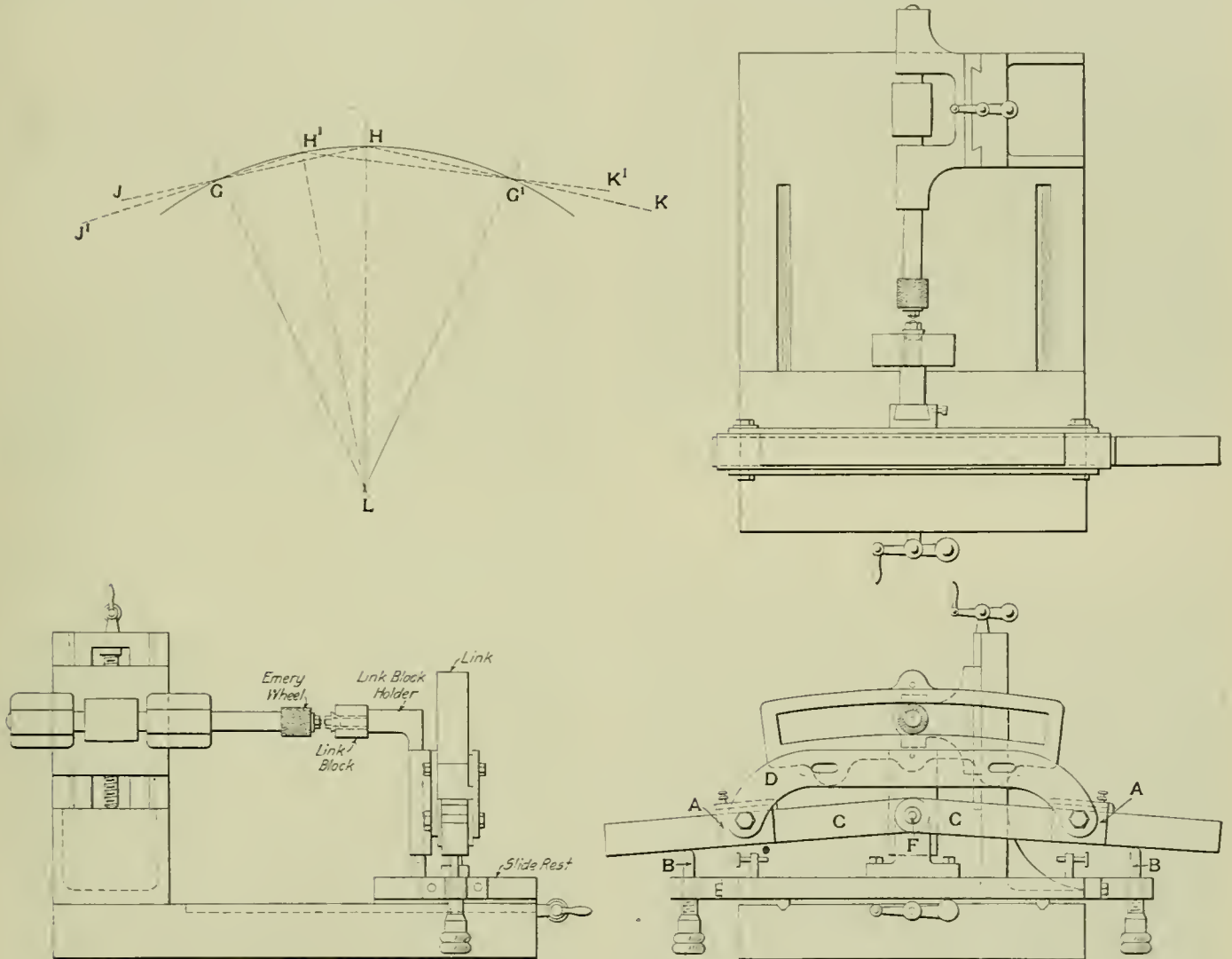

Link and Link Block Grinding Machine.

of operation is to set the bars at the proper angle to give the desired radius of curvature to the link; then bolt the link to the frame *D* and move the latter to and fro, raising or lowering the emery wheel so that it will be in contact with one face or the other of the link.

The principle on which the machine works is the old geometrical one that equal angles at the circumference of a circle are always subtended by equal arcs. A familiar application is to be found in the method of drawing a circle by means of two straight-edges held at a constant angle to each other, and moved across two pins. For example let *G G'* be two pins, and *H J*, *H K* be the edges of two straight edges held together at *H* at a constant angle. If the two straight edges are moved to and fro

points *G G'* are moved over the straight edges. It is evident that if this is done the imaginary arc *G H G'*, will always coincide with the path of *H*, and any other point, such as a point on the link that is bolted to the frame *D* will describe a circle concentric with the arc *G H G'*. The link block is also ground on this machine, being fastened to the holder, as shown, which is connected to the frame *D* and has the same arc motion as the link. The adjustments possible with this machine are such that links of any radius from 38 to 130 in. may be ground on it.

TWENTY-FOUR O'CLOCK SYSTEM ON THE CONTINENT.—At present the time tables of the Belgian, Italian, Spanish and French railways show times from 1 to 24 o'clock.

SHOP SAFEGUARDS*

BY W. H. SNYDER,

General Foreman, New York, Susquehanna & Western, Stroudsburg, Pa.

There is no more important question than that of the safety of human beings. Railways especially are put to a great expense in bringing their equipment up to the requirements of the Interstate



Fig. 1—Safeguards Covering the Gears on a Lathe and Planer.

Commerce Commission; the laws which compel them to apply a certain style handhold or step and to drill staybolts in a locomotive boiler to a certain depth and diameter are all done for safety.

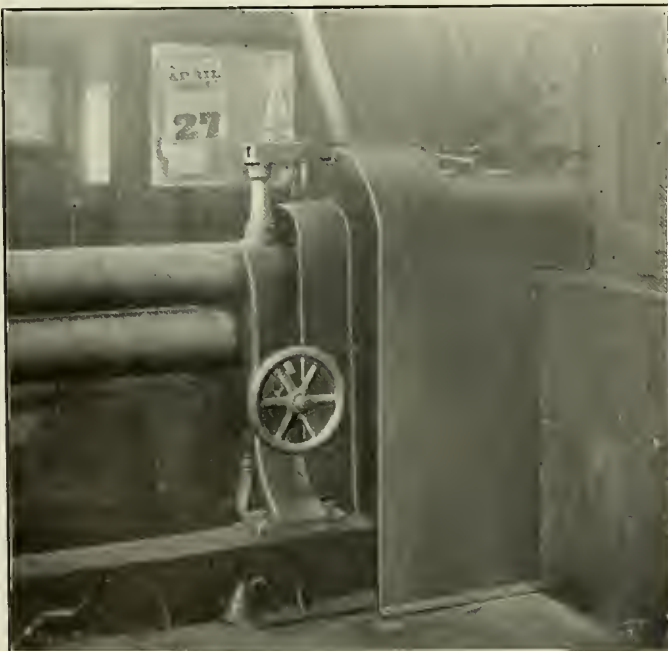

Fig. 2—Safeguarding the Gears and Pulleys of a Power Roll.

All employees should be awakened to the importance of safety and protection, and should always be on the lookout for their safety, as well as for that of their fellow workmen.

*Entered in the Safety Competition, which closed June 1, 1912.

Many accidents are prevented by installing safety devices, and if this is combined with care a large number of accidents can be avoided. When men are first started to work on machines they should be fully instructed by the foremen on how to operate them safely and they should be cautioned from time to time. Each workman should be made to feel that he is a safety inspector



Fig. 3—Protecting the Workmen From the Breakage of a Main Belt.

and any suggestions from him should be cordially recognized. The state legislatures throughout the country are directing unusual attention to the prevention of accidents to operatives and

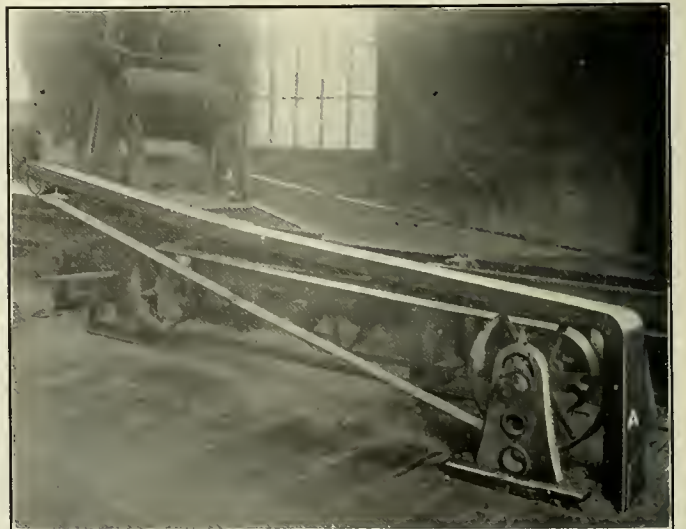

Fig. 4—A Neat Guard over a High Speed Belt on a Wood Planer.

manufacturers are anticipating them in safeguarding their employes.

Foremen are essential factors in this work and should be carefully selected for their ideas of caution and discipline and the desire to prevent accidents. Safety devices should be installed wherever possible; they will prevent many serious accidents and their use should be insisted upon wherever practical. Warning

signs will prevent many accidents. Oiling or cleaning machines around gears or any revolving parts should not be done while the machine is in motion. Workmen should wear tight-fitting clothing and under no consideration should they wear jackets outside of their overalls; the use of gloves should also be avoided around machinery that is in motion. These are some suggestions that if followed will greatly decrease the number of accidents. The safeguards must be maintained by periodical inspections to see that they are properly used for the purpose for which they were intended. These suggestions all come under the control of the foreman directly in charge and he must watch and educate those who show any tendency toward being reckless.

Two typical safeguards are shown in Fig. 1. *C* is a guard covering the large and small gears on a planer and *D* shows a well arranged guard covering the gears on a 24 in. lathe; the guard on the lathe is hinged at the bottom making it convenient to move when it becomes necessary to change gears. A safe-



Fig. 5—A Simple Device, Controlled from Several Points In the Shop, for Stopping the Engine.

guard around the gears and pulleys of a power roll is shown in Fig. 2.

A good substantial guard under a main belt is shown in Fig. 3. This is so arranged that if the belt should break it cannot strike anyone. A neat guard over a high speed belt on a wood planer is shown in Figure 4. This is hinged at the lower end of *A* to allow it to be adjusted when raising and lowering the cutting head.

A simple and useful device for stopping the shop engine by compressed air is shown in Fig. 5. The rack *A* is of 1 in. square iron, 12 in. long, and has a piston on the end which fits into the cylinder *B* which is 2 in. inside diameter. The cylinder is secured on a bracket in such a way as to allow the air pipe to be connected at the bottom. The gear on the throttle stem is 4 in. in diameter and the throttle can be closed by admitting air to the cylinder *B*, the rack driving the gear on the throttle stem. A pet cock is used for releasing the air from the cylinder so that,

if desired, the engine can be started again in a few seconds. In each department of the shop is one or more air valves, as shown in Fig. 6. The pipe *A* is painted a bright red for a distance of about 18 in. and the handle *B* of the valve is painted white,



Fig. 6—One of the Air Valves in the Shop for Stopping the Engine in an Emergency.

giving a good contrast. Alongside of this valve is a notice in a small frame, which reads as follows:

NOTICE, EMERGENCY VALVE.

This valve to be used only in case of danger to life or machinery. If any one is caught in machinery or anything is wrong with machinery that will do damage the valve should be opened until the machinery stops.

By actual test it has been found that the valve only has to be opened about four seconds to close the throttle, which brings the engine to a standstill in 21 seconds. These emergency valves



Fig. 7—Railing and Guards for Safeguarding Woodworking Machines.

are located in conspicuous places and every shopman knows their location. They are tested once a week.

A pipe railing around woodworking machines in the planing mill is shown in Fig. 7; a guard over a rip saw is also shown to the right at *A*. This is so arranged that it can be adjusted to

NEW LOCOMOTIVE BLOW-OFF VALVE

In some districts it is necessary to frequently open the blow-off valve while the locomotive is in operation on the road. In fact, in many sections a more frequent use of the blow-off valve would improve the operation of the locomotive and reduce the cost of boiler maintenance. It is, therefore, desirable to make the opening and closing of these valves as convenient to the

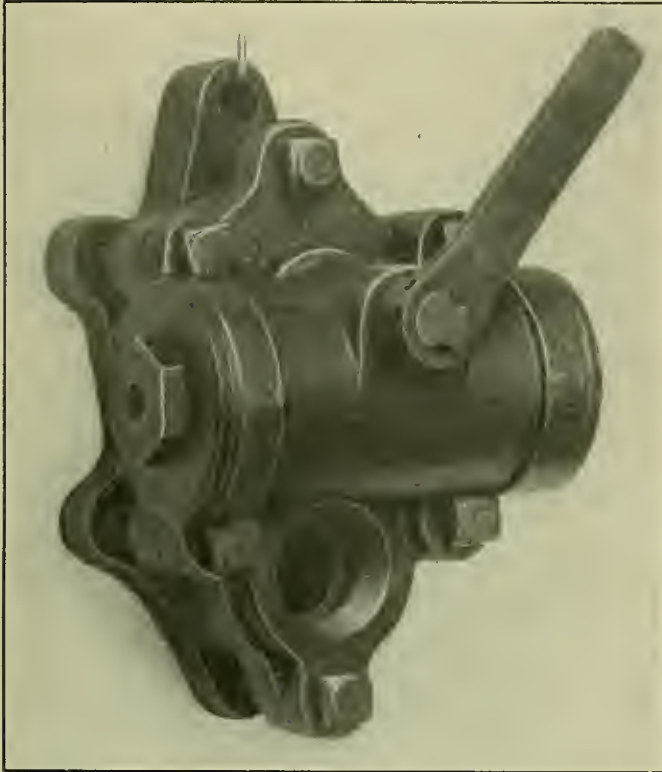

Osmer Locomotive Blow-Off Valve.

engineer as possible, and valves operated either by air or steam have been designed and successfully employed.

A blow-off valve of this type, designed and patented by J. S. Osmer, master mechanic, Chicago & North Western, Boone, Ia., is shown in the accompanying illustrations. It consists of two main parts, one of which is secured to the boiler by means of a

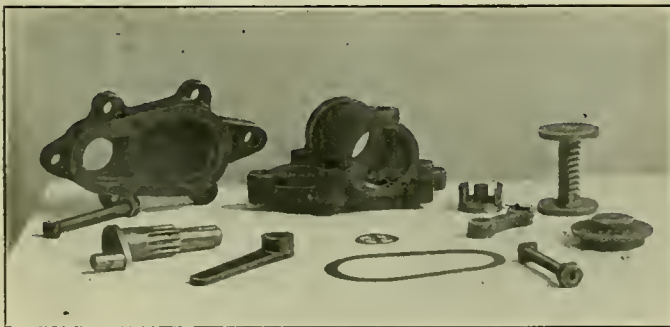

Parts of the Osmer Blow-Off Valve.

short pipe nipple and a stud. The other part, including the cylinder and all the operating mechanism, is secured to the first member by six bolts. There is a large opening in the outer casting which is placed opposite the opening in the boiler, and is tapped for connection to a pipe to carry the discharging sludge and hot water down between the wheels. This opening is closed by sliding a disc valve connected through a link to the crank on the end of the horizontal shaft. The shaft has teeth cut in it

which mesh with the teeth on a horizontal rack that has a piston head on either end. These pistons are provided with packing and have a steam tight fit in the cylinder. It will be seen that when air or steam pressure is admitted to one end of the cylinder, the movement of the pistons and rack revolves the crank shaft, which in turn moves the valve. When pressure is admitted to the opposite end of the cylinder the valve will be closed and the pressure in the boiler will keep it tightly seated. The crank shaft is extended through the casting and a lever, fastened to it, allows the manual operation of the valve at the engine house.

Several of these valves can be connected to the same operating valve in the cab, allowing them to be opened and closed at the same time.

SECTIONAL TUBE EXPANDER WITH KNOCKOUT ATTACHMENT

When using the ordinary sectional tube expander, it is necessary to strike the mandrel several blows on the side with a hand hammer to loosen it and remove the expanded. This frequently results in damage to the tool and sometimes requires considerable time and, at the best, it deteriorates the standard

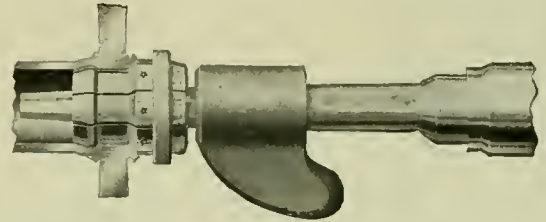

Faessler Expander, Showing Position of Mandrel Extractor While Tube Is Being Expanded.

and the quality of the work. To eliminate this difficulty, the latest type of expander designed by the J. Faessler Manufacturing Company, Moberly, Mo., has a quick acting knockout. It consists of a sleeve fitted closely over the mandrel and having an extended arm to receive the blows of the hammer.

After the mandrel is forced in place either the pneumatic or hand hammer strikes the end of this arm and the effect of the blow is such that the sections are loosened from the mandrel, and at the same time the lever action tends to withdraw the mandrel. Theoretically each hammer impact on the arm forces the collar against the adjacent expander segment, and moves it slightly lengthwise before the balance of the segments are af-

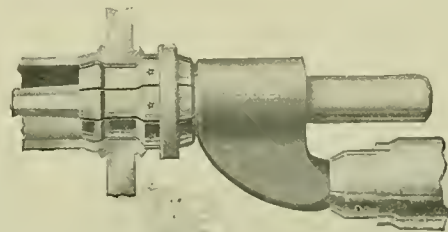

Faessler Expander with Hammer Applied to Mandrel Extractor.

fect. The contact of the collar and expander segments forms a fulcrum around which the entire sleeve moves and imparts a slight lateral impulse to the mandrel which tends to break the contact with the other expander segments. This device does not in any way interfere with the expansion, and is usually allowed to remain on the mandrel. It is found that it releases the mandrel much quicker than can be done by hand, and it does not jump out, but simply creeps backward with the greatest safety and convenience. Its use results in a decided increase in the number of tubes that a man can expand in a given time.

AUTOMATIC TEMPERATURE REGULATOR

Most of the first class passenger equipment now in service has electric current available at all times. This condition makes possible the application of a convenient method of regulating the temperature when the heating is by steam and from the locomotive, or by the use of Baker heaters.

A simple apparatus for performing this service has been designed by the Railway Utility Company of Chicago, and in the case of ordinary passenger cars consists of a sensitive mercury thermometer which has a platinum wire fused in the tube at the point reached by the mercury column when the temperature is 72 deg. Another similar wire is fused in the mercury bulb at the bottom. These two wires connect to the regulator of a small motor, which by a chain of gears operates the valve in the steam line. The arrangement is such that when the circuit to the thermometer is open the motor keeps the valve in the steam line open. When, however, the temperature reaches 72 deg. the mercury column in the thermometer closes the circuit and the motor is operated in the opposite direction and closes the steam valve. In each case the motor runs just long enough to close the valve and the amount of current used is very slight. The motor and its gearing connecting to the valve are enclosed in a dust-proof casing and secured under the body of the car, and the thermometer can be placed at any desired point in the interior.

Thermometer Arranged for Automatically Controlling the Steam Heat.

For use in sleeping cars, which should be kept cooler at night than during the day, a thermometer with two contacts is arranged, the circuit being made through a plug which can be inserted at either point to give the desired temperature.

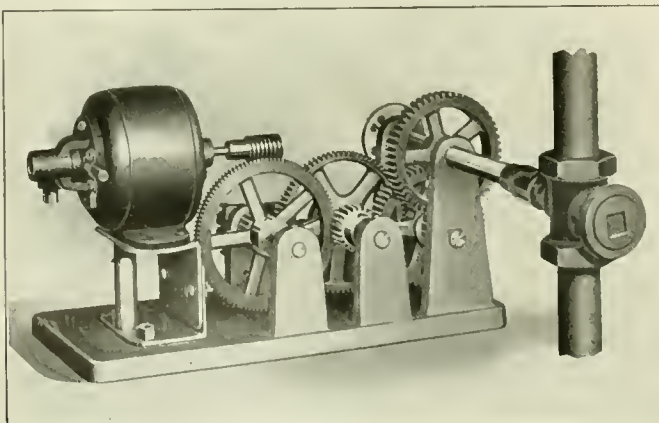

Apparatus for Closing and Opening the Valve in the Steam Line.

The same idea is carried still further for use in private cars where a thermometer may have several or more plugs for connection at different temperatures. In such cases each state-room would have a separate thermometer controlling the steam supply to individual radiators. When used in connection with Baker heaters the automatic control has the further advantage of preventing the burning out of the heater coils, which may occur when these cars are put in trains heated by a through steam line from the locomotive with the fire still burning in the heater. With vapor heating systems the valve in the heater line may be operated by a solenoid instead of a motor.

COUPLER YOKE SHEARING AND RIVETING PRESS

A powerful hydraulic press, designed and arranged particularly for the purpose of stripping yokes from coupler shanks and of riveting them on again, has been designed by the Watson-Stillman Company, New York, and is shown in the accom-

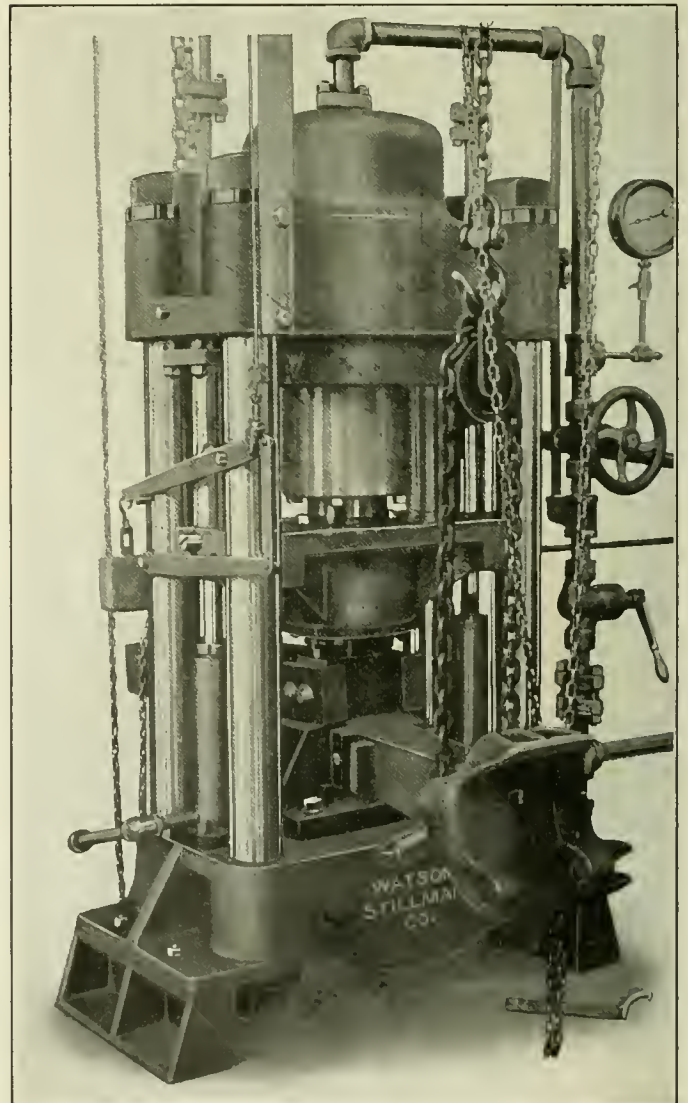

Press at the Completion of the Shearing Operation.

panying illustrations. Either operation, shearing or riveting, is effected by a single stroke of the ram, and the press is designed to handle standard coupler shanks up to 5 in. x 7 in., and will head rivets up to 1 1/4 in. diameter.

The body of the press is built in the most substantial man-

ner and ample room is provided for handling the work in and out. The press has a capacity of 200 tons, and is 6 ft. 8 in. in total height. The main ram has a diameter of 12 in. and a stroke of 6 in., and the clamping cylinders have 3 in. rams with 6½ in. stroke. There are two push-back cylinders for a more rapid return of the large ram. These are automatic in operation.

Specially designed blocks are furnished with the machine, and in the shearing operation the shank and yoke are laid on their sides and the downward stroke of the press simply pushes the shank out between the jaws of the yoke, thus shearing the

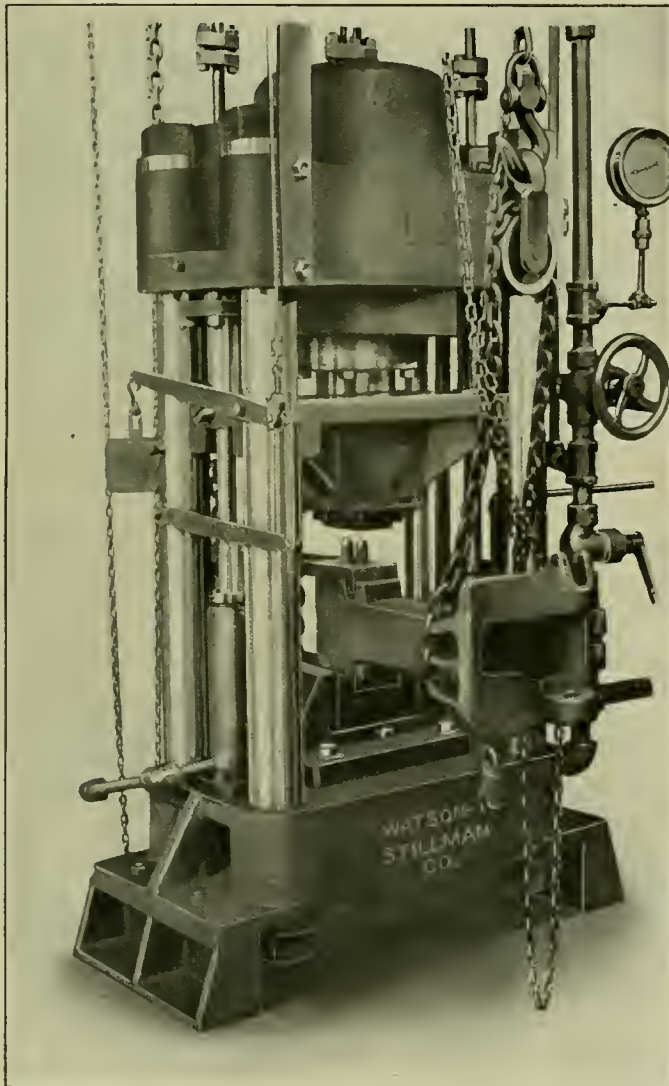

Press Ready for Riveting Yoke to Coupler.

rivets and freeing the shank at one stroke. One of the illustrations shows the completion of this operation. For riveting, the coupler and shank with the rivets in place are set upright, and on opening the valve the small rams first clamp the yoke to the shank and then the large ram descends on the rivets and heads them. The start of this operation is shown in the second illustration.

DE WITT CLINTON TRAIN PASSENGER.—Mrs. Eliza C. Haywood, a passenger on the first railway train that was run in New York, recently died at Chicago at the age of 91. She was a passenger on the line between Albany, N. Y., and Schenectady in the summer of 1831, which was hauled by the old De Witt Clinton locomotive.

COMBINATION PATTERN MAKERS' GRINDER

A useful combination tool for a pattern making shop, is shown in the accompanying illustration. On one side of the central bed is a 30-in. disc grinder with its work table, while on the opposite side and driven from the same shaft is a vertical drum sander with an adjustable table. The latter is connected to the driving shaft by a clutch which permits it to be operated independent of the grinder. The shaft is connected to a three horse power motor by a 3-in. chain belt. In the illustration the machine is shown with all gear guards removed.

On the grinder side of the tool is a 30-in. steel wheel ¾ in. thick, which runs at 750 revolutions per minute. This has a work table 14 in. wide by 40 in. long, which may be tilted and locked at any angle from 75 deg. to 135 deg. Large distinct graduations permit the exact adjustment, and the construction is such that the inside edge of the table remains within 1/32 in. of the disc regardless of its angular position. The work table also has a vertical adjustment of 25 in., and is supported by a round ver-

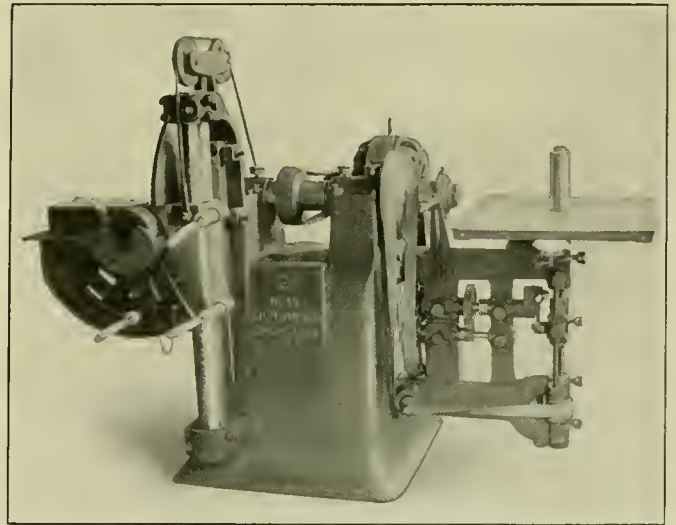

Combination Pattern Maker's Grinder.

tical shaft which permits it to be swung away from the grinding disc for convenience when setting the wheel or when facing off extra large patterns. There is a groove in the center of the table for the application of different attachments, four of which are furnished with the machine. These consist of a sizing circle gage for cylindrical and conical grinding, a sliding bevel gage for simple and compound angle grinding, a sizing bevel gage for simple and compound angle grinding to dimensions, and an angle plate for free-hand cornering of thin work. These attachments in combination with the possible movements of the table allow practically any kind of finishing work to be done with the machine. The disc carries an abrasive face that is cemented onto the steel plate, and it is not necessary to remove it for the application of a new grinding surface.

On the opposite side of the machine the drum sander has a work table 24 in. x 28 in., which may be tilted and locked at any angle from 85 deg. to 105 deg. from the axis of the sander. Here also a graduated scale is provided for accurate adjustment. The work table has a center round opening 8½ in. in diameter in which are fitted circular plates with center holes to accommodate various sizes of drums from 1 in. to 6 in. in diameter. The sand drum runs at 2,250 revolutions per minute, and has a perpendicular reciprocating movement while running which can be adjusted between zero and 4 in. The drum spindle is driven by a 2 in. quarter-turn belt, while the reciprocating crank is driven through gearing by 1½-in. belt.

This machine occupies a floor space of 54 in. x 84 in., and weighs 2,800 lbs. It may be either belt or motor driven and is manufactured by C. S. Besley & Company, Chicago.

ATTACHMENTS FOR TOOL ROOM LATHES

The American Tool Works Company, Cincinnati, Ohio, has provided a number of attachments on 14 in., 16 in., 18 in., and 20 in. standard high duty lathes, which make them especially suited to tool room work. Since the basis of these lathes is a standard machine any of the attachments may be applied with very little trouble to the same size machines already in service.

The most prominent of these special features is the relieving attachment which is designed to relieve or back off the flutes of rotary cutters, taps, reamers, end mills, hollow mills, dies, etc. This arrangement is universal in its action and internal relieving can be as easily performed as straight work. It is marked by an extreme simplicity in design, having but a few parts. The attachment is driven through a change gear mechanism supported by a bracket at the front of the headstock. The gear train has a small quadrant that is used to disengage the drive when not required. Power is taken from a spur gear on the end of the spindle and is transmitted through the change gear mechanism to the driving shaft which is journaled in a suitable bracket fastened to the left end of the carriage. Between this bracket and the tool rest are the universal joints which permit the cross movement of the tool slide. The driving shaft revolves constantly in one direction until the direction of the spindle is reversed at which time it ceases to operate. This valuable feature results from the use of a clutch between the cam and the driving shaft which is operative in one direction

only. There are three cams provided in addition to the change gears, giving the attachment an extremely wide range. The cams run in an oil bath and are located directly in front of the tool slide, permitting them to be readily in-

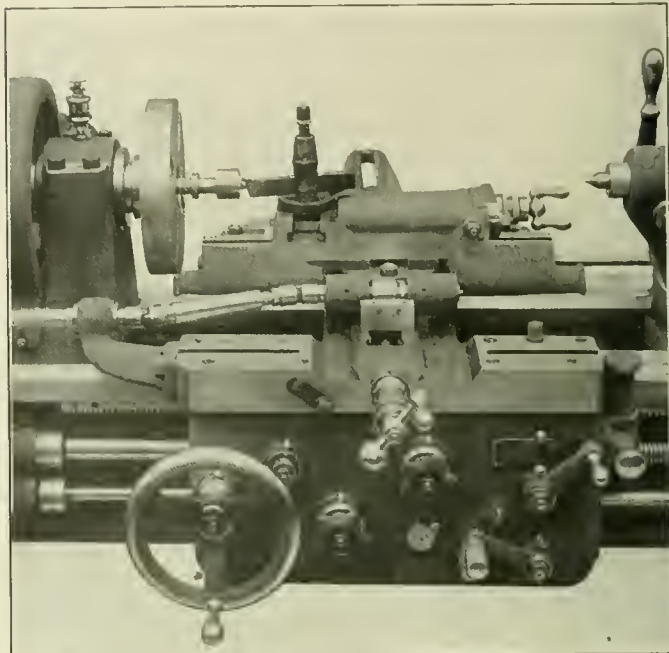

American Lathe, Showing End Relief Attachment.

terchanged. Possibly the most important and valuable feature of this new attachment is that which permits the tool slide to be operated at every 30 degrees, thus providing twelve operating positions within a circle. This permits the

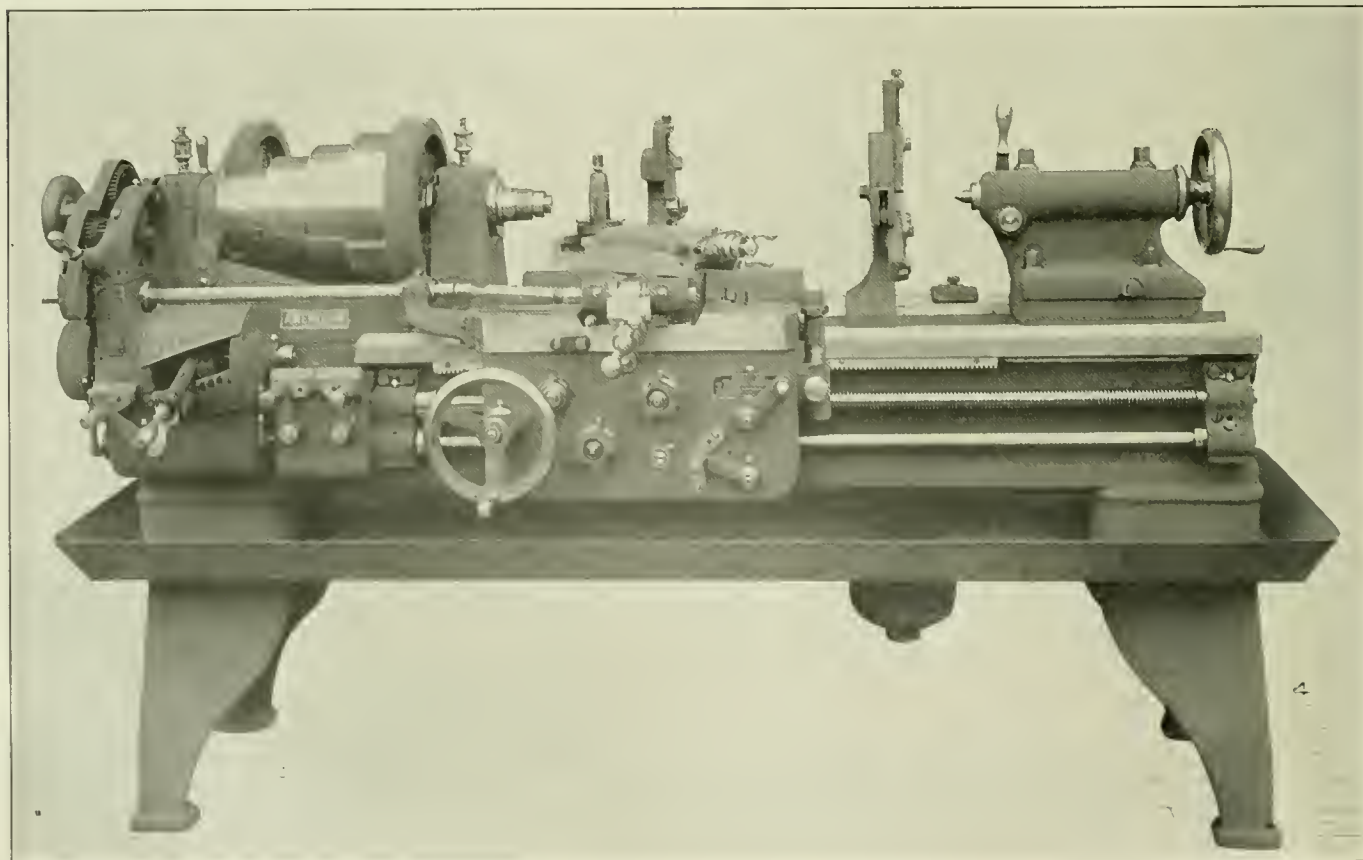

American High Duty Tool Room Lathe with Taper, Relieving and Draw-In Attachments, and Oil Pan.

relieving of side cutters, end mills and numerous jobs that have heretofore been done by hand. Convenient means are provided for the adjustment to obtain the various degrees of relief desired. This attachment can be applied to any "American" high duty lathe below the 24 in. medium pattern size.

Another special feature provided on the tool room lathe is a very simple design of taper attachment. This is bolted to the carriage and travels with it, and can be instantly thrown in operation by the tightening of one bolt. When ready for taper work the sliding shoe of the attachment is directly connected to the bottom slide of the tool rest by a heavy cast iron yoke. It is not necessary to disconnect the cross-feed nut when using this arrangement.

The draw-in attachment furnished with these lathes is simple, consisting of a long hollow steel bar, a hardened and ground steel taper bushing and as many collets as are necessary for holding the different diameters of work. The hollow bar which extends through the spindle has a handle wheel at one end and is threaded internally at the other. The bushing fits in the spindle nose and the collets are placed within it, the threaded end extending through and connecting with the long bar. The stock to be turned is passed through from the head end of the lathe and is gripped in the collet or chuck. The turning of the hand wheel one way or the other permits the work to be engaged or disengaged.

A sheet iron oil pan to catch the waste lubricant and prevent it from running over the floor is a usual and important attachment for a tool room lathe and has been applied in this case.

RADIAL ENGINE AND TENDER BUFFER

With the commonly used type of spring buffer between the locomotive and its tender, the wear on the drawbar pins and the holes, as well as on the face of the buffer, is considerable and requires frequent attention for proper maintenance. In many cases this is not followed up carefully, and it is not uncommon to find locomotives running without any compression

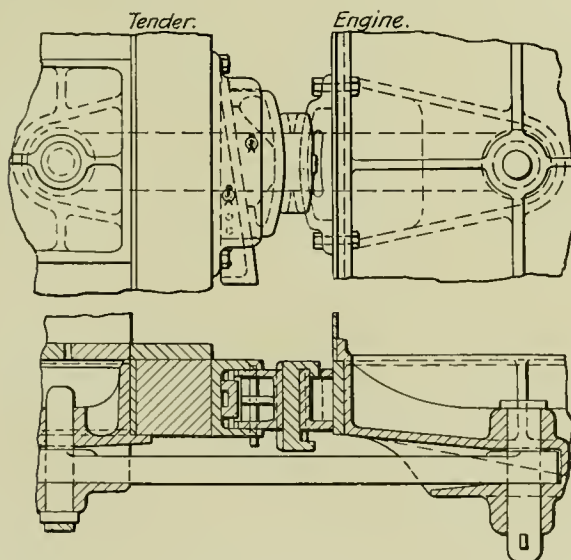

Application of "Radial" Buffer Between Engine and Tender.

in the buffer springs. This not only makes a hard riding locomotive, but causes excessive strains to be brought on the drawbar and increases the possibility of derailment.

For the purpose of overcoming these difficulties, a type of radial buffer has been designed by the Radial Buffer Company, New York, which does not use springs but has a wedge behind the tender buffing plates which permits the blocks to be ad-

justed to suit the length of the drawbar. The faces of the buffer on both the engine and tender are radial with the pin centers and between them is a floating block which gives a large bearing surface, independent of the relative position of the two blocks. Reference to the illustration will show the arrangement and construction. Service tests have indicated that the wear on faces and buffers, as well as on the drawbar pins and holes, will be small. This buffer can be run with not to exceed 1/16 in. slack, and thus practically makes the locomotive and tender act as one piece.

FORGING FLAT WRENCHES

BY SAM LEWIS,

Foreman Blacksmith, Grand Trunk Pacific, Rivers, Manitoba

A light flat wrench, so designed that it can be used in awkward places, is a handy tool for a mechanic and if it is well made considerable time will be saved and the bolts and nuts will be more carefully adjusted. The design shown in the accompanying illustration is satisfactory and may be easily forged. A ball is first formed on each end of the rod with a pair of swages, under a steam hammer. These are made in one heat and the rod is

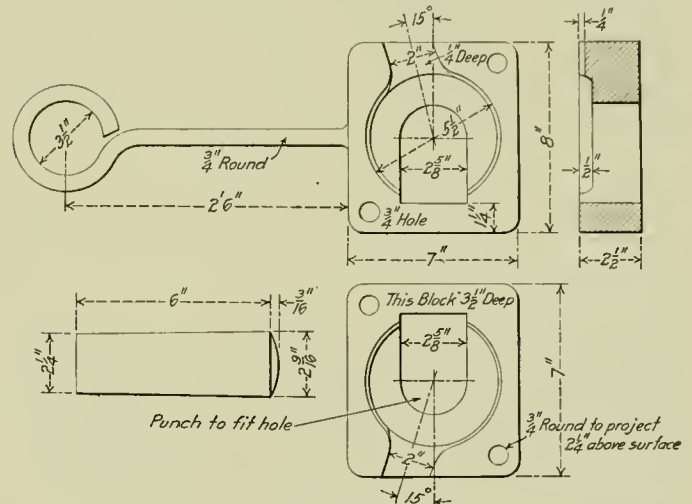

Dies for Shaping Flat Wrenches.

drawn out at the center. After a quantity have been made they are placed in the furnace and the ball ends are flattened to fit the dies of the different size wrenches. The punch and die shown herewith are used for making a wrench for a 1 5/8 in. nut. The diameter of the ball at the end of the rods should vary for the different sizes. For a 1 in. wrench the ball should be 2 3/4 in. in diameter for a 7/8 in., 2 1/4 in., and for a 1 5/8 in., 3 1/4 in.

MEXICAN WAY OF HANDLING A STRIKE.—Anticipating a strike of the American conductors and enginemen employed on the National Railways of Mexico, which had been called for 5 o'clock on the afternoon of April 17, on account of an alleged policy of discrimination against American employees in order to eliminate them from the service, the management issued an order discharging them at 3 o'clock on the afternoon of the 16th, just 26 hours in advance of the time set for the strike. According to press reports, the order found many of the men at distant points on the system; and, four days before, an order had been issued cancelling all passes for American employees and members of their families. About 1,000 American enginemen and conductors are said to have been affected. All trains run after the issuance of the order were manned entirely by Mexicans, but for a time it was necessary to abandon a part of the service.

GENERAL NEWS SECTION

The Pennsylvania Railroad has spent more than \$100,000 during the year 1911 in its campaign against trespassing. This is nearly one-fifth of the cost of maintaining the company's police force.

The Illinois Central made its first settlement under the Illinois workmen compensation law on July 22, when it paid \$3,500, the maximum under the law, for the death of a brakeman, who was killed June 4.

The Boston & Maine has issued rules against making bonfires on the company's property and forbidding the emptying of ashes into wooden receptacles, and smoking where inflammable materials are used. Spark arresters with a 3/16 in. mesh have been installed on nearly all locomotives, and these are to be inspected each week.

Both the Delaware, Lackawanna & Western and the Chicago & Alton have issued orders to the employees of the operating department, stating that the use of intoxicating liquors while on or off duty will be considered sufficient cause for dismissal. The Lackawanna goes a step further by prohibiting its men from visiting places where liquor is sold and enjoins them to use their time off duty so as to obtain sufficient rest from their labors.

The relief department of the Pennsylvania Railroad system reports that \$180,577.73 was paid to the employees during the month of July, 1912. Of this amount \$127,428.78 represents the payments made on the lines east of Pittsburgh and Erie, Pa. Since the establishment of the fund a total of \$33,704,578.52 has been paid out. On the Lines East of Pittsburgh \$31,407.33 was paid to families of members who died during last July, and \$12,750 was paid on the Lines West.

Efficiency committees have been organized on the Pere Marquette to investigate various subjects assigned to them. The following chairmen have been appointed: Train Tonnage, J. F. Deimling, chief engineer; Per Diem and Demurrage, H. O. Halsted, superintendent of transportation; Fuel Consumption and Train Supplies, W. L. Kellogg, superintendent motive power; Shop and Store Practice, W. C. Atherton, purchasing agent. These chairmen will report to F. H. Alfred, assistant general manager.

An examination for the position of engineer of tests at the Watertown Arsenal, Mass., with a salary of \$2,000 a year, will be conducted September 21 by the United States Civil Service Commission. The applicants must have had three years' experience, with some experience in testing engineering material, and must have been graduated from civil or mechanical engineering schools. Examinations for engineer draftsmen will be held September 11 and 12 in the supervising architect's office in the treasury department, the salaries ranging from \$1,600 to \$2,000.

A general safety committee has been inaugurated on the Illinois Central. It will consist of assistant general manager T. J. Foley as chairman; the superintendent of machinery, the engineer of maintenance of way, the chief claim agent, the chief surgeon and the general attorney. Meetings will be held every month in the office of the assistant general manager for the purpose of discussing methods that will prevent accidents. Division committees have been appointed which will hold conferences every month, and the chief claim agent will furnish evidence concerning the accidents happening through the month and they will be thoroughly discussed. Twenty-five hundred safety buttons bearing the motto "Always Safety First" are being distributed among the employees of both the Illinois Central and the Yazoo & Mississippi Valley.

The Missouri Pacific-Iron Mountain system has given the control of its hospital system to the employees of that road. The system includes large hospitals in St. Louis, Kansas City and Little Rock, a joint arrangement with the St. Louis Southwestern at Texarkana, Ark., for the use of its hospitals there, and arrangements at more than 30 other points along the line with sanitariums which look after the sick and disabled for the company. The railway company had to advance funds to establish this system, but small fees collected have placed the service on a self-sustaining basis, so that it can be legitimately turned over to the employees for their own management. The chief surgeon of the road, Dr. Paul F. Vasterling, is chairman of the board of managers.

Max H. C. Brombacher, an efficiency engineer of New York City, recently returned from a trip to Europe, where he spent six or seven months in making a study of the railway shops of England and the continent, with special reference to shop management. Mr. Brombacher will present his findings to the Interstate Commerce Commission in the form of a report which will include a large amount of statistical data. He visited the principal shops and headquarters of the railways of England, Switzerland, France, Grand Duchies of Baden and Hesse-Darmstadt, and the Kingdoms of Bavaria, Prussia, Saxony, Wurtemberg and the Austrian Empire. He reports that there should be a very good market for American machine tools abroad, as they are far superior to those he noticed in operation in industrial plants.

The United States Bureau of Mines makes the statement in a bulletin just issued that the present steaming capacities of steam boilers can be tripled or quadrupled by forcing over the heating surface three or four times the weight of gases now passed over them. "With well-designed mechanical-draft apparatus this greater weight of gases can be forced through the boilers at small operating cost," the bulletin states. "It is possible to increase the capacity of many of the present boilers in this way without reducing their efficiency much; in fact, by proper arrangement of the heating surfaces the efficiency can be made higher than the present rating. The efficiency of any boiler can be increased by arranging its heating surfaces in series with respect to the path of hot gases. New boilers of high efficiency can be constructed by making the cross section of the gas passages small in comparison with the length." These statements are contained in Bulletin 18 on the Transmission of Heat Into Steam Boilers, the authors being Henry Kreisinger and Walter T. Ray.

EMPLOYEES AND THEIR SAFETY.

H. W. Belnap, chief inspector of safety appliances, Interstate Commerce Commission, gave an address before a meeting of the Baltimore & Ohio employees at Philadelphia on the Employees' Responsibility for Their Own Safety. The keynote of the whole address may be taken from the following abstract:

No law, no matter how rigidly enforced, can correct evils that are directly chargeable to failure of employees themselves to do their duty and to exercise due precaution not alone for their own safety, but also for the safety of others. We know that employees often fail to exercise ordinary precaution in the performance of their work. This failure is often a form of thoughtlessness in which the chief motive is haste, and generally it is true that some ease or saving of time to themselves is secured by almost every unnecessary risk they take.

The use of safety appliances on cars is an important factor in the prevention of accidents. The commission's records show that of the total deaths and injuries suffered by trainmen in

1893, 44.33 per cent. were due to coupling and uncoupling cars. This percentage has steadily decreased from year to year until in 1911 it was but 6.3 per cent.

A thoughtful and active mind is the first necessity for safety, but in the hazardous occupation of train operation it seems that attention to safety has been secondary and occasional instead of continuous and of prime importance. If we can instill the idea that it is more honorable and more professional to be cautious and prudent than to take unnecessary risks a great reduction in the accident records will result.

DOUBLE DECK STREET CAR

Experimental double deck street cars have recently been placed in service in both New York and Pittsburgh. A few double deck cars have been built previously for special purposes in this country, but have not proved a success because of the height of the car being too great to afford a proper clearance for the overhead trolley wire, and also because of the delays in handling the passengers to and from the upper deck. The combination of an upper deck with the stepless car, which was recently introduced in New York City, makes the New York double deck car only a little higher than the standard street cars, the distance from the top of the rail to the top of the car being less than 13 ft. This car was designed by Frank Hedley, manager, and J. S. Doyle, superintendent of car equipment of the New York Railways Company, and was built by the J. G. Brill Company. It is 44 ft. long and 8 ft. 3 in. wide, and has a seating capacity for 88, 44 of these being in the lower part of the car. The total seating capacity has been found by actual experiment to be 171 passengers. This makes the weight of the car per passenger about 266 lbs.

The Pittsburgh car was built in the repair shops of the Pittsburgh Railways Company from the bodies of two short open cars from which the platforms had been removed. This car has been arranged with two side entrances and is 48 ft. long and 14 ft. 3 in. high from the top of the rail to the top of the car. Unlike the New York car, which has the stairways at either end, the stairs are in the center of the car. One of the side entrances is used for an entrance and the other for an exit. The seating capacity of the upper deck is 52 and the lower one 60, a total of 112. The greatest number of passengers carried in actual service has been 184, but the car was planned for a maximum seating capacity of 208.

SAFETY COMMITTEES

A large number of safety committees have recently been appointed on the railways in this country. The Union Pacific has established a system which is comprised of a central safety committee, division committees and district shop committees. The central committee will be permanent, consisting of the four general managers. Each division committee includes the superintendent and members of his staff and ten or more employees. The district shop committees will consist of one employee from each of the different branches of shop work and one from the general store.

The Oregon Short Line has inaugurated a safety campaign, which is similar to that of the Union Pacific, the division committees being empowered to appoint sub-committees to make special reports.

The safety committee on the Oregon-Washington Railroad & Navigation Company consists of a central committee which includes one assistant general manager as chairman, all the other assistant general managers, superintendent of water lines, general storekeeper, assistant general attorney, general claims agent, and chief surgeon. There are division committees consisting of the division superintendents and their staffs and a district shop committee similar to that of the Union Pacific. Each committee will meet once a month, and special meetings may be called at any time.

The Southern Pacific of Mexico and the Sonora Railway or-

ganized safety committees August 1. The general committee includes the general superintendent as chairman, one assistant general superintendent as vice-chairman and secretary, one assistant general superintendent, general freight and passenger agent, chief surgeon, master mechanic, superintendent of the Sonora division, and the attorney at Guaymas. There are also division committees appointed for each division.

The safety organization on the Lehigh Valley presents a new feature. A prize will be awarded in each department, on each division, every year to the employee who makes the best suggestion towards improvement in safe operation. The prize will consist of a month's vacation with pay, and the winner will also receive an honor button, to be retained by him as long as he remains on the honor roll. The members of the general safety committee are the general manager, the superintendent of transportation, superintendent of motive power, the maintenance of way engineer, the claims attorney, and an officer or employee appointed by the general manager. The division committees will be made up of officers and employees.

The central safety committee on the Southern Pacific will be composed of division superintendents, and on each division there will be a committee composed of the superintendent and members of his staff from the various departments, with employees from the different classes of work. Each of these employees will be chairman of another district committee, who will report the work of the sub-committees to the central committee.

The Cincinnati, Hamilton & Dayton has started a "safety first" campaign, which will be similar to that of its parent company, the Baltimore & Ohio.

The Rock Island has organized a safety bureau which will consist of several committees composed of general district and division officers, district safety supervisors, and a large number of employees from the rank and file in the various departments, the total membership approximating 600. L. F. Shedd has been appointed general safety supervisor, with headquarters in Chicago. He will have charge of the safety organization. The general safety committee will be composed of the assistant to the second vice-president, as chairman, the general managers of the three districts, the chief engineer, claims attorney, general claim agent, chief surgeon and general safety inspector, who will act as secretary. The district safety committees will be composed of the district officers with the assistant general managers as chairmen, and the division safety committees of division officers and employees with the division superintendents as chairmen. There will also be terminal, division and shop safety committees at the principal terminals and shops.

The Indiana State Railway Commission has issued a statement that safety committees have been established by all railways operating in that state, except the Grand Trunk and the New York, Chicago & St. Louis.

CARS FOR THE REFRIGERATOR PACIFIC FRUIT EXPRESS

One thousand new refrigerator cars, equipped with collapsible tanks with a capacity of 11,000 lbs. of ice, will soon be delivered to the Pacific Fruit Express Company, a subsidiary of the Southern Pacific Company. The collapsible tanks will enable the company to use the cars for ordinary freight during the periods that they are not required for perishables. The first instalment of these new cars will soon be started westward, and they will immediately go into service. This order of 1,000 new cars is an increase of 10 per cent. in the total refrigerator equipment of this company, making it 11,000 cars. The latest refrigeration ideas have been adopted in the building of the cars and a most effective insulation will line the interiors. Five years ago the Pacific Fruit Express Company had 6,600 of these cars, but the growing fruit and produce business of California, Oregon, Washington, Idaho and other Pacific coast states has caused nearly a thousand additional cars to be purchased annually.

MEETINGS AND CONVENTIONS

New York Railroad Club.—A. W. Whiteford will read a paper on the Relation of Boiler Design to Evaporation and Safety at the meeting which is to be held on Friday evening, September 20. It will deal with the low water and other tests made at Coatesville, Pa., under the direction of Dr. W. F. M. Goss and will be accompanied by lantern slides.

Central Railway Club.—The next regular meeting will include the fall outing of the club, and will be held at Dunkirk, September 12. The club will go from Buffalo to Dunkirk by boat, leaving the former place at 9.30 a. m., arriving at Dunkirk about 12.30 p. m. The plant of the American Locomotive Company will be visited and a paper will be read by Henry Gardner, supervisor of apprentices of the New York Central, on a Practical Application of the Routing System to Locomotive Repairs.

American Society of Mechanical Engineers.—It is expected that this society will give considerably more attention to railway subjects in the future than it has in the past. The Committee on Meetings recently appointed a number of sub-committees on the industries, one of which was on the railroads. The personnel of the committee is as follows: E. B. Katte, chairman; George M. Basford, T. N. Ely, Dr. W. F. M. Goss, W. B. Potter, N. W. Storer, H. H. Vaughan and R. V. Wright. There is a possibility of one of the sessions of the annual meeting in December being entirely given over to a discussion of subjects of special interest to railways.

Illuminating Engineering Society.—The sixth annual convention of the Illuminating Engineering Society will be held at the Hotel Clifton, Niagara Falls, Ont., September 16 to 19. A large number of papers and reports will be presented. A report on Progress deals with recent developments in the lighting industry, both in this country and abroad. There will also be reports on Nomenclature and Standards and on Steel Mill Lighting. Among the individual papers which will be read are those on Indirect and Semi-Indirect Illumination; Diffuse Reflection; A Study of Natural and Artificial Light Distribution in Interiors; The Physiology of Vision; The Efficiency of the Eye Under Different Systems of Illumination; Illumination Charts, and the Determination of Illumination Efficiency. The office of the general secretary of the society, Preston S. Millar, is at 29 West Thirty-ninth street, New York City.

The following list gives names of secretaries, dates of next or regular meetings, and places of meeting of mechanical associations.

- AIR BRAKE ASSOCIATION.—F. M. Nellis, 53 State St., Boston, Mass. 1913 convention to be held at St. Louis, Mo.
- AMERICAN RAILWAY MASTER MECHANICS' ASSOC.—J. W. Taylor, Old Colony building, Chicago.
- AMERICAN RAILWAY TOOL FOREMEN'S ASSOCIATION.—A. R. Davis, Central of Georgia, Macon, Ga.
- AMERICAN SOCIETY FOR TESTING MATERIALS.—Prof. E. Marburg, University of Pennsylvania, Philadelphia, Pa.
- AMERICAN SOCIETY OF MECHANICAL ENGINEERS.—Calvin W. Rice, 29 W. 39th St., New York.
- CAR FOREMEN'S ASSOCIATION OF CHICAGO.—Aaron Kline, 841 North 50th Court, Chicago; 2d Monday in month, Chicago.
- INTERNATIONAL RAILWAY FUEL ASSOCIATION.—C. G. Hall, McCormick building, Chicago.
- INTERNATIONAL RAILWAY GENERAL FOREMEN'S ASSOCIATION.—William Hall, Chicago & North Western, Escanaba, Mich.
- INTERNATIONAL RAILROAD MASTER BLACKSMITHS' ASSOCIATION.—A. L. Woodworth, Lima, Ohio.
- MASTER BOILER MAKERS' ASSOCIATION.—Harry D. Vought, 95 Liberty St., New York.
- MASTER CAR BUILDERS' ASSOCIATION.—J. W. Taylor, Old Colony building, Chicago.
- MASTER CAR AND LOCOMOTIVE PAINTERS' ASSOC. OF U. S. AND CANADA.—A. P. Dane, B. & M., Reading, Mass. Convention, September 10-13, Albany Hotel, Denver, Col.
- RAILWAY STOREKEEPERS' ASSOCIATION.—J. P. Murphy, Box C, Collinwood, Ohio.
- TRAVELING ENGINEERS' ASSOCIATION.—W. O. Thompson, N. Y. C. & H. R., East Buffalo, N. Y.

PERSONALS

It is our desire to make these columns cover as completely as possible all the changes that take place in the mechanical departments of the railways of this country, and we shall greatly appreciate any assistance that our readers may give us in helping to bring this about.

GENERAL.

HENRY ALLEN has been appointed assistant boiler inspector of the Alberta division of the Canadian Pacific.

ALLEN HARWOOD BABCOCK, who has been appointed consulting electrical engineer of the Southern Pacific Company, with office at San Francisco, Cal., was born August 12, 1865, at Buffalo, N. Y. He attended the public schools at Oakland, Cal., Phillips Exeter Academy, the University of California and Lehigh University. In November, 1891, Mr. Babcock became a draftsman in the San Francisco office of the Thompson - Houston Electric Company, and was made assistant engineer of the same company in December of the following year. He went with the Standard Electric Company of California in July, 1898, where he was assistant engineer until May, 1899, and was then promoted to superintendent. In



A. H. Babcock.

June, 1901, he was appointed electrical engineer of the California Central Gas & Electric Company; in July, 1902, he went with the North Shore Railroad as electrical engineer, and from December, 1903, until the date of his recent promotion to consulting electrical engineer, he was electrical engineer of the Southern Pacific Company, with office at San Francisco.

A. J. BAUMBUSH has been appointed general foreman of the New York Central & Hudson River, at the Grand Central Terminal, New York. He will be in charge of inspection, repairs and cleaning of all equipment entering the terminal, whether owned by the New York, New Haven & Hartford or the New York Central.

E. L. BURDICK, assistant engineer of tests of the Atchison, Topeka & Santa Fe, with office at Topeka, Kan., has resigned to go with one of the Westinghouse companies. Effective September 1.

H. G. BURNHAM, chemist and engineer of tests of the Buffalo, Rochester & Pittsburgh, at Du Bois, Pa., has been appointed engineer of tests of the Northern Pacific, with headquarters at St. Paul, Minn.

C. C. CORKRAN has been appointed chief clerk of the motive power department of the Chesapeake & Ohio at Richmond, Va.

S. J. DILLON, master mechanic of the Trenton Terminal division of the Pennsylvania Railroad at Camden, N. J., has been appointed master mechanic of the West Jersey & Seashore and the Camden Terminal division, with headquarters at Camden, N. J., succeeding F. G. Grimshaw, promoted.

F. A. FAIRLIE has been appointed locomotive superintendent of the Nitrate Railway, Ltd., with office at Iquique, Chile.

J. A. FARLEY has been appointed accountant of the motive power department of the Chesapeake & Ohio, at Richmond, Va.

J. R. SEXTON, who has been appointed mechanical superintendent of the Northern district of the Western lines of the Atchison, Topeka & Santa Fe, with office at La Junta, Colo., as announced in our August issue, was born in New England on April 5, 1863, and was graduated from the public schools of Plattsmouth, Neb., in 1879. He began railway work in April of the same year as machinist apprentice for the Chicago, Burlington & Quincy. After completing his apprenticeship he was a machinist in various shops for three years from 1883, and from November, 1886, to January, 1890, he was erecting and roundhouse foreman of the Burlington at Plattsmouth. He was then promoted to general foreman at Alliance, Neb., and went to the Great Northern as district foreman at Devils Lake, N. D., in April, 1901. He was with the Union Pacific at Cheyenne, Wyo., from November, 1902, to June, 1904, first as roundhouse foreman and then as general foreman. On June 24, 1904, Mr. Sexton went with the Atchison, Topeka & Santa Fe, with which road he has been consecutively general foreman at Cleburne, Tex., until November 15, 1910, and master mechanic of the Missouri division at Shop-ton, Iowa, from the latter date until June 1, 1912, when he was promoted as noted above.



J. R. Sexton.

Frank Zeleny, whose appointment as engineer of tests of the Chicago, Burlington & Quincy, with headquarters at Aurora, Ill., was announced in our August issue, was born December 5, 1876, at Hutchinson, Minn. He attended the University of Minnesota from 1894 to 1898, graduating with the degree of mechanical engineer. In September, 1898, he began railway work with the Chicago, Burlington & Quincy, where he was a special apprentice until January 17, 1902. On the latter date he was appointed assistant to the superintendent of shops at Aurora, which position he held until July 3, 1912, the date of his appointment as engineer of tests of the same company with headquarters at Aurora. At the direction of a committee appointed by the Master Mechanics' Association in June, 1899, to ascertain to what extent the recommendations of the association were put in practice, Mr. Zeleny prepared an alphabetical and a classified index of the subjects of all re-



Frank Zeleny.

ports, papers and discussions from the formation of the association in 1868 to that time.

GEORGE B. FOOTE, chief timekeeper for shop accounting of the Lake Shore & Michigan Southern, at Collinwood, Ohio, has been appointed chief clerk to the master mechanic at Cleveland, Ohio.

ROBERT ROBERTSON, who has been for some time in the mechanical department of the Guayaquil & Quito, at La Tacunga, Ecuador, has been appointed superintendent of motive power and floating equipment, with headquarters at Huigra, succeeding C. O. Bertsch, resigned.

J. G. SMITH has been appointed assistant locomotive superintendent of the Nitrate Railways, Ltd., with office at Iquique, Chile.

ARTHUR SQUIRES has been appointed chief mechanical engineer of the Chilean State Railways, with office at Santiago, Chile.

J. H. TURNER, chief clerk to the master mechanic of the Lake Shore & Michigan Southern at Cleveland, Ohio, has been appointed chief clerk to the division superintendent, with headquarters at Cleveland, Ohio.

S. J. WAGAR has been appointed chemist and engineer of tests of the Buffalo, Rochester & Pittsburgh, vice H. G. Burnham, resigned to accept service in a similar position on the Northern Pacific.

MASTER OF MECHANICS AND ROAD FOREMEN ENGINES

JOHN W. BRANTON, general foreman of the Illinois Central at Mounds, Ill., has been appointed master mechanic of the Centralia district, with office at Centralia, Ill., succeeding R. H. Horn, assigned to other duties.

F. L. CARSON has been appointed master mechanic of the San Antonio & Aransas Pass, with office at Yoakum, Tex., succeeding T. F. Sullivan, resigned.

J. A. CLOUGH has been appointed master mechanic of the Southwestern Railway, with headquarters at Archer City, Texas.

C. C. ELMFS has been appointed master mechanic of the Texas & New Orleans, with office at Houston, Tex., succeeding F. Galvin.

J. O. ENOCKSON, formerly roundhouse foreman of the Chicago, St. Paul, Minneapolis & Omaha, at Altoona, Wis., has been appointed master mechanic, with headquarters at Sioux City, Iowa.

W. S. GADEN, general foreman of the Southern Railway at Memphis, Tenn., has been appointed master mechanic of the Memphis Union Station Company, Memphis, Tenn.

J. HAYWARD has been appointed locomotive foreman of the Canadian Pacific at North Bend, B. C., vice C. H. Tedlock, resigned.

R. A. JONES has been appointed district master mechanic of the Canadian Pacific at Saskatoon, Sask., vice J. D. Watson, resigned.

W. A. KLINE, locomotive engineer of the Central of Georgia, has been made road foreman of engines of the Columbus division, with headquarters at Columbus, Ga.

C. A. LITTLE has been appointed locomotive foreman of the Canadian Pacific at Red Deer, Alta., vice D. G. McDonald, assigned to other duties.

W. H. MORTON has been appointed locomotive foreman of the Canadian Pacific at Rosebery, B. C., vice H. Ingram, resigned.

CAL SPAULDING, road foreman of engines of the East Iowa division of the Chicago & North Western, has been trans-

ferred to the West Iowa division, with headquarters at Boone, Iowa.

PERRY STARKS, road foreman of engines of the West Iowa division of the Chicago & North Western, has been transferred to the East Iowa division, with headquarters at Boone, Iowa.

ROBERT WALLACE has been appointed general road foreman of engines of the Cincinnati, Hamilton & Dayton, with office at Cincinnati, Ohio.

J. H. WOOD has been appointed road foreman of equipment on the St. Louis division and Kansas City Terminal division of the Rock Island Lines, vice G. G. Hoffman, resigned.

CAR DEPARTMENT

MONT AMOS, bonus inspector of the Atchison, Topeka & Santa Fe at Gallup, N. Mex., has been appointed assistant car foreman.

J. G. ARMSTRONG, rip track foreman of the Southern Railway at Birmingham, Ala., has been appointed chief car foreman, with headquarters at Memphis, Tenn.

JOHN BEIBER, assistant rip track foreman of the Atchison, Topeka & Santa Fe, at Richmond, Cal., has been promoted to coach foreman.

C. J. BURGOYNE has been appointed general foreman of passenger car inspectors for the Philadelphia Terminal division of the Pennsylvania Railroad, vice G. E. Strattan, promoted.

E. G. CHENOWETH, mechanical engineer of the Erie Railroad at Meadville, Pa., has been appointed assistant superintendent of the car department of the Chicago Terminal division of the Rock Island Lines, with office at the 124th street shops, Blue Island, Ill.

T. H. GOODNOW, general superintendent of the Armour Car Lines at Chicago, has been appointed assistant superintendent of the car department of the Chicago & North Western, with office at Chicago, succeeding C. H. Osborn, resigned to engage in other business.

WILLIAM H. HANSON has been appointed car foreman of the Chicago & North Western, with headquarters at Council Bluffs, Iowa.

J. A. LINN, assistant car foreman of the Southern Railway at Spencer, N. C., has been appointed car foreman of the El Paso & Southwestern, with headquarters at Douglas, Ariz.

J. L. MCCARTHY has been appointed assistant rip track foreman of the Atchison, Topeka & Santa Fe, at Richmond, Cal., vice John Beiber, promoted.

WILLIAM QUEENAN, formerly general foreman of the car department, has been appointed assistant superintendent of shops in charge of the car department of the Chicago, Burlington & Quincy, at Aurora, Ill.

FRED E. SUMMERS, bonus inspector on the repair track of the Atchison, Topeka & Santa Fe at Clovis, N. Mex., has been appointed car foreman, with headquarters at Vaughn, N. Mex., vice W. F. Tudor, deceased.

SHOP AND ENGINE HOUSE

JOHN D. BARTHELL has been appointed general foreman of the Illinois Central at Mounds, Ill., vice J. W. Branton, promoted.

J. BATHIE, boilermaker foreman of the Canadian Pacific at Cranbrook, B. C., has resigned.

JOE BIESER, boilermaker of the St. Louis Southwestern of Texas, has been appointed boiler shop foreman at Tyler, Tex., vice C. C. Shepherd, resigned.

J. L. BRALEY has been appointed erecting foreman of the Cedar Rapids, Ia., shops of the Rock Island Lines, vice W. T. Abbington, promoted.

F. L. COLES has been appointed foreman of the locomotive department of the Rock Island Lines at Herington, Kans., vice H. F. Klinklaus, resigned.

PATRICK I. COSTILLO has been appointed night round house foreman of the Atchison, Topeka & Santa Fe, with headquarters at La Junta, Colo.

B. L. DAVIES, formerly assistant foreman of the Chesapeake & Ohio, at Russell, Ky., has been appointed general foreman, with headquarters at Hammond, Ind.

WILLIAM LINN DAVIS, night roundhouse foreman of the Atchison, Topeka & Santa Fe, at Eighteenth street, Chicago, has been made roundhouse foreman at Chanute, Kans.

HENRY DURTSCHKE, roundhouse foreman of the Erie, at Marion, Ohio, has been appointed general foreman, with headquarters at Kent, Ohio.

J. C. GOULDSBARRY, gang foreman of the Pittsburgh & Lake Erie at McKees Rocks, Pa., was recently appointed foreman at Beaver Falls, Pa.

W. E. GRAY has been appointed boiler shop foreman of the International & Great Northern at Palestine, Tex.

H. L. HAHN, formerly assistant foreman in the boiler department of the Atchison, Topeka & Santa Fe at Albuquerque, N. Mex., and later general boiler inspector of the Oregon Short Line, with headquarters at Salt Lake City, has been appointed foreman of the boiler department at Albuquerque.

L. A. HARDING, general foreman of the Chicago & North Western at Eagle Grove, Ia., has been promoted to night engine house foreman at Boone, Iowa.

F. C. HASBROUCH, formerly assistant roundhouse foreman of the Chicago & Eastern Illinois at Danville, Ill., has been promoted to the position of general foreman, with headquarters at Terre Haute, Ind.

WILLIAM H. HAWKER, locomotive engineer on the Chicago, St. Paul, Minneapolis & Omaha, has been appointed roundhouse foreman, with headquarters at Altoona, Wis.

WILLIAM H. JAMES, machinist on the Chicago & North Western, has been appointed roundhouse foreman at Council Bluffs, Iowa.

MARK JEFFERSON, gang foreman at the Sayre, Pa., shop of the Lehigh Valley, has been appointed general foreman of the shops at Buffalo, N. Y.

J. M. KILPOYLE, roundhouse foreman of the St. Louis Southwestern of Texas, has been appointed general foreman at Tyler, Tex.

W. C. LELAND, roundhouse foreman of the Southern Railway at Greenville, S. C., has been appointed roundhouse foreman of the El Paso & Southwestern at Douglas, Ariz.

GEORGE F. LINCK, machinist of the Atchison, Topeka & Santa Fe, has been appointed machine foreman at La Junta, Colo.

W. H. McAMIS, roundhouse foreman of the Central of Georgia, has been appointed general foreman at Columbus, Ga.

W. H. McDONALD, machinist on the Atchison, Topeka & Santa Fe at Clovis, N. Mex., has been appointed general foreman of the Florida East Coast at St. Augustine, Fla.

T. E. MERRITT has been appointed general foreman of the El Paso & Southwestern at Douglas, Ariz.

E. O. MILLER, foreman boilermaker of the Southern Railway at Sheffield, Ala., has been appointed general foreman, with headquarters at Memphis, Tenn.

H. E. MORROW has resigned as foreman on the International & Great Northern at Palestine, Tex., to engage in other business.

J. MULLEN has been appointed assistant engine house foreman of the Canadian Pacific at Cranbrook, B. C.

H. O. PALMER has been appointed foreman of the El Paso & Southwestern at Hachita, New Mexico.

A. A. POTIET, boilermaker of the Texarkana & Ft. Smith, has been appointed foreman, with headquarters at Port Arthur, Tex.

JAMES POWERS, machinist of the Lehigh Valley, has been appointed gang foreman in the Sayre, Pa., shop.

C. L. RITSMAN has been appointed machine shop foreman of the Wheeling & Lake Erie, with headquarters at East Toledo, Ohio.

CHARLES R. SHELLINGER, engineer of the Chicago & North Western has been appointed night roundhouse foreman, with headquarters at Council Bluffs, Iowa.

WEVER D. SMITH, who recently completed his apprenticeship, has been appointed machine foreman of the Atchison, Topeka & Santa Fe at Argentine, Kan.

EARNEST V. SMITH, boilermaker of the Seaboard Air Line, has been appointed foreman boilermaker at Jacksonville, Fla.

W. J. SPAULDING has been appointed foreman of the El Paso & Southwestern at Bisbee, Ariz.

L. A. STOLL, formerly general foreman of the locomotive department, has been appointed assistant superintendent of shops in charge of the locomotive department of the Chicago, Burlington & Quincy, Aurora, Ill.

BEN FRANKLIN TUNE, machinist of the Nashville, Chattanooga & St. Louis, has been appointed gang boss at Nashville, Tenn., to succeed A. H. Corbett, resigned to go into business.

J. S. TYLER, shop foreman on the Chicago & North Western at Casper, Wyo., has resigned to go into business.

A. WATT, locomotive foreman of the Grand Trunk Pacific, has been appointed general foreman at Prince Rupert, B. C.

PURCHASING AND STOREKEEPING

G. W. ALEXANDER, storekeeper of the Central of Georgia at Cedartown, Ga., has been transferred to Savannah, Ga.

M. J. POWER has been appointed general storekeeper of the Canadian Pacific lines east of Fort William, Ont., with office at Montreal, Que., succeeding J. H. Callaghan, deceased.

B. H. ROTUREAU, storekeeper of the Central of Georgia, at Savannah, Ga., has been transferred to Macon, Ga.

ELLIOTT S. WORTHAM, assistant to the vice-president and purchasing agent of the Chicago & Alton at Chicago, has been appointed manager of purchases and supplies, with office at Chicago, and the office of purchasing agent has been abolished.

OBITUARY

WILLIAM A. DERBY, acting engineer of tests of the Chicago, Burlington & Quincy, with office at Aurora, Ill., died at the city hospital at Aurora on June 30. Mr. Derby was born October 22, 1872, at Burlington Iowa. He attended the grammar school, high school and Elliott's Business College at Burlington, attended Iowa College at Grinnell, Iowa, for three years, and spent four years at the Armour Institute of Technology at Chicago. He entered the service of the Burlington in July, 1898, in the laboratory at Aurora. In 1903 he was made assistant engineer of tests, and on February 4, 1910, was promoted to acting engineer of tests.

NEW SHOPS

ARIZONA EASTERN.—Bids will soon be called for on a 20-stall engine house and repair shops at Phoenix, Ariz.

ATCHISON, TOPEKA & SANTA FE.—A contract has been awarded for the building of an engine house at Marceline, Mo.

BALTIMORE & OHIO.—The final plans for the improvements at Garrett, Ind., include a new engine house of 18 stalls, which is to be 100 ft. in depth, and an oil house 34 ft. x 50 ft. Both buildings will be constructed of brick with composition roofs. The company has also let a contract for a cinder pit 150 ft. long, wide enough to admit engines on two parallel tracks. In addition there will be a gravity coaling station having a storage capacity of 8,000 tons, from which engines can take coal on two tracks. A sand house will be constructed having a capacity of 500 tons, and there will also be two concrete inspection pits 300 ft. long. The improvements, including track changes, will cost in the neighborhood of \$200,000.

BINGHAM & GARFIELD.—A five-stall engine house, car repair shop and coaling station are being built at Magna, Utah.

CANADIAN PACIFIC.—Plans are being prepared for a 10-stall engine house at Grand Forks, B. C.

CHICAGO & ALTON.—Plans are being made to erect new shops at Bloomington, Ill., at an estimated cost of \$35,000.

CHICAGO, MILWAUKEE & ST. PAUL.—The construction of a 26-stall engine house has been begun at Perry, Iowa.

CLEVELAND, CINCINNATI, CHICAGO & ST. LOUIS.—A new engine house will be built at Cairo, Ill., at a cost of \$20,000. A contract has also been placed for a new machine shop at Springfield, Ohio.

GRAND TRUNK.—A 25-stall engine house, with provision for an addition of 10 extra stalls, and repair shops will be built at Prescott, Ont. The total cost of the improvements will be about \$150,000.

MICHIGAN CENTRAL.—A contract has been placed with George B. Swift & Company, Chicago, for a new engine house at Bay City, Mich., to cost \$200,000. The construction of the car shops is also about ready to be started.

NEW YORK, NEW HAVEN & HARTFORD.—A contract has been awarded for the construction of a new brick locomotive shop at Readville, Mass.

SOUTHERN PACIFIC.—This road is preparing to begin work on an enlargement of its shops at Houston, Tex., to cost approximately \$400,000. The new buildings will include a boiler and blacksmith shop, 120 ft. x 310 ft.; a lumber shed, 70 ft. x 240 ft.; machine and erecting shop, 130 ft. x 310 ft.; a new power house, an oil house and a sand house.

WABASH.—The receivers of this road have been authorized to issue certificates to the amount of \$500,000 for new locomotive shops at Decatur, Ill., which will eventually cost \$750,000. These will be the main shops of the system. A new engine terminal will also be built at Delray, Mich.

LOCOMOTIVES AND CARS IN THE UNITED STATES.—The Interstate Commerce Commission has issued statistics for the fiscal year ended June 30, 1911, which show that 61,327 locomotives were in service at that time, an increase of 2,380 over the previous year. Of the total number 14,301 were classified as passenger; 36,405 as freight; 9,324 as switching, and 1,297 were unclassified. The total number of cars of all classes was 2,359,335, or 69,004 more than the previous year. This equipment was divided as follows: 49,818 passenger cars; 2,195,511 freight cars, and 114,006 special company cars.

SUPPLY TRADE NOTES

The Holeomb Steel Company, Syracuse, N. Y., has opened a sales office at 95 Liberty street, New York.

The Moore Patent Car Company, St. Paul, Minn., has moved its main office to the Germania Life building.

The New Castle Steel & Iron Company, New Castle, Del., has been incorporated and will manufacture cars.

Heine Safety Boiler Company, St. Louis, Mo., has moved their Boston office to 10 Post Office Square.

The Grip Nut Company, Chicago, is enlarging its plant at South Whitely, Ind., and is installing ten new 6-spindle nut tapping machines.

The Westinghouse Air Brake Company has removed its Chicago office from room 1545 Railway Exchange building to room 827 in the same building.

The Ralston Steel Car Company, Columbus, Ohio, has almost completed the rebuilding of its plant. The improvements will increase the capacity to 40 cars a day.

The Chicago office of the Jeffrey Manufacturing Company, Cleveland, Ohio, has been moved to the McCormick building. S. S. Shine is the district manager, and will have charge of the Chicago office.

The Hess-Bright Manufacturing Company announces the removal of its office from the corner of Twenty-first street and Fairmount avenue, Philadelphia, Pa., to the corner of Front street and Erie avenue.

Darwin R. James, Jr., has been made president of the Pyrene Manufacturing Company, New York, succeeding P. L. Wilbur, resigned. Edward A. Clapp has been made secretary of the company, succeeding Otto Kelsey, resigned.

The Westinghouse Machine Company, Pittsburgh, Pa., has sent out a circular explaining the use to which the funds, received through the recent sale of the stock of the Electric Properties Company, New York, have been put.

H. F. Wardell has resigned as assistant manager of the Central Locomotive & Car Works, Chicago, to engage in the railway equipment business on his own account, and has opened an office at 302 Railway Exchange building, Chicago.

E. L. Burdick, assistant engineer of tests of the Atchison, Topeka & Santa Fe, with headquarters in Topeka, Kan., has been appointed mechanical engineer of the Westinghouse Electric & Manufacturing Company, East Pittsburgh, Pa., with office in that city.

Frank J. Muleahy, vice-president and general manager of the Crane Valve Company, Bridgeport, Conn., died on August 19 of complications following an operation for appendicitis on August 10. Mr. Muleahy was born in Cleveland, Ohio, in 1853.

B. N. Osburn has resigned his position as president of the Boss Nut Company, Chicago, to become president and treasurer of the Auto Refrigeration Company of the same city. J. T. Benedict, vice-president of the Boss Nut Company, has been made president, succeeding Mr. Osburn.

F. L. Irwin, chief engineer of the Ralston Steel Car Company, Columbus, Ohio, with office in that city, was killed on August 13 by a train while he was returning in an automobile from the company's plant. Mr. Irwin was 37 years old and had been with the Ralston company since its organization.

The Newcastle Steel & Iron Company, Newcastle, Pa., has been incorporated in Pennsylvania, to make steel cars. A plant is to be built at Newcastle. The incorporators are Edwin N. Ohl,

Andrew B. Berger, W. H. Schroder and E. H. Brainard, all of Pittsburgh, Pa. Edwin Ohl may take an active part in the management of the company.

K. F. Nystrom has been appointed mechanical engineer of the Acme Supply Company, Chicago, with office in that city. Mr. Nystrom was formerly connected with the Southern Pacific as designing engineer for its electric motor cars, and later was assistant mechanical engineer at the St. Charles, Ill., plant of the American Car & Foundry Company.

The Titanium Alloy Manufacturing Company, Pittsburgh, Pa., during 1911, shipped 3836818 lbs. of titanium alloy. This is used in amounts up to 0.6 per cent. in the treatment of steel. Taking 0.4 per cent. as the average percentage of titanium alloy used in the treatment of steel, the amount shipped during 1911 would be sufficient to treat 428,216 gross tons of steel.

On August 1 Robert W. Hunt & Company, Chicago, assumed the inspection of locomotives and passenger equipment for the Illinois Central. In addition to the superintendence of construction at the various locomotive and car plants, the service will include the inspection, at point of manufacture, of various specialties entering into the construction of locomotives.

The Griffin Car Wheel Company, Chicago, will enlarge its plant at Boston, Mass., by building an addition to the foundry, a new machine shop and auxiliary buildings. It is estimated that these additions will increase the present capacity by more than 200 wheels a day. The company will also enlarge its plant at St. Paul, Minn., increasing its capacity by more than 150 wheels a day.

Frederick B. Buss, until recently representative of the National Lock Washer Company, Newark, N. J., with office in Chicago, died in Chicago on August 13. Mr. Buss had been engaged in the railway supply business in Chicago from 1871 until a few months ago, when failing health forced him to relinquish active work, though he retained his connection with the company in an advisory capacity.

J. M. Odenheimer, for the past four years manager of the New York office of the Pennsylvania Flexible Metallic Tubing Company, Philadelphia, Pa., has been appointed sales manager for the B. E. Tilden Company, of Chicago, makers of the Tilden wrecking frogs. Mr. Odenheimer will continue to handle the railway business of the Pennsylvania Flexible Metallic Tubing Company. His headquarters are in the Whitehall Bldg., 17 Battery Place, New York City.

The General Electric Company, Schenectady, N. Y., has declared a 30 per cent. stock dividend in addition to the regular quarterly dividend of 2 per cent. A special meeting of the stockholders was held August 29 to vote on the question of increasing the capital stock from \$80,000,000 to \$105,000,000. After this increase, a dividend of \$30 per share, payable in stock of the company at par, will be paid out of the surplus earnings to stockholders of record, December 31, 1912.

The Vulcan Engineering Sales Company, Chicago, has taken the selling agency for the line of structural and plate working machinery, punches, shears, rolls, bulldozers, etc., made by the Rock River Machine Company, Janesville, Wis. This is in addition to the lines now controlled by the Vulcan company, which include molding machines and foundry equipment made by the Hanna Molding Machine Company, and metal sawing machinery and shop equipment made by the Q. M. S. Company.

The Case Crane & Engineering Company, Columbus, Ohio, has been formed, and has taken over the plant and business of the Case Crane Company. The new company will be under entirely different management than the old, and will have the personal supervision of Paul T. Norton, of the Jeffrey Manufacturing Company, who has been appointed president and general man-

ager. Among the directors and stockholders are: S. P. Bush, president of the Buckeye Steel Castings Company; J. F. Stone, president of the Seagrave Company; J. A. Jeffrey, president of the Jeffrey Manufacturing Company; Col. James Kilbourne, president of the Kilbourne & Jacobs Manufacturing Company; O. A. Miller, president of the Ohio Paper Company; and J. H. Frantz, vice-president of the Columbus Iron & Steel Company.

Charles C. Higgins has opened a Chicago office in the Railway Exchange building for Suffern & Son of New York. It is planned to handle work along production engineering lines,



Charles C. Higgins.

especially for the rail-ways. Mr. Higgins was born in Aurora, Ill., in 1876. He attended the public schools and high schools in Aurora, and in 1890 was graduated as a mechanical engineer from the University of Minnesota. He served as a special apprentice on the Chicago, Burlington & Quincy, after which he was assistant to the engineer of tests, traveling fireman, roundhouse foreman, and general foreman at different points in Nebraska. In 1907 he went with the American Brake Shoe & Foundry Company as a traveling salesman, and in 1910 he entered the service of the motive power department on the Atchison, Topeka & Santa Fe, and was associated with H. W. Jacobs, assistant superintendent of motive power, from which position he resigned July 1 to enter the service of Suffern & Son.

C. H. Osborn has resigned as assistant superintendent of the car department of the Chicago & North Western to become vice-president of the Mid-Western Car Supply Company, Chicago. Mr. Osborn was born at Westfield, Mass., March 31, 1875, and was graduated from the Sheffield Scientific School, Yale University, in the class of 1895. He entered the employ of the Chicago & North Western in the same year, and after serving as a special apprentice in the mechanical department filled successively the positions of engine house foreman, division foreman, master mechanic, and for the past four years, assistant superintendent of the car department. In going with the Mid-Western Car Supply Company



C. H. Osborn.

Mr. Osborn will have charge of the mechanical department and will devote special attention to the development and sale of the one-piece combination body and truck bolster, which was exhibited at the M. C. B. and M. M. conventions at Atlantic City in June.

The B. F. Goodrich Company, Akron, Ohio, has purchased the properties and business of the Diamond Rubber Company, New York, and hereafter the two organizations will be operated as one. The officials of the enlarged company will be as follows: B. G. Work will continue as president; H. E. Raymond will continue as second vice-president and sales manager; C. H. Raymond will continue as secretary; W. A. Means will continue as treasurer; F. A. Hardy, formerly president of the Diamond company, has been made chairman of the board of directors; F. H. Mason, formerly vice-president of the Goodrich company, has been made vice-chairman of the board of directors; A. H. Marks, formerly vice-president and general manager of the Diamond company, has been made first vice-president and general manager; E. C. Shaw, formerly manager of works of the Goodrich company, has been made second vice-president and works manager; W. B. Miller, formerly secretary of the Diamond company, has been made second vice-president and assistant sales manager; G. E. Norwood, formerly assistant treasurer of the Diamond company, has been made assistant treasurer. The Diamond Rubber Company will now operate as the Diamond Sales Division of the B. F. Goodrich Company.

Henry W. Jacobs, who recently resigned as assistant superintendent of motive power of the Santa Fe, has been made president of the Oxweld Railroad Service Company, Chicago.



Henry W. Jacobs.

This company was organized to introduce the use of oxy-acetylene welding on railways. G. H. Pearsall and C. B. Moore, who were recently made vice-presidents of the Jacobs-Shupert U. S. Firebox Company, New York, as noted in the August issue of the *American Engineer*, have also been made vice-president and vice-president and treasurer, respectively, of the Oxweld company. Mr. Jacobs was born in Atchison, Kan., September 28, 1874. At the age of 13 he began his apprenticeship as machinist molder and

structural iron worker in the Seaton Foundry & Machine Company, Atchison. After serving five years with that company, he went to the United States gun shop, Washington, D. C., as machinist. He familiarized himself with the design, construction and performance of marine engines, as for several years he was engaged in testing marine machinery on vessels. He then went to the Sprague Electric Company, New York, and later to the Crocker-Wheeler Company, Ampere, N. J. He was also in the employ of R. Hoe & Company, makers of printing presses and newspaper machinery, as tool designer. In 1899 he was made superintendent of the Vulcan Engineering Company, New York, engaged in general repair work and building stationary and marine machinery. Afterwards he entered railway service as tool foreman of the Chicago, Burlington & Quincy. He held this position at various shops of that road until 1903, when he was made shop demonstrator of the Omaha, Neb., shops of the Union Pacific. Later he was given supervision of shop practices and methods in all the repair shops of that company. In 1904 he was made engineer of shop methods for the Atchison, Topeka & Santa Fe, and in December, 1906, assistant superintendent of motive power, with jurisdiction over the entire system, which position he held until July 1, 1912.

CATALOGS

BLOWERS.—McEwen Bros., Wellsville, N. Y., have issued bulletin No. 2, describing steam blowers. Results of tests are included, as well as price lists and tables of dimensions.

PUMPING BY COMPRESSED AIR.—The Ingersoll-Rand Company, New York, has issued a catalog describing and illustrating the methods of lifting or pumping water by compressed air. Various installations are shown, together with data as to their efficiency and cost of operation.

WHEEL PRESSES.—The Watson-Stillman Company, New York, has issued catalog No. 85, illustrating and describing their hydro-pneumatic wheel presses. These presses are built for belt or motor drive. The catalog also contains a specification table for 60 to 600-ton presses.

ENGINES, FORGING PRESSES AND HEAVY MACHINERY.—The Mesta Machine Company, Pittsburgh, Pa., has issued a 48-page illustrated booklet showing various views of their shops, and of their products, including steam and gas engines, air compressors, forging and bending machines, heavy gears and pulleys.

STORAGE BATTERY TRUCKS.—Home-made tractors using a storage battery and electric motors are being used with great advantage in several railway shops. Trucks of this kind can now also be purchased and a bulletin, No. 13-B, issued by the Jeffrey Manufacturing Company, Columbus, Ohio, illustrates several types furnished by it.

REAMERS.—The Kelly Reamer Company, Cleveland, Ohio, has issued a catalog on adjustable reamers with high speed steel blades. The catalog is well indexed and contains a description of the various types of reamers manufactured by this company and instructions as to how to use them. Price lists are given with each type of reamer described.

STEAM TURBINES.—A folder has been issued by the Kerr Turbine Company, Wellsville, N. Y., describing the Economy steam turbine. This turbine is an improvement over the old style Kerr design, the difference in the two being that the new turbine has a blade and vane construction, which produces a flow of steam parallel to the turbine shaft.

BOLT AND NUT MACHINERY.—One of the most interesting exhibits at the last convention of the Master Mechanics' and Master Car Builders' Associations, was the demonstration of semi-automatic designs of bolt and nut machinery furnished by the National Machinery Company, Tiffin, Ohio. The machines, demonstrated at that time, are illustrated and briefly described in a leaflet just issued by that company.

PRACTICING EFFICIENCY AND KNOWING COSTS.—The Emerson Company, New York, is sending out a brochure under this title which contains a reprint of a letter sent to a New England manufacturer by Harrington Emerson, the president of the company. The argument, presented in an interesting and striking manner, is that system and efficiency are very different things, and that efficiency is by far the more important of the two. In the words of Mr. Emerson, "efficiency is the relation between what is and what ought to be. To determine what actual costs are is a clerical task, but this helps very little if we do not know what the costs ought to be."

ELECTRICAL OPERATION OF RAILWAY SHOPS.—The General Electric Company, Schenectady, N. Y., has issued bulletin No. 4959, which is profusely illustrated, showing various electrical installations. The particular points discussed are the independent drive as against the group drive and the alternating current as against the direct current, the conclusion arrived at being that the individual system of drive has in several cases replaced the group system and alternating current is used in preference to the direct current. Illustrations are given of installations in the

Readville repair shops of the New Haven, the Chicago shops of the Rock Island lines, the Huntington shops of the Chesapeake & Ohio, and the Albany shops of the New York Central.

HERRINGBONE GEARS.—With the continued increase in the power and speed of many classes of machinery, the subject of proper gears is continually becoming of greater importance. While within their limitations, there is probably no better arrangement for transferring power than the spur gear, there are serious objections to them in some cases and increased interest and attention is being given to the herringbone gear. These offer advantages in connection with the smoothness of action, noiseless operation, freedom from end play and better results at high speed than any other means of connecting parallel shafts. A complete discussion of the subject with illustrations of the various applications and arrangements of gears of this character will be found in a catalog recently issued by the Earle Gear & Machine Company, Wyoming & Stenton Aves., Philadelphia, Pa.

REFRIGERATOR CARS.—A refrigerating, heating and ventilating system for cars designed to handle perishable products is briefly described and well illustrated in a catalog being issued by the Moore Patent Car Company, St. Paul, Minn. With this system the ice box is located just under the roof at the centre of the car and ducts are provided under the floor and around the sides for stimulating the circulation. For heating, a heater is installed under the floor of the car, and the passages are so arranged that the incoming fresh air is heated and discharged near the top of the car. From here the arrangement of intakes and ducts insure a thorough circulation. A large part of the catalog is given up to letters received from various users of this system of refrigeration and these, combined with the tests, a large number of which are recorded, indicate the success of the Moore system under very difficult conditions.

COLD METAL SAWS.—It is believed that the first metal cold saw cutting off machine made in this country was designed and built by the Newton Machine Tool Works of Philadelphia in 1889. The wonderful progress that has been made in these machines since that date is strikingly indicated by an examination of the ninety-nine pages in catalog No. 47 now being issued by that company. As is pointed out in the catalog, a metal sawing machine is really a milling machine and all the usual practices in the operation of the latter should be observed in the operation of cold saws. This company has kept this fact clearly in mind in the designing of all types of its saws. The catalog illustrates and fully describes special saws for practically every possible purpose, as well as saws for universal use. For all heavy duty saws, the inserted tooth type is adopted, but other classes of blades are also shown. This is probably the most complete collection of illustrations of machines of this character that has ever been issued.

MACHINE TOOL ACCURACY BULLETIN.—Users of machine tools, both large and small, would find it worth while to carefully investigate the methods of manufacture of the builders from whom they contemplate making purchases. A high quality of product is about the cheapest thing that can be purchased in labor saving machines and the user will do well to become acquainted with the quality of the tool even before he makes any investigation as to price. In order to bring before possible purchasers the attention that is being paid to this feature in its shops, the American Tool Works Company, Cincinnati, Ohio, is issuing a bulletin in which are described the methods followed by it in testing the various kinds of machines during the process of manufacture. Illustrations are included which make extensive explanation unnecessary, and although the bulletin contains but 30 pages, it covers a large number of important features on lathes, planers, shapers and drill presses. A perusal of this bulletin will bring to light some features that will be surprising to those who have not made themselves acquainted with the care with which a modern quality machine is built.

AMERICAN ENGINEER

"THE RAILWAY MECHANICAL MONTHLY"

(Including the Railway Age Gazette "Shop Edition.")

PUBLISHED ON THE FIRST THURSDAY OF EVERY MONTH, BY THE
SIMMONS-BOARDMAN PUBLISHING COMPANY,
83 FULTON STREET, NEW YORK, N. Y.

CHICAGO: Transportation Bldg. CLEVELAND: Citizen's Bldg.
LONDON: Queen Anne's Chambers, Westminster.

EDWARD A. SIMMONS, *President.* HENRY LEE, *Secretary.*
L. B. SHERMAN, *Vice-President.* A. E. HOOVEN, *Business Manager.*

The address of the company is the address of the officers.

ROY V. WRIGHT, *Editor.* R. E. THAYER, *Associate Editor.*
E. A. AVERILL, *Managing Editor.* WILLIAM FORSYTH, *Associate Editor.*
GEORGE L. FOWLER, *Associate Editor.*

Subscriptions, including the eight daily editions of the *Railway Age Gazette* published in June in connection with the annual conventions of the Master Car Builders' and American Railway Master Mechanics' associations, payable in advance and postage free:

United States, Canada and Mexico.....\$2.00 a year
Foreign Countries (excepting daily editions)..... 3.00 a year
Single Copy 20 cents

Entered at the Post Office at New York, N. Y., as mail matter of the second class.

VOLUME 86.

OCTOBER, 1912.

NUMBER 10.

CONTENTS

EDITORIALS:

| | |
|---------------------------------------|-----|
| Paint Testing Bureaus | 499 |
| Service Tests of Locomotives..... | 499 |
| The Prize Winner | 499 |
| Steel Box Cars | 499 |
| Wood Working Tools for Car Shops..... | 500 |
| Master Painters' Association | 500 |
| Locomotives on the Santa Fe..... | 500 |
| Air Brake Hose | 501 |
| Locomotive Boiler Tests | 501 |
| New Books | 501 |

MISCELLANEOUS:

| | |
|---|-----|
| An Analysis of Wood Working Machines..... | 509 |
| Shop Scheduling and Routing System..... | 539 |

ILLUSTRATED:

| | |
|--|-----|
| New Box, Stock and Refrigerator Cars..... | 502 |
| Vacuum Relief Valve | 508 |
| Tender Derailments | 513 |
| Dust Remover for Hair Picking Machine..... | 514 |
| New Motive Power on the Santa Fe..... | 515 |
| Maintenance of Locomotive Boilers..... | 519 |
| Pneumatic Clamp for Testing Triple Valves..... | 522 |
| Piston, Piston Rod and Cross Head Repairs..... | 523 |
| Triplex Compound Locomotive | 528 |
| Comparative Service Tests of Locomotives..... | 529 |
| Railway Master Painters' Association..... | 531 |
| Caillé Feed Water Heater..... | 538 |
| High Speed Metal Cutting Machine..... | 540 |
| Beaudry Peerless Hammer..... | 541 |
| New Car Wheel Boring Tool..... | 541 |
| Yoke Riveter | 542 |
| Comparative Tests of Freight Locomotives..... | 543 |
| Exhaust Ventilator | 544 |
| Rolls for Reclaiming Scrap Iron..... | 544 |

GENERAL NEWS SECTION:

| | |
|--------------------------------|-----|
| Notes | 546 |
| Meetings and Conventions | 547 |
| Personals | 549 |
| New Shops | 551 |
| Supply Trade Notes | 552 |
| Catalogs | 554 |

Paint Testing Bureaus

In the report of the test committee of the Master Painters' Association, O. P. Wilkins, chairman of the committee, suggested the idea of establishing paint testing bureaus throughout the country whereby the various samples of paint may be tested under varying climatic conditions, and in this way a comprehensive study can be made of various paints. This has already been started by the committee sending to five members of the association various samples to be exposed and tested under similar conditions. If such a bureau could be permanently established it would be of great value to the association and the railways at large.

Service Tests of Locomotives

In this issue will be found reports of two comparative road tests of locomotives. In one case they were made to determine the economy of the superheater and brick arch, and in the other to determine the economy of one type of freight locomotive as compared with an entirely different type. Tests of this simple character are of decided importance from an operating standpoint, although hardly accurate or complete enough to be of any considerable value to a designer. Since, however, it is the every day service of the locomotive on the road and the amount of fuel and water it requires to do the desired work that counts, such tests, which can be easily made by any company and do not require any elaborate facilities or apparatus, are of great practical value and should be more frequently undertaken.

The Prize Winner

G. H. Roberts, machine foreman of the Long Island Railroad, at Richmond Hill, N. Y., has been awarded the first prize of \$25 in the competition on repairs to pistons, piston rods and crossheads, which closed September 1. Mr. Roberts describes methods installed by him in another large eastern railway shop. His article, together with a contribution from C. L. Dickert, assistant master mechanic, Central of Georgia, Macon, Ga., is given in this issue. In awarding the prize to Mr. Roberts, the judges took into consideration the difference of design of the parts and in the equipment available for repairs. While Mr. Dickert's time for the different operations is lower than Mr. Roberts', it was decided that under the conditions, and in view of the fact that Mr. Robert's description was much more comprehensive, his was the more valuable contribution.

Steel Box Cars

The decision of the Pennsylvania Railroad to use a wooden lining in its latest design of steel freight cars was reached after a most careful study of conditions, the consultation including representatives of the different departments of the road as well as shippers. The design is such, however, that if it seems advisable for certain traffic under certain conditions a steel lining can be used without any material change in the present framing. These cars follow the principle incorporated in the steel passenger cars on that road, in the use of a strong center sill to which the weight of the car body and part of the lading is transferred through the medium of two sets of cantilevers, set somewhat inside of the center plates, and the end sills. The use of pressed steel members for the side posts and braces permits the use of a joint that is equivalent in strength to the rest of the member without extra parts or complication. By using very heavy floor boards, intermediate longitudinal sills were made unnecessary, thus saving considerable weight.

The design of the roof is one of the most interesting features of the car. Thin plates, with butt joints, resting on steel carlines which are spaced without reference to the side posts, form the roof structure. The joint of the sheets comes midway be-

tween the carlines and the top cover plate is ridged to lend stiffness to the structure. The design and arrangement of the eaves are such that there can be no entrance of rain or snow through the narrow ventilation opening between the roof sheet and the side plate. A roof built up in this form can be removed intact with very little difficulty. A steel frame house car of this kind approaches a steel passenger car in rigidity and strength, and there would seem to be no reason why the roof made up of thin steel plates with riveted joints will not be thoroughly satisfactory.

Another interesting feature of the car is found in the steel door, wherein spot welding has been freely used in place of riveting. This door is securely held in place at each of its four corners, no matter what its position may be.

Master Painters' Association

The forty-third annual convention of the Master Car and Locomotive Painters' Association, held in Denver, Colo., September 10-13, cannot justly be said to be one of the best conventions the association has ever held. It seems that the members were not very willing to present the papers requested of them, and that the secretary had considerable difficulty in getting together a sufficient number of papers. If the association is to maintain its previous record and standing the members should not hesitate to do all in their power to make it a success, and this demands co-operation. While it may be hard for many of them to express themselves clearly on paper, they should make a special effort to do so, even if the secretary finds it necessary to edit or rewrite the reports after they are sent in.

The papers should be written in sufficient time to allow the secretary to have them printed and distributed to the members fully two weeks before the association meets. In this way they will have ample opportunity to thoroughly analyze them so that any disputable or questionable points may be brought up during the convention and thoroughly threshed out. Last year advance copies were sent out and the discussions were very good, but this year with no advance copies it was noticeable that the discussions were restricted to one or two points that a listener happened to pick out in each paper as it was read. The fact that the test committee's report, one of the best ever presented to the association, received no discussion, clearly brings out the value of the advance copies, for many questions were asked the committee privately, outside of the convention hall, by members who, if they had had an opportunity to read the paper before the convention, would have brought them up during the sessions to the advantage of all the members present.

The attendance was exceptionally good considering the distance the majority of the members had to travel, but care should be taken not to select such extreme meeting points every year, for it is a big question as to whether the members will travel as far every year. Although their transportation is free in most cases, there is considerable expense attached to the long trips. In deciding the next place of meeting, would it not be advisable to choose a more centrally located city?

Air Brake Hose

The last revised specifications of the M. C. B. Association for air brake hose seemed to insure a satisfactory product up to a comparatively recent time. In the last few years, however, complaints about the quality of air brake hose have been very general and in considerable volume, and it is evident that the present specifications do not insure a hose suitable to meet present conditions. A committee of the M. C. B. Association is now working on new specifications and will report at the next convention. Tests and records in the past have indicated that mechanical injury was the chief cause of hose failure, but at a meeting of the Rubber Conference, recently held in

New York, it appeared that there was another factor in the failure of air hose which is of even greater importance. Careful inspection and tests of over 22,000 pieces of condemned air hose which were taken from the cars of a large number of railways and were collected from a number of different points showed that porosity was responsible for 82 per cent. of the removals, while mechanical injury of any kind was responsible for but slightly over 10 per cent. This information was received with considerable surprise and is a much stronger argument in favor of revising the specifications than are the failures from mechanical injury, which in many cases can be corrected by a revision of the design of the attachments or in the method of handling. The hose examined which showed porosity was tested by the underwater method and an examination of the inside of a large number of pieces showed the porous condition to have no regular location. In some cases it covered the whole hose and in others it was local and at various points. The rubber manufacturers did not seem to be able to offer an explanation or correction for this difficulty, although it appeared that in general it was probably due to the use of shoddy and ingredients which deteriorate after a few months' service.

Although the specifications call for three hand made calenders for the tube, it is probable that in most cases this requirement is not carried out and the tube is made in one piece. If that is the case and a large amount of shoddy, the principle source of which is now worn out automobile tires, is used, it is quite possible that the very small pieces of flint which have worked into the rubber of the tire will appear in the tube and after constant bending, stretching and contraction that the hose undergoes in service, these small particles will cut microscopic holes throughout the whole tube, making it porous. Even if this quality of material was used, but the tube was made in three calenders, this difficulty would probably quite largely disappear. It has therefore been suggested that the center calender be made of a different color so that when a tube is cut it will be readily apparent to the inspector that the three calenders have been used.

Among the other features that have been suggested as being advisable to be included in the new specifications in order to insure a better quality of material are the increasing of the stretching tests of the 2-inch marks from 8 in. as at present to 12 in., and the insertion of a tensile strength requirement. In one case, at least, a strength of 1,400 lbs. per sq. in. has been suggested. The increasing of the stretching test is to insure against over cured material while the tensile strength requirements will insure against under cured rubber.

Locomotives on the Santa Fe

There is probably no railway company in the country that has a larger number of different types and classes of locomotives than the Santa Fe, nor is there any which has a larger variety of conditions for the locomotives to meet. This company has been noted for years for its willingness to experiment with a new design which seemed to offer an opportunity for improvement in either power or efficiency, and it has now, or has had in operation, an example of practically every suggested advance in locomotive design that has been developed during the past ten years. In view of these facts, the locomotives recently delivered, which include four types, are suggestive of what experience, under the conditions on that road, has indicated to be the best arrangement. These locomotives, however, should not be accepted as conclusive on these features, since they are intended for only certain districts and probably would not fulfill the requirements at other points. Nevertheless the application of a high temperature superheater to all except the switching engines shows that the low degree superheater has not been found as economical as was expected, all things being considered. Again the purchase of locomotives of the Santa Fe type fitted with simple cylinders and a superheater instead of the tandem compound cylinders previously used, checks the re-

sults on other roads where compounds have been discarded for superheater simples. It also indicates the conclusion that locomotives of this type are preferable to small Mallets, coinciding with the experience of the Chicago, Burlington & Quincy.

The retention of the balanced compound feature of the Pacific type is particularly interesting, since this company has had a large number of balanced compounds in operation for a number of years, and is practically the only one that has retained the design after a trial. It will be noted that a superheater has been applied. The decision to apply radial stay fireboxes to all of this order of locomotives can be subjected to different interpretations. There are now over two hundred locomotives fitted with sectional fireboxes in operation on this road, and all reports that have been given out have been distinctly favorable. Such troubles as are generally known to have occurred, seem to have been in the matter of design rather than in principle. It, however, appeared wise to the management to await further experience with those of the sectional type now in service before applying more. All things considered this order of locomotives is designed along very sound and conservative lines, and includes nothing of an experimental nature.

Wood Working Tools for Car Shops

On page 509 L. R. Pomeroy presents in a characteristic manner a study of the work performed by each tool in a shop making repairs to 70 wooden passenger cars and 714 freight cars per month. This, so far as we know, is the first time that any information of this kind has been published or even collected. About three years ago, Mr. Pomeroy made a somewhat similar study of the metal working tools to be used in the Scranton shops of the Delaware, Lackawanna & Western. This was published in the *American Engineer and Railroad Journal* in April, 1909, and was based on the performance the tools could fairly be expected to give. The present study, on the other hand, is based on what the tools are actually doing in a well organized shop which has been in operation for a number of years and clearly shows the value of a study of this character preliminary to the selection of the tools, their arrangement or the designing of the buildings.

Locomotive Boiler Tests

Designers of locomotive boilers have always been handicapped by the lack of exact data as to the relative value of firebox and tube heating surface. There have been numerous attempts to evolve an equation to express the relation of the two, based on experience with different arrangements and proportions of existing boilers. One of the best known of these, which was accepted and generally used for several years, was put forth by H. H. Vaughan in a paper before the Western Railway Club. He stated that by dividing the total tube heating surface of the boiler by the square root of the length of the tubes the quotient would be an amount of heating surface, each square foot of which would be equivalent to a square foot in the firebox. In other words, in a boiler with 16 ft. flues the firebox heating surface was four times as valuable as tube heating surface, with 20 ft. flues it would be nearly four and a half times as valuable, and with 25 ft. flues, it would be five times as valuable. This equation seemed to fit the conditions fairly well for some time, but was finally shown to be inaccurate. The indications were that the divisor was not large enough and that actually the firebox was more valuable than was indicated. Since that time boiler designers have generally decided this question for themselves and each uses his own formula.

When it was announced that comparative tests were to be made at Coatesville between two boilers, one a radial stay and the other of the sectional type, and that each was first to be tested with the firebox and barrel of the boiler separated from each other so far as water and steam were concerned, it seemed

that the exact information so long desired would be obtained. These tests have now been completed, and although the complete report has not been issued, a paper prepared by a representative of the company that furnished the facilities for making the tests, presented at the last meeting of the New York Railroad Club, contains some of the results. It appears that with oil fuel the firebox in the boilers did from 40 per cent. to 50 per cent. of the total work; with long flame coal the firebox did from 33 per cent. to 48 per cent., while with short flame coal it did about 8 per cent. less. The tests in this respect are summed up by stating that a square foot of firebox surface is equivalent to 7.6 sq. ft. of tube heating surface. These boilers had 290 2¼ in. tubes, 18 ft. 2 in. in length over the tube sheets. The total heating surface of the radial stay boiler was about 3,003 sq. ft., of which 245.3 sq. ft., or about 8 per cent., was in the firebox.

Inasmuch as these tests were made primarily for the purpose of comparing the two types of fireboxes and not for determining the relative value of the firebox and tube heating surface, the methods employed introduced conditions not present in a normal boiler, such as the cutting off of the circulation between the barrel and the firebox, and the interjection of cold water through a perforated tube directly over the crown sheet. It is probable that this relation of the value of the two surfaces does not exactly express the facts under normal conditions. It probably, however, is not very greatly in error and shows beyond doubt that the firebox heating surface is considerably more important than has been generally believed. It checks the results that have been obtained with combustion chambers where it has been found that the cutting out of from 700 sq. ft. to 800 sq. ft. of tube heating surface and replacing it with about one-tenth as much firebox heating surface, does not reduce the boiler capacity.

Some other results of the tests quoted in the paper show the possibilities of boiler capacity. With a combustion of 119 lbs. of coal per sq. ft. of grate per hour, 1,669 boiler horse power was developed, or one boiler horse power for 1.8 sq. ft. of total heating surface. This required an evaporation of 19.13 lbs. of water per sq. ft. of heating surface per hour which was equivalent to 8.78 lbs. of water per pound of coal. Under these conditions the over-all thermal efficiency of the boiler was more than 65 per cent. The economy of the brick arch was also clearly proved in these tests.

NEW BOOKS

International Railway Fuel Association. Proceedings of the Fourth Annual Convention, Chicago, May 22-25, 1912. Bound in paper. 315 pages, illustrated. Published by the association, C. G. Hall, C. & E. I. R. R., McCormick building, Chicago, Secretary. Price, 50 cents.

The deliberations of this association at its last convention were of particular interest and importance. This is especially true in connection with instructive methods for improvement in locomotive firing. There is probably no feature of locomotive operation that presents as great opportunities for improvement as in the methods employed by the firemen. A number of roads are actively taking up this subject, and the methods being used on some of the more progressive were fully illustrated and demonstrated at this meeting. Other important subjects discussed were the inspection of fuel, the use of anthracite coal, and locomotive drafting. In the latter paper, H. B. MacFarland, engineer of tests, Santa Fe, presented some startling figures in connection with the amount of power consumed by back pressure on a locomotive. He also gave preliminary figures of some experiments he is making with artificially induced draft. Dr. W. F. M. Goss presented a paper on the subject of fuel as a factor in locomotive capacity, in which he outlined a locomotive that possibly may be required in the future, which had 150 sq. ft. of grate area. Each subject aroused most active and valuable discussion, all of which is included in the proceedings. A list of members with their addresses has also been inserted in this volume.

NEW BOX, STOCK AND REFRIGERATOR CARS

Steel Frame Freight Equipment With Steel Roofs The Framing is Suitable For Three Types of Cars.

In harmony with the decision to eventually have all of its cars of the all-steel type, a freight car, the framing of which can be used practically without change for either box, stock or refrigerator cars, has been designed in the mechanical engineer's office of the Pennsylvania Railroad. The all-steel design is not feasible for the two latter types of cars, and in considering the box car design, the advisability of the use of steel was taken up with the transportation, traffic, claim and other departments of the railway, as well as with a number of shippers. The decision arrived at from this discussion favored the use of a wooden floor and a wooden lining, and the new box cars are being built in this manner. If at any time it seems

cars now being built are carried on standard arch bar trucks, having 5½ in. x 10 in. journals. The box and stock cars have an inside length of 40 ft. 6 in., a width of 8 ft. 10 in. and a clear height inside of 8 ft. The maximum width over the eaves is 9 ft. 11½ in., and the total length of car outside of end sills is 42 ft. 6 in. The top of the floor is 3 ft. 7½ in. above the top of the rail.

UNDERFRAME.

The underframe of these cars follows the same plan employed in the steel passenger cars on this road, wherein all of the weight of the car and lading is transferred to the center sills through the medium of two cantilevers, one at either end,

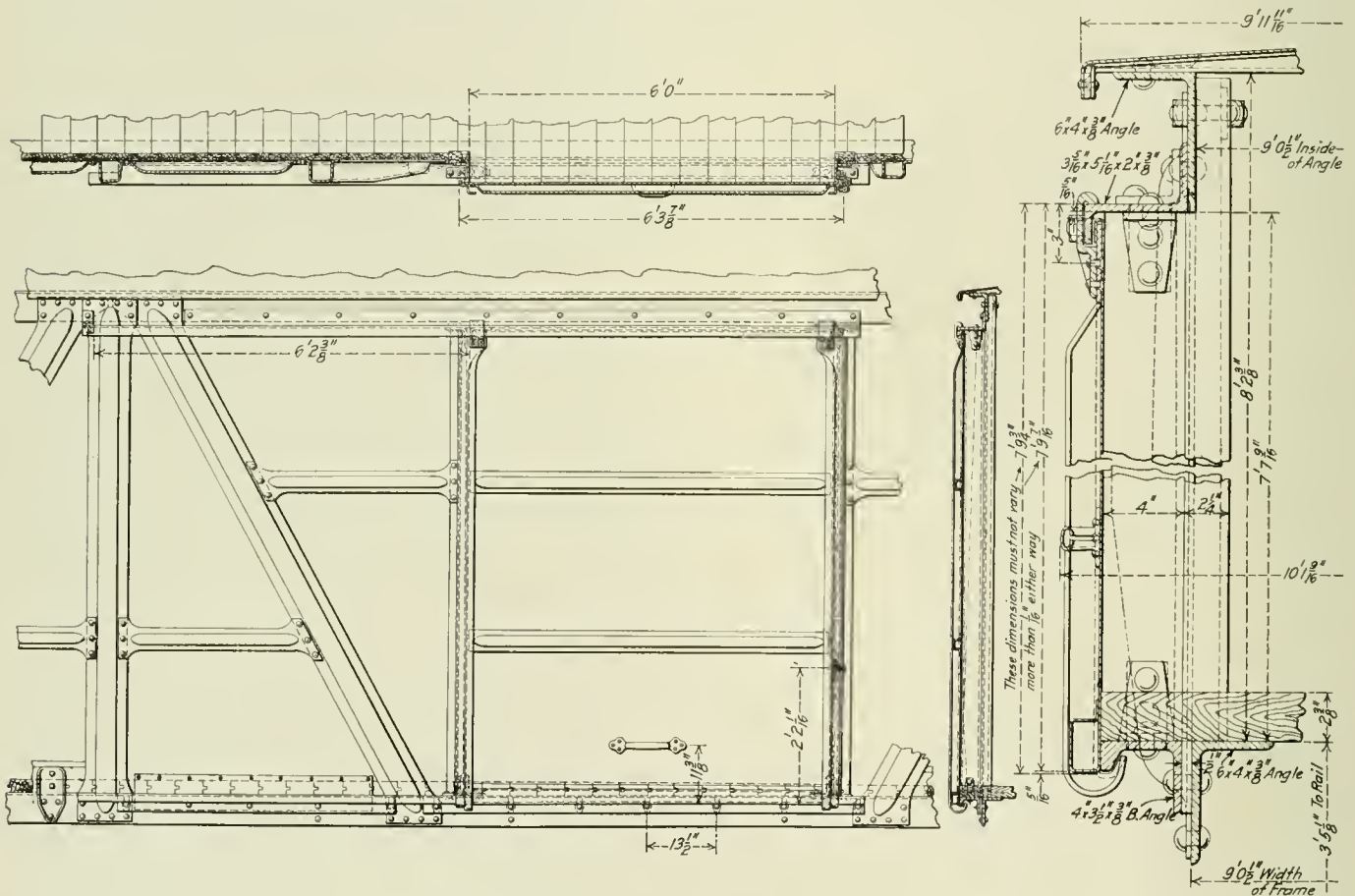

All-Steel Door Used on the Steel Frame Box Cars.

desirable to use a steel inside finish, it can be substituted without material change in the structure.

The box car thus consists of a steel underframe of the fishbelly center sill type, but differing from previous designs as will be explained later; steel side framing formed of posts and braces in pressed shapes secured to angles at the top and bottom; an all-steel roof made up of steel carlines and steel roof sheets, the latter having riveted butt joints with an outside and inside cover plate; a 2 3/8 in. tongue and grooved wooden floor and a 1 1/4 in. tongue and grooved side and end lining on the inside of the posts and with the joints running vertically. The stock and refrigerator cars differ from this only in the lining. The box cars have sliding all-steel doors of special design, while the stock and refrigerator cars have flush doors. All

located 7 ft. 4 in. inside the center plate, and the two end sills. Thus the body bolster, as it is customarily built, does not appear in this design and the framing at that point is only such as is needed for stiffness and to carry the side bearings. The center sills are formed of 3/8 in. plate pressed with 4 in. flanges at top and bottom. The sill is 20 in. deep between the cantilever connections and narrows to 11 in. at a point 22 11/16 in. inside the center plate and continues this section to the end sill. A 4 in. x 4 in. x 9/16 in. angle is riveted to the bottom of each sill on the inside, and extends continuously between the inside draft lug faces, which are incorporated in the center plate casting and are located about 15 in. outside the center pin at either end. A 3/8 in. x 24 in. top cover plate extends continuously for the full length of the center sills.

floor being constructed of $2\frac{3}{8}$ in. material, giving ample strength to carry the lading without such supports.

SUPERSTRUCTURE.

The side framing consists of a series of posts and braces, each formed of $\frac{3}{8}$ in. open hearth steel pressed in "U" shape of varying cross section, as is shown in the detail of one of the posts. The shape of these members is such as to give the greatest resistance to side thrust at a point about one-third of the distance above the floor. The side flanges are wide and the ends are flat, being riveted directly to the sill and plate. This type of post was selected on account of its great strength and light

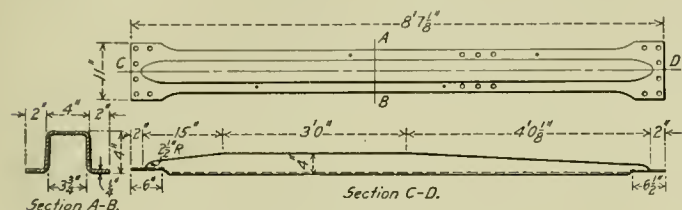

Pressed Steel Posts for Steel Freight Cars.

weight, and the opportunity given for a strong connection at the joint. Sufficient rivets can be inserted to develop the full strength of the member without the necessity of using angles or gusset plates. These posts and braces are secured at the top to a 4 in. x 6 in. x 3/8 in. angle which has its shorter leg extending outward. At the bottom, the angle forming the side sill has its shorter leg extending inward. The posts and braces are indented at the ends to fit around the angles, giving a smooth surface on the interior of the car for the attachment of the lining.

It will be noted that the main posts are located at the connection of the cantilever to the side sills and a large portion of the

themselves are bulb angles and are fastened to the plate and sill at either end.

The short horizontal struts of the same general style as the posts and braces, and secured between them at various points, are included as a means of fastening the side lining rather than part of the frame structure. The corner posts are 4 in. x 4 in. x 3/8 in. angles and have one leg cut away at the bottom where they are riveted to the side sills. Inasmuch as they pass outside of the end lining and are securely riveted to it, and are also fastened to the side sill, this does not offer a point of weakness. The end of the car has a post in the centre, and diagonal braces from the upper corners to the center sill on either side. These pass outside the steel end sheathing and are securely attached to it. They transfer practically all the weight of the car body and a portion of the lading directly to the end of the centre sills at this point. Practically all the rivets at the connections between the principal members in the side framing are 3/4 in.

Specially designed steel carlines are spaced 3 ft. 9 1/2 in. apart, being located without reference to the posts. These rest on top of the plate and are continued outside and flanged down at the ends. The 1/8 in. steel roof sheets are in sections of the same width as the distance between carlines, but the joint comes midway between the carlines. Above the butt joint between the sheets the upper cover plate is formed with a ridge in the centre which adds to the stiffness of the structure. One-quarter inch rivets are spaced close together at the joint and no calking is required. The roof sheets on the cars now under construction are not continuous across the car and the joint at the center is formed by flanging up the edges and riveting them together. At the eaves the roof sheets are carried out beyond the plate and flanged over and a 3/8 in. x 1 in. strip is riveted along the edge on the inside, forming a stiffening piece. The roof structure is secured to the car framing at the sides by only ten

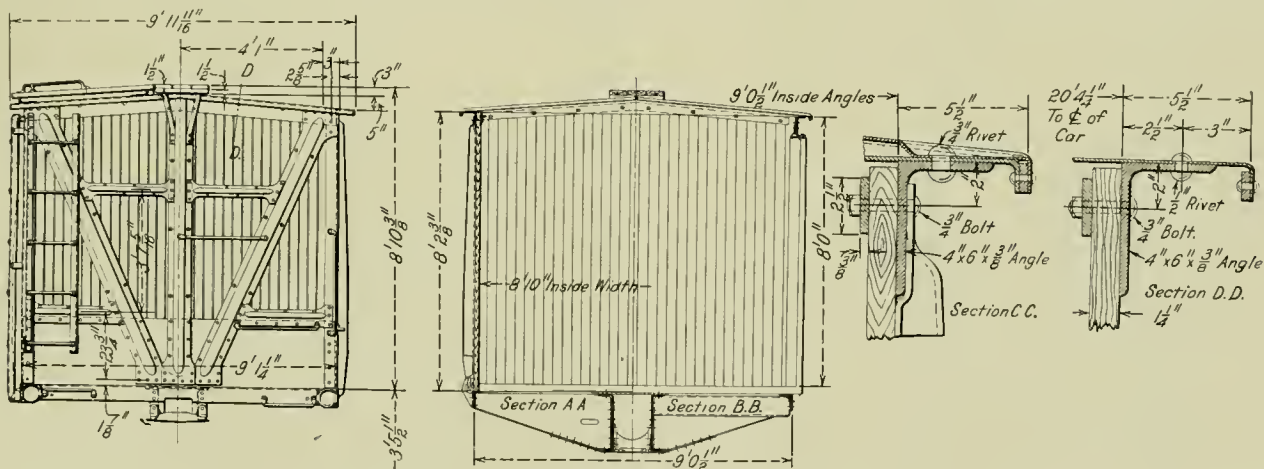

End Elevation and Sections of Steel Frame Box Car.

weight of the car body superstructure, as well as part of the lading, will be carried through these posts and the cantilevers to the center sills. The weight from either side is transferred to them at the top by the diagonal braces which are of the same general form and style. Another post is located between the main posts and the end of the car. It will be seen that this does not come opposite the center plate and none of the load is transferred to the underframe at this point. The weight of the roof carried by this member is transferred up through the diagonal braces and distributed equally to the main post and to the end framing. Both the upper and lower longitudinal members of the truss are continuous for the full length of the car body. The side sill is reinforced under the door by a 4 in. x 3 1/2 in. x 3/8 in. bulb angle riveted to it. The Z bars installed for door slides also give some reinforcement at the top of the openings. The door posts

rivets on each side. These are at the carlines where the sheet is bumped down and a 3/4 in. rivet passes through the sheet, carline and outwardly extending leg of the angle forming the plate. At the end of the car, the carline is formed of a 4 in. x 6 in. x 3/8 in. angle of the proper shape, and the roof sheets extend over it and are secured to it by a large number of 1/2 in. rivets. Here the eaves are carried over in the same manner as at the sides.

The running boards are fastened to two short sections of Z-bars, riveted directly to the carlines and through the roof sheets as is shown in the illustration.

The wooden side lining is secured on the inside of the frame at the top by means of a 3/8 in. x 2 1/2 in. bar on the inside of the lining, which is held by 3/4 in. bolts passing through the plate and with nuts on the inside. It will be noted that the top of the lining is somewhat below the top of the plate and that be-

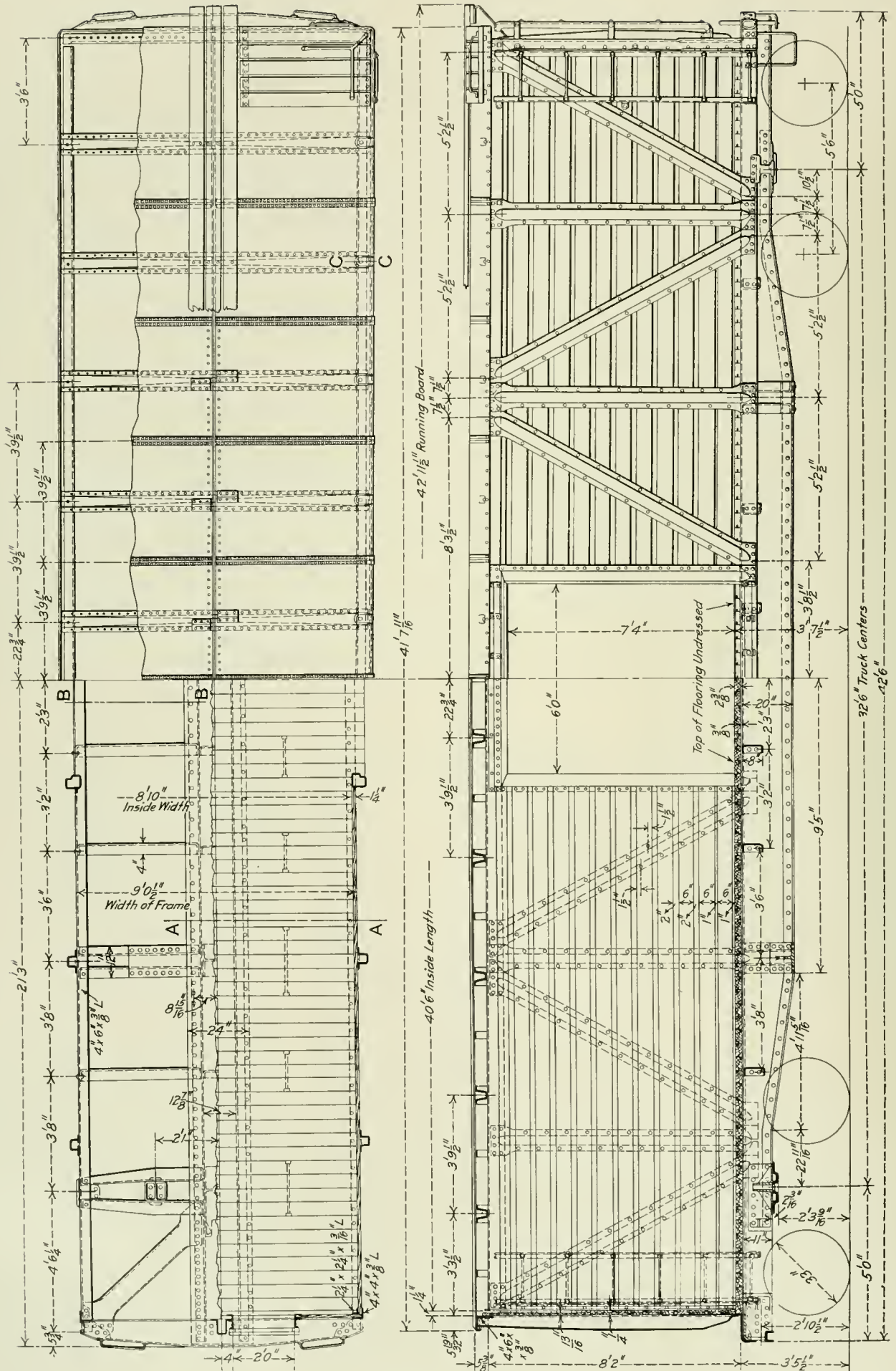

Stock Car Which Practically Differs from the Box Car Only in the Lining and the Type of Door.

tween all carlines there is an open space between the plate and the roof sheet, equal to the thickness of the carlines at this point. This permits excellent ventilation of the car without the possibility of the entrance of snow or rain. At the bottom the side lining extends inside of the floor down to the side sill, and is held on the outside by a wooden strip fitted between the posts and braces, which is held by castings riveted to the side sills. In

angle is continued to the first post. At the top the Z-bars are flattened out and secured in the flange at the upper part of the sheet. At this point are also riveted the carrying irons which are not provided with rollers but slide with metallic contact on the abbreviated Z-bar at the top of the door opening, which also extends to the first post.

The door is thus secured at each corner, both top and bottom, no matter what its position may be. It is entirely smooth on the inner surface and is set out sufficient to clear the side posts and braces. The floor is carried out to meet the door in the opening, the extension being supported by the bulb angle. The sides of the opening are filled by bulb angles of the proper width which are secured to the top and bottom members of the door frame by corner irons, and are also riveted to the sill and side plate. These members form the door posts and are backed up by 2 in. hard wood strips. The Z-bars at either side of the door are flanged from steel plates, and the one at the back of the door is carried around the edge of the sheet to form a lip and seal the opening. The door stop is another Z-bar flanged from plate and secured on the outside of the door post. It extends out a sufficient distance to form a stop for the full height of the door. The handle is riveted directly to the sheet and does not increase the side clearance of the car.

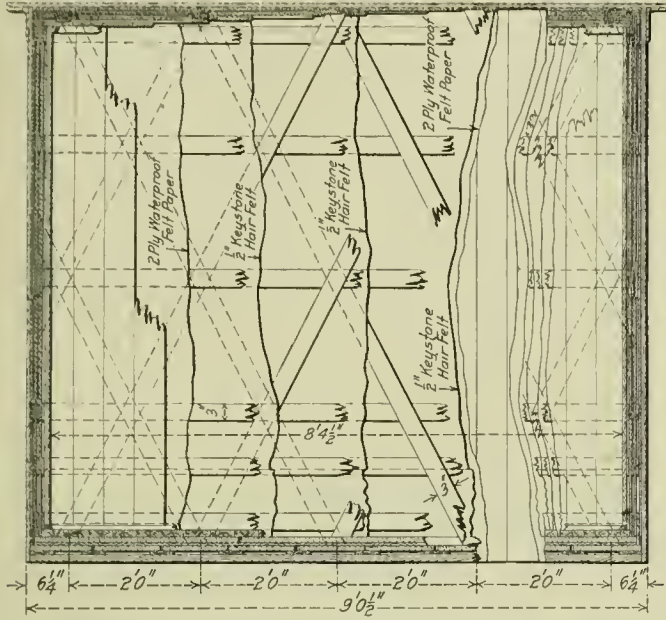

Section of Refrigerator Car Showing Method of Applying Insulation.

addition, the lining is secured to the posts and braces by numerous screws. At the end of the car the lining only extends down to the top of the steel plate.

DOORS.

An all-steel door of exceptionally light and simple design has been applied on the box cars. It consists of a sheet of 1/8 in.

The adaptation of this framing to a stock car is shown in one of the illustrations. The only changes are in the method of securing the lining or slats and the arrangement of the door. The underframe, side framing and roof structure are practically identical with the box car. Since the slats run horizontally there is no necessity for the horizontal struts between the posts and braces. The hard wood strips forming the slats are 1 1/4 in. x 6 in. and are secured directly to the framing by 3/8 in. bolts with the nuts on the outside. An end door is desired in this car, and it will be seen that there was sufficient room between the end post and the diagonal brace in the upper part of the car. This door is arranged to slide toward the side of the car. There is a small 2 1/4 in. x 2 1/4 in. x 3/16 in. angle on the inside of the corners to hold the end of the wooden slats. The doors on this

STOCK CAR

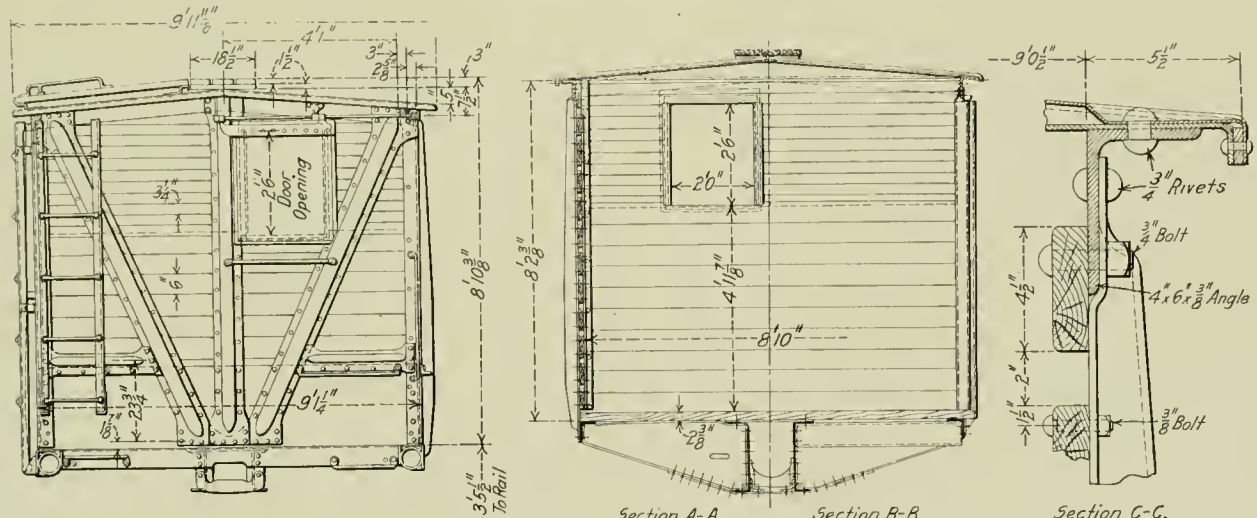

End Elevation and Sections of Steel Frame Stock Car.

steel of the proper size flanged over in box section at the bottom and in "U" section at the top. An upward extending flange at the box section is spot welded to the main sheet. There are two horizontal pressed steel members of "U" section equally spaced on the outside of the sheet and spot welded in place. At either side are Z-bars, spot welded in place. These are formed over in hook shape at the bottom and pass under and back of the edge of the bulb angle secured below the floor opening. This

car are of the flush sliding type that has been standard for this type of equipment on the Pennsylvania.

REFRIGERATOR CARS.

The framing of the refrigerator car does not differ from the box or stock car except at the door posts, where on account of the smaller door opening, the regular pressed steel post has been included and the doors are carried on separate wooden posts

AN ANALYSIS OF WOOD WORKING MACHINES

Tools Required in a Car Repair Shop for General Repairs to 70 Passenger and 714 Freight Cars Per Month.

BY L. R. POMEROY,*

In laying out a new wood working shop for car repairs, it is desirable to have accurate information as to the amount of work that will be required of each machine for a certain definite output, as well as the length of time the machine will require to perform the operations.

So far as the writer knows there is no data available that will answer satisfactorily for this purpose and, therefore, in preparing for the design of a new shop of this character, a study of a large shop now in operation was made. The informa-

tion was obtained from a study of the shop records, the work system and at an efficiency probably as good as the average railway shop of its size in the country. This shop furnishes material for repairs made at the same point, as well as considerable material which is shipped to outside points.

In preparing the tables the method employed in arriving at the machine tool time was on the basis of the actual piece work prices and the number of pieces and operations. The latter were taken at the average of going conditions and schedules, covering six months' operation, checked by a careful

TABLE III—TIME CHARGED MACHINES FOR CHANGING, ADJUSTING, SHARPENING, ETC.

| | Times per Mo. | Shaper. | Sash Tenoner. | Sash Mortiser. | Gainer and Tenoner. | Saws. | Dowel Machine. | 4-Side Planer. | Matcher. | Inside Moulder. | Rotary Bed Planer. | Single Surfacer. | Buzz Planer. |
|---|---------------|---------|---------------|----------------|---------------------|-------|----------------|----------------|----------|-----------------|--------------------|------------------|--------------|
| For chamfer, bead and round..... | 150 | 25. | | | | | | | | | | | |
| For sash..... | 20 | 13. | | | | | | | | | | | |
| For tongue and groove..... | 5 | 1.67 | | | | | | | | | | | |
| For O. G. ¼ and ½ round..... | 100 | 16.66 | | | | | | | | | | | |
| For square work, small head..... | 50 | 5. | | | | | | | | | | | |
| For square work, large head..... | 100 | 16.66 | | | | | | | | | | | |
| For crown moulding..... | 20 | 13. | | | | | | | | | | | |
| Set tenoner for sash and sharpen..... | 25 | | 20.80 | | | | | | | | | | |
| Set tenoner plane..... | 50 | | 13.30 | | | | | | | | | | |
| Set for gaining..... | 25 | | 4.15 | | | | | | | | | | |
| Set gainer plane..... | 25 | | | | 4.15 | | | | | | | | |
| Set gainer with form..... | 20 | | | | 6.65 | | | | | | | | |
| Set for grooving..... | 100 | | | | | 16.65 | | | | | | | |
| Set for marquetry..... | 10 | | | | | 6.65 | | | | | | | |
| Set when rolls changed..... | 5 | | | | | | 2.50 | | | | | | |
| Set when rolls not changed..... | 15 | | | | | | 5.00 | | | | | | |
| Removing knives and sharpening..... | 35 | | | | | | 5.83 | | | | | | |
| Set for square edge from dimensions..... | 100 | | | | | | | 16.65 | | | | | |
| From T. and G. to dimension..... | 20 | | | | | | | 10. | | | | | |
| Set for Murphy roof strips..... | 1 | | | | | | | | 2.50 | | | | |
| Set for ash corners..... | 2 | | | | | | | | | 2.31 | | | |
| Set and sharpen..... | 25 | | | 4.15 | | | | | | | | | |
| Change knives and spurs, large G..... | 2 | | | | 2.31 | | | | | | | | |
| Change knives and spurs, sill G..... | 2 | | | | 2.31 | | | | | | | | |
| Changing knives (3)..... | 5 | | 2.5* | | | | | | | | | | |
| Changing knives (3)..... | 5 | | | | | | | | | | 2.50 | | |
| Changing knives (2)..... | 3 | | | | | | | | | | | 2.50 | |
| Changing knives..... | 16 | | | | | | | | | | | | |
| Change and sharpen sidehead..... | 2 | | | | | | | | | 1.00 | | | |
| Change and sharpen sidehead..... | 3 | | | | | | | | | | 2.00 | | |
| Change knives (2)..... | 5 | | | | | | | | | | | | 5.83 |
| Set knives for fluted roofing..... | 6 | | | | | | | | | | | | |
| Set for window belt strips..... | 10 | | | | | | | | | | 8.32 | | |
| Set for sideheads..... | 3 | | | | | | | | | | | | |
| Set top and bottom cylinders..... | 8 | | | | | | | | | | | | |
| Sharpen with file and stone, sideheads..... | 8 | | | | | | | | | | | | |
| Sharpen with file and stone, top cylinder..... | 8 | | | | | | | | | | | | |
| Sharpen with file and stone, bottom cylinder..... | 8 | | | | | | | | | | | | |
| Total..... | | 90.99 | 38.25 | 4.15 | 15.42 | 23.30 | 13.33 | 25.10 | 6.56 | 12.63 | 2.50 | 2.50 | 5.83 |
| Sharpen and set for T. & G. dimensioner..... | | | | | | | | 16.65 | | | | | |
| Sharpen and set for G. & W. planer..... | | 2.5 | | | | | | | | | | | |

* G. & W. planer.

tion thus collected was tabulated and permits a ready determination of the number and kind of wood working tools that would be required for any output desired. By segregating the repairs under various headings and into unit operations, which can be easily done either by an arbitrary selection based on a knowledge of the subject or by records available at any shop operating under similar conditions, it will be seen that the data given in the following tables give accurate information on the size and kind of tools that will be required, as well as the number of each type. If tools of greater or less capacity than those shown in the table are desired, the data here given can be easily prorated to give correct results.

The shop selected for the study was the Fitchburg shop of the Boston & Maine, which is working under a complete piece

analysis of three years' output. The time was then determined in the following manner:

Average time = Piece work price x Number pieces per month ÷ Average hourly rate.

In many cases the piece work price in the schedule covered the complete operation, which comprehended many tool operations. In such cases the price was segregated into the component machine movements participating in and forming a part of the completed portion, aggregate, or lump sum rate, on a percentage basis, the proper percentage being determined by observation and time study tests.

Table Number 1 represents material operations where the repairs were made and the material applied directly at the shop, in the nature of heavy repairs. It will be seen that the different tools and number of each kind are at the head of the columns,

*Consulting Engineer, 105 West 40th Street, New York City.

TABLE 1—DETAILED DISTRIBUTION OF WORK ON A TIME BASIS.

| ITEM AND QUANTITY. | 18" Rip Saw. | 24" Rip Saw. | 22" Rip Saw. | Self-feed Rip Saw. | Combination Rip and C. O. Saw. | Edging Saw. | Swag C. O. Saw. | Ry C. O. Saw. | Hand Saw. | Buzz Planer. | Tenoner and Shaper. | Outside Moulder. | Inside Moulder. | Gray & Wood Planer. | Vertical Borer. | 1-Spindle Borer. | Horizontal Mortiser. | H. C. Mortiser. | Horizontal Mortiser. | Rotary Bed Planer. | Single Surfer. | Sash Tenoner. | Panel Machine. | Sash Mortiser. | Timber Planer. | |
|--|--------------|--------------|--------------|--------------------|--------------------------------|-------------|-----------------|---------------|-----------|--------------|---------------------|------------------|-----------------|---------------------|-----------------|------------------|----------------------|-----------------|----------------------|--------------------|----------------|---------------|----------------|----------------|----------------|-------|
| Number of tools..... | 2 | 1 | 1 | 1 | 1 | 2 | 2 | 2 | 3 | 2 | 4 | 1 | 1 | 1 | 3 | 1 | 1 | 1 | 1 | 1 | 1 | 1 | 1 | 1 | 1 | |
| Arms, canopy passenger.....25 | 1.33 | 6.24 | 6.24 | 6.24 | 1.98 | 0.64 | 2.63 | 1.18 | 2.00 | 1.03 | 2.00 | 9.33 | 9.33 | 0.64 | 0.64 | 0.64 | 0.64 | 0.64 | 0.64 | 0.64 | 0.64 | 0.64 | 0.64 | 0.64 | 0.64 | |
| Arms, canopy, caboose.....12 | 1.04 | 0.40 | 0.40 | 0.40 | 1.03 | 0.40 | 0.60 | 0.60 | 2.50 | 1.00 | 2.50 | 1.20 | 1.20 | 0.40 | 0.40 | 0.40 | 0.40 | 0.40 | 0.40 | 0.40 | 0.40 | 0.40 | 0.40 | 0.40 | 0.40 | |
| Arms, arch finish.....30 | 1.00 | 0.17 | 0.17 | 0.17 | 6.45 | 1.53 | 1.02 | 1.02 | 1.38 | 1.02 | 1.38 | 1.38 | 1.38 | 0.33 | 0.33 | 0.33 | 0.33 | 0.33 | 0.33 | 0.33 | 0.33 | 0.33 | 0.33 | 0.33 | 0.33 | |
| Bars, pulp cars.....10 | 12.31 | 5.59 | 5.59 | 5.59 | 8.15 | 5.45 | 7.11 | 3.54 | 3.10 | 3.10 | 3.10 | 3.10 | 3.10 | 0.33 | 0.33 | 0.33 | 0.33 | 0.33 | 0.33 | 0.33 | 0.33 | 0.33 | 0.33 | 0.33 | 0.33 | |
| Battens.....15 sets and 575 pcs. | 2.00 | 6.24 | 6.24 | 6.24 | 8.15 | 5.45 | 7.11 | 3.54 | 3.10 | 3.10 | 3.10 | 3.10 | 3.10 | 0.33 | 0.33 | 0.33 | 0.33 | 0.33 | 0.33 | 0.33 | 0.33 | 0.33 | 0.33 | 0.33 | 0.33 | |
| Belt rail.....600' | 6.24 | 6.24 | 6.24 | 6.24 | 8.15 | 5.45 | 7.11 | 3.54 | 3.10 | 3.10 | 3.10 | 3.10 | 3.10 | 0.33 | 0.33 | 0.33 | 0.33 | 0.33 | 0.33 | 0.33 | 0.33 | 0.33 | 0.33 | 0.33 | 0.33 | |
| Beads.....2,500' | 6.24 | 6.24 | 6.24 | 6.24 | 8.15 | 5.45 | 7.11 | 3.54 | 3.10 | 3.10 | 3.10 | 3.10 | 3.10 | 0.33 | 0.33 | 0.33 | 0.33 | 0.33 | 0.33 | 0.33 | 0.33 | 0.33 | 0.33 | 0.33 | 0.33 | |
| Door.....2,500' | 6.24 | 6.24 | 6.24 | 6.24 | 8.15 | 5.45 | 7.11 | 3.54 | 3.10 | 3.10 | 3.10 | 3.10 | 3.10 | 0.33 | 0.33 | 0.33 | 0.33 | 0.33 | 0.33 | 0.33 | 0.33 | 0.33 | 0.33 | 0.33 | 0.33 | |
| Door.....2,500' | 6.24 | 6.24 | 6.24 | 6.24 | 8.15 | 5.45 | 7.11 | 3.54 | 3.10 | 3.10 | 3.10 | 3.10 | 3.10 | 0.33 | 0.33 | 0.33 | 0.33 | 0.33 | 0.33 | 0.33 | 0.33 | 0.33 | 0.33 | 0.33 | 0.33 | |
| W. box (pss).....170 | 0.25 | 4.92 | 4.92 | 4.92 | 6.45 | 1.53 | 1.02 | 1.02 | 1.38 | 1.02 | 1.38 | 1.38 | 1.38 | 0.33 | 0.33 | 0.33 | 0.33 | 0.33 | 0.33 | 0.33 | 0.33 | 0.33 | 0.33 | 0.33 | 0.33 | |
| Brake beams.....10 | 6.13 | 59.86 | 59.86 | 59.86 | 8.15 | 5.45 | 7.11 | 3.54 | 3.10 | 3.10 | 3.10 | 3.10 | 3.10 | 0.33 | 0.33 | 0.33 | 0.33 | 0.33 | 0.33 | 0.33 | 0.33 | 0.33 | 0.33 | 0.33 | 0.33 | |
| Boxes, emergency.....24 | 6.13 | 59.86 | 59.86 | 59.86 | 8.15 | 5.45 | 7.11 | 3.54 | 3.10 | 3.10 | 3.10 | 3.10 | 3.10 | 0.33 | 0.33 | 0.33 | 0.33 | 0.33 | 0.33 | 0.33 | 0.33 | 0.33 | 0.33 | 0.33 | 0.33 | |
| Boxes, equipment, etc.....108 | 59.86 | 59.86 | 59.86 | 59.86 | 8.15 | 5.45 | 7.11 | 3.54 | 3.10 | 3.10 | 3.10 | 3.10 | 3.10 | 0.33 | 0.33 | 0.33 | 0.33 | 0.33 | 0.33 | 0.33 | 0.33 | 0.33 | 0.33 | 0.33 | 0.33 | |
| Blocks, various.....2,716 | 59.86 | 59.86 | 59.86 | 59.86 | 8.15 | 5.45 | 7.11 | 3.54 | 3.10 | 3.10 | 3.10 | 3.10 | 3.10 | 0.33 | 0.33 | 0.33 | 0.33 | 0.33 | 0.33 | 0.33 | 0.33 | 0.33 | 0.33 | 0.33 | 0.33 | |
| Boards.....7 1/2 M' | 28.30 | 28.30 | 28.30 | 28.30 | 28.30 | 28.30 | 28.30 | 28.30 | 28.30 | 28.30 | 28.30 | 28.30 | 28.30 | 28.30 | 28.30 | 28.30 | 28.30 | 28.30 | 28.30 | 28.30 | 28.30 | 28.30 | 28.30 | 28.30 | 28.30 | 28.30 |
| Roof.....35 M' | 28.30 | 28.30 | 28.30 | 28.30 | 28.30 | 28.30 | 28.30 | 28.30 | 28.30 | 28.30 | 28.30 | 28.30 | 28.30 | 28.30 | 28.30 | 28.30 | 28.30 | 28.30 | 28.30 | 28.30 | 28.30 | 28.30 | 28.30 | 28.30 | 28.30 | 28.30 |
| Lining.....15 M' | 28.30 | 28.30 | 28.30 | 28.30 | 28.30 | 28.30 | 28.30 | 28.30 | 28.30 | 28.30 | 28.30 | 28.30 | 28.30 | 28.30 | 28.30 | 28.30 | 28.30 | 28.30 | 28.30 | 28.30 | 28.30 | 28.30 | 28.30 | 28.30 | 28.30 | 28.30 |
| Floor.....10 M' | 28.30 | 28.30 | 28.30 | 28.30 | 28.30 | 28.30 | 28.30 | 28.30 | 28.30 | 28.30 | 28.30 | 28.30 | 28.30 | 28.30 | 28.30 | 28.30 | 28.30 | 28.30 | 28.30 | 28.30 | 28.30 | 28.30 | 28.30 | 28.30 | 28.30 | 28.30 |
| Running.....50 M' | 28.30 | 28.30 | 28.30 | 28.30 | 28.30 | 28.30 | 28.30 | 28.30 | 28.30 | 28.30 | 28.30 | 28.30 | 28.30 | 28.30 | 28.30 | 28.30 | 28.30 | 28.30 | 28.30 | 28.30 | 28.30 | 28.30 | 28.30 | 28.30 | 28.30 | 28.30 |
| Letter.....50 M' | 28.30 | 28.30 | 28.30 | 28.30 | 28.30 | 28.30 | 28.30 | 28.30 | 28.30 | 28.30 | 28.30 | 28.30 | 28.30 | 28.30 | 28.30 | 28.30 | 28.30 | 28.30 | 28.30 | 28.30 | 28.30 | 28.30 | 28.30 | 28.30 | 28.30 | 28.30 |
| Finish.....110' | 28.30 | 28.30 | 28.30 | 28.30 | 28.30 | 28.30 | 28.30 | 28.30 | 28.30 | 28.30 | 28.30 | 28.30 | 28.30 | 28.30 | 28.30 | 28.30 | 28.30 | 28.30 | 28.30 | 28.30 | 28.30 | 28.30 | 28.30 | 28.30 | 28.30 | 28.30 |
| Miscellaneous.....65 | 28.30 | 28.30 | 28.30 | 28.30 | 28.30 | 28.30 | 28.30 | 28.30 | 28.30 | 28.30 | 28.30 | 28.30 | 28.30 | 28.30 | 28.30 | 28.30 | 28.30 | 28.30 | 28.30 | 28.30 | 28.30 | 28.30 | 28.30 | 28.30 | 28.30 | 28.30 |
| Body bolsters.....65 | 1.23 | 0.83 | 0.83 | 0.83 | 1.23 | 1.33 | 3.34 | 0.84 | 7.00 | 0.84 | 7.00 | 7.00 | 7.00 | 1.33 | 1.33 | 1.33 | 1.33 | 1.33 | 1.33 | 1.33 | 1.33 | 1.33 | 1.33 | 1.33 | 1.33 | |
| Bracing, passenger and baggage.....65 | 0.83 | 0.83 | 0.83 | 0.83 | 1.23 | 1.33 | 3.34 | 0.84 | 7.00 | 0.84 | 7.00 | 7.00 | 7.00 | 1.33 | 1.33 | 1.33 | 1.33 | 1.33 | 1.33 | 1.33 | 1.33 | 1.33 | 1.33 | 1.33 | 1.33 | |
| Bracing, caboose and freight.....50 | 9.00 | 0.70 | 0.70 | 0.70 | 2.12 | 0.01 | 10.65 | 0.13 | 22.92 | 0.13 | 22.92 | 22.92 | 22.92 | 0.82 | 0.82 | 0.82 | 0.82 | 0.82 | 0.82 | 0.82 | 0.82 | 0.82 | 0.82 | 0.82 | 0.82 | |
| Bump beams.....27 | 2.00 | 2.00 | 2.00 | 2.00 | 2.12 | 0.01 | 10.65 | 0.13 | 22.92 | 0.13 | 22.92 | 22.92 | 22.92 | 0.82 | 0.82 | 0.82 | 0.82 | 0.82 | 0.82 | 0.82 | 0.82 | 0.82 | 0.82 | 0.82 | 0.82 | |
| Body bolts.....178 | 1.44 | 0.10 | 0.10 | 0.10 | 2.12 | 0.01 | 10.65 | 0.13 | 22.92 | 0.13 | 22.92 | 22.92 | 22.92 | 0.82 | 0.82 | 0.82 | 0.82 | 0.82 | 0.82 | 0.82 | 0.82 | 0.82 | 0.82 | 0.82 | 0.82 | |
| Cases, drawers, etc., mail car.....28 | 0.10 | 0.10 | 0.10 | 0.10 | 2.12 | 0.01 | 10.65 | 0.13 | 22.92 | 0.13 | 22.92 | 22.92 | 22.92 | 0.82 | 0.82 | 0.82 | 0.82 | 0.82 | 0.82 | 0.82 | 0.82 | 0.82 | 0.82 | 0.82 | 0.82 | |
| Cases, baggage and caboose car.....5 | 0.10 | 0.10 | 0.10 | 0.10 | 2.12 | 0.01 | 10.65 | 0.13 | 22.92 | 0.13 | 22.92 | 22.92 | 22.92 | 0.82 | 0.82 | 0.82 | 0.82 | 0.82 | 0.82 | 0.82 | 0.82 | 0.82 | 0.82 | 0.82 | 0.82 | |
| Casing edg., pass. and caboose.....15 | 17.80 | 3.12 | 3.12 | 3.12 | 2.40 | 2.40 | 2.40 | 2.40 | 2.40 | 2.40 | 2.40 | 2.40 | 2.40 | 2.40 | 2.40 | 2.40 | 2.40 | 2.40 | 2.40 | 2.40 | 2.40 | 2.40 | 2.40 | 2.40 | 2.40 | |
| Doors, frames, sash, battens, rails.....43 | 3.12 | 2.40 | 2.40 | 2.40 | 2.40 | 2.40 | 2.40 | 2.40 | 2.40 | 2.40 | 2.40 | 2.40 | 2.40 | 2.40 | 2.40 | 2.40 | 2.40 | 2.40 | 2.40 | 2.40 | 2.40 | 2.40 | 2.40 | 2.40 | 2.40 | |
| Doors, drawers, caboose.....15 | 2.32 | 2.40 | 2.40 | 2.40 | 2.40 | 2.40 | 2.40 | 2.40 | 2.40 | 2.40 | 2.40 | 2.40 | 2.40 | 2.40 | 2.40 | 2.40 | 2.40 | 2.40 | 2.40 | 2.40 | 2.40 | 2.40 | 2.40 | 2.40 | 2.40 | |
| Dowels, wood.....1,500 | 2.40 | 2.40 | 2.40 | 2.40 | 2.40 | 2.40 | 2.40 | 2.40 | 2.40 | 2.40 | 2.40 | 2.40 | 2.40 | 2.40 | 2.40 | 2.40 | 2.40 | 2.40 | 2.40 | 2.40 | 2.40 | 2.40 | 2.40 | 2.40 | 2.40 | |
| Dowels, metal.....20 | 2.40 | 2.40 | 2.40 | 2.40 | 2.40 | 2.40 | 2.40 | 2.40 | 2.40 | 2.40 | 2.40 | 2.40 | 2.40 | 2.40 | 2.40 | 2.40 | 2.40 | 2.40 | 2.40 | 2.40 | 2.40 | 2.40 | 2.40 | 2.40 | 2.40 | |
| Finish, P. M. B. & H.....20 | 2.40 | 2.40 | 2.40 | 2.40 | 2.40 | 2.40 | 2.40 | 2.40 | 2.40 | 2.40 | 2.40 | 2.40 | 2.40 | 2.40 | 2.40 | 2.40 | 2.40 | 2.40 | 2.40 | 2.40 | 2.40 | 2.40 | 2.40 | 2.40 | 2.40 | |
| Frames, door.....20 | 2.40 | 2.40 | 2.40 | 2.40 | 2.40 | 2.40 | 2.40 | 2.40 | 2.40 | 2.40 | 2.40 | 2.40 | 2.40 | 2.40 | 2.40 | 2.40 | 2.40 | 2.40 | 2.40 | 2.40 | 2.40 | 2.40 | 2.40 | 2.40 | 2.40 | |
| Filling.....2,800' | 0.80 | 1.06 | 1.06 | 1.06 | 1.25 | 0.53 | 2.77 | 1.66 | 1.83 | 1.66 | 1.83 | 1.83 | 1.83 | 0.53 | 0.53 | 0.53 | 0.53 | 0.53 | 0.53 | 0.53 | 0.53 | 0.53 | 0.53 | 0.53 | 0.53 | |
| Guards, dust.....250 | 1.06 | 1.06 | 1.06 | 1.06 | 1.25 | 0.53 | 2.77 | 1.66 | 1.83 | 1.66 | 1.83 | 1.83 | 1.83 | 0.53 | 0.53 | 0.53 | 0.53 | 0.53 | 0.53 | 0.53 | 0.53 | 0.53 | 0.53 | 0.53 | 0.53 | |
| Gates, horse cars.....2 | 1.08 | 1.08 | 1.08 | 1.08 | 1.25 | 0.53 | 2.77 | 1.66 | 1.83 | 1.66 | 1.83 | 1.83 | 1.83 | 0.53 | 0.53 | 0.53 | 0.53 | 0.53 | 0.53 | 0.53 | 0.53 | 0.53 | 0.53 | 0.53 | 0.53 | |
| Gibs.....75 | 1.01 | 1.01 | 1.01 | 1.01 | 1.25 | 0.53 | 2.77 | 1.66 | 1.83 | 1.66 | 1.83 | 1.83 | 1.83 | 0.53 | 0.53 | 0.53 | 0.53 | 0.53 | 0.53 | 0.53 | 0.53 | 0.53 | 0.53 | 0.53 | 0.53 | |
| Freight platform.....25 | 1.01 | 1.01 | 1.01 | 1.01 | 1.25 | 0.53 | 2.77 | 1.66 | 1.83 | 1.66 | 1.83 | 1.83 | 1.83 | 0.53 | 0.53 | 0.53 | 0.53 | 0.53 | 0.53 | 0.53 | 0.53 | 0.53 | 0.53 | 0.53 | 0.53 | |
| Trans.....20 | 4.18 | 2.87 | 2.87 | 2.87 | 1.04 | 0.43 | 4.10 | 4.63 | 3.89 | 4.63 | 3.89 | 4.63 | 4.63 | 3.89 | 4.63 | 3.89 | 4.63 | 4.63 | 3.89 | 4.63 | 3.89 | 4.63 | 4.63 | 3.89 | 4.63 | |

while the articles or pieces shaped and machined are in the first column. The time required for each tool operation, determined on the basis described, is then given in the columns under each

tool heading. It will be seen that while in some operations work on but one tool is required, there are others that required as high as seven different tools for completion.

Table Number 2 gives the same information in connection with material that is furnished to outside repair points, covering light or running repairs such as are made in terminal or junction yards. In connection with this table it might be mentioned, that, while the number of cars in the total that are credited to the shop for this outside operation are based on general repairs determined by an average time per car, obtained from the shop operation for the heavy home repairs, as a matter of fact this material for outside repair or inspection points represented light repairs on 430 cars, while the equivalent number of cars equated on a heavy repair basis represents 80 cars.

Table Number 3 gives the detail time for sharpening, changing and adjusting knives and rolls on the various tools, this being a

TABLE I (CONTINUED).

| ADDITIONAL ITEMS. | Jig Saw. | Dowel Machine. | Lathe. | Planer. | Resaw. | Matcher. |
|-------------------------|----------|----------------|--------|---------|--------|----------|
| Arch finish | 3.00 | | | | | |
| Dust guards | 1.25 | | 0.75 | | | |
| Hopper cov. | 0.58 | | | | | |
| Sash, blocks, etc. | 2.33 | | 0.18 | | | |
| Boards | | | | | | 54.17 |
| Dowels | | 6.23 | | | | |
| Drawers, etc. | | | | 2.40 | | |
| Resawing | | | | | 11.83 | |
| Total | 7.16 | 6.23 | 0.93 | 2.40 | 11.83 | 54.17 |

TABLE II CAR MATERIAL FURNISHED OUTSIDE POINTS.

| ITEM AND QUANTITY. | Rip Saw, 18", 22", 24". | Self-feed Rip Saw. | Comb'n Rip and C. O. Saw. | Edging Saw. | Sw. C. O. Saw. | Ry. C. O. Saw. | Band Saw. | Buzz Planer. | Single Surfacer. | Shaper. | 3-S. V. Borer. | I-S. H. Borer. | Rotary Bed Planer. | 4-S. Timber Planer. | Matcher. | Lathe. | Tongue and Groove. | Inside Moulder. | G. & W. Planer. | Jig Saw. | Vert. H. C. Mortiser. | Panel Machine. | |
|--------------------------------|-------------------------|--------------------|---------------------------|-------------|----------------|----------------|-----------|--------------|------------------|---------|----------------|----------------|--------------------|---------------------|----------|--------|--------------------|-----------------|-----------------|----------|-----------------------|----------------|-------|
| Battens, standard...250 | 6.25 | | 2.98 | | | | | 2.08 | 3.50 | 4.17 | | | | | | | | | | | | | |
| Beads, glass.....1,200 | 3.60 | | 0.17 | 0.40 | | | 0.50 | | 3.40 | | | | | | | | | | | | | | |
| Brake beams.....10 | | | | | | | | | | | | | 0.50 | 4.17 | | | | | | | | | |
| Blocks, truss.....250 | 2.08 | | | | | 2.09 | | | | | | | | | | | | | | | | | |
| Boards— | | | | | | | | | | | | | | | | | | | | | | | |
| Lining.....3,500' | | | | | | | | | | | | | | | | | | | | | | | |
| Finish.....4,000' | | | | | | | | | | | | | | | | | | | | | | | |
| Running.....15,000' | | 5.67 | | | 11.66 | | | | | | | | 3.33 | 2.90 | 13.33 | | | | | | | | |
| Floor.....2,500' | | | | | | | | | | | | | | | | | | | | | | | |
| Pratt door.....50' | | | | | | | | | | | | | | | | | | | | | | | |
| Bolsters.....290 | 6.83 | | | | | 7.99 | | | | | 8.33 | | | | | | | | | | | | |
| Dust guards.....200 | 0.67 | | 0.66 | | 0.50 | | | 1.33 | 0.84 | | | | | | | 0.50 | | | | | | | |
| Ladder sides.....250 | 2.08 | | | | | 0.50 | | | | | | | | | | | | | | | | | |
| Plates and planks.....275 | 2.50 | | | | | 7.92 | | | | | 1.58 | | | | | | | | | | | | |
| Sills, various.....500 | | | | 2.50 | | 11.64 | | 2.50 | 1.66 | | 18.80 | | | | | | 5.00 | | | | | | |
| Sheathing, pass.....5,000' | 6.70 | | | | | | | | | | | | | | | | | 8.30 | | | | | |
| 1,600' | | | | 3.73 | 3.67 | | | | | | | | | | | | | | | | | | |
| Stakes.....250 | | | | | | 4.16 | 1.66 | | | | | | 16.66 | | | | | | | | | | |
| Step treads.....250 | 3.42 | | 1.91 | 0.42 | | | | 2.33 | 1.82 | 2.07 | | | | | | | | | | | | | |
| Step brake.....30 | | | | | | | | | | | | | | | | | | | | | | | |
| Step pass. side.....25 | | | | | | | | | | | | | | | | | | | | | | | |
| Stops, frt. car door.....150 | 1.25 | | 1.25 | | | | | | | | | | | | | | | | | | | | |
| Studding, frt. car.....100 | | | | | 0.49 | | | | | | | | | | | | | | | | | | |
| Saddles, frt. & cab. c.....675 | | | | | 1.70 | | | | | | | | | | | | | | | | | | |
| Tie & dft. timbers.....150 | | | | | | 12.50 | | | | | | | | | | | | | | | | | |
| Truck sills.....20 | | | | | 1.27 | | 0.83 | | | | | | | | | | | | | | | | |
| Total | 35.38 | 5.67 | 6.97 | 7.05 | 18.02 | 48.07 | 21.21 | 8.23 | 10.26 | 8.10 | 37.29 | 9.28 | 40.91 | 12.40 | 13.33 | 0.50 | 5.00 | 8.30 | 53.53 | 1.00 | 21.00 | 3.33 | |

TABLE IV—MATERIAL OTHER THAN CAR REPAIRS.

| ITEM AND QUANTITY. | 18", 22", 24" Rip Saw. | Self-feed Rip Saw. | Comb. Rip and C. O. Saw. | Edging Saw. | Sw. C. O. Saw. | Ry. C. O. Saw. | Band Saw. | Buzz Planer. | Single Surfacer. | Shaper. | I-S. H. Borer. | Rotary Bed Planer. | Dowel Machine. | Lathe. | G. & W. Planer. | Gainer and Tenoner. | Inside Moulder. |
|---|------------------------|--------------------|--------------------------|-------------|----------------|----------------|-----------|--------------|------------------|---------|----------------|--------------------|----------------|--------|-----------------|---------------------|-----------------|
| Closet stand.....1 | 1.28 | | | | 1.70 | | | 0.21 | 0.18 | 0.09 | | | | | | | |
| Bridges, gangplanks for freight houses.....70 | 4.80 | | | 8.40 | 8.60 | | | | | | | 4.80 | 11.40 | | | | |
| Blocking carriage.....50 | 2.50 | | | | | 0.50 | | | | | | 1.50 | 0.50 | | | | |
| Blocking, wreck trains.....4,000' | | | | | | 108.33 | | | | | | | | | | | |
| Barrel heads.....25 | 0.08 | | | | 0.05 | | 0.20 | | | | | | 0.17 | | | | |
| Boards, playing card.....36 | 3.00 | | 3.00 | | | | | | | 0.60 | 4.80 | | | | | | |
| Carpenters' tool boxes.....36 | 3.00 | | 2.40 | | | | 0.90 | | 2.10 | 1.80 | 1.80 | | | | | | |
| Desks, stand. office.....1/2 | 0.83 | | 0.16 | | | | | | 0.35 | 0.35 | 0.08 | | | | | | |
| Folder racks (pass. stations).....3 | 0.24 | | | | 1.41 | 0.24 | | | 0.17 | 1.00 | 0.30 | | | | | | |
| Handles, brush and lant. hook.....197 | 8.96 | | 4.76 | | | | | | | 2.40 | | | | | | | |
| Horses, carpenter.....48 | 7.32 | | | | | 14.72 | | | 3.33 | 2.25 | | | | | | 5.33 | |
| Gages, car insp.....2 | 1.65 | | | | | 0.90 | | | 2.20 | 2.30 | | | | | | | |
| Keg heads.....36 | 0.14 | | | | 0.14 | | 0.70 | | | | | | 0.42 | | | | |
| Ladders— | | | | | | | | | | | | | | | | | |
| 8'.....36 | | | | | | | | | | | | | | | | | |
| 8'-15'.....10 | | | | | | | | | | | | | | | | | |
| 15'-20'.....5 | | | | | | | | | | | | | | | | | |
| 20'-30'.....5 | | | | | | | | | | | | | | | | | |
| Step.....12 | 6.55 | | | | | 3.70 | | 1.80 | 1.50 | 0.40 | | | 1.50 | 0.53 | | | |
| Push car sills.....40 | 0.53 | | | 0.27 | | 0.26 | | | | | | 0.68 | 0.93 | | | | |
| Pail bottoms for canvas colp. pails.....24 | | | | | | 0.11 | 0.33 | 0.34 | 0.28 | 0.56 | | | | | | | |
| Pickets, fence.....50 | 0.14 | | | | 0.14 | | | | | | | | 0.67 | | | | |
| Rollers, freight house.....125' | | | | | | 4.17 | | 1.57 | | | | | 1.56 | | 10.40 | | |
| Signs, cinder.....25 | 0.35 | | | | 0.17 | | | 0.52 | | 0.83 | 0.18 | 0.51 | | | | | |
| Stretchers, cab. and bag. car.....25 | 4.50 | | | | | 6.00 | | 3.00 | 2.50 | | 3.00 | | 3.00 | 6.50 | | | |
| Window lifts.....5 | | | | | | | | | | | | | | | | | |
| Wheel clubs.....3 | | | | | | 0.18 | 0.90 | | | | | | | 0.72 | | | |
| Wheel levers.....12 | 0.40 | | | | | 0.40 | 0.60 | | | 0.80 | | | 1.60 | | | | |
| Wedges.....700 | | | | | | 4.67 | | | | | | | | | | | |
| Flagsticks.....1,660 | 20.59 | | | | | 7.02 | | 12.88 | 18.50 | 1.00 | 2.60 | | 6.30 | 3.09 | | | 9.15 |
| Totals | 69.97 | | 10.32 | 13.34 | 21.49 | 142.51 | 3.63 | 28.47 | 33.06 | 6.46 | 19.63 | 17.90 | 10.80 | 20.52 | 0.72 | 5.33 | 9.15 |

necessary part of the operation which must be included in the total and is not included in Tables 1 or 2.

Table Number 4 gives the machine tool time spent on various operations furnished on order for the various departments of the road, being material other than for car repairs.

In Table Number 5 will be found a summary giving a recapitulation of all the operations shown on Tables 1 to 4 inclusive, and brought together as a grand total in Column 5. Column 6 gives the load factor which was determined as follows:

Load factor = Total machine time ÷ (Number of tools x 26 days x 9 hours.)

Columns 5 and 6 are equated to an equivalent number of freight cars on the basis of five hours per car, which is found to be the average obtained from segregating the time consumed

TABLE V—SUMMARY.

| Column Number..... | 1 | 2 | 3 | 4 | 5 | 6 |
|--|-----------------------------------|------------------------------------|----------------------------------|---|---------------------|----------------|
| No. of Tools. | General repairs. | Material furnished outside points. | Material other than car repairs. | Time changing, adjusting, and sharpening tools. | Total machine time. | * Load factor. |
| 4 Rip saws { 2-18" } { 1-22" } { 1-24" } | 292.68 | 35.38 | 67.97 | 23.30 | 419.33 | 0.45 |
| 1 Self-feed rip saw..... | 60.09 | 5.67 | | | 65.76 | 0.28 |
| 1 Comb. Rip & C. O. saw.. | 145.84 | 6.97 | 10.32 | | 163.13 | 0.70 |
| 2 Edging saws | 40.40 | 7.05 | 13.34 | | 60.79 | 0.13 |
| 2 Swing C. O. saws..... | 373.98 | 18.02 | 21.49 | | 413.49 | 0.88 |
| 2 R'y C. O. saws..... | 153.70 | 48.07 | 142.51 | | 344.28 | 0.74 |
| 3 36" band saws..... | 223.83 | 21.21 | 3.63 | | 248.67 | 0.36 |
| 2 Buzz planers, 16"-12".. Gainers and tenoners— | 148.07 | 8.23 | 28.47 | 5.83 | 190.60 | 0.41 |
| 1 Horz. car gainer..... | | | | | | |
| 1 Comb. G. & T., double | 303.08 | 5.00 | 5.33 | 15.42 | 328.83 | 0.35 |
| 1 End tenoner | | | | | | |
| 1 Small overhead gainer. | | | | | | |
| 1 Double head shaper..... | 84.93 | 8.10 | 6.46 | 90.99 | 190.48 | 0.81 |
| 1 Inside moulder, 5"..... | 60.37 | 8.30 | 9.15 | 12.63 | 90.45 | 0.39 |
| 1 Outside moulder, 8"..... | 33.94 | | | | 33.94 | 0.15 |
| 1 Gray & Woods planer, 36" | 175.77 | 53.53 | 0.72 | 2.50 | 232.52 | 1.00 |
| 2 3-spindle vertical borers.. | 424.50 | 37.29 | | | 461.79 | 0.98 |
| 1 1-spindle horizontal borer. | 27.12 | 9.28 | 19.63 | | 56.03 | 0.24 |
| 1 Horizontal H. C. mortiser | 46.94 | | | | 46.94 | 0.20 |
| 1 Vertical H. C. mortiser.. | 187.99 | 21.00 | | | 208.99 | 0.90 |
| 1 Rotary bed planer..... | 137.13 | 40.91 | 17.90 | 2.50 | 198.44 | 0.85 |
| 1 Single surfacer, 24"..... | 174.39 | 10.26 | 33.06 | 2.50 | 220.21 | 0.94 |
| 1 Sash and blind tenoner... 1 Panel machine..... | 55.19 | | | 38.25 | 93.44 | 0.40 |
| 1 Sash and door mortiser.. | 4.13 | 3.33 | | | 7.46 | 0.03 |
| 1 Berlin 4-side tim. planer. | 56.64 | | | 4.15 | 60.79 | 0.26 |
| 1 Jig saw | 151.98 | 12.40 | | 58.40 | 222.78 | 0.95 |
| 1 Dowel machine..... | 7.16 | 1.00 | | | 8.16 | 0.03 |
| 1 Lathe | 6.23 | | 10.80 | 13.33 | 30.36 | 0.13 |
| 1 Daniels planer, 24"..... | 0.93 | | 20.52 | | 21.45 | 0.09 |
| 1 Saw mill (resaw)..... | 2.40 | | | | 2.40 | 0.01 |
| 1 Matcher | 11.83 | | | | 11.83 | 0.05 |
| 1 Matcher | 54.17 | 13.33 | | 6.56 | 74.06 | 0.31 |
| Total machine hours..... | 3,445.41 | 374.33 | 411.30 | 276.36 | 4,507.40 | 0.46 Avg. |
| Equivalent cars— | | | | | | |
| Freight | 550 | 80 | 84 | | 714 | |
| Passenger | 70 | | | | 70 | |
| Total machine hours (Col. 5). | | | | | | |
| * Load factor = | Number tools x 26 days x 9 hours. | | | | | |
| Approximate hours per month..... | { Passenger car | | | | | 5.84 |
| | { Freight car | | | | | 6.00 |

on freight cars, as given in Table 1 and divided by the number of freight cars comprehended in that table.

A study of tables of this character prepared for any shop now in operation will readily show which tools are being used to full capacity and which are lying idle the larger part of the time. It will often permit the rearrangement of the work so that a single tool can be made to do the duty of two or three, or on the other hand it will show just what new equipment will be necessary to increase the capacity of the shop.

The ideal load factor is very greatly influenced by certain machines and operations that are, from the nature of the case, intermittent and infrequent in their operation and scope, which particular machines would be required if only 50 cars were re-

paired and yet, are capable of handling work of the character adapted to these particular machines for 500 or more cars, just as in a locomotive shop, a driving wheel lathe that could handle the tire turning for 500 locomotives per year would be required in a smaller shop handling only 50 engines a year. Consequently considerable judgment and experience is necessary in pro-rating or focusing the results of such an analysis as the foregoing to comprehend or apply to the needs or requirements of shops of different or varying capacities.

TENDER DERAILMENTS

The following diagnosis of the cause of tender derailments is taken from a letter from E. W. Summers, president of the Summers Steel Car Company, Pittsburgh, Pa., which was published in the *Railway Age Gazette* of September 27, 1912. Very few problems have given so much trouble to railway officers as has that of tender derailments, and Mr. Summers gives a simple and logical reason of its cause and suggestions as to the solution of the difficulty. He says:

"It is easy enough to know the cause of a wreck where there is a collision, or a switch is left open, but on a straight track with rails apparently in normal condition, the problem is different. Note the phrase, "apparently in normal condition." After the wreck, with the rails and cross ties all torn up and the ballast swept away, investigation proves little or nothing. Everything is so twisted that we cannot tell what happened first. Whether the report is "rails spread," or "defective rail," or "cause unknown," it is all the same—we learn nothing from it. With the track absolutely straight and solid it will not happen, but you cannot keep a track in such a condition.

"The trouble is that we are shooting thousands of tons along the track at almost cannon ball speed and attempting to deflect its course without making provision for the resistance necessary to cause such deflection. In rounding curves provision is made for the reaction necessary to change the course of the train, but slight kinks occur in straight track without provision for taking care of the disturbance set up. Lateral kinks in the rails are provided for by loose fits of journals and journal bearings and swing or roller motion devices which permit the wheels to move sideways, back and forth, without deflecting the main mass of the car body from its line of travel. Vertical irregularities are usually taken care of by the truck springs which permit the wheels to move up or down relative to the car body without changing its course.

"There are times, however, when by reason of violent side rocking of the car body or traversing a warped track surface, the truck springs are compressed solid, and when this happens coincident with a vertical change in the rail surface, the whole of the loaded car has to be deflected from its course. This causes a portion of the stored energy of the moving car to be converted into vertical impact on the rail. Let us analyze this:

"Take the weight centered at the axis of a wheel on an engine tender, say 2,000 lbs., which includes wheel, axle, journal box and contents. This mass or weight moving along the track at the rate of a mile a minute or 88 feet per second, will have a stored energy of 242,000 ft. lbs. This amount is arrived at as follows:

$$\frac{2,000 \times 88 \times 88}{64.4} = 242,000$$

"In Fig. 1 the 242,000 ft. lbs. measured off at a-b is shown graphically. The wheel runs against an obstruction of the rail at E, the point of contact being at an angle of 45 deg. from the line of travel through the center of mass at a. Drawing a line from a to E we have the line of resistance, and a line drawn perpendicular to a-E and passing through b intersects a-E at c. The line c-d represents the vertical reaction at E equal to 121,000 ft. lbs., and a-d represents the horizontal reaction at E equal to

121,000 ft. lbs. They are both equal because the resistance contact point *E* is at an angle of 45 deg. with the line of force *a-b*. Fig. 1 was considered with the obstruction at an angle of 45 deg. with the line of force in order that the force diagram might be easily understood. It is an exaggeration of conditions and would be sure to cause a wreck.

"Fig. 2 shows a condition that is likely to be found at crossings or frog points, where the point of the frog comes in contact with the wheel tread about 4 in. in advance of the center of the wheel. With this condition, the 242,000 ft. lbs. is measured at *a-b*. A line is now drawn through *b* perpendicular to *a-E* at *c*. Then *d-c*, 53,000 ft. lbs., equals the vertical reaction at *E*; and *a-d*, 12,500 ft. lbs., equals the horizontal reaction at *E*. This

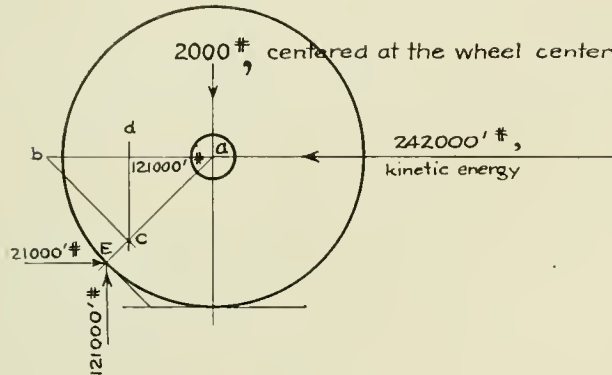

Fig. 1.

is the case when the mass in moving along the rail has to lift only the wheel load of 2,000 lbs. over the slight elevation at *E*. In other words, the wheel raises that slight amount so quickly that the great mass of the car body and its load is not moved up at all, the truck springs absorbing the wheel movement.

"This cannot occur if, from side swaying of the car body, the truck springs are compressed solid at a time coincident with the wheel coming in contact with the frog point. In that case the greater mass of the car body must move up with the wheel and the mass lifted may be 20,000 lbs. instead of 2,000 lbs. The vertical and horizontal reaction at *E* will be increased in the

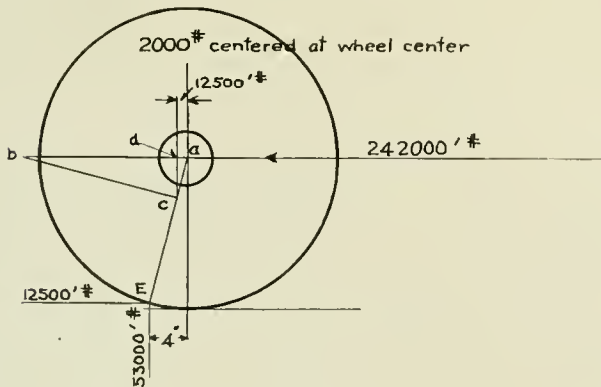

Fig. 2.

ratio as 2,000 is to 20,000, or 10 times as great, the vertical reaction being 530,000 ft. lbs., and the horizontal 125,000. In this case the vertical and horizontal reactions at *E* are produced because of the 20,000 lbs. resistance against the upward movement of the wheel, but the force that is pushing the wheel along the track is applied to the truck through the center plate; the wheel striking the frog point is retarded by an unbalanced force of 125,000 ft. lbs., while the one on the other end of the axle has no obstruction, the two ends of the axle and their wheels must therefore travel on at different velocities.

"What is the result? Derailment, either from rails spreading, or the wheel flange crossing over the rail, or something breaks.

It's all the same, the train is ditched and somebody gets busy with a report on the cause of the wreck.

"The real cause is defective equipment—defective in design; defective because of the gradual increase in load and speed of trains without taking into account the necessity for flexibility between the truck and the heavy rigid car body. The engine boiler has been taxed for heating, lighting, braking, signaling, more tonnage and higher train speed. The engine tender has been built higher, longer and heavier, its center of gravity being in some cases as high as 8 ft. above the rail, its spring capacity almost nil. Too much spring movement causes too much rocking with this high center of gravity.

"Wreck after wreck has occurred from this cause, often attended with loss of life. The example of a frog point obstruction shown in Fig. 2 is only used as a basis of calculation. The defective track may be a low or high joint, a loose joint with one rail having a solid support and the other not. There are many conditions of frozen or frost heaved track that produce the result. The unbalanced horizontal and vertical reactions may be more or less than in the example. What I wish to call attention to is the fact that there is an unbalanced reaction on the wheel, sufficient to slew the truck, which will either spread the rails or break a wheel flange, or cause the flanges to mount the rail and go over, or something gives way from the excessive stress set up which causes derailment, and that it can be remedied by a more flexible connection between the truck and the car which does not permit of the concentration of all the load on half the springs or wheels."

DUST REMOVER FOR HAIR PICKING MACHINE

Machines for cleaning the hair and moss stuffing used in seat cushions, particularly those in locomotives and cabooses, are usually very disagreeable for the operator and others in the vicinity because of the large amount of dust that is thrown in the air. W. W. Warner, assistant general foreman of the Kent, Ohio, shops of the Erie, has arranged a dust collector which overcomes this difficulty and at the same time improves the efficiency of the machine as a cleaner. It consists of a large galvanized iron box which is connected to the picking

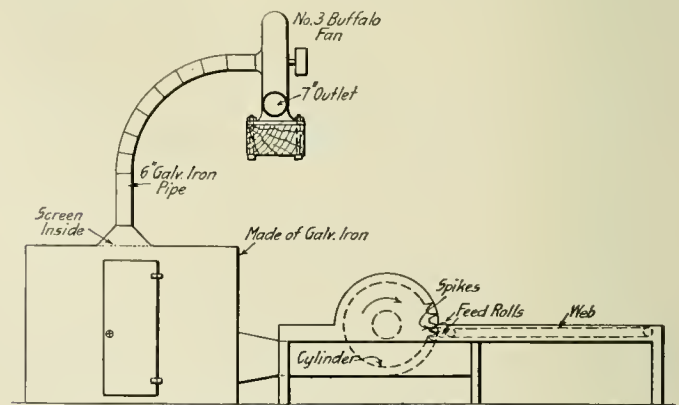

Suction Blower on a Hair Picking Machine.

machine by a sheet iron cylinder, so arranged that after the material leaves the machine it drops in it. Except for this opening the cylinder is air tight. There is a connection from the top of the iron box to a No. 3 Buffalo fan which operates as an exhauster and creates a partial vacuum inside the box and in the cylinder extending to the cleaning machine. The hair or moss when cleaned is sucked in the box and the dust and dirt is drawn up through the fan and discharged outside the building. There is a screen across the suction of the fan which prevents any of the material escaping from the box.

NEW MOTIVE POWER ON THE SANTA FE.

Seventy Locomotives of Four Types Have Recently Been Put in Service, Including Twenty Balanced Compounds.

The Atchison, Topeka & Santa Fe has recently received 70 locomotives of the following types from the Baldwin Locomotive Works:

- 20 Santa Fe type for oil burning.
- 10 Pacific type for oil burning.
- 10 Pacific type for coal burning.
- 10 consolidation for oil burning.
- 14 switching for oil burning.
- 6 switching for coal burning.

In general, the new locomotives are very similar to those of the same types already in service. The differences between the former engines and the new ones are due to the general development in locomotive design and to changes made necessary by minor weaknesses, or by local conditions. While the new power represents the latest development in locomotive construction, the various details so far as possible are interchangeable with corresponding parts of the older locomotives. In most instances where revision of design of individual parts has been necessary because of weakness, the new parts have been made

converted to Mallet compounds by the addition of forward units.* The new locomotives are of the same general design as those previously built. The most notable change lies in the use of superheated steam in single expansion cylinders instead of saturated steam in tandem compound cylinders and a slight increase in weight due chiefly to the use of a larger boiler. The shell diameter at the front end, has been increased from 78¾ in. to 80¾ in., and the tubes have been lengthened from 20 ft. to 21 ft. The grate area and other firebox dimensions, however, are practically unchanged.

The superheater is of the Schmidt type, with 36 elements, placed in as many 5½ in. flues. The steam piping is arranged in accordance with recent practice, and superheated steam is delivered direct to the steam chests through outside pipes. Inside admission piston valves, 16 in. in diameter, control the steam distribution. These valves are driven by the Walschaert gear and are set with a lead of ¼ in. The Ragonet power reverse mechanism has been applied as a result of continued trial on



Powerful Simple Freight Locomotive of the 2-10-2 Type for the Santa Fe.

interchangeable with the corresponding parts of older engines, thus reducing the number of patterns as well as the amount of repair material required for stock.

The boilers of all the new engines have radial stay fireboxes and all the locomotives for road service are equipped with Schmidt superheaters. The reversion in this order, to the 2-10-2 type locomotive for heavy freight service is a matter of considerable interest, indicating, as it does, the success achieved by the former engines of this type. The retention of the balanced compound in heavy duty passenger service is also noteworthy. These locomotives are among the most highly developed thus far built, and their successful performance can safely be assured. A more detailed discussion of the principal features of the various classes follows:

SANTA FE TYPE.

The first locomotives with this wheel arrangement were placed in service on the Santa Fe in 1903, and during the years 1903-1907, a total of 160 locomotives of this type were built by the Baldwin Locomotive Works for service on the mountain divisions. Some of these engines have undergone extensive alterations since they were first constructed, and several have been

previous engines of other classes. The main cylinders are oiled by a five-feed lubricator which has a lead to each steam pipe and one to each cylinder barrel.

The frames are of 40 point carbon steel, with main sections 5 in. wide cast in one piece with single front rails. Transverse braces of cast steel are placed midway between the adjacent pairs of driving pedestals, except at the rear where the brace is placed close to the fifth driving axle. This brace forms a seat for the sliding shoes which support the front end of the firebox. Just back of the fifth pair of pedestals the rear frames are spliced to the main frames. The rear truck is of the Rushton type with inside journals, the same as has been applied to the previous engines of the same general design. The back end of the firebox is supported on an expansion plate bolted to the foot plate.

Due provision has been made for bracing the frames at the front end. Just forward of the cylinders they are secured to a cast steel deck-plate; while between the cylinders and the leading driving pedestals is a most substantial transverse brace of cast steel which supports the driving brake shaft. The brake cylinders are bolted to the guide yoke. Each guide bearer is

* See *American Engineer and Railroad Journal*, May, 1911, page 171.

braced by a longitudinal cast steel tie, which is bolted at its forward end to the top of the steam chest.

As in the ten-coupled locomotives of the Santa Fe type recently built for the Chicago, Burlington & Quincy* counterweights are keyed to the main axle between the frames to compensate for deficiency of weight in the wheel centers.

The equipment of these locomotives includes cylinder relief

ing. The high pressure piston rods are somewhat shorter than the low pressure, in order to allow sufficient clearance between the main rods and the first driving axle. When the inside cranks are on the back dead center, the crossheads are immediately above this axle. The inside guides are of the Laird type, this design having been adopted because it provides a maximum amount of clearance under the crossheads. These guides are

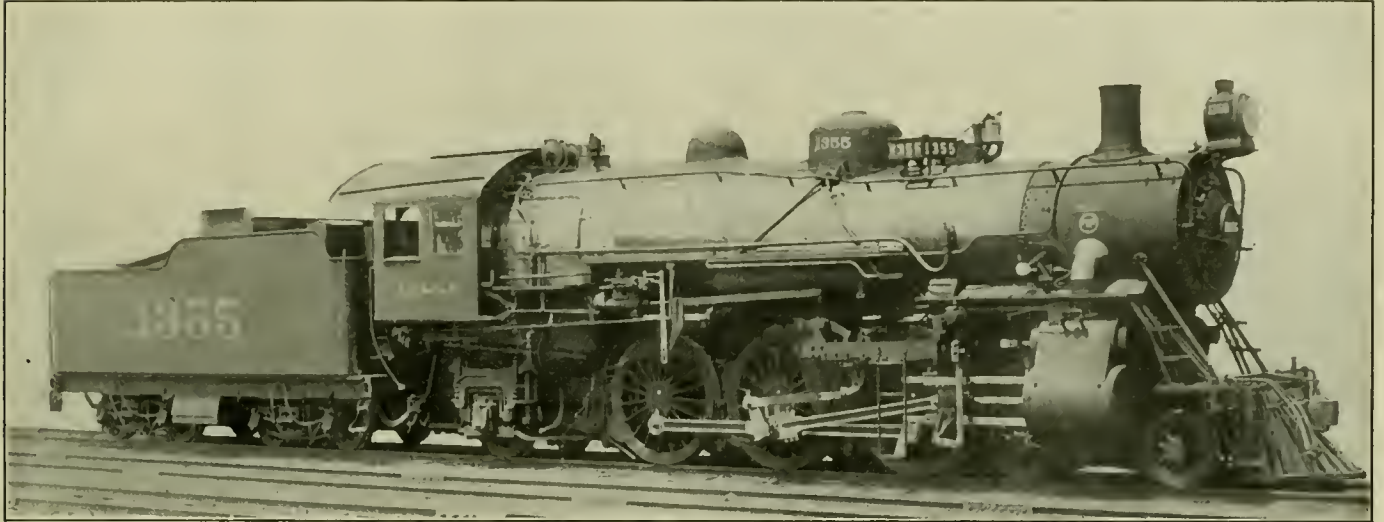

Balanced Compound Pacific Type Locomotive With Superheater for the Santa Fe.

valves, as well as drifting valves of the Sheedy pattern. Flange lubricators are applied to the leading pair of driving wheels. The oil-burning equipment is in accordance with the railway company's practice. A 2 in. Booth burner is used and it is placed in the forward end of the firebox.

PACIFIC TYPE.

These locomotives are generally similar to the twenty-eight balanced compound Pacific type engines built for this road last

supported in front by the yoke which braces the outside guides and is independent of the back cylinder heads. At the back they are bolted to a substantial steel casting which extends the full depth of the leading driving pedestals. This casting has two openings formed in it, through which the high pressure main rods pass. Immediately in the rear of this casting, the upper frame rails are braced by the valve motion bearer. Another brace, a short distance ahead of the rear driving pedestals, is bolted to both the upper and lower frame rails. The trans-

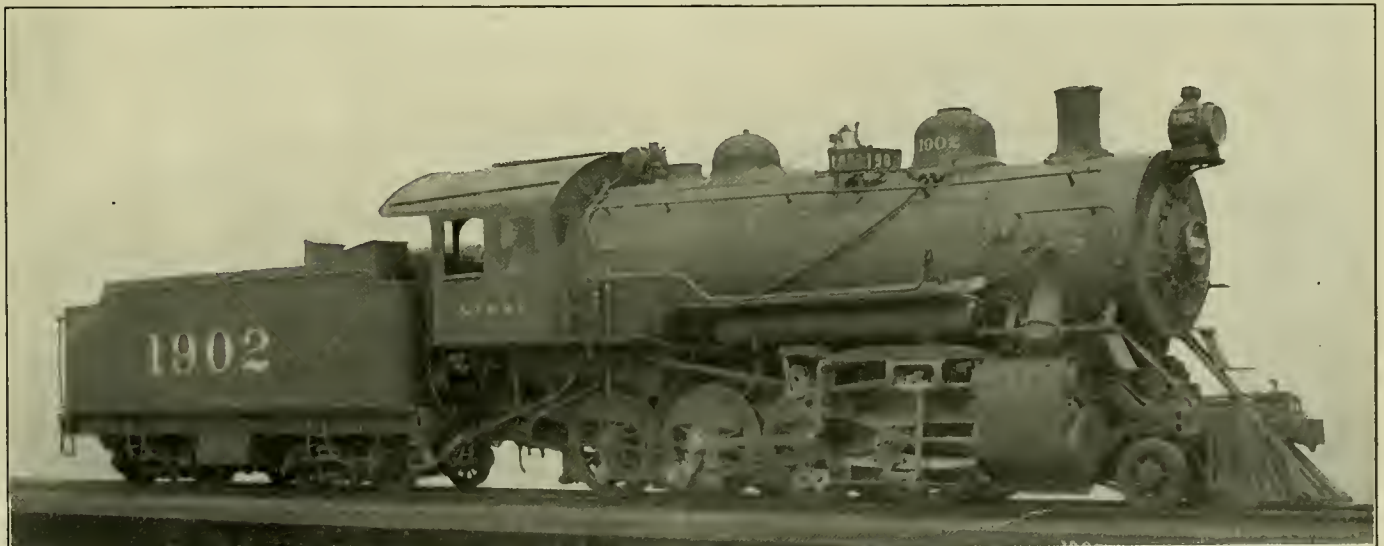

New Superheater Consolidation Locomotive for the Santa Fe.

year by the Baldwin Locomotive Works.† The tractive effort, working compound, is 34,000 lbs.

The inside or high pressure cylinders are placed on an angle of $7\frac{1}{2}$ deg., with their centers $26\frac{3}{4}$ in. above the outside cylinder centers, measured on the vertical center line of the cylinder cast-

verse bracing of the frames in a four cylinder balanced engine presents some difficult problems, but in the locomotive under discussion a most satisfactory arrangement has been worked out.

The design of the superheater calls for no special comment. The steam pipes pass out through the sides of the smoke-box and deliver steam directly to the steam chests. The construction of the cylinder castings is thus materially simplified, the

* See *American Engineer*, May, 1912, page 231.

† See *American Engineer*, February, 1912, page 65.

more so as the valves are arranged for inside admission to the high pressure cylinders. Walschaert motion is used, and as the gears are driven from the outside pins they are arranged in the same manner as when using outside admission valves on a single expansion locomotive. The gears are controlled by the Ragonnet power mechanism.

The coal burning locomotives are equipped with brick arches, and the grates and fire-door are operated by pneumatic power. The ash pan has three hoppers, with swing bottoms which can be operated independently of each other. Special attention has been given to equipping the locomotives so that they can be conveniently handled.

CONSOLIDATION LOCOMOTIVES.

These locomotives exert a tractive effort of 48,800 lbs. and carry an average weight of nearly 49,000 lbs. on each pair of driving wheels. The general design is based on that of consolidation engines which were placed in service by the Santa Fe in 1908.* The weight has been somewhat increased, due to enlarging the boiler to accommodate the superheater.

A wagon-top boiler with wide firebox is used in this design, and the front portion of the mudring is sloped to secure sufficient depth at the throat. The staybolts are so spaced that a brick arch with water tubes can be applied, if at any time it is desired to change the locomotives to coal burners.

As in the other road engines, the superheater is arranged with outside steam pipes, and the valves are driven by Walschaert gear. In the present instance, the link and reverse shaft bearings are bolted to the guide bearer. The combining levers are pinned directly to the valve stems. A longitudinal bearer is placed on each side of the locomotive, and is supported between the cylinder casting and the guide yoke. To this bearer is bolted a bracket which supports the valve rod crosshead. This arrangement provides an efficient brace for the guide yoke, in addition to a valve rod support which is independent of the main guides.

The frames are 4½ in. wide, with double front rails. A transverse brace, extending the full depth of the pedestals, is placed midway between the second and third, and third and fourth axles respectively. The firebox is supported by sliding shoes in front and an expansion plate at the back.

SWITCHING LOCOMOTIVES.

These engines are all equipped with Stephenson link motion, the steam distribution being controlled by 12-in. piston valves. They have wagon-top boilers with long fireboxes placed above the frames. The cylinders are 20 in. x 26 in., and with 51 in. wheels and a steam pressure of 180 lbs.; the tractive effort is 31,200 lbs. The total weight, equipped for coal burning, is 154,000 lbs. The design is one which the Santa Fe has used in general switching service with very satisfactory results.

The general dimensions of the road engines are given in the following table:

| TYPE. | 2-10-2 | 4-6-2 | 2-8-0 |
|--|---------|-------------|---------|
| Gage, ft. & in..... | 4-8½ | 4-8½ | 4-8½ |
| Service | Freight | Passenger | Freight |
| Fuel | Oil | Coal or Oil | Oil |
| Tractive effort, lbs. | 63,580 | 34,000 | 48,800 |
| Weight in working order, lbs. | 295,900 | 268,500 | 226,300 |
| Weight on drivers, lbs. | 248,900 | 163,500 | 195,500 |
| Weight on leading truck, lbs. | 21,400 | 54,600 | 30,800 |
| Weight on trailing truck, lbs. | 25,600 | 50,700 | |
| Weight of engine and tender in working order, lbs. | 470,000 | 440,000 | 385,000 |
| Wheel base, driving, ft. & in. | 19-9 | 13-8 | 15-6 |
| Wheel base, total, ft. & in. | 35-10 | 35-1 | 24-6 |
| Wheel base, engine and tender, ft. & in. | 66-4 | 61-11 | 58-3 |
| RATIOS. | | | |
| Weight on drivers ÷ tractive effort | 3.92 | 4.80 | 4.00 |
| Total weight ÷ tractive effort | 5.66 | 7.80 | 4.63 |
| Tractive effort x diam. drivers ÷ equivalent heating surface | 630.00 | 570.00 | 748.00 |
| Equivalent heating surface ÷ grate area | 95.60 | 75.80 | 78.30 |

* See American Engineer and Railroad Journal, March 1908, page 112.

| | | | |
|--|--------|--------|--------|
| Firebox heating surface ÷ equivalent heating surface, per cent. | 3.36 | 4.80 | 5.38 |
| Weight on drivers ÷ equivalent heating surface..... | 43.30 | 37.30 | 52.80 |
| Total weight ÷ equivalent heating surface | 51.50 | 61.30 | 61.00 |
| Volume both cylinders, cu. ft. | 22.70 | 12.10† | 16.10 |
| Equivalent heating surface ÷ vol. cylinders | 253.00 | 358.00 | 231.00 |
| Grate area ÷ vol. cylinders.. | 2.57 | 4.72 | 2.92 |

CYLINDERS.

| | | | |
|------------------------------|---------|---------------|----------|
| Kind | Simple | Compound | Simple |
| Diameter and stroke, in..... | 28 × 32 | 17½ × 29 × 28 | 23½ × 32 |
| Kind of valves..... | Piston | Piston | Piston |
| Diameter of valves, in..... | 16 | 15 | |

WHEELS.

| | | | |
|--|----------|---------|----------|
| Driving, diameter over tires, in. | 57 | 73 | 57 |
| Driving, thickness of tires, in. | 3½ | 3½ | 3½ |
| Driving journals, main, diameter and length, in..... | 11 × 12 | 11 × 10 | 10 × 12 |
| Driving journals, others, diameter and length, in..... | 10 × 12 | 9 × 12 | 9 × 12 |
| Engine truck wheels, diameter, in. | 29¼ | 34¼ | 29¼ |
| Engine truck journals, in.... | 6½ × 10½ | 6 × 10 | 6½ × 10½ |
| Trailing truck wheels, diameter, in. | 40 | 50 | |
| Trailing truck journals, in... .. | 7½ × 12 | 8 × 14 | |

BOILER.

| Style | W. T. | W. T. | W. T. |
|--|-------------|---------------|----------------|
| Working pressure, in..... | 170 | 210 | 185 |
| Outside diameter of first ring, in. | 80¾ | 70 | 78¾ |
| Firebox, length and width, in. | 108 × 78 | 109½ × 76¼ | 95½ × 71¼ |
| Firebox plates, thickness, in. | ¾ & ⅝ | ¾ & ⅝ | ¾ & ⅝ |
| Firebox, water space, in..... | 6 | F & S-5, B-4½ | F, 4½, S & B-4 |
| Tubes, number and outside diameter, in. | 251-2¼ | 199-2¼ | 256-2 |
| Flues, number and outside diameter, in. | 36-5½ | 26-5½ | 34-5¾ |
| Tubes, material and thickness | Iron No. 11 | Iron No. 11 | Iron No. 11 |
| Flues, material and thickness | Iron No. 9 | Iron No. 9 | Iron No. 9 |
| Tubes, length, ft. & in..... | 21-0 | 21-0 | 14-9 |
| Heating surface, tubes, sq. ft. | 4,174 | 3,233 | 2,658 |
| Heating surface, firebox, sq. ft. | 193 | 210 | 200 |
| Heating surface, total, sq. ft. | 4,367 | 3,443 | 2,858 |
| Superheater heating surface, sq. ft. | 910 | 619 | 565 |
| Equivalent heating surface, sq. ft.*..... | 5,732 | 4,371 | 3,706 |
| Grate area, sq. ft..... | 58.5 | 57.6 | 47.2 |

TENDER.

| | | | |
|---|---------|---------|---------|
| Wheels, diameter, in..... | 34¼ | 34¼ | 34¼ |
| Journals, diameter and length, in. | 5½ × 10 | 5½ × 10 | 5½ × 10 |
| Water capacity, gals..... | 9,000 | 9,000 | 8,500 |
| Coal capacity, tons or gals... .. | 3,300 | 12 | 3,300 |

* Equals evaporating heating surface plus 1.5 times superheater surface.
† Equivalent simple cylinders.

PASSENGER TRAFFIC.—The revenue received from passengers carried on the railways in the United States during the year ended June 30, 1911, was \$997,409,882, which is an increase of \$25,726,683 over that of 1910.

PASSENGER TRAFFIC AT C. & N. W. CHICAGO TERMINAL.—The Chicago & North Western has compiled figures showing that the total number of arrivals and departures at its new Chicago passenger terminal during the first year since the station was opened on June 4, 1911, was 18,797,500, an average of 51,500 per day. During May, 1912, 47,215 persons were served in the lunch room and dining room, while the total for the year was 585,200. The volume of United States mail moving in and out of the terminal has averaged 150 tons a day.

EXHAUST STEAM INJECTOR.—On some of the English locomotives an injector is being applied, which is operated by steam taken from the exhaust pipe. These injectors are of the non-lifting type and capable of feeding against a pressure of 120 lbs. per sq. in. with exhaust steam only. A small supplementary live steam jet is also included in the latest design introduced by Davis & Metcalfe, Ltd., which enables the injector to feed against pressures up to 300 lbs. per sq. in. They operate on the same principle as a high pressure injector and have two draft tubes and a combining nozzle. The exhaust steam passes through an oil separator before reaching the injector. The combining nozzle is constructed on the flap nozzle system. The auxiliary live steam connection is of sufficient size to operate the injector when the locomotive is standing.

MAINTENANCE OF LOCOMOTIVE BOILERS

Rules and Instructions for Washing-Out, Inspecting and Testing of the Boiler and Its Appurtenances.

BY WALTER R. HEDEMAN

In order to maintain locomotive boilers in the highest state of efficiency, it is necessary that they be washed out, inspected, and tested at regular intervals. Aside from the maintenance standpoint the performance of these functions is compulsory according to the federal boiler inspection laws for the promotion of the safety of employees and the traveling public.

To do the work in a systematic manner, uniform rules and instructions should be issued to all concerned to govern them in the various operations. Not only is it necessary for the washing-out, inspection, and testing to be done regularly, as specified in the rules, but an accurate record must be kept of all work done, so that at all times the officer under whose supervision a locomotive is, will know whether a boiler is due for any of the above operations. To facilitate the washing

bolt test of each locomotive boiler; this in addition to the individual record kept in cab and card box. At the same time he must fill out the regular staybolt test report form, which is illustrated in Fig. 4.

The boiler inspectors at each station should make up daily a list of locomotives that are due for washing out, testing and examination of staybolts; these lists should be brought to the attention of the engine despatchers, leading hostlers, boiler washers, and all others concerned. The leading hostlers and others employed at the ash pits should also make an examination of the card record in the card box in the cab of each incoming locomotive, and keep informed as to whether the fires should be knocked on account of washing-out or because of the staybolt test being required. They should also notify

| Form | | | |
|---|------------------------------------|-------|-------------------------|
| B. & O. R. R. CO. MOTIVE POWER DEPARTMENT. LOCOMOTIVE NUMBER _____ | | | |
| THE BOILER OF THIS LOCOMOTIVE WAS WASHED OUT, THE GAGE COCKS AND WATER GLASS COCKS WERE CLEANED AND THE SAFETY VALVES WERE TESTED AND SET O. K. AS INDICATED BELOW: | | | |
| ENGINE HOUSE. | WORK PERFORMED. | DATE. | SIGNATURE OF INSPECTOR. |
| | Boiler Washed | | |
| | Gage and Water Glass Cocks Cleaned | | |
| | Safety Valves Tested and Set O. K. | | |
| | Boiler Washed | | |
| | Gage and Water Glass Cocks Cleaned | | |
| | Safety Valves Tested and Set O. K. | | |
| | Boiler Washed | | |
| | Gage and Water Glass Cocks Cleaned | | |
| | Safety Valves Tested and Set O. K. | | |
| Date Taken Out of Service | | | |
| Date Placed in Service | | | |
| See Other Side | | | |

| | | | |
|--|------------------------------------|-------|------------------------|
| | WORK PERFORMED. | DATE. | SIGNATURE OF INSPECTOR |
| ENGINE HOUSE. | Boiler Washed | | |
| | Gage and Water Glass Cocks Cleaned | | |
| | Safety Valves Tested and Set O. K. | | |
| | Boiler Washed | | |
| | Gage and Water Glass Cocks Cleaned | | |
| | Safety Valves Tested and Set O. K. | | |
| | Boiler Washed | | |
| | Gage and Water Glass Cocks Cleaned | | |
| | Safety Valves Tested and Set O. K. | | |
| Date Taken Out of Service | | | |
| Date Placed in Service | | | |
| NOTE—One of these cards, properly filled out, must be placed in cab of each and every locomotive in service and forwarded every three months (at the time the quarterly inspection is made) to the Supt. of Motive Power or Division Master Mechanic for his record. | | | |
| | | | Master Mechanic. |
| See Other Side | | | |

Fig. 1.—Arrangement of Boiler Inspection and Washout Card Which is Kept in the Locomotive Cab.

out the mechanical department should provide all boilers with suitably located wash-out plugs.

GENERAL INSTRUCTIONS.

Each locomotive in service must be provided with a record card similar to the one shown in Fig. 1, which is to be kept in a metal box as shown in Fig. 2. This is located in the cab as shown in Fig. 3. As inspectors do the work called for on the card, the engine number, station where work is done, date when done, as well as the name of the one doing the work, should be entered in their proper places, and the card placed in the card box in the cab.

The boiler inspector at each station must keep a book record of the date of washing-out and also of the examination and stay-

the boiler inspector and others concerned when they find home or foreign division locomotives for which this work is due.

When a locomotive assigned to one division may be in temporary service on another, the master mechanic of the division on which the locomotive is assigned must notify the master mechanic of the division on which the locomotive is in service of the times that the boiler wash-out, staybolt test and boiler examination are to be performed.

INSTRUCTIONS FOR THE WASHING-OUT.

Locomotive boilers as a rule should be washed at least once during the following periods: Passenger and freight locomotives once every 10 days; switching and helping locomotives once every 15 days. These periods should be lengthened or

shortened wherever advisable, and the weather, service, or mileage conditions justify.

The following methods should be adhered to in washing out locomotive boilers. Blow out the boiler through the blow-off cock until the water has been discharged, after which the blow-off cock should be closed to retain the remaining steam pressure until the staybolts have been tested. After the stay-bolt test the blow-off cock should again be opened to let out the remaining steam and water. When all the water and steam have been blown out, the washout plugs and hand hole plates should be removed.

Wash out the water legs, as well as around the firebox flue

tion before it is returned to service. Every boiler having lap joint longitudinal seams without reinforcing plates should be examined with especial care to detect grooving or cracks at the edges of the seams.

If boilers are equipped with fusible plugs they must be removed and cleaned of scale at least once every month. The exterior of every boiler should be thoroughly inspected before it is put in service, and whenever the jacketing and lagging are removed. The jacketing and lagging should be removed at least once every five years, and a thorough inspection made of the entire exterior of the boiler. The jacketing and lagging should also be removed whenever, on account of indications of leaks, the inspector considers it desirable or necessary.

RULES FOR TESTING BOILERS.

All locomotive boilers must be subjected to a hydrostatic pressure of 25 per cent. above the rated working pressure before being placed in service. This test must be made not less than once each six months, and the water must be heated to about the boiling point immediately before pressure is applied. When it is being made an authorized representative, who is thoroughly familiar with boiler construction, must personally witness the test and thoroughly examine the boiler while under test.

A record of each hydrostatic test must be made on a standard form, Fig. 4, provided for the purpose; each item on the blank must be filled in and the form signed by the authorized representative witnessing the test, who must add in the space provided for remarks anything worthy of note. The date of all hydrostatic tests must be given promptly to the superintendent of motive power by the master mechanics, duplicates of the forms to be kept at the station where the test is made, and a book record kept in the office of the master mechanic.

STAYBOLT TEST.

The staybolts of locomotives in service must be tested not less frequently than once each 15 days. Staybolts must also be tested immediately after each hydrostatic test. When these tests are made, there must not be less than 50 lbs. of

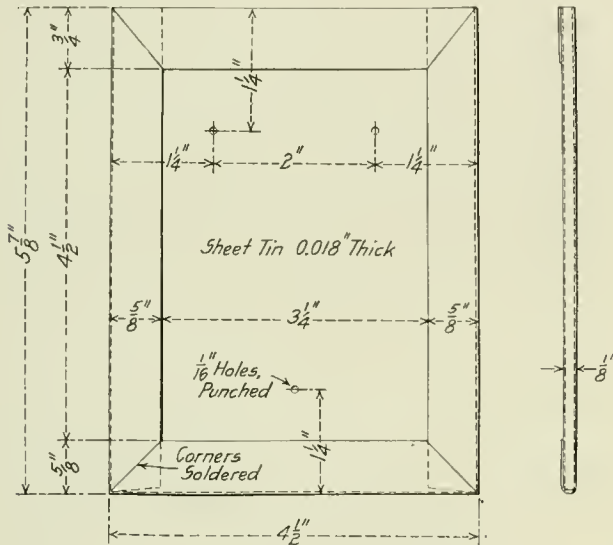

Fig. 2—Box for Holding Boiler Washout Card.

sheet and the furnace door opening. Wash off the crown sheet, the top of the flues, and the cylindrical portion of the boiler, beginning at the smokebox end and following back by washing through the holes in the sides and at the bottom of the shell. Repeat the washing out of the boiler legs, and over the fire door neck to remove the scale that has been washed down from the top of the crown sheet and flues.

Coat the threaded portion of the washout plugs with a mixture of graphite and black oil, and reapply the washout plugs and hand hole plates and fill the boiler. Wherever possible heated water should be used for washing out and filling the boilers. Under no circumstances should the crown sheet be washed before the boiler legs have been washed.

INSPECTION OF BOILERS.

The interior of every boiler should be thoroughly inspected before it is put in service, and whenever a sufficient number of flues are removed to allow examination. All flues of boilers in service, except as otherwise provided, should be removed at least once every three years, and a thorough examination should be made of the entire interior of the boiler. After the flues are taken out the inside of the boiler must have the scale removed and be thoroughly cleaned. The entire interior of the boiler must then be examined for cracks, pitting, grooving, or indications of overheating and for damage where mud has collected, or heavy scale formed. The edges of plates and all laps, seams and points where cracks and defects are likely to develop, or which an exterior examination may have indicated to be weak, must be given an especially minute examination.

It must be seen that braces and stays are taut, that pins are properly secured in place, and that each is in condition to support its proportion of the load. Any boiler developing cracks in the barrel must be taken out of service at once, thoroughly repaired, and reported to be in satisfactory condi-

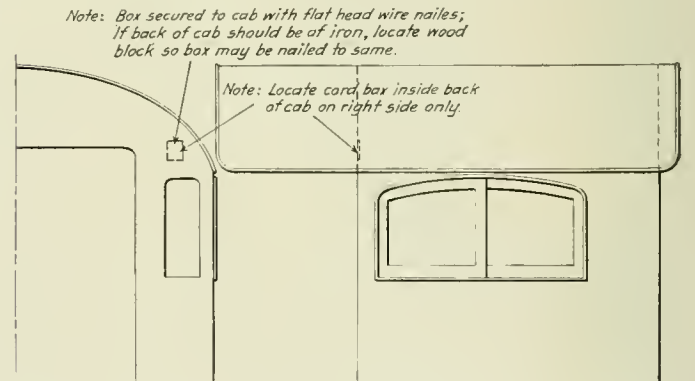

Fig. 3—Location in Cab of Box for Holding Boiler Washout Card.

steam pressure on the boiler, which will produce a sufficient strain on the staybolts to cause the separation of the parts of broken ones. If the boiler is not under steam, the examination may be made after drawing all the water from the boiler.

An inspector especially trained for the service must tap with a hammer each staybolt and crown sheet stay accessible on the firebox end, and those not accessible must be tapped whenever possible on the outside end. Staybolts having tell-tale holes must, in addition to the hammer test, be carefully inspected to insure that all of the tell-tale holes are open, using a drill for this purpose when necessary. No boiler may be allowed to remain in service when there is more than one broken staybolt in any part of the firebox.

All tell-tale holes in staybolts must be thoroughly cleaned by a drill before the hydrostatic test, and when the locomotives

are in the shop for classified repairs. All staybolts must have tell-tale holes drilled 3/16 in. diameter by 1/4 in. deep, and the crown sheet stays must be so drilled when specified.

Flexible staybolts must undergo a special examination not less frequently than once each 18 months, by removing a number of caps in different locations for examination of sleeves

and bolts, preferably while the locomotives are in the shop for classified repairs, and prior to the hydrostatic test.

Precautions must be taken to insure the removal of all defective bolts, and a careful examination must be made of bolts adjacent to the broken ones.

The staybolt inspector must keep an accurate record of the

REPORT OF STAYBOLT TEST AND FIREBOX INSPECTION.

Locomotive boiler No. Class. At Station.
 Date Examined by

Show Location of Entirely Broken Staybolts by Marking X in Black. Show Partially Broken Staybolts by Marking X in Red on Diagrams.

| | |
|---|---------------------------|
| Number of staybolts found entirely broken in right side sheet..... | Number renewed..... |
| Number of staybolts found partially broken in right side sheet..... | Number renewed..... |
| Number of staybolts found entirely broken in left side sheet..... | Number renewed..... |
| Number of staybolts found partially broken in left side sheet..... | Number renewed..... |
| Number of staybolts found entirely broken in backhead sheet..... | Number renewed..... |
| Number of staybolts found partially broken in backhead sheet..... | Number renewed..... |
| Number of staybolts found entirely broken in throat sheet..... | Number renewed..... |
| Number of staybolts found partially broken in throat sheet..... | Number renewed..... |
| Number of staybolts found entirely broken in crown sheet..... | Number renewed..... |
| Number of staybolts found partially broken in crown sheet..... | Number renewed..... |
| Total number of entirely broken staybolts..... | Total number renewed..... |
| Total number of partially broken staybolts..... | Total number renewed..... |

Date staybolts were renewed..... Condition of furnace door sheet.....
 Are all staybolts drilled with tell-tale holes?..... Condition of firebox tube sheet.....
 Were renewed staybolts drilled with tell-tale holes?..... Condition of furnace door ring.....
 Number of staybolts found with tell-tale holes obstructed..... Condition of mud ring.....
 Were all obstructed tell-tale holes cleaned out or redrilled?..... Condition of boiler tubes.....
 Condition of crown sheet..... Condition of arch tubes.....
 Condition of crown sheet staybolts..... Condition of boiler washout and arch tube plugs and hand hole plates.....
 Condition of right side sheet..... Condition of brick arch.....
 Condition of left side sheet..... Condition of boiler with respect to washing out (See Instructions).....

Memoranda:

Boiler tested with ... lbs. water pressure..... Safety valves set at ... lbs.....
 Working pressure ... lbs..... Authorized working pressure ... lbs.....

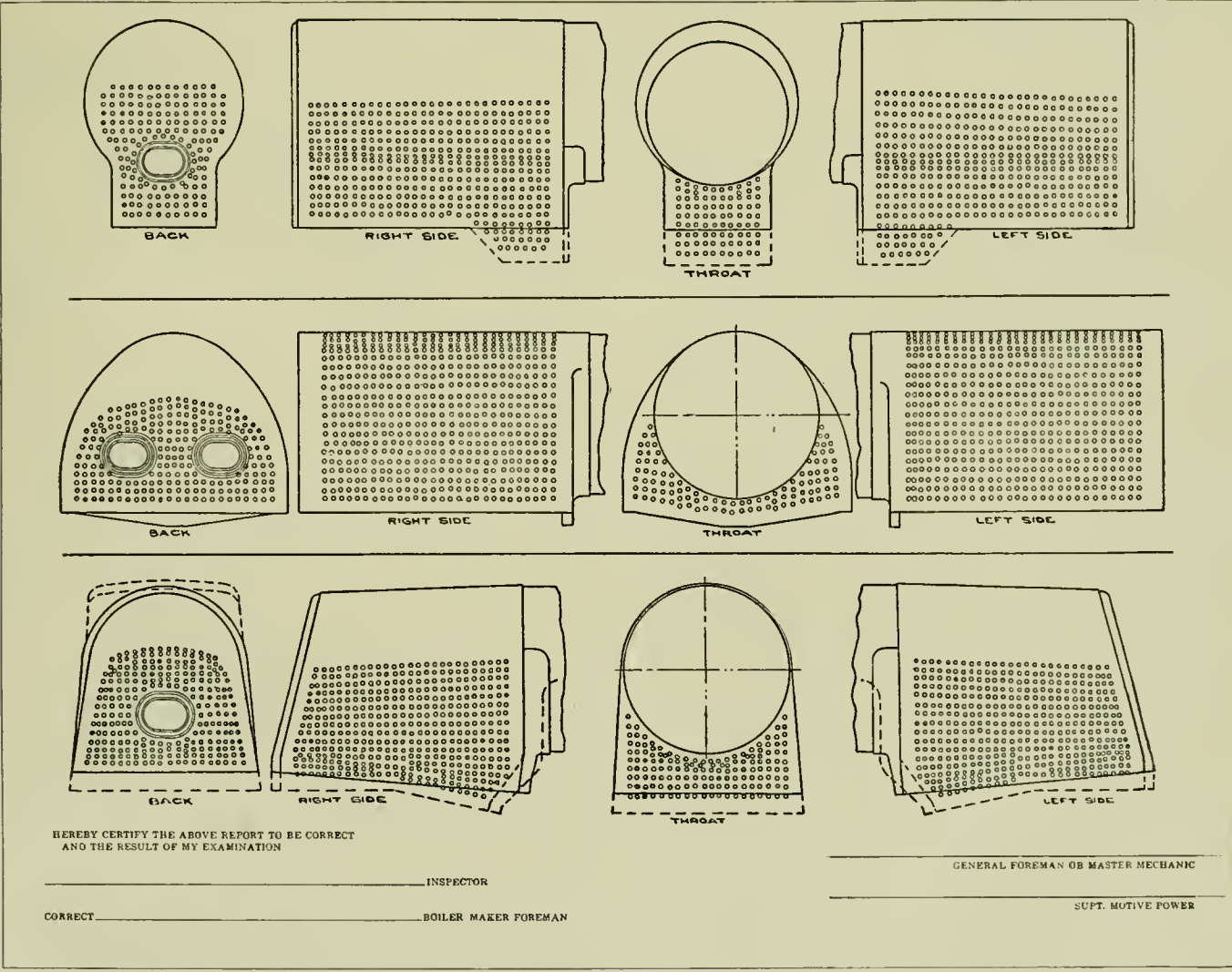

Fig. 4—Form for Report of Staybolt Test and Firebox Inspection.

location of each broken bolt, marking it on the form shown in Fig. 4, and must forward it to the master mechanic or foreman in charge. Master mechanics must promptly report dates of all staybolt tests.

WASHING AND BLOWING OUT OF WATER GAGES.

The boiler inspector must see that the water gage is washed and cleaned at each boiler washing. This should be done before reducing the boiler pressure, by opening the drain cock in the bottom of the gage and allowing first the water and then the steam to blow. As a general rule this will accomplish the cleaning of the gage, but to insure a perfect condition of the gage, after the steam and water pressure has been reduced the drain cock, water and steam valves should be removed and a wire run through the openings. This can be done without disturbing the glass.

After the cleaning of the boiler and when pressure is again applied the water gage should have the drain cock opened, and the water and steam should be allowed to blow through the fittings to note if gage is thoroughly cleaned. Master mechanics and road foremen should insist on the engineers blowing out the gage at the beginning of each trip. All water glasses should be supplied with two valves or shut off cocks, one at the upper and one at the lower connection to the boiler, also a drain cock. It should be so constructed and located that they can be easily opened and closed by hand. The spindles of all gage cocks should be removed and the cocks thoroughly cleaned of scale and sediment at least once every month. All gage cocks must be tested before each trip and must be maintained in such condition that they can be easily opened and closed by hand without the aid of a wrench or other tool.

SETTING OF SAFETY VALVES.

Safety valves should be set by the gage used on the boiler to pop at pressures not exceeding 6 lbs. above the allowed steam pressure, the gage in all cases to be tested before the safety valves are set or any changes are made in the setting. When setting safety valves the water level in the boiler must not be above the highest gage cock. Safety valves should be tested under steam at least once very three months, and also when any irregularity is reported.

RESPONSIBILITY FOR BOILERS.

It must be understood that the above rules apply to all locomotive boilers, whether in freight or passenger service, and that they are in direct charge of the master mechanic in whose district they may be placed.

Locomotive boilers must be tested and inspected in conformity with the requirements of the law. Where no laws exist, the above rules must be adhered to. Where laws do exist, but do not require tests as rigid as the above, the necessary additional tests must be made to conform both to the law and to these rules.

The mechanical department can tell from the report of the staybolt test and fire-ox inspection whether any chronic weaknesses develop in the boilers, and can remedy them by strengthening the sheets or applying flexible stays in place of common ones.

PREVENTING SLIPPED ECCENTRIC BLADES.—On the Chicago & North Western, it is the practice to fit babbit blocks in the slotted opening of the eccentric strap on either side of the bolts that hold the blade. These blocks are the proper shape to fit around the bolt and to fill in the slotted opening. Various sizes are kept in stock, and after the valves are set the nuts are taken off and these blocks are fitted on either side of the bolt. The nut is then replaced and tightened. In this way there is no danger of a slipped blade, if the nuts become loosened.

PNEUMATIC CLAMP FOR TESTING TRIPLE VALVES

A simple device for holding a triple valve while undergoing test, after being cleaned or repaired, is shown in the accompanying illustrations. It was designed by J. A. Jesson, Louisville & Nashville, Corbin, Ky., and consists simply of a casting 7 in. in diameter and 10 in. long, which includes a base for attaching it to a bench. One end is faced off and recessed for receiving the triple valve and will accommodate all types of quick action valves. A separate plate is necessary when testing plain triple valves. At the opposite end the casting is bored out to a diameter of 4 in. x 6 in. depth, and a large solid piston with leather packing is inserted. A hole is drilled through the casting to this opening and a connection is made to the air supply. Passages are also drilled to the recess at the opposite end for connection to the auxiliary reservoir and to the dummy brake cylinder. A boss on the end of the piston has a hole through which a rod is passed that supports a yoke surrounding the whole casting. At the end where the valve is attached this yoke is arched to clear the triple valve flange

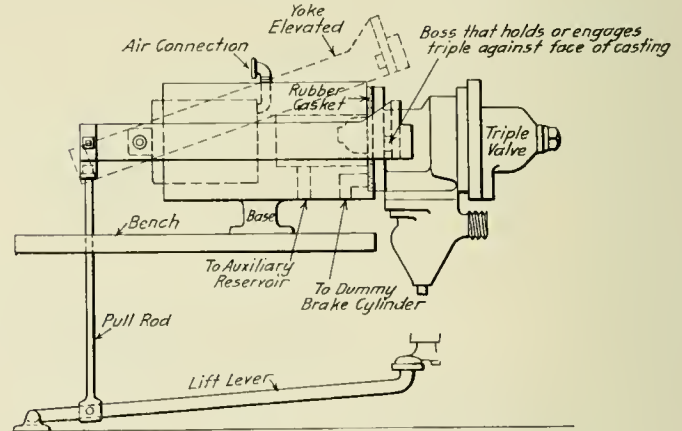
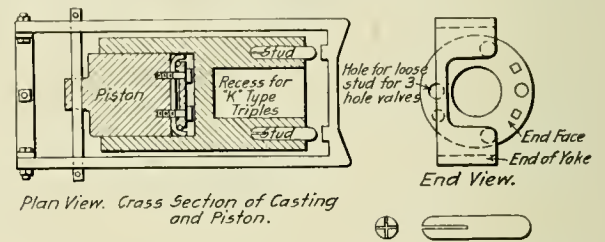

Clamp for Holding a Triple Valve When Testing.

and body, and is provided with bosses arranged as is shown in the illustration. At the back end of the yoke is a cross connection and a bar reaches to a foot treadle allowing the forward end of the yoke to be raised up by foot pressure. The open position is shown by the dotted lines. There are two or three loose pins fitted at the proper point for keeping the valve in place.

With the foot on the treadle the yoke is raised so that the valve can be slipped in place, after which the foot pressure is released and the yoke falls in position. The air is turned on and the valve is clamped securely against the leather gasket where it is held during the testing operation. When the air is discharged from the piston a slight downward pressure on the triple valve loosens the yoke and permits it to be raised up with the foot treadle.

NEW YORK SUBWAYS—A resolution has been approved by the New York State Public Service Commission for the construction of a moving platform subway in Thirty-fourth street. It will extend from Third to a little beyond Eighth avenue.

PISTON, PISTON ROD AND CROSSHEAD REPAIRS

Methods Employed in Two Different Shops. Submitted in the Competition That Closed September 1.

FIRST PRIZE

BY G. H. ROBERTS,

Machine Foreman, Long Island Railroad, Richmond Hill, N. Y.

The writer was fortunate enough to have the opportunity to put in effect some original and possibly radical ideas in handling the machine and fitting work in one of the largest railway shops in this country, and was able to make a large saving in the cost of the repairs on pistons, rods, etc., besides bringing the work up to such a standard that necessary work was finished and ready for engines before they were due out of shop instead of old material in an inferior condition being reapplied to engines.

In a shop turning out two locomotives a day, four new piston heads and rods a day are required as a rule. This is enough to keep a boring mill working on pistons continuously and two or three lathes on rods.

The following methods were put in effect on the piston and crosshead job and in a remarkably short time the pistons and

to the center of the boring mill table from the under side. The bushing has a shoulder to keep it from being pulled through the hole. The heads are not finished on the front face. The bearing for the nut is faced off when the head is on the rod just before the nut is applied.

Operation No. 1 is accomplished as follows:

| | |
|--------------------------|---------|
| Set up | 20 min. |
| Rough face and top | 15 " |
| Total | 35 " |

The speed is 35 ft. per minute, and the feed on the face is $\frac{1}{8}$ in. and $\frac{1}{4}$ in. on the top. The cut on the face is from $\frac{1}{4}$ in. to $\frac{1}{2}$ in. deep and about $\frac{3}{8}$ in. on the top.

Operation No. 2 consists of cutting the grooves for the packing rings. Two tools are used, one $\frac{1}{2}$ in. wide on the left side to rough out the groove and one $\frac{3}{4}$ in. wide on the right side to finish the groove. A $\frac{1}{64}$ in. feed is used at 35 ft. per minute cutting speed. The time for two grooves is 25 minutes.

On operation No. 3 of finishing the outside to fit the cylinder,

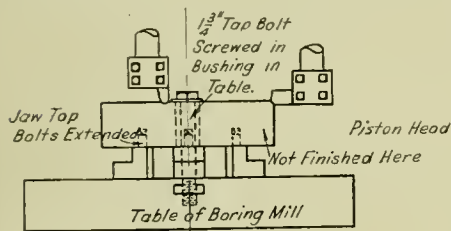

Piston Heads
Operation No. 1.

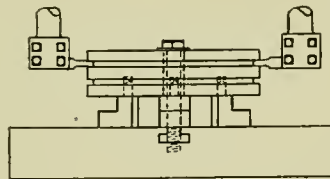

Piston Heads
Operation No. 2.

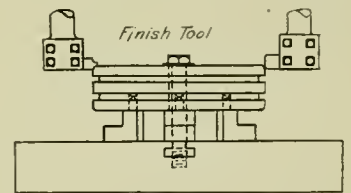

Piston Heads
Operation No. 3.

crossheads were in the lead where formerly they brought up the rear. One vertical boring mill turned all the piston heads, besides doing part of the cylinder head work; two lathes more than kept up the rods and had considerable time for other work, where formerly two and sometimes three lathes were on piston rods.

One of the illustrations shows the first operation on a 21 in. piston head $5\frac{1}{4}$ in. thick, with a $3\frac{1}{2}$ in. hole for piston rod fit, the rod having a $\frac{3}{8}$ in. x $\frac{3}{8}$ in. collar depressed in the head. The piston head has two $\frac{3}{4}$ in. x $\frac{3}{4}$ in. packing rings

a broad tool is used with $\frac{1}{4}$ in. feed at 35 ft. per minute. This cut requires 15 minutes. The corners are rounded off while the cut is running down by using a fillet tool in the other head.

Operations 4, 5 and 6 are shown in one illustration. Three clamps are applied to the outside of the head and the bolt in the center is removed, allowing the hole to be finished. This requires about 5 minutes. The operation of finishing the rod fit requires the following times:

| | |
|------------------------------|---------|
| Drill | 10 min. |
| Ream hole to plug gage | 10 " |
| Counterbore for collar | 5 " |
| Remove from machine | 7 " |
| Total | 32 " |

The boring mill hand is furnished the proper size to turn the piston by the machine shop inspector, who inspected all the work. This saves at least 15 minutes that is ordinarily used by the machine hand to locate the engine and caliper the cylinders himself.

After the piston head is turned the cored holes in the face are drilled and tapped on a radial dress for a $1\frac{1}{4}$ in. socket pipe plug. The drill press hand also applies the plugs, using a square ended wrench 15 in. long. The time required to drill, tap and apply 6 plugs is 40 minutes. A $1\frac{1}{2}$ in. high speed drill is used on the cored holes. The plugs are screwed about $\frac{1}{16}$ in. below the face of the head and the edge is hammered over so that the plug cannot work out.

The plug and bushing gages used on the piston rods and heads are illustrated.

PISTON RODS.

The piston rods are taken in the rough and cut to length and centered in a 6 in. bore Gisholt lathe, requiring from 20 to 30 minutes to complete one rod. It takes at least twice as long

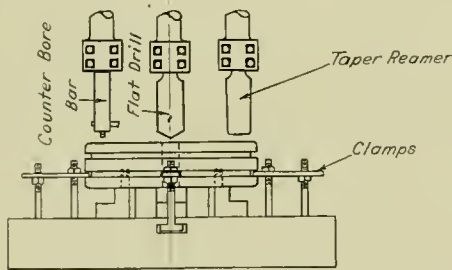

Piston Heads.
Operations No. 4, 5 & 6.

and six holes in the front face to allow for core removal. By setting the head on top of the chuck jaws and extending the jaw tap bolts up in three of the core holes a unique method of holding the head was obtained, allowing the whole wearing surface to be finished in one setting, besides finishing the hole for the rod. The head is held down by a $1\frac{3}{4}$ in. bolt through the cored hole for the rod and screwed in a tapped bushing applied

to do this in an engine lathe, where one compromise forging is used for various lengths and diameters of rods. The rods are then delivered to the engine lathe to be rough turned and fitted to the crosshead. This operation requires two hours at 45 ft. speed and 1/32 in. feed.

The keyway is scribed by the lathe hand and the rod is passed

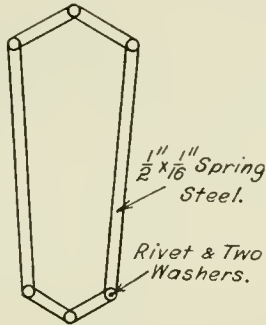

Adjustable Gage for Getting Size & Taper of Piston Rod Keys.

on to the keyway cutting machine, where 45 minutes is required to cut a 3/8 in. keyway in a 3 1/2 in. rod and one hour for a 3/4 in. keyway in a 4 in. rod. The keyway cutting machine rigged up with an adjustable head for setting the scribed lines to the cutters is shown in one of the illustrations. The advan-

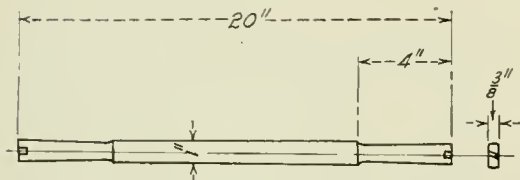

Double Ended Cutters Used. Made of High Speed Steel.

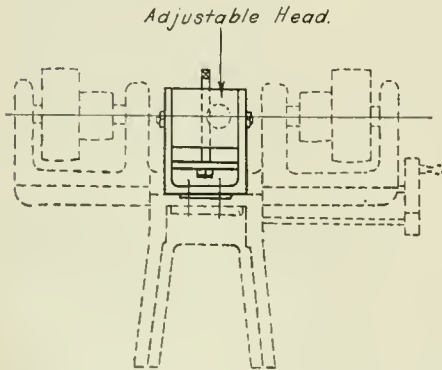

Adjustable Head.

tage of this head is plainly shown when a rod is to be applied to a crosshead where care has not been exercised in laying off the keyway in the crosshead central with the hole for the rod. Double end cutters are used which are made of high speed steel.

After the keyway is cut the bench hand takes the rod and applies it to the crosshead to have the key fitted. The adjustable gage to get the size and taper of the key quickly is shown, which

saves about 10 minutes over the old method of laying off the key. The piston rod keys are made of spring steel, annealed, and are purchased in bars and nicked and broken off to the required lengths by the blacksmith. The steel is purchased in the required thicknesses and does not require planing on the sides. The edges are shaped to lines scribed from the adjustable gage. These keys require from 30 to 45 minutes to plane to fit. The variation in time is due to the different widths of keys. After

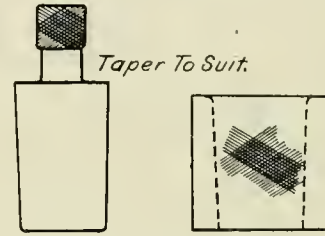

Plug & Bushing For Piston Rod & Head Fits.

the key is shaped the bench hand dresses the ends on an emery wheel, requiring from 8 to 10 minutes per key. They are then drilled for the cotter pin and stamped.

After the key is fitted, the rod is passed to a second lathe where it is turned to fit the bushing gage and the thread is cut. This requires 45 minutes at 60 ft. cutting speed, 1/16 in. roughing and transferred to the 1/64 in. finishing feed.

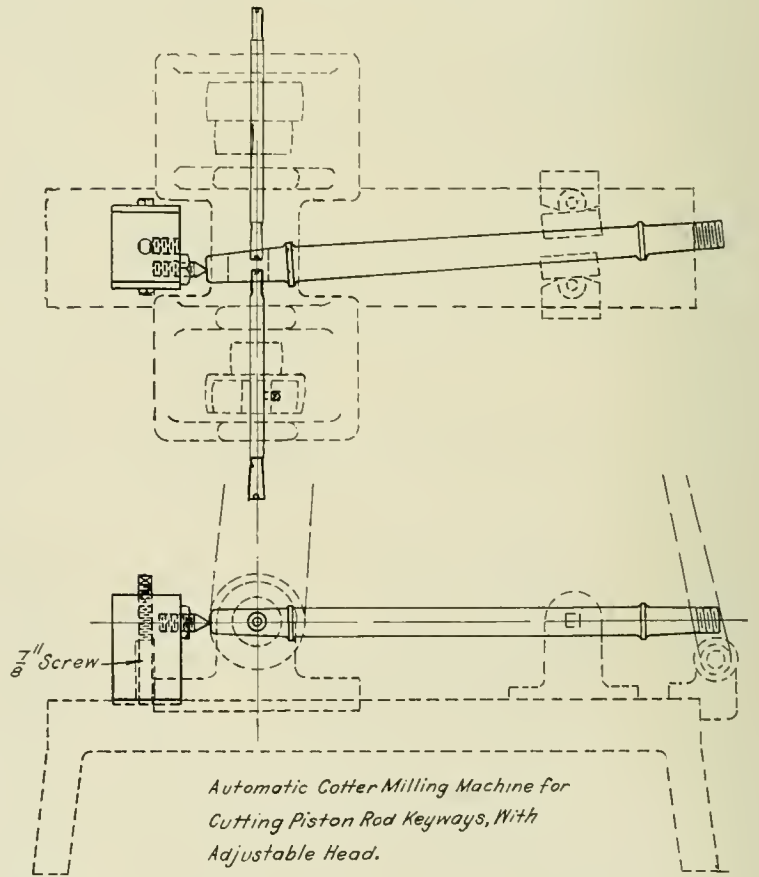

Automatic Cutter Milling Machine for Cutting Piston Rod Keyways, With Adjustable Head.

The rod is then transferred to the grinder. Grinding requires from 20 to 30 minutes.

Considerable trouble has been experienced on several railways with the piston heads getting loose on the rod. By allowing 3/16 in. for the rods to be drawn in the head, tightening up the nut and then hitting the rod with a sledge, this trouble can be avoided. An apparatus that has been made to hold the

rod and head in position to use a large wrench to tighten the nuts securely is illustrated. After this was installed all trouble with loose heads ceased. The time required with two men is from 15 to 20 minutes. With this method no twisting strain is placed on the piston rod.

PISTON PACKING RINGS.

In operation No. 1 of making piston packing rings on a 36 in.

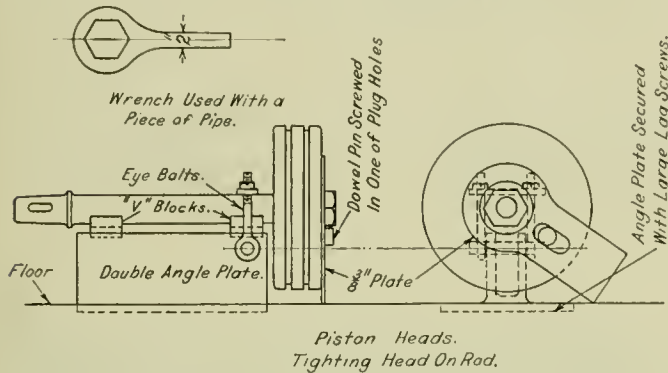

or 42 in. vertical boring mill both heads are used. The time required is as follows.

| | |
|-----------------------------|--------------|
| Set up the casting | 25 min. |
| Roughing out inside and out | 90 " |
| Finish outside | 30 " |
| Total | 145 " |

The cutting speed is 40 ft. per minute, the feed 3/32 in. and the cut from 1/4 in. to 1/2 in. deep.

In operation No. 2—cutting off the rings with a gang tool—the corners are rounded off with a hand tool after the ring is partly cut off. The tools in the gang tool are set ahead of each other so each ring can be faced to exact thickness with a tool in the other head. The time required is as follows:

| | |
|-------------------------------|--------------|
| Grind and set gang tool | 20 min. |
| Cut off 12 rings 3/4 in. wide | 90 " |
| Total | 110 " |

The cutting speed is 35 ft. per minute and the feed is 1/64 in.

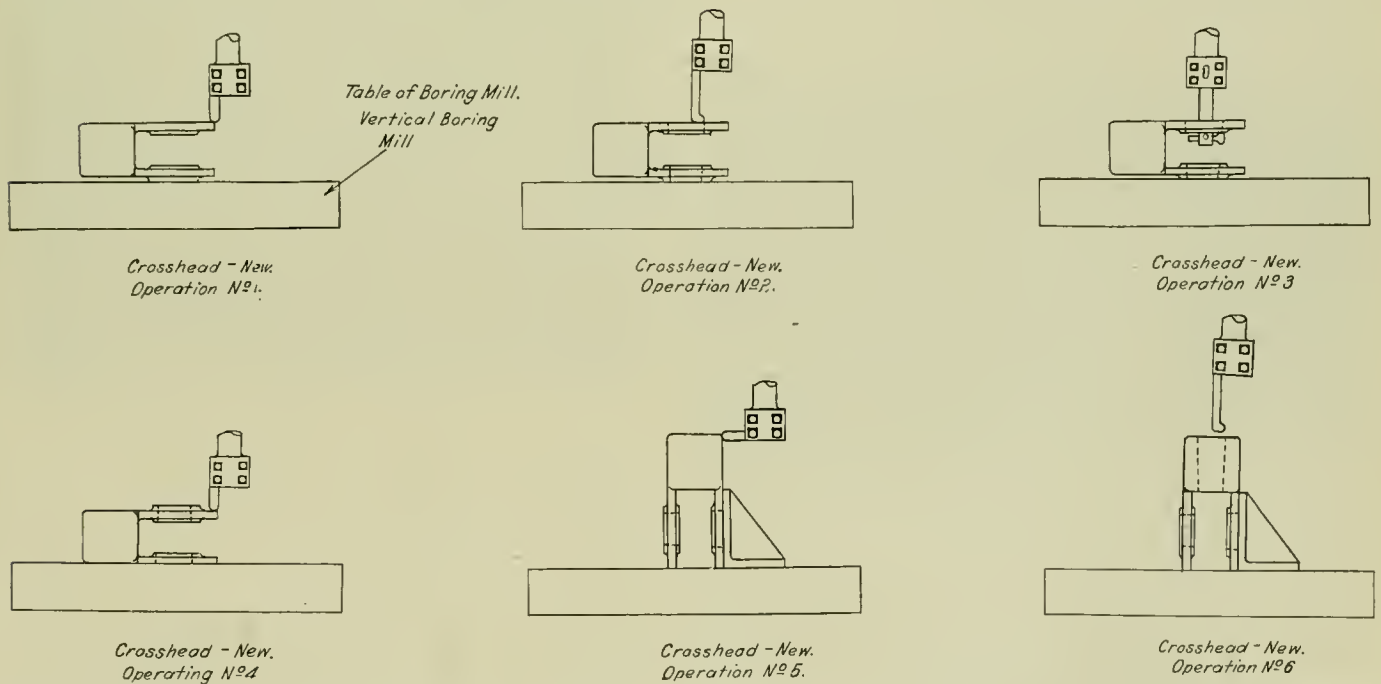

The piston heads have two 3/8 in. dowel pins at the bottom of the groove to keep the rings from shifting. The rings are turned 1/4 in. larger than the diameter of the cylinders for

spring and are cut out square across for the dowels. A piece 1 1/8 in. thick is cut out of the rings with a handle chisel and sledge, requiring about half a minute a ring for a machinist

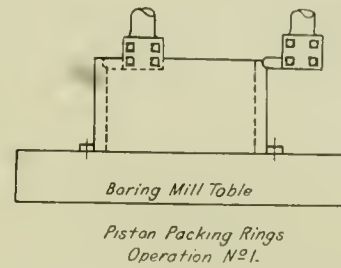

and helper. The rings are then dressed on the edges with a file and tried in the cylinder.

CROSSHEAD.

Operation No. 1 on a new 16 in. standard type crosshead with detachable shoes is performed on a 42 in. vertical boring mill.

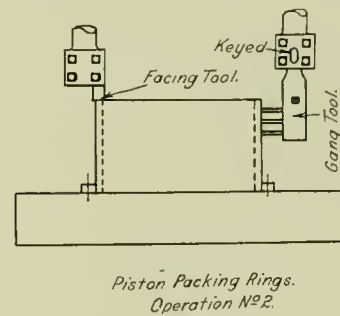

The crosshead is laid out and the back face is faced off, requiring one hour to lay out and set up and 30 minutes to rough and finish the face. A cutting speed of 45 ft. per minute and a 1/8 in. feed are used.

Operation No. 2 requires 30 min. to drill the hole and 30 minutes to bore it taper. It is fitted to the plug gage.

Operation No. 3 consists of facing the inside faces and requires 40 minutes.

Operation No. 4 of turning the boss on the outside requires

20 minutes to reset and 30 minutes to turn the boss and face it. Operation No. 5 requires 30 minutes to reset and 45 minutes to rough and finish the shank.

The next operation consists of boring the hole and reaming to the plug gage, requiring 1½ hours.

The crosshead is now ready for planing on the flanges for the shoes, using a mandrel and V block on the bed of a planer. This operation requires 1½ hours. A broad tool is used which makes it necessary to feed down but twice on each shoe, as the tool is wider than half the width of the guide.

The piston rod and wrist pin holes frequently require reaming, but in a great many shops very little of this work is done. Inserted tooth reamers of high speed steel were made for this job and all holes are cleaned up that show any sign that the old rod or pin were loose; 25 to 35 minutes are required to ream either hole.

The crosshead shoes are cast steel with a babbitt lining of ⅛ in. thickness. The shoes are spotted with the point of the drill to help hold the babbitt. The shoe is then heated and tinned. After this is done the shoe is set on end and a wooden former is clamped to it, using fire clay at the bottom to stop the babbitt from running out. After the shoes are babitted they are applied to the crosshead and if the bolt holes are not true they are reamed out and new bolts applied.

A recapitulation of the times given shows the total operation to require 16 hours 43 minutes, being subdivided as follows:

| | |
|---|----------|
| Finishing new piston head | 152 min. |
| Completing the rod and putting on head..... | 334 " |
| Finishing two packing rings..... | 22 " |
| Finishing a new crosshead..... | 495 " |

CENTRAL OF GEORGIA PRACTICE

BY C. L. DICKERT

Assistant Master Mechanic, Central of Georgia, Macon, Ga.

Removing the piston from a locomotive, which includes the removal of the casing, front cylinder head, cutting loose from the crosshead, removing rod packing and putting the piston and rod on the floor, requires on an average of twenty-five minutes. The time of this operation, of course, will vary largely, depending on the difficulty that is found in separating the rod and the cross head. The above time is a fair average.

PISTON HEAD.

Piston heads are finished on a 36 in. Bullard vertical turret lathe in an average time of 81⅓ minutes, which includes facing, boring, turning and grooving. This operation, on a test, has been completed in 64½ minutes, the detail time being shown in the accompanying table. The illustration shows the various operations so clearly that no explanation is required. The time of 81⅓ minutes is the average for a day's work.

After the head is removed from the vertical turret lathe, the seven core holes are reamed and tapped on a 6-foot radial drill. This operation requires 11 minutes. Making the seven

plugs on a 2 in. x 24 in. turret lathe require 14 minutes and screwing them in the head and riveting them over takes 7 minutes. These plugs are made from the proper size iron and only requiring nicking, threading and cutting off. They are

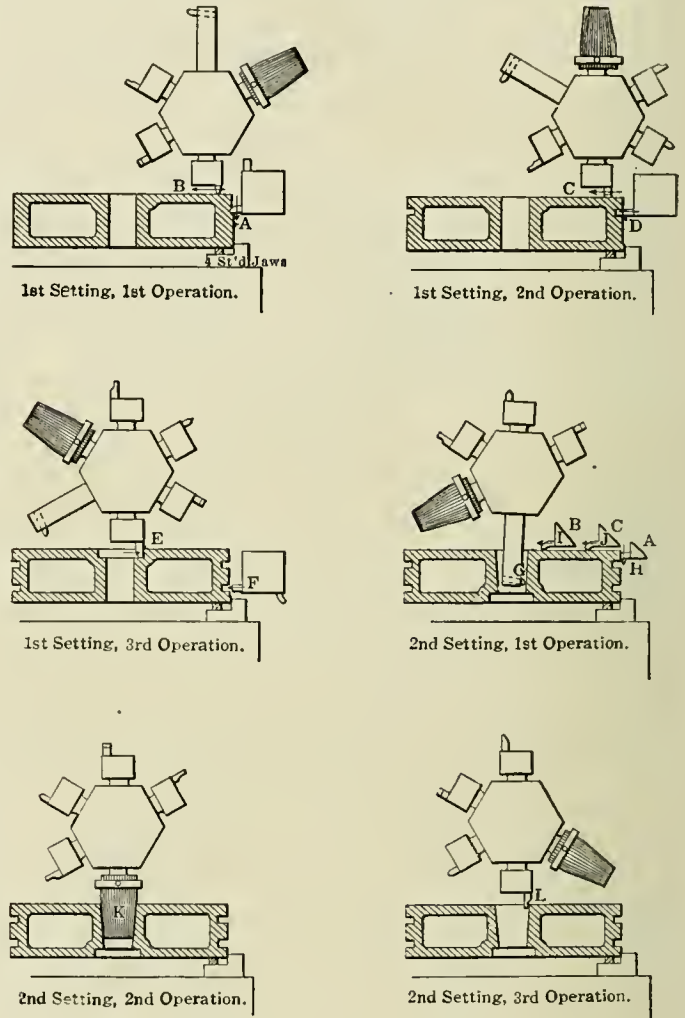

Finishing a Piston Head on a Vertical Turret Lathe.

manufactured in quantities, being threaded with an automatic die head, and are placed in stock and issued as needed.

The complete operation of finishing the piston head thus requires 113⅓ minutes.

PISTON ROD.

The standard piston rod is shown in one of the illustrations. The material is Cambria steel, old car axles being used. Cut-

OPERATIONS AND TIME REQUIRED FOR MACHINING A 2 1/4 IN. PISTON ON A 36 IN. VERTICAL TURRET LATHE.

| | Surface Item Machined. | Operations. | Depth of Cut | Feed Per Rev. | Rev. Per Min. | Minutes Each Operation | Minutes Required Actual |
|----------------|------------------------|----------------------------------|--|---------------|---------------|------------------------|-------------------------|
| Setting No. 1. | 1 | Chuck work | | | | 4 | 4 |
| | 2 | A One tool, 6½ in. length of cut | } Simultaneous Cuts... | 1/8 in. | 1/12 | 6 | 6½ |
| | 3 | B One tool, 9 in. length of cut | | 1/8 in. | 1/12 | 6 | 9½ |
| | 4 | C One tool, 9 in. length of cut | } Simultaneous Cuts... | 1/64 in. | 1/3 | 6 | 2½ |
| | 5 | D One tool, 1 in. x 1 in. groove | | 1/96 | 6 | 11 | 11 |
| | 6 | E One tool, ¾ in. x 2 in. cut | | 1/24 | 6 | 3 | |
| | 7 | F One tool, 1 in. x 1 in. groove | | 1/96 | 6 | 11 | 11 |
| | 8 | Remove piston | | | | 2 | 2 |
| Setting No. 2. | 9 | Chuck work | | | | 4½ | 4½ |
| | 10 | G Set tool and finish | } Speed up to 34 rev. after H, I and J are finished. These operations performed while boring G | 5/16 in. | 1/12 | 6 | 20 |
| | 11 | H Set tool and finish | | 1/8 in. | 1/12 | 6 | 1 |
| | 12 | I Set tool and finish | | 1/8 in. | 1/12 | 6 | 8 |
| | 13 | J Set tool and finish | | 1/64 in. | 1/3 | 6 & 20 | 1¼ |
| | 14 | K Ream | | | | 2 | 2 |
| | 15 | L Fillet | | | | ½ | ½ |
| TOTAL.... | | | | | | 86¾ | 64½ |

Piston in rough, 2 1/4 in. x 7 in., weight, 410 lbs.
Piston when finished, 2 1/4 in. x 6 3/4 in., weight, 337 lbs.
Metal removed, 73 lbs.

Kind of metal, Hunt-Spiller metal. Time consumed in machining six pistons, from floor to floor was 8 hours and 10 minutes, including oiling machine, grinding and setting tools and absence from machine that occurs during day's work. Average per piston, 81 2/3 minutes.

ting off to the proper length and annealing in the blacksmith shop requires 25 minutes for one rod. This is much longer than the average would be if the cutting off and annealing were done in quantities as is the usual practice. After being cut to length the pieces are transferred to the machine shop on industrial cars and are placed on a drill press for centering. The machine used is a small radial and this operation requires 5 minutes per rod. A jib crane serves the drill and also the 26 in. motor driven heavy duty lathe which is used for roughing. The roughing operation is performed at a speed of 49.55 ft. per minute and with a feed of 1/6 in., the average stock removed being 61/64 in. This operation requires 47 minutes, divided as follows:

| | |
|--------------------------------------|----------------|
| Put in machine and adjust tools..... | 5 min. |
| Facing ends | 20 min. |
| Roughing (2 cuts) | 20 min. |
| Removing from lathe | 2 min. |
| Total | 47 min. |

The same crane transfers the rods from the roughing lathe to a rack back of the finishing lathe, which is arranged to hold

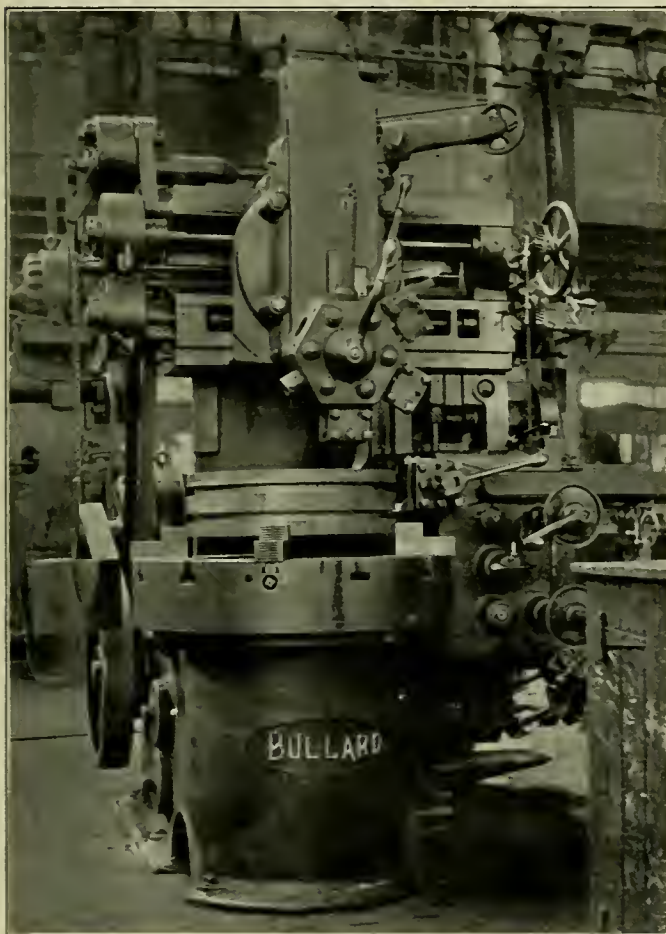

Finishing a Piston Head at the Macon Shops.

12 rods. The finishing lathe is a 24 in. motor driven machine and here the rod is finished for the crosshead and piston fits: the threads are turned, and the body of the rod is sized to within 1/64 in. These operations require 94 minutes, the detail time being as follows:

| | |
|--|----------------|
| Finishing diameters A. & B. 1/64 in. above size..... | 10 min. |
| Finishing piston fit | 20 min. |
| Finishing crosshead fit | 20 min. |
| Threading piston end | 12 min. |
| Threading crosshead end | 12 min. |
| Total | 94 min. |

The rod is then transferred to the press just behind the finishing lathe where the head is pressed on and the nut applied. This press is converted from an old crank pin press and is ad-

mirably suited to the work. This operation requires 10 minutes.

After the head is pressed on, the rod is transferred to the grinder, where the 1/64 in. remaining stock is removed. The time required for this operation is 12 minutes, of which 2 is used in chucking the rod and adjusting the machine.

The whole operation of finishing the rod and applying the head thus requires 193 minutes.

PISTON PACKING.

A stock of packing drums is maintained on a platform under a gantry crane just outside the machine shop and the rings are manufactured for stock. The crane is provided with a magnet

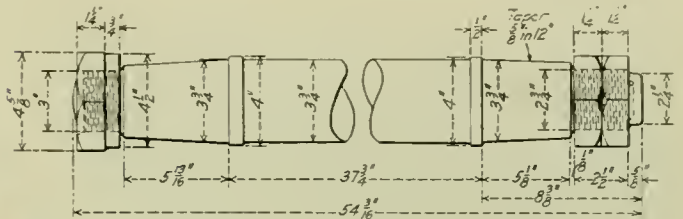

Standard Piston Rod.—Central of Georgia.

and the drums are loaded on an industrial car and transferred to the boring mill. After being finished to standard size they are delivered to the store room and issued on order. When rings are needed a messenger gets them from the stock and delivers them to the proper section of the shop, where they are cut and fitted to the head.

The drums are made in sufficient length to cut from 15 to 18 rings and from 38 to 54 rings will be completed in nine hours, the number depending on the ring size and the amount of stock to be removed. The mill has two heads, one used for boring and the other for turning, the two operations being performed at the same time. From 1/4 to 1/2 in. of stock is removed by both tools. The rings are cut off with a six cutter gang tool,* which brings them to exact size without further machining. Each ring has two water grooves which are made with the other head while the gang tool is cutting off the rings. The average time for turning, boring, and cutting off two rings is 24 minutes. This is the average on the basis of several days' output.

The rings are cut to suit the size of the cylinders on a specially

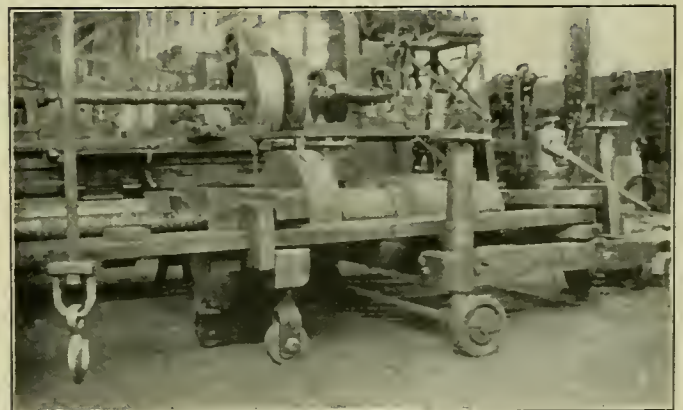

Crank Pin Press Arranged for Forcing on Pistons.

designed packing ring saw which has two adjustable blades.† A ring can be cut in less than a minute at any desired angle and fits perfectly when closed in the cylinder. It will then require three minutes to apply the two rings to the head. The time for finishing and applying the piston rings totals 29 minutes.

CROSSHEADS.

Removing the crossheads from the engine will require 17 minutes. The old tin is then melted off with an oil burner.

*See American Engineer and Railroad Journal, April, 1911, page 131.
 †See American Engineer and Railroad Journal, February, 1911, page 59.

Molds are placed on the head and new metal is poured in before the body has an opportunity to cool. The metal is heated on an oil burner forge. The complete operation requires 34 minutes. The crossheads are then placed on a 26 in. shaper, being clamped to the side of the table, and planed to size. The chucking and planing, complete, consumes 37 minutes.

The complete operation of repairing the crosshead where no work except the bearings on the guide is performed thus requires 88 minutes.

Applying the crosshead to the locomotive and lining the guides ready to apply the piston and rod will take on the average about 150 minutes.

Placing the piston in the cylinder, coupling up to the cross-

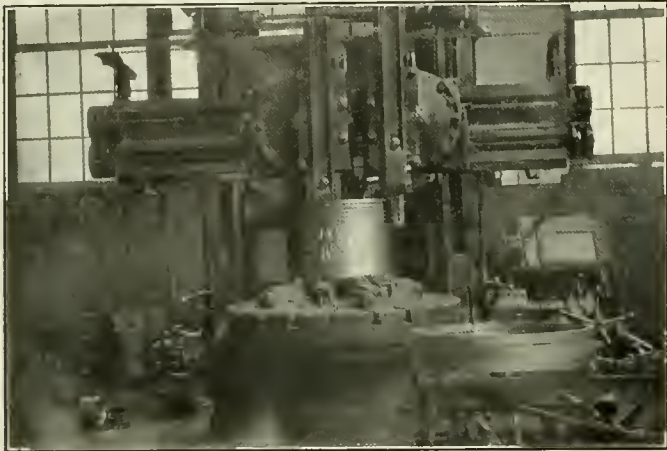

Cutting Packing Rings With a Gang Tool.

head, putting on the front cylinder head and casing and getting new striking points takes 150 minutes.

The total time for the whole operation, including lining up the guides, is thus 739 minutes or practically 12½ hours, being divided as follows:

| | |
|---|----------|
| Removing piston from locomotive..... | 25 min. |
| Completing piston head | 114 min. |
| Completing rod and pressing on head..... | 193 min. |
| Finishing and applying two packing rings..... | 29 min. |
| Finishing repairs to crosshead | 88 min. |
| Applying crosshead and lining guides | 150 min. |
| Applying piston, putting on cylinder head, casing, etc..... | 150 min. |
| Total | 739 min. |

TRIPLEX COMPOUND LOCOMOTIVE

The weight of the loaded tender of Mallet locomotives is usually 40 to 50 per cent. of that of the engine ready for service. Some of these loaded tenders with four-wheel trucks weigh 175,000 to 180,000 lbs., and those with six-wheel trucks as much as 230,000 lbs. This has suggested the idea that the weight of tenders, when only 25 per cent. of the load of coal and water remains, would be sufficient for the adhesion required by a pair of large compound cylinders. The weight of the tender with 25 per cent. load would be over 100,000 lbs., which furnishes a sufficient load for a tractive effort of 25,000 lbs., and the weight

of the locomotive running gear and machinery adds enough for the desired tractive effort.

An interesting and ingenious design which is based on this principle is illustrated herewith. The engine is practically an ordinary Mallet with a working tender, but, instead of having the high and low pressure cylinders of different sizes, the locomotive is constructed with a pair of high pressure cylinders attached to the frames connected with the back part of the boiler and two pairs of low pressure cylinders, one of them being at the rear end of the tender; all the cylinders are of the same size, so that a compounding ratio of two to one is obtained. For instance, if the boiler carries 200 lbs., there would be 100 lbs. back pressure in the high pressure cylinders. This would give a mean effective pressure of 100 lbs. per sq. in. in all of the cylinders with the reverse lever in the corner.

The horizontal pipe with a ball joint in the cylinder saddle, which takes the exhaust from the high pressure cylinders to the low pressure cylinders, has given practically no trouble in Mallets now in service, and this is simply duplicated in the rear of the new design by making a pocket with a ball joint in the foot plate and taking the exhaust steam from the high pressure cylinders back to this foot plate, as well as forward to the front cylinder. The reason the cylinders on the tender are placed at the rear end is in order to make a suitable length swivel pipe which has the ball joint in the foot plate and which is analogous to the receiver pipe connecting the high and low pressure cylinders at the front of the engine. This pipe would be entirely too short for good service if the cylinders were at the front end of the tender, and besides, it allows a truck at the end, so that the locomotive can be run in either direction with equal satisfaction.

This engine has been worked out from a Great Northern locomotive as a base, and it is found that with a slight increase in the weight and cost, and without any increase in length, there is obtained about 50 per cent. more tractive effort, the working tender being so arranged that with only 25 per cent. of fuel and water remaining there will be sufficient weight to give the full adhesion.

Since the cylinders are all the same size, the pistons, valves, crossheads, and even rods are the same throughout the engine. The link motions will be practically the same and the spring riggings are the same on the front and back sections. The driving boxes may be made alike and this, together with the fact that there is really nothing in the way of experiment in the separate elements of the design, should make it a desirable type for heavy grade work. It is intended to take the exhaust from the rear section and pass it to the atmosphere by a separate pipe, or, if desired, it can be used for heating the water in the tender in cold weather. The special features of this design have been patented by George R. Henderson, and assigned to the Baldwin Locomotive Works.

RAILWAY CAPITALIZATION.—The Interstate Commerce Commission in its twenty-fourth annual statistical report states that on June 30, 1911, the par value of the amount of railway capital outstanding was \$19,208,935,081, which includes the capital held by the railway companies as well as by the public.

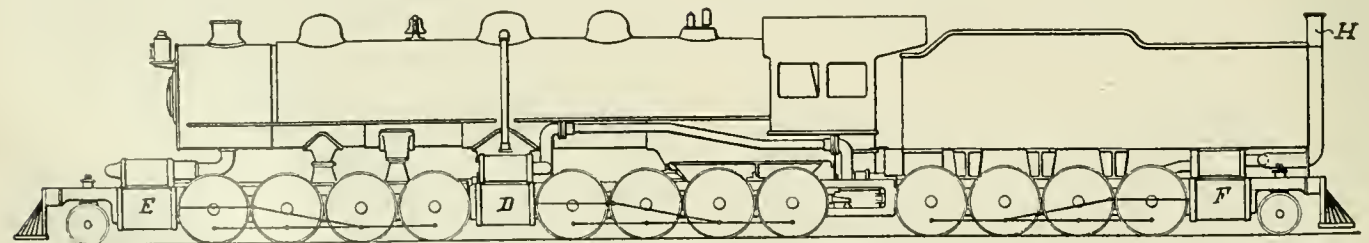

Proposed Triplex Compound Locomotive with Engine and Tender.

COMPARATIVE SERVICE TESTS OF LOCOMOTIVES

Road Trials on the B., R. & P. to Determine the Efficiency of the Superheater and Brick Arch.

The Buffalo, Rochester & Pittsburgh has a locomotive of the 2-8-2 type fitted with the latest design of Street automatic stoker, which includes a conveyor in the tender. The same road has also applied at its Du Bois, Pa., shops, superheaters of the top header type, as well as Security brick arches to several locomotives of the 4-4-2 type, as well as to some of the 2-8-0 type. In addition, a recent order of Pacific type locomotives was fitted with superheaters and brick arches by the builders. It was thus in position to make comparative trials in road service of a 2-8-2 type locomotive stoker fired and hand fired, of both an Atlantic type and a consolidation locomotive without superheater or brick arch in comparison with identical locomotives fitted with both of these devices, as well as of Pacific type locomotives originally designed to include superheater and brick arch. Such tests were made during the month of June with results which are given below.

In making the tests every precaution was taken to insure accuracy in connection with the coal and water consumption, weight of train, time, speed and distance. The coal was put up

SUPERHEATER AND BRICK ARCH TESTS.

There were three separate series of tests of the superheater and brick arch, two being comparative. The first series were on three Pacific type locomotives built by the American Locomotive Company,* which have the following general dimensions:

| | |
|------------------------------------|------------------|
| Total weight | 258,000 lbs. |
| Weight on drivers | 163,500 lbs. |
| Tractive effort | 36,340 lbs. |
| Cylinders | 24½ in. x 26 in. |
| Diameter of drivers | .73 in. |
| Steam pressure | 200 lbs. |
| Diameter of boiler | .74 in. |
| Number and diameter of tubes | 240—2 in. |
| Number and diameter of flues | 32—5½ in. |
| Length of tubes | 20 ft. |
| Heating surface, firebox | 234 sq. ft. |
| Heating surface, tubes | 3,391 sq. ft. |
| Heating surface, total evaporative | 3,625 sq. ft. |
| Heating surface, superheater | 757 sq. ft. |
| Grate area | 56.5 sq. ft. |

Of the four runs, two were made with one locomotive and one each with the other two. In each case a distance of 96.82 miles was covered. The train consisted of six cars of which four were coaches, one a cafe car, one baggage and one mail.

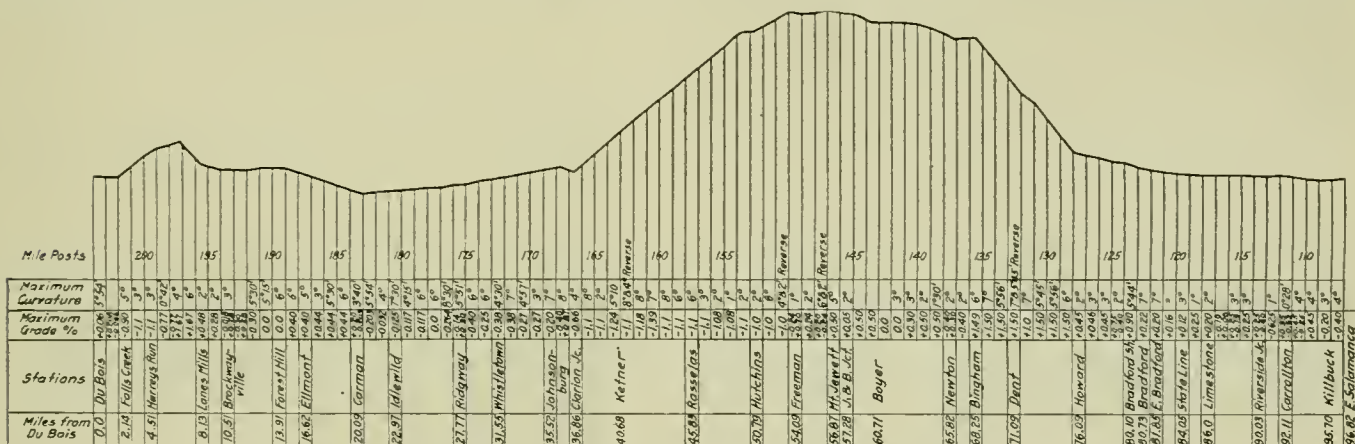

Profile of That Part of the Buffalo, Rochester & Pittsburgh on Which Locomotive Tests Were Made.

in 100 lb. sacks and the tank was fitted with gage glasses at diagonally opposite the corners and was accurately calibrated previous to the tests. A Hausshalter speed, time and distance indicator was installed in a special car which was included in each of the trains.

The trains were operated between Du Bois and Salamanca, a distance of 96.82 miles. The profile of this section of the road is shown in the accompanying illustration.

STOKER TESTS.

In the tests with the stoker locomotive it was found that the machine would develop the full power of the locomotive and that its operation was reliable. In as much as the fuel furnished the stoker was of a quality which could not be fired by hand while the coal on the hand fired test was an excellent grade of run of mine, the coal consumption either total or per ton-mile is not comparable. The stoker locomotive handled the same tonnage at about the same speed as the hand fired engine, and when a mixture of slack and nut was used there was no trouble in keeping the fire in good condition. On one run a very fine slack coal was put on the tender, and with this, considerable raking and some firing by hand were required. As might naturally be expected there was a slight increase in consumption of fuel by the stoker under these conditions.

The average weight of cars including passengers and lading was 286.5. The locomotive weighed 214 tons, giving an average weight of total train of 500 tons. The coal in each case was an excellent grade of run of mine and the weather and rail conditions were good. On two trips there were five slow orders on account of work on road and bridges, on another one there were six and another nine slow orders. The schedule provides two hours and forty-eight minutes for this train and on each run there were from seven to eleven minutes made up, there being eight stops in three cases and nine on the fourth run.

These stops consumed from thirteen to fifteen and one-half minutes on each trip. The average speed of the four trips, actual running time, was 42.6 miles per hour. In the following table is given the coal and water consumptions, averages of the four trips for the three locomotives.

| | |
|--|----------------|
| Length of run | 96.82 miles |
| Actual running time | 2 hrs. 27 min. |
| Number stops | 8.25 |
| Number slow orders | 6.25 |
| Ton mileage, cars | 27,739 tons |
| Ton mileage, total | 48,458 tons |
| Lbs. of coal used, total | 6,275 lbs. |
| Lbs. of coal per 100 ton-miles (includes weight of locomotive) | 12.93 |
| Lbs. of coal per 100 ton-mile (cars only) | 22.55 |
| Lbs. of coal per sq. ft. grate area per hr. | 41.38 |

*See American Engineer, May, 1912, page 251.

| | |
|---|--------|
| Lbs. of water used per hr. | 19,410 |
| Lbs. of water per lb. of coal. | 8.385 |
| Lbs. of water per sq. ft. evaporative heating surface per hr. | 5.35 |
| Lbs. of water per 100 ton-miles (includes weight of locomotive) | 107.53 |
| Lbs. of water from and at 212 deg. per lb. of coal. | 10.14 |
| Lbs. of water from and at 212 deg. per sq. ft. of heating surface per hr. | 6.46 |

The speed curves show that speeds of 60 miles per hour were frequent for short distances.

Atlantic type locomotive No. 162 is of the same class as No. 163 and was fitted with a Security brick arch and Schmidt superheater at the Du Bois shops. There were no other changes made in the locomotive. The alteration in the heating surface is shown in the following table of dimensions:

| | Saturated. | Superheated. |
|-----------------------------|---------------------|---------------------|
| Total weight | 173,000 lbs. | 183,000 lbs. |
| Weight on drivers | 99,000 lbs. | 113,700 lbs. |
| Size of cylinders | 20 1/4 in. x 26 in. | 20 3/4 in. x 26 in. |
| Diameter of drivers | 72 in. | 72 in. |
| Steam pressure | 200 lbs. | 200 lbs. |
| Tractive effort | 25,173 lbs. | 25,173 lbs. |
| Diameter of boiler | 70 1/8 in. | 70 1/8 in. |
| Heating surface, firebox | 194 sq. ft. | 221.1 sq. ft. |
| Heating surface, tubes | 2,798.4 sq. ft. | 2,157.4 sq. ft. |
| Heating surface, total | 2,992.4 sq. ft. | 2,378.5 sq. ft. |
| Superheater units | | 26 |
| Superheater heating surface | | 480 sq. ft. |
| Grate area | 54.4 sq. ft. | 54.4 sq. ft. |

The train was practically the same as that used in the tests of the 4-6-2 type locomotive, and had an average weight of 288 tons, including passengers and lading, on the superheater tests and 289 tons on the saturated steam tests. The former locomotive weighed 189 tons as compared with 186 tons for the latter. The distance was 96.82 miles and the schedule allowed two hours and forty-eight minutes. The weather in each case was fair, wind light and rail good. On the first trip with the superheater locomotive there were ten slow orders in addition to nine stops and 4 min. 50 sec. were lost on the trip. On the second trip there were but five slow orders in addition to the nine stops and the run was made in three minutes less than schedule time. On the third trip, with the saturated steam engine, there were five slow orders and nine stops, and fifteen minutes were lost. On the fourth trip there were five slow orders and nine stops and three and a quarter minutes were lost. The coal in each case was an excellent grade of run of mine. The following table will permit a comparison of the coal and water consumption of the two locomotives. The percentage column is based on 100 per cent. for the superheater engine.

| | Superheated. | Saturated. | Per Cent. |
|--|--------------|------------|-----------|
| Length of run, miles | 96.82 | 96.82 | 100.0 |
| Actual running time, hrs. | 2.5 | 2.63 | 105.3 |
| Number of stops | 9 | 9 | 100.0 |
| Number of slow orders | 8 | 5 | 62.5 |
| Ton mileage (cars only) | 27,884 | 27,981 | 100.3 |
| Ton mileage (including weight of locomotive) | 42,504 | 42,117 | 99.1 |
| Lbs. of coal used, total | 6,350 | 7,300 | 115 |
| Lbs. coal per 100 ton-miles (including weight of locomotive) | 14.90 | 17.30 | 116.1 |
| Lbs. of coal per sq. ft. of grate area per hr. | 41.44 | 45.60 | 110 |
| Lbs. of water, total | 49,090 | 59,552 | 121.3 |
| Lbs. of water used per hr. | 17,451 | 20,208 | 115.8 |
| Lbs. of water per lb. of coal | 7.74 | 8.16 | 105.5 |
| Lbs. of water per sq. ft. evap. heating surface per hr. | 7.33 | 6.75 | 92.1 |
| Lbs. water per 100 ton-miles (including weight of locomotive) | 115.51 | 141.38 | 122.4 |
| Lbs. of water from and at 212 deg. per hr. | 21,168 | 24,481 | 115.7 |
| Lbs. of water from and at 212 deg. per lb. of coal | 9.38 | 9.88 | 105.3 |
| Lbs. of water from and at 212 deg. per sq. ft. heat. surface per hr. | 8.88 | 8.17 | 92 |

Four runs were made with two consolidation locomotives which were identical with the exception that one was fitted with superheater and brick arch which had been applied at the company's shops. These locomotives have the following dimensions:

| | Saturated. | Superheated. |
|-----------------------------|-----------------|-----------------|
| Total weight | 184,000 lbs. | 194,000 lbs. |
| Weight on drivers | 164,000 lbs. | 173,500 lbs. |
| Cylinders, diam. and stroke | 21 in. x 28 in. | 21 in. x 28 in. |
| Drivers, diameter | 57 in. | 57 in. |
| Steam pressure | 200 lbs. | 200 lbs. |
| Tractive effort | 36,827 lbs. | 36,827 lbs. |

| | Saturated. | Superheated. |
|------------------------------|---------------|-----------------|
| Diameter of boiler | 70 in. | 70 in. |
| Heating surface, firebox | 190 sq. ft. | 218.8 sq. ft. |
| Heating surface, tubes | 2,672 sq. ft. | 2,154.6 sq. ft. |
| Heating surface, total evap. | 2,862 sq. ft. | 2,373.4 sq. ft. |
| Heating surface, superheater | | 460 sq. ft. |
| Superheater, number units | | 28 |
| Grate area | 54.4 sq. ft. | 54.4 sq. ft. |

The same excellent quality of run of mine of coal was used in each of the four runs, all of which were hand fired. The weather and rail conditions were good and the same for each run. In each case a helper was used from Falls Creek to McMinns Summit, a distance of four miles. On the runs with the superheater locomotive this consisted of a consolidation locomotive with 21 in. x 28 in. cylinders, 57 in. drivers, and a tractive effort of 35,27 lbs. A larger helper was used on the saturated steam tests; it was a 22 in. x 28 in. consolidation with 56 in. drivers, 200 lbs. steam pressure, and a tractive effort of 41,140 lbs. A pusher engine was attached at Clarion Junction and helped the trains to Freeman, a distance of about 17 1/4 miles. This was a decapod with cylinders 24 in. x 28 in., 52 in. drivers, 200 lbs. steam pressure, and a tractive effort of 52,730 lbs. The same locomotive was used at the same places on each of the runs and no deduction is made for the work that either the helper or pusher did in handling the train, nor are their weights or coal consumption included in the results.

The average of the two trips with the superheater locomotive and the two trips with the saturated engine give the coal and water consumption shown in the following table. The per cent column is based on 100 per cent. for the superheater locomotive.

| | Superheated. | Saturated. | Per Cent. |
|--|--------------|------------|-----------|
| Length of run (miles) | 95 | 95 | 100.0 |
| Actual running time (hrs.) | 6.23 | 6.67 | 107 |
| Number of stops | 12.5 | 17.5 | 140 |
| Ton mileage (cars only) | 227,760 | 212,472 | 93.3 |
| Ton mileage (includes weight of locomotive) | 242,913 | 227,098 | 93.5 |
| Lbs. of coal (total) | 11,950 | 16,050 | 134 |
| Lbs. of coal per 100 ton-miles of cars | 5.25 | 7.5 | 142.9 |
| Lbs. of coal per 100 ton-miles (includes weight of locomotive) | 4.89 | 7 | 143.3 |
| Lbs. coal per sq. ft. of grate area per hr. | 24.93 | 31.29 | 125.5 |
| Lbs. of water (total) | 91,894 | 126,650 | 137.9 |
| Lbs. of water per hr. | 10,432 | 13,446 | 128.9 |
| Lbs. of water per lb. of coal | 7.69 | 7.89 | 102.7 |
| Lbs. of water per sq. ft. of evap. heating surface per hr. | 4.39 | 4.69 | 106.8 |
| Lbs. of water per 100 ton-miles (includes weight of locomotive) | 37.85 | 53.77 | 141.8 |
| Lbs. of water from and at 212 deg. per lb. of coal | 9.30 | 9.52 | 102.4 |
| Lbs. of water from and at 212 deg. per sq. ft. evap. heating surface per hr. | 5.31 | 5.65 | 106.5 |

The result of these tests very clearly shows the advantage of the superheater and brick arch for both passenger and freight service and the Buffalo, Rochester & Pittsburgh is now engaged in equipping other locomotives with these appliances as rapidly as possible.

MANUFACTURING IN THE UNITED STATES.—The Bureau of Statistics of the Department of Commerce and Labor has placed the total value of the manufactures for 1912, excluding foodstuffs exported, at \$1,021,753,918. The value of the exports in 1912 is more than double that in 1903 and three times that of 1898. The principal articles in 1912 were iron, steel, copper, mineral oil, cotton manufactures, cars, coaches, automobiles and paper.

DEATH RATE IN AMERICAN COAL MINES.—The United States Bureau of Mines has issued a report which shows that 2,517 men were killed in the mines last year, as against the highest record of 3,197 in 1907. Dr. Joseph A. Holmes, director of the Bureau of Mines, states that although there has been a decreasing number of men killed for every million tons of coal mined since 1907, the United States is still far below the standard of safety it should reach. The bureau is co-operating with the mine operators, which will tend to improve the present conditions.

RAILWAY MASTER PAINTERS' ASSOCIATION

Reports Were Presented on Car Renovators, Treatment of Concrete Floors and Care of Steel Car Roofs.

The forty-third annual convention of the Master Car and Locomotive Painters' Association was held in Denver, Colo., September 10-13, 1912. J. T. McCracken, master painter of the Interborough Rapid Transit, New York, presided. The opening prayer was made by Dr. Elmer E. Higley, pastor of the Grace M. E. Church and the association was welcomed to the city by Henry J. Arnold, mayor of Denver. Chas. E. Copp, foreman painter of the Boston & Maine, Concord, N. H., responded to the mayor. J. F. Enright, superintendent of motive power and car department of the Denver & Rio Grande and President McCracken then made addresses.

MAINTENANCE OF STEEL CARS

J. T. McCracken (I. R. T., New York).—We have 500 steel cars, which have been in service about 8 years, and owing to their having been painted properly at the beginning, we have not found it necessary, as yet, to remove the old paint. Our actual cost of keeping these cars in this condition, based on a 14 months' schedule of shopping, is 18 cents per day.

F. M. Pribble (L. & A., Stamps, Ark.).—It pays to keep any class or style of structure well painted, especially steel cars, which yield so readily to the ravages of rust, and more especially when these cars are exposed to wide atmospheric changes, sometimes being moved from one place to another in the course of a few hours where climatic conditions, etc., are entirely different. Rust, once given a start, is tenacious and hard to handle and will spread in a surprising manner, eating its way back under a seemingly solid film of paint.

J. Spirk (C. R. I. & P., Davenport, Iowa).—Some of our steel gondolas were loaded with hot cinders, which burned off the paint and left the steel bare. The rust soon played havoc with these spots. I scraped them with a steel wire brush, washed with benzine, put on a good coat of paint, and I venture to say that, by that timely attention, a considerable expense was saved.

F. A. Weis (C. R. R. of N. J., Elizabeth, N. J.).—The approximate cost of sand blasting and painting an 80,000-lb. capacity steel coal car is \$11, and the average life of the paint is 5 years. The original thickness of the metal sheets used for the sides of coal cars is $\frac{1}{4}$ in., and if they are allowed to deteriorate to about $\frac{1}{8}$ in., it will be necessary to replace them. The insides of these cars are not painted and deterioration is at about the rate of 5 ozs. per square foot of surface per year, due principally to the action of the weather and sulphurous acids due to decomposition of the lading. The exterior surface, if not painted, and if exposed to the weather, will deteriorate at about

REPORT OF TEST COMMITTEE

The test committee presented for the consideration of the members various test panels comparing turpentine substitutes with the pure turpentine, also of white pigments, high grade metal preservers and red lead, and a test of exterior body varnishes for passenger equipment. The turpentine test consisted of 8 substitutes and pure turpentine. The panels were exposed June 9, 1911, and examined June 1, 1912, with the results in favor of the pure turpentine. The eight samples really represented three general types of turpentine substitutes, viz., wood turpentine, petroleum spirits from a paraffin base, and petroleum spirits from an asphalt base. One or more of these three formed the base for the bulk of substitutes on the market at the time the tests were started. The accompanying table shows the physical properties of each sample, price per gallon, and the standing at conclusion of test:

The excellent showing made by the eight substitutes after 12 months' exposure is remarkable. Sample *A* is the pure turpentine, and as will be seen it gave the best results. It seems to have made no difference as to what the base of the substitute was, for they all stood up remarkably well. For instance, sample *E* finished second in the test, and it was made of petroleum spirits from an asphalt base; sample *G* finished third, and it was made of petroleum spirits from a paraffin base; sample *B* finished fourth, and it was made from a wood base. The very little difference in the results obtained from these three kinds of substitutes would indicate that the base of the substitute has little to do with the quality of the finished product.

Looking at these three substitutes from a flash standpoint we have sample *E* with a flash at 96 deg. F.; sample *G* with a flash at 114 deg. F.; and sample *B* with a flash at 98 deg. F., which would indicate that the flash point is not a proper gage for determining the relative value of a substitute. The specific gravity of the three samples *E*, *G* and *B* were respectively .823, .831 and .843, while pure turpentine runs about .866. This also proves that it is necessary to have a practical test in order to determine the real value of the material. By taking the above table and carrying or extending this line of reasoning to all the substitutes affords an interesting study to the practical man, as well as the theoretical. The working qualities of samples *B*, *C*, *D*, *I*, were similar to that of pure turpentine with the exception that neither of the samples flattened out like the pure turpentine. Samples *E*, *F*, *G*, were much slower drying than the pure turpentine. Sample *H* dried more rapidly to the touch than pure turpentine, but when fol-

| No. | Color. | Odor. | Specific Grav. | Flash, degs. F. | Boiling point degs. F. | Residue on evaporation (per cent.) | Insoluble H ₂ SO ₄ test (per cent.) | Base. | Price. | Finish at conclusion of test. |
|-----|-------------|-------|----------------|-----------------|------------------------|------------------------------------|---|-------|--------|-------------------------------|
| A | Water white | Pine | .866 | 103 | 320 | .0043 | 20.0 | Rosin | \$0.98 | First |
| B | Water white | Pine | .843 | 98 | 320 | .0043 | 56.7 | Wood | .38 | Fourth |
| C | Water white | Oily | .793 | 97 | 300 | .0016 | 98.3 | Par. | .27 | Eighth |
| D | Prime white | Oily | .818 | 98 | 305 | .0004 | 100.0 | Asph. | .18 | Ninth |
| E | Pale yellow | Pine | .823 | 96 | 310 | .0007 | 95.0 | Asph. | .23 | Second |
| F | Prime white | Oily | .778 | 86 | 280 | .0002 | 98.3 | Asph. | .14 | Seventh |
| G | Water white | Pine | .831 | 114 | 336 | .0049 | 96.7 | Par. | .30 | Third |
| H | Water white | Oily | .766 | 110 | 340 | .0020 | 100.0 | Par. | .11 | Fifth |
| I | Water white | Pine | .832 | 105 | 318 | .0060 | 93.4 | Par. | .37 | Sixth |

3 ozs. per sq. ft. of surface each year. It is evident that, with these rates of deterioration, if the cars are not painted, the sheet will be reduced to about $\frac{1}{8}$ in. in thickness at the end of ten years. If they are painted, it would be about 17 years before it would be necessary to replace the sheet. Thus at a cost of \$44 for sandblasting and painting, it is possible to obtain seven years' more service.

lowed up with a succeeding coat it showed a tendency to soften. This was more or less true with all the operations from priming to color coats, which were the same as standard treatment given to passenger cars on the Norfolk & Western. At the time this test was started pure turpentine was 98 cents per gallon, which of course made the substitutes more interesting on account of price, but since pure turpentine has dropped

to 46 cents a gallon. As long as pure spirits of turpentine remain around the 50 cent mark it will be given preference by the majority of the painters. Should it advance rapidly in price, as some two years ago, we will have some intelligent information on which to base our future actions.

A test of carbonate of lead against a lead-zinc proposition was also shown. The lead-zinc was a composition of zinc oxide and lead sulphate with approximately 50 per cent. of each material. It is produced by the sublimation process, is very white, extremely fine, and works well under the brush, but on exposure it fails to measure up to the standard set by "Old Dutch Process" carbonate lead. A test of "Old Dutch Process" white lead was made in competition with the same material with an addition of 10 per cent. of asbestine. The asbestine greatly improved the wearing properties of the white lead, but the roughness of the paint film collected smoke, soot, dust, etc., to such an extent that it over-balances the increased wearing properties of the sample mixture. Three coats were applied to each panel made up with pure raw linseed oil. A supposedly high grade metal preserver was exposed in comparison with red lead and a good carbon paint, with the result favorable to the red lead and carbon paint.

VARNISH TEST.

Fourteen samples of the regular purchased stock of exterior coach body varnish were received from roads in various parts of the country for test. They were transferred to specially constructed dustproof cups numbered from 1 to 14, and a correct record made of the name, road, price, and other information. Fourteen first quality, well-seasoned poplar panels $\frac{7}{8}$ in. x 8 in. x 5 ft. long, grooved and finished to represent a car siding, were selected, which subsequent to the finishing were sawed into one foot lengths. The panels were given the regular standard treatment for coaches on the Norfolk & Western, which included priming, surfacer (4 coats), rubbing, and two coats of color, and then numbered in gold from 1 to 14 corresponding with the number of varnish samples. The varnish samples were then applied in proper order—three coats of each sample to the corresponding numbered panels, allowing 48 hours between coats for drying. All operations were performed by the same man, under the same conditions, and in as nearly the same time as possible. The panels were allowed to stand one week after the last coat of varnish was applied to thoroughly harden. They were then sawed up into one foot lengths as before mentioned, which produced five panels of each kind of varnish, or 70 panels in all.

A complete set of 14 panels was shipped to each of the following members with a print showing manner of exposure, and they were requested to expose them: J. H. Pitard, Whistler, Ala.; H. M. Butts, Albany, N. Y.; T. J. Hutchinson, London, Ont.; A. P. Dane, Reading, Mass., and O. P. Wilkins.

All panels were exposed during the month of July, and had a southern exposure at an angle of 45 deg., which, by placing them at the points named should place us in position to secure some definite information when the panels are reassembled at the conclusion of the test. There are no marks or anything outside of the numbers to indicate the kind of varnish used in the test, and it is the purpose of the committee to keep the key to the test, and when the final examination is made to report results by number to the association.

The report was signed by O. P. Wilkins (N. & W., Roanoke, Va.), chairman; W. O. Quest (P. & L. E., McKees Rocks, Pa.); W. W. Valentine (T. & O. C., Bucyrus, Ohio); A. R. Giren (C. P. W. Toronto, Ont.); and J. F. Mays (Southern Railway, Selma, Ala.).

VESTIBULE END FINISH

C. A. Hubbs (S. P., Sacramento, Cal.).—Vestibules finished with either natural mahogany or birch stained to match mahogany are the most cheerful, do not show dust like a darker

or painted surface, and if not allowed to be out too long before shopping, require but little work to be put in good condition. We have tried a mahogany ground and stripping with oil color, but this is too much like a painted surface and looks muddy. If the new finish of the vestibule is of birch, no shellac should be applied, as the birch contains an acid or sap which causes the shellac to peel in a short time. Varnish should be used next to the stain. Less panels and moldings would tend to make the work more economical. The vestibule finish on our steel coaches is grain mahogany and varnish.

W. Mullendorf (I. C., Chicago).—The interior of the vestibule of a steel car grained to match the interior of the car will be found equally as hard a task to maintain as that of the wooden car. I find the interior of the vestibule painted and finished practically the same as the exterior of the car is the most appropriate finish for this class of work and the only remedy to overcome all of the ailments that the painter has run up against for years in trying to keep the interior of the vestibule up in the natural state. This has been tried out on some of the leading railways of the country, and has given good results from a practical standpoint.

C. E. Copp (B. & M., Concord, N. H.).—It looks better to finish the interior of the vestibule like the interior of the car. If they are so treated when they are built, I believe in maintaining them in that way as long as they can be kept in good repair without too much labor. In the older cars it is best to paint them some suitable tint. We give them one preparatory coat of lead and suitable vehicles, and then finish them with a coat of enamel; the color is about an olive tint and it produces good results. The cars should be built with a less expensive wood in the vestibule and painted in the same manner, from the wood up as to primers and surfacers, etc., as the exterior of the car, but the color should be a harmonious tint.

J. H. Pitard (M. & O., Whistler, Ala.).—The vestibule is much more exposed than the interior of the car and the damage to the wood and finish will be greater than in the interior. For a long time we removed the varnish and bleached out the stains, and maintained the vestibules as they were originally, but found it cost about 4 times as much to maintain them, with the same amount of service, in the natural wood, as it did the interior of the car. We now paint the vestibule of the car inside the same as the body of the car outside, except that we lighten the color two or three shades, so that the vestibule will not be so dark.

Conclusion.—It was voted as the sense of the association that the natural wood, stained or grained finish, makes an appropriate finish for the interior of wood vestibule ends from the standpoint of appearance.

INTERIOR CAR RENOVATORS

A. J. Bruning (L. & N., Evansville, Ind.).—If you scrub a car on the interior once every thirty days for 18 to 24 months, you are bound to cut off the varnish on the edges. Your window sills, blinds and sash stops become weather beaten unless you go over them after each application of soap and water with a renovator. This adds life to the varnish, protects the edges, keeps the window sills from getting weather beaten and makes the car look fresh and new. The renovator should be a light body, non-drying oil, and one that wipes dry and leaves a polish to the work. Cars can also be cleaned with renovator without using soap and water, providing they are taken in time, or before the dirt gets ground into the varnish.

H. E. Brill (A. T. & S. F., San Bernardino, Cal.).—At terminal points a renovator is very useful, providing the car is thoroughly wiped dry and the corners cleaned and dusted. If this is not done the car will look worse than it did before. The work should be directly in charge of a competent painter, as careless use of a renovator is not only a detriment to the varnish, but makes a heavy job when the cars are shopped. I have several cars that have a good many coats of varnish, and with

the use of a good varnish renovator, they can be kept in good condition for several years without applying more varnish.

F. J. Curtis (C. R. I. & P., Valley Junction, Iowa).—The interior varnish of a car should be cleaned by: first, washing with good soap and water, rinsing off and drying with chamois skin, and second, the renovator should be put on sparingly with white cotton waste and then wiped thoroughly with dry waste.

G. Warlick (C. R. I. & P., Chicago).—On a car with a polished surface a liquid made of equal parts of renovator and vinegar will give good results. It should be kept well stirred and only a little used at a time. It takes the dirt off the polished work, and leaves it in very fine condition, and it does not require much labor.

A. J. Bush (D. & H., Oneonta, N. Y.).—I would suggest that you add a little rotten stone to that liquid.

J. H. Pitard (M. & O., Whistler, Ala.).—In some cases, where the varnish has become dull, the car can be kept in service for some little time with the use of a good renovator. Sometimes we begin to use it before the varnish shows the need of it, and that is a waste of money.

C. E. Copp (B. & M., Concord, N. H.).—The nature of the renovator to be used is of course very important. In one instance I found a renovator being used that required that the varnish be removed clear down to the wood when the car was shopped for general repairs. On investigation it was found that by applying this renovator to clean glass and allowing it to stand in a warm room for 7 days it would make a good gold size. I would rather use nothing than a thing of that sort. A renovator should be applied to a clean surface, and should be non-drying, and should not produce a film on glass in a warm room. It should be tested first, and if after standing two or three weeks it shows no disposition to dry, or if the atmosphere evaporates it, it is probably a safe renovator to use. In that case it should be rubbed as dry as possible. I would not apply a renovator on the interior of a car that would produce a film on a test exposure.

T. J. Hutchinson (G. T., London, Ont.).—No matter what renovator you use, it should be made in the nature of an emulsion, and it should never be used or applied by an inexperienced person.

Mr. Pitard.—A very thin liquid cleaner is far preferable to an emulsion cleaner. The emulsion cleaners, in going around corners and moldings, and inaccessible places, are difficult to wipe out, and very often the cleaning is entrusted to careless operators who neglect to get the cleaner out of the corners, and the result is that flying dust will accumulate, and in the course of time the corners will be in a bad condition.

Mr. Hutchinson.—If we had the renovator at the proper consistency before using it on all cars, that might be all right. But very often we have to clean cars that are not shopped, and adding vinegar to the renovator and making it into an emulsion saves time and future trouble, if it does not happen to be rubbed out in a corner here and there.

Conclusion.—It was voted that the association should go on record as recommending that a competent practical painter be placed in charge of all cleaning of equipment of all kinds at terminal points.

CONCRETE CAR FLOORS

A paper was presented by Leo H. Nemzek, chief chemist for John Lucas & Company, Philadelphia, Pa., on the treatment and finish of passenger car concrete floors. An abstract follows:

Concrete is treated both to preserve it and to improve its appearance. The proper method of treating is oftentimes neglected in order to obtain the decoration at the lowest possible cost. Finished concrete will contain a certain amount of quicklime which has a saponifying action on fatty oils. It is very porous and the expansion and contraction resulting from frequent absorption of water has a weakening effect. The greater the proportion of cement the less will be the absorption qual-

ities and the older the concrete the less capillarity it will have. This should be borne in mind when applying the filler coat to the concrete.

Waterproofing compounds mixed in with the concrete tend to weaken it and the same may be said concerning the materials added for decoration. The colors that have proved the most successful are natural earth pigments, which are practically inert and therefore have no harmful effects. Water soluble dyes have been used to give brilliancy with no harmful effects, but the former are to be preferred, as they are fast color, while the stains invariably fade. It is advisable when contemplating finishing concrete in a color, to write to the suppliers of the cement to learn of the coloring materials which can be safely used.

The absorption of grease and oil not only tends to disfigure a floor, but has a disintegrating action. Many types and grades of mineral oil when allowed to penetrate into concrete that was not thoroughly dry were found to possess a disintegrating influence, but on old surfaces there is no noticeable indication of this. Linseed oil in a concrete mixture does not make it waterproof or make it impervious to the absorption of oils.

The natural grinding action or wear on the surface of a concrete floor will cause a dust which readily adheres to the surface of untreated floors, in a manner which makes it impossible to remove it. By painting, the floor is made sanitary, because it may be kept clean and free from all traces of dust and dirt, and oils and grease may be kept from penetrating into the concrete. It is possible to obtain the same color and decoration on concrete floors that is to be had by the painting of wood.

A treatment of the concrete surface which has for its object the elimination of whatever free alkali is present on and near the surface will in practically every instance prove injurious to the concrete. The general results of experiments along this line indicate that it is not advisable to attempt the elimination or change of the alkali to some other form, by chemical reagents.

The most satisfactory results have been obtained by the use of a thin varnish-like mixture which is especially adapted for work of this character. This filler is practically a wash which penetrates into the concrete and destroys whatever action alkali would have on an oil paint coat. In the process of neutralizing any free alkali with which this filler comes into direct contact products are formed, which assist in making a thorough bond within the concrete, without weakening the structure. Capillarity is destroyed by the oxidized film, which results upon drying. The paint coat which follows the filler can then be selected to obtain the desired decoration and will assist in correcting for all the forces that exert deteriorating influences on naked concrete.

In applying the paint two factors must be given careful attention. While the pigment is a requisite of considerable importance, the vehicle will in almost every instance determine the wearing properties. Floors are subject to hard usage. It is necessary, therefore, to use a material which will oxidize to a hard dry film and at the same time retain sufficient elasticity to withstand the strains to which it is subjected. The material best adapted for this kind of work will not alone give satisfactory results. It must be applied in a manner which will insure a thorough bond in the concrete itself.

Ordinary floor paints which prove satisfactory when used over wooden surfaces give equally as good results when used over a properly applied filler. The wear closely resembles that found on a wooden floor. The paint coat invariably possesses somewhat better bonds within the concrete and the service in many cases is superior to that obtained from the same paint applied on wood.

Before applying the filler, all dust and loosely adhering particles of concrete should be brushed away. If the surface is very hard and smooth it may be necessary to go over it thoroughly with a stiff wire brush, as otherwise the penetration will not be sufficient to allow the paint coat to form its hold

within the concrete, with the result that flaking will soon follow. At no time is it advisable to use water in cleansing the floor in preparation for painting; because of the tendency that concrete has for holding moisture, it requires a long time to thoroughly dry out. Peeling is likely to result if the floor is not dry at the time it is treated. Wherever possible, the floor should be allowed to stand for three to five weeks so as to give the concrete ample time to dry-out.

When painting floors which have any grease or oil adhering to them, wash them with benzine before applying the filler, otherwise it cannot perform its proper functions. If any neglect occurs in this respect the paint coat which follows will, because of the lack of penetration, soon break away in the form of "scaling." Frequently, concrete floors are encountered which do not dry out evenly, or which show a variation in hardening, due to unevenness in the size of the particles of sand and stone. If a paint coat is applied without first treating the surface with a filler, the finish will lack uniformity and show gloss spots. The use of a filler makes an even appearance certain

case a too heavy application of the filler has been made, it should be cut with turpentine before applying the paint.

It is not necessary to again apply a filler when repainting floors. One coat of paint applied so that it can be brushed out well will give the best results. In preparing the surface for repainting no strong alkali should be used for cleaning, as it will not only act upon the paint, but if not thoroughly removed will also effect the following coat. It is advisable to go over the surface with warm water and soap, and allow sufficient time to elapse for drying.

The accompanying illustrations show the concrete floors under varying conditions. In each case the actual size is shown. Fig. 1 shows a perfect condition of ordinary floor paint applied over a proper filler. The paint film is in perfect condition. Fig. 2 shows an ordinary floor paint over an untreated surface. The disintegration shown was also found in the case of cement floor paints applied over the same surface.

Fig. 3 shows an ordinary floor paint applied over an improperly applied filler. The excessive scaling is clearly indicated.

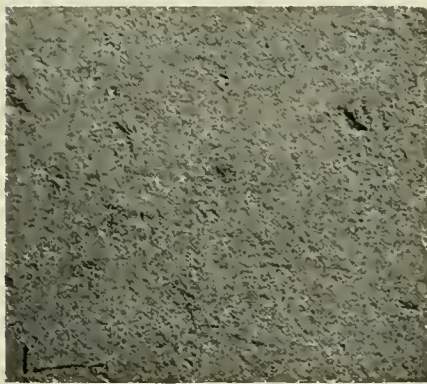

Fig. 1.

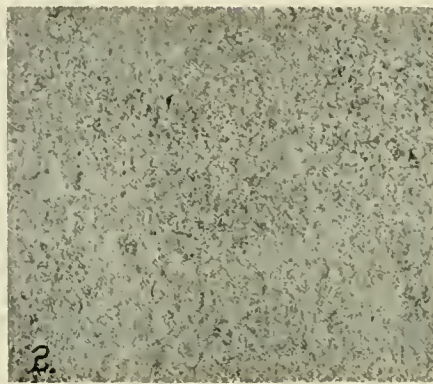

Fig. 2.

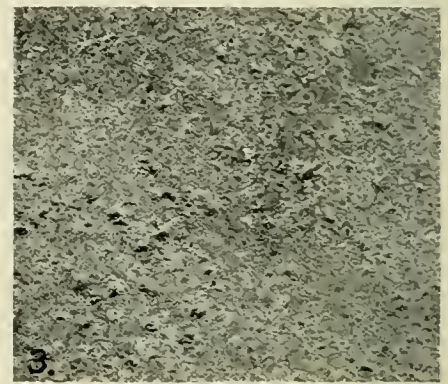

Fig. 3.

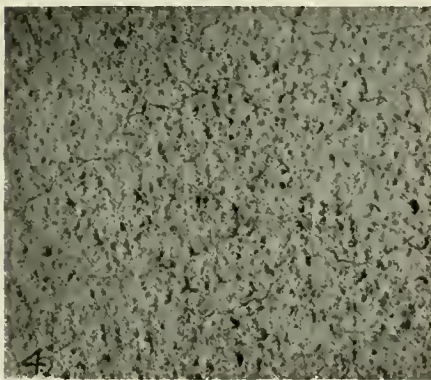

Fig. 4.



Fig. 5.

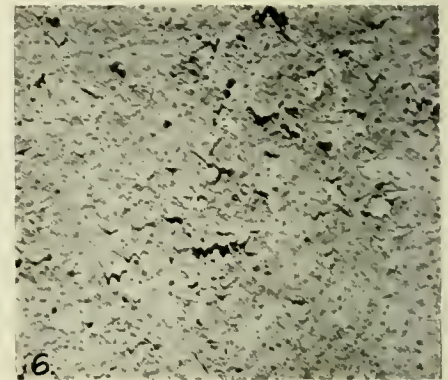

Fig. 6.

Comparison of Concrete Floor Surfaces Which Have Been Treated by Proper and Improper Methods.

While it is true in other branches of painting that the application of several thin coats is preferable to thick coats, this method of application is even more necessary for the painting of concrete floors. While good results can be obtained from the application of one coat over a filler, the best service value is given where two coats are used, the first especially being applied thin.

In applying a filler care must be exercised so as not to obtain a varnish-like surface, which may result from a too heavy application, or in many cases can be traced to the character of the concrete. When properly applied the filler penetrates into the concrete and when dry the only thing that would indicate its application is a slight staining effect. No gloss should be perceptible. If the surface left after the application of the filler shows a glossy appearance the results obtained by applying a paint coat over it will in most cases prove unsatisfactory. In

The same paint was used on the samples shown in Figs. 1 and 2. The same condition was noted in the case of cement floor paints applied over an improperly filled surface.

Fig. 4 illustrates a brittle character of the paint coat. The vehicle portion of this paint was constructed so as to be only slightly subject to the action of the alkali present in the concrete. Fig. 5 shows the appearance of a paint coat after six months' wear over an untreated surface. This is also typical of the results obtained with cement floor paints under similar conditions. Fig. 6 illustrates the disintegration caused by the action of the alkali in the concrete on the vehicle portion of the paint coat.

REMOVING PAINT FROM LOCOMOTIVE JACKETS

W. H. Pratt (Erie, Huntington, Ind.).—When necessary to remove old paint from locomotive jackets we lay them out flat and cover them with a solution of caustic soda and lime and

hard wood ashes when we have any. This is allowed to stand over night and when the paint is loosened, it is scraped off and the jackets are thoroughly washed with plenty of water. They are then washed with a solution of acetic acid and water, and when thoroughly dry the underside is covered with a good mineral paint and the outside with a primer. This method has given good satisfaction and may be done by a handyman.

J. W. Houser (C. V., Chambersburg, Pa.).—A good plan is to put the locomotive jacket into a lye vat. We have a man in our machine shop who does the lye work on different parts of the engines, and he removes the paint from the engine jackets that are in bad condition. At times it is not necessary to lye off the jacket as a whole, and in those cases we scrape whatever parts are necessary.

J. P. Langerslik (C. C. C. & St. L., Columbus, Ohio).—We find that method the most economical.

Conclusion.—It was voted to be the sense of the association that the best and most economical method of removing old paint from locomotive jackets is to immerse them in a lye vat.

CARE OF STEEL PASSENGER CAR ROOFS

T. Spirk (C. R. I. & P., Davenport, Iowa).—When painting steel roofs be sure that they are free from rust and well prepared for the priming coat. That coat must be of solid pigment and pure oil, well brushed on, so that an elastic crust will be formed which will adhere to the steel and become a good foundation for the following coats. The surface must be covered with a solid body of paint, so dampness and cinders will not get to the steel. You will hardly find anything better than red lead, for a foundation coat, at least.

E. L. Younger (M. P., Little Rock, Ark.).—The steel roof should be sand blasted or pickled before painting, to remove all the scale and rust. A passenger car roof receives harder treatment than any part of the car with the exception of the floor, on account of the locomotive cinders, of workmen scarring the paint while making repairs and on dining cars, while ice is being put in the refrigerator. On account of these injuries the roofs should be painted every six months.

W. O. Quest (P. & L. E., McKees Rocks, Pa.).—The principal trouble in keeping paint on a steel roof is caused by the sun. If you paint over any dross or scale the paint becomes dry and absorbent, and the water will get in and rust the roof. The scale should be removed by sand blasting if possible.

J. A. Pitard (M. & O., Whistler, Ala.).—A good way to remove the scale is by pickling the plate in dilute muriatic acid in a vat. The trouble with steel roofs is not so much from scale as it is from the action of cinders wearing away the paint while the car is in service. On our canvas and tin roofs we paint the ends of the cars with a thick paint containing medium coarse sand to offset the effect of the cinders and it gives good results.

EXTERIOR PASSENGER CAR PAINTING

F. M. Pribble (L. & A., Stamps, Ark.).—The A. B. C. system is used in our shops, and if the carpenters will use surfacer *A*, or the liquid primer that is in use, instead of glue, to stick the sheathing together, much better results will be obtained, as the boards will expand and contract freer, and not injure the painted surface. After the wood has been thoroughly cleaned of dust and the fibre removed from about the screw holes, the primer should be applied evenly, and brushed in well; the laps should be smoothed out to prevent blistering. The primer should be of uniform consistency and penetration. After it has stood 72 hours, the surfacer *B* should be applied, being thoroughly brushed in. The puttying should be done the next day and 4 coats of surfacer *C* applied, sufficient time being allowed for each coat to dry. The final guide coat or stain is then applied, the latter consisting of dry yellow ochre with sufficient *C* surfacer for a binder, and a small amount of light chrome yellow for

color thinned to the proper consistency with turpentine. On our road the water and stone method is used for rubbing down. After the car is rubbed and dry, the surface is gone over with No. 1½ garnet paper and the defects faced up with putty; two coats of the body color are applied, the ornamenting done and three coats of varnish applied, three days being allowed between each coat for drying. The sash is treated in the same manner and at the same time as the rest of the car.

On cut-in work the cleaners thoroughly clean the inside of the car, removing seat cushions, etc., and the dust and dirt are removed from both the inside and outside by compressed air. The exterior is then carefully washed down with linseed oil soap. The surface is rubbed with No. 1½ garnet paper which scratches it sufficiently to give a good "toe-hold" for the new coats of color and varnish. The sandpapering precedes the scraping out and puttying because it brings into greater prominence many defects which would otherwise escape the eye of the average workman. The surface is then gone over with a scraper and all fissures, fractures, etc., carefully cleaned out to a solid foundation and touched up with surfacer *B*. These are faced up the next day with hard-drying putty. Should any patching by carpenters be necessary, it is done immediately after shopping and brought to a surface with the balance of the car.

When a scar is hardly large or deep enough to require a patch, but too large for putty, plaster of paris mixed with glue water may be used, and the hole or scar should not be filled quite to a surface. This will dry absolutely hard in a short time, and the glue water imparts sufficient elasticity to insure its holding. When it is dry a little facing up with hard-drying putty gives a smooth finish which is entirely imperceptible.

The gold on letters and stripes is next gone over with steel wool in the hands of a careful workman and cleaned up and brightened to a surprising extent. An hour's expenditure of energy will pay big dividends in the appearance of gold on your cut-in job. The puttied holes are next sandpapered smooth and spotted out with color and the car is cut-in with the body color, the broken gold is touched up, and two or three coats of finishing varnish are applied, according to the requirements of the old surface.

Where systematic car-shopping is in vogue, and the car is returned to the shop for refinishing in a reasonable length of time, the touch-up method can often be employed instead of cutting-in, and a good appearing job be turned out. It is a well-known fact that the greater the depth of pigment and varnish over the old surface, the deeper will be the ugly checks and fissures when they make their inevitable appearance, hence the advisability of "touching-up" if the old surface is in condition to warrant it and broken spots requiring putty and matched color are not too numerous. Systematic terminal cleaning greatly increases the possibilities in this class of work and, indeed, to every phase of coach finishing, and pays big dividends in added life to the varnished car.

This paper deals with ideal conditions, when there is plenty of time to do the work. I give my primer all the advantage in drying I possibly can, because I believe the priming coat is the painter's greatest trouble. We find that it usually takes from 20 to 25 days on a new job or a burnt-off job to get a good piece of work.

E. A. Wittes (Terminal Ry. Assoc., St. Louis, Mo.).—We painted passenger cars with white lead and linseed oil up to about two years ago, but now we use a process by which a car can be finished in about 10 days. The priming is done on the first day; puttying and kniving on the second; sand papering and the first coat of surfacer on the third; two coats of surfacer and sand papering on the fourth; sand papering and two coats of body color on the fifth; lettering and first coat of varnish on the sixth, and on the next three days one coat of straight finishing varnish is applied each day. We do no rubbing or striping on the cars.

QUALIFICATIONS OF A FOREMAN PAINTER

A paper was presented on this subject by C. E. Copp, foreman painter, of the Boston & Maine at Concord, N. H. An abstract follows:

The qualifications of a foreman painter may be classified under four heads: physical ability, mental ability, education and ethics. The exacting nature of the present-day rush in the paint shop requires that the foreman be of sufficient strength to stand the strain. He should be an example of good discipline to his men and then he can with propriety and justice enforce shop discipline. He must not make threats, but what he says he will do he must be careful to perform to retain their obedience and respect.

He should be conversant with new ways to arrive at correct conclusions as to the nature and value of the materials he is using and the results that will follow their use and exposure to the effects of wear and weather. These are found in mechanical and experimental ways and tests. There should be a working harmony between the foreman painter and the railway chemist, or testing department. The practical, experienced painter is a valuable co-worker with the chemist.

The foreman painter should be equipped with at least a good common school education. He should know how to clearly express himself on paper. He will need often to be quick and accurate at figures. He must have an executive and managerial ability in order to produce the most and best work from a large force.

Concerning his ethical status, a foreman painter should be a *Man*, he should not be the tool of anybody—not even of his superior officers, but should have a mind of his own and be fearless in expressing it. He should not be owned, body and soul, by anybody, but be free and independent to express an opinion as to the merits or demerits of materials or methods followed, and to make changes in any of them for the good of the service. It is expected that the foreman painter will have warm friendships, not only with his superiors, but amongst the supply trade, if he is friendly, square and honorable in his dealings, and it is right and proper that he should. But he must reserve the privilege to differ with anybody at any time as to the quality of what he is receiving for supplies and to “kick” when necessary, or to make changes if needful.

REMOVING STAINS FROM NATURAL FINISH

J. R. Ayres (U. & M. V., Syracuse, N. Y.).—We have had fair success with the following solution where the stains were not too deep. Dissolve one pound of oxalic acid in 1½ gallons of water. Take 8 ozs. of cream of tartar and add slowly enough hot water to dissolve the tartar. Allow this to cool and stir in the acid solution. Apply the mixture with a brush over the parts to be bleached and when dry, sand paper to remove the coating. If the stain is not removed repeat the operation and wash thoroughly with hot water.

On stains that cannot be removed with this solution, I have used the following: Dissolve 4 lbs. of chloride of lime and ½ lb. of soda crystals in one gallon of water. Cover the spots with a thin layer of white cotton waste and keep the waste saturated with the solution until the discoloration has been removed. Then wash it with a solution of sulphuric acid and water to remove the chlorine.

These formulas will remove almost any discoloration but the grain of the wood will be raised and it will be necessary to use a cabinet scraper in order to resurface the wood before refinishing.

J. W. Houser (C. V., Chambersburg, Pa.).—We have used oxalic acid for many years with good success. I have had better success by adding a little alum to it. We have done much cleaning in that way, and it obviates the scraping.

E. F. Biegelow (N. Y. C., W. Albany, N. Y.).—We have always used oxalic acid applied hot and allowed it to dry, and then washed off again with hot water, the wood being allowed

to dry before proceeding to finish. That will take off a water stain, but we find on our ash and oak cars quite a number of other stains, particularly the stain that comes around a nail which the oxalic acid will not remove.

C. E. Copp (B. & M., Concord, N. H.).—If a new oak headlining comes to you unfinished, and you undertake to take out any stains by the application of acid, provided those stains have any residue of iron in them, they will look worse than ever after a while.

W. O. Quest (P. & L. E., McKees Rocks, Pa.).—If you attempt to varnish the same day you do your bleaching, and do not allow ample time for the bleaching to dry, it will turn all kinds of colors, otherwise you will have no trouble. If you will use four parts of oxalic acid and one of common washing soda, you will find it has less tendency to turn the work dark. You can make your oxalic acid yourself. It is simply nitric acid and sugar, and is, of course, a deadly poison. On account of the sugar it will naturally be sticky, and if you attempt to varnish before it is dry, your varnish remains tacky. It is like a coat of shellac; you must not varnish either before they are dry. We do a lot of bleaching. We do not tear off the varnish when an abrasion occurs. Our men are on piece work, but we put the men on day work to bleach out the spots.

J. S. Gilmer (So. Ry., Knoxville, Tenn.).—As to the iron stains, the tannic acid in the solution makes tannins of iron, which is dark. Take tincture of iron and tannic acid and mix them together, and while each is a kind of yellow liquid, they will immediately turn perfectly black. That is the trouble in those stains. We have had some experience in getting rid of them. We took nitric acid and put it on the black spot. That will turn it a kind of brownish yellow, and to get rid of that I use caustic soda on the nitric acid; afterward we rinse it off and bleach it with oxalic acid. We have got very good results. We clean our seat ends by dipping them in a vat of caustic soda and as the varnish is loose enough to remove we take them out and rub it off with a stiff brush. It is then rinsed off and allowed to bleach in a vat of warm oxalic acid. The mahogany will bleach perfectly, but with the oak we sometimes have to let it dry, wash off and dry again, then return to the vat again. By careful watching the acid will not eat in enough to loosen the joints. It is estimated that this method is twice as quick as scraping.

T. R. Cowan (C. P., Montreal, Que.).—We have had trouble with oxalic acid. Our cars have real mahogany for the exterior finish. We have never had any trouble with the varnish. The difficulty we find is that it seems impossible to bleach out mahogany. Even when the carpenters scrape it, the stain is still there. We can get nothing that will help it. We touch up the black spots with one color and when the car comes back we find an altogether different color.

T. J. Hutchinson (G. T., London, Ont.).—When you have bruises and blemishes in the mahogany, the cabinet maker must remedy it. We paint them out and grain in imitation, and we find that is satisfactory in a sense.

MAINTENANCE OF STEEL AND WOODEN PASSENGER CARS

John Gearhart (Penn. R. R., Altoona, Pa.).—We have up to the present time been getting about 50 per cent. more service from the steel than from the wooden cars; in fact, since the advent of the steel car on our lines about the only people yet called on for repair work are the painters and truck repairmen. As to the relative difference in the cost of maintenance on the exterior of cars, after almost five years' service of the steel car it is our impression that this maintenance is greatly in favor of the steel equipment; our experience with wooden cars showed that every time a car was shopped for class or slight repairs it was necessary to replace anywhere from a half-dozen to a dozen panels and the same number of battens due to the panels being

split or being scraped by baggage trucks, etc., which, of course, is all eliminated on steel equipment.

On the interior of the steel car we are having more or less trouble with rust due to acids, etc., used when the cars are under construction; we have also experienced considerable cracking of the paint and varnish. This latter trouble will be overcome in time as we are now getting ready to change our practice from air to mechanical drying by installing a baking oven sufficiently large to take care of the largest of our passenger cars.

G. Warlick (C. R. I. & P., Chicago, Ill.).—We have just passed through the first shopping of our steel cars. On our road there are about 200 steel passenger cars and about 1,100 wood passenger cars. The cost for the exterior of the steel passenger cars when they are shopped for Class 1 repairs (which means cutting in and varnishing) is about the same as a wooden car of the same size; the interior of the steel cars is finished in mahogany and oak and receives the same treatment as a wood car and costs about the same for labor and material. There is, however, a saving on the floors of a steel car which do not have to be painted. The cost of painting a car which comes in for Class 2 repairs (which means removing the paint by sand blast or other methods) will be about 10 per cent. more than for a wooden car; there will also be an additional expense of glazing or scraping in; you can figure about \$8 to \$12 for this operation.

The roofs will require more care, as they will have to be brushed with a steel wire brush to remove rust and keep them well painted. While there may be, as above stated, more labor on the steel car, it is turned back into service sooner, which evens up the difference in the cost of maintenance.

Mr. Gearhart: The maintenance of the roofs on some of our cars has not cost any more than to coat them over. We are giving them two coats instead of the one we used to give the canvas roof. My experience has been that it is better to have everything on a steel car sand blasted. We made some tests, and in the instances where we did not remove the scale, inside of two years the scale was removing the paint. I would sand blast the cars all over when we repaint them. The cold rolled steel should be sand blasted for we find the paint is coming off the inside sheets. We should have insisted upon the manufacturers sand blasting it before they painted it.

O. P. Wilkins (N. & W., Roanoke, Va.).—One reason for not sand blasting the roof is that it does not receive the same treatment as the rest of the car. My experience has been that where sand blast is used, and you only put on a few coats of paint, the film is very thin compared with the body of the car and it soon wears through and corrodes. I found that a surface not sand blasted was better after three years than one sand blasted. I reasoned that the sand blasted surface is more or less honeycombed; these little pinnacles that project up through the thin paint wear off and expose the iron and corrosion sets in, and it reaches under the paint. By using acid pickle and a vat for the roof sheets, we thought we would get better results than with the sand blast, as our cars are to receive only four coats of paint.

W. O. Quest (P. & L. E., McKees Rocks, Pa.).—A heavy sand should be used in sand blasting, for the light sand will not get all the scale off. It should be about the size of rice.

FREIGHT CAR ROOFS

W. Bailey (B. & M., Concord, N. H.).—I question the necessity for the painting of the roofs. From the experience I have had I have about come to the conclusion that there is very little if anything to be gained by painting them.

J. H. Pitard (M. & O., Whistler, Ala.).—I differ with Mr. Bailey. Very often the best of lumber is not used in our car roofs, and unless everything that can be done is done to preserve them, they very quickly become bad.

W. H. Truman (N. & S., Newbern, N. C.).—We generally give them one good coat of oil primer. I do not believe it is economy to apply more than one or two coats.

G. Warlick (C. R. I. & P., Chicago).—I think the freight car roofs should be well protected. The money paid out by the railroads on damages for goods spoiled by water is tremendous, and everything that will add to the preservation of a car roof is real economy.

J. W. Fryer (N. C. & St. L., W. Nashville, Tenn.).—We use spruce for car roofs, and judging from the experience we have had with it, I believe it lasts better without painting.

G. Derrick (P. M., Grand Rapids, Mich.).—We carry a great deal of furniture, and find it more necessary to protect the roofs than even the sides of the car. We put two coats of paint on all our roofs.

Mr. Bailey.—Of course as long as the wood has moisture in it, it will rot. Suppose you put two or three coats on your roof; with the men going over it in their work, they will break the paint clear of the wood. A little hole in the paint will allow moisture to get under the paint, and it will not dry out as quickly as it would without any paint there.

G. Schumpp (L. & N., Louisville, Ky.).—We have a double layer roof on our cars. For the last four years we have not painted our roofs at all. We dip them first in linseed oil, and lay them out to dry, stacked up. Then the carpenter puts them on. We built 150 stock cars four years ago, and we find that our roofs, prepared as I have stated, last better than any other roof we have tried.

J. H. Whittington (C. & A., Bloomington, Ill.).—I believe the dipping process is good. We made a large trough, deep and wide and long enough to take in fifteen or twenty boards, and on the inside of the trough we have four brushes, so fixed that they come together. We rigged the device up ourselves. We use common laborers and after the boards are in for a few minutes, we put them through the brushes, and it takes off the surplus paint.

A. Hunicke (M. K. & T., Sedalia, Mo.).—Our material, yellow pine, white pine, etc., contains a great deal of pitch and resin, and it is necessary to paint them. If you do not, they will rot in a short time. We have a machine run by electric motor, and it dips 1,200 boards an hour. They run through about 12 ft. of paint, and the surplus paint is drained off at the other end. If a roof is thoroughly saturated in that manner, we find that in the hot sun and the various weather conditions we have in our section, it will last a number of years longer than if it were not treated at all.

T. J. Hutchinson (G. T., London, Ont.).—In London we paint our roofing and sheathing in a stack, with a long-handled brush. We do enough at one time to last us a week, and we aim to have a week's supply ahead to dry. We take particular pains to see that the roofs are thoroughly painted, because we had a number of claims made for damage to grain shipped in them. We supply our out-stations with a stencil to mark all roofs that are not safe or watertight, as a guide to the shippers. I think the initial painting of a freight car, particularly the roof, is the important part. I believe much of the money paid for damaged merchandise might be saved if the practice was followed generally.

W. O. Quest (P. & L. E., McKees Rocks, Pa.).—We dip our roof boards before giving them their regular coat of paint. They are run through a trough which has an arrangement of scrubbing brushes on one end. Even though you have a double roof, the lower roof being of galvanized iron, we have to look to the preservation of the wood, for it will dry up and the tongues and grooves will fail to meet. If you have them tongue and grooved and well painted, and driven up well, you have a better chance to hold the roof in place.

Conclusion.—It was voted to be the sense of the association that it is considered good practice that all roofs of freight cars

be well protected with paint. Either creosote or paint can be used.

OTHER BUSINESS.

The next place of meeting will be selected from the following three places, Ottawa, Can.; Detroit, Mich., and Chattanooga, Tenn.

J. F. Enright, superintendent of motive power and car department of the Denver & Rio Grande, and Warner Bailey, retired master painter of the Boston & Maine were elected honorary members.

The following officers were elected: A. J. Bush, Delaware & Hudson, Oneonta, N. Y., president; O. P. Wilkins, Norfolk & Western, Roanoke, Va., first vice-president; T. J. Hutchinson, Grand Trunk, London, Ont., second vice-president, and A. P. Dane, Boston & Maine, Reading, Mass., secretary and treasurer.

CAILLÉ FEED WATER HEATER

BY H. H. PARKER

A design of feed water heater for locomotives, which since its invention in 1908 has met with much success on the railways of the Continent, particularly in France, has been experimentally applied to a large consolidation locomotive on the Seaboard Air Line. This heater is of the type that employs exhaust steam which is conducted to a drum where it circulates on the inside of a nest of tubes and is condensed by the cold feed water which fills the drum around the outside of the tubes. The condensed steam is discharged to the right of way between the rails. The feed water is handled by a double pump which simultaneously draws cold water from the tank and forces it in the heater and with the same stroke draws water from the top of the heater and discharges it to the boiler.

The diagram shows the arrangement of the apparatus as applied to some French locomotives, which illustrates the principle but not the exact construction used on the Seaboard Air

Line. It will be seen that there is a passage from the exhaust pipe, entrance to which is controlled by a valve that can be adjusted by the engineman. Through this passage the exhaust steam is carried to one end of the heater where it communicates to a closed header at the forward end of the nest of tubes that are enclosed within a large steel drum which is carried under the running board. In passing through the length of the tubes it is condensed and discharged from the heater at the opposite end. The feed pump is very similar in design to a Westinghouse air pump, having the same type of steam cylinder and valves; on the Seaboard Air Line it has two separate cylinders, one below the other. It is secured to the frame underneath the cab and back of the heater. Water from the tank flows to the lower pump cylinder by gravity, and is discharged to the bottom of the heater. The upper cylinder takes its suction from the top of the heater drum, and discharges directly to the boiler check valves on the left hand side in the usual location. The suction for hot water is at the opposite end of the drum from the cold water inlet.

In addition to the steam from the exhaust pipe, the exhaust from the air pump and from the hot water pump are also carried through the heater and will keep the water hot while the locomotive is not moving. It will be noticed that there is a spring operated valve in the exhaust steam line before it reaches the heater which acts as a temperature regulator and will be seated when the pressure in the nest of tubes reaches a pre-determined point. There is also a safety valve at the opposite end of the drum to prevent too large a pressure on the nest of tubes.

In the cab are located three extra gages, one showing the water pressure in the heater drum, one showing the temperature of the water in the heater, and the third in the French arrangement showing the pressure on the hot water feed pipe, but in the American adaptation this gage shows the steam pressure on the pump line.

The preliminary trips of this locomotive preceding the test runs, indicate that the advantages claimed abroad will be sub-



Consolidation Locomotive on the Seaboard Air Line Fitted with a Feed Water Heater.

stantiated. On one of the runs when the train was on a heavy grade and the engine was working to its capacity, the steam pressure at the time being 185 lbs., the pump was started and delivered water at 210 deg. temperature to the boiler and during the time it was running the steam pressure continued to rise. Under the same conditions if the injectors had been used the pressure would probably have been reduced at least 10 lbs.

A 5¼ in. nozzle is standard on these locomotives, and when the heater was first applied a 5 in. tip was inserted with the idea that since a certain proportion of the steam passed to the heater, a smaller tip would be necessary to give the desired draft. After the first trip, it was changed back to 5¼ in., and it is believed that it can be still further increased and still maintain a temperature of between 200 and 215 deg. in the heater.

While no data as to economy is yet available from this locomotive, the tests which have been made on foreign railways indicate that a fuel saving of from 14 per cent. to 16 per cent. can be expected. In Roumania a difference of 16.55 per cent. in the amount of fuel was indicated on alternate runs of locomotives fitted with a feed water heater and with injectors. On the French Northern Railway the tests showed an

SHOP SCHEDULING AND ROUTING SYSTEM

Henry Gardner, supervisor of apprentices of the New York Central & Hudson River, read a paper on "A Practical Application of the Routing System to Locomotive Repairs," at the September meeting of the Central Railway Club. A number of years ago Mr. Gardner devised a shop schedule system* for the Concord, N. H., shops of the Boston & Maine, which was introduced with splendid results. The schedule which he described at the club meeting was one which he developed and introduced in the West Albany shops of the New York Central. This shop has an output of 80 or 90 engines a month, and naturally requires a rather more elaborate schedule system than the one which was used at Concord. The following article is based upon Mr. Gardner's paper, the discussion at the meeting and informal discussion on the boat which brought the club members back from Dunkirk to Buffalo.

This system primarily gives in advance a date to each foreman for finishing every leading operation that is performed in his department. When an engine arrives on the pit the schedule

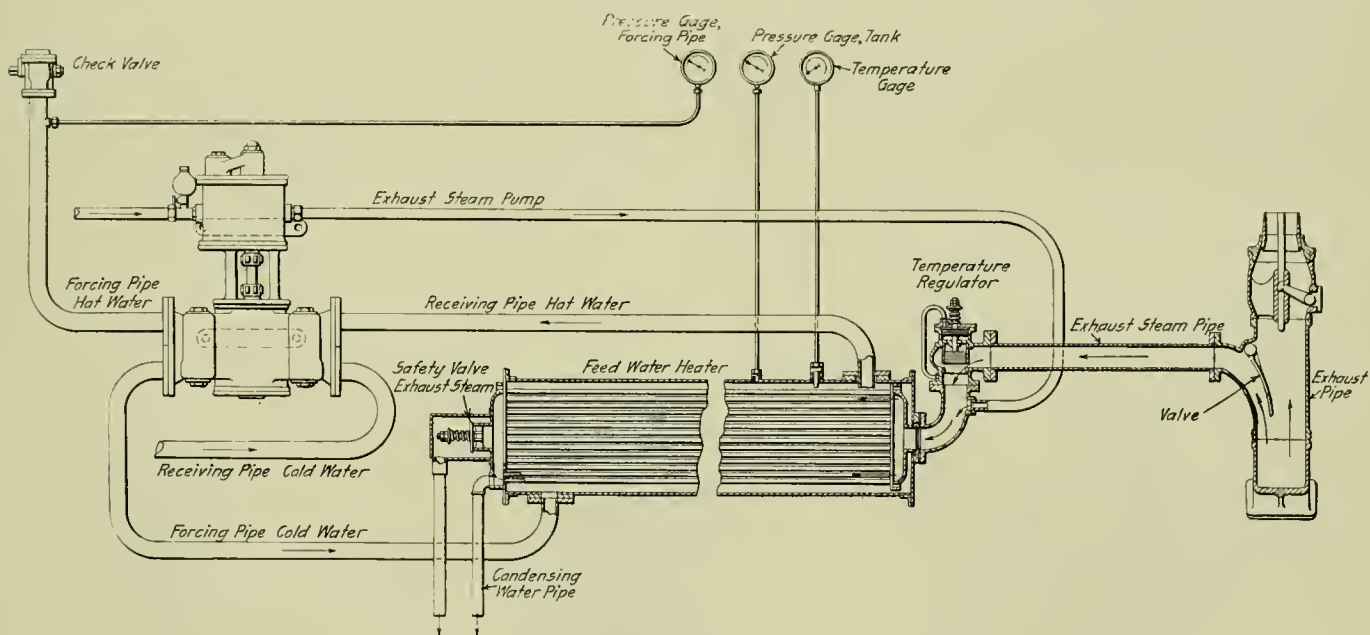

Diagrammatic View of a Caille Locomotive Feed Water Heater.

economy of 17.5 per cent., while on the French State Railway a saving of 16.75 per cent. was indicated in freight service. The results of these tests has led to the application of large numbers of this type of heater to locomotives in France, as well as in Belgium, Russia and Spain. Middendorf Williams Company, Baltimore, Md., are the American agents for Huffer Company, Paris, who control the rights of this device.

LARGE SHIPMENT OF FARM TOOLS.—The Great Northern recently shipped to Winnipeg, Man., the largest trainload of farming implements which ever arrived in Winnipeg in a single consignment. It consisted of two sections, totaling 100 freight cars, each carrying a tractor engine. The duty on this machinery was \$62,000.

AUTOMOBILE PRODUCTION.—At a recent conference between railway officers and automobile makers at Detroit, Mich., it was stated that 100,000 freight cars would be required during the twelve months of 1913 to make the necessary shipments. This would amount to 2,000 cars a week, and an estimated yearly production of 330,000 automobiles.

clerk looks it over carefully and notes the class of repairs and the different parts which are to be repaired or renewed. He then goes to the schedule office and makes out a set of dates which show when all of these parts or operations should be finished in any one department and moved to the next department, or to the erecting shop ready for the engine. Each foreman of a department gets a sheet with a set of dates for all the material which he handles. In some cases two or more foremen will receive the same dates for the same material, so that they can check each other if mistakes occur.

The work is laid out in the office so that the schedule clerk can tell at a glance just where each piece is, when it went there, and when it will be delivered to the erecting shop. He can tell when each portion of the engine will be assembled and when it should be delivered. He can also tell when a piece is delayed in any department and the cause, and can hurry the material or straighten out the trouble, whatever it may be. Each day the schedule office issues a report showing the condition of the work in the shop and just what operations or delivery of material should occur on that day in each department. Another

*See American Engineer & Railroad Journal, May, 1905.

daily report issued by this office tells where each part is delayed and how many days it is late; in the "Remarks" column on this form is given the cause for the delay and the date the part or operation is promised to be completed.

The schedule office contains but two men, a foreman, or chief clerk, and an assistant. This small force is all that is required to give out the dates for repairing more than 80 engines a month. Since each engine calls for 278 dates, under this system an output of 80 engines a month means that the schedule clerk and his assistant must find and write down 22,240 dates per month. This would be an impossible task for two men if it were not for a special calendar slide rule which when once set for a certain schedule makes it a short job to call off the dates. A schedule sheet or "key" sheet is used with the rule and each engine or class of engine has its own fixed schedule.

The schedules and route sheets are made up from a knowledge of the work that the shop can do and has done in the past. Some engines are given 18 days, and others 14 or 24 days, according to the work to be done upon them. When the total number of days for an engine is determined, each separate erecting shop operation is allowed a certain time and then all the departments concerned are given dates conforming to these dates, because, as already stated, the whole scheme hinges upon the delivery date.

There are many different blanks and forms of several colors used in this work, but they would in any case have to be varied to suit the conditions arising in each shop where this system might be introduced. The principles, however, will apply to similar work anywhere. Some of the forms are used to convey the dates from the schedule office to the foremen, while others, on pink paper, are delay or condition reports. There are also check sheets used by the assistant who goes into the shop each afternoon and checks all the operations and material listed in every department. This checking is very important, and upon it depends the delay and condition reports referred to.

One interesting feature of this work is the despatch board in the schedule office. This board is about 5 ft. long x 3½ ft. wide, and is ruled into small squares made by 73 vertical and 30 horizontal columns. The vertical columns stand for all the scheduled operations and material, and in order to locate them quickly a horizontal T square slider is used on the board and the names of the parts are printed on the slide—one name for each column. The horizontal columns represent the days of the month. When a job is scheduled for a certain day the engine number is entered on the line for that day, and in the column for the class of work to which the job belongs. Then by pushing the T square slide up to the line for a given day all the operations and material for that day are shown by reading the entire length of the line. When too many engine numbers appear in any one square it means that the department interested is overloaded and the schedule clerk moves some jobs ahead or back to relieve the congestion.

This system literally ties together all departments concerned and its effect upon the foremen and workmen is quite noticeable. There is much less friction between departments, since the dates stand for the general foreman's order to deliver the material, and any man going to a department to hurry some part is told that he will get it on the date set for it. The responsibility is never placed upon the wrong man, and when a workman is at fault the delay report shows it correctly, and if he has a blackboard over his bench for recording dates the board advertises very plainly the fact that he is delinquent. These assigned dates are just like so many tasks or jobs given out in logical order by the general foreman, and every man works with better satisfaction when he knows each day just what he is going to do and that it is just what the superintendent wants him to do.

Under this system the piece workers get more work and get it regularly, which results to their benefit. The foremen all like the system, because, if lived up to, their labors are very much

lightened. They do not have to continually rush about prodding first one department and then another, and consequently their time is put in to better advantage supervising and instructing the men and forwarding material. The result of all this is better and more accurate work and more contentment and good feeling all over the plant. It is hard to estimate the cost of lack of harmony in a shop, but the co-operative spirit induced by systematic methods is greater than usually realized.

No claim has been made by the management for any direct saving in cost of repairs under these improved methods, but if such a system as described is religiously lived up to it cannot fail to decrease shop operating costs. There will also be a saving from quicker deliveries of engines since these schedules provide for minimizing delays and an engine is worth from \$40 to \$50 a day to the company.

This routing system is not properly defined as scientific management, but is a form or type of these advanced methods. It is scientific management in so far as any modern and efficient form of management may be termed scientific. The schedule office, as it is called, is very closely allied to the planning department advocated by F. W. Taylor, H. L. Gantt, H. Emerson and others.

There can be no question but that this work is a step in the right direction, as has been confirmed by the railways who have adopted similar methods. But no new system will succeed without the hearty support of the management; not only the foreman and the superintendent, but the superintendent of motive power and the general manager must give it their endorsement and approval. Men are quick to notice whether a new plan is backed or not, and human nature is such that, without proper backing, the best system may fail through neglect to conscientiously follow its principles.

As we view it this system forces everybody to do his duty. The man in authority who wants a system which will force everybody else to do his duty but leave him free to do as he pleases is too often evident; such a man could not introduce this system successfully; having once endorsed it he also must live up to the dates and schedules. Unquestionably this work will become more and more popular in railway repair shops; the principles involved can be applied to the car shop as to the locomotive shop, and to the little or the big shop.

HIGH SPEED METAL CUTTING MACHINE

A machine using a flat saw blade which will cut through a 6 in. diameter bar of machinery steel in 20 minutes, or through a 12 in. I-beam in 10 minutes, leaving a face which is true and

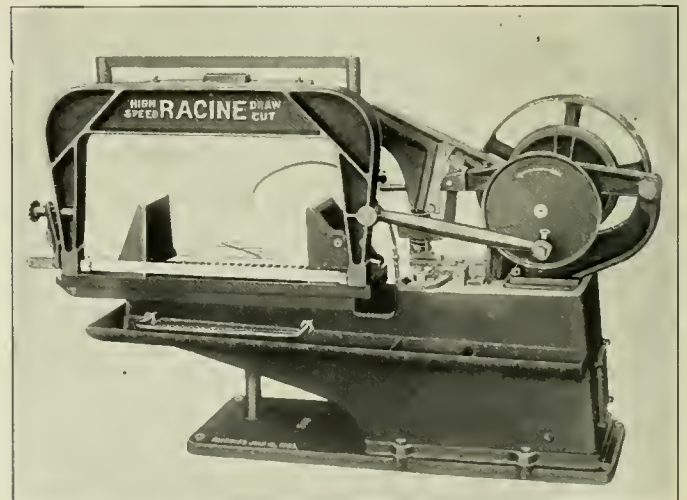

High Speed Metal Saw.

square, is being built by the Racine Tool & Machine Company, Racine Junction, Wis. It is a development of a power hack saw carried to a point where it becomes a tool of precision and can be classed with other high grade machine tools. While it uses a saw blade, the frame carrying it is remarkably rigid and is carried by a support, so designed as to prevent any possibility or tendency for movement outside of the true vertical plane. The cutting is performed by the draw stroke and the blade is lifted clear on the return stroke. A geared circulating pump applies a cutting compound to the blade while in operation, allowing it to be run efficiently at high speed.

The machine consists of a substantial base on which is mounted the vise for carrying the work and the frame carrying the driving mechanism. The vise is arranged to swivel at any angle up to 45 deg., and has a capacity for cutting an 11 in. bar at this angle. The saw frame is supported at the top by an arm which is pivoted near the driving shaft. An eccentric on the shaft, operating through an auxiliary arm that is connected with the main arm through a toothed quadrant, lifts the frame and blade slightly when the saw is on the return stroke. The power is transferred to the frame through a connecting rod attached at a point on the frame very close to the connection of the blade. Arrangement is made so that the saw frame remains automatically at any height when lifted up, allowing the stock to be placed in the machine without interference. This machine will accommodate stock measuring 12 in. x 15 in., and uses blades from 17 in. to 24 in. in length. It has a net weight of 500 lbs., occupies a floor space of 24½ in x 66 in., and has a height over all of 41 in. It can be arranged for either belt or motor drive. In the latter case a speed box is provided giving three different speeds.

BEAUDRY PEERLESS HAMMER

A new power hammer of the belt driven type, designed for comparatively light general forging and specially for tool work

coil springs, leather straps or rubber cushions, every working part being made of steel. The ram, which can be obtained in seven different weights, varying from 25 lbs. to 200 lbs., is connected to the spring arms by two pairs of steel links. These are arranged to give the maximum freedom and lift of the ram and impart through the spring arms a very elastic blow. The tension on the spring arms and links is adjusted and maintained by tension nuts in the spring box.

A foot treadle extending around the machine is connected to the idle pulley bearing against the loose belt and by means of a varying pressure, any desired speed or force of blow can be obtained. A brake band fitted around the extension of the driving pulley is connected with the arm of the idle pulley so that the hammer is stopped instantly when the treadle is released.

The anvil is cast separate from the bed and is attached to it by bolts at the base and by two strap bolts. A wood filler is inserted between the anvil and the bed to eliminate vibration. The anvil is so placed that any length bars can be worked either way of the dies and it has an independent and adjustable shoe.

Special attention has been given to the material and the design of all parts of this machine. The ram is of steel fitted in heavy U-shaped guides. Arrangement is made for adjusting it on the connecting rod to allow for varying heights above the dies. It is, however, at all times almost wholly contained within its guides, insuring perfect alinement and a true, square blow. The guides are fitted with taper gibs to take up any wear that develops.

NEW CAR WHEEL BORING TOOL

Two hundred cast iron wheels bored in 10 hours is a record made recently at one of the plants of a car manufacturing company. These wheels were all for 5 in. x 9 in. axles, the size of

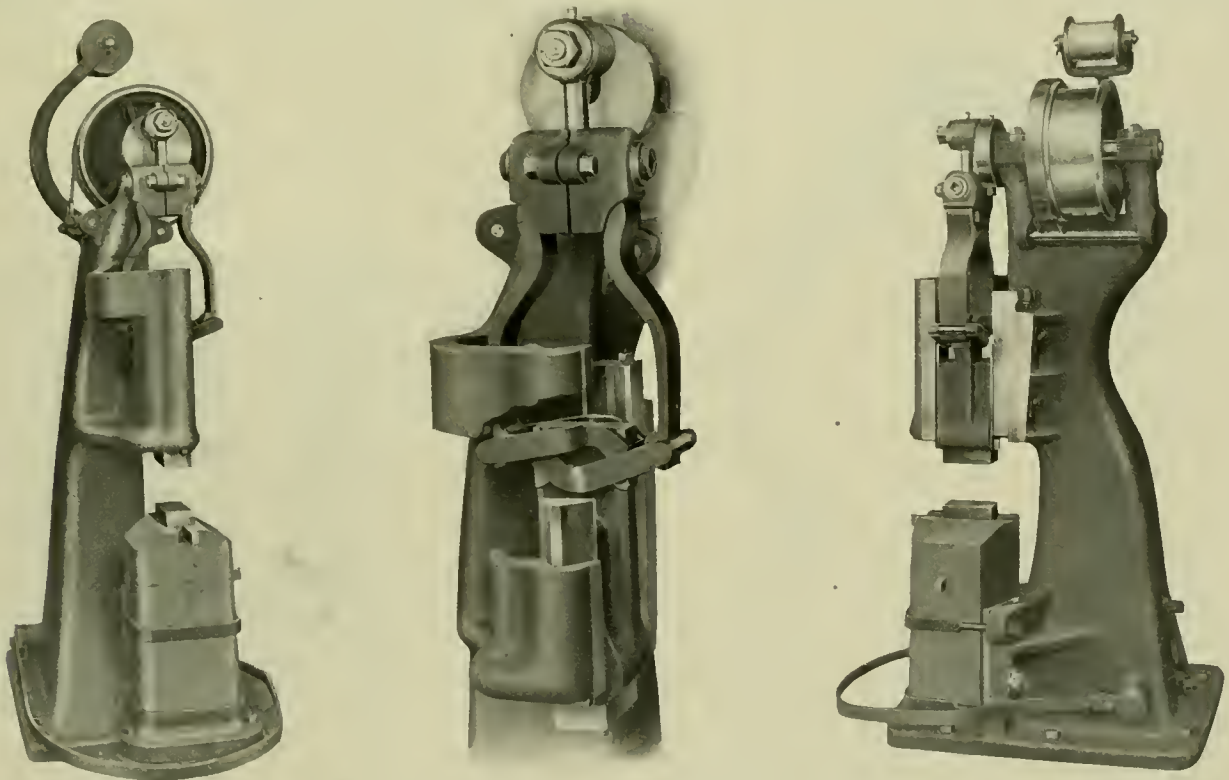

New Beaudry Peerless Power Hammer for General Forging Work.

or other forging that requires extreme quickness of blow, has been designed by Beaudry & Company, 141 Milk street, Boston. This hammer, like its heavier predecessor, has no beam,

the bore being 6½ in. Each wheel was bored in two independent cuts to fit standard gages. The boring machine was a Niles, about four years old, and the Davis expansion car wheel boring tools

of an especially powerful design, recently developed primarily for boring steel wheels, were used.

The boring tool used does not differ greatly in principle from the former "two-in-one" tool designed by the Davis Boring Tool Company of St. Louis, which has made such a wonderful improvement in the output of car wheel boring machines. These tools are fitted with two cutters, each being arranged for micrometer adjustment. The lower one is a roughing tool, and



Expansion Boring Tool for Cast Iron Wheels.

with it the hole is bored to very near its finished size. After it has passed through, a single cutter in the upper part of the arbor is provided for chamfering the hole. This cutter is quickly adjusted by means of a screw and can be easily removed after the finishing cutters have started to bore. After the hole is rough bored and chamfered, the finishing cutters are expanded to the proper size, the actual time required for this operation

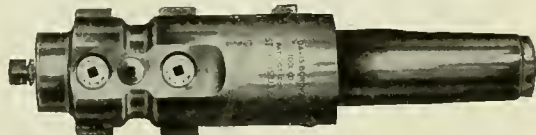

Expansion Boring Tool for Steel Wheels.

being about six seconds. They are then passed through with a very coarse feed since only a light cut is required and a perfectly smooth hole results.

On the tool for steel wheels the shape of the cutting edge has been changed somewhat and the body of the tool has been strengthened for heavier work. For use in setting the cutting

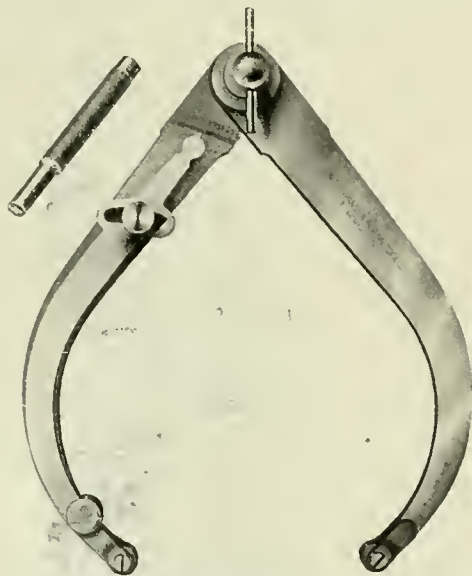

Micrometer Callipers for Setting Boring Tools.

edges of these tools a type of micrometer caliper has been developed with which the wheel fit on the axle can be calipered and the amount of reduction desired for the fit can be made by shifting the leg of the caliper which carries an arm on a micrometer scale, as is shown in the illustration. With the caliper thus set, the cutting edge of the tool can be adjusted directly to size. For the next larger axle the micrometer leg only is reset and the difference in the reading noted. The cutters are then adjusted by their dials to the increased size. Thus by using the micrometer reading on the calipers the cutters can be accurately made larger or smaller without direct calipering.

YOKE RIVETER.

BY Z. B. CLAYPOOL,

Apprentice Instructor, St. Louis & San Francisco, Springfield, Mo.

The yoke riveter illustrated is used for removing short pieces of staybolts left in the outside boiler sheets, after they have been broken down with the staybolt breaker and the firebox has been removed. The boiler shell is stood on end and the yoke riveter

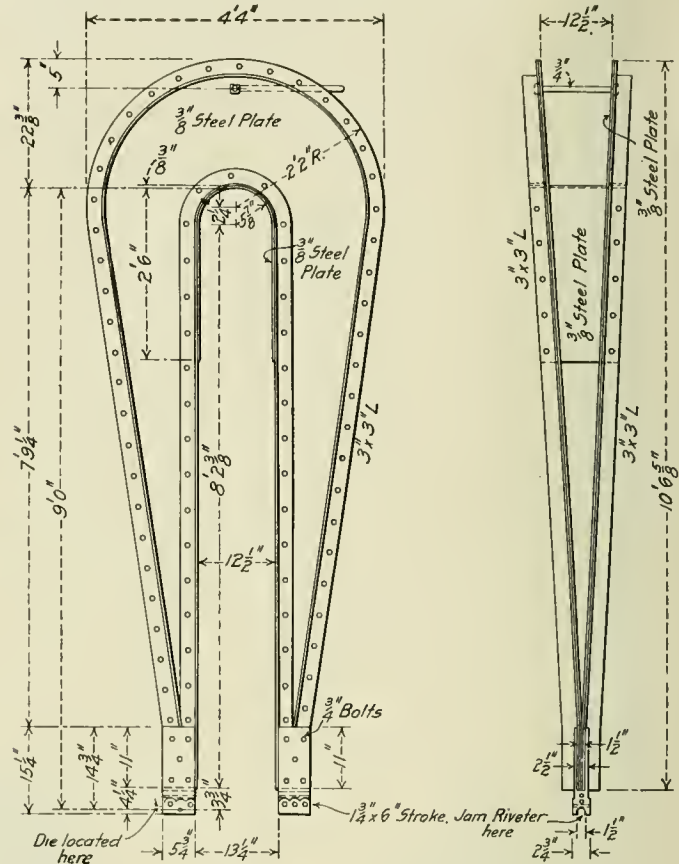

Yoke Riveter for Removing Staybolts.

is hung over the shell from a jib crane, and with it the short pieces are knocked out of the holes. This method has proved more efficient and economical than previous methods. The cost of material was \$0.63, and the cost of labor was \$53.57, a total

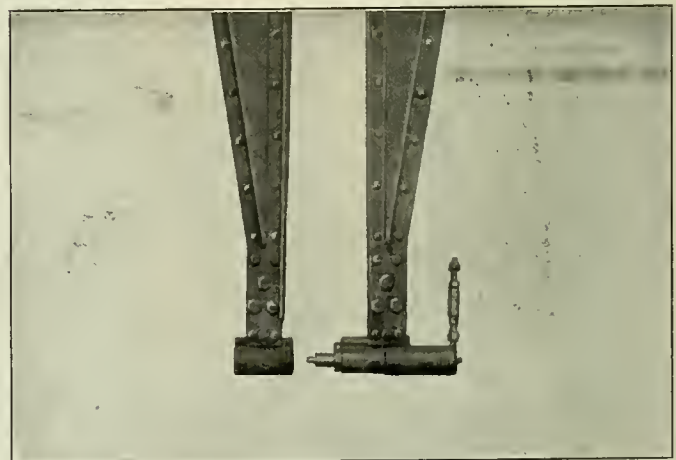

End of Yoke Riveter Showing the Tool and Die.

of \$124.20. The jam riveter, die and holders were purchased from the Chicago Pneumatic Tool Company. The riveter has a cylinder diameter of 1 3/4 in., and a stroke of 6 in. The frame was built at the Springfield shops, and has been in service about two years.

COMPARATIVE TESTS OF FREIGHT LOCOMOTIVES

Records of Mikado and Consolidation Engines in Regular Road Service on the Lackawanna.

A saving of from 29 per cent. to 32 per cent. in coal and 27 per cent. in water per ton-mile in freight service has been effected on the Delaware, Lackawanna & Western by the introduction of a heavy and powerful class of Mikado type locomotives of the latest design in place of consolidation locomotives of a straight forward conventional design. This is shown by the results of comparative road tests between the new Mikados built for this company by the American Locomotive Company, and described in the September, 1912, issue of this journal, page 459, and consolidation locomotives previously used in the same service and purchased last year from the same builders.

As a result of their greater economy, the Mikados, though 32 per cent. heavier and much more powerful than the consolidations, burn 21 per cent., or from 2 to 3 tons less coal per trip than the latter, and yet haul 14 per cent. heavier trains at the same or higher speeds.

The trials were in no sense a scientific test to determine the relative efficiency of the two designs. The object was merely to compare the performance of the two classes of locomotives with respect to fuel and water consumed and load and speed in the same service and under average operating conditions,

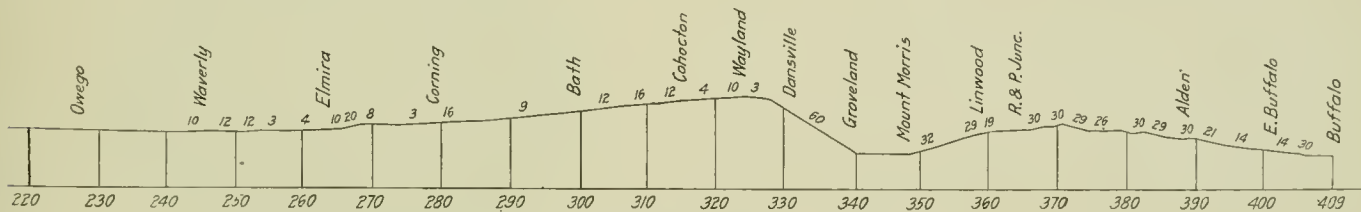

Profile Delaware, Lackawanna & Western Between Owego and Buffalo on the Lackawanna.

with a view to determining just what average benefits, if any, the Mikados effected in handling the traffic.

All observations were made on the Buffalo division between Elmira and East Buffalo, a distance of 141 miles, the profile of which is shown in the illustration. Records were kept of

TABLE NO. 1.
SUMMARY OF AVERAGE RESULTS.

| Type. | Westbound. | | Per cent. Difference. | Eastbound. | | Per cent. Difference. | Average Per cent. |
|--|------------|---------|-----------------------|------------|---------|-----------------------|-------------------|
| | 2-8-0. | 2-8-2. | | 2-8-0. | 2-8-2. | | |
| Distance | 141 | 141 | | 141 | 141 | | |
| Ton-miles per trip | 420,537 | 469,248 | 11.5 | 332,533 | 386,183 | 16.1 | 13.8 |
| Scoops fired per trip | 1,564 | 1,491 | | 1,263 | 1,275 | | |
| Coal fired per trip, tons | 13.7 | 10.8 | 21 | 11.05 | 9.25 | 19.4 | 20.2 |
| Time, total, hrs. & min. | 10.25 | 10.17 | | 11.17 | 9.10 | | |
| Time, dead, hrs. & min. | 2.18 | 1.38 | | 3.08 | 2.21 | | |
| Running time, hrs. & min. | 8.07 | 8.39 | | 8.09 | 6.49 | | |
| Speed, miles per hour | 17.3 | 16.4 | 5 | 17.6 | 20.7 | 17.6 | 6.3 |
| Pounds of coal per 1,000 ton-miles (exclusive of engine and tender) | 65 | 45.9 | 29.4 | 66.7 | 47.5 | 28.8 | 29.1 |
| Pounds of water per 1,000 ton-miles (exclusive of engine and tender) | 571.3 | | | | *416. | | 27.2 |

* Average for all trips.

four runs of each class of locomotive, two in each direction. A short run from Elmira to Mount Morris was also made with one of the consolidations. As this is not exactly comparable with the through runs, the record of this trial is not in-

cluded in any of the following tabulations of average results, except in Table No. 2, which shows the relative performance from Elmira to Wayland.

The consolidation locomotives were comparatively new and have been in service only a year and were in good condition

TABLE NO. 2.
COMPARATIVE AVERAGE RESULTS ON EASY GRADES.
Elmira to Wayland (Westbound).

| Type. | 2-8-0. | 2-8-2. | Per cent. Difference. |
|---|--------|--------|-----------------------|
| Distance, miles | 62½ | 62½ | |
| Time, total, hours and minutes | 5.00 | 4.07 | |
| Time, delayed, minutes | .48 | .41 | |
| Running time, hours and minutes | 4.12 | 3.26 | |
| Speed, miles per hour | 15 | 18.25 | 21.6 |
| Tonnage behind tender | 2,989 | 3,328 | 11.4 |
| Number of scoops | 1,016 | 826 | |
| Coal, pounds | 17,780 | 11,977 | 23.6 |
| Pounds of coal per 1,000 ton-miles (exclusive of engine and tender) | 95 | 57.6 | 39.3 |

of repair. Whatever advantage there was between the two classes of locomotives in this respect was, of course, however, in favor of the Mikados. To offset this, however, the engineers were not familiar with the operation of the Mikado locomotives.

Coal was measured by the number of scoops fired, the average weight of a scoopful having first been determined by actual weight. A record of the number of scoops was kept by means of counters.

On the consolidations a No. 5 scoop was used, the average weight of the scoopful being 17½ lbs.; while the Mikados were fired with a No. 3 scoop, the average weight being 14½ lbs. This is reflected in the results given below in which the difference in the amount of coal burned per trip is much greater than the difference in the number of scoops shoveled. Two

TABLE NO. 3.
COMPARATIVE AVERAGE RESULTS ON HEAVY GRADES.
Cleveland to Wayland (Eastbound).

| Type. | 2-8-0. | 2-8-2. | Per cent. Difference. |
|---|--------|--------|-----------------------|
| Distance, miles | 14 | 14 | |
| Running time, minutes | 80 | 79 | |
| Speed, miles per hour | 10.4 | 10.6 | |
| Tonnage behind tender | 2,145 | 2,550 | 18.7 |
| Coal fired, pounds | 4,687 | 4,462 | 4.8 |
| Pounds of coal per 1,000 ton-miles (exclusive of engine and tender) | 156 | 125 | 20. |

firemen were used on the consolidations, which is the regular practice, while one fireman handled the Mikados.

The weight of water per inch of depth in the tanks was accurately determined and the water level measured through the manhole.

No attempt was made to surround the tests with special conditions. On every run, both the locomotives and the crew operating them were those assigned in the regular course. A

good quality of coal and of the same grade was used on all the runs

Table No. 1 gives separately a summary of the average results of the westbound and eastbound trips; also the percentage difference. It will be observed that the Mikados made a decidedly better performance in tonnage handled and consumption of coal. They showed up splendidly in the test, steamed freely and handled the train perfectly at all times. They burned from 19 to 21 per cent. less coal per trip than the lighter consolidations, and they hauled from 11 to 16 per cent. heavier trains. Westbound there was little difference in the total time, running time and speed between the two classes of engines, though the Mikados averaged 40 minutes less delayed time. Eastbound the Mikados took their heavier trains over the road in considerably faster time than the consolidations.

On the westbound trips, the solid train was taken through from terminal to terminal in all cases; but, eastbound, cars were switched off and taken up at various points en route. The work done per trip by the locomotives is consequently expressed in each case in ton-miles. It is interesting to compare the performance of the two classes of locomotives over particular portions of the division showing their relative merits under varying grade conditions.

Table No. 2 gives a summary of the comparative performance of the two classes westbound between Elmira and Way-

far as details and general design are concerned, represent, in the main, the common conventional practice for locomotives of their type.

A comparison of the principal dimensions of the two classes of engines is given in Table No. 4.

EXHAUST VENTILATOR

A new type of ventilator, designed to exhaust air from buildings, has been placed on the market by Paul Dickinson, Inc., Chicago, and is called the Dickinson Aeolus ventilator. The suction in the main flue or pipe is caused by the deflection of the air currents in the outside flues. The air currents passing upwardly in these suction flues create a positive draft in the flue or pipe in passing over the top edge of the pipe. The flues are six in number, and as can be seen from the illustration, are rectangular in form. By making the flues rectangular, and by leaving the spaces in between them open, a greater suction is created by the moving air currents. These principles and facts were developed from tests.

In order to get the maximum amount of efficiency from em-



Dickinson Aeolus Ventilator for Buildings.

ployees, it is necessary to furnish them with the best air obtainable, and to do this at a minimum cost and up-keep a good ventilator is necessary. These ventilators in addition to being made of any sheet metal, are also made in cast iron, where conditions require that material of extreme durability be used.

ROLLS FOR RECLAIMING SCRAP IRON

It is the custom of most roads to carefully go over the scrap pile and recover usable material, but even when this is most carefully done there is much metal sold as scrap which could be made usable with the proper facilities. Instances are not infrequent where scrap material has been drawn down under a hammer to a size desired, or even in some cases turned down in a lathe and thus saved, but at a very high cost which would not be justified except for emergencies.

For the purpose of making practically all scrap bars or plates again usable, the Ajax Manufacturing Company, Cleveland, Ohio, has for a number of years been experimenting with a small set of rolls and has now perfected a machine which will handle from four to ten tons of metal a day. With this, bars 2 in. in diameter, or less, can be drawn down to and including 1/2 in. in diameter, or any intermediate size, and by installing another set of rolls flat or square pieces of the same relative size can be handled.

TABLE NO. 4.
COMPARISON OF PRINCIPAL DIMENSIONS.

| Type. | 2-8-2. | 2-8-0. |
|--|----------|---------|
| Cylinders, diam. and stroke, in..... | 28 X 30 | 26 X 30 |
| Driving wheels, diam. in..... | 63 | 57 |
| Boiler, outside diam., front end, in..... | 86 1/2 | 81 1/2 |
| Boiler pressure, lbs. | 180 | 170 |
| Firebox, length, in. | 108 | 111 1/2 |
| Firebox, width, in. | 84 1/2 | 75 1/2 |
| Tubes, number and diameter..... | 304-2 | 445-2 |
| Flues, number and diameter..... | 43-5 3/8 | |
| Tubes and flues, length, ft. & in..... | 21 | 15-2 |
| Heating surface, tubes, sq. ft..... | 4,593 | 3,513 |
| Heating surface, firebox, sq. ft..... | 261 | 202 |
| Heating surface, total, sq. ft..... | 4,854 | 3,715 |
| Grate area, sq. ft..... | 63 | 58.2 |
| Superheating surface, sq. ft..... | 1,085 | |
| Weight on driving wheels, lbs..... | 236,500 | 210,500 |
| Weight on leading truck, lbs..... | 27,500 | 25,500 |
| Weight on trailing truck, lbs..... | 48,000 | |
| Weight, total of engine, lbs..... | 312,000 | 236,000 |
| Weight of tender, lbs..... | 159,700 | 157,300 |
| Wheel-base, driving, ft. & in..... | 17-0 | 17-6 |
| Wheel-base, engine, ft. & in..... | 35-2 | 26-5 |
| Wheel-base, engine and tender, ft. & in..... | 67-3 1/2 | 60-11 |
| Maximum tractive effort, lbs..... | 57,100 | 51,400 |

land, a distance of 62 1/2 miles. From the profile it will be seen that most of this distance is an easy ascent averaging about .2 per cent. with some short down grades and level stretches. Under these conditions the Mikados hauled a 11 per cent. heavier train at 21 1/2 per cent. higher speed and burned 23 1/2 per cent. less coal. This gives an average saving of 39 per cent. per 1,000 ton-miles.

A comparison of the performance of the two classes of locomotives under heavy grade conditions is shown in Table No. 3, which gives the average results running from Groveland to Wayland, a distance of 14 miles, all but two miles of which is an ascending grade averaging 1.09 per cent.. Consolidations were used as helpers on this grade for both classes of locomotives. It will be seen that under these conditions the Mikados hauled 18 per cent. more tonnage than the consolidation at the same speed, and burned a little less coal. The Mikados showed a saving of 20 per cent. in coal per 1,000 ton-miles.

As a result of the introduction of the new engines, helper service on the Groveland grade has been reduced, and three of the helpers formerly used have been released for road service.

The Mikados are equipped with superheaters having 1,085 sq. ft. of heating surface, as well as brick arches. The consolidations have neither superheaters nor brick arches, and as

A pair of splitting rolls are included with the machine which will permit the splitting of very wide pieces to dimensions that can be handled by the rolls.

This machine is of the three-roll-high type and is made in several sizes, the standard machine handling the sizes of material mentioned above. It is massive in its construction and arranged for full adjustment both vertically and laterally. The rolls are of a special steel best suited to the work of rolling hot metal, and

2 to 5 ft. long, depending on the section, the larger the bar the shorter the length to which it is cut. These are heated in a suitable furnace and are started through the rolls, the first pass reducing the bar to an elliptical shape and the return pass again reducing it to a round. The process is repeated down the roll until the stock is reduced to the size desired. A complete set of in and out guides are provided making the operation of handling the stock very simple. A crew of four or five

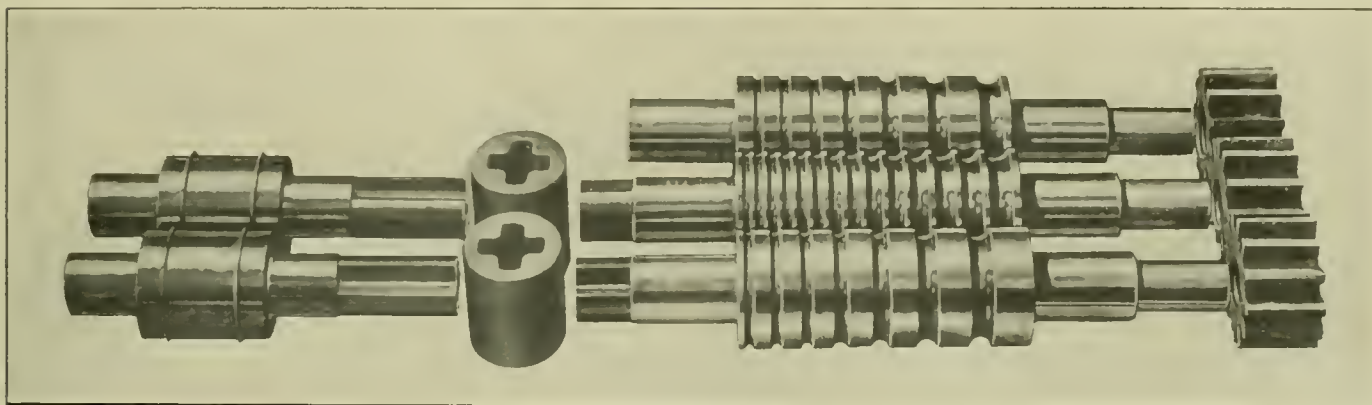

Three Rolls for Re-rolling Scrap Iron to Round Bars of Any Size. The Splitting Rolls Are Shown at the Left.

are carried in large bearings which are bushed with phosphor bronze. This machine can be furnished either belt or motor driven, in the former case requiring from twenty to forty horse power, but in the latter case a fifty horse power motor is recommended. The rolls have a peripheral speed of about 300 ft. per minute.

The scrap bars are ordinarily cut in lengths varying from

men consisting of one roller, an assistant roller, a heater, a helper and a man to carry the re-rolled bars to the cooling table is generally required. For a production of from six to eight tons per day, it is stated that the fuel cost will average only about \$6.

Rolls of this design are already in successful use in the shops of a number of the larger railway systems.

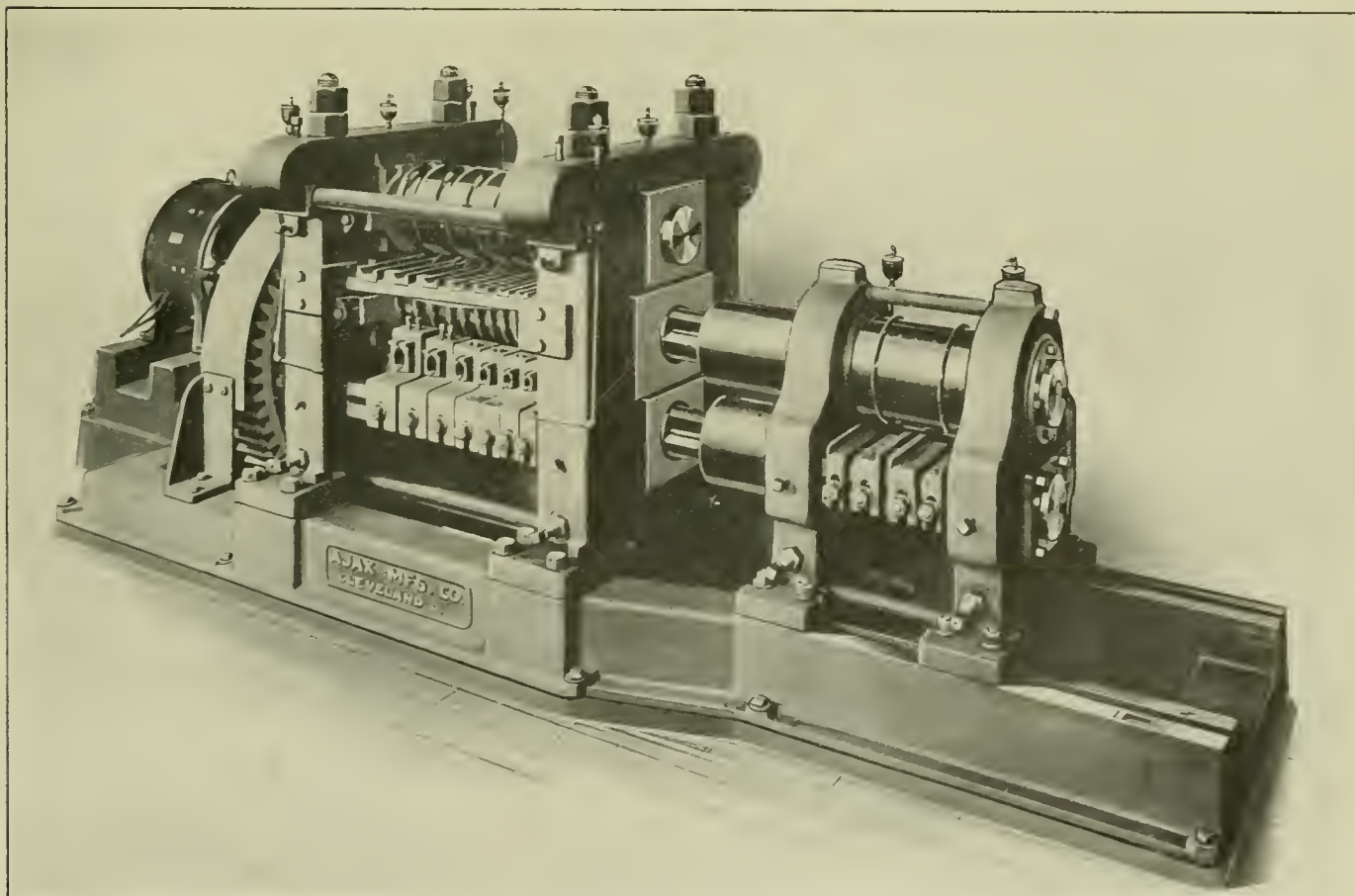

Ajax Reclaiming Rolls for Re-rolling Scrap Iron.

GENERAL NEWS

An appeal has been made to the State Department at Washington by the Southern Pacific for the protection of its employees and property in Mexico.

The United States Civil Service Commission announces that the examination for engineer draftsman which had been appointed for September 11, has been postponed to October 16 and 17.

H. G. Askew, statistician for the Texas railways, has issued a statement showing that during the fiscal year 1912 these roads paid \$2,923,944 in settlement of damages for personal injury, an increase of \$420,114 over the previous year.

The executive committee and the arbitration committee of the Master Car Builders' Association recommend the elimination of the penalization feature of the interchange rules and the addition of a fixed percentage to the bills for repairing cars which the using company renders to the car owners.

The Canadian Pacific, acting on the appeal of its telegraphers, following the recent decision by a government board, has agreed to increase their pay 12 per cent. and to make the work day ten hours instead of eleven. There will also be an increase in the rate of pay for overtime. The operators had demanded 15 per cent. increase.

All passenger trains on the Pennsylvania have been limited to a speed of 70 miles per hour at all times. This applies to the lines both east and west of Pittsburgh. Very few schedules call for speeds higher than this and the order will, therefore, not materially affect the present trains except when they are trying to make up lost time.

The General Electric Company has adopted a pension plan similar to those in force on a number of railways; namely, one per cent. of the average pay for ten years multiplied by the number of years in service. The men will be compelled to retire at 70 years and the women at 60 years, with a conditional limit of 65 years for men and 55 for women. No pension will exceed \$125 a month.

The sixth annual meeting and dinner of the Veteran Association of the New York, Chicago & St. Louis was held in Chicago, September 7, with about 300 employees in attendance. The association is composed of men who have been in the service of this road 25 consecutive years or more and it has a total membership of about 400, ranking from the general manager down to the shop and track employees.

A train of three electric cars propelled by power from Edison storage batteries was run over the Long Island Railroad last week from the Pennsylvania station, Manhattan, to Long Beach and back, carrying a party of guests. These cars have been built under the direction of R. H. Beach for the United Railway of Havana, Cuba. The cars weigh 39,000 lbs. each and have fixed axles. There are 200 battery cells in each car.

A commemorative medal was awarded to the Chicago & North Western by the International Exposition of Hygiene, for the exhibit at Dresden, in 1911, as displayed and interpreted by the American Museum of Safety. The exhibit illustrated the methods of the safety committee system, which was first introduced on railways by the Chicago & North Western in 1910, and which has since been largely adopted by the railways of this country.

A labor bureau has been established on the Baltimore & Ohio at Baltimore, Md., for the purpose of securing both skilled and unskilled labor for all departments of railway service. H. R. Bricker, labor agent, is in charge of the bureau and branch offices will be established at Philadelphia, Washington, Cincinnati, Cleveland and Chicago. The bureau has no connection

with any contract labor system and no charge will be made for the services performed.

An important saving in the amount of payments for fire losses along its right of way is reported by the Atchison, Topeka & Santa Fe as the result of a special campaign for improvement in this respect. In 1910 the company had claims for 1,509 fire losses, amounting to \$100,605. In 1911 there were 574 fires with claims amounting to \$51,000. In the fiscal year 1912 the number of fires had been reduced to 135, and the expenditure for the payment of claims to only \$6,000.

The Pennsylvania has 612 locomotives that are equipped with pumps and hose for extinguishing fires. During the past four years this apparatus has been used 153 times. The original equipment, which consisted of a hose connection placed in the branch pipe between the injector and the boiler, has been replaced by a special form of extinguisher by which the water is taken directly from the tender and is discharged through an ejector, whereby the high pressure steam from the boiler may be used at its best advantage. Each engine is equipped with 150 ft. of 2½-in. hose and a 15-in. cast iron nozzle with a discharge opening of 5⁄8 of an inch. With this equipment the engine can throw a stream of water 70 ft.

The council of the Verein Deutscher Ingenieure has invited the American Society of Mechanical Engineers to hold a joint meeting with them at Leipzig, Germany, June 23-25, 1913. The meeting is to be followed by an official tour of the industrial centers in Germany and will include a trip on the Rhine and special opportunities for a comprehensive study of the great Museum of the Technical Arts and Industries at Munich. Many establishments will be thrown open that could not be visited under other auspices, and extraordinary and unique opportunities will be afforded to the visitors to familiarize themselves with the latest developments in the various industries. In addition to these visits, which will be a part of the official tour, the society is in receipt of invitations from individual firms throughout Germany. It is hoped that a party may be arranged sufficiently large to warrant chartering an entire steamer.

The "Safety Rally" that was to be held in Kansas City, Mo., September 14, as was mentioned in the August issue of the *American Engineer*, has been postponed to Saturday evening, October 19. The Santa Fe is planning to run excursion trains from several points on their lines. The meeting has been widely advertised throughout the vicinity by posters, and it is expected that the meeting will be the largest and most enthusiastic ever held in the interest of the safety of railway employees. C. W. Kouns will preside at the meeting, and addresses will be made by General Manager Tyler of the Frisco and R. C. Richards, general claim agent and chairman of the central safety committee of the Chicago & North Western. It is also proposed to have employees of different roads give three to five minute talks on their ideas of the effectiveness of personal injury reduction by the individual efforts of the employees in co-operation with the railways. C. W. Egan, general claim agent of the Baltimore & Ohio, and L. F. Shedd, general safety supervisor of the Chicago, Rock Island & Pacific, will also exhibit a large number of moving pictures, illustrating the safe and unsafe ways of doing various kinds of railway work.

SHOP CONTROVERSY SETTLED ON THE ALTON

President B. A. Worthington of the Chicago & Alton has recently settled a controversy with the company's shop employees at Bloomington, Ill., which for a time appeared to present serious aspects. Nine employees of the boiler shop decided they could no longer afford to pay the union dues and dropped their membership, whereupon the organization petitioned the management to discharge the men unless they returned to the union. The company took the position that the matter was one for the union

to settle itself without interference by the management and the case had been submitted to the officers of the shop federation when President Worthington called a mass-meeting of the employees at Bloomington and went there to address them.

Mr. Worthington began by explaining that one of the first problems presented to him on assuming the presidency of the road was to take care of the deferred maintenance of equipment, amounting to about \$500,000, and that his first idea was to have the work done in outside commercial shops in order to get the deferred work done as quickly as possible without interfering with current repairs. His attention having been called, however, to the fact that the shops at Bloomington had been closed for several months previously, he decided that it would be to the advantage of the employees and to the town if this money, 60 per cent. of which would take the form of wages for labor, were spent in having the work done at Bloomington. It developed that there was a shortage of machinists and the company secured 50 machinists from an employment agency at Cleveland. Mr. Worthington said that these men were engaged without reference to whether or not they were union men, and he discussed the entire situation with general reference to the relations between capital and labor in a frank and informal way, finally asking for a rising vote of the men as to whether they preferred to have the locomotives and cars taken from the Bloomington shops and repaired in outside shops or to have the half million dollars spent in Bloomington. Practically all those at the meeting stood up, signifying their preference for the latter. In a conference later with the federation committee Mr. Worthington declined interference with the matter and the question was soon dropped.

CHICAGO & ALTON'S FUEL CAMPAIGN

The Chicago & Alton has made arrangements to carry on a fuel economy campaign which will be under the jurisdiction of George H. Baker, president of the Railway Educational Association of New York. Mr. Baker will devote 75 per cent. of his time to this work without compensation, believing that the effect of a campaign of this sort on his association will warrant the giving of his services free. He will travel about the road in a car especially fitted up for his use by the road, giving lectures and practical talks to the men at the engine terminal points. There will be two practical assistants who have previously fired on the road, and who will ride the engines, giving the firemen practical demonstrations of the methods to be followed. Mr. Baker will issue a book of instructions to be distributed to the men having anything to do with the handling of fuel. Bulletins have also been sent out by J. T. McGrath, superintendent of rolling stock, calling the attention of all the employees to the following points:

The loading of engine tanks so that the coal will not be wasted by being scattered over the road, the prompt housing of engines at terminals, the conservative firing of the coal, working the engine at the shortest cut-off practicable, the economical use of the injector, the waste due to the blowing of safety valves, and the fundamental principles of combustion. This bulletin is to be displayed at all the engine houses, and is especially addressed to engine house foremen, engineers, firemen and hostlers. Mr. Baker served the Chicago & Alton as a fireman, and the Wabash as an engineer, and since then has devoted considerable of his time to the study and investigation of fuel economy on locomotives. By this campaign he expects to decrease the Chicago & Alton's fuel bill by more than \$100,000 annually.

The road, in connection with this work, has issued the following statement: "The cost of fuel is the chief operating expense of this company and exceeds \$1,100,000 annually. This expense can be reduced by efforts of employees to economize and avoid waste. The management looks to the locomotive engineers and firemen for the greatest saving of fuel, and other employees, by their co-operation, also can assist."

MEETINGS AND CONVENTIONS

National Machine Tool Builders' Association.—The fall convention will be held at the Hotel Astor, New York City, October 16-18.

St. Louis Railway Club.—The first regular meeting of the St. Louis Railway Club for the fall season was held Friday evening, September 13, at the Mercantile Club building, St. Louis. Samuel O. Dunn, editor of the *Railway Age Gazette*, delivered an address on Government Regulation of Railway Operation.

Western Railway Club.—G. W. Cravens, president of the Cravens Electric Company, Chicago, read a paper at the September 17 meeting on the subject of electrical equipment of railway shops. It discussed briefly the general features of design of a railway repair shop and the characteristic features of the electrical equipment.

International Association for Testing Materials.—The sixth congress of this association was held in the Engineering Societies building, New York, from September 3 to 7. The association now numbers about 2,400 members, distributed in one hundred and thirty different countries. There are 472 members in the United States. The total registration at the congress was about 650, of which 75 were ladies. Among the many papers presented to the congress, those of especial interest to the railways included seven on the subject of rails; also on the subjects of hardness, testing and wear, test of wear of steels, hardness of steel, testing steel tubes, and welding steel.

Northern Railway Club.—At the July meeting a paper on the Automatic Train Pipe Coupler Problem was presented, and will be discussed at a later meeting. The author briefly reviewed the history of the development of automatic connectors, and concluded by stating that in his opinion there are four essential requirements for a successful connector: First, there shall be no spring mechanism. Second, that coupler heads do not extend beyond the face of the knuckle. Third, there should be an arrangement permitting the attachment of an ordinary hose if necessary. Fourth, the angle cock should be dispensed with.

New York Railroad Club.—At the first meeting of the season on September 20, A. W. Whitford presented a paper on the Relation of the Locomotive Boiler Design to Efficiency, Maintenance and Safety. It consisted largely of a discussion of the construction and advantages of the sectional type of firebox as manufactured by the Jacobs-Shupert U. S. Firebox Company, and gave a brief account of some of the results of the comparative tests which were finished at Coatsville last June between a boiler of this type and a standard radial stay boiler. The paper was thoroughly illustrated with lantern slides and moving picture views of the low water tests. In the discussion, S. S. Riegel, mechanical engineer, Delaware, Lackawanna & Western, gave an account of some tests he made several years ago which clearly demonstrated the value of firebox circulation. These were fully described in the June, 1909, issue of the *American Engineer & Railroad Journal*, page 253, and showed an increase of 55 per cent. in the water evaporated from the boiler fitted with a water tube firebox as designed by Mr. Riegel, when compared with the ordinary type of boiler. Representatives of the Lehigh Valley reported that the Jacobs-Shupert boilers in service on that road are giving satisfactory results.

Co-operative Safety Congress.—A Co-operative Safety Congress is to be held at the Hotel Pfister, Milwaukee, Wis., September 30 to October 5. All of Wednesday afternoon October 2, was scheduled as a transportation session, at which R. C. Richards, general claim agent and chairman of the central safety committee of the Chicago & North Western presided as chairman. The speakers included: A. Hunter Boyd, Jr., chair-

man of the general safety committee of the Baltimore & Ohio; H. W. Belnap, chief inspector of safety appliances of the Interstate Commerce Commission; Geo. Bradshaw, general safety agent of the New York Central Lines; S. M. Braden, general superintendent of the Chicago & North Western. Rooms at the hotel were assigned for safety exhibits under the direction of C. W. Price of the Wisconsin Industrial Commission.

Chief Car Inspectors' and Car Foremen's Association.—At the thirteenth annual convention, held in Chicago on August 27, 28 and 29, the following officers were elected: President, J. L. Stark, general car inspector, Hocking Valley, Columbus, Ohio; vice-president, F. C. Schultz, chief interchange inspector, Chicago; secretary, Stephen Skidmore, foreman car department, Cleveland, Cincinnati, Chicago & St. Louis, Cincinnati, Ohio. The sessions of the convention were devoted to a general discussion of the interpretation of the interchange rules of the Master Car Builders' Association.

M. C. B 1913 COMMITTEES

Following is a list of the subjects and the chairmen of committees which will report at the 1913 convention of the Master Car Builders' Association:

STANDING COMMITTEES.

Arbitration, J. J. Hennessey, C. M. & St. P., Milwaukee, Wis.; Revision of Standards and Recommended Practice, T. H. Goodnow, C. & N. W., Chicago, Ill.; Train Brake and Signal Equipment, R. B. Kendig, N. Y. C. Lines, New York City; Brake Shoe and Brake Beam Equipment, Prof. Chas. H. Benjamin, Purdue University, Lafayette, Ind.; Coupler and Draft Equipment, R. L. Kleine, Penna. R. R., Altoona, Pa.; Rules for Loading Material, A. Kearney, N. & W., Roanoke, Va.; Car Wheels, William Garstang, C. C. C. & St. L., Indianapolis, Ind.; Safety Appliances, C. E. Fuller, U. P., Omaha, Neb.

SPECIAL COMMITTEES

Car Trucks, J. T. Wallis, Penna. R. R., Altoona, Pa.; Prices for Labor and Material, F. H. Clark, B. & O., Baltimore, Md.; Train Lighting and Equipment, T. R. Cook, Penna. Lines, Pittsburgh, Pa.; Train Pipe and Connections for Steam Heat, I. S. Downing, L. S. & M. S., Cleveland, Ohio; Nominations, F. W. Brazier, N. Y. C. & H. R., New York City; Arrangements, C. E. Fuller, U. P., Omaha, Neb.; Tank Cars, A. W. Gibbs, Penna. Lines, Philadelphia, Pa.; Specifications for Tests of Steel Truck Sides and Bolsters for Cars of 80,000, 100,000, 150,000 Lbs. Capacity, Prof. E. C. Schmidt, University of Illinois, Urbana, Ill.; Capacity Marking of Cars, C. E. Fuller, U. P., Omaha, Neb.; Lettering Cars, D. F. Crawford, Penna. Lines, Pittsburgh, Pa.; Damage to Freight Equipment by Unloading Machines, P. F. Smith, Jr., Penna. Lines, Toledo, Ohio; Air Brake Hose Specifications, M. K. Barnum, I. C., Chicago, Ill.; Conference with Association of American Railway Accounting Officers, D. F. Crawford, Penna. Lines, Pittsburgh, Pa.; Revision of Present Specifications, C. D. Young, Penna. R. R., Altoona, Pa.; Car Construction, W. F. Kiesel, Jr., Penna. R. R., Altoona, Pa.

M. M. 1913 COMMITTEES

Following is a list of the subjects which will be reported on and the chairmen of the committees for the 1913 convention of the American Railway Master Mechanics' Association:

STANDING COMMITTEES.

Revision of Standards, W. E. Dunham, C. & N. W., Winona, Minn.; Mechanical Stokers, T. Rumney, C. R. I. & P., Chicago, Ill.

SPECIAL COMMITTEES.

Specifications for Cast-steel Locomotive Frames, C. B. Young, C. B. & Q., Chicago, Ill.; Main and Side Rods, W. F. Kiesel, Jr., Penna. R. R., Altoona, Pa.; Safety Appliances, D. F. Crawford, Penna. Lines West, Pittsburgh, Pa.; Design, Construction and Inspection of Locomotive Boilers, D. R. MacBain, L. S. & M. S., Cleveland, Ohio; Steel Tires, L. R. Johnson, C. P., Montreal, Que., Can.; Minimum Requirements for Headlights, D. F. Crawford, Penna. Lines West, Pittsburgh, Pa.; Standardization of Tinware, A. J. Poole, S. A. L., Portsmouth, Va.; Superheater Locomotives, J. T. Wallis, Penna. R. R., Altoona, Pa.; Subjects, G. W. Wildin, N. Y. N. H. & H., New Haven, Conn.; Specifications for Material Used in Locomotive Construction, H. T. Bentley, C. & N. W., Chicago, Ill.; Use of Special Alloy Steels and Heat-treated Steel in Locomotive Construction, C. D. Young, Penna. R. R., Altoona, Pa.; Smoke Prevention, E. W. Pratt, C. & N. W., Chicago, Ill.; Engine Tender Wheels, William Garstang, C. C. C. & St. L., Indianapolis, Ind.; Arrangement, D. F. Crawford, Penna. Lines West, Pittsburgh, Pa.

INDIVIDUAL PAPERS.

Tests of Superheater Locomotives, by Dean C. H. Benjamin, Purdue University, Lafayette, Ind. Three Cylinder Locomotives, by J. Snowden Bell, New York.

The following list gives names of secretaries, dates of next or regular meetings, and places of meeting of mechanical associations.

- AIR BRAKE ASSOCIATION.—F. M. Nellis, 53 State St., Boston, Mass. 1913 convention to be held at St. Louis, Mo.
- AMERICAN RAILWAY MASTER MECHANICS' ASSOC.—J. W. Taylor, Old Colony building, Chicago.
- AMERICAN RAILWAY TOOL FOREMEN'S ASSOCIATION.—A. R. Davis, Central of Georgia, Macon, Ga.
- AMERICAN SOCIETY FOR TESTING MATERIALS.—Prof. E. Marburg, University of Pennsylvania, Philadelphia, Pa.
- AMERICAN SOCIETY OF MECHANICAL ENGINEERS.—Calvin W. Rice, 29 W. Thirty-ninth St., New York.
- CAR FOREMEN'S ASSOCIATION OF CHICAGO.—Aaron Kline, 841 North Fiftyeth Court, Chicago; 2d Monday in month, Chicago.
- INTERNATIONAL RAILWAY FUEL ASSOCIATION.—C. G. Hall, McCormick building, Chicago.
- INTERNATIONAL RAILWAY GENERAL FOREMEN'S ASSOCIATION.—William Hall, Chicago & North Western, Escanaba, Mich.
- INTERNATIONAL RAILROAD MASTER BLACKSMITHS' ASSOCIATION.—A. J. Woodworth, Lima, Ohio.
- MASTER BOILER MAKERS' ASSOCIATION.—Harry D. Vought, 95 Liberty St., New York.
- MASTER CAR BUILDERS' ASSOCIATION.—J. W. Taylor, Old Colony building, Chicago.
- MASTER CAR AND LOCOMOTIVE PAINTERS' ASSOC. OF U. S. AND CANADA.—A. P. Dane, B. & M., Reading, Mass.
- RAILWAY STOREKEEPERS' ASSOCIATION.—J. P. Murphy, Box C, Collinwood, Ohio.
- TRAVELING ENGINEERS' ASSOCIATION.—W. O. Thompson, N. Y. C. & H. R., East Buffalo, N. Y.

RAILROAD CLUB MEETINGS

| CLUB. | NEXT MEETING. | TITLE OF PAPER. | AUTHOR. | SECRETARY. | ADDRESS. |
|--------------------|---------------|---|----------------------|--------------------|-------------------------------------|
| Canadian | Oct. 8 | The Car Inspector..... | L. C. Ord..... | Jas. Powell..... | Room 13, Windsor Hotel, Montreal. |
| Central | Nov. 8 | Brake Operation on Long Freight Trains. | John P. Kelly..... | H. D. Vought..... | 95 Liberty St., New York. |
| New England..... | Oct. 8 | The Story of Brushes and the Material Entering Into Them | Lew C. Hill..... | Geo. H. Frazier.. | 10 Oliver St., Boston, Mass. |
| New York..... | Oct. 18 | "Liquid Fuel. Its Use and Abuse in Railroad Shop Practice"..... | W. N. Best..... | H. D. Vought... | 95 Liberty St., New York. |
| Northern | Oct. 5 | | | C. L. Kennedy... | 401 Superior St., Duluth, Minn. |
| Pittsburgh | Oct. 25 | Annual Meeting—Election of Officers..... | | J. B. Anderson... | Union Station, Pittsburgh Pa. |
| Richmond | Oct. 11 | The Health of Railroad Men..... | Dr. E. C. Levy.... | F. O. Robinson... | C. & O. Ry., Richmond, Va. |
| S'th'n & S. West'n | | | | A. J. Merrill..... | 218 Grant Bldg., Atlanta, Ga. |
| St. Louis..... | Oct. 18 | Prevention of Accidents, Safeguarding Employees, etc. | F. C. Schwerdtmann.. | B. W. Frauenthal | Union Station, St. Louis, Mo |
| Western | Oct. 11 | Telpherage Systems..... | H. M. Harding.... | | |
| | Oct. 15 | Tests of Locomotive Headlights..... | C. M. Larson..... | Jos. W. Taylor... | 390 Old Colony Bldg., Chicago, Ill. |

PERSONALS

It is our desire to make these columns cover as completely as possible all the changes that take place in the mechanical departments of the railways of this country, and we shall greatly appreciate any assistance that our readers may give us in helping to bring this about.

GENERAL.

GEORGE H. BAKER has been appointed fuel director in charge of fuel economies on the Chicago & Alton. His efforts will be directed to the reduction of consumption and waste of fuel. From 1879 to 1881 he served as a fireman on the Kansas City division of the Chicago & Alton, and later served six years as engineer on the Wabash. He is president of the Railway Educational Association, with offices in New York.

JOHN BENZIES, smoke inspector of the Rock Island Lines, has been appointed fuel inspector at Chicago, Ill., vice F. Wilson, promoted.

G. H. BUSSING, superintendent of motive power of the New Orleans Great Northern, at Bogalusa, La., having resigned to accept service elsewhere, that position has been abolished.

O. E. GILLILAND has been appointed district safety supervisor, Third District, of the Rock Island Lines, with headquarters at El Reno, Okla.

F. G. GRIMSHAW, master mechanic of the West Jersey & Seashore and the Camden Terminal division of the Pennsylvania Railroad at Camden, N. J., has been appointed assistant engineer of motive power of the Western Pennsylvania division, with office at Pittsburgh, Pa.

A. M. DARLOW, who was recently appointed superintendent of motive power of the Buffalo & Susquehanna Railroad and the Buffalo & Susquehanna Railway Company, served his apprenticeship on the Vandalia Railroad. Later he went to Cornell University and was graduated from there in 1906. He entered the service of the Chicago & Eastern Illinois as a special apprentice and shop draftsman, and in 1910 was made engine-house foreman of the Chicago Terminal of the Chicago & Eastern Illinois at Dalton, Ill. In 1911 he was transferred as engine-house foreman to Danville, Ill. He was appointed mechanical engineer of the Buffalo & Susquehanna in May, 1911, and in April, 1912, he was



A. M. Darlow.

made general storekeeper as well as mechanical engineer. As superintendent of motive power of this road he has charge of the mechanical and the store departments.

D. B. LOTHIAN has been appointed district safety inspector of the Rock Island Lines, with headquarters at Topeka, Kans.

J. T. McGRATH, superintendent rolling stock of the Chicago & Alton, with headquarters at Bloomington, Ill., has resigned, effective October 1, and will be succeeded by J. E. O'Hearne, master mechanic of the Wheeling & Lake Erie.

STANLEY S. WAGAR, whose appointment as chemist and engineer of tests of the Buffalo, Rochester & Pittsburgh, with office

at Du Bois, Pa., has been announced in these columns, was born in December, 1886, at Troy, N. Y., and was educated at Rensselaer Polytechnic Institute. He began railway work in May, 1910, with the Union Pacific as material inspector, and from April to September, 1911, was assistant chemist on the Missouri Pacific. He was then with the St. Louis & San Francisco as chemist until August, 1912.

WILLIAM HOLLAND WINTERROWD, who was recently appointed mechanical engineer of the Canadian Pacific, with headquarters at Montreal, Canada, was born April 2, 1884, at Hope, Ind.



W. H. Winterrowd.

He attended the public schools at Shelbyville, Ind., and in 1907 was graduated from Purdue University. In 1905 he was employed for a short time as a blacksmith's helper on the Lake Erie & Western, at Lima, Ohio, and in 1906 served as car and air-brake repairman for the Pennsylvania Lines West at Dennison, Ohio. After leaving the university he was employed as a special apprentice on the Lake Shore & Michigan Southern, serving in that capacity until 1908, when he was made engine-house foreman of the Lake Erie, Alliance &

Wheeling, at Alliance, Ohio. In 1909 he was made night engine-house foreman of the Lake Shore & Michigan Southern at Youngstown, Ohio, and in 1910 was transferred as engine-house foreman of the same road to Cleveland, Ohio. Later in the year he was promoted to assistant to the mechanical engineer of the Lake Shore, which position he held until he was recently appointed mechanical engineer of the Canadian Pacific.

MASTER MECHANICS AND ROAD FOREMEN OF ENGINES

JAMES ASHCROFT has been assigned to duty as road foreman on the Grand Trunk Pacific, covering the territory from Transcona to Melville and the Yorkton Branch.

E. J. BRENNAN has been appointed master mechanic of the Du Bois shops of the Buffalo, Rochester & Pittsburgh, with headquarters at Du Bois, Pa.

NEWTON CAGE, assistant road foreman of engines of the Connellsville division of the Baltimore & Ohio, has been promoted to road foreman of engines.

S. J. DILLON, who has been appointed master mechanic of the West Jersey & Seashore, and the Camden Terminal division of the Pennsylvania Railroad, with headquarters at Camden, N. J., as announced in our September issue, was born near Hollidaysburg, Pa., on April 15, 1862. He was educated in the Altoona public schools, also at Professor Davis' Business College, and took a special course in mechanical drawing. On September 1, 1879, he entered the service of the Pennsylvania Railroad as a helper and messenger in the Altoona machine shops and has been in the continuous service of that company ever since. In March, 1881, he was made machinist's apprentice, becoming machinist at the Altoona machine shops in May, 1885. He was transferred to the test department on April 1, 1892. In November, 1895, he was appointed assistant engine-house foreman of the New York division at Jersey City, N. J., and was promoted to foreman of the locomotive department of the Meadows shops,

New York division, on January 1, 1898. He was appointed general foreman of passenger-car inspectors of the New York division, with headquarters at Jersey City, in December, 1898, and was made master mechanic of the South Amboy division on December 1, 1902. In April, 1908, he was appointed division master mechanic of the Amboy division with headquarters at Camden.

J. S. GOLITHON has been appointed master mechanic of the Bellingham Bay & British Columbia, with office at Bellingham, Wash., succeeding J. A. Haley, resigned.

J. P. KENDRICK has been appointed master mechanic of the Middle and Pittsburgh divisions of the Buffalo, Rochester & Pittsburgh, with headquarters at Punxsutawney, Pa.

C. E. LANGTON has been appointed master mechanic of the Marshall & East Texas, succeeding F. A. Walsh, resigned to engage in other business.

J. P. LOUX, assistant master mechanic of the N. J. & L. division of the Lehigh Valley, has been appointed master mechanic of the M. & H. division, at Hazelton, Pa., succeeding T. H. Malican, resigned.

M. F. McCARRA has been appointed master mechanic in charge of all equipment of the Louisiana Railway & Navigation Company, with office at Shreveport, La., succeeding T. Nicholson, resigned.

B. H. MILLER, an engineer on the Connellsville division of the Baltimore & Ohio, has been promoted to assistant road foreman of engines. His headquarters will be at Rockwood, Pa.

F. MORAN, road foreman of engines of the Grand Trunk Pacific, will devote his attention to the Regina Branch and to the Third District, Melville to Watrous.

H. J. OSBORNE has been appointed master mechanic of the Louisiana division of the Rock Island Lines, with headquarters at Eldorado, Ark., succeeding W. F. Moran, transferred.

C. D. SMITH has been appointed road foreman of the Grand Trunk Pacific, covering the territory from Watrous to Biggar, including the Oban-Battleford and Biggar Calgary branches; he will report to J. R. Mooney, at Wainwright, Alberta.

A. K. STANLEY has been appointed master mechanic of the Houston & Texas Central, at Sherman, Tex.

W. H. WILLIAMS, master mechanic of the Buffalo, Rochester & Pittsburgh, at Du Bois, Pa., has been appointed master mechanic of the Buffalo & Rochester divisions, with headquarters at East Salamanca, N. Y., succeeding P. C. Zang, resigned.

F. WILSON, fuel inspector of the Rock Island Lines, has been appointed road foreman of equipment, with headquarters at Cedar Rapids, Iowa.

A. S. WRIGHT has been appointed locomotive foreman on the Grand Trunk Pacific at Regina, vice A. J. Roberts, resigned.

CAR DEPARTMENT

W. O. ANKER has been appointed day coach yard foreman of the Rock Island Lines, with headquarters at Valley Junction, Iowa, vice John Swival, transferred.

J. P. BRENDEL, foreman of the cabinet shop of the Southern Pacific, has been appointed assistant general foreman of the car department, with headquarters at Sacramento, Cal.

W. S. BUCKLER, assistant foreman of the Southern Pacific, has been appointed foreman of the cabinet shop, with headquarters at Sacramento, Cal.

R. A. FITZ, foreman of the Lake Shore & Michigan Southern at 26th street, Cleveland, Ohio, has been appointed foreman of freight repairs, with headquarters at Nottingham, Ohio.

G. H. HOPPER, foreman of the Lake Shore & Michigan Southern, at Youngstown, Ohio, has been appointed foreman of the car department of the Lake Front shop at Sandusky, Ohio.

F. A. ISAMINGER has been appointed chief car inspector of the Trinity & Brazos Valley, with headquarters at Teague, Tex., vice A. K. Stanley, promoted.

T. H. KLUNDER has been appointed night coach yard foreman of the Rock Island Lines, at Valley Junction, Iowa.

S. LINDMAN, foreman of freight repairs of the Lake Shore & Michigan Southern, at Nottingham, Ohio, has been appointed foreman of the car department, with headquarters at Youngstown, Ohio.

L. J. WILSON has been appointed acting car foreman of the Rock Island Lines at Armourdale, Kans., vice William Bonner, resigned.

SHOP AND ENGINE HOUSE

R. BENEDICT, erecting foreman of the Atchison, Topeka & Santa Fe, at Richmond, Cal., has been appointed roundhouse foreman, with headquarters at Bakersfield, Cal.

J. W. BREWER has been appointed superintendent of the Mount Clare, Baltimore, Md., shops of the Baltimore & Ohio. He was born September 6, 1880, at Grafton, W. Va., and began railway work on September 24, 1895, as an engine cleaner on the Baltimore & Ohio, and has been in the service of that road ever since. From November, 1896, to November, 1900, he was machinist's apprentice, and in November, 1900, was appointed machinist. Three years later he was made roundhouse foreman, and in 1904, was appointed gang foreman of the erecting shop. He was promoted in 1907 to erecting-shop foreman. In 1908 he was appointed assistant master mechanic, and two years later he was made master mechanic, which position he held at the time of his recent promotion as superintendent of shops, as above noted. He will also perform the duties of master mechanic as heretofore. The Mount Clare shops are the principal ones on the Baltimore & Ohio system. Most all of the heavy repair work to locomotives and cars, from all lines, is done at Mount Clare, and about 3,000 skilled mechanics and shopmen of various grades are steadily employed there.

J. R. COOK has been appointed general foreman of the Atchison, Topeka & Santa Fe, at Clovis, N. M., vice O. V. Morrison, resigned.

W. F. CROSBY, boilermaker of the Central Vermont, has been appointed foreman boilermaker, with headquarters at St. Albans, Vt.

CHARLES H. DOUGLASS, boilermaker of the Central Vermont, has been appointed boiler inspector, with headquarters at St. Albans, Vt.

W. J. DOVITT has been appointed roundhouse foreman of the Rock Island, with headquarters at McFarland, Kans., vice F. L. Coles, promoted.

I. H. DRAKE, machine-shop foreman of the Atchison, Topeka & Santa Fe at Cleburne, Tex., has been appointed general foreman at Raton, N. M.

C. E. EGAN has been appointed general foreman of the Missouri, Kansas & Texas at Waco, Tex.

G. I. EVANS has been appointed superintendent of locomotive shops of the Canadian Pacific, at Angus, Montreal, Que. He was born in May, 1880, at Montreal. He began railway work on April 1, 1900, with the Canadian Pacific as a draftsman, remaining in that position until March, 1906, when he was promoted to chief draftsman. In July, 1910, he was appointed mechanical engineer of the Canadian Pacific, which position he held at the time of his appointment as superintendent of shops.

R. T. GORMAN has been appointed roundhouse foreman of the Atchison, Topeka & Santa Fe, at Needles, Cal., vice E. W. Tucker, transferred.

G. E. JOHNSON has been appointed division foreman of the Atchison, Topeka & Santa Fe, at Gallup, N. M., vice E. M. Sanjule, promoted.

RANCE JOHNSON, boilermaker of the Atchison, Topeka & Santa Fe, has been appointed foreman boilermaker, with headquarters at La Junta, Colo.

J. Z. KUHN has been appointed roundhouse foreman of the Atchison, Topeka & Santa Fe, with headquarters at Clovis, N. M., vice J. R. Cook, promoted.

C. E. LINDEMAN, apprentice instructor of the Atchison, Topeka & Santa Fe, at Richmond, Cal., has been appointed machine foreman at La Junta, Colo.

W. B. LYONS, machinist of the Atchison, Topeka & Santa Fe, at Richmond, Cal., has been appointed machine foreman, at Bakersfield, Cal.

A. G. McDUGAL has been appointed boiler-shop foreman of the Denver & Rio Grande, with headquarters at Salt Lake City, Utah.

W. MURPHY has been appointed night engine-house foreman of the Missouri, Kansas & Texas, at Dallas, Tex., vice E. Owens, promoted.

E. OWENS, night engine-house foreman of the Missouri, Kansas & Texas, at Dallas, Tex., has been appointed general foreman of the same road, at Gainesville, Tex.

T. T. RYAN has been appointed assistant engine-house foreman of the Atchison, Topeka & Santa Fe at Raton, N. M.

E. M. SANJULE, division foreman of the Atchison, Topeka & Santa Fe, at Gallup, N. M., has been appointed general foreman, with headquarters at Riverbank, Cal.

WILLIAM SAPP has been appointed night roundhouse foreman of the Atchison, Topeka & Santa Fe, with headquarters at Sweetwater, vice J. A. Whithurst, resigned.

R. T. SHEA, general inspector of shops of the New York Central & Hudson River, at New York, resigned recently.

J. A. WHITHURST, night roundhouse foreman of the Atchison, Topeka & Santa Fe, at Sweetwater, has been appointed general foreman of the Orient Railway, at San Angelo, Tex.

PURCHASING AND STOREKEEPING

W. A. GILLESPIE has been appointed storekeeper of the Frisco Lines, with headquarters at De Quincey, La., vice Neal Cavin, resigned.

J. H. HOLLUB has been appointed assistant to the superintendent of stores of the National Railways of Mexico, with headquarters at San Luis Potosi, Mex.

F. S. HUBBARD has been appointed traveling storekeeper of the Lake Shore & Michigan Southern, with headquarters at Collinwood, Ohio.

L. J. McHUGH has been appointed storekeeper of the Lake Shore & Michigan Southern at Air Line Junction, Ohio, vice F. S. Hubbard, promoted.

J. M. VELASCO has been appointed storekeeper of the San Luis Potosi division of the National Railways of Mexico, with headquarters at San Luis Potosi, Mex., vice G. Rios del Rio, who has resumed his duties as storekeeper of the Chihuahua division, with headquarters at Chihuahua, Mex.

W. L. VENE, purchasing agent of the Tennessee Central, at Nashville, Tenn., has resigned, and the position has been abolished. The duties of purchasing agent have been assumed by the president.

NEW SHOPS

ATCHISON, TOPEKA & SANTA FE.—A new machine shop and an engine house will be built at Winslow, Ariz.

CHICAGO, MILWAUKEE & ST. PAUL.—A 40-stall engine house will be built at Sioux City, Iowa, and the car shops will be enlarged.

CHICAGO, PEORIA & ST. LOUIS.—Car shops will be erected at Springfield, Ill., at a cost of \$60,000.

CHICAGO, ROCK ISLAND & PACIFIC.—A one-story 20-stall engine house will be built at Manley Junction, Ill.

CHICAGO & NORTH WESTERN.—The report for the year ended June 30, 1912, shows that the terminal facilities at Proviso, Ill., have been enlarged and improved by the construction of a 58-stall, 90-ft., brick engine house, a machine shop, a power house and other buildings. At Boone, Ia., a 36-stall, 90-ft., brick engine house, a power house, a machine shop and miscellaneous buildings have also been completed. At the Chicago shop plant, a brick extension to the power house, 108 ft. x 30 ft., has been built.

CHICAGO, ST. PAUL, MINNEAPOLIS & OMAHA.—The report for the year ended June 30, 1912, shows that an engine house, a machine shop and oil house were built at Omaha, Neb., jointly with the Chicago & North Western, and additions were made to the machine shop at St. Paul, Minn. Work was started grading north of Twentieth avenue, North, Minneapolis, Minn., for putting up a 30-stall engine house with turntable, heating plant, etc., connected with a building for machine shop, boiler room and coaling station.

CLEVELAND, CINCINNATI, CHICAGO & ST. LOUIS.—Additions will be made to the repair shops at Springfield, Ohio. The contract has been awarded to Lauderbach & Sieverling, Springfield. The contract for the engine house at Elkhart, Ind., has been awarded to H. A. Peters Company, Chicago. Additional shops will be built at Beech Grove, Ind., at an estimated cost of \$175,000.

GREAT EASTERN LUMBER COMPANY.—This concern is building seven miles of railway near Savannah, Ga., and will build an engine house and repair shop.

ILLINOIS CENTRAL.—The machine shops at Jackson, Tenn., were damaged by fire on September 7 to the extent of \$40,000. They will be rebuilt at once.

MANUFACTURERS' RAILWAY.—Bids have been received for an engine house and machine shop, 80 x 390 ft., of concrete and steel construction, to be erected at St. Louis, Mo.

MICHIGAN CENTRAL.—The new engine house that is being built at Bay City, Mich., will contain 40 stalls instead of 30, as previously stated, and the capacity of the machine shops will be increased about one-third over the original plans.

MINNEAPOLIS & ST. LOUIS.—A 15-stall engine house constructed of concrete and steel will be built at Oskaloosa, Iowa. One of the stalls will be used as a boiler room and another as a machine shop.

MISSOURI, KANSAS & TEXAS.—The building of the car repair shops at East Waco, Tex., will be started in a short time, and a water-treating plant will be built at Waco at a cost of about \$75,000.

MISSOURI PACIFIC.—The annual report for the year ended June 30, 1912, shows that during the year a new 95-ft. brick, 27-stall engine house, with machine shop, was built at Argenta, Ark. The extensive shop buildings were completed at Hoisington, Kan.; at Falls City, Neb., and at East Bottoms (Kansas City), Mo.

NEW ORLEANS TERMINAL COMPANY.—An engine house will be built at New Orleans, La., to meet the demands of the Frisco and Southern railways.

NEW YORK, NEW HAVEN & HARTFORD.—A 30-stall engine house will be built at Mansfield, Mass., to be used in connection with the proposed electric train service between Boston, Mass., and Providence, R. I.

NORFOLK & WESTERN.—The contracts for a new engine house and shop buildings at Lamberts Point, Va., have been awarded to John P. Pettyjohn & Co., Lynchburg, Va. The work is now under way.

PENNSYLVANIA RAILROAD.—Plans have been made for putting up new rest houses at Sunnyside yard, Long Island City, at the Pennsylvania station in New York City, and at Waverly Transfer, N. J. A two-story brick building, 40 ft. x 66 ft., is to be built at the Sunnyside yard. It will have a lunch room and kitchen on the first floor, and the second floor will be used for lockers and sleeping rooms. A two-story brick structure will be put up at the New York terminal. It will have lunch and locker rooms. A one-story building is to be built at Waverly Transfer.

PENNSYLVANIA RAILROAD.—The contract for the erection of a 36-stall engine house at Indianapolis has been awarded to the Whitherspoon-Enger Company, Chicago.

SOUTHERN PACIFIC.—The plans for the construction of new machine shops at South Portland, Ore., have been approved. The total cost will be about \$200,000. The work has begun on the enlargement of the shops at Tuscon, Ariz. The main building will be 100 ft. x 200 ft., and will be equipped for handling repairs to the largest locomotives. The plans also provide for a 350,000-gal. tank.

UNION PACIFIC.—It is reported that a 28-stall engine house, a coaling station, water tank, etc., will be built at North Platte, Neb., during the present fiscal year.

WABASH.—The construction work on the new locomotive repair shops at Decatur, Ill., has been awarded to the Decatur Bridge Company.

ANTHRACITE COAL IN PENNSYLVANIA.—According to a statement issued by the United States Geological Survey, the output of anthracite coal in Pennsylvania during 1911 was 80,732,000 gross tons, which have a value of \$175,853,000. This surpasses the previous record by 4,700,000 tons.

COAL PRODUCTION IN THE UNITED STATES.—The United States Geological Survey has issued statistics which show that the total production of coal in the year 1911 was 496,188,308 short tons, which had a value at the mines of \$625,910,115. This is a decrease from 1910 of 5,408,070 tons, the decrease being attributed wholly to the depressed condition of the iron and steel trade during the year.

CHILEAN GOVERNMENT RAILWAY STATISTICS.—In 1901 the Chilean government railways had in use 292 locomotives, 4,057 freight cars, and 323 passenger coaches, while in 1911 the numbers were 633 locomotives, 7,194 freight cars, and 452 passenger coaches. The receipts of the lines increased in the decade from \$5,360,520 to \$11,513,040, while the operating expenses increased from \$6,177,270 to \$14,132,078.

AN IMPROVED ROAD ROLLER.—A steam road roller has been built by Ruston, Prostor & Company, Ltd., Lincoln, England, which uses superheated steam and is equipped with a feed-water heater. It weighs 12 tons, and is geared to run at 1½ and 3 miles an hour. The superheater coils are placed in front of the boiler flues in the smoke box and the feed water heater is placed in the exhaust pipe, and performs a dual service, that of heating the feed water and of muffling the exhaust.

SUPPLY TRADE NOTES

The Keith Car Company, Chicago, has increased its capital stock from \$30,000 to \$100,000.

J. McKay Duncan has been appointed sales manager of the Westinghouse Electric & Manufacturing Company for the Pittsburgh district, vice W. F. Fowler, resigned.

The Jeffrey Manufacturing Company, Columbus, Ohio, has removed its branch office at Chicago to the seventeenth floor of the McCormick building on Michigan avenue.

The management of the Preston Car & Coach Company, Preston, Ont., has secured the Canadian manufacturing rights of the gasoline-electric cars recently tried out on the Canadian Northern.

The Pratt & Whitney Company, New York, has opened an office and salesroom for small tools and gages at 336 West Fourth street, Cincinnati, Ohio. The new office will be in charge of C. M. Pond.

Frank G. Wright, formerly works manager at the Indiana Harbor plant of the American Steel Foundries, has been appointed general manager of the Ohio Steel Foundry Company, Lima, Ohio.

Joseph T. Markham, for several years general sales agent of the Sellers Manufacturing Company, Chicago, has been made vice-president of the St. Louis Car Wheel Company, with headquarters in St. Louis.

The wages of the laborers of the Bethlehem Steel Company, South Bethlehem, Pa., have been increased from 13½ cents an hour to 14½ cents an hour. About 3,000 men will be affected by this change.

Henry C. King, treasurer of the American Safety Tread Company, Lowell, Mass., has been made president and general manager of that company, succeeding William S. Lamson, who died at his home in Lowell on August 16.

The Canadian Locomotive Company, Ltd., Kingston, Ont., which has been increasing the capacity of its plant from five to 18 locomotives per month, has orders on hand for enough locomotives to keep the plant running at full capacity for the next 12 months.

The Pilliod Company, New York, during June, July and August, received orders for as much new business as during the entire fiscal year ended May 31, 1912. Additions being made to the plant at Swanton, Ohio, will increase the capacity by 66.2-3 per cent., and are now nearly completed.

The Kerr Turbine Company, Wellsville, N. Y., has found it necessary to open an office in Pittsburgh, Pa. It is located in the Oliver building and is in charge of R. M. Rush, who was formerly with the Deavo-Doyle Company. F. B. Allen, formerly connected with the Cleveland office of the Cooper-Hewitt Company, is also associated with Mr. Rush.

The Buffalo Brake Beam Company, New York, will open a branch office at Hamilton, Ont. A portion of the land occupied by the Hammant Steel Car Company has been leased, and the erection of temporary quarters is already under way. The business and staff of the branch office now located at Brantford, Ont., will be moved to Hamilton.

The Western Electric Company, New York, has taken over the business of the Cleveland Electrical Supply Company, Cleveland, Ohio, and has opened a branch office at 724 Prospect avenue, Cleveland, the former address of the supply company. H. A. Speh, formerly in the Buffalo, N. Y., office of the Western Electric Company, has been made manager.

W. O. Jacquette, formerly vice-president of Manning, Maxwell & Moore, Inc., New York, has been made vice-president of the American Shop Equipment Company, Chicago, with office at 30 Church street, New York. The American Shop Equipment Company handles shop devices, including oil furnaces for welding, forging, melting and annealing.

Richard J. Sheridan, formerly assistant to H. A. Fabian, manager of purchases and supplies of the New York, New Haven & Hartford, with office in Boston, Mass., has been appointed eastern agent of the Chicago Railway Equipment Company, succeeding C. P. Williams, resigned to go to the National Lock Washer Company, Newark, N. J., with office in Chicago.

Olin, Giberson & Hilands, Inc., eastern selling agents for the Sligo Iron & Steel Company, Connellsville, Pa., maker of iron bars for bolts; the Keystone Tube Works, Inc., Uniontown, Pa., maker of light gage tubes; and for the Central Tube Company, Pittsburgh, Pa., maker of conduits and pipes, have moved their offices from 2 Rector street, New York, to 30 Church street.

Stewart D. Anderson, eastern representative of the Standard Railway Equipment Company, Pittsburgh, Pa., with office in New York, and formerly with the Hutchins Car Roofing Company, Detroit, Mich., with office in Chicago, died in Richmond, Va., on September 5. Mr. Anderson was born in Buffalo, N. Y., in 1848, and had been with the Standard company for about 11 years.

Charles P. Williams, who has been eastern agent for the Chicago Railway Equipment Company, with office in New York, has resigned to become connected with the National Lock Washer Company, Newark, N. J., with headquarters at Chicago. Mr. Williams was formerly connected with the Chicago, Milwaukee & St. Paul, the Michigan Central, the Canadian Pacific and the Minneapolis, St. Paul & Sault Ste. Marie, and with the M. J. Holden Company of Montreal, Que.

The Westinghouse Electric & Manufacturing Company, Pittsburgh, Pa., has declared a dividend of 1 per cent. on the common stock, for the quarter ended September 30. Six months ago 1 per cent. was declared on the common stock. The common stock dividend is payable October 30 to stock of record September 30. The following statement was authorized by the chairman of the board of directors: The action of the directors means that the common is established on a 4 per cent. basis and will continue on a 4 per cent. basis unless there develop less favorable conditions than the present outlook indicates. Increases in the dividend will be subject to future consideration.

E. Harrison Symington, western agent for the T. H. Symington Company, Baltimore, Md., with office in Chicago, died in Baltimore on September 5, after undergoing two operations for internal injuries. About five years ago Mr. Symington sustained severe injuries from a fall from his horse, and the recent operations were due to that accident. He was 34 years old and was graduated from Lehigh University in 1898 as a mechanical engineer. He was a member of the Saddle and Cycle, the University, the Chicago and the Athletic clubs in Chicago, and of the Baltimore Country Club and the Maryland Club in Baltimore.

Charles E. Lee, general superintendent of the Boston & Maine, with office in Boston, Mass., has resigned to go to the Commercial Acetylene Company, New York, as general manager, with office in New York. Mr. Lee was born August 19, 1860. He began railway work in 1877 as an operator on the Boston, Clinton, Fitchburg & New Bedford, now a part of the New York, New Haven & Hartford. From 1879 to December, 1896, he was operator and train despatcher on the Worcester, Nashua & Rochester and its successor, the Boston & Maine. In December, 1896, he was appointed superintendent of the Worcester, Nashua & Portland division of the Boston & Maine, and in August, 1903, was appointed assistant general manager. On September 1, 1906,

he was appointed to the position of general superintendent of the same road.

At a special meeting of the board of directors of the Cambria Steel Company, Johnstown, Pa., on September 26 last, William H. Donner, of Pittsburgh, Pa., was elected president, succeeding

Charles S. Price, resigned; and J. Leonard Replogle, heretofore assistant to president, was elected vice-president. Mr. Donner was born at Columbus, Ind. His first important business engagement was as treasurer and manager of the National Tin Plate Company, of Anderson, Ind., which he organized in 1894; but he is perhaps best known as being responsible for founding the town of Monessen, Pa., which sprung up simultaneously with the organization of the National Tin Plate Company at that town. Both concerns

were absorbed by the American Tin Plate Company in the latter part of 1898. Mr. Donner's next venture in the steel business was in the organization of the Union Steel Company, of Pittsburgh, Pa., which built a plant at Donora, Pa., and was responsible for the beginning of that town. The Union Steel Company consolidated with the Sharon Steel Company, of South Sharon, Pa. (now Farrell, Pa.) and was taken over by the United States Steel Corporation early in 1903. Mr. Donner will continue to live in Pittsburgh, where he has an office in the Frick building, but will spend part of his time at Johnstown. J. Leonard Replogle, the new vice-president, was born in Bedford county, Pa., May 6, 1876, and was educated in the public schools of Johnstown. He was just 13 at the time of the memorable Johnstown flood, from which he and his family barely escaped with their lives.

The loss of everything made it necessary for Mr. Replogle to go to work, and he entered the employ of the Cambria Steel Company as an office boy. He served successively as clerk; shipper; assistant superintendent of the axle department; superintendent of the forge, axle and bolt departments; assistant to the assistant general manager; superintendent of the order department; assistant general manager, and assistant to

president. Mr. Replogle is a director and a member of the finance committee of the Johnstown Trust Company; a director of the American Automobile Association; and a member of the American Electric Railway Association, the Western Railway Club, the Johnstown Country Club, the Johnstown Automobile Club and the Duquesne Club, Pittsburgh.



William H. Donner.



J. Leonard Replogle.

CATALOGS

BABBITT.—The Lumen Bearing Company, Buffalo, N. Y., has issued a catalog describing its various babbitt metals, including their characteristics and physical properties.

BRIQUETTING MACHINERY.—The United States Engineering Company, 80 Wall street, New York, as representative of Wm. Johnson, Armley, Leeds, England, is issuing a catalog which illustrates and describes several different designs of machinery for coal briquetting plants. Cross sections of complete plants which show the arrangement of the machinery, belting and conveyors that are recommended by this company under different conditions have also been included.

SECTIONAL STEEL BUILDINGS.—The Ruby Manufacturing Company, Chicago, has issued a new illustrated folder describing its line of sectional, portable fireproof steel buildings for a large variety of uses, including garages, boat houses, contractors' buildings, bunk houses, tool houses, engine houses, handcar houses and power plant buildings. These buildings contain no combustible material of any kind, the frames being built of heavy steel angles on the truss principle, designed for stability and durability.

VANADIUM STEEL.—A booklet is being issued by the United Steel Company, Canton, Ohio, which contains very interesting and valuable information in connection with tests of chrome vanadium steel. Illustrations are included showing the results of the different tests on springs, gears, axles, bars, etc., which convincingly indicate the ability of this material to withstand punishment. This booklet will be found valuable by the engineer who wishes to use this highly developed material and desires accurate information on the latest tests.

ACETYLENE WELDING IN LOCOMOTIVE REPAIRS.—A leaflet being issued by the Davis-Bourmonville Company, New York, gives photographs and a brief description of a number of different repairs to locomotive boilers recently made in a large eastern repair shop where an oxy-acetylene welding plant is in use. These give the time required, the amount of oxygen consumed and the cost in each case. A report of a pulling test of welds on boiler plate indicates that, when properly made, such a joint is practically equal in strength to the solid sheet.

ACETYLENE GAS.—The International Oxygen Company, New York, has published bulletins 5, 6 and 7, which describe the methods and machinery used in generating acetylene gas; also the Eycosec oxy-acetylene welding torches and practical hints and data for the use of operators. Leaflets have also been printed giving a report of tests of cells for the electrolytic production of oxygen and hydrogen; also an abstract of a paper concerning oxy-hydrogen as used in street railway construction and the I. O. C. oxy-hydrogen platinum melting process.

ORDER GUIDE FOR CAR PARTS.—The J. G. Brill Company, Philadelphia, Pa., is issuing Order Guide No. 201, which is intended for the convenience of the user in obtaining repair parts for any cars manufactured by the J. G. Brill Company, American Car Company, G. C. Kuhlman Car Company, John Stevenson Company, Danville Car Company, and the Wasson Manufacturing Company. On each left hand page of the book is an illustration of a part both complete and in detail, each section being numbered, while on the facing page is a corresponding number with the name of the part. The illustrations are all reproductions of photographs.

GRIP RELIEF IN BOLT HEADING MACHINES.—A folder is being sent out by the National Machinery Company, Tiffin, Ohio, which is confined to a discussion of the proper design for a spring grip relief or safety device to guard the machine against damage in case some object should get between the gripping dies and pre-

vent them coming together. It has been customary on most machines to use an arrangement which employs either a bolt or shearing pin, or a spring arrangement. The disadvantages of this construction are pointed out in the folder, and the arrangement which automatically reseats itself and does not in any way impair the holding power of the grip, which has been designed by this company, is fully illustrated and described.

MODERN WELDED PIPE.—An interesting pamphlet illustrated in colors is being issued by the National Tube Company, Pittsburgh, Pa. It concisely, but fully covers the essential points in the manufacture of steel pipe and tubing from the iron ore to the commercial product. Methods of making lapp and butt welded tubing and pipe are both explained, as is also the method by which a uniform quality of steel suitable for pipe making can be obtained. This company manufactures its steel from the ore and uses a Bessemer product which is perfectly suited for its needs. Considerable space is devoted to the relative effect of corrosion on steel or iron pipes, and it is conclusively shown that the steel pipe or tube will not suffer by the comparison under normal conditions. The proper tools for threading pipe are considered at some length. This book will be found most interesting to all users of either pipe or tubes, and contains new information of considerable value.

MALLET ARTICULATED LOCOMOTIVES.—In Record No. 72 from the Baldwin Locomotive Works, Philadelphia, Pa., is found an excellent discussion of the advantages of the articulated type of locomotive in general, as well of the detail parts as designed by this company. Phantom views make the arrangement of piping and steam passages easily understood, and locomotives both with and without reheaters and feed water heaters are shown in this manner. Drawings and photographs of some of the more important details are also included. Several pages are devoted to instructions in the proper method of handling articulated locomotives. It is stated that if the wheels of the forward group slip frequently while those of the rear group do not, it is an indication that steam is leaking past the high pressure valves and that these should be examined for blows. Other similar instructions for break downs or troubles peculiar to this type are clearly explained. The latter half of the book is given up to descriptions, illustrations and dimensions of many different designs of articulated locomotives built by the Baldwin Works.

DIRECT CURRENT RAILWAYS.—An attractively bound book of 132 pages, devoted to direct current railways using pressures of 1,200, 1,500 and 2,400 volts, has just been issued by the General Electric Company, Schenectady, N. Y. The first part contains a number of tables comparing the costs of 1,200-volt systems to those operated at 600 volts. For this purpose four different systems are assumed each 100 miles in length, one operating 9,000 car miles per day with a schedule speed of 45 miles per hour for three-car trains and the other three operating 3,000 car miles per day with schedule speeds of 35, 25 and 15 miles per hour for one-car trains. Every possible cost is considered and the result shows that for all electrical costs, including operation, fixed charges for the 1,200-volt system would be but 84 per cent. of the 600-volt system in the first case, 86 per cent. in the second, 90 per cent. in the third and 94 per cent. in the fourth. Following this is a section devoted to illustrated descriptions of the apparatus for a high voltage direct current railway system, such as generators, motors, controllers, etc. Locomotives for operating on roads of this character are fully described, specifications of a number of examples being included. The remainder of the book is given up to illustrated descriptions of various examples of high voltage, direct current systems in all parts of the country. The book contains a large amount of valuable information on the subject and will be found of much interest and value to electric railway operators and others interested in electric traction.

AMERICAN ENGINEER

"THE RAILWAY MECHANICAL MONTHLY"

(Including the Railway Age Gazette "Shop Edition.")

PUBLISHED ON THE FIRST THURSDAY OF EVERY MONTH, BY THE
SIMMONS-BOARDMAN PUBLISHING COMPANY,
83 FULTON STREET, NEW YORK, N. Y.

CHICAGO: Transportation Bldg. CLEVELAND: Citizen's Bldg.
LONDON: Queen Anne's Chambers, Westminster.

EDWARD A. SIMMONS, *President.* HENRY LEE, *Secretary.*
L. B. SHERMAN, *Vice-President.* A. E. HOOVEN, *Business Manager.*
The address of the company is the address of the officers.

ROY V. WRIGHT, *Editor.* R. E. THAYER, *Associate Editor.*
E. A. AVERILL, *Managing Editor.* WILLIAM FORSYTH, *Associate Editor.*
GEORGE L. FOWLER, *Associate Editor.*

Subscriptions, including the eight daily editions of the *Railway Age Gazette* published in June in connection with the annual conventions of the Master Car Builders' and American Railway Master Mechanics' associations, payable in advance and postage free:

United States, Canada and Mexico.....\$2.00 a year
Foreign Countries (excepting daily editions)..... 3.00 a year
Single Copy 20 cents

Entered at the Post Office at New York, N. Y., as mail matter of the second class.

Statement of the ownership, management, etc., of the *American Engineer*, published monthly at New York, N. Y.:

Editor, Roy V. Wright, New York, N. Y.
Managing Editor, E. A. Averill, New York, N. Y.
Business Manager, A. E. Hooven, New York, N. Y.
Publisher, Simmons-Boardman Publishing Co., New York, N. Y.

STOCKHOLDERS:

A. C. Boardman, Riverdale, N. Y. Henry Lee, New York, N. Y.
B. Boardman, New York, N. Y. Ray Morris, New York, N. Y.
D. Boardman, New York, N. Y. J. B. Rines, New York, N. Y.
F. Boardman, Committee, New York, N. Y. L. B. Sherman, Chicago, Ill.
Samuel O. Dunn, Chicago, Ill. E. A. Simmons, New York, N. Y.
E. T. Howson, Chicago, Ill. Roy V. Wright, New York, N. Y.

BONDHOLDERS:

Francis Boardman, Committee, New York, N. Y. W. W. Newcomb, New York, N. Y.
S. Wright Dunning, New York, N. Y. Charles M. Pratt, New York, N. Y.
A. B. Henszey, Philadelphia, Pa. William H. Shuey, Chicago, Ill.
S. E. Kellogg, Newton, Mass. Jacques L. Vauclain, Philadelphia, Pa.
Estate of W. W. Newcomb, Brooklyn, N. Y. C. W. Walton, Ridgewood, N. J.

SIMMONS-BOARDMAN PUBLISHING CO.,
By E. A. Simmons, President.

Sworn to and subscribed before Jno. H. Carr, a Notary Public for Kings County, N. Y. (No. 133), whose certificate is filed with the County Clerk of New York County (No. 9), on October 7, 1912.

VOLUME 86. NOVEMBER, 1912. NUMBER 11.

CONTENTS

EDITORIALS:

| | |
|--|-----|
| Javanic Type Locomotive..... | 555 |
| Earning Capacity of Freight Cars..... | 555 |
| Steel Passenger Cars in Service..... | 555 |
| Changes in Rules of Interchange..... | 556 |
| Locomotive Piston Speed..... | 556 |
| Baker Locomotive Valve Gear..... | 556 |
| Electric Locomotives..... | 556 |
| Valve Gears on Compound Locomotives..... | 556 |
| Shop Practice and the Small Shop..... | 557 |
| Reducing Smoke from Locomotives..... | 557 |
| New Books..... | 557 |

ILLUSTRATED:

| | |
|--|-----|
| Piston, Piston Rod and Crosshead Repairs..... | 559 |
| Diagram for Piston Speeds..... | 562 |
| Large Mikados for the Rock Island..... | 563 |
| The Vauclain Drill..... | 566 |
| Problem of Electric Locomotive Design..... | 569 |
| Car Shop Kinks..... | 573 |
| The Baker Locomotive Valve Gear..... | 575 |
| Electric Locomotives for the Southern Pacific..... | 581 |
| Reducing Smoke on Switch Engines..... | 583 |
| Designing Volute Springs..... | 584 |
| Paint Shop Kinks..... | 585 |
| Powerful 2-8-8-0 Type Locomotive..... | 587 |

| | |
|---|-----|
| Heavy Duty 18-Inch Lathe..... | 593 |
| Gravity Coupler Centering Device..... | 594 |
| Heavy Frog and Switch Planer..... | 597 |
| Twenty-four Inch Shaper..... | 597 |
| Vertical Chucking Machine..... | 598 |
| Flangeless Shoes and Wedges..... | 599 |
| Electric Speed Indicator..... | 600 |
| Milling Cutter, Reamer and Drill Grinder..... | 601 |

MISCELLANEOUS:

| | |
|--|-----|
| Engine House Supervision..... | 572 |
| Value of Variable Exhaust Nozzles..... | 578 |
| Accidents in Shops and Engine Houses..... | 579 |
| Railway Electrical Engineers' Association..... | 591 |
| Steel Passenger Car Painting..... | 594 |
| Density of Locomotive Smoke in Chicago..... | 596 |

GENERAL NEWS SECTION:

| | |
|-------------------------------|-----|
| Notes..... | 601 |
| Meetings and Conventions..... | 603 |
| Personals..... | 604 |
| New Shops..... | 607 |
| Supply Trade Notes..... | 608 |
| Catalogs..... | 609 |

Javanic Type Locomotive

A new type of locomotive has come into existence and has been given this designation by the builders. The Hannoversche Maschinenbau-Actien Gesellschaft, Hannover, Germany. In the numeral classification this locomotive would be a 2-12-2 tank type. It is for a 3 ft. 6 in. gage and has 43½ in. drivers. The four center pairs of drivers are rigid, while the first and sixth pairs are coupled on the Golsdorf system which employs flexible side rods. It is fitted with a Schmidt superheater, carries 171 lbs. boiler pressure and has a total weight of 164,500 lbs.

Earning Capacity of Freight Cars

According to a committee report presented at a meeting of the operating officials of the Illinois Central, an abstract of which was published in the October 11 issue of the *Railway Age Gazette*, the earning capacity of each freight car on that road is \$2.34 a day. If Sundays, holidays and bad order cars are eliminated, the gross earning capacity of each car is about \$3.85 a day and its net revenue is \$1.15. The average movement of all freight cars on the Illinois Central during the busy season is 27 miles a day, which is equal to 3 hours moving in trains and 21 hours, or 87 per cent. of the time, on the sidings. It is found that a car, on an average in the busy season, is employed per month as follows: 13 days in loading and unloading; 3½ days in moving in trains, and 13½ days standing awaiting movement, switching or repairs. It is estimated that each car costs the owners 52 cents a day for interest and repairs.

Steel Passenger Cars in Service

A circular issued by the Special Committee on Relations of Railway Operation to Legislation for the purpose of ascertaining the progress of the building of steel and steel underframe passenger equipment shows that on December 31, 1911, there were 5,347 all-steel passenger cars in service on 225 railroads in the United States. This is about 9.6 per cent. of the total passenger equipment on these roads; 2,399 cars or 4.3 per cent. had steel underframes. It was found that of the cars built during 1911, 59 per cent. were all-steel and 20.3 per cent. were steel underframe. Of the cars under construction at the time of the report, which numbered 1,211, 76.8 per cent. were all-steel and 16.2 per cent. were steel underframe, leaving but 7 per cent. wooden cars. The percentage of all-steel cars being built increased 750 per cent. during the 3 years from 1909 to 1912, and the indications are that the additions to this equipment from now on will be practically all either steel or steel underframe. In connection with the same report, it was found that it would cost \$632,746,000 to replace the 48,126 wooden cars now in service in the United States. At 5 per cent. this amount gives an interest charge of \$31,637,300 a year. At the present time there are six bills pending in Congress requiring existing wooden passenger

equipment to be replaced by all-steel and the periods suggested during which this is to be done vary from June 1, 1915, to January 1, 1918. In other words, if these bills are passed, it will compel the railway companies to spend from \$100,000,000 to over \$200,000,000 per year for passenger equipment.

Changes in Rules of Interchange

On September 7, 1912, there was submitted to the members of the Master Car Builders' Association a letter ballot calling for a vote on the question of abrogating the rules which penalize the delivering line for owners' defects, and also on the proposed adding of a direct percentage of 10 per cent. to the total labor and material charges as shown on monthly bills. The result of the vote on both of these proposals was heavily in the affirmative and the arbitration committee of the association has revised the rules of interchange accordingly. The Executive Committee has decided that the new rules will take effect on November 1, 1912. Changes have been made in the following rules: Nos. 4, 33, 48, 53, 55, 57, 59, 64, 95, 105, 106 and 122. Copies of the changes are now being issued by the secretary.

Locomotive Piston Speed

Several years ago a number of large freight locomotives which had small wheels and cylinders with a 32 in. stroke were put in service on one of the Eastern railways. On the same division there were consolidations which were considerably lighter in weight but had practically the same diameter of cylinders and a 28 in. stroke. The lighter engines are today handling the same tonnage trains as the much more powerful locomotives and are doing it on considerably less coal and water. This is an example of the influence of the length of stroke on the capacity of the locomotives in actual service. It is desirable to have the speed of the piston as low as possible, especially on locomotives which work at a late cut-off and, where the wheels are small, the stroke should be short if a reasonable speed is to be maintained. This feature seems to be fully considered in recent locomotive designs and will probably be given even closer attention in the future. For the benefit of designers and others who wish to determine the piston speed under different conditions, we publish on page 562 of this issue a diagram, prepared by L. R. Pomeroy, which permits a ready determination of the combination of length of stroke and diameter of drivers to give any desired piston speed at any rate of travel.

Baker Locomotive Valve Gear

The story of the article on the Baker locomotive valve gear, which appears elsewhere in this issue, is a most interesting one and will undoubtedly appeal to our readers. R. S. Mounce, the author, is of an analytical turn of mind and likes to get to the bottom of things. Moreover he has had considerable experience in the setting and the analysis of locomotive valve gears. When the Baker gear was first drawn to his attention a year or two ago he studied all of the literature available with an idea of making a careful analysis of its operation. From the data which he was able to obtain he was unable to get sufficient detail knowledge of it to enable him to analyze it thoroughly. Last June while attending the conventions at Atlantic City his attention was drawn to a model of the gear which was on exhibition there. He studied this over carefully and gained a good knowledge of its construction and working. On returning home he made a study of the action of the gear and analyzed it thoroughly. Fortunately, at just about this time the Erie applied two of these gears to locomotives at Jersey City and he was enabled to watch their application closely and follow them somewhat after they went into service. This article is a result of his investigation and study, and is undoubtedly the most simple and thorough treatment of the gear that has ever been prepared.

Because of the increasing use of this gear on different roads the article will undoubtedly prove of interest and value to many of our readers.

Electric Locomotives

W. N. Storer, in a paper presented before the recent convention of the Association of Railway Electrical Engineers in Chicago, an abstract of which appears elsewhere in this issue, suggests that the great improvement in the efficiency of steam locomotives in recent years is largely due to the fact that the electric locomotive had developed to a point where it appeared to be a strong competitor for trunk line work. In some degree it is possible that this new and possibly dangerous rival spurred the steam locomotive designers to greater efforts, but it is hard to believe that practically the same progress and improvement in steam locomotives would not have taken place even had there been no such pending competition. The demands of the traffic department have been sufficient at all times to compel a continued enlargement and improvement of the locomotive and from the beginning this development has been continuous and fairly constant. It has been marked by periods of distinct changes where radical developments have been made, as for instance, the wide firebox, the Mallet type locomotive and the superheater, but between these points there has been a continual refinement and improvement of the design. It is true that in no previous decade has there been so much done in making the steam locomotive better and more efficient as in the last one, but the same was also true of the previous decade and the one preceding that. It will probably be equally true of the next. Locomotives being built today are better machines than those built last year and decidedly better than those built three years ago. While the electrical engineers are entitled to great credit for their progress and accomplishments, it is hardly fair to credit the present state of art in respect to steam locomotives to their activity. It is very doubtful if the steam locomotive of today would have been any different or any less advanced than it is, if there had never been any threatened invasion of its field.

Valve Gears on Compound Locomotives

On many of the foreign railways where the engine crews' wages depend very largely on the coal, water and oil consumption of the locomotive, it has been found advisable to install valve gears on compound locomotives so arranged that the engineman can adjust the point of cut-off in the high and low pressure cylinders independently. Usually these locomotives are also fitted with a variable exhaust nozzle. Such locomotives are generally provided with gages which give information as to temperatures and pressures at every point where the knowledge would be of any advantage in saving fuel. Under these conditions, with the incentive of higher wages, these devices are constantly being used and adjusted with most satisfactory and profitable results. In this country, refinements of this nature have been given spasmodic trials at various times, but generally without success. When the variable exhaust nozzle has been tried it has been found that it very soon corrodes and is held solidly in one position, due to not having been operated. The final result of every experiment of this kind that has been attempted in this country has been the return to the stationary nozzle. It is desirable that the amount of power developed by each of the units of a Mallet locomotive should be the same. In compound cylinders, however, this cannot be exactly true except at a single point of cut-off with a certain steam pressure. Although it does not vary greatly under normal conditions, such variations as do occur can be corrected by adjusting the point of cut-off in one of the cylinders independently of the other, and the valve gear of the 2-8-8-0 type locomotives for the Great Northern illustrated in this issue is arranged to readily permit this. Some time ago this company fitted up a locomotive with an experimental separate cut-off arrangement on the two pairs of

cylinders and made tests to ascertain how the work was divided by the two groups of wheels when the engine was operating at different speeds on different grades. It was found that when a constant pressure was maintained in the receiver pipe the division of the work was more nearly equal. The best receiver pipe pressure for the experimental engine was found to be 60 lbs. and instructions were issued to operate the locomotive so that the gage for the receiver pipe would show this pressure at all times. In regular service this worked out very satisfactorily when operating on rolling grades, but of course when the engines were working on hills there was no occasion for varying the cut-off. The new locomotives will be subjected to tests to determine what receiver pipe pressure will be necessary in order to properly equalize the work, and instructions will be issued to engineers on these locomotives to maintain this pressure on the receiver gage at all times.

Shop Practice and the Small Shop

The best method of doing any particular work in one shop may be altogether wrong or impossible in another. This is partially due to the difference in machine tools that are available in the two cases and partially to the different designs of the same parts on different roads or on different locomotives. How much this may affect the time required for the work is well illustrated by the articles on repairs to pistons, piston rods and crossheads, which appeared on page 523 of the October issue, and the same work as described by Mr. Black on page 559 of this issue. In the former cases, both of which are descriptions of methods used in large modern, thoroughly equipped shops, the total time for doing the work was twelve hours and twenty-nine minutes, and sixteen hours and forty-three minutes, respectively, while in the smaller shop, with its lack of special tools and of special arrangements for this particular work, it requires twenty-four hours and fifty minutes. We publish Mr. Black's description as an example of what can be done under adverse conditions. For instance, it will be seen that there is no radial drill available for drilling and tapping the staybolt holes in the piston head, and no piston rod grinder or vertical turret lathe, any one of which would have made a decided difference in the time of doing the work. Furthermore, he is handicapped, compared with some other shops, by having a piston head requiring staybolts, as well as in the design of the crosshead.

While each shop must adopt methods that are suited to its own conditions, it should not be assumed that because work has been done in a certain way in the past, this is the best way for it to be done now. It is seldom that an outside expert cannot go in a shop and point out ways of improving many of the practices of machining parts, even those which are handled in large quantities. This is more often due to his knowledge of how the same work is being done in other places and his adaptation of the better methods to the local conditions. It is with this object in mind that the shop practice articles have been printed in these columns. While probably no method described could be adopted without change in another shop, the ideas which governed the originator of the methods can be adapted to any shop, often with decided improvement.

Reducing Smoke from Locomotives

While it is desirable to reduce the smoke emission of all locomotives as far as practicable, it is the switch engines, working in thickly settled districts, that should receive the closest attention. The Lake Shore & Michigan Southern has been most successful in its efforts to reduce smoke from this source, and D. R. McBain, superintendent of motive power, explained the methods by which this had been accomplished to the National Association for the Prevention of Smoke at its recent Indianapolis, Ind., meeting.

A liberal extract of his address is given elsewhere in this issue. So far as the construction of the locomotive itself is concerned, there are three features that have been found of primary importance. The first and greatest is probably the superheater, which in itself in no way affects the efficiency of the combustion in the firebox, but from the fact that its presence reduces the amount of coal consumed on a switch engine by a very large amount—40 per cent, being reported in some cases—the smoke emitted, independent of other factors, is reduced in the same proportion. In this connection, however, the fact that less coal is required and that the steam pressure is maintained much more easily, permits the fireman to give closer attention to his method of firing; or, in other words, it is made possible for him to do what Jim Skeever's fireman found impossible, i. e., to fire for smoke instead of steam. In this way the superheater has a still further effect on the amount of smoke.

The next feature mentioned by Mr. McBain is a brick arch which is conceded to be the most important agency for improved combustion that can be applied to the locomotive. The arch in the switch engines on the Lake Shore is larger and covers a greater area than the customary arrangement used on road engines. It is so designed that the strong exhaust will have little effect on the fuel bed, and a considerably thinner fire can be carried. It forces a most thorough mixture of the gases and gives them ample time for complete combustion before entering the flues. As a further adjunct, steam jets on either side of the firebox just above the fuel bed are recommended. These jets assist in mixing the products of combustion and inject a further supply of oxygen above the fuel bed.

These three appliances, when combined with the proper maintenance of the locomotive as a whole, have practically eliminated the smoke emission from switch engines, and at the same time have given a large reduction in the coal and water consumption. In a busy yard this increased efficiency is of more importance than simply the saving in the cost of the fuel, as it reduces the necessity of the engines frequently leaving their work to obtain renewed supplies—particularly of water. The new arrangement is also favored on the locomotives which work around and through passenger stations because of the absence of dirty water and cinders thrown from the stack. Claims for damage to wearing apparel from this source will often amount to a very considerable sum in the course of a year.

NEW BOOKS

Light, Its Use and Misuse. Bound in paper, 20 pages, 6 in. x 9 in. Illustrated. Published by The Illuminating Engineering Society, 29 West Thirty-ninth street, New York. Copies free.

This pamphlet has been prepared to furnish the public with information on the general principles of light and illumination. The illustrations are particularly good and present to the reader in an impressive way the difference between good and bad illumination with the same amount of light. The pamphlet, in itself, is an object lesson and is printed on dull finished paper with ink that is free from reflection. The text matter throughout is interesting.

Applied Methods of Scientific Management. By Frederick A. Parkhurst. Illustrated. Bound in cloth, 320 pages, 6 in. x 9 in. Published by John Wiley & Sons, 43 East 19th street, New York. Price \$2.00.

A series of articles under the above title, written by Mr. Parkhurst, appeared in *Industrial Engineering* during 1911. These have been collected and amplified, and now appear in book form. The actual detailed application of the methods of scientific management to a comparatively small manufacturing plant is given, and the processes of installation and the results are illustrated by statistics obtained from actual records. The

manufacturing company referred to is the Ferracute Machine Company, makers of presses and dies at Bridgeton, N. J., which normally employs about one hundred men. The net result of the application of the new methods was a large increase in the output with a decided decrease in the unit labor cost. How and why this was accomplished is fully explained.

Railway Storekeepers' Association. Proceedings of the ninth annual meeting. Illustrated. Bound in cloth, 217 pages, 6 in. x 9 in. Published by the Railway Storekeepers' Association, J. P. Murphy, Secretary, Box C, Collinwood, Ohio.

At the ninth annual convention of the Railway Storekeepers' Association, held in Buffalo, N. Y., May 20 to 22, a number of important subjects were brought up for discussion and action. Among these were reclaiming of scrap material and line inspection. The standardization of both tinware and grain doors was discussed, as well as the uniform grading and inspection of lumber, methods of accounting, preparing packages for shipment, and increasing the efficiency of the department as a whole. The proceedings includes a list of the members of the association, the committees for the coming year and a copy of the constitution and by-laws.

Proceedings of the Western Railway Club—1911-1912. Illustrated. Bound in cloth, 266 pages, 6 in. x 9 in. Published by the Western Railway Club, J. W. Taylor, Secretary, 390 Old Colony Bldg., Chicago. Price \$2.00.

For many years the Western Railway Club has held a prominent place among the railway clubs, and an examination of this volume of proceedings for the year ending last June, indicates that the members propose to see that it maintains its present standing. There were nine papers presented for discussion, as follows: Some Experiments with Car Trucks; Oxy-Acetylene Welding; Use of Denatured Alcohol in Railway Service; Terminal Brake Testing; Head-end Electric Train Lighting; Steel Wheels; Locomotive Valve and Cylinder Lubrication; Revision of the Rules of Interchange and Water Treatment and Boiler Troubles. The complete verbatim discussions accompany the papers, and lists of the members attending the meetings, as well as the new members for the year, are given. The volume is well indexed.

American Machinist's Grinding Book. By F. H. Colvin and F. A. Stanley. Illustrated. Bound in cloth, 376 pages, 6 in. x 9 in. Published by the McGraw-Hill Book Co., 239 West 39th street, New York. Price \$3.00.

The purpose of the authors in bringing out this volume is well described in the preface as follows: "The grinding machine in its various forms and the numerous grinding processes has assumed a place of such importance in the manufacture of machinery and the finishing of metal parts in general, that it has been considered desirable to bring together in the form of a reference book, such data on these machines, wheels and methods, as are likely to be of interest and service to grinder purchasers and operators, and to the men responsible for results in the grinding department." The book is most complete and thorough. It has nineteen chapters and contains 286 illustrations and 36 tables. The last chapter is entitled, "Helps and Suggestions," and gives information on all features of interest to the operator. The proper kind of wheels to be used on different classes of work is given and tables are included, giving the best shapes for grinding all classes of tools.

The Coking of Coal at Low Temperatures, with a Preliminary Study of the By-Products. By S. W. Parr and H. L. Olin. Bulletin No. 60 of the Engineering Experiment Station of the University of Illinois. Copies may be obtained upon application to W. F. M. Goss, director of the Engineering Experiment Station, University of Illinois, Urbana, Ill.

The studies give the details of a large number of experiments on the low temperature distillation of coal not exceeding approximately 750 deg. F. Certain fundamental principles have

been developed which underlie the coking of coals of the Illinois type. A striking illustration is given of the fact that even a small amount of oxidation of the coal diminishes or destroys its coking power. Superheated steam was used to remove all traces of an oxidizing atmosphere. Freshly mined coal was found to be essential in the experiments. The by-products consist of illuminants of high candle power, of tarry material which consists in the main of oils, and a coke which has a composition somewhat similar to that of the so-called smokeless coals. The nitrogen recovery is small, not exceeding 5 per cent. of that material present in the coal. The results seem to justify the conclusion that a fuel can be produced suitable for use in domestic appliances, as well as under industrial conditions, and that the theoretical principles developed point to the possibility of making a good type of coke from Illinois coals.

Modern Organization. By Charles De Lano Hine. Bound in cloth, 110 pages, 4¾ in. x 7¼ in. Published by the Engineering Magazine Company, 140 Nassau street, New York. Price \$2.00.

About four years ago, the first installation of Major Hine's unit system of organization was made on the Nebraska division of the Union Pacific. During the following three years it was continually extended until it covered twenty-seven operating divisions and six general operating jurisdictions. While it would be impossible to make any changes on a railroad, especially one so fundamental as the change in the system of organization, without causing some confusion, it is considered very surprising by those who have been in a position to know all the facts, how little confusion has resulted in this case. This feature alone has done much to prove the soundness of the principles involved. That it has promoted efficiency in practically every direction is acknowledged. It has been more successful on some divisions than on others, and where the application of the principles has been the most consistent and earnest, the corresponding benefits have been the greatest, but in no case has there been any evidence of any loss of efficiency under the new system. A series of articles by Major Hine in the *Engineering Magazine*, descriptive of this new system, which ran from January to July, 1912, have been published in book form and form a comprehensive definition of the author's philosophy of management and an explanation in some detail of the manner of putting it in effect. Major Hine states in one place that, "Organization is a necessity and not an accident. Organization exists in response to some need of the social order. The type of organization adopted, however, is often accidental and frequently unscientific. There are so many more men who know how than there are who know why, that departures from sound principle should be expected rather than otherwise." The fundamental principles of the system of organization described are those of correcting over-specialization and over-standardization by simple changes of official relation and departmental routine. No elaborate system is introduced, but, on the contrary, the whole operation of the department is simplified. There are no changes made affecting the rank and file, but that most objectionable practice commonly known as "government by chief clerks" is entirely eliminated. The changes in official status are generally in the direction of a broadened authority and opportunity. The reasons for the often expensive differences between the line and staff are explained in one of the chapters, and the manner in which this system of organization makes impossible such a clash of authority or professional friction, is explained. The book is most interesting and is complete in its general description. There arise, however, in the reader's mind many questions in regard to details which are not clearly explained, such as, for instance, the arrangement when the master mechanic's office may be a considerable distance from the superintendent's headquarters, the handling of emergencies in one department by a man whose training and experience have been altogether in another line, the unequal rates of pay for men carrying the same title, etc.

PISTON, PISTON ROD AND CROSSHEAD REPAIRS

Showing What Can Be Done in the Smaller Shops
Without Special Tools or Facilities for the Work.

BY GEORGE BLACK,

Canadian Pacific, West Toronto, Canada.

The best method for handling this work will vary at different places, depending on the equipment available, and what might be an excellent method in one shop would not be at all correct at another. While the operations will, in general, be the same in the large as in a small shop, the quantity of work done in the former will justify the devoting of a certain number of machine tools entirely to this class of work, as well as the purchase of tools especially fitted for this work, while in the small shop the work has to be done on machines that are also used for other repairs. In the small shop, therefore, the most that can be done is to arrange the available machinery

ing up the worn or broken places with the oxy-acetylene apparatus. A very badly worn shoe can be built up again and made equal to a new one at an expenditure of seventy cents for oxygen, carbide and soft wire. The time required to do this would be about 50 minutes, and an apprentice boy can easily shape out the liner fits in 90 minutes, again making the shoe standard in every particular.

Side liners are carried in stock already machined, and the fitting and laying off of four liners ready for drilling and counter-sinking will require 15 minutes. They are drilled and counter-sunk in 21 minutes. A speed of 350 r. p. m. is used on the hand feed for drilling 15/32 in. holes and a speed of 300 r. p. m. is used for countersinking. Detailed times of the operation are as follows:

| | |
|---|--------|
| Prepare machine and set work..... | 3 min. |
| Drill 28 15/32 in. holes..... | 8 min. |
| Change tool and speed and countersink 28 holes..... | 8 min. |
| Remove work and clear machine..... | 2 min. |

The liners are then returned to the fitter and applied to the side plate and crosshead. They are held by 3/8 in. copper rivets. The fitting, riveting and finishing of the job complete will require 60 minutes for the four liners.

The sectional liners are also carried in stock, machined to size and the fitting and applying of six of them requires 30 minutes. After they are in place the side plates and bolts are applied, nuts put on and split keys inserted. This work will consume 60 minutes more.

The complete operation of repairing this type of crosshead

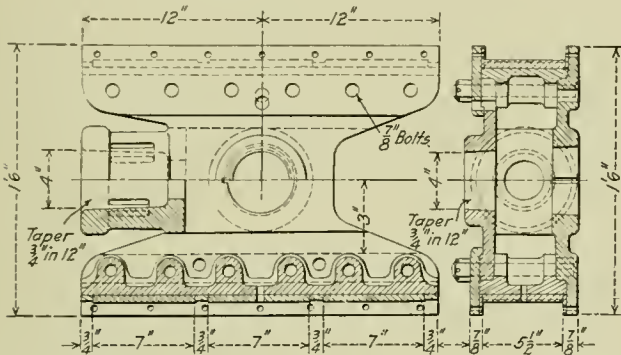

Type of Crosshead to Which the Operations Described Are Applicable.

on a compromise basis so that it will be equally well suited for the various more important operations. In the following discussion the reader should understand that the methods are those which are believed to be the best possible for a small shop without special tools for this class of work.

The first operation consists of removing the front cylinder head and its casing, disconnecting the crosshead, and removing the piston head and its rod from the cylinder to the floor. This operation, including the dropping of the main rod requires 57 min., which is divided as follows:

| | |
|--|---------|
| Remove front cylinder casing and head..... | 20 min. |
| Remove wrist pin and drop main rod..... | 12 min. |
| Disconnect piston rod from crosshead..... | 15 min. |
| Remove crosshead, piston, packing and gland..... | 10 min. |

Total 57 min.

CROSSHEAD REPAIRS.

One of the illustrations shows the type of crosshead that is to be repaired. It is refitted at a bench near the engine in the erecting shop. To thoroughly refit it means the renewing of six sectional liners and four side liners. To do this it is necessary to remove twelve 7/8 in. bolts and twenty-eight copper rivets along the side liners. This operation usually requires about 60 minutes.

An examination of the crosshead and cast steel shoes is next made. The former is inspected for defects around the throat and key slot, and the latter for wear on the retaining bars, due to the sectional liners becoming loose and floating back and forth. It is quite possible that the retaining bars may already have been calked up in an endeavor to hold the liners tight. If they are worn or otherwise broken so that they are not standard, it is our custom to reclaim the shoes by build-

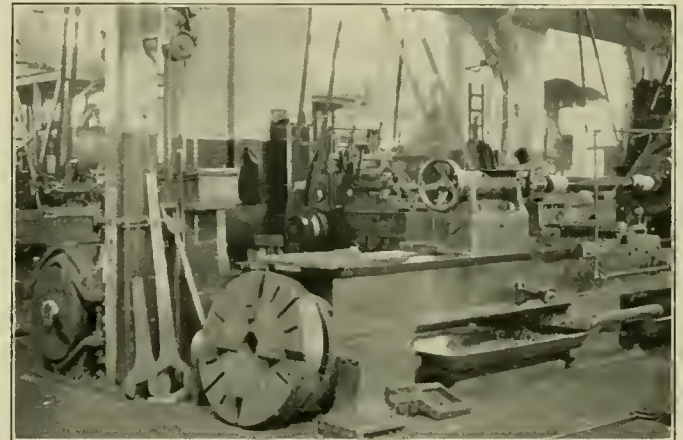

View Showing the Clamp for Holding Piston Heads, and the Lathe for Finishing Rods.

as described will thus consume a total of 386 minutes as follows:

| | |
|--|----------|
| Removing side plates and side liners..... | 60 min. |
| Reclaiming shoes | 140 min. |
| Fitting and drilling four side liners..... | 36 min. |
| Applying side liners..... | 60 min. |
| Fitting and applying six sectional liners..... | 30 min. |
| Assembling and bolting up..... | 60 min. |

Total 386 min.

BORING THE CYLINDER.

If the cylinder needs reboring, a three year erecting shop apprentice removes the back cylinder head, cleans the counter-

bore and sets up the boring bar. The boring bar used at these shops is the Underwood, manufactured by H. B. Underwood & Co., Philadelphia. The machinist checks the setting of the bar and the apprentice then proceeds to take the necessary cuts, being careful to leave a witness mark. An air motor drives the boring bar at a speed of 4 r. p. m., and the roughing cut will carry a feed of 3/32 in. per revolution. While, of course, the time will vary with the condition of the cylinder and the number of cuts necessary, the average time for this work will be from 10 to 12 hours.

PISTON ROD.

The first operation of separating the piston rod and head consists of removing the pin through the nut. If this can be taken out by hand the operation requires from 5 to 15 minutes. However, not infrequently it is necessary to drill out this pin, and in that case the piston head and its rod are taken to a drill press and a long forged drill is used in order to clear the head. It will require on an average of about 40 min. to take out the pin by this method. This includes the transfer of the parts and the cleaning of the machine. The head and rod are then returned to a special vise which clamps the head and permits the removal of the nut by means of a long wrench. This operation will require about 32 minutes. The head and

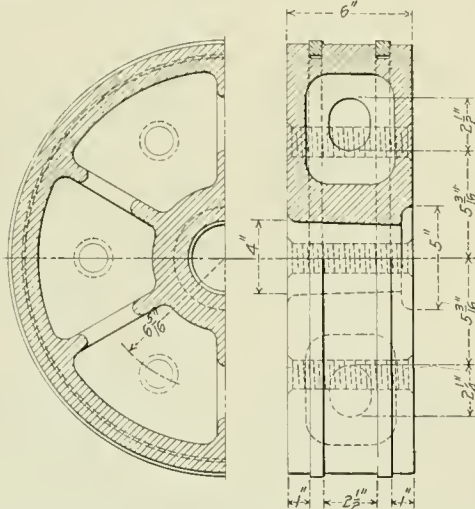

Piston Head to Which the Times Given for Repairs Apply.

rod are then taken to the regular wheel press and separated. This operation requires 20 minutes, which includes preparing the press and removing the rod and head after being separated.

Before removal from the head, if the rod is not too badly worn, the crosshead fit is painted with a mixture of white lead and lard oil, and given a sledge hammer test for flaws around the keyhole. If defects appear, the rod is scrapped or made into a shorter rod for a smaller engine. If there are no defects it will be trued up and used again. It is the practice at this shop to keep three or four piston rods and heads on hand in a semi-finished condition, which in the case of the rods would include complete machining except the two fits.

With a new rod, the first operation will be centering both ends and cutting to length. This work is done on a lathe manufactured by Dean, Smith & Grace, of England, which swings 30 in. over the bed and is very powerful. The total time for centering and cutting off the new rod is 59 minutes. The detailed operations are shown in the following table:

| | |
|--|---------|
| Prepare the machine, mark centers and chuck the rod..... | 15 min. |
| Drill center | 5 min. |
| Face the end..... | 4 min. |
| Countersink center | 4 min. |
| Reset rod and mark for length..... | 6 min. |
| Drill center | 8 min. |
| Change tool and face end to length..... | 8 min. |
| Countersink center | 4 min. |
| Remove rod and clear machine..... | 5 min. |

The time required for turning the rod, including making the fit at the crosshead end will be 184 minutes, of which rough and finish turning of the body requires 121 minutes and the finishing and filing of the crosshead fit consumes 63 minutes. Making the piston head fit is a similar operation and will require the same time of 63 minutes. Threading the rod and fitting the nut will take 30 minutes more. After the crosshead fit is completed and before the rod is finally taken out of the crosshead, the key slot is scribed. It is then transferred to a drill where a jig, shown in one of the illustrations, is used to give the correct angle to the slot. Four 5/8 in. holes are drilled

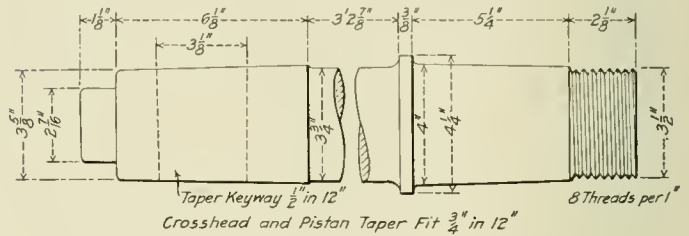

Piston Rod to Which the Operations Specified Apply.

through the rod. This requires 52 minutes, including the preparation of the machine, setting of the chuck, installation and removing of the jig, etc. From the drill the rod passes to the milling machine where it is clamped in V blocks and an end mill breaks in the four 5/8 in. holes. A spiral mill then finishes the slots to width. This operation requires 91 minutes, the detailed operation being as follows:

| | |
|---------------------------------------|---------|
| Prepare machine and set V blocks..... | 15 min. |
| Set mill and rough out slot..... | 32 min. |
| Change tool and finish mill slot..... | 34 min. |
| Remove rod and clear machine..... | 10 min. |

If a new key is required a tin template is made from which the blacksmith forges a key and punches a cotter pin hole. Forging the key will take 60 minutes, and filing and fitting it in the rod and crosshead will require 60 minutes more.

The total time for finishing the rod complete is 479 minutes, divided as follows:

| | |
|--|----------|
| Centering and cutting to length..... | 59 min. |
| Rough turning fits and finish turning rod..... | 121 min. |
| Finish and fit crosshead end..... | 63 min. |
| Finish and fit piston end..... | 63 min. |
| Threading and fitting nut..... | 30 min. |
| Drilling and milling keyway..... | 143 min. |
| Total | 479 min. |

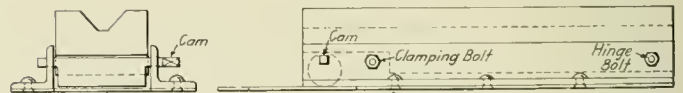
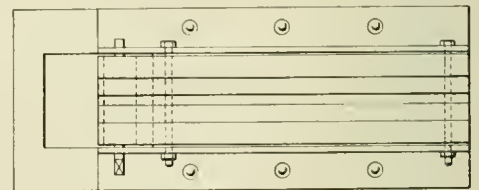

Jig for Drilling Key Slot in Piston Rods.

For facilitating the operation of separating the crosshead and the piston rod during the time the fits are being made a dummy wrist pin and taper drift are used. This arrangement is shown in one of the illustrations.

PISTON HEAD.

At this shop the turning of the piston head is performed in two operations, viz., rough and finish turning. The head to which these times apply is shown in one of the illustrations.

The rough turning requires 156 minutes, detailed as is shown in the following table:

| Operation | R. P. M. | Feed. | Cut. | Time. |
|---|----------|----------|-----------------|---------|
| Prepare machine, chuck and true up piston | | | | 15 min. |
| Set tool and cut | | | | 2 min. |
| Face piston | 10 | 3/8 in. | 3/16 in. | 15 min. |
| Change tool and speed | | | | 2 min. |
| Rough bore (3 cuts) | 33 | 1/16 in. | 1/8 in. | 15 min. |
| Change tool and speed | | | | 2 min. |
| Turn outside diam. (2 cuts) | 10 | 3/8 in. | 3/16 in. | 18 min. |
| Change tool and set cut | | | | 2 min. |
| Rough grooves (2) | 10 | H.† | 3/4 in. x 1 in. | 30 min. |
| Change tool and speed | | | | 2 min. |

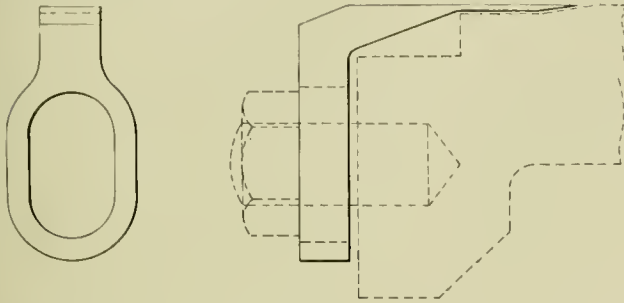

Guide for Entering Piston Packing in the Cylinder.

| | | | | |
|---------------------------------------|----|---------|----------|----------|
| Recess for nut | 25 | H. | 3/4 in. | 8 min. |
| Remove tool, reset and true up head | | | | 12 min. |
| Change speed, set tool and cut | | | | 3 min. |
| Turn outside diameter | 10 | 3/8 in. | 3/16 in. | 5 min. |
| Change tool and face piston | 10 | 3/8 in. | 3/8 in. | 15 min. |
| Remove tool and piston, clear machine | | | | 10 min. |
| | | | | 156 min. |

The finished turning of the head consumes 98.5 minutes, as is shown in the following table:

| Operation | R. P. M. | Feed. | Cut. | Time. |
|---|----------|----------|----------|----------|
| Prepare machine, chuck and true up head | | | | 15 min. |
| Set tool and cut | | | | 2 min. |
| Finish turn outside diameter | 10 | 1/16 in. | 1/16 in. | 5 min. |
| Change tool, radius edge | 10 | H. | H. | 2.5 min. |
| Change tool, finish turning grooves to gage (2) | 10 | 1/64 in. | H. | 10 min. |
| Change tool and speed | | | | 2 min. |
| Finish turning recess for nut | 25 | H. | 1/16 in. | 5 min. |
| Reset and true up head | | | | 12 min. |
| Change tool and speed. Set top rest taper | | | | 5 min. |

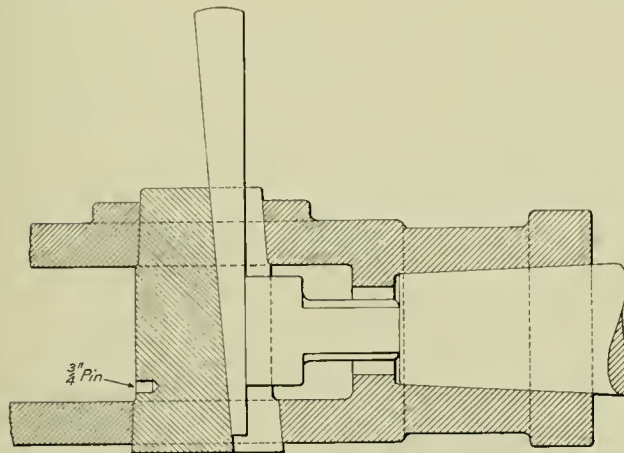

Wedge for Separating the Piston Rod and Crosshead.

| | | | | |
|------------------------------|----|----------|----------|-----------|
| Bore rod fit taper | 33 | H. | 3/8 in. | 8 min. |
| Change tool and speed | | | | 2 min. |
| Ream rod fit (standard)* | 22 | H. | 3/8 in. | 10 min. |
| Change tool and speed | | | | 2 min. |
| Radius edge rod fit | 33 | H. | 3/8 in. | 1 min. |
| Change tool and speed | | | | 2 min. |
| Finish turn outside diameter | 10 | 1/16 in. | 1/16 in. | 3 min. |
| Change tool and radius edge | 10 | H. | 1/16 in. | 2 min. |
| Remove and clear machine | | | | 10 min. |
| Total | | | | 98.5 min. |

* A flat reamer is used with hard wood blocks to steady it.

† H indicates feed by hand.

It will be noted that there are six staybolts through this head. It is removed from the lathe and taken to the drill press. The

drilling and tapping of the holes requires 84 minutes. The drill used is not of the radial type and it is necessary to reset the work for each hole. This is an example of the handicap a small shop is compelled to undergo, which accounts for the seemingly excessive time required for some of this work. The staybolts are threaded in a double head Acme machine and are applied to the piston head, cut off and riveted over on either side. This operation requires 47 minutes.

The head is now pressed on the rod and then clamped in the special vise shown in one of the illustrations to have the nut applied and drawn up. The time required for performing this operation is 47 minutes. It is then taken to the drill press and a pin hole drilled through the nut and rod, and a one-half inch pin applied. This takes 40 minutes.

The total time for finishing a new piston head complete and applying it to the rod is thus seen to be 482.5 minutes, divided as follows:

| | |
|--|-----------|
| Rough turning piston head | 156 min. |
| Finish turning piston head | 98.5 min. |
| Drilling and tapping holes for staybolts | 84 min. |
| Applying staybolts | 47 min. |

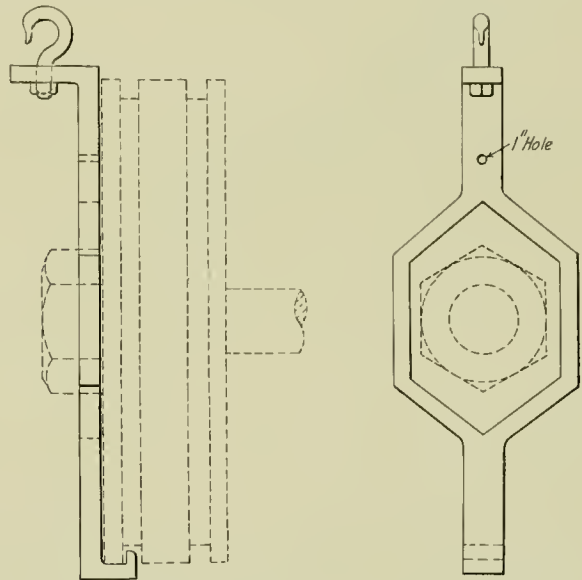

Jig for Lifting Pistons and Rods, Also Used for Cylinder Heads.

| | |
|-----------------------------------|------------|
| Pressing on head and applying nut | 57 min. |
| Drilling hole and applying pin | 40 min. |
| Total | 482.5 min. |

PISTON PACKING RINGS.

The packing rings are all machined to gage and are cut from the customary form of cylindrical casting provided with lugs on one end for clamping to the faceplate of the boring mill. A 60 in. boring mill is used on this work and the time for boring, turning and parting the rings is 22 minutes each. The detailed operations are shown in the following table:

| | |
|--|----------|
| Prepare machine, set and clamp casting | 15 min. |
| Set tool and cut | 2 min. |
| Face top of casting | 2 min. |
| Change and set tools and cut | 3 min. |
| Bore inside and turn outside of casting | 30 min. |
| Change tool and set cut | 2 min. |
| Finish turning outside of casting | 9 min. |
| Change and set tools and cut | 4 min. |
| Part off ten 3/4-in. rings to gage | 150 min. |
| Remove base of casting and clear machine | 8 min. |

The rings are first cut in two and then applied to the cylinder and the amount of lap is marked. This extra end is then cut off and the ends squared up with a file. The time for fitting two rings in this manner will be 50 minutes, which includes applying them to the piston head.

For putting the piston and rod in the cylinder after the rings are in place, a form of finger has been designed for guiding the packing as the piston enters, and is shown in one of the illus-

trations. Four of these are used and eliminate the trouble of the rings striking the shoulder.

In this connection an attachment for lifting the head into place has been designed. This is also shown in one of the illustrations. It simply hooks in one of the packing ring slots at the bottom and slips over the nut and thus does not require any direct fastening to keep it in place. This device is also used in applying the front cylinder heads, a one inch hole being drilled in the lifter through which the casing stud enters and the head is held by a nut.

The whole operation of applying the piston to the cylinder, connecting up the crosshead, applying the piston and rod packing, putting up the head and casing and marking the striking points requires 121 minutes divided as follows:

| | |
|---|-----------------|
| Oil and apply the piston to cylinder..... | 15 min. |
| Apply gland and packing and couple up to crosshead..... | 38 min. |
| Put up cylinder head and casing..... | 60 min. |
| Mark striking points..... | 8 min. |
| Total | 121 min. |

DIAGRAM FOR PISTON SPEEDS

By L. R. POMEROY.*

The piston speed of a locomotive is a function of the rate of travel over the track, the diameter of the drivers and the length of the stroke, and when the travel is expressed in miles per hour and the other two factors in inches, the piston speed, in feet per minute, can be expressed by the following formula in which *P* equals piston speed; *M*, miles per hour; *S*, stroke and *D*, diameter of drivers.

$$P = \frac{56MS}{D}$$

While this is a simple formula for calculation, most designers and computers prefer to use the graphical form and the diagram shown herewith is arranged to give piston speeds accurately for train speeds between 15 and 85 miles per hour and for various

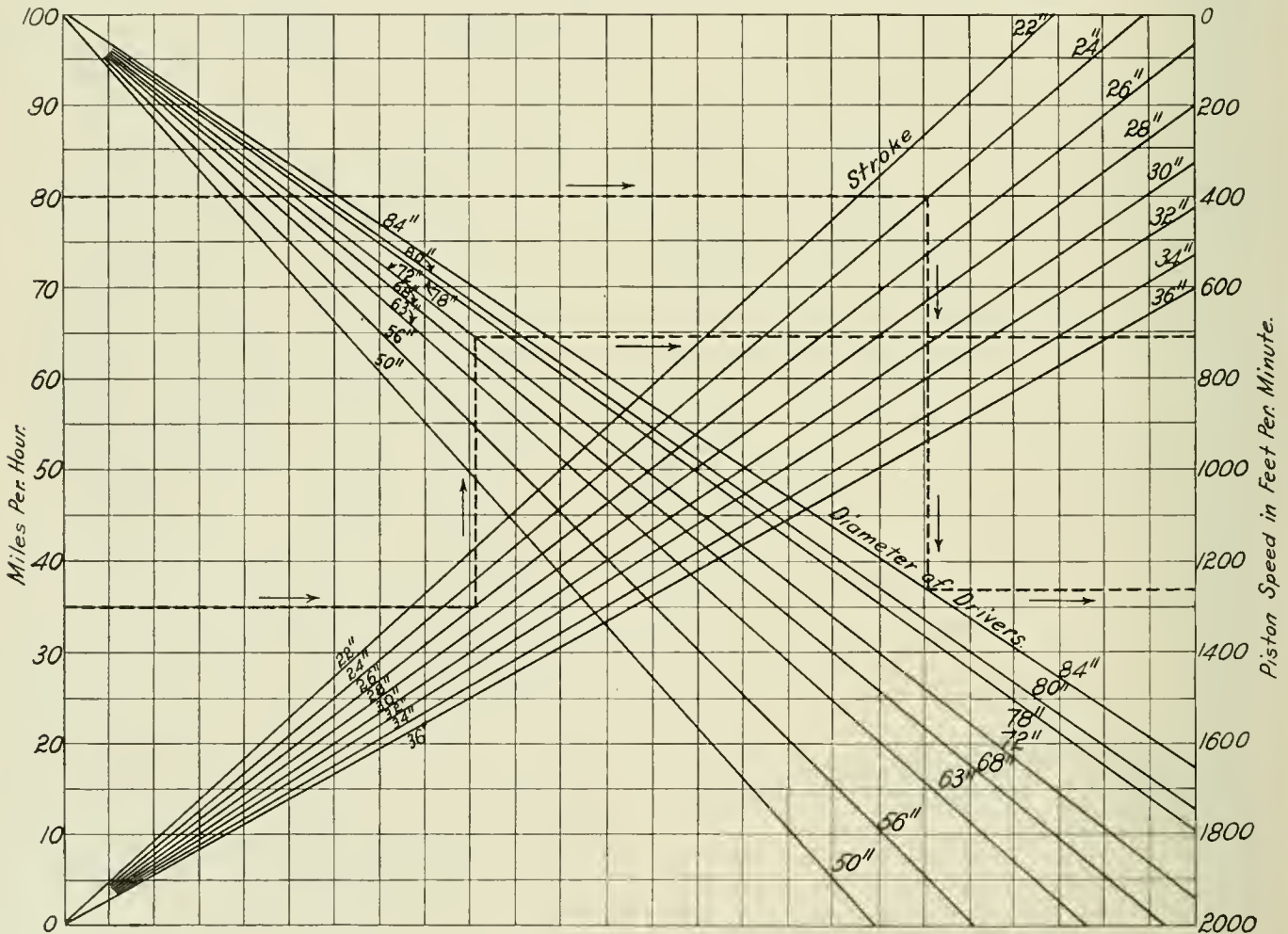

Diagram for Obtaining Piston Speeds for Any Given Rate of Travel When the Stroke and Diameter of Drivers Are Known.

The complete time for repairing the piston head and cross-head, including removal and application to the locomotive is thus seen to take 1,490 minutes, divided as follows:

| | |
|--|-------------------|
| Repairing crosshead | 386 min. |
| Making new piston rod complete..... | 479 min. |
| Making new piston head, complete..... | 482 min. |
| Making and applying two packing rings..... | 22 min. |
| Applying to locomotive..... | 121 min. |
| Total | 1,490 min. |

MOTOR OMNIBUSES FOR LONDON.—In order to meet the enormous increase of traffic in London, the Metropolitan Electric Tramways Company has ordered 300 motor omnibuses which have double decks.

strokes from 22 in. to 36 in. and driving wheel diameters from 50 in. to 84 in. In using the diagram, it is entered from the left hand side on the scale of train speeds and the horizontal line is followed until the stroke desired is reached. A vertical line is then followed to the intersection of the proper diameter of drivers and then horizontally to the scale on the right hand side where the resulting piston speed can be found. Two examples, one at 80 miles per hour, 24 in. stroke and 84 in. drivers, and the other at 35 miles per hour, 26 in. stroke and 72 in. drivers are shown by the dotted lines.

It is also possible to use the diagram for obtaining any of the four variables when the other three are known.

* Consulting Engineer, 105 West Fortieth Street, New York.

LARGE MIKADOS FOR THE ROCK ISLAND

A 45 Per Cent. Increase in Tonnage With the Same Fuel Consumption as Compared With Consolidations.

Fifty locomotives of the 2-8-2 type have recently been put in service on the Chicago, Rock Island & Pacific, and are proving most satisfactory from the standpoint of economy, in one case hauling trains of 45 per cent. greater tonnage than the consolidations previously in use, with approximately the same fuel consumption. Forty of these locomotives were built by the Baldwin Locomotive Works and ten by the American Locomotive Company. The accompanying photograph shows the

These locomotives are now operating on the Iowa, Missouri, Kansas and El Paso divisions. On the last division between Herington and Pratt, Kans., a distance of 126 miles with numerous grades of 42 ft. to the mile, the Mikados are handling trains of 2,400 tons and burn about 10 tons of coal. Consolidation locomotives having 23 in. x 30 in. cylinders, 185 lbs. of steam, and a tractive effort of 39,612 lbs., which had previously been in service at this point, hauled trains of 1,650 tons and

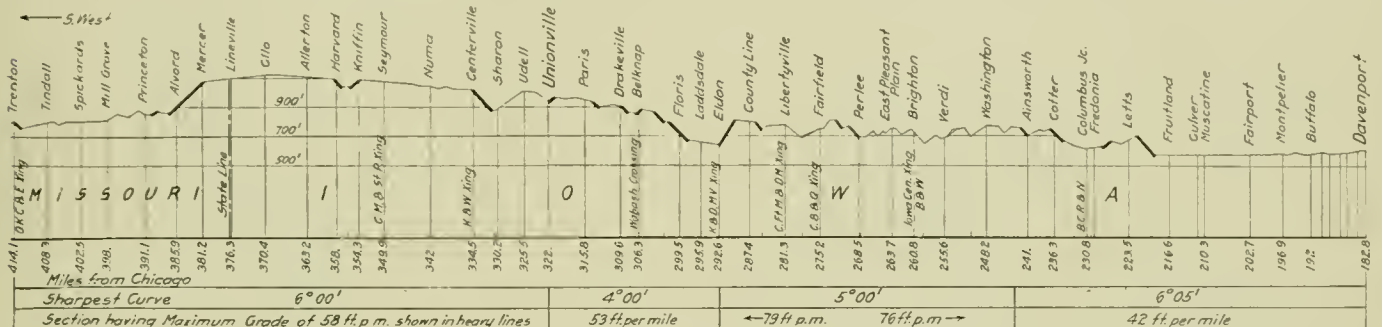

Profile of the Rock Island Between Davenport, Iowa, and Trenton, Mo., Where the 2-8-2 Type Locomotives Are in Service.

Baldwin engines and the drawings are for those built by the American Locomotive Company. There is practically no difference in the two designs except in the boiler, where the Baldwin engines have four more 2¼ in. tubes. This and the difference in details effect the weights as shown below.

In general the design is similar to the engines built for the Erie about a year ago.* There are two important differences in the design, however, one being the length of the stroke, which is 30 in. on the Rock Island and 32 in. on the Erie, and the other the smaller grate area of 63 ft. on the Rock Island

burned the same amount of coal. The consolidation locomotives are not equipped with superheaters and have 336 2 in. flues, 15 ft. 6 in. long, giving a heating surface of 2,710 sq. ft., a grate area of 50.2 sq. ft., firebox heating surface of 168 sq. ft., and a total weight of 213,000 lbs.

On the Missouri division, where the largest number of Mikados are now in service, they handle trains of 1,780 adjusted tons from Silvis (Davenport) to Eldon, Ia., and from Eldon, Ia., to Trenton, Mo., about 121 miles, they handle 2,200 adjusted tons. In the same two districts consolidations handle

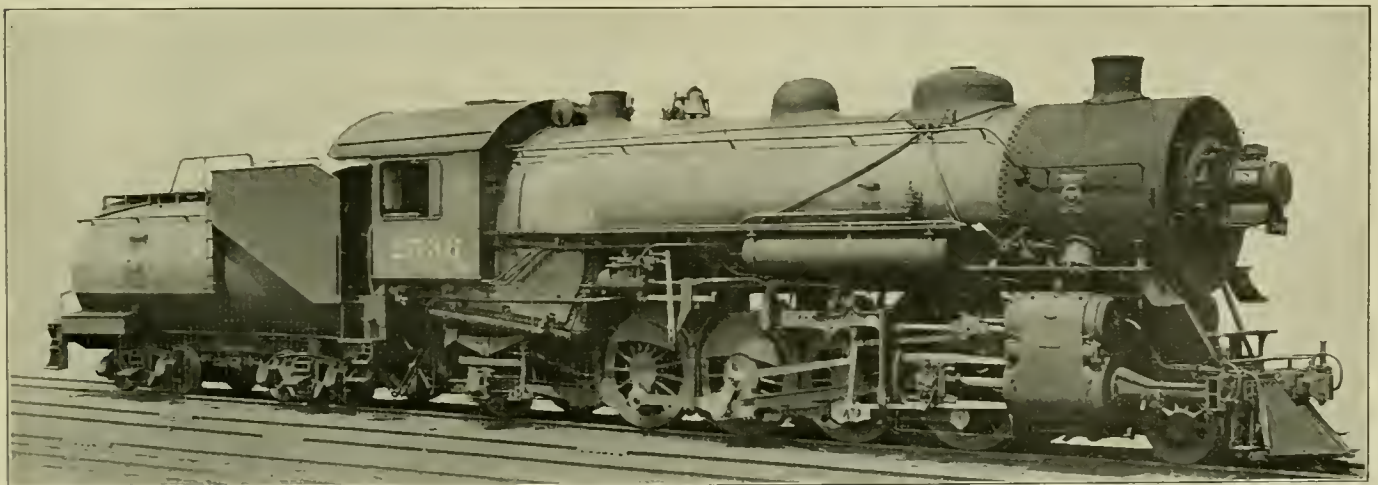

Typical Modern Freight Locomotive of the 2-8-2 Type; Rock Island Lines.

as compared with 70 ft. on the Erie. The steam pressure on the Rock Island engine is 180 lbs., which offsets the shorter stroke and gives these locomotives practically the same tractive effort as the Erie design. The smaller grate area was specified on the basis of the experience with the Erie engines. Both designs have superheaters and brick arches, the latter being supported on four 3 in. water tubes.

1,250 and 1,550 adjusted tons. Eastbound, the tonnage for the Mikados is 2,100 adjusted tons from Trenton to Eldon and 1,620 adjusted tons from Eldon to Silvis; for the consolidations it is 1,480 and 1,140 adjusted tons, respectively. The car factor of this territory is 6. The grades and curvature of these two districts are shown in the illustrations. A study of the design shows that while there have been incorporated all of the improvements which have proved successful in service, nothing

*See American Engineer, February, 1912, page 87.

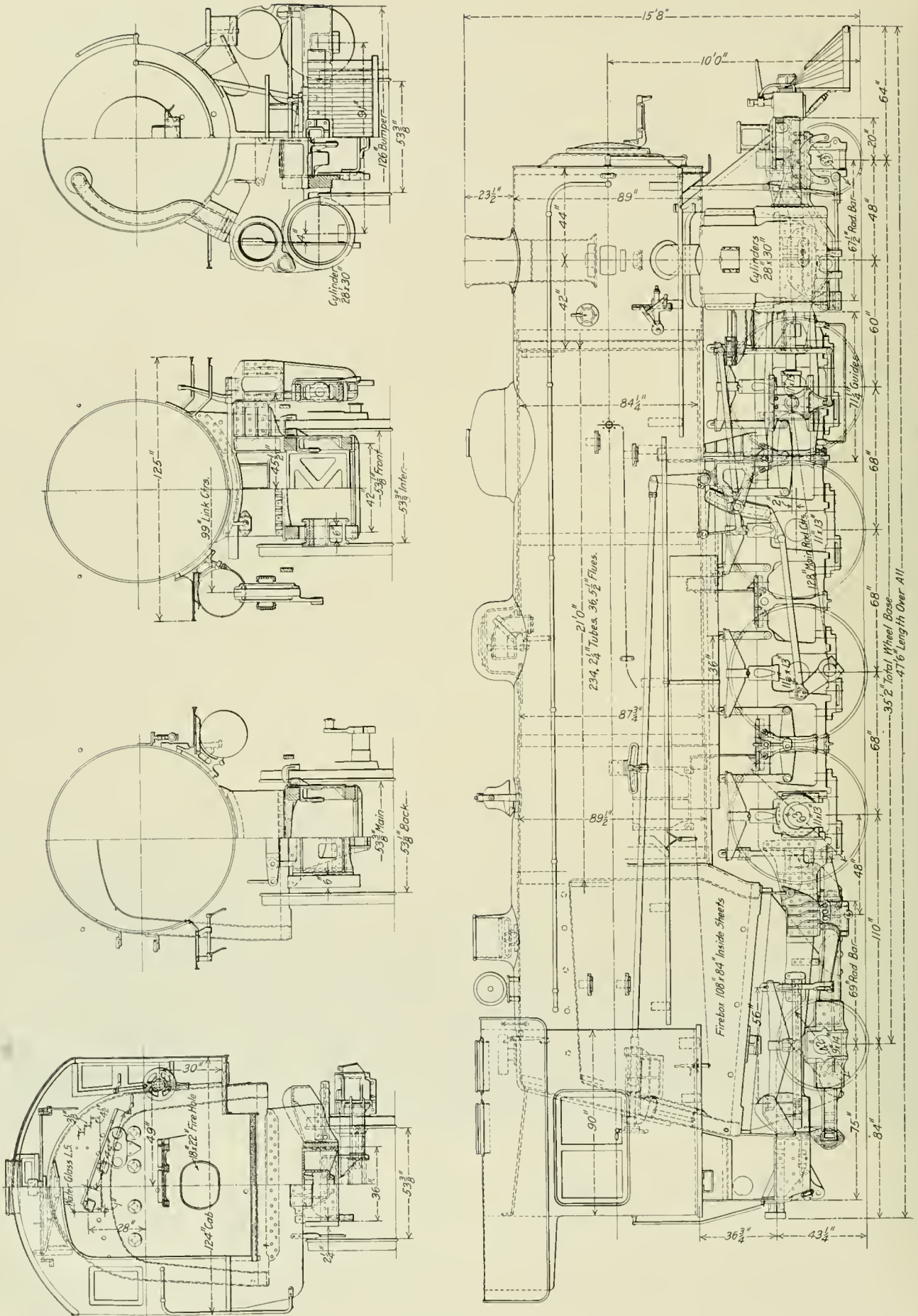

Locomotives of the 2-8-2 Type as Built for the Rock Island by the American Locomotive Company.

unusual was specified. The boiler is of the straight top type and measures 86 in. at the front end, and the firebox is as deep and has as large a volume as it is possible to arrange. The mud ring at the throat sheet is 25¼ in. below the bottom of the barrel, which gives ample room for the installation of the brick arch tubes. The total depth of the firebox at the front

Outside steam pipes, which are now being almost universally used on new superheater locomotives, are included in this design. The steam distribution is controlled by 16-in. piston valves and the Baker valve gear on the Baldwin engines. Walschaert valve gear is used on those built by the American Locomotive Company. The cylinders are bushed, and are fitted with vacuum

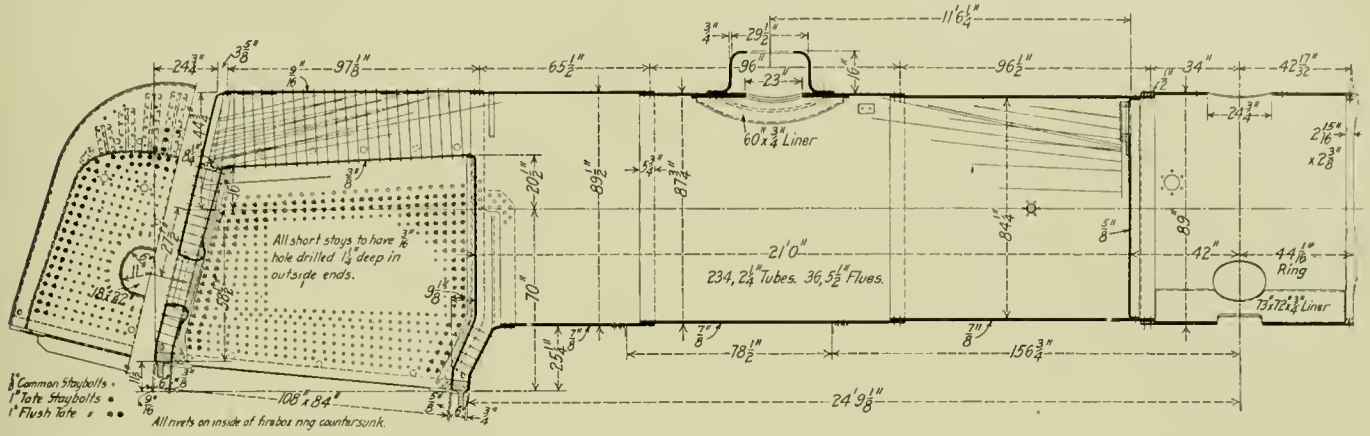

Boiler of 2-8-2 Type Locomotives for the Rock Island.

end is 90 in. The 2¼ in. boiler tubes are spaced with 7/8-in. bridges, and the 36 superheater flues are arranged in four horizontal rows in the upper part of the boiler. The dome is set well forward, being on the middle course, and is of steel plate, flanged from one piece. Flexible staybolts to the number of 550 are used in the firebox. The crown and side sheets are all in one piece, as is also the outside wrapper sheet.

relief valves, as well as drifting valves. The piston rod is extended through the front cylinder head, and its crosshead is carried by a self-centering guide. The Ragonnet power reverse gear, operated by compressed air, has been applied to the forty built by Baldwins. The other ten have a screw reverse gear arranged as is shown in the elevation drawing.

The tender is of the Vanderbilt type, and carries 9,000 gal. of water and 16 tons of coal. The frames have plate steel end

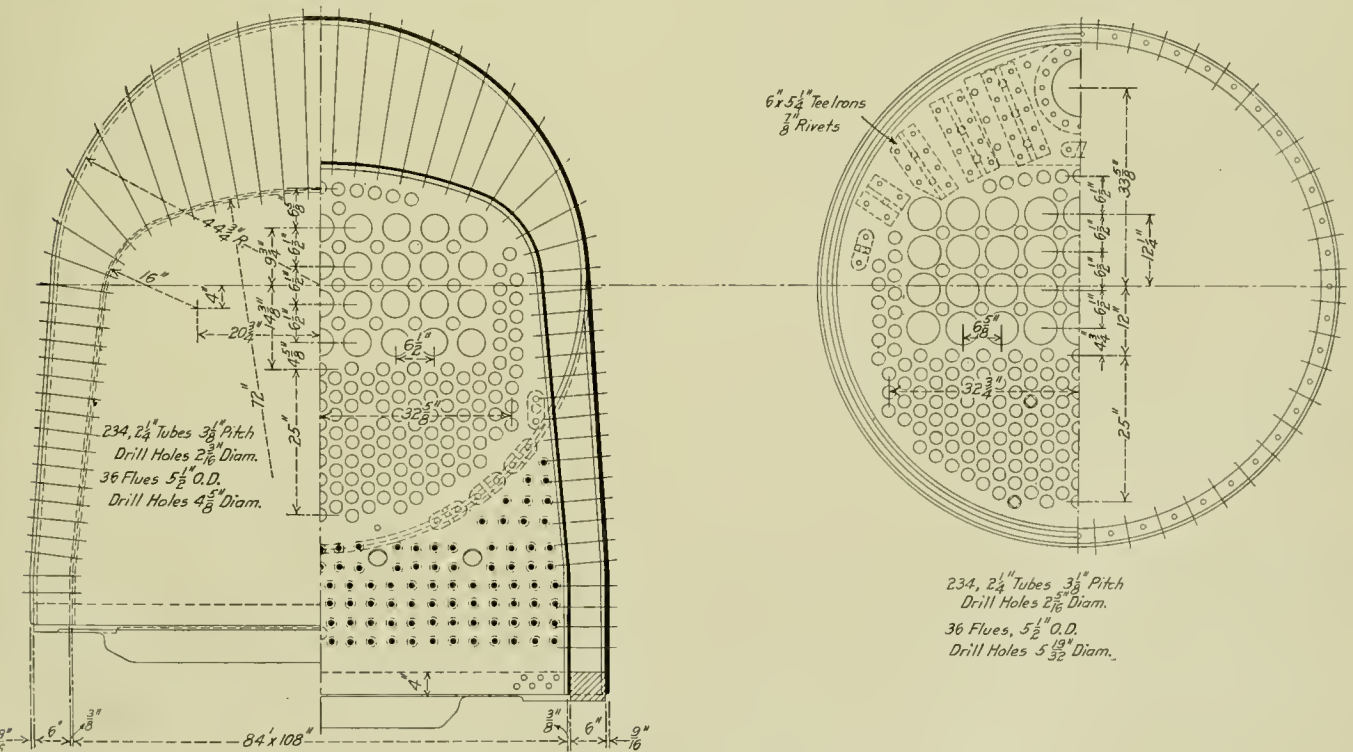

Sections of the Firebox and Boiler of the Rock Island Mikados.

a width of 6 in., and a depth of 7 in. over the pedestals. The front rails are single and are cast as an extension of the main frames. They measure 6 in. in width and are 11 in. deep at the connection of the cylinders. As a further source of strength there is a rib on the bottom of the frame 2 in. in width and 4 in. deep, extending the length of the cylinders.

sills, and the trucks have cast steel side frames and bolsters. The general dimensions, weights and ratios of the Baldwin locomotives are given in the table below. The others differ slightly in respect to weights and heating surface. They have 238,000 lbs. on drivers, 52,500 lbs. on trailer truck and 29,500 lbs. on engine truck. This gives a total weight of 320,000 lbs.

There are 234 2 1/4 in. tubes and the total heating surface is 4,215 sq. ft., of which 252 sq. ft. is in the firebox.

General Data.

| | |
|--|------------------|
| Gage | 4 ft. 8 1/2 in. |
| Service | Freight |
| Fuel | Bit. coal |
| Traction effort | 57,100 lbs. |
| Weight in working order | 348,850 lbs. |
| Weight on drivers | 243,200 lbs. |
| Weight on leading truck | 25,500 lbs. |
| Weight on trailing truck | 50,150 lbs. |
| Weight of engine and tender in working order | 480,000 lbs. |
| Wheel base, driving | 17 ft. |
| Wheel base, total | 35 ft. 2 in. |
| Wheel base, engine and tender | 67 ft. 2 1/2 in. |

Ratios.

| | |
|--|--------|
| Weight on drivers ÷ traction effort | 4.26 |
| Total weight ÷ traction effort | 5.58 |
| Traction effort × diam. drivers ÷ equiv. heating surface* | 640.00 |
| Total equiv. heating surface* ÷ grate area | 89.10 |
| Firebox heating surface ÷ total equiv. heating surface*, per cent. | 4.60 |
| Weight on drivers ÷ total equiv. heating surface* | 43.20 |
| Total weight ÷ total equiv. heating surface* | 56.40 |
| Volume both cylinders, cu. ft. | 21.40 |
| Total equiv. heating surface* ÷ vol. cylinders | 263.00 |
| Grate area ÷ vol. cylinders | 2.94 |

Cylinders.

| | |
|---------------------|-----------------|
| Kind | Simple |
| Diameter and stroke | 28 in. x 30 in. |

Valves.

| | |
|-----------------|------------|
| Kind | Piston |
| Diameter | 16 in. |
| Greatest travel | 6 in. |
| Outside lap | 1 1/16 in. |

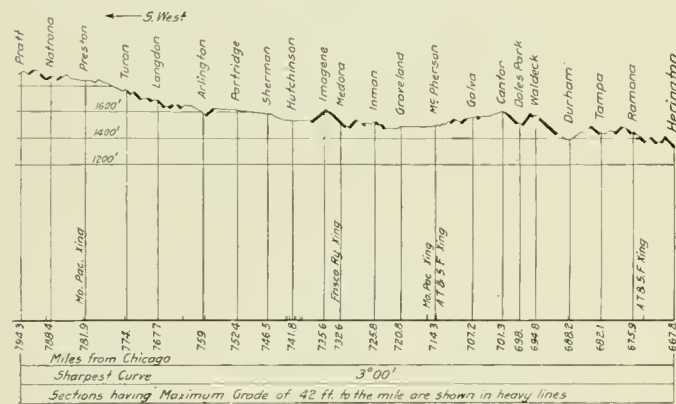

Profile of Part of the El Paso Division of the Rock Island.

| | |
|--------------------|----------|
| Inside clearance | 1/16 in. |
| Lead | 3/4 in. |
| Type of valve gear | Baker |

Wheels.

| | |
|---|---------------------|
| Driving, diameter over tires | 63 in. |
| Driving, thickness of tires | 3 1/2 in. |
| Driving journals, main, diameter and length | 11 1/2 in. x 13 in. |
| Driving journals, others, diameter and length | 11 in. x 13 in. |
| Engine truck wheels, diameter | 33 in. |
| Engine truck journals | 12 in. |
| Trailing truck wheels, diameter | 42 in. |
| Trailing truck journals | 14 in. |

Boiler.

| | |
|------------------------------------|------------------------|
| Style | Straight |
| Working pressure | 180 lbs. |
| Outside diameter of first ring | 86 in. |
| Firebox, length and width | 108 in. x 84 in. |
| Firebox plates, thickness | 3/8 in. and 5/8 in. |
| Firebox, water space | 6 in. |
| Tubes, number and outside diameter | 238—2 1/2 in. |
| Flues, number and outside diameter | 36—5 1/2 in. |
| Tubes, thickness and material | No. 10, B. W. G., Iron |
| Flues, thickness and material | No. 9, B. W. G., Steel |
| Tubes, length | 21 ft. |
| Heating surface, tubes | 4,004 sq. ft. |
| Heating surface, firebox | 260 sq. ft. |
| Heating surface, total | 4,264 sq. ft. |
| Superheater heating surface | 848 sq. ft. |
| Grate area | 63 sq. ft. |
| Center of boiler above rail | 120 in. |

Tender.

| | |
|-------------------------------|----------------|
| Type | Vanderbilt |
| Wheels, diameter | 33 in. |
| Journals, diameter and length | 6 in. x 11 in. |
| Water capacity | 9,000 gals. |
| Coal capacity | 16 tons |

*Equivalent heating surface equals 4,264 + (1.5 × 848) = 5,536 sq. ft.

THE VAUCLAIN DRILL*

BY A. C. VAUCLAIN and H. V. WILLE.

Speaking generally, there can be no better definition of economical drilling than "rapid drilling"—the saving of time. The fact that a drill will cut at some phenomenal speed, or will consume such and such an amount of power means nothing so far as productive capacity is concerned. The object in view is the removal of chips.

The productive possibilities of any metal-cutting tool are limited by its stress and heat resisting capacities. The temperature at which it will continue to operate successfully depends on the

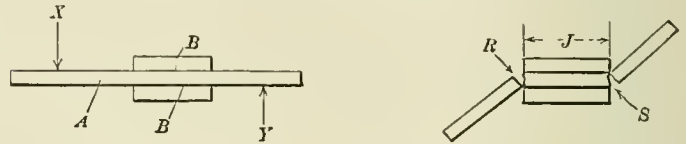

Splitting Action Illustrated by Means of a Wire In a Vise.

excellence of material and manufacture, but the rapidity of heat generation and the stresses set up in the tool depend on the design of the tool and the selection of feeds and speeds.

With a given excellence of material and manufacture, the strength of the tool must depend on the extent and disposition of the section. The size of the drill is necessarily limited by the size of the hole to be drilled. The section of the drill has a lesser area than that of the hole, since space must be provided for the discharge of chips from the hole. The design of the drill should therefore be that which will give it the maximum of strength and strength conservation.

Cutting stress is practically independent of the cutting speed,

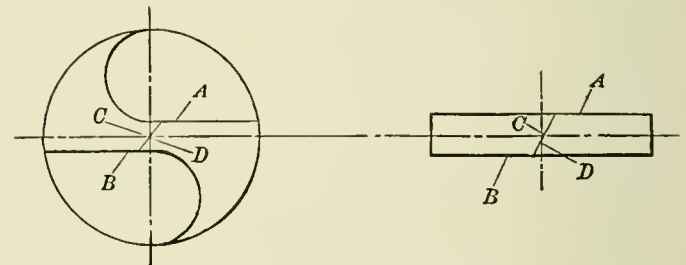

Construction of the Commonly Used Types of Twist and Flat Drills.

and, with a given feed, is proportional to the lip angle of the cutting edge. The cutting stress does not increase as rapidly as the feed. The rapidity with which cutting heat is generated depends on the cutting speed, the depth of feed and the lip angle of the cutting edge.

Since both the stress and heat are influenced by the keenness of the cutting edge, it is desirable that the lip angle be as small as possible. But it must be blunt enough to carry off the heat and to support the chip pressure, which falls more or less back of the actual cutting edge, according to the depth of feed. Since

*To be presented before the American Society of Mechanical Engineers at the December meeting. Published in the October issue of its Proceedings.

the chip is torn, not cut from the work, rupture between work and chip precedes the actual cutting edge. The heavier the feed, the farther back from the cutting edge will its pressure fall on the tool.

Under ideal conditions, the torsional capacity of the drill should be its limit of cutting strength. This does not obtain in the present commonly used types of drill, and they break down very considerably below their torsional strength. Why this is so will be explained later in detail.

The feed remaining constant, the horse power consumption will

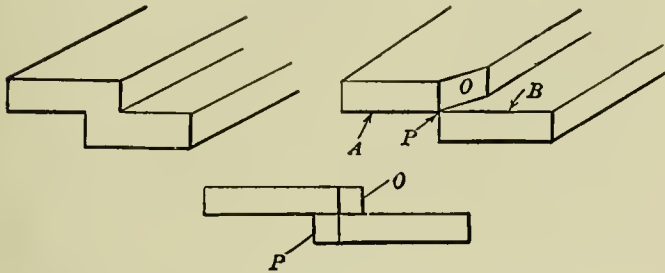

Diagrammatic Illustration of the Principle of Design of the Vauclain Drill.

be proportional to the speed. This is true both of the power consumed by the machine and that consumed in cutting. The speed remaining constant, the power consumed in cutting does not increase as rapidly as the feed and the power consumed by the machine remains constant for all feeds.

From this, it will be seen that the most economical method of chip production is by giving preference to the feeds rather than the speeds. Power, time and drills will be saved thereby.

The section scheme of drills now commonly used is shown in one of the illustrations. While there are many modifications of

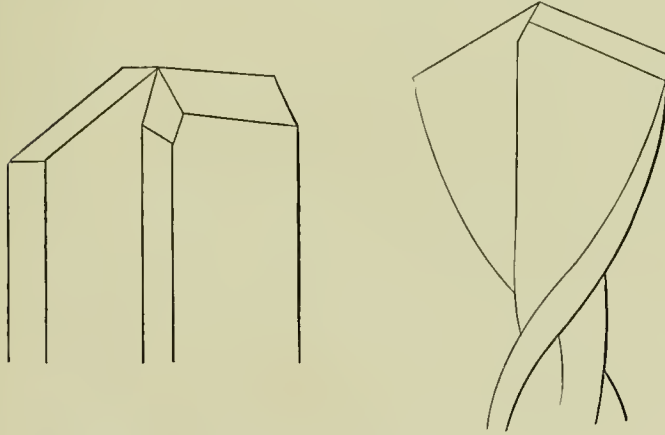

Bar Ground to Form a Drill and then Twisted.

these, they suffice to illustrate the common characteristic, which is that the cutting edges *A* and *B* pass to one side of the axis of motion of the drill instead of through the axis. In this respect there is no difference between the flat and twist drills. It will be seen that in this scheme the drill has four distinct edges, *A*, *B*, *C* and *D*, and that the usual name given to it of "two-lip" drill is not correctly applied.

It is customary for the included angle *E* to be of 118 deg., and the cutting edges *C* and *D* therefore have an unfavorable lip angle. These edges constitute what is commonly called the chisel point, and their cutting resistance is very great. The cutting edges *A* and *B* cut more freely than the cutting edges *C* and *D* and a tendency to longitudinal fracture of the drill is set up thereby. This is the cause of the splitting of drills. In explanation of this splitting tendency, one of the illustrations represents a section of brittle wire *A* held in vise jaws *B*. If sufficient pressure is applied, as indicated by the arrows *X* and

Y, the wire will break at *R* and *S*, due to the resistance of the vise and to the forces *X* and *Y* tending to revolve it about its axis.

Those portions of the wire not within the vise jaws represent, in the drill, the cutting edges *A* and *B*, and are free cutting, due to their favorable lip angle. That portion of the wire held within the jaws represents the cutting edges *C* and *D*, or the chisel point, imbedded in the work and having to overcome a high cutting resistance due to the unfavorable cutting lip angle of these edges. Under very heavy feeds, these two edges tend to stand still, while edges *A* and *B* continue to cut, with the result that the drill is fractured in a manner similar to the breaking of the wire. In the drill the width of the vise jaws becomes in-

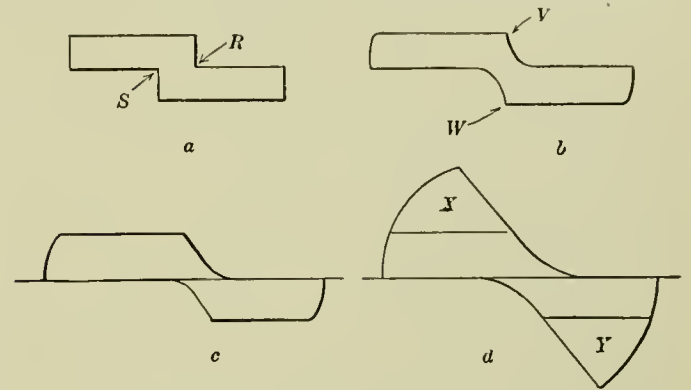

Successive Sections Showing the Development of the Vauclain Drill.

finitesimal and the fractures *R* and *S* coincide and constitute the longitudinal splitting of the drill.

In the commonly used types of drills there are but two methods of reducing the chisel point, viz.: by thinning the drill at its center, or by pointing. By the former method the resistance to longitudinal splitting becomes lowered, and by the latter method the cutting edges lose their support at and near the center of the drill.

By the foregoing it will be seen that the feed possibilities of the ordinary types of drills are not very great. Either the drill

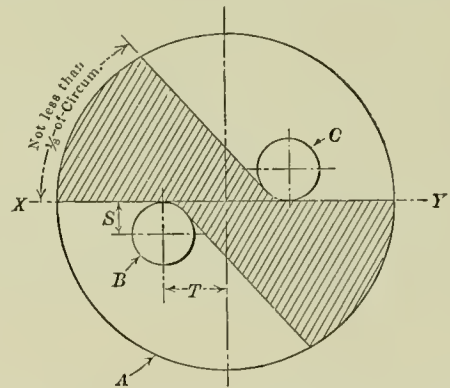

Circle *A*=circumference of drill. Diameter of circles *B* and *C*= $\frac{3}{16}$ diameter of drill. $S=\frac{3}{32}$ of diameter of drill. $T=\frac{3}{16}$ of diameter of drill. *XY*=indicates cutting edges.

Diagram Showing the Exact Shape of the Vauclain Drill.

will split or its cutting edges will break under heavy feeds, long before its torsional capacity is reached.

The Vauclain drill is a "heavy feed" drill adapted to the most economical method of metal cutting and of great strength, due to its design. In order better to describe the drill, the section scheme will first be explained diagrammatically and the development of the actual section will then be illustrated. The first view shows a bar comprising two flat bars overlapping and integrally connected, as indicated. By beveling, as shown at *O* and *P*, in the next view, the edges *A* and *B* are made to

TABLE I—COMPARISONS OF STRENGTH OF VAUCLAIN AND ORDINARY TYPES OF DRILLS.

| Test | Kind of Drill | Feed per Rev. | Speed R.p.m. | Inches per Min. | Holes Drilled | Total Inches Drilled | Compare to Test | Condition of Drill After Test | See Note |
|------|---------------|---------------|--------------|-----------------|---------------|----------------------|-----------------|-------------------------------|----------|
| 1 | Regular | 0.009 | 300 | 2.70 | 1 | 3.875 | 6 | O. K. | A |
| 2 | Regular | 0.0145 | 300 | 4.35 | 1 | 3.875 | 7 | O. K. | |
| 3 | Regular | 0.020 | 300 | 6.00 | 1 | 3.875 | 8 | O. K. | |
| 4 | Regular | 0.030 | 300 | 9.00 | 1 | 3.875 | 9 | O. K. | |
| 5 | Regular | 0.050 | 300 | 15.00 | 0 | 0. — | 10 | Broke—see note | |
| 6 | Vauclain | 0.009 | 300 | 2.70 | 1 | 3.875 | 1 | O. K. | B |
| 7 | Vauclain | 0.0145 | 300 | 4.35 | 1 | 3.875 | 2 | O. K. | |
| 8 | Vauclain | 0.020 | 300 | 6.00 | 1 | 3.875 | 3 | O. K. | |
| 9 | Vauclain | 0.030 | 300 | 9.00 | 1 | 3.875 | 4 | O. K. | |
| 10 | Vauclain | 0.050 | 300 | 15.00 | 1 | 3.875 | 5 | O. K.—see note | |
| 11 | Regular | 0.009 | 170 | 1.53 | 1 | 3.875 | 16 | O. K. | C |
| 12 | Regular | 0.0145 | 170 | 2.465 | 1 | 3.875 | 17 | O. K. | |
| 13 | Regular | 0.020 | 170 | 3.40 | 1 | 3.875 | 18 | O. K. | |
| 14 | Regular | 0.030 | 170 | 5.10 | 1 | 3.875 | 19 | O. K. | |
| 15 | Regular | 0.050 | 170 | 8.50 | see note | 1.000 | 20 note | Broke—see note | |
| 16 | Vauclain | 0.009 | 170 | 1.53 | 1 | 3.875 | 11 | O. K. | D |
| 17 | Vauclain | 0.0145 | 170 | 2.465 | 1 | 3.875 | 12 | O. K. | |
| 18 | Vauclain | 0.020 | 170 | 3.40 | 1 | 3.875 | 13 | O. K. | |
| 19 | Vauclain | 0.030 | 170 | 5.10 | 1 | 3.875 | 14 | O. K. | |
| 20 | Vauclain | 0.050 | 170 | 8.50 | 1 | 3.875 | 15 | O. K.—see note | |
| 21 | Regular | 0.009 | 170 | 1.53 | 1 | 3.875 | 26 | O. K. | E |
| 22 | Regular | 0.0145 | 170 | 2.465 | 1 | 3.875 | 27 | O. K. | |
| 23 | Regular | 0.020 | 170 | 3.40 | 1 | 3.875 | 28 | O. K. | |
| 24 | Regular | 0.030 | 170 | 5.10 | 1 | 3.875 | 29 | Broke emerging | |
| 25 | Regular | 0.050 | 170 | 8.50 | ... | ... | 30-31-32 | | |
| 26 | Vauclain | 0.009 | 170 | 1.53 | 1 | ... | 21 | O. K. | F |
| 27 | Vauclain | 0.0145 | 170 | 2.465 | 1 | ... | 22 | O. K. | |
| 28 | Vauclain | 0.020 | 170 | 3.40 | 1 | ... | 23 | O. K. | |
| 29 | Vauclain | 0.030 | 170 | 5.10 | 1 | see note | 24 | O. K. | |
| 30 | Vauclain | 0.050 | 170 | 8.50 | 1 | ... | 25 | O. K. | |
| 31 | Vauclain | 0.050 | 208 | 10.40 | 1 | ... | 25 | O. K. | |
| 32 | Vauclain | 0.050 | 245 | 12.25 | see note | 1.000 | 25 | Broke—see note | |

A. Drill broke after point had penetrated to 1/4 in. diameter, broke into many pieces; split. Torque is practically proportional to the square of the diameter, hence, since A broke when point had penetrated to only 1/8 in. diameter, B showed 170 per cent the strength of A.
 B. Drill was permitted to emerge from work without knocking out feed; a slight crack in one cutting edge developed after drilling at rate of 15 in. per min. and emerging.
 C. Drill broke into many pieces after penetrating 1 in. in last hole. Drilling at rate of 8.50 in. per min. split.
 D. Since no heavier feeds were obtainable in the machine this drill was afterward run at 208 r.p.m. and 0.050 feed and broke only when emerging from bottom of hole; drilling at rate of 10.40 in. per min. and emerging. Taking into consideration that D emerged and C did not, the difference in strength is much greater than that indicated by the difference in inches per minute.
 F. In order to get an actual comparison with C which broke at 1 inch penetration, this drill was not allowed to emerge from the work. It broke drilling at rate of 12.25 in. per min.; after penetrating 1 in. Drill broke torsionally and did not split.

TABLE II ENDURANCE TESTS OF VAUCLAIN AND ORDINARY TYPES OF DRILLS.

| Test | Kind of Drill | Feed per Rev. | Speed R.p.m. | Inches per Min. | Holes Drilled | Total Inches Drilled | Compare to Test | Condition of Drill After Test | See Note |
|------|---------------|---------------|--------------|-----------------|---------------|----------------------|-----------------|-------------------------------|----------|
| 33 | Regular | 0.009 | 300 | 2.70 | 42 | 162.75 | 34 | Cutting edges worn | A |
| 34 | Vauclain | 0.020 | 208 | 4.16 | 42 | 162.75 | 33 | Cutting edges worn | |
| 35 | Regular | 0.020 | 300 | 6.00 | 21 | 81.37 | 36 | Cutting edges burned | B |
| 36 | Vauclain | 0.030 | 208 | 6.24 | 21 | 81.37 | 35 | Cutting edges O.K. | |
| 37 | Regular | 0.020 | 300 | 6.00 | 6 | 23.25 | 38-39 | Badly burned | |
| 38 | Vauclain | 0.030 | 208 | 6.24 | 26 | 105.75 | 37 | Cutting edges O.K. | C |
| 39 | Vauclain | 0.030 | 208 | 6.24 | 35 | 135.12 | 37 | See note | |
| 40 | Vauclain | 0.0145 | 208 | 3.02 | 20 | ... | 41 | O. K. | D |
| 41 | Regular | 0.009 | 208 | 1.87 | 20 | ... | 40 | O. K. | |
| 42 | Regular | 0.009 | 300 | 2.70 | 11 | ... | 43 | O. K. | |
| 43 | Vauclain | 0.0145 | 245 | 3.55 | 11 | ... | 42 | O. K. | |
| 44 | Regular | 0.009 | 300 | 2.70 | 10 | ... | 45 | O. K. | |
| 45 | Vauclain | 0.0145 | 245 | 3.55 | 10 | ... | 44 | O. K. | |
| 46 | Vauclain | 0.020 | 245 | 4.90 | 5 | ... | 47 | O. K. | |
| 47 | Regular | 0.0145 | 245 | 3.55 | 5 | ... | 46 | O. K. | |
| 48 | Regular | 0.0145 | 300 | 4.35 | 10 | ... | 49-52 | O. K. | E |
| 49 | Vauclain | 0.020 | 300 | 6.00 | 10 | ... | 48 | O. K. | |
| 50 | Regular | 0.020 | 300 | 6.00 | 25 | ... | 51 | Burned corners | B |
| 51 | Vauclain | 0.020 | 300 | 6.00 | 39 | ... | 50 | Burned corners | |
| 52 | Vauclain | 0.020 | 300 | 6.00 | 10 | ... | 48 | O. K. | |

A Cutting edges of Vauclain drill less worn than regular drill.
 B Chisel point also burned.
 C Broke in 26th hole by running into another hole.
 D Spindle of machine ran hot, causing "jumping" of speed, and cutting edges; broken by resulting shocks. Drill at one period stood still, but did not fracture except at cutting edges.
 E Point O. K.

meet at the axis of the bar. Since these beveled surfaces are at an angle with the axis the integral connection between the two flat bars remains unbroken.

The next two views indicate how the end of the bar would appear when ground to form a drill and how it would appear if twisted. Following this the first of the four end views gives the section of the bar in its original form. Introducing fillets at R and S gives the form shown in b and removing the corners W and V modifies it as in c. In d, by adding areas X and Y to the section, its torsional value is increased and the exact section profile of the drill is shown in the following illustration.

Tests have been made for the purpose of comparing the or-

TABLE III—COMPARATIVE TESTS OF ORDINARY AND VAUCLAIN DRILLS.

| Test | Kind | Feed per Rev. | Speed, R.P.M. | In. per Min. | H.P. Expended | Per Cent Saving |
|------|----------|---------------|---------------|--------------|---------------|-----------------|
| 53 | Regular | 0.00599 | 300 | 1.797 | 10.86 | ... |
| 54 | Regular | 0.02 | 87 | 1.74 | 10.30 | ... |
| 55 | Vauclain | 0.02 | 87 | 1.74 | 5.03 | 51.2 |
| 56 | Vauclain | 0.00599 | 300 | 1.797 | 4.73 | 56.4 |

dinary and the Vauclain types of drills. In order to secure uniform conditions care was taken that the different drills tested should be alike in quality of drill steel, heat treatment and tempering. The material drilled was a tough forging grade of steel of about 0.45 carbon. Tables 1, 2 and 3 show the horse power saved by giving the preference to the feeds, also the relative strength and endurance of the ordinary and the Vauclain types of drills. The size of drill used in all tests was 1 9/64 in. By examination of these diagrams it will be seen that the chisel point is eliminated without central thinning of the drill and without weakening the cutting edges.

STEEL GUIDES.—J. J. Conolly, superintendent of motive power of the Duluth, South Shore & Atlantic, had a number of eight-wheel locomotives, fitted with the ordinary form of four-bar guides, made of wrought iron, case hardened, that gave a great deal of trouble by springing and breaking. This was remedied, and quite inexpensively, by substituting steel. The material was obtained from old driver tires. Before removing the tires from the centers they were turned off, leaving the flange as a rib, and were then cut to the proper width with a cutting-off tool, a ring of metal being cut from the outer face of the tire. This done, the tire was removed and cut to proper lengths, which were then straightened in the blacksmith shop. The wearing surface was then planed smooth and straight, the ends drilled and the guide applied. This not only makes a guide that does not break, but one that is stiffer and wears better than that first applied by the builders.

BACK PRESSURE IN LOCOMOTIVES.—Locomotives have been built and are in service with steam passages of such dimensions or design that the back pressure can never be minimized as much as it should by any front end arrangement. Again, there are valve gears in use which do not permit of sufficient variation in the steam distribution, particularly in the four-cylinder type of compound engine, to properly relieve the back pressure. In my opinion these features should first be corrected; then the drafting arrangements in the front end are a matter of detail or of secondary importance, for it must be clear to all who have given the subject any thought, that where defects exist in either of the features I have just mentioned, very little, if any, benefit can be derived from front end adjustments, for if back pressure is caused by defective steam passages or valve gears it will exist regardless of the degree of refinement that may be obtained in front end adjustments.—W. E. Symons at the Railway Fuel Association Convention.

PROBLEM OF ELECTRIC LOCOMOTIVE DESIGN

A Discussion and Brief Description of the Various
Types Now In Service in This Country and Abroad

BY N. W. STORER,

General Engineer, Westinghouse Electric & Manufacturing Company, East Pittsburgh, Pa.

It has been said that the delivery of transportation is the business of all railways. The source of the power required for this work is one of the, if not the most, important elements that combine to produce this output. For many years the steam locomotive was without a rival. It had a complete monopoly of the business and like some other monopolies it lacked the incentive of competition. Since the electric locomotive entered the field, however, there appears to have been a great awakening among steam locomotive designers which has undoubtedly

to the best advantage, for a large amount of money would have to be spent unnecessarily. The subject should be studied with the greatest care, the best system determined, and electrification adopted where there will be a distinct economic advantage.

PROBLEM OF ELECTRIC LOCOMOTIVE DESIGN.

The manufacturing companies have done a tremendous amount of work in developing the various systems of electrification and the design of electric locomotives. It has been

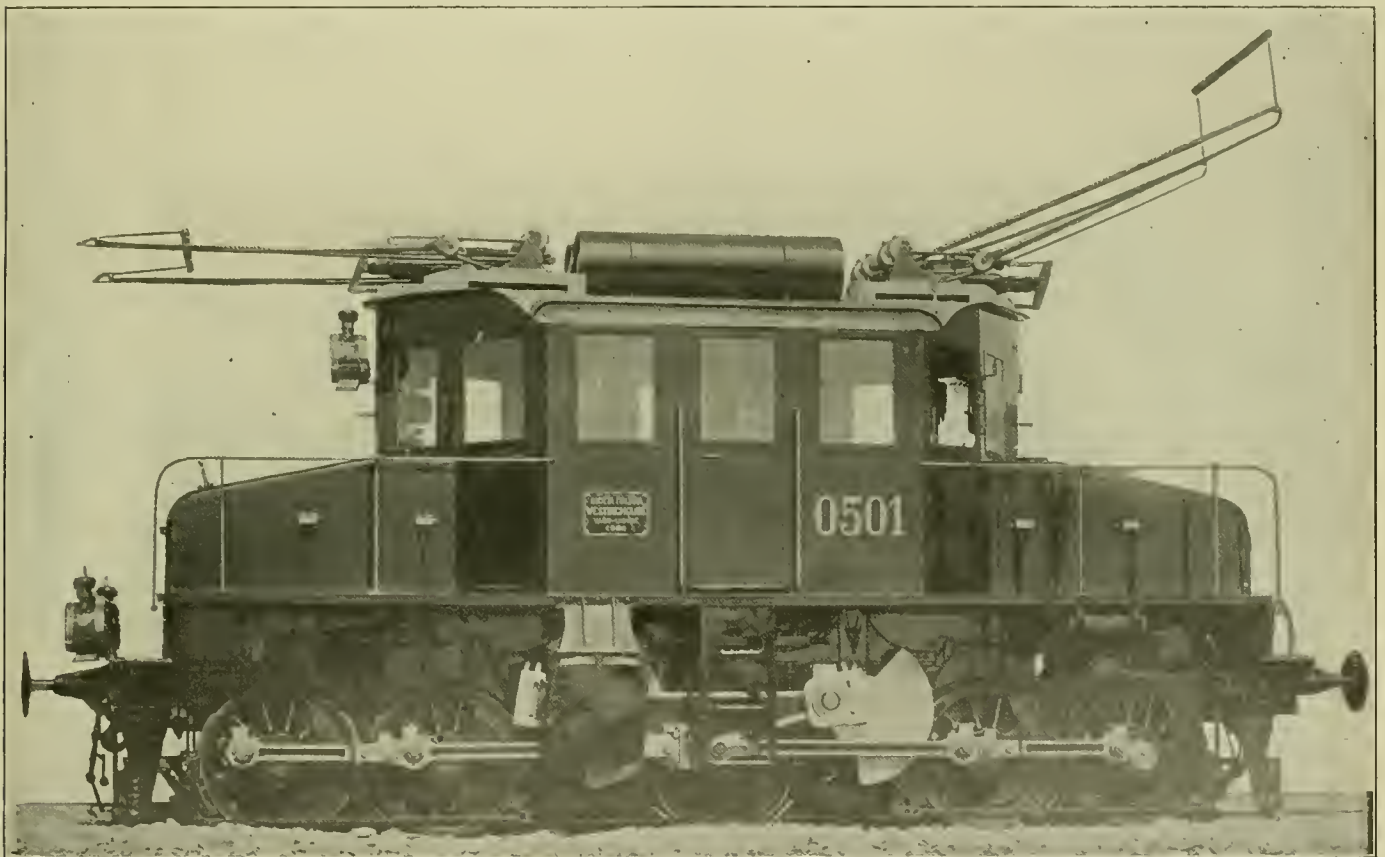

Electric Locomotive with Side Rods and Scotch Yokes.

delayed all electrification of railways and possibly has prevented for many years at least the electrification of most of them. The improvements in the steam locomotive have led to the production of the enormous units that are now standard. These great machines have produced such excellent results that the electric locomotive has no longer such comparative advantages as were apparent even ten years ago, and while I believe that the electrification of a large part of our railways is certain to be accomplished at some time I also believe that the improvement in steam locomotives has removed the crying necessity for it, except in special instances.

The railways should not be pushed into terminal electrification by legislation before they are ready to handle the problem

found especially that the low center of gravity on the electric locomotive of the type which was early proposed, instead of being an advantage, was a decided disadvantage, and it has been recognized for many years that one of the greatest problems, if not the greatest, in the electric locomotive is the transmission of the torque of the motor to the driving wheels. There have been a great many combinations proposed, and quite a large number of different types have been built and are now in operation, but there are very few transmission systems that are absolutely satisfactory from all points of view. In this respect, as in most others, every design is a compromise of the conflicting elements not simply in the locomotive itself, but on the roadbed and in the shop as well.

The necessity for a careful study by the manufacturers of the entire problem of railroading, if the best type of locomotive

* Abstract of a paper presented at the convention of the Association of Railway Electrical Engineers, Chicago, October 24, 1912.

is to be produced, is fully recognized by them. The designers of electric locomotives and the people who are to furnish the apparatus for electrifying railroads must come into closest touch with the operating officers of the roads, who should give them the benefit of their experience. No suggestion can be made that is too small to receive consideration. In the last analysis all must agree that the best locomotive is the one that will deliver the transportation required of it with the lowest sum total of expense. This, of course, not only includes the first cost, and the cost of maintenance and depreciation of the locomotive itself, but the first cost and cost of maintenance, depreciation and operation of the entire installation, as well as the cost of power at the locomotive and the cost of upkeep of the roadbed. It is because there is so little definite and reliable information on all these various subjects that there are so many different opinions concerning the systems of electrification and the proper design of locomotives.

The standard type of single reduction geared street car motor has been eminently satisfactory for street car service, but the difficulties connected with it have increased enormously as speeds and the power of motors have increased, until today it is generally believed to be poor practice to gear locomotives directly to the axle except for slow speed work. Several reasons have contributed to this belief: First, the spur gears are sub-

jected to severe punishment when run at high speeds when rigidly connecting so much inertia in the wheels and the armatures, and to still greater punishment from shocks due to the roadbed. It has also been found that the pinions on the motor pushing downward on the gears are subject to much more severe treatment than when the motor pinion is pushing upward. Second; the dead weight of the motor is on the axle and its low center of gravity will cause serious injury to the track when operating at high speeds. There will also be a heavy side thrust of the wheel flange against the rail on curves and where the locomotive has a tendency to nose. Although steam locomotives have this same nosing tendency they do not injure the track because the mass or center of gravity is so high above it. This same feature should be sought for in the electric locomotive. Chiefly for these reasons the speed of most locomotives having heavy motors geared directly to the axles is limited to about 30 m. p. h. This type of locomotive, however, is comparatively simple and it is cheap and easy to maintain.

on a quill surrounding the axles and connected to it through springs, is open to some of the same objections as the first type. This also has low center of gravity, although it is considerably higher than the first type, but all the weight is spring supported so that the track does not get the direct blow. The original New Haven locomotive nosed quite badly at high speeds, but by the addition of an idle axle at each end of the locomotive and a toothed cam-centering device between the cab and the trucks, this was entirely cured. The cam is arranged so that when the truck moves sidewise it must lift the cab, which tends to throw it back to the central position. The locomotives now have no tendency to nose even at speeds up to 75 and 80 m. p. h., where formerly they nosed badly at 50 and 60 m. p. h. However, even with the motors carried by springs, the track is liable to more or less damage unless it is kept in good condition. Every electric locomotive which goes to the New Haven must have no dead weight on the axles, as it is believed that any dead weight on the axle aside from the wheels and axles themselves is unnecessary and extremely detrimental to the track. Therefore, the motors are mounted on the quill with springs as described.

In the third type the motors are mounted above the axle and drive gears mounted on the quills. This type is used on the latest New Haven electric locomotive,* which has the same

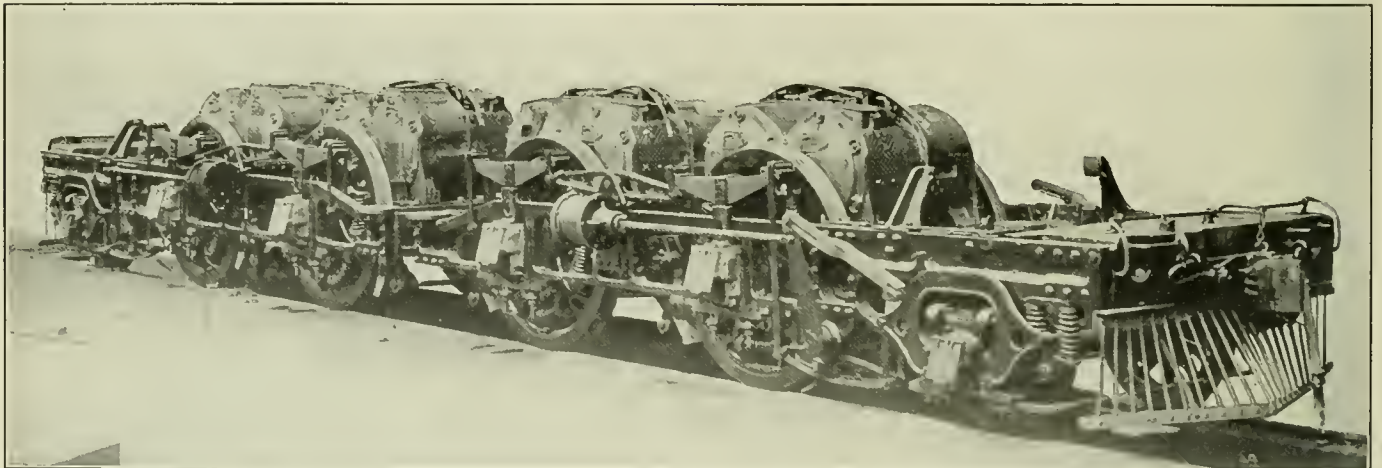

Running Gear of New Haven Electric Locomotive with Four Motors for Each Axle.

TRANSMISSION OF POWER IN ELECTRIC LOCOMOTIVES.

The big question is how to connect the motors with the driving wheels so as to provide a high speed locomotive that will have a reasonable cost of maintenance, and at the same time be a good riding machine; that is, one that will do the least possible damage

*See *American Engineer*, July, 1912, page 363.

wheel arrangement as the original New Haven type. This locomotive has a high center of gravity and the quills are so spaced that they have a total play of 3 in. about the axle, $1\frac{1}{2}$ in. above and below, which allows for imperfections in the track. These engines ride very smoothly. They have been in service on the New Haven and in the Hoosac tunnel on the Boston & Maine, and forty more are now under construction for the New Haven. This type has been built both with a single motor per axle and with twin motors of the same total capacity per axle. After building a number of the former, whose motors were so large as to require double gears, it was found that the same output could be obtained with less weight and less cost by substituting two motors for the one large one. This arrangement is illustrated herewith, and has the following advantages: First, only one gear is required, as both motors drive through the same gear. Second, the two motors are lighter and easier to handle and cheaper to maintain than the large one. There is no more chance for damage in the small motors than there is in the big ones, as they have practically the same number of coils in the motor and the same number of connections and commutator bars and brushes and brush holders as the big motors; and the small motors are much easier to repair and handle. Third, the motors in this case are interchangeable, with the exception of the field castings, with the motors which are used on the New Haven multiple unit motor cars. Fourth, two motors being connected permanently in series gives in effect one motor of double voltage, and consequently half current. This reduces the carrying requirements of cables and switches to one-half, and thus makes a substantial saving in the cost of control equipment. While these locomotives are now built for single phase operation, they would have practically the same advantages on direct current. The twin motor scheme adapts itself well to high voltage d. c. operation.

The fourth type of locomotive, that with the motors mounted high up in the cab and connected to drive wheels through cranks, parallel rods and jack shaft, is the type adopted by the Pennsylvania Railroad† for the New York terminal. They have a very high center of gravity and although the weight on the driving axle is about 56,000 lbs., and consequently requires stiff springs, the locomotive has riding qualities corresponding to the best steam locomotive. There is no tendency to nosing and no bad effects on the track. These locomotives are the most powerful electric locomotives ever built, and have shown themselves to be reliable, having a record for the first year, with 33 locomotives in service, of but 13 train minutes delay chargeable to the locomotives. They have a guaranteed tractive effort of 60,000 lbs. and have actually developed over 75,000 lbs. at the drawbar. This corresponds to a crank pin pressure of over 100,000 lbs. Of course, the normal pressure on crank pins is not nearly so high, but it is sufficient to impose strains on the jack shaft bearings that are very hard to hold. The locomotives will haul a train weighing as much as eight hundred tons up a 2 per cent. grade. The main rods are set at an angle of 45 deg., which is much to be preferred to the vertical motor rods adopted for the first locomotive built for the German State Railways. These were practically failures and it is understood that future locomotives will have motor rods arranged similarly to those of the Pennsylvania. It has been found that locomotives of this type require very careful adjustment to maintain the shafts parallel and properly centered and quartered.

The use of side rods on an electric locomotive introduces some different problems from those found in the steam locomotive. As there are no reciprocating parts such as piston rods, the parts are susceptible to perfect balance which is usually impossible in the steam locomotive. The rods must be very much larger than for a corresponding steam locomotive because the entire power has to be transmitted through one set of pins and rods at certain points in the revolution while the steam engine

transmits the power from only one cylinder. The steam engine has another advantage in that the main rods on the two sides are connected to loose ends, while the rods on the two sides of the electric are connected to opposite ends of the motor shaft as well as the jack shaft, which introduces a great many chances for inaccurate workmanship in quartering and tramping and consequent knocking in the pins and bearings.

The fifth type of locomotive, that employing the Scotch yoke for transmitting the power from the motors to the driving axles, has been used exclusively for the three phase locomotives on the Italian state railways. The first ones have been in service some 10 or 12 years on the Valtellini line and have given excellent results. The later ones, some 35 in number, which are shown in one of the accompanying photographs, have been used about two years on the Giovi line near Genoa. These machines have some excellent qualities, light weight, powerful motors, and motor weight entirely spring supported. They have, however, been used only in slow and moderate speed service, so their performance at high speeds remains to be shown. These locomotives also require very accurate adjustment although not so close as the one with side rods and jack shafts, as the Scotch yoke drives one axle through a sliding block and the others through parallel rods connected to the yoke by knuckle pins. Spherical crank and knuckle pins are largely used with this type of drive.

The sixth and last type mentioned drives the locomotives through a combination of gears and side rods, or gears and Scotch yokes. A number of such locomotives have been built, the most notable being the one for the Loetschberg Tunnel in Switzerland and the one for the Midi Railway in France. The former has two 1,000 h. p. motors each connected by a helical tooth gear to a jack shaft, which is slightly above the driving axles, and thence by parallel rods to three pairs of driving wheels. Although the motor speed is extremely high, the gears operate practically noiselessly and with high efficiency. The duty on the jack shaft bearings is much easier than when side rods only are used, since the reciprocating pressures are practically all in a horizontal direction, and can therefore be cared for much more easily. Either of these types has a fairly high center of gravity. While either locomotive is subject to criticism for having both gears and side rods, it must be admitted that the arrangements for both are such as to give the best results. The jack shafts for side rod drive should be located in the same horizontal plane as the driving axles, consequently the problems connected with tramping and quartering, and with bearings would be reduced to a minimum. In some respects, this design is superior to either straight geared (gears on axles) or straight side rod types, and it is probable that a great many locomotives with gears and side rods will be built. The twin motors may be used here, thus reducing the gears to the lowest number or the smallest width of face.

SHIPMENTS OF IRON ORE.—The total shipments of iron ore on Lake Superior was 36,338,382 tons to October 1, as against 24,837,137 tons to the same time of last year, which is an increase of 11,501,245 tons.

INSULATING STEEL PASSENGER CARS.—“I believe the difficulties of insulating steel passenger cars could be overcome by placing a strip of non-conductive material between the side post and inside finish and by eliminating the air space entirely. Vegetable fibre, filling the entire space, could be used to great advantage especially if this insulation could be manufactured so as to have a sponge-like appearance, thus dividing the space into millions of small and closed air cells. Such insulation would be cheap and effective and there would be no danger of fire as it is enclosed by fireproof materials. I am sure such a car could also be heated in the same way as our wooden coaches, and the efficiency in both cases would be practically the same.”—A. Stoikowitz before the Canadian Railway Club.

†See *American Engineer*, December, 1909, page 490.

ENGINE HOUSE SUPERVISION

BY A. C. LOUDON.

Ask almost any engine house foreman and he will tell you that he has so much to look after that he hardly knows where to begin; in fact, he is overloaded and much overloaded with work. The majority of engine house forces have not enough supervision, although this is not so much the case with large engine houses as those located at moderate size terminals. The more important engine houses require large appropriations for pay rolls and it is easier to work in an extra man or two than with a smaller one.

Take the case of a 20-stall engine house located in an eastern state and handling an average of 25 engines daily with a maximum of about 40 during the busiest season. The entire staff, including laborers and coal men, consists of 35 men and one foreman only. The practice followed is a common one. The foreman is on duty during the day and turns the work over at night to a hostler, who does not even have authority over the skilled labor. The results in such cases are almost always unsatisfactory. The foreman is waked during the night four or five times a week to settle questions that arise and concerning which the hostler and machinists will not accept responsibility. After a few such night trips to the engine house he becomes worn out, his brain will not work properly, and he makes mistakes which result in engine delays, overtime and other unnecessary expenses. He is called to account for it, and all too frequently is discharged when he is not at fault and has not had a fair show, because he was overworked.

On the other hand if the foreman's rest is not disturbed, almost as much trouble results from blunders made by the irresponsible hostler. Lack of tact in dealing with the transportation officers is frequent in such cases, requiring long and involved explanations and apologies by the foreman. Blunders are made in holding engines for repairs that are trivial, or in letting engines go when they should be held, with engine failures resulting; and in calling engine men out of their turn, resulting in the payment of "run arounds."

In the particular house under consideration there are two different hostlers with very different temperaments on night duty alternate weeks, and both these conditions prevail to a considerable extent. One man will accept no responsibility and sends for the foreman in every case, while the other is anxious for authority and takes every opportunity to grasp it. The result is that between settling questions for one man at night and getting the other out of trouble during the day, in addition to his daily responsibility, the foreman soon becomes almost a physical wreck and escapes complete break-down only by taking a vacation.

The question may be asked, why are not one or the other, or both of the men discharged? The answer is simply that it is impossible to get a man capable of properly handling an engine house at night on twelve-hour shifts for \$60 or less a month; and further, the education and training of the average hostler is not such as to fit him for such a position. No better men are available if these two are discharged and no more money can be obtained for better salaries. In fact the foreman's salary is only \$1,000 per year.

That such a condition is undesirable will be generally admitted, but it can be remedied. First, give the foreman a reasonable salary. Without casting any slur on the many excellent men who have "made good" under prevailing conditions, it is nevertheless a fact that there are annually lost to the railways many men who would make good officers, and this mainly because of the low salaries paid. If a foreman be given a reasonable salary he will be more contented and much more willing to give the best of his powers to the solution of the problems before him.

Next, give him reasonable hours so that he can get his rest

and keep himself physically fit to perform his work at all times. To accomplish this it will be necessary that he have a competent, well-paid night foreman to whom he can hand over responsibility at the end of the day. The night foreman should receive a salary reasonably near to that of the foreman and should stand in line for promotion to the foreman's position. It will help in his training to have him occasionally change off with the foreman, the latter taking the night shift. At such times each man should assume the full duties of the position he is at the time filling. This will familiarize the night man with the general office work, the handling of correspondence and the ordering of material. In case the foreman has had little or no night experience, as is frequently true, the change will familiarize him with what the night man has to contend with. The very fact that the night work has to be carried on in the dark makes it more difficult.

There should also be a competent "charge hand," or shop foreman, in direct charge of the men in the engine house. This man should have no work but the supervision of repairs, and if necessary should have gang foremen under him. The hostler can then handle the ash pit men and cleaners, and if the force is not too large, the coal men. The shop foreman should periodically change with the night foreman, and thus become familiar with his duties, while the latter, by coming back to the position of shop foreman, temporarily, will be prevented from becoming rusty on engine repair methods.

Another consideration in the case of the foreman is his clerk. Can anyone consistently claim that \$50 a month is a reasonable salary for a clerk in an engine house office? The number of reports required from engine house foremen is legion, and it is continually increasing. The necessity and use of some of these reports may properly be held in question, but at the same time they are required by the master mechanic's office. Furthermore, they are required on specified dates, and if they are not in the office of the higher officer on those dates his chief clerk immediately begins to make life a burden for the engine house foreman and his clerk. It requires a man of intelligence to handle engine house office work and a sufficient salary should be allowed to attract a good class of men.

The burden of hand-written correspondence should also be taken off both foreman and clerk and a stenographer supplied, who could also act as an assistant clerk. Moreover, the stenographer should not be required to furnish his own typewriter, and he should be paid enough salary to insure getting a man who has at least a speaking acquaintance with the English language. The clerk will then be able to give proper attention to his reports, to develop methods and make suggestions for eliminating, combining or otherwise shortening them, and to work in close conjunction with the foreman in the matter of the efficient ordering and handling of material.

It is a good plan to periodically hold "get together" meetings of all the foremen, including the clerk. The discussions may cover anything coming up in the course of handling the engine house and will tend to encourage what is absolutely essential for the efficient working of any engine house—cooperation.

To apply these methods to the engine house under consideration would mean a direct increase in the monthly pay roll of at least \$300, and consequently an increase in the cost per engine handled. On the other hand it is believed that the resultant economies would far more than offset this increase. The men would have direct supervision at all times and would not be required to waste time looking for the foreman to settle questions arising in the course of their work. By the closer supervision a rearrangement of the assignment of work could be made which would combine some duties and thus reduce the number of men required. It would reduce the number of engine delays and the number of engine failures, and, as a result of these, the number of train delays. It is impossible to

express such savings in figures. It would also tend to bring about much better relations with the transportation officers.

It would result in a much more efficient handling of material with a corresponding saving, and in the foremen being able to spend a portion of their time in developing labor and time saving kinks. The combined savings, if they could be expressed in money, would undoubtedly show a figure many times greater than the cost of the increased salaries.

There is, however, too much attention given in many cases to the cost per engine handled. Many motive power officers fix a flat rate per engine for all engine houses regardless of size and conditions. There are then two previously set quantities to deal with—the appropriation and the rate per engine. Consequently, if the engine despatch is too small to bring out the required unit cost, the foreman sees a call to the carpet coming his way and resorts to the easiest way, under the circumstances, of avoiding it—padding the engine despatch report. Undoubtedly a low unit cost is desirable and even essential, but fictitious figures should not be allowed, nor a low unit cost obtained, by poorly maintained power with its resultant demoralizing effects. Encourage engine house foremen to show their actual unit cost and give them more assistants to reduce the unit cost in an all-around efficient manner.

CAR SHOP KINKS

BY ALBERT W. HOLBROOK,
Draftsman, Boston & Maine, East Fitchburg, Mass.

ADJUSTABLE CLAMP.

The adjustable clamp shown in Fig. 1 is very serviceable in the car department carpenter shop for door, panel and sash work. It is made up of a wooden beam with a series of holes

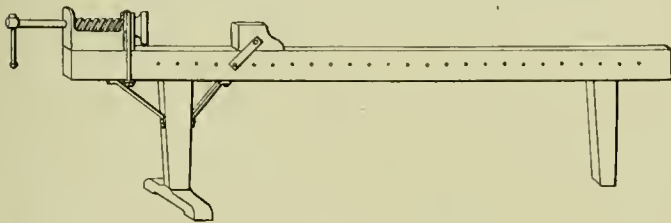

Fig. 1—Adjustable Sash Clamp.

so that the rear jaw or head may be adjusted. It is mounted on two legs, the front one having a cross piece at the bottom to give the necessary stability. The front head is provided with the regular vise screw.

WOOD BITS.

A series of special wood bits is shown in Fig. 2. Bit *A* is used for cutting out plugs for covering countersunk screws or

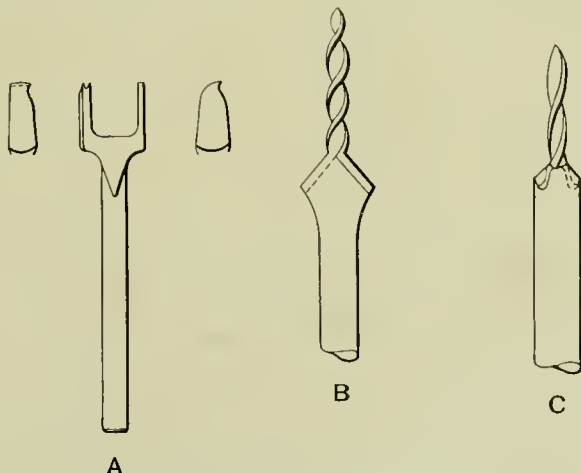

Fig. 2—Wood Bits for Car Work.

bolts. One side of the bit does the cutting and the other side removes the chips. Countersinking bits are shown at *B* and *C*. These are used for boring screw holes requiring countersunk heads, *B* being used for heavy work and *C* for light work, such as box casings. Bits of this sort can be made from old machine tool drills.

SWING CUT-OFF SAW.

The special feature of the swing cut-off saw shown in Fig. 3 is the truing rods on each side. These rods are fastened to the lower end of the saw frame and extend outward to the ceiling above. Each rod is provided with a turnbuckle, which allows

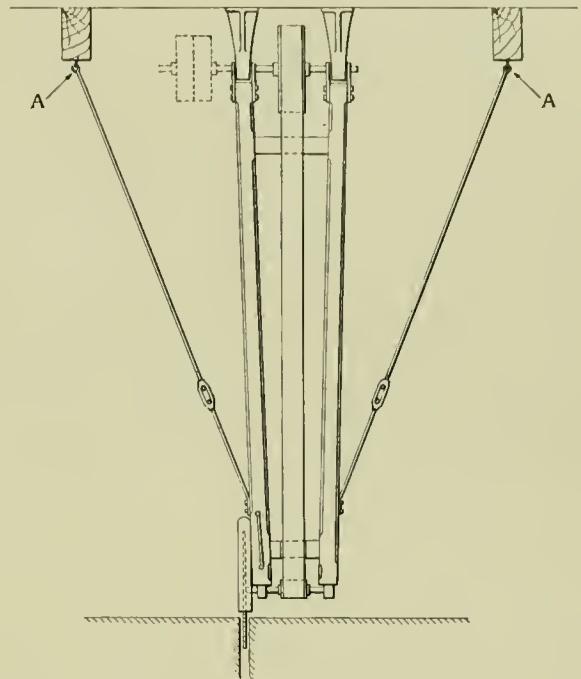

Fig. 3—Swing Cut-Off Saw.

an exact and rigid adjustment. Care should be taken when applying these rods to the saw that their upper joint *A* is on a line with the axis of the pulley shaft, for if they are not the frame of the saw will be strained every time it is swung. This arrangement keeps the saw running in a straight path and reduces the number of broken saws.

BENDING BRAKE SHAFT BEARINGS.

The arrangement shown in Fig. 4 is used for making brake shaft bearings or other forgings of this character. Two separate blocks, cut out to give the desired shape, are held by two links, as shown, one on each side. The bar to be forged is placed

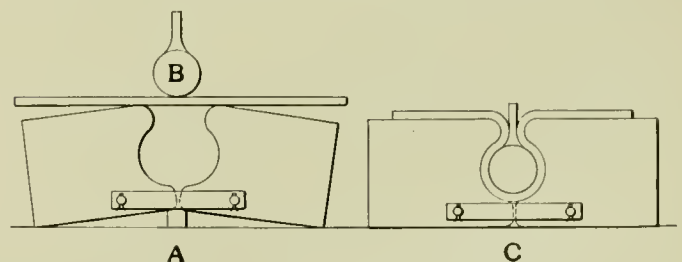

Fig. 4—Dies for Forming Brake Shaft Bearings.

on top of the dies with the blocks raised in the center by a wooden block, as shown at *A*. The plunger *B*, which may be applied to an air press or may be in the form of a set driven by a sledge hammer, then forces the iron bar into the die. At about one-half its stroke the wooden block or plug that holds the two dies open should be removed, allowing the blocks to fall on the level surface, as shown at *C*. This method is very

simple and allows the rods to be bent in one heat, giving a much more uniform bend than if done by hand.

SASH CLAMP.

The clamp shown in Figs. 5 and 6 is used to clamp sash on all four sides. The end clamps *E E* are operated through the rod *B* which is connected to one end of the lever *C*, the left hand one being connected to the lever through the rods *F* and *G*. The opposite clamps *H* are held by set screws, and may be adjusted in the slot in which they are set. The side clamps are connected

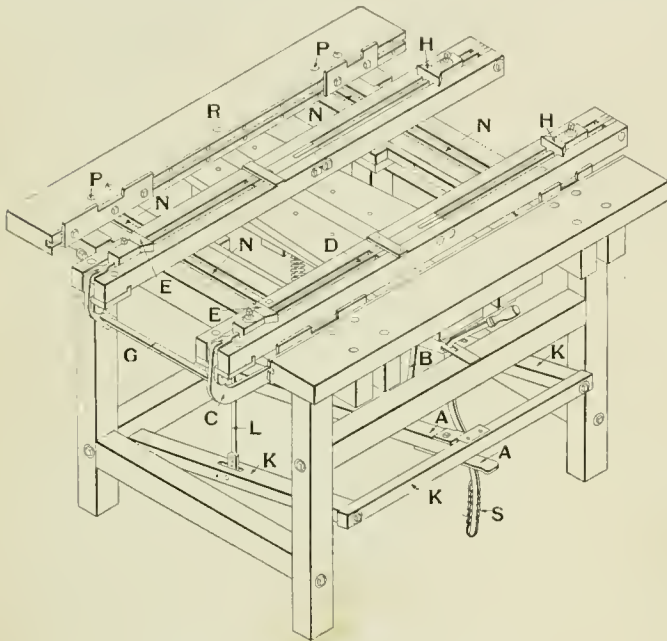

Fig. 5—Four-Sided Sash Clamp.

to the treadle through the rods *L* and the levers *M*, which move the clamp jaw *R*. The treadle is held in the clamped position by the notched lever *S*, which has two sets of notches at right angles to each other. The notches on the side are used to engage the treadle *A*, which operates the end set of clamps, while the other notches are used for the treadle *K*, which operates both the side and end clamps together.

WHEEL GAGES.

The gages shown in Fig. 7 are used for mounting wheels on axles. Gage *A* is used to determine when the wheel has been

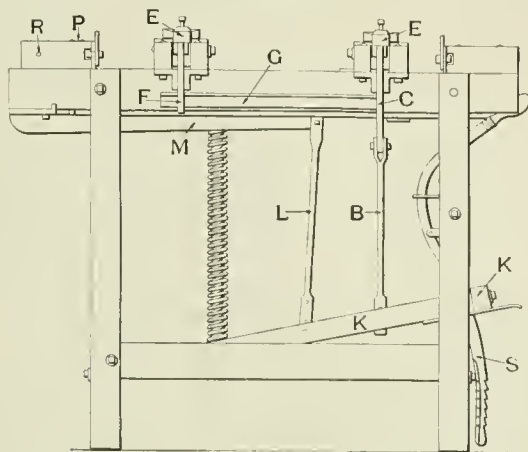

Fig. 6—Side, End and Top Views of Sash Clamp.

pressed on far enough. The center of the axle is first located and the axle placed in the press ready for the wheel. The broad end of the gage is placed on the inside of the flange, as

shown, while the other end extends along the axle; the wheel is forced on until this end coincides with the center of the axle. The other wheel is applied in the same way. The gage *B* is

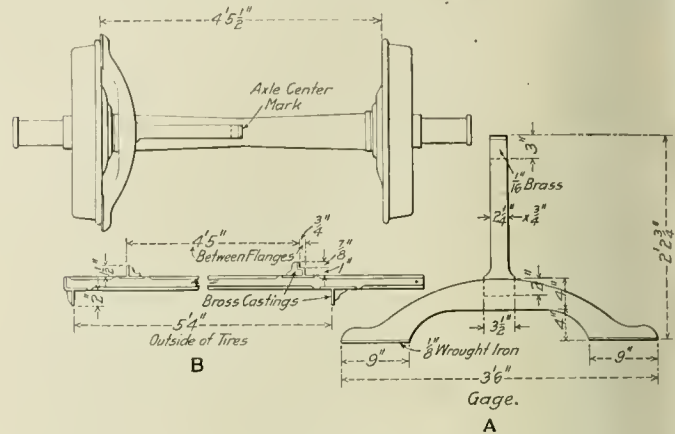
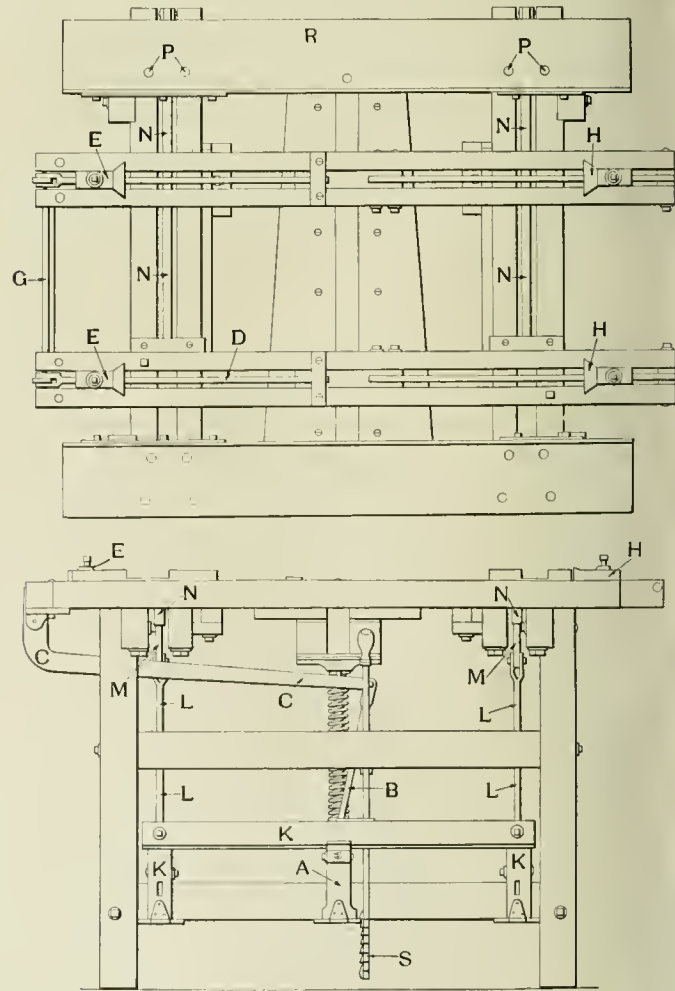

Fig. 7—Gages for Mounting Wheels.

used for measuring the distance between the flanges and the outside of the tires.

INDIAN RAILWAYS.—During 1911 seven hundred and fifty miles of new railways were opened in India, which makes a total of



32,839 miles. There were 390,000,000 passengers carried and 71,270,000 tons of freight. The return on the capital invested in the lines in operation amounted to 5.87 per cent.

THE BAKER LOCOMOTIVE VALVE GEAR

A Description of the Gear, an Analysis of Its Motions and the Method of Setting Valves.

BY R. S. MOUNCE.

The Baker locomotive valve gear in its present form is the result of a development extending over several years. The proof of its merit lies in the fact that its use is being extended, not only on new locomotives, but also on old ones, especially in cases where the Stephenson gear has been unsatisfactory on account of the springing and consequent distortion of valve events resulting from long valve rods or long eccentric rods. It was thought at one time that the Walschaert gear successfully met every disadvantage of the Stephenson gear. It did greatly reduce the weight of the reciprocating parts and the areas of wearing surfaces, but it does not eliminate the troublesome shifting link with its sliding block, nor does it materially improve the steam distribution. The Baker gear resembles the Walschaert in many respects and offers every one of the advantages claimed for the latter, but with three important additional advantages, which are:

(1) The oscillating link, by far the most troublesome part of

located back of the fixed center A of the reverse yoke, and the upper arm FG points forward instead of backward; and the valve rod connection K of the combination lever is above its bell crank connection H , instead of below it. In all cases the eccentric crank pin follows the main crank pin at an angle of approximately 90 deg.

The crank pin circle, Fig. 3, is divided in twelve parts. Each division is numbered and the corresponding number is placed on the path of each moving part in order to show its position in relation to the crank pin during one revolution in forward motion. The diagram shows the exact path of each part of the Baker gear during one complete cycle in full gear forward motion. The position No. 10 for which each part is shown by full line center lines was selected because it shows the parts most clearly in their respective relation to each other.

The motion imparted to the valve is a combination of two motions: one, from the eccentric rod, transmitted through the

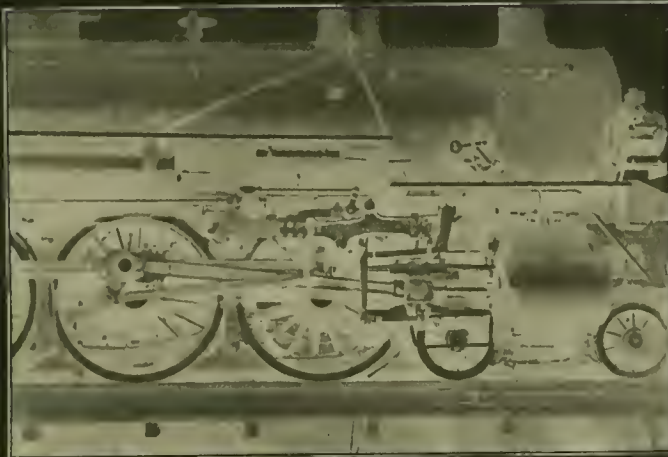

Fig. 1—Application of Baker Valve Gear for Inside Admission.

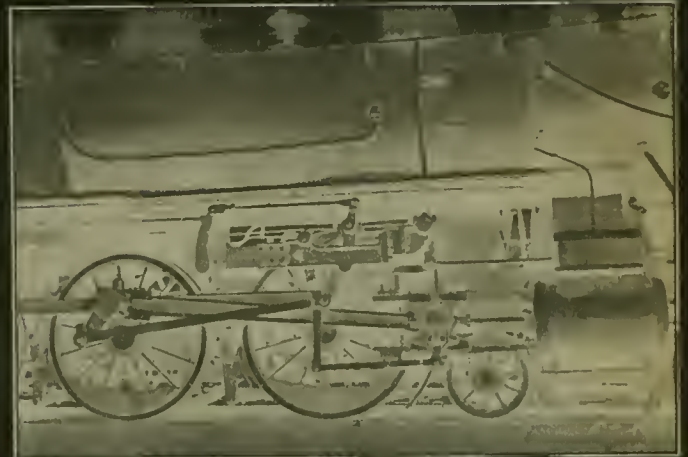

Fig. 2—Application of Baker Valve Gear for Outside Admission.

the Walschaert gear, is eliminated, and for it are substituted in the Baker gear a set of levers, all of whose connections are of the pin and bushing type.

(2) The Baker gear has in actual test shown a saving of more than 5 per cent. in steam consumption for a given power over the Stephenson gear, and while the saving might not be quite so great over the Walschaert, it would nevertheless be considerable.

(3) The total weight of the reciprocating parts of the Baker gear is considerably less than that of the Walschaert.

In general, the Baker gear, on account of its entire lack of sliding connections, the fact that each bearing is essentially of the pin and bushing type, and because of its extremely light weight and rigid construction, will undoubtedly require less maintenance than other outside gears; besides, the accuracy of its valve setting will remain for a much longer period due to its necessarily slight wear.

ANALYSIS OF THE MOTION.

The following description refers wholly to the kinematic diagram, which shows the Baker gear arranged for inside admission valves. For outside admission valves two changes are made, namely: the fixed center C (Fig. 3) of the bell crank is

eccentric rod, gear connection rod and bell crank, which causes the valve to follow the piston at an angle of 90 deg. (with outside admission valves the valve leads the piston at the same angle), the other from the crosshead through the combination lever, which at mid-valve stroke displaces the valve from its mid-position a distance equal to the sum of the lap and lead.

The reverse yoke and the radius bar take the place of the link and link block in the Stephenson or Walschaert gear. They comprise the reversing mechanism and the direction and amount of motion transmitted from the eccentric crank is determined by the position of these two parts. The middle point of the gear connection rod is attached to the lower end D of the radius bar, whose upper end is attached to the reverse yoke at B . The point D can move only in an arc of a circle whose center is at E . The upper point of the gear connection rod is attached to the bell crank at F and can move only in an arc of a circle whose center is at G . The shape of the path of the lower point D of the gear connection rod, to which the front end of the eccentric rod is attached, is therefore determined by the two arcs FF' and Dd . It is seen that when the point D falls on the arc FF' , the point F will be a stationary point and no motion will be transmitted to the valve from the eccentric crank, and





the nearer this point approaches the arc FF' , the shorter will be the motion imparted to the valve; also when the point B is drawn past this arc, the direction of motion of the point F relative to the motion of the piston will change and consequently the engine will be reversed. It is to be noted that the lower point of the bell crank H travels through the same angle as does the point F , and that the function of the bell crank is simply to transform the motion from vertical to horizontal. The fore-

several steps required are given below in their proper order. The right side of the engine is generally considered and it is not necessary to make a further explanation for the left side. These rules apply to either outside or inside admission valves. The parts mentioned in the following discussion are shown on the kinematic diagram.

(1) The combination lever should first be checked to the blueprint to make sure that the two arms are of the proper length.

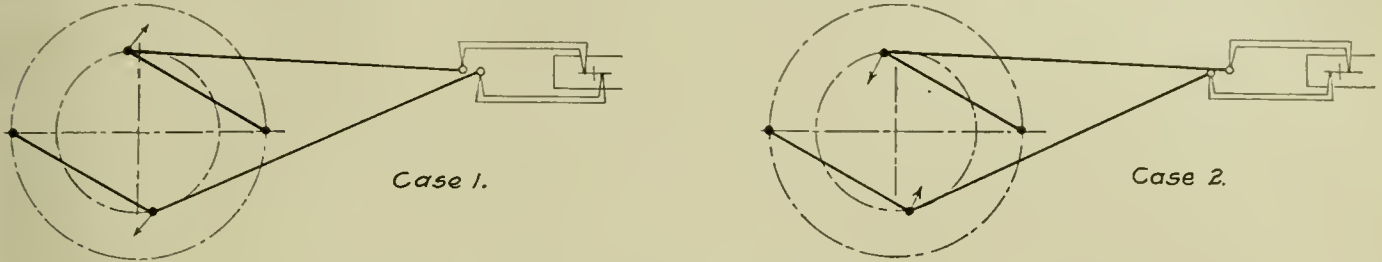

Fig. 4—Adjustment of Eccentric Crank.

going explains how the gear is reversed and how the travel of the valve is decreased and the cut-off shortened by "hooking up" the reverse lever. The dash line center lines show the change in position of each part of the gear when the reverse lever is placed in the back notch—main crank pin, eccentric crank and crosshead remaining stationary.

Valve diagram No. 1, Fig. 3, is drawn to suit the dimensions

This will insure the proper lead when the other parts have been adjusted. The length of the union link should then be checked by plumbing the lower arm of the bell crank and the combination lever which is connected to it. Then with the crosshead in its mid-stroke position see if the length between centers of the union link corresponds to the distance between the center of the crosshead arm and the center of the bottom hole of the com-

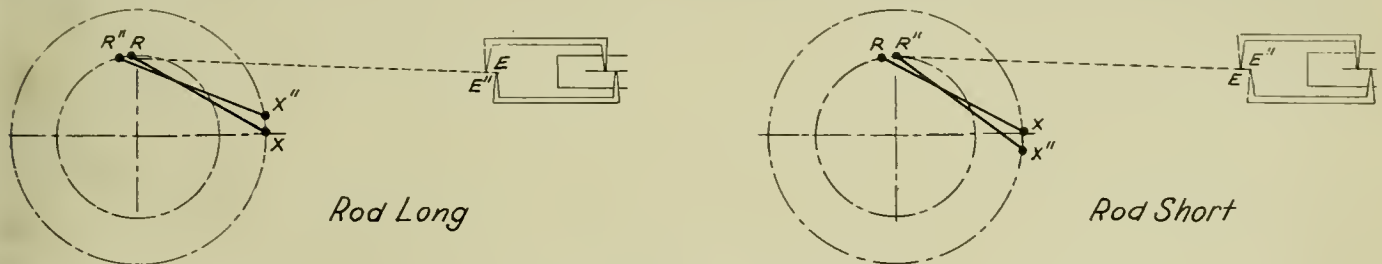

Fig. 5—Adjustment of Eccentric Rod.

of the valve and parts. It shows the long port opening and the free exhaust obtaining at full gear. Diagram No. 2, Fig. 3, shows the valve ellipse for full gear plotted from the kinematic diagram. There are three points to be noted. (1) That the port is fully opened when the piston has traveled 14 per cent. of its stroke and that this occurs so rapidly that the effect of pre-admission due to the $\frac{1}{4}$ inch lead is practically eliminated. (2) That there is a dwell of about 35 per cent. on the full port open-

bination lever. If the difference is over $\frac{1}{2}$ in. the union link should be adjusted.

(2) Connect up the valve gear and both main rods. Obtain the dead centers as usual.

(3) To Place the Eccentric Crank in Its Proper Relation to the Main Crank.—The reverse lever can be at any position during this adjustment. Catch either dead center and from a point near the front end of the eccentric rod make a tram mark on

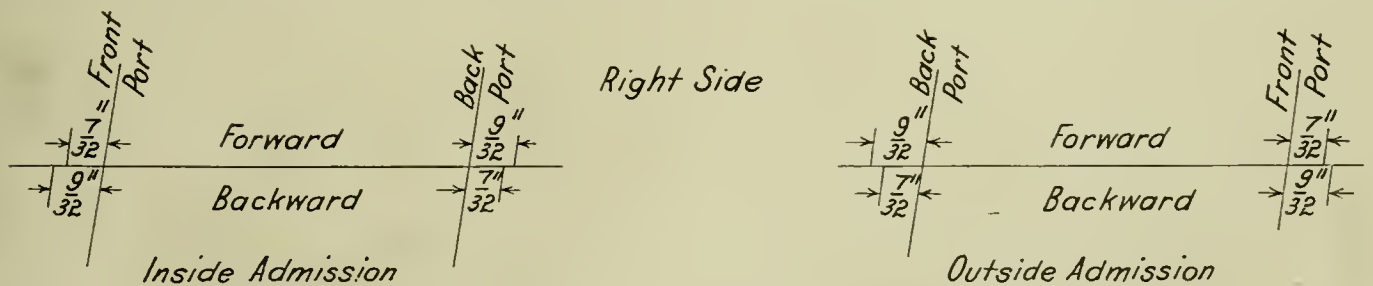

Fig. 6—Correct Adjustment of Valves of Baker Gear as Shown by Marks on Valve Stems.

ing. (3) And that, although the port closing requires about 36 per cent. of the stroke, the velocity of the valve movement is great enough to give a quick cut-off. These facts go to show why a material saving in steam consumption is possible by the use of the Baker gear.

SETTING THE VALVES.

The method used to set the Baker gear is in some respects similar to that practiced in setting the Walschaert gear. The

face of the top guide bar. Then catch the other dead center and from the same point on the eccentric rod make a second mark on the upper guide. The two marks should coincide. If they do not it is necessary to move the eccentric crank further from the center of the wheel or nearer to it, as the case may be, until the two tram marks coincide. See Fig. 4 for an illustration of these two cases. The amount of this change should not be very great, because if the diameter of the eccentric crank circle is materially increased or diminished, it may be necessary

to shorten or lengthen the eccentric crank in order to maintain the proper eccentric crank pin travel.

(4) *To Adjust the Length of the Eccentric Rod.*—With the reverse lever in the front notch and the wheel placed on either dead center (assume that the front center is selected), make a mark on the valve stem with a valve tram, Fig. 5; then place the reverse lever in the back notch and make a second mark on the valve stem. If the two marks coincide the eccentric rod is of the proper length. If they do not coincide, it is evident that the rod is either too long or too short. In that case, move the wheel about one inch backward from the dead center and go through the same procedure as described above. If the tram marks come nearer together it shows that the rod is too long and it is simply necessary to move the wheel further from the dead center until a point is found at which there will be no movement of the valve stem when the engine is reversed. This point having been found, tram from the same point on the front of the eccentric rod used in paragraph (3), making a mark on the top guide. Then return the wheel to the forward dead center and make a second tram mark on the guide. The distance between these two marks is the amount the eccentric rod will have to be shortened.

If, when the wheel is moved backward from its forward dead center, and the process outlined above has been followed, the valve stem movement increases, it shows that the eccentric rod is too short. In that case, move the wheel ahead of its forward dead center until a point is found at which there will be no movement of the valve stem when the engine is reversed, then return to the dead center and proceed as described before. The distance between the two tram marks made on the guide will be the amount which the eccentric rod will have to be lengthened.

It has been found best to leave the eccentric rod about $\frac{1}{8}$ inch short in order to give a better equalization of the cut-off from shopping to shopping, making allowance for the wear of the parts and the settling of the engine in service. This will, of course, throw the lead out about $\frac{1}{32}$ in., but it is generally acknowledged that a slight variation in the lead is of much less importance than unequal cut-offs.

The reason for the adjustment just described can be readily understood by referring to the diagram. It is seen that the points 1 and 7 correspond to the dead centers. When the crank pin is located at either of these points, the front end of the eccentric rod is at the point of intersection (1 and 7) of the full gear forward and full gear backward paths, Ee and $E'e'$ and that if the eccentric rod is of the proper length, there will be no movement of the front end of the rod (and no motion transmitted to the valve rod) when the reverse lever is moved.

(5) *To Adjust the Valve Rod.*—Another adjustment to be made is that of the valve rod, and the method of doing this is too well known to require any explanation here.

(6) *To Adjust the Valve Travel.*—It is assumed that the main reach rod was adjusted when applied, so that with the reverse lever in mid-position, the reverse arm stands plumb. After the other adjustments have been made, the backward and forward full gear travel should be equalized by adjusting the short reach rods which connect the reverse arms to the reverse yokes. If the rules are followed as outlined there should be practically no variation in the cut-offs. If, however, there should be any great variation, it may be necessary to make a further change in the length of the eccentric rod. If cut-offs are long on the front end in forward motion and short on the front end in backward motion, the rod is too long. If cut-offs are just the reverse, then the rod is too short. When the adjustments have been made and the valves are run over for checking, the marks on the stem should be as shown in Fig. 6.

The last job to be done in setting the Baker gear is to key the eccentric crank fast to the main crank pin. This is left until last, so that any variation from that source may be detected while there is still opportunity to make a correction.

The two photographs show the Baker valve gear applied to passenger engines, both of which were formerly equipped with the Stephenson gear. One has inside admission, and the other outside admission valves.

VALUE OF VARIABLE EXHAUST NOZZLES*

Some ten years ago while studying the question of locomotive design and operation abroad, I frequently rode on French locomotives and noticed particularly the degree of refinement obtained in the steam distribution of four-cylinder compound engines. I have ridden in the cab of a French locomotive of this type handling a passenger train at a speed of from 90 to 100 kilometers (56 to 62 miles) per hour, when, by a slight adjustment of the valve gear, which resulted in lowering the back pressure on the low pressure pistons, the engine immediately increased its speed by about 15 kilometers (9 miles) per hour without supplying any more steam from the boiler or increasing the throttle opening. I think it safe to say that if the officers of the American railways would give this matter more thought and study, providing means whereby locomotives should primarily be provided with steam passages and valve gears offering the least possible resistance in the way of back pressure on the pistons while in operation, then with an adjustable exhaust nozzle permitting a variable adjustment to meet the different conditions of service, and then finally following up the valuable suggestions in Mr. McFarland's paper,† they could decide on certain standards of design suitable for all localities that would result in saving much more than many of the devices which are now being applied to locomotives, give in the way of a return on the money invested.

I do not wish to be understood as criticizing either the compounding or the superheating of steam from an engineer's standpoint, for a man who would criticize or condemn either would thereby automatically eliminate himself from the ranks of the engineering profession or of progressive railway men. There are, however, cases where men become so completely absorbed in a certain thought or idea that they are unconsciously oblivious to others of as great or greater importance, and I think it is not overstated to say that in many instances men in the engineering, as well as in other professions, have ridden a hobby when there were other directions in which they could better apply their energies. In other words, in railway practice, there are some cases even at the present time where it would seem that those in charge of the design and operation of locomotives were almost stumbling over \$10 bills in their effort to locate nickels and dimes.

Doubtless many of the locomotives in service which show excessive back pressure are equipped with superheaters costing \$1,200 to \$1,500, and in many kinds of service the investment will bring good returns in a very short time. I think it might safely be said, however, that in many cases the engines thus equipped could, at an expense of \$50 or less, be fitted with a variable exhaust nozzle that would bring even greater returns in the way of increased efficiency. Again, valve gears designed so as to permit of independent adjustment between the high and low pressure engines are also conducive to the same results and are considered by many of the foremost engineers on the other side as absolutely essential to the economic operation of four-cylinder locomotives. In this I am inclined to think they are entirely right, and that we in America have overlooked this very essential feature, together with the other features which I have already mentioned.

* Part of a discussion by W. E. Symons at the convention of the Railway Fuel Association.

† Locomotive Drafting and Its Relation to Fuel Consumption. See *American Engineer*, June, 1912, page 300.

ACCIDENTS IN SHOPS AND ENGINE HOUSES

An Address Before the First Co-operative Safety Congress Which Was Held at Milwaukee Last Month.

BY GEORGE BRADSHAW,
General Safety Agent, New York Central Lines.

The great majority of injuries in shops and enginehouses naturally occur in the use of tools, machinery and appliances. Of the preventable portion of this class of injuries, according to my observation, a larger percentage is due to improper physical conditions than to improper methods or personal carelessness. It follows, therefore, that the chief factor in the prevention of injuries from these sources consists in the installation and maintenance of proper safeguards. In other words, while training of the "human element" is important in shops and enginehouses, as elsewhere, and should not be neglected, it is believed that in these particular branches of the service, the most serious attention should be given to a regulation of physical conditions.

For many years, voluntarily or otherwise, we have been adding safeguards to our cars and engines until today it is difficult to think of additional mechanical devices to make this class of equipment more safe. But while we have been turning out cars and engines well nigh perfect in this respect, until recently we have done practically nothing in the way of protection, by safeguards, from injury by the numerous complicated and hazardous machines used in the manufacture and repair of this equipment.

It is true we have safety appliance laws in most, and perhaps in all states, and factory inspectors whose duty it is to assist in their enforcement. The fact remains, however, that not until recently has a great deal of attention been paid to these laws. Their purpose is all right, but they are too general and indefinite, and railway men are beginning to realize that safety laws and factory inspectors can at best accomplish only a small part of what is really required to make our machines and shops reasonably safe. In all of the large shops of the New York Central Lines we have, and have had for some time, a force of men working continually installing safeguards. This work is being done in spite of the fact that inspections have been made by factory inspectors and the shops pronounced O. K. We knew they were not O. K., because we read the accident reports. But we are trying to make them O. K. and believe they will be when we get through with them. Following are some of the principal causes of injuries in shops and enginehouses:

UNGUARDED MACHINERY.

The safeguarding of machinery is a subject too extensive to be treated in detail within the limits of this paper. I shall, therefore, attempt to discuss the matter only in a general way. Familiarity with machinery arising from constant use has a tendency to create in the minds of many operators a sense of disregard for the hazards existing and, in fact, in the minds of some, even a contempt for such hazards. The application to a machine of a practicable safeguard not only serves to prevent injuries which might result from the use of the machine, but, at the same time, serves indirectly the useful purpose of impressing upon the operator the importance of safety precaution on his part. In other words, safeguards exert both a mechanical and moral influence.

In the application of a safeguard it should be remembered that we are obliged to protect not only the careful but also the careless employee. In fact, so generally and completely should machinery be guarded that even the most careless and reckless man in the shop will be protected. Safeguards, wherever pos-

sible, should be so constructed that they will provide automatically the necessary adjustment, as, for instance, guards over gears at the ends of lathes, which must necessarily be opened in order to adjust the gears, should be attached to the machines by hinges so that the guards will swing shut into place of their own accord, thus preventing a careless operator from removing them or affecting their efficiency. Guards for circular saws should extend completely over the teeth of the saws and be adjustable by means of gravity to varying thicknesses of timber. In other words, where possible, a safeguard should be made "foolproof." Following are some of the machines for which safeguards are especially necessary:

Planers.—The openings in the base of planers beneath the carriage should be covered by thin sheet metal to prevent employees from depositing therein material or tools, thus rendering themselves liable to be injured by the movement of the carriage. If this cover is properly applied it will not in any way interfere with the operation.

Band Saws.—The upper and lower wheels should be completely enclosed on both sides. The teeth on the back or return part of the saw between the table and the upper wheel should be protected by means of angle irons so that the operator cannot come in contact with them. There should also be an angle iron or other form of protection in front of the wheels to prevent the saw from flying and striking a workman in case it should break.

Set Screws on Revolving Spindles.—These, wherever located, should be countersunk or protected by safety collars. Many serious injuries result from exposed set screws.

Flywheels, Pulleys and Gears.—When within seven feet of the floor they should be enclosed so as to prevent contact with movable parts which might occur on account of slipping or falling, or on account of clothing becoming caught, and also to prevent injuries which might be due to striking movable parts with material or tools.

Belts of Larger Size.—If located over passageways or places where employees work or congregate, such belts should have a structure extending the entire distance beneath the pulleys, of such material and construction as will prevent the belt, in case of breakage, from falling and striking the workmen.

Walkways for Oilers.—Where necessary to oil overhead machinery, a secure passageway with a railing on each side should be provided for the entire distance. In many shops no protection is afforded men whose duty it is to oil overhead machinery. They are required to crawl along beams, narrow planks unsecured, and, in some cases, to crawl between fast moving belts where a slight misstep or slip might cause them to be caught and crushed to death.

Emery Wheels.—The greatest trouble with emery wheels is not in their breaking, although this does happen occasionally and sometimes results in serious injury. More trouble arises from flying particles of dust thrown off which frequently cause injuries to the eyes of operators. Such injuries, it is true, are generally not serious, but they are annoying and cause considerable loss of time. Protection can be afforded against injuries by breakage by means of a guard extending entirely around the rim surface of the wheel, except the necessary grinding surface above the rest. The guard should be made of boiler plate or material of equal strength. Enclosure of the sides of

the wheels is not, as a rule, necessary since it has been found by experience that when the wheel breaks the pieces do not ordinarily fly to the side with sufficient force to cause injury. Protection from flying particles can be afforded to a considerable extent by attaching to the guard a glass shield extending over the rest.

The breaking of emery wheels is, perhaps, more often due to material becoming wedged between the rest and the rim of the wheel than to any other one cause. For this reason, great care should be taken to see that the rest is kept as closely adjusted to the rim of the wheel as possible. The Norton Company, Worcester, Mass., has given considerable attention to this subject and has incorporated its experiences in an interesting and valuable illustrated pamphlet entitled "Protection for Grinding Wheels," a copy of which, all who are interested would do well to procure.

As a general rule sufficient scrap material can be found about the average shop for the construction of necessary safeguards and, where possible to construct the guards in the shops, it is much preferable to buying them, for the reason that "home made" guards ordinarily serve the purpose better on account of being constructed for the particular machines to which they are applied and employees are likely to be more interested in guards which they construct themselves than in those which the company buys.

INSUFFICIENT LIGHT.

Injuries are often indirectly due to insufficient light. But few of our shops are lighted as they should be. The efficiency of the lights is greatly impaired in many shops by a failure to keep them properly cleaned and maintained. The fact that dirt and soot rapidly accumulate on the globes, it would seem, is permitted to serve as an excuse for not cleaning the lights frequently, whereas it is just the reason that this should be done. In every shop or roundhouse of consequence some one should be designated to clean and attend all lights at least every other day. Electric lights, of course, are the most satisfactory, and the tungsten style of lamp has been found to give the best results. Natural light, especially in new shops, can generally be provided by means of windows and sky-lights. These should be kept cleaned regularly and frequently.

Closely related to light is that of ventilation, which should always be provided for by special overhead construction, especially in blacksmith shops, grinding rooms and similar places. No forge or hearth should be operated without a hood of ample size discharging outside of the building.

FLYING PARTICLES.

Many eye injuries of a serious nature are due to pieces of metal thrown off in chipping or grinding. These injuries can be largely prevented by providing employees in this branch of the service with goggles. Those used by men engaged in chipping should be made of thick glass; for grinders, an ordinary cheap style of goggle which can be purchased for about five cents each, or less, will serve the purpose.

It is often urged by those who oppose the use of goggles that employees will not wear them. Some weeks ago we distributed to employees in the principal shops of the New York Central Lines who have occasion to do grinding or chipping a supply of goggles with a request that they give them a trial. We have just received reports to the effect that employees very generally volunteer to use them and express themselves to the effect that the goggle is a "good thing." We are, therefore, arranging to supply every man, whose duties require him to do metal chipping, with a pair of goggles especially constructed to afford protection from this source. We have decided to use the goggle known as the Julius King No. 1021-3040, which is the goggle adopted by the International Harvester Company and by many of the plants of the United States Steel Corporation, both

of which concerns, we are reliably informed, tried and tested many different styles before deciding to adopt this particular make.

We are arranging to provide employees using grinding wheels with the ordinary style of goggles above referred to. It is not our intention to compel employees to use these goggles, except so far as we may be able to do so by arousing their desire to co-operate in the matter and, from our experience thus far, we feel that they will be quite generally used.

OBSTRUCTION OF PASSAGEWAYS.

One of the most prolific, as well as unnecessary, sources of injury to employees in shops and roundhouses is the obstruction of aisles and passageways by tools, rubbish and materials. Positive instructions should be issued and enforced in every shop requiring all employees to keep passageways clear. Any one who has made frequent inspections of shops will realize the necessity for this. Not only does the obstruction of aisles and passageways present a probable cause of injury, but it greatly interferes with the proper movements of employees, and thereby decreases their efficiency. It requires practically no effort or expense to keep aisles and passageways clear; it is simply a matter of habit. A shop, like an office or residence, can be kept in a disorderly and untidy condition, or in an orderly and proper condition, depending upon the one in charge. It ordinarily requires but little time to get employees in the habit of storing tools, material and rubbish in the proper places and in a proper manner. In one shop I know of the passageways are clearly indicated by white lines painted on the floors. Employees are required to keep the space between these lines entirely clear of obstructions. As a rule, however, I doubt if it is necessary to indicate the passageways by means of lines, or otherwise, as their limits are generally well understood.

FOREMEN IN CHARGE.

The prevention of accidents in shops and roundhouses depends, to a considerable extent, upon the foreman. If he is impressed with the importance of accident prevention and is personally interested in the subject, he will find numerous means of preventing injuries which could not otherwise be effected. Therefore, those who are in charge of safety movements will do well to convert, if necessary, the foremen and those in immediate charge to the cause of safety. There should, in fact, be fewer injuries in proportion to the number of men employed in shops and roundhouses than in any other branch of railroad service for the reason that the foreman has his men congregated in a very limited area where he knows them personally and is constantly in contact with them. In other words, he can, if he will, see and know just what the employees in the ranks are doing or not doing to make their work safe. As is the foreman, so will be the employee. Therefore, general officers in charge of shops should impress upon those in immediate charge of men that they will be held personally responsible for every case of injury in their jurisdiction which could have been prevented by ordinary prudence and vigilance.

Following are some of the precautions which employees in shops and enginehouses should observe:

Don't wear loose, baggy clothing in working around moving machinery.

Don't walk on railway tracks, and before crossing any track, "Stop, Look and Listen."

Report all unsafe conditions and practices to the foreman in charge or other proper person.

Explain fully to your helper the proper methods of work. A little time spent by a mechanic in imparting instructions to his helper may save one or both an injury.

Never jump on moving cars or engines. This is a risk which no shopman is required to take and which he cannot afford to take.

Never strike tempered steel with a hammer or metal object.

Stop machines before oiling, wiping or repairing. In shops of the New York Central Lines we have attached to every machine, the nature of which makes it at all necessary, a metallic sign reading "Stop This Machine Before Repairing, Oiling or Wiping."

Foremen should be required personally to give every employee entering the service full and complete instructions concerning the safe methods of doing the work to which he is assigned. They should require employees, and enforce the requirement by discipline if necessary, to keep all safeguards in proper position, and especially should investigate carefully all cases of injury in their jurisdiction with a view of avoiding a recurrence. After all, eternal vigilance is the price of safety.

ELECTRIC LOCOMOTIVES FOR THE SOUTHERN PACIFIC

Fifteen electric locomotives are being delivered to the Southern Pacific for use on its Pacific coast properties in freight and switching service. Twelve of them are equipped for operation on either 600 or 1,200 volt direct current lines, and three are arranged for 600 or 1,500 volt operation. The mechanical parts were built by the Baldwin Locomotive Works and the electrical equipment was constructed and installed by the Westinghouse Electric & Manufacturing Company.

While designed primarily for freight service, these locomotives may also be used for passenger trains if desired. With natural ventilation the motors and auxiliary apparatus on each locomotive have sufficient capacity to give a continuous tractive effort of 5,600 lbs. With the blowers in operation, the locomotive will exert continuously a tractive effort of 11,520 lbs. and a pull of 21,600 lbs., at a speed of 17.6 miles per hour, can be obtained for a period of one hour with 600 volts at the motors. A momentary tractive effort of 30,000 lbs. can be exerted when on clean, dry rails.

Each locomotive has four motors, each having a normal rating of 225 horsepower with natural ventilation and 250 horsepower with forced ventilation at 600 volts. Each motor is

geared to the axle and their location and arrangement on the truck is shown in one of the illustrations.

The trucks are of the equalized pedestal type with one-piece rectangular frames. The pedestals are protected by shoes. The wheels are 36½ in. in diameter, have cast steel centers and tires held in place by bolted fastenings. The journals are 5½ in. x 10 in. Four 13 in. channels 30 ft. in length form the longitudinal members of the underframe. These connect heavy cast iron end sills and are stiffened and braced by flanged

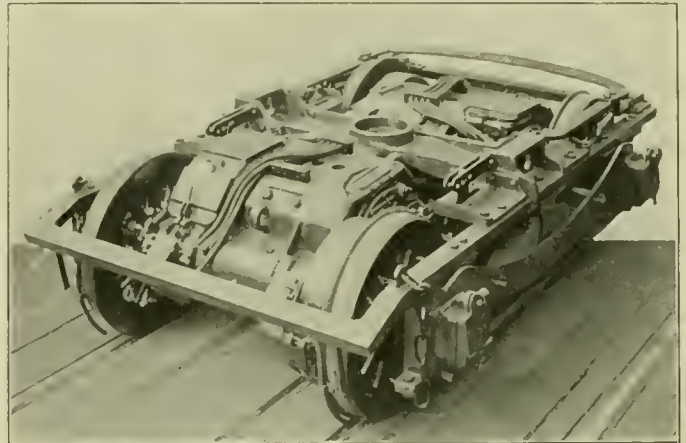

Truck for Southern Pacific Electric Locomotive.

diaphragms and the heavy steel floor. The body bolsters consist of plates 15 in. wide and 1½ in. thick continuous across the bottom of the channels. The center plate is secured directly to this plate bolster. Steel plates, ½ in. thick, cover the entire underframe, and are riveted to all of the longitudinal sills and to the braces. Above these there is a ¼ in. diamond plated steel flooring.

The centrally located steel cab measures 18 ft. in length by 9 ft. 6 in. in width. The entrance is through end doors at diagonally opposite corners, the hoods at either end, of the cab

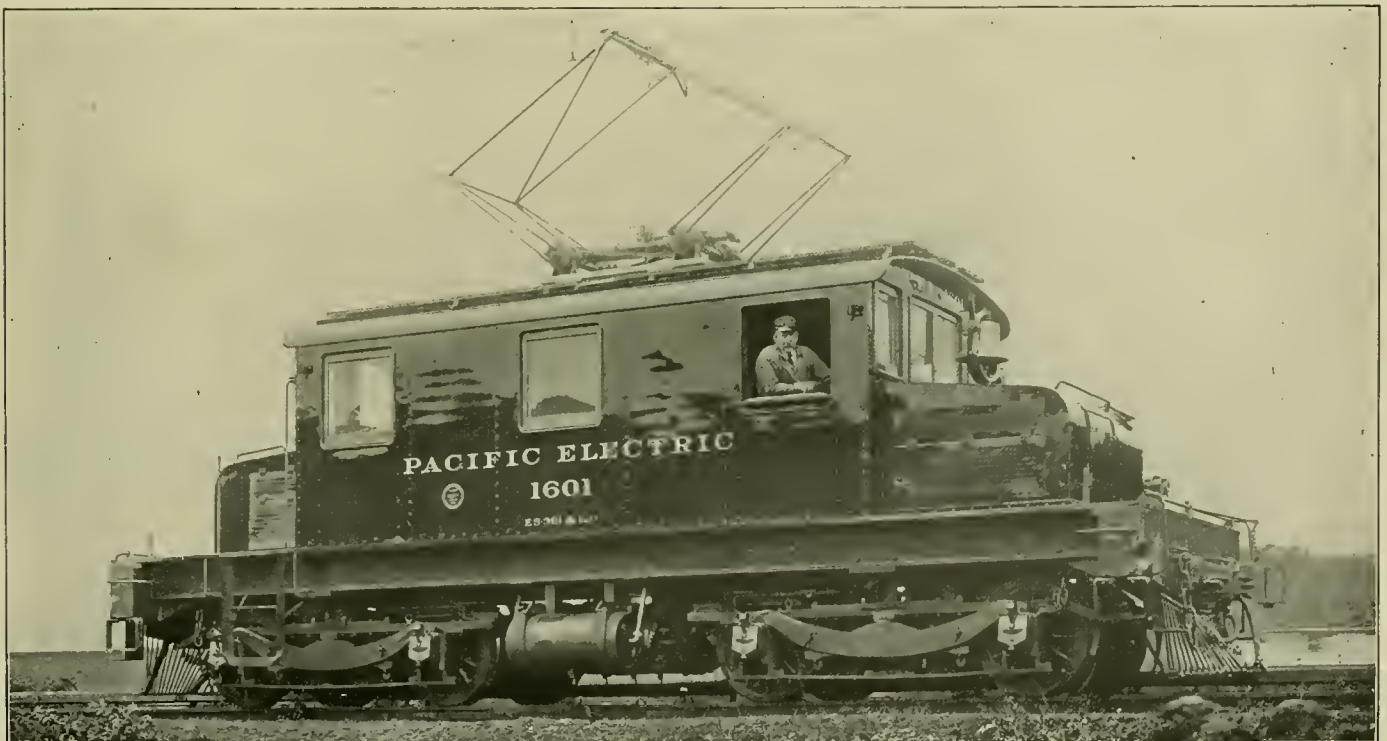

Electric Locomotive for the Southern Pacific.

being placed off center to give a passageway from the ends of the locomotive to the doors. The locomotives are equipped throughout in accordance with standard railway practice and have M. C. B. couplers, steel pilots, safety appliances, etc.

Three running positions are provided on the controller for 600 volts and two for either 1,200 volts or 1,500 volts. A pneumatically operated series-parallel switch gives the proper connections for the running positions, and is operated by a control switch from either end of the cab. It is so designed

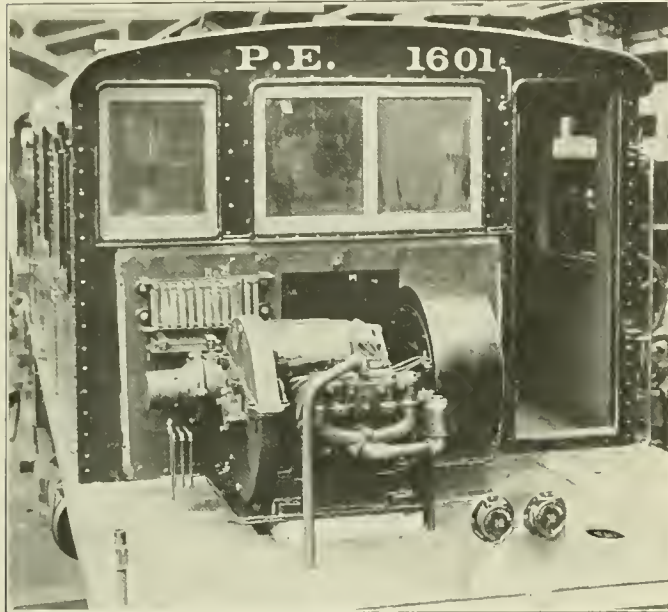

End Hood Removed Showing Dynamotor and Air Compressor.

that the two motors comprising each pair may be connected in series or parallel with each other at the will of the operator. An interlocking arrangement has been provided that makes it impossible to operate the series-parallel switch except when the circuit on the main motor is opened.

There are eleven notches on the master controller with the motors in full series; nine notches with the motors in series-parallel, and nine with the motors in full parallel. On 1,200 or 1,500 volts the motors are operated only in full series and

equipped with train line receptacles and jumpers and any number of units can be controlled by one operator.

A relay has been provided which will open all the circuits of the motors whenever the trolley passes a specially arranged aerial brush contactor. This insures an open circuit through the motors when the trolley passes a section insulator. It is necessary to bring the master controller to the "off" position before the relay can be reset. An over-speed relay is also provided.

Two dynamotors are installed under the hoods, one at either end of the locomotive, and operate the air compressors for the brakes as well as the fans for forced ventilation of the motors. These dynamotors run constantly and drive the air compressors, which have a displacement capacity of approximately 50 cu. ft. of free air per minute, by a pneumatically operated friction clutch that is controlled by the main reservoir pressure. The fan for forced ventilation is mounted on the extended shaft of the dynamotor and runs continuously. These fans serve as a light load to limit the speed of the dynamotors when the air compressors are not in use. Each dynamotor has two sets of armature and field windings both mounted in the same slots and on the same poles. When the locomotive is operated on 1,200 volts the two windings are connected in series and the current for the lights and control apparatus is tapped midway between the two, providing a voltage of 600. When operating on a 600 volt line circuit, one set of armature and field coils is cut out and the remaining set operates as in a series motor.

Some of the principal dimensions of these locomotives are as follows:

| | |
|-------------------------------------|-----------------|
| Rigid wheel base..... | 7 ft. 4 in. |
| Total wheel base..... | 25 ft. |
| Distance between truck centers..... | 17 ft. 8 in. |
| Driving wheels, diameter..... | 36½ in. |
| Journals..... | 5½ in. x 10 in. |
| Width over all..... | 10 ft. |
| Height to top of cab..... | 11 ft. 5½ in. |
| Weight, total..... | 120,000 lbs. |

A CORRECTION

In the description of a pneumatic clamp for testing triple valves on page 522 of the October issue, the chamber for the piston was given as 4 in. in diameter by 6 in. deep. This should have been 6 in. in diameter by 4 in. deep.

COAL FOR BELGIAN RAILWAYS.—It is proposed to introduce a bill in the Belgian chamber to approve the agreement which has

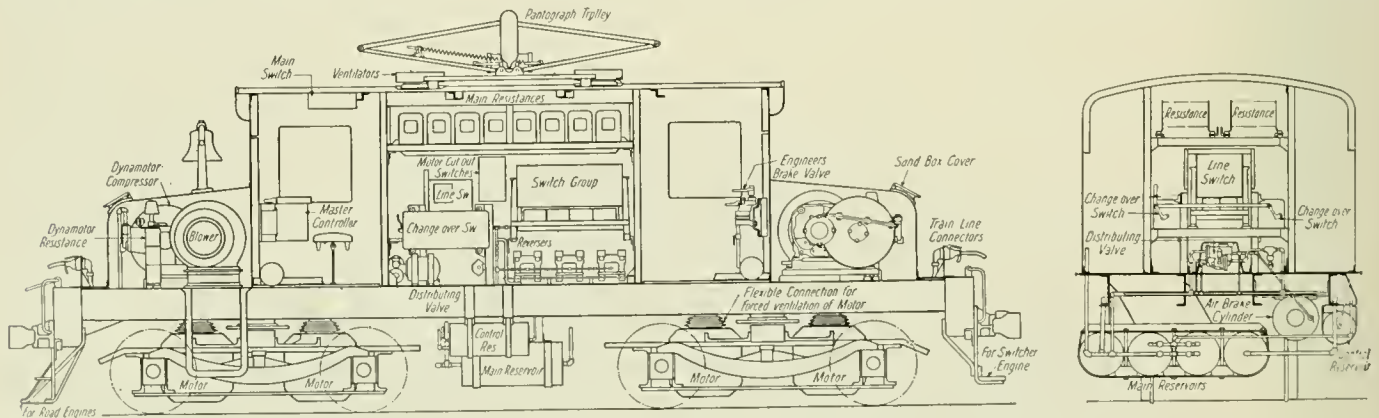

General Arrangement of Apparatus on Southern Pacific Electric Locomotive.

in series-parallel. When it is desired to operate on 1,200 volts, two hand-operated drum type switches are employed which simultaneously readjust the divisions in the main resistance and lock the series-parallel switch in the series position. The same number of notches are then available on the master controller for 1,200 volt operation as for 600 volt operation for the full series or the series-parallel position. Each locomotive is

recently been concluded in connection with the decision to reserve for home uses all future orders of coal from the Belgian state railways. According to the agreement the Belgian collieries will have to supply all the coal required by the railway's administration at a rate per ton based on the price fixed by the mining administration. Only small orders for special coal will be placed outside of Belgium.

REDUCING SMOKE ON SWITCH ENGINES

D. R. MacBain, superintendent of motive power of the Lake Shore & Michigan Southern, presented a paper before a meeting of the International Association for the Prevention of Smoke at Indianapolis, Ind., on September 25, 1912, in which he discussed smoke elimination on switch engines. Parts of this paper are given below:

Without attempting to place them in the order of their importance, the things that are necessary to successfully avoid the emission of smoke on hand-fired terminal power are: A boiler and

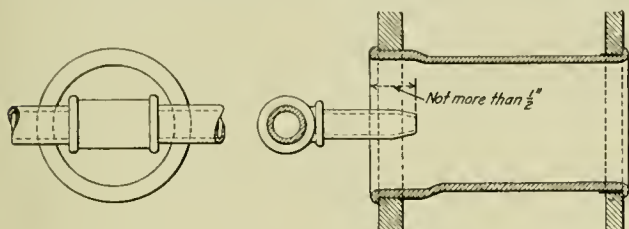

Fig. 1—Arrangement of Steam Jets Through the Water Legs.

firebox in as nearly perfect condition as possible; careful, intelligent and vigilant effort on the part of the engine crew; proper care of boiler appurtenances; a good blower of sufficient size; the steam jet arrangement for the introduction of sufficient quantities of air over the top of the fire, when needed; a suitably designed brick arch properly installed and maintained; good drafting of the locomotive so that forcing the fire will be unnecessary; a well proportioned superheater; the proper cleaning of smoke emitted from engines being fired up at engine houses.

The utilization of any one of the above will accomplish something in the way of smoke elimination, but the use of all of them combined will result in work very close to the 100 per cent.

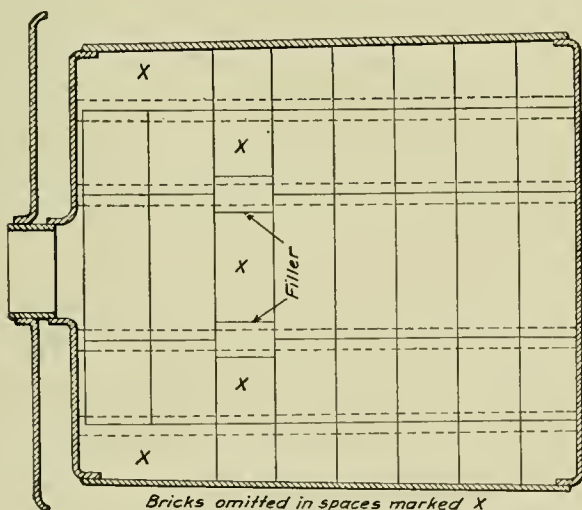

Fig. 2—Recommended Arrangement of Brick Arch in Switch Engines.

mark at all times, even with the use of the most highly volatile fuels.

The flues should be kept tight and clean at all times, and the openings in the grates should be kept open. The grate operating rigging should be kept in good condition so as to be easily operated, and so that the grates can be shaken often enough to admit of the proper admission of air through the fire at all times.

A good blower is necessary and an operating valve on each side of the cab within convenient reach of both engineer and fireman is most desirable, in order that either may start the blower quickly in case of necessity.

The use of the steam jets in the firebox in connection with the blower, as an aid in the prevention of smoke, is essential, as,

if the jets are used without the blower, sparks may be blown back in the cab. Fig. 1 illustrates the manner in which the steam jets should be arranged. It will be noted that the jets should not enter the outside of the air tube more than 1/2 in., and it has been demonstrated that 40 or 50 lbs. steam pressure is ample for their use. That pressure will suffice to develop all the benefit that can be derived from the use of the steam jets, and the noise incidental to their use will be much reduced and rendered less objectionable. It is therefore advisable to apply a steam reducing valve in the line between the throttle and the jets. The steam jets drive the currents of cold air closely over the surface of the fire in such a manner as to cause an intermingling with the escaping gases and thus aid in their combustion. A good job of smoke prevention can be accomplished with the blower and steam jets in combination, provided the engine crew is properly instructed and that conscientious and intelligent use is made of them.

The next essential in securing the best results is a suitably designed brick arch, the installation of which on power doing work of an intermittent nature, such as on switch engines, where long continued service is not necessary, should be about as shown in Fig. 2. The spaces marked X are the only open-

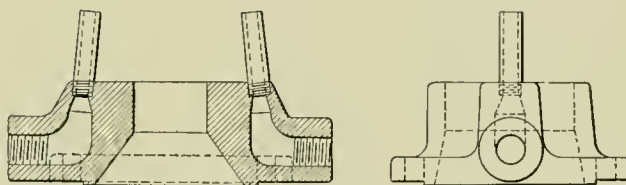
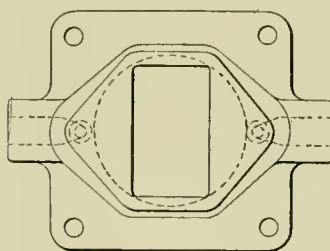

Fig. 3—Rectangular Nozzle Used on the Lake Shore.

ings through the arch. The arch, acting as a baffle wall, produces an even flow of the gases of a uniform temperature, and by reason of the fact that the arch is incandescent and the gases are compelled to travel a greater distance before reaching the flues, combustion is materially improved and smoke emission is reduced correspondingly.

In drafting a locomotive so that it will generate steam as freely as possible, and at the same time obviate the necessity of crowding the fire, there are a number of points that ought not to be lost sight of. There should be some arrangement whereby there will always be not less than one-eighth of the door area open and unobstructed for the admission of air over the top of the fire, whether the engine is standing or working. The opening under the diaphragm should be not less than four-fifths of the total flue area. The diameter of the smoke-stack should be not smaller than four times the diameter of the nozzle, if the nozzle is round. I do not, however, recommend a round nozzle, as the rectangular nozzle, shown in Fig. 3, has proved superior to it.

The reasons for referring to the nozzles and smoke-stack in connection with the elimination of smoke are that easy egress to the atmosphere of the steam jet from the exhaust and the gases entrained thereby is essential. The ideal condition is to have the steam jet from the exhaust nozzle pass out through the center of the smoke-stack, without coming in contact with the walls of it at any point. The jet should pass out with a

L_3 = total length of the tapered bar.
 P = thickness of the tips or ends of the tapers.
 T_1 = width of the tip or end of the inside taper.
 T_2 = width of the tip or end of the outside taper.
 S = uniform clearance between coils throughout from tip to tip (varies from 1/32 in. to 1/16 in. for bar 1/8 in. to 1/2 in. in thickness).
 D_1 = mean effective diameter of the smallest coil.
 D_n = mean effective diameter of the n^{th} coil.
 (All of the above dimensions are to be expressed in inches.)
 N = number of coils (not including tapers).
 G = modulus of elasticity of steel in torsion = 12,600,000.
 W = maximum capacity of spring in pounds.
 f = maximum permissible fibre stress of the spring in lbs. per sq. inch (60,000 for buffer springs and 80,000 for carrying springs).
 δ_1 = the deflection in inches of the smallest coil, under the load W .

For computing each desired dimension, the following formulas can be used. Figure 1 shows the bar, and the completed spring with the reference letters as used in this case:

$$n = \frac{D - (d + 2h)}{2(b + s)}$$

$$D = 2n(b + s) + (d + 2h)$$

$$L = n\pi \left(\frac{D + d}{2} \right)$$

$$L_1 = \frac{3\pi}{4} \left(d + \frac{b}{2} - \frac{s}{4} \right)$$

$$L_2 = \frac{3\pi}{4} \left(D - \frac{b}{2} + \frac{s}{4} \right)$$

$$L_n = \frac{\pi}{4} \left[(2n + 3)(D + d) \right]$$

$$P = \frac{b - 3s}{4}$$

$$T_1 = h - \frac{\delta_1 L_1}{\pi D_1}$$

$$T_2 = h - \frac{\delta_1 L_2}{\pi D_1}$$

$$A = \frac{b + s}{4}$$

$$D_n = d + 2nb + (2n - 1)s$$

$$W = \frac{2fb^2b^2}{3D_1(1b^2 + h^2)}$$

$$\delta_1 = \frac{\pi f \sqrt{b^2 + h^2}}{2Gb} \cdot D_1^2$$

$$H = \frac{L \delta_1}{\pi D_1} + h$$

$$H_1 = 1.1 \frac{L \delta_1}{\pi D_1} + h$$

It is the practice among some makers to use a top and bottom taper equal to a complete circle in length and a lateral taper only 3/4 of a complete circle in length as shown in Fig. 2. In this case the notation and formulas are the same as those above with the exception of the following:

$$n = \frac{D - (d + 3b + s)}{2(b + s)}$$

$$D = (2n + 1)(b + s) + (d + 2b)$$

$$L_1 = \pi \left(d + \frac{13b}{16} - \frac{3s}{16} \right)$$

$$L_2 = \pi \left(D - \frac{13b}{16} + \frac{3s}{16} \right)$$

$$L_3 = \frac{\pi}{2} \left[(n + 2)(D + d) \right]$$

$$D_n = d + \left(\frac{4n + 1}{2} \right) \left(b + \frac{4n - 1}{2} s \right)$$

Actual practice has demonstrated that a taper of 3/4 of a complete circle in length affords ample stability as a seat or base to a spring; so that in making the tapers a complete circle in length, that much useful space is being wasted, and for a given inside diameter the maximum capacity is accordingly reduced.

PAINT SHOP KINKS

BY T. J. HUTCHINSON,
 Foreman Painter, Grand Trunk, London, Ont.
 REVOLVING TABLE FOR PAINTING.

The table shown in Fig 1 is provided with a swivel top and is used for painting, graining and varnishing sash, cleaning glass and painting water coolers. The sash or article placed thereon may be turned easily without having to be lifted. The castings are such as are generally used on parlor car chairs. The lower one is screwed to a heavy oak turned base and the top one to a

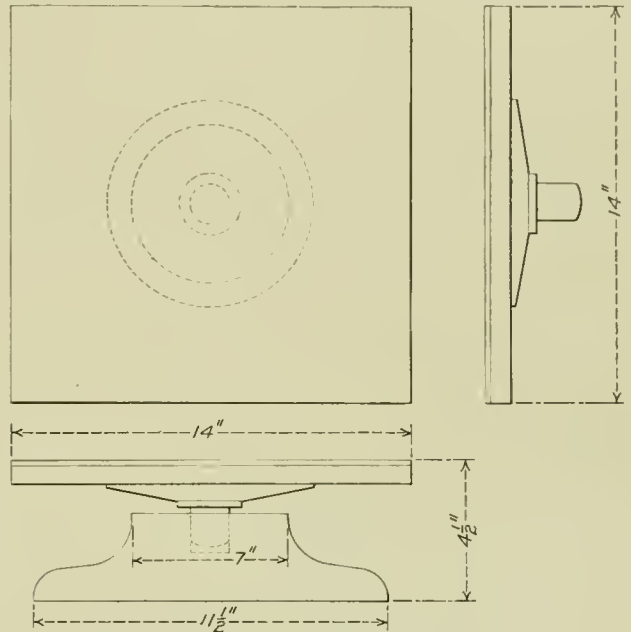

Fig. 1—Revolving Table for Painting Sash, etc.

block 14 in. square, the upper side of which is covered with rubber. Our pieceworkers find that this device greatly facilitates their work. Old parlor car chair swivels can be obtained from scrap and the initial cost of the device is next to nothing. When once this arrangement is used it will be found to be indispensable.

PAINTERS' DUSTER RACK.

The duster rack shown in Fig. 2 was devised to enable our stockman to keep track of the brushes without having to give



Fig. 2—Rack for Holding Painter's Dust Brushes.

too much of his time to it. The rack is a shelf supported on brackets and placed conveniently near the stockman's desk, with holes bored for the number of brushes required, each workman's check number being stamped on the duster and rack alike. Each day these dusters are returned to this rack, where the stock-

man can see at a glance if any are missing. The month previous to the introduction of this rack over a dozen dusters were lost; since then we have had no trouble of this kind.

STENCIL WASHING RACK.

To clean and care for railway car stencils expeditiously and economically became an important matter when piecework was introduced. The rack which is shown in Fig. 3 aids us greatly in this work. It is 5 ft. high with a trough and shelf below, the entire face of which is covered with sheet zinc. The top

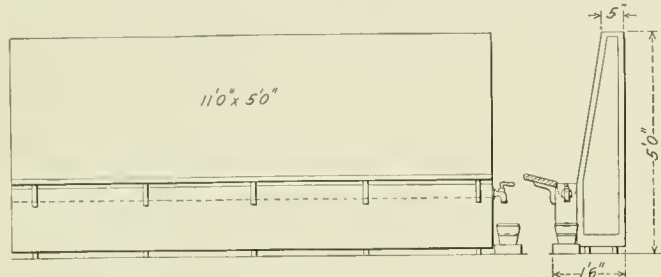

Fig. 3—Rack for Washing Stencils.

slopes to the rear, and enables a liberal use of benzine in cleaning, which is caught in the trough and runs into the pail at the end of the rack, from which it can be used again. By the use of the faucet the benzine can be retained in the trough until the work is completed, if so desired.

COACH DOOR RACK.

Railway coach doors receive more abuse in service than any other part of the interior fittings. Therefore they require greater varnish protection. We find that this can be attained most effectively when the doors, after being varnished, can be placed flat-

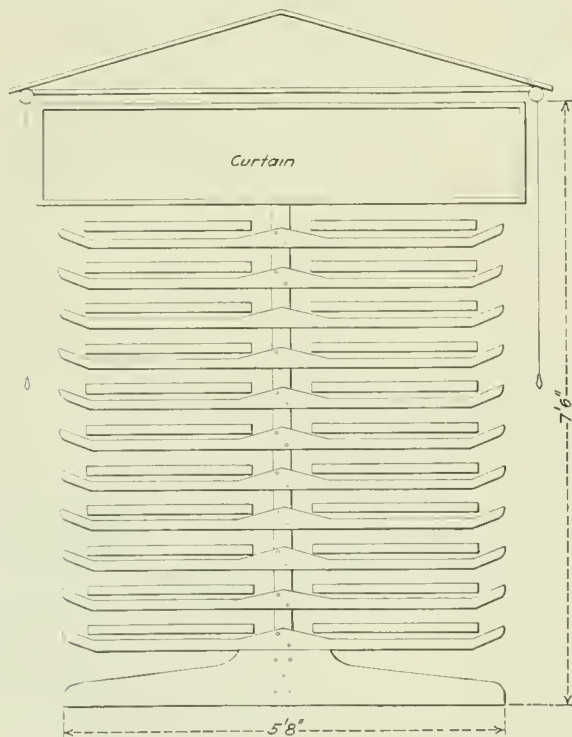

Fig. 4—Rack for Storing Coach Doors.

wise while drying. The dimensions of the rack shown in Fig. 4 are 5 ft. 8 in. wide, 6 ft. 6 in. long and 7 ft. 6 in. over-all in height. It is enclosed with four spring roller shades to protect the varnished work from the dust, and is made of two upright posts, securely bolted to a heavy base wide enough to support the upper structure. To each of the two posts 13 arms or brackets are secured. These brackets are so shaped that only

the extreme edges of the doors touch them when placed in the drying position.

CARBOYS FOR PAINT VEHICLE.

A systematic way of preparing the vehicle used for priming and surfacer coats for new and burnt off work must commend itself to the practical painter. The three carboys shown in Fig. 5 contain the paint vehicle for the priming and surfacer coats; each carboy holds about fifteen gallons and is air-tight, thus preventing the contents from getting fat. The oil, turpentine and japan are mixed in proper proportions for the coats, put into the carboys and drawn off by syphon as required. This arrangement prevents mistakes by the stockman and uniform results are assured. J. W. Davidson, chemist of the Chicago & North Western, introduced the use of the carboy and syphon system for this purpose.

LONG-HANDLED BRUSH FOR FREIGHT CARS.

One of the most economical kinks in painting railway freight cars is the use of the long-handled brush. When this method was introduced on our road, I had a local brush manufacturer make a brush similar to the ordinary whitewash brush, but having double the stock securely bound with brass instead of

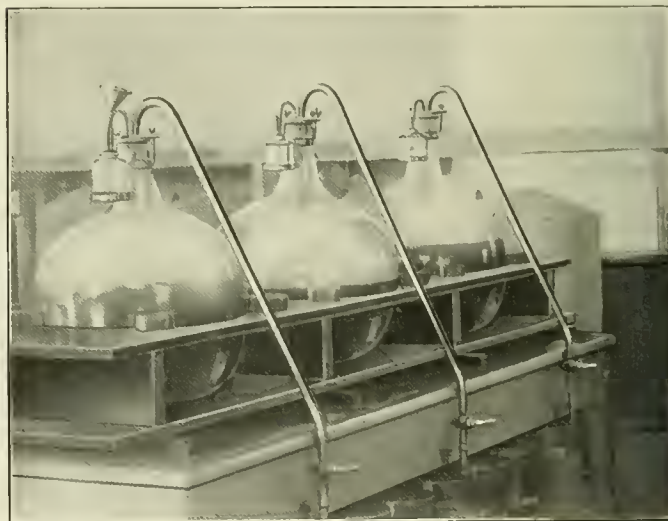

Fig. 5—Carboys for Holding Paint Vehicle.

the usual leather binding, the handle being of sufficient length to reach the top of the highest box car. With the short-handled brush still used on some lines, much time is taken up in erecting and handling the necessary staging, but in using this brush no staging of any kind is required and the time formerly needed for coating has been reduced fully one-half.

DEAD WEIGHT OF VEHICLES PER PASSENGER.—“In looking back on the history of transportation we find that a horse-drawn carriage will weigh about 1,500 lbs. to 2,500 lbs., seating, on an average, four passengers and a driver, which gives a dead weight per passenger of from 300 lbs. to 500 lbs. This vehicle will move at a speed of 6 miles to 8 miles an hour over a roadbed not comparable to the worst kind of railway track. An automobile weighing 5 tons, seating 7 passengers and containing its own power plant, moving with almost the same average speed as a passenger train over a far inferior roadbed, gives a dead weight per passenger of about 1,428 lbs. The dead weight per passenger of a steel railway coach amounts to from 1,200 to 1,700 lbs., and, permitting the points of superior comfort and safety to be balanced by the poor roadbed and the weight of the power plant of automobiles we must ask the question: ‘Is there no possibility of getting below the automobile limits of dead weight per passenger, and is this reduction possible without sacrificing safety and comfort?’”—A. Copony before the Canadian Railway Club.

POWERFUL 2-8-8-0 TYPE LOCOMOTIVE

Has a Tractive Effort of 100,000 Lbs. Working Compound and a Device For Varying the Relation of the Point of Cut-Off in the Two Sets of Cylinders.

A tractive effort of 100,000 lbs. working compound, with 63 in. drivers, places the new locomotives recently delivered to the Great Northern by the Baldwin Locomotive Works among the most powerful on our records. They are also the first engines with this wheel arrangement, although this company has a number of Mallet locomotives of the 2-6-8-0 type in operation.

These locomotives form the fifth class of Mallets in use on the Great Northern. The first engines of the type were purchased in 1906 for pusher service. They are of the 2-6-6-2 type, have 21½ in. and 33 in. x 32 in. cylinders, 55 in. drivers and a tractive effort of 71,600 lbs. The total weight is 355,000 lbs. with 316,000 lbs. on the drivers.* In the following year some locomotives of the same wheel arrangement, but designed for regular road service, were purchased. These have 20 in. and 31 in. x 30 in. cylinders, 55 in. drivers, a tractive effort of 57,940 lbs., a steam pressure of 210 lbs. and a total weight of 302,650 lbs., of which 263,350 is on drivers.† The third class, of the 2-6-8-0 type,

In comparison with other large Mallet locomotives, the new Great Northern engines rank sixth in regard to total weight and are a very close second to the record holders on the Virginian in respect to power. They are fitted with Emerson high degree superheaters which have 1,368 sq. ft. of surface measured on the inside of the tubes. This slightly exceeds the area of the superheaters on the Virginian engines, which are of the Schmidt type. In evaporative heating surface, the Great Northern engine is somewhat less both in the firebox and in the tubes than the Virginian, and the boiler is 10 in. less in diameter, both at the front ring and at the largest point. There is also considerable difference in the grate areas, which are 99.2 sq. ft. on the Virginian and 78.4 sq. ft. on the Great Northern. Eight of the twenty-five engines, however, are arranged for oil burning. It will be noted that no feed water heater is provided in the front part of this boiler, as was the case in the previous order. The tubes have been increased to 24 ft. in length and the remainder

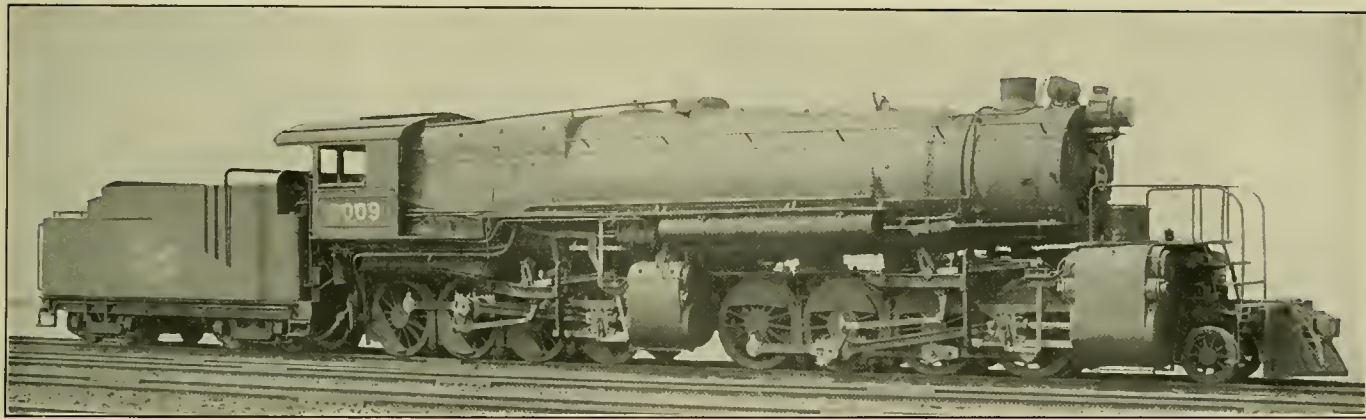

Mallet Locomotive Having a 100,000-Pound Tractive Effort When Working Compound; Great Northern.

were built in 1910. These have 23 in. and 35 in. x 32 in. cylinders, 55 in. drivers and a tractive effort of 82,000 lbs. They are fitted with Emerson superheaters, giving 480 sq. ft. of heating surface, and have feed water heaters incorporated in the front sections of the boilers. They have a total weight of 378,300 lbs., of which 359,600 lbs. is on drivers.‡ In 1910 this company also converted some consolidation locomotives to Mallets by the addition of a new front unit which gave a locomotive of the 2-6-8-0 type. There is a feed water heater in the new front section, and a superheater was applied in the old boiler.§

The locomotives just received are considerably larger than any of the previous classes. They have a total weight of 450,000 lbs., of which 420,000 lbs. is on drivers. The cylinders are 28 in. and 42 in. x 32 in. The steam pressure has been raised to 210 lbs. while the diameter of the drivers has been increased from 55 in., which has been standard on previous Mallets on this road, to 63 in. The theoretical tractive effort working compound is 36 per cent. larger than that of the engines purchased in 1910 and 55 per cent. larger than the pusher engines purchased in 1906.

of the space has been incorporated in a very large combustion chamber which adds 81 sq. ft. to the firebox heating surface.

In some cases it appears that the amount of power developed by the two groups on a Mallet locomotive varies with the variation in speed and in the point of cut-off in the high pressure cylinder. Since it is desirable that the work of the locomotive be equally divided between the two groups of wheels, an arrangement whereby the relative point of cut-off in the high and low pressure cylinders can be varied at the will of the engine-man, has been applied to these locomotives. This result is accomplished by use of a slotted arm on the reverse shaft of the high pressure engine where it connects with the reach rod carried forward between the frames for operating the low pressure gear. The position of the block in the slotted arm is controlled by a screw gear in the cab and a change of 20 per cent. in the point of cut-off of the low pressure engine is permitted. The construction of this arrangement will be described later.

Boiler.—The boiler is of the Belpaire type, the square section being continued to the front end of the combustion chamber. The center barrel sheet is conical, increasing the diameter from 90 in. at the front end to 102 in. at the dome ring. In-as-much as the firebox is set over the top of two 63 in. driving wheels, the throat sheet is very shallow. In fact, the flat portion of the grate which extends forward from the back of the mudring for about 83½ in. is but slightly below the level of the bottom of the boiler barrel. At this point the grate slopes downward to the

* For illustrated description see *American Engineer & Railroad Journal*, October, 1906, page 371.

† For illustrated description see *American Engineer & Railroad Journal*, June, 1907, page 213.

‡ For illustrated description see *American Engineer & Railroad Journal*, August, 1910, page 308.

§ For illustrated description see *American Engineer & Railroad Journal*, October, 1910, page 399.

front of the mudring, which is $6\frac{3}{4}$ in. below the back, giving a throat sheet only about 10 in. in depth. The combustion chamber is 58 in. in length and is flattened on its under side to give a clearance of $9\frac{5}{8}$ in. from the boiler shell. The clearance on the sides is about 6 in. The crown sheet is continuous for the full length of the firebox and the combustion chamber and is carried by expansion bolts. Flexible stay bolts are freely used in the

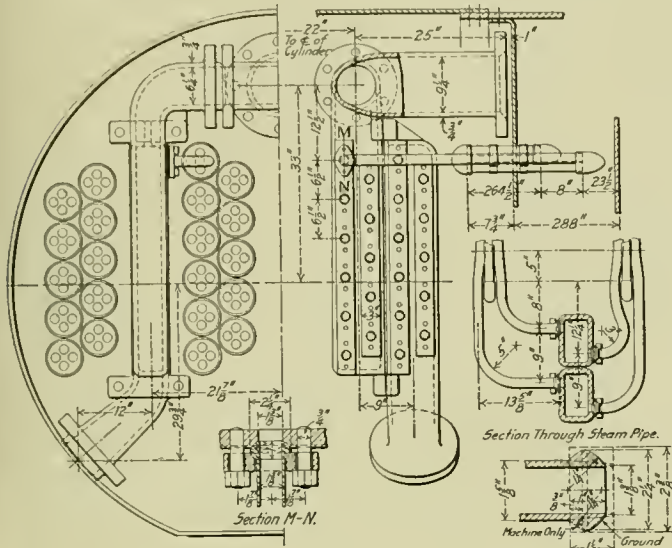

Latest Design of Emerson Superheater.

sides of the firebox and exclusively in the staying of the sides and bottom of the combustion chamber.

There are 332 boiler tubes of $2\frac{1}{4}$ in. diameter and $42\ 5\frac{1}{2}$ in. boiler flues for the superheater elements. The arrangement of these is shown in one of the illustrations. The main dome has a height of $10\frac{1}{2}$ in. and is formed of a single piece of flanged steel. Restricted clearance limits necessitated the mounting of the safety valves and whistle on a steel casting which is de-

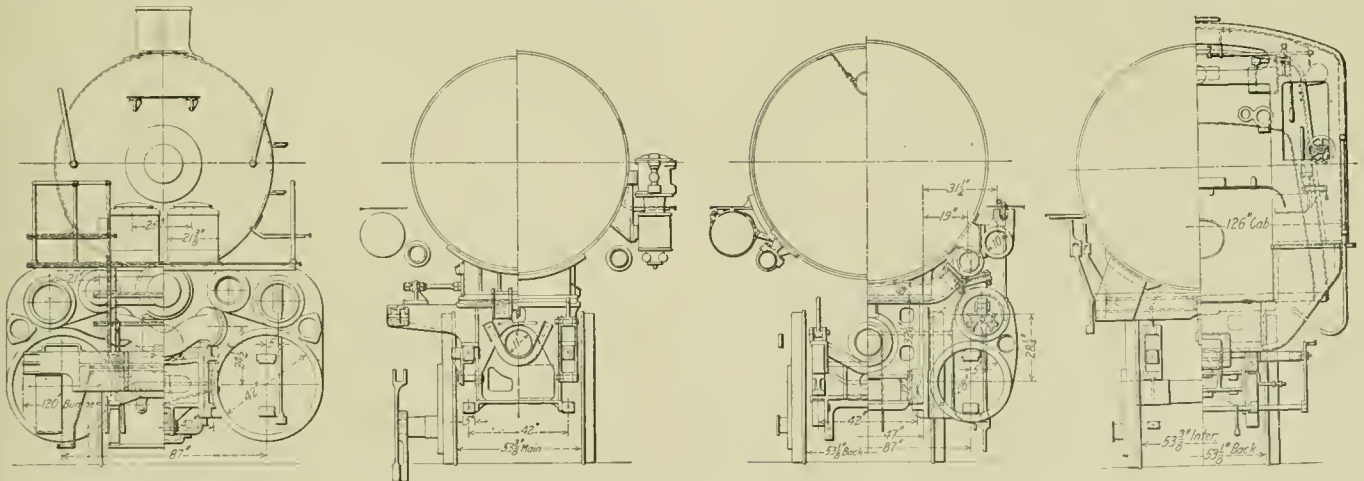

Sections of Powerful Mallet Locomotive on the Great Northern.

pressed in a 26 in. opening cut in the boiler shell just back of the main dome. The single firedoor measures 16 in. x 20 in. The grates on the seventeen coal burning locomotives are arranged to rock in four sections and have drop grates at the rear. In lieu of a brick arch of the usual type, a fire brick wall is built across at the back of the combustion chamber. This is 42 in. high, 9 in. thick and its front face is $42\frac{1}{2}$ in. from the tube sheet.

In the superheater a new method of fastening the tubes to the header has been designed, which is somewhat similar to the construction on the Schmidt design. The saturated and super-

heated headers are cast separately and bolted together, there being one pair on either side of the front end, located as is shown in the illustration. The double looped elements connect to the headers on either side, and the pipes are bent at right angles and fitted with ball joints which seat directly on the sides of the header castings, being held in place by plates, each of which is secured by two studs. The elements extend back in the flues to a point of about 20 in. from the back flue sheet and give an area, measured on the inside of the pipes, of 1,368 sq. ft., making this the largest high degree superheater ever applied. The steam leaves the superheater headers by pipes through the side of the smoke-box, and the equalizer pipe, which in some previous designs has been connected to the headers, is, in this case, installed between the two outside steam pipes at a point just ahead of the cylinders.

Steam Piping.—The exhaust from the high pressure valves is carried through passages in the cylinder and saddle to a chamber directly above the articulated connection. Here is seated the ball joint of the receiver pipe. The cast steel ball is screwed and then welded by the acetylene process to the 11 in. receiver pipe. It is seated on two adjustable brass rings which are faced with babbitt and have a ring of packing material fitted between them. These rings are held in place by a packed gland. The receiver pipe is 24 ft. 5 in. long and at its forward end is slip-jointed to a cast steel Y connection, one branch of which leads to the side of each low pressure steam chest. The exhaust piping for the low pressure engine is in accordance with the builders' previous standards, having a ball joint at the Y connection that is secured to the front of the two steam chests and conveys the exhaust steam to the centre line of the locomotive. From this joint it is carried back to a ball joint at the bottom of the smoke box. This ball is held in place by a coil spring. Between the two is a slip joint packed by snap rings and water grooves. The design is so worked out that when the exhaust pipe is removed, the receiver pipe can be slid in place or removed from the front end of the locomotive without further dismantling.

Cylinders, Valves and Valve Gear.—The cylinders are all cast

separate from their respective saddles. The high pressure saddle is composed of two pieces, the upper comparatively small part being riveted directly to the boiler. The main saddle is then bolted to this and the cylinder castings are bolted to the saddle and also to the frames. Each frame is extended forward under the saddle in the form of a single rail 12 in. in depth, and thirteen of the 49 bolts holding the cylinder in place pass through this frame. The parts are also keyed together at the front, and the extension of the frame ahead of the cylinders fits between rails of the front frames to prevent them from getting out of vertical alignment. At the low pressure cylinders, the saddle,

which acts as a support for the cylinders but carries no superimposed weight, forms part of the frames. This is in accordance with the previous practice of the builders. Each cylinder casting is held in place by twenty-two $1\frac{1}{2}$ in. bolts and is lipped over the saddle so that the bolts are free from shear.

The steam distribution to all cylinders is controlled by inside admission 15 in. piston valves of the built-up type. The high pressure valves are of the usual design, but in the low pressure steam chests double ported valves have been installed.* The Walschaert valve gears are operated by a Raggonet power reverse gear. The lift shaft of the high pressure engine is straight and supported by brackets secured to the guide yoke. On the right hand side it carries the arm connecting to the power reverse gear, and on either side are arms supporting the hangers to the radius bars. In-as-much as the shaft is set very low, the connection of these hangers to the radius rods is formed in lugs cast on the bottom part of the bars, considerably increasing the length of the hangers. On the lift shaft at the centre is another arm extending downward in a vertical direction when the mechanism is at mid gear. This has a slotted opening in which a block is fitted. Secured to this block and fitted around it and the arm is a reach rod which also extends back of the block for a distance of about $10\frac{1}{2}$ in. At the forward end it connects to a small crosshead in the centre of the high pressure saddle, from which another rod reaches forward to the reverse gear on the low pressure unit. Fitted around the lift shaft of the high pressure engine is a sleeve which has two arms, one extending up on the right hand side of the locomotive and connecting to a screw operating mechanism in the cab, the other one, $10\frac{1}{2}$ in. in length, extending backward and connecting to the end of the extension of the front reach rod back of the block. Thus by means of the screw gear in the cab the length of the lever arm controlling the movement of the low pressure reverse mechanism can be changed and the relative point of cut-off of the two cylinders can be altered at will. This relation, however, will be maintained independent of the reversing or movement of the power reverse gear which will control both gears at all times. When the high pressure engine is in full gear the cut-off of the low pressure cylinders can be reduced with this device to a minimum of 20 per cent. An extra steam gage which gives the pressure in the receiver pipe has been located in the cab.

Extension piston rods have been omitted on both the high and low pressure cylinders of these locomotives. The pistons have dished bodies of cast steel with cast iron bearing rings which are 6 in. in width except at the bottom, where they are increased to 8 in. Each piston is also fitted with two packing rings which are sprung in place. The valve stem crossheads are supported on brackets forming part of the back head of the steam chest, a practice which can now almost be considered standard for new locomotives.

Frames.—The frames are annealed open hearth cast steel, and particular attention has been given to transverse bracing. On both the front and back frames cast steel braces are placed midway between adjacent driving axles and are bolted to both the upper and lower frame rails. The two rear braces on the front group are cast in one piece with the lower section of the waist bearer. Both of these bearers are under load and the forward one has a spring centering device.

The front truck is equalized with the leading pair of driving wheels, while the second, third and fourth pairs of the front group are independently equalized on each side of the locomotive. At the rear, equalization is continuous on either side without cross connection.

Restricted clearance limits made it difficult to place sand boxes on the top of the boiler and a supply of sand is carried in two boxes placed over the front deck plate. Sand is delivered in front of the leading driving wheels only. The bell is placed

on the left hand side on the round of the boiler because of clearance restrictions.

The oil supply for the high pressure cylinders is conveyed direct to the steam chest, but that for the low pressure cylinders is discharged at the back end of the receiver pipe. The low pressure cylinder cocks are pneumatically operated by a small cylinder placed over the forward deck plate.

The tender frame is composed of 12 in. channels. The trucks are of the equalized pedestal type with cast iron chilled wheels weighing 925 lbs. each.

General dimensions, weights and ratios are given in the following table:

| <i>General Data.</i> | |
|--|---|
| Gage | 4 ft. $8\frac{1}{2}$ in. |
| Service | Freight |
| Fuel | 17 coal, 8 oil |
| Tractive effort, compound..... | 100,000 lbs. |
| Weight in working order, estimated..... | 450,000 lbs. |
| Weight on drivers, estimated..... | 420,000 lbs. |
| Weight on leading truck, estimated..... | 30,000 lbs. |
| Weight of engine and tender in working order, estimated..... | 600,000 lbs. |
| Wheel base, driving | 43 ft. 3 in. |
| Wheel base, rigid..... | 16 ft. 6 in. |
| Wheel base, total..... | 52 ft. 6 in. |
| Wheel base, engine and tender..... | 83 ft. 1 in. |
| <i>Ratios.</i> | |
| Weight on drivers ÷ tractive effort..... | 4.20 |
| Total weight ÷ tractive effort..... | 4.50 |
| Tractive effort × diam. drivers ÷ equivalent heating surface*..... | 740.00 |
| Equivalent heating surface* ÷ grate area..... | 108.20 |
| Firebox heating surface ÷ equivalent heating surface*, per cent..... | 3.84 |
| Weight on drivers ÷ equivalent heating surface*..... | 49.40 |
| Total weight ÷ equivalent heating surface*..... | 53.00 |
| Volume equivalent simple cylinders, cu. ft..... | 33.60 |
| Equivalent heating surface* ÷ vol. cylinders..... | 253.00 |
| Grate area ÷ vol. cylinders..... | 2.34 |
| <i>Cylinders.</i> | |
| Diameter and stroke..... | 28 in. & 42 in. × 32 in. |
| Kind of valves..... | Piston |
| Diameter of valves..... | 15 in. |
| <i>Wheels.</i> | |
| Driving, diameter over tires..... | .63 in. |
| Driving, thickness of tires..... | .37 in. |
| Driving journals, main, diameter and length..... | .11 × 12 in. |
| Driving journals, others, diameter and length..... | .10 × 12 in. |
| Engine truck wheels, diameter..... | .33 in. |
| Engine truck, journals..... | .6 × 12 in. |
| <i>Boiler.</i> | |
| Style | Belpaire |
| Working pressure | 210 lbs. |
| Outside diameter of first ring..... | .90 in. |
| Firebox, length and width..... | .117 $\frac{1}{4}$ in. × 96 $\frac{1}{4}$ in. |
| Firebox plates, thickness..... | $\frac{1}{8}$ in. & $\frac{5}{8}$ in. |
| Firebox, water space..... | F., 6 in.; S. & B., 5 in. |
| Tubes, number and outside diameter..... | 332—2 $\frac{1}{4}$ in. |
| Flues, number and outside diameter..... | 42—5 $\frac{1}{2}$ in. |
| Tubes, material and thickness..... | Steel, No. 11 B. W. G. |
| Flues, material and thickness..... | Steel, No. 8 B. W. G. |
| Tubes, length | .24 ft. |
| Heating surface, tubes..... | 6,120 sq. ft. |
| Heating surface, firebox | 326 sq. ft. |
| Heating surface, total | 6,446 sq. ft. |
| Superheater heating surface | 1,368 sq. ft. |
| Grate area | 78.4 sq. ft. |
| <i>Tender.</i> | |
| Frame | 12 in. channels |
| Wheels, diameter | .36 in. |
| Journals, diameter and length..... | .51 $\frac{1}{2}$ × 10 in. |
| Water capacity | 8,000 gals. |
| Coal capacity | 13 tons |

* Equivalent heating surface equals $6,446 + (1.5 \times 1,368) = 8,498$ sq. ft.

ELECTRIC TRACTION IN GREAT BRITAIN.—Electric operation on railroads in Great Britain covered lines having a total length of 258 miles of single track at the end of 1911, according to the most recent official reports. Of this amount 206 $\frac{3}{4}$ miles are operated solely by electricity. In 1910 the mileage using electricity was 229 $\frac{3}{4}$. The increase has been largely on the London, Brighton & South Coast.

AVERAGE NET RETURN ON THE VALUE OF PROPERTY.—Approximately the percentage of net return on the capital value of manufactures in 1900 was 17.119 per cent. and that on the cost of road and equipment of railways was 4.650 per cent. In 1910 when the capital value of manufactures had increased 105.3 per cent., the percentage of net return was 12.041 per cent., while on the cost of road and equipment of railways, which had increased 40.2 per cent., the percentage of net return was 5.729 per cent.

*See *American Engineer*, March, 1912, page 141.

RAILWAY ELECTRICAL ENGINEERS' ASSOCIATION

Program Included Reports on Shop Practice, Shop and Postal Car Lighting, Steam Turbines, Etc.

The fifth annual convention of the Association of Railway Electrical Engineers was held in the Auditorium Hotel, Chicago, October 20-25. F. R. Frost, electrical engineer of the Atchison, Topeka & Santa Fe at Topeka, presided. The secretary-treasurer reported a cash balance of \$1,044 and a total membership of about 550.

AXLE LIGHT EQUIPMENT.

A report on Data and Information was submitted by a committee of which E. W. Jansen (Ill. Cent.) was chairman. Following is an abstract of that part referring to axle light equipment:

One of the most important points to be considered in placing axle light equipment on the car is a good suspension and the method in which the suspension is attached to the truck. On cars with steel trucks the suspension should be secured to the truck without any chance of vibration. It is advisable, where possible, that large axle and dynamo pulleys be used. This will increase the life of the belt. A statement of belt mileage made on different classes of cars using the highest grade of 5-in. 4-ply rubber belt with 11-in. dynamo pulleys and 21-in. axle pulleys, is given as follows:

| | Jan. | Feb. | March. | April. | May. | June. |
|---------------------------|--------|--------|--------|--------|--------|--------|
| Cars | 117 | 118 | 121 | 117 | 109 | 117 |
| Belts | 48 | 26 | 34 | 19 | 28 | 19 |
| Average mileage per belt. | 25,952 | 44,032 | 37,192 | 59,702 | 45,155 | 79,878 |

The reason for the low mileage in winter months is because of the ice and extremely cold weather.

From a report of the light failures, that is, those cars which arrived at a terminal with less than 25 volts, or 35 volts where tungsten lamps were used, it was shown that out of 120 cars, 14 failures were shown in January, or 88,900 miles per failure; six failures, or 199,000 miles per failure, in February; 13 failures, or 101,000 miles per failure, in March; 11 failures, or 107,000 miles per failure, in April; seven failures or 187,000 miles per failure, in May, and two failures, or 661,000 miles per failure, in June. From the statistics of 58 different roads it was shown that 13,736 cars were lighted by electricity and 29,075 were lighted by other means, or about 32 per cent. are lighted by electricity. Of these 1,673 have straight storage; 481 are lighted with turbines; 2,073 have the head end system and 7,100 have the axle generating system.

SHOP PRACTICE.

The committee on shop practice, C. J. Causland (Penn.), chairman, presented a report of what is considered good practice by shop engineers of the leading railways. An abstract of the report follows:

Power Plant.—Steam turbines are being used to a very large extent in railway power plants, due to their smaller size and greater economy than reciprocating engines, but there is still much to be said in favor of the latter. They are favored by many engineers for driving direct current generators, with the turbine as the favorite for alternating current machines. One point which has always been mentioned in favor of the reciprocating engine is the use of its exhaust steam for heating the shops, but this applies only to non-condensing engines, usually. Recent developments in steam turbines have brought about a type designed especially with a view to using it in connection with steam heating systems. The large amount of glass used in railroad shops, with the consequent great radiation of heat, makes the heating problem an important one, but beyond the province of this report.

The switchboard should not merely contain panels enough for

all of the generators and feeders, but each panel should have a complete equipment of meters, switches, etc., in order to allow of the fullest knowledge and control of conditions in each circuit.

If the power is to be transmitted over any very great distance, which seldom happens in railway shops, the voltage should be as high as possible for safety, in order to reduce the amount of copper required for the lines and to keep the terminal voltage up to as nearly normal as possible. Either a. c. or d. c. distribution can be made safely at 440 volts and this is high enough for any railway shop at present constructed, and if the power plant is properly located it will do for any plant that will probably ever be constructed.

The electric distribution system should be kept away from the heat of the steam pipes and the practice of putting the cables in ducts placed alongside a pipe tunnel, instead of having them in it, is better practice. This plan is followed in the Big Four shops at Beech Grove, Ind.

Where alternating current is used it is customary to locate transformers at the various distribution centers for stepping down the voltage to that required for the lights or motors. Usually these are located on poles outside the buildings, sometimes inside, but when the distribution system is underground the transformers must be inside the buildings or in manholes. At the Pullman shops manholes are placed at each of the principal distribution centers, outside the buildings, with the step down transformers therein for reducing the voltage from 2,300 volts to 110, 220 or 440 volts as required.

Shop Equipment.—Each shop presents conditions of its own. One of the most important things is a good set of accurate records of time, operations, materials, machines, men and methods. Another is as to whether group drive or individual drive is going to be best for any one department or the entire shop.

There is practically no argument as to the use of anything but electric motors where they are at all applicable, and that means practically any place where power is used to produce motion. Among the benefits gained through their use are decreased transmission shaft losses, increased production through easy speed control, accurate knowledge of power required for any given purpose, ease of power control and distribution, flexibility of machine arrangement, reduced vibration of buildings and machines and the elimination of most belt troubles.

The present tendency in locomotive shop equipment is to increase the number of machine tools per pit. The average is between 6 and 8 per pit, with many shops having from 5 to 6, but the tendency is towards from 8 to 10 per pit in several of the newer shops. There is no fixed rule, apparently, as to how many tools of each kind will be required per pit, but an average of a large number of shops shows the following proportions:

| | |
|----------------------|--------------|
| Turning tools | 50 per cent. |
| Cutting tools | 25 per cent. |
| Drilling tools | 11 per cent. |
| Grinding tools | 7 per cent. |
| Miscellaneous | 7 per cent. |

Nearly all wood-working machines in electrically operated shops are fitted with individual motors because of the comparatively large amount of power required. Induction motors with squirrel cage windings are used for this purpose on account of the freedom from sparking and the constant speeds.

The use of the automatic controlling devices is increasing. Suitable devices for both variable and constant speed motors are now available, most of them being arranged for push button control. The use of push buttons reduces the chances of injury to both workmen and tools, and makes it so easy to start and

stop the machines that the men will stop them during idle periods instead of allowing them to run and waste power. The automatic starters also have certain protective features which are valuable, most of them opening the circuit on overload.

Another useful practice is being followed in regard to compressed air supply. This is the placing of small motor-driven air compressors in all shops requiring air outside of regular working hours. In this way a small amount of compressed air may be provided without operating the large air compressors in the main power houses.

The use of electrically operated safety devices of a variety of kinds could be extended to good advantage, and a new system for this purpose will soon be placed on the market. This is designed to stop the machinery instantly in case of accident and may be operated from any part of the shop. Automatic fire alarm systems are also being neglected and the risk greatly increased as a result, with no good excuse. This is also worth consideration and improvement.

STEAM TURBINES.

A paper on the Commercial Efficiency and Application of Small Steam Turbines was presented at the Wednesday afternoon session by W. J. A. London and Ashley P. Peck. A brief abstract follows:

As a general rule, the small turbines are applied to the auxiliaries of a plant, such as exciters, boiler feed, circulating and hot well pumps, where the exhaust steam may be used in the feed water heaters or for other purposes; in such instances the efficiency of the turbine may be sacrificed to gain additional reliability, for the ultimate thermal efficiency will be high. Less work is required in the care of these units than in the ordinary reciprocating engines, and they stand considerable hard usage, instances being known where turbine pumps have run while completely submerged in water. As prime movers for generators for power and light the turbine has the advantage of occupying small floor space, requiring little attention and no adjustments during long periods, and maintaining its original efficiency. They may be successfully applied to direct current generators, using 500 volts or less.

In the discussion of this report the question of exhaust or low pressure turbines was considered, and it was pointed out that where there were sudden demands for current presenting several peak loads throughout the day the exhaust turbine was not a valuable adjunct. However, in the case of an evenly loaded plant, such as a manufacturing plant or a railroad shop, an exhaust turbine will prove economical.

INDUSTRIAL LIGHTING.

In a paper on Industrial Lighting by B. F. Fisher, Jr., several important points concerning shop illumination were considered. In the first place, the problem should be very carefully studied as to the location, reflection and power of the lamps. They should be so located as to provide the light where desired and as efficiently as possible. In many old installations a large part of the light is absolutely wasted by being allowed to diffuse too generally over areas where it is not needed.

The arc light and high power incandescent lamp were recommended for general use in rooms with high ceilings, the arc or mercury vapor lamp for medium high ceilings and the mercury vapor and incandescent lamps for low ceilings. In the case of the medium ceiling, the mercury vapor lamp was recommended in preference to the arc when it was desired to eliminate sharp shadows. The proper diffusion of light may be obtained by using the necessary deflectors and by their use the power required for lighting may be greatly reduced. The power of the lamps should be as high as possible to give the desired illumination. Of course, different problems will require different arrangements and numbers of lamps. Cases where shadows are very undesirable will require a larger number of lights than where the shadows are not considered and they will be of less power,

but where it is desired to increase the illumination it should be done by higher power lamps rather than by increasing the number of low power lamps.

The comfort of the employees should be considered. It will be found that artificial illumination at dawn, twilight or gloomy weather will require considerably more candle power than after dark, and shops operating under those conditions should be equipped to give that extra amount of light. Much may be gained by the proper arrangement of the circuits; for instance, where a shop works through from daylight to darkness, as many do in the winter months, the circuits should be arranged parallel to the windows so that at the beginning of darkness the circuit in the center of the shop may be turned on first and so on out to the windows.

Care should also be taken in the original lay-out of a shop to provide for any change in the location of the machinery; in other words, the units should be so located that a machine may be operated with equal efficiency, as regards light, from any angle.

Another important point brought out was that of keeping the lights and reflectors clean and free from dust and dirt, for it is very easy to lose 50 per cent. of the original illumination in this way. A man should be commissioned to keep both the reflectors and the lamps clean, washing them with soap and water, if the full benefit of the lighting system is to be realized. The lamps should be located where they will not become spattered with oil or grease or other dirt.

POSTAL CAR LIGHTING.

A. J. Sweet presented a paper on Postal Car Lighting, in which he mentioned shadows, light in the eyes of the mail clerks, specular reflection, and the intensity of light, as being four important points to be considered. The shadows may be somewhat eliminated by the correct location of the light units. The lights should be high enough so they will not shine in the eyes of the men. The specular reflection may be greatly reduced and almost eliminated by sufficient diffusion of the light and this is best obtained by the indirect lighting system, which, however, has not been found practical in postal car service. The intensity of the light should be at least $2\frac{1}{4}$ foot-candles at the reading height above the floor and $3\frac{1}{2}$ foot-candles would be considered very satisfactory. The efficiency of the illumination of the car will be largely influenced by the type of reflector used on the lamps and the way in which the light is directed to where it is needed. It was shown that with various types of reflectors a light efficiency from 25 to 62 per cent. could be obtained, the 25 per cent. being obtained in the indirect lighting system and the 62 per cent. with the use of a mirror reflector. The illuminated metal reflector was rated at 44 per cent. efficiency and was recommended for use in this service, as it was the only reflector that gave a high efficiency that could be considered practical, as the mirror, the prismatic and the opal reflectors were likely to be broken in cleaning due to rough handling.

Mr. Sweet recommended the 50-watt lamp as giving the best service and being more economical as to wiring, fixtures, etc. He also pointed out that the cost of perfect maintenance will more than pay for itself in the increased lighting efficiency. In other words, it would be much cheaper for the railroads to reduce their factor of safety in the intensity of light and keep the lights well maintained. A system should be inaugurated so that the reflectors to be cleaned may be replaced by reflectors already cleaned; they should be taken from the car and given a thorough washing.

C. M. Reed, chairman of the postal car committee for the Railway Mail Service, mentioned specifications on lighting that are to be presented in the near future. He intimated that a lighting efficiency of $99\frac{1}{3}$ per cent. would be required of all postal cars and that this would be determined from the trip

failures. If a road will guarantee this efficiency, candles will be allowed for auxiliary lighting. If, however, a road does not agree to this efficiency, or if it is found that this efficiency cannot be maintained, an auxiliary lighting system will be required of either oil or gas. Mr. Reed also recommended the single row of lights along the ceiling. On request of several of the members present he agreed to consider instructing the mail clerks to report any defects or items, whereby the efficiency of the equipment may be increased, directly to the inspector by means of a note directed to him and placed in a box in the switchboard locker. The system on the Lehigh Valley was spoken of, whereby the postal clerks leave notices to the inspectors in the switchboard locker and also notify conductors when anything serious is the trouble with the lighting system; in this way it is possible for the conductor to wire ahead for an electrical inspector to board the train and correct the difficulty if possible. It was clearly shown that the postal car committee on the part of the government was ready in any way to help the railroads in maintaining the efficiency of their postal car equipment.

OTHER PAPERS.

Committee reports were also presented on the Train Lighting Practice, Installation of Wiring, Improvements, Standards and Specifications.

The report of the committee on train lighting practice, F. E. Hutchinson (C. R. I. & P.), chairman, included the various methods of operating electric lighted cars, the cleaning of batteries, and reports on electric lighted cars. It was stated that the sediment removed from the batteries should not be thrown away as it could be sold for \$40 a ton. A form of inspector's report was also recommended.

The committee on wiring considered engine houses, machine shops, engine rooms, boiler rooms, storehouses, oil houses, coal sheds, cinder pits, passenger and freight stations. In most every case the wiring was recommended to be run in conduit and that the fittings should be of the standard grades of sherardized or galvanized material. The insulation of the wire should be of high quality rubber, paper or varnish cambric, and all the wiring should follow as closely as possible the National Board of Underwriters' code. It was especially brought out that considerable money could be saved by studying carefully the general problem of wiring.

Under the subject of improvements a report of the several companies manufacturing axle lighting equipment, axle pulleys, belt fasteners, electric meters, ball bearings, generator connectors, lighting systems, storage batteries, car lamps and fixtures, fans, motors, electrical instruments, headlights, ventilating equipment, wire and wiring devices, etc., was presented showing the improvements made in their special lines.

The committee on standards presented its recommendations in contrast to those recommended by the M. C. B. committee on train lighting. In most every case these standards were identical, the exceptions being in the notices required on the switchboard locker, which in the case of the Electrical Engineers, are more complete, and in the M. C. B. recommendation No. 12 was objected to. Also there was a difference of five cents in the labor cost for electrical service; the M. C. B. Association recommended 30 cents, while the Electrical Engineers recommended 35 cents. A consensus of opinion is to be obtained from the members of the association concerning other recommendations which will be forwarded to the M. C. B. committee on train lighting.

Complete specifications were presented on rubber belting for axle generators, rubber covered wire and cables, and incandescent lamps which were referred to letter ballot.

A paper was also presented by N. W. Storer, general engineer, Westinghouse Electric & Manufacturing Company, on Electric Traction, an abstract of which is presented elsewhere in this issue.

OTHER BUSINESS.

The following officers were elected for the ensuing year: D. J. Cartwright, electrical engineer, Lehigh Valley, president; C. R. Gilman, chief electrician, Chicago, Milwaukee & St. Paul, first vice-president; H. C. Meloy, chief electrician, Lake Shore & Michigan Southern, second vice-president; Joseph A. Andreucetti, general foreman, Chicago & North Western, secretary and treasurer. The following executive committee was also elected: L. S. Billau, assistant electrical engineer, Baltimore & Ohio; E. W. Jansen, electrical engineer, Illinois Central; F. E. Hutchinson, chief electrician, Chicago, Rock Island & Pacific; C. J. Causland, chief electrician, Pennsylvania Railroad; Willard Doud, shop engineer, Illinois Central, and W. A. Del Mar, electrician, New York Central & Hudson River. The next annual meeting will be held in Chicago, and the semi-annual meeting in Atlantic City.

HEAVY DUTY 18-INCH LATHE

A powerful engine lathe which, while having no particularly new features of a general nature, is an excellent example of the modern tool for heavy duty is shown in the accompanying illustration. This machine has been designed and is built by the Mueller Machine Tool Company, Cincinnati, Ohio. It is strong and rigid in every particular, and the most modern types of speed and feed changing devices have been provided. The standard machine is provided with a three-cone belt drive and has double back gears of the slip gear type, the changes being made through the medium of a lever conveniently placed at the front of the machine. The back gear ratios are $3\frac{1}{2}$ and $10\frac{1}{2}$ to 1. There are nine spindle speeds ranging in geometrical progression from 13 to 300 and the screw cutting arrangement

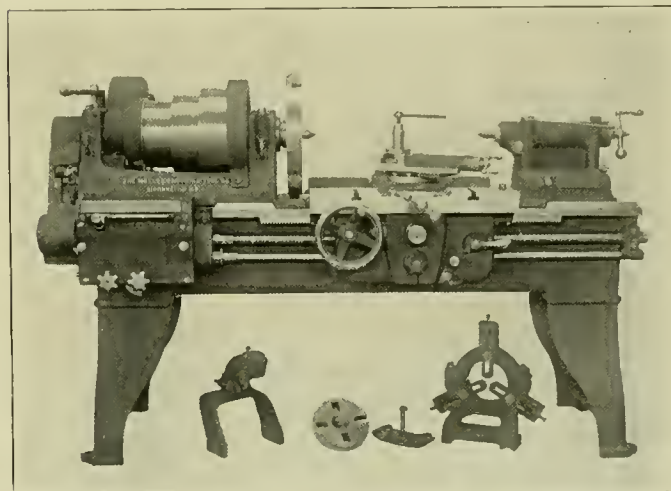

New Mueller 18-in. Lathe.

provides for 45 changes of thread, ranging from two to sixty, including the $11\frac{1}{2}$ in. pipe thread. These are all obtained within the quick change gear box and a chasing dial on the carriage permits the catching of threads at any point without stopping the machine. The feeds are all positively geared and can be started, stopped or reversed in the apron or head, for either a cross or lateral feed motion, only when the lead screw nut is disengaged.

To prevent the bottom slide on the carriage from overhanging its bearings when large diameter pieces are being turned, both the tailstock and headstock are set off center. The machine will swing $18\frac{1}{2}$ in. over ways and $13\frac{1}{4}$ in. over the carriage.

All materials used are those which have been decided to be the best for the different purposes after long experience in lathe building. All gears in the gear box, and many others throughout the machine, are of steel cut on special cutters and

all are completely covered. The spindle is of carbon crucible steel and runs in phosphor bronze bearings. The cast iron parts, including the bed, have the metal distributed in the most effective manner to resist the strains imposed.

This lathe will turn a length of 2 ft. 4½ in. between centers; has a 6 ft. 3¼ in. bed and weighs 3,200 lbs. A motor drive or a longer bed can be obtained if desired.

GRAVITY COUPLER CENTERING DEVICE

A device for centering couplers which does not require the aid of springs is shown in the accompanying illustrations. It includes a cast steel carry iron of much the same form that is now generally used in steel freight cars, the essential difference being that there are two concave recesses cored in the center.

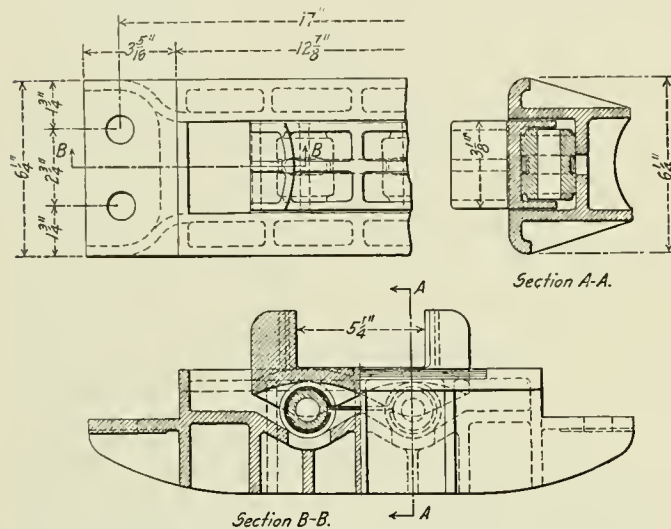

Powers' Gravity Centering Device for Couplers.

Two cast steel rollers connected by a bar, rest in these recesses and on them rests the carriage that carries the shank of the coupler. It is evident that when the coupler is off center on either side it will be lifted up and its weight will tend to force the rollers to the bottom of their cavities and thus return the

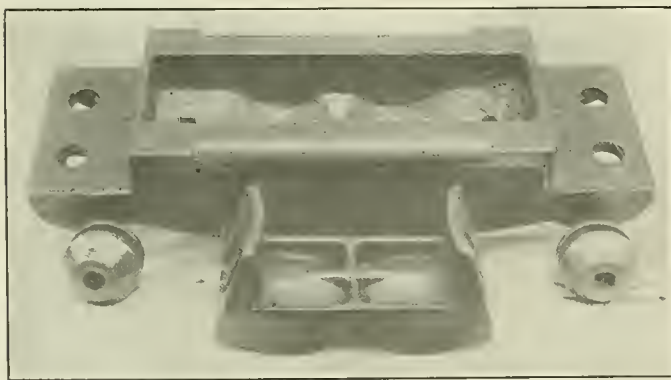

Details of Gravity Centering Device for Couplers.

shank to the central position. This device adds but about eighteen pounds to the weight of the car. It is evidently durable and not subject to either wear or disarrangement. It has been patented by Robert E. Powers and is furnished by the Powers Gravity Company, Montreal, P. Q.

NEW JERSEY RAILROAD VALUATION.—The valuation of railroad property in New Jersey has been increased \$38,000,000, making a total of \$324,541,117. The taxes will amount to \$6,183,530.

STEEL PASSENGER CAR PAINTING*

BY J. W. LAWRIE,

Manager, German-American Chemical Works, Milwaukee, Wis.

Paints for steel have different functions, in many respects, than those for wood. In painting steel we have the absorption into the pores to only an extremely limited extent, compared to that which we have in painting wood. For this reason there must be some other way adopted for getting the strong clinging effect that the pores of wood afford as an anchorage for the paint coats. It is almost necessary to assist an oil paint with something which is a better adherer to steel than linseed oil. For this reason a certain amount of varnish is found in all steel primers. At the same time the pigments which have answered for wood may or may not do for steel. It has been established in a practical way, as well as experimentally, that the fewer the number of paint coats on steel, which will give the maximum protection, the longer wearing and better service will the paint coating give.

The pigment must give the color and shade desired, opacity and thickness of film; it affects the life of the paint, both by its actinic action due to its color absorption, etc., and its chemical effect on the oils or vehicle. It should be such as to give the maximum inhibition of corrosion on the steel. Corrosion itself may be due to several factors. Moisture must be present for continuous corrosion; acid, gases and oxygen assist, and any free acid, such as is used in pickling steel, is a strong inducer of corrosion. When these causes are considered an attempt to get ways of overcoming their effects and so approach perfect inhibition of corrosion can be made. It must be borne in mind, however, that inhibition of corrosion is only one of the desirable qualities of a paint for steel.

There are essentially two or perhaps three great classes of pigments as regards their effect on steel. These classes can be called the electrical, the chemical and the passifiers. Examples of the passifiers are the chromates, which seem to render the steel immune to oxidation.

In line with the electrolytic theory of the corrosion of steel, the differences in electrical potential produce a current of electricity in the direction of the high to low, or positive to negative. The different pigments show considerable difference in their relation to steel, and for this reason if pigments are used which are positive to steel, then in any flow of current the positive material would go into solution and the negative material, or, in this instance, the steel, would be protected. Such pigments would therefore be inhibitors of corrosion of steel. Those of the same potential, or neither positive nor negative to steel, would be neutrals, and those negative would be accelerators.

The chemical pigments are those which through their particular chemical properties, such as acidity, either direct or through hydrolysis, neutrality, or alkalinity, affect the steel so as to inhibit or accelerate corrosion. It is practically established that there is a minimum alkalinity below which there is no inhibition, and also with too strong alkalinity the action of the pigment on the vehicle oils is so pronounced that such pigments are detrimental to the life of the paint. Practically all pigments belong to both the electrical and chemical classes. A pigment may be positive to steel, and yet in itself, or by hydrolysis, be so acid in action that instead of being, as would be expected, an inhibitor, it is, instead, a strong accelerator of corrosion. In the same manner, a negative pigment may be sufficiently alkaline as to become an inhibitor. Many pigments are both positive and alkaline, and therefore extremely good inhibitors. Others are neutral, either through opposing electrical and chemical properties (as applied to inhibition, etc.), or are neutral of themselves in all respects. Again, other pig-

* Abstract of a paper presented at the Eighth International Congress of Applied Chemistry, held in New York, September, 1912.

ments are negative and acid, and so strong accelerators. There are, of course, all grades and stages in these valuations. It is, however, possible by test to identify the different properties of the different pigments and combinations of pigments, and so classify them as to their actual value for inhibiting corrosion.

It is possible to measure directly differences in potential between pigments and steel, and also the relative acidity or alkalinity, either as a direct property or as one produced by hydrolysis. These tests can be applied directly to most pigments, but not to all. There is one test which may be considered final and fair. That is, an actual exposure test of the pigments combined into paints and applied to steel panels under different exposure and weather conditions. It must be admitted at once that such tests are not absolute, but their relative value cannot be disputed. It is impossible from the results of such tests as those at Atlantic City to say that the American vermilion is 10 times as good a pigment as some other pigment which would be rated at 1. The relative fact is that American vermilion is a first-class inhibitor of corrosion, whereas the paint rated at 1 is not an inhibitor and is probably one of the negative pigment paints, and therefore an accelerator.

The writer has been experimenting for a long time with the so-called razor blade test for both pigment and vehicle. The test is made by completely separating the pigment from the vehicle by solvents and the centrifuge, so that there is no trace of the vehicle left with the pigment. The pigment is then re-ground until all of it passes through a 100-mesh sieve. It is then made into a stiff paste, with water, spread out on a square of filter paper and the emiered razor blade is wrapped up in the pigment in such a manner that the pigment is in intimate contact with the surface of the blade all over. The wrapping up of the blade properly has much to do with the success of the experiment. The blades are left for about 21 days, being kept moist all the time. They are then cleaned, re-weighed, and the loss in weight, together with the appearance of the blade, gives the value of the pigment for steel protection. The results so obtained have been followed with outdoor exposure panels, and the conclusions arrived at from the razor blade test check with wonderful accuracy the results obtained by exposure. As examples of these checks the relative values placed on some of the Atlantic City steel panels and the losses on the razor blades are given as follows:

| | Loss Razor Blade. | Atlantic City rating. |
|---------------------------|----------------------|--------------------------|
| American Vermilion | .0005 | 10 |
| Sublimed White Lead | .0015 | 9 |
| Corroded White Lead | .0247 | 2½ |
| Red Lead | .0003 | 9 |
| Zinc Chromate | .0004 | 9 |

Tests on over 200 different pigments and mixtures of pigments have been made with the exposure test for a check. The results indicate that when properly carried out the blade test is reliable and of great value where time is such an important factor as in large testing laboratories.

In like manner the vehicle can be tested for its value as a resister of moisture and gases. The emiered and weighed razor blade is dipped into the separated vehicle and given two coats, with proper drying intervals. The blade is then subjected to alternating treatments with water and moist sulphur dioxide, and carbon dioxide gases. This treatment is continued for a period of 11 days. The blades are then cleaned and re-weighed. The appearance and loss in weight give the relative value of the vehicle as a resister of moisture and gases. Here the filmometer may be used with great success. This particularly where tests are made on paints from competing companies, and designed for the same purpose. The test of the resistance of the film to acid and gas penetration is of extreme importance. We have in railway service to contend with sulphur dioxide and carbon dioxide gases, as well as an almost continuous presence of moisture. For this reason the paint must be able to exclude these gases and moisture. This exclusion depends largely on the nature of the vehicle. Straight

linseed oil or soya bean or other like oils, will not exclude completely. If, however, a gum varnish is added to the oil the porosity is largely stopped. This, of course, is more or less perfect, according to the amount of varnish used, its kind, etc. At the same time the physical condition of the pigment must be considered, as too coarse a pigment will practically always leave a porous film. Too much varnish on the other hand, especially in a priming coat, will leave a glossy surface, to which the second coat will not adhere well. At the same time it is well established that varnish will not carry a large amount of pigment and give successful outdoor surface. It is for this reason that there have been so many failures with the so-called "quick process methods" of finishing steel cars.

Many tests have been made to establish the value of baking the paints on steel cars. Our results and practical experience, based on these tests, have shown that the life of the baked paint on steel is prolonged wonderfully and also the adherence to the steel itself is very much better. At the same time the baking has the additional value of making the vehicle much more impervious to moisture and gases than the same vehicle unbaked. Numerous experiments with certain kinds of vehicles baked gave a resistance in this way of almost three times that of the same vehicle unbaked. The mechanical difficulties of baking an entire car are large. In this respect, the removable sheathing of the modern Pullman is of a decided advantage, as it can be readily taken off, the paint removed, the sheathing re-painted, baked and placed back again on the car as before. There are some other difficult problems involved in the baking of the paint. It is the best practice at the present time to bake the surfacer. This baking produces an extremely hard and brittle coat. Up to the present, when it is necessary to refinish such a car, no chemicals have been found which will successfully remove this baked surface. It is, however, possible to remove all coating over the surfacer and then rebuild up again in the regular manner. Here again the problem of baking the entire car is paramount and so far the problem has not been solved with entire success.

The baking temperature and length of time baked have a great deal to do with the life service of the paint. In general, the lower the temperature and the longer the time the paint is baked, the better the wear, service and resistance to moisture, and the more elastic the film. Twelve hours at 180 deg. F. are better than five hours at 280 deg. F.

There is no longer any argument with regard to the preparation of the steel for painting. Wherever possible sandblast. Pickle only when no other means are available to remove scale and rust. Pickling with sulphuric acid gives under the usual factory methods the best accelerator of corrosion of any agent met with in regular railway service. Capillary attraction is an extremely powerful force. The sulphuric acid by this force enters the spaces between the crystals of the steel and is held very tenaciously. A mere dipping in a bath of water or several baths of water fails to remove all the acid and with the hydroscopic nature of sulphuric acid an ever-increasing area of steel is subjected to acid action. The whole sheet begins to corrode under the paint coat. Even with a paint which is inhibitive and moist-proof such action will soon destroy these valuable properties. The action of the acid is cyclic and almost unending. Ferrous sulphate is readily converted to ferric sulphate and with moisture to ferric hydrate. Under these conditions the ferric hydrate is precipitated out of solution and does not re-act further with the acid. The acid is re-generated and again re-acts with the steel, etc. The ferric oxide formed is electro-negative to steel and with moisture and acid a current is established, carrying iron ions from the steel into solution. These are precipitated out as more ferric hydrate or oxide and so again the action proceeds ad infinitum. It would be better to pickle with hydrochloric acid than with sulphuric acid even at a higher cost, because this acid is not hydroscopic; it is volatile at a low temperature and its capillary force is small

compared to that of sulphuric acid. If it is necessary to pickle with sulphuric acid, then wash with a stream of hot running water, so as to overcome by heat, force and dilution the capillary strength of the acid. Treat with lime water and wash again, dry and oil.

There is one feature of steel car building that is generally neglected. The outside surface of the steel is taken care of in a more or less respectful manner, but the inside of the sheet is usually given a coat of slush paint and the scale is seldom removed. Oil may be on the surface, or rust already formed. This treatment is certainly to be condemned. The inside of the outside and the outside of the inside sheets form a box with little ventilation, but usually holding a great deal of moisture. The paints used are seldom good resisters of moisture, and as a result corrosion starts and is aided by the conditions until there is often danger that the inside of the sheet will corrode through before the paint on the outside has seen decent service. As color is of no interest in this case it is easily possible to apply a good inhibiting and moisture resisting paint on these unseen sides of the sheets of steel and so prolong the life of the car very much. It is also a matter of general safety to properly paint this material, as it is impossible to get at the surface for repainting after the car is in service.

Where molding abuts on steel sheets it is usual to interpose sheet copper between the two pieces of steel. This is to produce as near a water tight joint as possible. The fact remains that the joint is never entirely water tight. Copper is electro-negative to steel and the steel therefore goes into solution and rapid destruction takes place. Aluminum, on the other hand, is electro-positive to the steel and so it goes into solution and saves the steel. It soon coats over with oxide and thus the reaction is largely diminished. The steel itself is entirely protected.

There are several essential properties which should be possessed by the different kinds of paint used on steel. The usual procedure is first, sandblast, next prime, and follow usually with a second but different primer; then filler and surfacer, color and varnishes. The essentials of a good first primer or first coat of paint on steel are that it adhere well to the steel, present a good surface for the second coat, and that it have a pigment that is a good inhibitor of corrosion. It is not essential that the vehicle be altogether gas and moisture proof, although it is better so. The second coat should adhere well to the first one. It should be primarily a paint that is a good excluder of gases and moisture. It does not have to have a strongly inhibiting pigment, but it is better with such a pigment. It is usual after the application of the fillers and surfacers to rub down to a smooth finish with water and pumice. This treatment requires undercoats, which will resist the water, and next to the steel a pigment that will prevent corrosion, even if some moisture gets through the outer coats. It has been possible to get better results from two coats instead of a single primer combining all qualifications. It is more practical also to get the resistance to moisture by making both coats moisture proof than by depending on the second coat alone.

The fillers or surfacers are designed to give a film such that it can be rubbed down to a smooth surface without tare and still be flexible. Most of them are fairly brittle and all of them are hard. The brittleness is increased with the baking. It is, however, possible to make a surfacer which will be hard enough to rub well and still be very elastic. Such an elastic surfacer will give to the paint coats as a whole much better wear and freedom from checking than a more brittle and non-elastic surfacer. The coats of color, etc., following the fillers are never or seldom baked. It is very difficult to hold the shades and finish constant when we bake the finishing color coats and varnishes.

HIGH FLYING.—Georges Legagneux, flying in a Marane monoplane September 17, rose to a height of 18,372 ft.

DENSITY OF LOCOMOTIVE SMOKE IN CHICAGO.

The average locomotive in the city of Chicago at the present time is making smoke the density of which is 14.92 per cent., according to records compiled by the engineers of the Chicago Association of Commerce Committee on Smoke Abatement and Electrification. This shows a decided improvement over the conditions recorded by the city smoke commission three years ago, when the average density was reported as 23.3 per cent. The percentage gives the ratio of actual performance to worst possible performance; that is, if a locomotive emitted dense black smoke all the time this record would be reported at 100 per cent. If it gave out no smoke at all the percentage would be zero. The figures give the results of innumerable observations covering the entire city, designated as Zone A, and also a zone beyond the city limits, designated as Zone B.

The committee's records covering all observations of locomotives are as follows:

| | |
|--|-----------------|
| In terminal yards and round houses. | |
| Zone A (52 locations)..... | 11.77 per cent. |
| Zone B (14 locations)..... | 18.97 per cent. |
| Zones A and B combined..... | 12.56 per cent. |
| In general service. | |
| Zone A (comprising 141 divisions)..... | 19.31 per cent. |
| Zone B (comprising 91 divisions)..... | 26.02 per cent. |
| Zones A and B combined..... | 21.12 per cent. |
| In yard service. | |
| Zone A (71 yards)..... | 16.7 per cent. |
| Zone B (27 yards)..... | 23.4 per cent. |
| Zones A and B combined..... | 18.2 per cent. |

The total average in Zone A is 14.92 per cent. The average for Zone B is 19.12 per cent.

The grand total for Zones A and B is 16.42 per cent, which is the average density of locomotive smoke in the entire field covered by the investigations.

While figures are not available for an exact comparison, the recent reports of city smoke inspectors give even lower averages of smoke production, but the higher figures of the committee's engineers are held to be the result of a more exhaustive investigation, substantiated by voluminous records giving one minute interval observations for every half mile of track in the territory under surveillance.

The method of the committee has been to station its observers at an average distance of one-half mile apart along the line under observation at a particular time. Every effort is made to keep the knowledge of the presence of the observers from the enginemen, lest such knowledge have the effect of causing temporarily improved performance. The observers make records every minute of each locomotive in sight, and in this way a train going the entire length of the line is in turn observed by each observer stationed along the line.

The average density of smoke from stationary stacks in the city limits was reported as 10.27 per cent.; outside the city limits 25.97 per cent.; total average 13.08 per cent.

Steam vessels in Zone A are reported at 14.64 per cent.; in Zone B, 26.82 per cent.; the total average being 15.47 per cent.

POWER REQUIRED TO DRIVE ENGINE LATHES.—The following formula for the power required by engine lathes was reported by a committee of the Association of Railway Electrical Engineers at its recent annual meeting: Horse power = feed in inches × depth of cut in inches × inches cut per minute × number cutting tools × constant for material.

The constants for the various metals are as follows:

| | |
|--|------|
| Brass | 0.1 |
| Cast iron (soft)..... | 0.3 |
| Wrought iron and cast iron (hard)..... | 0.35 |
| Mild steel | 0.4 |
| Medium steel | 0.5 |
| Tire steel | 0.6 |

HEAVY FROG AND SWITCH PLANER

A new design of 36-in. frog and switch planer has recently been placed on the market by the Cincinnati Planer Company, Cincinnati, Ohio. The chief difference between this planer and the previous designs is that it is driven by a 50 h. p. motor mounted on top of the housings, and driving a countershaft with four 34-in. aluminum alloy pulleys. A massive frame supports the upper and lower shaft bearings holding them rigidly, so that there will be no spring while the heaviest cut is being taken. Four inch belts are used. The V-ways have a force feed lubrication which keeps a film of oil between the bed and the table at all times.

In other respects, the machine is similar to this company's

device and the levers are so arranged that the machine may be operated from either side. The driving shafts are large in diameter, and are made from special crucible steel. The driving pulleys are so constructed as to require oiling only once in sixty days. The bull wheel and rack are unusually large, having a 12-in. face and $1\frac{1}{2}$ -in. pitch.

TWENTY-FOUR INCH SHAPER

In response to the demand of steel mills, railroad shops and drop forging shops for a shaper which will develop the full capacity of high speed steel tools on the heaviest class of work, Gould & Eberhardt, Newark, New Jersey, have designed a new

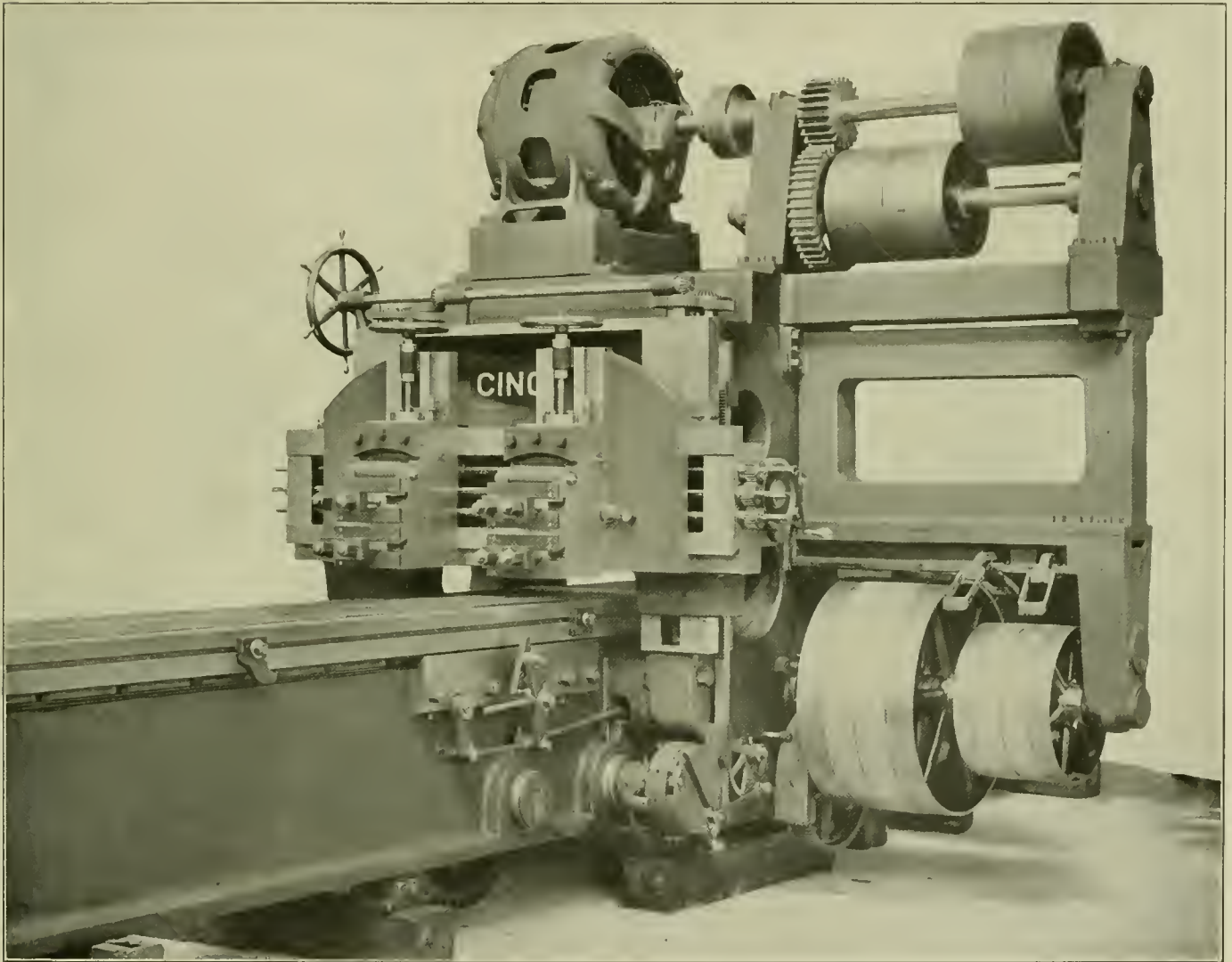

New Design of Cincinnati 36-Inch Frog and Switch Planer.

previous 36-in. planer having a 32-in. table, housings with a 10-in. face, a 20-in. cross-rail, automatic cross and vertical feed heads and solid crucible steel rack and gearing. The table has an inside bearing on the bed, for its entire length, for resisting the side pressure of heavy cuts. Adjustable steel gibs are provided on each side to prevent lifting. The housings are secured to the bed by large bolts and dowel pins and a tongue groove $1\frac{1}{2}$ in. deep by 5 in. wide. The cross-rail is secured to the housings by an extra set of clamps on the inside, in addition to the usual outside set of clamps. If desired, the cross-rail may also be fastened to the housings at various heights by large dowel pins. The belt shifting mechanism is provided with a safety locking

24 in. shaper which is designated as the Invincible type. A new patent construction permitting the position of the main bull gear to be raised considerably has been included in the design. This in itself has greatly increased the machine's mechanical efficiency, but in addition, there are a number of other new features, among which may be mentioned the increasing of the diameter of the bull gear hub from $3\frac{3}{4}$ in. to 6 in.; the increase in the size of the V bearings and gib which are arranged so that there is a solid metal to metal contact on each side of the ram bearing, and a reduction in the overhang of the crank pin. The crank pin thrust is taken by solid walls in the bull gear, no straps or bolts being used. There is a new front table support of much

heavier construction and the machine throughout has been made considerably more massive than the standard machine.

In raising the center of the bull gear, which is now $4\frac{1}{4}$ in. higher than in the standard 24 in. machine, the fulcrum of the lever was not changed and thus the working arm of the main lever is lengthened in relation to the load arm, greatly increasing the power of the ram. In making this change the whole bull gear construction was re-designed.

Two or three years ago a test was made on two Gould & Eberhardt shapers at the University of Michigan, one machine having a V gib ram and the other a square gib ram. The report on these tests stated that the V form of ram was superior in all but one of the points investigated. In the horizontal deflections the square machine had an advantage, but in vertical deflection, wear, general efficiency and convenience, the V shape showed a marked superiority. On the basis of this report the gib on the new machine has been given an angle of 55 deg. instead of 45 deg. previously employed and is able to better withstand the horizontal strains without losing any of the advantages of the V type bearing for vertical strains. At the same time a new construction of gib bearing, which allows a solid metal

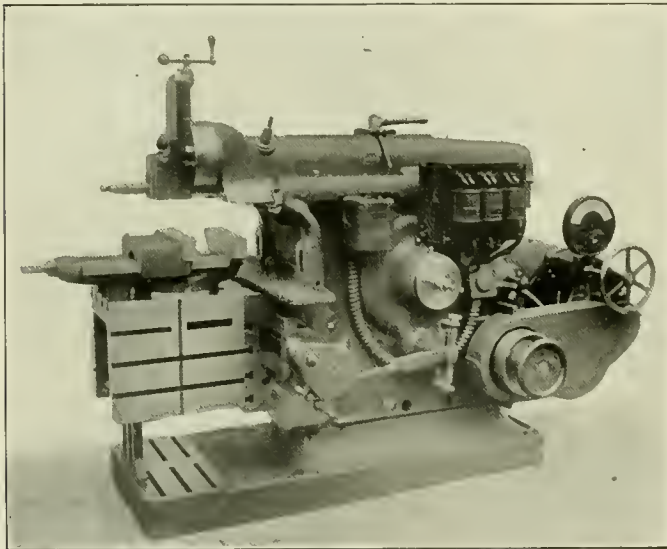

Gould & Eberhardt Shaper, Invincible Type.

contact on both sides of the ram bearing, has been adopted. The taper gib is in two parts and may be adjusted from the side, near either the front or back. This adjustment is obtained by means of set screws between the ram bearing and the solid bearing in the frame.

In connection with the construction of the bull gear the overhang of the crank pin was considerably reduced, which further increases the efficiency under heavy cuts. The crank pin is held to the large bull gear by solid V ways, similar to the bearings of the ram. The ratio of the patent "double train gear drive," used on these machines, has been increased by giving the shaper a greater initial speed and increasing the ratio of the gearing. This gives more power to the machine in both single and back gear. The ratio in single gear is 6.64 to 1, and in back gear, 32.06 to 1. Careful attention has been given to the oiling systems for the various moving parts, and ample metal is provided in all of the vital parts to give them the required stiffness. The shaper weighs 4,800 lbs., and is shown in the illustration with a direct connected Reliance variable speed motor, automatic starter and Dynamic brake control.

LOCOMOTIVE REPAIRS.—The Pennsylvania Railroad is now employing in its locomotive repair shops an average of 2.7 men for each locomotive owned.

VERTICAL CHUCKING MACHINE

A machine suitable for handling all classes of work requiring a chuck, such as bushings, car wheels, gears, etc., as well as some work which is generally done on a vertical boring mill, has been designed by H. Bickford & Company, Lakeport, N. H. Machines of this type have an advantage over a lathe, particularly on heavy work, since the force of gravity is an aid in centering rather than a hindrance, and the greatly increased rigidity of the tool spindle over the tool post permits the use of much heavier cuts at a higher speed. Because of its simplicity, it is possible to produce a machine in this form, of high class workmanship, which can be sold at a low price.

Most of the features of construction are clearly shown in the

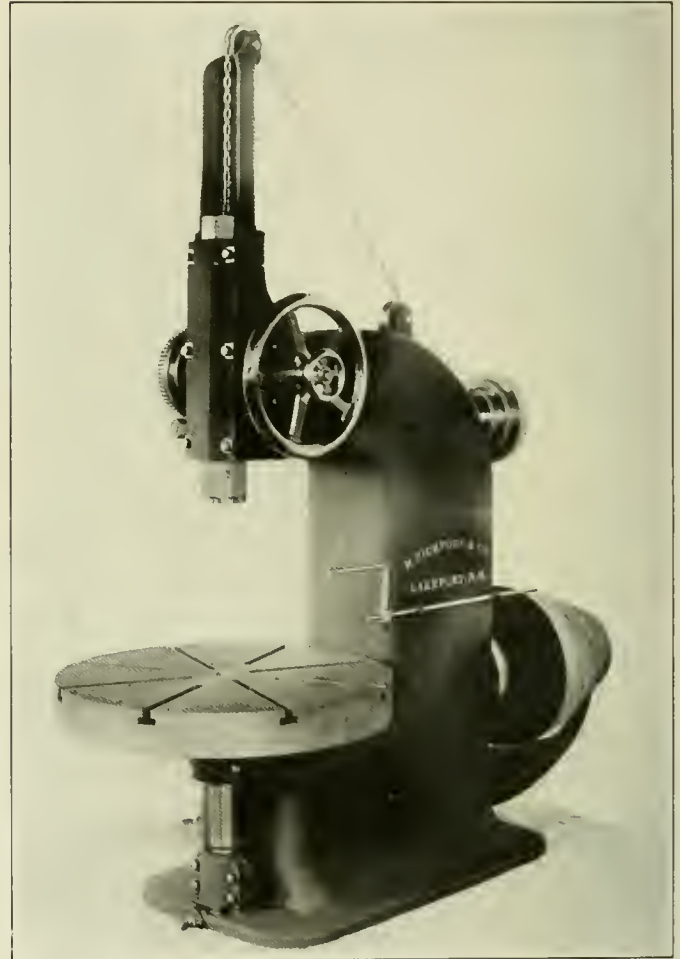

Special Vertical Machine for Chucking Work.

illustration; the tool spindle is octagonal in shape, measuring 5 in. across the flats, and is counterbalanced by a weight inside the frame. The power feed is operated by a large friction worm gear running in oil, which is driven by a feed shaft connected with the main driving shaft by a $1\frac{1}{2}$ in. belt on four-step cone pulleys, giving four feeds.

The table is supported by a large spindle fitted with two large, easily accessible bearings. An adjustable, hardened and ground steel step submerged in oil carries the weight of the table and resists the thrust. The table is driven by planed beveled gears and the driving shaft has three long bearings.

The machine will take work 37 in. in diameter and accommodates a height of 23 in. under the spindle. The spindle has a total movement of $29\frac{1}{8}$ in. and the machine occupies a floor space of 7 ft. 6 in. by 3 ft. $1\frac{1}{2}$ in. The extreme height is 8 ft. $5\frac{1}{4}$ in.

with others of the proper thickness, all without dismantling any other part of the locomotive.

The flangeless shoe and wedge are also shown in one of the illustrations, and consist simply of blocks of machinery steel of the same shape and size as the usual shoe and wedge, but without the flanges. Flat pieces of cold rolled, case hardened steel of the proper thickness and width are riveted to the frame jaws to take the place of the flanges. The shoe and wedge blocks are made slightly narrower than the total width over the flanges. This construction makes the labor cost of machining comparatively small and also does away with the constant breakage of flanges. The rivet holes in the plates and the frame are drilled to a jig and extra plates can be carried in stock and be quickly applied. In connection with the flangeless shoe and wedge, part of the inside flange on the wedge side of the driving box is removed and the wedges can be taken out and lined without dismantling any other part of the locomotive.

The removable driving box brass in its earlier form was illustrated in these columns,* and the latest construction is shown herewith. It consists simply of turning the outside of the crown brass 1/32 in. smaller in diameter than the box fit, slotting off one edge of the brass with a taper of 3/8 in. per ft., and installing a suitably shaped steel wedge of the proper thick-

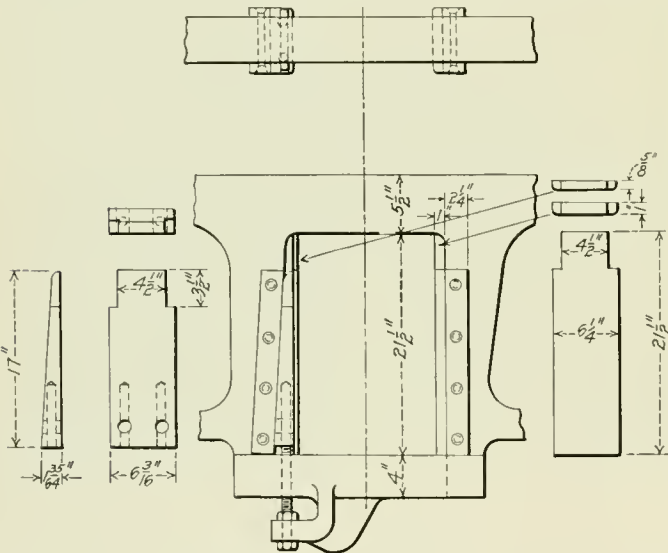

Flangeless Shoe and Wedge.

ness to give a driving fit of at least 15/8 in., which will produce a pressure between the brass and the box equal to that obtained if the brass was forced in under an hydraulic pressure of 30 tons. The wedge has a lip and is secured to the box by a 5/8 in. stud bolt having a lock nut. As a further safeguard to prevent all possibility of the brasses coming out in case the wedge is broken or works loose, a tapered key is dropped in between suitably cast lugs on the box above the brass and projects over the end of it for a distance of 1/2 in.

Boxes arranged for use with removable brasses are all carefully slotted with jigs, and the wedges, keys, etc., are all standard and interchangeable. Special jigs are provided for boring the brass, which is done before it is applied to the box. The success obtained from the use of these jigs and standard parts has been such that it is practically never necessary to refit the driving box cellar because of the legs of the box being sprung too much, or too little.

LARGE FORCE ON CAR REPAIRS.—The Pennsylvania Railroad is now employing 11,500 men on repairs to freight cars. This is one man for every thirteen cars owned by the company.

*See American Engineer & Railroad Journal, May, 1911, page 188.

ELECTRIC SPEED INDICATOR

A properly constructed magneto-generator will produce a voltage that varies directly as the speed of its armature, and when such an instrument is connected to a revolving shaft through a belt or gearing and the circuit is closed through a direct current voltmeter, the scale of which indicates revolutions per minute instead of volts, a thoroughly reliable speed indicator is obtained. The scale on the voltmeter can be made to read the number of revolutions of the armature shaft and the percentage reduction or increase given by the belt or gearing can be used as a corrective factor, or different scales can be applied to the meter, and the speed may be obtained direct. Speed indicators of this type have a wide field of application, particularly as the meter can be placed in any desired distant location. In addition to revolutions per minute, the scale on the meter can be made to show feet per minute, percentage fast or slow, cycles per second, miles per hour, etc.

By the use of a graphic recording meter a complete record of the operation of the train or machine is possible, and in this form it is particularly applicable to locomotives. A magneto-

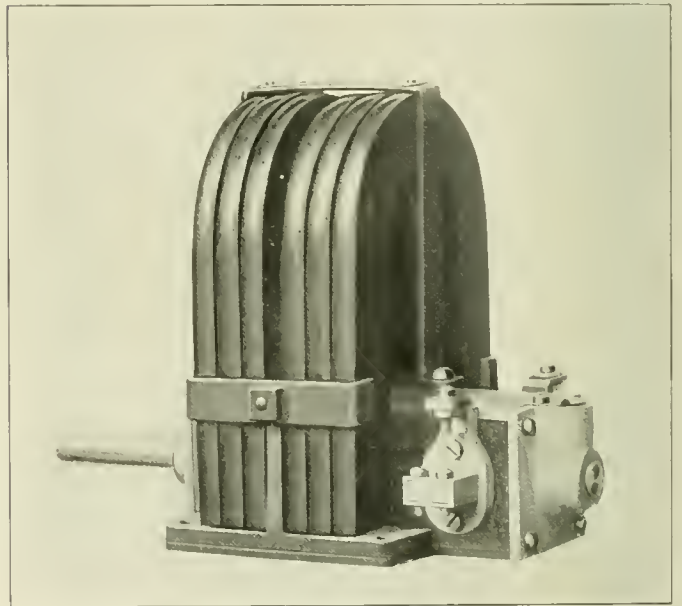

Magneto-Generator Arranged as a Speed Indicator.

generator designed for this purpose and shown in the illustration, is manufactured by the Holtzer-Cabot Electric Company, Chicago, Ill. It is especially arranged for use with meters manufactured by the Westinghouse Electric & Manufacturing Company, Pittsburgh, Pa. This instrument is small, having over-all dimensions of only 6 in. x 10 in. x 10 in., and is strongly constructed.

EMPLOYEES' LIFE INSURANCE.—A workman who has been in the employ of the Michigan Stove Company, Detroit, Mich., for thirty days, has his life insured by the company without cost. Married men are insured for \$500 each and single men for \$250. This is the second corporation to take out such policies and the first manufacturing company.

TELEGRAPHY.—The number of miles of telegraph owned and the number of telegrams transmitted by the Western Union Telegraph Company in recent years has been as follows:

| Year. | Miles. | Telegrams. |
|-----------|---------|------------|
| 1907..... | 205,646 | 74,804,551 |
| 1908..... | 208,477 | 62,371,287 |
| 1909..... | 211,513 | 68,053,439 |
| 1910..... | 214,360 | 75,135,405 |
| 1911..... | 219,219 | 77,780,732 |

MILLING CUTTER, REAMER AND DRILL GRINDER

A new tool used for grinding milling cutters, reamers and drills has recently been placed on the market by the Wilmarth & Morman Company, Grand Rapids, Mich. It is driven by a one-horsepower motor and will grind face and side milling cutters up to 12 in. in diameter; straight or tapered reamers up to 17 in. long with flutes not over 11½ in. long; angle milling cutters with any angle up to 8 in.; plain milling cutters of any type up to 8 in.; gear cutters up to 5½ in.; hobs up to 5½ in.; forming

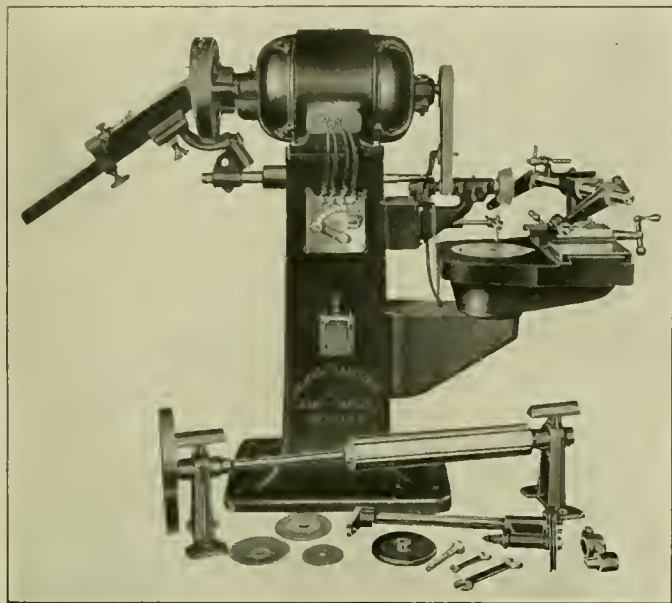

New Milling Cutter, Reamer and Drill Grinder.

cutters of any length up to 5½ in. in diameter, and flutes or taps up to 11½ in. long. The machine will take either straight or tapered cylindrical work up to 7¼ in. in diameter and 11½ in. long. The distance between the centers is 17 in. and holes can be ground in tunnel work up to 4 in. deep and of a 10½ in. swing. The drill-grinding attachment is the regular New Yankee non-calipering type, which only requires the drill to be placed in the holder to have it properly adjusted for grinding.

LONG DISTANCE TRUCK RIDER.—On the arrival of a sleeping car from Bukarest, Roumania, at one of the Paris stations, a youth of 20 was found on the trucks underneath who had ridden all the way for 36 hours in that position without food or drink, and was so coated with dust and dirt that it required a resort to the station water supply to make out what sort of an animal he was.

CORROSION OF STEEL PASSENGER CARS.—"In an experimental way the use of calcium chloride applied in fixed receptacles between the outside and inside sheets of steel passenger cars would be worth trying, since it is a powerful moisture absorbing agent and will not harm steel or metals. In all cases the inside finish ought to be applied as tight as possible and all fissures closed."—*A. Copony before the Canadian Railway Club.*

TRANSPORTATION OF CUT FLOWERS IN FRANCE.—The export of fresh cut flowers from the south of France has increased to such an extent that the Paris-Lyons-Mediterranean Railway has been running a special train since October, 1911, to further assist the florists. All the cut-flower cars are assembled at Marseilles and are then directed to their destinations by express. The inauguration of the special train service has considerably shortened the time of transport.

GENERAL NEWS

The roundhouse of the Atchison, Topeka & Santa Fe at San Angelo, Tex., was destroyed by fire on the morning of October 16; estimated loss, \$50,000.

The Missouri Pacific has completed the transfer of its hospital property and funds to an organization of its employees. The cash turned over to the men by the company amounted to \$193,768.

The Memphis, Dallas & Gulf has been sued to the amount of \$1,800 for violations of the safety appliance laws. A suit has also been filed against the Chicago & South Bend at Indianapolis, Ind., for the same reason.

The Chicago Great Western has posted notices in their shops at Oelwein, Ia., as follows: "Unless you are willing to be careful to avoid injury to yourself and fellow workmen don't ask for employment; we don't want careless men in our employ."

A copy of the new manufacturers' standard flange fittings which became effective October 1 may be had by addressing W. H. Douglas, secretary, Committee of Manufacturers on Standardization of Fittings and Valves, 30 Church street, New York.

At an exhibition of drawings at the Toronto Exhibition, the apprentices of the Grand Trunk at Stratford, Ont., took six prizes for mechanical drawing, getting a total of \$32 out of \$40. The remaining \$9 went to the apprentices from Point St. Charles, Que.

The use of the common drinking cup has been prohibited on all interstate railroad trains by a quarantine order issued October 30, by the Secretary of the Treasury. The order was made on the recommendation of Surgeon-General Blue of the Public Health and Marine Hospital service.

The arbitrators who are considering the question of the wages of locomotive enginemen on the eastern roads have resumed their sittings after a recess of a month. It is not expected that a decision will be issued before the middle of next week, the statistical examinations, which are a part of the board's investigation, being still unfinished.

At the annual meeting of the Erie Employees' Relief Association held September 17 at Salamanca, N. Y., a total membership of 3,400 members was reported. The treasury balance to October 1, 1912, was \$21,148.76. This association is purely a mutual benefit organization. It has no compulsory fees and is composed entirely of employees of the Erie system in all departments of the service.

The articulated car, which was recently mentioned as being in service on the Boston Elevated Railway, consists of two 4-wheel passenger cars connected by a central compartment which rests on the ends of the two cars and is used only for entrance and exit purposes. The car will traverse 35-ft. curves and is adapted for the pay-as-you-enter feature, the conductor being stationed opposite the doors of the central compartment; all doors are operated by a pneumatic apparatus.

During the year ending June 30, 1912, there were 131 fewer persons injured on the Atchison, Topeka & Santa Fe east of Albuquerque, 18 fewer employees killed and 1,146 fewer employees injured on trains or in shops than in the previous year. There were also 32 less persons killed and 86 less injured in trespassing in crossing accidents, making a total of 50 less killed and 1,363 less injured. During eleven months of the fiscal year a reduction of nearly \$250,000 in claims was made on the entire system as compared with the previous year.

The thirty-four million mark in the disbursement of the relief funds of the Pennsylvania Railroad System was passed last month. Exactly \$34,119,716.77 has been paid in benefits to employees and their families in the twenty-six years and eight months that the

relief fund has been operative on the Pennsylvania. In September the amount paid from the relief funds on the lines of the Pennsylvania, both east and west of Pittsburgh, totaled approximately \$200,000, of which 29 per cent. went to the families of members who died, while the remaining 71 per cent. was paid to members disabled by sickness or otherwise incapacitated for work in the company's service.

The University of Pittsburgh has issued a pamphlet, entitled Bulletin No. 1, giving an outline of the investigation of the smoke nuisance, which is being carried on by the Department of Industrial Research of the university. This investigation, financially provided for by a gift from a Pittsburgh business man, is under the direction of Professor R. K. Duncan, director of the Department of Industrial Research. He has secured the assistance of specialists from other universities and of physicians, architects and other persons specially qualified, in Pittsburgh. Six of these specialists are giving their entire time to the work. It is estimated that the United States, as a whole, suffers a loss of over \$500,000,000 yearly in damage to merchandise, defacement of buildings, injury to life, excessive cost of labor, etc., because of imperfect combustion of coal. So far as Pittsburgh is concerned, Professor Duncan intends to determine the amount of this loss as accurately as possible.

A new publication has been started by the newly formed Chamber of Commerce of the United States called the *Nation's Business*. It is printed in the form of a daily newspaper, and in the first issue the object of the paper is described as follows: "The *Nation's Business* is the organ of the Chamber of Commerce of the United States of America and is prepared for the use of editorial writers, commercial organizations and constituent members. The *Nation's Business* will gather for the use of newspapers and organizations current information regarding the development of the nation. Every reader is, therefore, invited to be a correspondent regarding local matters in the financial, agricultural, mining, manufacturing, transportation, distribution and educational fields; also in the professions, the government and altruism. The names of those other than editors, organizations, or constituents who desire to receive the *Nation's Business* regularly will be registered at the rate of \$1 for 20 issues." The editor is E. Grosvenor Dawe.

The Erie Railroad has purchased the American Locomotive Company's experimental Pacific type locomotive No. 50,000, which was designed and constructed by the builders at their own expense for the purpose of obtaining information as to the possibilities of increased capacity and improved economy in passenger locomotives for difficult service through the application of the latest knowledge in general proportions, details of design, materials and fuel saving devices. The locomotive was fully described in the January issue of the *American Engineer*, page 5. In service tests it has shown 13 per cent. greater average economy compared with another Pacific of like weight equipped with the same fuel saving devices, though not developed to the same degree, and over 25 per cent. greater economy than one of conventional design. Its success in service last winter on the Erie in maintaining a most difficult schedule under the worst weather conditions experienced in years, demonstrated its exceptional capacity. The influence which this engine has had on subsequent locomotive design marks it as a distinct advance in locomotive engineering.

Statistics have been compiled by the Pennsylvania Railroad showing the extent to which its employees keep themselves from being injured and preserve their health. The number of injured persons on the rolls of the relief department per annum per thousand Pennsylvania employees has decreased from 11 in 1902 to 8.3 in 1911. Accidental deaths per thousand employees has decreased from 4.9 to 1.9, or more than 60 per cent. The number of cases of illness was 35.4 per one thousand employees in 1902 and 29.2 in 1911. Deaths from sickness were 8.5 per thousand

employees in 1902 and 7.5 in 1911. These statements cannot be compared with the statements of persons injured which are published by the government, as the Pennsylvania's figures represent the proportion constantly disabled or sick, while the other statistics consider only casualties. The following table compares the Pennsylvania's record with those reported by the Interstate Commerce Commission for the whole country and per Group 2 (New York, New Jersey, Pennsylvania, Delaware and Maryland):

| | EMPLOYEES KILLED PER 1,000 PERSONS EMPLOYED. | | |
|------------------------|--|-------|-------|
| | 1908. | 1905. | 1902. |
| Pennsylvania R. R..... | 1.8 | 4.4 | 4.9 |
| United States | 2.37 | 2.43 | 2.49 |
| Group 2 | 2.68 | 2.82 | 3.00 |

The years of the railroad company end on December 31, while the government year ends on June 30, but this probably does not make any serious difference in the meaning of the comparisons.

BOILER INSPECTION RULES

At a general session of the Interstate Commerce Commission, held at its office in Washington, D. C., on September 12, 1912, it was ordered that Rules 29 and 35, as approved in the order of the commission entered June 2, 1911, be amended to read as follows:

Twenty-nine: Siphon.—Every gage shall have a siphon of ample capacity to prevent steam entering the gage. The pipe connection shall enter the boiler direct and shall be maintained steam tight between boiler and gage. The siphon pipe and its connections to the boiler must be cleaned each time the gage is tested.

Thirty-five: Setting of safety valves.—Safety valves shall be set to pop at pressures not exceeding 6 lbs. above the working steam pressure. When setting safety valves two steam gages shall be used, one of which must be so located that it will be in full view of the person engaged in setting such valves; and if the pressure indicated by the gages varies more than 3 lbs. they shall be removed from the boiler, tested, and corrected before the safety valves are set. Gages shall in all cases be tested immediately before the safety valves are set or any change made in the setting. When setting safety valves the water level in the boiler shall not be above the highest gage cock.

It was further ordered that the amendments to Rules 29 and 35 be made effective on and after January 1, 1913.

Professor E. C. Schmidt, in charge of the department of railway engineering of the University of Illinois, has been commissioned by the Japanese government to design a railway dynamometer car for the Imperial Government Railways. The car will be built in this country under the supervision of Professor Schmidt, and is expected to be delivered next spring to the representative of the Japanese government. The car is to be 48 ft. long, 8 ft. 6 in. wide, adapted at present for 3 ft. 6 in. gage, with provision for changing later to 4 ft. 8½ in. gage. It is to be equipped with vacuum brakes, and the design of such details as drawbar, buffers, journal boxes, etc., is to conform to Japanese railway standards. The car is to be of the hydraulic dynamometer type, such as has been developed at the University of Illinois. The recording apparatus will permit the measurement of tractive efforts up to 80,000 lbs., and will provide also for the measurement of speed, time, distance, vibration, buffer thrust, etc. The car and the apparatus will be designed for a maximum speed of 85 m. p. h. An axle generator and storage battery will be provided to supply current for operating the recording apparatus and for lighting purposes. The work has been undertaken at the instance of S. Matsuno, chief of the motive power section of the central division of the Japanese Imperial Government Railways, who has supplied the general specifications for the design.

MEETINGS AND CONVENTIONS

Cleveland Engineering Society.—At a special meeting of the Cleveland Engineering Society held October 22, G. F. Ahlbrant presented an illustrated paper entitled "Ingot Iron Versus Steel." Mr. Ahlbrant is connected with the American Rolling Milling Company, Middletown, Ohio.

Western Railway Club.—At the October meeting a paper was presented by C. M. Larson, assistant chief engineer of the Wisconsin Railroad Commission, on "Headlight Tests." The tests covered both the distance at which an object could be distinguished, and also the effect of the light from the headlight on clear signals. Oil, acetylene gas and electric headlights were compared.

New York Railroad Club.—Liquid Fuel, Its Use and Abuse, was the subject of the paper presented by W. W. Best at the October meeting of the New York Railroad Club. It included the analyses of several different grades of fuel oil and discussed and described different methods of burning oil, both in stationary furnaces and locomotives. Lantern slides showing various types of equipment were used as illustrations by the author.

National Council for Industrial Safety.—The National Council for Industrial Safety was organized by those attending the Co-Operative Safety Congress held at Milwaukee, Wis., recently under the auspices of the Association of Iron and Steel Electrical Engineers. Plans for an organized national campaign for the promotion of industrial safety were adopted and arrangements made for the next safety congress in 1913 in connection with the annual meeting of the Association of Iron and Steel Electrical Engineers. Fred C. Schwedtman, of the National Association of Manufacturers, was elected chairman of the congress.

Southern & Southwestern Railway Club.—The subject of fuel oil for use on railways was quite fully covered by J. F. Ryan of the Texas Oil Company at the September meeting. The action of the oil on the flues and firebox sheets, the proper method of eliminating black smoke and handling oil burning apparatus on a locomotive as well as instructions for engineers and firemen, etc., were given in the paper. The proper method of storage and some data as to oil consumption in boilers and furnaces under different conditions were also included. The discussion consisted largely of questions and answers between the members and Mr. Ryan.

Chicago Car Foremen's Association.—The annual meeting of the Car Foremen's Association of Chicago was held at the Karpen building on the evening of October 14. After a short business session for the election of officers the programme included a vaudeville entertainment, dancing and a buffet luncheon. The officers elected were as follows: President, F. C. Schultz, chief joint inspector, Chicago Interchange Bureau; first vice-president, J. W. Senger, master car builder, Lake Shore & Michigan Southern; second vice-president, Geo. F. Laughlin, general superintendent, Armour Car Lines; treasurer, M. F. Covert, assistant master car builder, Swift Refrigerator Transportation Company; secretary, Aaron Kline.

American Society of Mechanical Engineers.—The annual meeting, December 3-6, 1912, promises to be one of considerable interest to railway men. The committee on meetings has recently appointed a number of sub-committees, among which is one on railroads. This sub-committee, with E. B. Katte as chairman, consists of the following members: G. M. Basford, W. G. Besler, A. H. Ehle, T. N. Ely, W. F. M. Goss, A. L. Humphrey, W. F.

Kiesel, W. B. Potter, N. W. Storer, H. H. Vaughan and R. V. Wright. On Thursday morning, December 5, simultaneous sessions will be held under the direction of the sub-committees on railroads, iron and steel, and cement manufacture. Papers on the Proper Selection of Steam Locomotives and Train Lighting will be presented and discussed at the railroad session, and it is also expected that a paper on the Electric Locomotive Problem will be presented.

R. R. Y. M. C. A. Conference.—The fourteenth annual conference of the Railroad Department of the Young Men's Christian Association of North America was held in Chicago October 3, 4, 5 and 6. Nearly 2,000 railway men and delegates from all parts of the United States and Canada were present, including 100 prominent railway officials and executives. H. U. Mudge, president, Chicago, Rock Island & Pacific, acted as chairman of the committee on local arrangements. Addresses were made by W. A. Garrett, vice-president, Chicago Great Western, who spoke of the importance of the railroad department of the Y. M. C. A. to the railways. Other speakers during the conference were G. W. Stevens, president of the Chesapeake & Ohio; B. F. Bush, president of the Missouri Pacific and Denver & Rio Grande; John Carstensen, vice-president of the New York Central Lines. Cyrus H. McCormick, president of the International Harvester Company; Miss Helen Miller Gould and W. G. Lee, president Brotherhood of Railway Trainmen.

Canadian Railway Club.—At the September meeting, A. Copony, chief draftsman of the car department of the Grand Trunk, Montreal, presented a paper on Suggestions and Discussions from Steel Passenger Cars. This is one of the most extensive discussions on the subject that has appeared and practically all the more important problems are analyzed. Mr. Copony presents strong arguments in favor of the single deck or, "turtle back" car, claiming that, in this form, a car can be built which will be lighter, easier heated and ventilated, cheaper to construct and more attractive to the traveling public in every way. He advocates the use of spot welding in place of riveting throughout the whole structure. Considerable attention is given to the matter of corrosion, especially on the inside surface of the outside steel sheets, and several novel suggestions are made in this connection. The possibility of using roller bearings is considered and the importance of the slip, due to the difference in the diameters of the wheels on the same axle, is shown to be greater than is usually assumed. Insulation, inside finish, ventilation, sanitation, etc., are each given attention in the paper. A table containing the general data, including weight, type of insulation, heating, lighting and ventilation systems, etc., of twenty-four all steel passenger cars, forms an appendix. In the discussion, there was considerable opposition to the author's advocacy of the single deck type of car.

National Machine Tool Builders' Association.—The eleventh annual convention of this association was held at the Hotel Astor, New York, October 16-18. There was a large attendance and very active interest in the proceedings. The following papers were presented for discussion: Export Trade, by W. A. Vialle, Brown & Sharpe Manufacturing Company, Providence,

RAILROAD CLUB MEETINGS

| Club. | Next Meeting. | Title of Paper. | Author. | Secretary. | Address. |
|--------------------|---------------|---|---------------------|-------------------|-----------------------------------|
| Canadian | Nov. 12 | Terminals | L. C. Fritch..... | as. Powell..... | Room 13, Windsor Hotel, Montreal. |
| Central | Nov. 8 | Brake Operation of Long Freight Trains.. | John P. Kelly..... | H. D. Vought.... | 95 Liberty St., New York. |
| New England.... | Nov. 12 | Electric Installation on a Battleship.... | J. J. Crain..... | Geo. H. Frazier.. | 10 Oliver Bldg., Boston, Mass. |
| New York..... | Nov. 15 | Operation of Superheater Locomotives.... | G. E. Ryder..... | I. D. Vought.... | 95 Liberty St., New York. |
| Northern | | | | C. L. Kennedy.... | 401 Superior St., Duluth, Minn. |
| Pittsburgh | | | | I. B. Anderson.. | Union Station, Pittsburgh, Pa. |
| Richmond | Nov. 11 | Improved Combustion of Fuel..... | W. L. Ray..... | F. O. Robinson.. | C. & O. Ry., Richmond, Va. |
| S'th'n & S. West'n | Nov. 21 | History and Late Improvements of Locomotive Fireboxes | | A. J. Merrill.... | 218 Grant Bldg., Atlanta, Ga. |
| St. Louis | Nov. 8 | The St. Louis Terminals—Up to Date.... | Dr. Wm. Taussig.... | B. W. Frauenthal | Union Station, St. Louis, Mo. |
| Western | Nov. 19 | The Telpherage System for Shops and Terminals | H. M. L. Harding... | Jos. W. Taylor... | 390 Old Colony Bldg., Chicago. |
| Western Canada.. | Nov. 11 | Layout of Yards..... | L. G. Legrand..... | W. H. Rosevear.. | P. O. Box 1707, Winnipeg, Man. |

R. I.; The Use of an Association Catalog in the Development of Foreign Markets, by Stanley H. Bullard, Bullard Machine Tool Company, Bridgeport, Conn.; How United States Patents Might Be Made of Greater Value to the Patentees, by Samuel W. Banning, Banning & Banning, Chicago; What We Should Do in the Way of Influencing Tariff Legislation, by Frederick W. Grier, Cincinnati Milling Machine Company, Cincinnati, Ohio; and How Could the Association Be Benefited by the Formation of a Mechanical Section, by E. J. Kearney, Kearney & Trecker Company, Milwaukee, Wis. The question of the formation of a mechanical section of the association was referred to a special committee for further investigation. Again considering the advisability of changing the name, which was first brought up at the semi-annual meeting at Atlantic City, it was resolved to retain the present title. The following officers were elected for the ensuing year: E. P. Bullard, president; A. T. Barnes, first vice-president; R. K. LeBlond, second vice-president; A. E. Newton, treasurer, and C. L. Taylor, secretary.

Railway Business Association Dinner.—The fourth annual dinner of the Railway Business Association will be held December 19, at the Waldorf-Astoria Hotel, New York. The speakers will be James J. Hill and the Hon. W. L. Mackenzie King, former Canadian minister of labor. Mr. Hill will discuss the needs of the country for more and better railway facilities and the financial ability of the roads to meet those needs. At this juncture, when the country is having a painful reminder of the inefficiency of carrying facilities, Mr. Hill's acceptance, changing his previous arrangements in order to be in the United States for the dinner, is a high compliment to this association as a movement and as an organization which provides annually a striking occasion for the delivery of important pronouncements. Mr. King is regarded as one of the highest authorities in the world on the relations of the public to labor disputes. He is the author of the much discussed Canadian Industrial Disputes Investigation Act, the basis for a law recently enacted by the Union of South Africa, and now under investigation for use in England. Mediation between railways and their employees has formed a large part of the operations under the Canadian act, so what Mr. King may say will have special interest for American business men. There will be but two speakers and the dinner this year will begin promptly at 7 o'clock. Instead of laying between 800 and 900 covers as heretofore, the seats will be restricted to 633, in order to be sure that every table will be within earshot of the speakers.

The following list gives names of secretaries, dates of next or regular meetings, and places of meeting of mechanical associations.

- AIR BRAKE ASSOCIATION.—F. M. Nellis, 53 State St., Boston, Mass. 1913 convention to be held at St. Louis, Mo.
- AMERICAN RAILWAY MASTER MECHANICS' ASSOC.—J. W. Taylor, Old Colony building, Chicago.
- AMERICAN RAILWAY TOOL FOREMEN'S ASSOCIATION.—A. R. Davis, Central of Georgia, Macon, Ga.
- AMERICAN SOCIETY FOR TESTING MATERIALS.—Prof. E. Marburg, University of Pennsylvania, Philadelphia, Pa.
- AMERICAN SOCIETY OF MECHANICAL ENGINEERS.—Calvin W. Rice, 29 W. Thirty-ninth St., New York. Annual meeting, December 3-6, Engineering Societies' Building, New York. Railroad session, Thursday morning, December 5.
- CAR FOREMEN'S ASSOCIATION OF CHICAGO.—Aaron Kline, 841 North Fiftieth Court, Chicago; 2d Monday in month, Chicago.
- INTERNATIONAL RAILWAY FUEL ASSOCIATION.—C. G. Hall, McCormick building, Chicago.
- INTERNATIONAL RAILWAY GENERAL FOREMEN'S ASSOCIATION.—William Hall, Chicago & North Western, Escanaba, Mich.
- INTERNATIONAL RAILROAD MASTER BLACKSMITHS' ASSOCIATION.—A. L. Woodworth, Lima, Ohio.
- MASTER BOILER MAKERS' ASSOCIATION.—Harry D. Vought, 95 Liberty St., New York.
- MASTER CAR BUILDERS' ASSOCIATION.—J. W. Taylor, Old Colony building, Chicago.
- MASTER CAR AND LOCOMOTIVE PAINTERS' ASSOC. OF U. S. AND CANADA.—A. P. Dane, B. & M., Reading, Mass.
- RAILWAY STOREKEEPERS' ASSOCIATION.—J. P. Murphy, Box C, Collinwood, Ohio.
- TRAVELING ENGINEERS' ASSOCIATION.—W. O. Thompson, N. Y. C. & H. R., East Buffalo, N. Y.

PERSONALS

It is our desire to make these columns cover as completely as possible all the changes that take place in the mechanical departments of the railways of this country, and we shall greatly appreciate any assistance that our readers may give us in helping to bring this about.

GENERAL.

G. H. BUSSING has been appointed superintendent of motive power of the Mexico North Western, with headquarters at Madera, Chih., Mexico.

R. L. CHANDLER has been appointed supervisor of piecework of the New York Central & Hudson River, and will have supervision of the methods and practice in connection with piecework in the locomotive and car departments, reporting to the superintendents of motive power and rolling stock respectively. The position of general inspector of shops has been abolished.

J. R. GOULD, general superintendent of motive power of the Chesapeake & Ohio, and the Chesapeake & Ohio of Indiana, with office at Richmond, Va., has changed his title to superintendent of motive power. The position of superintendent of motive power on each general division is discontinued, and C. H. Terrell, superintendent of motive power at Huntington, W. Va., has been appointed assistant superintendent of motive power, with office at Richmond, and W. P. Hobson, superintendent of motive power at Covington, Ky., has been appointed master mechanic of the Cincinnati division. H. M. Brown, master mechanic at Covington, Ky., has been appointed shop superintendent at Huntington, W. Va.

J. T. JOHNSTON has been appointed assistant general boiler inspector of the Atchison, Topeka & Santa Fe Coast Lines, with headquarters at Los Angeles, Cal., vice Gus Mhleisen, assigned to other duties.

W. L. KELLOGG, superintendent of motive power of the Pere Marquette, has removed his headquarters from Detroit, Mich., to Wyoming.

GEORGE P. KEMPF has been appointed engineer of tests of the Chicago, Milwaukee & St. Paul, succeeding R. H. Morrison, resigned.

A. M. MCGILL, superintendent of the Sayre, Pa., shops of the Lehigh Valley, has been appointed assistant superintendent of motive power, with office at South Bethlehem, Pa.

JAMES RILEY, electrical engineer and superintendent motive power and equipment of the Choctaw Railway & Lighting Company, McAlester, Okla., has been appointed electrical engineer of the Missouri, Kansas & Texas, with headquarters at Parsons, Kan.

W. L. ROBINSON, road foreman of engines of the Baltimore division of the Baltimore & Ohio, at Baltimore, Md., has been promoted to supervisor of fuel consumption.

MASTER MECHANICS AND ROAD FOREMEN OF ENGINES

E. BECKER, master mechanic of the Northern Wisconsin and Lake Shore divisions of the Chicago & North Western, has been appointed division master mechanic at Escanaba, Mich., succeeding F. Slater, transferred.

RAYMOND E. BELL has been appointed master mechanic of the Galveston division of the Gulf, Colorado & Santa Fe, with headquarters at Galveston, Tex.

J. H. BENDER has been appointed master mechanic for the receivers of the Denver, Laramie & Northwestern, with headquarters at Utah Junction (Denver), Colo., to succeed E. Nedro, resigned.

W. A. BLACK has been appointed locomotive foreman of the Grand Trunk, with headquarters at Coteau Junction, Que., vice L. J. McLaughlin, transferred.

A. BROWN has been appointed locomotive foreman of the Canadian Pacific, with headquarters at Fort William, Ont., vice A. McArthur, transferred.

R. W. BROWN, an engineer on the Illinois division of the Baltimore & Ohio Southwestern, has been appointed road foreman of engines of the Indiana division of the Cincinnati, Hamilton & Dayton, with headquarters at Indianapolis, Ind.

CHARLES BROWN has been appointed locomotive foreman of the Canadian Pacific, with headquarters at North Bend, B. C., vice W. E. Hayward, transferred.

F. L. CARSON has been appointed master mechanic of the San Antonio & Aransas Pass, with headquarters at Yoakum, Tex.

W. A. CHAMBERLIN has been appointed master mechanic of the Pere Marquette, with headquarters at Saginaw, Mich., vice F. C. Pickard, resigned.

J. F. HILL, shop superintendent of the Wheeling & Lake Erie at Brewster, Ohio, has been appointed master mechanic, with headquarters at Brewster, succeeding J. E. O'Hearne, resigned.

HARRY M. HUTSON has been appointed division master mechanic of the Baltimore & Ohio, with headquarters at Grafton, W. Va.. He was born in 1869 at Piedmont, W. Va., and was

graduated from the Allegheny County Academy, Cumberland, Md., in 1886. The same year he entered the service of the Baltimore & Ohio as machinist apprentice at Piedmont. He left the Baltimore & Ohio four years later to take up mechanical drawing at the Scranton School, and one year later returned to the service of the Baltimore & Ohio and then held various positions in the mechanical department until his appointment as machine shop foreman at Cumberland. Later he was engine house fore-



H. M. Hutson.

man at Keyser, W. Va., until February 14, 1912, when he was made general foreman, at Grafton.

A. McARTHUR has been transferred to Sutherland, Sask., as locomotive foreman of the Canadian Pacific, vice J. Sindall, transferred.

C. A. McCARTHY has been appointed master mechanic of the Indian Territory division of the Chicago, Rock Island & Pacific, with headquarters at Shawnee, Okla., vice W. B. Embury, transferred.

M. J. McDONALD has been appointed trainmaster and road foreman of equipment of the Chicago, Rock Island & Pacific, with headquarters at Trenton, Mo., and with jurisdiction over subdivision 31.

L. J. McLAUGHLIN, locomotive foreman of the Grand Trunk at Coteau Junction, Que., has been transferred to Brockville, Ont.

Z. B. MANSFIELD has been appointed acting road foreman of equipment of the Chicago, Rock Island & Pacific, with jurisdiction over the entire Indian Territory division.

F. C. PICKARD has been appointed master mechanic of the Buffalo division of the Delaware, Lackawanna & Western, with office at East Buffalo, N. Y., succeeding F. G. Colwell, resigned.

JOHN R. REEVES has been appointed traveling engineer of the Guayaquil & Quito, Ecuador, succeeding F. B. Wilmot, resigned.

J. C. RHODES has been appointed road foreman of equipment of the Chicago, Rock Island & Pacific, at Eldon, Iowa, with jurisdiction over subdivisions 30 and 30A.

E. SCHULTZ, roundhouse foreman of the Chicago & North Western at Milwaukee, Wis., has been appointed master mechanic of the Northern Wisconsin and Lake Shore divisions, with headquarters at Green Bay, Wis., succeeding E. Becker, transferred.

E. C. SHIPLEY has been appointed road foreman of engines of the Baltimore division of the Baltimore & Ohio.

J. C. SHREEVE has been appointed master mechanic of the Joliet division of the Elgin, Joliet & Eastern Railway, with headquarters at Joliet, Ill., and jurisdiction over the Joliet shops and points north of Joliet.

R. W. SIVERS has been appointed acting road foreman of equipment of the Chicago, Rock Island & Pacific, at Trenton, Mo., and has jurisdiction over subdivisions 32, 32A, 32B, 33 and 33A.

F. SLATER, division master mechanic of the Chicago & North Western at Escanaba, Mich., has been transferred to Kaukauna, Wis., succeeding W. Hutchinson, deceased.

C. E. STEWART has been appointed locomotive foreman of the Grand Trunk Pacific at Biggar, Sask., in charge of locomotive and car departments, vice G. Carruthers, assigned to other duties.

J. WHITEFORD has been appointed master mechanic of the Illinois Central, with headquarters at Centralia, Ill.

T. WINKEL has been appointed master mechanic of the Gulf division of the International & Great Northern, with headquarters at Palestine, Tex.

CAR DEPARTMENT

B. F. CLOUD has been appointed car inspector of the Chicago, Rock Island & Pacific, with headquarters at Wilburton, Okla.

J. W. CROUCH has been appointed foreman of the coach shops of the St. Louis & San Francisco, at the Springfield, Mo., North shops.

GEORGE B. FORSYTHE has been appointed assistant foreman of the car department of the Pennsylvania Lines West of Pittsburgh, with headquarters at Conway, Pa., vice W. A. Guy, promoted.

J. F. GILBERT has been appointed car foreman of the Atchison, Topeka & Santa Fe at Waynoka, Okla., vice F. E. Armstrong.

JAMES HALL, assistant general foreman of the car department of the Southern Pacific, at Sacramento, Cal., has been appointed general car foreman of the Coast division, with office at San Francisco, Cal., succeeding D. D. McRae, master car repairer, transferred.

A. KESTERSON has been appointed rip track foreman of the St. Louis & San Francisco, with headquarters at the Springfield, Mo., North shops, succeeding J. H. Hoffman, assigned to other duties.

GEORGE KING has been appointed car inspector of the Chicago, Rock Island & Pacific at Pratt, Kan., vice Charles Lambert, resigned.

CHARLES O. KROFT has been appointed car foreman of the Atchison, Topeka & Santa Fe at Wellington, Kan.

F. C. LINN, general car foreman of the San Antonio & Aransas Pass, has been appointed master car builder, with headquarters at Yoakum, Tex.

J. H. MACHA has been appointed car foreman of the Atchison, Topeka & Santa Fe, at Shawnee, Okla., vice C. W. Rice, transferred to other duties.

E. J. SHREMP has been appointed assistant freight car builder foreman of the Pennsylvania Lines West of Pittsburgh, with headquarters at Conway, Pa., vice J. A. Shremp, promoted.

JOS. A. SHREMP has been appointed car builder freight foreman of the Pennsylvania Lines West of Pittsburgh, with headquarters at Conway, Pa., vice G. B. Forsythe, promoted.

E. W. VENAMON has been appointed car foreman of the Chicago, Rock Island & Pacific, with headquarters at El Dorado, Ark., vice E. W. Martin, assigned to other duties.

A. A. WAGNER has been appointed coach yard foreman of the Chicago, Rock Island & Pacific, with headquarters at Valley Junction, Iowa.

SHOP AND ENGINE HOUSE

HARRY ADAMS, foreman of the San Antonio & Aransas Pass at Kennedy, Tex., has been promoted to the position of division foreman, with headquarters at Houston, Tex.

J. W. ADAMS has been appointed general foreman of the Baltimore & Ohio shops at Mt. Clare, Baltimore, Md.

N. S. AIRHART has been appointed general foreman of the locomotive department of the Rock Island Lines, with office at Cedar Rapids, Iowa, vice G. W. Cuyler, resigned.

JOSEPH WALTER APPLEBY, division foreman of the San Antonio & Aransas Pass at Houston, Tex., has been appointed foreman of the motive power and car department at Corpus Christi, Tex.

G. A. BELCHER, roundhouse foreman of the Atchison, Topeka & Santa Fe, at La Junta, Colo., has been transferred to Deming, N. M., as roundhouse foreman.

T. BERTRAM, shop foreman of the Canadian Pacific at Moose Jaw, Sask., has been transferred to Revelstoke, B. C.

F. T. CHASE has been placed in charge of the shops of the Missouri, Kansas & Texas, at Smithville, Tex.

FLOYD G. CLARK, night assistant roundhouse foreman of the Chicago & North Western at East Clinton, Ill., has been promoted to the position of night roundhouse foreman at the same place.

G. W. CLARK has been appointed locomotive foreman of the Grand Trunk System at the new roundhouse terminal at St. Lambert, Que.

P. CONIFF has been appointed assistant superintendent of shops of the Baltimore & Ohio, with headquarters at Mt. Clare, Baltimore, Md.

P. I. COSTELLO, night roundhouse foreman of the Atchison, Topeka & Santa Fe, at La Junta, Colo., has been appointed foreman, with headquarters at Las Vegas, N. M.

J. D. COSTELLO has been appointed erecting foreman of the Atchison, Topeka & Santa Fe, at Clovis, N. M., vice E. H. Reynolds, resigned.

P. S. FELLOWS has been appointed tool foreman of the Pennsylvania shops at Renovo, Pa.

P. L. GARDNER has been appointed foreman of the blacksmith shop of the Trinity & Brazos Valley, with headquarters at Teague, Tex., succeeding T. F. O'Leary, resigned.

B. A. ELDRIDGE, of Argentine, Kan., has been appointed general foreman of the Atchison, Topeka & Santa Fe, at Arkansas City, Kan., vice E. P. Gray, who is absent on account of illness.

THOMAS GRANT, tool foreman of the Delaware & Hudson at Oneonto, N. Y., has been transferred to the company's new shops at Watervliet, N. Y.

PAUL D. HAMILTON, machinist on the Atchison, Topeka & Santa Fe has been appointed night roundhouse foreman, with headquarters at La Junta, Colo., vice P. I. Costillo, transferred to Las Vegas, N. M.

E. C. HAUSE has been appointed general foreman of the Georgia & Florida, with headquarters at Douglas, Ga.

W. E. HAYWARD, locomotive foreman of the Canadian Pacific at North Bend, B. C., has been appointed roundhouse foreman at Vancouver, B. C.

H. HOOD has been appointed roundhouse foreman of the Cotton Belt, with headquarters at Tyler, Tex.

W. F. HOWARD has been promoted from gang foreman to machine foreman of the Atchison, Topeka & Santa Fe, with headquarters at Cleburne, Tex.

C. E. JOHNSTON, machinist on the erecting floor of the Atchison, Topeka & Santa Fe, at San Bernardino, Cal., has been appointed night roundhouse foreman at Bakersfield, Cal.

JOHN S. JONES, roundhouse foreman of the Chicago & North Western at East Clinton, Ill., has been promoted to the position of roundhouse foreman at Clinton, Ia., succeeding W. A. Egan, resigned.

A. H. KARTER, machinist on the St. Louis Southwestern, has been promoted to the position of machine foreman, with headquarters at the new shops which are now nearing completion at Pine Bluff, Ark.

HENRY LEWIS has been appointed machine foreman of the Atchison, Topeka & Santa Fe, at Clovis, N. M., vice William Barnes.

H. L. McLAW has been appointed roundhouse foreman of the Missouri, Kansas & Texas at Greenville, Tex.

W. O. MORTON has been appointed roundhouse foreman of the Chicago, Rock Island & Pacific, at Forty-seventh street, Chicago, vice T. E. McQuade, assigned to other duties.

HARRY W. MOSLEY has been appointed assistant general foreman of the Erie shops at Hornell, N. Y., vice H. W. Sasser, transferred.

T. H. NANNEY, foreman of the erecting shop of the Buffalo & Susquehanna, has been appointed general foreman at Galeton, Pa.

GEORGE E. PARKER, foreman boilermaker of the Chicago & Eastern Illinois, at Villa Grove, Ill., has been appointed foreman boilermaker of the El Paso & Southwestern, with headquarters at Douglas, Ariz., vice M. J. Young, resigned.

BERNARD R. REYNOLDS, engine inspector of the Atchison, Topeka & Santa Fe, has been appointed day roundhouse foreman, with headquarters at La Junta, Colo., vice G. A. Belcher, transferred to Deming, N. M.

D. G. ROBERTS, formerly master smith of the Delaware & Hudson at Oneonto, N. Y., has been appointed in the same capacity at the new shops at Watervliet, N. Y.

WILLIAM SAPP has been appointed roundhouse foreman of the Atchison, Topeka & Santa Fe, with headquarters at Sweetwater, Tex., vice J. A. Whithurst, resigned.

MERTON E. SARGENT, night roundhouse foreman of the Chicago & North Western at East Clinton, Ill., has been promoted to

the position of assistant day roundhouse foreman, at the same place.

ARTHUR SEAL, machinist and assistant roundhouse foreman of the Buffalo & Susquehanna, has been appointed erecting shop foreman, with headquarters at Galeton, Pa.

J. C. SEEGER has been appointed superintendent of the shops of the Lehigh Valley at Sayre, Pa.

CHARLES SHAYNE has been appointed roundhouse foreman of the Erie, with headquarters at Huntington, Ind.

J. SINDALL, locomotive foreman of the Canadian Pacific at Sutherland, Sask., has been transferred to Cranbrook, B. C., as shop foreman.

CHARLES F. SMITH has been appointed erecting foreman of the Chicago, Rock Island & Pacific, at Forty-seventh street, Chicago, vice Edward Schell, resigned.

T. F. SULLIVAN has been appointed assistant roundhouse foreman of the Atchison, Topeka & Santa Fe, with headquarters at Cleburne, Tex.

H. P. SYFAN, night roundhouse foreman of the Denver & Rio Grande at Alamosa, Colo., has been transferred to Chama, N. M.

W. H. VOIGT has been appointed night roundhouse foreman of the Trinity & Brazos Valley, with headquarters at Teague, Tex.

W. H. WALKER has been appointed locomotive foreman of the Grand Trunk System at Turcot, Can., vice J. D. Scott, resigned.

W. F. WALLACE, assistant roundhouse foreman of the Atchison, Topeka & Santa Fe, has been appointed gang foreman at Cleburne, Tex., succeeding W. F. Howard, promoted.

L. E. WALLIS has been appointed erecting foreman of the Atchison, Topeka & Santa Fe shops at Cleburne, Tex.

EDGAR E. WHITEBREAD, day assistant roundhouse foreman of the Chicago & North Western at East Clinton, Ill., has been promoted to the position of night roundhouse foreman, with headquarters at Clinton, Ia.

PURCHASING AND STOREKEEPING

F. A. STARR, foreman of the coach shops of the St. Louis & San Francisco, at the Springfield, Mo., North shops, has been appointed general foreman of the storeroom.

R. O. WOODS has been appointed division storekeeper of the Mobile & Ohio, with headquarters at Meridian, Miss., with supervision over mechanical department material at Meridian, and also of roadway and bridge building material on M. and M. district.

OBITUARY

ROBERT H. ROGERS, at one time an associate editor of the *American Engineer & Railroad Journal*, died at a private hospital in New York on October 23. Mr. Rogers was a graduate of the Baltimore Polytechnic Institute, and entered railway service as a machinist's apprentice on the Baltimore & Ohio. In 1895 he was made general piece work inspector of that system, and was later roundhouse foreman at the Pittsburgh terminal. He resigned this position to become shop foreman of the Mexican Central at Mexico City, and in 1898 joined the staff of the *Philadelphia Times* and *North American*. Later he was appointed assistant master mechanic of the Baltimore & Ohio at Mt. Clare, Md., and in February, 1905, was appointed master mechanic on the New York, New Haven & Hartford at South Boston. On January 1, 1908, he undertook a general and thorough inspection of the locomotive equipment of the Erie, on the completion of which he spent several months in foreign countries studying locomotive practice.

NEW SHOPS

ATCHISON, TOPEKA & SANTA FE.—Plans are being prepared for the new shops at Albuquerque, N. M. The estimated cost is \$1,600,000. It is also reported that new shops and an engine house will be built at Wichita, Kan.

BALTIMORE & OHIO.—A contract has been awarded to P. Farrel, Cincinnati, Ohio, for the construction of an engine house, turntable, and sand house at Somerset, Pa.

CANADIAN PACIFIC.—A machine shop will be erected at Wilkie, Sask.

CHICAGO & ALTON.—An additional engine house will be built at Chicago, Ill.

CHICAGO, MILWAUKEE & PUGET SOUND.—It is reported that a site has been purchased at Lewistown, Mont., for shops and terminal facilities.

CHICAGO, MILWAUKEE & ST. PAUL.—An engine house and blacksmith shop will be built at Bensonville, Ill.

CHICAGO, PEORIA & ST. LOUIS.—A contract has been placed for car and machine shops at Springfield, Ill., the estimated cost to be \$50,000.

CHICAGO, ROCK ISLAND & PACIFIC.—The work on the 20-stall engine house, turntable, cinder pit, machine shops, power house, water plant, coaling station and divisional terminal facilities at Manly, Ia., will begin in the early part of next year. Bids are also being asked for by this company for a one-story machine shop of structural iron and brick to be built at the same place. Plans are being made for the erection of a large engine house and repair shops at Des Moines, Ia. A two-story wood-working shop in the pattern department is to be added to the Silvis shops at Moline, Ill.

CINCINNATI, NEW ORLEANS & TEXAS PACIFIC.—An engine house and coaling station of concrete construction will be built at Ludlow, Ky.

CLEVELAND, CINCINNATI, CHICAGO & ST. LOUIS.—A brick engine house will be built at Harrisburg, Ill., to be one story high, 200 ft. long and 100 ft. wide, and new car shops will be erected at Danville, Ill.

GALLATIN VALLEY.—Arrangements are being made for an engine house at Bozeman, Mont.

GULF, COLORADO & SANTA FE.—The plans for the improvement at Brownwood, Tex., include \$45,000 for a 12-stall engine house; \$11,000 for a standard 45-ft. turntable; \$10,000 for a machine shop; \$8,500 for a car shop; \$8,000 for a power house and \$5,500 for a sand house.

LAKE SHORE & MICHIGAN SOUTHERN.—It is reported that the erection of the large shops at Elkhart, Ind., will begin early next year and be completed by the end of the year.

MIDLAND VALLEY.—The engine house and repair shop that were recently destroyed by fire at Pawhoska, Okla., will be rebuilt and re-equipped.

MISSOURI, KANSAS & TEXAS.—Plans have been prepared for the construction of an engine house at Mokane, Mo. The shops at Houston, Tex., will be moved to a 49-acre tract of land recently purchased between Cottage Grove and Eureka.

NASHVILLE, CHATTANOOGA & ST. LOUIS.—The site for the new shops at Paducah, Ky., has been obtained and the construction work will begin in the near future.

NORTHERN PACIFIC.—It is expected that a 40-stall engine house, machine shops and division offices will be built at Carlton, Minn.

SOUTHERN PACIFIC.—Shops will be established at Alpine, Tex., for joint use with the Kansas City, Mexico & Orient.

WABASH.—A contract has been awarded to C. W. Gindele & Company, Chicago, for the concrete foundation, brick and mill work on the locomotive repair shop to be built at Decatur, Ill.

SUPPLY TRADE NOTES

The National Tube Company, Pittsburgh, Pa., has opened a branch office at Boston, Mass.

The National Tube Company, Pittsburgh, Pa., has opened a branch office at St. Paul, Minn.

Mark A. Ross has resigned as treasurer and director of the Pyle-National Electric Headlight Company, Chicago.

William Horace Corbin, vice-president of The Joseph Dixon Crucible Company, Jersey City, N. J., died on Wednesday, September 25.

E. G. Buckwell, secretary and manager of sales of the Cleveland Twist Drill Company, Cleveland, Ohio, has gone abroad on a two months' business trip.

The Preston Car & Coach Company, Preston, Ont., has secured the Canadian manufacturing rights of the gasoline cars recently tried out on the Canadian Northern.

E. F. G. Meisinger has been appointed representative of the railroad department of S. F. Bowser & Co., Ft. Wayne, Ind., for the territory west of the Rocky mountains.

S. F. Bowser & Company, Fort Wayne, Ind., announce that E. H. Briggs has been added to their sales staff in the railroad department. He will cover the southwest territory.

The Republic Iron & Steel Company, Youngstown, Ohio, has resumed the payment of the $1\frac{3}{4}$ quarterly dividend on its preferred stock, which has been omitted since January 1, 1912.

The Commercial Acetylene Company, New York, has changed its name to the Commercial Acetylene Railway Light & Signal Company. The new name better explains the activities of the company.

The Railroad Supply and Equipment Club in the Karpen building, Chicago, has made arrangements for a series of lectures on mechanical subjects to be given in its assembly hall on Saturday evenings.

The Titanium Alloy Manufacturing Company, because of the rapidly increasing demand for its products, has found it necessary to remove its general sales department to the works at Niagara Falls, N. Y., and has created a district office at Pittsburgh, Pa.

At a meeting of the directors of the American Locomotive Company, held on October 31, 1912, all of the officers of the company were re-elected with the exception of H. F. Ball, vice-president, who declined re-election. No successor to Mr. Ball was elected.

W. D. Matthews, a director of the Canadian Pacific Railway Company, has been elected a vice-president of the Canadian General Electric Company to fill the vacancy caused by the death of H. P. Dwight, president of the Great North Western Telegraph Company.

C. A. Carscadin, formerly vice-president of the Kirby Equipment Company, Chicago, and representative of the Globe Seamless Steel Tube Company, of Milwaukee, has been appointed general sales agent of the Spencer Otis Company, with offices in the Railway Exchange, Chicago.

The Griffin Wheel Company, of Chicago, is to be reorganized under Massachusetts laws. The present Illinois corporation has a capitalization of \$8,000,000. The new company will have an authorized issue of \$12,000,000 common stock, of which \$9,500,000 will be issued, and \$9,000,000 preferred stock, of which \$6,000,000 will be issued.

William Wharton, Jr. & Company, Inc., Philadelphia, Pa., announce the merger of its interests and the Taylor Iron & Steel

Company, of High Bridge, N. J. It will continue under the name of Wm. Wharton, Jr. & Company, Inc., while the Taylor Iron & Steel Company will hereafter be known as the Taylor-Wharton Iron & Steel Company.

The Locomotive Superheater Company, New York, is building a plant at East Chicago, in the neighborhood of the property which has been acquired by the locomotive builders for western plants, for the manufacture of superheaters for application to old locomotives. It is expected that the plant will be placed in operation about the first of the year.

The regular quarterly dividend of $2\frac{1}{2}$ per cent. has been declared by the Independent Pneumatic Tool Company of Chicago. It is reported that the business of the company for the fiscal year ending September 30 will show an increase of over 25 per cent. above that of the previous year. Plans are now being prepared for a large addition to the factory at Aurora, Ill.

The board of directors of the Joseph Dixon Crucible Company, Jersey City, N. J., has made the following changes in the officers and board of directors on account of the death of Vice-president William H. Corbin: George E. Long, former treasurer, has been made vice-president to succeed Mr. Corbin; J. H. Schermerhorn, former assistant secretary and assistant treasurer, has been elected to membership in the board of directors, and has been made treasurer. Albert Norris has been elected to the office of assistant secretary and assistant treasurer.

Reginald M. Campbell has been appointed to a position in the sales department of the National India Rubber Company, with headquarters in New York. Mr. Campbell was for six years in the electric street railway and lighting department of the Western Electric Company, Chicago. For the next five years he acted as district sales agent for the Ohio Brass Company in the New York and New England territories. Later he was made eastern sales manager for the Peter Smith Heater Company, Detroit, Mich., with offices in New York. His time now will be devoted to the sale of bare and insulated wires and cables for all types of electrical equipment.

Among the railroads that have recently given repeat orders for the Street locomotive stoker are the Norfolk & Western, Chesapeake & Ohio, and the Baltimore & Ohio. The Norfolk & Western has 15 Mallet locomotives in service equipped with this stoker and 25 more of the same type have been ordered. The Chesapeake & Ohio has had 30 Mikado locomotives using this stoker in service since the month of June and will receive 25 additional engines in November. The Baltimore & Ohio uses these stokers on five large Mallets and 20 more are being equipped as fast as they go through the shops. This road will also have this stoker applied to 50 Mikados being built by the Baldwin Locomotive Works, 20 of which have been received. The Hocking Valley will also use this stoker on five Mikado engines which will be received during November.

At the annual meeting of the stockholders of the Carbon Steel Company, New York, the following board of directors was elected for the ensuing year: Charles McKnight, Gilbert G. Thorne, Edward C. Hoyt, George S. Macrum, Edward F. Slayback, D. E. Corbett and Thomas Patterson. At a meeting of the board of directors the following officers were elected: President, Charles McKnight; vice-president, Gilbert G. Thorne; second vice-president, George S. Macrum; treasurer, James Thorne; and secretary, D. E. Corbett. The company is spending approximately \$100,000 on its works at Pittsburgh, Pa. The capacity of the forge shops has been increased, and a new 500-ton forging press has been installed. The stockholders have authorized a \$2,000,000 bond issue to take care of the present bonded indebtedness and to furnish additional working capital. A sufficient amount of the bonds has been underwritten to provide for all present needs.

CATALOGS

BROWNHOIST BUCKETS AND TUBS.—Catalog E of the Brown Hoisting Machinery Company, Cleveland, Ohio, describes a large and varied line of grab buckets and various kinds of tubs designed and manufactured by it. It contains 56 pages, and is fully illustrated.

LATHES.—Catalog No. 42 from the South Bend Machine Tool Company, South Bend, Ind., contains 35 pages devoted to illustrations and descriptions of screw cutting engine lathes which are shown in a number of sizes. A description of the detail parts is included.

CASE HARDENING STEEL.—A book of useful information and practical rules on case hardening, pack hardening and annealing of steel was issued some time ago by the Ideal Case Hardening Compound Company, United States Rubber building, New York. This work proved so popular that the fourth revised edition is now being sent out.

HYDRAULIC ACCUMULATORS.—In catalog 84, the Watson-Stillman Company, 50 Church street, New York, gives fully illustrated descriptions of the seven principle types of hydraulic accumulators which it manufactures. A few pages are devoted to accumulator accessories and to special hydraulic testing apparatus, reservoirs, etc.

PIPE THREADING MACHINERY.—The Landis Machine Company, Waynesboro, Pa., is issuing catalog No. 20, in which its well known rotary automatic threading die head is shown as adapted for pipe and nipple threading. In addition, a manually operated, stationary die head for pipe work that has recently been developed, is fully described.

CRANES AND HOISTS.—Pneumatic hoists, hand power traveling cranes and jib cranes in various types and capacities are well illustrated and described in leaflets being issued by the Vulcan Engineering Sales Company, Fisher building, Chicago. Each of the various designs is briefly described, and the purpose to which it is particularly adapted is specified.

CRANES AND FOUNDRY EQUIPMENT.—Catalog 99 from the Whiting Foundry Equipment Company, Harvey, Ill., furnishes, in a condensed form, descriptions and illustrations of cranes and other foundry equipment. This equipment is shown in a large variety of sizes and designs suitable for gray iron, brass, car wheel, pipe, steel and malleable iron foundries.

MOTORS AND GENERATORS.—Bulletin 155 from the Crocker-Wheeler Company, Ampere, N. J., thoroughly discusses the design of induction motors for operating on 60 cycle alternating current. It contains twenty pages. Bulletin 156 from the same company is devoted to the subject of the motor-generating sets for all purposes and shows various sizes and arrangements.

PNEUMATIC RAMMERS.—Pneumatic rammers for use in foundries are a comparatively recent innovation, but their simple construction and advantages are rapidly bringing them into general use. Bulletin 121 from the Chicago Pneumatic Tool Company, Fisher Building, Chicago, illustrates and describes several sizes and designs of rammers, as well as two types of pneumatic sand sifters.

CARS AND TRUCKS.—A 92-page cloth bound book issued by the McGuire-Cummins Manufacturing Company, 400 North Sangamon street, Chicago, illustrates a large number of cars that have been built by it for various electric railways. Cars of all classes are shown, each is briefly described, and a table of general dimensions is given. This company has also constructed freight equipment suitable for use in ordinary trunk line service.

BOLT HEADING MACHINE.—The maintenance of alignment of the heading and gripping slides on a bolt header or flanging machine plays a very important part in determining the quality

and quantity of the product. National Header Talk No. 3, issued by the National Machinery Company, Tiffin, Ohio, is devoted to a discussion of the adjusting liner system on the National wedge grip header. This feature is fully illustrated and described.

COLD METAL SAWING MACHINES.—A cold metal saw, with a capacity for 6 in. rounds and squares, or 10 in. I-beams, is fully illustrated and described in a leaflet being issued by the Vulcan Engineering Sales Company, Fisher building Chicago. It is of the periphery drive type, having a friction type feeding mechanism which can be adjusted while the machine is in operation. It is very powerful, and carries an 18 in. diameter saw blade.

SWITCHBOARD PANELS.—Bulletin 4996, from the General Electric Company, Schenectady, N. Y., is devoted to alternating current switchboard panels with oil switches on a pipe framework back of the panels. These are for three phase, three wire, 240, 480, and 600 volt, 25 to 60 cycle circuits. The panels are fully illustrated and described and wiring diagrams are included. The bulletin contains 44 pages. A similar bulletin, No. 4995, describes direct current switchboards, for double polarity, 125, 250 and 600 volt circuits.

MECHANICAL DRAFT.—The various methods of applying fans to stationary boilers with the purpose of producing artificial draft are fully covered in a booklet issued by the American Blower Company, Detroit, Mich., which is designated as Publication No. 343. A discussion of the principles of combustion and of the different ways of creating draft are included, and a portion of the book is given up to the consideration of the relative advantages of induced and forced draft. A number of illustrations of both systems are shown.

TUBE EXPANDERS.—Hand and power driven boiler tube expanders, in a variety of styles and sizes are thoroughly illustrated and described in Bulletin No. 20, issued by Gustav Wiedeke & Company, Dayton, Ohio. The design of these expanders is based on an extensive experience confined exclusively to this field, and the catalog indicates that all reasonable requirements for locomotive use have been fulfilled. This company also furnishes sectional expanders, as well as the roller type to which this catalog is devoted.

LOCOMOTIVE CRANES.—A handsomely illustrated 63-page catalog is being issued by the Ohio Locomotive Crane Company, Bucyrus, Ohio. The illustrations include a full collection of the details of the equipment used on the standard type of cranes, as well as many views of different types of locomotive cranes at work. This company devotes its attention exclusively to this class of equipment, and is prepared to furnish cranes of various types from 5 to 50 tons capacity, operated by either compressed air, steam or electricity.

LOCOMOTIVE CRANES AT GARY.—Forty-two locomotive cranes were purchased from the Industrial Works of Bay City, Mich., for use in the construction of the United States Steel Corporation plant, at Gary, Ind. These have been used for many different purposes and have been in operation from the beginning of the excavation to the present time. Some of the work that they have performed is shown in a series of 28 photographs, bound in book form, now being issued by the Industrial Works. The pictures are reproduced in sepia and the book is most attractive.

FOSTER SUPERHEATERS.—The Foster patent superheater consists of a series of single loop pipes connecting two headers, each pipe being formed by a seamless drawn steel tube on the outside of which is fitted a series of cast iron annular gills or flanges placed close together. On the inside of each straight section is an inner tube, sealed at both ends, which forces the steam against the heating surface. These superheaters are for

stationary boilers and are fully illustrated and described in a catalog issued by the Power Specialty Company, 111 Broadway, New York.

FREIGHT AND PACKAGE HANDLING MACHINERY.—A 27-page catalog, designated as Bulletin No. 74, and issued by the Jeffrey Manufacturing Company, Columbus, Ohio, contains 134 illustrations of mechanical equipment designed especially for the economical transfer of various materials. In each case the equipment is shown in operation and practically every condition of local transportation is represented. Among the new apparatus of this kind, shown therein, is an improved type of finger tray elevator for raising and lowering packages, boxes and barrels, and a swinging tray elevator platform.

BURNING FUEL OIL.—As the use of fuel oil in place of coal continues to increase, interest in burners and other apparatus for handling and transferring this fuel becomes more active. The advantages of oil fuel are well known, and wherever the cost will permit, it is being exclusively employed for both stationery and locomotive boilers, as well as furnaces. A large, fully illustrated catalog from Tate-Jones & Company, Empire building, Pittsburgh, Pa., shows burners of various sizes and designs, as well as pumps and other appliances required in connection with the use of fuel oil.

ROLLER BEARINGS FOR CARS.—Roller bearings for car journals have been used on some railways for ten years, and a catalog recently issued by the Standard Roller Bearing Company, Philadelphia, Pa., designated as Bulletin 26, shows the financial returns which have been made possible through this medium alone. These bearings are now quite extensively used on light rolling stock, and the development indicates that there will soon be possibilities for similar applications on standard railway cars. The catalog includes sectional drawings of a number of designs, as well as a large number of photographs of car journal boxes and trucks.

GASOLINE ELECTRIC GENERATING SETS.—The use of electricity for private lighting and power purposes has been heretofore largely restricted to districts having a central power station. The improvement of both the gasoline engine and the small electric generator has now reached a point where electric generating sets that are easy and inexpensive to operate and are thoroughly reliable can be obtained in practically any desired size. Catalog 205 from the B. F. Sturtevant Company, Hyde Park, Mass., illustrates several sizes of direct connected sets for this purpose. It also gives fully illustrated descriptions of all the details of the apparatus, and includes dimensioned diagrams.

REVERSING MOTOR PLANER DRIVE.—Several years ago the Triumph Electric Company, Cincinnati, Ohio, recognizing the demand for a direct connected electric planer drive, began a series of experiments with the view of developing a design that would fill all requirements. Early in this work it was found necessary to build special motors to suit both the planer and controller, and many interesting inventions have been embodied in final arrangement, for which patents are now pending. This equipment has successfully met severe service demands for the past two years and is fully illustrated and described in Bulletin 501. Curves showing the speed of the platen at various points of the cycle, as well as the current consumption, are included.

INSULATION OF RAILWAY EQUIPMENT.—The Union Fibre Company, Great Northern building, Chicago, is issuing a pamphlet containing 109 pages, which fully discusses the construction of refrigerator cars. It includes a brief history of the development of insulation for this purpose and discusses at some length the theory of insulation. The process of manufacturing Linofelt is described, illustrations of the different processes in the manufacture being freely used. Recommendations as to the proper

method of installing insulation on the cars are given and photographs of cars in different stages of construction are used as a demonstration. Tests of refrigerator cars under various normal, as well as very difficult, conditions are included, and a chapter is devoted to steel passenger car insulation.

INGOT IRON.—In 1904 the United States Department of Agriculture made a thorough investigation as to the causes of the rapid corrosion of steel fence wire. The results of this research were published in Bulletin 239, which suggested that the impurities in steel, especially manganese, was the chief cause. Following this suggestion, the American Rolling Mill Company, Middletown, Ohio, started a comprehensive research to devise a means of manufacturing iron free from impurities. The result of this work was the production of a metal called American Ingot iron. An attractively illustrated pamphlet of 44 pages is now being issued by this company, in which the statements of scientists, engineers and users, that have appeared either in the technical press or before various engineering societies, as well as in correspondence, are republished. The illustrations show the uses to which this rust resisting material is now being adapted and photographs of the mills where it is manufactured.

LUBRICATORS AND ATTACHMENTS.—The latest catalog of the Detroit Lubricator Company, Detroit, Mich., contains 232 pages and covers lubricators for practically all purposes, including both the gravity and force feed types, and also illustrates a most comprehensive line of lubricator attachments. The section devoted to locomotive lubricators illustrates new designs which are proving capable of fulfilling the different requirements of the modern large superheater locomotives. They are shown in various sizes, having from two to eight feeds, and a capacity of from two to ten pints. Each is fitted with an oil control valve which allows the feeds to the cylinders being shut off without interfering with the feeds to the air pump and without disturbing the setting of the feed regulating valves. Special lubricators for air cylinders of air pumps are shown in several different sizes. A device which has proved most valuable on large superheater locomotives assigned to long runs has been designed by this company and is illustrated in this book. It consists of a tank with a capacity of about three pints so arranged that the oil can be transferred from it to the lubricator at will. In the back part of the catalog will be found a complete numbered list with prices of all repair parts for all different types of lubricators. The catalog is fully indexed and the illustrations are particularly clear.

STORAGE BATTERY CARS.—On September 24, 1912, the first electric storage battery train ever operated, ran from the Pennsylvania station, New York City, to Long Beach, Long Island. It was made up of three Beach-Edison battery cars, carrying one hundred and thirty-six passengers, and maintained the schedule of the Long Island express trains from New York to Long Beach and return. For the round trip of 49.2 miles, which was made at an average speed of 27.4 miles an hour, the power consumption was 622 ampere hours at an average voltage of 220. The maximum speed was 42 miles an hour and a speed of 17.8 miles an hour was maintained on a 2 per cent. grade, two miles in length. The cars in the train were built by the Federal Storage Battery Company, Silver Lake, N. J., for the United Railways of Havana. Each car is 38 ft. in length and is equipped with 220 cells of Edison nickel-steel alkaline batteries, which are carried under the transverse seats. Each car is driven by four ten horse power, series-wound motors. A full description of these cars, as well as of a number of other cars which this company has in service in various parts of the country, will be found in a recent catalog designated as Bulletin No. 31. Full data on the cost of operation, power consumption and other technical features including the charging of batteries, etc., are given.

AMERICAN ENGINEER

"THE RAILWAY MECHANICAL MONTHLY"

(Including the Railway Age Gazette "Shop Edition.")

PUBLISHED ON THE FIRST THURSDAY OF EVERY MONTH, BY THE
SIMMONS-BOARDMAN PUBLISHING COMPANY,
83 FULTON STREET, NEW YORK, N. Y.

CHICAGO: Transportation Bldg. CLEVELAND: Citizen's Bldg.
LONDON: Queen Anne's Chambers, Westminster.

EDWARD A. SIMMONS, *President.* HENRY LEE, *Secretary.*
L. B. SHERMAN, *Vice-President.* A. E. HOOVEN, *Business Manager.*
The address of the company is the address of the officers.

ROY V. WRIGHT, *Editor.* R. E. THAYER, *Associate Editor.*
E. A. AVERILL, *Managing Editor.* WILLIAM FORSYTH, *Associate Editor.*
GEORGE L. FOWLER, *Associate Editor.*

Subscriptions, including the eight daily editions of the *Railway Age Gazette* published in June in connection with the annual conventions of the Master Car Builders' and American Railway Master Mechanics' associations, payable in advance and postage free:

United States, Canada and Mexico.....\$2.00 a year
Foreign Countries (excepting daily editions)..... 3.00 a year
Single Copy 20 cents

Entered at the Post Office at New York, N. Y., as mail matter of the second class.

VOLUME 86. DECEMBER, 1912. NUMBER 12.

CONTENTS

EDITORIALS:

| | |
|---|-----|
| Burlington Mikados | 611 |
| Chart for Tractive Efforts..... | 611 |
| Methods in French Work Shops..... | 611 |
| Entertainment at Atlantic City Conventions..... | 612 |
| Fifty Dollars for Best Car Article..... | 612 |
| A S M E Code for Locomotive Tests..... | 612 |
| New Books | 613 |

ILLUSTRATED:

| | |
|---|-----|
| Electric Systems for Train Lighting..... | 614 |
| Erecting Shop Kinks..... | 618 |
| Mikados for the Burlington..... | 619 |
| Engine House Facilities for Mallet Locomotives..... | 622 |
| Largest Narrow Gage Locomotives..... | 623 |
| Adjusting Safety Valves..... | 624 |
| Repairing Boiler Check Valve..... | 624 |
| Manufacture of Brake Beam Hangers..... | 625 |
| Shop Kinks | 627 |
| The Safety Habit..... | 631 |
| Maintenance of Piston Valves..... | 633 |
| Shonfelt-Vaughan Fusible Plug..... | 637 |
| Temperature Tests on Superheater Locomotives..... | 637 |
| Erecting Shop Kinks..... | 639 |
| Air Pump Governor Repairs..... | 639 |
| Chart for Obtaining Tractive Efforts..... | 641 |
| Checking Tool Outfits..... | 641 |
| Non-Parallel Axle Trucks..... | 642 |
| Removing Wheels from Mallets..... | 642 |
| Machine Shop Kinks..... | 643 |
| Engine Truck Boxes with Chilled Faces..... | 644 |
| Miscellaneous Shop Kinks..... | 645 |
| Floor Type Boring Machine..... | 648 |
| Graphite Lubricator | 648 |
| High Speed Hack Saw..... | 649 |
| Wiltbonco Water Gage..... | 649 |
| Combination Saw and Rotary Planer..... | 650 |
| Bracket Fan | 650 |
| Hack Saw Blade..... | 651 |
| Motor Application to a Punch and Shear..... | 651 |
| Shaft Coupling for Motor Drive..... | 651 |

NON ILLUSTRATED:

| | |
|---|-----|
| Apprenticeship Plans on the Illinois Central..... | 622 |
| Management of a Drawing Room..... | 629 |
| The Parcel Post..... | 632 |
| Shop Electrification..... | 644 |
| Smoke Problem in Chicago..... | 651 |

GENERAL NEWS SECTION:

| | |
|-------------------------------|-----|
| Notes | 652 |
| Meetings and Conventions..... | 653 |
| Personals | 654 |
| New Shops | 656 |
| Supply Trade Notes..... | 657 |
| Catalogs | 658 |

The Burlington Mikados

An order of one hundred locomotives of the Mikado type by the Chicago, Burlington & Quincy is a good indication of the secure position which this type of locomotive now holds on the railroads of this country. This road, like others in the same district, has long stretches of very low grade line and handles large amounts of bulk commodity at moderate speeds as well as perishable products that require high speed. The design of the locomotives selected is evidently well suited to heavy tonnage trains of both kinds, and this large order was placed after experience with 2-8-2 type locomotives of about 18 per cent. less hauling capacity and of Mallets of about an equal percentage greater drawbar pull. On other roads, in both the east and west, the 2-8-2 type has been very satisfactory for work where moderate grades are encountered, and it would seem that this type has sufficient flexibility to allow it to be adapted successfully to a large range of operating conditions, a fact which was never true of the consolidation type.

Chart for Tractive Efforts

The solving of commonly used equations by the graphical method has many advantages. It not only is a great time saver, but largely eliminates the probability of error. The more progressive computers and designers generally prefer data presented in curve form and not infrequently, for their individual convenience, transpose any formula that they frequently use. Among locomotive designers there is probably no formula more generally used than that for obtaining the locomotive tractive effort, and while at first sight this might seem to be a difficult formula to put into convenient and useful graphical form, L. R. Pomeroy has been successful in accomplishing it, as will be seen by reference to page 641. With this chart it is a simple matter to observe the effect of changes in any particular dimension or to work backwards and ascertain the necessary length of stroke, diameter of drivers, etc., to give the desired result. We desire to publish as many simple and practical charts of this character as it is possible to obtain, and would be glad to receive from our readers copies of anything of this kind they may have prepared for their own use, which have not already been published, or suggestions as to formula in common use which it would be advisable to transfer to the graphical form.

Methods in French Work Shops

French locomotives are known to be designed and constructed with great care, and they frequently have been offered as a model for American motive power men. While these facts, in a general way, have been known and drawings showing the details of construction have been available to some extent, there has been practically no information published in English on the exact method pursued in the shops for renewing and repairing the various parts. The article on page 633 describing in detail how piston valves and their bushings are machined and assembled in the shops of the Eastern Railway of France is therefore of special interest. It will be seen that the reputation of the French workman for carefulness and accuracy is not undeserved. It is also evident that the designer is allowed a freedom in his selection of materials and given an opportunity to produce the best machine without unreasonable restrictions as to its cost, a condition which does not hold on all of the roads in this country. There has been considerable discussion as to the causes and remedies for the leakage of piston valves in this country, and it is quite evident that the French railways do not propose to have any trouble of this kind. If the same methods were followed on our locomotives of using a floating valve; boring the valve chamber bushings after they are in place; turning the rings to give equal pressure in all directions and to have a perfect circular fit at the beginning, while leaving them entirely free from the duty of supporting

the valve, and machining all parts to dimensions so accurate that the effect of the expansion of the various metals must be considered, it is quite probable that complaints of leakage in piston valves would be heard no more. A micrometer is a novelty in most American railway shops, but it is evident, from the account of doing this work, that it is a commonly used instrument with the French workman. It must be recognized that extreme accuracy on locomotives is an extravagance in some cases, but in other particulars it is a decided economy, although its first cost, like many other economical features, may seem to be very high. It may be that the French methods are more accurate than good business policy dictates, but it is equally possible that American shop methods may be in error on the other side.

Entertainment at Atlantic City Conventions

Now that it has been decided to again hold the Master Car Builders' and Master Mechanics' conventions at Atlantic City, the subject of what changes, if any, should be made in the entertainment features is being given considerable attention. The radical change made last year in these particulars has brought forth a number of suggestions for still further improvement. The changes that have been made are conceded by all to be based on the right principle, and while the net results were subjected to some unfavorable criticism the causes seem to be all of minor importance; even the strongest champions of the new plans admit that some improvement is possible, however, and it is quite probable that some alterations in the arrangements will be made this year. The whole subject was very frankly discussed in the June 19, 1912, issue of the *Daily Railway Age Gazette*, published at the closing of the convention, and it was truly stated that "the one principle to be borne in mind is that everything else should be made decidedly subsidiary to the business purposes of the associations. The sessions of the conventions come first and full opportunity to study the exhibitions comes next in importance, and whatever to any considerable degree interferes with these things or may be construed as interfering with them, should be frowned down." In the same article there were some excellent suggestions as to improvements in the entertainment features which we believe the entertainment committee would do well to carefully consider. The most important of these is, that all the social features should be held in the evening on the pier and that all exhibits should be kept open during the evening. It is very truthfully stated that practically every other industrial exposition in the United States, whether it be the Railway Appliance Association exhibit in Chicago, or an automobile or agricultural show, is held open during the evening. As an argument it is pointed out that every railroad man who attends the convention does not want to dance, and if the exhibits are kept open in the evening and all the social affairs are held on the pier, those who prefer looking over the exhibits to the social functions would have an opportunity of so doing. Furthermore, many railroad men spend only a day or two at the conventions and they would no doubt welcome as a great improvement the innovation of keeping the exhibits open at night. It has been felt by many of the exhibitors that the benefits accruing from their exhibits hardly justify the expense, this being due principally to the small amount of time allowed the members, who are regular attendants at the meeting, for carefully inspecting the exhibits. On the other hand, and for the same reason, the attendance at the meetings has been affected. If the exhibits are held open in the evening the time available for inspecting them will be increased 50 per cent. to those railroad men who attend all of the meetings. The expense for lighting would not be prohibitive, and the opportunity for more leisurely examination would be most beneficial to both the exhibitor and the railroad man. Arrangements can undoubtedly be made so that only part of

the men employed by the exhibitors will have to be on duty during the evening and they can be relieved during part of the day.

\$50 for the Best

Car Article

No one can question the great importance of the car department in railway operation. This is especially so when it is recalled that there are about 40 cars in service for every locomotive, representing probably a greater capital investment than for locomotives; that it costs about as much to maintain them, and that the possibilities of reducing the amount of damage to lading by better design and construction are very great. A slight mistake in design may cause an increase of a few cents, or a dollar or so, in making repairs to a certain part, but the number of cars in an order is usually so great that the sum total to be expended is a large item, although there is no way of checking it up so that it can be forcibly presented to those in charge of buying or designing the cars. Beginning with the January, 1913, issue we propose to devote much more attention to car department matters than we have in the past—in fact, the intention is to have a department devoted entirely to that subject. Unfortunately car department readers are far behind their brothers in the locomotive department in contributing to our columns, and therefore we shall try to encourage them by offering a first prize of \$50 for the best article on freight car design submitted before February 15, 1913. A second prize of \$25 will be given, and any other contributions which are accepted for publication will be paid for at our regular space rates. The article may consist either of a discussion of the methods of design or it may be written by the practical man, not a designer, calling attention to features which should be considered by the designers, but that are often overlooked by them because of their lack of familiarity with the practical conditions under which the cars are to be used, repaired or maintained. Thousands and thousands of dollars have often been expended by the railroads for repairs which would have been entirely unnecessary if the designers had been more familiar with these conditions. And yet, because of the fact that the repairs were made a few at a time at various points throughout the country, and only cost a small amount for each car, and because of the difficulty in getting an exact estimate of the total amount of repairs for any one part, the officers have not realized the seriousness of the mistake. Moreover the average designer and many of the men who control the specifications for the cars have not had an adequate idea of the necessity for making the cars water, burglar and leakage proof. What suggestions can you make to secure better results? What methods of design have you developed either to make the car or its parts of proper strength and durability, or to design the car in such a way as to prevent damage to the lading. Note that the competition is open to both the designer and the practical man—the first to tell how it should be done from his standpoint; the second to tell where the designer has fallen down and what he should look out for to get better results. Possibly the designer is not given a fair chance? If so, what should be done to insure better results and where does the trouble lie?

A. S. M. E. Code for Locomotive Tests

In 1909 a committee on power tests was appointed by the American Society of Mechanical Engineers, and given the duty of revising and extending the present test codes of the society relating to power plant apparatus. This committee has presented a preliminary report which is published in the November issue of its Proceedings and will be presented at the annual meeting this month. Twelve codes for testing individual apparatus are presented in the second part of the report, the first part being devoted to standards and general matters. Among these is a code for locomotive tests which contains some suggestions that will probably arouse

considerable discussion. Codes are given for what are termed shop tests, or tests made where the power is absorbed by a brake, and for road tests where the locomotive is in regular operation on the road. Under the latter head the proposed code provides that the fire shall be thoroughly cleaned, ashes and refuse removed from the smoke box and ash pan, and the fire burned down as low as possible just before the locomotive leaves the engine house. The average thickness of the firebed is to be then noted as well as the steam pressure, water level and the time, and it is to be considered that this is the starting time of the test. Weighed coal is then to be used and the regular work of the test started. It is provided that the water data only shall be taken just before the train starts. As the end of the route is approached the fire shall be burned down to such an extent as to leave, as near as practicable after cleaning, the same amount of live coal on the grate as that observed at the start. On reaching the terminal, the steam pressure, water level and time are to be noted and the test is then completed. Practically the same conditions and provisions hold for the shop tests.

For road test the code provides that the length of time on which the hourly rates of combustion and evaporation are based is the total time that the throttle valve is open and not the elapsed time between the starting and stopping times.

It would seem that both of the features just mentioned should be subject to more elaborate treatment, especially in connection with the tests of freight locomotives which not infrequently consume considerable fuel while standing on side tracks. Provision should be made for deducting this as well as the fuel consumed by auxiliaries, if the hourly rate of combustion is based only on the time during which the throttle is open. It is specified in the proposed code that the dimensions of heating surface of boilers and superheaters are those surfaces in contact with the fire or hot gases. In this connection it should be remembered that the amount of heating surface given in published descriptions of locomotives and in the data from locomotive builders is measured on the outside of the tubes between the tube sheets or, in other words, is the area of the tube in contact with the water. The firebox heating surface, however, is usually based on the fire side of the sheet, and includes the heating surface of the back tube sheet.

The standard units on which to base the various measures of capacity as recommended are, for boilers: "One pound of water evaporated into dry steam from and at 212 deg. per hour." For locomotives, "One indicated horse power developed in the main cylinders," and "one dynamometer horse power delivered to the drawbar."

The recommended standards of efficiency and economy for locomotives are as follows: Pounds of dry fuel per i. h. p. per hour and per d. h. p. per hour; pounds of dry steam per i. h. p. per hour, and per d. h. p. per hour and pounds of dry fuel per ton-mile.

The report is accompanied by thirty-four appendices, giving detailed instructions as to the methods to be pursued in using the various pieces of apparatus and in the location of apparatus and instruments for locomotive tests. It is directed that the water meter should be attached to the suction pipe of the injector at a point where it can be conveniently read when the train is in motion. A check valve should be provided to prevent hot water backing through it when starting and stopping the injector. It is recommended that a rod be attached to the reverse lever and carried forward to the observation box on the pilot, where a scale should be provided to show its position. It further states that a rod should be likewise connected to the throttle valve lever for the same purpose. For giving the temperature in the front end a bulb thermometer reading to 1,000 deg. Fahr. and inserted so that the bulb occupies a position below the top of the exhaust nozzle and between it and the front tube sheet, should be used. For temperatures over 2,000 deg. Fahr. an optical, pneumatic or radiation pyrometer is specified.

NEW BOOKS

Boundaries and Landmarks. By A. C. Mulford. Cloth bound, 5½ in. x 8 in., 89 pages, 19 illustrations. D. Van Nostrand Co., New York. Price \$1.00.

This work is unique among books on surveying in that it does not describe methods of measuring boundary lines, but discusses the establishing of new landmarks and the finding of old ones. It is intended to familiarize the surveyor with the different types of old boundaries that exist throughout the country. The author has not tried to write a handbook, the style of the work being suggestive rather than specific.

Mechanical World Pocketbook, Diary and Year Book for 1913. Illustrated. Bound in cloth, 330 pages, 4 in. x 6 in. Published by Emott & Co., 65 King street, Manchester, Eng. Price, 16 cents.

In this, the twenty-sixth edition of this pocketbook and diary, several new sections have been added and a number of others have been completely revised. New data and tables will be found in the section on gas engines, while that on oil engines has been greatly extended, particularly in connection with the Diesel engine. There is a new section on heat and another on chain driving. Spiral gearing is also the subject of a new section. A diary and memorandum for 1913 follows the reference section.

Comparative Trials of Gasolene and Alcohol Internal Combustion Engines. By R. W. Strong and Lawson Stone. Illustrated. Bound in paper, 243 pages, 6 in. x 9 in. Published by the Bureau of Mines, Department of the Interior, Washington, D. C.

A complete account of the work of the Bureau of Mines in connection with the testing of the comparative fuel values of gasolene and denatured alcohol in internal combustion engines will be found in this bulletin (No. 43). The tests were very elaborate and the report contains the full data which is shown both in tabular and curve form. The net results of the tests indicate that denatured alcohol gives the greater efficiency.

Railway Tool Foremen's Association. Proceedings of the fourth annual convention. Illustrated. Bound in paper, 109 pages, 6 in. x 9 in. Published by the American Railway Tool Foremen's Association, A. R. Davis, Secretary, Macon, Ga. Price, 50 cents.

At the fourth annual convention of this association, held in Chicago, July 9-11, 1912, papers on Milling Cutters and Reamers; Standardization of Carbon Tool Steel; Tempering of Tool Steel in the Electric Furnace; Standardization of Steel for Small Tools, and Checking Shop Tools were presented for discussion. The full text of the papers and of the discussion, as well as the report of the secretary and treasurer, a list of the officers and the members of the various committees are given in this volume. Topics for discussion at the next convention have been selected, and are published therein, as well as a complete list of the members of the association, with their addresses.

Railway Master Mechanics' Association. Proceedings of 1912 convention. Illustrated. Bound in cloth, 432 pages, 6 in. x 9 in. Published by the American Railway Master Mechanics' Association, J. W. Taylor, Secretary, 390 Old Colony building, Chicago. Price, \$2.50.

The reports and papers presented at the last annual convention, together with a full verbatim account of the discussions, are given in this volume. These cover the following subjects: Cast Steel Locomotive Frames; Contour of Tires; Design, Construction and Inspection of Locomotive Boilers; Engine Tender Wheels; Flange Lubrication; Main and Side Rods; Maintenance of Superheater Locomotives; Mechanical Stokers; Requirements for Headlights; Safety Valves; Standardization of Tinware, and Steel Tires. Full specifications and drawings of the standards of the association are included, as well as a list of the members and their addresses. The officers, members of committees to report at the next convention and the subjects to be discussed, as well as the constitution and by-laws of the association, form part of the volume.

ELECTRIC SYSTEMS FOR TRAIN LIGHTING

“Light Failures on Well Maintained Electric Service Now Average in the Neighborhood of 1 Per 1,000,000 Miles.”

The following account of the electric systems used for train lighting in this country is taken from a paper on Train Lighting, which was presented before the Railroad Sessions of the annual meeting of the American Society of Mechanical Engineers, held in New York on Thursday morning, December 5, by H. A. Currie, of the New York Central & Hudson River, and Benjamin F. Wood, of the Pennsylvania Railroad. The first part of the paper was given over to a review of the subject of train lighting from the time candles were used to the present day. The methods employed are given in historical order and comprise the candle, oil, gas and electric lighting systems. The systems appear to occupy a period of 25 years each, beginning with candle lighting in 1825. The early methods of candle and oil lighting are described in brief outline. The gas lighting period is gone into more fully and the systems in general use are described. Then follows in still more detail a consideration of the electric lighting period, from which the following is taken:

Early in 1881 the London, Brighton & South Coast had in operation a straight storage battery system with a battery under each car, the battery being charged during the layover period at terminals. Bichromate primary batteries were tried on trains in France during the year 1885. The scheme was abandoned, however, when the first set of batteries had run down and renewal of the electrodes and acid was necessary. About this time both the Pennsylvania Railroad and the Boston & Albany tried out the straight storage system. The general opinion was that the system was practical, but too expensive for general use.

In 1888 the Chicago, Milwaukee & St. Paul had in service a train equipped with a head-end system consisting of a boiler, engine, generator, etc., installed in a separate car for supplying light to the train. The present system, developed later, uses steam from the locomotive.

The axle driven generator was developed coincidentally with electric lighting. The first installation of this kind consisted of a generator connected to a relatively high capacity battery and hand-operated main switch and pole changer, regulation being effected through the inherent regulation of the batteries taking the excess current at high speeds, thereby holding the voltage nearly constant by armature reaction. Later the brushes were automatically shifted with the speed for voltage regulation. The next step was to allow the belt to slip at speeds in excess of the speed required to deliver current at normal voltage.

STRAIGHT STORAGE SYSTEM.

In this system, each car is provided with a storage battery, which must be charged at terminals during the layover period. A consideration of the requirements for successful operation reveals the following essentials: The capacity of the battery must be in excess of the demand for current to operate lamps, fans, etc., for the longest run between charging periods. The power plant, or other outside source of power, must be of sufficient capacity to meet the maximum demand for charging current. The layover time at terminals must be sufficient to cover all necessary shifting and charging of the batteries at the proper rate. The yard must have a sufficient number of tracks provided with charging outlets, so arranged that the charging of batteries will not interfere with shifting operations.

Two considerations enter into the determination of the size of the battery—the demand for current and the weight of the battery. The demand for current will vary with the type of car used, the number and size of lamps and other electrical apparatus installed and the time during which this apparatus is used.

The battery must be divided into units of a weight that may be readily handled. The batteries in general use in train lighting service have a rated capacity of approximately 300 ampere-hours. This is about the maximum limit of capacity for Plante's type batteries having weight low enough for convenience in handling. The great majority of cars on which this system is used are equipped with a 64 volt lead-lead, or nickel-iron battery with cells connected in series. A few cars are operated at other voltages, viz., 26, 30, 32 and 110. Two battery boxes are generally provided and secured to the under side of the car, one on each side equidistant from the ends of the car, and with the front or door side slightly back of the line of outside finish. The cells are put up in double compartment, lead-lined wood tanks provided with handles, rollers, etc., for convenience in handling. The two halves of the battery are connected in series and leads are run to the switchboard in the end of the car. Taps are taken off these leads at the battery terminals and run to charging receptacles, conveniently located on each side of the car.

The ampere-hour meter is coming into general favor as an indicator of the state of charge of the battery. As an adjunct a shunt trip circuit breaker is sometimes installed, the connections being such that, when the battery is fully charged, the pointer on the meter closes a circuit which energizes the shunt trip and opens the breaker, thus cutting the battery off charge. The source of power available for charging purposes at terminal

TABLE 1.—COSTS OF VARIOUS SYSTEMS OF PASSENGER CAR ILLUMINATION.

| | 1825-1850 Candles | 1850-1875 Oil | 1875-1900 GAS | | | 1900 ELECTRIC | | |
|---------------------------------------|----------------------|------------------|------------------|-----------------|--------------------|--------------------|---------------------|---------------|
| | | | Gas- lene | Pintac h | Acety- lene | Head- End | Straight Storage | Axle Coach |
| Passengers carried..... | 4-20 | 20-50 | 50-60 | 60-70 | 60-70 ¹ | 30-40 | 40-50 | 60-70 |
| Candle Power..... | 4-10 | 20-60 | 200 | 300 | 400 | 350 | 250 | 450 |
| Fixtures and Connections. | 0 to \$3 | \$10-\$60 | \$500 | \$400 | \$500 | \$700 ² | \$800 | \$1000 |
| ² Cost of Plant..... | | | | 60 ³ | \$40 | 25 | 20 | |
| ² Yearly Operating Cost... | 15-25 | 40-120 | 150 | 150 | \$200 | 750 | 500 | 200 |
| Yearly Haulage Cost..... | | | 150 | 200 | \$200 | 400 | 300 | 400 |
| Interest, Insurance and Taxes..... | | | 50 | 50 | \$60 | 100 | 62 | 145 |
| ⁴ Total Yearly Cost..... | 20 | 60-100 | 350 | 400 | \$500 | 1250 | 1350 | 750 |
| Cost per Year per Seat... | 1 | 1 50-2 | 6 | 7 | \$5 | 31 | 34 | 12 |

¹ At the time of the prevalence of these systems only limited trains were so equipped.

² Including all maintenance.

³ Share per car considering whole train.

⁴ Average

⁵ Based on capacity for 500 cars.

BASIS for above figures, Passengers Carried suppose all seats to be occupied. The Fixtures and Connections are in nearly every case from actual installations. Cost of Plant is the first cost divided by the capacity in number of cars supplied. Yearly Operating Cost includes fuel or power and attendance and maintenance but not all are actual costs, but are filled out by close estimates. Yearly Cost per Seat is simply an arbitrary means of comparing cost per passenger.

yards must be of the proper voltage and of capacity sufficient to meet the maximum demand. The charging voltage provided is usually 50 per cent. higher than the normal voltage of the battery. Hand or automatically operated resistance devices are provided for reducing the voltage of the individual charging lines to the proper point. The batteries are charged while on the car under normal conditions. When the layover period is short it is sometimes necessary to exchange a discharged battery for one fully charged.

The operating schedule of cars equipped with this system must be worked out to allow sufficient layover at terminals to permit the charging of batteries and shifting of cars. Anything that

restricts the shifting operations necessitates either additional yard trackage, additional motive power, or both. As cars produce a revenue only when in service, it is the aim of the transportation department to decrease the layover period to a minimum.

HEAD END SYSTEM.

The head-end system consists essentially of a steam-driven generator located in the baggage car or on the locomotive. Proper controlling apparatus is provided and train lines are run from the generator through the entire length of the train, flexible connections being used between cars. It comprises the following apparatus: A generator, usually steam turbine-driven, placed in the baggage car or on the locomotive, and furnished with steam from the locomotive; the necessary indicating, regulating, and controlling apparatus placed near the generator and in an accessible position; train line wires of the proper size on each car and running the entire length of the train, flexible connections being made between cars, in the vestibule; batteries, consisting of a suitable number of cells connected in series and placed in battery boxes attached to the under side of the cars; lamp regulators are sometimes installed in the cars to compensate for the line drop and to maintain constant voltage at the lamps.

The successful operation of this system requires that a sufficient amount of steam at the proper pressure be provided when lighting is necessary. As it is the object of the transportation department to get trains to their destination on time, lack of steam is felt first by the lighting system, the pressure being reduced or steam cut off entirely so that the schedule may be maintained. When the train is broken-up en route, it is obvious that each section must either be equipped with a battery to insure light until the train is again made-up, or provided with some auxiliary light. A member of the train crew must be capable of operating the generating apparatus and of making running repairs and adjustments en route.

Head-end systems are generally operated at 64 or 110 volts, although in late years the introduction of tungsten lamps has gone a long way to eliminate the need of the high voltage equipments and comparatively few railroads are now using 110 volts. It is apparent that the use of the head-end system must be restricted to a few trains having assigned runs or that it must be extended to cover all the cars operated by the railroad in electrically-lighted trains.

AXLE GENERATOR SYSTEM.

The axle generator systems used in this country comprise the following principal parts: An axle-driven generator mounted on the car truck. (Abroad where rigid trucks are used the axle generator is frequently secured to the under side of the car body.) A suspension by which the axle generator is supported from the truck frame. A drive, connecting the armature shaft to the axle. A regulator for controlling the voltage and output of the generator at all train speeds. An automatic switch designed to open on reverse current for the purpose of preventing discharge of the battery through the generator. A regulator for controlling the voltage impressed on the lamp circuits. A battery of a suitable number of cells to supply current when generator current is not available.

For the successful operation of the system, the following requirements must be met: The polarity of the generator terminals must remain unchanged with a movement of the car in either direction. At all train speeds, from the cutting-in speed of the generator to the maximum, the generator output and voltage must be maintained within the desired working limits. The generator must be automatically connected and disconnected from the battery circuit as the train speed rises above or falls below the critical speed. The lights may be burned at any time and the transfer of this load from the battery to the generator and vice versa must result in no appreciable change

in the candle power of the lamps. The voltage impressed on the lamp circuit must be maintained within such limits as will give satisfactory illumination and reasonable life of lamps.

The early axle generators were practically all of the constant current type. The generator maintained a constant current, and only that portion went to the battery that was not required by the lights. The generator output could be varied by hand adjustment, and it was necessary to adjust the generator output so that there would be an approximate balance between the battery input and battery output, account being taken of the battery ampere-hour efficiency. This requires consideration of both the ampere capacity of the generator, and the ampere-hour demand during the trip. The demand varies with the number and size of lamps installed, the run in which the car is operated, the number and duration of stops, and the proportion of total running time of the train below cutting-in speed. A change of the car from local to through service, or vice versa, required a complete readjustment of the regulation. A failure to so readjust would quickly result in battery deterioration, the plates becoming sulphated with a low generator output, while a corresponding high output would boil away the electrolyte. In a variation of this method the battery was charged at a definite rate, generally the normal charging rate, while the generator output varied with the lamp load. In more recent systems constant current is maintained until the generator voltage, increasing as the counter e. m. f. of the battery, reaches a definite value, after which one of two results will obtain, depending upon the design of the control apparatus. In one the generator voltage is held approximately constant producing what is known as the taper charge or a gradual decrease in the rate of charge. In the other, the generator voltage is automatically reduced to the "floating" e. m. f. of the battery and maintained approximately constant. This is known as "stop charge" regulation.

Both methods originally depended upon the operation of a voltage coil actuating a switch, which in turn changed the field current by means of resistance. Premature closing of the battery stop charge switch resulted in undercharging and consequent sulphating, while delayed closing caused overcharging and the boiling away of the electrolyte.

These devices are being superseded by a system using a voltage coil in the regulator instead of the voltage switches previously mentioned. Here the current output is maintained constant to the full generator capacity regardless of the current demand, and the battery must supply all current in excess of the capacity of the generator. As the battery becomes charged the generator voltage gradually increases and at a predetermined voltage the voltage regulating coil takes the control of the generator from the current regulating coil and when the battery becomes fully charged the current decreases until the battery is "floating on the line." As the voltage on the battery on charge is approximately 30 per cent. higher than on discharge, it is necessary to provide some means of lamp regulation in order to keep a constant voltage on the lamps. In the early axle generating systems this was accomplished by introducing a fixed metallic resistance into the lamp circuit at the instant the automatic switch closed transferring lamp load from battery to generator. This method, however, was not altogether reliable as the generator voltage varied with the condition of the battery and the number of lamps burning. The variation of the voltage due to these conditions soon led to the development of a variable metallic resistance in place of the "fixed" resistance. In this method of regulation the amount of resistance in the circuit was varied by means of the operation of a small auxiliary motor operated by a voltage relay or other means.

A later type of lamp regulator employed, as a means of regulating resistance, a series of carbon blocks, the resistance being varied by varying the pressure on these blocks, the variation of pressure being determined by a pilot voltage coil connected across the lamp mains.

In this country it is the general practice to support the axle

to develop special oils that would remain fluid at low temperatures. Those now used have a freezing point of 10 deg. Fahr. For ball bearing lubrication grease should be free from acid or alkali; should not oxidize or evaporate; should not gum or lose its body.

LAMPS AND VOLTAGE.

The early train lighting lamps were of the ordinary multiple burning type regularly manufactured, and as the demand increased manufacturers took up the development of lamps especially adapted to train lighting. One of the requisites of these lamps is that the smallest size bulb consistent with reasonable life of lamp be used. Among the early lamps was a foreign-made carbon-filament lamp operating at 4 watts per c. p. Some time later, a carbon lamp operating at 3.5 watts per c. p. was developed by American manufacturers.

It was found that the future of electric car lighting depended to a large extent upon whether or not lamps of still higher efficiencies could be manufactured in large quantities. About this time the tungsten lamp was introduced in regular multiple burning service and investigations were immediately started with a view to adapting it to car lighting. The use of tungsten lamps, however, was looked upon with some doubt on account of the extremely fragile nature of the filament, especially in the smaller sizes. Eventually a 25-watt lamp was developed. This did not improve conditions appreciably, since many of the carbon-filament lamps were approximately of the same wattage. Further investigations resulted in the development of a 15-watt lamp which improved conditions sufficiently to warrant its use in large quantities, and made it possible to light a car at a reasonable current demand. With the introduction of tungsten lamps the standard voltage of axle generators has been changed from 60 to 30 volts.

Coincident with the introduction of tungsten lamps into train lighting service there was introduced the so-called "hot filament" system. The basis for this system was the belief that a tungsten filament of the early type when heated to about 400 deg. Fahr., was less fragile than when cold, so that by maintaining the filaments at this temperature the life of lamps could be materially increased. A circuit switching arrangement was provided whereby the lamps were operated across 30 cells of battery when light was desired and across the two remaining cells of the battery at other times, this being sufficient to keep the filaments at a dull red. Later, the introduction of the drawn wire filament rendered this system unnecessary, and it has been abandoned.

Metalized-filament lamps with small opal bulbs, operating at about 2½ watts per c. p. were developed for berth lighting. These lamps gave satisfaction at first, principally because berth lights had never before been furnished. As the public became educated to their use, the demand for more light in berths became pronounced, so that it has been found necessary to use the 15-watt tungsten lamp as a berth lamp, and the use of metalized-filament berth lamps is decreasing very rapidly.

Tungsten lamps for train lighting purposes are now furnished in 10, 15, 20, 25 and 50-watt sizes, although the bulk of demand is concentrated upon 15 and 50-watt lamps. Spherical bulbs are used almost exclusively, 3¾ in. in diameter for the 50-watt lamp and 2 5/16 in. in diameter for the smaller sizes.

The voltage of the lamps is necessarily dependent upon the voltage of the generating system. An investigation of the records of the principal railroads shows the use of the following voltages at the present time: 24, 26, 30, 32, 60, 64 and 110. The bulk of the demand for train lighting lamps is concentrated on two voltage groups, the 30 volt, which includes lamps between 25 and 34, inclusive, and the 60 volt, which includes lamps of from 50 to 65 volts, inclusive. From an engineering standpoint, it is highly desirable that as many of the voltages, wattages and sizes of bulb as is possible be eliminated. From a manufacturing standpoint, it is desirable that some variation be al-

lowed in the voltages, as a large number of high-voltage and low-voltage lamps are accumulated in the manufacture of lamps of a fixed voltage. This brings up the question of the inspection of lamps before purchase.

On account of the method of manufacture of train lighting lamps, manufacturers have found it most convenient to inspect the lamps for initial variation by holding them at a fixed candle power, allowing the voltage and current to vary. From the railroad standpoint, this method of inspection seems to be wrong, as the voltage of the circuit is maintained at a very closely fixed value in actual service. If the manufacturers could be persuaded to do so, it would be much more desirable to have lamps inspected by holding them at a predetermined voltage, allowing the variations to take place in the wattage and candle power. According to the present method of inspection, a variation of 5 per cent. above and below in voltage and 8 per cent. above in watts is allowed. If the demand is concentrated too greatly upon one type of lamp, it will probably be necessary to increase these limits. On the other hand, if the railroads among themselves can standardize their voltage close enough for each voltage class to permit the use of any of the lamps on any railroad, the demand for any one voltage lamp will probably not be great enough to make the increasing of the limits of inspection above mentioned necessary.

Until recently little attention has been given to the development of reflectors adapted particularly to railroad service. There are several very efficient ones now on the market which in some cases have increased the intensity of the light on the reading plane in a passenger car as much as 65 per cent. without changing the current consumption or the candle power of the lamps. To secure the best results, attention must be given to the proper location of the filament relative to the reflector.

The question of sockets also plays an important part in car lighting. The socket must be sufficiently rugged in its construction to withstand the jar and vibration encountered in the handling of passenger equipment cars. It must also be so constructed that when the lamp is screwed home there will be sufficient spring in the inner shell and contact to lock the lamp in position, holding it so tight that it will not become unscrewed by the jar and vibration.

STANDARDIZATION.

The Association of Railway Electrical Engineers has made recommendations as to the standardization of many of the details pertaining to electric car lighting and a number of the railroads of the country have already indicated their intention of following these recommendations by changing their equipment to conform to the recommended practice. The standard voltages recommended by the Association of Railway Electrical Engineers are: 60 volts (nominal) for straight storage and head-end systems; 30 volts (nominal) for axle generator systems.

The lead battery has been fairly well standardized and the construction recommended includes a two-compartment lead-lined tank with rubber jars. The principal variations from the standard in the lead batteries are that some roads are now using lead covers in place of the rubber covers, this change being made to lessen the danger to battery repairmen on account of gas explosions, and the difference in the method of making the connections to the battery posts. The difference in batteries are not of such a character as to preclude the interchange of batteries on different roads. The nickel-iron battery is manufactured only by one company, and therefore the battery is of standard construction and dimensions.

FOREST FIRES.—The department of agriculture has issued bulletin 117, which is devoted to forest fires, their causes and prevention. It is stated that the average annual number of human lives lost in the United States due to this cause is 70 and that the value of trees destroyed is at least \$25,000,000.

ERECTING SHOP KINKS

BY C. A. CURTIS, JR.,
Mt. Clare Shops, Baltimore & Ohio, Baltimore, Md.

AIR RESERVOIR HOIST.

A portable hoist for lifting air reservoir in place is shown in Fig. 1. It is made of telescopic pipe, the larger pipe being 7 ft. long with pointed steel ends riveted in the bottom as shown at *A*. The smaller pipe should be less than 1 in. in diameter and about 6 ft. long, which will accommodate engines with running boards less than 12½ ft. above the track. The reservoir is lifted by a cable; one end is hooked over the running board and the cable is passed under the tank, through a clamp pulley located on the edge of the running board, and

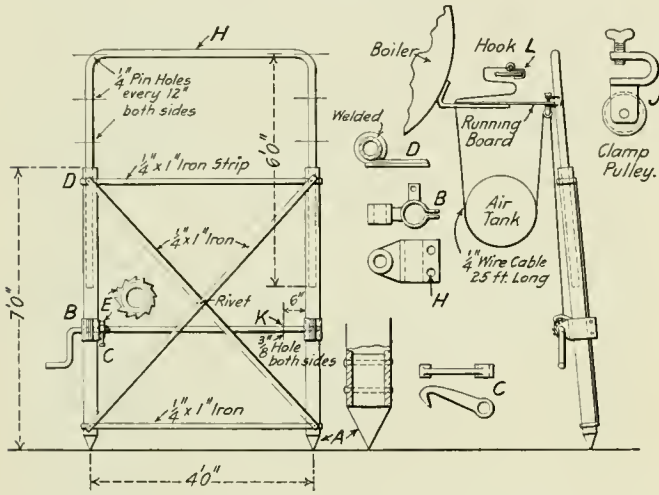

Fig. 1—Hoist for Applying Air-Reservoir Tanks.

is fastened to the rod *K* on which it is wound. This rod or shaft is rotated by a handle. The bearing *B* is provided with a lug to hold the pawl *C* for the ratchet wheel *E*. The left hand bearing is the same as *B* without this lug. They are both clamped to the large pipe by bolts extending through the holes *H*. The smaller pipe is provided with ¼-in. pin holes located 12 in. apart to give any desired height up to about 12½ ft. The braces are fixed to the framework as shown at *D*. This apparatus may be easily handled by two men, and will be found

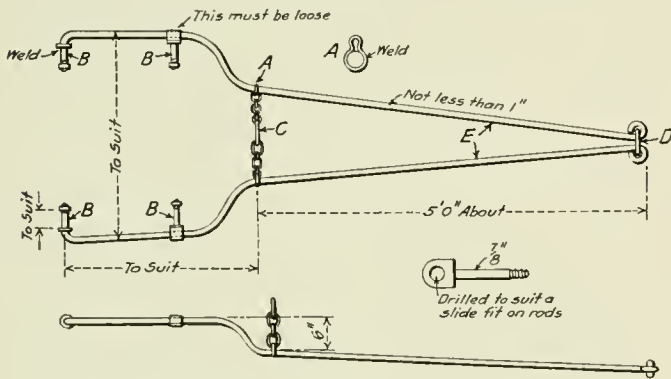

Fig. 2—Device for Lifting Tee-Head to Place.

an improvement over the old method of lifting the reservoir in place by screw jacks, which requires considerable blocking and takes a longer time and more help.

APPLYING TEE-HEAD.

The placing of the tee-head in position in the smoke-box is a hard proposition for two men and an awkward one for three on account of the restricted space. With the device shown in Fig. 2 the work may be done by one

man with the help of an overhead crane. It is made of two rods *E* not less than 1 in. in diameter and formed as shown in the illustration. At the wide end the rods are bent and threaded, and fit in the holes in the tee, as indicated in Fig. 3. Collars are welded on the rods to fit against the flange. The other bolts are free to slide on the rods to allow for

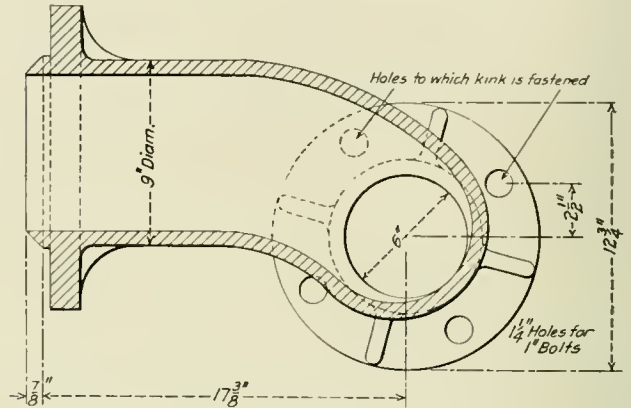

Fig. 3—Tee-Head, Showing the Holes Through Which the Lifting Rods Are Attached.

various sizes of tees. A chain, with an eye *C* for the crane hook is located about 5 ft. from the end of the device, and is welded to the rods at *A*. The rods are held together at the end by a link *D*. With the lifting rods bolted in place the crane hook may be lowered through the smoke stack and hooked into the ring *C*. The workman can balance the whole apparatus at *D* with one hand and signal the crane man with the other, and in this way lift and fit the tee on the stud bolts.

GUARD FOR CHISEL BARS.

The performance of heavy chisel work with a sledge hammer is at its best a rather hazardous operation, for oftentimes the sledge will not hit the chisel squarely on the head and, glancing

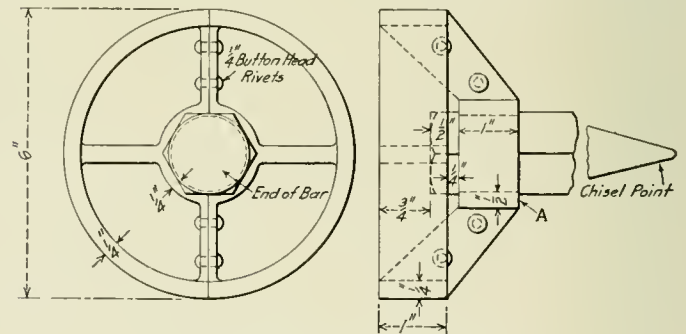

Fig. 4—Guard for Chisel Bar.

off, is liable to either hit the man holding the chisel bar or cause the man swinging the sledge to lose his balance and fall. For this reason the guard shown in Fig. 4 may be considered a safety appliance. It fits in a recess cut in the bar and the halves are riveted together so that they cannot be taken off inadvertently and mislaid. It is bell-shaped, and should the hammer miss the chisel head it would be caught in the guard, and in this way protect the man holding the bar.

DAYLIGHT WORKING HOURS IN HONDURAS.—In Belize, British Honduras, the English "daylight saving scheme" has been put in effect. To more economically adjust the ordinary working hours of the people to the hours of daylight, during the season when days are short, all of the clocks in the city were set ahead twenty minutes; so the amount of daylight time which otherwise might be wasted in the morning in making one's toilet can be availed of after business hours for outdoor games.

MIKADOS FOR THE BURLINGTON

One Hundred Powerful Locomotives of the 2-8-2 Type with Emerson Superheaters Put in Service.

In 1910 the Chicago, Burlington & Quincy received an order of Mikado locomotives from the Baldwin Locomotive Works which have a tractive effort of 49,500 lbs. These locomotives have 27 in. x 30 in. cylinders and carry 170 lbs. steam pressure. The total weight is 271,000 lbs. Within the past few weeks the first of another order of one hundred locomotives of the same type and from the same builders has been put in service. These engines have a maximum tractive effort of 60,000 lbs., an increase of over 21 per cent., as compared with those now in use, which has been obtained, however, with an increase of only about 12 per cent. in total weight. Both classes are fitted with superheaters and, as will be seen in the accompanying table of dimensions comparing these two classes with the engines of the 2-10-2 type which were received early in 1912, the heating surface has been increased over 27 per cent. and the grate area 44 per cent. An increase of one inch in the diameter of the cylin-

when considered in connection with the power delivered. In the accompanying table are shown a number of ratios of this engine compared with four other Mikados and a Santa Fe type locomotive. It will be seen that in percentage of total weight on drivers they are exceeded by one design of the same type, while on the contrary, the average weight per driving axle is the lowest and the tractive effort is as large as any except the Chesapeake & Ohio. If we assume that a maximum indicated horsepower is attained at a 700 ft. per minute piston speed, and that, at this speed, a tractive effort equal to 62 per cent. of the maximum can be obtained, a fair basis for comparison of capacity and power is given. This figure and the speed at which it will be attained is shown in the table. If a further assumption is made that 21 lbs. of water will be required for each horsepower hour a comparison of the boilers can be made and it will become evident if the evaporation per square foot of heating surface is



Powerful Mikado Type Locomotive for the Burlington.

ders and of 10 lbs. in the steam pressure increases the maximum pressure on the crank pin by slightly over 14 per cent. The increase of 2 in. in the length of the stroke accounts, however, for the variance between the percentage increase in pressure on

higher than can normally be expected. On this basis it will be seen that all of the locomotives in the table should be able to deliver the power specified for each and that the Burlington engine will require as low a rate of evaporation as any of those

| Road | C. B. & Q. | Erie. | C. R. I. & P. | C. & O. | D. L. & W. | C. B. & O. |
|---|------------|----------|---------------|-----------|------------|------------|
| Type | 2-10-2 | 2-8-2 | 2-8-2 | 2-8-2 | 2-8-2 | 2-8-2 |
| Total weight, lbs. | 378,700 | 320,600 | 318,850 | 315,000 | 312,000 | 303,400 |
| Weight on drivers, lbs. | 301,800 | 237,150 | 243,200 | 243,000 | 236,500 | 231,000 |
| Per cent. of weight on drivers. | 79.7 | 74 | 76.3 | 77.1 | 76 | 76.4 |
| Average weight per driving axle, lbs. | 60,300 | 59,288 | 60,800 | 60,750 | 59,125 | 57,750 |
| Tractive effort, lbs. | 71,500 | 57,460 | 57,100 | 60,800 | 57,000 | 60,000 |
| Maximum I. H. P.* | 2,750 | 2,330 | 2,470 | 2,500 | 2,470 | 2,470 |
| Speed at which maximum I. H. P. is delivered, m. p. h. | 23 | 25 | 27 | 25 | 27 | 26 |
| Heating surface, evaporating sq. ft. | 5,161 | 4,155 | 4,264 | 4,051 | 4,859.1 | 4,627 |
| Heating surface, superheater sq. ft. | 970 | 843 | 848 | 845 | 1,065 | 961 |
| Evaporative heating surface ÷ superheater heating surface. | 5.32 | 4.94 | 5.03 | 4.8 | 4.56 | 4.82 |
| Evaporation per sq. ft. evaporative heating surface per hour, lbs.† | 11.2 | 11.75 | 12.15 | 12.95 | 10.65 | 11.20 |
| Weight on drivers per H. P., lbs. | 109.5 | 101.5 | 98.5 | 97.3 | 96 | 93.7 |
| Total weight per H. P., lbs. | 137.5 | 137.5 | 129 | 126 | 126 | 122.5 |
| Fuel consumption per hour, lbs.‡ | 7,210 | 6,110 | 6,480 | 6,560 | | 6,480 |
| Fuel consumption per sq. ft. grate area per hour, lbs. | 86 | 87.5 | 102.5 | 98.7 | | 83 |
| Reference in <i>American Engineer</i> —month and page | May, 231 | Feb., 87 | Nov., 563 | Mar., 128 | Sept., 459 | |

* Taken at 700 ft. piston speed, tractive effort assumed to be 62 per cent. of maximum.

† Steam consumption assumed to be 21 lbs. per H. P. hour.

‡ On the basis of 8 lbs. of water per lb. of coal at speed of maximum horse power.

the crank pin and of the tractive effort. The diameter of drivers is the same in both cases.

In comparison with other locomotives of the same type these new Burlington engines are especially noticeable for their weight

shown, with one exception. In the next two items, however, the success of the efforts of the designer are more clearly shown and both the weight on drivers and total weight per horsepower are the lowest of any similar locomotive, being but 93.7 lbs. and

122.5 lbs. respectively. If it is further assumed that 8 lbs. of water can be evaporated for each pound of coal, at the speed corresponding to the maximum indicated horsepower, it is indicated that about 83 lbs. of fuel must be consumed on each square foot of grate per hour, the total fuel consumption per hour being 6,480 lbs. for the Burlington engine.

In many ways these locomotives can be considered as a development based on the design of the 2-10-2 engines and as far as possible the details on the two classes have been made interchangeable. The boilers have the same outside diameter at the front ring and have the same arrangement of both tubes and flues. The barrel is necessarily considerably shorter and the combustion chamber is eliminated and the tubes have been shortened to 21 ft. The taking out of the combustion chamber made the sloping bottom of the third sheet of the barrel unnecessary and in this case the same diameter is continued to the firebox. This reduction in the width of the back tube sheet made it undesirable to place as many boiler tubes outside the outer row of superheater flues as was previously used and five on each side have been eliminated which accounts for the reduction in the total number of tubes. The mudring is the same width but somewhat shorter than the 2-10-2 type and the wrapper sheet has been carried straight back at the top instead of having a drop of 6 in., as in the previous arrangement. The mudring is 4 in. in width at the back and 6 in. at the front and gradually increases from 4 in. to 6 in. on the sides, this being the same design as previously used. A new feature has been introduced in the shape of an 18½-in. opening for the auxiliary dome

| | 2-8-2 type, 1910. | 2-8-2 type, 1912. | 2-10-2 type, 1912. |
|---|----------------------|----------------------|-----------------------|
| Cylinders, diameter and stroke, in..... | 27 x 30 | 28 x 32 | 30 x 32 |
| Driving wheels, diameter, in..... | 64 | 64 | 60 |
| Steam pressure, lbs..... | 170 | 180 | 175 |
| Grate area, sq. ft..... | 54.2 | 78 | 88 |
| Water heating surface, sq. ft..... | 3,659 | 4,627 | 5,161 |
| Superheating surface, sq. ft..... | 693 | 961 | 970 |
| Weight on drivers, lbs..... | 207,000 | 231,000 | 301,800 |
| Weight, total engine, lbs..... | 271,000 | 303,400 | 378,700 |
| Tractive effort, lbs..... | 49,500 | 60,000 | 71,500 |

which permits the boiler to be easily entered for inspection. There are 481 flexible stays used in the sides, throat and back. These are grouped in the usual manner. The inside firebox sheet is in one piece instead of having a separate crown sheet as on the 2-10-2 type. The front end has been made 8 in. shorter, the reduction all being ahead of the center line of the stack.

The cylinders are arranged with inside steam pipes and have an equalizing pipe at the back connecting the two live steam passages, this being the usual way of equalizing the work on the two headers of the Emerson type of superheater with which these locomotives are fitted. The valves are 14 in. in diameter and a Ragonnet reverse mechanism is applied. Although this reverse gear is to be normally operated with compressed air, a steam connection has been arranged for emergency use. The cylinders are fitted with both by-pass and vacuum relief valves. The oil is distributed in the live steam passages, there being no oil connection to the cylinder barrel.

The frames are 5 in. in width with single front sections 11 in. in depth extending under the cylinders. The trailer frames are separate castings. The front deck plate is cast with rear extensions which fit against the inside faces of the front frame sections under the saddle and are secured by the horizontal frame and cylinder bolts. The deck plate has a downwardly extending lug on each side which serves as a support for the driving brake shaft. The brake cylinders are bolted to the main frames just ahead of the first driving pedestals.

All the driving tires are flanged and they are set with sufficient play to enable them to traverse 20 deg. curves. The main axle and the main crank pins are of oil tempered steel. Castle nuts are very freely used throughout the whole locomotive.

A coal pusher is fitted on the tender and cast iron wheels are

used under fifty of the tenders. The other fifty have rolled steel wheels.

The general dimensions, weights and ratios are given in the following table:

| General Data. | |
|--|---------------------------|
| Gage | 4 ft. 8½ in. |
| Service | Freight |
| Fuel | Bit. coal |
| Tractive effort | 60,000 lbs. |
| Weight in working order | 303,400 lbs. |
| Weight on drivers | 231,000 lbs. |
| Weight on leading truck | 29,400 lbs. |
| Weight on trailing truck | 43,000 lbs. |
| Weight of engine and tender in working order | 480,000 lbs. |
| Wheel base, driving | 16 ft. 9 in. |
| Wheel base, total | 35 ft. 9 in. |
| Wheel base, engine and tender | 67 ft. ¾ in. |
| Ratios. | |
| Weight on drivers ÷ tractive effort | 3.85 |
| Total weight ÷ tractive effort | 5.06 |
| Tractive effort × diam. drivers ÷ total evaporating heating surface | 809.00 |
| Total evaporating heating surface ÷ grate area | 59.30 |
| Firebox heating surface ÷ total evaporating heating surface, per cent. | 5.50 |
| Weight on drivers ÷ total evaporating heating surface | 49.90 |
| Total weight ÷ total evaporating heating surface | 65.50 |
| Volume both cylinders, cu. ft. | 22.70 |
| Total evaporating heating surface ÷ vol. cylinders | 204.00 |
| Grate area ÷ vol. cylinders | 3.44 |
| Cylinders. | |
| Kind | Simple |
| Diameter and stroke | 28 in. x 32 in. |
| Valves. | |
| Kind | Piston |
| Diameter | 14 in. |
| Lead | ¼ in. |
| Wheels. | |
| Driving, diameter over tires | 64 in. |
| Driving, thickness of tires | 4 in. |
| Driving journals, main, diameter and length | 11 x 12 in. |
| Driving journals, others, diameter and length | 10 x 12 in. |
| Engine truck wheels, diameter | 37½ in. |
| Engine truck journals | 6 x 10 in. |
| Trailing truck wheels, diameter | 42½ in. |
| Trailing truck journals | 8 x 14 in. |
| Boiler. | |
| Style | Straight |
| Steam pressure | 180 lbs. |
| Outside diameter of first ring | 88½ in. |
| Firebox, length and width | 117 x 96 in. |
| Firebox plates, thickness | ¾ & 5/8 in. |
| Firebox, water space | F.—6; S.—4 to 6; B.—4 in. |
| Tubes, number and outside diameter | 275—2¼ in. |
| Tubes, thickness | No. 11 B. W. G. |
| Flues, number and outside diameter | 30—6 in. |
| Flues, thickness | No. 8 B. W. G. |
| Tubes, length | 21 ft. |
| Heating surface, tubes | 4,373 sq. ft. |
| Heating surface, firebox | 254 sq. ft. |
| Heating surface, total | 4,627 sq. ft. |
| Superheater heating surface | 961 sq. ft. |
| Grate area | 78 sq. ft. |
| Tender. | |
| Frame | 12 in. channel |
| Wheels, diameter | 33 in. |
| Journals, diameter and length | 5½ x 10 in. |
| Water capacity | 9,200 gals. |
| Coal capacity | 14 tons |

PANAMA CANAL TOLLS.—President Taft has prescribed the tolls for the Panama Canal, in accordance with the report of Prof. Emory R. Johnson, professor of transportation and commerce of the University of Pennsylvania. The rate will be \$1.20 for each net ton, 100 cu. ft. of space in a ship being regarded as one ton. Vessels in ballast without passengers will be charged 40 per cent. less than the rate for vessels carrying passengers or freight. Warships other than transports, colliers, hospital and supply ships are to pay fifty cents per displacement ton. Transports and other auxiliaries are to pay \$1.20 per ton.

STEEL PASSENGER CAR EQUIPMENT ON THE PENNSYLVANIA.—There are 1,538 coaches and combination coach and baggage cars, 68 dining cars, 144 baggage cars, 159 postal cars, 34 baggage and mail cars, 11 parlor cars, 4 miscellaneous cars and 520 Pullman cars of the all-steel type in service on the Pennsylvania Railroad. In addition there are on order or under construction 296 coaches, 18 dining cars, 25 passenger and baggage cars, 2 baggage cars, 4 postal cars, 38 baggage and mail cars, 10 parlor cars and one office car of the all-steel type. This gives a total of 2,872 all-steel passenger equipment cars in service or on order for this road.

ENGINE HOUSE FACILITIES FOR MALLET LOCOMOTIVES

NEW APPRENTICESHIP PLANS ON ILLINOIS CENTRAL

Two original ideas have been incorporated in the new engine house of the Chesapeake & Ohio at Clifton Forge, Va. The locomotives at this point are very largely of the Mallet type, and the driver drop pits are arranged in pairs so that wheels from either group on the locomotive may be dropped at the same time. The distance between the two drop pits is the same as that between the corresponding wheels in the two groups of drivers.

On some of the other tracks 24 in. sections of the pit rail are cut out and secured to a block and again installed in such a manner that they cannot readily be displaced. This is for convenience in removing or tightening tires, renewing driving

The educational department of the Illinois Central has entered into agreements with the local school authorities at McComb, Miss., Waterloo, Iowa, and Centralia, Ill., whereby the high school students may receive practical instruction in the trades in the Illinois Central shops. In this way a young man is able to continue his school work and at the same time earn a little money and learn a trade. He will receive the same instruction as a regular apprentice and will be required to sign the regular form of indenture. The young men deciding to avail themselves of this opportunity are divided into groups of two; one will work the full day in the shop, while the other attends school. They will alternate each day, the one entering the

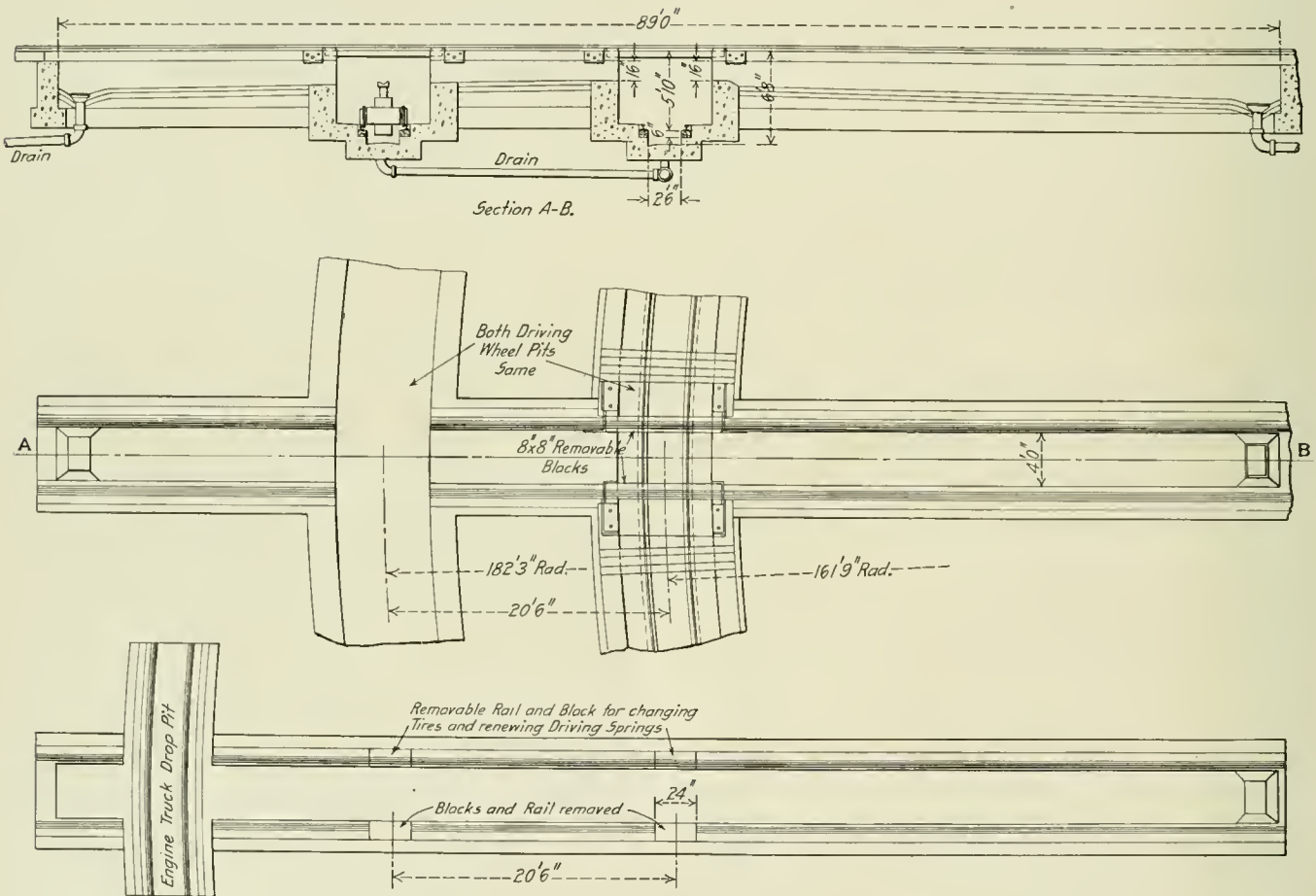

Arrangement of Double Drop Pits and Short Removable Rail Sections in the Chesapeake & Ohio Engine House at Clifton Forge, Va.

springs, etc. The method followed is to block between the driving box and the binder on the wheels which require attention, then remove the short 24 in. section of rail and move the locomotive until the blocked wheel is over the open space. It is then possible to easily remove the tire. The great flexibility of Mallet locomotives makes it difficult to jack them up for the purpose of making these repairs, and this scheme seems to answer the purpose very well. We are indebted to E. A. Murray, master mechanic at Clifton Forge, Va., for this information.

shop taking up the work where the other left off the night before. One-half hour's instruction is given the young men every day they are in the shop. This instruction is on practical shop arithmetic and drawings, being the same as given to the regular apprentice.

The young men will receive the same salary as the other apprentices, but as they are in the shop only one-half the time, they, of course, will only receive one-half the weekly wage of the regular apprentice. During the summer they are expected to spend their whole time in the shop, and at the end of four years of their high school training they will have spent two years and five months in the shop, but because of their training the Illinois Central will allow them three years' time, which means that the school apprentice will have to spend only one year more in the shop before he is made a regular journeyman. When the young man graduates from high school he has a job ready for him paying 18 cents an hour for the first six months

ELECTRIFICATION OF FRENCH RAILWAYS.—For some time past the French State Railway authorities have been conducting electrification experiments on a stretch of the Western Railway, and it is reported that results have been so satisfactory that it has been decided to go into the matter on a larger scale. Contracts for 100 electric locomotives have just been placed with French and Belgian builders.

and 20 cents an hour for the second six months, which is better than most of the college apprentices receive when starting in their special apprenticeship course. The standards for the boys are exacting and failure to make the required showing in either the shop or the school will be sufficient cause for dismissal. The system has proved quite popular, and there are more than 18 students availing themselves of this opportunity at McComb. As soon as arrangements can be made, the system will also be installed at Vicksburg, Miss., and Paducah, Ky.

LARGEST NARROW GAGE LOCOMOTIVES

Two locomotives have recently been completed by Beyer, Peacock & Co., Manchester, England, for the Tasmanian government railways, which are the heaviest and most powerful ever built for a 3 ft. 6 in. gage road. They are of the Garratt type; one is for passenger service and the other for freight. This type of locomotive comprises a boiler carried on a girder frame connecting two carrier trucks, each of which

concerned and each has four simple cylinders 12 in. in diameter with 20 in. stroke and drivers 60 in. in diameter. The tank on the front group has a capacity of 1900 gals. of water and that on the rear engine carries 1100 gals. of water and 4 tons of coal. The locomotive complete with full tanks of water has a total weight of 211,792 lbs. It weighs 162,036 lbs. without fuel or water in the tanks. The maximum weight per driving axle is 26,680 lbs. The cylinders are provided with piston valves operated by Walschaert valve gear, which is on the outside of the locomotive in the customary location and operates the inside valves by a rocker pivoted to the frames in front of the cylinders and connecting to the front extension of the valve stems of the two valves on each side of the locomotive. This arrangement is permitted as the inside and outside cranks are at 180 deg., giving the two valves opposite motion. A screw reverse gear in the cab controls the valve gear on both trucks simultaneously. The steam pipes have a ball joint in the exact centre of the pivoted connection to the boiler frame and thus do not require a slip joint.

A Schmidt superheater has been applied having 24 elements and giving a heating surface of 333 sq. ft. The boiler has a

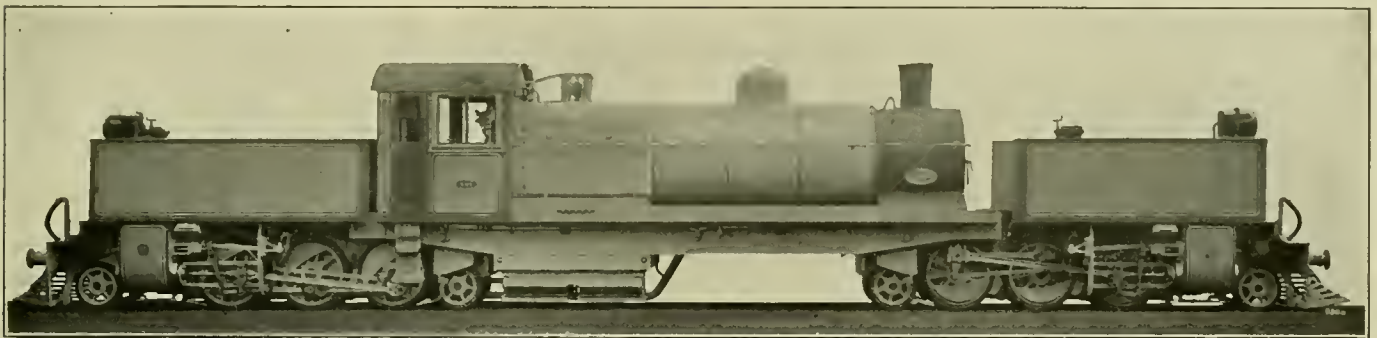

Powerful Freight Locomotive of the Garrett Type for a 3 ft. 6 in. Gage Line.

practically consists of a complete locomotive without a boiler. The girder frame has a swivel connection near the inside end of both trucks and the trucks also carry large water tanks, the one at the rear of the boiler having a coal space. This arrangement avoids all restrictions on the size and shape of the boiler except the road clearance limit and a wide, deep type of firebox can be easily provided. At the same time a very powerful locomotive can be constructed that can safely traverse sharp curves and have a very small average weight per axle.

These locomotives were built after three years' experience with a locomotive of the same type built for a 2 ft. gage section

diameter of 5 ft. 3 3/8 in. at the front end and contains 225 1 3/4 in. tubes and 24 5 1/4 in. flues, which are 11 ft. 3 3/8 in. in length. The firebox has a grate area of 39.3 sq. ft. and a heating surface of 155.5 sq. ft. This gives a total evaporative heating surface of 1686 sq. ft. The boiler pressure is 160 lbs. per sq. in. The firebox is of copper.

Other dimensions of these locomotives are:

| | |
|--|---------------|
| Diameter of truck wheels..... | 28 1/2 in. |
| Diameter of trailer wheels..... | 32 1/2 in. |
| Driving wheel base..... | 6 ft. |
| Total wheel base of locomotive..... | 61 ft. 10 in. |
| Distance between pivot points on trucks..... | 30 ft. 6 in. |

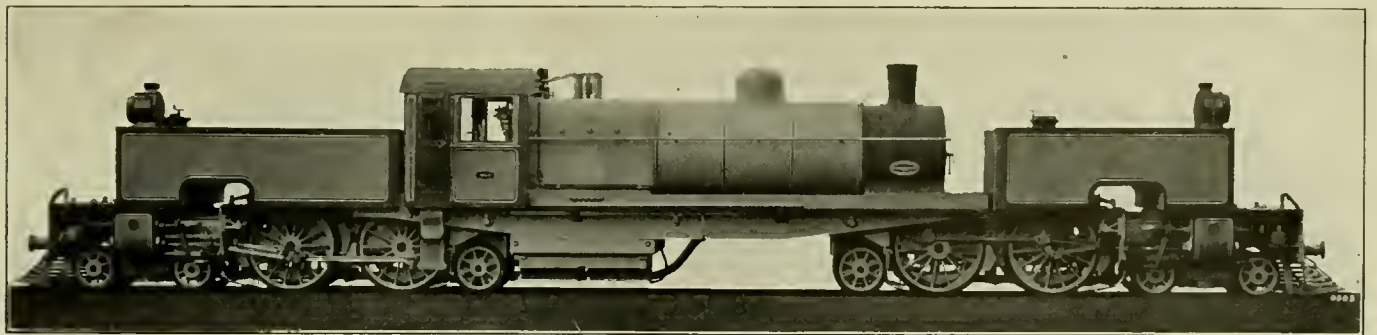

Garrett Type Passenger Locomotive for the Tasmanian Railway.

of the Tasmanian lines. The passenger locomotive is designed for speeds of 50 miles an hour on straight track and 30 miles an hour on curves of 330 ft. radius. It is of the 4-4-2-2-4-4 type or, in other words, comprises two separate sets of running gear of the Atlantic type, set back to back and connected by the boiler frame. The two trucks are identical so far as running gear is

The water tanks have equilibrium connections and the locomotive is fitted with a speed indicator and two electric headlights.

The freight locomotive is of the 2-6-2-2-6-2 type. The boiler is identical with that on the passenger locomotive and the total weight of the engine loaded is 201,724 lbs. With empty tanks the weight is 152,120 lbs. The engines on each group are two

cylinder simple, the cylinders being 15 in. x 22 in. The drivers are 42 in. in diameter and the rigid wheel base is 8 ft. The total wheel base of the locomotive is 60 ft. 8 in. and the distance between swivel points is 29 ft. 8 in. The front water tank capacity is 1900 gals., and the back water tank 1100 gals., and 4 tons of coal. These locomotives are designed for a speed of 20 miles an hour on reverse curves of 330 ft. radius. The construction of details is similar to the passenger locomotive wherever possible. The freight engine has two acetylene headlights instead of electric as on the passenger locomotive.

According to *Engineering*, from which this information is taken, the engines are fully able to satisfy all conditions specified and gave great steadiness and flexibility on the trial track laid down at the builders' works to represent the worst conditions that would be met in service.

ADJUSTING SAFETY VALVES*

BY C. L. DICKERT,

Assistant Master Mechanic, Central of Georgia, Macon, Ga.

For the past eight years the testing and adjusting of safety valves at the Macon shops of the Central of Georgia has been most successfully performed on the device shown in the accompanying illustration. This consists of two old air brake cylinders; one 12 in., and the other 6 in. in diameter, the smaller being secured on top of the larger, and each fitted with a piston having a common piston rod. On the top of the smaller cylinder is a cap threaded for a 3 1/4 in. safety valve. Bushings are made to fit this cap and allow the application of other sizes of valves. A standard gage and also a connection to the shop air supply line is connected to the 2 in. passage in the cap. An

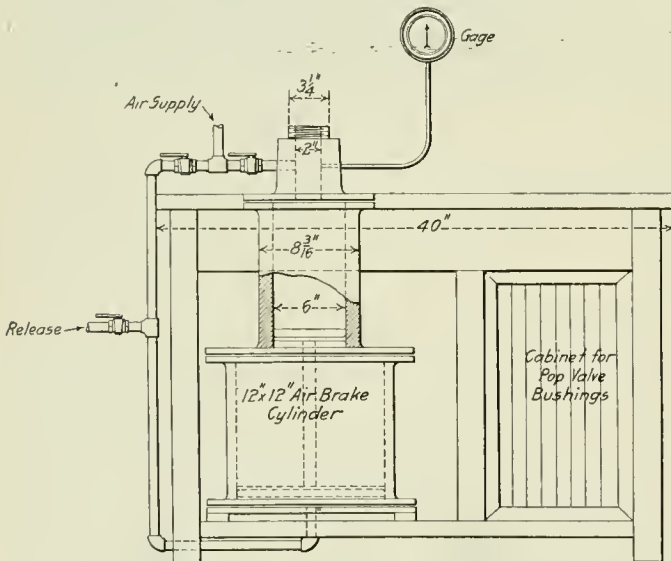

Device for Testing and Adjusting Safety Valves.

air line is also carried to the bottom of the larger cylinder. The arrangement of the piping and the location of the valves for admission and release are shown in the illustration. All of this apparatus is fitted in a special bench which has a cabinet for storing the fittings and parts.

After the safety valve to be tested and adjusted is secured in place, a valve is opened which admits air above the piston of the upper cylinder. When the full pressure of the shop supply line, usually 100 lbs., is attained, the valve controlling this connection is closed and air is admitted to the bottom of the large cylinder.

*Mr. Dickert informs us that the idea of this machine was obtained a number of years ago from some mechanical journal. As the name of the paper has been forgotten, proper credit cannot be given, but in view of the value of the device, which is evidently not generally known, it seems advisable to again give it publicity.—EDITOR.

Manipulation of the valve on the pipe furnishing air to this cylinder gives any desired pressure in the upper cylinder and on the safety valve, from 100 lbs. to 225 lbs. When the safety valve opens, the pressure in the top of the upper cylinder is released and the supply to the large cylinder is then cut off and the release valve is opened. Pressure is then again admitted to the top of the upper cylinder, forcing the pistons to the bottom of their stroke and putting the machine in readiness for the next test.

With this device it has been found that it is not necessary to adjust the safety valves after they have been applied to a locomotive and a supply of repaired valves properly set can be maintained in stock ready for application to any locomotive that goes through the shop or for shipping to an outside round-house. There is of course a slight difference in the point of release of a valve when used in connection with air and steam pressure, but it is the practice in this shop for one man to do all of this work and it takes but a short time for him to become familiar with the corrective factor that should be used so that the valves will release properly under steam pressure. As a further check, however, this specialist is present when the engine is fired up as it leaves the shop and assures himself that the valves are correct by actually forcing them to release under steam pressure when they are in place on the boiler. At present from 90 to 100 valves per month are being adjusted on this device. When the valves are shipped to outlying points a local inspector or foreman is required to test them under actual conditions after they have been applied to the locomotive.

REPAIRING BOILER CHECK VALVE

BY CHARLES MARKEL.

A useful tool for reseating the boiler check cap joint is shown in the accompanying illustration. All that is required is to remove the check cap and insert the pilot plug in the threaded portion of the valve. The cutter is placed over this pilot and is turned by a wrench which grips the hexagonal head. The tool

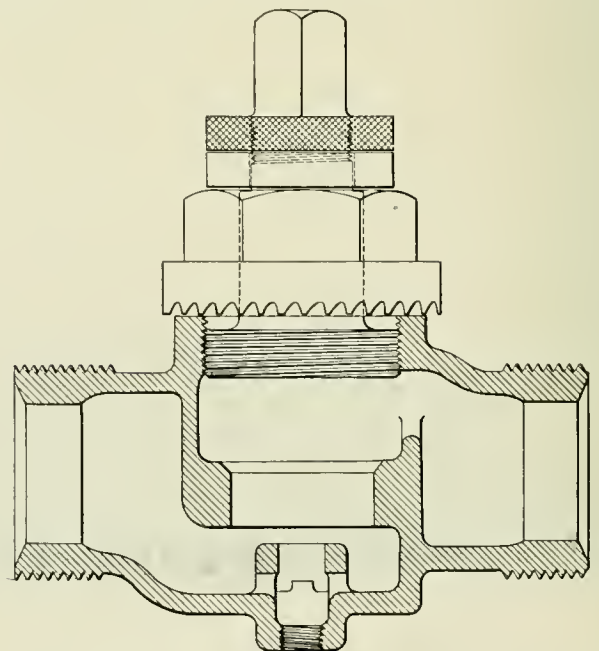

Reamer for Facing the Boiler Check Cap Joint.

is fed down by a knurled collar which is threaded to the pilot and is turned by hand. A first-class joint can be made and much labor is saved, as the check valve does not have to be removed from the boiler.

THE MANUFACTURE OF BRAKE BEAM HANGERS

Methods Used at the Cleveland Shops of the Erie, by Which They Are Made at a Labor Cost of Five Cents Each.

BY R. S. MOUNCE.

On a railway which requires upwards of 35,000 brake beam hangers each year, it is of great importance that the manufacturing cost be lowered to a minimum. The Cleveland shop furnishes about one-third of the total requirements of brake beam hangers and these are made up in one or two lots per year. Special tools have been designed and methods best suited to a rapid output have been developed with such satisfactory results that the hangers are now manufactured at a total labor cost of 5 cents each. This price includes everything except cutting the stock to the proper length, and carting the finished hangers to

operation 2 immediately after 1, but they were unsuccessful, as it was found that sufficient heat was not retained to permit of a good smooth end being formed after the second operation. Two men have been used on this part of the work, but it was found that one man could do almost as much work as two, and, of course, at a considerably lower cost. Man No. 1 works continuously, but the other two men do not commence until there

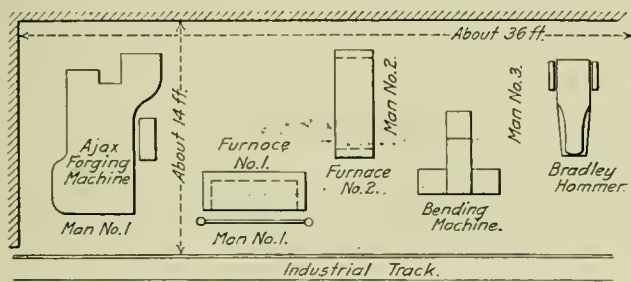

Fig. 1—Arrangement of Machines and Furnaces for Manufacturing Brake Beam Hangers.

the storehouse. Until recently the pin holes were drilled, but now they are punched, which, taking into consideration the difference in labor of drilling and of punching, as well as the fact that the hangers do not have to be carted from the blacksmith shop to the machine shop, made a saving of about 0.66 cents per hanger. The following description applies directly to the several drawings which show in considerable detail the methods employed and the tools used in the process of manufacture.

METHOD OF MANUFACTURE.

Reference to the arrangement of machines and furnaces, as shown in Fig. 1, indicates that the floor space required for manu-

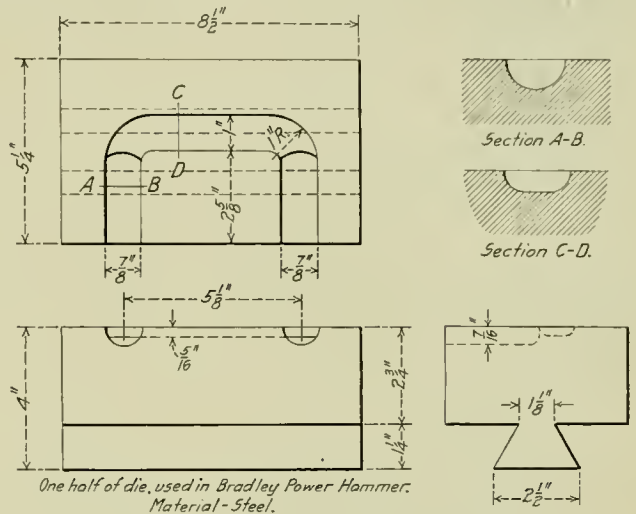

Fig. 3—Flattening Die for Brake Hangers.

are two hundred or more hangers ready to be bent and flattened. They work until they have caught up with man No. 1, and are then taken off the brake hanger job until there is another pile of partly finished hangers ready for them.

Man No. 2 tends furnace No. 2, which, it will be noted, is open on both sides to permit of obtaining a long heat in the middle of the bar, which is necessary for the bending operation. The bars are centered with a deep center punch mark, in order to

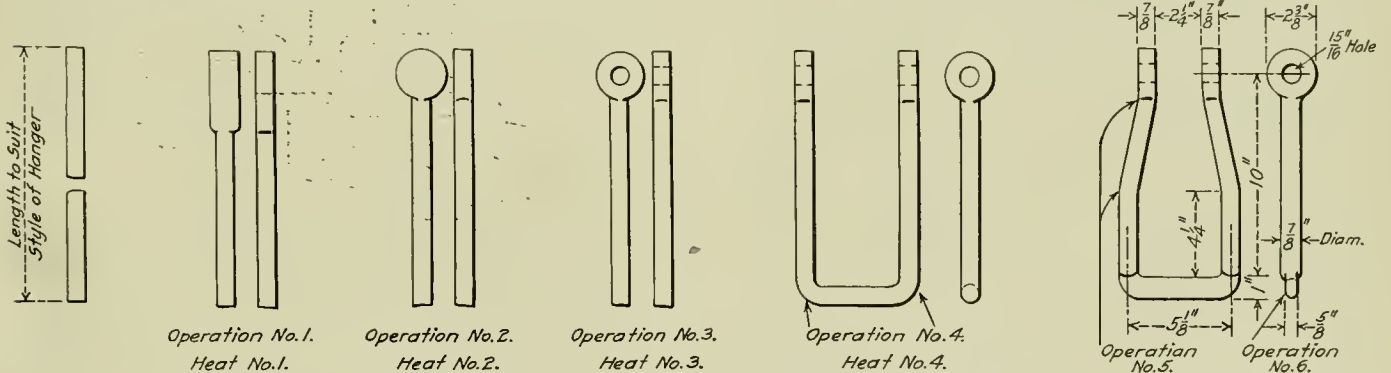

Fig. 2—Successive Operations of Manufacturing Brake Hangers.

facturing brake hangers is very small, being about 36 ft. x 14 ft. The stock is cut to the proper length and piled close to furnace No. 1. Man No. 1 takes care of this furnace and operates the Ajax forging machine, where the ends of the hangers are forged and the holes punched. Referring to Fig. 2, it is seen that this part of the work requires three operations per end, with one heat for each operation. Attempts have been made to perform

facilitate placing them on the bending machine so that the legs will be of the same length after bending, and so that the holes will come in line. They are then placed in the furnace.

Fig. 2 shows that the three operations—bending, offsetting and flattening—require one heat. Man No. 2 takes the hanger from the furnace and places it against the stationary former E, Fig. 5, of the bending machine. Man No. 3 is stationed on the oppo-

site side of this machine in a position to operate the several air valves. Air is then applied to the head cylinder, which moves the bending former C against the brake hanger, giving it the form shown by Fig. 2, operation No. 4. The hanger is then

hanger, giving them the proper offset. This completes operation No. 5. Another heat is unnecessary for operation No. 6, which simply consists in flattening the bottom of the hanger as shown by the last sketch on Fig. 2. This is done by man No. 3, who

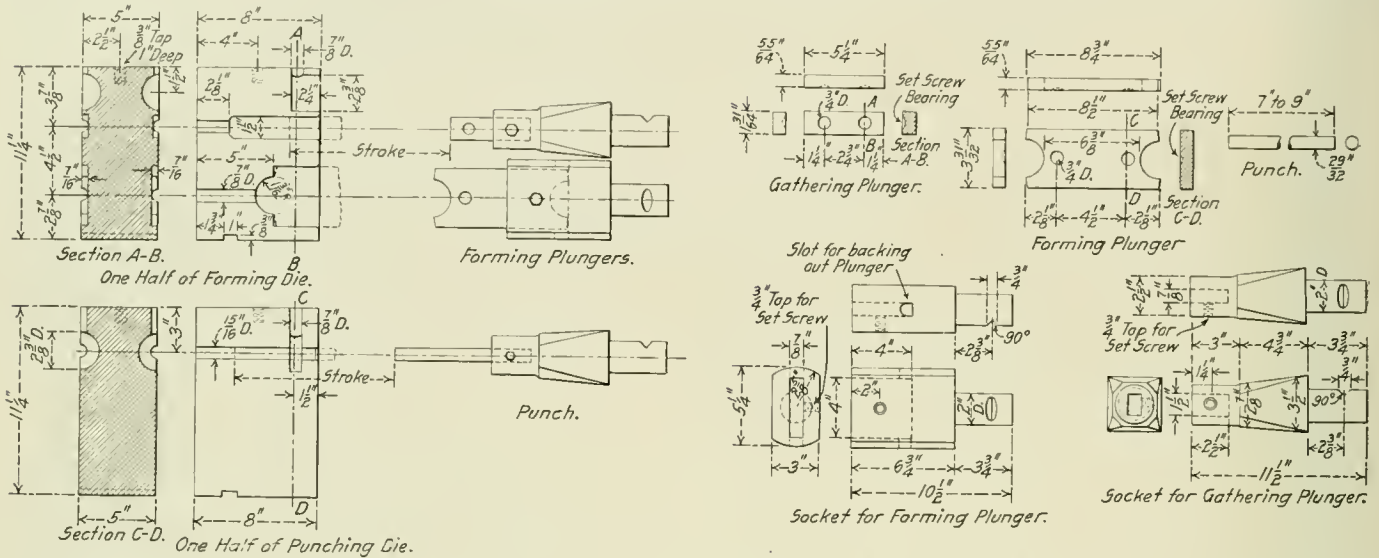

Fig. 4—Dies and Plungers for Forming and Punching Brake Hanger Ends.

placed against the lower section of the stationary former D. The bending former is moved against it, to hold it rigidly in place, and then air is applied to the two cylinders which move the toggles A and the toggle formers B against the legs of the

removes the hanger from the bending machine and immediately places it over the lower half of the die shown in Fig. 3, which is fitted to the anvil of a Bradley power hammer. A few light blows of the hammer, which carries the other half of the die,

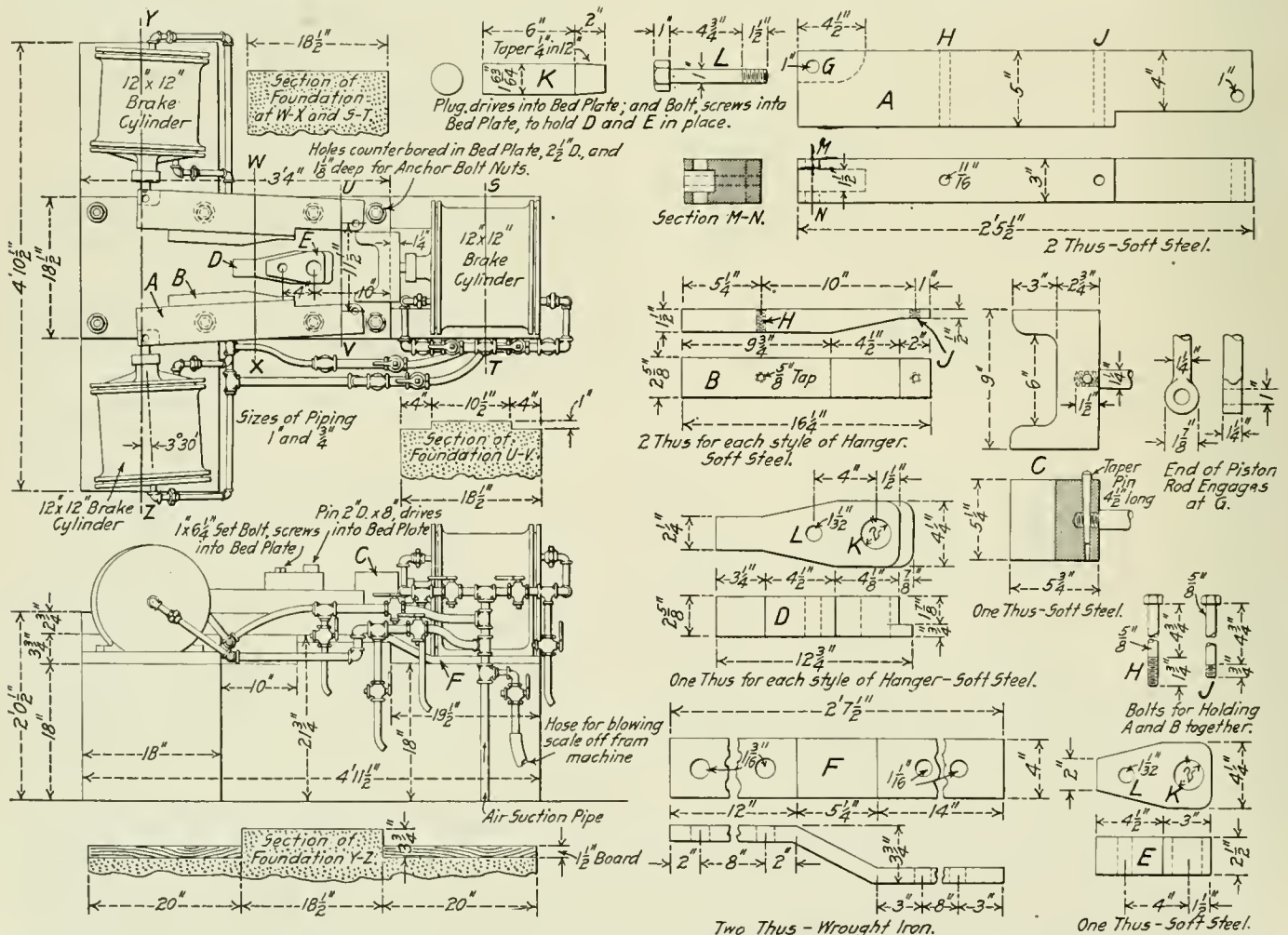

Fig. 5—General Arrangement and Details of Bending Machine for Brake Hangers.

MANAGEMENT OF A DRAWING ROOM

Co-operation, Fair Dealing and Suitable Environment Are as Important Here as in the Shop.

BY FOLBERT A. SCHMIDT.

Public attention has recently been drawn very pointedly to the subject of scientific management, and since prominent business establishments have frequently been cited as illustrations of its success, favorable as well as unfavorable interests have given it serious consideration. While for some time active and successful work has been devoted to effecting a high efficiency in machines, the value of good management in the development of men and the greater importance in business life of efficiency in men as against efficiency in machines is but beginning to be realized.

For a drawing room, where efforts are chiefly devoted to originating and where a creative spirit prevails, scientific management may seem to be an audacious suggestion. It is impossible to direct and plan for the progress of original work and the new science of time study is of no avail to a production which depends on the designer's mind and his initiative. But while it might be understood that production of an original nature is not to be dominated by method or system, and that no definite time can be set for its completion, the importance and the necessity may be realized for applying the scientific habit of thought to the fruitful development of men and to conditions which favor their favorable inspiration.

For all work there must be determined the theoretical point of its highest efficiency, both by science and experiments, by studying closely the most suitable conditions under which the work is to be performed, by determining what manipulations are necessary and how to carry them out with the greatest economy and by supplying the best of tools and prescribing how to use them.

Advantageous conditions under which efficient work is performed in a drawing room are exhaustive ventilation, proper temperature, good light, a thorough cleanliness and ample and sanitary provisions for the other necessities of the body.

Proper ventilation and temperature must be ascertained scientifically and adhered to conscientiously by the management. By no means should their regulation be made by the draftsmen, as it would then be performed according to momentary necessities and personal feelings and would not be efficient. We are more or less apt to take colds—some are very sensitive to unsuitable temperatures and since it is a fact that the efficiency of a man's energy drops one-half or more when his well being is only slightly interfered with, it is evidently in the interest of a good management to prevent all neglectfulness in the caretaking of men.

A thorough cleanliness is extremely advisable in a department where a number of men are confined to a comparatively small space from eight to nine hours a day. Besides the bad effect on men's energy, which I have mentioned with regard to insufficient ventilation, uncleanly surroundings are accompanied by drawings which are unclean and lack high efficiency in consequence, not to speak of the lost time and effort devoted to the attempt to keep the sheets clean.

One other important feature that may greatly increase the capacity of a drawing room is good light. Its advantage is much greater than is generally assumed, and the comparatively small means required to reach efficiency in this respect make it all the more remarkable that so few steps are taken to provide it. The expense of a rearrangement to obtain ample light for all is little in comparison to the time saved and the comfort rendered. This is especially true with regard to the tracers.

To find the most efficient way of performing work, it is analyzed as to its elementary manipulations; the absolute necessity and the purpose of each is decided by experimental truth and science, and a system is applied according to which fixed functions take place in the proper sequence. In making drawings under present conditions, each draftsman has adopted a system to which he has trained himself as best he could and according to which he does his work. As a rule these systems are very much alike. Each draftsman has his own individual way of doing many things and, according to ability, his work distinguishes itself by economy and practicability. At times it can be observed that a man has found his way to a system of a remarkable efficiency. If a man has steadfast qualities that develop strong habits, he does his work persistently according to a fixed system, thus producing efficiency to a certain degree, whereas a less thorough and steady man works in many different ways, always according to his notions and momentary conclusions. A man with many years' experience is not necessarily an efficient man, only he who seeks "truth for authority and not authority for truth," is the best man in the end. These facts lead to the conclusion that, however much freedom there must be granted to the draftsman, as mentioned above, the mechanical functions of producing the drawings should be clutched by a method that has been established by experimental truth and science and to which all must become subjects. The advantages are avoidances of errors, saving of time and the occasion for a stringent co-operation.

Hand in hand with the study of the elementary functions of the work goes the task of investigating what are the most suitable tools with which these functions are to be performed. Tools must always be in first class condition; if not, much time is lost and speedy and precise work is hindered. Hence an inspection of the tools should be undertaken from time to time; the men must be advised to report even slight faults and for each tool in use an emergency outfit should be kept in stock to prevent delay. At present negligence in this respect can often be observed which approaches narrow-minded avarice. Narrow minded, because economy thus practiced has always the reverse effect by causing expenses quite unproportionate to the cost of even luxurious instruments. These expenses are not only due to inefficient working, but largely also to the disgust of the men who realize that the results from their honest striving and ability are counteracted by the insufficient conditions under which they are asked to work and for which the management has the responsibility. We realize that the square deal to the men alone would command the supply of first-class instruments, besides the economical interest of an intelligent management that requires it. For tools which are not furnished by the company, standards should be issued, as for equal results, equal values are needed.

Good tools are a good investment, especially when exhaustive instructions are given how to care for them and how to use them. At present the rule stands good, that different men may very well use different tools for the same purpose in order to reach the best results. This rule is wrong according to the principles of efficient management in a drawing room, because it involves avoidable difficulty in reading the drawings and is the occasion of errors and waste of time. In order to effect a uniform appearance of the drawings, the different characteristic lines, figures, etc., are determined and for the accomplishment

of each, the appropriate grade of pencil is issued by stating its number. For tracing, the thickness of the different lines are settled definitely and each tracer may be furnished with a sample and an instruction sheet which will ensure uniform production. Repairing tools and using them are separate features, wherefore the sharpening of drawing pens and the like should be performed by an especially assigned man who is trained and skilled and produces the best and quickest work. Experience teaches that a laborer with even the least intelligence is capable of becoming expert in a small limited occupation, if it suits his inclination, and if he gets the amount of practice which trains him to do his work perfectly.

In a drawing room more than anywhere else, efficient management depends on the competence and the personality of the manager. Since ways and means for the accomplishment of work are therefore almost entirely devised and decided by individual strength and individual judgment, the methods vary in different concerns, however much alike their purpose. Authorities in the management of drawing offices maintain that the working capacity of the newly engaged body of experienced men becomes normal only after six months of studious adaptation to the new conditions. This makes comprehensive and systematic training of the men a necessity, especially so when a science of the work has been developed. Besides, a good management owes it to itself, as much as to the men, to assist in every way possible the latter's acquirement of experiences, which are to be used to the advantage of the concern.

The present conditions are utterly inefficient in this respect. For instance, a tracer is at a loss to understand a certain part of the drawing he is to copy. At first he tries to discover the meaning of the perplexing part himself, thus losing time. It may be that sooner or later he comes to think that he has found it and goes ahead with his work; but whether he really has the right conception is another question and the cost of his error multiplies itself, since one mistake causes others and higher paid men are concerning themselves with it afterwards. Furthermore when somebody else corrects it and no information regarding it reaches him, there is nothing to prevent the tracer from making the same error again. On the other hand it may be that he cannot decide as to the proper meaning of the concerned part and that he has to leave his desk to hunt the designer. Considerable time may easily elapse before the tracer gets the advice desired, because the designer may have been called away under similar circumstances or is engaged in a task which does not permit ready accommodation. When finally the information is given, it takes place in an unconcerned and imperfect manner.

All tracers ought to be assembled in a tracing department, furnished with suitable special contrivances and located in the part of the building which offers the best light. A foreman should be installed in charge of it, who is to instruct the tracers as to the science of their work and explain complications in the drawings that cannot be understood. We bear in mind that the drawings are now finished according to one uniform method, which enables every competent man to read their meaning. This fact itself facilitates tracing greatly, cancels many avoidable questions and makes possible a third person's true conception of its meaning and full ability to give advice regarding it.

A designer is to create, not to instruct! These are features far apart and must be considered so. Just in this lies the great advantage of system, that the combination is divided into its natural parts, each of which is taken care of separately in order to warrant an ideal co-operation.

In selecting the men for their proper places in a drawing room, two principal items are distinguished, designing and managing. A good constructor is very seldom at the same time a good manager, owing to the fact that the personal qualities required for each are quite different and their combination is probably impossible. A practical, active man with capacity to ar-

range and a strong sense for system should therefore be taken away from the board and make room for a fellow who thinks constructively and combines logical reasoning with the kind of a memory from which the wanted advice can be drawn and applied in a restful and concentrated manner.

Selecting a man to the occupation of checking is difficult and seldom is given the proper attention. The efficient performance of this work requires qualities to a high degree, which enable objective and impersonal dealing with the other man's production, and the denial of his own opinions in the interest of the company. In other words, it demands a judicial mind. Many a piece of work is changed by the checker, when in its original shape it would have served its purpose, sometimes on account of his inability to forego his own ideas, and often also because of a personal misunderstanding. It involves waste of effort and unnecessary discouragement of the men. Besides, by selecting trustworthy men, who would treat the work with due respect and the honest will to comprehend the originator, considerable addition is made to peaceful co-operation.

Owing to the original work and the uncertain course it may take, the development of a definite system, which will ensure perfect co-operation for all occasions, is probably the most difficult problem to be undertaken in a drawing-room. Yet co-operation, the goal of all efficient management, is aimed for successfully in many different ways.

A man's engagement with a business concern is a serious matter and the responsibility in which both are involved must not be underestimated, if results are to give satisfaction to both and an understanding be effected that brings about confidence and a truly social condition.

An employee devotes to his company daily from eight to nine hours of his active life, for which he receives a fixed price, and for which theoretically he should try his best and use every possible effort in the interest of his employer. Does the management, however, treat and regard its men in a manner which warrants their serious and complete devotion to their work? In many cases this question cannot be answered in the affirmative, which means that harmonious co-operation, based on the perfect understanding between the management and the men, is retarded. But efficiency lies in the good will and the diligent attitude with the men and is brought about only by conscientiously shouldering the duties which arise in the management of men. By positive subjection to the realized responsibilities on the part of the management, the men are led to acknowledge and bear cheerfully their own responsibility, and not to waste the time which does not belong to them, but which they are more or less at liberty to use according to individual estimation. Good management has the duty to comfort the men with the most suitable working conditions and to appreciate earnestly and actively the services rendered, so that working is in no wise disturbed or discouraged. By no means should the treatment of men be such that a degree of slavery is felt. The men must be met in a friendly way and with appreciation, so that rather a convinced feeling is produced that all are united in working for one purpose, which consummation is a pleasure and means actual profit.

An ideal co-operation requires proper division of the work and its accomplishment in suitable quarters. The knowledge of the men's personal inclination, which precedes their selection, and has been obtained by earnest observations of individual qualities, is needed to distribute the work suitably. The average man is naturally inclined to a particular line of work and dislikes to practice contrary to his categories. To influence a man's specializing in his favorite pursuit is therefore important for the fruitful development of his competence, as well as for the efficient and economical output of work. It appears that these simple rules, established time and again, are generally realized to be true enough, but that the allowed number of exceptions is exceeded, thus converting the exception to the rule.

In endeavoring to get the proper division of work, attention

should be given to have it done in harmony with the state of development of the men. This prevents designation of a problem to a man not yet capable of mastering it. On the other hand by gradually increasing the scope of the problems assigned, the men's gradual and fruitful development is ensured. It is customary to have the drawings of the youngest detailer traced by the youngest beginner. Quite to the contrary, the work of a detailer who is not yet familiar with the science of his occupation, should be designated to the most experienced copiest, so that conditions are somewhat equalized. In this respect also an increase of efficiency is made by co-operation.

In drawing-rooms in general it is observed, and I suppose assumed to be quite the proper thing by many, that the management pays its men as little as possible. The natural result is that the men are keeping their production down to the affordable minimum. It means a vast difference, whether a man really tries to do his best, or whether he does just enough to keep above the firing line. Good management, which attempts co-operation with its men, concerns itself earnestly with their qualities and encourages and rewards honest striving in due time. It is wrong to wait until the men have to come and beg for that which belongs to them. Raising the men's salaries is of grave importance, and doing it in the nick of time produces the confidence and gratitude on which co-operation is founded. If the character of the men has been given some observation, confidence may justly be shown according to individual qualities. At present the treatment of men has the strong tendency to presuppose a general mistrust by principle. If there is no obvious confidence set in the men, they have none to justify and are denied the spur to best efforts, perseverance and economy. The results of the checker's work are not very conspicuous when he is dealing with the production of a clever and conscientious man. In order to satisfy his manager, who wants to "see" work, the checker undertakes changes for which there is not the slightest cause and which often destroy harmonies, created at cost of deep thought and laborious concentration on part of the designer. Quite upset by the appearance of his corrected sheet, which he meant to have done well, the latter inquires why these unreasonable changes have been made and receives the unhesitating reply that it has merely been done as a matter of self defense. The eminent iniquity of such proceeding never fails in its sad reaction on general economy and the spirit of the work.

Co-operation is effected by doing a certain amount of routing of the men's work. Since one step depends on another to smaller or larger degree, it is necessary to undertake them in the proper sequence, so that the first is fully completed before the second, relying on the first, is begun. Thus all work is started on the sound basis of sufficient information, the inefficiency of going over the same ground again and again is dispensed with and the occasion is given for speed production and good spirit with the men. Furthermore, all instructions, instead of giving them in a personal, offhand manner, should be written on an instruction sheet.

Thoroughly systematizing the work and conscientious supervision of its smallest details affirms steady co-operation. Hence a classification of the rooms, the desks, tracings and so forth should be endeavored in order to furnish the means for transparent oversight and simplified management. Footing on this classification, by which objects are named by means of symbols in an unmistakable manner, a production bulletin board may be installed, to show the progress of each characteristic work on the different desks. It permits a designation and supply of work to its proper quarters ahead of time, to realize what amount of work has been accomplished, and it offers a fair chance to calculate the forces required to arrive at completion within a specified time.

High efficiency, the watch word of the day, is forced on railways as well as all other industries by the ever increasing compe-

tion and spells the difference between success and failure in many obvious cases. It is developed by scientifically selecting the ingredients for a stringent co-operation, and, before all, the upright and conscientious deal between man and man.

THE SAFETY HABIT*

BY J. D. KELLY,
La Junta, Colo.

Accidents which occur on railways, not only in the shops and roundhouses, but in the yard and on the road, must, in the main, be attributed, not to a lack of safety devices, nor to any indifference on the part of the railway to the welfare of its employees and patrons, but rather to individual carelessness. Safety appliances may and should be devised and applied wherever their use will render less hazardous the various occupations in connection with railroading. The men who direct



An Engine House Office Building Decorated with the Safety Sign.

the policies of the railways realize this to the fullest extent, and there can be but little complaint that the precautions necessary to protect the life and limb of employees and the public are neglected, or that the rules which they provide for the conduct of their business are in any way lax.

A full realization of the situation is shown by the action of the various great roads of the United States, who, during the past few years, have inaugurated campaigns of safety among their employees. Hardly a railway of importance could be mentioned which does not have its safety committees, composed of employees of all grades who investigate and report on all matters pertaining to the general safety; hardly a road but that has put in circulation literature designed to educate its employees in methods of safety.

Certain risks may be eliminated by the provision of safety devices, but by far the greater proportion cannot, and may only be guarded against by constant caution on the part of those

*Entered in the Safety Competition, which closed June 1, 1912.

whom they endanger. Those risks which come under the first or avoidable class are easily handled, it merely being a matter of devising and installing guards to eliminate them. The minimization of accidents due to the second class is the problem which requires the gravest consideration. Carelessness is an inborn characteristic of the average man and the substitution of caution is a matter of education. This fact is realized by at least one of the great railways and the methods which it is pursuing to accomplish this end are worthy of description.

The road in question is the Santa Fe, and the campaign of education is under the direction of a man eminently fitted for the place, the chief claims attorney. Where other roads deputize certain persons to serve on committees of safety the Santa Fe enrolls the services of each and every employee in the cause. Lectures are given in the shops and reading rooms by officers and men of prominence in other lines, with the idea of bringing home to each individual his responsibility, not only



The Safety Sign Over a Shop Door.

for his own safety, but for that of his fellow workmen and the patrons of the road, who are dependent upon the care which he exercises in the discharge of his duty, whether he be an engineer in charge of a train, a despatcher, operator, or a mechanic in the shops.

Ministers and priests of the various churches along the line have lent able support to the safety movement by holding special services for railway men, at which "safety" has been made the subject of sermons, and the virtue of caution as a conservator of life and limb has been extolled. *The Employees' Magazine*, which is published monthly and reaches every member of the great family, from the president to the Mexican section laborer, calls constant attention to the need of caution and through the medium of special articles, points out ways and means of circumventing the prevalent risks in the various branches of railway work.

Perhaps the most effective idea which has been developed is the use of the phrase, "Get the Safety Habit," and its practical adoption as a part of the Santa Fe symbol. Realizing that

lectures and sermons may be heard and forgotten; that articles may be written, only to be read by the few, and that the effect of all may be annulled in a moment of thoughtlessness, the idea of the adoption of a catch phrase in conjunction with the road's emblem, as an ever present reminder, was an inspiration. The use to which this phrase has been put is well illustrated in the accompanying photographs of signs of various sizes, with which the walls of the shops have been decorated. It is not easy to forget to be careful, with the admonition to "Get the Safety Habit" constantly in view.

It is not to be understood that the adoption of a wide policy of education has in any way hindered a proper attention to details. Each shop is carefully inspected for the purpose of detecting the points of danger. Machine gears in such a position as to expose operators or passers-by to the danger of being caught and maimed are enclosed. Emery wheels are carefully guarded; pits are provided with covers or railing; dangerous practices, such as shooting bolts, are prohibited.

Safety committees are a good thing, and by their well directed efforts many accidents may be prevented. Safeguards in shops and safety appliances on cars and locomotives help to curtail the list of casualties. The elimination of grade crossings, the provision of effective right of way fences and the enforcement of stringent rules against trespass on the railway property, add their part to the general safety. But, after all has been done along these lines, there still remains the great majority of serious and fatal accidents, which no amount of foresight on the part of the management could have prevented; where no safeguard could have been provided, to secure their avertment—in short, the cases due to individual carelessness. The campaign which the Santa Fe is carrying out is not only directed toward the elimination of the class of accidents which lie strictly within the province of safety methods and devices, but also aims at the minimization of that greater class which may be curtailed only by inspiring each employee with a full realization of his responsibility.

THE PARCEL POST

For forty years the American people have demanded a parcel post. Forty-three foreign countries already have a parcel post, and there is no record of any foreign country ever having discontinued such a service after having started it.

The first zone is quadrangular but not square in shape, since it is bounded on east and west by meridians of longitude which, of course, converge as they go north and diverge as they go south. All other zones are roughly circular in shape. Zone two includes all units of area outside zone one which lie either wholly or in part within a circle drawn from the center of a given unit of area, the circle to have a radius of 150 miles.

The third zone includes all the territory outside of zone two, within the radius of a circle of 300 miles, and with the same proviso that all units of area through which its boundary circle passes are a part of that zone. The fourth zone has a radius of 600 miles, the fifth zone a radius of 1,000 miles, the sixth zone a radius of 1,400 miles, the seventh zone a radius of 1,800 miles, and the eighth zone includes all units of area outside of zone seven.

The matter of units of area and of zones is somewhat complicated. But it seems much more complicated than it really is. The reasons for establishing such a system are clearly set forth by Senator Bourne, in his report on the post-office appropriation bill. There are at the present time some 60,000 post offices in the United States.

It costs now 64 cents to send four pounds of books either across the city, or across the continent. Under the parcel post law it will cost 8 cents to send the same package across the city and 48 cents to send it across the continent.—*Railroad Man's Magazine*.

of the valve body or piston: c the length of cut needed to obtain the "spring" considered necessary; a ring was cut from a shell of suitable dimensions, whose outside and inside diameters, D and D' , were as follows:

$$D = d + \frac{c}{\pi}$$

$$D' = d' + \frac{c}{\pi}$$

This ring was then faced to a width corresponding as closely as possible to those of the grooves in the valves or pistons. After having been cut, the rings were fitted to their grooves and the ends filed so as to permit of a free movement in the steam chests or cylinders, a play of about .02 in. being left between the ends for expansion along the line of the smallest

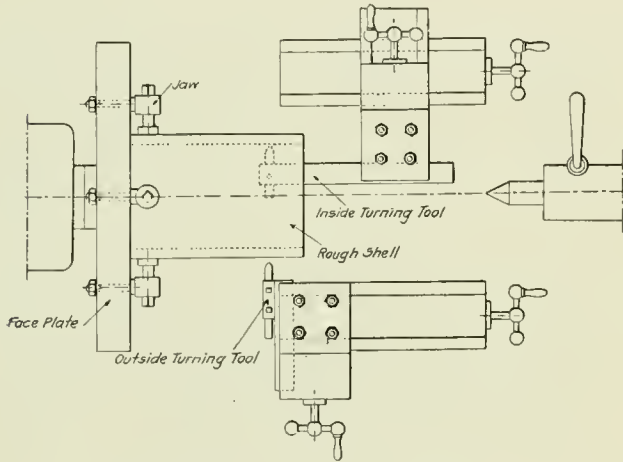

Fig. 2—Turning and Boring the Shell.

diameter. But all this work, which was done, for the most part, with a file, was long and expensive; while the rings made in this manner were not round, but tended to assume an oval shape as in Fig. 9, which caused constant leakages and unequal wear in the bushings and cylinders. Furthermore, this method was frequently very annoying, because the workman who made the rings was obliged to wait for the valve bodies and piston heads to be finished in order to get the exact diameter and width of the grooves.

In order to avoid these inconveniences, a complete change has been made in the method of machining rings for both the

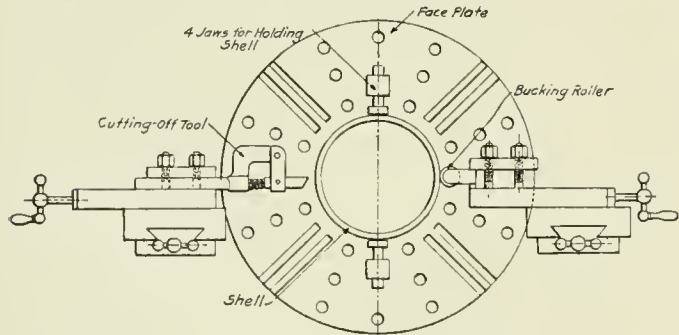

Fig. 3—Cutting Off the Rings.

valves and cylinders, and now all of the work is done on the lathe, and no attention is given to any other workman.

In the present method the different operations may be divided in two classes, viz.: Those that can be performed in advance, thus working in with the regular shop routine, and those which can only be done after the measurements of the grooves in the valves have been obtained.

The two series of operations include: (1) The roughing off of the shells and the cutting of the rough rings; (2) the cutting of the rings to width, the cutting of the slot and the turning of the outside and inside eccentricity.

In any well-organized shop there should always be on hand enough rough rings to fit out one or two engines of each class. These should be prepared in what may be called leisure time,

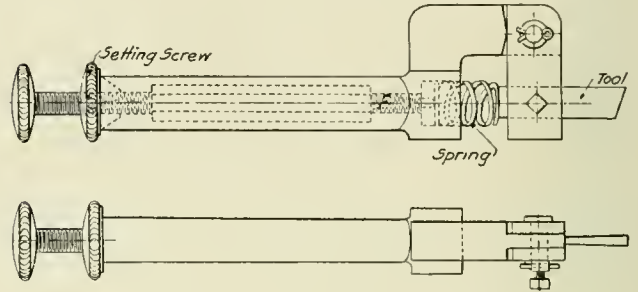

Fig. 4—Tool for Cutting Off the Rings.

or when no other work is pressing. Given a ring to be finished from the rough condition, it should be large enough to be cut in accordance with a rule established by experience, with a kerf that is usually .07 of the diameter, and then to be turned so as to eliminate the oval form and make it truly circular. It should be noted that the deformation of the rings after cutting is an important matter, and that it varies with the diameter and the thickness of the rings, so that it is necessary to ascertain experimentally the diameter that should be given to the rough rings.

When these diameters have been determined, a shell of the proper size should be taken and mounted, as shown in Fig. 2, in a lathe fitted, if possible, with two tool posts set on the same carriage. The cutting speed may then be taken at from 46 ft. to 50 ft. per minute, with a feed of about .04 in., and taking two cuts at once, one inside and one outside. It is also a good idea, in order to prevent chattering and facilitate centering, to have the jaws of the chuck on the face plate turned to fit the drum.

The shell having been turned to the proper size, the rings

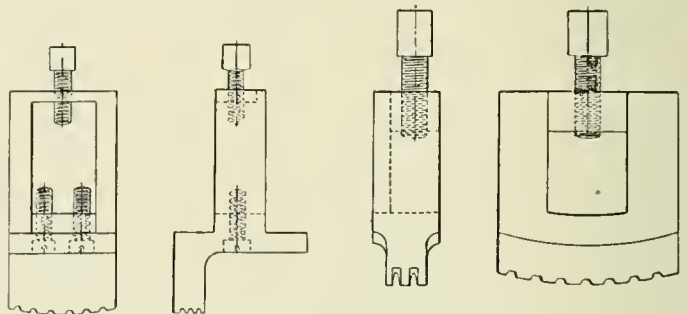

Fig. 5—Jaw for Universal Chuck.

are cut off with a width from .08 in. to .12 in. wider than the grooves which are to receive the finished rings. The method of cutting the rings is shown in Fig. 3. The special cutting-off tool is mounted on the front carriage, while a roller is attached to the one at the back and is intended to hold the shell up in place and prevent it from springing away from the cutting tool. The cutting-off tool that has given the best results is shown in Fig. 4. It is pivoted and provided with an abutting spring, which rests against a regulating screw, by which not only the tension of the spring can be regulated, but the cutting angle of the tool as well. With this arrangement a high output can be obtained without any danger of breaking the tool, because the spring acts as a regulator and prevents the digging in of the tool, in spite of coarse grain and hard

spots that are so often found in cast iron. The cutting speed is practically the same as that for the turning, namely, from 46 ft. to 50 ft. per minute.

The work of finishing the rings is assigned, as far as possible, to the lathe hand who straightens the grooves, and is performed as follows:

Rings of the proper diameter are held in a universal chuck.

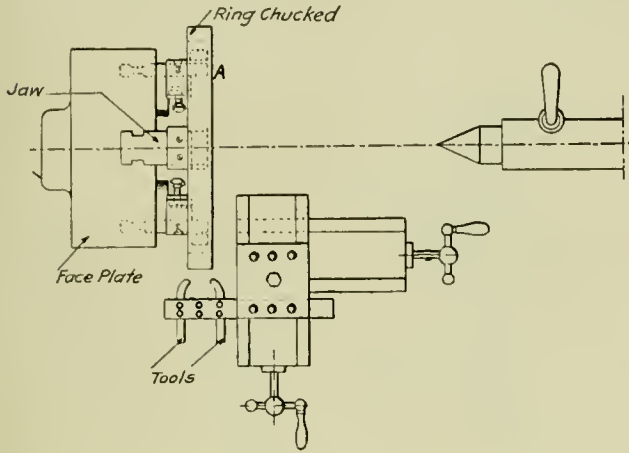

Fig. 6—Cutting the Rings to Width.

The jaws of the chuck are a little narrower than the grooves in the valve, as shown in Fig. 5. The rings are held, as at A, Fig. 6; their sides are faced and brought to size by means of double tools, as shown in Fig. 7, which are easily adjusted by a gage of sheet metal, which is introduced between them, after it has first been put in the groove and marked. The workman then has nothing to do except feed in the cross carriage to finish the rings to width. The cutting speed ranges from 52 ft. to 59 ft. per minute.

For cutting the kerf, an arbor, A, Fig. 8, fitted with a shoul-

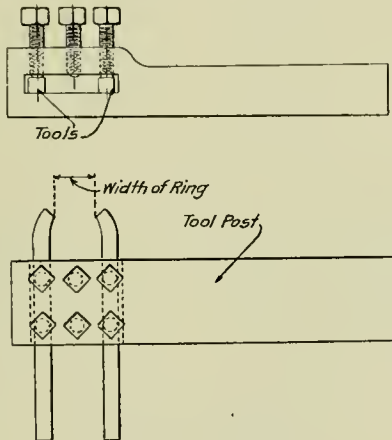

Fig. 7—Tool for Cutting Rings to Width.

der is used. On it are mounted two circular saws about 4.75 in. in diameter and about .05 in. thick. The eye is about 1.18 in. in diameter and is notched for the key. These saws are separated by rings, so that the distance between their outside faces is equal to a trifle less than the length of the kerf. The whole is held tight by a nut and washer in the usual manner.

Four rings are then set, one over the other, on the tool carriage and clamped and cut by the two saws acting together. The latter are run at a speed of about 90 revolutions per minute, and the carriage is run in until all of the rings are cut through. The time required for setting the rings, cutting and taking them out of the machine, varies from two to three minutes. After the ends have been filed off to fit, they are ready for the outside and inside turning.

When the rings are closed after the kerf has been cut, they will assume an oval form, which must be entirely done away with, if it is desired to avoid the excessive leakages that are sure to occur where the rings do not fit closely against the circular walls of the bushings. On the other hand, we have seen that, in order to be perfectly free in its place, a valve ring should always be thinner at the bottom, that is at the ends, than the depth of the groove measured on a radial line. At the same time, the thickness at the top should be appreciably greater, in order that it may take up, as far as possible, the greater space resulting from the eccentric position of the valve, which is constantly carried on the bottom of the bushings, as is shown in Fig. 1, if leakage through the split in the rings is to be avoided. The width of the opening in the rings,

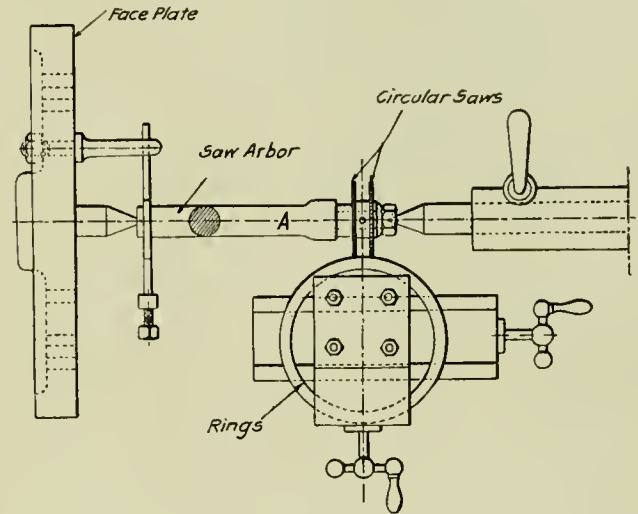

Fig. 8—Cutting Piece Out of the Packing Ring.

when in place, is about .02 in. at the smallest diameter, but increases with the wear of the rings and the bushing.

The rough turned rings are drawn together by flexible straps, as shown in Fig. 9.

Between the ends of each ring a sheet of metal, about .02 in. thick, is placed to correspond to the normal distance between them when in place. The rings thus clasped are mounted on a special fitting, as shown in Fig. 10, which consists of two plates of the same diameter, of which No. 1 is screwed to the lathe spindle, while the other, No. 2, is mounted on the first by means of four studs. The holes for these studs in plate No. 1 are slightly elongated to permit of a displacement cor-

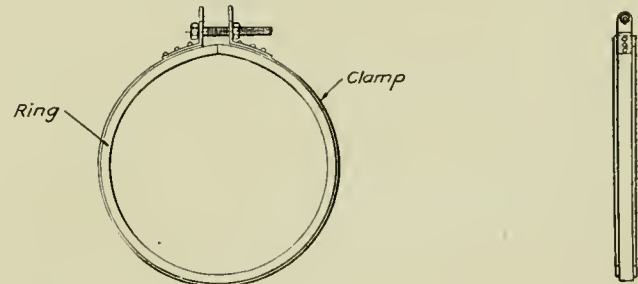

Fig. 9—Clamp for Packing Ring.

responding to the eccentricity of the rings. The drum C, of proper dimensions to receive the clasped rings, is automatically centered on the plate A.

When the two plates are bolted together in perfect concentricity, the clasped rings are put on the drum, taking care to place the ends opposite the holes for the holding studs of A. This position is then marked on the plate. A ring of somewhat smaller diameter is then put between the plate and the first packing ring, in order to protect the device from mutila-

tion. The last ring at the outside projects a little beyond the drum and is held in place by means of a spherical block, or cap, held by a nut and washer. The straps which have served to hold the rings are then removed, and the outside is turned by taking two cuts. The first makes the rings round, while the second, which can be adjusted if the rings are to be of different diameters, brings them down to size; that is to say, to a size corresponding accurately to the smallest diameter of

the rings are turned to give a play between the bottom of the groove and the ring of from .008 in. to .012 in. at the top.

The inner edges are also chamfered in order to avoid the sharp angles which might prevent the rings from seating on the bottom of the grooves.

The rings are then taken down and inspected singly; drilled diametrically opposite the kerf with a hole about $\frac{1}{4}$ in. in diameter to receive the pin which is to prevent turning.

This method produces rings of proper form and accurate

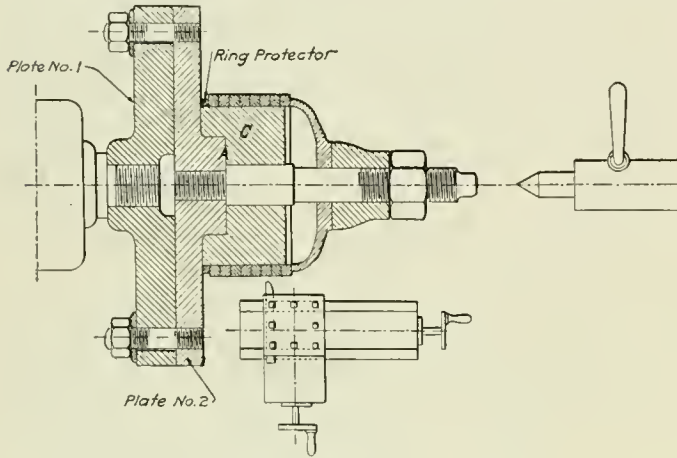

Fig. 10—Turning Outside of Rings.

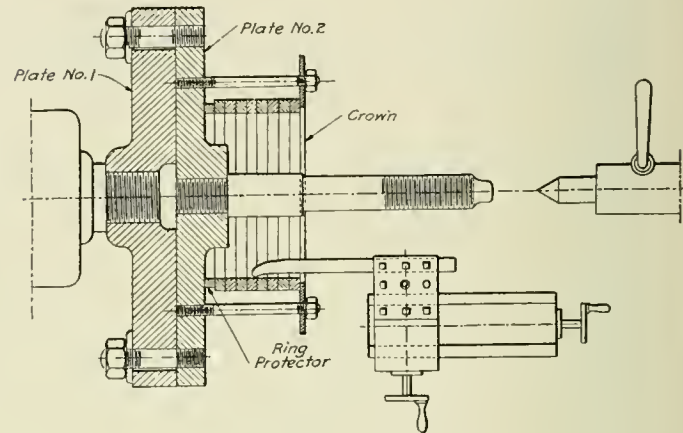

Fig. 11—Turning Inside of Rings.

each bushing. The play of .02 in. provided between the ends of the rings to meet this diameter, is obtained by the .02 in. sheet, previously inserted, which remains in place.

When the finishing cut has been taken it is well to take a very light chamfering cut at the joints between the rings, so as to remove any burrs which might have a tendency to act as scrapers and remove the lubricant. Finally the surface is

dimensions, besides being far more rapid and economical than the old method.

When piston rings are to be turned, in order to avoid using the self-centering drum, a cam apparatus is employed, which is based upon the same principle as is used for automatically centering the exhaust nozzles and the threads used for setting guides. This apparatus is shown in Fig. 12. No eccen-

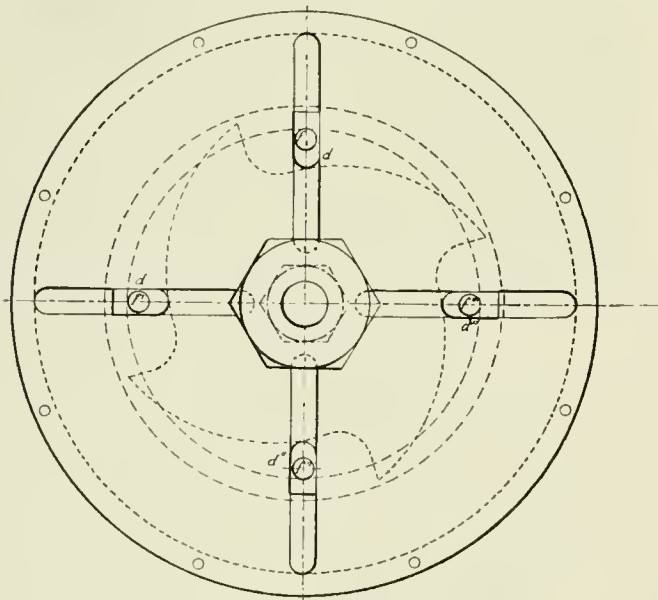
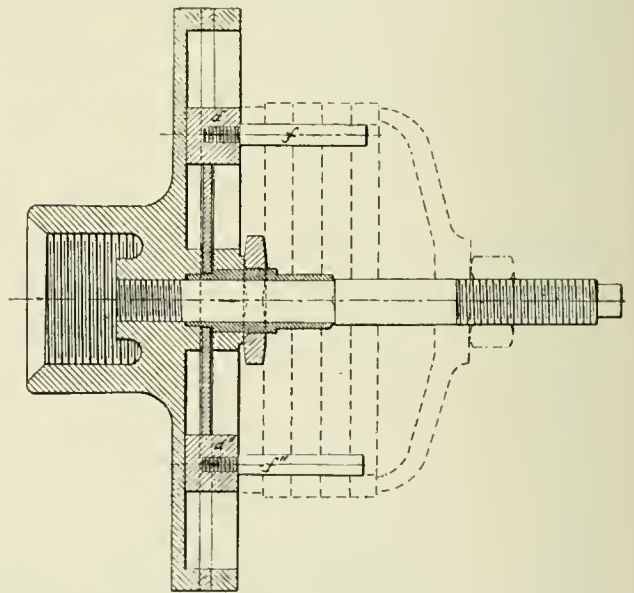

Fig. 12—Apparatus for Centering Inside of Piston Rings.



polished, so that when they are put in service the rings may be as frictionless as possible.

It then only remains to finish the inside. For this purpose, and without dismantling the rings, a crown, shown in Fig. 11, is bolted to plate No. 2, which has a bearing on about the outer half of the rings. It is held in place by four bolts. When this crown has been so tightened that it will hold the rings, the holding nut is run back and the holding cap removed, as well as the centering drum. Plate No. 2 is then moved over No. 1, so as to obtain the necessary eccentricity, and the insides of

tricity is given to the piston rings, since the piston rods and extension rods should be kept at the true axis of the cylinder.

When piston valves were first used, the center, or bull rings, were made of cast iron, but for the sake of preserving the bushings, which should, as far as possible, be kept from wearing oblong, bronze was later substituted for the cast iron.

These rings are fitted to rub lightly on the body of the valve, while, on the outside, they are turned to a diameter .02 in. less than that of the bushing. With this, the rings are free to expand without any increase of frictional resistance. These

bull rings ought to bear upon the bottom of the bushings so as to insure the necessary tightness on a line with the ends. The wear on them is confined to a rather limited arc, so that they last for a long time; and when they are to be repaired it is sufficient to turn them through 90 deg., so that they can always retain their original thickness at the bottom. This expedient, which has no disadvantage, usually extends the life of the rings to the time when they will have to be replaced because of the re boring of the bushings; that is, after a life of from 112,000 to 125,000 miles.

SHONFELT-VAUGHAN FUSIBLE PLUG

BY E. S. DEWAY.

A new design of safety or fusible plug has been in experimental use for several years on the locomotives of the Southern Pacific and on several occasions has given warning which prevented serious boiler explosions.

This plug is shown in the illustration and consists of a brass body properly threaded for screwing in the crown sheet and arranged to extend well above the upper surface of the sheet. This upper projection has a fair sized opening at the top in which is fitted a brass plug with a head, somewhat less in diameter than the space in the body around it. This plug is closely fitted in the opening but is not tight. Its end is flush with the top of the body so as to prevent any collection of scale at this point. A seal of tin or other metal, fusible at a comparatively low temperature, is interposed between the head of this plug and the brass body and fuses the two parts together.

It will be seen that the seal of fusible metal is entirely separated

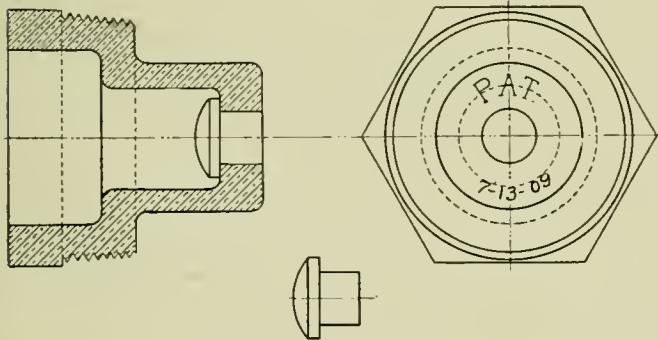

Shonfelt-Vaughan Fusible Boiler Plug.

from the water space above the crown sheet and is thus exempt from the liability of corrosion and it is also protected from the direct action of the heat in the firebox. A characteristic feature of the seal is that it is not connected to the body or the disc by any form of interlocking projections. When the water in the boiler is at the proper height the seal is protected by the cooling action of the water surrounding the body of the plug and is also somewhat insulated from the heat of the firebox by being set at a level higher than the crown sheet and inside a cavity. When the water level becomes too low the fusible metal will soften and release the small brass plug which is immediately blown out by the pressure of the steam above it and a fair-sized opening is given for escaping steam which will deaden the fire and give an unmistakable warning of low water.

Experience with fusible plugs fitted with babbitt alone has shown that they frequently soften and let the steam pass through at one point, but that the remainder of the metal is then cooled and kept at a low temperature by the escaping steam so that a positive and unmistakable warning is not given. It is for this reason that the brass plug, sealed in place, is used in this design. Experience has shown that when it once reaches the fusing temperature there is no possibility of the plug remaining in place and not giving the necessary warning.

TEMPERATURE TESTS ON SUPERHEATER LOCOMOTIVES

Some interesting results, in connection with the temperature of various points in a locomotive boiler fitted with a Schmidt superheater, have been obtained by Prof. Lomonsoff and M. Czezott, on the Tashkent Railway in Russia. The locomotive on which the tests were made had cylinders 21.6 in. x 27.6 in., driving wheels 72 in. in diameter, and a total heating surface of 2,210 sq. ft., of which 441 sq. ft. was superheater surface. The length of tubes was 14 ft. 6 in., grate area 30 sq. ft., steam pressure 191 lbs., and the locomotive weighed

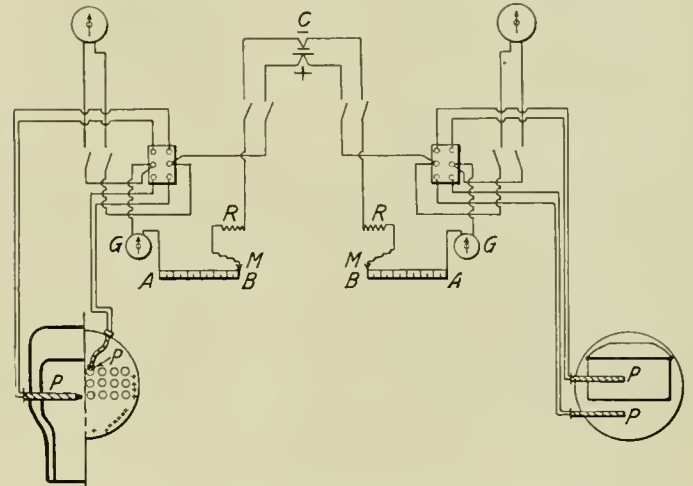

Fig. 1—Arrangement of Wiring and Apparatus for Making Temperature Tests.

about 73 tons. The return bends of the superheater elements were 26.8 in. from the tube sheet.

An account of these tests was published in *The Engineer* (London), July 26, from which the following has been taken: These tests relate principally to the variation of the temperature of the gases of combustion under different conditions of working. The apparatus employed is shown diagrammatically in Figs. 1 to 3. Figs. 1 and 2 show a locomotive boiler fitted with pyrometers for taking different temperature measurements. The pyrom-

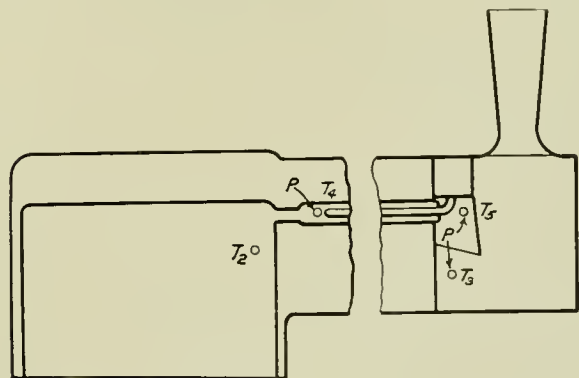

Fig. 2—Points at Which Temperature Readings Were Taken.

eters are marked P, and it will be seen that measurements were taken at four points. One point is in the firebox, at a position denoted in the diagrammatic longitudinal section of the boiler as T_2 . Another point was at T_3 in the smokebox. These two records give the temperature of the gases of combustion entering and leaving the ordinary boiler tubes of the locomotive. Two other measurements were recorded, viz., at points denoted by T_4 and T_5 . These two records give the temperatures of the gases of combustion feeding the superheater elements—the first the temperature of the gases as they

reach the bend of the superheater tubes, and the second as they leave the superheater. It is believed that this is the first attempt to take temperature records within the large smoke-tubes at a point such as that denoted by T_4 .

The wiring for the instrument is shown in Figs. 1 and 3. The method employed was devised by Mr. Kroukovsky, professor of electro-technics at the High School of Mining at Ekaterinoslay. Its essential feature is that, instead of using sensitive voltmeters in connection with the pyrometer, a com-

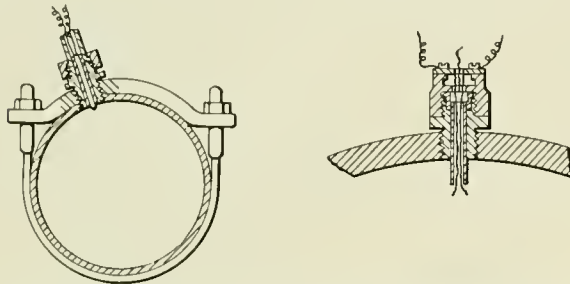

Fig. 3—Method of Inserting Pyrometer in Large Superheater Flue and of Carrying Connections Through the Boiler Shell.

pensated galvanometer is used, and the apparatus so arranged that all readings are taken with the pointer at zero. The result of this is that a substantial instrument, little likely to be affected by the vibration of the train, can be used, and yet accurate readings obtained. In the installation under notice the instruments are in duplicate, and the connections for the four pyrometers are taken to two switches, so that readings for all four can be taken on two scales. The reading instruments were all in the dynamometer car behind the tender. In the diagram, Fig. 1, C represents the cell; G, G represent the galvanometers, of about 4.5 ohms resistance; R, R the rheostats; $A, B, A B$ scaled resistances; and $M M$ cursors with slide over the scales $A B, A B$. Two check instruments are also inserted in the circuits. When taking records the cursor M is moved along the resistance $A B$ until the galvanometer pointer is at zero, when the reading of the scale $A B$ gives a measurement of the temperature. The method of in-

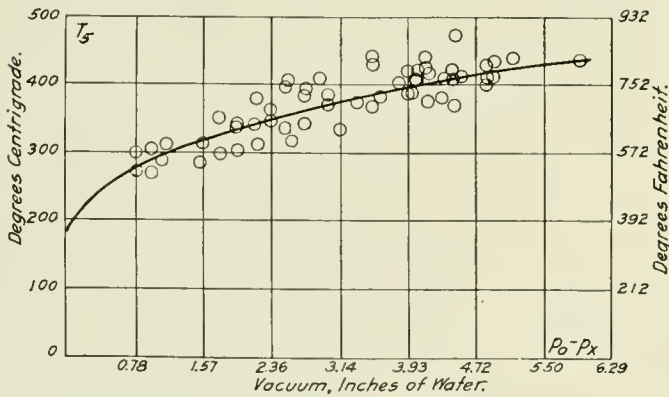

Fig. 4—Typical Readings Showing How Curves Were Plotted.

serting the pyrometer into the large smoke tubes, in order to secure temperatures at the point T_4 , is shown in Fig. 3, as is also the manner in which the connections for this pyrometer were carried through the boiler shell.

The results of some of the experiments are shown in Figs. 4 and 5. These are plotted to vertical scales of degrees, and to horizontal scales of smokebox vacuum in inches of water. Fig. 4 shows a typical curve, with the actual points as recorded. A feature of considerable interest which may be noticed in connection with the temperature of the gases leaving the barrel, is that at the higher rates of working the temperature of the gases leaving the superheater tubes in less than that

of the gases leaving the ordinary boiler tubes. This suggests that the resistance at the higher rates becomes too great in the large smoke-tubes for the gases of combustion to be divided between them and the ordinary boiler tubes in the same ratio as happens at low rates of combustion. The inference naturally must be that superheat does not increase, as it is often contended it does, at a rate varying directly with the rate of combustion or draft, but that the rate falls off at the higher rates of working. This is confirmed by a study of other tests. It was found that moisture was present in the steam at the dome, usually to the amount of 4 to 5 per cent., while many instances of 10 per cent. moisture had been recorded. These figures confirmed results obtained by

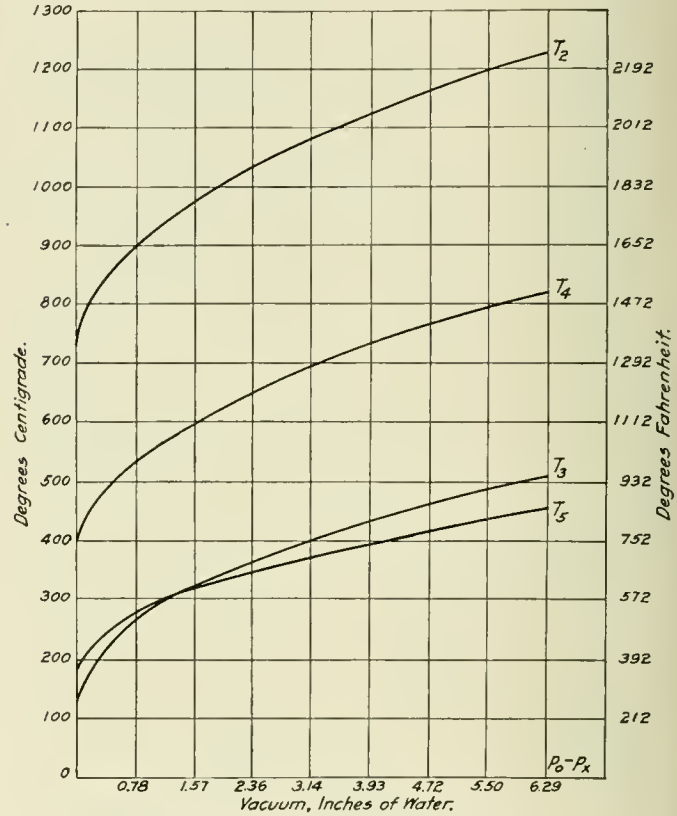

Fig. 5—Curves for Temperatures at Four Points Under Different Intensities of Draft.

these experimenters independently on the Ekaterinynsky and Rybinsky railways; and it is their opinion that these are ordinary figures for waters containing appreciable quantities of carbonates.

LUNCH COUNTER CAR.—A lunch counter car has been installed on the Southern Pacific between San Francisco and Los Angeles, Cal. The counter extends the length of the car along one side, with the regulation stools in front of it. Meals will be served at all hours.

CONDITION OF FARM PRODUCTS IN THE U. S.—The Department of Agriculture has prepared an average for this year of all of the farm crops throughout the United States. Preliminary estimates of production have been made of certain crops as follows, with comparisons and farm prices for November 1, for the past two years:

| Crops. | Production. | | | Price. | | |
|-----------------|-----------------------|-----------|-----------|------------------|------------------|------------------|
| | 1912. Preliminary. | 1911. | 1910. | Nov. 1, 1912. | Nov. 1, 1911. | Nov. 1, 1910. |
| Corn, bu..... | 3,169,137 | 2,531,488 | 2,886,260 | 58.4 | 64.7 | 52.6 |
| Wheat, bu..... | 720,333 | 621,338 | 635,121 | 83.8 | 91.5 | 90.5 |
| Oats, bu..... | 1,417,172 | 922,298 | 1,186,341 | 33.6 | 43.8 | 34.9 |
| Barley, bu..... | 224,619 | 160,240 | 173,832 | 53.8 | 84.9 | 55.3 |
| Rye, bu..... | 35,422 | 33,119 | 34,897 | 68.8 | 83.1 | 71.6 |

ERECTING SHOP KINKS

BY JAMES STEVENSON,
Gang Foreman, Pennsylvania Railroad, Olean, N. Y.

CROW-BAR SUPPORT.

The arrangement shown in Fig. 1 is made of bar iron, 4 in. wide x 1/2 in. thick, and is so constructed that it will rest on the floor and provide a good support, through one of the 2 in. holes drilled in the upright portion, for a crow-bar while

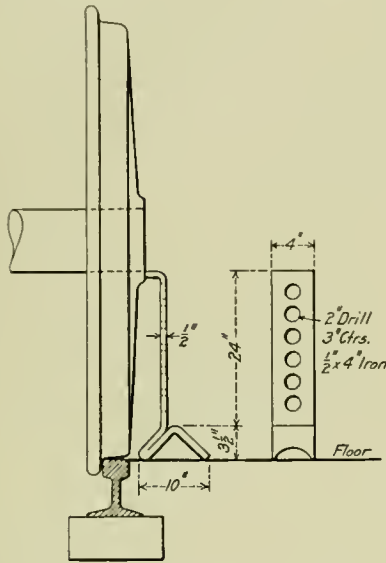

Fig. 1—Support for Crow-Bar.

lifting the pedestal braces in place. It is light and easily handled, and can be made in any blacksmith shop. It will also prove useful for other classes of work, where it is necessary to get a series of different lever heights for crow-bars.

APPLYING AIR PUMPS TO LOCOMOTIVES.

The device shown in Fig. 2 has proved satisfactory for removing and applying air pumps to locomotives. It consists

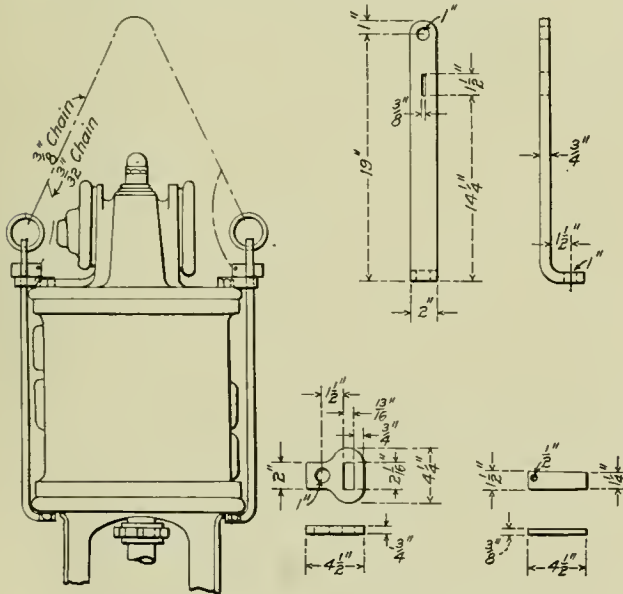

Fig. 2—Arrangement for Lifting Air Pumps.

of two supports made of 2 in. x 3/4 in. bar iron which hook on the lower steam cylinder head studs of the pump. Sliding lugs slip over the top studs and are held in position by a

tapered key. Rings are provided at the top of the supports for a 3/8 in. chain. This provides a positive grip on the pump and when the arms are placed diametrically opposite, the pump may be raised in a vertical position. The arrangement is safe, as the two lugs cannot slip from the studs after the taper key has been driven in. This key is held to the 3/8 in. chain by a small chain, so that it will not be lost.

AIR PUMP GOVERNOR REPAIRS

BY J. A. JESSON,
Air Brake Foreman, Louisville & Nashville, Corbin, Ky.

A method of boring out the steam cylinder of a 1-in. air pump governor is shown in Fig. 1. The arbor *A* has a stem *B* which has a close fit in the guide *C*. It is held fast to the top of the guide by the nut on the end of the stem and the steel washer *D* which has a close fit in the recess at the lower end of the guide *C*. The lower end of the stem is turned down to 3/8 in. to receive a standard nut. This part also serves as an arbor for a milling cutter to true up any irregularities on both ends of the guide. The reamer *E* should have a snug fit on the arbor and should be ground for cutting brass.

These cylinders can be bored out to 1/8 in. larger than their

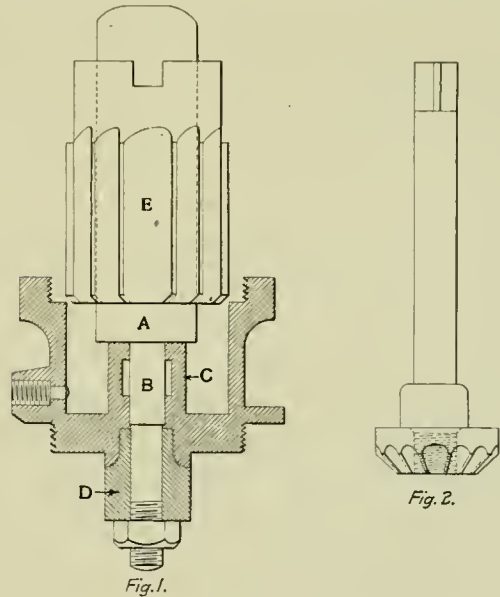

Reamers for Repairing an Air Pump Governor.

original diameter, as the manufacturers furnish pistons and rings for every additional 1/32 in. up to that limit. The steam valve stems are made larger than the standard sizes in increments of 1/64 in. Since the steam valve and piston are rigidly connected it is necessary that the guide should be bored each time the cylinder is bored, which may be done by a sensitive drill or a bench drill, standard fluted reamers being used. Fig. 2 shows a reamer for facing off the steam valve seat of the governor which is often out of line with the valve guide due to the warping or springing of the metal. The reamer is screwed on the shank so that it may be used with a shank that exactly fits the valve guide. Where the valve seat is cut too deep, a facing reamer should be used to cut it down.

EQUIPMENT ON THE FEDERATED MALAY STATES RAILWAY.—In February, 1912, the Federated Malay Railway had in service 114 locomotives, of which 33 were of Pacific type, 38 of the ten-wheel type, and 43 were smaller engines. On the same date there were 2,229 freight cars of various types and 271 passenger cars.

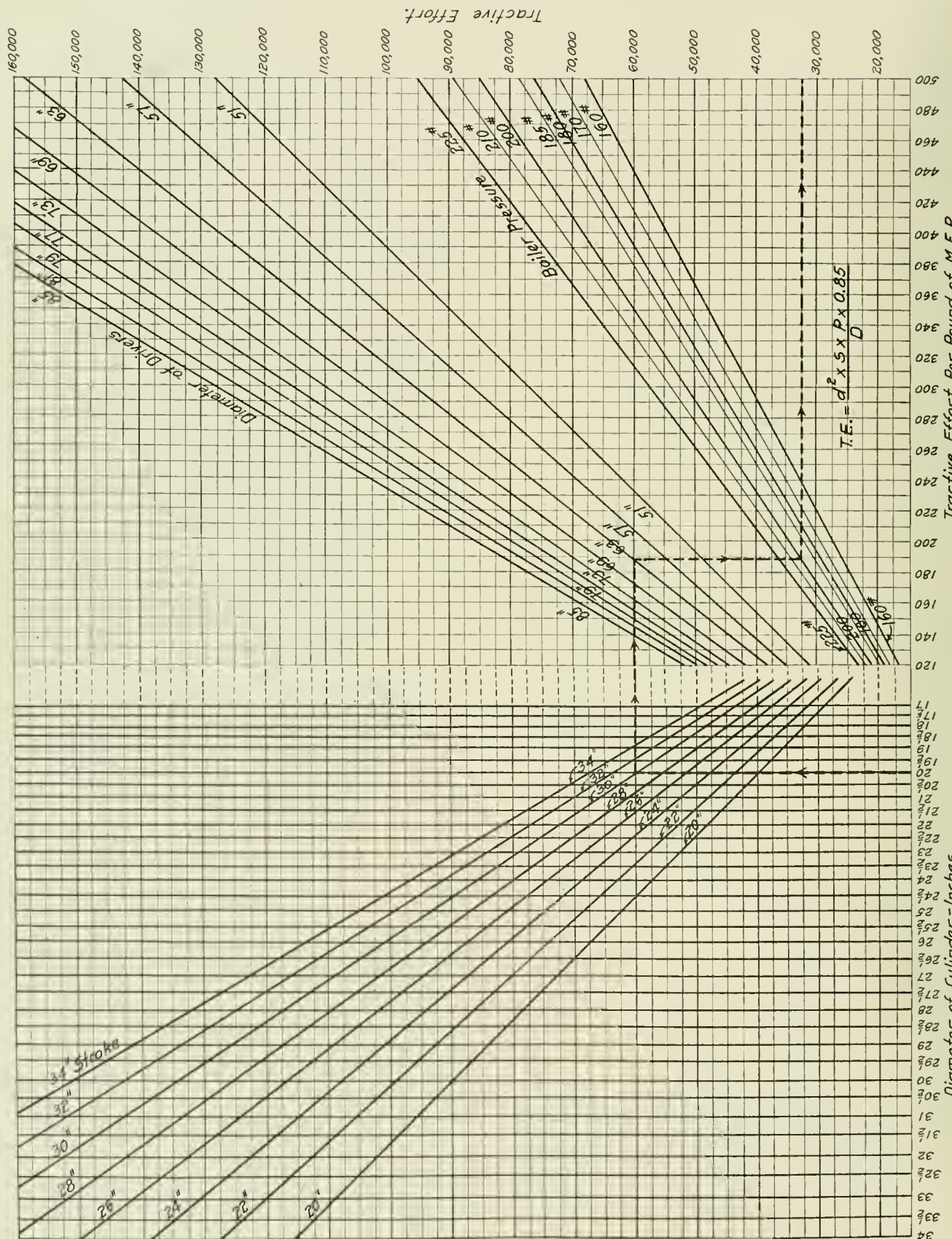

Chart for Obtaining Quickly Either the Total Tractive Effort or the Tractive Effort Per Pound of Mean Effective Pressure.

CHART FOR OBTAINING TRACTIVE EFFORTS

BY L. R. POMEROY.*

A locomotive tractive effort formula contains four variables and in the preliminary investigation of a proposed design it not infrequently is desirable to ascertain the effect of changes in each or all of them. While the tables available permit a ready determination of tractive effort for exact sizes, it is sometimes necessary to know the effect of an increase of one-quarter inch in the diameter of the cylinder or the wearing down of the tires which would decrease the diameter of the drivers by small amounts. Furthermore for a complete range, the tabular arrangement of this data makes a fairly voluminous pamphlet. In view of these facts the accompanying chart has been prepared and will be found to give results that are accurate within 500 lbs. It is based on a mean effective pressure equal to 85 per cent. boiler pressure.

In obtaining the tractive effort of an existing locomotive the chart is entered from the bottom of the left hand section at the proper diameter of cylinders. This line is followed to the intersection of the diagonal line corresponding to the stroke and then horizontally to the intersection of the diameter of drivers and then downward to the boiler pressure and horizontally to the right hand scale, where the tractive effort will be found. If the tractive effort per pound of mean effective pressure is desired, the boiler pressure curves are not considered and the line is carried directly down from the diameter of drivers to the scale at the bottom of the sheet. The example shown as an illustration is a 20 in. x 30 in. cylinder, 63 in. wheels and 200 lbs. boiler pressure. It shows that the tractive effort is slightly less than 32,500 lbs., and the tractive effort per pound of mean effective pressure is about 190 lbs.

CHECKING TOOL OUTFITS

At the last meeting of the Railway Tool Foremen's Association, there was considerable discussion on checking systems for tools, and it was finally recommended by the association that there should be a charge placed on each tool check issued to

Form 1248 Standard
ORIGINAL
Santa Fe.

MECHANICAL DEPARTMENT.

The following tools have this date been delivered to _____ 19____
employed as _____
at _____ Shop.

| No. | DESCRIPTION |
|-----|-------------|
| | |
| | |
| | |

Form 1248 Standard
CHECKED.

| DATE | SHORTAGES |
|------|-----------|
| | |
| | |
| | |
| | |

I agree to return or pay for above tools.

Occupation _____

Approved: _____ Foreman.

INSTRUCTIONS.

This receipt must be made in duplicate. Original to be retained by Master Mechanic or Shop Foreman, duplicate to be given the employee to whom tools are issued.

All tools will be checked on the first day of each month, also when employee leaves the service, and in case of shortage, which cannot be satisfactorily explained, a bill will be made against the employe for value of missing tools.

Foreman must check and O. K. duplicate list before these check will be issued.

DECEMBER 1912

Face and Back of the Receipt for Tools which is Signed by the Workman.

a workman. In this connection, the system in force on the Santa Fe for issuing a set of tools to a man when he first enters the service and afterward keeping track of them, was mentioned.

When a workman enters the service of that road he is issued

*Consulting Engineer, New York.

a set of tools varying as to number and kind depending on his work, and Form 1248, shown in one of the illustrations, is filled out in duplicate giving the number of chisels, hammers, wrenches, etc., in the spaces provided. This list is signed by the workman, who thereby agrees to return or to pay for all of the tools on the list. The original is filed in the tool room and the duplicate is given to the man. On the back of this

Hall-2-07-5M-4657 (Form 1279 Standard.)
SANTA FE.

(Insert name of Railway Company.)
ORDER FOR TIME CHECK.

TIMEKEEPER: _____ 190..

Please issue Time Check to.....

Number.....for services during.....190.., as.....

Foreman.

Tool List checked up and found to be.....

Tool Room Foreman.

Locker Key.....

General Foreman.

THIS ORDER MUST BE PRESENTED before a time check is issued

form is a space for entering the date and any shortages that may be found when the list is checked over. All the tools in the shop are checked on the first of each month and also when

Hall 2 10 10M 170 8 (Form 2026 Standard.)
Santa Fe.

IN ALL CASES WHERE TOOLS ARE LOST, BROKEN OR DAMAGED, THIS CARD MUST BE FILLED OUT
TOOL BREAKAGE CLEARANCE.
(ONLY ONE TOOL TO EACH CARD.)

No. _____ has _____ size _____

(SHOP LETTER, NUMBER AND NAME.)

(GIVE FULL NAME OF TOOL.)

as a result of Defective Material
 Accident
 Ignorance
 Carelessness

O. K.

This card must be signed by your Foreman, one of the following:

| | |
|---------------|-------|
| INITIALS HERE | DATE |
| _____ | _____ |
| _____ | _____ |
| _____ | _____ |
| _____ | _____ |
| _____ | _____ |

Check Here
 Worn Out
 Damaged
 Broken
 Lost

Clearance Card for Lost or Broken Tools.

the employee leaves the service. If any shortage that cannot be satisfactorily explained is discovered, the employee is required to pay for the missing tool. An employee desiring to leave the service, after having his tool list checked over is given a copy of Form 1279, which must be properly filled out and signed before he can receive his time check.

If on checking over at the first of the month or at any other time it is found that any tool is lost or damaged, Form 2025 is filled out and properly signed, which acts as a release for any shortage shown on the back of Form 1248. This form is used for tools that are permanently in the man's possession, as well as those which he draws from the tool room. In the latter case, the presentation of this clearance card, properly filled out, permits the man to recover his tool check.

TAIL END TRAIN MARKERS.—The Philadelphia & Reading has decided to use lamps for tail end markers for trains, in the day time as well as at night, in place of the green flags.

NON-PARALLEL AXLE TRUCKS

A construction for four-wheel trucks, which does not require the axles to maintain even an approximately parallel position is being tried experimentally on several foreign electric railways. This design was originated and is controlled by the Warner International and Overseas Engineering Company, Ltd., of London. In a general way the system might be described as consisting of two radial trucks, arranged in a manner similar to a two wheeled engine truck, which are pivoted at or near the center of the main truck frame. The main frame is supported by a flexible connection at each of its four corners, as well as at the one or two pivot pins.

This arrangement in its simplest form is shown diagrammatically in the accompanying illustration, which was used in the columns of *Engineering* of London. Here the truck frame is

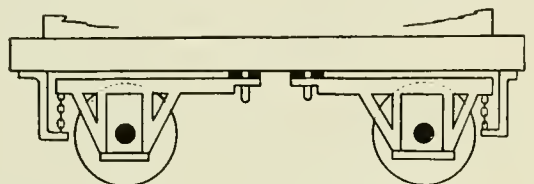

Diagrammatic Illustration of the Warner Non-Parallel Axle Truck.

shown as supported by chains at each corner and with separate pivot pins. In actual practice links, arranged for radial movement, are used in place of the chains at the corners. It will be seen that when either of the two radial trucks is deflected to one side that end of the frame will rise and a pull will be transmitted to the truck which will tend to restore it to its normal position.

Motor and trailer trucks designed on this principle have been applied to some cars on the Metropolitan Railway of Paris, as well as on the London County Council Tramway. While the general principles of the system are the same in all cases the

constructional details vary greatly. No difficulty, however, is found in applying either the motors or the brake rigging, and the springs are arranged in practically the same manner as is used on a two wheel radial truck. The center pin is used as a common pivot pin for both the radial frames where possible, and the weight of the car body is usually transferred directly to the center of the main truck frame, which in turn is supported from the radial frames at six points.

REMOVING WHEELS FROM MALLETS

BY S. H. LEWIS,

Assistant Superintendent of Motive Power, Virginian Railway, Princeton, W. Va.

When a Mallet locomotive is brought to the shop it is customary to disconnect the low pressure unit, run it out from under the boiler and handle the two parts separately. This entails considerably more work than is necessary when a hoist of sufficient capacity to lift the whole locomotive is available. The necessary removal and replacement of a number of parts, some of which are quite troublesome to handle, is required, and furthermore, the low pressure engine frames and cylinders are awkward to transport and take up additional shop space.

At the Princeton, W. Va., shop of the Virginian Railway the erecting shop is served by a 200-ton traveling crane. This shop is of the transverse type and has a 75 ft. transfer table just outside the building. On the opposite side of the transfer table is a rod and wheel shop in which the engine trucks, rods, driving wheels and driving boxes are repaired. When a Mallet locomotive is brought to the shop for repairs it is disconnected from its tender and placed on the transfer table. When opposite the desired pit in the erecting shop it is drawn in by means of a snatch block and cable operated by the transfer table motor. Having a crane of the proper capacity to lift the whole locomotive, it becomes necessary to secure the low pressure unit to the boiler at its front end, and for this purpose



Mallet Locomotive Lifted by a 200-Ton Niles Crane; Virginian Railway.

the smokebox front is removed and triangular shaped pieces of steel are bolted to the low pressure extension frames by two of the frame bolts. These pieces remain on the locomotive permanently. Flat hooks are fastened to them and fit over the smokebox front ring. To prevent the hooks from slipping, they are held in place by curved straps bolted to the ring through the holes intended for the smokebox front bolts. With this arrangement the entire locomotive may be lifted, as shown in the photograph. The pedestal binders, main rods, brake rigging, etc., are removed or loosened and the locomotive is lifted by connections from the foot plate and from the front part of the smokebox. The engine truck is then run on the transfer table and the driving wheels with the side rods and driving boxes in place are pulled from under the locomotive to the transfer table by means of a cable operated by the transfer table motor. The boiler and frames are then lowered to temporary

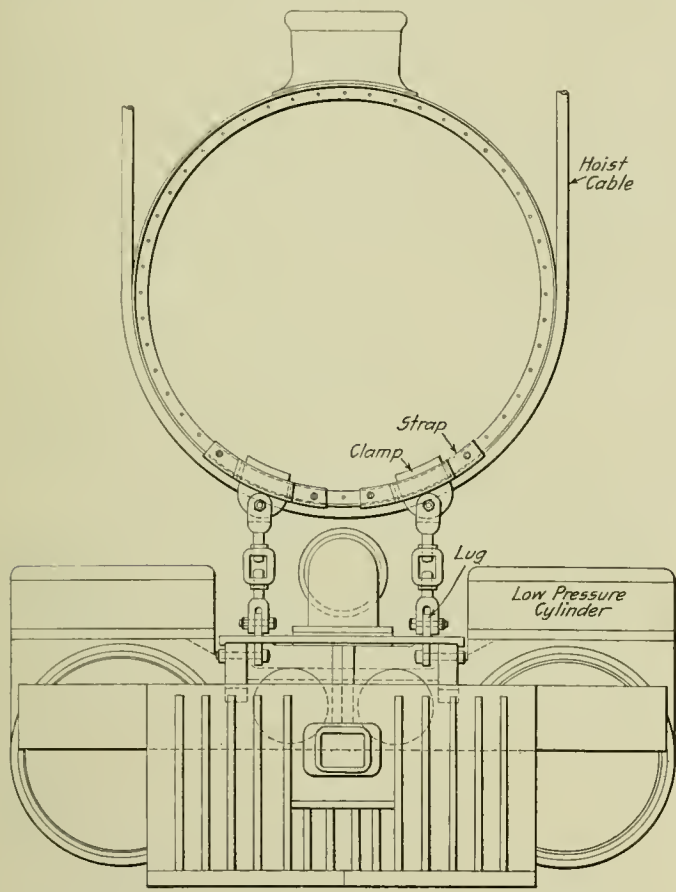

Method of Fastening Low Pressure Cylinders to the Boiler of a Mallet Locomotive so That it can be Lifted by a Crane.

truck wheels which are stored at the back end of the pit and rolled under the locomotive after the driving wheels are removed.

After the wheels, rods, etc., are on the transfer table it is moved opposite the desired pit in the wheel shop, and these parts are drawn in by means of the cable and snatch block. Electric cranes are provided in the wheel shop for handling the different parts. The other parts of the locomotive are machined in the main machine shop, which is under the same roof as the erecting shop.

PASSENGER CAR VENTILATION IN GERMANY.—The rule as to windows in passenger cars in Germany has been that they must not be opened on both sides of the car without the consent of all occupying the compartment. Now on city and suburban trains in Berlin neither window in the front compartment of each car may be opened without unanimous consent.

MACHINE SHOP KINKS

BY SAMUEL MAGILL,

Apprentice Shop Instructor, Atchison, Topeka, & Santa Fe., Topeka, Kan.

CHUCK FOR PLANING SIDE ROD KEYS.

A chuck whose bed is planed to the standard taper of the rod key is shown in Fig. 1. It is made 33 3/4 in. long x 16 1/2 in. wide over-all, and will hold several keys rigidly while they are being

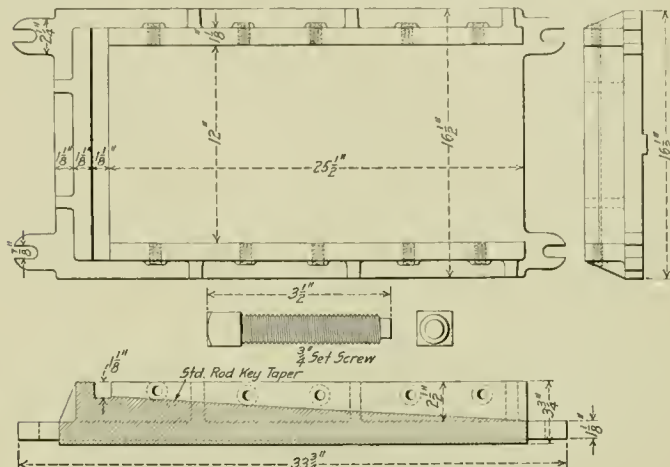

Fig. 1—Chuck for Rod Keys.

planed to the correct taper. A tongue on the bottom of the chuck fits in the slot in the table of the planer and lugs are provided at each corner for clamping.

JIG FOR ECCENTRIC BLADES.

The clamp shown in Fig. 2 is used when drilling and milling the jaws of an eccentric blade. It is made of block having a slot cut in the bottom to accommodate one side of the eccentric blade

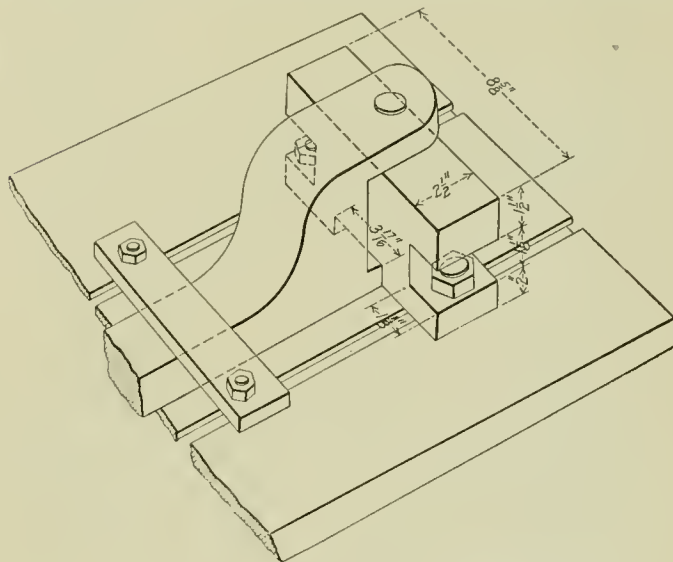

Fig. 2—Clamp for Eccentric Blade.

jaw and is clamped to the drill or milling machine, as shown in the illustration. It provides a rigid chuck and leaves the upper jaw free to be drilled or milled.

SLOTING ECCENTRIC BLADES.

The tool shown in Fig. 3 is used for slotting out the jaws on eccentric blades. It is made to the special shape shown in the illustration, which has proved most satisfactory. A 1 1/8 in. square

bar of tool steel is flattened out to a width of 3 in., and a thickness of 1 in. This tool is held in a tool holder $2\frac{1}{4}$ in. square by two $\frac{7}{8}$ in. cap screws. This provides a rigid tool, with which

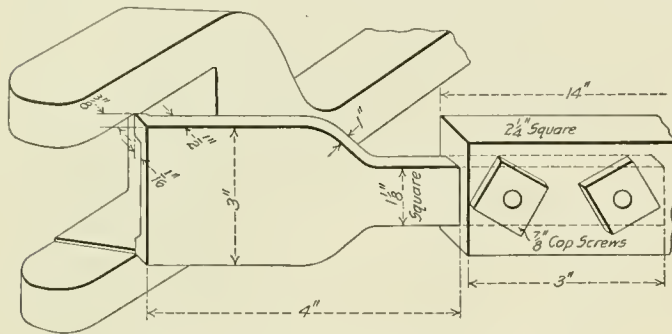

Fig. 3—Tool for Slotting Eccentric Blades.

an eccentric jaw can be slotted out in five minutes. The cutting tool is ground to the required width of the jaw and is so finished that both sides are slotted at the same time.

ENGINE TRUCK BOXES WITH CHILLED FACES

BY B. E. GREENWOOD,

General Foreman, Seaboard Air Line, Portsmouth, Va.

An engine truck box which when delivered from the foundry only requires the drilling of oil holes and of cellar bolt holes to be ready for service, has been in use on the Seaboard Air Line for two or three years with most satisfactory results. This box is cast with chilled surfaces on either face and in the shoe and wedge channels. The chills have smooth faces and the surface

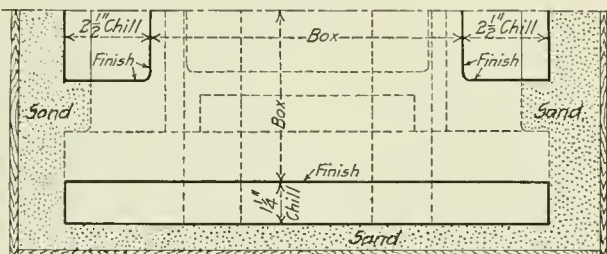

This View Shows the Pattern Ready to be taken from the Sand, Leaving the Chills in Place.

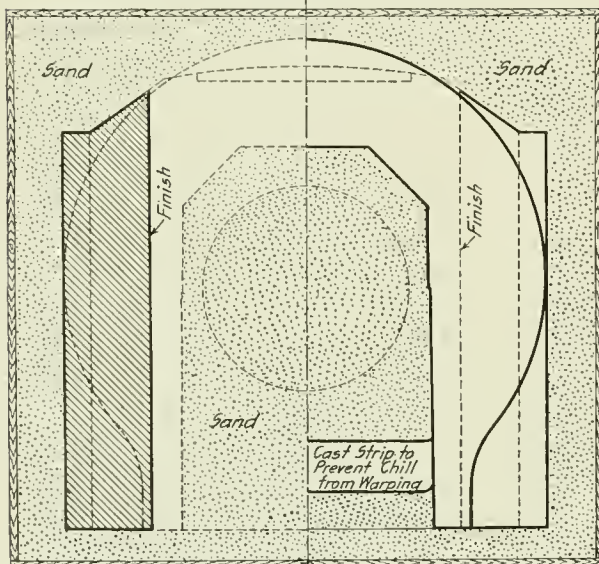

Section at Center.

Outside Face of the Chill.

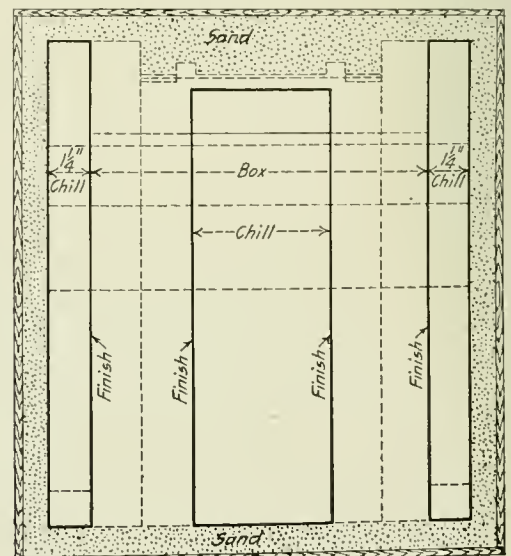

Side of Box with the Sand Removed.

Arrangement and Form of Chills for Engine Truck Boxes.

of the casting at these points is all that can be desired. The illustration shows the form and the location of the chills in the flask. A brass hub liner is used on the wheels in connection with these chilled boxes.

SHOP ELECTRIFICATION

George W. Cravens, president of the Cravens Electric Company, Chicago, read a paper on "The Electrical Equipment of Railway Shops," before the September meeting of the Western Railway Club, of which the following is an abstract:

There are certain general laws which may be used as a guide in studying conditions and will help in formulating the preliminary layout of a shop. The best thing to do is to make a careful, comprehensive and detailed study of existing shops, old and new, especially those operating under conditions similar to the assumed conditions of the new one.

ELECTRICAL EQUIPMENT.

After having settled all of the preliminary questions, the next thing is to prepare a list of the lights, motors, etc., required for each department. The tools needed, consideration of group or individual drive, method of operation and control, kind and number of lights in shops and yards, miscellaneous applications of power, such as for heating, welding, etc., all must be taken into account. A preliminary power diagram should then be made up.

Having determined the machine tool layout and other factors effecting the amount and distribution of power the next thing to do is to make a complete wiring or power distribution diagram. After the general wiring diagram is finished the details of the power distribution in each building should be taken up separately and worked out in detail.

The best location for the power house is undoubtedly as near the center of the load of the plant as possible. This should include ultimate load, as well as present load, in so far as it can be determined. This is especially true of direct current plants on account of transmission losses, due to the general use of lower voltage than with alternating current. If the power is to be transmitted for any great distance the voltage should be as high as possible for safety in a shop.

Direct-current motors are usually designed for use on con-

Note: The dotted lines represent the engine truck box. Full lines the chills.

stant potential circuits, three kinds being available for driving machine tools: series-wound, shunt-wound and compound-wound. Each of these has its field of usefulness, as well as its limitations. They are also made for use on the multiple-voltage system, but are not in very general use on account of the comparatively complicated controllers required. It is also necessary to use a motor large enough to deliver full load at the lowest voltage, which makes this system expensive to install.

Alternating current motors are also usually designed for use on constant voltage systems and are of two kinds, synchronous and asynchronous. That is, they are designed to run at a fixed speed in the first case or at varying speeds in the second case, the latter finding the widest application in machine shops. Motors of this kind may be obtained for operation on single-phase, two-phase or three-phase circuits, the single-phase and three-phase being the most used. For variable speed work the three-phase motor is better, the asynchronous or induction motor finding the widest application.

Reliable data as to the power required to drive the different classes of machines is very hard to obtain from outside your own shop, so that the best thing to do is to get a large motor and attach it to the machine in question and test it. Some time ago Prof. Flather conducted a series of tests to determine the power required to drive machine tools when cutting various metals, and he found that the results agreed very closely with the following formula:

$$HP = F \times D \times S \times C.$$

Wherein—

- F = feed in inches,
- D = depth of cut in inches,
- S = cutting speed in inches per minute,
- C = a constant whose value depends on the material worked.

If more than one tool is cutting at one time, the power required will increase in proportion to the number working:

The values of C are as follows:

| | |
|----------------------------------|--------------|
| Cast Iron | 0.35 to 0.40 |
| Soft Steel and Wrought Iron..... | 0.45 to 0.50 |
| Hard and Machinery Steel..... | 0.70 to 0.80 |
| Crucible Steel | 1.00 to 1.10 |

Based upon the weight of metal removed in pounds per minute, the above formula can be changed to the following:

$$HP = F \times D \times S \times W \times K.$$

Wherein most of the symbols carry the same meanings as before, the others being W = weight per cubic inch of the metal being worked on and K = HP coefficient for that kind of metal, as given below:

| | |
|----------------------------------|------------|
| Hard Steel | 2.65 h. p. |
| Soft Steel and Wrought Iron..... | 2.40 h. p. |
| Cast Iron, Hard..... | 1.36 h. p. |
| Cast Iron, Soft..... | 1.00 h. p. |

The weights of the various metals as used in the above are as follows, in pounds per cubic inch:

| | |
|-------------------|-------|
| Steel | 0.284 |
| Wrought Iron..... | 0.278 |
| Cast Iron | 0.258 |

It will be noted that the figures given as the values for the constant K equal the actual horse power required at the motor for each pound of metal removed per minute, regardless of the rate of cutting.

It must not be thought that the cost of electric power for operating a shop will be the equivalent of the full load capacity of all the motors installed, for that is not the case. Figures based upon the records of nearly 200 shops which have come to my attention show the average load to be but 30 per cent. of the rated capacities of the motors installed.

At present there is a tendency towards increasing the number of machine tools per pit. The average is between 6 and 8 per pit with many shops having from 5 to 6, but the tendency is towards from 8 to 10 per pit in several recent shops. As to how many tools of each kind will be required there is no fixed rule, but a survey of the field shows the following proportions in existing shops:

PERCENTAGE OF TOOLS OF EACH TYPE PER ERECTING PIT.

| | |
|----------------------|--------------|
| Turning tools | 50 per cent. |
| Cutting tools | 25 per cent. |
| Drilling tools | 11 per cent. |
| Grinding tools | 7 per cent. |
| Miscellaneous | 7 per cent. |

A short time ago a table was published in one of the railway papers giving the number of machine tools total and of each class per erecting pit, and this showed the average to be slightly over 9 tools per pit. The table is as follows:

| MACHINE TOOLS OF EACH CLASS PER PIT. | |
|--------------------------------------|-------|
| Lathes | 3.925 |
| Boring Mills | .875 |
| Planers | 1.00 |
| Shapers | .5 |
| Slotters | .458 |
| Millers | .375 |
| Drills | 1.083 |
| Grinders | .666 |
| Miscellaneous | .708 |
| Total | 9.59 |

LIGHTING.

For the offices, drafting rooms and stations the indirect system of lighting is coming forward rapidly on account of its efficiency and very pleasing appearance as well as its freedom from glare. Carbon filament lamps stand the handling as drop and portable lights better than the Tungsten filament, although the new drawn wire type is much more rugged than those first made. Guards should be placed on all portables to protect them and to reduce the danger of fire.

For large areas, such as locomotive machine shops, foundries and yards, the flaming arc lamp is best suited because of its high power and great penetrative ability. Mercury vapor lamps are used to some extent in medium sized shops and power plants, and Tungsten lamps of various capacities, singly or in groups, are used to an increasing extent in machine shops, mills, power plants and many other places where there is no smoke to penetrate.

The best system of illumination for large shops is a combination of flaming arc lamps for general illumination with Tungsten clusters for group lighting and incandescent drop lights for machines. Good lighting consists in throwing the light on the work and not in the eyes of the worker.

MISCELLANEOUS SHOP KINKS

BY C. C. LEECH

CYLINDER PACKING RING FACING CHUCK.

The chuck shown in Fig. 1 is used for facing packing rings on a lathe. It consists of a mandrel *D* which is forced into a cast iron coupling *C*. A face plate *A* is held to this coupling by eight screws. The chuck jaws *B* slide in *T* slots in the face plate and are regulated by the conical bushing *E* which slides freely on the mandrel and is held in position by the nut *G*. The ends of the

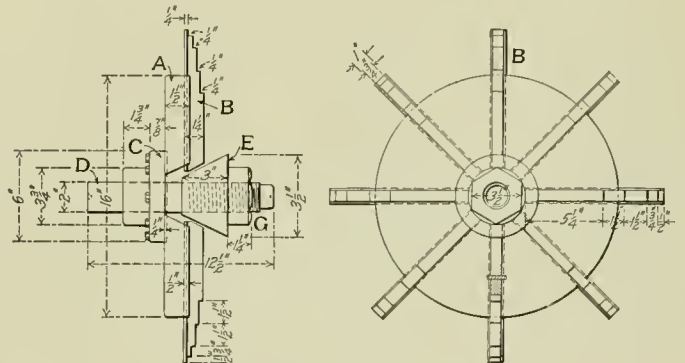

Fig. 1—Chuck for Facing Packing Rings.

jaws are planed to accurately fit the cone. To apply the packing ring withdraw the cone, slide the jaws inward and place the packing ring on the proper steps on the jaws. Then force the cone in against the ends of the jaws, causing them to move outward simultaneously and make a good even bearing on the inside of the packing ring. The mandrel *D* is fitted in the lathe centers

and is driven by an ordinary dog. This arrangement can be used in any lathe large enough to swing it.

PIPE RACK.

The pipe rack shown in Fig. 2 is made of 1/2 in. x 2 in. iron bars which are tied together with 3/4 in. iron rods. This rack is handy for odd pieces of pipe, in that it has a floor of wood and

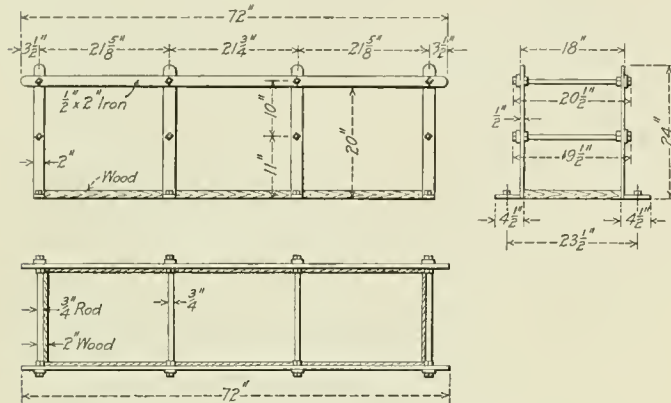

Fig. 2—Rack for Small Pieces of Pipe.

the ends are boxed in so that the pipe will not fall out. It should be located near the pipe machines and will prove convenient for the workmen.

TOOL FOR REPAIRING FIRE HOSE.

The device shown in Fig. 3 is used for applying brass ferrules to the inside of the ends of fire hose so as to make a tight joint with the coupling. It consists of a steel shaft C, which extends through a steel cylinder D. This shaft is threaded at one end and is shaped as shown. Keyways are provided at E in the portion

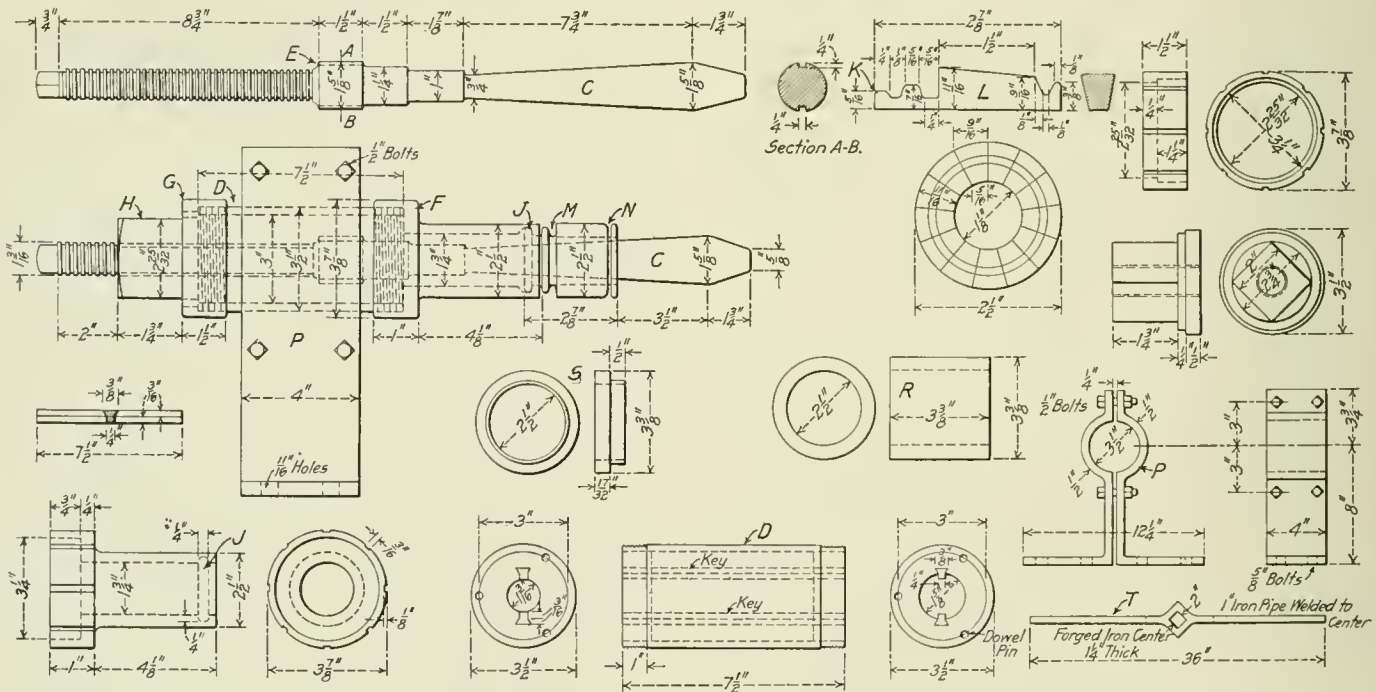

Fig. 3—Tool for Repairing Fire Hose.

which is 1 5/8 in. in diameter. These keyways keep the shaft C from turning and slide freely on keys located in the steel cylinder D. This cylinder is 1/4 in. thick and has two heads 1 in. thick forced in at either end, each being held by three dowel pins. A 1 5/8 in. hole is bored in the right hand end and a 1 3/16 in. hole in the other end. The keyways are dovetailed in the heads as shown and run the full length of the cylinder, being parallel with the center line. The outside of the cylinder at both ends is

threaded to receive the brass spanner nuts F and G. The nut G has a 2-25/32 in. hole to accommodate the brass driving nut H, which runs freely on the thread on the left hand end of the shaft C. The nut F has an extension 4 1/8 in. long x 2 1/2 in. in diameter, as shown. It also has an inside annular groove J to hold the projections K of the brass segments L which surround the

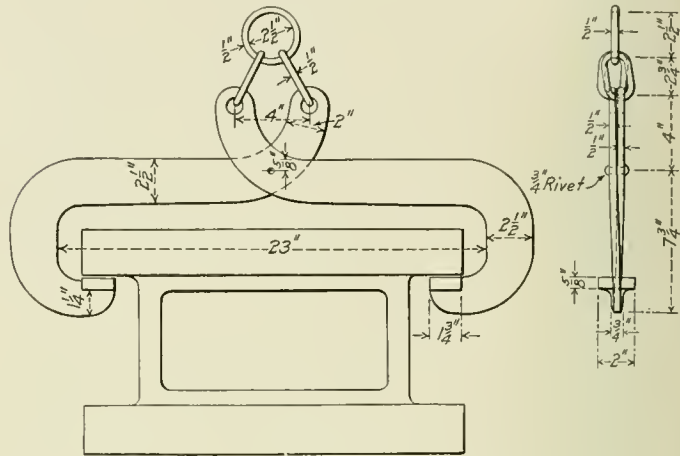

Fig. 4—Tongs for Lifting Driving Boxes.

tapered portion of the shaft, as shown in the general arrangement. As will be seen from the detail drawing of these segments, the inside surfaces are tapered to conform to the taper of the steel shaft. They are held in place about the shaft by rubber bands located in the grooves M and N. The whole arrangement is held by a clamp P, which may be bolted to a table or any convenient object. This clamp rigidly holds the steel cylinder D. Two brass bushings R and S are used on the barrel of the nut F,

according to which end of the hose is to be repaired. The bushings are first placed over the barrel and a very thin annealed copper ferrule is placed in the hose. It is then put on over the shaft with the ferrule coming directly over the brass segments and fitting against the bushing R or S, which in turn fits snugly against the head of the nut F. This ferrule is expanded into the hose by pulling the steel shaft through the brass segments by the nut H with the wrench T. This operation should be per-

FLOOR TYPE BORING MACHINE

On page 376 of the July issue of this journal there appeared an illustrated description of a new horizontal boring machine designed by the Rochester Boring Machine Company, Rochester, N. Y. This machine is an excellent example of the latest development of this type of machine tool which has shown probably greater improvement in the last few years than any other tool for general use. The machine illustrated was of the table type and incorporated many new and novel features. The control was practically all centralized at the saddle and the automatic safety arrangements to prevent damage to the mechanism were most complete.

Practically the same machine is now being built in the floor type, as is shown in the accompanying illustration. It is suit-

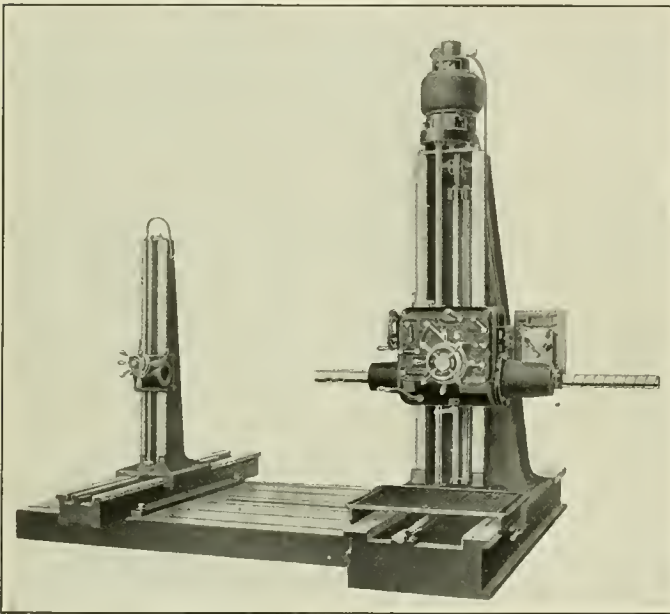

Rochester Floor Type Horizontal Boring, Drilling and Milling Machine.

able for boring, drilling, horizontal or vertical milling, tapping, splining, oil grooving or rotary planing, and is provided with power speed, feed and traverse in every direction, all of which are reversible. No two feeds or speeds can be engaged at the same time, nor can the power rapid traverse in different directions be thrown in until the feeds are disengaged. No two traverses can be engaged at the same time and limit stops are provided for every traverse in both directions.

This machine has the same type of concentric screw feed that is used on the table type. This was illustrated by sectional views and was fully described on page 377 of the July issue. It employs a long bronze nut engaging a square screw thread on the spindle. The nut comes in contact with the side of the thread only and the end thrust in either direction is taken on ball bearings of large diameter. In this way a very long bearing is obtained and the wear is greatly reduced. The nut rotates at the same speed as the spindle when the feed is disengaged, but runs faster or slower than the spindle at a rate depending on the amount of feed desired when the gears are engaged. When the machine is used for milling the end thrust is taken on the saddle direct by a separate bronze thrust bearing.

In the floor type machine the column is of very heavy construction with a long, wide base. It is side braced and designed to give the maximum rigidity in every direction. It is adjustable along the bed by hand or power, and reversible power feeds are provided for milling. Power rapid traverse brings it quickly to any desired position. The saddle is counter-

weighted and in addition to having the various levers for controlling the feeds, speeds and traverses, it carries the lever for starting, stopping and reversing the machine which is performed without stopping the main driving shaft.

When electric driven, the motor is mounted on top of the column as is shown in the illustration. This arrangement eliminates many gears and shafts, and gives a high efficiency of transmission, permitting the use of smaller motors. When belt driven the pulley is at the rear of the bed and drives the vertical shaft through beveled gears.

Friction clutches are used on the vertical high speed shaft and also for engaging power feeds, thus providing yielding points which prevent damage to the mechanism. All gears and moving parts are enclosed and fully protected. A self-oiling system supplies lubrication for the driving and feeding mechanism.

GRAPHITE LUBRICATOR

Graphite in either stick, powdered or flake form, depending on the character of the surface to be lubricated, has been successful as a lubricant for bearings and in some cases for cylinders exposed to a high temperature. Difficulty has been encountered when material of sufficient purity was not employed,

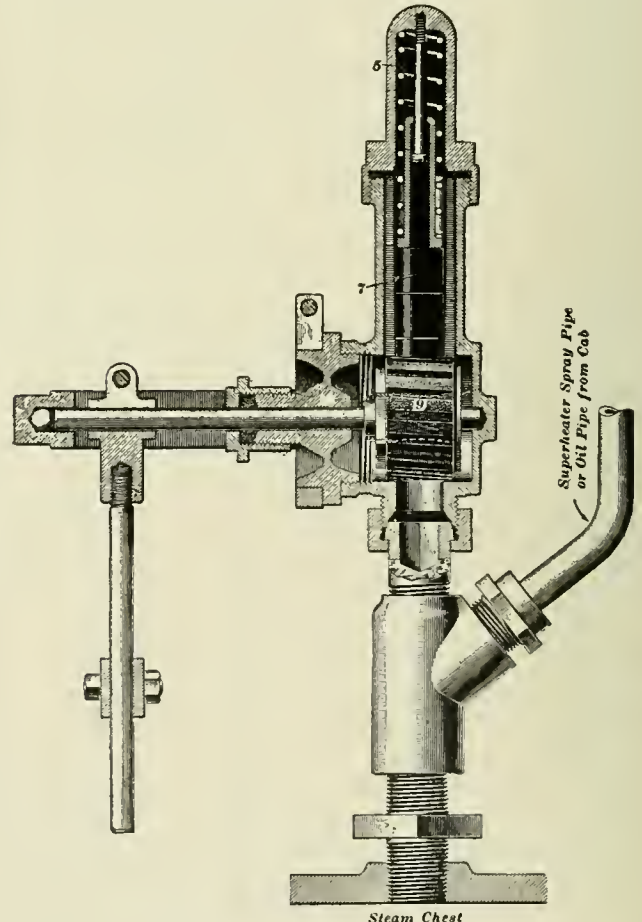

National Graphite Lubricator.

and also, when fed automatically, in keeping the supply continuous.

A lubricator for supplying graphite to locomotive cylinders and valves where it is to be used in connection with oil, is shown in the accompanying illustration. This device uses graphite in stick form, and is applied in a vertical position on the top of the steam chest, the graphite being discharged by gravity to the live steam chamber. The stick of graphite is held on top of a

toothed abrasive wheel by means of a spiral spring. This abrasive wheel is rotated through the medium of a connection to the valve stem or a similar moving part of the locomotive. The finely divided graphite is discharged to an opening just below the abrasive wheel and from here goes to the steam passage. A connection is arranged for the oil pipe from the cab just above the attachment to the steam chest so that the graphite powder mixes with the oil stream on its way to the valve chamber.

This lubricator is being tried experimentally on the Delaware & Lackawanna, and is reported to be entirely satisfactory on superheater locomotives. One stick of graphite, which is supplied in pieces one inch in diameter by one inch in length, will furnish lubrication, with the addition of a small quantity of oil from the hydrostatic lubricator in the cab, for a service of from 75 to 150 miles. This lubricator is furnished by the National Graphite Lubricator Company, Scranton, Pa.

HIGH SPEED HACK SAW

A power hack saw in which the length of the stroke is automatically regulated by the size of the stock in the vise is shown in the accompanying illustration. This machine is manufactured by E. C. Atkins & Co., Indianapolis, Ind., and it is stated that the gain due to the full stroke of the blade, automatically obtained, varies from 25 to 100 per cent. in time, and also results in a considerable saving in the number of blades used, as the wear on them is distributed over a greater area. The machine is arranged for slightly lifting the blade on the return

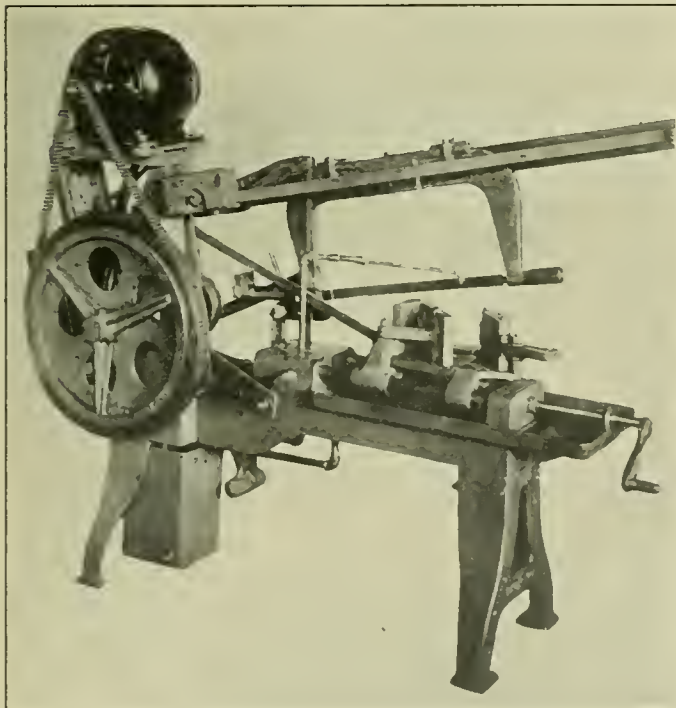

A High Speed Power Hack Saw.

stroke, the device for this purpose consisting of a friction grip working on a heavy upright bar adjusted by a counterbalance weight.

The details of the construction of the machine which is shown driven by a Crocker-Wheeler 1/2 h. p. direct current motor will be evident from the illustration. A complete lubricating system is provided. A swivel vise can be applied, if desired, permitting the cut to be made at any angle up to 45 degrees. An automatic stop is provided for stopping the cut at any desired depth. A controller attached to the motor bracket enables any speed being obtained from 50 to 100 strokes per minute.

WILTBONCO, W, WATER GAGE

Klinger type water gages have advantages, especially in connection with safety, which are causing them to be applied to locomotives in large numbers. It has been found, however, that the cost of maintenance of this type of water glass has been comparatively large, and, while it is not of sufficient importance to threaten their removal, it amounts to enough to make a study of methods of reducing it worth while. The Jerguson Manufacturing Company, 10 Post Office Square, Boston, Mass., has manufactured gages of this type from their introduction and has recently perfected a form of con-

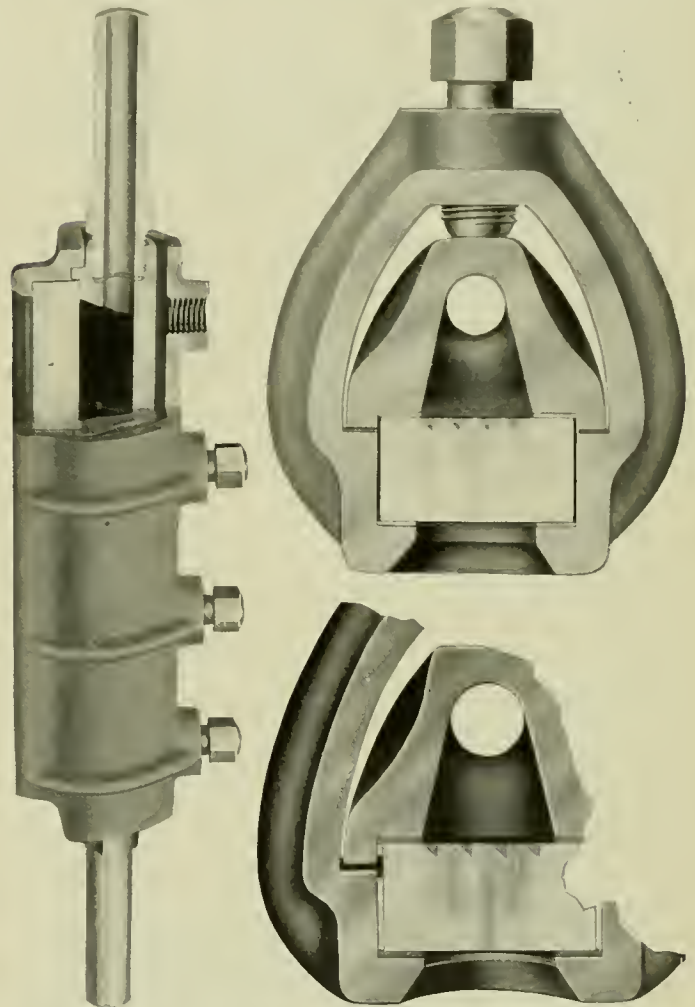

Wiltbonco, W, Klinger Type Water Gage.

struction which, it is believed, overcomes many of the weak features of previous arrangements and will greatly reduce the maintenance cost. This gage is designated as style W, and consists of a brass body and a separate brass back piece, the latter including the steam and water cavity. The Klinger glass is held between these two parts, which are properly shaped to receive it and is gripped by means of pressure obtained by four set screws (five in the larger sizes), equally spaced on the back of the body. The general form and arrangement of this construction is clearly shown in the illustrations.

The chief source of expense on gages of this type has been the renewal of glasses, compelled either by leakage or breakage due to an uneven clamping action, and it is these two faults that the new design aims to overcome. It will be seen that three gaskets have been introduced between the steam space and the face of the glass. These are so arranged that it is necessary for the steam to work by each of them successively before a leak can develop. The two gaskets on the

front and back of the glass are of fibre, 1-32 in. thick, and the construction allows a liberal width of seat on the metal. The third gasket is between a lip on the back piece and the main body, and comes at the side of the glass about one-quarter of the distance from the back. This is a 1-16 in. gasket of elastic material and formed so as to seat against the glass, as well as between the lip on the back piece and the body. Its shape is clearly shown in one of the illustrations. The introduction of this gasket is one of the principal features of advantage of this new design. Its elasticity is such as to permit any unevenness in the thickness of the glass to be compensated and give an equal pressure on the fibre gaskets at the top and the bottom throughout the full length, while, at the same time, the elastic gasket will also be steam tight. The form of the back piece is one which gives great rigidity, and since it is held in place by four set screws, there is little probability of an unequal pressure being exerted at any point which will tend to put too great a strain on the glass.

Another feature that has received close attention in this design is weight. A No. 4 size weighs about 5 lbs., which is from 2½ to 4 lbs. less than previous designs of the same size. This feature is of considerable importance, especially where the gage is used to replace the ordinary water glass without renewing the fittings. In other particulars the new design is the same as previous Klinger type gages, in that the water shows black and steam white and that the connections are of the proper size and form to permit it to be applied in place of the ordinary round glass without any changes in the fittings.

COMBINATION SAW AND ROTARY PLANER

Among the improvements made on the Q M S saw and rotary planer are the belt-motor drive and improvements in the arbor bearings. The belt drive replaces a direct gear and pinion drive and gives a factor of safety if the saw should become stuck in the work. The arbor bearing is made in two sections so that any wear may be automatically taken up by tightening the sleeve surrounding the bushing. This machine is mounted on a circular base (not shown in the illustration) which revolves on

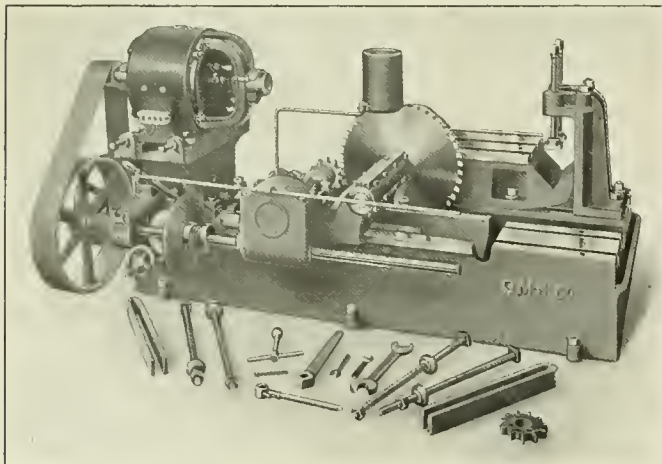

Combination Metal Saw and Rotary Planer.

roller bearings, and in this way allows the cutting of long pieces of material from any angle. The milling head is removed by loosening a few bolts and removing the split bearing. Both the milling head and saw blade have separate arbors, so that a change may be quickly made. The table has lateral adjustment, and when the milling head is not in use it is moved down so that the V-block which is a part of the table may be used for holding the work while it is being sawed, the clamps sliding in

the T-slots of the bed. The motor is placed on adjustable slides to allow the tightening of the belt at all times.

The feed is of the adjustable variable friction type and can be changed from ¼ in. to 1 in. per minute. Both the milling cutter and the saw are driven by a sprocket wheel which has a forward adjustment to allow for 5 in. wear on the diameter of the saw blade. This sprocket drives a large gear on the periphery of the milling cutter and operates on the back of the teeth of the saw. The adjustable friction feed may be changed when the machine is in operation. The motion is transmitted to the feed screw through a clutch which may be disengaged, permitting adjustment of the carriage by hand. The machine is provided with an adjustable stop for the travel of the carriage. The Vulcan Engineering Sales Company, Chicago, are distributing agents for the Q M S products.

RAILWAY BRACKET FAN

A new bracket fan for railway car service has been designed by the General Electric company. The unique feature of the fan is a detachable baseplate, which allows it to be removed from the car interior at the approach of the winter season without removing any screws or marring the car finish. The plate remains permanently attached to the car, and when the fan is

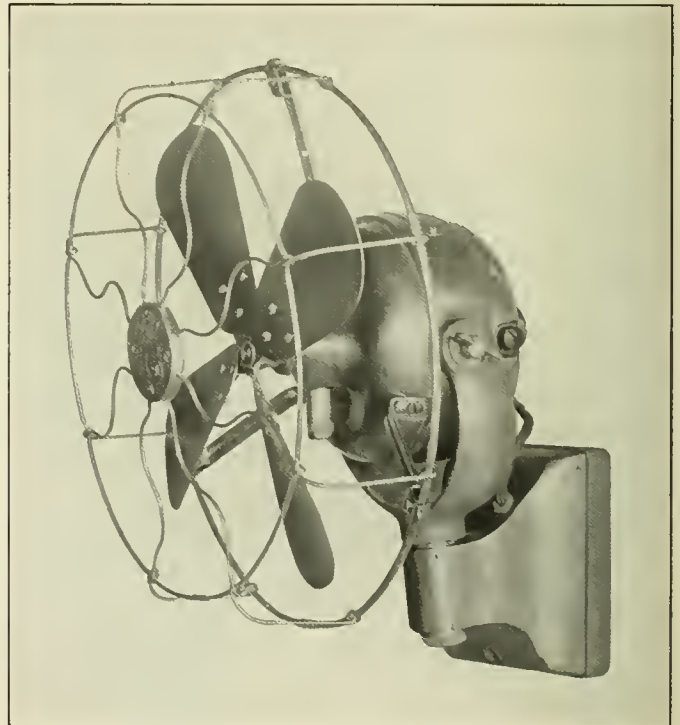

Bracket Fan Used in Illinois Central Parlor Car.

taken down a neat cover finished in harmony with the car fittings is applied over the plate.

Either the fan motor base or the cover is readily mounted on the baseplate, without the use of tools of any description. Attaching these fixtures is accomplished by simply hooking the pins, with which the motor base and cover are provided, over the large screws on the baseplate. Spring contacts are provided on the face of the baseplate, which make contact with plates on the motor base, so that the fans are mounted and taken down without disturbing any wiring connections. The fan is arranged for both horizontal and vertical adjustment, and will remain in any position desired.

The motor is totally enclosed and dust proof. Standard fans are provided with single voltage, constant speed motors; but

motors wound for combination thirty and sixty volts can be furnished if desired. This is accomplished by opening and closing a single contact, which not only changes the motor winding but at the same time alters the value of the control resistance. The armature laminations and commutator are mounted on a separate brass sleeve and are pressed on the shaft, which is of large diameter, and can be removed without injury in case it is desired to make repairs to the armature. The field coils are held in place by steel pins and are removable. Large brushes are used and the brush holders may be readily taken out by loosening a screw. The bearings are of the self-aligning type.

Easy accessibility to the commutator and motor interior is secured through the drop cover at the rear of the motor. The fan hub is fitted with oil slings, whereby all oil working out on the shaft is diverted back to the oil wells and prevented from creeping to the blades and being thrown over the car deck.

HACK SAW BLADE

A new design of hack saw blade has been invented by Alex. Reitlinger, of 201 William street, New York, which is arranged for cutting in both directions. The teeth are separated in groups of four, each adjacent group being formed to cut in the opposite direction. Comparative tests with this type of blade and several of the ordinary designs are said to have indicated that a saving of from 30 to 50 per cent. in time can be attained

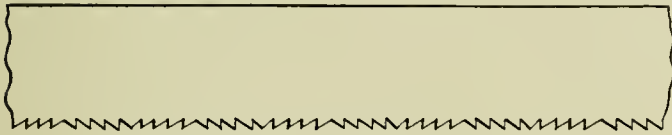

Hack Saw Blade for Cutting on Both Strokes.

with it when cutting by hand. Furthermore it is found that it gives a smoother and cleaner cut. When used on a machine which lifts on the return stroke, it is stated that it has a life equal to the ordinary saw in one direction and can then be reversed and will last as long again, thus giving the service of two blades of the customary arrangement.

MOTOR APPLICATION TO A PUNCH AND SHEAR

A remarkably well arranged motor application for a large punch and shear is shown in the accompanying illustration. This tool in the Saginaw, Mich., shops of the Pere Marquette, is a

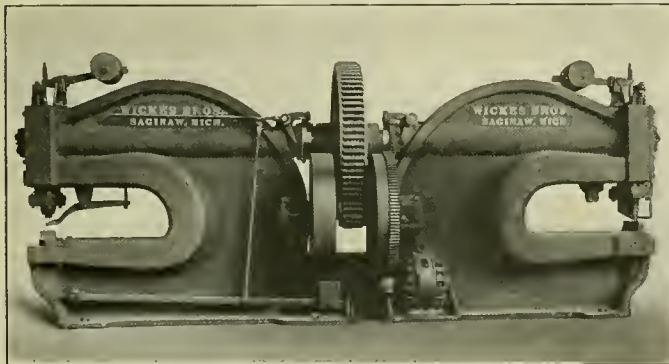

Well Arranged Motor Drive on a Large Punch and Shear.

powerful machine having a 42 in. throat opening at each end and a punching capacity of 1 1/4 in. diameter through 1 1/2 in. of mild steel. The machine will shear a 2 1/4 in. square bar. The motor is located in a well protected position and occupies otherwise comparatively useless space. It is geared direct to the main

shaft by simple reduction gearing, giving a minimum transmission loss. The motor used is a 10 horse power Westinghouse, operating on alternating current at 220 volts.

SHAFT COUPLING FOR MOTOR DRIVE

A flexible coupling made entirely of crucible cast steel has been designed by McEwen Brothers, Wellsville, N. Y. It was first used, and has proved successful, as a coupling between a steam turbine and a direct connected pump; in this service it ran twenty-four hours a day for several months without attention. It is particularly adapted also for the reversible motor drive on machine tools and for motor driven blowers, etc. The

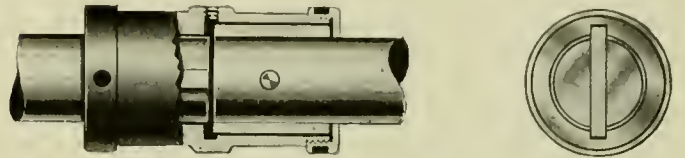

Flexible Shaft Coupling for Motor Drive.

coupling is small and is arranged so that the keys pass through the shafts. The two keys are set at right angles and are arranged to permit the shafts to be considerably out of alinement. Because of the ample key bearing surface and good lubrication from the packing of heavy oil or soft grease, there is no noise or tendency toward serious wear.

SMOKE PROBLEM IN CHICAGO

In a paper presented before a recent meeting of the Western Society of Engineers, Chicago, Osborn Monnett, chief smoke inspector of Chicago, explained the method of inspection in that city.

It has been found that the more information the department can convey to the railroads the better the results. For instance, by giving the smoke densities for the various locations, a railroad may find that its per cent. density at a certain point is very satisfactory, whereas at another railroad center it is not at all satisfactory. By analyzing these smoke density reports for the various localities, a railroad is enabled to determine the points where its engines need special attention and to discover why it is that they cannot have a uniform smoke density throughout the city.

SMOKE STANDING OF THE VARIOUS RAILROADS IN THE SUMMER OF 1912.

| Railroad. | No. of Observations. | Engine Units. | Smoke Units. | Percent. Density. | Standing 1911. |
|---------------------------|----------------------|---------------|--------------|-------------------|----------------|
| 1. C. B. & O..... | 329 | 1,089 | 191 | 3.51 | 1 |
| 2. A. T. & S. Fe..... | 66 | 122 | 28 | 4.75 | 8 |
| 3. C. G. W..... | 40 | 75 | 21 | 5.6 | 3 |
| 4. Illinois Central.... | 409 | 919 | 321 | 6.98 | 11 |
| 5. Michigan Central... | 45 | 98 | 43 | 8.98 | 15 |
| 6. C. M. & St. P..... | 112 | 225 | 105 | 9.36 | 2 |
| 7. N. Y. C. & St. L.... | 57 | 136 | 70 | 10.3 | 20 |
| 8. B. & O. C. T..... | 58 | 126 | 67 | 10.63 | 7 |
| 9. L. S. & M. S..... | 197 | 606 | 355 | 11.55 | 10 |
| 10. C. & A..... | 74 | 191 | 111 | 11.62 | 25 |
| 11. C. I. & L..... | 42 | 89 | 54 | 12.15 | 18 |
| 12. C. & W. I..... | 36 | 74 | 45 | 12.16 | 21 |
| 13. C. I. & S..... | 38 | 156 | 95 | 12.18 | 22 |
| 14. C. & E. I..... | 136 | 420 | 262 | 12.47 | 24 |
| 15. C. R. I. & P..... | 291 | 792 | 509 | 12.85 | 14 |
| 16. C. & N. W..... | 580 | 1,384 | 898 | 12.94 | 5 |
| 17. Grand Trunk..... | 168 | 312 | 204 | 13.08 | 17 |
| 18. Pere Marquette.... | 17 | 44 | 29 | 13.18 | 12 |
| 19. Pennsylvania..... | 489 | 1,086 | 782 | 14.4 | 9 |
| 20. Wabash..... | 128 | 274 | 204 | 14.89 | 16 |
| 21. C. R. & I..... | 24 | 84 | 63 | 15 | 28 |
| 22. Belt Ry..... | 238 | 556 | 458 | 16.87 | 13 |
| 23. Illinois Northern.... | 57 | 164 | 147 | 17.92 | 29 |
| 24. Wisconsin Central.. | 24 | 44 | 40 | 18.18 | 4 |
| 25. B. & O..... | 85 | 217 | 227 | 20.92 | 6 |
| 26. Mfgs. Junction.... | 8 | 13 | 14 | 21.54 | Not Listed |
| 27. Erie..... | 87 | 193 | 210 | 21.76 | 19 |
| 28. Chicago Junction.... | 14 | 33 | 41 | 24.84 | 26 |
| 29. E. J. & E..... | 38 | 180 | 282 | 31 | 30 |
| 30. Unidentified..... | 2 | 5 | 8 | 32 | 23 |
| 31. Chi. Short Line..... | 1 | 4 | 8 | 40 | Not Listed |
| Total..... | 3,890 | 9,721 | 5,892 | 12.12 | |

GENERAL NEWS

In accordance with the new Arizona law requiring the use of high-power headlights on locomotives, the Atchison, Topeka & Santa Fe will have their locomotives equipped with electric headlights as fast as the manufacturers can supply them.

A department of safety has been established on the Vandalia, which will be composed of general and division committees, similar to those on many of the other roads. J. W. Coneys, division superintendent at Indianapolis, has been appointed chairman.

An announcement has been made by Professor Edward C. Schmidt of a gift of the University of Illinois by the Midvale Steel Company, of Philadelphia, of four axles and four pairs of supporting wheels for the new locomotive laboratory which is now under construction.

R. C. Richards, general claim agent of the Chicago & North Western, in a report of the first year's operation of the Safety Committee on that road, states that a decrease of 18 per cent. in personal injuries and deaths has been attained and that the money saving alone will amount to about half a million dollars.

Preparations are being made by the post office department to install pneumatic mail tubes between the Grand Central Terminal, New York, and the Pennsylvania Terminal. There will be two tubes approximately 1.3 miles long and 24 in. in diameter, and they will carry bags weighing 100 lbs. They will replace the mail wagons which run 20 hours a day, carrying a total of more than 4,000 bags of mail.

It has been announced that the Denver & Rio Grande will at once take steps to electrify important sections of their road. The first unit will be installed on the line from Helper, Utah, to Salt Lake City, a distance of 114 miles. The second unit will be over the Tennessee Pass, in Colorado, which runs from Salida, Col., to Minturn, a distance of 87 miles. The work is expected to begin the first of next year. Power will be obtained from hydro-electric plants located in the vicinity of these divisions.

The railroads running into Atlanta have a common agreement not to employ a person who has ever sued any of them, and under this they have blacklisted him and prevented him from getting work, asserts William M. Savage, a switchman, in a \$10,000 damage suit filed in the superior court against the Seaboard Air Line. Savage states that he worked as a switchman for the Seaboard; and was injured in an accident, resigned and brought suit against the road. He won the suit and then applied to the Atlanta, Birmingham & Atlantic for a job as switchman. He obtained a temporary position with the A. B. & A., and that road wrote the Seaboard for recommendation, and the Seaboard, he alleges, made two false statements in reply. This letter and the agreement between the railroads, says Savage, caused him to be dismissed.—*Atlanta Constitution*.

SOUTHERN PACIFIC EMPLOYEES' CLUBS

The Southern Pacific and the allied lines of the Harriman group have for six years carried on a systematic, startlingly effective war against the saloon—the railroader's worst foe. Besides the strict enforcement of Rule G, prohibiting the use of intoxicants on or off duty, the companies have built sixteen club-houses for the employees at operating centers. Neat rooms, well-cooked, wholesome food of the best quality, non-intoxicating drinks, cigars, candy, and tobacco were provided for the men in these club-houses. Billiard and pool tables, bowling alleys, libraries, shower-baths, lounging places, halls for dances and meetings, were placed at their disposal. Almost from the beginning these club-houses became extremely popular, and proved to be powerful factors in enforcing Rule G, effective

competitors of the saloon. In one small railway town of three thousand souls twenty-nine saloons flourished when the club-house was opened. Six months later half a dozen drinking places closed their doors. The others showed fight. Club-house employees were bribed to give poor service, cooks were induced to poison the men's food; as a last resort, the entire club-house crew was bought to go on strike. But the saloons lost. Two years after the opening of the club only seven of the original twenty-nine bars were left. Twenty-two closed for lack of patronage. At Tucson the floor of the club-house had to be relaid four times in six years. At Green River, a Wyoming division point so desolate and dreary that few workers remained after the first pay-day, the club-house lengthened the average term of service from less than thirty to more than ninety days. Everywhere the superintendents reported greater efficiency, sobriety, and self-respect among club-house patrons. Undoubtedly the clubs' influence upon the human factor assisted materially in bringing about the record of four years' safe travel, lately noticed in the newspapers. The victories won in the fight against the saloon by the institution have been permanent and progressive, thanks to the novel principles upon which the management of the club-houses is based. F. G. Athearn, the social engineer who founded the clubs, acted on the theory that institutions similar to the Young Men's Christian Associations would not reach the class of men he dealt with. Departing from the accepted standards of social welfare work, Mr. Athearn studied the methods of the enemy, the saloon, and adapted them to the railway's purposes. The saloon requires neither dues nor membership cards from its patrons. Neither do the railway clubs. They are open day and night to every employee who wishes to make use of their facilities. As in the saloon, all club patrons stand upon a plane of social equality—the same courtesy that greets the aristocratic engineer or conductor is extended to the humble section worker. Like the home and the saloon, the walls of the club-houses are innocent of signs prohibiting swearing, smoking, expectorating. There are no rules of conduct. The men's freedom of movement and action is as unrestricted as it is in the saloon. But the subtle influence of wholesome, neat environment has in no instance failed to prevent abuses. The men are expected to behave as gentlemen—and they do. They pay their way just as they do in the saloon, though no profit is derived from the operation of the club-houses except the indirect benefit resulting from cleaner, stronger, healthier manhood. This enterprise has vigorously suppressed every tinge of paternalism and patronage in order to lay hands upon that most elusive, unwilling individual, the adult, independent, self-respecting worker, and keep him out of the danger zone of the saloon.—*The Outlook*.

SAFETY "DON'T" BOOK.

The Pennsylvania Railroad has had printed for distribution among its employees, 50,000 copies of instructions for the guidance and protection of the employees. This publication takes the form of a "Don't" book and is printed in Italian and Polish, as well as in English. Some idea of the small details the Pennsylvania is watching can be seen from the contents of the "Don't" book. The following are a few of the "Don't's":

"Don't go under a train to make repairs or adjustments, until full protection has been secured.

"Don't place coal on tenders in such a manner that it may fall off.

"Don't think because a wire is dangling it is harmless. If necessary to remove it, use two sticks or boards.

"Don't wear gloves or loose clothes when working with machinery or tools.

"Don't use tools in bad order."

The Pennsylvania Railroad inaugurated its safety campaign a number of years ago, and only recently it received a medal for being the American employer to do most in 1911 for the protection of its employees.

MEETINGS AND CONVENTIONS

Western Railway Club.—At the monthly meeting held at the Auditorium Hotel, Chicago, on November 19, H. McL. Harding, of the Westinghouse Electric & Manufacturing Company, presented an illustrated paper on The Telferage System as Applied to Shops and Terminals.

Central Railway Club.—John P. Kelly presented a paper at the November meeting on the subject of wheel sliding under heavy passenger equipment in which he mathematically and graphically illustrated the causes of sliding wheels. Special attention to brake designing that will take in consideration the effect on the equalizing springs of the truck was suggested.

American Institute of Mining Engineers.—An informal meeting of the Iron and Steel division of the American Institute of Mining Engineers was held in New York, November 7. Benjamin Talbot, of the Cargo Fleet Iron Works, Middleborough, England, described a new method of getting rid of piping and segregation in steel ingots by compressing the ingots after the outer portion has cooled and while the interior is still liquid.

M. M and M. C. B. Conventions.—At a joint meeting of the executive committee of the Master Car Builders' Association, American Railway Master Mechanics' Association and the Railway Supply Manufacturers' Association, held at the Hotel Belmont, New York, on Thursday, November 14, it was decided to hold the June convention at Atlantic City, N. J. The sessions of the Master Mechanics' Association will be held on June 11, 12 and 13, and those of the Master Car Builders' Association on June 16, 17 and 18, 1913. A strong effort was made to have the conventions at Washington, D. C., those favoring Atlantic City winning by the narrow margin of 12 to 10.

Western Canada Railway Club.—A. Hatton, superintendent of car service, Canadian Pacific, was the author of a paper on telephone train despatching, presented at the October meeting. The general principles of the apparatus and the advantages of its operation were briefly covered by the author. The discussion brought out the fact that an equipment of this character is very much more expensive than the telegraph, but it is believed that its advantages in operation fully off-set its greater cost. Reports from members who have had experience in the actual use of the telephone circuits were enthusiastic in its favor and indicated that the despatcher's work was reduced fully one half as compared with the use of the telegraph.

Meeting of Illinois Central Operating Officials.—The first annual meeting of the operating officers of the Illinois Central and Yazoo & Mississippi Valley was held at the Auditorium hotel in Chicago on October 7 and 8. W. L. Park, vice-president and general manager, presided. Reports were made on the following subjects: Co-operation; Undesirability of Criticising without Suggesting a Remedy; Always Safety First; Courtesy; Maintenance of Track and Structures; Maintenance of Automatic Track Signals by Track Foremen; Improvement in the Maintenance and Observation of Signals; How to Secure the Maximum Use of Freight Cars; Increased Tonnage per Locomotive Mile; Prevention of Loss and Damaged Freight; and a discussion of the reduction in the number of freight cars at terminals.

Railway Club of Pittsburgh.—A brief paper on the subject of electric welding, which was fully illustrated with lantern slides, giving views of work done on locomotives and machine tools, was presented at the September meeting by L. J. Hibbard, general manager, L. J. Hibbard Company, New York. The author said that there is nothing constructed of iron or steel, whether castings, forgings or rolled, regardless of size, that cannot be welded by the metal electrode. He also spoke of cutting with the electric arc, but the manner in which this is done was not explained. The discussion consisted largely of questions which brought out the fact that the success of the operation depends largely on the skill of the operator. Several members related successful experiences with electric welding on boilers, frames, cylinders and driving wheels.

Canadian Railway Club.—The value of the work of the car inspector was convincingly set forth by L. C. Ord, general car inspector of the Canadian Pacific, in a paper before the October meeting of this club. The things that a car inspector is required to watch, how he does it and the reason for the many rules by which he is governed were fully covered by the author. In the discussion, it was suggested that greater efforts should be made in connection with the education of car inspectors and of assisting them in their work. The importance of the "safety first" movement was strongly dwelt on by one speaker who stated that the car department was one of the most fruitful fields for activity in this direction. The use of surprise tests and the arranging of a more direct channel of communication between the operating officers and those in charge of car maintenance was suggested.

The following list gives names of secretaries, dates of next or regular meetings, and places of meeting of mechanical associations.

- AIR BRAKE ASSOCIATION.—F. M. Nellis, 53 State St., Boston, Mass. Convention, May 6-9, 1913, St. Louis, Mo.
- AMERICAN RAILWAY MASTER MECHANICS' ASSOC.—J. W. Taylor, Old Colony building, Chicago. Convention, June 11-13, 1913, Atlantic City, N. J.
- AMERICAN RAILWAY TOOL FOREMEN'S ASSOCIATION.—A. R. Davis, Central of Georgia, Macon, Ga.
- AMERICAN SOCIETY FOR TESTING MATERIALS.—Prof. E. Marburg, University of Pennsylvania, Philadelphia, Pa. Annual convention, June, 1913.
- AMERICAN SOCIETY OF MECHANICAL ENGINEERS.—Calvin W. Rice, 29 W. Thirty-ninth St., New York. Annual meeting, December 3-6, Engineering Societies' Building, New York. Railroad session, Thursday morning, December 5.
- CAR FOREMEN'S ASSOCIATION OF CHICAGO.—Aaron Kline, 841 North Fiftieth Court, Chicago; 2d Monday in month, Chicago.
- INTERNATIONAL RAILWAY FUEL ASSOCIATION.—C. G. Hall, McCormick building, Chicago. Convention, May, 1913, Chicago.
- INTERNATIONAL RAILWAY GENERAL FOREMEN'S ASSOCIATION.—William Hall, Chicago & North Western, Escanaba, Mich.
- INTERNATIONAL RAILROAD MASTER BLACKSMITH'S ASSOCIATION.—A. L. Woodworth, Lima, Ohio. Convention, August 18, 1913, Richmond, Va.
- MASTER BOILER MAKERS' ASSOCIATION.—Harry D. Vought, 95 Liberty St., New York. Convention, May 26-29, 1913, Chicago.
- MASTER CAR BUILDERS' ASSOCIATION.—J. W. Taylor, Old Colony building, Chicago. Convention, June 16-18, 1913, Atlantic City, N. J.
- MASTER CAR AND LOCOMOTIVE PAINTERS' ASSOC. OF U. S. AND CANADA.—A. P. Dane, B. & M., Reading, Mass. Convention, Sept. 9-12, 1913, Ottawa, Can.
- RAILWAY STOREKEEPERS' ASSOCIATION.—J. P. Murphy, Box C, Collinwood, Ohio.
- TRAVELING ENGINEERS' ASSOCIATION.—W. O. Thompson, N. Y. C. & H. R., East Buffalo, N. Y. Convention, August, 1913, Chicago.

RAILROAD CLUB MEETINGS

| Club. | Next Meeting. | Title of Paper. | Author. | Secretary. | Address. |
|------------------|---------------|------------------------------------|---------------------|--------------------|-----------------------------------|
| Canadian | Dec. 10 | Tunneling | S. P. Brown..... | Jas. Powell..... | Room 13, Windsor Hotel, Montreal. |
| Central | Jan. 9 | Loading and Unloading of Cars..... | Arthur Hale | H. D. Vought... | 95 Liberty St., New York. |
| New England... | Dec. 20 | Fire Protection | F. H. Wentworth... | Geo. H. Frazier... | 10 Oliver Bldg., Boston, Mass. |
| New York | Dec. 20 | Christmas Entertainment | | H. D. Vought... | 95 Liberty St., New York. |
| Northern | | | | C. L. Kennedy... | 401 Superior St., Duluth, Minn. |
| Pittsburgh | Dec. 19 | Heat Treatment of Steel..... | A. F. Mitchell..... | J. B. Anderson... | Union Station, Pittsburgh, Pa. |
| Richmond | Dec. 9 | Baker Valve Gear..... | Ross Graham | F. O. Robinson... | C. & O. Ry., Richmond, Va. |
| St. Louis | Dec. 13 | Investments in General..... | H. L. Sittel..... | B. W. Frauenthal | Union Station, St. Louis, Mo. |
| Western | Dec. 17 | | | Jos. W. Taylor... | 390 Old Colony Bldg., Chicago. |

PERSONALS

It is our desire to make these columns cover as completely as possible all the changes that take place in the mechanical departments of the railways of this country, and we shall greatly appreciate any assistance that our readers may give us in helping to bring this about.

GENERAL.

J. A. BURKE has been appointed fuel inspector of the Atchison, Topeka & Santa Fe, with headquarters at Clovis, N. M. His territory will be the Pecos division and that part of the Plains division south of Amarillo.

W. T. DAVIS has been appointed superintendent of air brakes of the Chicago & Alton, at Bloomington, Ill.

H. B. MACFARLANE, engineer of tests of the Atchison, Topeka & Santa Fe, has had his office transferred from Topeka, Kan., to Chicago.

J. F. SHEAHAN has been appointed superintendent of motive power of the Atlanta, Birmingham & Atlantic, with headquarters at Fitzgerald, Ga., succeeding R. L. Doolittle, resigned.

H. CLEWER, master mechanic of the Chicago, Rock Island & Gulf, with headquarters at Fort Worth, Tex., has been appointed superintendent of locomotive operation of the Rock Island Lines, with office at Chicago. He will superintend the work of the supervisors of locomotive operation, through the master mechanics, to effect further economies in the use of fuel, locomotive supplies, lubricating material, and in the operation of the locomotive. He will also render every assistance possible, through the various officers, to improve the maintenance, efficiency and operation of the locomotive by further instructive methods, in order that the cost of locomotive operation may be reduced and its efficiency improved. Mr. Clewer was born on March 30, 1869, at Jackson, Ohio. He began railway work May 20, 1888, as machinist helper for the Kansas City, Osceola & Southern, and was subsequently until June 24, 1894, a locomotive fireman and engineer on that road. He then went to the Chicago & Alton as a locomotive engineer, and was later road foreman of engines and master mechanic, resigning in May, 1902, to go to the Chicago, Rock Island & Pacific as a locomotive engineer. He served successively as roundhouse foreman, road foreman of engines and master mechanic until his recent appointment as superintendent of locomotive operation of the entire system.



H. Clewer.

MASTER MECHANICS AND ROAD FOREMEN OF ENGINES

H. P. ARNOLD has been appointed road foreman of equipment of the Louisiana division of the Chicago, Rock Island & Pacific, with headquarters at El Dorado, Ark., vice J. E. Mourne, transferred.

A. V. BIRCH has been appointed master mechanic of the Southern district of the Minneapolis, St. Paul & Sault Ste. Marie.

T. W. CALLAHAN has been appointed master mechanic of the Missabe division of the Great Northern, with headquarters at Superior, Wis.

CLARENCE H. CHAMBERS has been appointed road foreman of engines of the Atchison, Topeka & Santa Fe, with headquarters at Dodge City, Kan.

A. L. FILLMORE has been appointed master mechanic of the Northern district of the Minneapolis, St. Paul & Sault Ste. Marie, with office at Stevens Point, Wis.

HUGH GALLAGHER, traveling engineer on the Illinois division of the Atchison, Topeka & Santa Fe, has been appointed master mechanic of the Arkansas River division, with headquarters at La Junta, Colo. He will also have charge of a portion of the Colorado division between La Junta and Canon City.

C. F. GILLASPY has been appointed traveling engineer of the Northern district of the Minneapolis, St. Paul & Sault Ste. Marie.

BRISTOL F. GRAM has been appointed traveling engineer of the Minneapolis, St. Paul & Sault Ste. Marie, with headquarters at Glenwood, Minn.

W. W. HAMILTON has been appointed road foreman of engines of the Missouri division of the Atchison, Topeka & Santa Fe, with headquarters at Shopton, Iowa, vice D. Leary, assigned to other duties.

E. C. HANSE, general foreman of the Georgia & Florida at Douglas, Ga., has been appointed acting master mechanic, with headquarters at Douglas, succeeding J. F. Sheahan, master mechanic, resigned to accept service with another company.

JOHN W. HENDRY has been appointed assistant master mechanic of the Minneapolis, St. Paul & Sault Ste. Marie, with headquarters at Thief River Falls, Minn.

L. LEYSAHT, general foreman of the St. Louis roundhouse of the St. Louis & San Francisco, has been appointed master mechanic in the Brownsville territory, with headquarters at Kingsville, Tex.

W. J. McLEAN, who was appointed master mechanic of the Duluth, Rainy Lake & Winnipeg, a subsidiary of the Canadian Northern, in May, has been appointed master mechanic also of the Duluth, Winnipeg & Pacific, with headquarters at the West Duluth, Minn., shops.

GEORGE F. MAJORS has been appointed road foreman of equipment of the Illinois division of the Chicago, Rock Island & Pacific, with headquarters at Rock Island, Ill., and jurisdiction over Tri-Cities Terminal, Peoria and Bureau Lines.

A. L. MOLER has been appointed master mechanic of the Charlotte Harbor & Northern, in charge of motive power and equipment, with office at Arcadia, Fla., succeeding H. D. Jackson, resigned on account of ill health.

J. E. MOURNE has been appointed road foreman of equipment of the Chicago, Rock Island & Pacific, with headquarters at Trenton, Mo., having jurisdiction over the Missouri division territory west of Trenton.

EDWARD NORTON has been appointed master mechanic of the Atchison, Topeka & Santa Fe, with headquarters at Dodge City, Kan.

NELS OSGARD has been appointed master mechanic of the Superior division of the Great Northern, with headquarters at Superior, Wis.

W. C. SEALEY, general foreman of the Grand Trunk at the Toronto, Ont., shops, has been appointed assistant master mechanic of the middle and southern division, with office at Toronto. G. M. Wilson succeeds Mr. Sealey.

GEORGE D. SIEMANTEL has been appointed master mechanic of the St. Louis, Rocky Mountain & Pacific, with headquarters at Cimarron, N. M. Mr. Siemantel will have charge of both the mechanical and stores departments.

CAR DEPARTMENT

P. ALQUIST has been appointed general inspector of the car department of the Pere Marquette at Grand Rapids, Mich., vice W. H. Rourk, resigned.

GEORGE GLADSON has been appointed assistant car foreman of the St. Louis & San Francisco at Francis, Okla.

E. W. HARTOUGH has been appointed assistant chief car inspector of the Pere Marquette, with headquarters at Grand Rapids, Mich.

G. W. MOORE has been appointed general foreman of the car department of the St. Louis & San Francisco, at Kansas City, Mo., vice G. A. Robinson, resigned.

T. M. RAMSDELL, master car builder of the Chesapeake & Ohio, has been appointed master car builder of the Chicago & Alton, with office at Bloomington, Ill.

C. F. WHITNEY, general foreman of the car department of the St. Louis & San Francisco, at Chaffee, Mo., has been transferred to Memphis, Tenn.

SHOP AND ENGINE HOUSE

MARTIN DELACY has been appointed assistant night roundhouse foreman of the Chicago & North Western, with headquarters at East Clinton, Ill.

D. L. DELMIDA has been appointed foreman of the south section of the roundhouse of the Illinois Central at Springfield, Ill.

I. H. DRAKE has been appointed general foreman of the Atchison, Topeka & Santa Fe, with headquarters at Raton, N. M.

F. G. FISHER, roundhouse foreman of the St. Louis & San Francisco, has been appointed temporary general foreman, at Chaffee, Mo., vice A. McCormick, resigned.

RANCE JOHNSON, boiler foreman of the Atchison, Topeka & Santa Fe, at La Junta, Colo., has been transferred to Dodge City, Kan.

W. D. JOHNSTON has been appointed foreman of the locomotive department of the Chicago, Rock Island & Pacific, with headquarters at Valley Junction, Iowa, vice J. H. Wills, resigned.

W. H. McDONALD has been appointed assistant roundhouse foreman of the Atchison, Topeka & Santa Fe, with headquarters at Clovis, N. M.

THOS. E. MCQUADE has been appointed night roundhouse foreman of the Chicago, Rock Island & Pacific, with headquarters at Peoria, Ill., vice Lee Munger, resigned.

W. R. MABLE has been appointed roundhouse foreman of the Chicago, Rock Island & Pacific, with headquarters at Winnfield, La., vice H. P. Arnold, transferred.

G. MIHLEISEN, assistant general boiler inspector of the Coast Lines of the Atchison, Topeka & Santa Fe, has been appointed boiler foreman, with headquarters at La Junta, Colo., vice Rance Johnson, transferred.

F. C. MOELLER has been appointed night roundhouse foreman of the Chicago, Rock Island & Pacific, with headquarters at Burr Oak, Ill., vice W. O. Morton, promoted.

J. C. SATTERLEE has been appointed roundhouse foreman of the St. Louis & San Francisco, with headquarters at Birmingham, Ala., vice James Galtney, resigned.

WILLIAM T. STEVENSON, roundhouse foreman of the Atchison, Topeka & Santa Fe, at Cleburne, Tex., has been appointed general foreman, with headquarters at La Junta, Colo., vice E. J. McMahn, resigned.

T. L. WALTERS, roundhouse foreman of the Atlanta, Birmingham & Atlantic, at Fitzgerald, Ga., has been appointed roundhouse foreman of the Central of Georgia, with headquarters at Macon, Ga.

ELMER WARING, day engine inspector of the Atchison, Topeka & Santa Fe, at Waynoka, Okla., has been appointed night roundhouse foreman, vice George Cummings, resigned.

PURCHASING AND STOREKEEPING

CLINTON D. BALDWIN has been appointed purchasing agent of the Bangor & Aroostook, with office at Milo Junction, Maine.

H. C. MACKLIN, purchasing agent of the Seaboard Air Line at Portsmouth, Va., will also have jurisdiction over the Tampa Northern.

J. R. MULROY, general storekeeper of the St. Louis & San Francisco, at Springfield, Mo., has been appointed general storekeeper of the Pullman Company, with office at Pullman, Ill.

A. H. YOUNG, traveling storekeeper of the St. Louis & San Francisco, has been appointed general storekeeper, with headquarters at Springfield, Mo., to succeed J. R. Mulroy, resigned.

OBITUARY

REUBEN WELLS, who was a railway mechanical officer, well known to the last generation, died at his home in Paterson, N. J., on November 8, at the age of nearly 83 years. He was



Reuben Wells.

born in Chester county, Pennsylvania, on January 1, 1829, and was a farmer boy until he was 17 years old. He then became a machinist apprentice on the Reading Railroad. From there he went to Shelbyville, Ind., as master mechanic of several roads, which were afterwards consolidated under the name of the Jeffersonville, Madison & Indianapolis, now a part of the Pennsylvania. It was while here, in 1868, that he designed and built one of the heaviest locomotives of its day for operating on the Madison incline. It attracted a

great deal of attention at the time, and a report of it and its performances appeared in the proceedings of the Master Mechanics' Association for 1871. The diverse duties of the master mechanic at that time may be realized by the following instance. In the summer of 1863 two army corps from the army of the Potomac had to be moved to Nashville, Tenn., as quickly as possible and with no more public notice than was necessary. The army officer in charge of transportation arrived at Indianapolis only a few hours before the first company of the troops, and as both the president and the superintendent of the road were out of reach, Mr. Wells was for six days in entire charge of the road, operating it exclusively for the transportation of the troops from Indianapolis to Louisville. During this week, therefore, he acted as superintendent, master mechanic, yard master and even train dispatcher. He was with the

J. M. & I. for 25 years, during five years of which he was a trustee of Purdue University. In 1878 he went to the Louisville & Nashville as superintendent of machinery. He was appointed general manager in 1884, and the next year was made assistant to the president. In 1887 he left the Louisville & Nashville to become superintendent of the Rogers Locomotive Works, at Paterson. He was made manager of the works in 1900, and retained this position after the absorption of the Rogers Works in the American Locomotive Company. He resigned in April, 1907. From the date of its formation, and during the whole period of his active life, he was a prominent member of the American Railway Master Mechanics' Association, serving that organization as president from 1882 to 1884, and exerting an important influence on the actions of the society, in whose discussions he took great interest.

M. A. MALLOY, master mechanic at the South Pittsburgh, Pa., shops of the Pennsylvania Railroad, died on November 3, at Pittsburgh. He was born at Salem, W. Va., on September 30, 1855, and was educated in the public schools. After completing his apprenticeship in a machine shop at Hollidaysburg, Pa., he entered the service of the Pennsylvania Railroad on April 14, 1879, as a machinist at the Altoona machine shops, and in April, 1881, was made inspector. In October, 1883, he was promoted to a gang leader, and in 1894 was made foreman. On January 15, 1902, he was made assistant master mechanic at the South Pittsburgh shops of the same road, and one year later he was promoted to master mechanic at the South Pittsburgh shops, which position he held to the time of his death.



M. A. Malloy.

HOWARD JAMES, director of purchases of the Great Northern Railway and vice-president and general manager of the Great Northern Steamship Company and president of the Northern Steamship Company, and S. B. Plechner, purchasing agent of the Great Northern Railway, were killed on November 24, when the automobile in which they were driving upset near "North Oaks," the country home of James J. Hill, located about eight miles north of St. Paul, Minn. Mr. James was born August 12, 1862, and began railway work in December, 1882, as clerk in the general freight department of the St. Paul, Minneapolis & Manitoba. From 1886 to 1888, he was secretary to the general manager of that road and was then for one year treasurer and purchasing agent of the Eastern Railway of Minnesota. In September, 1889, he became superintendent of the Northern division of the St. Paul, Minneapolis & Manitoba and the Great Northern at Barnesville, Minn., and from 1892 to September, 1895, superintendent of the Minneapolis Union. He was then made purchasing agent of the Northern Steamship Company, and in August, 1899, purchasing agent of the Great Northern Railway. Mr. James became director of purchases of the Great Northern Railway, vice-president and general manager of the Great Northern Steamship Company and president of the Northern Steamship Company, in September, 1905. Mr. Plechner also had been with the Great Northern Railway for a number of years.

NEW SHOPS

ATCHISON, TOPEKA & SANTA FE.—The engine house and machine shops at Long View, Tex., were destroyed by fire on October 25.

BOSTON & MAINE.—Plans have been prepared for building frog shops at Nashua, N. H. The list of tools for the new Billerica shops near Lowell, Mass., will be made public in the near future. The shops are planned for repairing 30 locomotives, 200 passenger cars and 1,000 freight cars a month. B. S. Hinckley is the purchasing agent, and is located at Boston.

CANADIAN PACIFIC.—It is reported that this road will erect car shops at Toronto at an approximate cost of \$500,000. It is reported that this road will also build large car shops at Moose Jaw, Sask.

CANADIAN NORTHERN.—Bids will soon be called for for the building of a blacksmith shop and engine house at Port Mann, B. C.

CHESAPEAKE & OHIO.—Improvements will be made at Russell, Ky., on the engine house and shops. Expenditures will amount to approximately \$1,000,000.

CHICAGO, MILWAUKEE & ST. PAUL.—A new engine house will be built at Austin, Minn., and the shops will be electrified.

CLEVELAND, CINCINNATI, CHICAGO & ST. LOUIS.—The work of building the new engine house at Cairo, Ill., will soon be begun and the plans for the electrification of the yards, engine house and machine shops at Hillsboro, Ill., have been completed.

LOUISVILLE & NASHVILLE.—It is reported that this company will build car shops at Irvine, Ky. An extension of the line is now being made from Winchester, Ky., to Irvine.

MISSOURI & NORTH ARKANSAS.—A contract has been made by the directors and receivers of this road for new shops at Harrison, Ark. It is reported that \$125,000 has been appropriated for this work.

MICHIGAN CENTRAL.—It is reported that a machine shop will be erected at Jackson, Mich.

MISSOURI PACIFIC.—A new 12-stall engine house, blacksmith shop, boiler shop, oil house and other improvements will be erected at Atchison, Kan., at an approximate cost of \$35,000.

NEW YORK, NEW HAVEN & HARTFORD.—Contracts have been awarded for a repair shop at Maybrook, Conn.

PENNSYLVANIA.—A new engine house will be built at Altoona, Pa., which will contain 40 stalls. A machine and blacksmith shop will also be built and equipped with an electric traveling crane. A mechanically operated coaling station will be erected with two 50,000 gallon water tanks. Smaller buildings will be included in the general plans and the structures will be made of steel and concrete. Plans have been prepared for the addition of nine new stalls to the engine house at Morrisville, Pa. A new blacksmith and machine shop will also be built. The construction of a large engine house at East St. Louis, Mo., has been started. There items are not confirmed.

QUEEN & CRESCENT.—The work of improving the shops and engine house at Ludlow, Ky., will be commenced in the near future.

SOUTHERN PACIFIC.—Plans have been made for an increase in the capacity of the Sparks, Nev., shops.

PULLMAN PASSENGERS.—During the last fiscal year, 24,256,000 passengers rode in Pullman cars. This is an increase of 4.6 per cent. over the previous year.

SUPPLY TRADE NOTES

The Alexander Milburn Company, Baltimore, Md., has just moved to its new premises, 1420 West Baltimore street.

Edwin Strassburger has been made vice-president of the Buffalo Brake Beam Company, New York, with office in St. Louis, Mo.

Charles H. Burt has been made general sales manager of the Robinson Coupler Company, Washington, D. C., with office in that city.

C. R. Jamison has resigned as sales manager of the Acme Supply Company, Chicago, to engage in business on his own account at Danville, Va.

The Industrial Car Company, Cleveland, Ohio, manufacturers of electric cars and locomotives, has changed its name to the Electric Locomotive & Car Company.

The S. Jarvis-Adams Company has changed its name to the Pittsburgh Iron & Steel Foundries Company, with general offices at its works at Midland, Pa.

A. Lichtenhein, Canadian representative of the Galena-Signal Oil Company, Franklin, Pa., with office in New York, died at his home in New Rochelle, N. Y., on October 31.

The erecting plant of the American Car & Foundry Company at Terre Haute, Ind., was destroyed by fire on November 18. The loss is estimated at between \$75,000 and \$100,000.

The Rumsey Car Door & Equipment Company, Chicago, has been incorporated by J. W. Rumsey, Oscar Hogin and W. H. Sheasby. The company will manufacture car doors and railway equipment.

The Chicago Bearing Metal Company, of Chicago, has purchased 8.44 acres on the north side of West Forty-third street near Western avenue, Chicago, on which to erect a new \$200,000 fireproof plant.

The sales of the Westinghouse Air Brake Company, Pittsburgh, Pa., during August and September, the first two months of the fiscal year, exceeded those in the corresponding period of last year by 75 per cent.

The Alexander Milburn Company, Baltimore, Md., maker of various kinds of acetylene apparatus, has moved its general offices from 505-7 West Lombard street, to larger quarters at 1420-6 West Baltimore street.

E. W. Strong, formerly in the publicity department of the American Locomotive Company, New York, has been appointed manager of the publicity department for the American Vanadium Company and the Vanadium Sales Company, Pittsburgh, Pa.

Walter A. Johnson has been appointed manager of the Atlanta, Ga., office of the Independent Pneumatic Tool Company, Chicago, succeeding John J. Keefe, deceased. Mr. Johnson has been connected with this company at its Pittsburgh office.

H. J. Downes has been appointed to the vacancy in the publicity department of the American Locomotive Company, New York, made by E. W. Strong's resignation. Mr. Downes has been with the American Locomotive Company for a number of years in the engineering department.

Charles L. Wright, chief of the briquetting division of the Government Bureau of Mines, has gone to the Roberts & Schaefer Company, Chicago, to take charge of its coal briquetting department. This company has acquired an operating plant where it is prepared to make briquetting tests for prospective clients.

Fred Lavis, 281 Reconquista, Buenos Aires, Argentina, who has charge of railway construction for the Argentine Railway Company, desires to obtain copies of catalogs issued by manufac-

turers of railway supplies, tools, machinery and various railway materials, including engineering supplies and drawing material.

William Marshall, president of the Anglo-American Varnish Company, of Newark, N. J., died at his home in Asbury Park, November 30, from heart disease. Mr. Marshall was very popular throughout the paint field, and will be especially missed by the members of the railway masters painters' associations. He was 64 years old.

Walter Rachals has gone with Westinghouse, Church, Kerr & Company, Pittsburgh, Pa., in their iron and steel works department. Mr. Rachals has been connected with the iron and steel business in the United States since 1895, and was chief engineer of the National Steel Company until this concern was consolidated with the Carnegie Steel Company.

John J. Keefe, southern representative of the Independent Pneumatic Tool Company, at Atlanta, Ga., died November 20, from an attack of typhoid fever. Mr. Keefe was born in Susquehanna, Pa., in 1866, having served most of his time in the mechanical departments of various railroads, until about ten years ago, when he entered the railway supply field.

The Crane Company, Chicago, has concluded negotiations for the purchase of more than 100 acres of land at South Kedzie and Archer avenues, to be used for a central plant, to cost about \$7,000,000 and employ 6,000 men. It is proposed to bring together on one side the various separate units of the Crane Company which are now located in various parts of the city. Work on the new plant will be started early next year.

At the annual meeting of the Pullman Company, Chicago, Le Roy Kramer was elected assistant to the president, succeeding C. S. Sweet, deceased. Mr. Kramer has held this position by appointment. All the officers of the company were re-elected and the directors were re-elected, except that F. O. Lowden succeeds H. C. Hulbert, deceased. George F. Baker was made a member of the executive committee, succeeding Mr. Hulbert.

Henry W. Jacobs, president of the Oxxwell Railroad Service Company, Chicago, has returned from a five weeks' trip abroad, in which he gave special attention to the investigation of oxy-acetylene welding and to the manufacture and exploiting of the Jacobs-Shupert fireboxes abroad. Arrangements for the handling of the Jacobs-Shupert fireboxes were made with Ganz & Company, of Budapest, Hungary, who have three large plants in Europe and make a specialty of building railway equipment, steamships, heavy gas engines and electrical machinery.

Cyril J. Atkinson, mechanical engineer, inventor and patentee of the Atkinson gas producer and other special devices pertaining to gas producers, has gone with Fairbanks, Morse & Company, of Chicago, who have assumed the Atkinson patents. This company will place Mr. Atkinson's service at the disposal of the public for adapting the Fairbanks Morse gas producers to meet the requirements of the industries desiring to substitute producer gas for fuel oil. Mr. Atkinson was previously connected with the Dornfeld-Kunert Company, Watertown, Wis.

J. W. Wright, formerly sales manager of Griscom-Spencer Company, has taken a position with the Magnolia Metal Company, New York, as special representative on the Pacific coast, with headquarters at San Francisco, Cal. William H. K. Gamble, formerly southern representative of Chas. A. Schieren & Company, will be the special representative in the southwestern territory, with headquarters at Dallas, Tex. A. E. Trachsel, formerly export sales manager of the Peerless Rubber Manufacturing Company, will travel throughout the West Indies and Latin American countries as their special representative. Gove S. Taylor has been made a representative in the Pittsburgh district and surrounding territory. Mr. Taylor was formerly manager of the Peerless Rubber Manufacturing Company.

CATALOGS

UNIONS.—The Jefferson Union Company, Lexington, Mass., has issued folders illustrating its straight, tee and elbow unions. These unions have a brass seat ring.

VISES.—The Emmert Manufacturing Company, Waynesboro, Pa., has issued a 32-page catalog describing the various Emmert vises and giving a table of dimensions together with the prices.

SECOND HAND LOCOMOTIVES.—H. F. Wardwell, Railway Exchange, Chicago, is issuing folders which illustrate and briefly describe overhauled locomotives and cars that he has for sale.

EXTINGUISHERS.—The H. W. Johns-Manville Company, New York, has issued a 12-page booklet describing the uses and construction of the J-M Success liquid chemical fire extinguishers. A price list is included.

CAR SEATS.—A 52 page catalog, designated as No. 204, is being issued by the J. G. Brill Company, Philadelphia, Pa. Seats for passenger cars of all kinds, more specially, however, for electric cars, are shown therein. Each type is illustrated and full dimensions and specifications are given.

POWER TRANSMISSION MACHINERY.—Shafting, shaft couplings, pillow blocks, shaft hangers, belt tighteners, pulleys, clutches and similar parts are fully described and illustrated in a catalog being issued by the Dodge Manufacturing Company, Mishawaka, Ind. A complete price list for the full range of sizes is included.

CYLINDER COCK.—A folder has been issued by the Watertown Specialty Company, Watertown, N. Y., illustrating and describing the Watertown automatic cylinder cock. This is small in size but has large port openings. It is so constructed that when the engine is running the valve automatically closes and as soon as the throttle is closed it automatically opens, allowing the cylinder to drain.

FUEL ECONOMIZER, HEATING PLANTS, BLOWERS, ETC.—A condensed catalog, No. 145, of the products of the Green Fuel Economizer Company, Matteawan, N. Y., has just been published. This company manufactures fuel economizers, draft fans, hot air heating systems, drying equipments, hot blast heaters, blowers, exhaust fans, ventilator wheels and steam fan engines. A brief description of these is included in the catalog together with a table of sizes and dimensions.

GRINDING WHEELS.—The Travelers Insurance Company, Hartford, Conn., is preparing a series of pamphlets which will cover the whole field of mechanical appliances and factory conditions that are dangerous to the lives and physical welfare of employees in all lines of work. It is on the subject of grinding wheels and contains 27 pages. It is illustrated and points out the details of both the design and operation of the machines that should be carefully watched in order to reduce the possibility of personal accidents.

MONORAIL TELPHERAGE SYSTEM.—An improvement has been made in the track-switch of the monorail telpherage system made by the Shaw Electric Crane Company, Muskegon, Mich. This switch has no moving parts and when once in place needs no further attention. The steering is done by the trolley operator who deflects the leading truck in the desired direction. This new arrangement is clearly described in Bulletin No. 73, which was recently published by the company. It also contains illustrations of various installations and tables of dimensions of the F. T. Trolleys of the single lift type.

COMPRESSION YOKE RIVETERS.—A clear explanation of the manner in which the Hanna type riveter obtains a maximum pressure through a considerable space and will drive rivets through either two or three $\frac{1}{2}$ in. plates giving equally satisfactory results in

both cases, without any adjustment of the die or die screw, is given in catalog No. 3, being issued by the Vulcan Engineering Sales Company, Fisher building, Chicago, Ill., distributing agents for the Hanna Engineering Works of Chicago. The operation of the machine is shown in diagrammatic form and is fully described. It employs both the toggle and the lever principle, the former being used during the first half of the piston stroke and the latter during the balance. The catalog also illustrates and describes the constructional features of the machine and shows it as arranged in a number of different sizes. A sectional view, with a full list of the names of the parts, is included.

BLUE PRINTING APPLIANCES.—Continuous blue printing machines, often accompanied by automatic, rapid dryers, now form a part of most progressive drafting offices. The opportunity for promptly obtaining a print without reference to the time of day or to the weather conditions appeals strongly to most managers and the further opportunity of locating the blue printing room in a small space wherever convenient, without reference to its window exposure or even to the presence of daylight, is very convenient for drawing rooms located in office buildings. In connection with the revolutionary change in the method of printing caused by the introduction of machines of this type, improvements in the other apparatus used in the same connection have been greatly encouraged and machines for making the paper and for washing and trimming the prints have now reached a high state of perfection. A catalog being issued by The C. F. Pease Company, 166 West Adams street, Chicago, illustrates and describes various machines for the blue print room. A suggested typical layout for a moderate sized room is included.

GENERAL ELECTRIC COMPANY BULLETINS.—A number of new bulletins, some of which supersede previous publications, are being issued by the General Electric Company, Schenectady, N. Y. Among these are No. A4004 fully covering the construction and operation of a steam flow meter. This supersedes No. 3846 on the same subject. Bulletin No. A4039 is devoted to direct current motor starting and speed regulating rheostats and panels and supersedes Nos. 4532, 4459 and 4600. Type R1 single phase motors are described in bulletin No. 4993, which supersedes No. 4855. No. A4036 supersedes No. 4917 on the subject of direct current excitor switchboard panels. Among the new bulletins is one on small switchboards for use with gasoline-electric sets. This is designated as A4307. Current-limiting reactance which is a device to be placed in series with generators and transformers to limit the flow in the circuit under short-circuit conditions, forms the subject of bulletin No. 4974. Bulletin No. A4034 illustrates and describes the type W long life flame arc lamp which is designed for street illumination.

STEAM TURBINES.—The DeLaval Steam Turbine Company, Trenton, N. J., has issued catalog D describing its multi-stage turbines. The book is very complete, being divided into five sections. The first section concerns the use of the single stage turbine, giving its various applications and a description of its important features. Section two considers the choice of the type of turbine to be used for various classes of work. This section will be found of special interest to shop engineers, or power plant designers in making their choice of power. Different types of turbines are considered for both direct and alternating current generators, centrifugal pumps and blowers. Section three considers the design and construction of the multi-stage turbine in detail. Various illustrations are shown, which makes the chapter comprehensive. Section four is devoted to the double helical speed reduction gear. This is of special design and has given excellent service. The fifth section compares the DeLaval multi-stage turbines with reciprocating engines, the special points considered being safety, steam consumption and adaptability for various kinds of work. The catalog is well illustrated and contains the DeLaval diagram and steam scale.



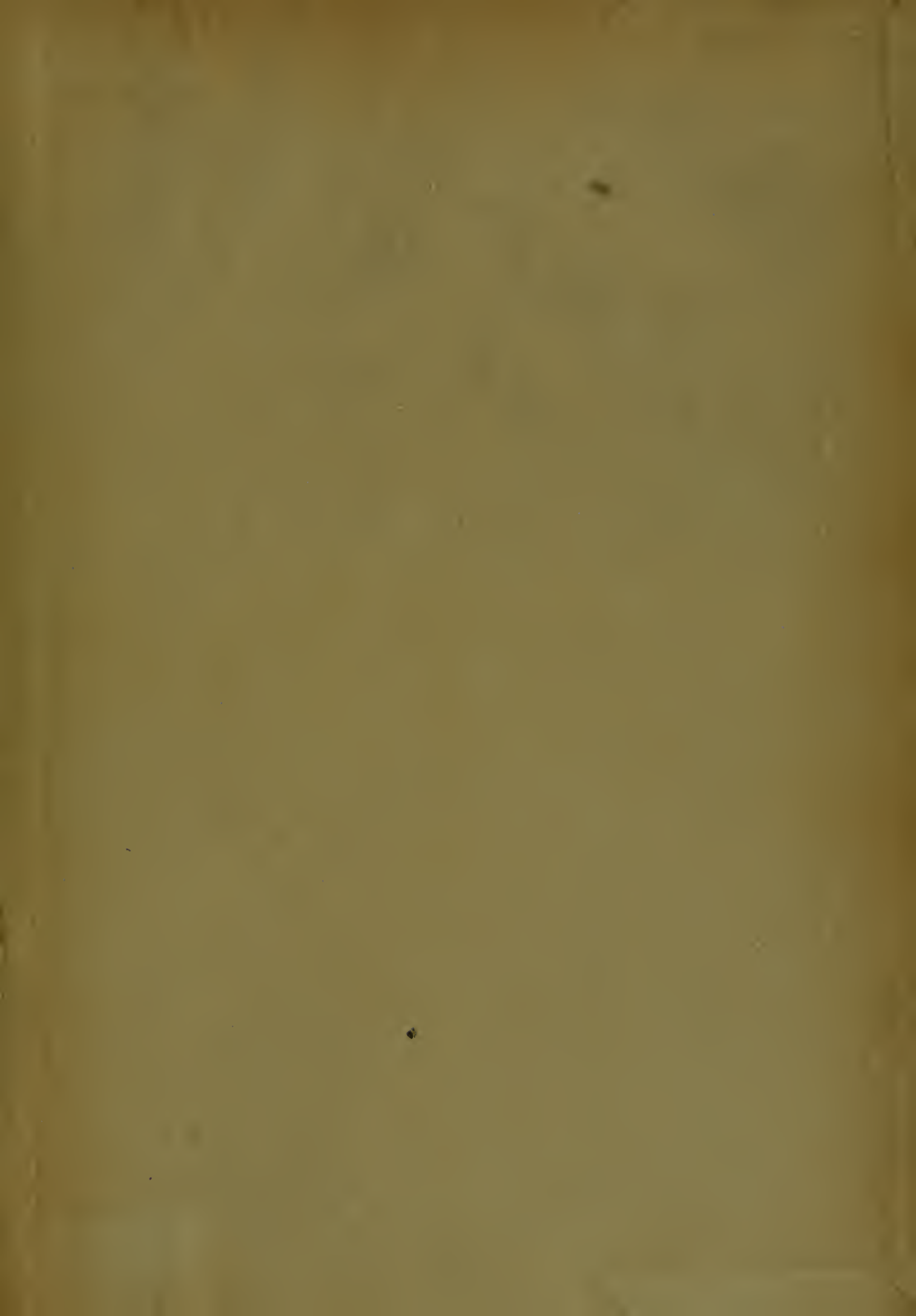

CARNEGIE LIBRARY OF PITTSBURGH



3 1812 04296 1152