

欽定西清古鑑

古  
320  
842



5  
16  
17  
18  
19  
20  
21  
22  
23  
24  
25  
26  
27  
28  
29  
30  
31  
32  
33  
34  
35  
36  
37  
38  
39  
40

古

320

846

13

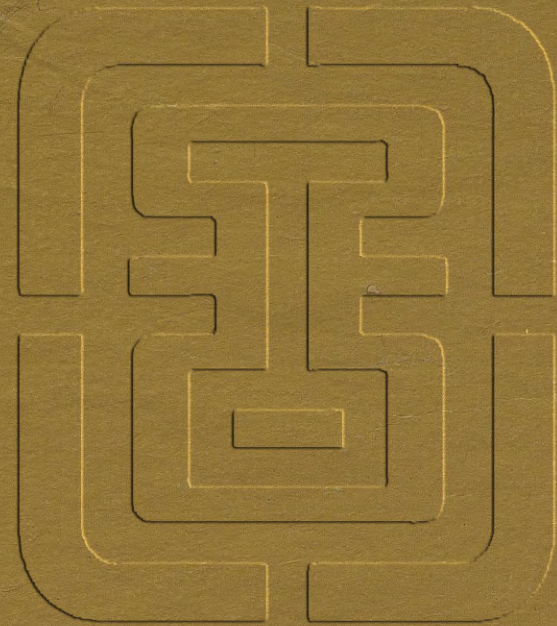
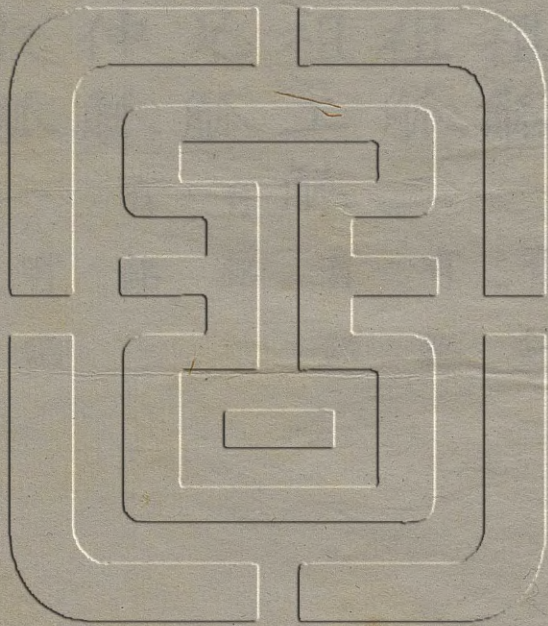

西清古鑑卷二十四目錄

觚二

周

祖觚一有銘

祖觚二有銘

祖工觚有銘

兄觚有銘

仲觚有銘

叔觚一有銘

叔觚二有銘

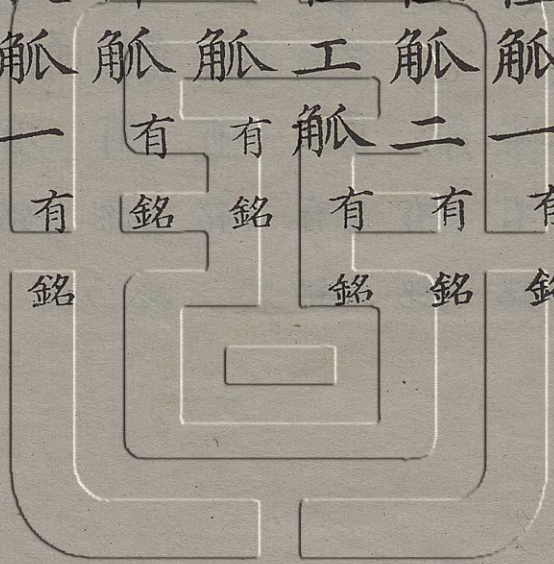
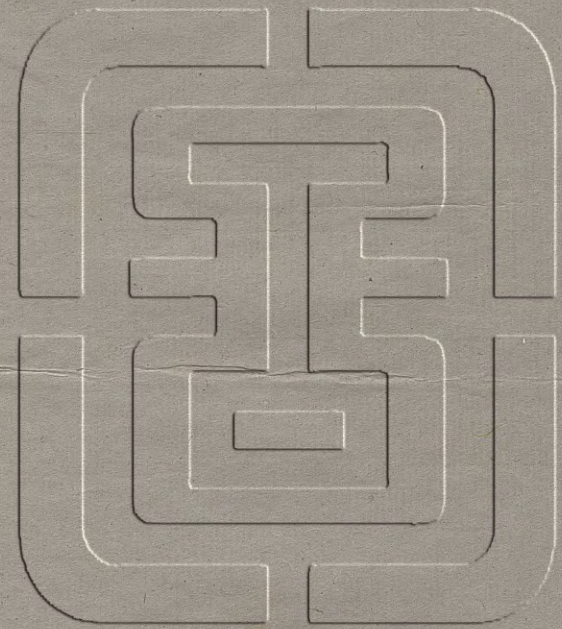

孫觚 有銘

側觚 有銘

甲觚 有銘

乙觚 有銘

子乙觚 有銘

丁乙觚 有銘

福觚 一 有銘

福觚 二 有銘

福觚 三 有銘

象觚 有銘

象形觚 有銘

犧觚 有銘

雞觚 有銘

執木觚 有銘

亞觚 一 有銘

亞觚 二 有銘

亞觚 三 有銘

亞觚 四 有銘

立旂觚 有銘

雷紋觚 一 有銘

雷紋觚二 有銘

雷紋觚三

雷紋觚四

雷紋觚五

雷紋觚六

雷紋觚七

雷紋觚八

雷紋觚九

雷紋觚十

雷紋觚十一

雷紋觚十二

雷紋觚十三

雷紋觚十四

雷紋觚十五

雷紋觚十六

雷紋觚十七

雷紋觚十八

雷紋觚十九

雷紋觚二十

雷紋觚二十一

有銘

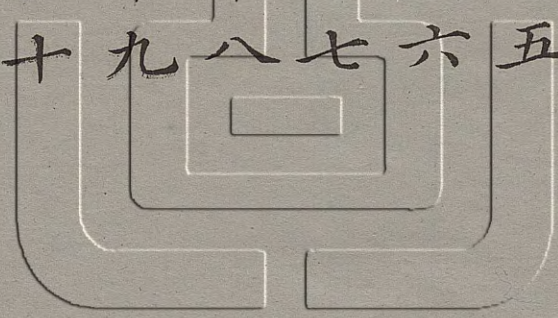
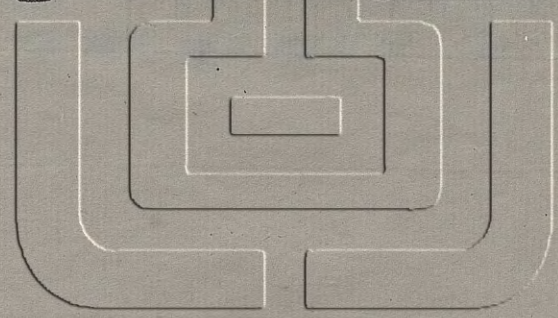

雷紋觚二十二

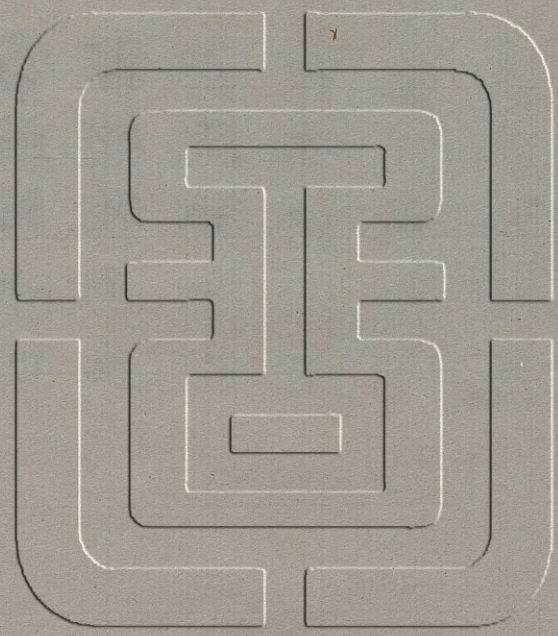

周祖觚一

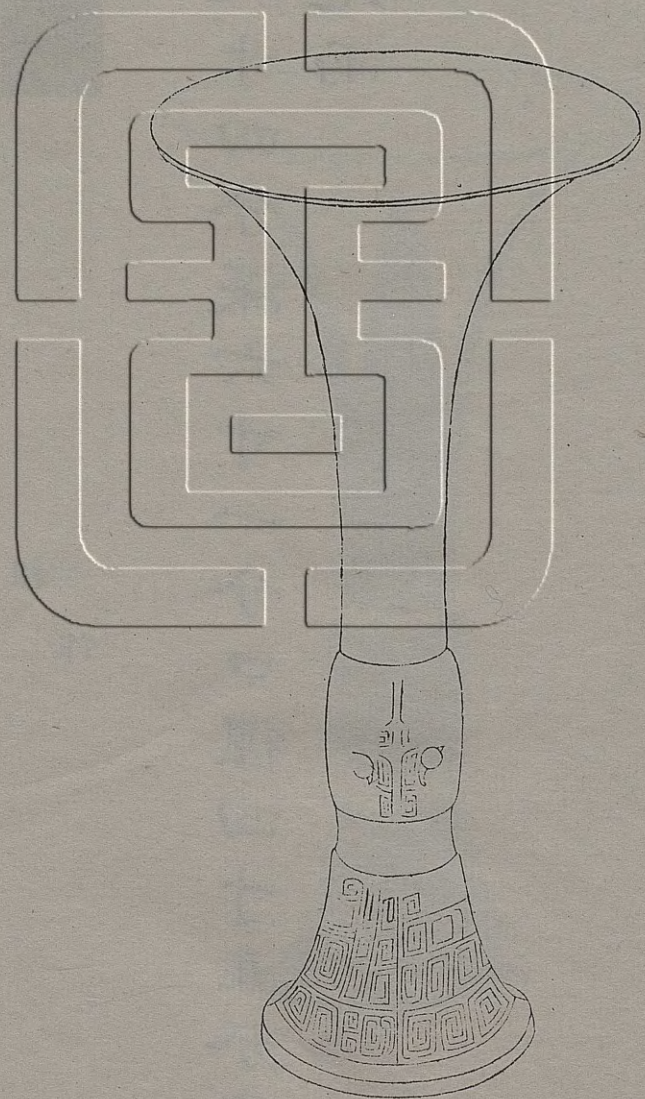



右高八寸四分深六寸一分口徑四寸五分重一十九兩

祖作

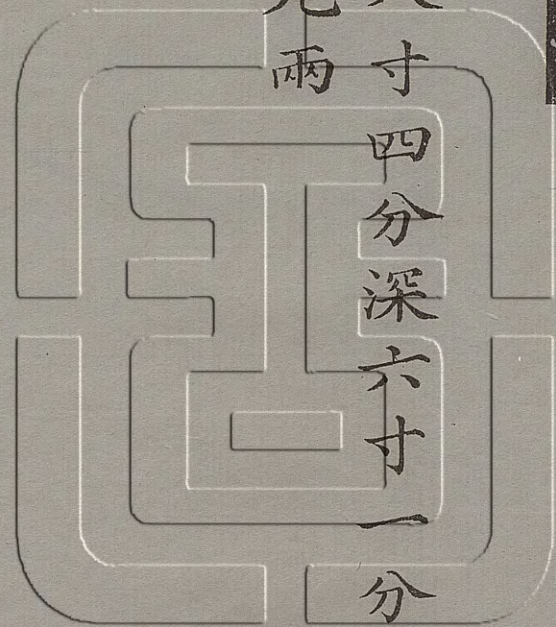

周祖觚二

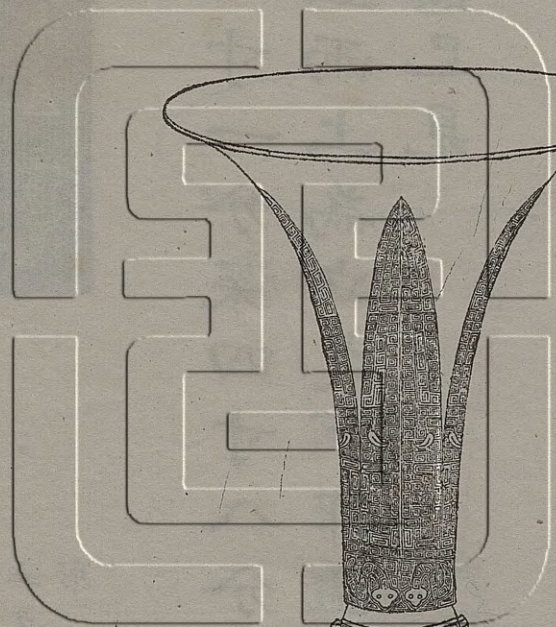
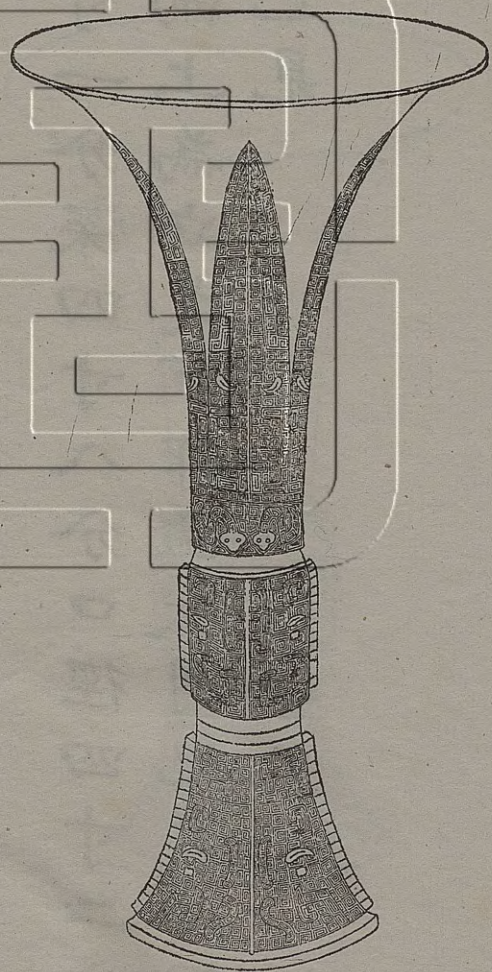



立戈祖  
形象

右高八寸一分深四寸八分口徑四寸二分重  
二十五兩上為立戈下作猛獸用紀武功詞不  
繁而意已見

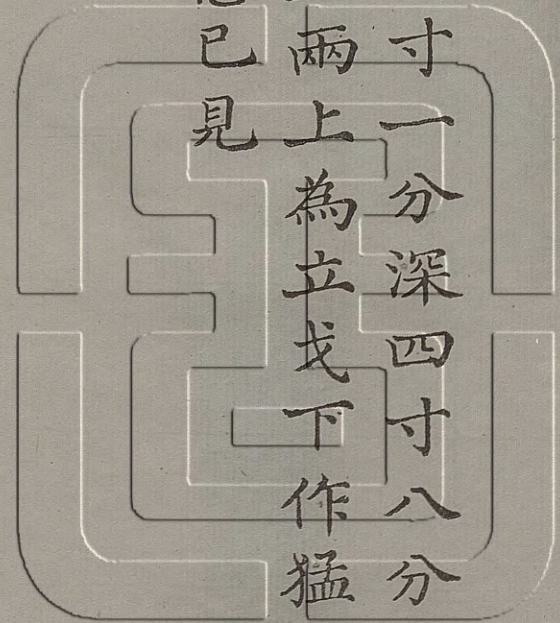

周祖工觚

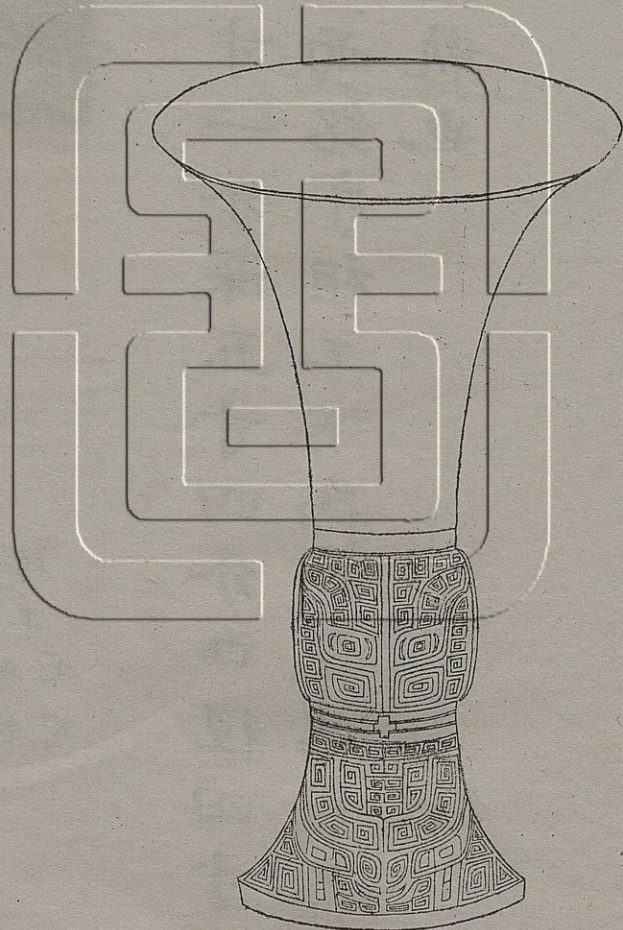



△工 卣

右高八寸一分深五寸四分口徑四寸四分重三十二兩銘字祖工下為手執七蓋七鬯皆主器者所執也

祖工手執  
七形

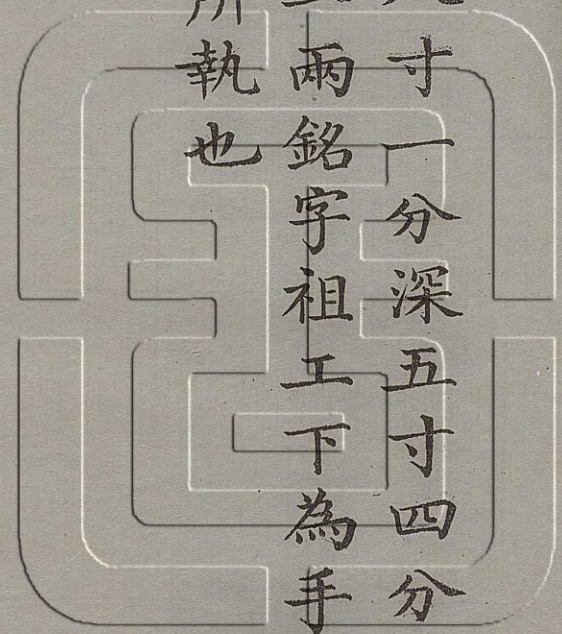

周兄觚

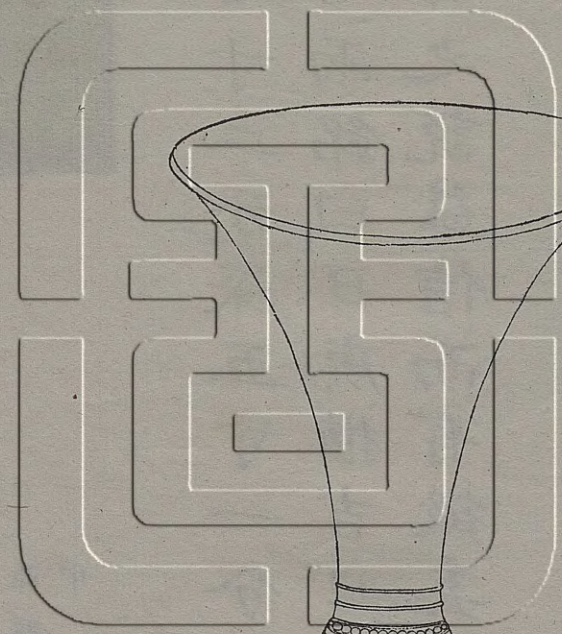
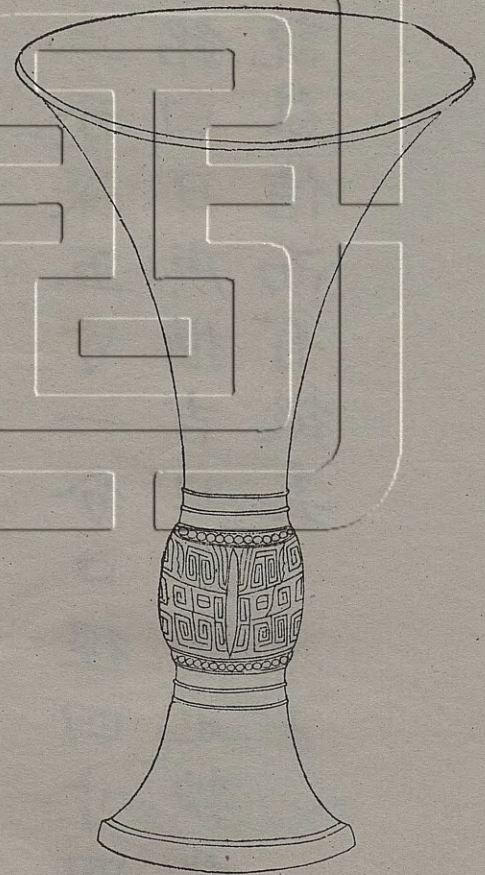

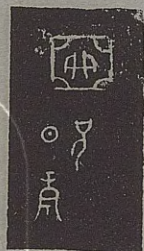

右高七寸二分深五寸一分口徑四寸四分重二十七兩銘曰日庚猶吉日庚午也按此則十干紀日之說益信而有徵矣

亞形冊兄  
日庚

周仲觚

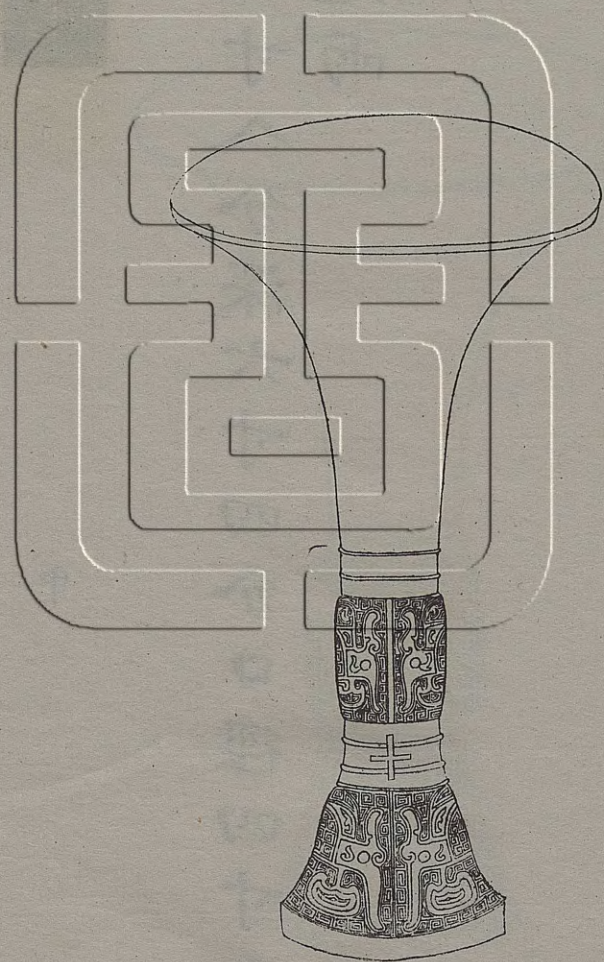

西清古鑑

卷二十四

觚

五

中

右高八寸八分深六寸四分口徑四寸七分重二十九兩

中



周叔觚一

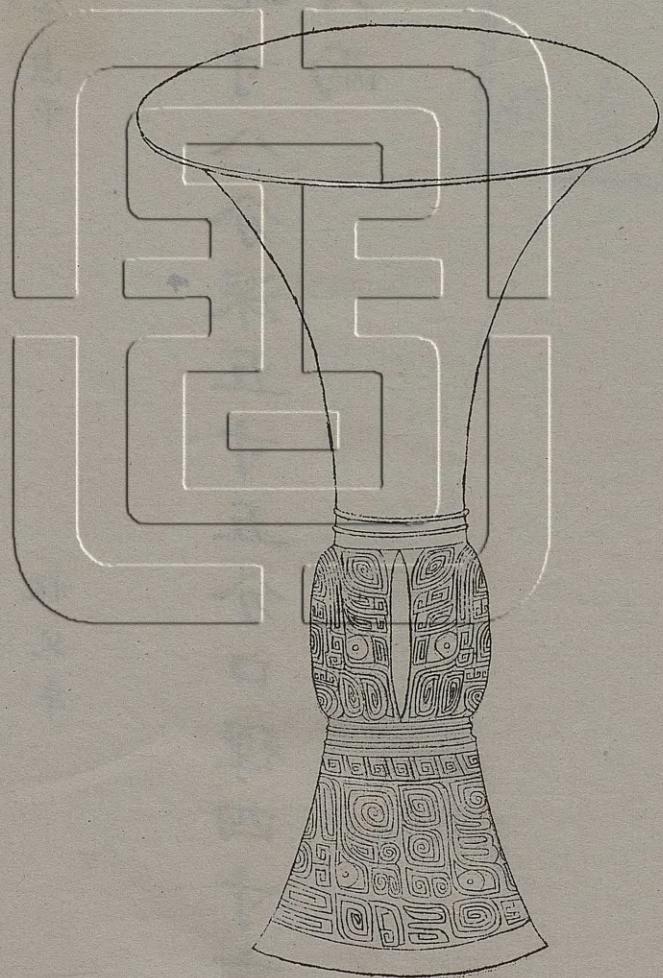

申父辛

叔父辛

右高七寸八分深五寸五分口徑四寸六分重二十六兩

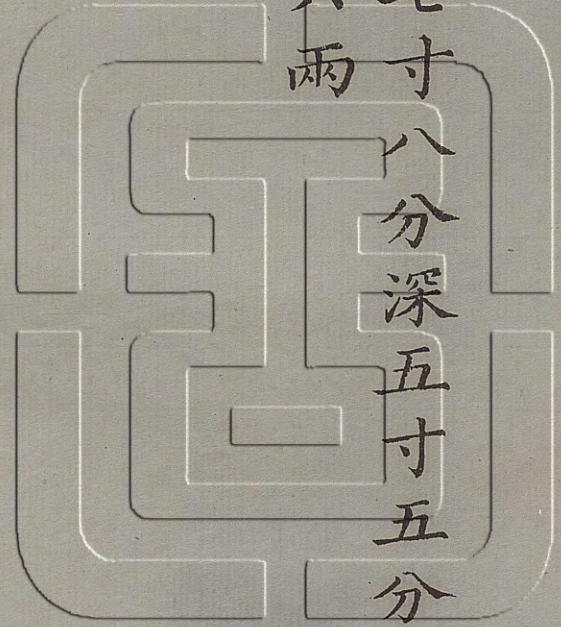

周叔觚二

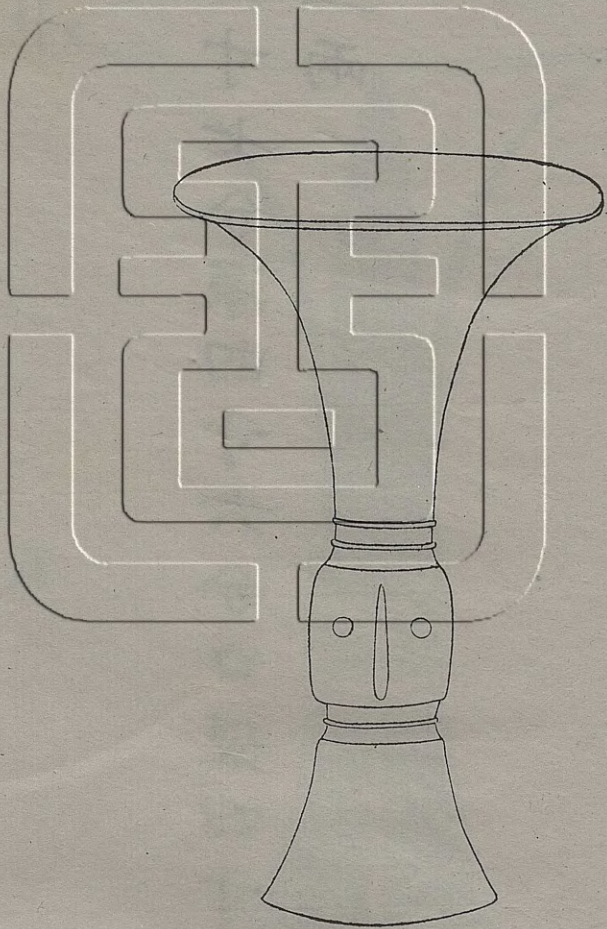

叔

右高六寸七分深四寸六分口徑四寸一分重  
二十三兩

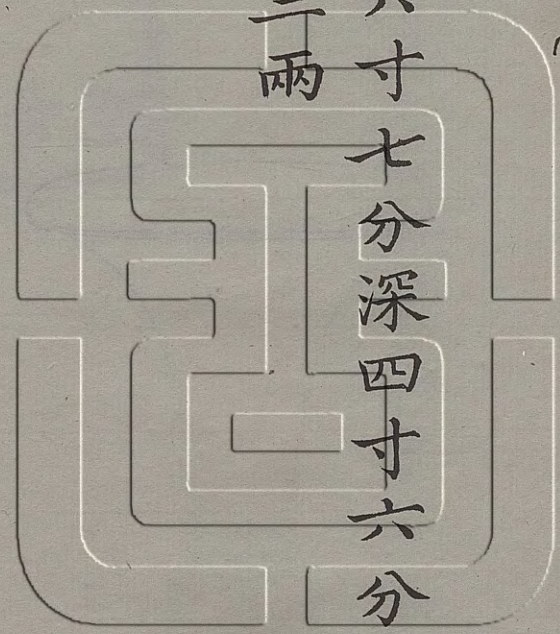

叔

周孫觚

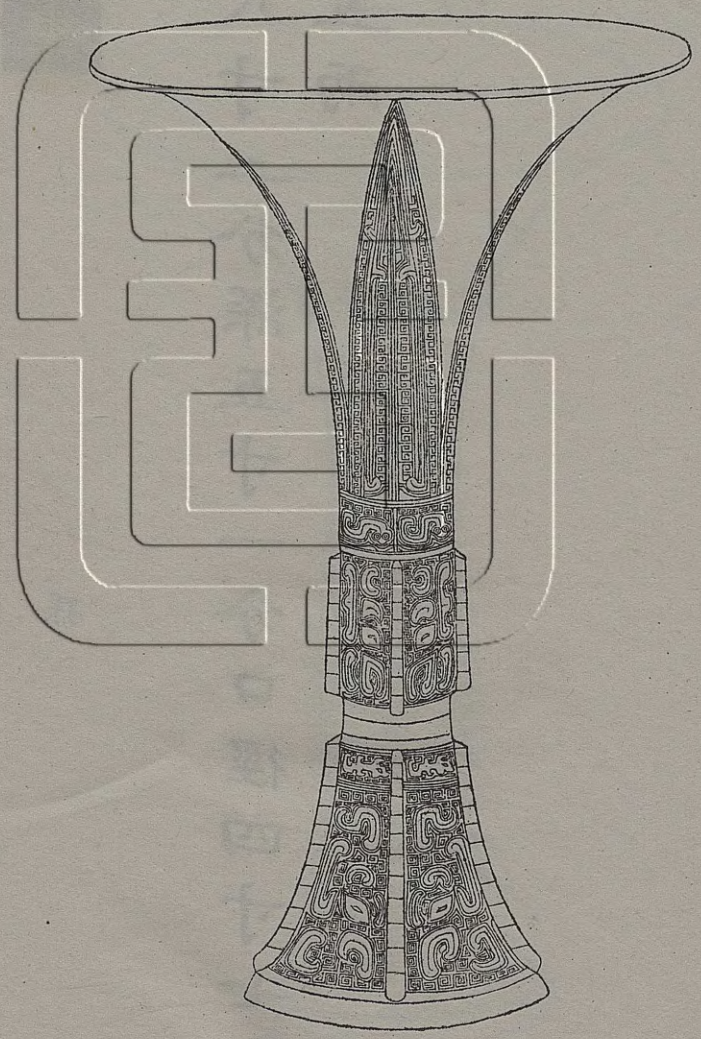



右高八寸一分深五寸一分口徑四寸七分重三十五兩

孫

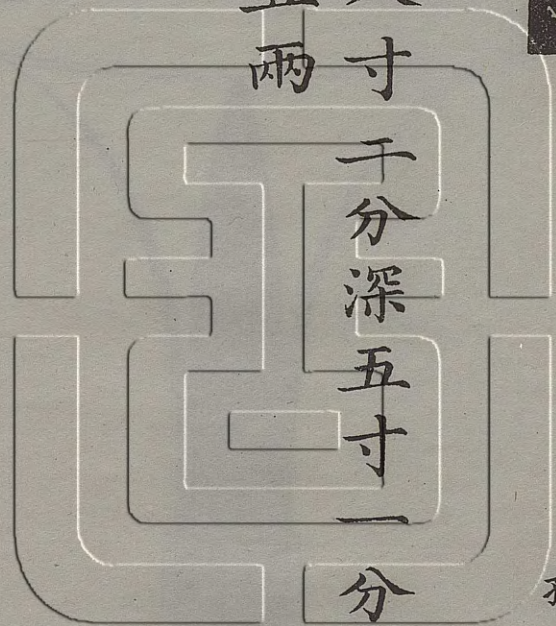

周側觚

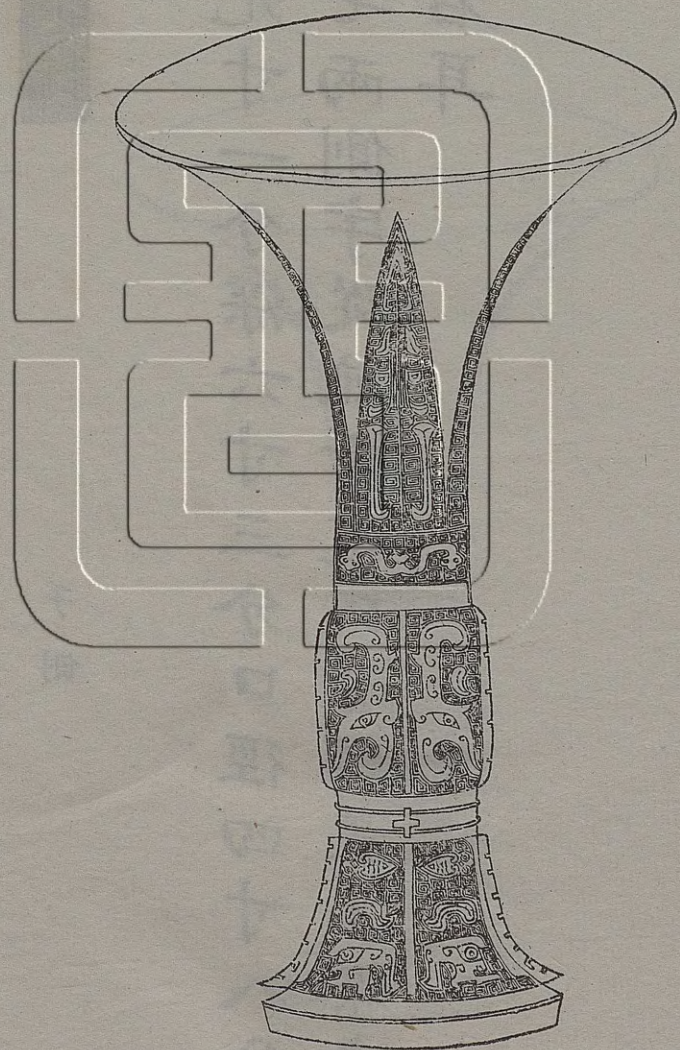

子側

子側

右高九寸一分深六寸三分口徑四寸八分重  
 二十七兩側字從撫古遺文音釋蓋主祭者自  
 識其名耳

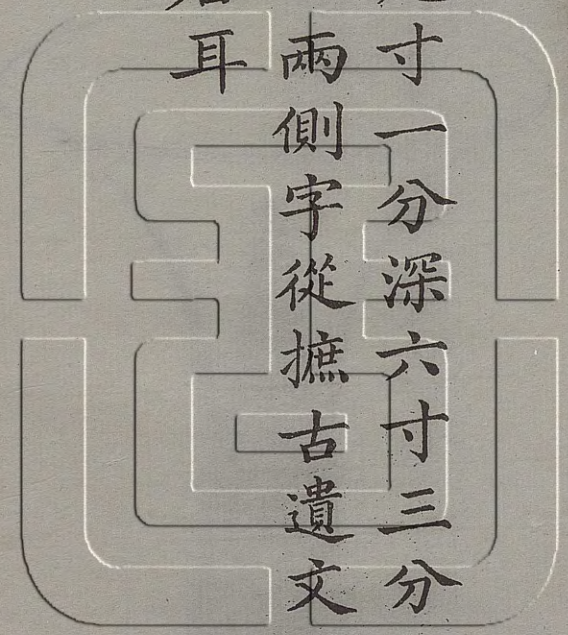

周甲觚

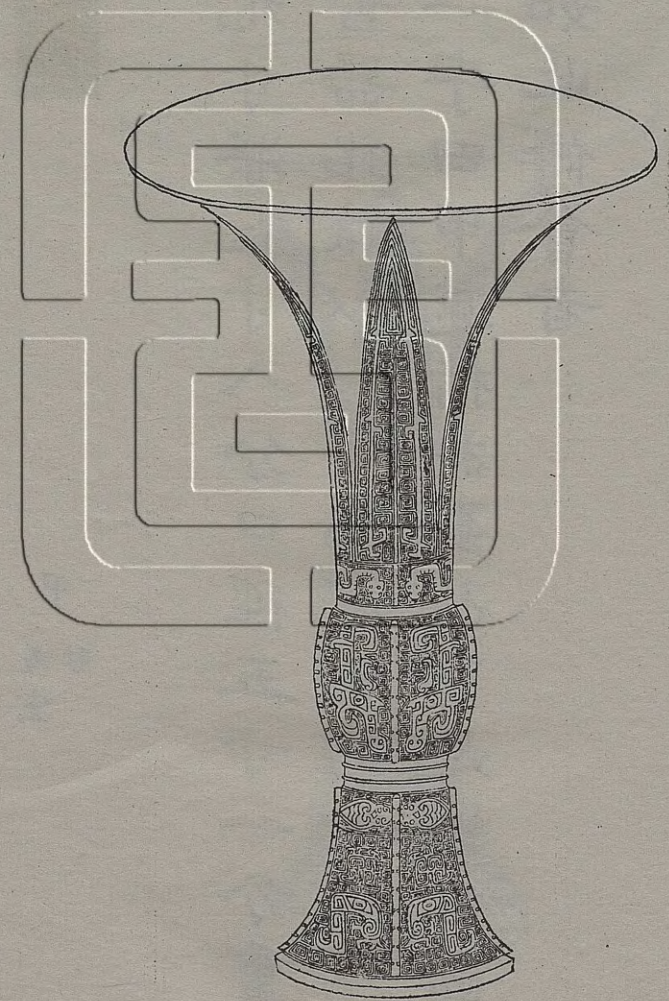

百清古鈔

卷二十四

觚

十  
圖

右高九寸深五寸八分口徑五寸一分重三十  
 五兩古器銘難以一字為定然陶隱居刀劍錄  
 以銘一字曰甲遽指為夏孔甲是博古圖之前  
 已有如此博會者

甲  
形屋室

周乙觚

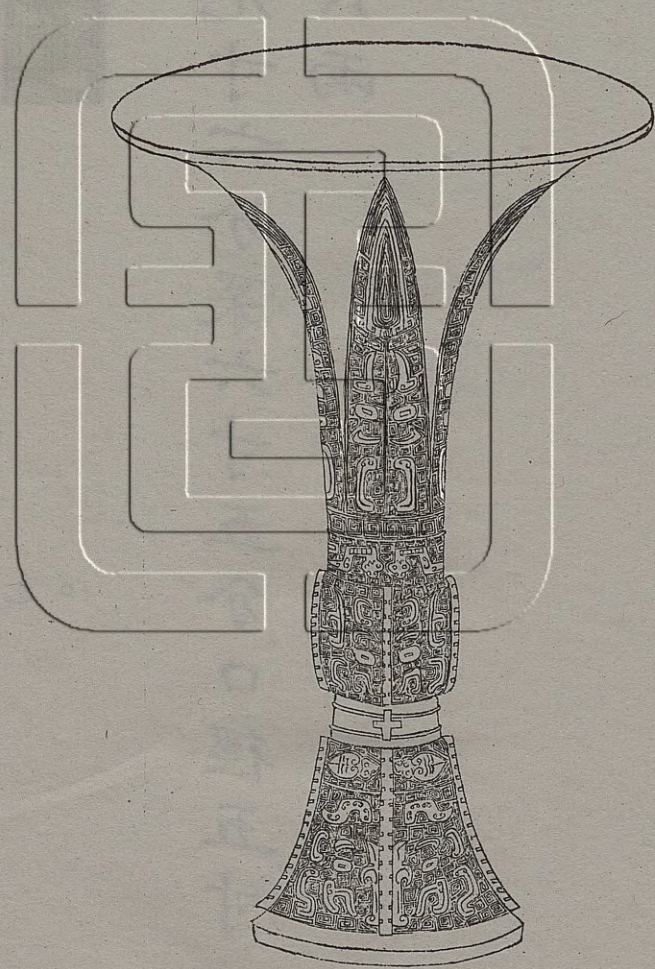





右高九寸六分深六寸五分口徑五寸一分重三十六兩

乙

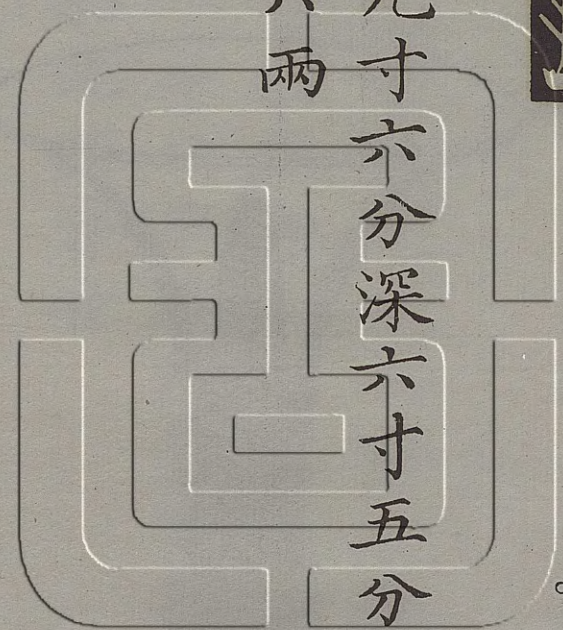

周子乙觚

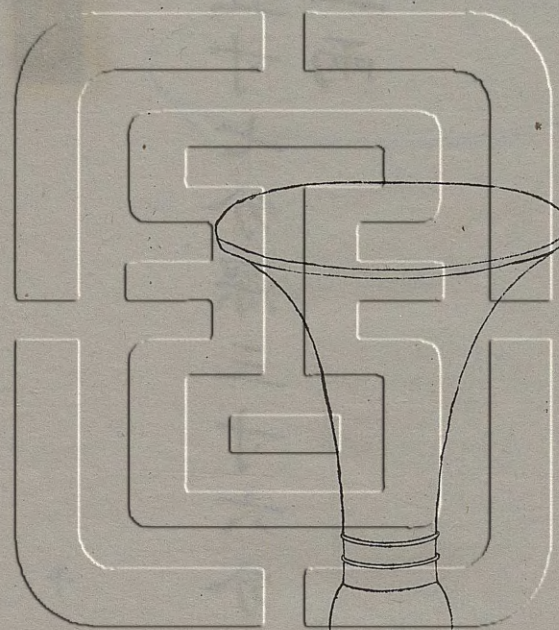
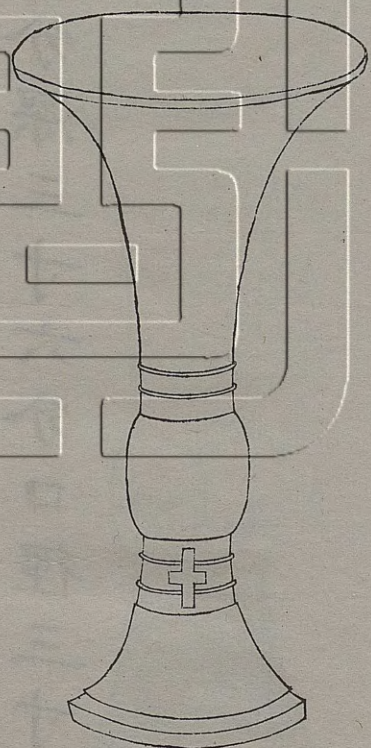

觚



右高五寸七分深三寸六分口徑三寸五分重一十三兩

子乙



周丁乙觚

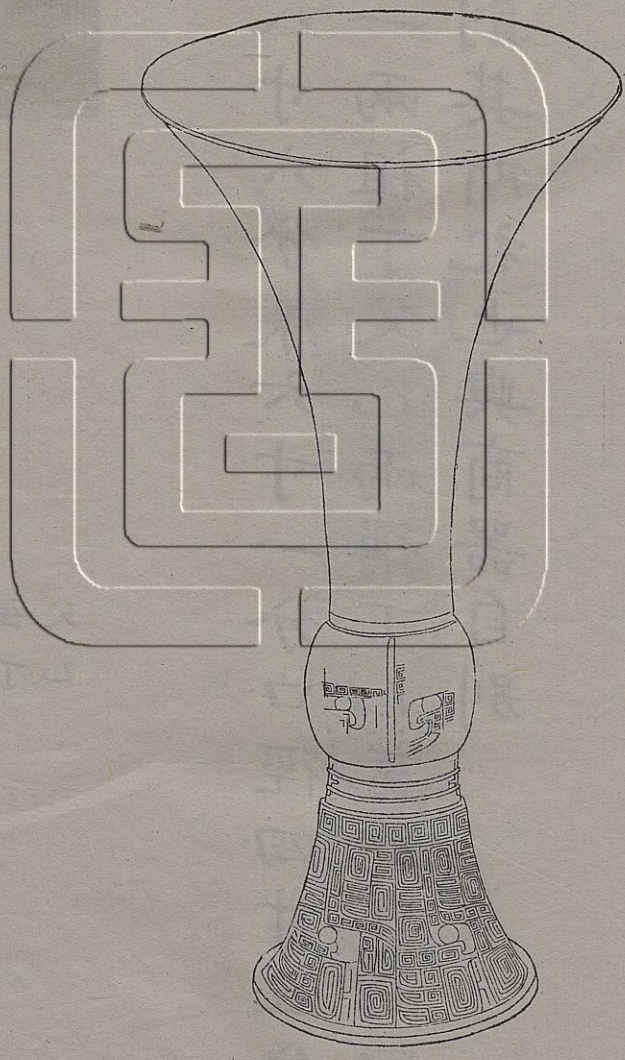

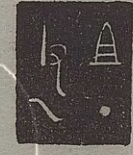

右高八寸六分深六寸一分口徑四寸五分重三十一兩祖丁父乙兩稱丁乙蓋紀日而曰祖曰父則其所祀也與商器自別

祖丁  
父乙

周福觚一

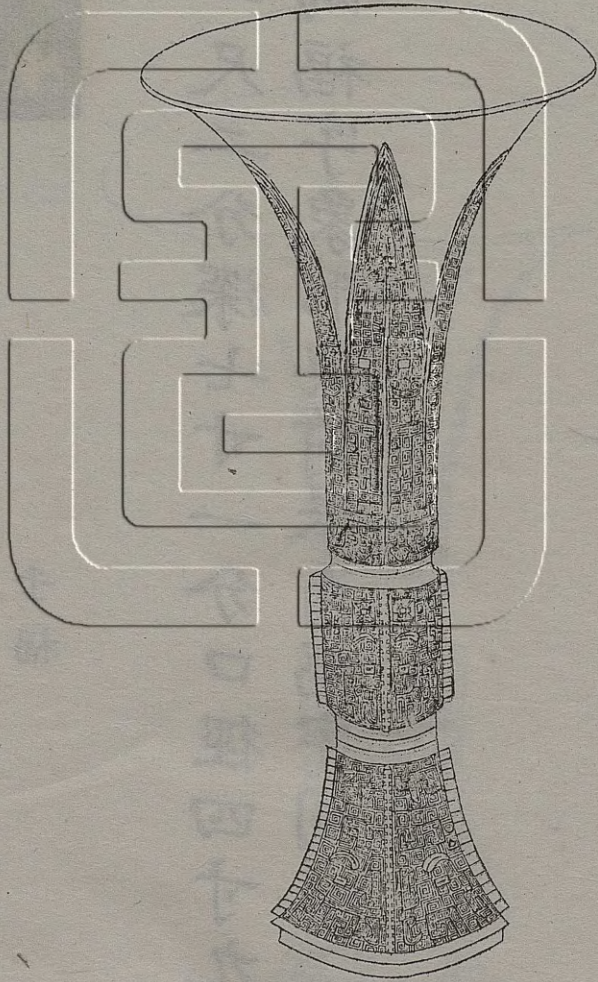



子福

右高一尺二分深七寸一分口徑四寸九分重三十兩福字象形與前舉卣福字同

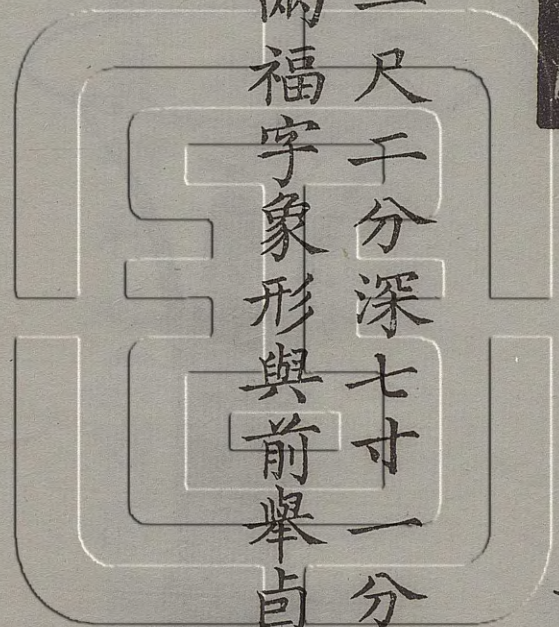

周福觚二

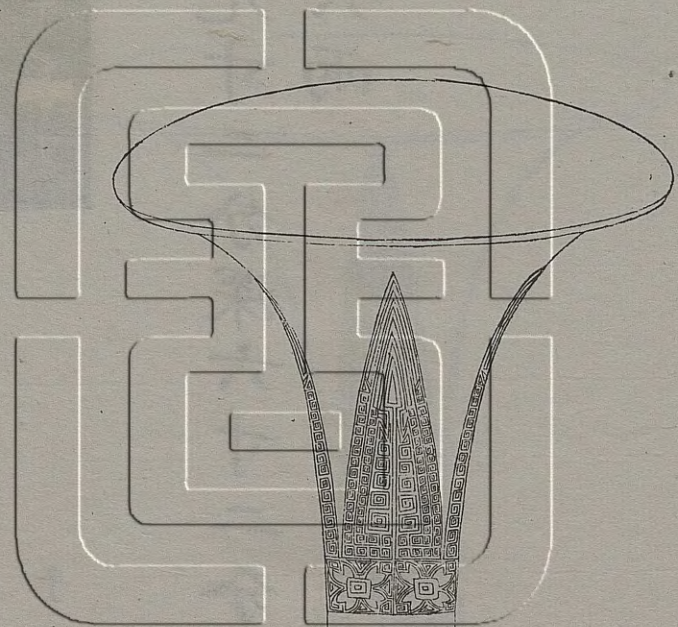
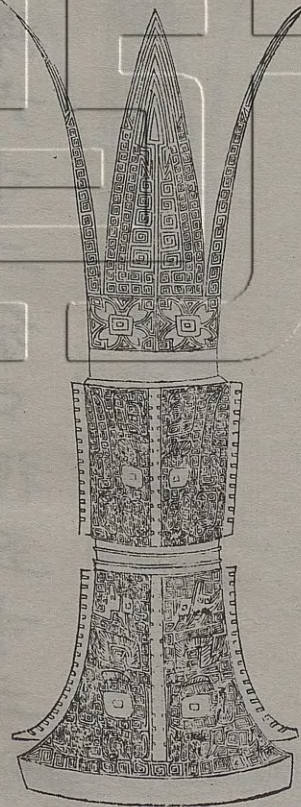



子福。

右高九寸二分深六寸二分口徑五寸二分重三十六兩

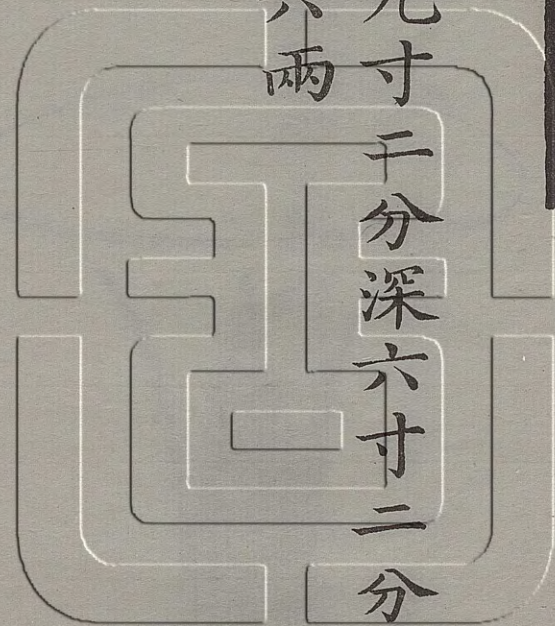

周福觚三

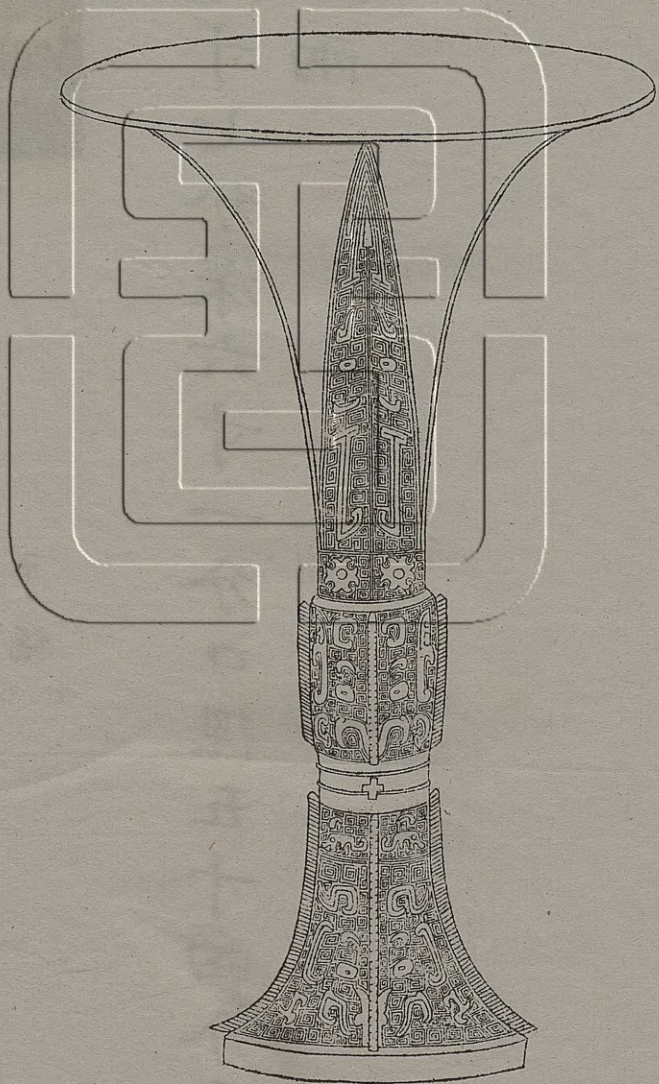



子福

右高九寸七分深六寸一分口徑五寸四分重三十五兩



周象觚

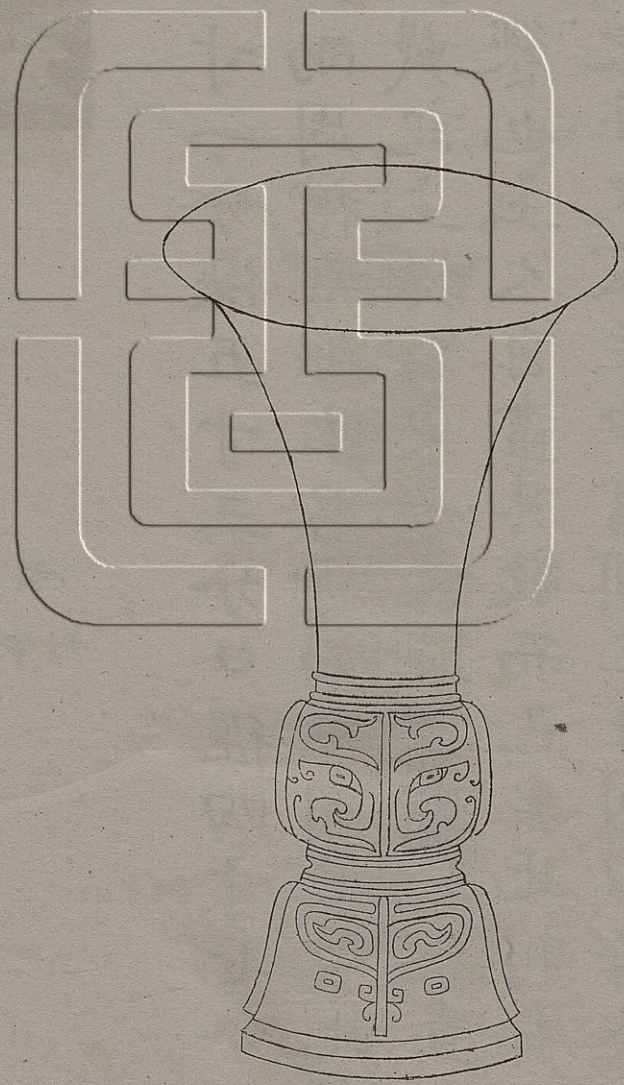



主  
形象

右高八寸一分深五寸三分口徑四寸七分重  
 三十五兩周禮賓繼主君皆如主國之禮此賓  
 主之主戴記主婦自東房又腥肆爛臠祭豈知  
 神之所饗也主人自盡其敬而已矣此則主祭  
 者皆謂之主又家主中雷國主社則以所祭為  
 主矣此銘作象意同象尊曰主者蓋指所祭言  
 之也

周象形觚

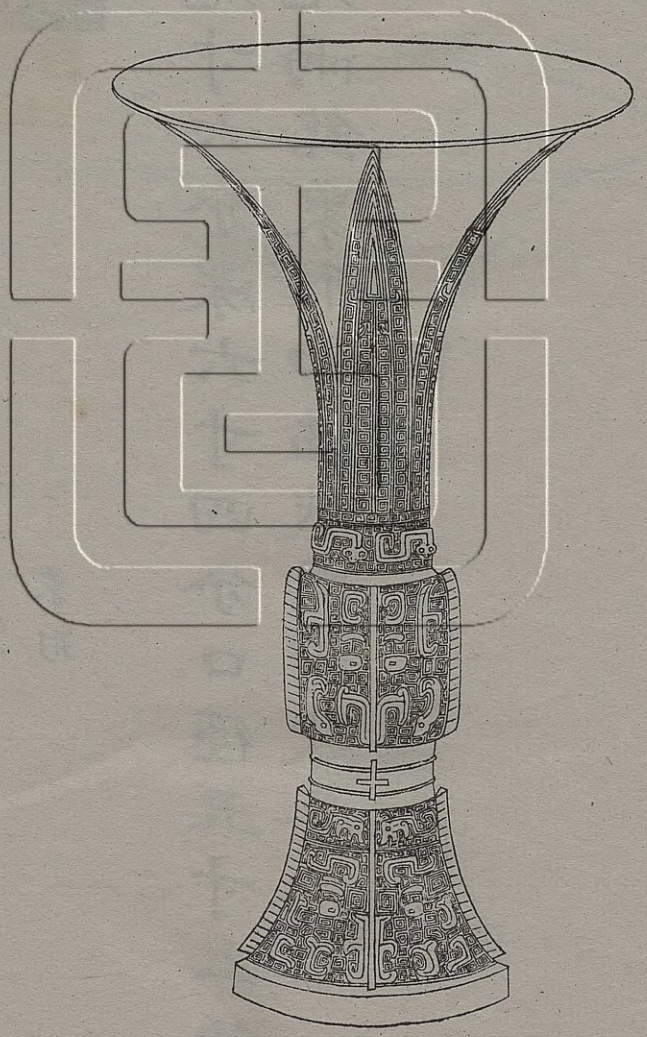



右高九寸六分深六寸四分口徑五寸二分重三十九兩銘象形如猛獸與前款異

象形

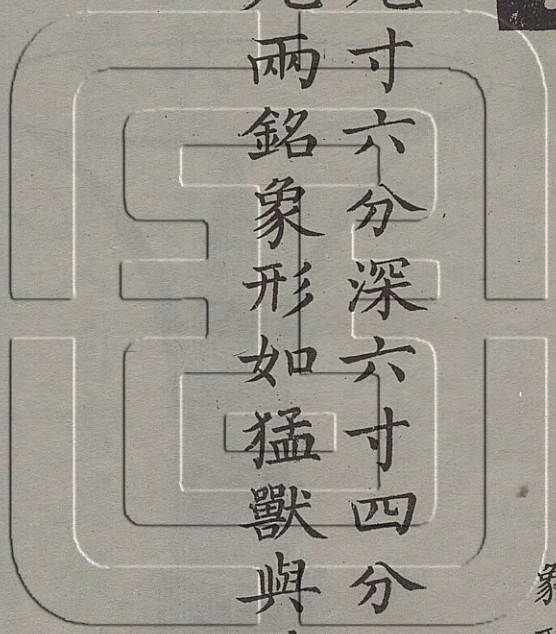

周犧觚

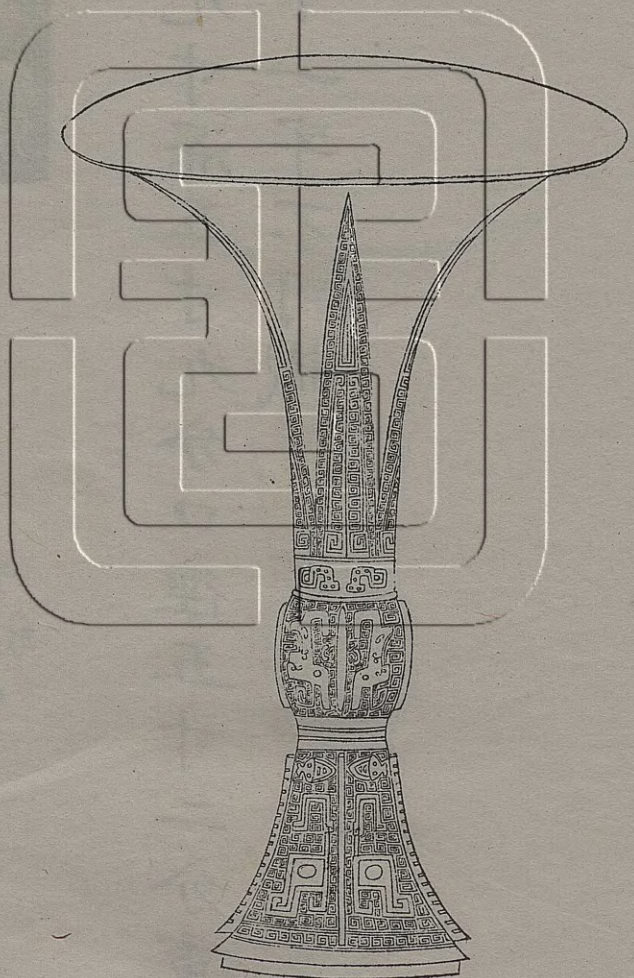



子  
形

子  
形  
○

右高九寸深五寸九分口徑五寸二分重二十七兩下一字不可識

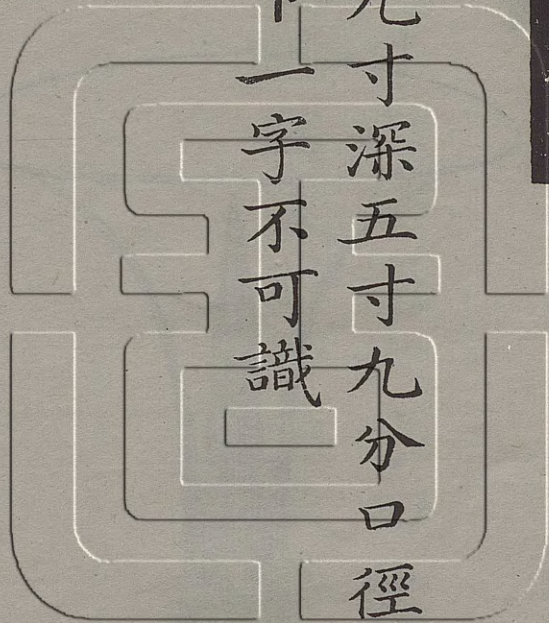

周雞觚

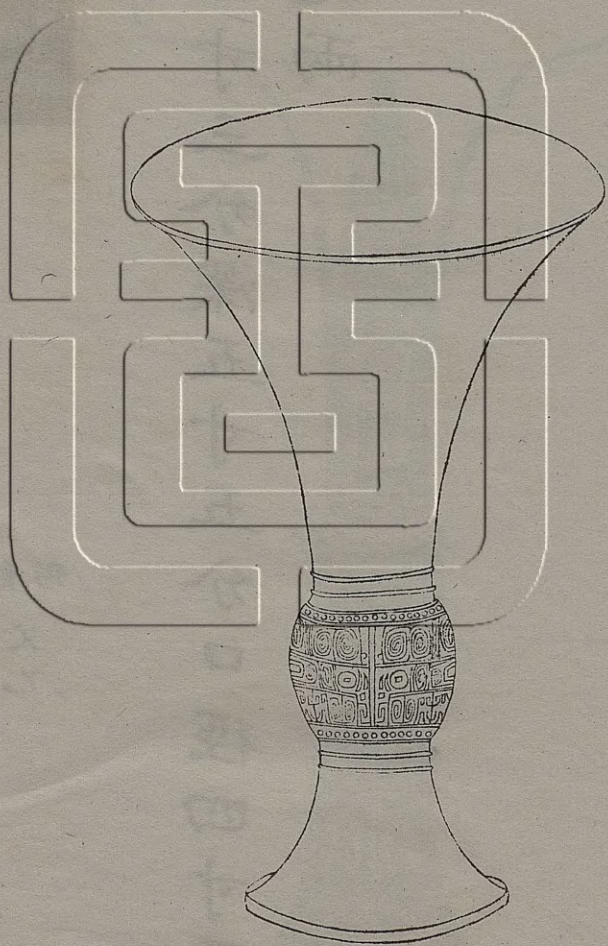

乙

右高七寸三分深五寸五分口徑四寸五分重二十九兩

形難父乙

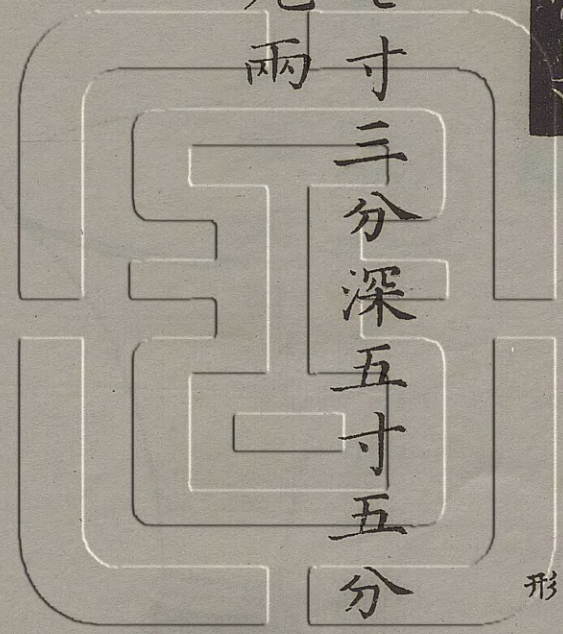

周執木觚

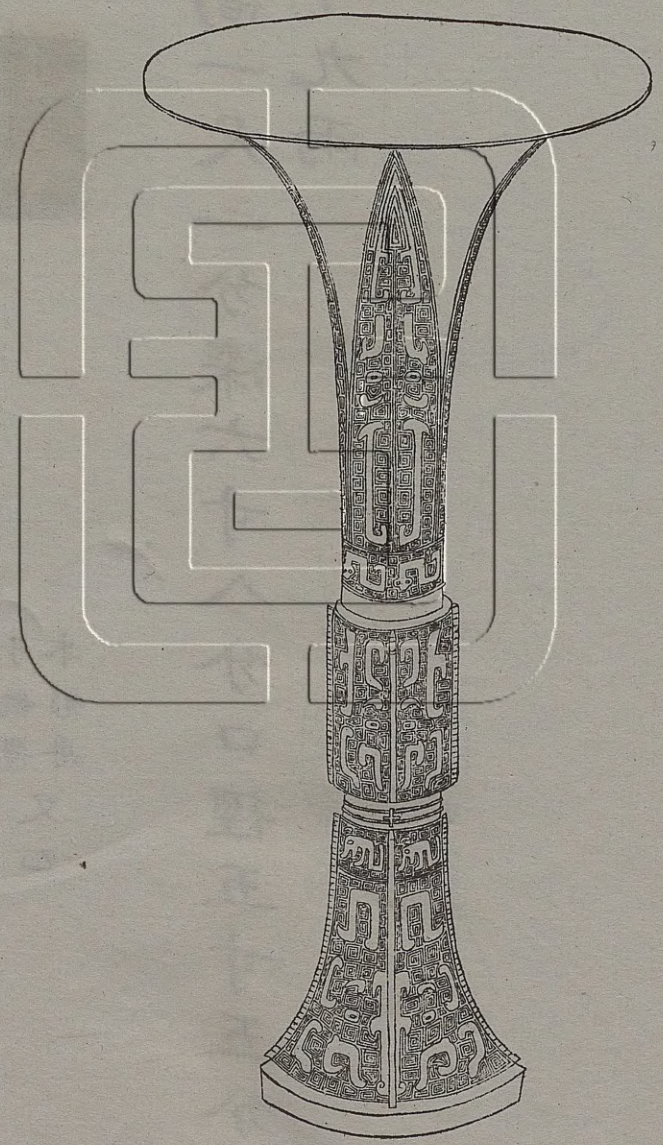



子執冊  
木形冊  
父乙

右高一尺一分深六寸八分口徑五寸五分重二十九兩

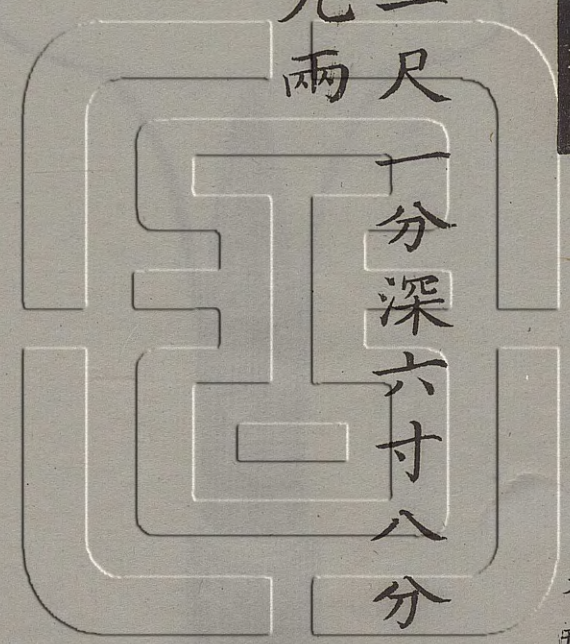

周亞觚一

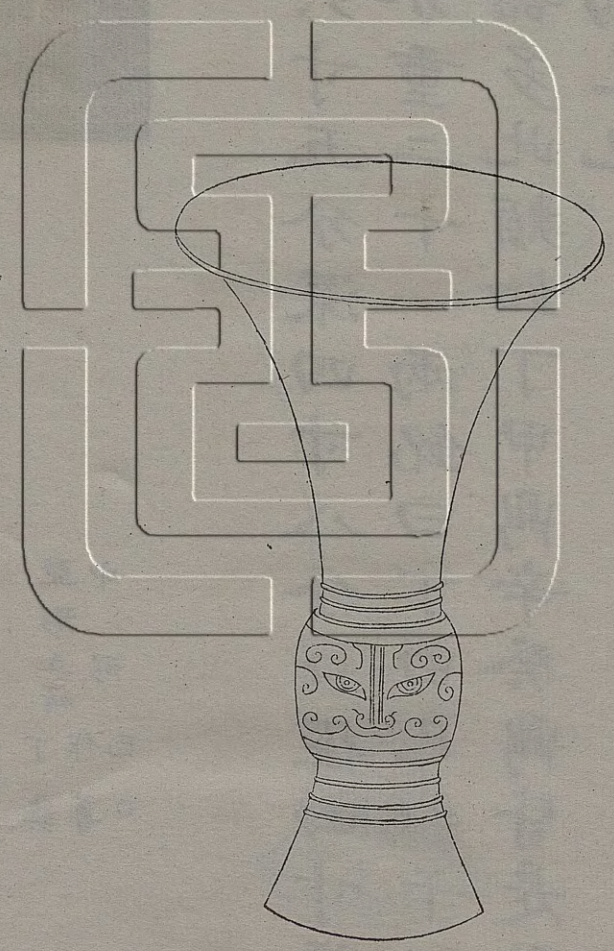



亞形立斝  
丁作  
尊  
已

右高六寸五分深四寸八分口徑四寸腹圍五寸四分重二十一兩銘曰丁曰已以干配干三代彝器多此類如丁甲鼎辛癸鼎皆是政不必疑已為已也

周亞觚二

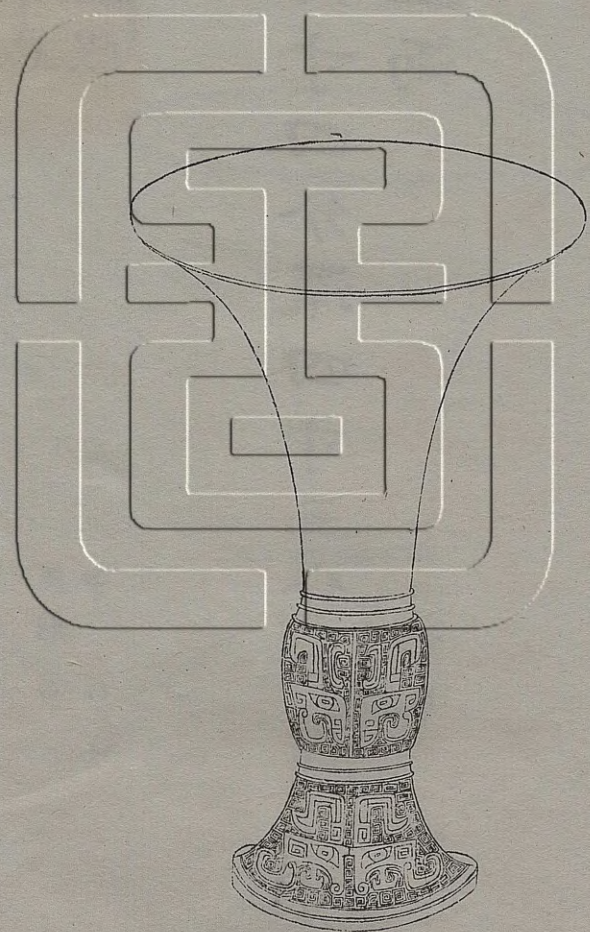

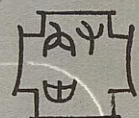

右高六寸四分深四寸三分口徑三寸九分重  
二十三兩

中亞形  
○○  
○

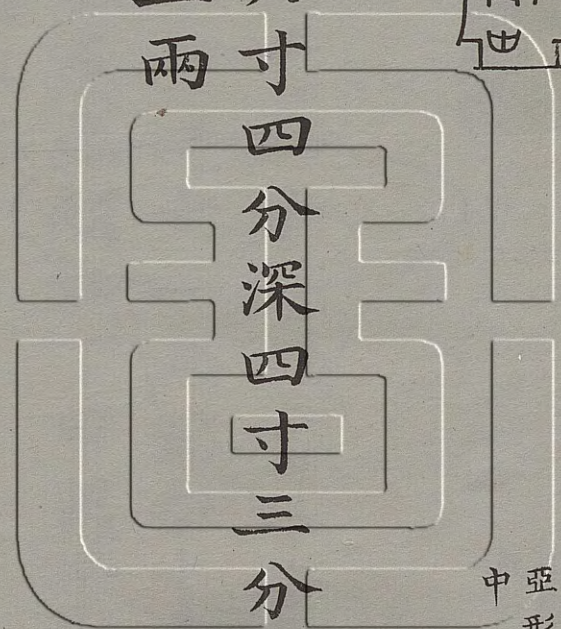

周亞觚三

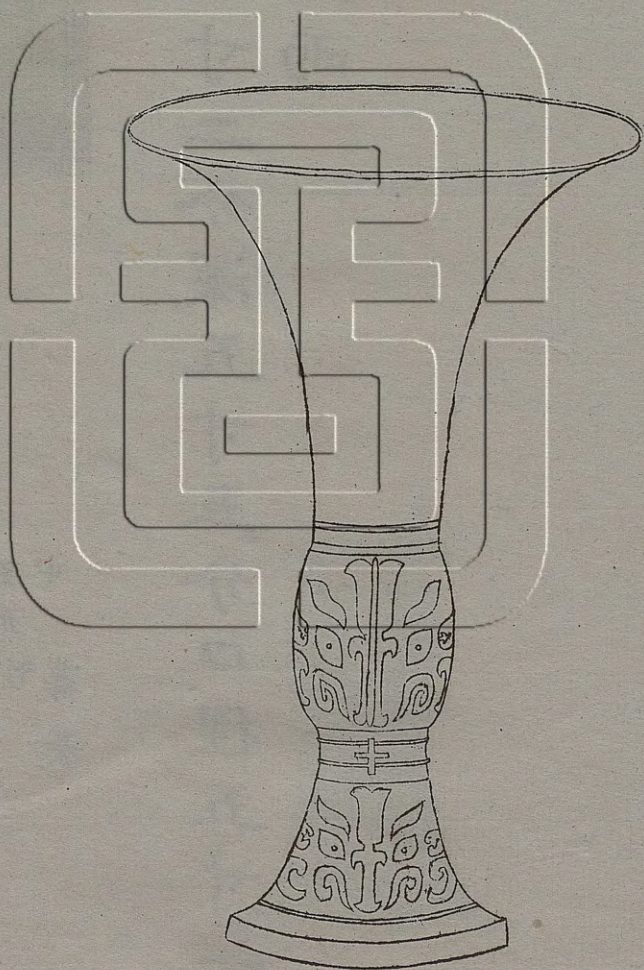



右高八寸二分深五寸五分口徑五寸一分重三十五兩

亞形格矢  
中形  
尊綦

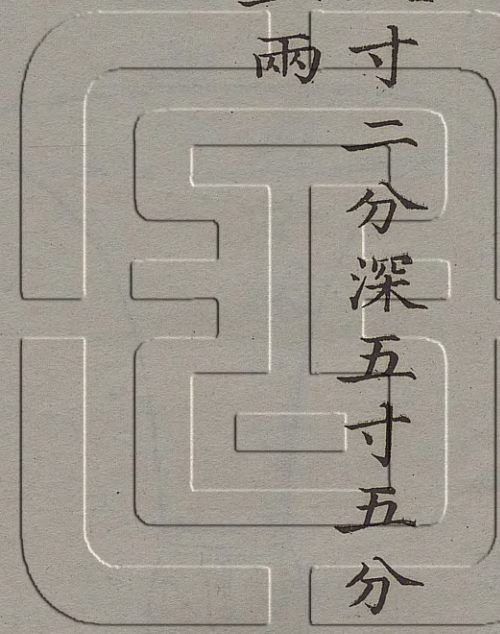

周亞觚四

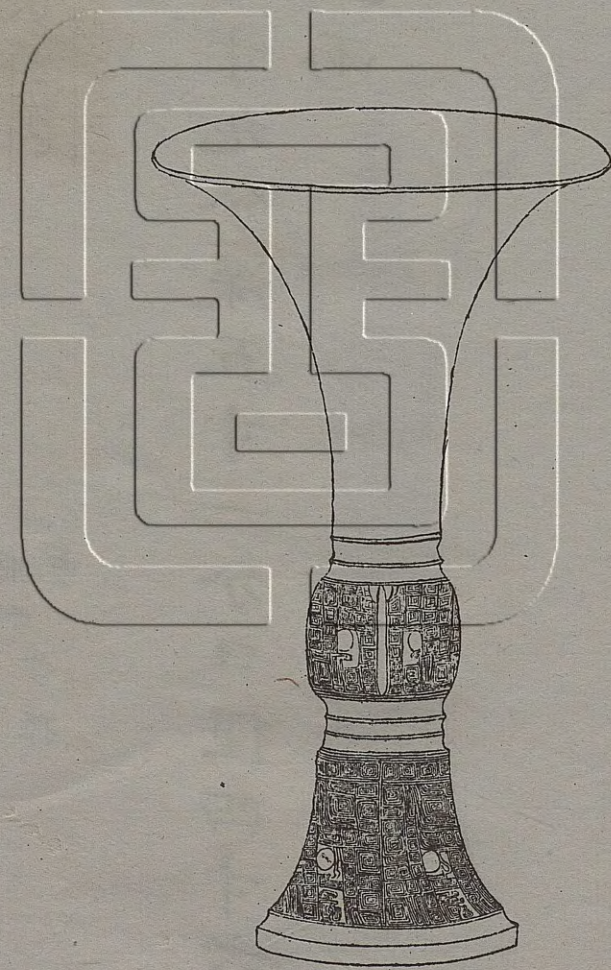

觚

020152

右高七寸九分深五寸一分口徑四寸六分重三十三兩

亞形子孫

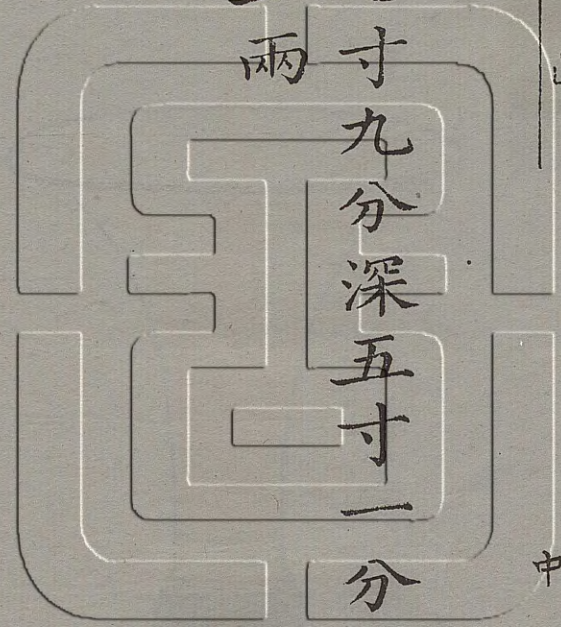

周立旗觚

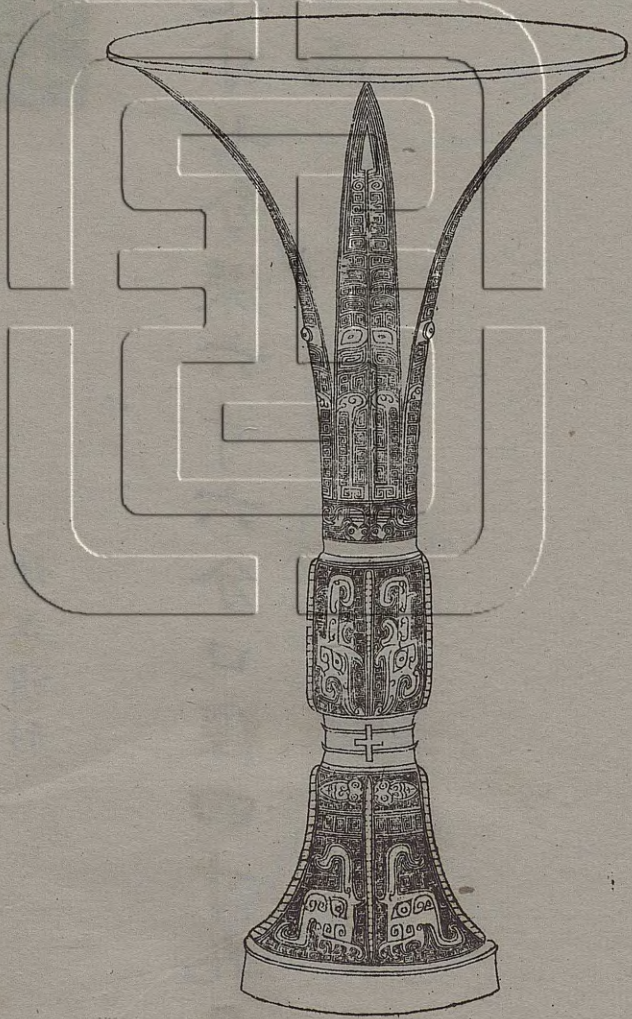

西清古鏡

卷二十四

觚

三



孫立旂形

右高九寸七分深六寸六分口徑四寸九分重二十七兩

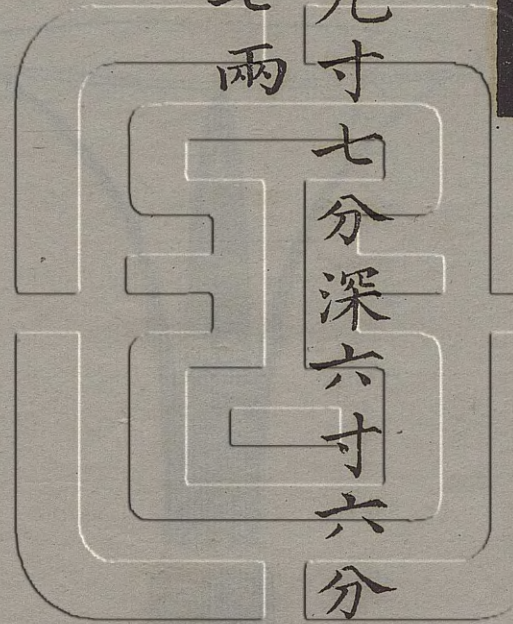

周雷紋觚一

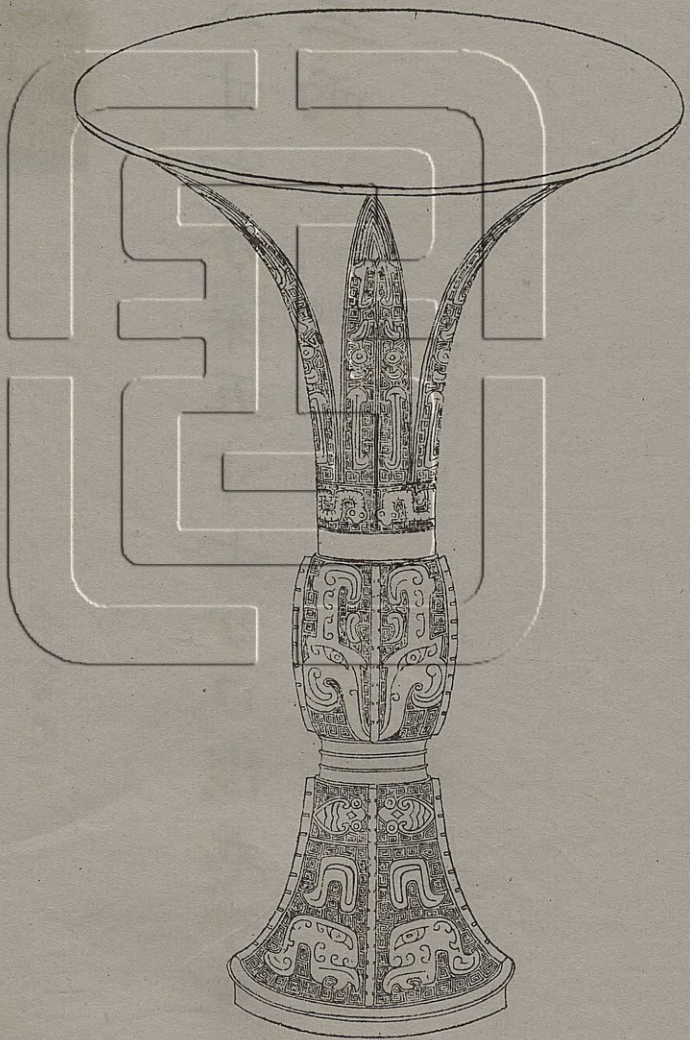



亦宜用

右高八寸七分深五寸七分口徑五寸五分重  
三十三兩

永寶用

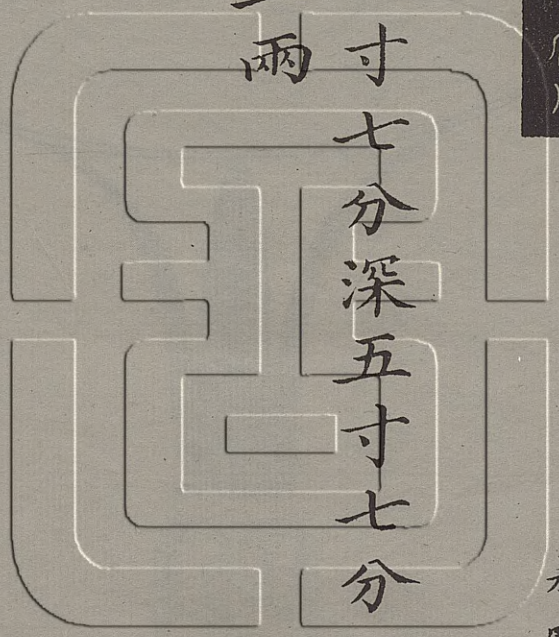

周雷紋觚二

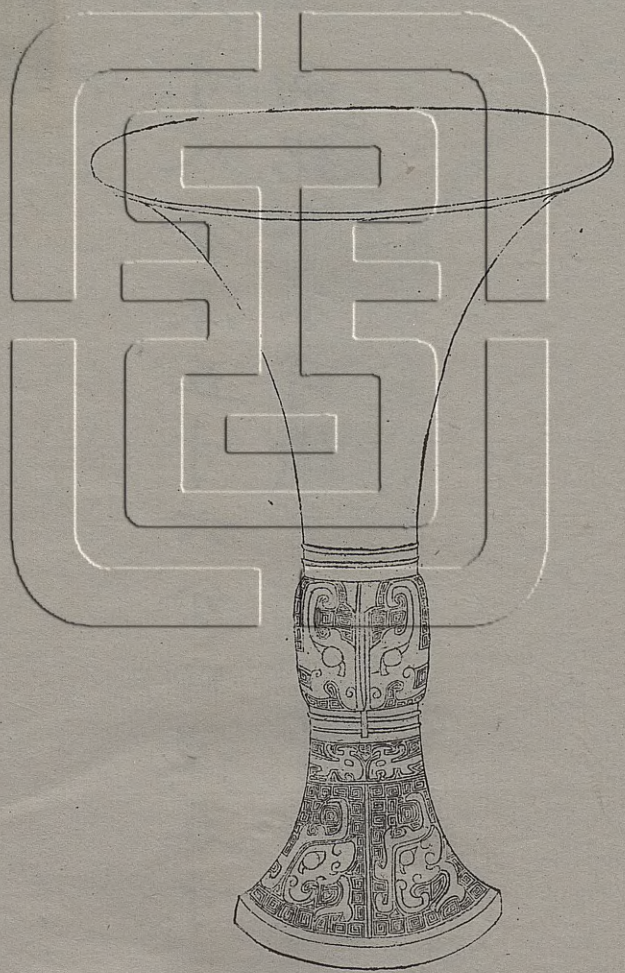

卣

右高八寸八分深五寸六分口徑五寸二分重三十一兩銘字不可識

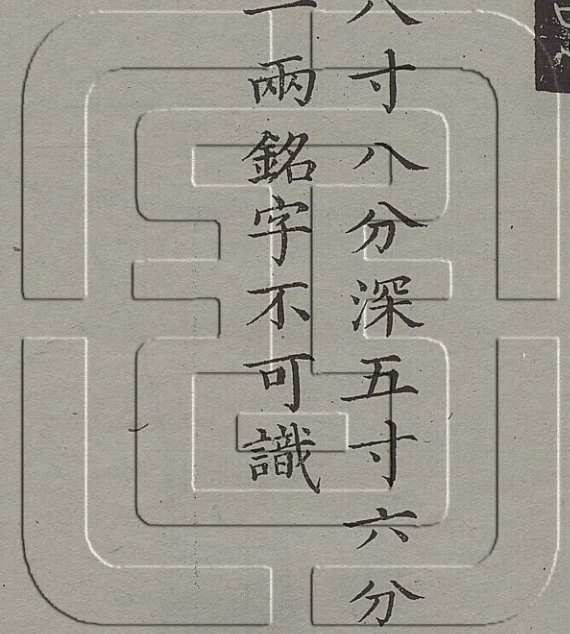

周雷紋觚三

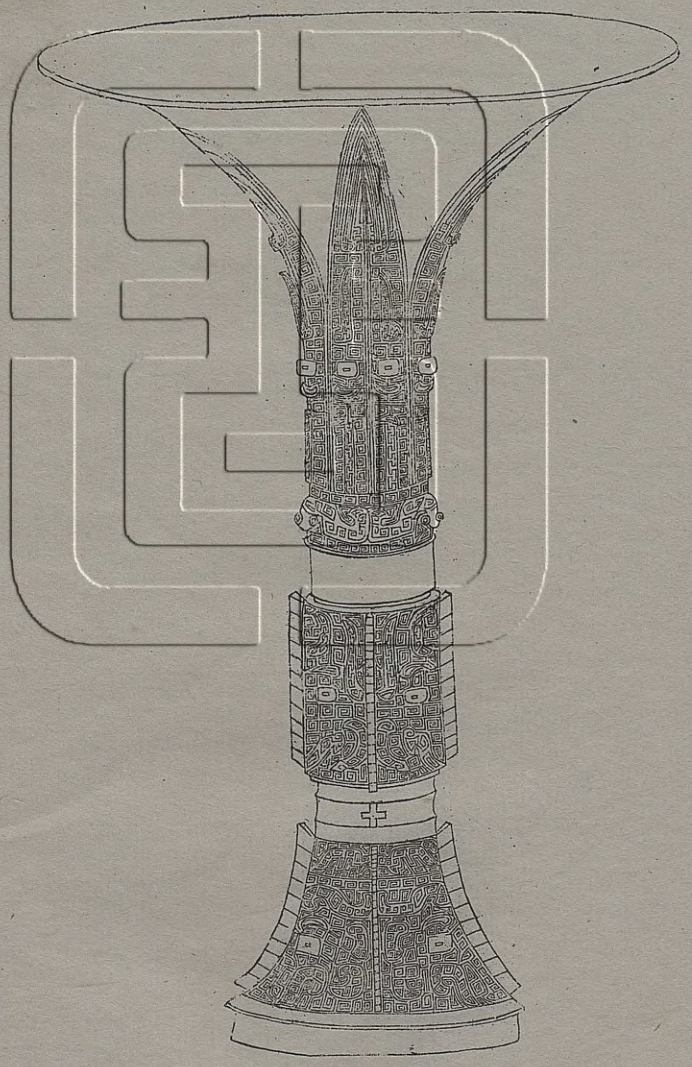

右高一尺一分深六寸九分口徑五寸四分重二十六兩

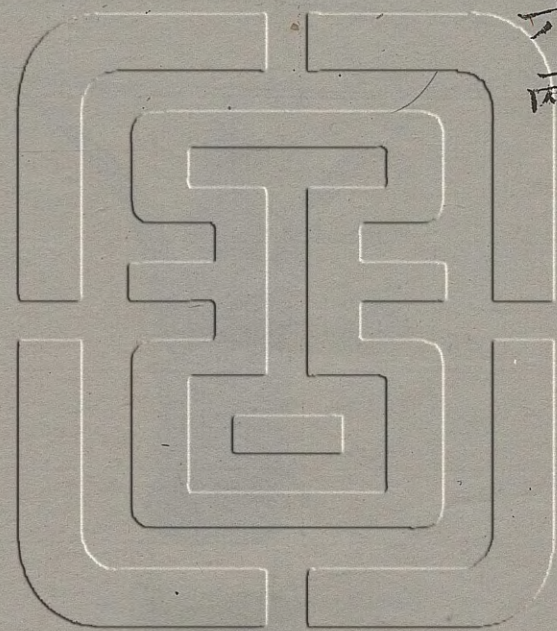

周雷紋觚四

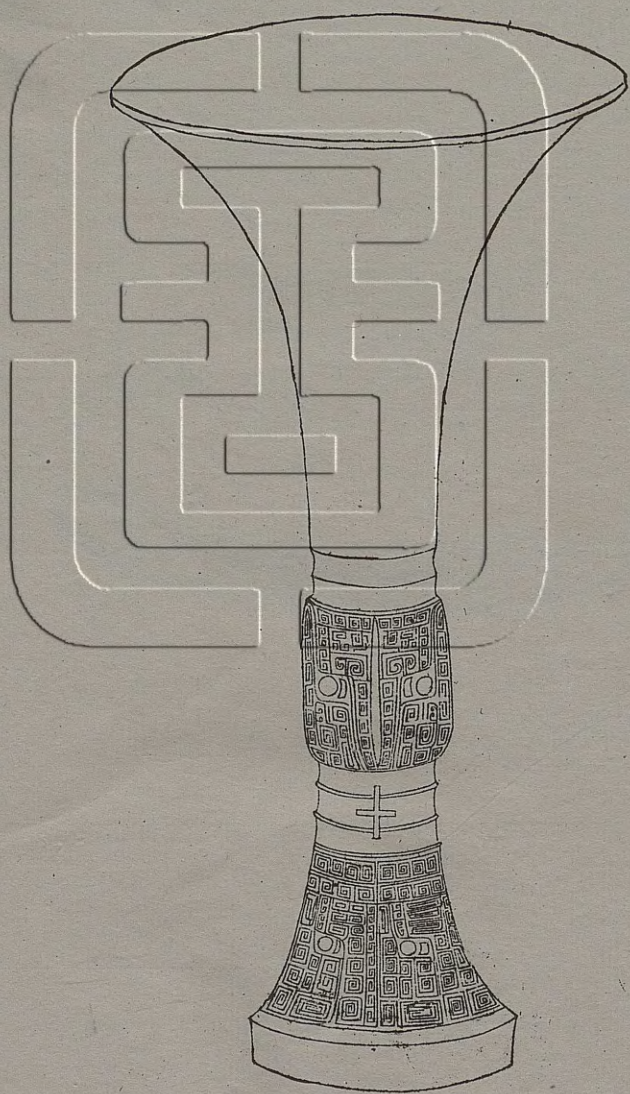

右高九寸二分深六寸五分口徑四寸六分重二十三兩

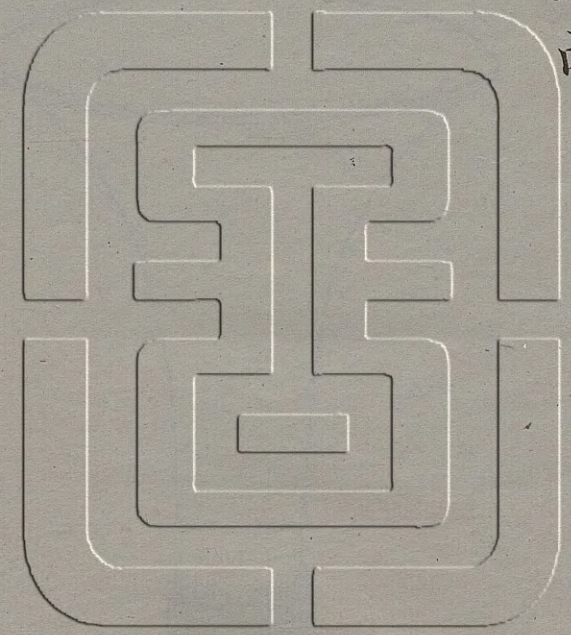

漢獸環甌七

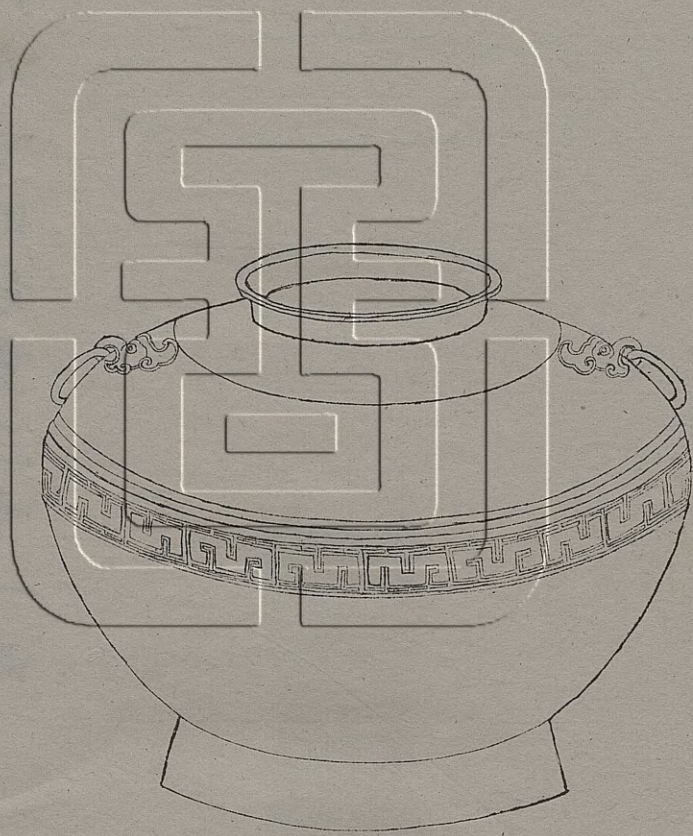

右高五寸一分深四寸五分口徑二寸八分腹圍一尺九寸四分重三十一兩

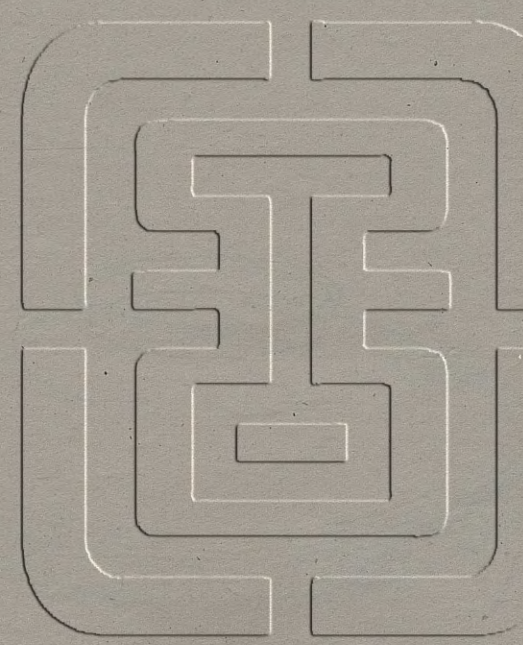

周雷紋觚六

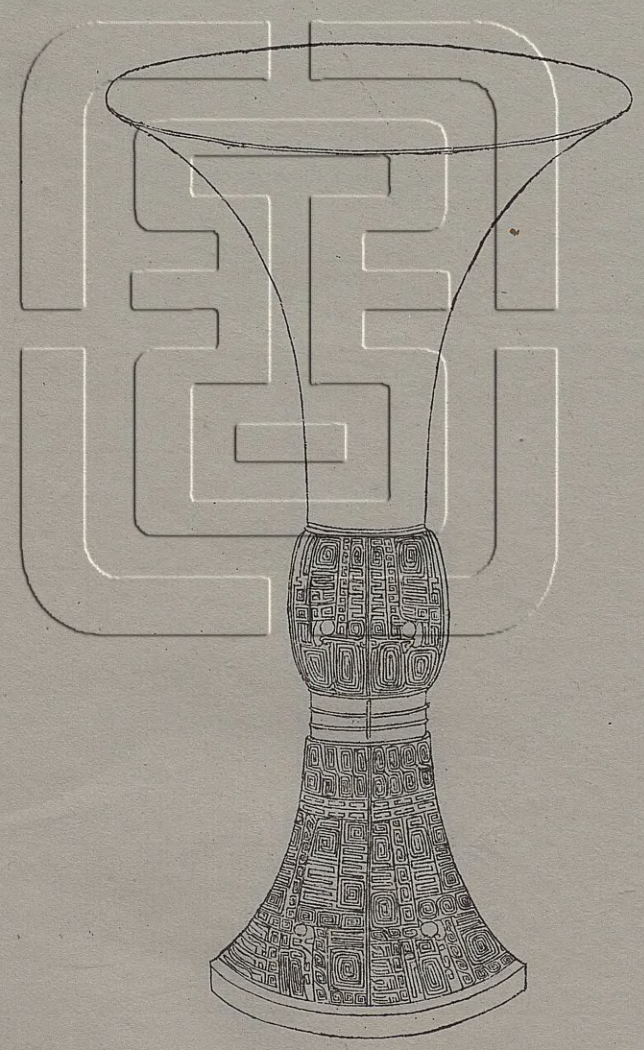

右高八寸六分深五寸五分口徑四寸八分重二十七兩

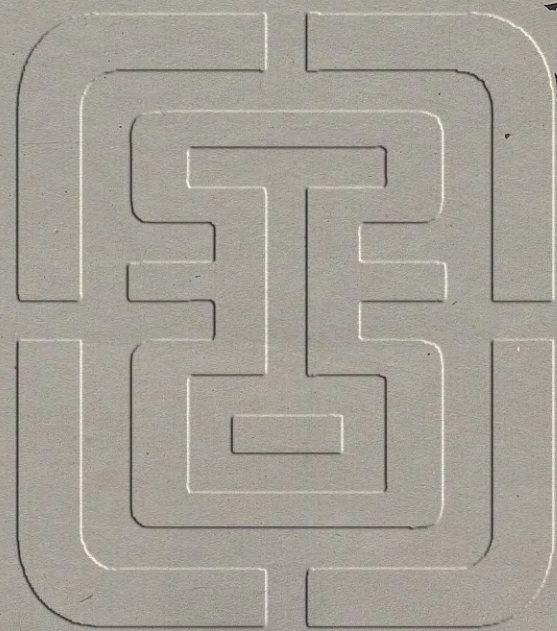

周雷紋觚七

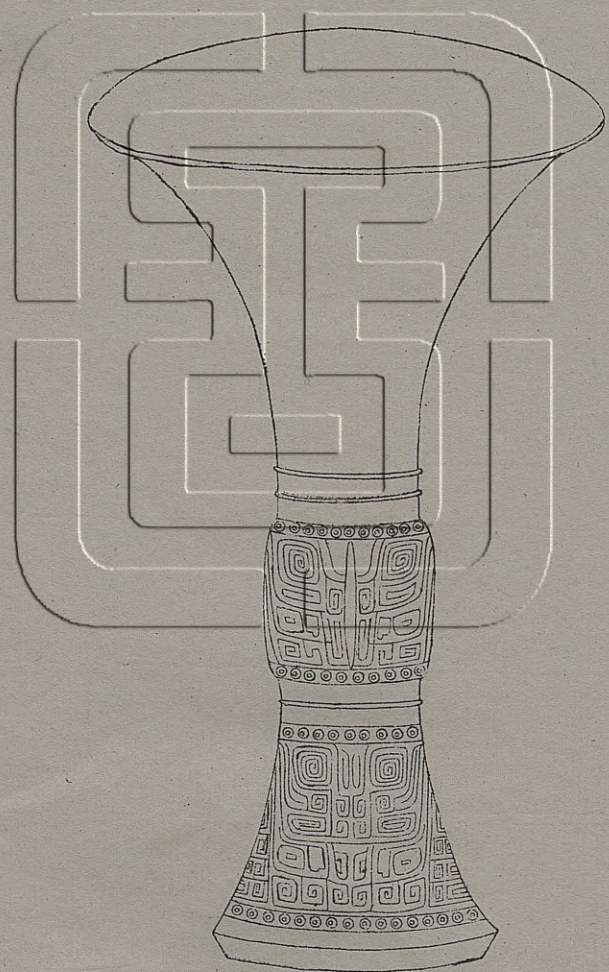

右高八寸三分深五寸二分口徑四寸七分重二十九兩

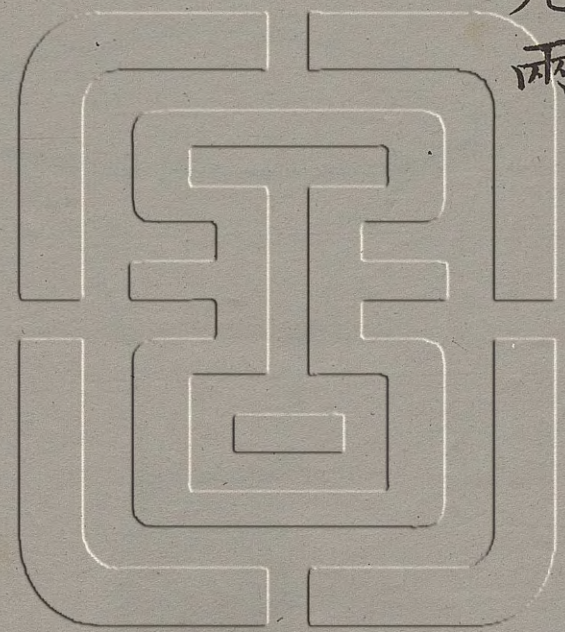

周雷紋觚八

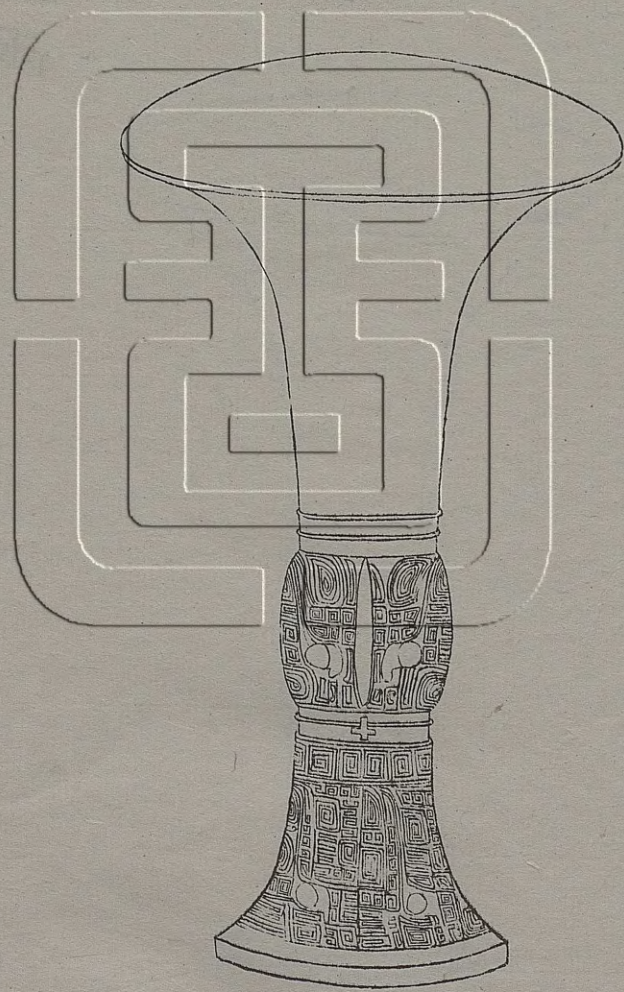

右高七寸九分深五寸二分口徑四寸六分重二十五兩

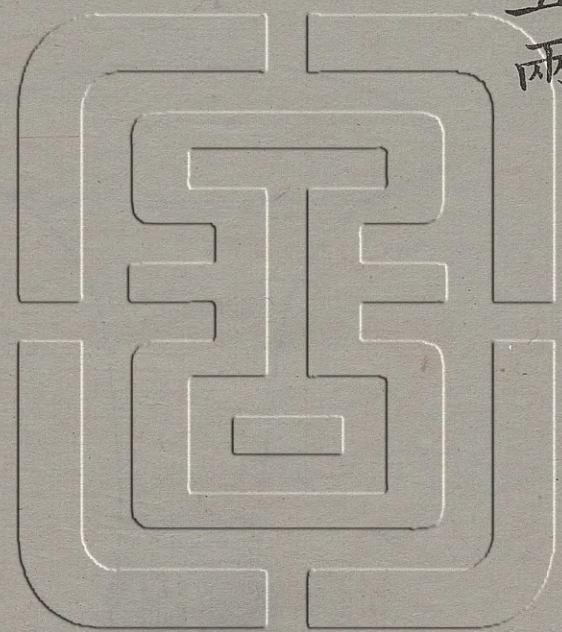

周雷紋觚九

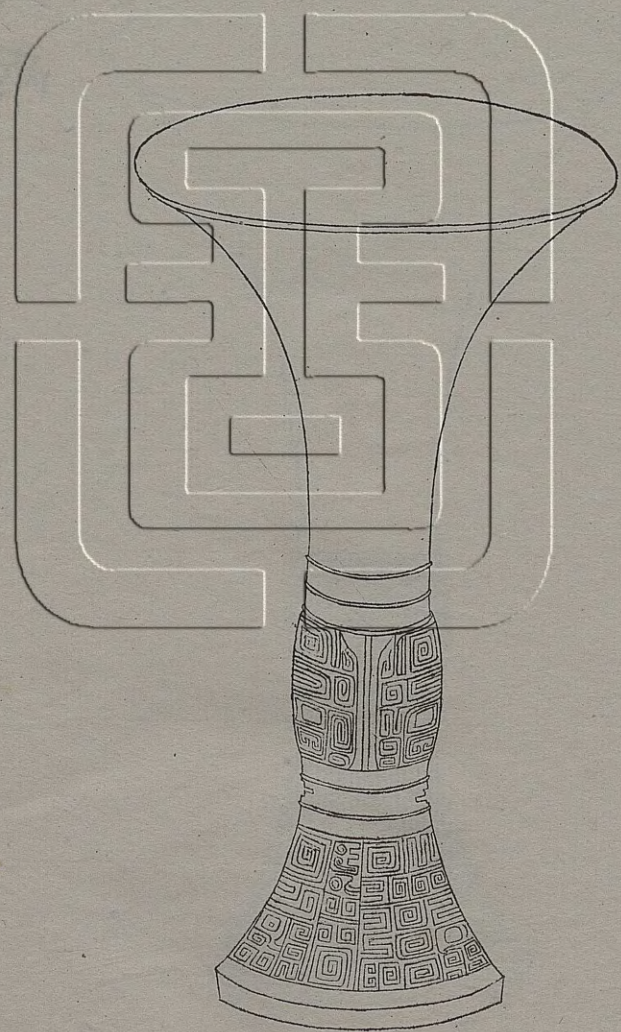



右高七寸八分深五寸三分口徑四寸七分重一十八兩

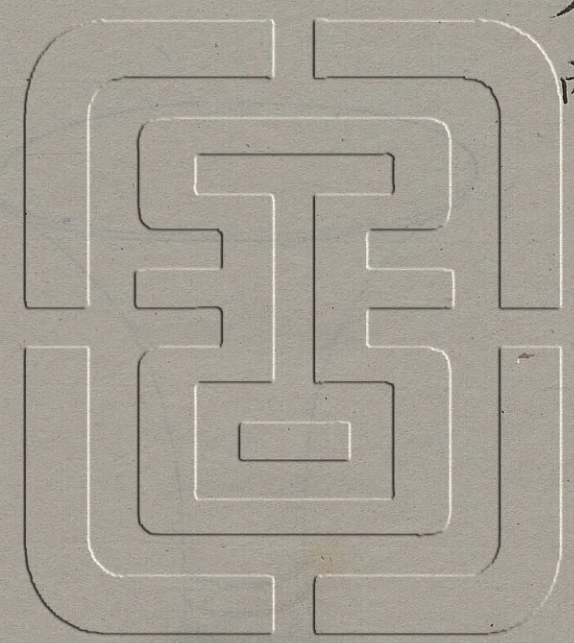

周雷紋觚十

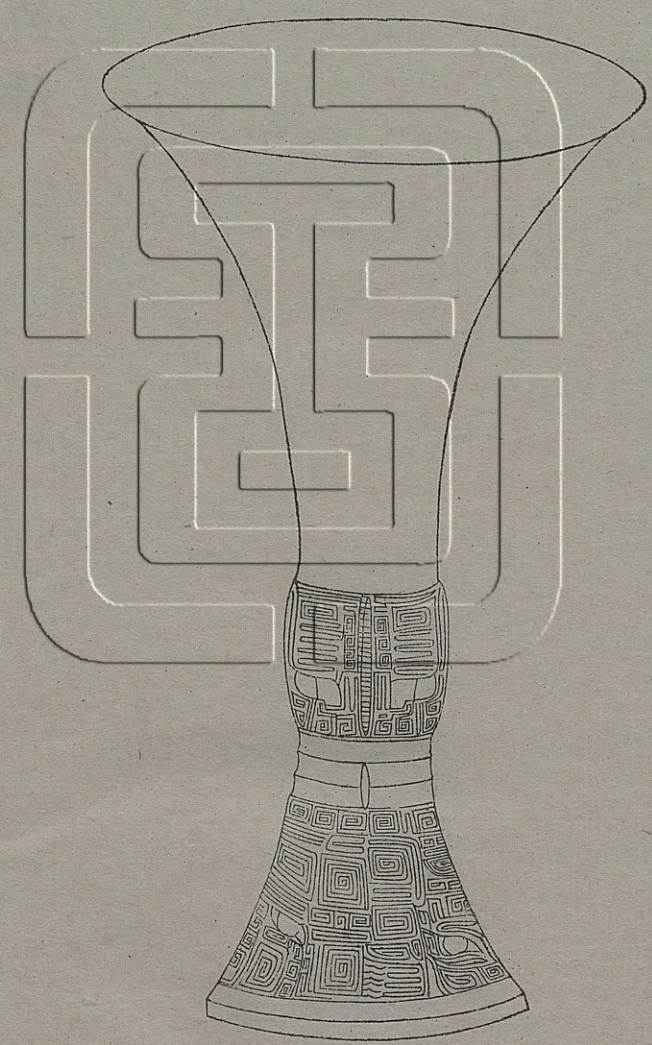

右高七寸八分深五寸三分口徑四寸七分重一十九兩

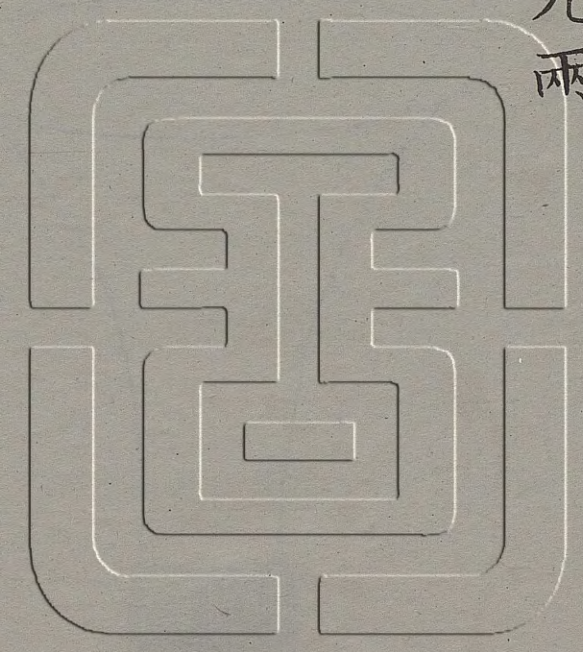

周雷紋觚十一

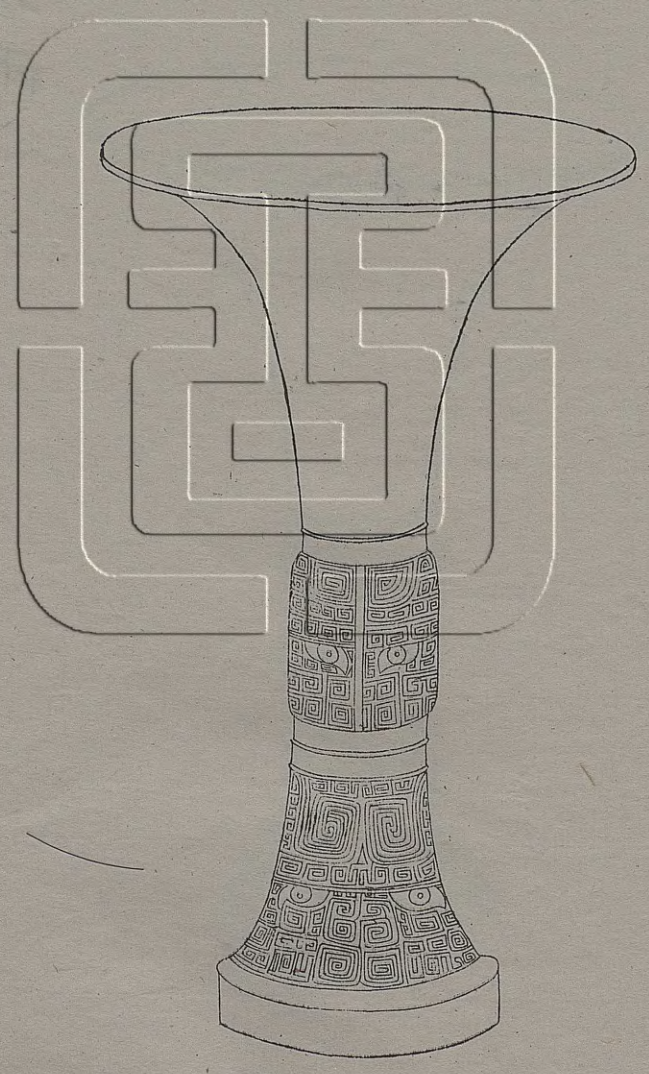

右高七寸八分深五寸三分口徑四寸五分重一十六兩

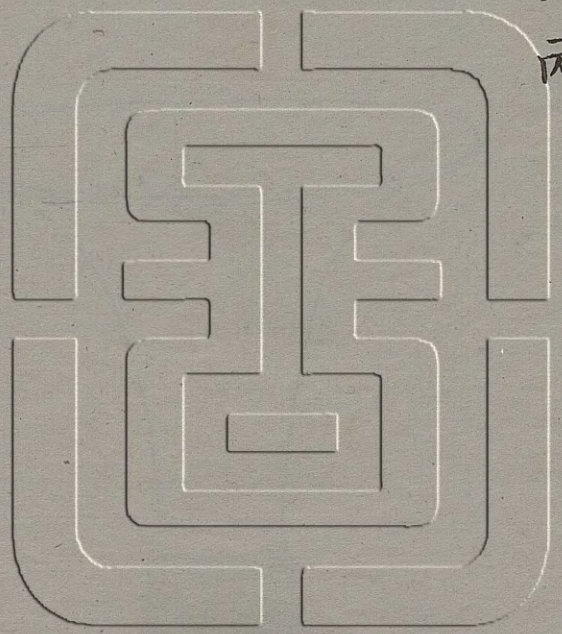

周雷紋觚十二

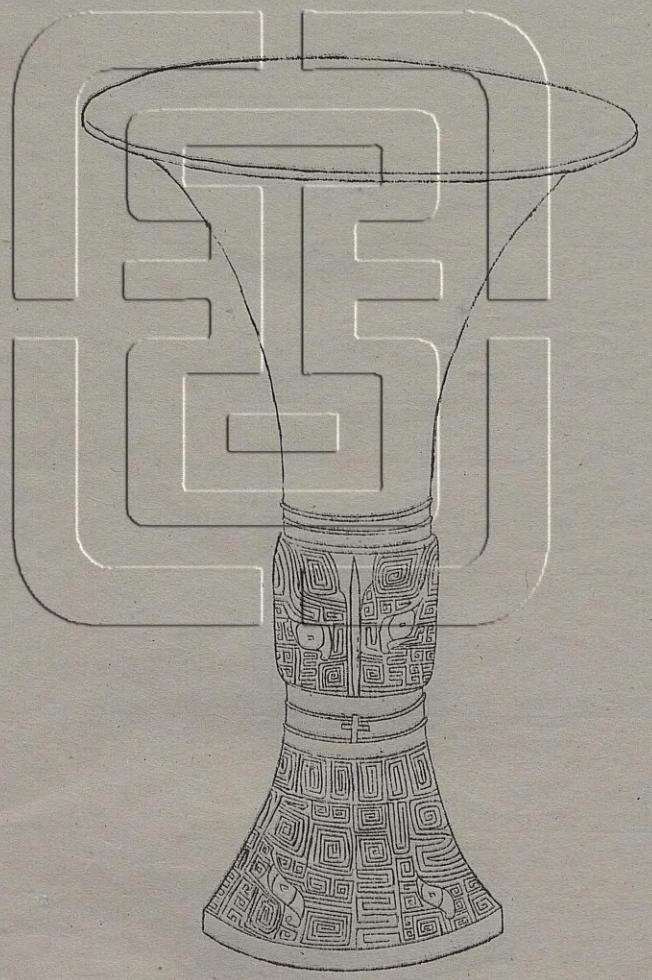

右高七寸七分深五寸口徑四寸四分重二十  
三兩

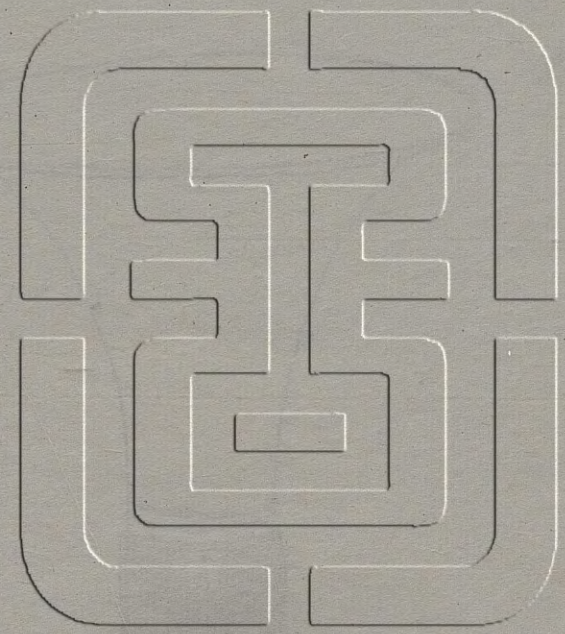

周雷紋觚十三

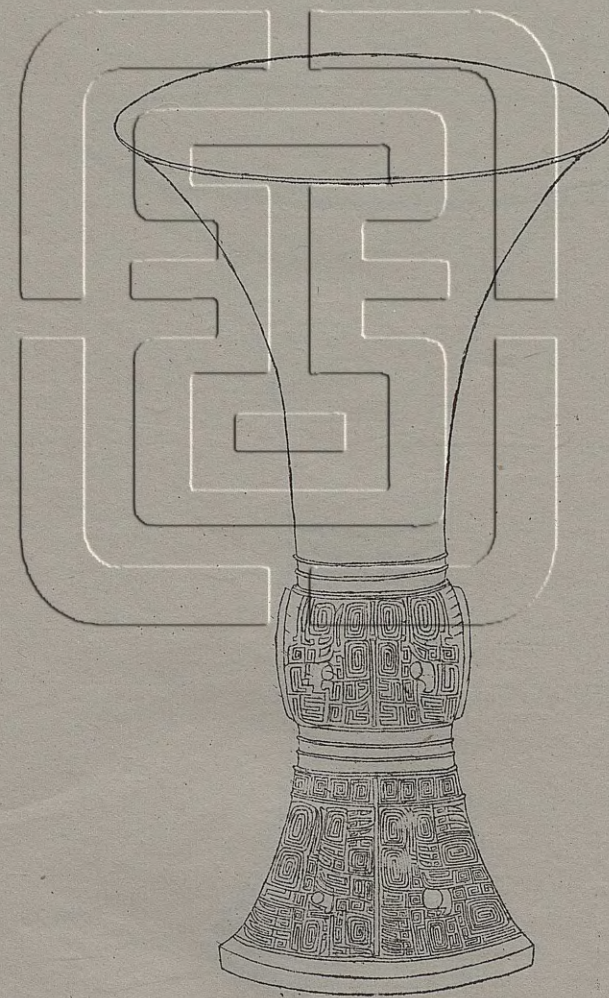

右高七寸七分深五寸口徑四寸七分重二十九兩

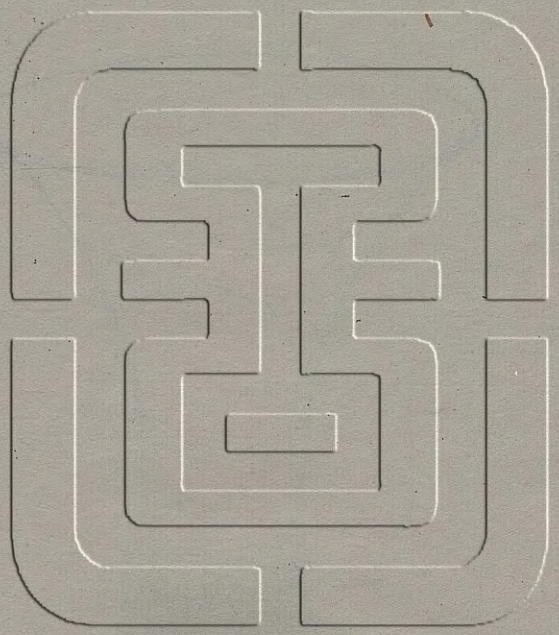

周雷紋觚十四

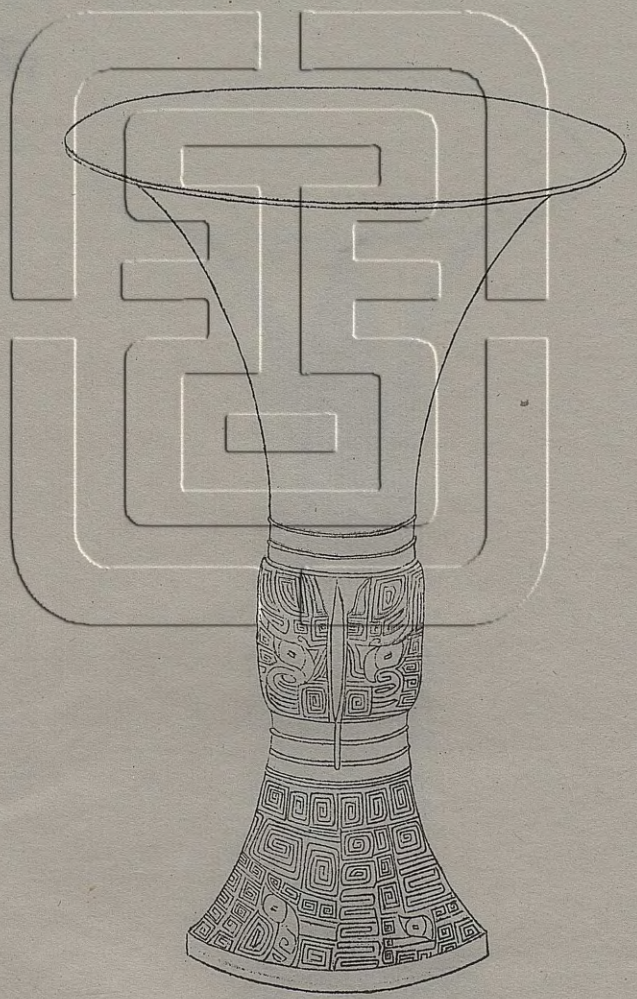

右高七寸七分深五寸二分口徑四寸五分重二十二兩

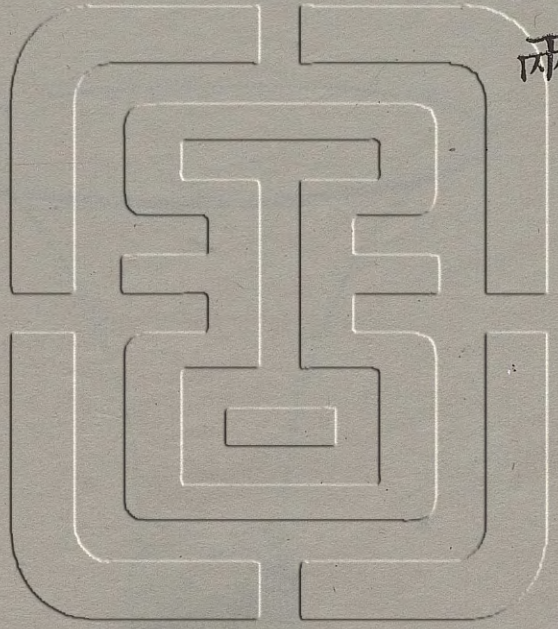

周雷紋觚十五

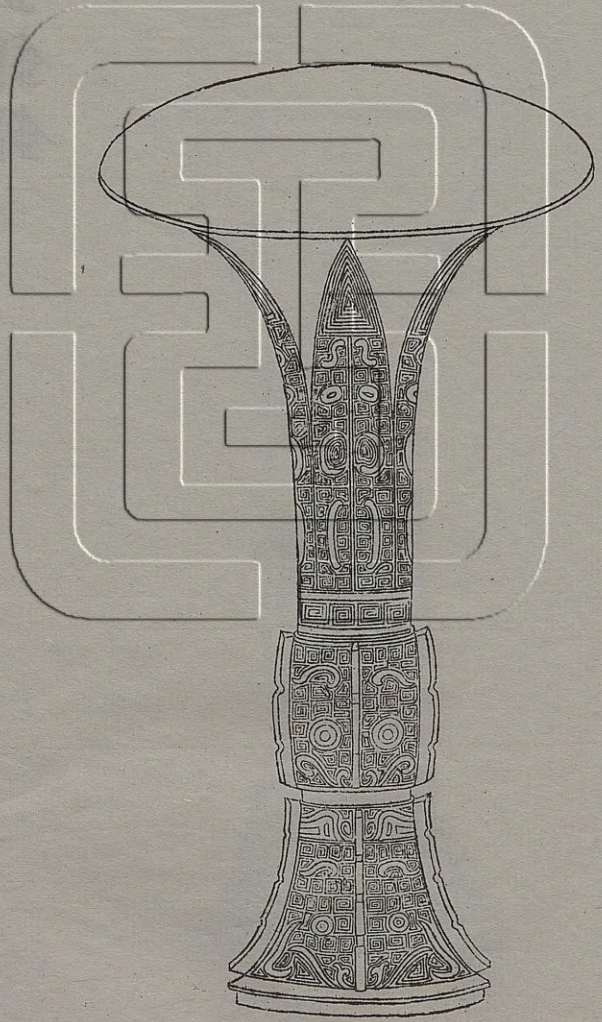

右高六寸七分深四寸二分口徑四寸重一十七兩金銀錯

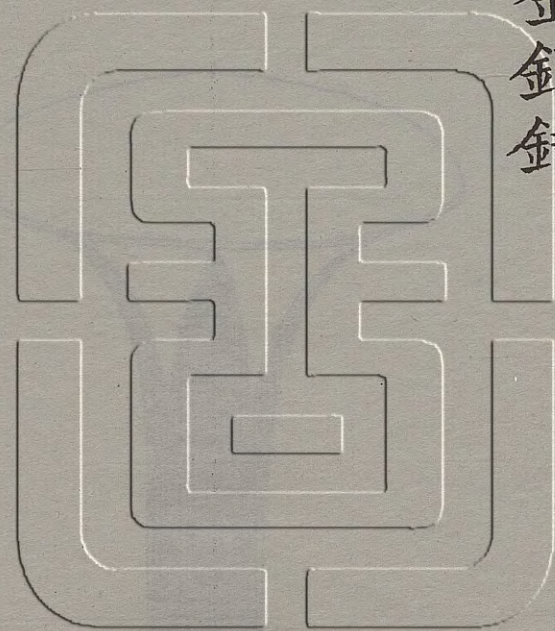

周雷紋觚十六

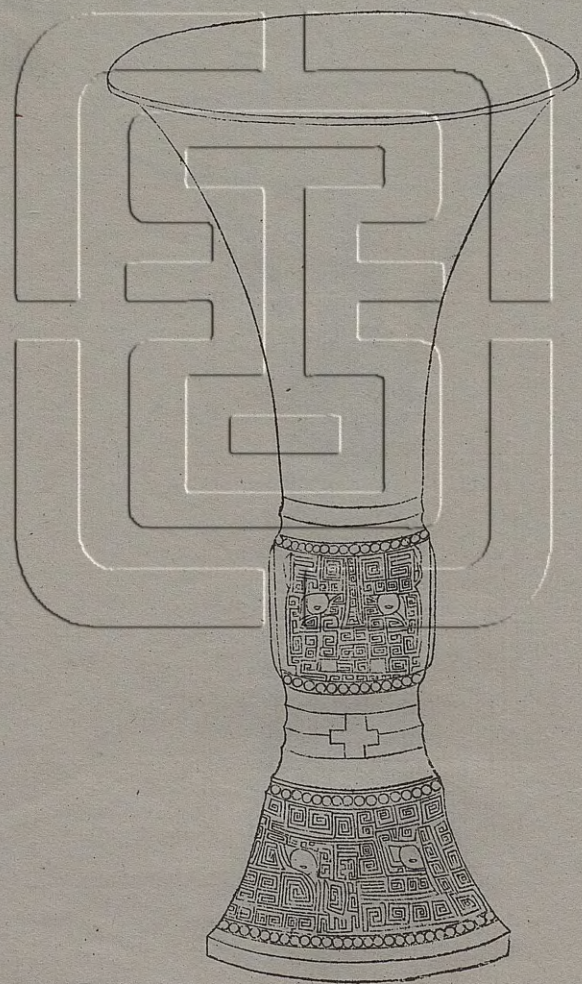

右高七寸六分深五寸二分口徑三寸八分重一十五兩

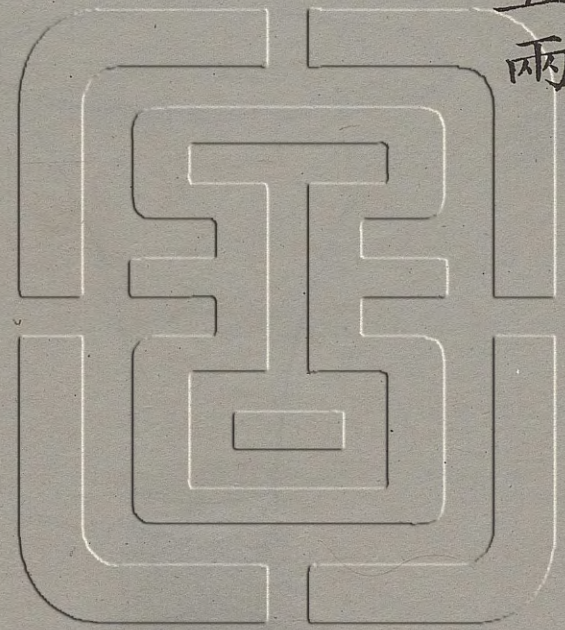

周雷紋觚十七

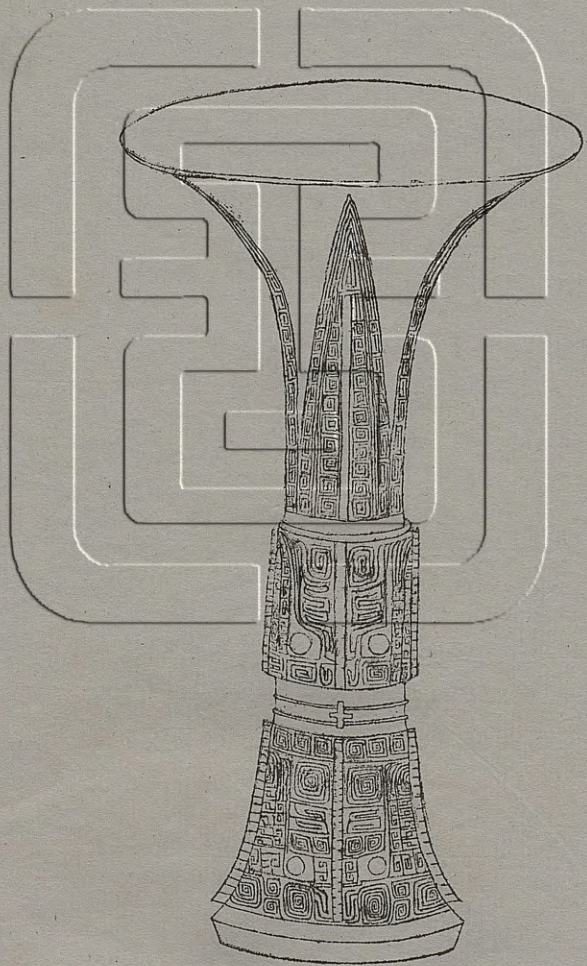



右高七寸三分深四寸八分口徑四寸三分重  
一十二兩

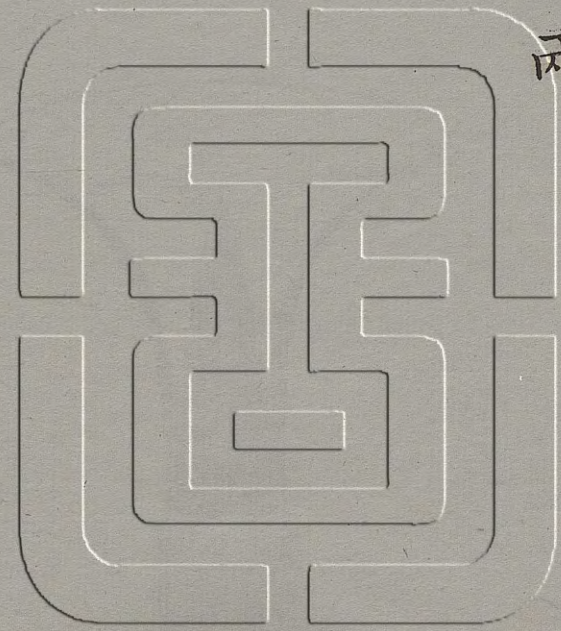

周雷紋觚十八

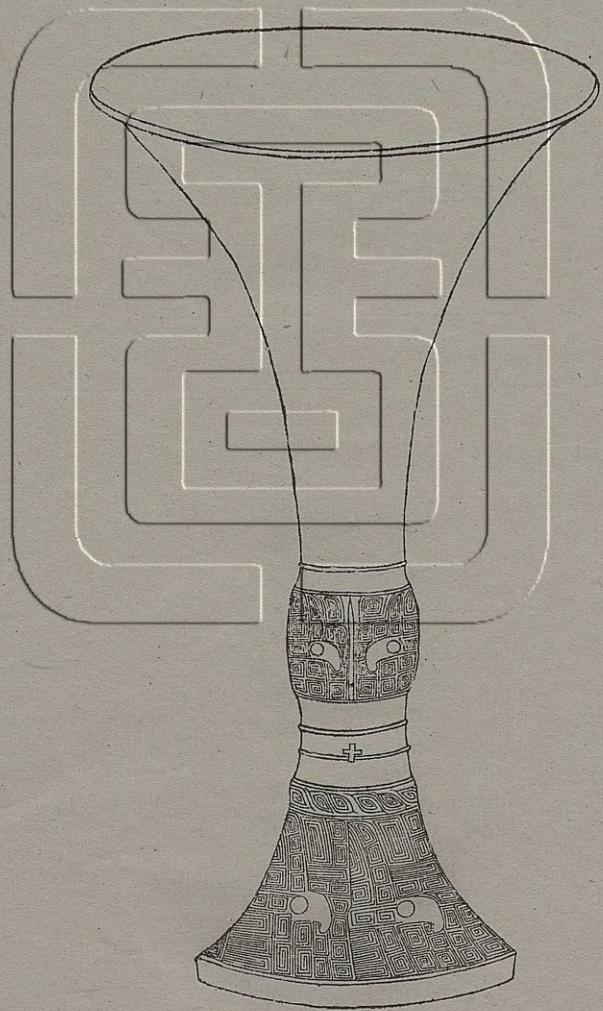

右高七寸深四寸七分口徑四寸一分重一十七兩

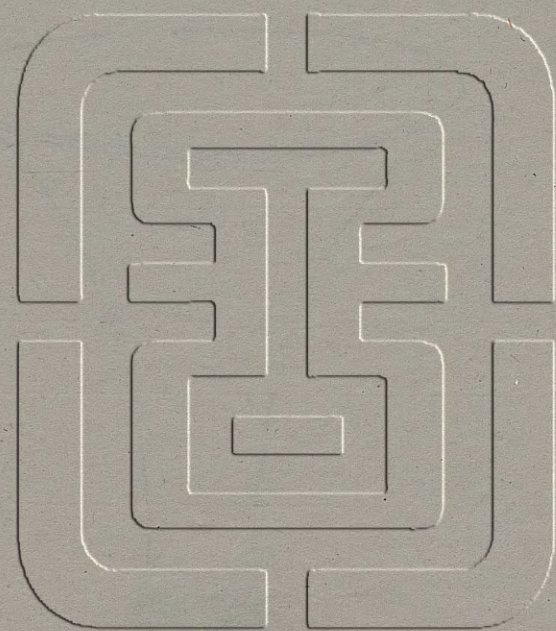

周雷紋觚十九

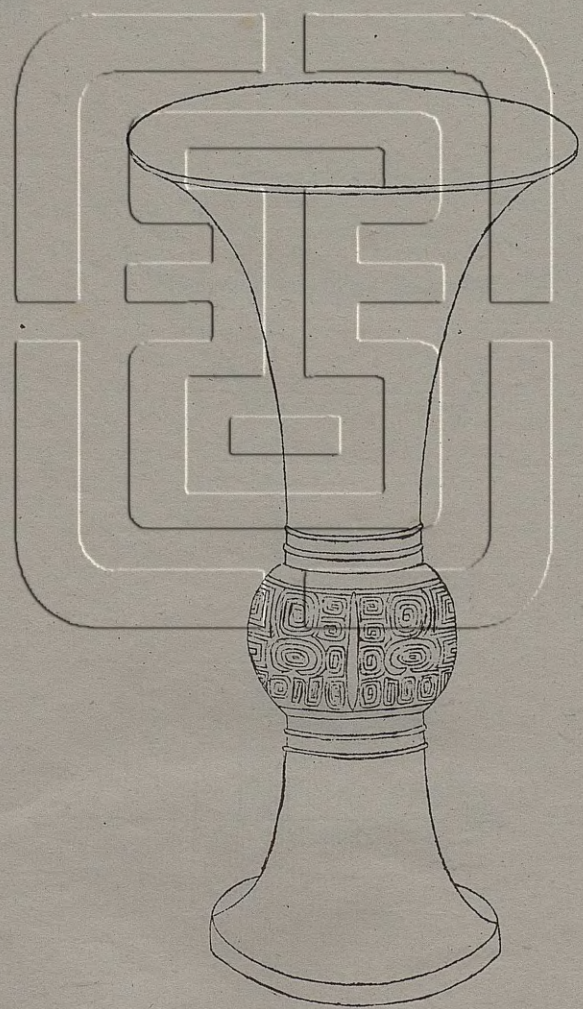

右高六寸六分深四寸六分口經四寸一分重二十兩

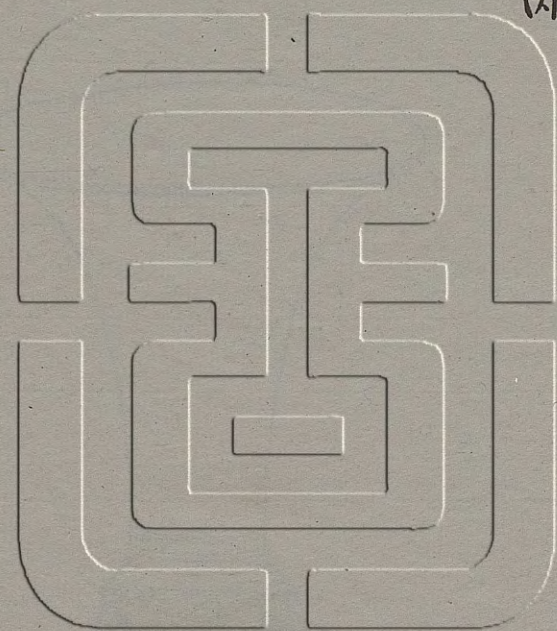

周雷紋觚二十

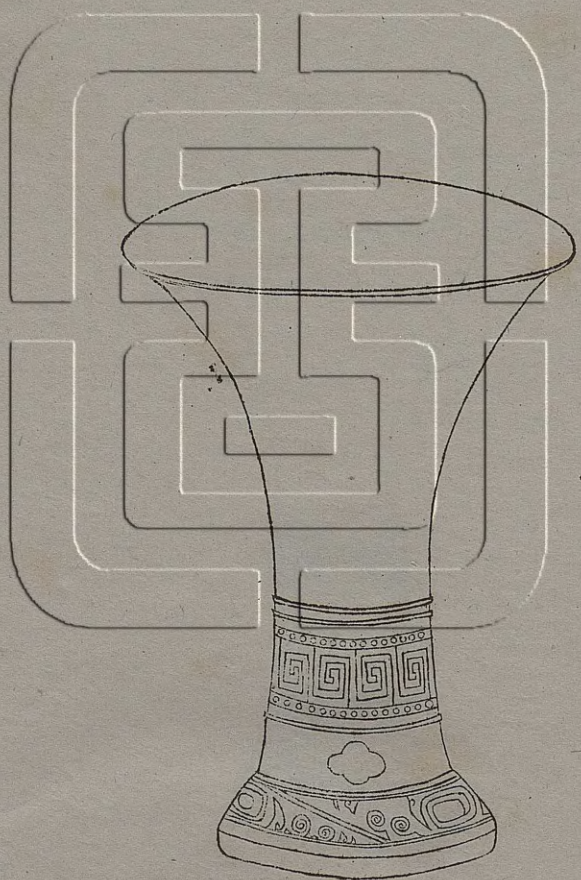

右高五寸九分深四寸一分口徑四寸一分重四十七兩

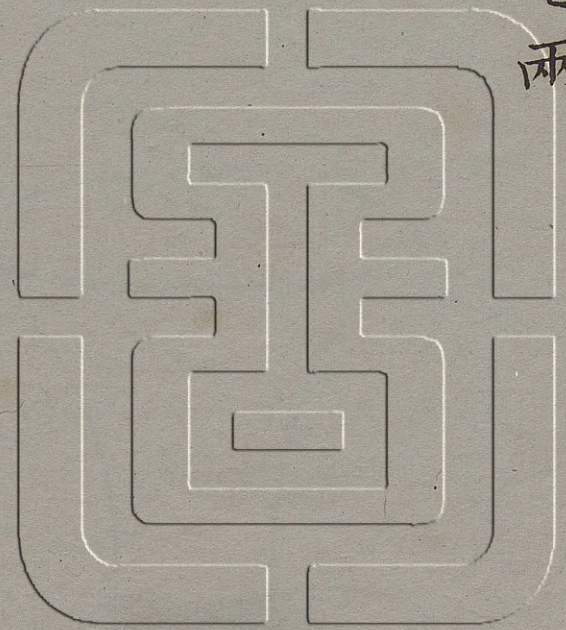

周雷紋觚二十一

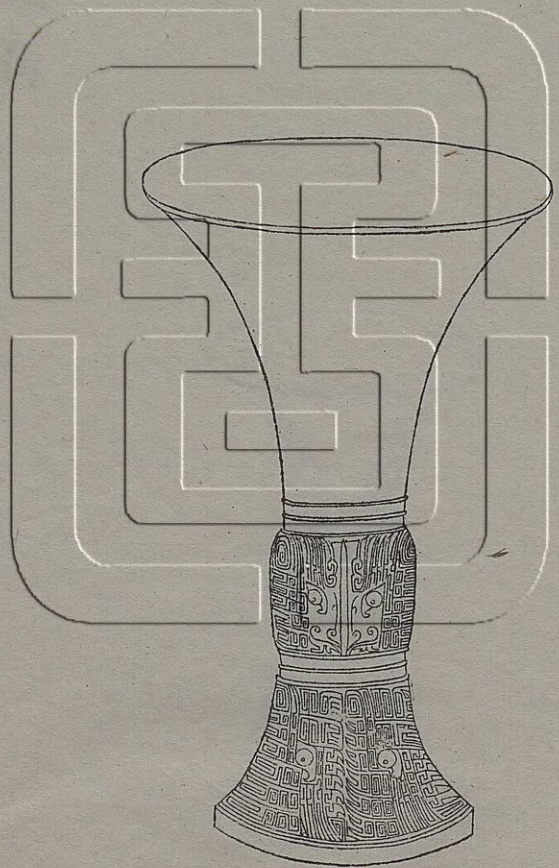

右高五寸一分深三寸六分口徑三寸三分重一十三兩

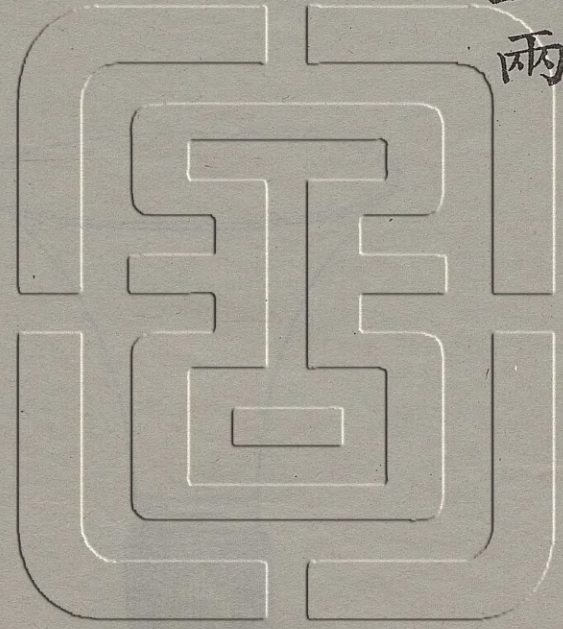

周雷紋觚二十二

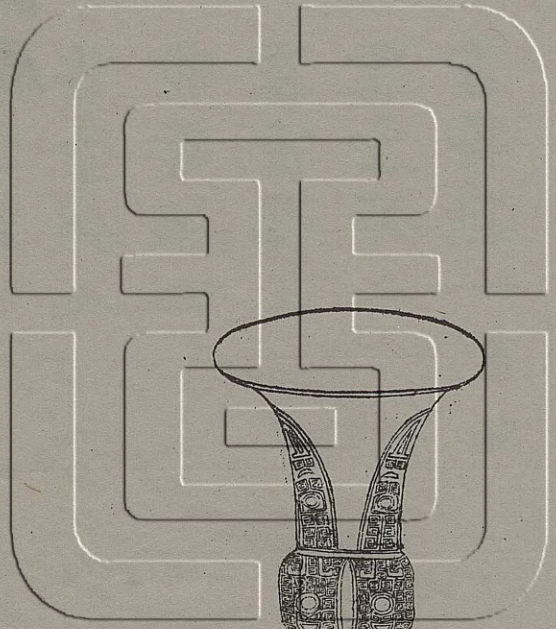
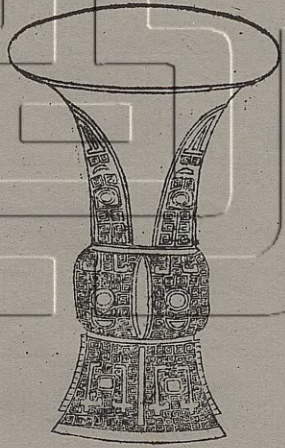

右高二寸九分深如之口徑二寸二分重五兩  
有半闕底

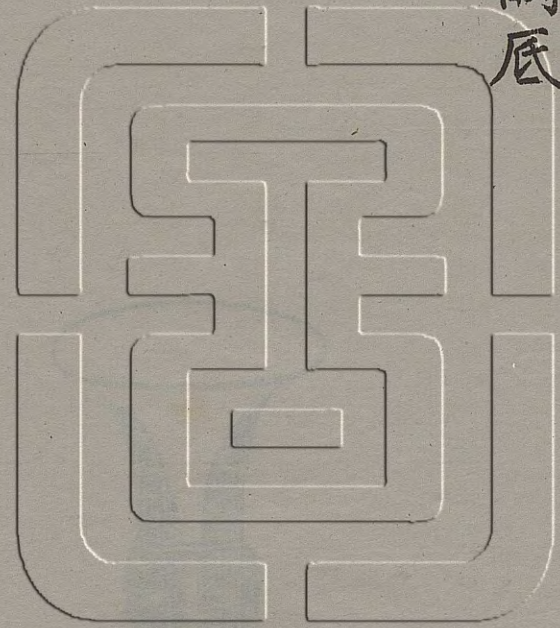

西清古鑑卷二十五目錄

觚三

周

雲雷觚一 有銘

雲雷觚二

雲雷觚三

雲雷觚四

雲雷觚五

雲雷觚六

雲雷觚七

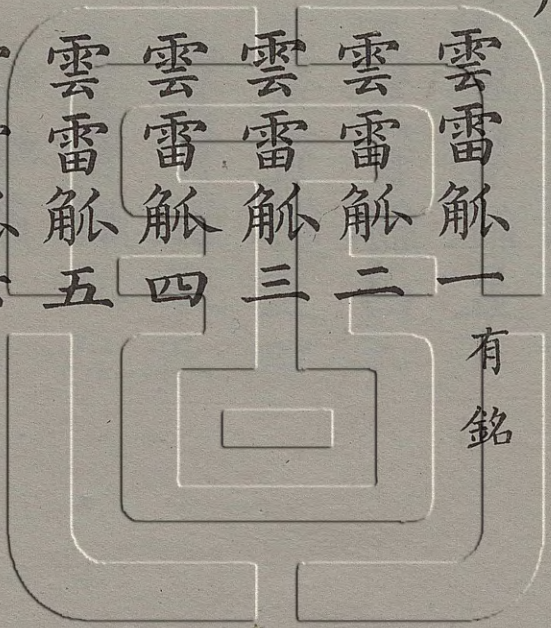

蟠虺觚

蟠螭觚

饗餐觚一

饗餐觚二

饗餐觚三

饗餐觚四

饗餐觚五

饗餐觚六

饗餐觚七

饗餐觚八

饗餐觚九

饗餐觚十

饗餐觚十一

饗餐觚十二

饗餐觚十三

饗餐觚十四

饗餐觚十五

饗餐觚十六

饗餐觚十七

夔紋觚一

夔紋觚二

夔紋觚三

素觚一

素觚二

素觚三

素觚四

素觚五

素觚六

素觚七

素觚八

素觚九

素觚十

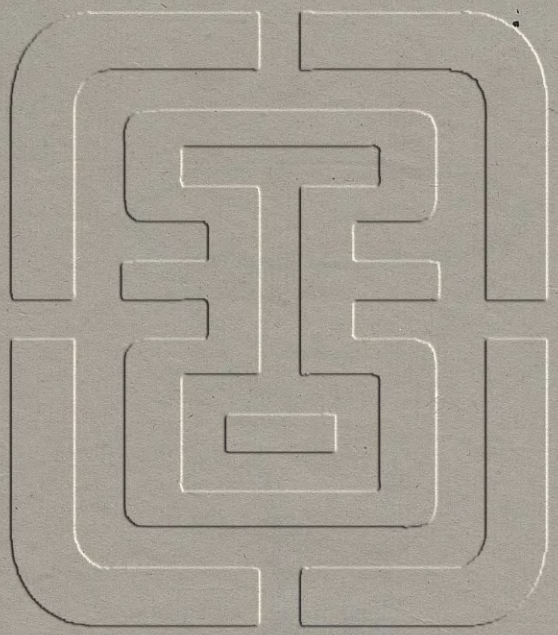
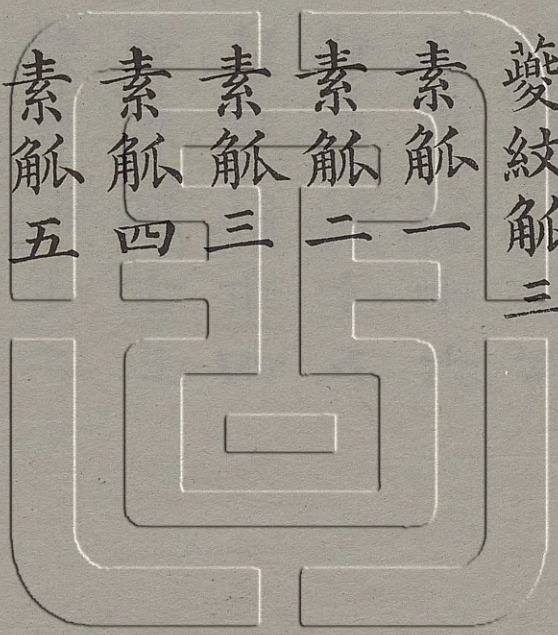



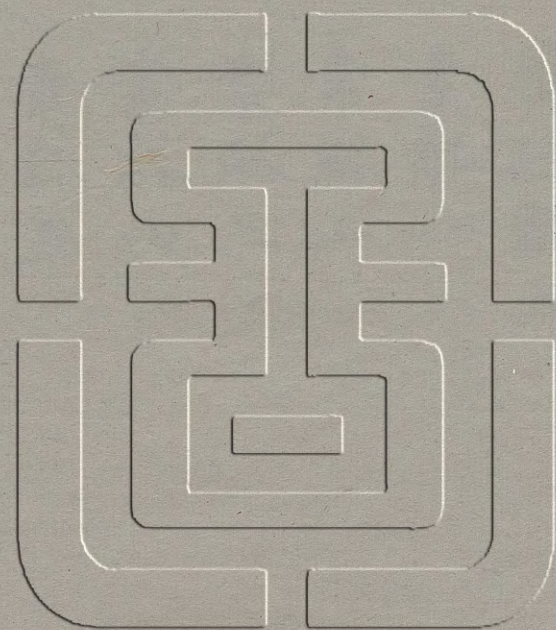

周雲雷觚一

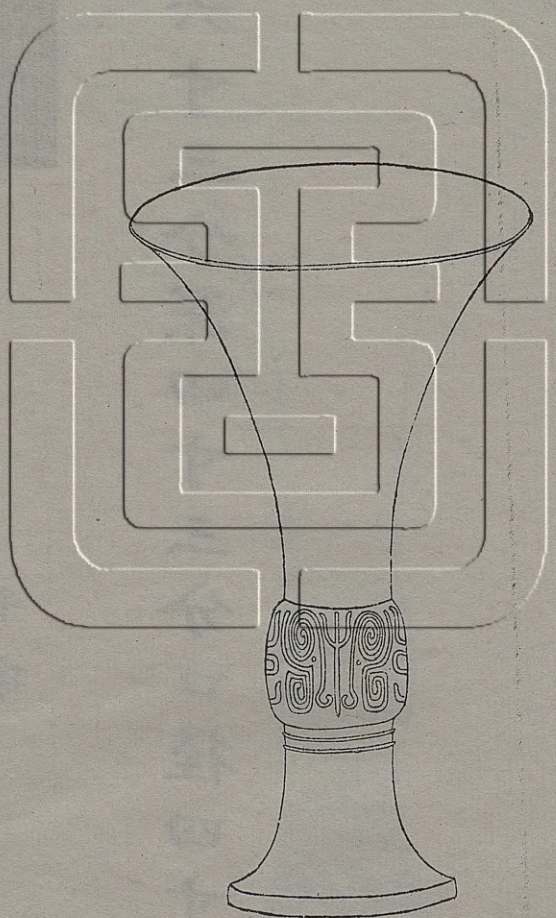



子孫

右高六寸三分深四寸三分口徑四寸重二十一兩

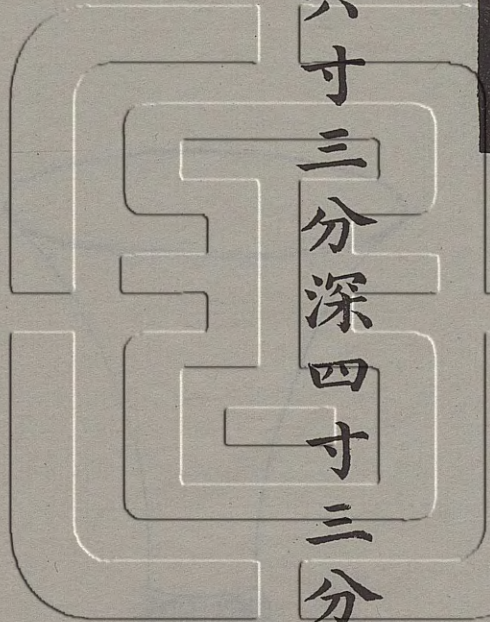

周雲雷觚二

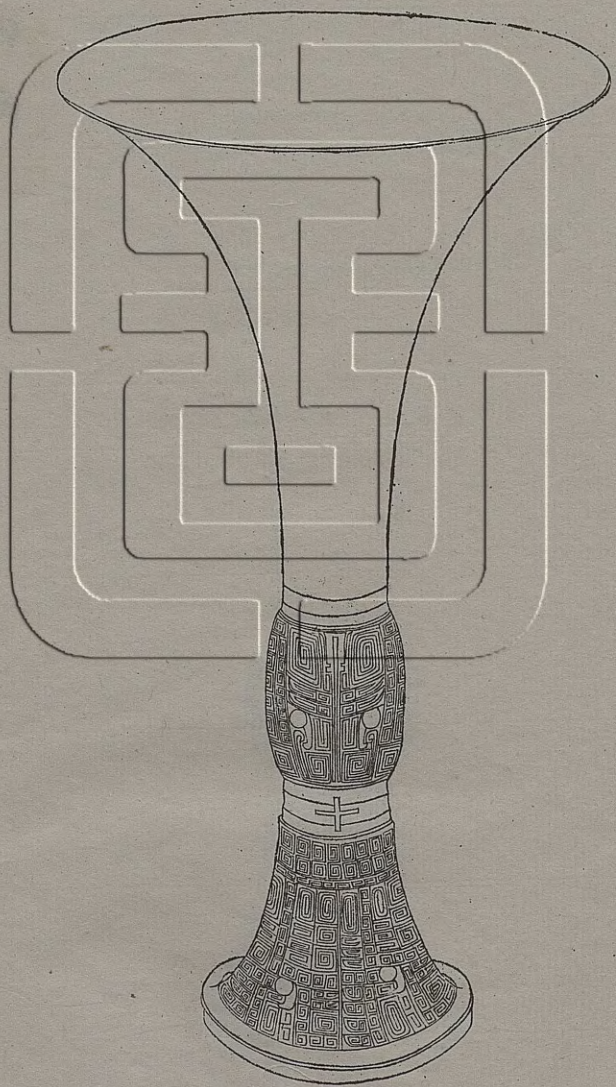

觚

二

右高八寸六分深五寸六分口徑四寸九分重二十四兩

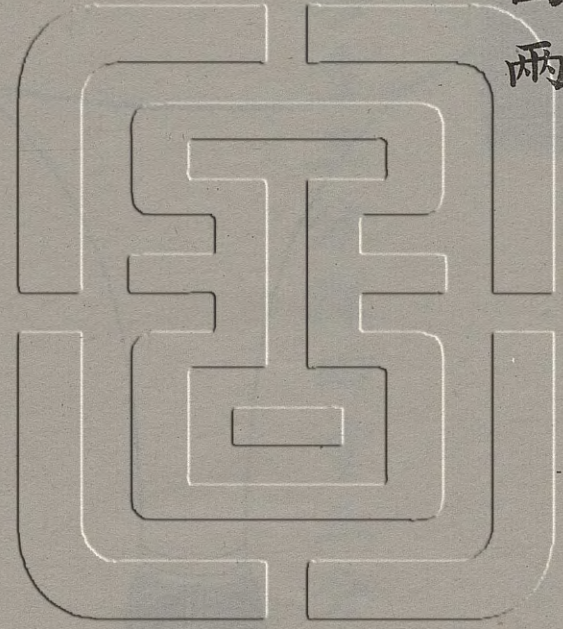

周雲雷觥三

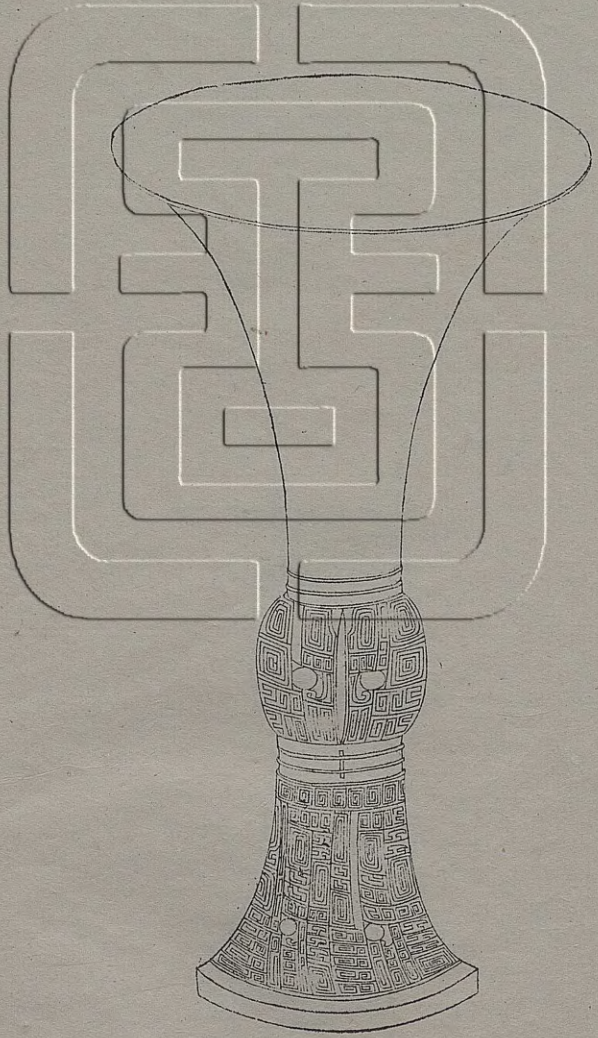

右高八寸深五寸一分口徑四寸六分重二十六兩

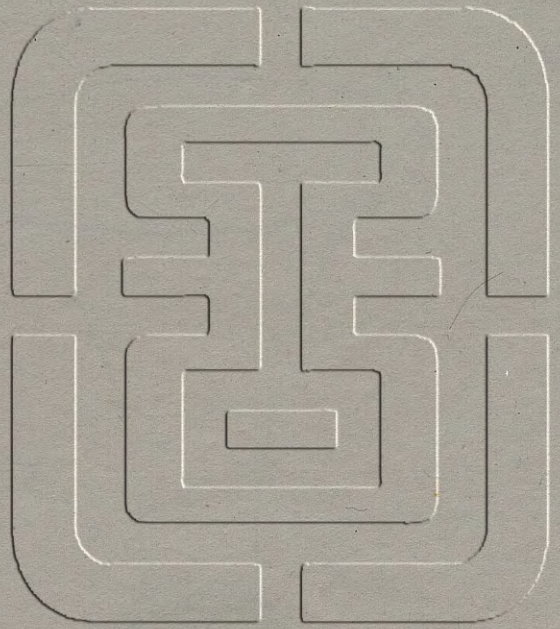

周雲雷觚四

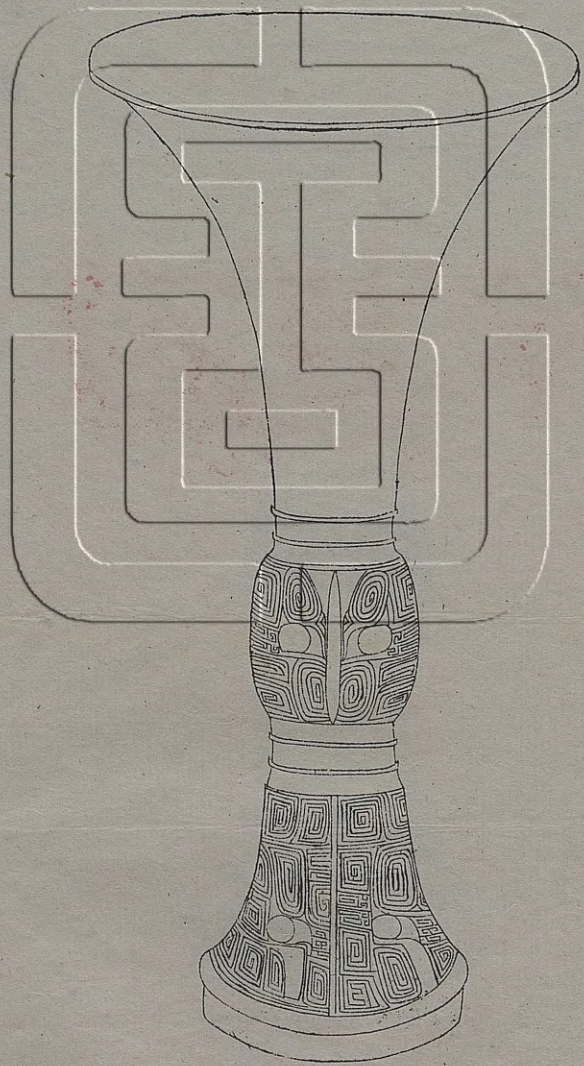

右高七寸九分深五寸三分口徑四寸六分重  
二十四兩

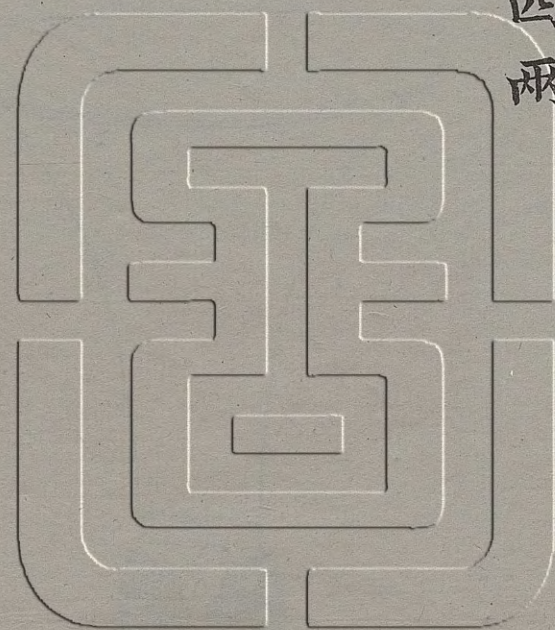

周雲雷觚五

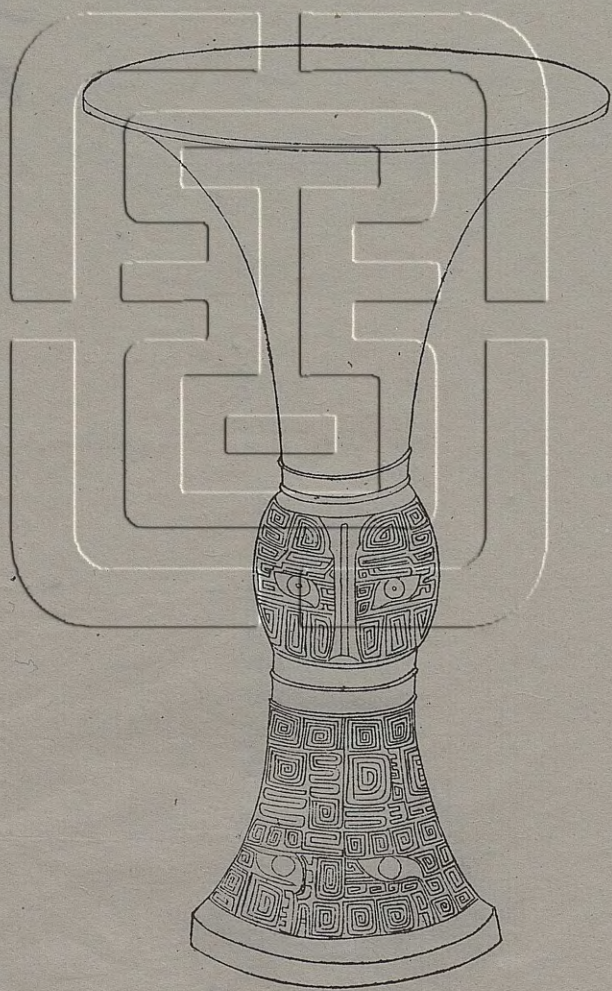

右高七寸八分深五寸二分口徑四寸五分重二十七兩

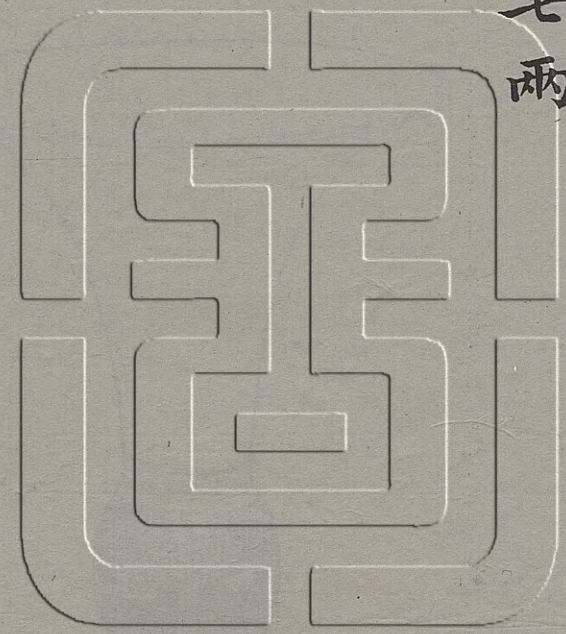

周雲雷觚六

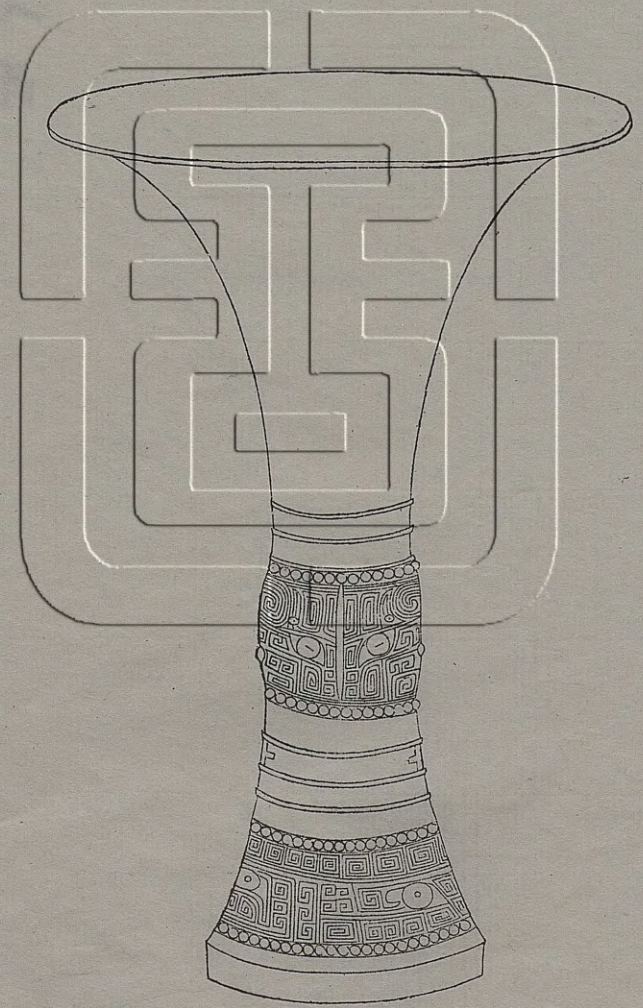

右高七寸七分深五寸二分口徑四寸二分重一十七兩



周雲雷觚七

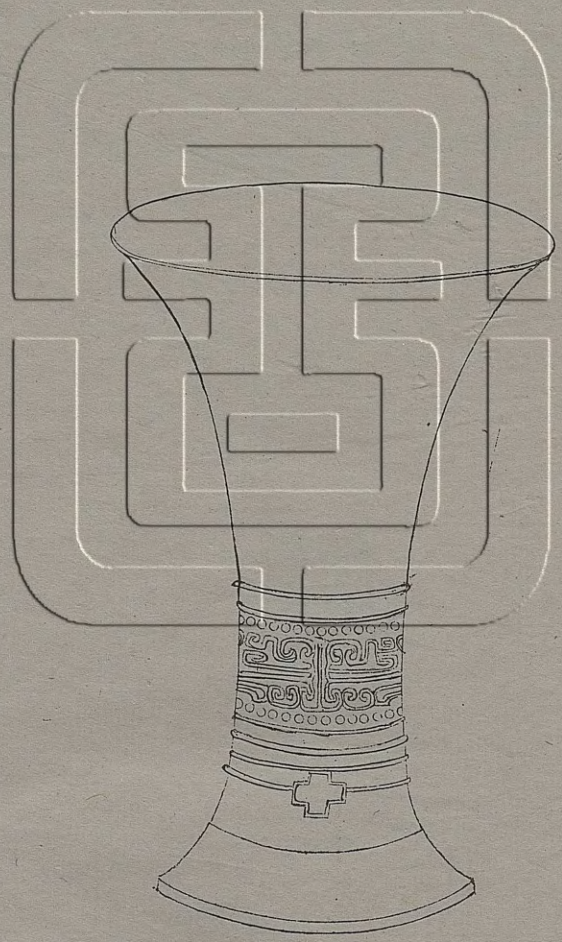

右高五寸八分深四寸四分口徑三寸九分重一十六兩

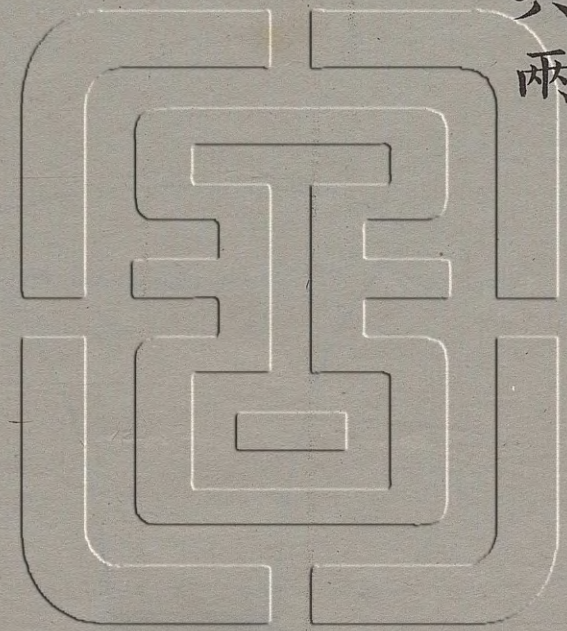

周蟠虺觚

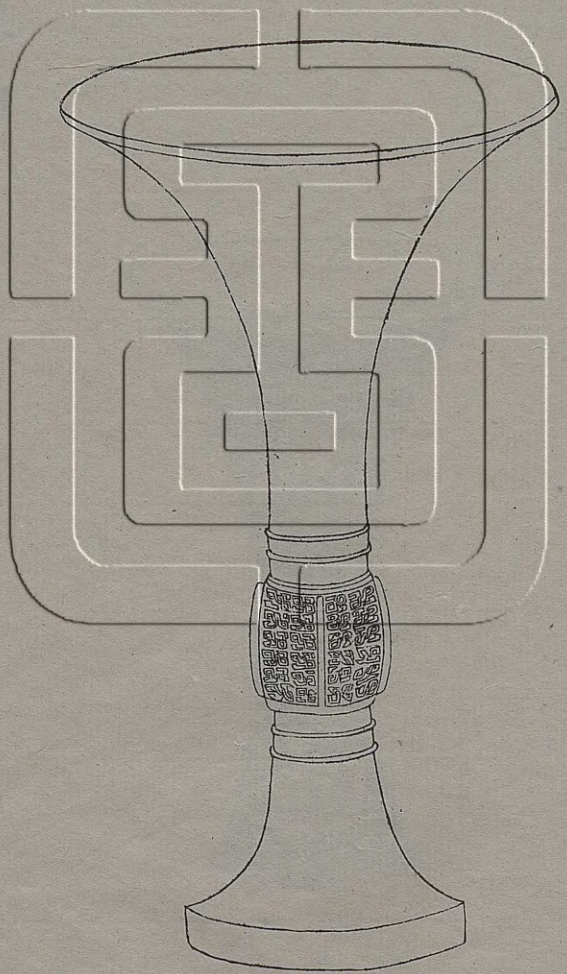



右高七寸五分深五寸九分口徑四寸五分重二十五兩

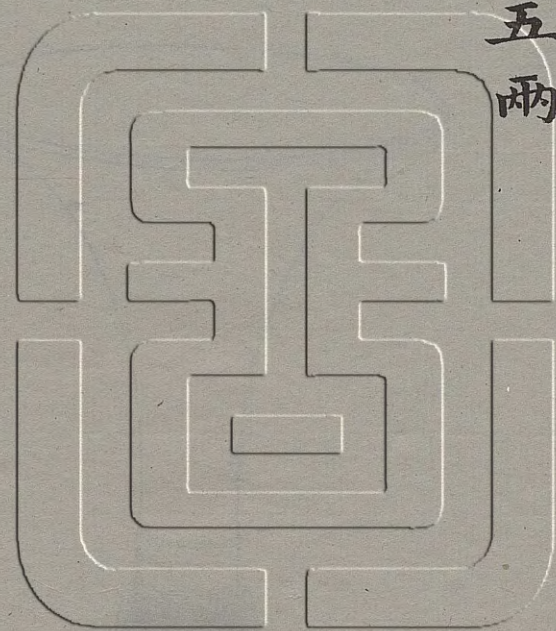

周蟠螭觚

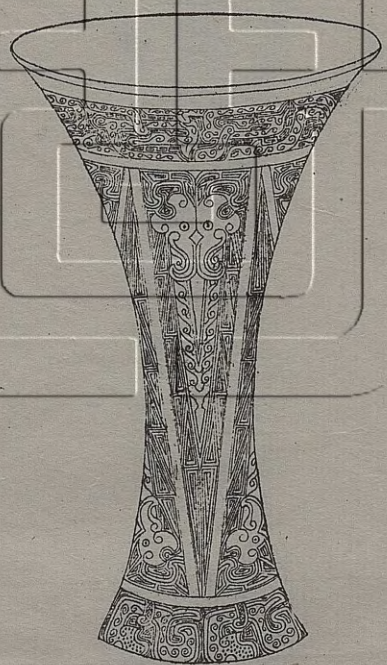
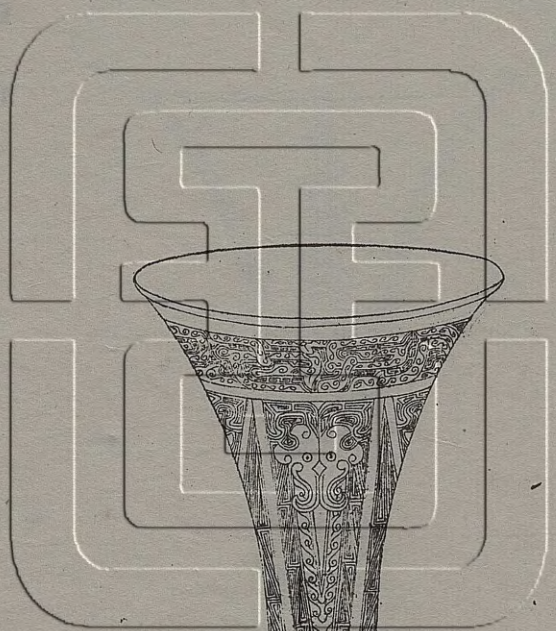

右高六寸二分深四寸二分口徑三寸五分重一十四兩

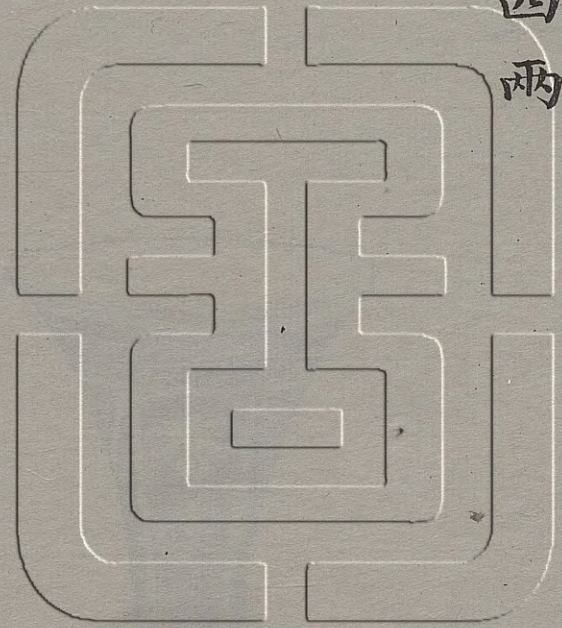

周饗簋一

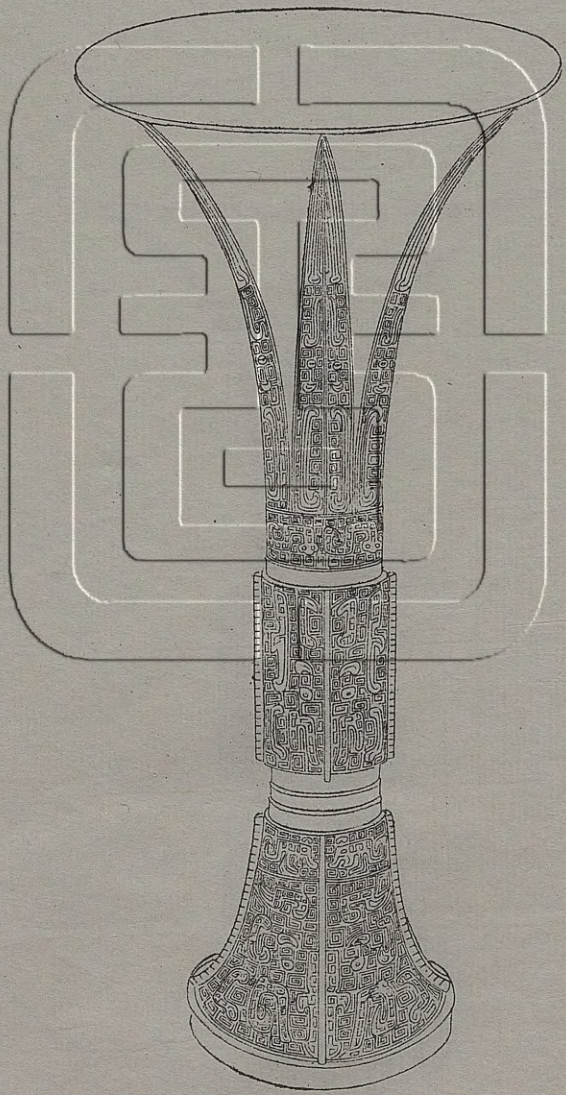

右高一尺二分深七寸一分口徑五寸重三十兩

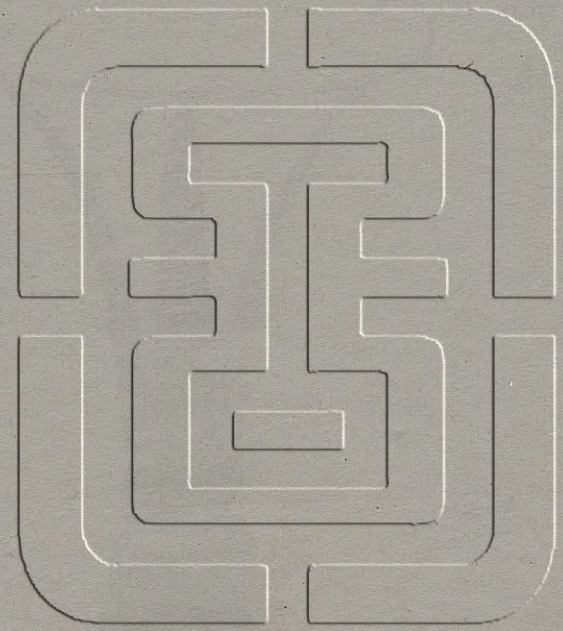

周饗饗觚二

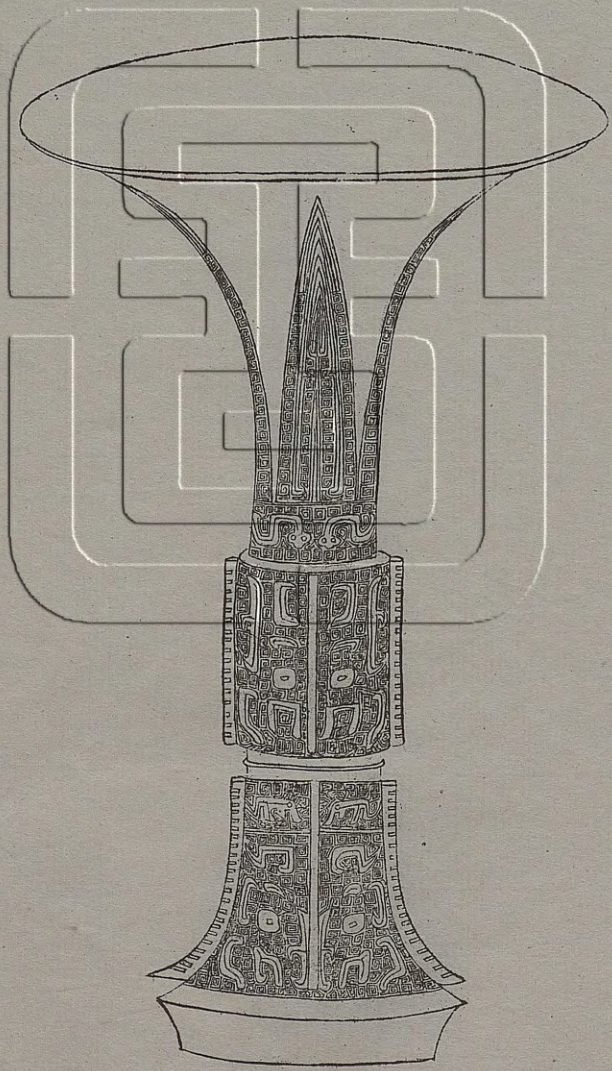

右高九寸八分深六寸六分口徑五寸四分重四十一兩

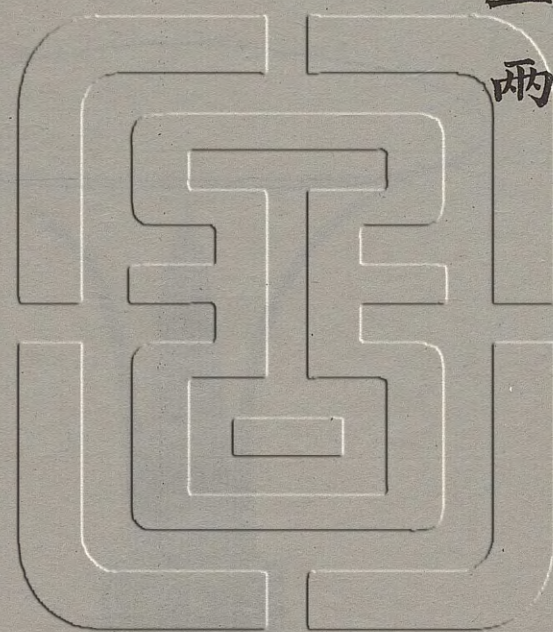

周饗餐觚三

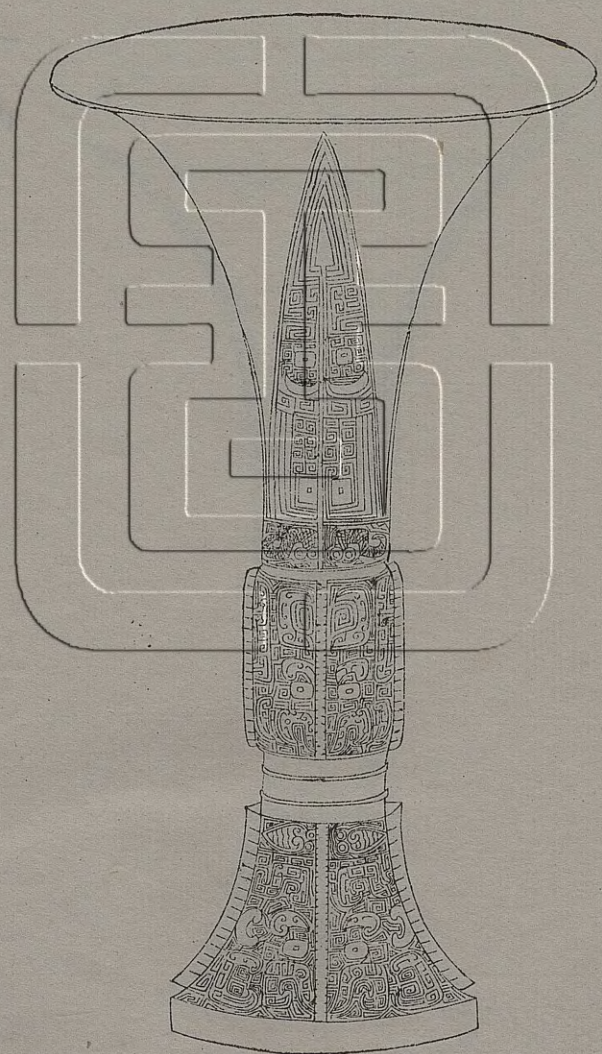

右高九寸四分深六寸六分口徑五寸一分重三十一兩

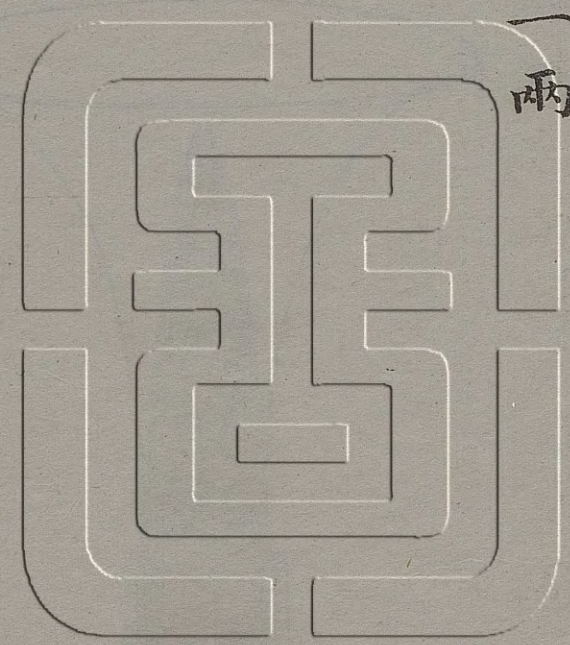

周饗饗觚四

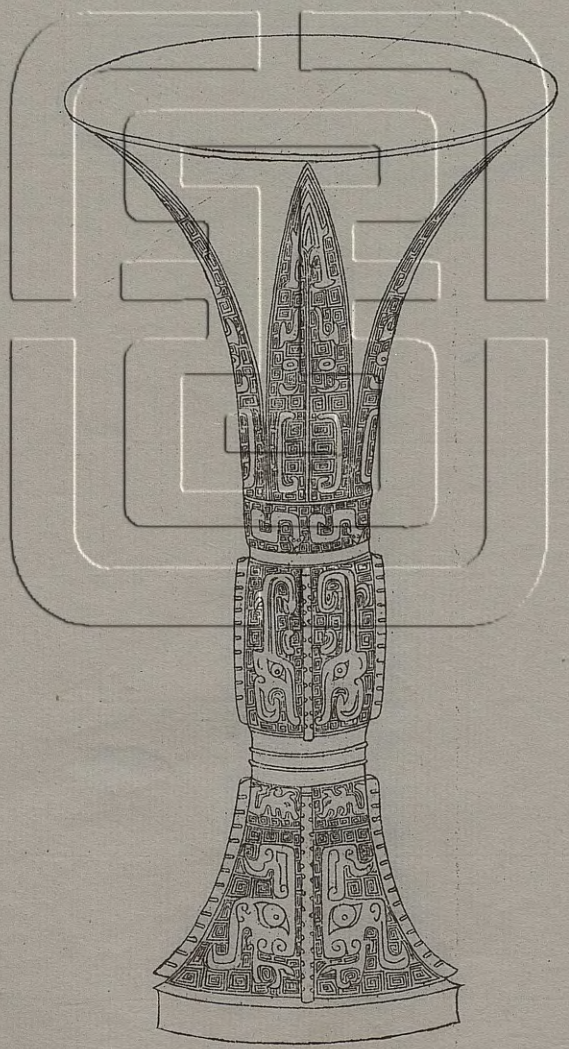

右高九寸四分深六寸口徑五寸一分重二十八兩

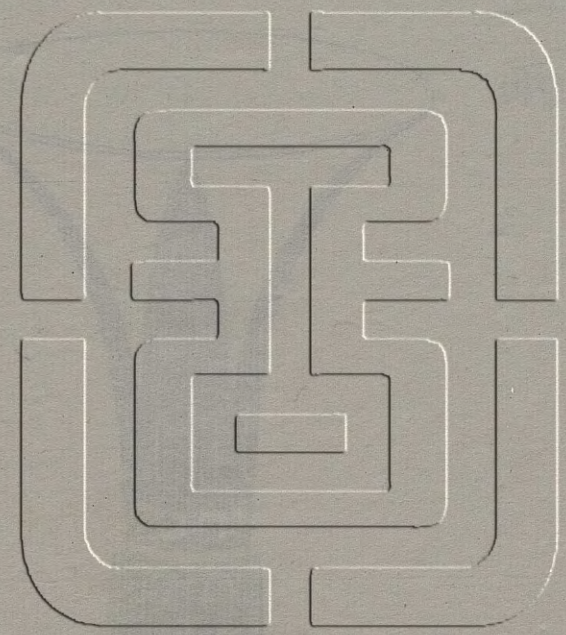

周饗饗觚五

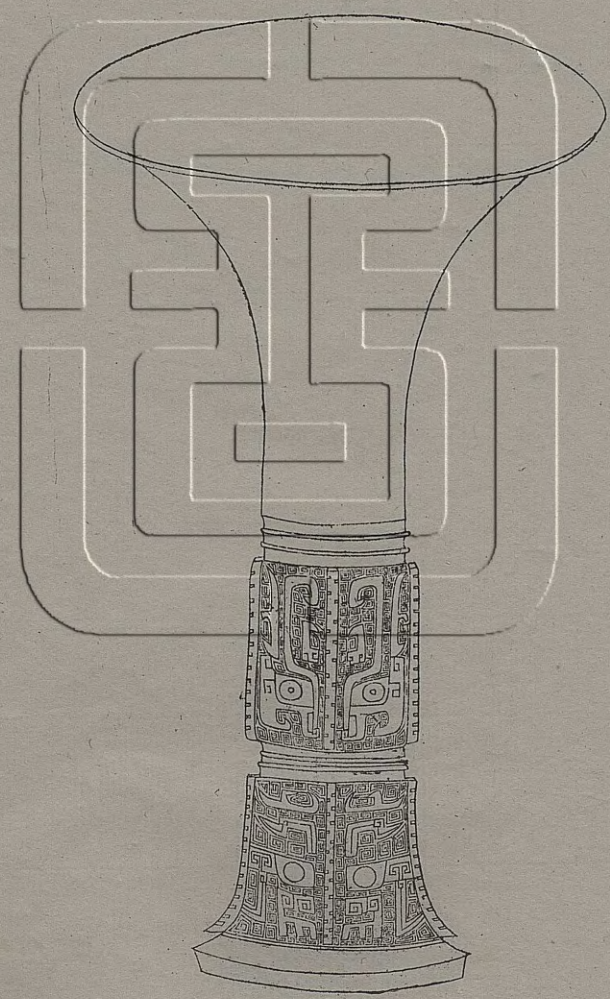

右高九寸深六寸三分口徑五寸一分重二十四兩

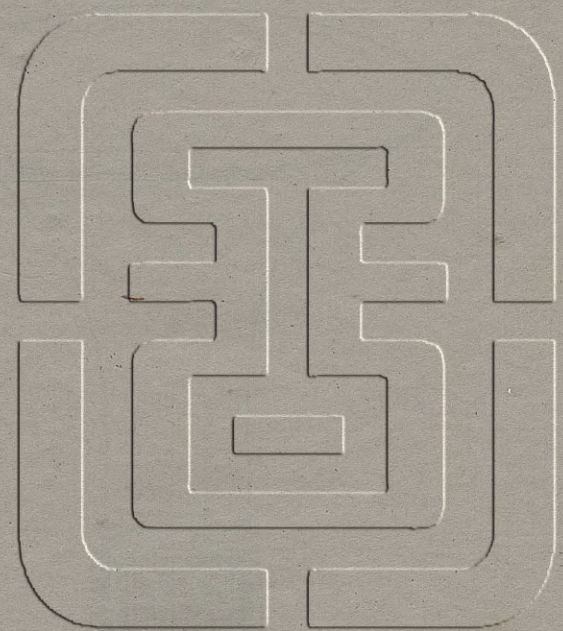

周饗饗觚六

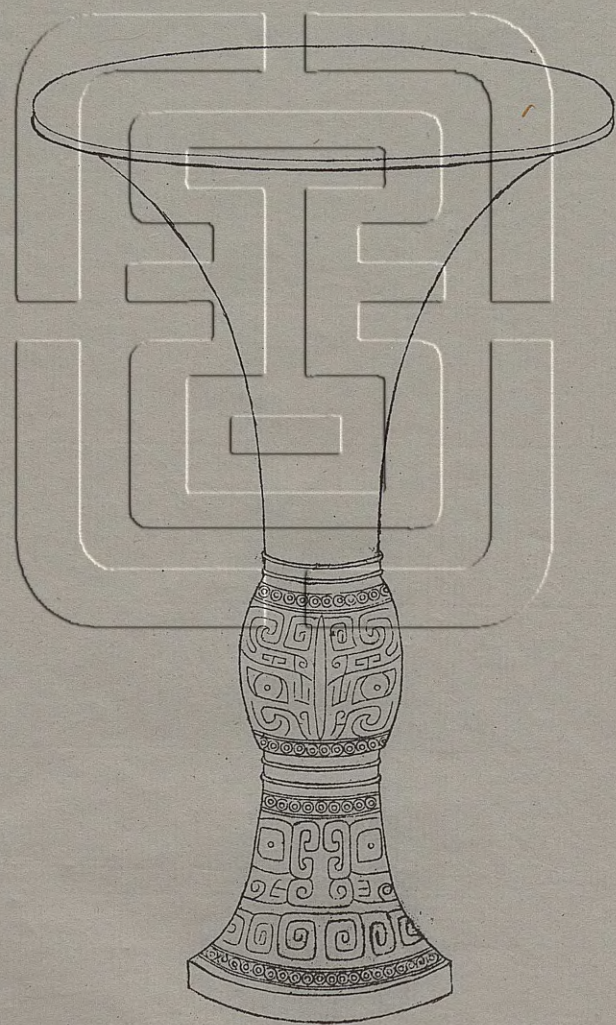

右高九寸一分深六寸一分口徑四寸九分重二十五兩

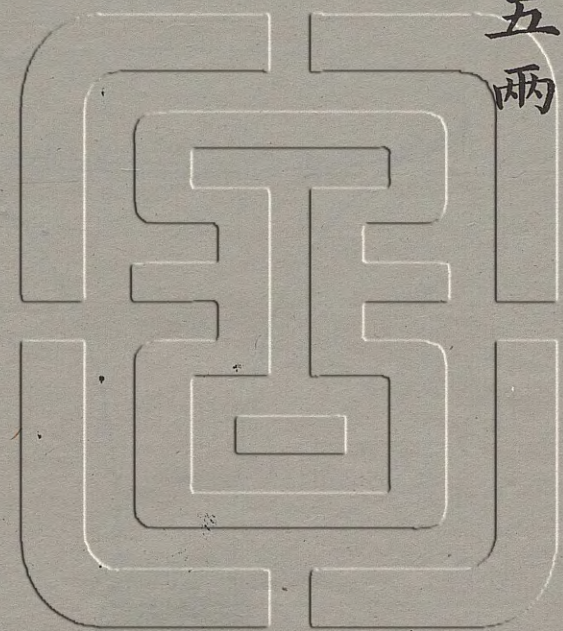

周饕餮觚七

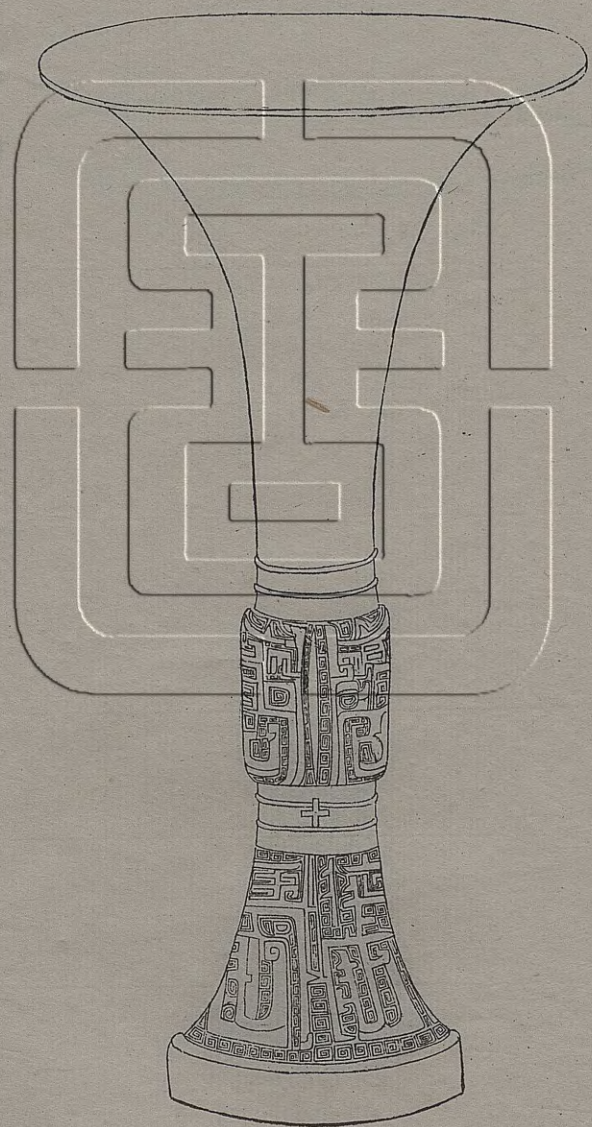



右高九寸二分深六寸二分口徑四寸八分重  
二十二兩

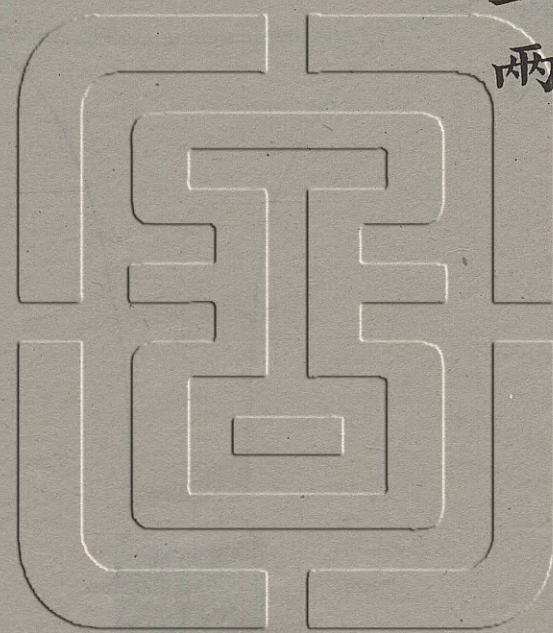

周饗饗觚八

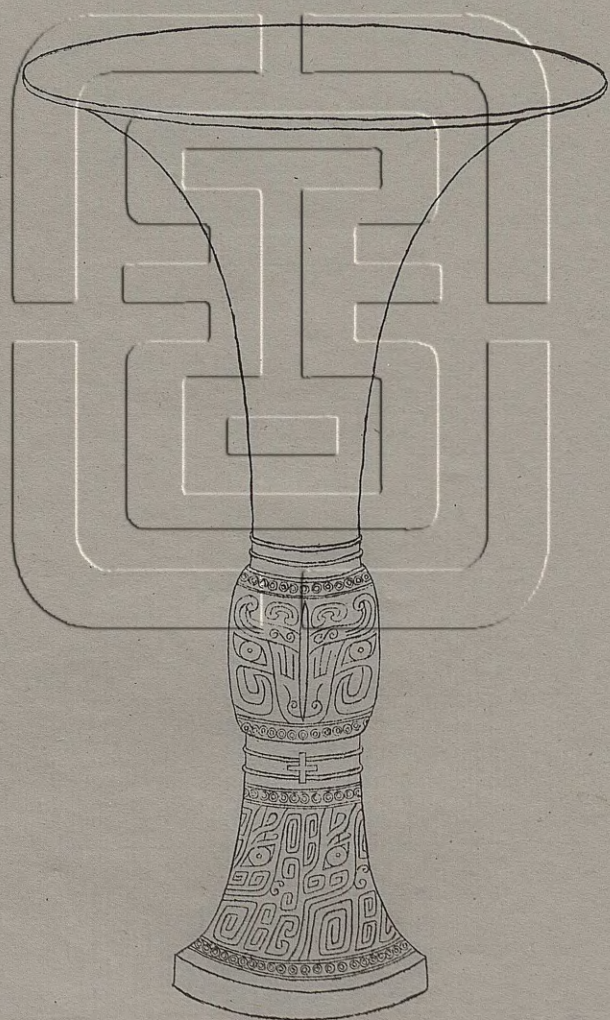

右高九寸二分深六寸五分口径四寸九分重二十一兩

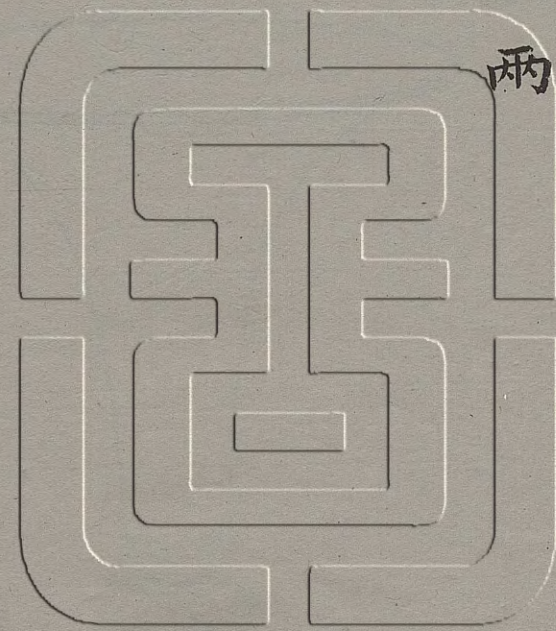

周饗饗觚九

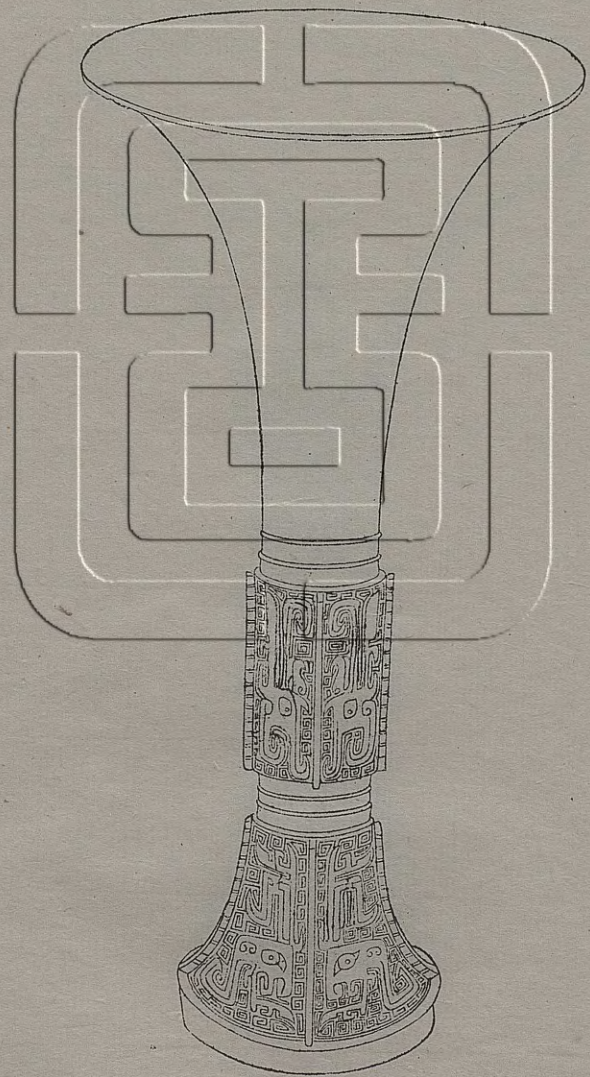

右高九寸九分深六寸四分口徑五寸重二十五兩

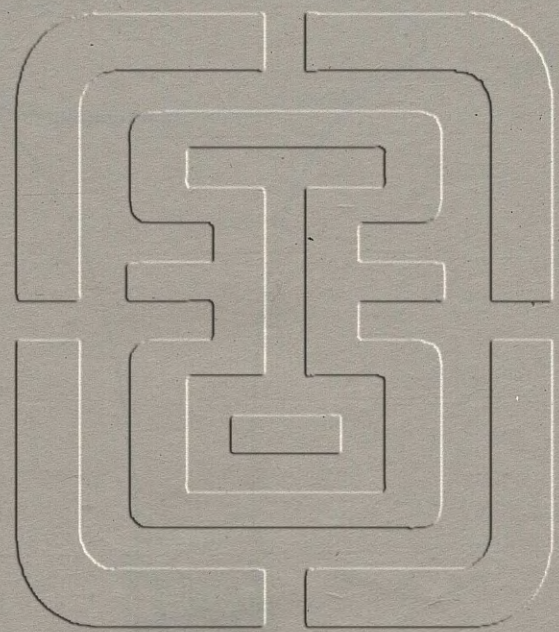

周饗饗觚十

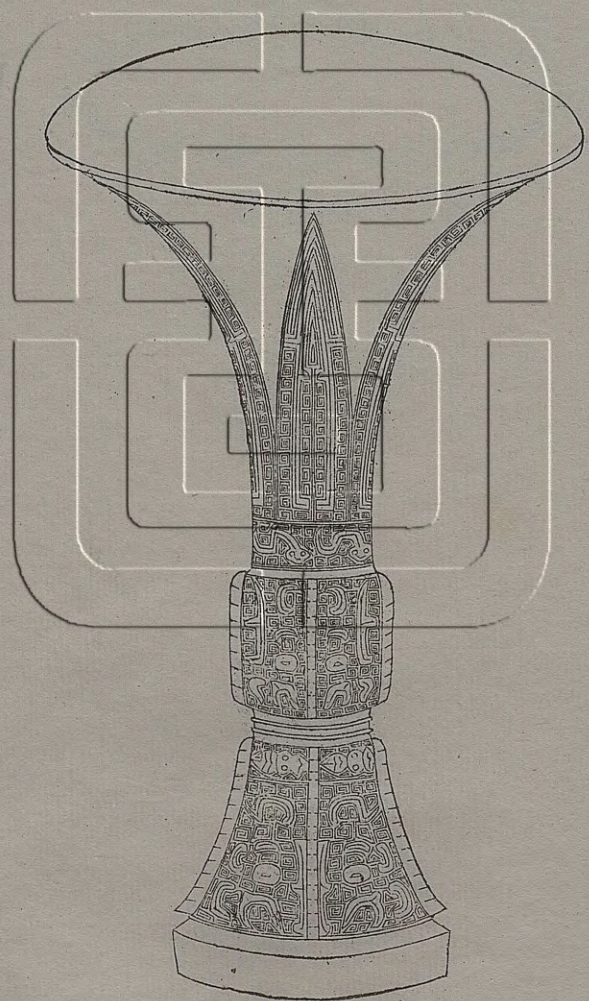

右高八寸四分深五寸四分口徑四寸六分重三十一兩

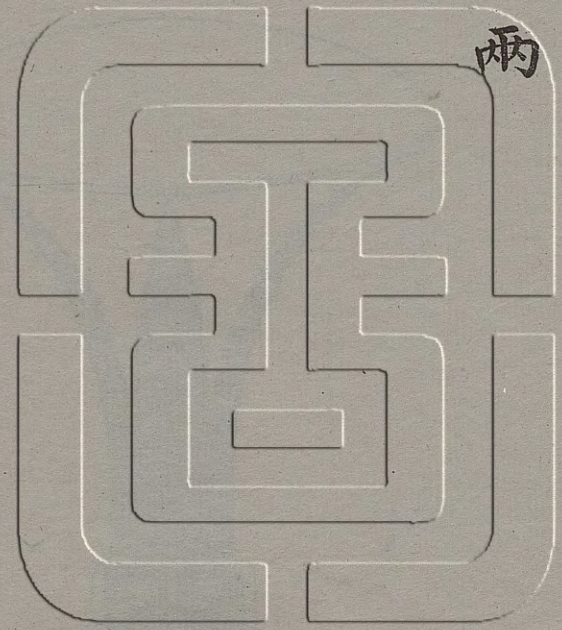

周饗饗觚十一

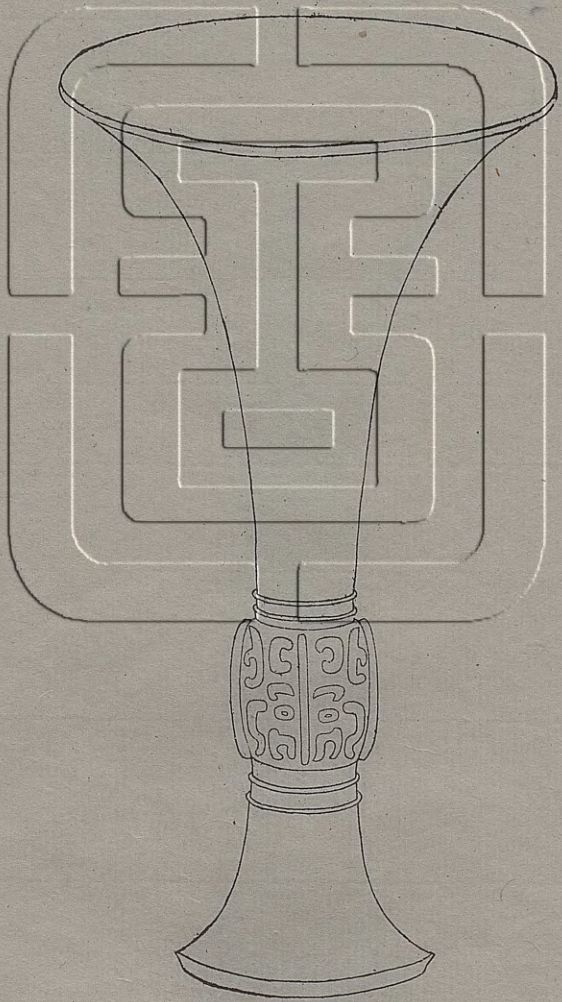

右高六寸四分深四寸六分口徑四寸重二十一兩

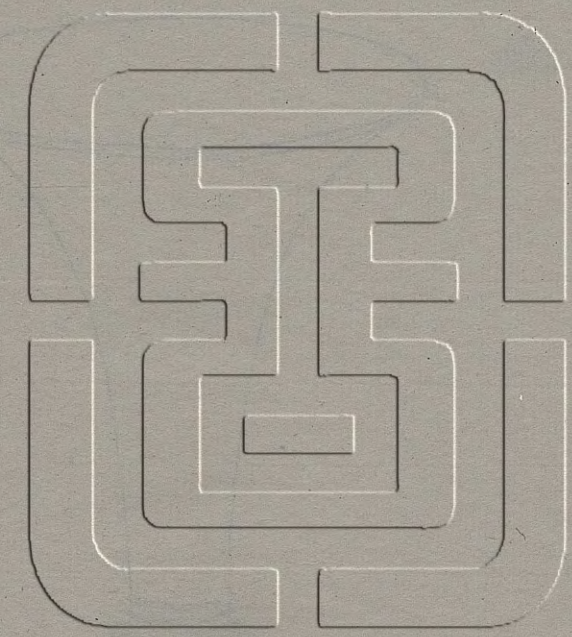

周饗饗觚十二

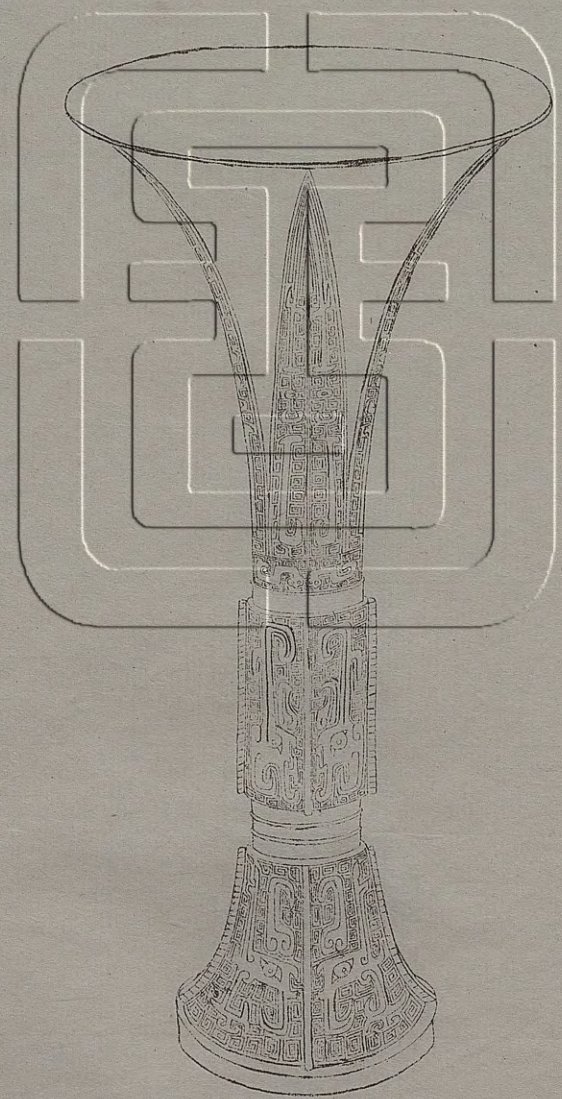

觚

右高八寸三分深四寸九分口徑四寸六分重  
二十三兩

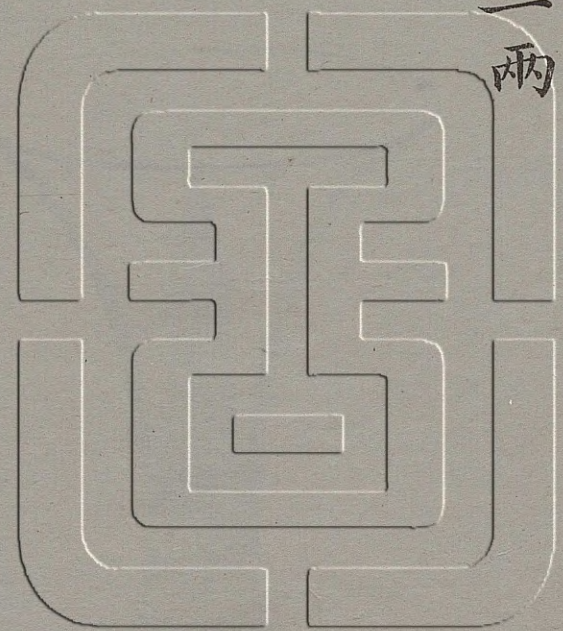

周寶簠觚十三

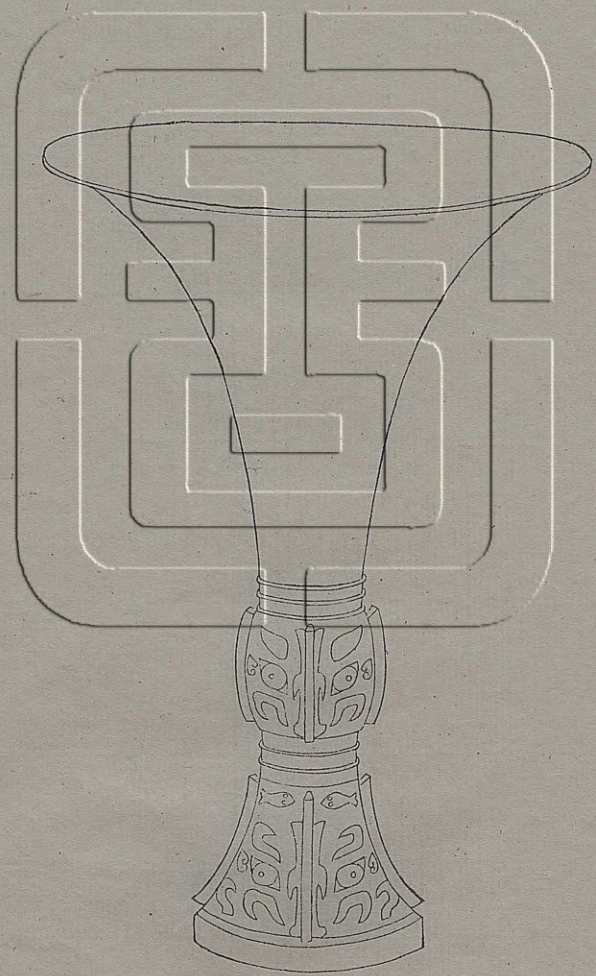

右高八寸一分深五寸一分口徑五寸重二十七兩

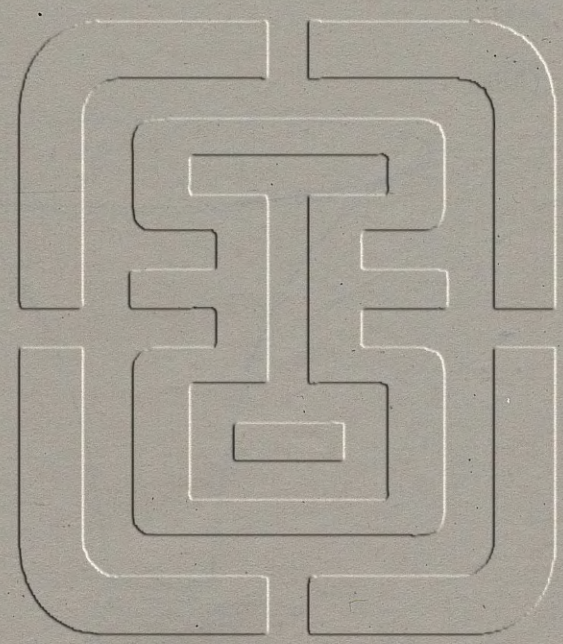

周饗簠觚十四

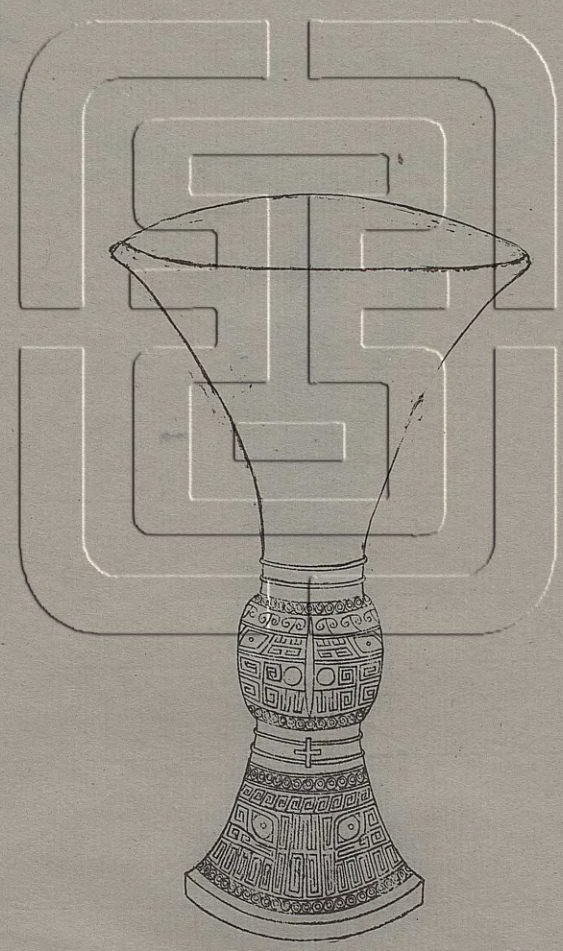

周饗簠觚十四

右高七寸五分深五寸二分口徑四寸一分重一十五兩

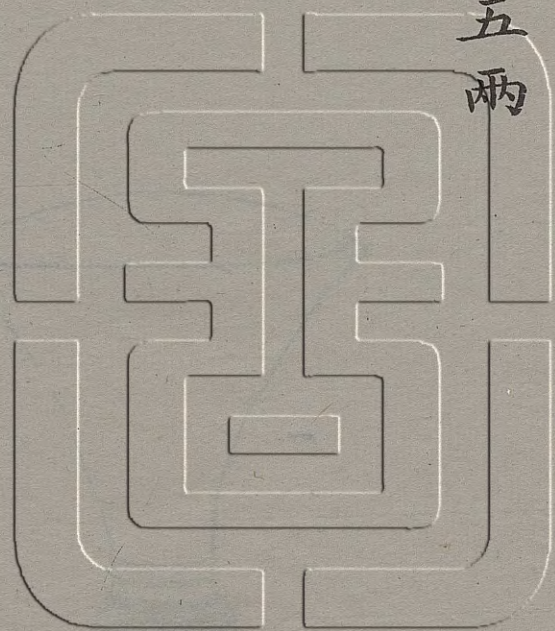

周饗餐簠十五

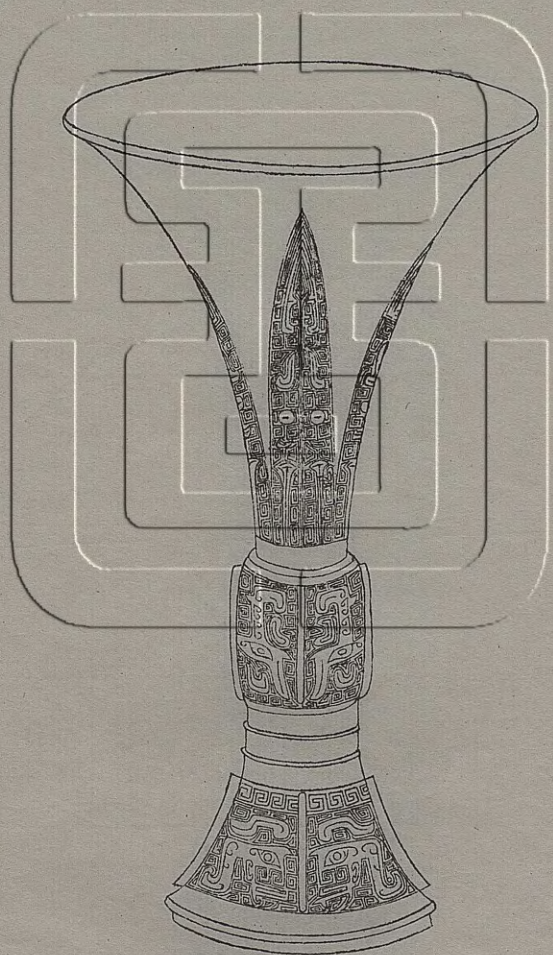



右高七寸四分深五寸三分口徑四寸五分重  
二十兩

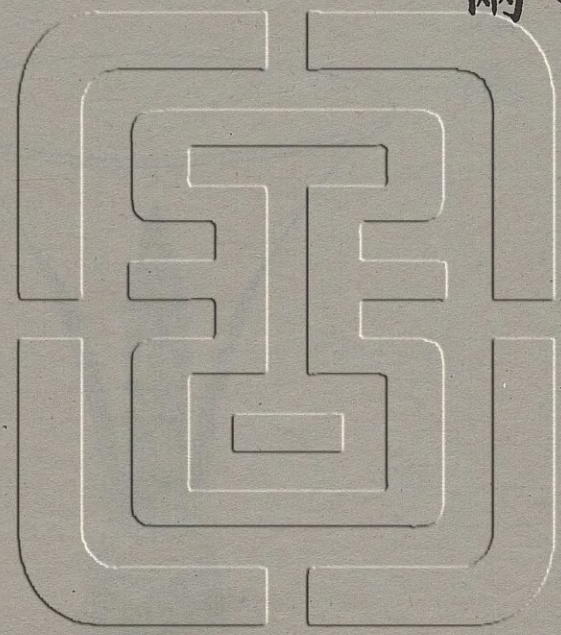

周饗餐觚十六

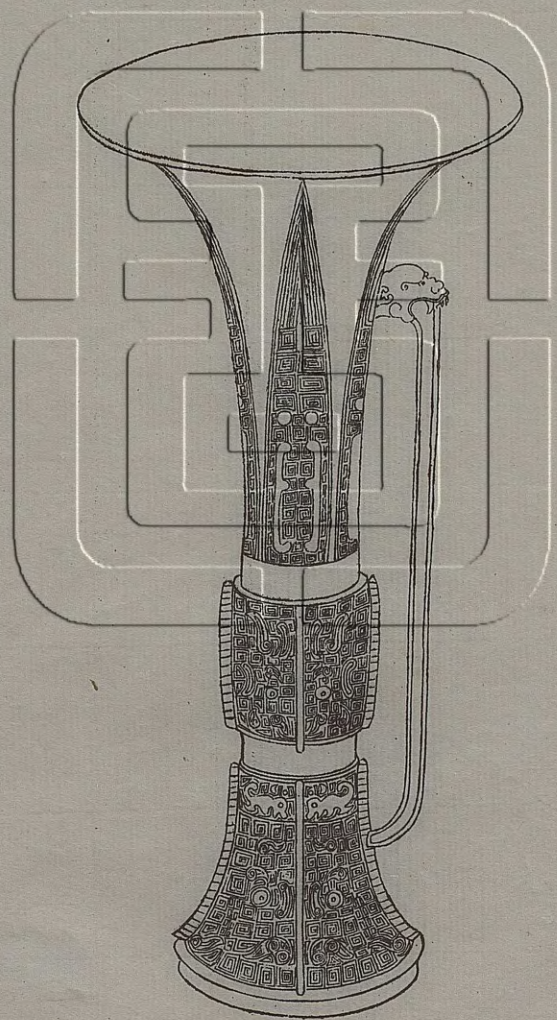

右高七寸九分深五寸九分口徑四寸一分重二十一兩有鑿與他製特異

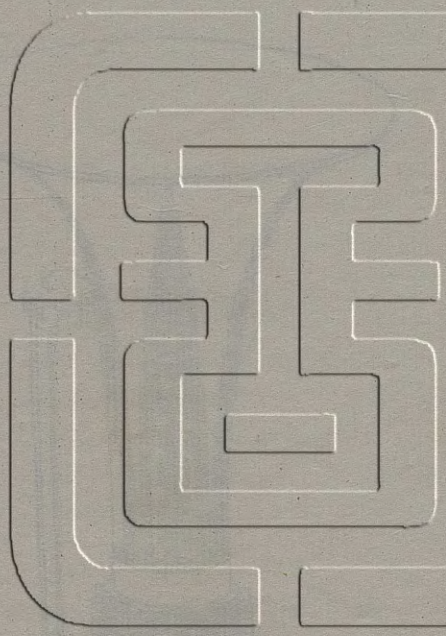

周鬯餐餐觚十七

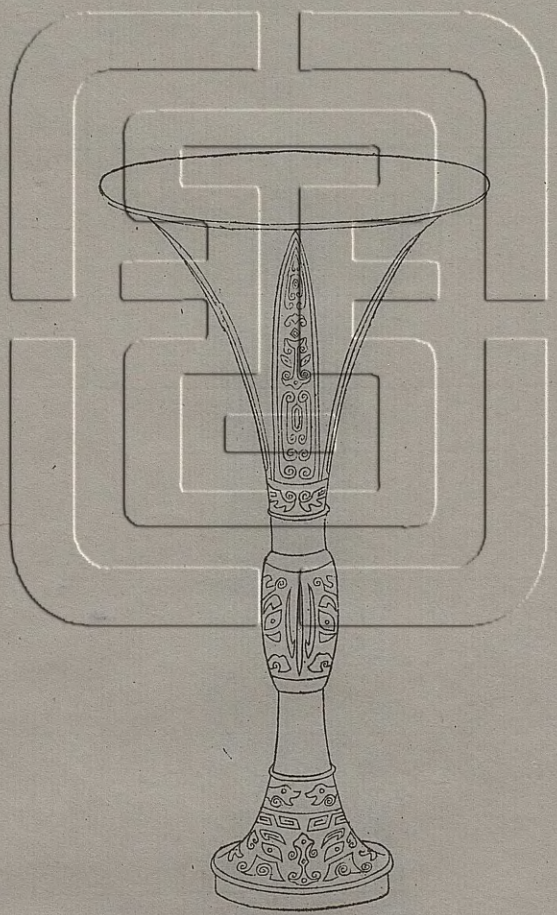

右高八寸三分深五寸五分口徑四寸三分重二十七兩金銀錯

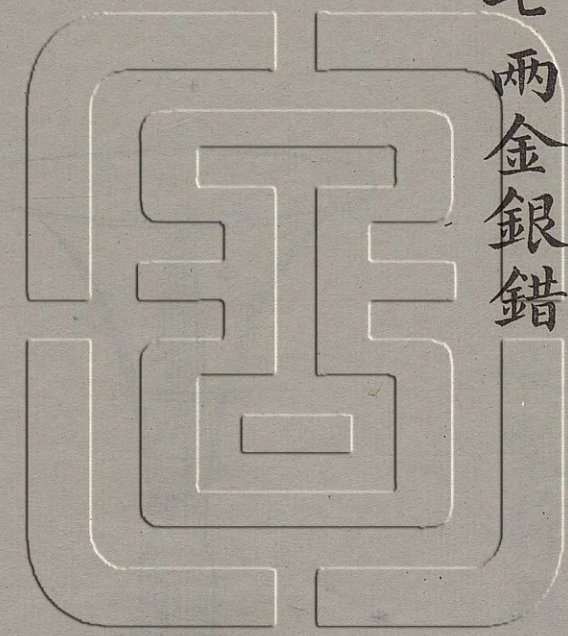

周夔紋觚一

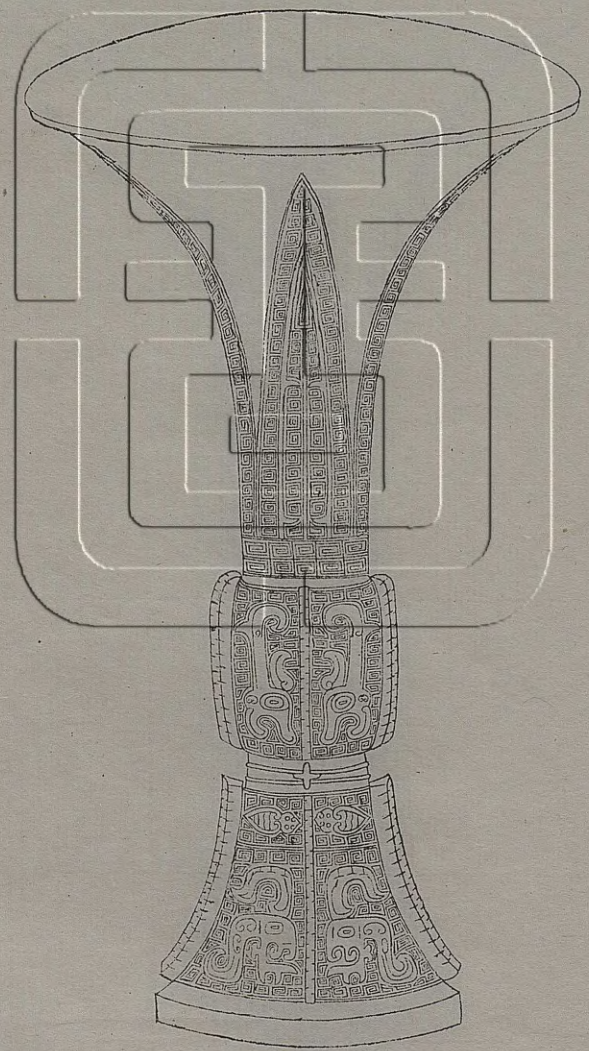

西清古鏡 卷二十一 觚

右高九寸五分深六寸六分口徑五寸一分重二十九兩

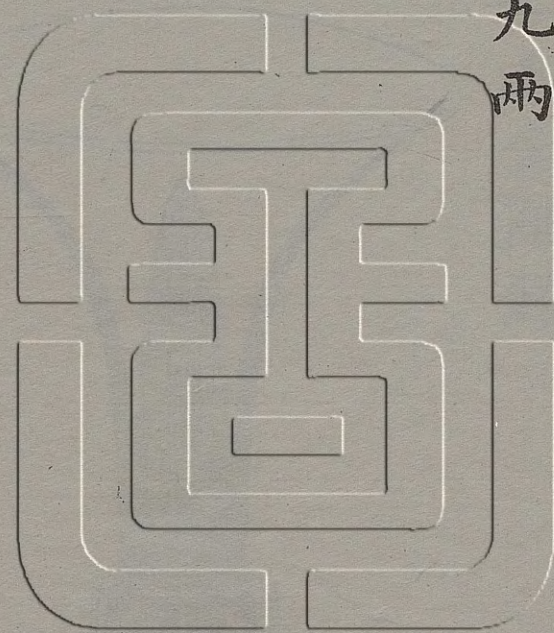

周夔紋觚二

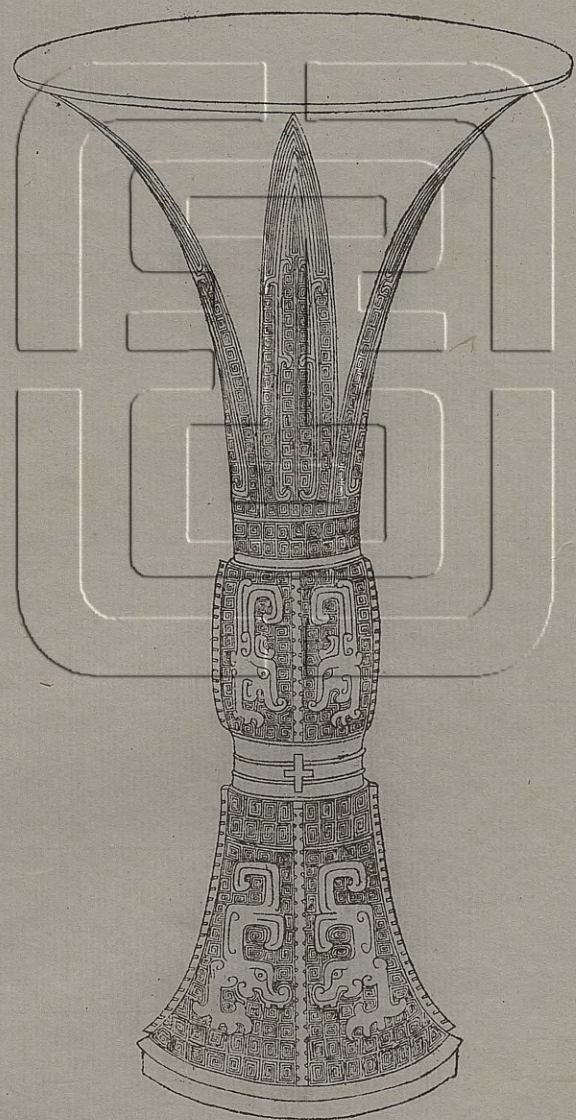

右高八寸五分深五寸四分口徑四寸八分重二十八兩

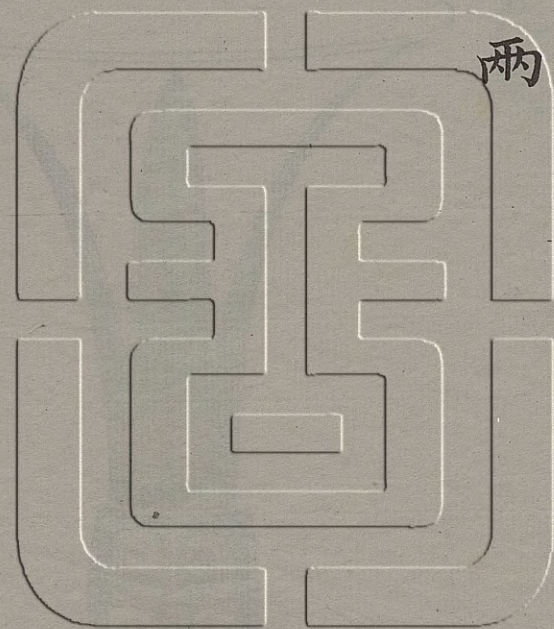

周夔紋觚三

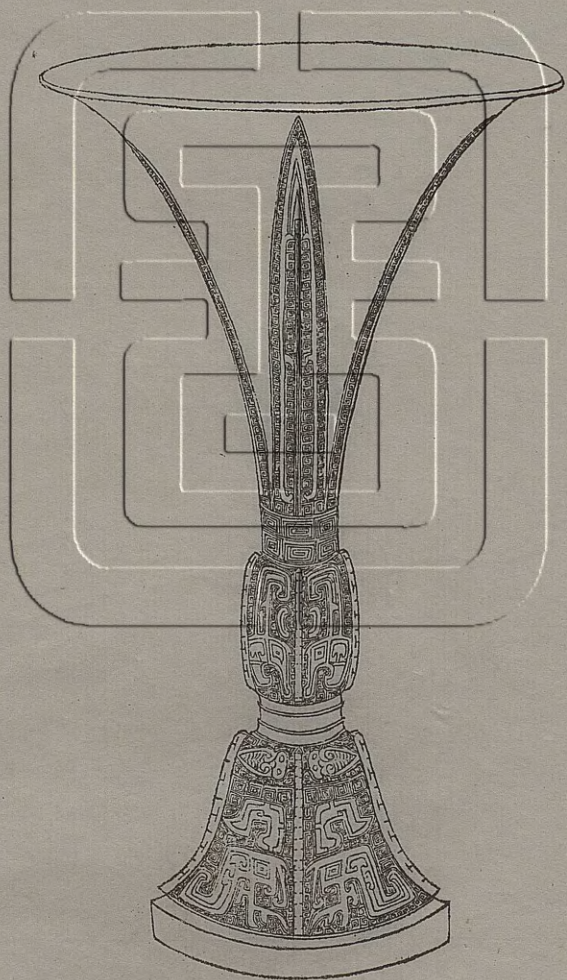

右高九寸五分深六寸六分口徑五寸一分重一十九兩

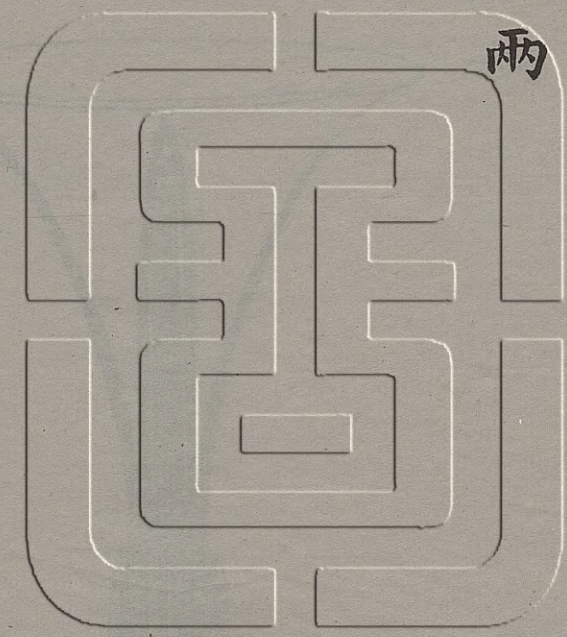

周素觥一

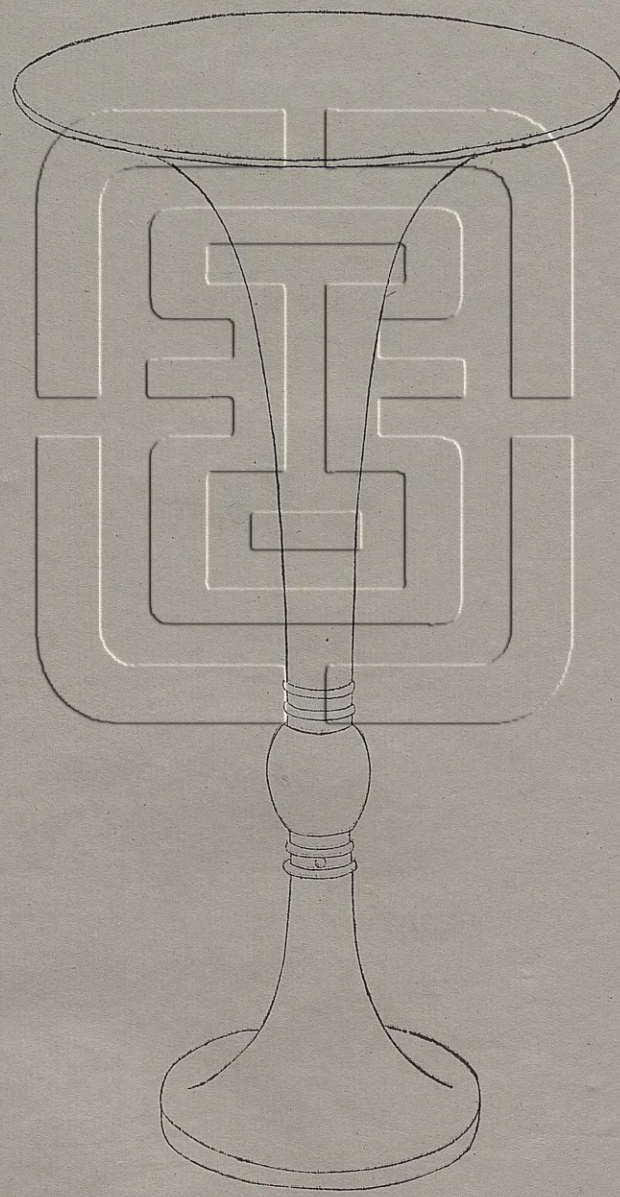

右高一尺八分深六寸八分口徑六寸五分重五十九兩

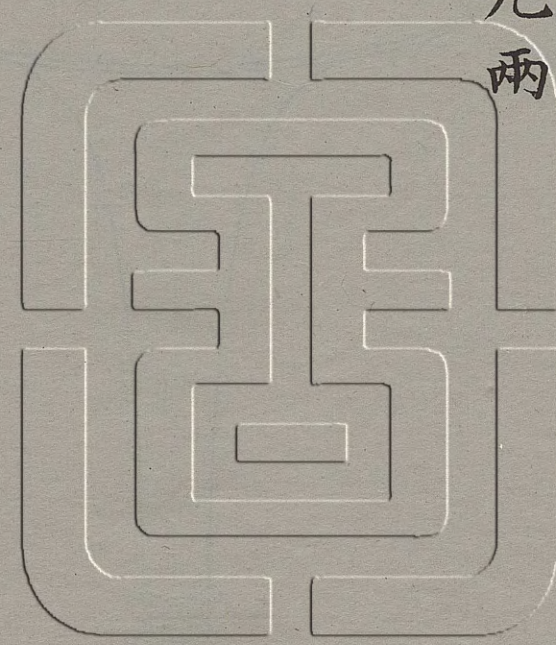

周素觚二

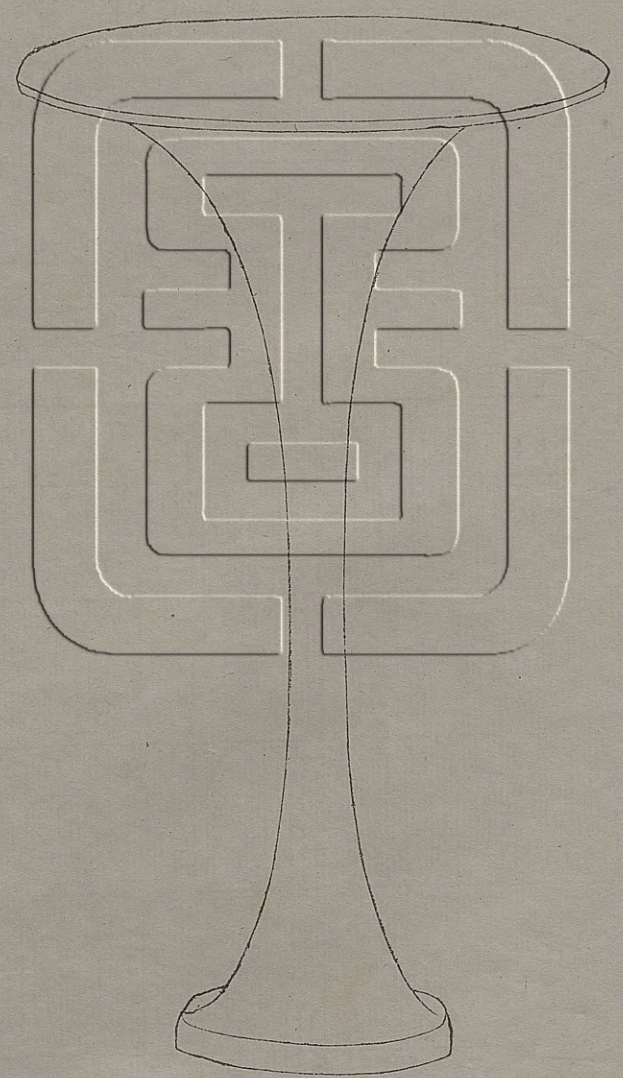

右高一尺四分深七寸口徑六寸重四十三兩

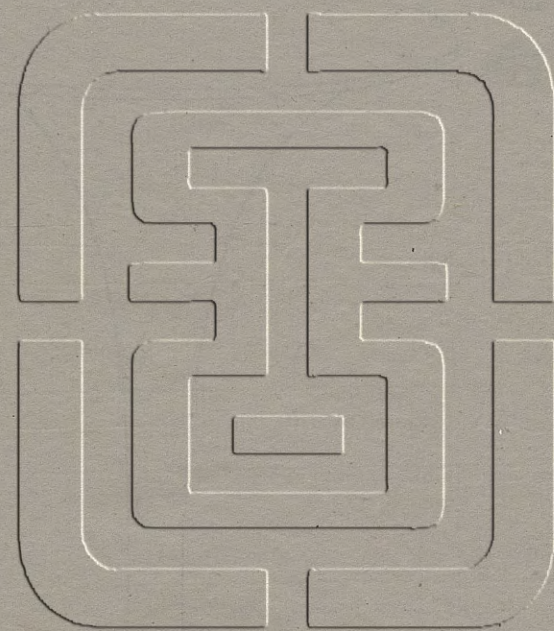

周素觚三

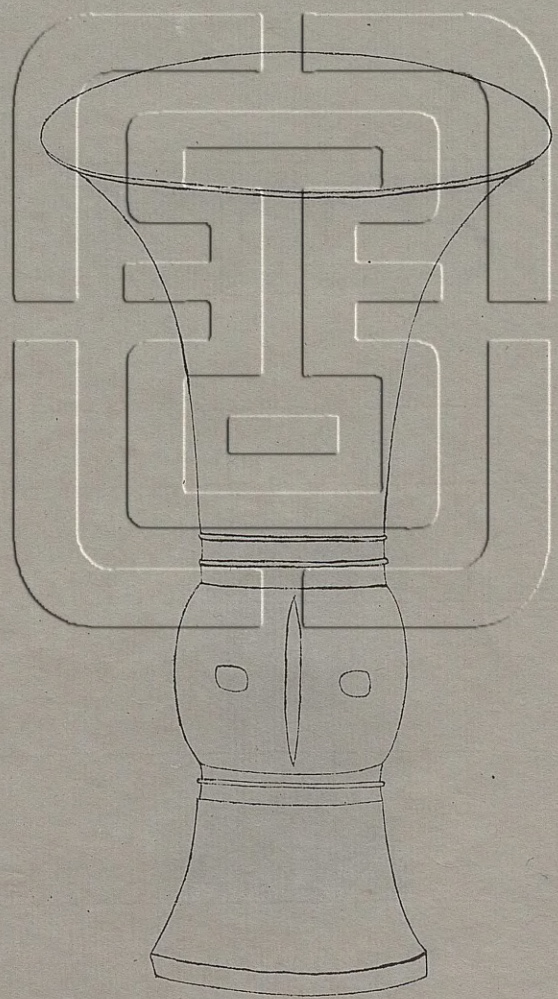



右高八寸五分深五寸八分口徑四寸七分重三十六兩

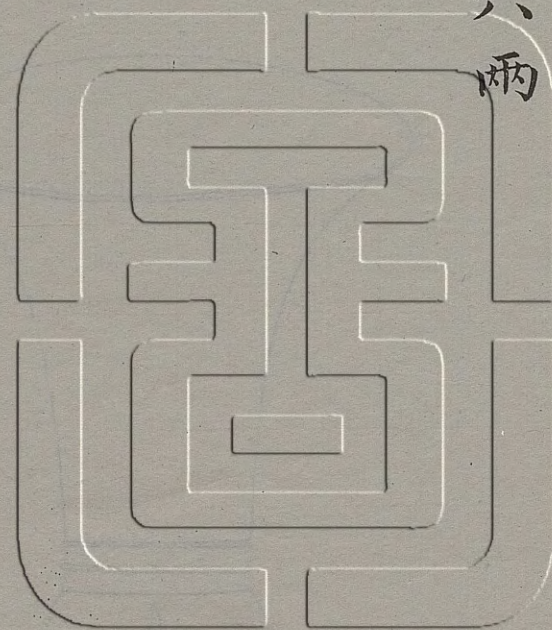

周素觚四

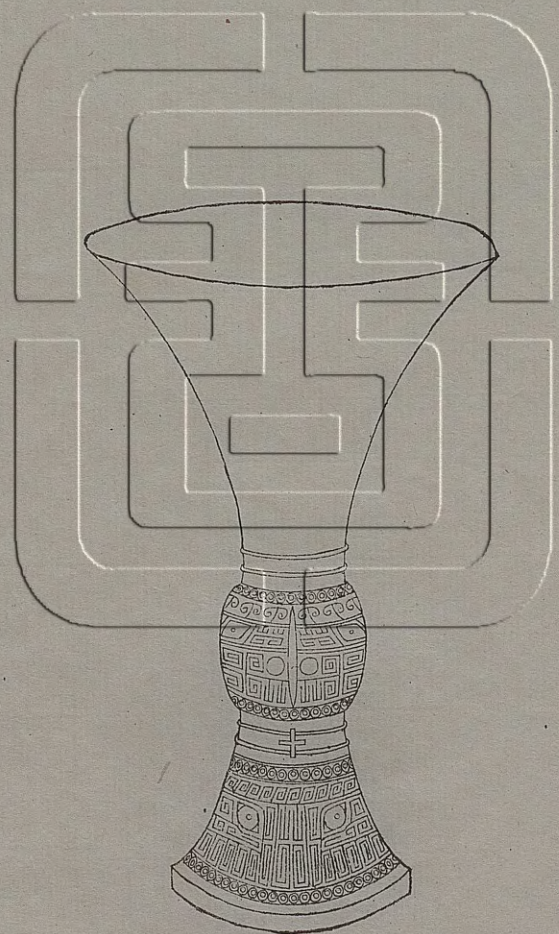

右高八寸二分深五寸六分口徑五寸重三十四兩

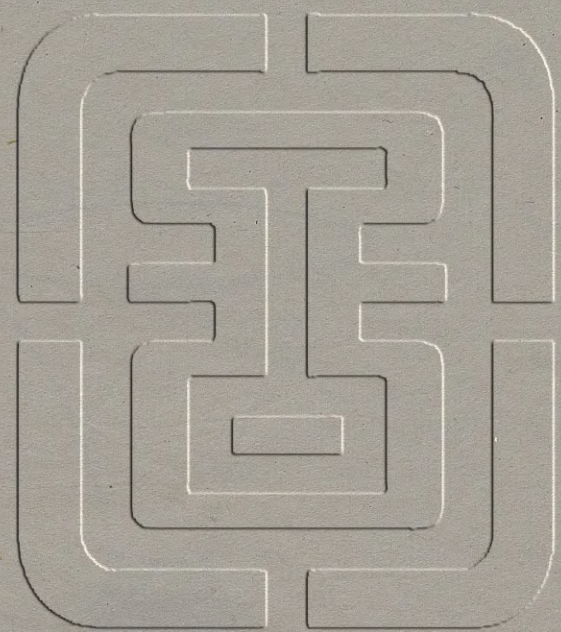

周素觚五

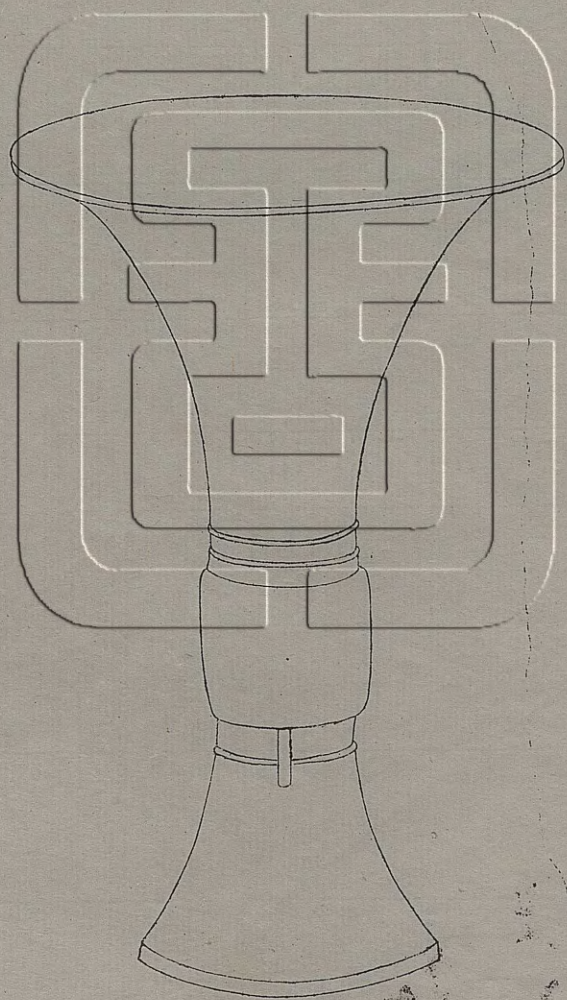

右高七寸九分深五寸二分口徑五寸重三十兩

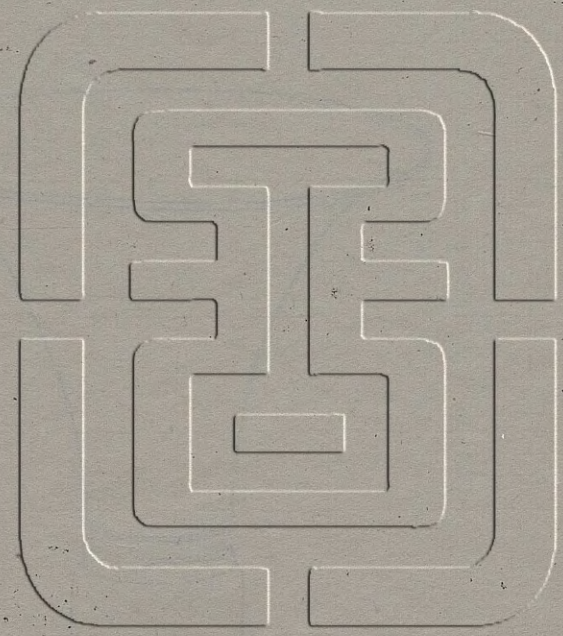

周素觚六

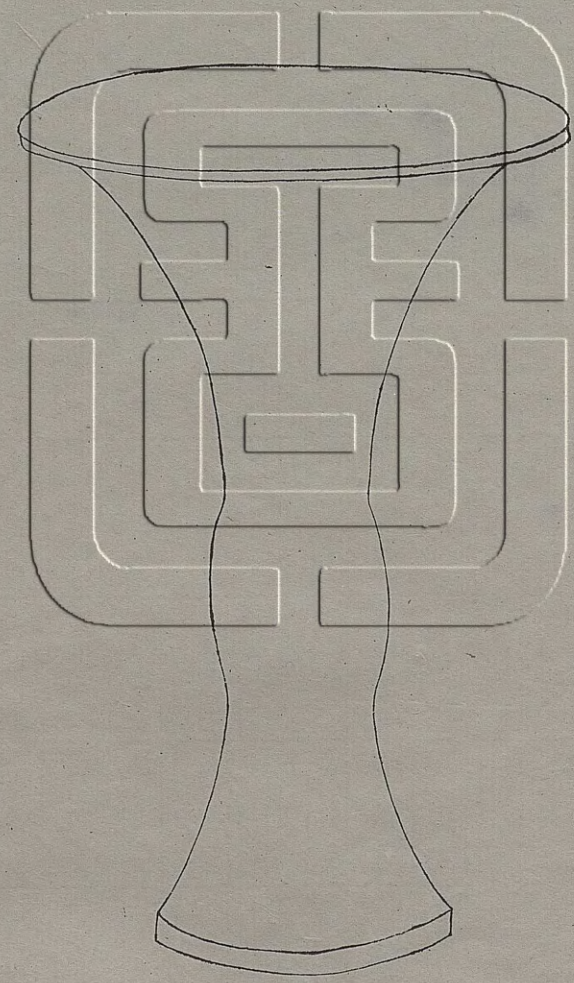

右高七寸六分深五寸二分口徑四寸五分重二十一兩

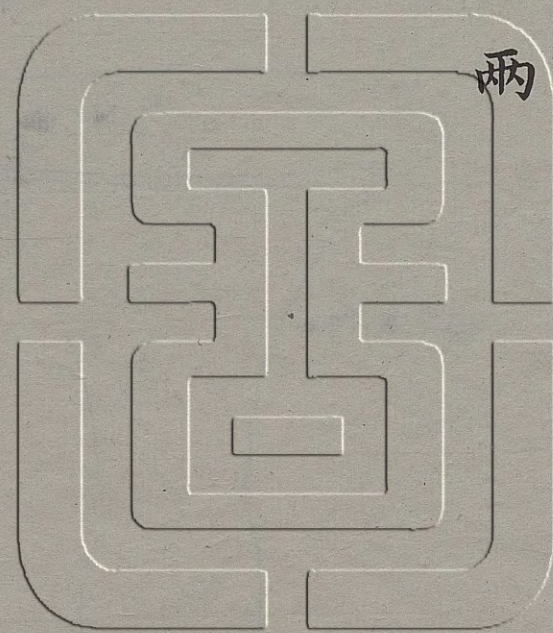

周素觚七

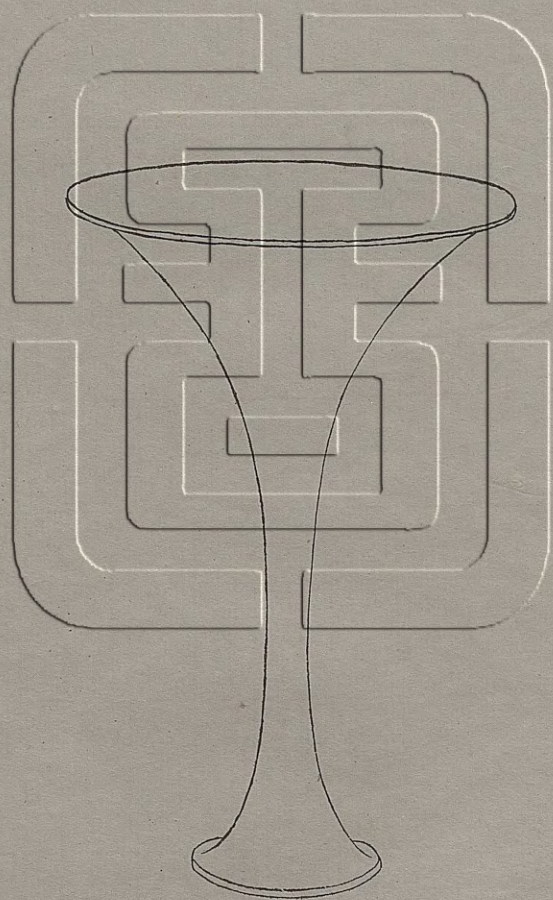

右高七寸五分深三寸八分口徑四寸二分重  
二十四兩

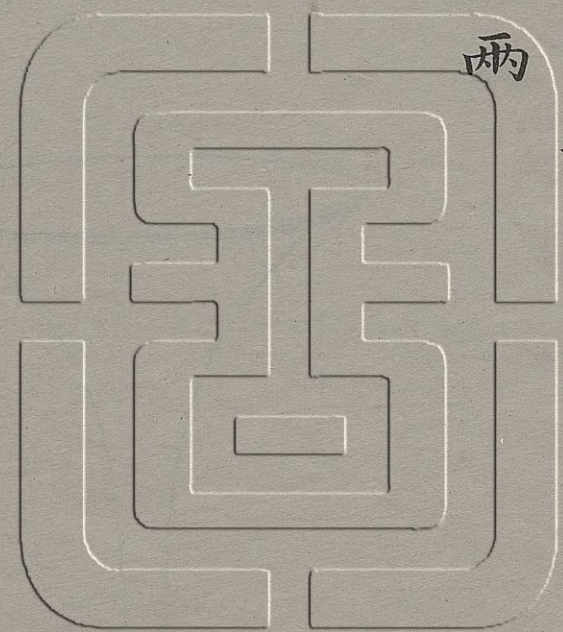

周素觚八

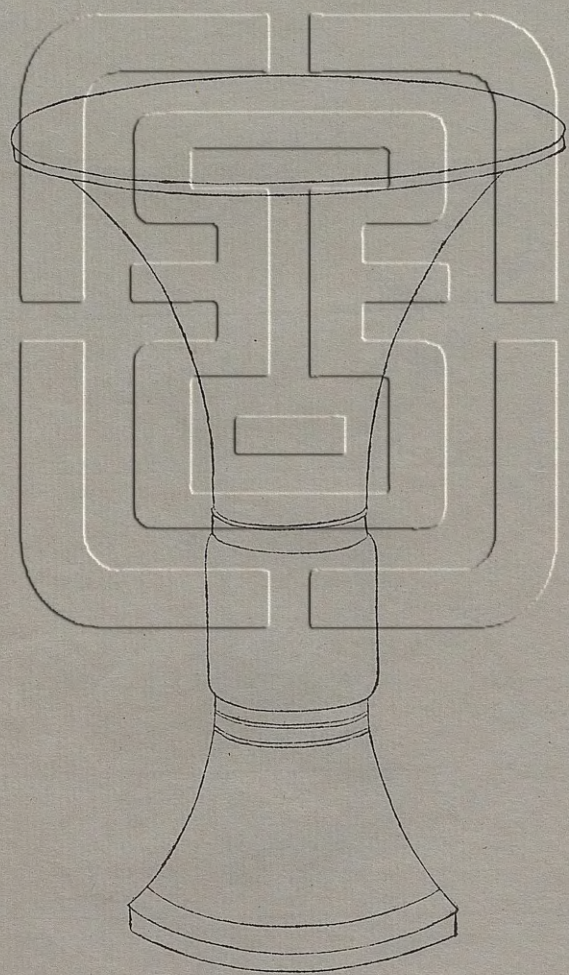

周素觚八

右高七寸四分深五寸四分口徑四寸七分重  
二十三兩



周素觚九

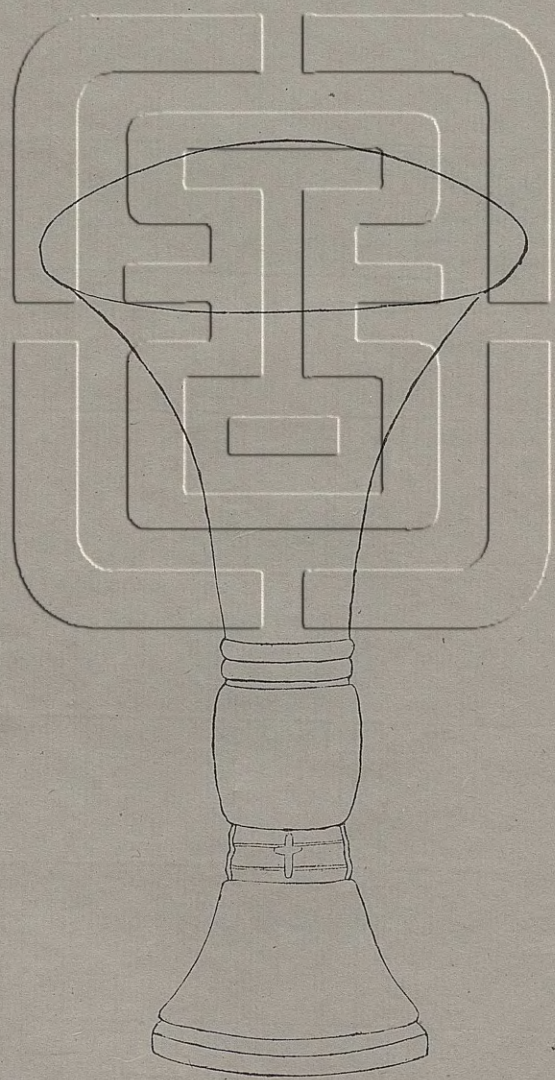

右高六寸六分深四寸五分口徑四寸重一十九兩

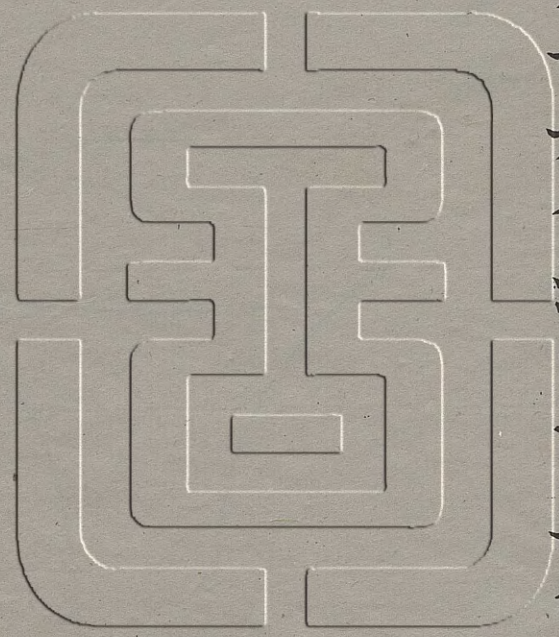

周素觚十

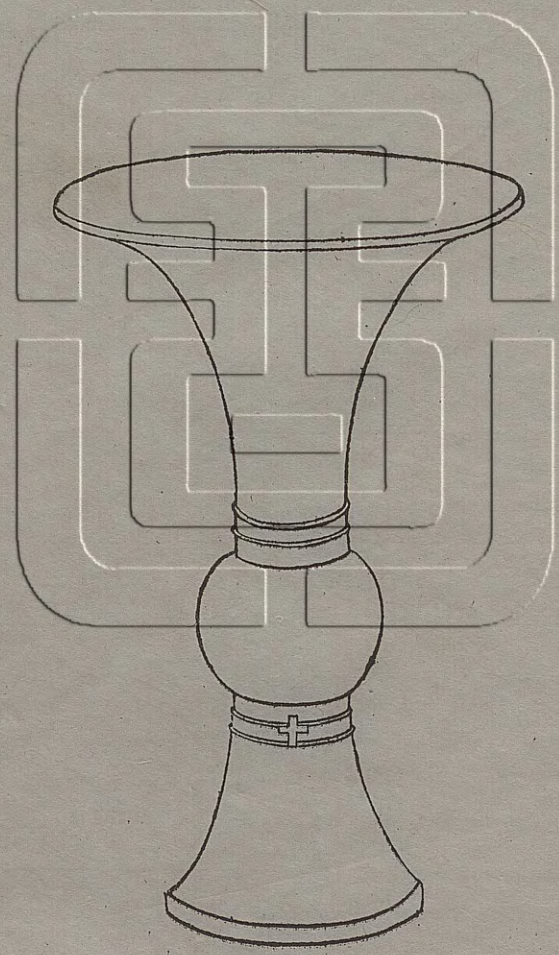

右高六寸四分深四寸三分口徑三寸九分重  
一十五兩

