

NPS ARCHIVE
1963
SMITH, W.

AN ADAPTIVE FILTER SYSTEM FOR RADIO COMMUNICATIONS

by

WILLIAM SPELLER SMITH, JR.
Lieutenant, U. S. Navy

B.S., U. S. Naval Academy
(1957)

SUBMITTED IN PARTIAL FULFILLMENT OF THE

REQUIREMENTS FOR THE DEGREE OF

MASTER OF SCIENCE

AND THE PROFESSIONAL DEGREE

NAVAL ENGINEER

at the

MASSACHUSETTS INSTITUTE OF TECHNOLOGY

May, 1963

Thesis
S608

Library
U. S. Naval Postgraduate School
Monterey, California

DUDLEY KNOX LIBRARY
NAVAL POSTGRADUATE SCHOOL
MONTEREY CA 93943-5101

AN ADAPTIVE FILTER SYSTEM FOR RADIO COMMUNICATIONS

by

WILLIAM SPELLER SMITH, JR.
Lieutenant, U. S. Navy

B.S., U. S. Naval Academy
(1957)

SUBMITTED IN PARTIAL FULFILLMENT OF THE
REQUIREMENTS FOR THE DEGREE OF
MASTER OF SCIENCE
AND THE PROFESSIONAL DEGREE
NAVAL ENGINEER

at the

MASSACHUSETTS INSTITUTE OF TECHNOLOGY

May, 1963

AN ADAPTIVE FILTER SYSTEM FOR RADIO COMMUNICATIONS

by

WILLIAM SPELLER SMITH, JR.

Submitted to the Department of Naval Architecture and Marine Engineering on May 17, 1963 in partial fulfillment of the requirements for the Master of Science degree in Naval Architecture and Marine Engineering and the Professional degree, Naval Engineer.

ABSTRACT

An experimental verification of the continuous adjustment procedure considered by Sakrison is undertaken in this thesis. The adjustment procedure permits design of a filter system by continuous adjustment of k system parameters so that the average error, weighted by a convex error criterion, is minimized. For experimental verification on typical analog equipment, this procedure is applied to the simple, yet typical, problem of separating a specified "voice" signal from broadband noise. The experimental work to determine the time required for convergence to a near optimum setting, the sensitivity of the system to the initial parameter settings, and the sensitivity of the system to the choice of parameters of the adjustment procedure showed that the adjustment procedure can be carried out on existing analog equipment. Further, since convergence times of well under 30 seconds can be obtained with this system and the system does perform satisfactorily over the required 30 db range in noise power density, it is applicable to use in an adaptive filter system for radio communications.

Thesis Supervisor: David J. Sakrison
Title: Assistant Professor of Electrical Engineering

ACKNOWLEDGMENT

The author wishes to thank Prof. David J. Sakrison for his guidance and encouragement while supervising this thesis.

TABLE OF CONTENTS

CHAPTER I - INTRODUCTION	page 8
A. INTRODUCTION	8
B. BACKGROUND	9
C. TWO ADAPTIVE CONFIGURATIONS	13
D. A PROPOSED ADAPTIVE SYSTEM	16
CHAPTER II - PROCEDURE	22
A. THE ANALOG COMPUTER	22
B. EXPERIMENTAL PROCEDURE	25
CHAPTER III - RESULTS	35
A. THEORETICAL RESULTS	35
B. EXPERIMENTAL RESULTS	47
C. DISCUSSION OF RESULTS	63
CHAPTER IV - CONCLUSIONS AND RECOMMENDATIONS	70
A. CONCLUSIONS	70
B. RECOMMENDATIONS	70
BIBLIOGRAPHY	72

LIST OF FIGURES

<u>Number</u>	<u>Title</u>	<u>Page</u>
I-1	Form of the filter(or predictor or model) to be designed.	10
I-2	Diagram of the continuous adjustment procedure for two parameters, x_1 and x_2 .	10
II-1	Output amplitude of K5M multiplier for 20 volt input amplitude.	24
II-2	Schematic diagram for absolute value error criterion.	27
II-3	Schematic diagram for square error criterion.	27
II-4	Schematic diagram for fourth order error criterion.	28
II-5	Computer program for experimental study of the two filter system.	28
III-1	Minimum $\overline{e^2}$ vs. noise power for $S_0 = 0.575$ volt ² sec.	38
III-2	k_{1opt} and k_{2opt} vs. noise power for $S_0 = 0.575$ volt ² sec.	39
III-3	Comparison of error from fixed filters with minimum as noise power changes.	40
III-4	$\overline{e^2}$ vs. k_1 and k_2 for $N_0 = 8.56 \times 10^{-3}$, $S_0 = 0.575$.	42
III-5	$\overline{e^2}$ vs. k_1 and k_2 for $N_0 = 8.56 \times 10^{-2}$, $S_0 = 0.575$.	43
III-6	Regression surface for $N_0 = 8.56 \times 10^{-2}$, $S_0 = 0.575$.	44
III-7	$\overline{e^2}$, k_1 , and k_2 versus S_0 for $N_0 = 8.56 \times 10^{-2}$.	46

III-8	Convergence time versus integrator gain.	48
III-9	Typical convergence of the k_i (with overshoot).	49
III-10	Convergence time versus A' .	50
III-11	Convergence times from various initial settings of k_1 and k_2 .	52
III-12	Experimental k_i vs. noise power for $S_o = 0.79$ volt ² sec.	53
III-13	$\overline{e^2}_{\text{meas}}$, $\overline{e^2}_{\text{min}}$, and $\overline{e^2}_{\text{calc}}$ from k_i expmt. vs. N_o for $S_o = 0.79$ volt ² sec.	54
III-14	Typical convergence of the k_i without overshoot.	57
III-15	Typical convergence of the k_i with overshoot.	57
III-16	Recording of run 4F3.	58
III-17	Recording of run 4F4.	58
III-18	Recording of run 4F5.	59
III-19	Recording of run 4F6.	59
III-20	Recording of run 4F7.	60
III-21	Recording of run 4F8.	60
III-22	Recording of run 4F9.	61
III-23	Recording of run 4F10.	61
III-24	Recording of run 4F14.	62

LIST OF TABLES

<u>Number</u>	<u>Title</u>	<u>Page</u>
I	Comparison of the optimum filter with a fixed filter.	20
II	Time constants of the filters used for experimental work.	30
III	Results of selected runs with four filters.	56

CHAPTER I

INTRODUCTION

A. INTRODUCTION

An experimental verification of the continuous adjustment procedure considered by Sakrison [1] ^{*#} is undertaken in this thesis. The adjustment procedure permits design of a filter system by continuous adjustment of k system parameters so that the average error, weighted by a convex error criterion, is minimized. For experimental verification on typical analog equipment this procedure is applied to the simple, yet, typical problem of separating a specified "voice" signal from broadband noise. The separation of the desired signal from an input consisting of the desired signal plus noise is accomplished by linearly combining the outputs of k low pass filters for minimum weighted error. The experimental procedure is to determine the time required for convergence, the sensitivity of the system to the initial parameter settings, and the sensitivity of the system to the choice of parameters of the adjustment procedure.

* Numbers in brackets refer to items in the Bibliography.

Hereafter referred to as "the adjustment procedure".

B. BACKGROUND

In order for the adjustment procedure to be applicable, the error criterion must be convex; and, other than requiring that they be from related, bounded ergodic processes, no restriction is placed on the input and output. The form of the filter considered here is shown in Figure I-1. It consists of k bounded, time invariant operations on the input. The outputs of these operations are to be linearly combined in such a manner as to optimize the system performance coefficients. If we let $f_{i,t}$ denote the output of the i^{th} such operation, $f_{i,t}$ must have a correlation with any linear combination of the other $f_{j,t}$ which has a magnitude less than one.

A block diagram of the basic system is shown in Figure I-2 for a system with two parameters, i.e. $k = 2$. This system obtains its convergence by approximating the gradient of the regression surface, $M(x_1, x_2) = E \{ W(e(t)) \}$, being searched and adjusting the values of x_1 and x_2 to move the system toward the minimum error. Through the function $c(t)$ a known plus and minus perturbation to the present setting of x_1 and x_2 is introduced. When the errors resulting from these plus and minus perturbations of the i^{th} parameter are measured, weighted by the chosen error

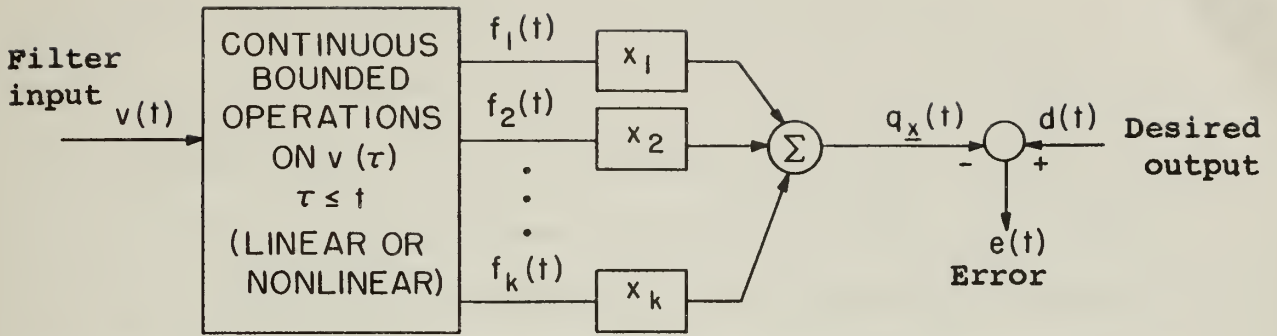
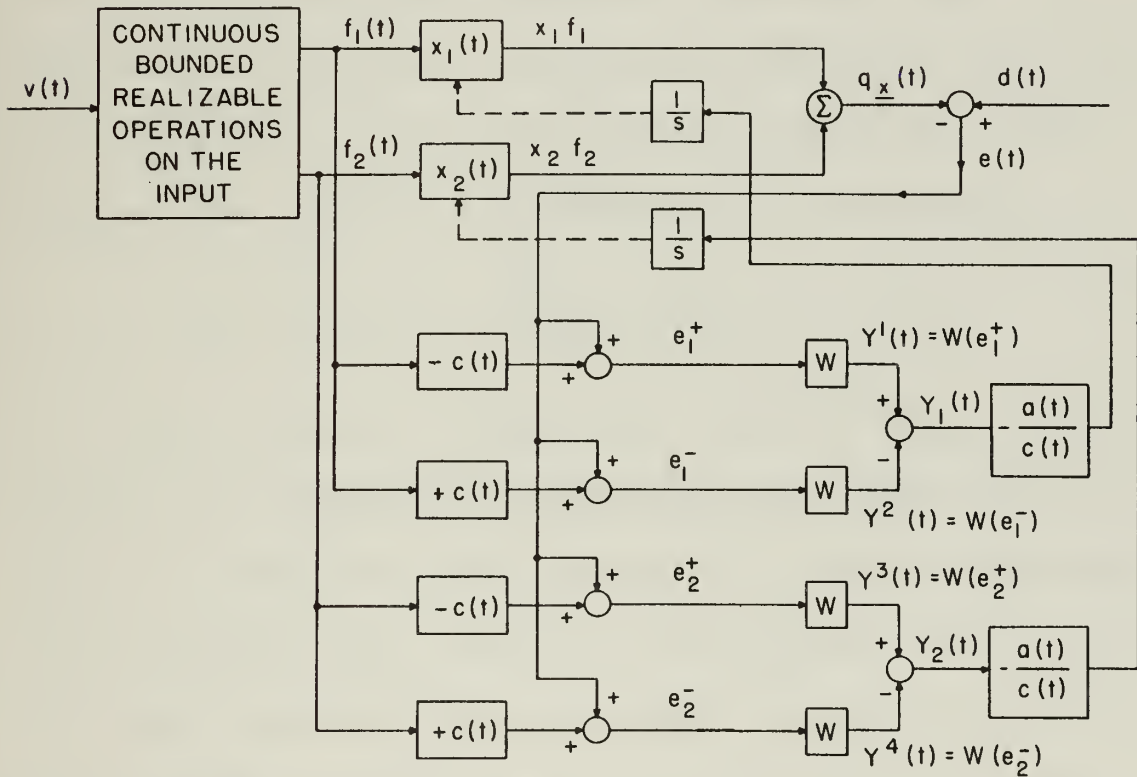

Figure I-1. Form of the filter (or predictor or model) to be designed.*



$$x_1(t) = x_1(l) - \int_l^t \frac{a(\tau)}{c(\tau)} Y_1(\tau) d\tau$$

$$x_2(t) = x_2(l) - \int_l^t \frac{a(\tau)}{c(\tau)} Y_2(\tau) d\tau$$

$$e_1^+ = -f_1(t)[x_1(t) + c(t)] - f_2(t)x_2(t) + d(t)$$

$$e_1^- = -f_1(t)[x_1(t) - c(t)] - f_2(t)x_2(t) + d(t)$$

$$e_2^+ = -f_1(t)x_1(t) - f_2(t)[x_2(t) + c_2(t)] + d(t)$$

$$e_2^- = -f_1(t)x_1(t) - f_2(t)[x_2(t) - c_2(t)] + d(t)$$

Figure I-2. Diagram of the continuous adjustment procedure for two parameters, x_1 and x_2 . *

* Both of these figures taken from [1].

criterion, and subtracted, the resultant function, $Y_i(t)/c(t)$, is a random variable whose mean is a difference approximation of the i^{th} component of the gradient in the direction of the optimum. The function $a(t)$ is a monotonically decreasing function which is then used to weight the value of the gradient. This weighting function, $a(t)$, approaches zero slowly enough that sufficient data is averaged to achieve the statistical optimum, yet approaches zero rapidly enough that the setting settles to a fixed value. The change of the parameter is then given by

$$x_i(t) = x_i(1) - \int_1^t \frac{a(y)}{c(y)} Y_i(y) dy.$$

The form $a(t) = K_a/(at + b)^\alpha$ and $c(t) = K_c/(ct + d)^\delta$ satisfy the mathematical requirements for convergence if $1/2 < \alpha \leq 1$ and $\delta > (1-\alpha)/4$. When $\alpha = 1$, we also require that $0 < a/K_a < 4K_0$. Here K_0 is the largest number such that the regression surface gradient in the direction of the minimum is always greater than K_0 times the distance to the minimum. The choice $\alpha = 1$ and $\delta \geq 1/4$ gives a rate of convergence which cannot be exceeded in general for all processes and error functions meeting the previously stated requirements. The initial convergence depends critically on the adjustment coefficients a/K_a , c/K_c , α , and δ .

A particular advantage of the adjustment procedure is that it is not restricted to the mean-square error criterion, and it can be carried out on analog equipment. In addition, if one desires to design analytically an optimum linear system, it is necessary to first measure the input and output statistics. After this either the Weiner-Hopf equation must be solved or, in the finite parameter case, a matrix must be inverted. An advantage offered by this adjustment procedure is that these two steps are replaced by a single, easily mechanized procedure.

In a system where some error criterion other than the mean-square error is of interest, this method offers the advantage of being able to handle the broad class of convex error criterion. This latter advantage disappears when the input and output are jointly gaussian since for this case the optimum filter for the mean-square criterion is the optimum filter for any convex error criterion [2] . For the case in which the signals involved are non-gaussian and a non-linear filter is desired, the adjustment procedure is again suitable. For the situation in which the noise is quasi-stationary (nearly constant over long periods with respect to the time required for the procedure to settle to a near optimum setting), this procedure would also be useful in an adaptive configuration.

It is to be noted that this system requires that the desired output signal be available. In this adjustment procedure duplication of the conditions under which the filter will have to operate (including real time data in the operational environment) spares one the necessity of having to measure the statistical character of the input and output. In a design based on mathematical calculation of the optimum coefficients for which the statistics are unknown, we must have available the desired output for a fairly long period of time in order to measure the appropriate statistics. Periodic application of the adjustment procedure to correct for slowly changing statistics requires that the desired output be available at the receiver for only a small percentage of the time. Moreover, in certain situations of interest the procedure can be carried out without the desired signal [1]. It is sufficient to know that the previously mentioned constraints are met.

C. TWO ADAPTIVE CONFIGURATIONS

There are two particular problems which are of interest to mobile military units for which this procedure might provide a suitable solution in an adaptive configuration.

Let us consider the problem of radio communications in the presence of atmospheric noise. Crichlow et al. [3] have published data on actual radio noise measurements at several locations. For a location near Front Royal, Va. at a frequency of 2.18 Mc. it was found that the four hour median of the noise level varied over a range of about 30 db during a mean 24 hour period. Deviations of up to 10 db of the one hour mean from the four hour mean were also recorded. However, it was found that when the short time variations in noise power are averaged over a long period (several minutes) the average noise power level is nearly constant for any given hour with variations seldom more than 2 or 3 db except during sunrise and sunset periods. Since the noise is quasi-stationary for a period of about an hour, it would be appropriate to apply the adjustment procedure in an adaptive fashion in a radio communication link if the procedure leads to convergence within a period of less than 30 seconds (convergence times much less than this have been obtained in the course of the present investigation). Such an adaptive system could be used to achieve either a fixed signal to noise ratio while varying the transmitter power or a maximum signal to noise ratio with fixed transmitter power.

A primary consideration for operation of some military communications systems is the concealment of the location of the transmitting unit from an enemy. With a capability of precisely adjusting the transmitter power for a desired signal to noise ratio at the receiver (to be accomplished by a feedback signal to the transmitting unit from the receiving unit whose location need not be concealed) we reduce the probability of enemy location of the transmitting site compared with a situation in which the same transmitter power is used for all noise conditions.

In the case of filtering an audio signal from varying noise, the use of statistical methods are possibly of marginal value since they result in a rather modest improvement over filters designed by intuitive methods (this point will be discussed later). This example was chosen for the present work, however, because it is fully adequate for the purpose of evaluating the adjustment procedure and could be easily implemented with available equipment.

One example of interest for military application in which substantial improvement is possible is in the field of magnetic detection devices. In particular, we might be interested in detecting submarines by aircraft using magnetic airborne detection (MAD) equipment. The problem here is that the background magnetic signature of the earth

changes with time as well as with geographic location. In such cases an aircraft might easily encounter several different backgrounds on one search flight. Different areas might be searched on different days, also causing a change in the background noise spectrum. If we assume an aircraft speed of 200 knots, we might anticipate that the signature of a submarine would last for no longer than five or six seconds as a pulse introduced into the background. Since this time is very short compared with the time over which the background noise remains approximately constant (an hour or so), the adjustment procedure could be efficiently applied here.

If one conducts experiments with friendly submarines, it is possible to predict the pulse shape to some accuracy. Thus, it will be possible to have available a desired signal for use in adapting the system to the needs at hand. A matched filter arrangement can be improved if there is a means of adjusting the filter to varying noise spectra, which is the case considered here.

D. A PROPOSED ADAPTIVE SYSTEM

For purposes of checking the convergence properties of the adjustment procedure, it was decided to employ the

procedure in a self optimizing or adaptive filter for separating a speech signal from broadband noise of slowly varying level. Specifically, an adaptive system which might have application in a radio communication network between ships was selected.

Fant [4] describes the long-term average of speech as being characterized by a 12 db per octave decay over the audio spectrum. He also shows some curves of the actual spectrum which suggest that restricting the circuit usage to certain types of messages (i.e. a tactical voice circuit) would result in a power density spectrum which would follow the 12 db curve on the average, but which would have significant plus and minus perturbations from this mean. With such a desired output spectrum, which is essentially a staircase function with steps of uneven height following the mean of 12 db per octave slope in the frequency domain, it was decided that an investigation should be made using an adaptive filter system consisting of k low pass filters spaced linearly throughout the useful portion of the audio band (250 to 2500 cps contains most of the useful intelligibility). The adaptive system would then compare the desired output with that actually being received and optimize the coefficients of the k filters for minimum mean-square error.

In order to show that an adaptive system has some merit in the use outlined above, let us examine the improvement in signal-to-noise ratio of the adaptive filter over a fixed filter. We will consider that we have available ideal bandpass filters with adjustable multiplicative coefficients (k_i). With N such filters linearly spaced over that portion of the audio band containing the useful intelligibility, the transfer function of such a filter is

$$k_i [U_{-1}(|\omega| - \omega_i) - U_{-1}(|\omega| - \omega_{i-1})],$$

where $U_{-1}(x-a)$ is a unit step function which is 0 for $x < a$ and 1 for $x > a$ and $\omega_i = 2\pi(250 + \frac{2250i}{N})$, $i = 0, 1, 2, \dots, N$. Note that N ideal bandpass filters can be obtained from a linear combination of $N + 1$ ideal low pass filters.

We then consider the spectrum of the desired signal as being of the form

$$\sum_{j=1}^M a_j [U_{-1}(|\omega| - \omega_j) - U_{-1}(|\omega| - \omega_{j-1})]$$

where $\omega_j = \omega_i$ for $i = j$ and $N = M$ and the a_j are perturbations from the form $\frac{K}{(j\omega + 628)^2}$ for the a_j evaluated at ω_j , and we assume that the a_j are constant over the increment $\Delta\omega = \frac{2\pi 2250}{M}$. We assume that the signal is subjected to additive noise of the same form as the signal with N_{oj} replacing the a_j . We also assume that

the N_{oj} are constant across the increment $\Delta\omega$ and that the cross correlation between the desired signal and the noise is zero.

With these assumptions the form of the mean-square error becomes

$$\overline{e^2} = \frac{1}{2\pi j} \int_{-j\infty}^{j\infty} S [1-H(s)] [1-H(-s)] ds + \frac{1}{2\pi j} \int_{-j\infty}^{j\infty} N |H(s)|^2 ds$$

where

$$S = \sum_{j=1}^M a_j [U_{-1}(|\omega| - \omega_j) - U_{-1}(|\omega| - \omega_{j-1})]$$

$$H(s) = \sum_{i=1}^N k_i [U_{-1}(|\omega| - \omega_i) - U_{-1}(|\omega| - \omega_{i-1})]$$

$$N = \sum_{j=1}^M N_{oj} [U_{-1}(|\omega| - \omega_j) - U_{-1}(|\omega| - \omega_{j-1})]$$

If we let $M = N$ for simplicity, the mean-square error is

$$\overline{e^2} = \frac{\Delta\omega}{\pi} \sum_{i=1}^N a_i [(1-k_i)^2 + k_i^2 N_{oi}]$$

Then by taking partial derivatives we find the optimum values

of k_i , $k_i \text{ opt} = \frac{a_i}{a_i + N_{oi}}$, and the minimum value of $\overline{e^2}$,

$$\overline{e^2}_{\min} = \frac{\Delta\omega}{\pi} \sum_{i=1}^N \frac{a_i N_{oi}}{a_i + N_{oi}} = \frac{\Delta\omega}{\pi} \sum_{i=1}^N N_{oi} k_i \text{ opt}$$

As a check note that when $N_{oi} = 0$, $k_i = 1$ and when $N_{oi} = \infty$, $k_i = 0$ for all i .

If we make a stepwise approximation to the mean speech power spectrum described by Fant [4] with $M = N = 10$ and

$$\Delta\omega = \frac{2\pi 2250}{M}, \text{ we have}$$

$$\begin{array}{lll}
 a_1 = 27.0 & a_5 = 3.31 & a_9 = 1.26 \\
 a_2 = 12.6 & a_6 = 2.46 & a_{10} = 1.00 \\
 a_3 = 7.08 & a_7 = 1.82 & \\
 a_4 = 4.74 & a_8 = 1.50 & .
 \end{array}$$

We now find the optimum k_i for $N_{oi} = 5.0$ for all i . We now consider that these $k_{i \text{ opt}}$ are those which would have been obtained if this particular type filter had been designed for the average condition. We further assume that the actual a_i of the signal are

$$\begin{array}{lll}
 a_1 = 30 & a_5 = 4 & a_9 = 1 \\
 a_2 = 13 & a_6 = 2 & a_{10} = 1 \\
 a_3 = 4 & a_7 = 2 & \\
 a_4 = 4 & a_8 = 1 & .
 \end{array}$$

These values are chosen to obtain about the same input signal to noise ratio as was available to the mean design. The performance of a fixed filter compared with the optimum filter is shown in Table I.

TABLE I

COMPARISON OF THE OPTIMUM FILTER WITH A FIXED FILTER

N_o	$\overline{e^2}_{\text{min}}$	$\overline{e^2}_{\text{fixed}}$	% improve	snr_{in}	snr_{out}	$\text{snr}_o / \text{snr}'_o$
.5	4.11	9.94	142.0	12.4	15.81	1.28
5.0	19.62	20.2	2.8	1.24	2.96	2.39
50.0	46.90	122.8	162.0	.124	.475	3.83

Thus, we see that significant improvements are possible with an adaptive system.

Having seen that for the case of the ideal bandpass filter it is possible to obtain improvement over a fixed system, we next turn to the problem of actually checking the convergence of such a system. Considerations to be dealt with below restrict the error criterion to either an absolute value or a mean-square criterion. Since the mean-square criterion is more amenable to analytic treatment, we have in this case some way of knowing if the results given by the system are near the optimum. Hence, the mean-square error criterion was chosen.

The spectrum of the desired voice signal is of second order. In order to obtain sharp resolution in our process we must then use filters of at least third order. To reduce the analytic treatment to reasonable proportions and to use the tables available in Newton, Gould, and Kaiser [5] to evaluate the error, third order filters were chosen. These tables provide an easy means of evaluating the mean-square error as a function of the variable parameters, k_i . Having the mean-square error in terms of the k_i permits us to find the optimum simply by solving the set of equations resulting from setting the partial derivatives with respect to each of the k_i equal to zero. It is then possible to calculate the minimum mean-square error for comparison with that found experimentally.

CHAPTER II

PROCEDURE

A. THE ANALOG COMPUTER

One of the advantages claimed by Sakrison for his adjustment procedure is that it can be realized on simple analog computing facilities [1]. A Philbrick analog computer was made available by the Dynamic Analysis and Control Laboratory so that this procedure might be checked. This computer consists of 20 universal linear operator units (K5U), 4 stabilized multiply/divide units (K5M), 6 unstabilized multiply/divide units (MU/DV), and an eight channel oscilloscope for output read-out.

The K5U units permit operations of the form

$$e_{\text{out}}(t) = e_0 + 10^m \sum_{i=1}^4 a_i e_{\text{in}_i}(t) \quad -11.10 \leq a_i \leq 11.10$$

or

$$e_{\text{out}}(t) = e_0 + 10^m \int \sum_{i=1}^4 a_i e_{\text{in}_i}(t) dt \quad m = 0, 1, 2, 3$$
$$-50.0 \leq e_0 \leq 50.0$$

These units have a frequency response which is flat to beyond 6000 cps.

The basic equation for the operation of the K5M units

is $e_{\text{out}}(t) = \frac{e_1(t)e_2(t)}{e_3(t)}$. These K5M units also permit the

addition of a constant to one of the two multiplication inputs, to the division input, or to the output. Figure II-1 shows the output amplitude response versus frequency for the K5M units. In addition it should be noted that the waveform was badly distorted above 1500 cps.

The MU/DV units have a response characteristic similar to that of the K5M units. In the multiplication mode

their output is of the form $e_{\text{out}}(t) = \frac{e_1(t)e_2(t)}{25}$. The

drift in these units is of such a magnitude that they must be checked at least once an hour to insure that they meet the accuracy required by the problem at hand.

The maximum range without saturation for all these units is ± 50 volts. There is an inherent noise level of about 0.035 volts rms in the multiplication units, and a noise level of less than 1 mv. in the K5U units. The above noise levels are referred to the input so that for high gains the noise is also amplified. All of these units are capable of driving up to four other units.

25
20
15
Output Amplitude (Volts)

MS
4-6-63

50 100 200 500 1000 2000
Frequency (cps)

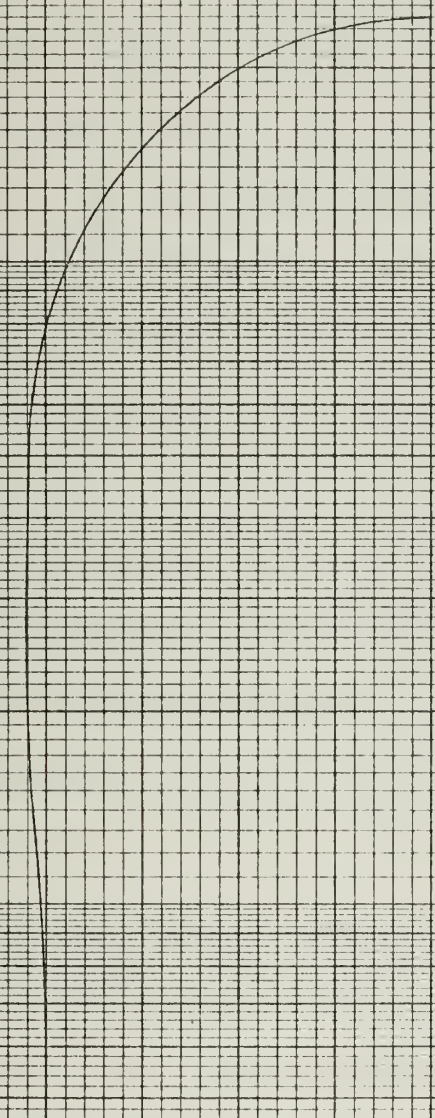

Figure II-1. Output amplitude of K5M multiplier for 20 volt input amplitude.

B. EXPERIMENTAL PROCEDURE

Experimental work was undertaken to insure that the adjustment procedure would lead to system parameter convergence on the available analog equipment. In particular, it was desired to know if the system parameters would converge within a time suitable for the application proposed and if the adjustment procedure was critically dependent on any of the adjustment parameters. Sakrison has shown that for a related discrete adjustment process the settings of the parameters of the adjustment process are quite important [6]. Certain settings of the adjustment parameters in the discrete case led to violent oscillations for a prolonged period of time before settling down, and for other settings the behavior was quite overdamped and convergence did not occur within a reasonable period of time.

The use of a mean-square error criterion in this experimental work has been mentioned above. The analytical convenience offered by this choice is obvious; however, our freedom of choice is not as great as might be implied since the number of available multipliers also restrict the criteria which may be considered. Better appreciation of the latter restriction is gained by examining the schematic

of three convex error criteria for adjustment of only two filter gains.

Figure II-2 shows the schematic diagram for the absolute value criterion. In this particular arrangement we have simplified the problem by assuming that $a(t) = c(t)$. It is seen from this figure that two multipliers are necessary for each parameter to be adjusted.

The arrangement shown in Figure II-3 is for the square error criterion. It will be noted that fewer linear operator units are required for this configuration than for the absolute value arrangement, but that the number of multipliers remains at two per parameter being adjusted.

In order to meet the requirements of a fourth power error criterion, Figure II-4, eleven multipliers or 4 per parameter being adjusted plus one common to all the adjustment parameters, are needed. For the analog computer available for this work the constraint imposed by the number of multipliers available quickly limits us to either the absolute value or to the square error criterion. The choice of the latter was then made on the basis of computational convenience.

It was decided that extensive studies of the performance of the adjustment procedure for a filter system consisting of two filters should be conducted. On

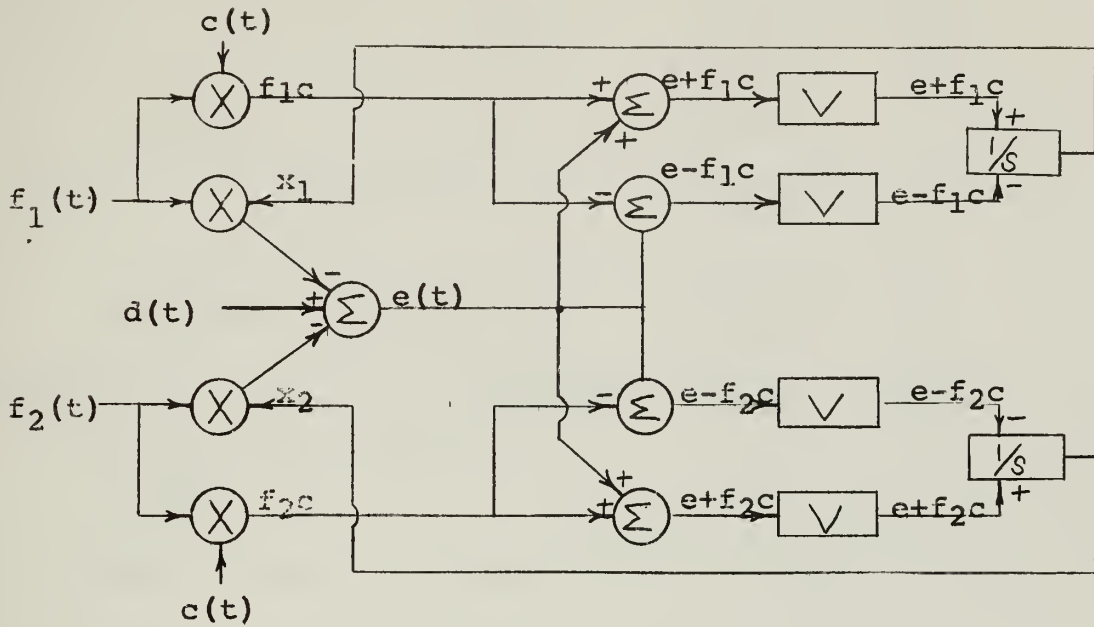
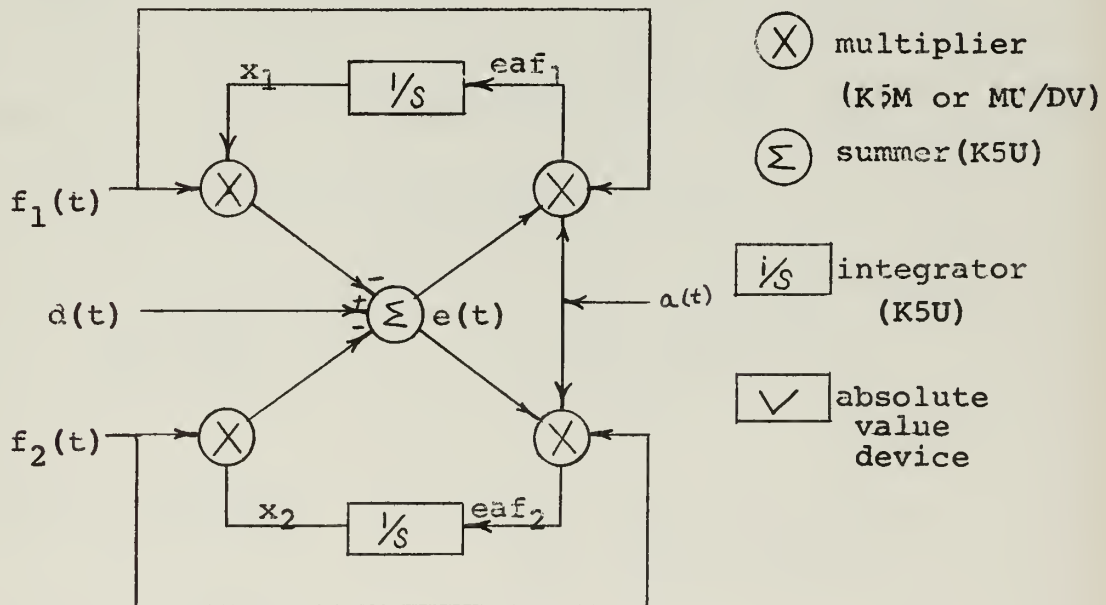

Figure II-2. Schematic diagram for absolute value error criterion.

LEGEND (for Figures II-2 to II-4)



- (X) multiplier (K5M or MU/DV)
- (Σ) summer (K5U)
- 1/s integrator (K5U)
- ∇ absolute value device

Figure II-3. Schematic diagram for square error criterion.

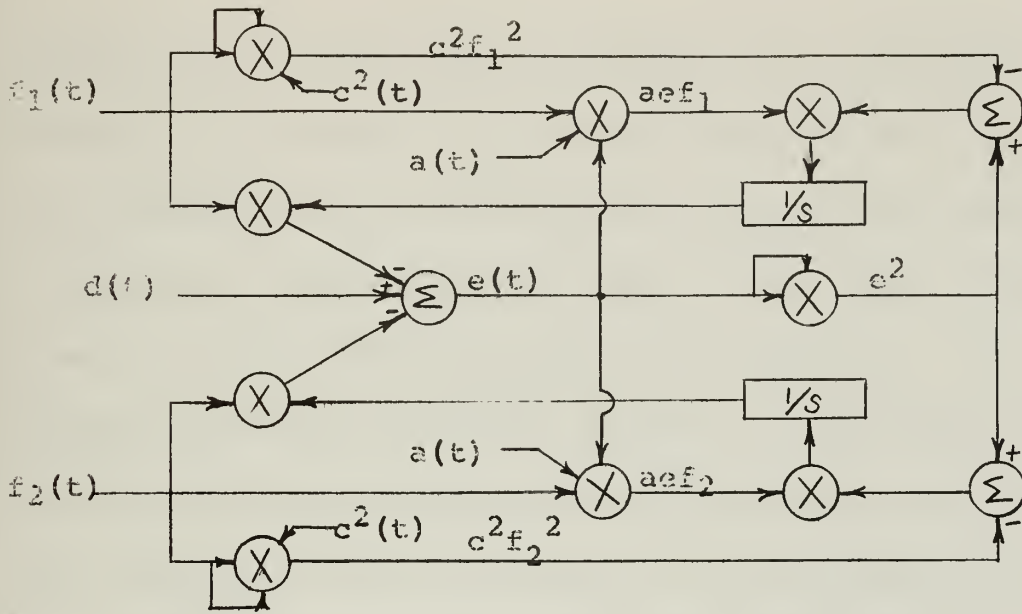

WS
580

Figure II-4. Schematic diagram for fourth order error criterion.

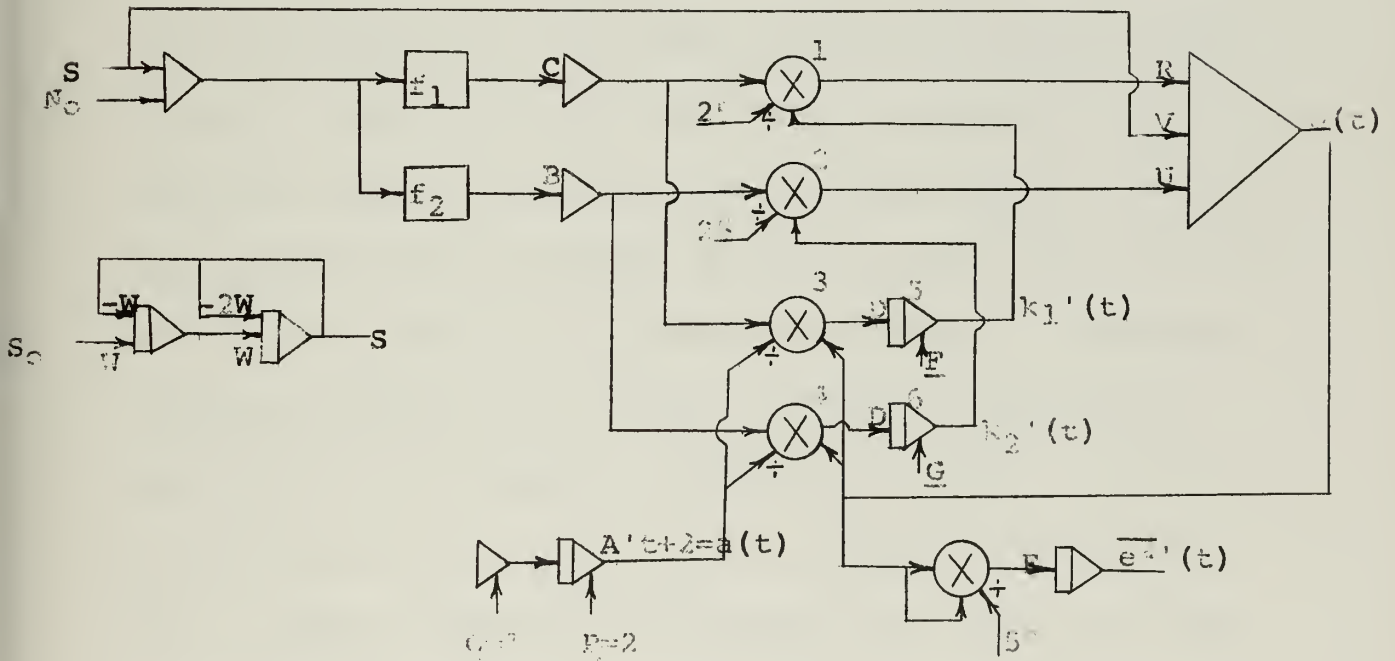

Legend:



Coefficient (K5U)



Integrator (K3U)



Multiplier (K5m or MU/DV)

X = Coefficient Gain

\underline{X} = Initial value

WS
580

Figure II-5. Computer program for experimental study of two filter system.

completion of these tests, examination of a four parameter should be conducted. In the four parameter case, analytical determination of the optimum values of the coefficients is difficult since available tables do not permit evaluation of twelfth and fourteenth order integrals. For purposes of this experiment, however, it was sufficient to show consistent values of the mean-square error from the four parameter system optimized by the adjustment procedure.

In the four parameter case eight K5U units are required for auxiliary uses associated with signal shaping, function generation, and summing operations common to all filters. Since one integrator (K5U) is required for each parameter adjusted and simulation of third order filters on the analog computer requires the use of three K5U units for each filter, there are an insufficient number of computing elements available for the four parameter case entirely simulated on the computer. Therefore, in order to obtain consistent results between the two and the four parameter case, filters formed by RC networks in the input and feedback paths of stabilized operational amplifiers were used. The form of the transfer function of the filters is

$$H(s) = \frac{a_0}{(a_1s+1)^2(a_2s+1)} .$$

The time constants of the filters used in the experimental work are shown in Table II.

Filters 2 and 3 were used for the two filter studies. The weightings of their outputs are the parameters to be optimized, and these are hereafter called k_1 and k_2 for filters 2 and 3 respectively.

TABLE II

TIME CONSTANTS OF FILTERS USED FOR EXPERIMENTAL WORK

<u>Filter number</u>	<u>a_0</u>	<u>a_1</u>	<u>a_2</u>
1	.239	.00130	.00635
2	.187	.000424	.000213
3	.185	.000252	.000130
4	.140	.000180	.0000916

Figure II-5 shows the computer program for the experimental work with two filters. This program follows the diagram shown in Figure II-3 except for the amplifiers following the filters. These amplifiers are necessary, in this case, to increase the level of the waveform at that point to avoid computer noise. In Figure II-5 capital letters are gains of the associated K5U units, underlined capital letters are initial conditions, and small letters denote the time function at the output of the associated unit. From Figure II-5 it is seen that $k_1 = \frac{CRk_1'}{25}$, $k_2 = \frac{BUk_2'}{25}$, and $\overline{e^2} = \frac{50\overline{e^2}'}{E}$, where the k_i are the parameters being optimized for minimum $\overline{e^2}$.

The desired output, S , is obtained by passing the output of a white noise generator through a filter of the form

$\frac{K}{(j\omega + 628)^2}$. This gives the desired approximation of a mean speech spectrum.

To the desired output was added white noise from another generator. A separate noise generator was used to insure minimum correlation between the desired output and the noise. This sum, when used as the input to the filter system, gave a good approximation to speech distorted by the type of noise likely from atmospheric sources.

The values of both the signal power density, S_0 , and the noise power density, N_0 , were determined by assuming that they were from white noise sources having a flat power density spectrum beyond the maximum frequency of interest. (Later measurements of the power density spectra of the two sources validated this assumption.) For the purpose of measuring N_0 , the output from the white noise generator was passed through a single pole low pass filter having a half-power cut-off frequency about equal to the highest value to be used in any of the test filters. The resultant waveform was squared and averaged by integrating the squared output for one second. The tables of Newton, Gould and Kaiser [5] were then used to determine the value of N_0 .

The procedure used to evaluate S_0 was the same as that above except that the white noise was shaped prior to being inserted into the single pole low pass filter. The same low pass filter was used for both cases.

The function $a(t)$ was generated by inserting a ramp of the form $A't + 2$ into the division input of a K5M unit and then multiplying the output of the K5M unit by the integrator gain, D , so that the form of $a(t)$ was $\frac{D}{(A't+2)}$. It was found that constants less than 2 in the ramp function caused internal saturation in the K5M units and that inconsistent results were obtained when such saturation occurred. Since the lowest constant value was desired to derive maximum benefit from $a(t)$ as a time function, the value 2 was chosen.

The experimental value of the mean-square error was found by squaring the error signal and integrating this value for a fixed time period. Time periods of 0.1, 1, and 10 seconds were used depending on the rate of change of the error.

For purposes of this study convergence time is defined as the time elapsed from activation of the system until the last time that the mean-square error falls to within 10% of its minimum value. That region containing all those points having their mean-square error within 10% of the

minimum value is hereafter called the convergence area.

Although this definition of convergence is quite arbitrary, it does give a fairly concise definition of the time taken to reach near optimum performance. A value less than 10% would lead to a greater variance in the convergence time due to the decreased gradient of the regression surface in the vicinity of the optimum.

Convergence times were obtained by stop watch measurements while observing an oscilloscope displaying k_1 versus k_2 and noting the time to enter the convergence area which had been drawn on the face of the CRT.

As a matter of convenience, the term "feedback loop" is defined as referring to that portion of the system from the output of the error summing K5U, $e(t)$ in Figure II-5, through multiplier 3(or 4) and integrator 5(or 6) to multiplier 1(or 2).

The results desired from the experimental work were:

- 1) the effect of the initial settings of the k_i on convergence time, 2) the effect of feedback loop integrator gain, D , on convergence time with A' fixed (note that the same gain setting is used for all feedback loop integrators),
- 3) the effect of changes of A' on convergence time for D fixed, 4) the range of noise power density over which it is possible to obtain convergence with S_0 fixed,

5) the values to which the k_i converge, and 6) any other information concerning the use of analog equipment to implement this adjustment procedure.

The desired form of the experimental data was: 1) numerical time values where convergence time was involved, 2) recordings of the k_i and $\overline{e^2}$ as functions of time, and 3) numerical data on the final values of the k_i . The recorded data were taken on a Sanborn two channel recorder. Final values of the k_i were recorded at the end of 50 seconds for $A' = 1$.

CHAPTER III

RESULTS

A. THEORETICAL RESULTS

In order to check on the accuracy of the convergence procedure, studies were made of the theoretical values of the optimum k_i and the minimum mean-square error for the two filter case. The problem to be solved was in the form

$$\begin{aligned} \overline{e^2} = & \int_{-\infty}^{\infty} \frac{S_0}{W^2 s^2 + 2Ws + 1} [1-H(s)] [1-H(-s)] \frac{ds}{W^2 s^2 - 2Ws + 1} \\ & + \int_{-\infty}^{\infty} N_0 H(s) H(-s) ds \end{aligned} \quad (1)$$

where $W = \frac{1}{628}$

$$H(s) = \frac{k_1 a_{0,2}}{(a_{1,2} s + 1)^2 (a_{2,2} s + 1)} + \frac{k_2 a_{0,3}}{(a_{1,3} s + 1)^2 (a_{2,3} s + 1)}$$

S_0 = Power density spectrum of the desired signal before shaping

N_0 = Power density spectrum of noise

$a_{i,j}$ = i^{th} time constant of j^{th} filter (see Table II)

We see that a sixth and an eighth order integral (in the Newton, Gould, and Kaiser sense [5]) must be evaluated

to obtain the desired result. Since such calculations are exceedingly long and many similar calculations were desired for purposes of properly evaluating the proposed experimental work, the use of a digital computer was expedient. Time was made available by the Civil Engineering Systems Laboratory on their IBM 1620 computer for this purpose.

A program was written which used the time constants of each of the filters, the signal power density, the noise power density, the experimental values of the k_i , and the time constant of the desired signal shaping filter to compute the necessary values of the experimental mean-square error, following the appropriate tables in Newton, Gould, and Kaiser [5]. It can be shown that solution of (1) following these tables leads to an equation of the form

$$\overline{e^2} = C_0 + C_1 k_1 + C_2 k_2 + C_3 k_1 k_2 + C_4 k_1^2 + C_5 k_2^2 \quad (2)$$

where the C_i are constants. The equations necessary for the computation of the optimum values of the k_i and the minimum mean-square error were easily obtained from (2). These equations were inserted in the digital computer program so that for any given set of values of signal power density, noise power density, and experimental k_i , it is possible to compute 1) the theoretical value of the mean-square error based on the experimental k_i , 2) the optimum k_i , and

3) the minimum mean-square error. The results of these theoretical studies are presented in Figures III-1 through III-7.

Figure III-1 shows the variation of the minimum value of the mean-square error with noise power while holding the signal power density fixed. With zero noise the minimum mean-square error is 3.784 volt², while with infinite noise the minimum mean-square error is 90.275 volt². For $N_0 = 8.56 \times 10^{-2}$ the noise contributes about half the error in the output of the optimum system.

Figure III-2 demonstrates the range of the k_i with varying noise power density for fixed signal power. It is to be noted that the k_i go to zero at infinite noise, so that the maximum possible error is when the system is completely silent. Such a range in the values of the k_i with changes in noise power density indicates that an adaptive system might be worthwhile even for this simple case.

If we pick the values of k_i that are optimum for one noise level as fixed coefficients of our filters, it is possible to demonstrate the effect of a fixed filter operating on an input of fixed signal power but varying noise power density. Such a comparison is presented in Figure III-3. We see that for a plot of the mean-square

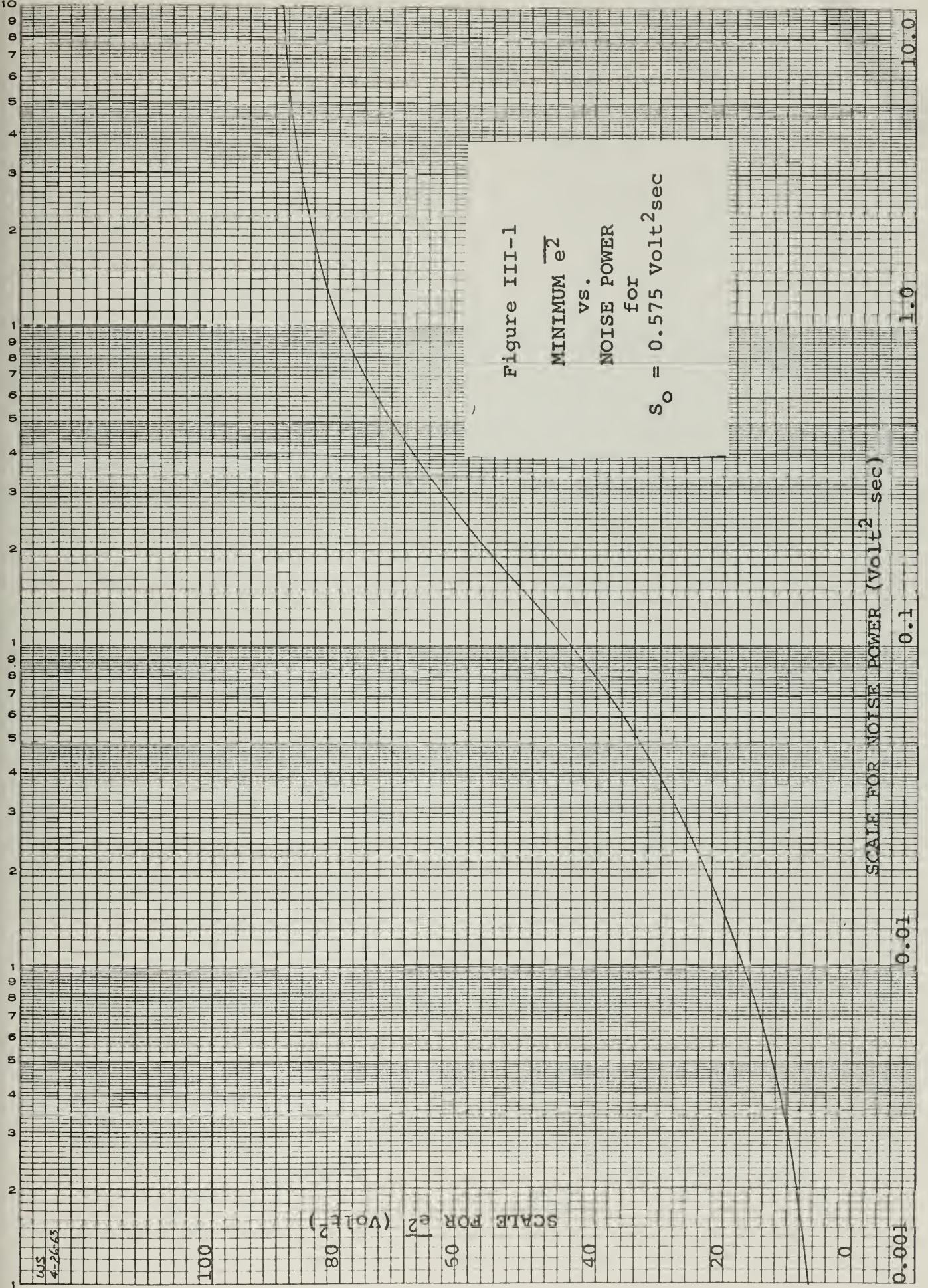

WS
4-26-63

100

SCALE FOR e^2 (Volt²)

80

60

40

20

0

0.001

0.01

0.1

1.0

10.0

SCALE FOR NOISE POWER (Volt² sec)

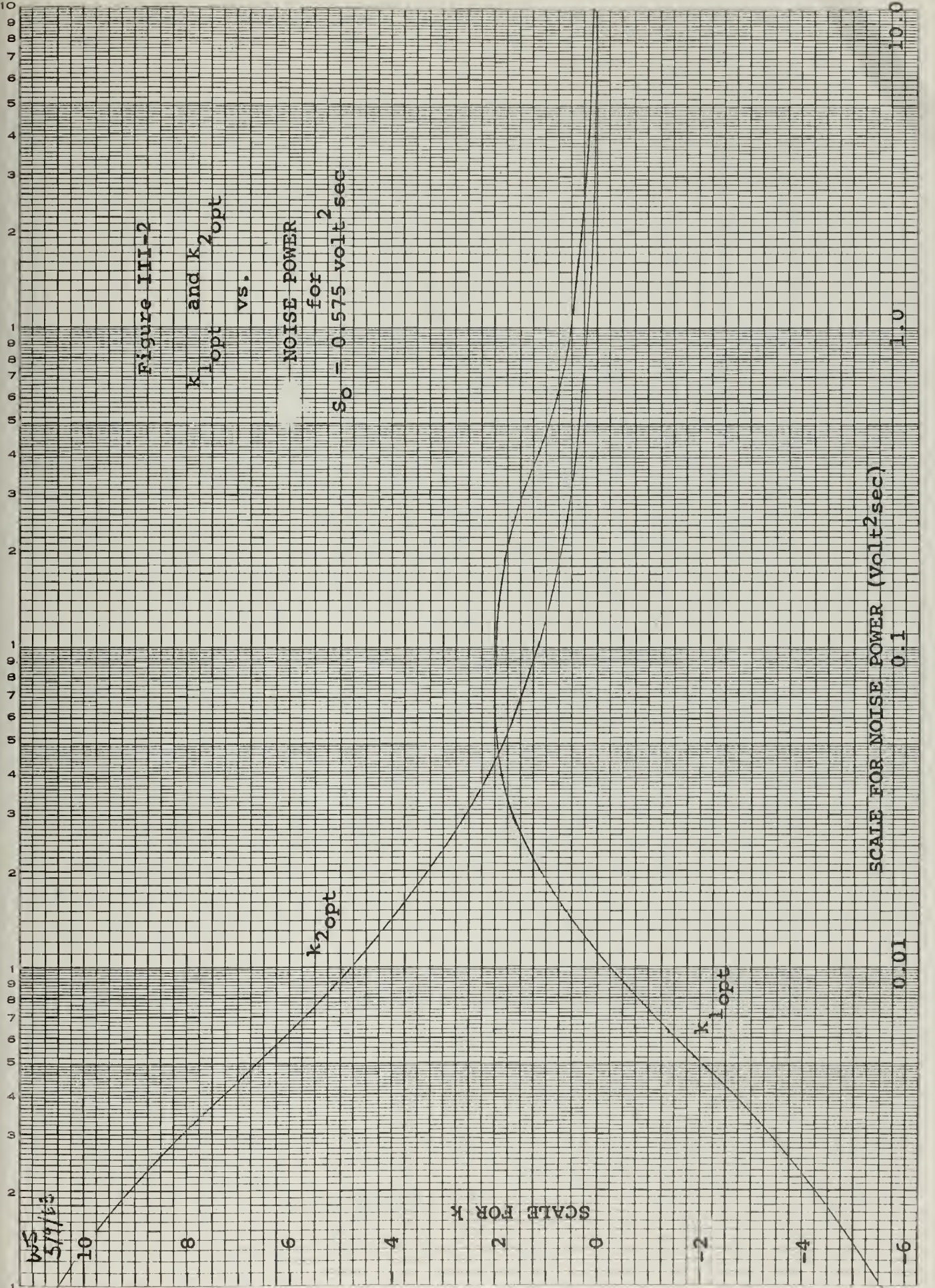

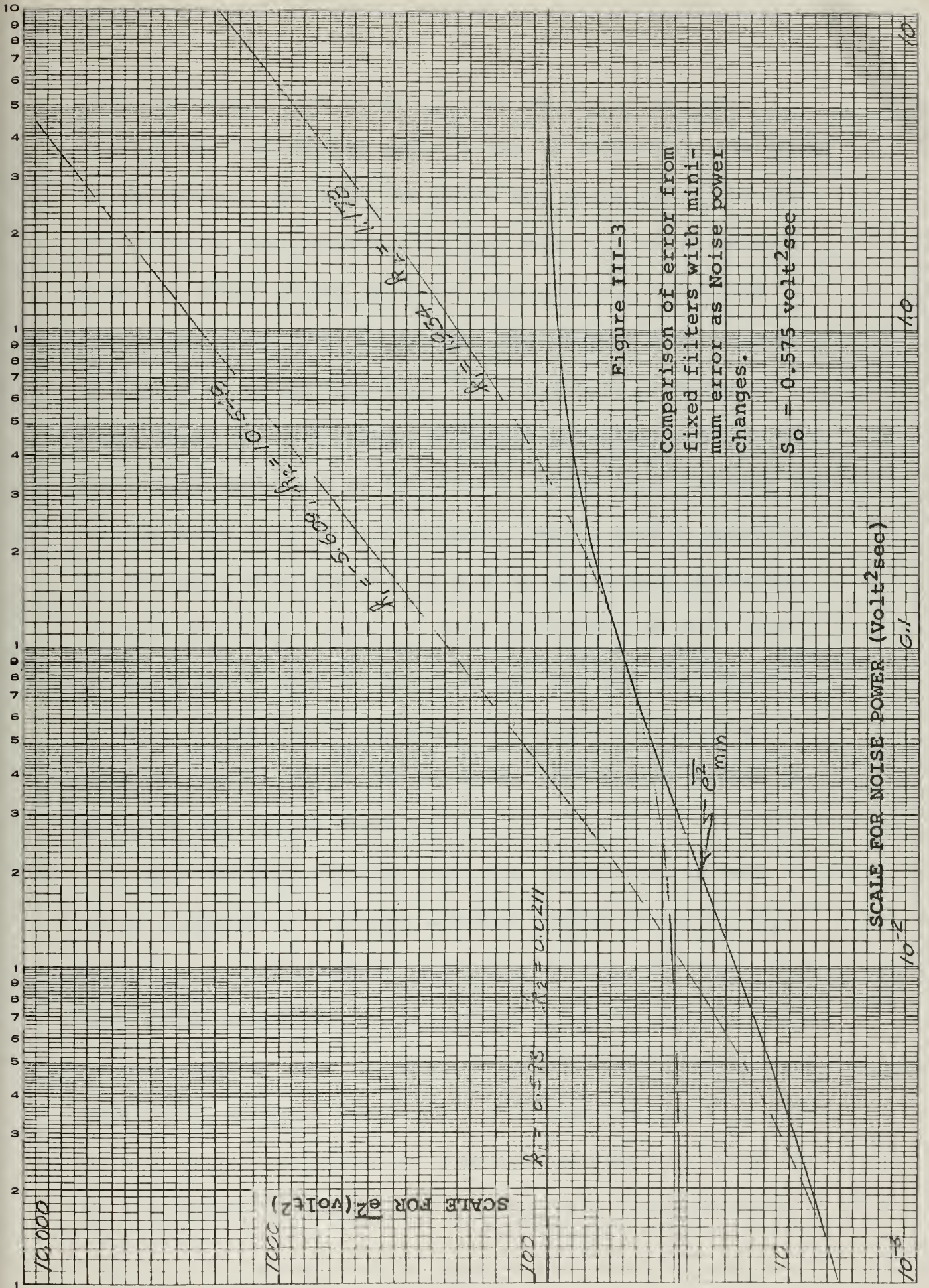

Figure III-3

Comparison of error from fixed filters with minimum error as Noise power changes.

$S_0 = 0.575 \text{ volt}^2/\text{sec}$

SCALE FOR NOISE POWER (VOLT²/sec)

error of each of the fixed filters versus noise power density, the mean-square error curve is tangent to the curve of the minimum error at the point for which the k_i of the fixed filter are optimum, but that when the noise changes from the value for which the k_i are optimum, the fixed filter error curve diverges from the minimum error curve. It should be noted here that for the simple case being considered, it is possible to obtain excellent results by the simple expedient of building a switch which selects one of the three sets of coefficients. While such a procedure is obviously more economical than an adjustment procedure in this particular case, it must be remembered that this is but a small part of the total system, and that addition of more filters would increase the number of possible combinations of the k_i to the point that manual switching would be out of the question.

For the case studied here, the regression surface being searched is a paraboloid when mapped using k_1 , k_2 , and $\overline{e^2}$ in a right-handed coordinate system. In order that the reader might observe the effect of noise power density on the shape of this surface, three graphical displays are made here. Figures III-4 and III-5 show the locus of points on the surface at planes of constant mean-square error for $N_0 = 8.56 \times 10^{-3}$ and 8.56×10^{-2} respectively. Figure III-6

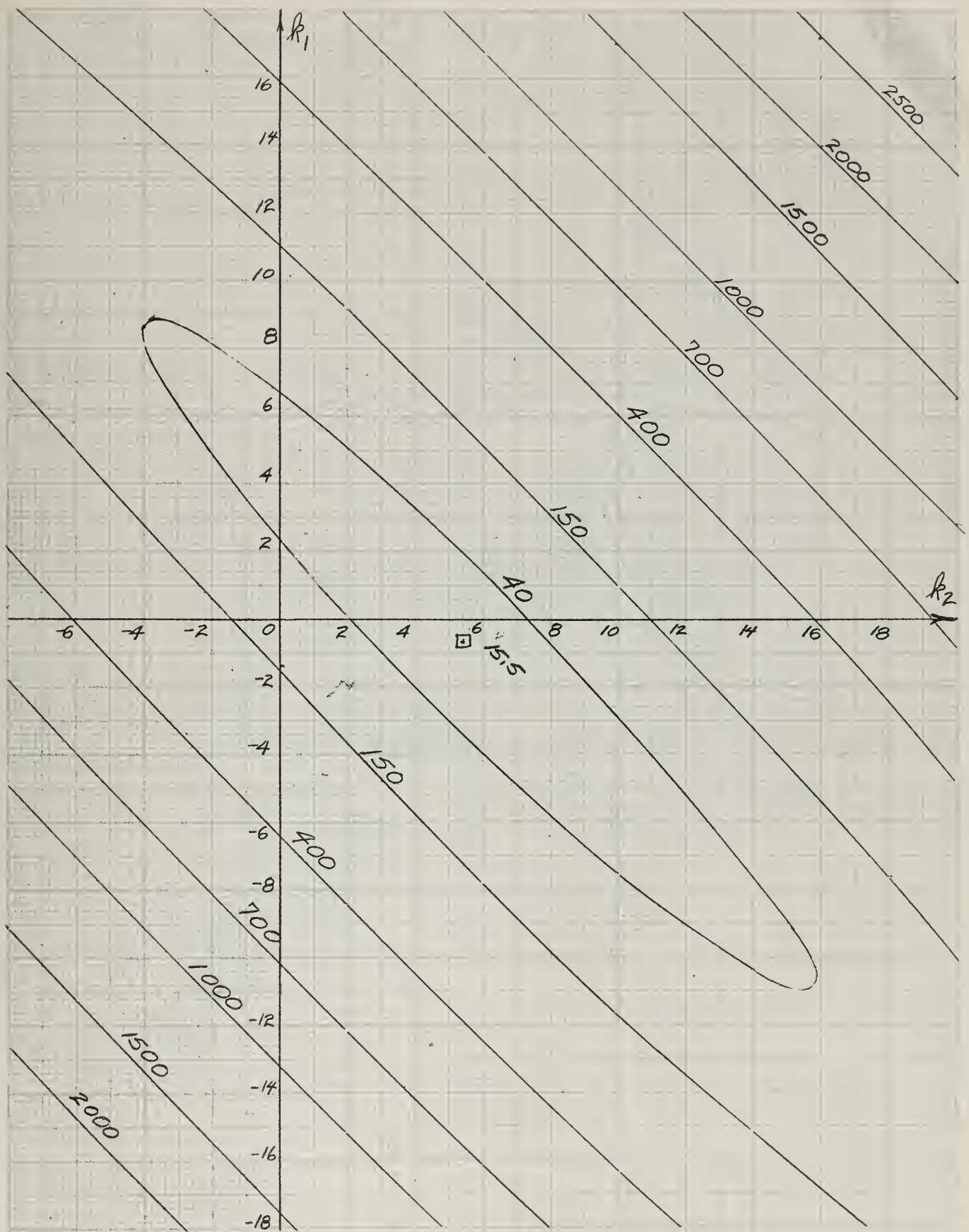

Figure III-4. $\overline{e^2}$ vs. k_1 and k_2 for $N_0 = 8.56 \times 10^{-3}$, $S_0 = 0.575$

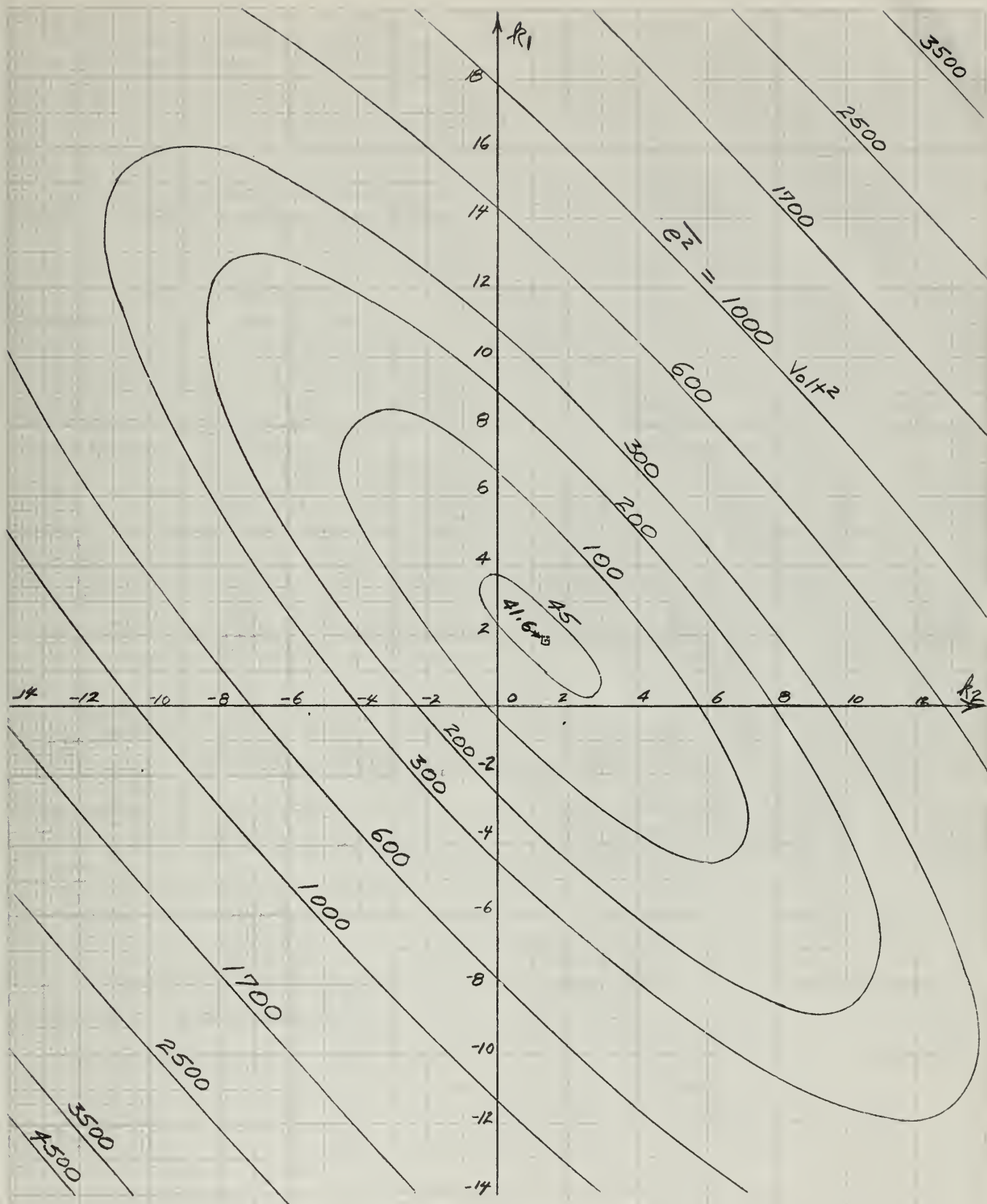

Figure III-5. $\overline{e^2}$ vs. k_1 and k_2 for $N_0 = 8.56 \times 10^{-2}$, $S_0 = 0.575$

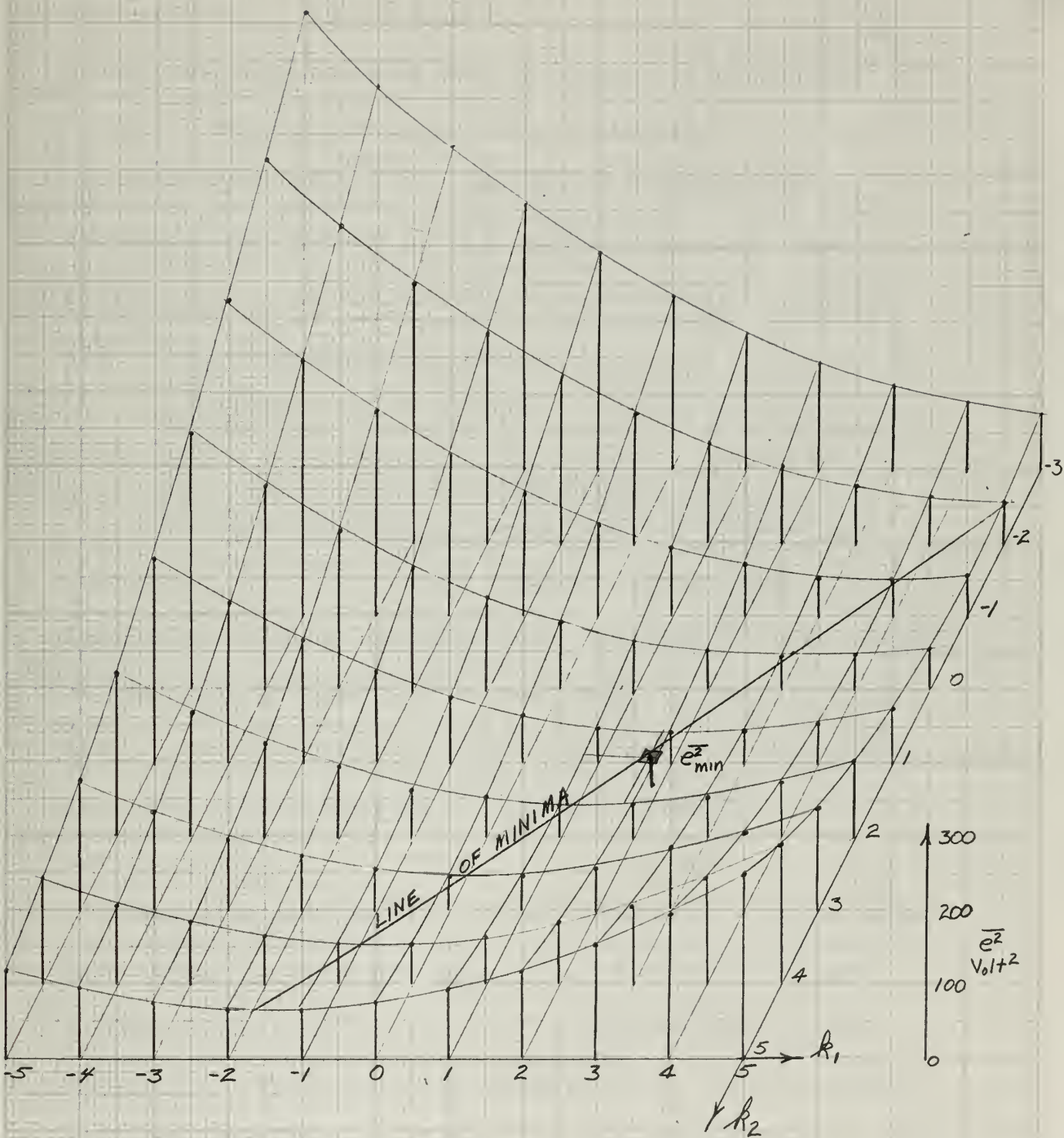

Figure III-6. Regression surface for $N_0 = 8.56 \times 10^{-2}$, $S_0 = 0.575$

shows the three dimensional configuration of the surface in the vicinity of the minimum for $N_0 = 8.56 \times 10^{-2}$. For both noise levels it is noted that the planes of constant \bar{e}^2 intersect the regression surface in ellipses. It is possible to determine the equation of the major axis (hereafter referred to as the line of minima) of these ellipses in terms of the k_i by algebraic manipulation of (2). These equations are found to be

$$k_1 = 4.704 - 1.005 k_2 \quad \text{for } N_0 = 8.56 \times 10^{-3} \quad \text{and}$$

$$k_1 = 3.213 - 1.036 k_2 \quad \text{for } N_0 = 8.56 \times 10^{-2}.$$

All of the theoretical cases considered above have been for $S_0 = 0.575 \text{ volt}^2\text{sec}$. The variation of S_0 from this value was also studied for $N_0 = 8.56 \times 10^{-2}$. The effect on minimum mean-square error and the k_i is shown in Figure III-7. We see that the effect on the error in this region for small perturbations of S_0 from its standard value is not too great.

The data obtained from these theoretical studies were used to define the convergence area in terms of k_1 and k_2 so that convergence times could be obtained as outlined in Chapter II. The computer program was also used to obtain the value of \bar{e}^2 based on the k_i for experimental runs. The results of the digital computer calculations are presented in this section as well as in the next section.

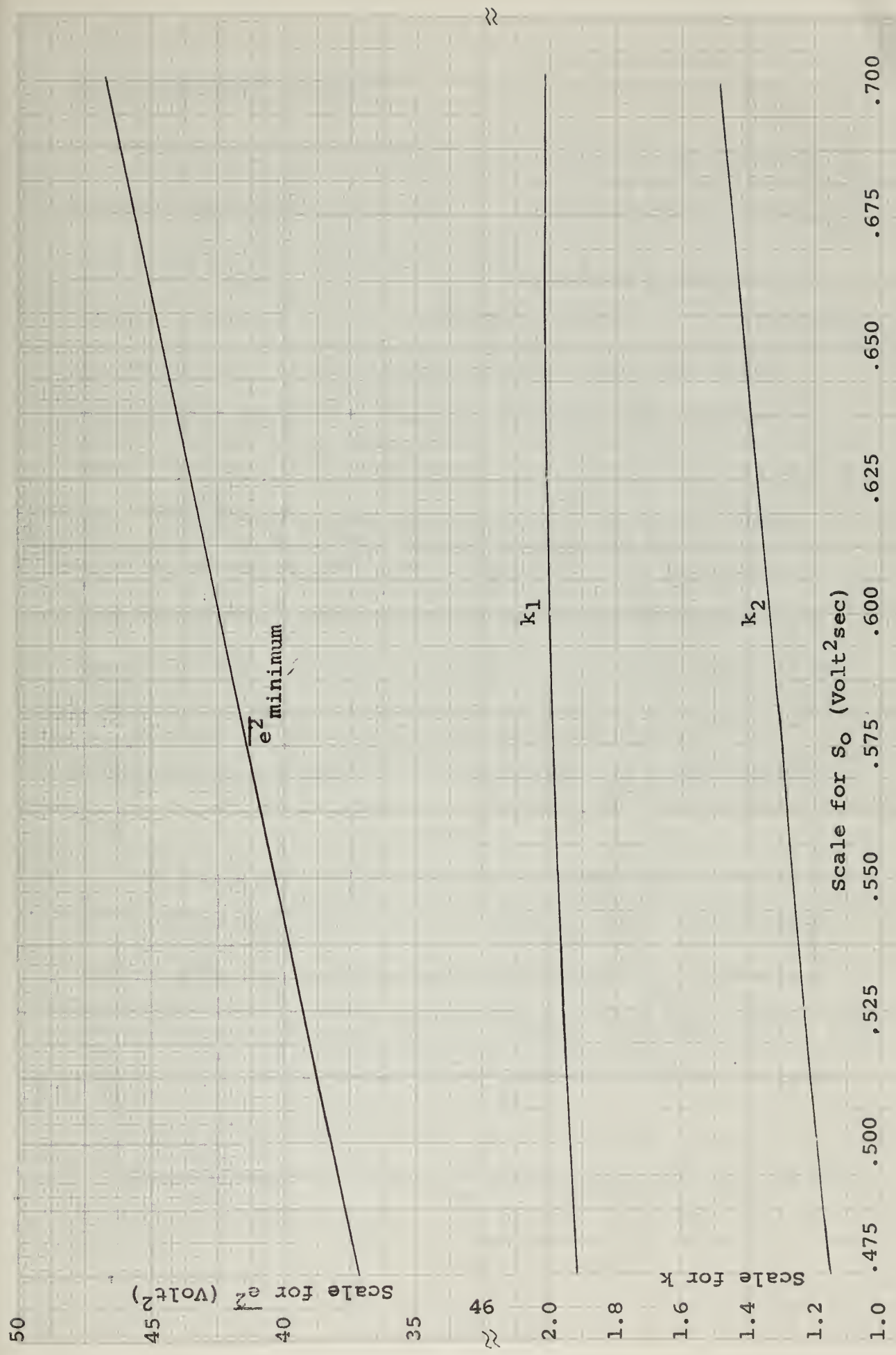

Figure III-7 $\overline{e^z}$, k_1 , and k_2 versus S_0 for $N_0 = 8.56 \times 10^{-2}$.

B. EXPERIMENTAL RESULTS

A study of the feedback loop integrator gain, D , as it affects the convergence time is presented in Figure III-8. (For this figure and those following $A' = 1$, $S_0 = 0.575$, and $N_0 = 8.56 \times 10^{-2}$ unless otherwise noted.) For values of D greater than 10 the system failed to keep the error within the convergence area for any consistent period of time. Further, convergence was not necessarily obtained at all. For runs with the gain less than 10 it was found that there was at most one overshoot of the convergence area and that it was in the initial phase of the convergence. On entering the convergence area after the initial overshoot, if any, it was found that the error remained within the convergence area throughout the remainder of the run.

An example of this overshoot is shown in Figure III-9. The initial settings of the k_i were $k_1 = k_2 = 12$ (hereafter the notation (k_1, k_2) will be used) with $D = 1$. Note that the line of minima was reached in about the same time as that taken by the system shown above starting at $(6,6)$ to reach the convergence area.

The variation of mean convergence time with A' for $D=1$ is shown in Figure III-10. For all of these runs the

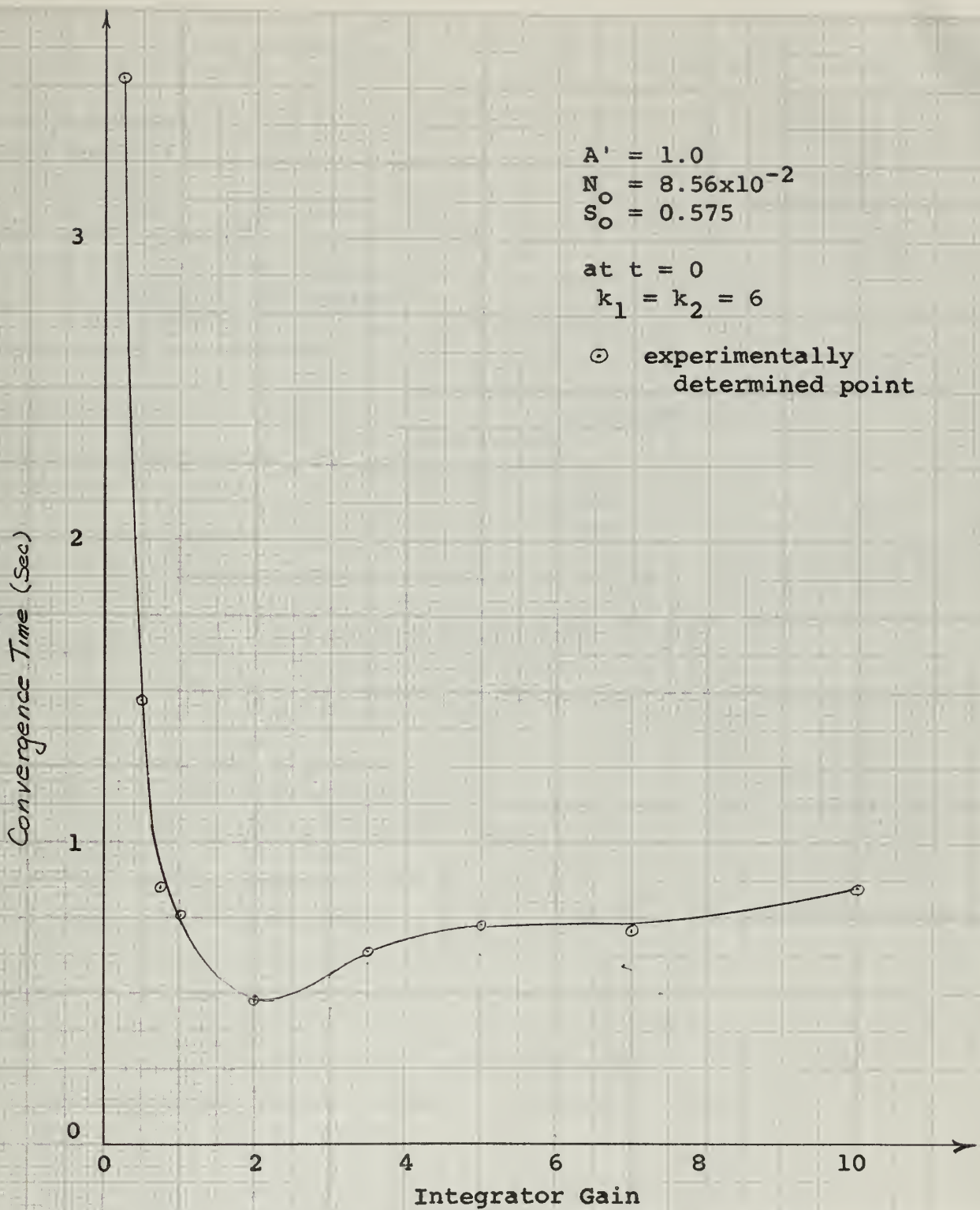

Figure III-8. Convergence time versus integrator gain.

$N_0 = 8.56 \times 10^{-2}$
 $S_0 = 0.575$
 $D = 3.0$
 $A' = 4.0$

NOTE: The elapsed time is shown alongside each plotted point. (time is in seconds)

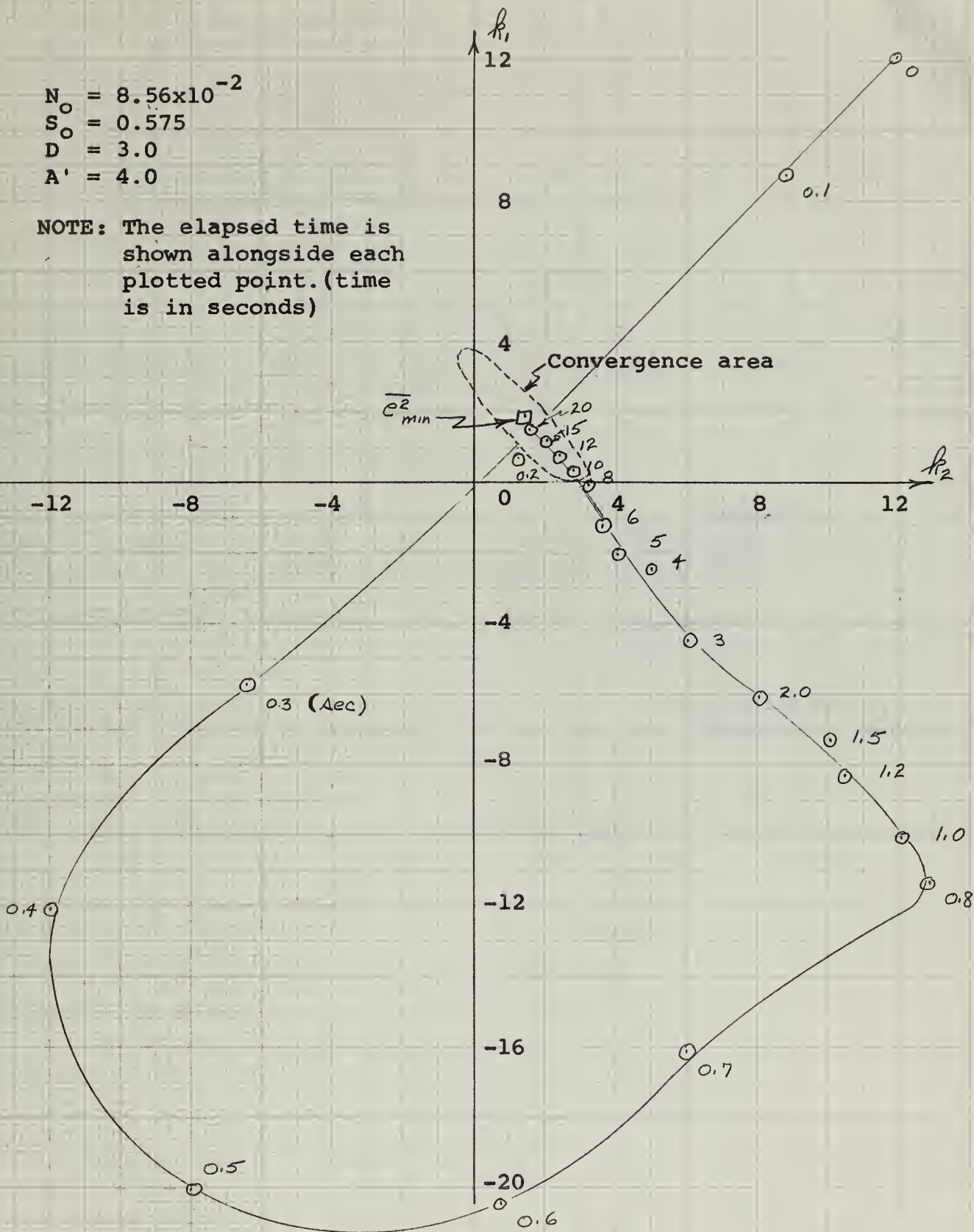

Figure III-9. Typical convergence of the k_i (with overshoot).

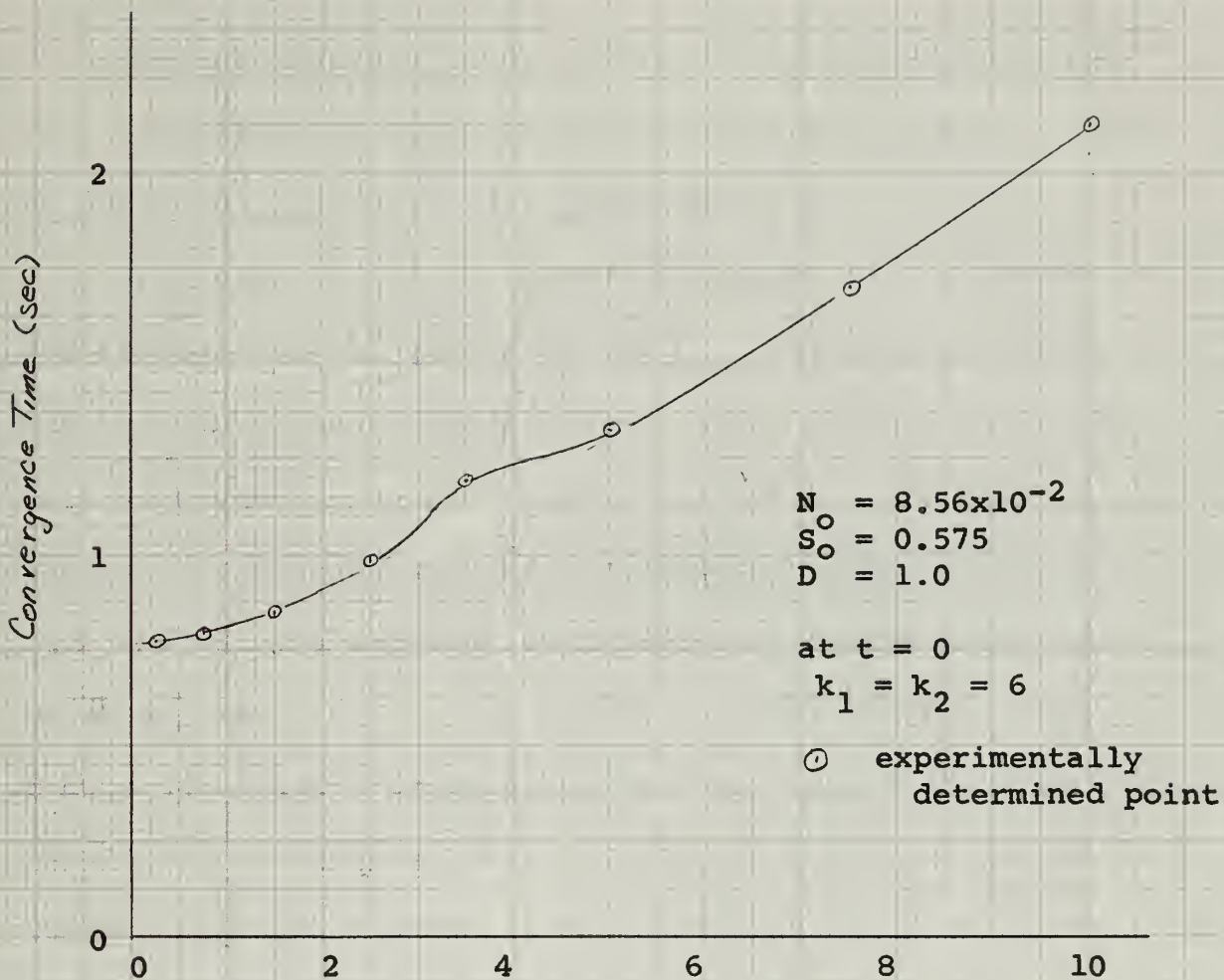
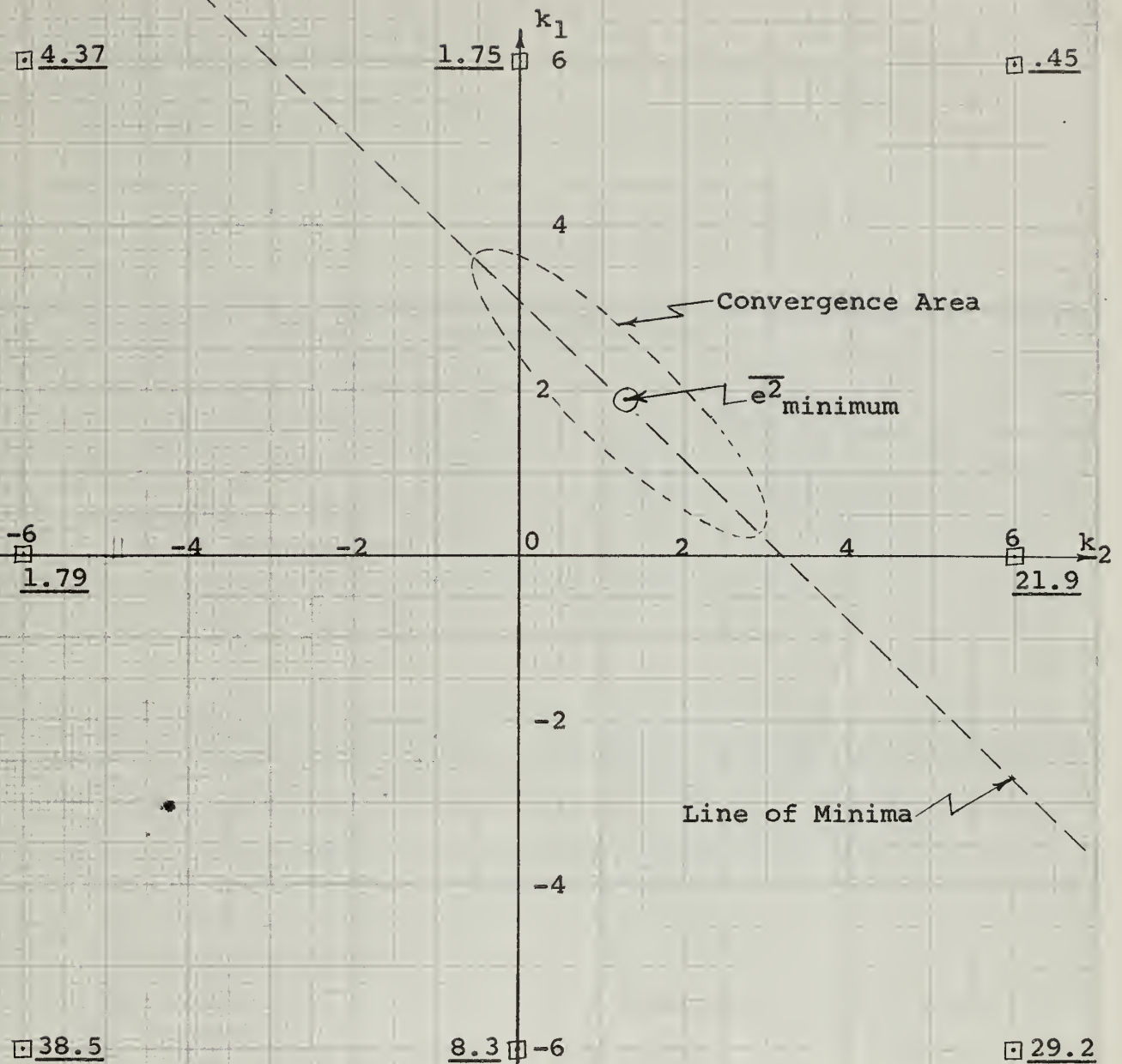

Figure III-10. Convergence time versus A'.

initial values were (6,6). The path followed from the initial point to entry into the convergence area was essentially the same in all cases (i.e. direct to the convergence area on a line nearly perpendicular to the line of minima). In no case did the system fail to converge.

In figure III-11 the mean convergence time is shown for several initial values of the k_i . The line of minima and the convergence area are also shown. In all cases the initial movement was nearly perpendicular to the line of minima. Large overshoot of the convergence area occurred from (-6,-6) and a slight overshoot of the line of minima occurred from (-6,0). For all of the runs shown on this figure the integrator gain, D, was two since this value permitted convergence times on all runs within 48 seconds, the maximum time allowed if $a(t)$ is to be fully utilized.

A demonstration of the results of the convergence procedure over a 30 db range of noise power density is shown in Figures III-12 and III-13. $S_o = 0.79 \text{ volt}^2\text{sec}$ was used for the runs in both these figures. The values of k_1 and k_2 to which the experimental runs converged and the theoretical values of the k_i over the 30 db range of noise power density are shown in Figure III-12. The minimum mean-square error, the mean-square error calculated by the method of the preceding section for the experimental



Initial Setting

Convergence Time

(6, -6)	4.37	Sec.
(6, 0)	1.75	"
(6, 6)	.45	"
(0, -6)	1.79	"
(0, 6)	21.9	"
(-6, -6)	38.5	"
(-6, 0)	8.30	"
(-6, 6)	29.2	"

$$S_0 = 0.575$$

$$N_0 = 8.56 \times 10^{-2}$$

$$A' = 1$$

$$D = 2$$

Figure III-11 Convergence times from various initial settings of k_1 and k_2 .

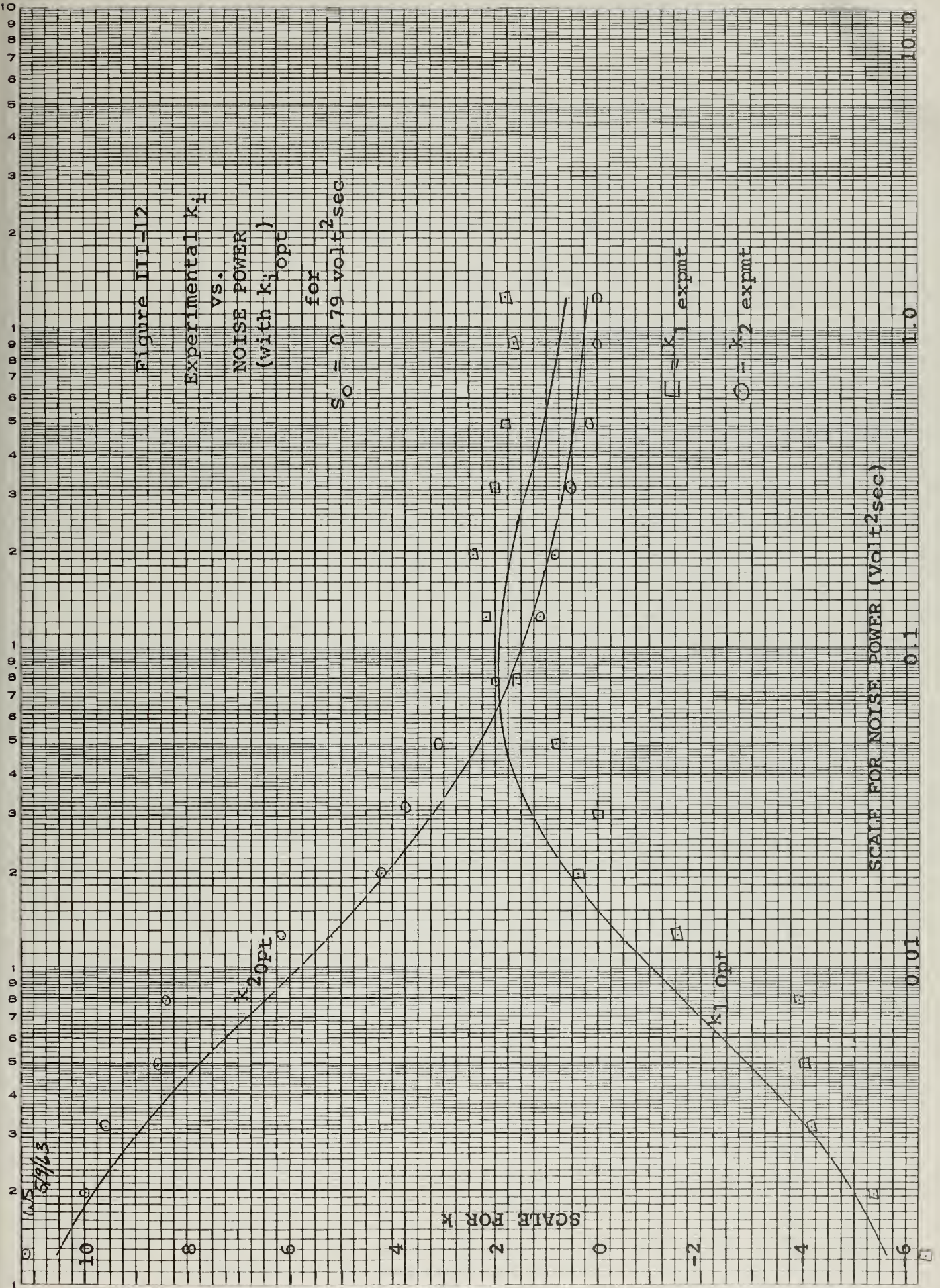

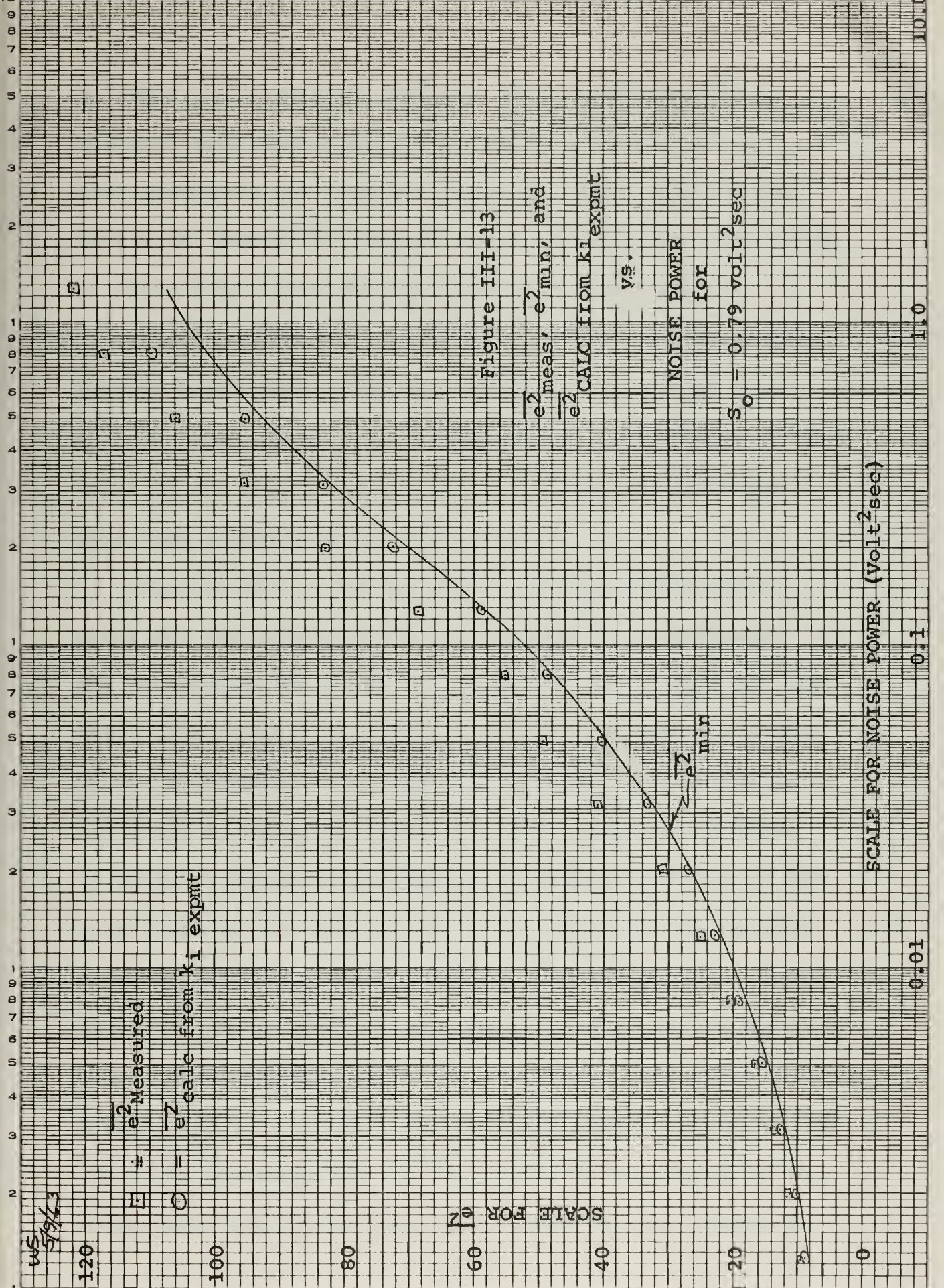

k_i based on the assumed spectra, and the experimentally measured mean-square error are shown in Figure III-13. Some saturation was encountered in the input K5U for the data point having the largest noise density, but this could be removed by linear attenuation of the input signal.

Figures III-14 and III-15 are typical recordings showing the convergence of the k_i versus time. Values of the k_i taken from these figures demonstrate the movement of the error to the line of minima and then into the convergence area when plotted as in Figure III-9.

Figures III-16 through III-24 show the mean-square error and the parameter k_2 (in this case k_2 represents the coefficient of filter 2) as a function of time for the four filter case. In order to demonstrate both the range of the mean-square error and the fact that the system error converges to about the same value for several conditions of internal parameter settings, two scales are used on the recordings of the mean-square error. The initial squared error is integrated from -50 volts for 0.1 seconds. After the error has reached a value near its minimum, the squared error is amplified by a factor of four and integrated from 0 volts for 0.1 seconds. The apparent discontinuity in the recording indicates the change of the initial value of the integrator, and the increased amplitude in the integrated

squared error a short time later indicates the introduction of the factor of four amplification. The results of several selected runs are shown in Table III.

TABLE III

RESULTS OF SELECTED RUNS WITH FOUR FILTERS

<u>D</u>	<u>Initial Value</u>				<u>Final Value</u>				<u>Final Mean-Square Error</u>	<u>Run Number</u>
	<u>k₁'</u>	<u>k₂'</u>	<u>k₃'</u>	<u>k₄'</u>	<u>k₁</u>	<u>k₂</u>	<u>k₃</u>	<u>k₄</u>		
For the following 7 runs $N_0 = 8.56 \times 10^{-2}$										
2	30	30	30	30	-2	10	7	-2	28.5	4F1
2	0	0	0	0	-3	19	-2	2	26.7	4F2
2	-30	-30	-30	-30	0	1	34	-27	32.0	4F3
2	-30	-30	30	30	-3	15	5	-3	25.0	4F4
2	30	30	-30	-30	-7	21	-19	13	25.0	4F5
5	30	30	30	30	-10	36	-22	14	25.0	4F6
.5	30	30	30	30	0	10	4	3	25.0	4F7
For the following 7 runs $N_0 = 8.56 \times 10^{-3}$										
2	30	30	30	30	-15	31	3	3	9.9	4F8
2	0	0	0	0	-15	30	9	0	11.1	4F9
2	-30	-30	-30	-30	-12	10	42	-25	9.9	4F10
2	-30	-30	30	30	-9	0	19	6	8.7	4F11
2	30	30	-30	-30	-21	48	-3	-4	9.9	4F12
5	30	30	30	30	-22	50	-16	6	11.1	4F13
.5	30	30	30	30	-9	17	9	9	9.9	4F14

NOTE: Multiply k_i' ^{by 0.2} to get k_i .

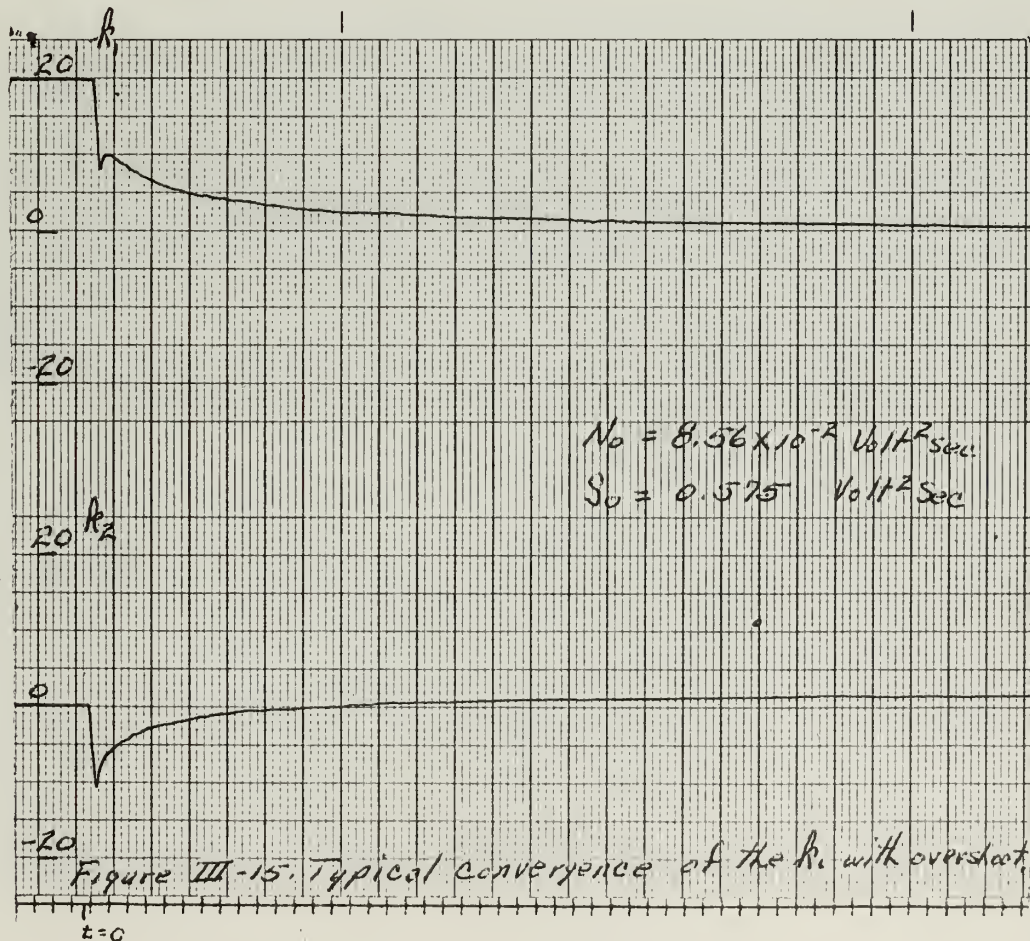
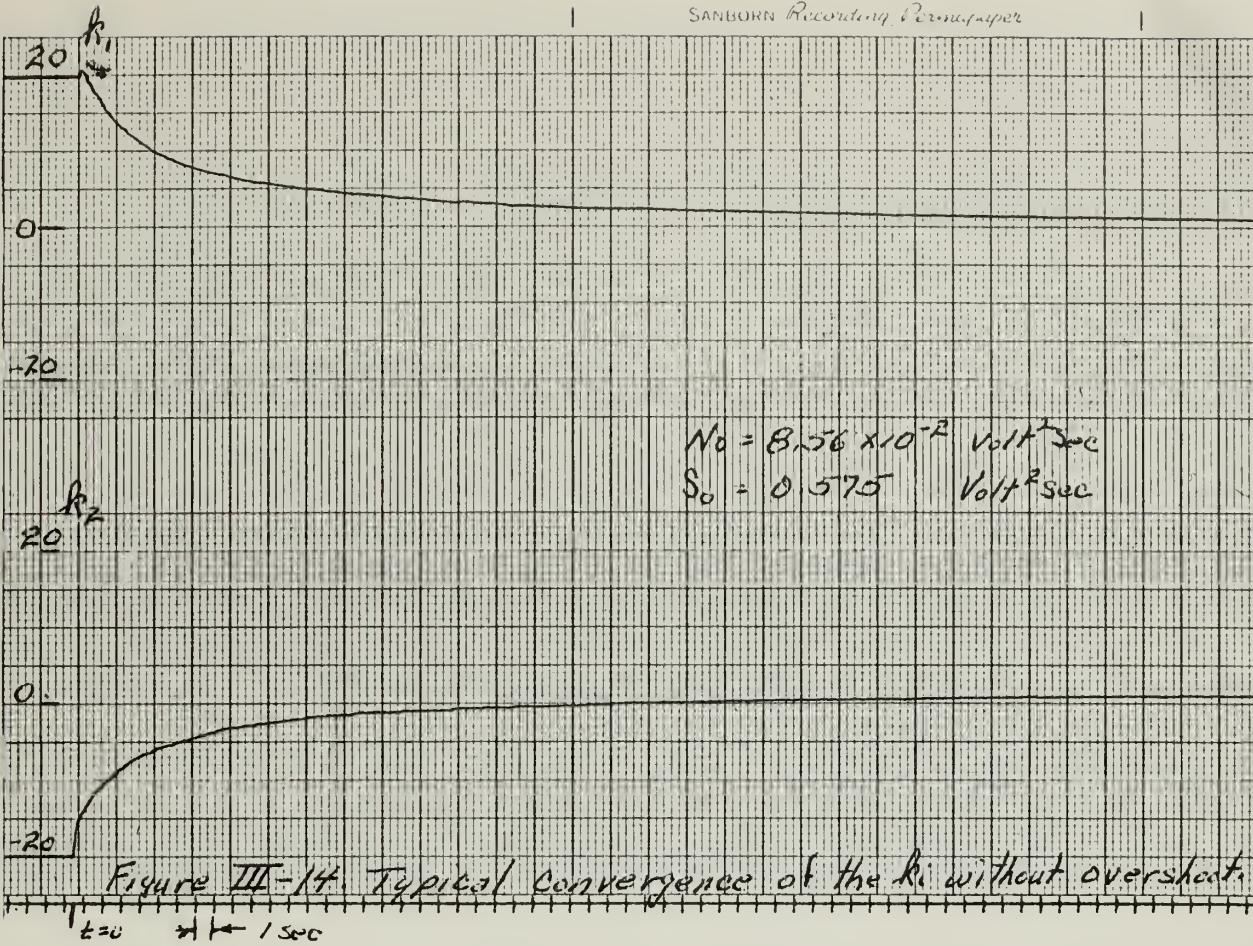

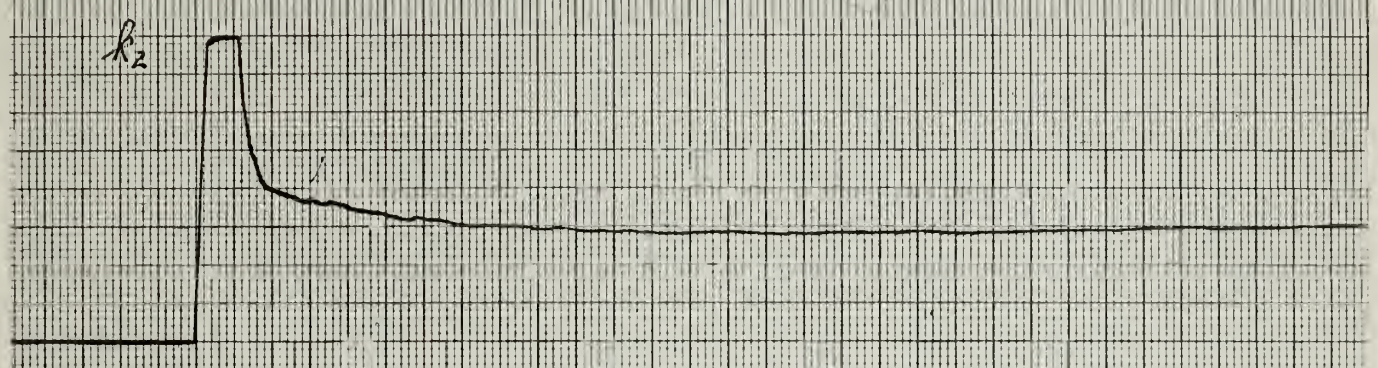
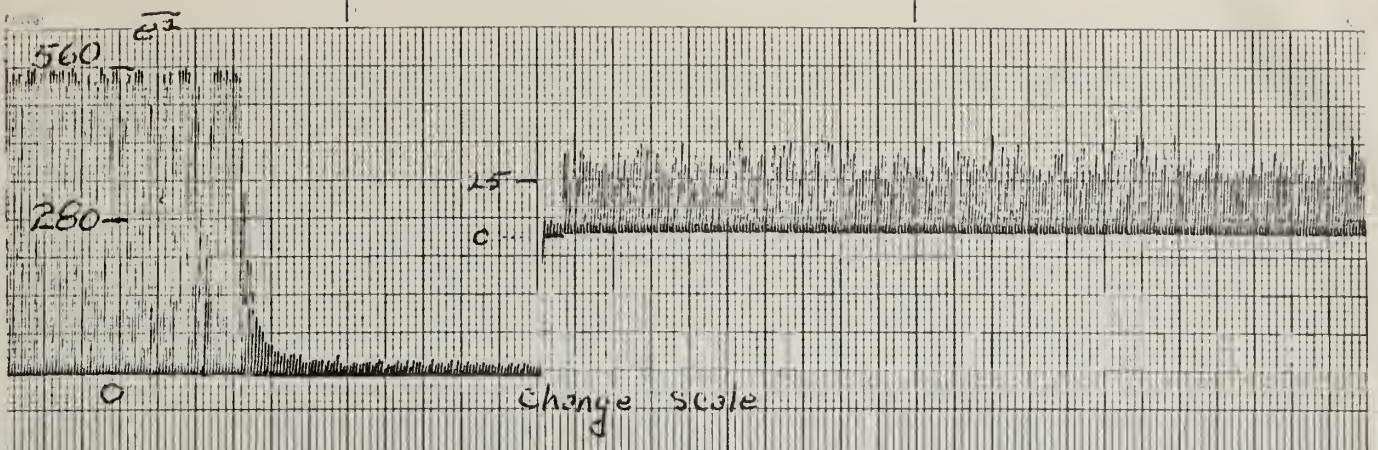

Figure III-16 Recording of run 4F3

SANBORN 6

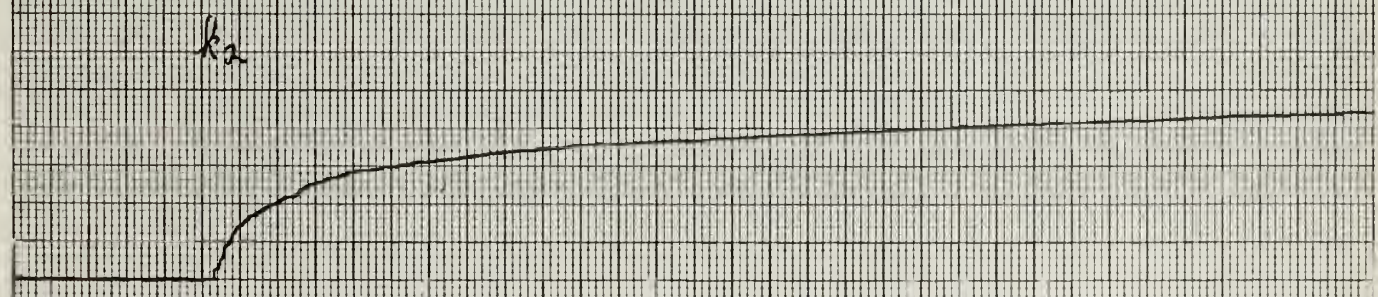
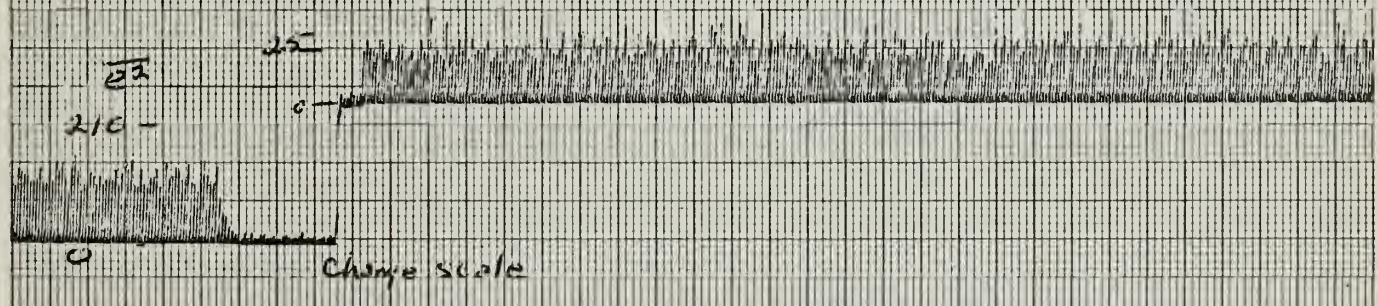

Figure III-17 Recording of run 4F4

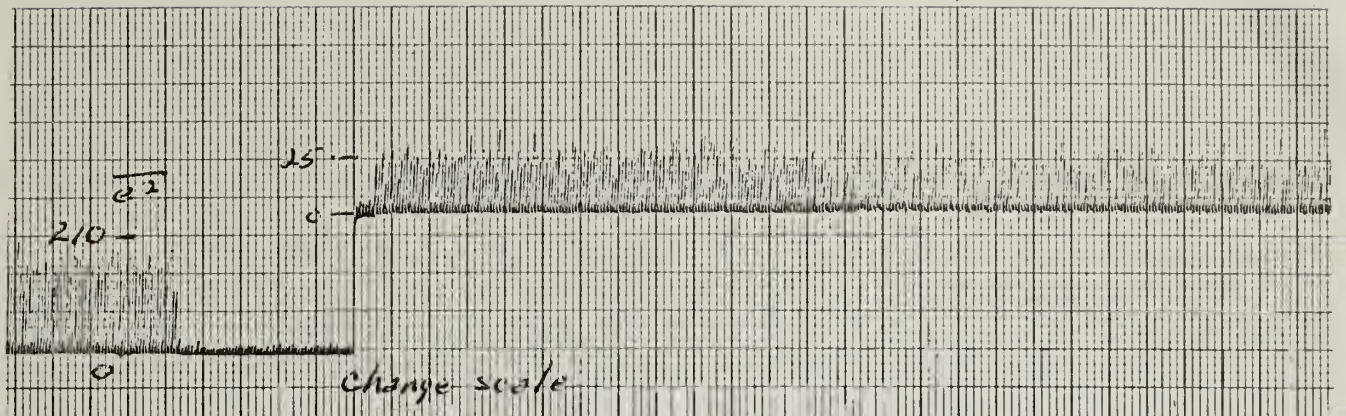

Figure III-18 Recording of run 4F5

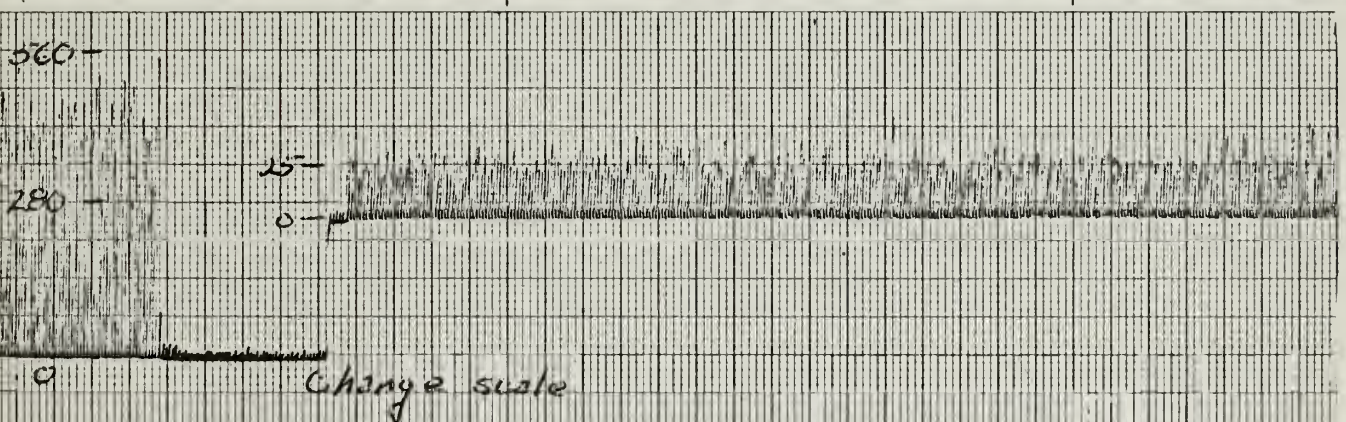
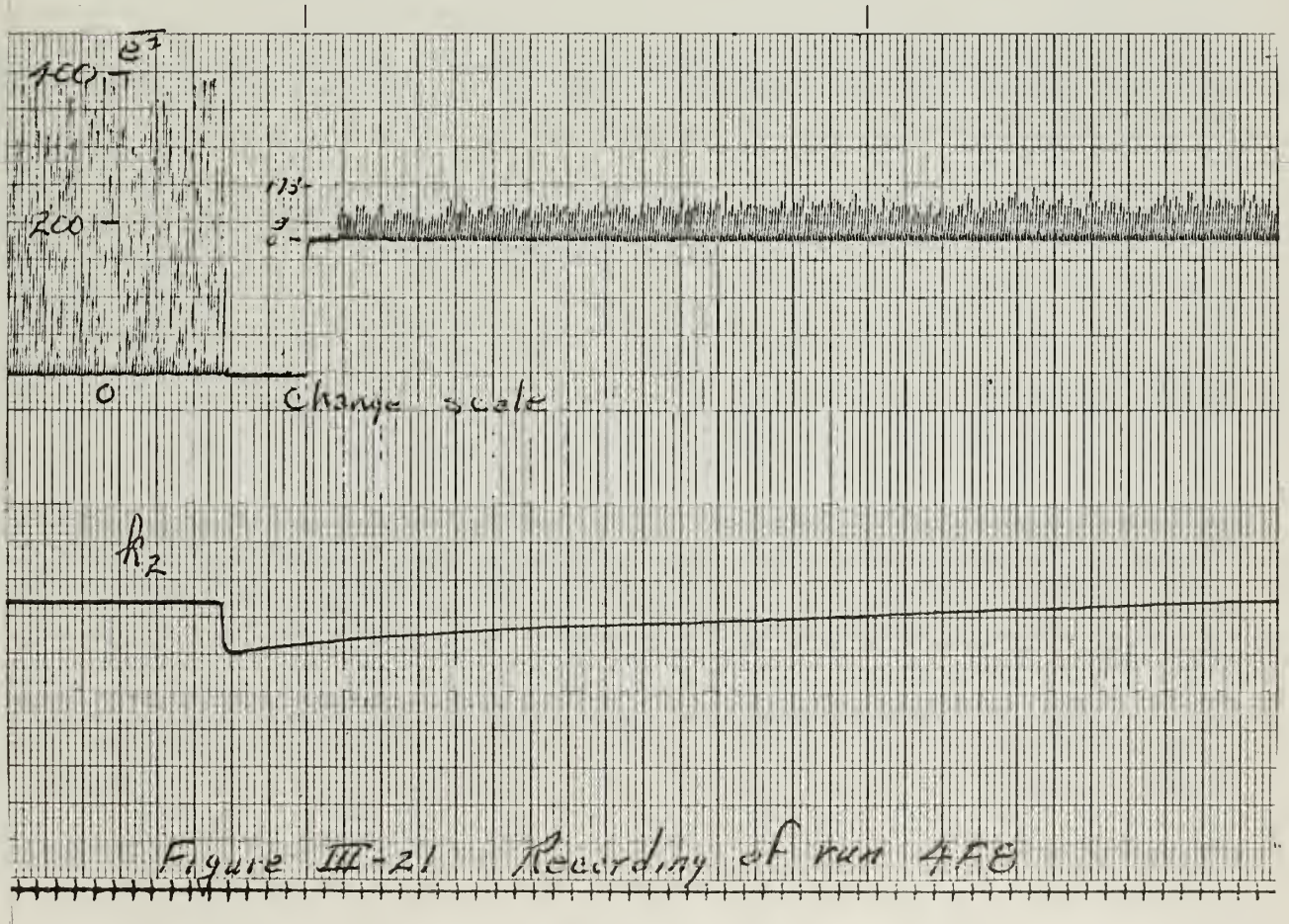
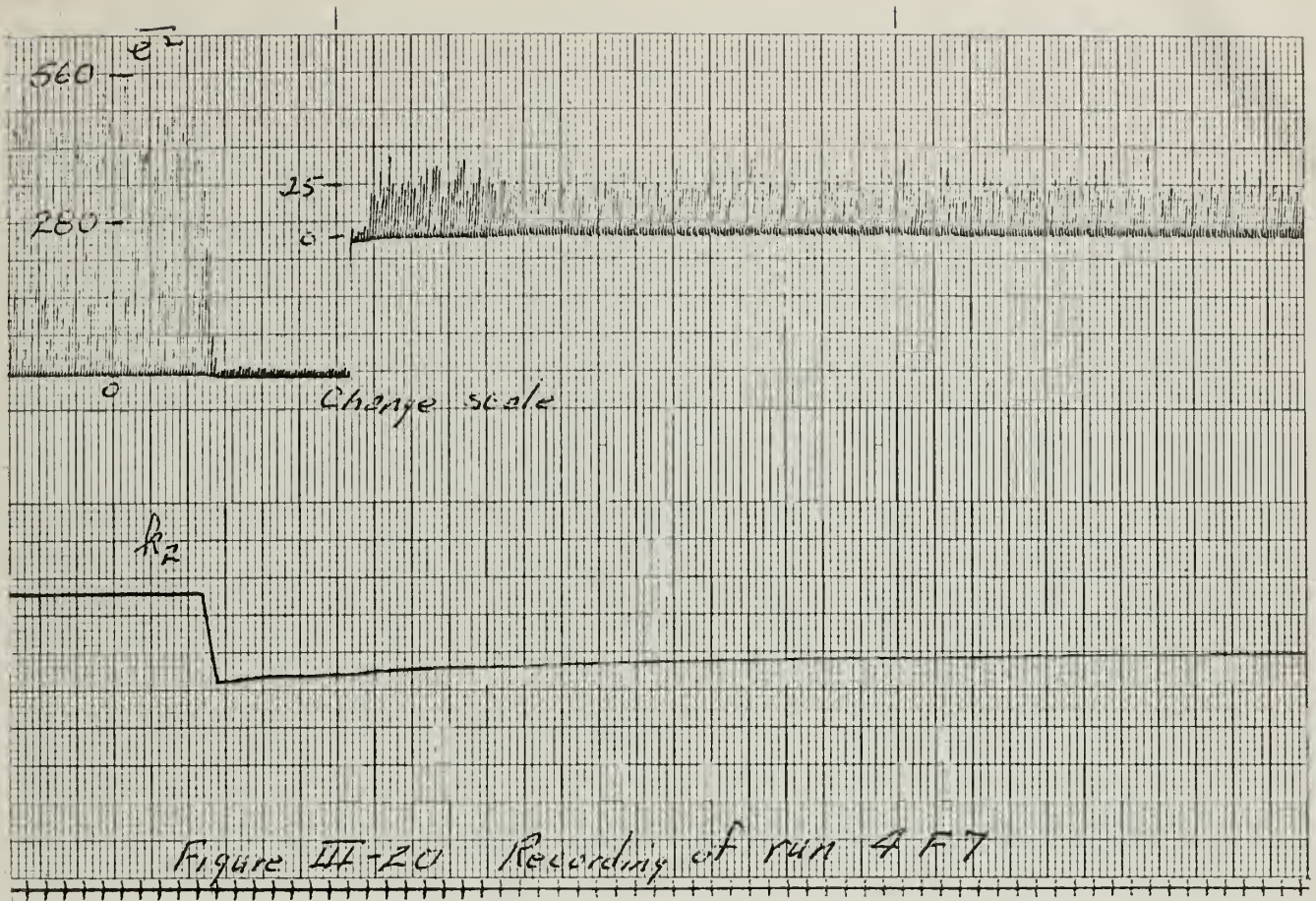

Figure III-19 Recording of run 4F6



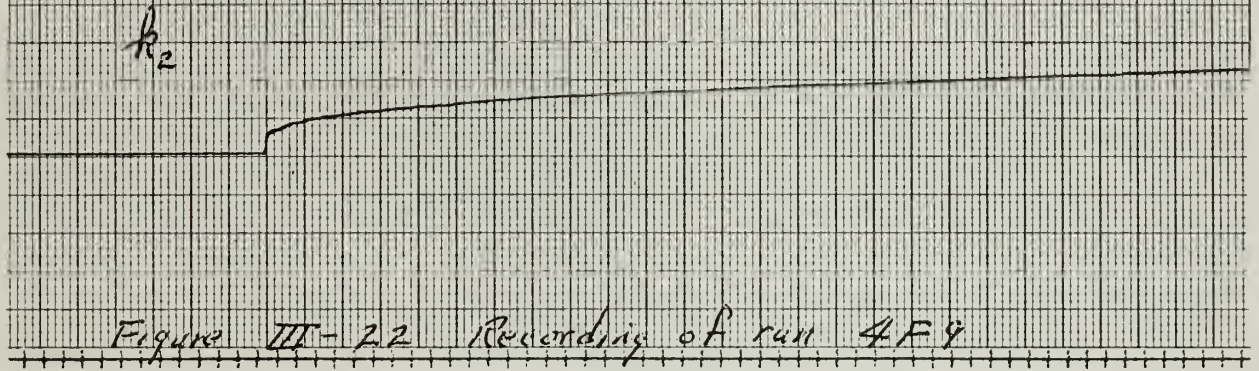
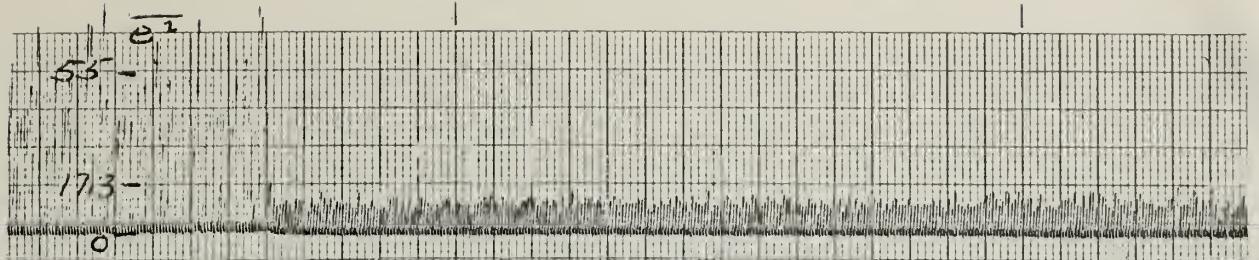

Figure III-22 Recording of run 4F9

SANBORN Records

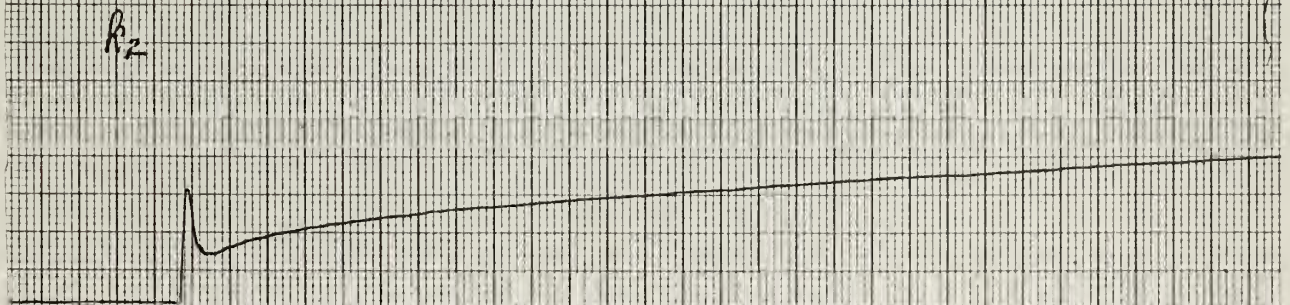
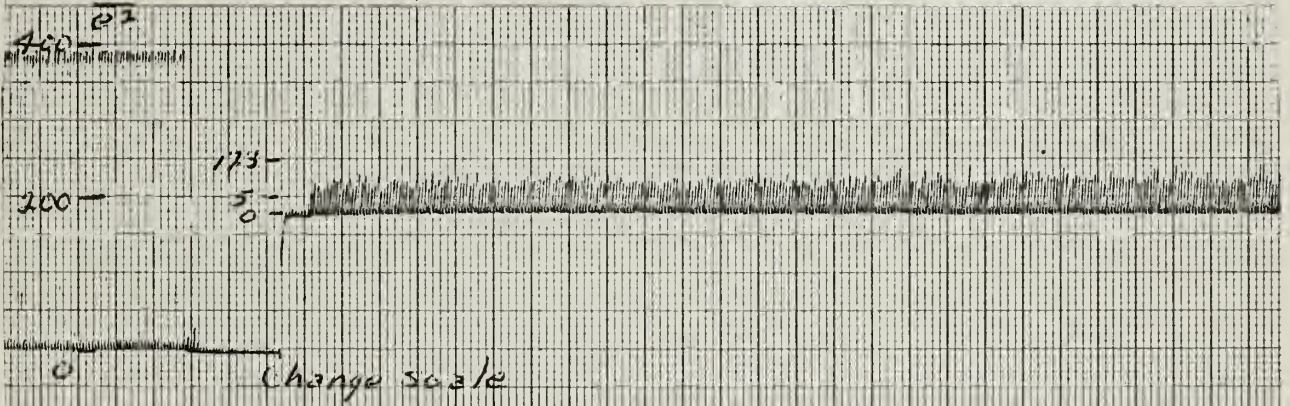

Figure III-23 Recording of run 4F10

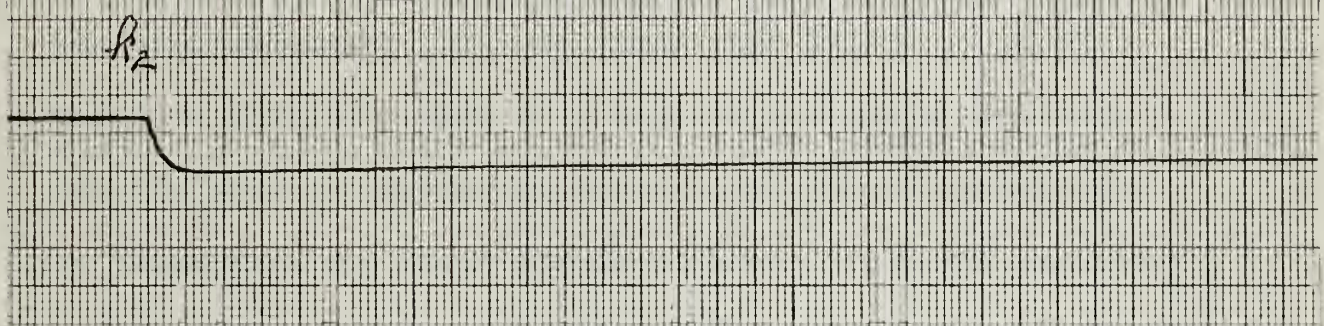
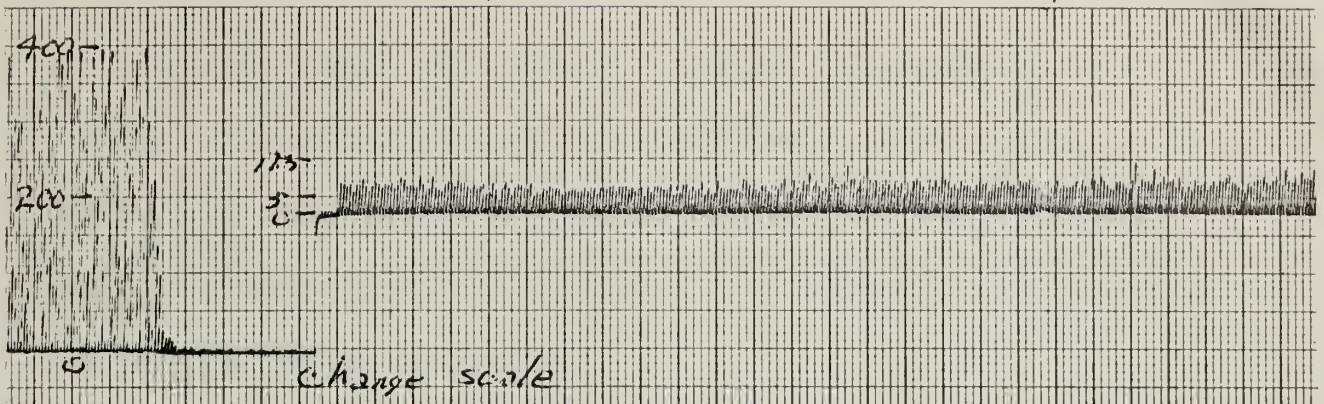

Figure III-24 Recording of run 4F14

It was found that about 45 minutes were required to set up the computer for each set of runs. The largest portion of this time was spent in adjusting the MU/DV units for the proper value of their division constant and removing the mean DC level from them.

Removal of the average DC level from the K5M units was also necessary. It was found that $0x0/50 \neq 0x0/20$ and that $0x50/50 \neq 0x50/20 \neq 0x20/50$ for operations with the K5M units. In view of the extreme ranges encountered in conducting the tests discussed above, this was particularly disconcerting. The values involved were small, on the order of 0.035 volts rms, but when these are integrated for a period of several seconds, they begin to contribute an error about which little can be done.

C. DISCUSSION OF RESULTS

In considering the effect of integrator gain, D , on convergence times when $A' = 1$, we first examine both extremes in gain settings. It is easily seen that for an integrator gain of zero, convergence can never be obtained, and we expect that small values of gain setting will lead to slow convergence. At high gains, the 50 volt upper limit of the computing equipment enters the problem in two ways.

First, $a(t)$ will be at a constant value (saturation) for $t \leq D/50 - 2$, $D \geq 100$. Second, since the function $A't + 2$ reaches its maximum value at $t = 48$ seconds for $A' = 1$, the minimum value which $a(t)$ can reach is $D/50$. Both of these effects violate the requirement that $a(t)$ decrease monotonically. The first effect means that the convergence procedure does not start to settle down until some time greater than zero, and the second effect may result in undamped oscillations if a near steady condition has not been reached by the system prior to the time $a(t)$ reaches its minimum value. In any event, we desire that $a(t)$ be as near zero as possible for t greater than some T_0 and that there be no initial saturation. Both of these conditions are met for small values of A' . In general, we expect that there will be some value of D which will minimize the time to convergence, and that there will be some range of settings of D about this minimum which will give suitable values of convergence time.

From Figure III-8 it is seen that an asymptotic approach to infinite convergence time is obtained for integrator gains approaching zero. Minimum convergence time is obtained for an integrator gain setting of two. Convergence time is found to remain nearly constant for integrator gains between four and seven. Further, it was observed that for

values of gain less than two, the system converged without any overshoot of the convergence area. However, for settings of D greater than two, overshoot became increasingly severe. Thus, the minimum time to convergence is obtained for a setting of D just less than that value which first results in oscillations.

The combined effect of the shape of the regression surface and the weighting of $a(t)$ shown in Figure III-9 is perhaps the best graphical portrait of the convergence process. The initial movement of the error perpendicular to the line of minima shown here is typical. There is an overshoot of the convergence area, but the system corrects itself and turns back toward the line of minima. As the error decreases while following the line of minima into the convergence area, we see the increasingly slower movement which is also characteristic of the system.

For the experimental system studied in this work the convergence time is less than one second for $A' < 2.5$. When the product $A't_c$ (where t_c = convergence time) is less than 0.2, we expect this product will be dominated by the constant 2 in $A't + 2$, and that there will be no further change in the convergence time for decreasing values of A' . This effect is shown in Figure III-10 where the curve of convergence time versus A' has a flat portion for $A' < 0.5$.

For each combination of noise power density and signal power density there is a fixed value of K_0 . Since it is required that $0 < A' \leq 4K_0$ when $D = 1$, it is expected that increasing A' beyond $A' = 4K_0$ will result in increasing amounts of time being taken for the system to converge. Although K_0 was not computed for this experimental system, it is noted that for $10 > A' > 2$ the convergence time increases linearly with A' . Since oscillations were absent throughout the range $0 < A' < 10$, we may conclude that the convergence procedure is not overly dependent on A' when convergence occurs prior to the time that $a(t)$ reaches its minimum value.

From the convergence times shown in Figure III-11, it is seen that the system takes very little time to reach the line of minima while taking the majority of the convergence time to move down the valley along the line of minima. For instance, if we look at the two points $(-6, 6)$ and $(0, 6)$, we see that the convergence time is about the same from both points, but that a slightly longer time is taken by the movement from the initial setting furthest from the line of minima. Looking at the two points $(6, 0)$ and $(6, -6)$ we see that the perpendicular distance to the line of minima is about the same, but that for the initial setting furthest from the convergence area, the convergence time

is about a third longer compared with the nearer initial setting.

The seeming deviation from this analysis is present if one considers the points (6,6) and (-6,-6). Here the discrepancy is due to an overshoot when starting from (-6,-6) which does not occur when starting from (6,6). After the overshoot occurs the system returns to the line of minima at about (10,-8) and the excessive time is spent in transit down the line of minima from that point. After a slight overshoot of the line of minima from the initial position of (0,-6), the system returns to the line of minima only a short distance from the convergence area. From the foregoing discussion we again see that the system giving the most rapid convergence results when the gain settings are so adjusted that the system is just on the verge of overshooting the convergence area. Moreover, the range in convergence times from 0.45 to 38.5 seconds is not indicative of the best possible performance of the system since all of these runs were obtained with that value of D and A' which gave minimum convergence time from (6,6).

The information shown in Figures III-12 and III-13 demonstrate that this system is capable of operating properly over a range of 30 db of noise. Thus the system is suitable for the proposed application in an adaptive filter for radio communications.

From Table III and Figure III-1 it is seen that in the four filter case, the error on completion of optimization is about 40% less than that obtainable with two filters. This is to be expected since with more third order filters, we can more closely approximate the second order desired signal.

A computer characteristic which may have introduced small inaccuracies in the experimental results was the inability to adequately compensate for the input dependent DC level of the multipliers. Admittedly this level was small, but it can become quite troublesome when the noise power density and/or the signal power density changes from one trial to the next as must be the case if this system is to be useful in the adaptive configuration. For this work we could adjust the DC level to a minimum at the optimum settings of the k_i so as to avoid drift after the system had reached its near optimum position. Such an adjustment is possible only because we knew a priori what the optimum settings were. An adaptive system is,

of course, unnecessary if we have such knowledge of the optimum settings. A way of avoiding this problem would be to heterodyne all signals up about some suitable carrier (say 10 Kc.) and work with the heterodyned signals.

CHAPTER IV

CONCLUSIONS AND RECOMMENDATIONS

A. CONCLUSIONS

We have shown that the adjustment procedure does produce the desired results for the mean-square error criterion. The time taken to converge can be controlled by adjustment of the feedback loop gain. Since convergence times of well under 30 seconds can be obtained with this system and the system does perform satisfactorily over the required 30 db range in noise power density, it is applicable to use in an adaptive filter system for radio communications. Further, it has been shown that the overall gain in performance over a fixed filter which can be achieved by even this simple example is of the order of 5 to 10 db at the extreme deviations of the noise power density from the fixed filter design value.

B. RECOMMENDATIONS

Although the adjustment procedure worked well here, it should be pointed out that the cost of stabilized multiplier units might make such a system impractical from an

economic viewpoint in the use proposed here. However, if use of this unit materially decreased the probability of enemy detection of a 25 million dollar ship, the expenditure of several thousands of dollars would be well justified. The possibility of reducing the cost of operational units from that of the highly specialized equipment used for this experimental work is great. For instance, further investigation of applications of this adjustment procedure might look into the possibility of heterodyning all signals about a suitable carrier and working with the heterodyned signals. This would avoid the DC drift problem encountered here and may permit the use of relatively inexpensive units for the multipliers as well as for the entire system.

The design engineer having access to existing analog computing equipment should consider this adjustment procedure as it offers reasonable savings in filter design time over that required by present statistical measurement and computational techniques.

BIBLIOGRAPHY

1. D. J. Sakrison, "An Iterative Method for the Design of Filters for Non-Mean-Square Error Criteria", to be published in IRE TRANS. on INFORMATION THEORY, July 1963.
2. S. Sherman, "Non-Mean-Square Error Criteria", IRE TRANS. on INFORMATION THEORY, vol. IT-4, no. 3 pp. 125-126, Sept. 1958.
3. W. Q. Crichlow, D. F. Smith, R. N. Morton, and W. R. Corliss, Worldwide Radio Noise Levels Expected in the Frequency Band 10 Kilocycles to 100 Megacycles, NBS circular 557, (GPO, Washington, D.C., 1955).
4. G. Fant, Acoustic Theory of Speech Production (Mouton & Co., The Hague, 1961).
5. G. C. Newton, Jr., L. A. Gould, and J. F. Kaiser, Analytical design of Linear Feedback Controls (John Wiley & Sons, New York, 1961).
6. D. J. Sakrison, "Application of Stochastic Approximation Methods to System Optimization", Sc.D. Thesis, M.I.T., May 13, 1961. Also available as M.I.T. R.L.E. Technical Report 391.

thes608

An Adaptive filter system for radio comm

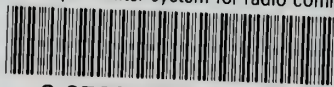

3 2768 002 00794 0
DUDLEY KNOX LIBRARY