





LOCOMOTIVE APPLIANCES

SUPPLEMENT TO

THE SCIENCE OF RAILWAYS

BY

MARSHALL MONROE KIRKMAN

PUBLISHED BY

THE WORLD RAILWAY PUBLISHING COMPANY.

337
W. 42nd St. N. Y. C.
337
W. 42nd St. N. Y. C.
337
W. 42nd St. N. Y. C.

337
W. 42nd St. N. Y. C.
337
W. 42nd St. N. Y. C.
337
W. 42nd St. N. Y. C.

NEW YORK AND CHICAGO:

THE WORLD RAILWAY PUBLISHING COMPANY.

1903.

TJ 607
K6

THE LIBRARY OF
CONGRESS,
Two Copies Received
MAR 28 1903
Copyright Entry
Mar. 28-1903
CLASS a XXa. No.
56282
COPY B.

COPYRIGHT BY
THE WORLD RAILWAY PUBLISHING COMPANY
1902, 1903.
All rights reserved.

WORLD RAILWAY PUBLISHING COMPANY

TG 556
K6

38470

THE HENNEBERRY COMPANY
PRINTERS... BINDERS... CHICAGO

CONTENTS.*

	PAGE.
Headlight	9
Pyle national electric.....	
Pressure regulators or reducing valves.....	30
Directions for the management of steam heating on railway trains.....	31
Mason.....	32
Gold.....	36
Climax.....	37
Eclipse.....	39
Taafel.....	41
Ross.....	43
Special automatic relief valve.....	45
Rules for engineers.....	47
Air brake apparatus.....	41
Duplex air pump—New York air brake.....	49
Triple valves—New York air brake.....	53
Westinghouse "1900" feed valve or train line governor—slide valve pattern.....	62
High pressure controlling apparatus.....	65
Brake shoes.....	68
The Sargent.....	70
Engine truck and tender.....	73
The Lappin.....	75
The Corning.....	78
Flexible metallic joints.....	81
The Moran.....	83
McLaughlin's.....	84
Climax.....	86
Pressure gauges.....	88
Siphons and siphon cocks.....	92
Crosby.....	95
Lane.....	99
Star.....	100
Ashcroft.....	101
Utica.....	102
Duplex air brake.....	104
Pressure recording gauges.....	110
Gauge hand or "pointer" pullers.....	112
Testing gauges.....	113
Pop safety valves.....	120
Coale.....	121
Star.....	122
Meady.....	124
Crosby.....	126
Consolidated.....	130
Ashton.....	132
Injectors.....	134
Sellers'.....	139
Nathan "simplex".....	148
Nathan "monitor".....	151
Metropolitan.....	152

*A List of Illustrations will be found at page 477 of this volume.

	PAGE.
Injectors (continued)	134
Hancock inspirator	156
Hancock "composite" inspirator	161
Lunkenheimer	163
Ohio	167
Niagara	168
Little Giant	169
Boiler washing and testing apparatus	171
Swing intermediate or line check valve	172
Oil cup for injectors and inspirators	173
The ejector or jet pump	174
Locomotive boiler checks	177
Locomotive slide valves	181
Richardson balanced slide	182
Allen-Richardson balanced slide	184
American balanced valve	187
Piston valve	197
Water gauges and gauge cocks	199
Mason air brake pump regulator or governor	203
Locomotive steam whistles	208
Stay-bolts	212
Locomotive eccentrics	219
Rod packing	221
United States metallic packing	222
United States valve-stem packing	225
Jerome metallic packing	227
Jerome valve-stem packing	229
Air pump metallic packing	231
United States air pump packing	231
Jerome air pump packing	232
Swab holders	234
Locomotive lubrication	235
Locomotive lubricator	235
Detroit triple feed	250
Detroit triple feed with tippett attachment	258
Michigan sight feed	264
Seibert sight feed	271
Force feed lubricators	274
Cory's	274
McCanna	277
Engine truck oil cellar and sight feed oil cup	280
Oil cups	284
Guide cups	285
Spindle feed cups	286
Open cups	287
Grease cups	288
Hand oilers	290
Lubrication of journals	291
Packing in journal boxes	292
Journal box dust guards	305
Harrison dust guard	305
Locomotive bell ringers	307
Gollmar	307
Sansom	311
Chicago	313
Automatic steam blowers	314
Huff	314
C. & N.-W. R'y blower valve	318

	PAGE.
Variable exhaust nozzles	320
Wallace & Kellogg's	321
Huff	322
Wallace & Kellogg's air pump exhaust feed water heater and cylinder lubricator	327
Boiler cleaners	330
McIntosh pneumatic blow-off cock	330
Hornish mechanical boiler cleaner	335
Climax blow-off cock	341
Little Giant pneumatic blow-off cock	343
Johnstone blow-off valve	344
Homestead blow-off valve	345
Automatic air and steam coupler	346
Linstrom syphon pipe	349
Locomotive feed-water strainers	351
Sellers'	351
Heath	353
H-D	353
Hancock	354
Snow flanger	356
Q and C—Priest	356
New engineer's brake valve—New York Air Brake Company	358
Automatic emergency recorder	365
Automatic brake-slack adjuster	369
Globe valves, relief valves, etc.	371
Crosby spring seat valve	372
Homestead straight-way valve	373
Steam chest vacuum valves	374
Richardson relief valve	375
Blackall relief valve	376
Richardson combined pressure and vacuum relief valve	377
Locomotive boiler coverings	379
Steam engine indicators	383
Crosby	384
Tabor	391
Ashcroft reducing wheels	398
Thompson	403
Reading indicator diagrams	405
Boyer speed recorder	407
Crosby locomotive revolution counter	421
Automatic couplers	422
Coupler emergency knuckle	423
Cast-steel for locomotive parts	425
Heating engine houses	428
Smoke jacks for engine houses	432
Fire kindlers	435
Jack screws and power hoists	437
Locomotive or car pusher	447
Track sanders	448
Leach "D"	449
"Sh"	455
Sherburne's arrangement for automatic sanding	458
Huff pneumatic	460
A. B. C.	464
"Mudd"	465
Pneumatic tools	469

INTRODUCTION.

In the case of many mechanical inventions, it has often happened that the machine left the hands of its inventor in its most complicated and cumbrous form, and it remained for the practical man and operator afterward to simplify it, without reducing the advantages of the mechanism as a whole, but rather increasing its efficiency. Thus, in the process of time, the machine, once complex and confusing in its many parts, became shorn of its excrescences, and simplicity rather than complexity characterized its construction. Such, however, has not been the case with the locomotive; early types were entirely lacking in the many appliances that now play so important a part in its operation, and which form the subject of this volume.

Time was, within the memory of many engineers, shopmen and others connected with the mechanical department of railways, when the contents of this volume could have been included in a brief pamphlet. In the early days there was nothing in the cab but the gauge cocks, throttle and reverse lever; upon the outside the attractive features were mainly rings, bands, and casings of polished brass, upon which the fireman lavished much time and labor in burnishing. To-day the locomotive engineer finds in his cab close at hand a multitude of appliances with which he must be familiar in order to be the master of his machine

and compel its prompt and unfailing response to his behests. Within the radius of his arm are a multitude of levers and cocks, the touching of which sets in motion complicated mechanisms that perform some necessary function in the movement of his train. Originally, the engineer's control was limited to his machine; now he is master of the whole train from the headlight on his engine's front to the last truck on the rear of his train. With his injector he controls his water supply; the automatic lubricator has supplanted the hand oiler; the air pump controls the brakes; his steam, air and steam heating gauges keep him advised of the needs of his train in these directions; his speed recorder tells him what work his engine is accomplishing; and so on. Each of these appliances, and many others treated of in this volume, has come into being to meet some apparent need or answer some well defined purpose, and the sum of them all has transformed the locomotive from the rampant, noisy, spasmodic pigmy of its inventor to the graceful, unfailing and swift giant of to-day. When it is remembered that it is but a part of the locomotive engineer's or fireman's business to be informed as to the construction, operation and care of these and many other appliances, it is not surprising that he should be classed among the most skilled artisans of the age.

It is essential that the engineer, fireman, shopman and mechanical student of railways should be familiar with the construction and operation of each of the subsidiary machines and devices, that, taken together, form the perfect modern locomotive, if he hopes to attain success in his profession, and the aim

of this work will be achieved if it makes the purpose, construction, operation and maintenance of locomotive appliances now in general use more clear to those interested.

Any treatise on designs, special attachments or inventions such as the locomotive appliances described herein, must necessarily be largely technical, else it would be untrue to its purpose, but I have not deemed it necessary to burden this book with mathematical formulas understandable only by those who have been initiated into the higher branches of mathematics. Indeed, my object has been to make this treatise so clear and simple that the youngest fireman may comprehend its statements.

In the compilation of this work I have had the benefit of the active advice and invaluable assistance of Mr. Edward Williams Pratt, Mechanical Engineer, a man of talent, and recognized authority on locomotive appliances, and who, in that connection, has been for many years a trusted and highly honored official of one of the largest and best managed railways of the world.

In conclusion, I would state that this volume is intended as a supplement to my larger and more comprehensive work, "THE SCIENCE OF RAILWAYS," which takes up the whole field of railway operation, and in which the duties of engineers and firemen, the operation of the locomotive, the air-brake, etc., are carefully set forth.*

M. M. KIRKMAN.

*See advertisement at end of book.—PUBLISHERS.

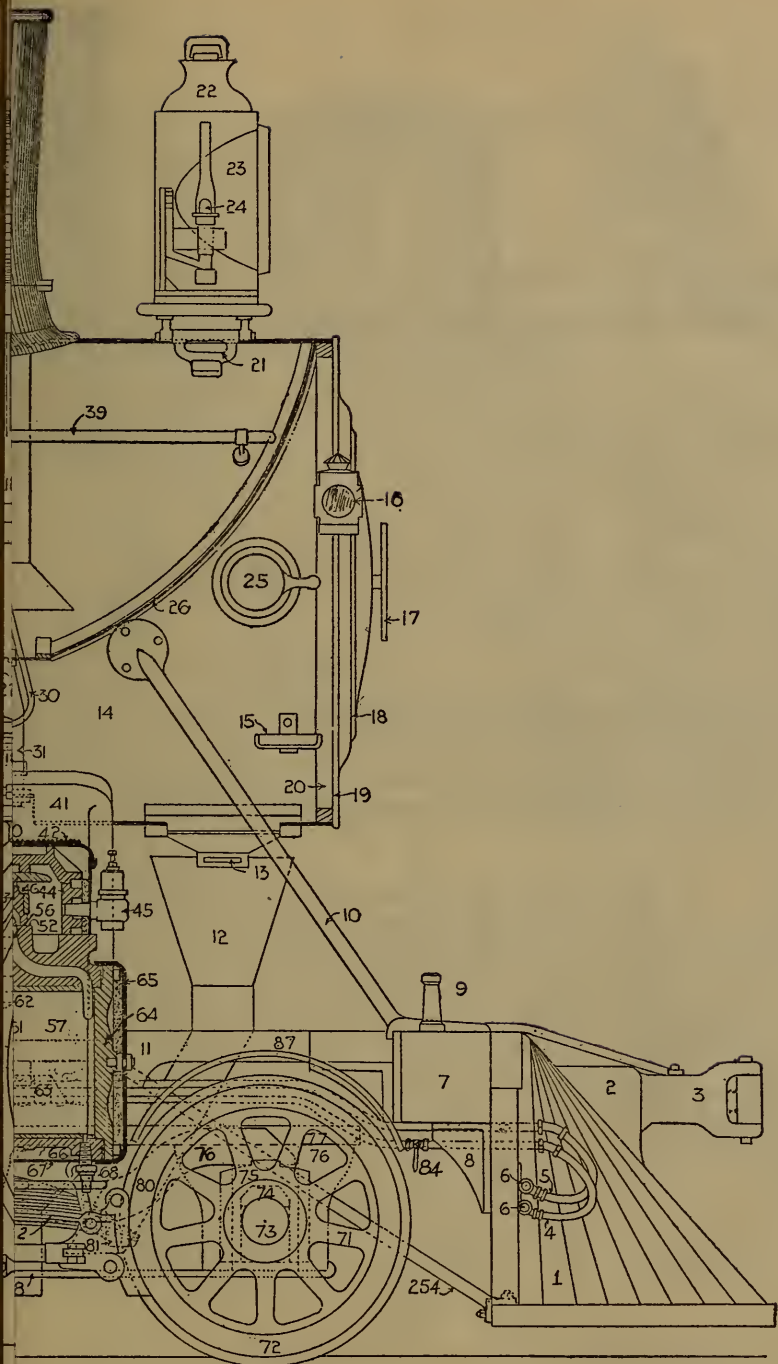

the locomotive being given a number so that it

DESCRIPTION OF THE LOCOMOTIVE, AS PER DIAGRAM HEREWITH.

- 1. Pilot.
- 2. Draw Bar Plate.
- 3. Coupler.
- 4. Air Signal Hose.
- 5. Air Brake Hose.
- 6. Hose Hangers.
- 7. Buffer Beam.
- 8. Pilot Bracket.
- 9. Funnel.
- 10. Arch Brace.
- 11. Front Frame.
- 12. Cinder Chute.
- 13. Cinder Chute Slide.
- 14. Extension Front.
- 15. Headlight Step.
- 16. Signal Lamp.
- 17. Number Plate.
- 18. Smoke Arch Door.
- 19. Smoke Arch Front.
- 20. Smoke Arch Rhr.
- 21. Headlight Bracket.
- 22. Headlight Case.
- 23. Headlight Reflector.
- 24. Headlight Burner.
- 25. Cleaning Door.
- 26. Netting.
- 27. Deflector Plate.
- 28. Deflector Plate Adjuster.
- 29. Air Pump Exhaust Pipe.
- 30. Blower.
- 31. Nozzle Stand.
- 32. Nozzle Tip.
- 33. Steam Pipe (2.)
- 34. Dry Nip Head.
- 35. Dry Pipe Joint.
- 36. Petticoat or Draft Pipe.
- 37. Stack Base.
- 38. Smoke Stack.
- 39. Front Hand Rail.
- 40. Oil Pipe Plug.
- 41. Cylinder Saddle.
- 42. Steam Chest Casting Cover.
- 43. Steam Chest Cover.
- 44. Steam Chest.
- 45. Relief Valve.
- 46. Balance Plate.
- 47. Balanced Slide Valve.
- 48. Valve Yoke.
- 49. Valve Stem.
- 50. Valve Stem Packing.
- 51. Valve Stem Connection.
- 52. Valve Seat.
- 53. Bridges.
- 54. Exhaust Port.
- 55. Front Train Line Cock.
- 56. Steam Ports.
- 57. Cylinder.
- 58. Back Cylinder Head.
- 59. Piston Packing.
- 60. Piston Rod.
- 61. Piston Head.
- 62. Piston Packing Rings.
- 63. Truck Center Casting.
- 64. Front Cylinder Head.
- 65. Cylinder Head Casting.
- 66. Cylinder Lagging.
- 67. Cylinder Casing.
- 68. Cylinder Cocks.
- 69. Cylinder Cocks Rigging.
- 70. Engine Truck.
- 71. Engine Truck Wheel.
- 72. Engine Truck Tire.
- 73. Engine Truck Axle.
- 74. Engine Truck Brass.
- 75. Engine Truck Box.
- 76. Engine Truck Pedestal.
- 77. Engine Truck Frame.
- 78. Engine Truck Pedestal Base.
- 79. Engine Truck Frame Brace.
- 80. Engine Truck Equalizer.
- 81. Engine Truck Spring Hanger.
- 82. Engine Truck Spring.
- 83. Engine Truck Spring Band.
- 84. Front Signal Line Cock.
- 85. Safety Hanger.
- 86. Truck Brake.
- 87. Wheel Guard.
- 88. Air Signal Pipe.
- 89. Guides.
- 90. Guide Yoke.
- 91. Guide Block.
- 92. Main Rod.
- 93. Main Rod Front Strap.
- 94. Key.
- 95. Crosshead Pin.
- 96. Crosshead.
- 97. Front Frame.
- 98. Air Drum Bracket.
- 99. Air Drum.
- 100. Pump Connection.
- 101. Train Pipe Connection from Main Reservoir.
- 102. Valve Stem Rod.
- 103. Train Pipe.
- 104. Wash Out Plugs.
- 105. Link.
- 106. Suspension Stud.
- 107. Link Block Pin.
- 108. Link Block.
- 109. Eccentric Connection, Back Up.
- 110. Eccentric Connection, Go Ahead.
- 111. Link Hanger.
- 112. Tumbling Shaft Arm.
- 113. Tumbling Shaft.
- 114. Tumbling Shaft Lever.
- 115. Counter Balance Spring and Rig.
- 116. Rooker.
- 117. Rooker Box.
- 118. Reach Rod.
- 119. Branch Pipe.
- 120. Check Valve Case.
- 121. Check Valve.
- 122. Fines.
- 123. Oil Pipe.
- 124. Horizontal Boiler Seam.
- 125. Circumferential Seam.
- 126. Boiler Lagging.
- 127. Boiler Jacket.
- 128. Jacket Bands.
- 129. Hand Rail.
- 130. Hand Rail Brackets.
- 131. Bell Stand.
- 132. Bell.
- 133. Air Bell Ringer.
- 134. Sand Box.
- 135. Sand Box Lever.
- 136. Sand Pipe.
- 137. Driving Wheel Tire.
- 138. Driving Wheel Centers.
- 139. Ash Pan.
- 140. Driver Brakes.
- 141. Driver Springs.
- 142. Driver Spring Equalizers.
- 143. Driver Spring Equalizer.
- 144. Driver Spring Hanger Brace.
- 145. Lower Rail of Frame.
- 146. Pedestal Brace.
- 147. Driving Box Shoe.
- 148. Driving Box Wedge.
- 149. Wedge Bolt.
- 150. Driving Box.
- 151. Driving Axle.
- 152. Side or Parallel Rod.
- 153. Rod Bush.
- 154. Main Rod Connection.
- 155. Main Frame.
- 156. Frame Brace.
- 157. Frame Splice.
- 158. Go Ahead Eccentric.
- 159. Back Up Eccentric.
- 160. Go Ahead Eccentric Rod.
- 161. Go Ahead Eccentric Strap.
- 162. Back Up Eccentric Rod.
- 163. Back Up Eccentric Strap.
- 164. Grate Shaking Rig.
- 165. Rocking Boxes.
- 166. Expansion Pad.
- 167. Expansion Link.
- 168. Running Board.
- 169. Air Cylinder Brake Pump.
- 170. Steam Cylinder Brake Pump.
- 171. Air Strainer.
- 172. Delivery to Drum.
- 173. Drip Cock.
- 174. Pump Piston Packing.
- 175. Pump Exhaust Connection.
- 176. Pump Steam Connection.
- 177. Governor.
- 178. Pump Valve Case.
- 179. Injector.
- 180. Injector Overflow.
- 181. Water Pipe.
- 182. Steam Pipe.
- 183. Steam Valve.
- 184. Primer.
- 185. Water Valve.
- 186. Fire Box.
- 187. Tube Sheet.
- 188. Radial Stay Bolts.
- 189. Sling Stay.
- 190. Stay Bolts.
- 191. Dry Pipe.
- 192. Stand Pipe.
- 193. Dry Pipe Hangers.
- 194. Hand Rail.
- 195. Throttle Pipe.
- 196. Throttle Valve.
- 197. Throttle Bell Crank.
- 198. Throttle Stem.
- 199. Dome.
- 200. Dome Cap.
- 201. Dome Casing.
- 202. Safety Valves.
- 203. Chime Whistles.
- 204. Whistle Rig.
- 205. Ventilator.
- 206. Cab.
- 207. Air Pump Lubricator.
- 208. Air Gauge.
- 209. Steam Gauge.
- 210. Steam Turret.
- 211. Injector Throttle.
- 212. Buoyant Cock.
- 213. Gauge Lamp.
- 214. Signal Whistle.
- 215. Air Pump Throttle.
- 216. Throttle Lever.
- 217. Sand Lever.
- 218. Reverse Lever.
- 219. Engineer's Brake Valve.
- 220. Gauge Cocks.
- 221. Quadrant.
- 222. Cut Out Valve.
- 223. Fire Door.
- 224. Cylinder Cock Lever.
- 225. Sight-Feed Lubricator.
- 226. Oil Can Spout.
- 227. Hand Hold.
- 228. Shako Lever Stub.
- 229. Ash Pan Damper Handle.
- 230. Whistle Signal Valve.
- 231. Brake Valve Reservoir.
- 232. Train Pipe.
- 233. Train Pipe Hose.
- 234. Signal Pipe.
- 235. Signal Pipe Hose.
- 236. Feed Pipe Hanger.
- 237. Feed Pipe.
- 238. Feed Pipe Hose.
- 239. Tail Piece of Frame.
- 240. Cab Bracket.
- 241. Counter Balance Weight.
- 242. Engine Brake Triple Valve.
- 243. Engine Brake Auxiliary Connection to Truck Brake Cylinder.
- 244. Driver Brake Cut Out Cock.
- 245. Truck Brake Cut Out Cock.
- 246. Bell Ringer Valve.
- 247. Air Pipe to Bell Ringer.
- 248. Air Pipe to Governor.
- 249. Main Reservoir Connection to Air Gauge.
- 250. Train Line Connection to Air Gauge.
- 251. Glass Water Gauge.
- 252. Main Crank Pin.
- 253. Back Crank Pin.
- 254. Pilot Brace.

- 127. Boiler Jacket.
- 128. Jacket Bands.
- 129. Hand Rail.
- 130. Hand Rail Brackets.
- 131. Bell Stand.
- 132. Bell.
- 133. Air Bell Ringer.
- 134. Sand Box.
- 135. Sand Box Lever.
- 136. Sand Pipe.
- 137. Driving Wheel Tire.
- 138. Driving Wheel Centers.
- 139. Ash Pan.
- 140. Driver Brakes.
- 141. Driver Springs.
- 142. Driver Spring Equalizers.
- 143. Driver Spring Equalizer.
- 144. Driver Spring Hanger Brace.
- 145. Lower Rail of Frame.
- 146. Pedestal Brace.
- 147. Driving Box Shoe.
- 148. Driving Box Wedge.
- 149. Wedge Bolt.
- 150. Driving Box.
- 151. Driving Axle.
- 152. Side or Parallel Rod.
- 153. Rod Bush.
- 154. Main Rod Connection.
- 155. Main Frame.
- 156. Frame Brace.
- 157. Frame Splice.
- 158. Go Ahead Eccentric.
- 159. Back Up Eccentric.
- 160. Go Ahead Eccentric Rod.
- 161. Go Ahead Eccentric Strap.
- 162. Back Up Eccentric Rod.
- 163. Back Up Eccentric Strap.
- 164. Grate Shaking Rig.
- 165. Rocking Boxes.
- 166. Expansion Pad.
- 167. Expansion Link.
- 168. Running Board.
- 169. Air Cylinder Brake Pump.
- 170. Steam Cylinder Brake Pump.
- 171. Air Strainer.
- 172. Delivery to Drum.
- 173. Drip Cock.
- 174. Pump Piston Packing.
- 175. Pump Exhaust Connection.
- 176. Pump Steam Connection.
- 177. Governor.
- 178. Pump Valve Case.
- 179. Injector.
- 180. Injector Overflow.
- 181. Water Pipe.
- 182. Steam Pipe.
- 183. Steam Valve.
- 184. Primer.
- 185. Water Valve.
- 186. Fire Box.
- 187. Tube Sheet.
- 188. Radial Stay Bolts.
- 189. Sling Stay.
- 190. Stay Bolts.
- 191. Dry Pipe.
- 192. Stand Pipe.
- 193. Dry Pipe Hangers.
- 194. Hand Rail.
- 195. Throttle Pipe.
- 196. Throttle Valve.
- 197. Throttle Bell Crank.
- 198. Throttle Stem.
- 199. Dome.
- 200. Dome Cap.
- 201. Dome Casing.
- 202. Safety Valves.
- 203. Chime Whistles.
- 204. Whistle Rig.
- 205. Ventilator.
- 206. Cab.
- 207. Air Pump Lubricator.
- 208. Air Gauge.
- 209. Steam Gauge.
- 210. Steam Turret.
- 211. Injector Throttle.
- 212. Buoyant Cock.
- 213. Gauge Lamp.
- 214. Signal Whistle.
- 215. Air Pump Throttle.
- 216. Throttle Lever.
- 217. Sand Lever.
- 218. Reverse Lever.
- 219. Engineer's Brake Valve.
- 220. Gauge Cocks.
- 221. Quadrant.
- 222. Cut Out Valve.
- 223. Fire Door.
- 224. Cylinder Cock Lever.
- 225. Sight-Feed Lubricator.
- 226. Oil Can Spout.
- 227. Hand Hold.
- 228. Shako Lever Stub.
- 229. Ash Pan Damper Handle.
- 230. Whistle Signal Valve.
- 231. Brake Valve Reservoir.
- 232. Train Pipe.
- 233. Train Pipe Hose.
- 234. Signal Pipe.
- 235. Signal Pipe Hose.
- 236. Feed Pipe Hanger.
- 237. Feed Pipe.
- 238. Feed Pipe Hose.
- 239. Tail Piece of Frame.
- 240. Cab Bracket.
- 241. Counter Balance Weight.
- 242. Engine Brake Triple Valve.
- 243. Engine Brake Auxiliary Connection to Truck Brake Cylinder.
- 244. Driver Brake Cut Out Cock.
- 245. Truck Brake Cut Out Cock.
- 246. Bell Ringer Valve.
- 247. Air Pipe to Bell Ringer.
- 248. Air Pipe to Governor.
- 249. Main Reservoir Connection to Air Gauge.
- 250. Train Line Connection to Air Gauge.
- 251. Glass Water Gauge.
- 252. Main Crank Pin.
- 253. Back Crank Pin.
- 254. Pilot Brace.

- 192. Stand Pipe.
- 193. Dry Pipe Hangers.
- 194. Hand Rail.
- 195. Throttle Pipe.
- 196. Throttle Valve.
- 197. Throttle Bell Crank.
- 198. Throttle Stem.
- 199. Dome.
- 200. Dome Cap.
- 201. Dome Casing.
- 202. Safety Valves.
- 203. Chime Whistles.
- 204. Whistle Rig.
- 205. Ventilator.
- 206. Cab.
- 207. Air Pump Lubricator.
- 208. Air Gauge.
- 209. Steam Gauge.
- 210. Steam Turret.
- 211. Injector Throttle.
- 212. Buoyant Cock.
- 213. Gauge Lamp.
- 214. Signal Whistle.
- 215. Air Pump Throttle.
- 216. Throttle Lever.
- 217. Sand Lever.
- 218. Reverse Lever.
- 219. Engineer's Brake Valve.
- 220. Gauge Cocks.
- 221. Quadrant.
- 222. Cut Out Valve.
- 223. Fire Door.
- 224. Cylinder Cock Lever.
- 225. Sight-Feed Lubricator.
- 226. Oil Can Spout.
- 227. Hand Hold.
- 228. Shako Lever Stub.
- 229. Ash Pan Damper Handle.
- 230. Whistle Signal Valve.
- 231. Brake Valve Reservoir.
- 232. Train Pipe.
- 233. Train Pipe Hose.
- 234. Signal Pipe.
- 235. Signal Pipe Hose.
- 236. Feed Pipe Hanger.
- 237. Feed Pipe.
- 238. Feed Pipe Hose.
- 239. Tail Piece of Frame.
- 240. Cab Bracket.
- 241. Counter Balance Weight.
- 242. Engine Brake Triple Valve.
- 243. Engine Brake Auxiliary Connection to Truck Brake Cylinder.
- 244. Driver Brake Cut Out Cock.
- 245. Truck Brake Cut Out Cock.
- 246. Bell Ringer Valve.
- 247. Air Pipe to Bell Ringer.
- 248. Air Pipe to Governor.
- 249. Main Reservoir Connection to Air Gauge.
- 250. Train Line Connection to Air Gauge.
- 251. Glass Water Gauge.
- 252. Main Crank Pin.
- 253. Back Crank Pin.
- 254. Pilot Brace.

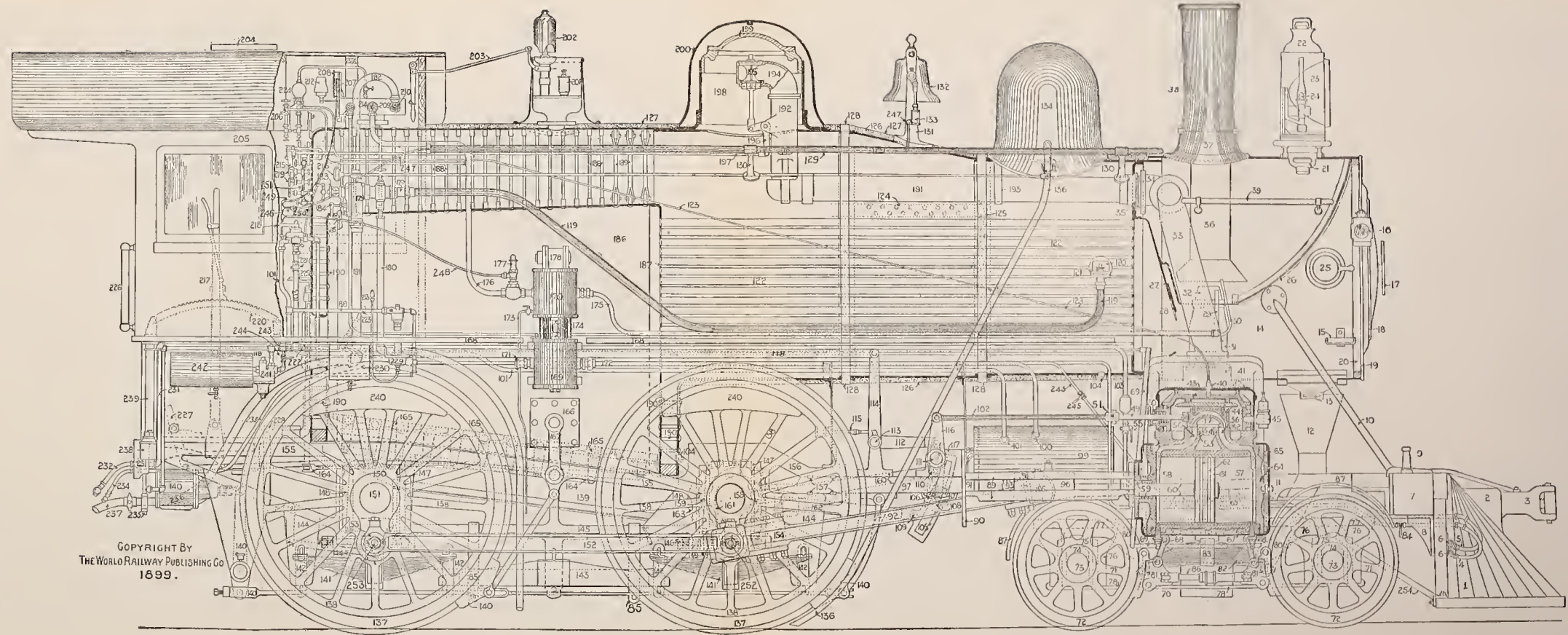

COPYRIGHT BY
THE WORLD RAILWAY PUBLISHING CO
1899.

THE AMERICAN STEAM LOCOMOTIVE.—Prepared exclusively for Kirkman's "SCIENCE OF RAILWAYS."

Particularizing the different parts of the locomotive and giving the names by which they are known to those connected with the Motive Power Department. It is at once a Chart and an Encyclopaedia, each part of the locomotive being given a number so that it may be recognized and quickly referred to.

HEADLIGHT.

THE PYLE-NATIONAL ELECTRIC HEADLIGHT.

It is a rule of the train service that engines running after sunset, or when obscured by fog or other cause, must display a headlight. As the headlight, apart from its function as a train signal, is also a safety device, its purpose being to disclose to the engineer the track that lies before him, it follows that its light must be characterized by brilliancy and penetration. Naturally, therefore, electricity has been made use of, and successfully, so that many high speed passenger locomotives are now equipped with electric headlights, and a full and detailed description of the mechanism and operation of the Pyle-National Electric Headlight is here given.

This headlight is composed of three principal parts, the engine, the dynamo and the lamp. Fig. 1 shows the general application of the whole to a locomotive; Fig. 2 shows the details of the engine and dynamo, and Figs. 3 and 4 show two styles of lamps.

The Engine—Its character, and instructions regarding its use.—The engine is known as the Pyle compound steam turbine. There are no wearing surfaces inside the engine requiring lubrication, hence there is no sight-feed lubricator in the cab.

Before starting the engine be sure the casing is thoroughly drained, and do not turn on steam too suddenly in starting the light, thus allowing time for

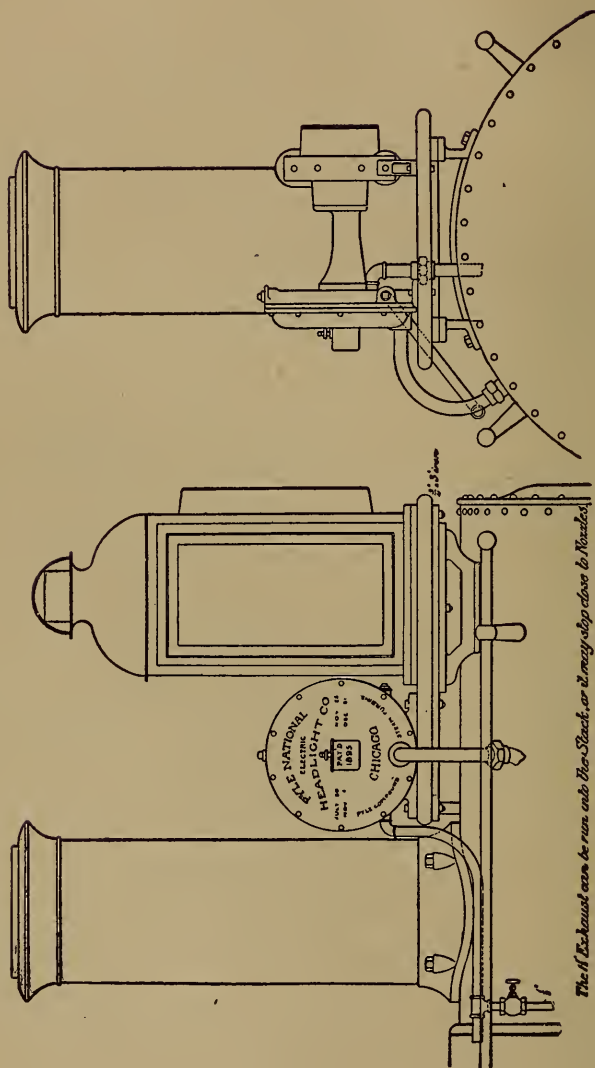

FIG. 1.

Showing Location of Electric Headlight on Locomotive.

the condensation to get out of the engine. It is most important to have dry steam.

Remove the plug in the top of the engine once or twice per month and pour in a little black oil. This will prevent corrosion of parts. The inside bearing only needs enough oil in the bottom for the loose ring to touch the oil and carry up on top of the shaft. If too much oil is used it will be thrown out of the ends of the cellar by the motion of the locomotive, which may ruin the armature. The outside bearing should be filled each trip. Valve or cylinder oil should be used in these bearings.

Round house inspectors should pull out one of the lead wires from the dynamo to lamp, turn on steam and take the speed. If the speed is above 2,500 revolutions per minute, the governor valves (No. 38, Fig. 2) are cut and should be "ground in" or faced off to make a perfect seat. This should be done once a month. If the valves become cut too badly the engine will "run away" and be broken by centrifugal force.

The Dynamo—Its construction, care and maintenance.—The dynamo is constructed on the latest scientific principles, and the electrical balance is so perfect that no sparks should be seen at the brushes. The armature is held in place on the engine shaft by one screw which can be easily taken out if occasion demands. The brushholders are fixed, and the brushes can be taken out and replaced without changing the tension of the springs. A graphite brush is used for the top and a carbon brush for the bottom, and if they be given only a few moments' care each trip, there will be no trouble at all when on the road.

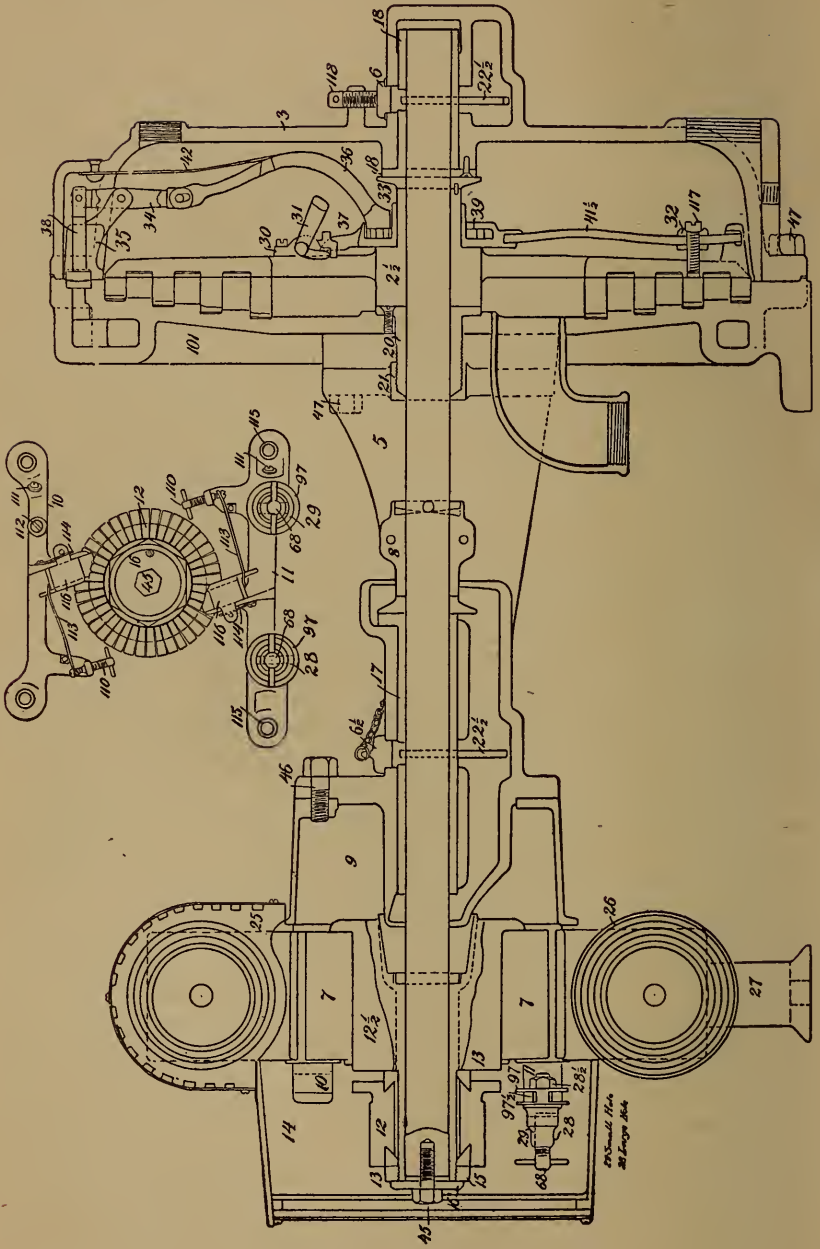

FIG. 2. Electric Headlight Engine.

The mica between the copper strips of the commutator should always be a trifle below the surface. If it gets too high, file it down with a small file. Do not get it too low, as it will collect dirt, etc., and cause a short circuit.

Be sure and have the brushes fit perfectly on the commutator. If they have poor contact, the brushes will spark. If the commutator is running dark and has the appearance of getting rough, clean it up. To do this nicely, remove the brushes and with a strip of No. 0 sand paper (not emery paper), about the width of the brushes, holding by the ends of the sand paper on the commutator while running. Do not press the sand paper on with the fingers, for if there are any low spots they will increase in size.

Names and Numbers of Parts. Fig. 2.

1	Main Casting, 5 rows Buckets.	31	Governor Weight.
2	Wheel, 5 rows Buckets.	32	Spring Clamp.
2½	Wheel, 4 rows Buckets.	33	Cast Iron Washer.
3	Engine Cap.	34	Connecting Link.
5	Box Yoke.	35	Governor Stand.
6	Oil Cover, outside.	36	Cross Arm.
6½	Oil Cover, inside.	37	Center Piece.
7	Pole Pieces.	38	Bronze Plunger, or Governor Valve.
8	End Thrust.	39	Graphite Ring.
9	Brass Yoke.	41½	Governor Springs.
10	Top Brush Holder.	42	Cap Spring.
11	Bottom Brush Holder.	45	Armature Lock Screw.
12	Commutator.	46	Cap Screw.
12½	Armature Spider.	47	Cap Screw.
13	Commutator Ring.	68	Binding Post Screw.
14	Dynamo Door.	97	Insulation Washer.
14½	Name Plate.	97½	Insulation.
15	Commutator Nut.	101	Main Casting, 4 rows Buckets.
16	Outside Washer.	105	Dynamo Feet, new style.
17	Long Bushing.	110	Brush Spring Adjusting Screw.
18	Short Bushing.	111	Connecting Screw for Inc. Wire.
20	Stuffing Box.	112	Connecting Screw for upper field.
21	Gland Nut.	113	Brush Spring.
22½	Oil Ring.	114	Brush Clamp Spring.
25	Top Field Washer.	115	Insulating Bushing.
26	Bottom Field Washer.	116	Brush Clamp.
27	Dynamo Feet, old style.	117	Governor Spring Adjusting Screw.
28	Binding Post, large hole.	118	Oil Cover, Set Screw.
28½	Binding Post Nut.	123	Top Field Cover.
29	Binding Post, small hole.	152	Top Field, complete.
30	Governor Weight Clamp.	152½	Bottom Field, complete.
30½	Governor Saddle Screw.		

If the brush tension spring is too tight, it creates friction, heat and unnecessary wear, both to the commutator and the brushes. If too loose it will spark and the commutator will not run clean. It should be just tight enough to prevent sparking. In this case a little judgment must be used, for if the brushes are not in the proper condition or the commutator smooth and true, there will be sparking at the brushes, no matter how much pressure is used. Do not forget that the commutator is the vital part of all dynamos, and none will run successfully without regular care and attention. The voltage of the dynamo is entirely too low to force a current through any portion of a man's body, so it may be handled freely without danger. A few moments' attention should be given each day to keep the plant in perfect condition. Failing to follow these instructions, the light may fail.

If the commutator becomes rough or out of round, it should be trued up in a lathe. The tool used must be very sharp, and light cuts must be taken; then polish it with fine sand paper. It must be carefully examined to see that no two sections touch, as the copper is liable to lag or burr from one section to the other, and before putting it back, it would be better to cut or file the mica (between each section) a little below the surface, for it does not wear away as fast as the copper, and if the mica is not cut away, it may lead to sparking. After doing this, be sure no ragged edges of copper stick up, for this will cut away the brushes rapidly. The speed of the armature should be as near 1,800 revolutions per minute as possible, unless the copper electrode burns off, when it should be reduced.

Sparking is caused from poor contact or none at all, which necessitates the current passing through the intervening space, thus producing a flash or spark.

The Lamp is simple, durable and reliable, and after a few trials it will be found an easy matter to trim it in the dark, should occasion demand. In putting in the top carbon, it will prove much better to remove the carbon holder (Nos. 87 and 88, Figs. 3 and 4) from the slide (No. 100). After securing the carbon in the holder, take it between the thumb and fore-finger and with the remaining fingers resting on the guide (No. 100) it can easily be put in place. If it is desired to clean the reflector, remove only the top guide (No. 100) by loosening thumb-nut (No. 79) at the end of the upper arm; then the guide, carbon and carbon-holder can easily be removed.

The tension spring (No. 93) in the lamp is for two purposes. It brings together the points of the carbons, so as to establish the arc when the dynamo is set in motion, for there must be a complete circuit before any current may be had. If the carbons are separated only a small fraction of an inch, the lamp will refuse to work, because the current will not jump across the separation. Sometimes there will be a deposit of scale on the point of the lower copper electrode which prevents the top carbon touching the copper and as the current will not go through this scale, no light will be had until it is removed. It is suggested that engineers see that the point of copper is clean before each trip.

Suppose all wires are connected and the lamp properly trimmed; turn on the steam and set the armature in motion. The current enters the lamp and passing

through or around solenoid magnet (No. 65) draws down the iron armature (No. 64). This in turn separates the carbons, thus forming the arc or light. It will be noticed that the spring is secured to the end of lever (No. 60) toward the carbons, or on the opposite end from the magnet and pulls against it. This prevents solenoid No. 65 from pulling the carbons too far apart. The volume of light will depend largely on the way this tension spring is regulated. It may be so tight that the magnet will be unable to separate the carbons, consequently there will be no light. If the dynamo be run too long while the lamp is this way, the armature will be burned out or the fields for the current become very heavy.

If the tension spring (No. 93) is very loose, the lamp

Names and Numbers of Parts. Fig. 3.

28	Binding Post, large hole.	75½	Top Clutch Screw Nut.
28½	Binding Post Nut.	76	Screw Eye.
29	Binding Post, small hole.	77	Clutch.
40	Reflector Bottom Clamp.	78	Clutch Rod Weight.
40½	Reflector Top Clamp.	78½	Clutch Rod.
41	Reflector Support.	80	Top Bracket.
50½	Lamp Base.	81	Thumb Screw.
51½	Lamp Column.	82	Clutch Foot.
52	Large Bottom Clamp.	82½	Clutch Foot Rod.
53	Small Bottom Clamp.	83	Upper Guide Bracket.
54	Hand Nut.	84	Middle Guide.
55	Hand Washer.	85	Lower Guide Bracket.
56	Top Bracket.	96¾	Mica Insulation.
58	Tension Spring Screw.	87	Top Carbon Clamp, male.
58½	Tension Screw Nut.	88	Carbon Clamp, female.
59	Top Lever.	88½	Carbon Holder Connecting
60	Small Lever.	89	Upper Guide. [Washer.
61	Dash Pot.	90	Magnet Yoke.
62	Magnet Insulation.	91	Carbon Holder Spring.
63	Magnet, Long Link.	92	Top Clutch Spring.
63½	Magnet, Short Link.	93	Tension Spring.
64	Magnet.	94	Upper Telescope Tube Spring.
65	Solenoid.	95	Lower Telescope Tube Spring.
66	Bottom Flexible Wire.	96	Upper Insulation Fibre.
67	Top Flexible Wire.	96½	Lower Insulation Fibre.
68	Binding Post Screw.	97	Insulation Washer.
69	Top Lever Screw.	97½	Brass Plate.
70	Bottom Guide and Tube.	98	Vertical Adjusting Screw.
71	Middle Telescope Tube.	99	Vertical Adjusting Nut.
72	Top Telescope Tube.	119	Guide Screw.
73	Malleable Iron Tip.	120	Solenoid Screw.
74	Set Screw.	121	Reflector Clamp Screw.
75	Top Clutch Spring Screw.		

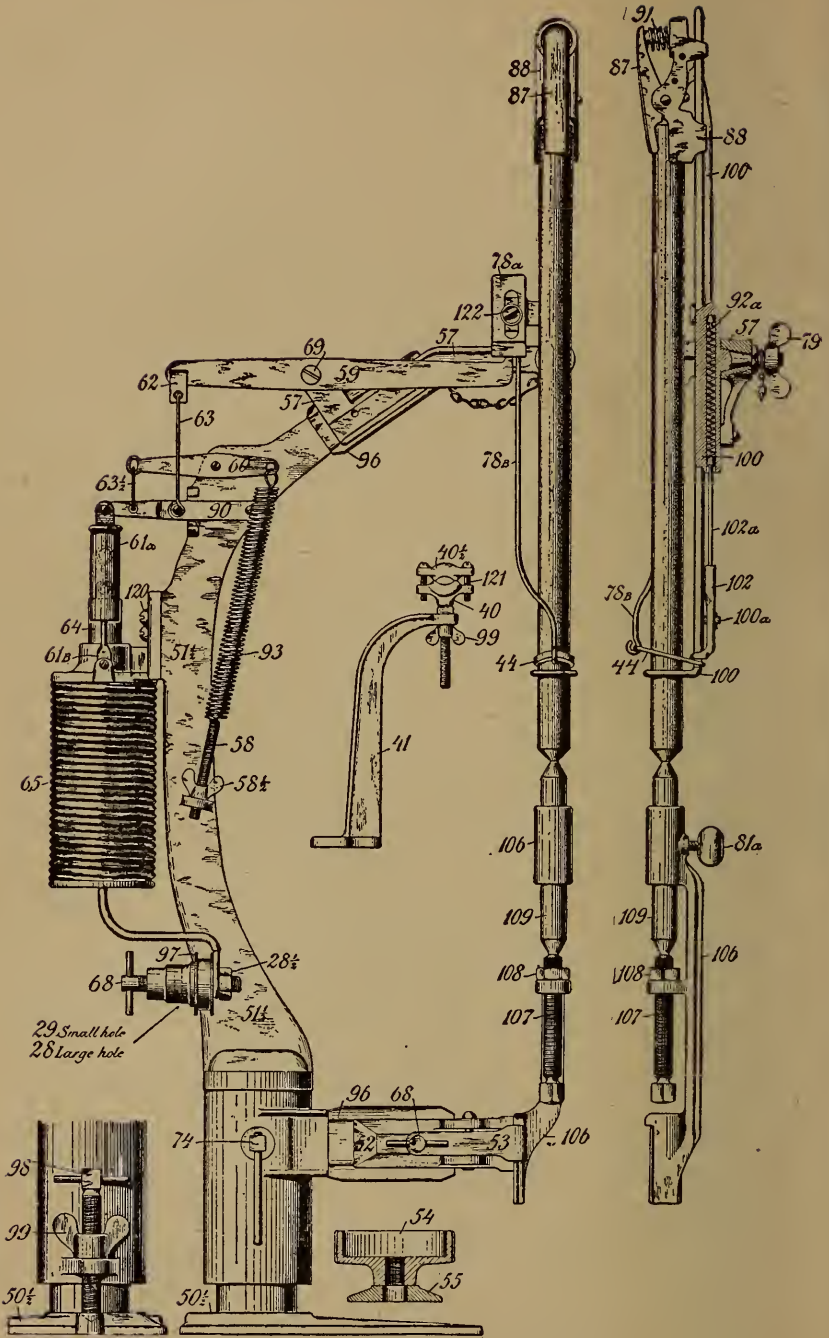

FIG. 4. Electric Headlight—Lamp "C."

will flash and go out, for the magnet will be drawn down too far. When the light goes out the current is broken, and there being no strength in the magnet, the spring will again bring the carbons together, then the current is instantly re-established. The spring should be adjusted so that the lamp will flicker just a little when the locomotive is at rest, for then all the light possible at a given speed of the armature is being obtained, and the light will burn steady when locomotive is running.

The wires leading back to the incandescent lamps may come together, causing a short circuit. This will put the light out. It may be known when this occurs, for the dynamo will be generating a heavy current, the speed will be quite low, and there will be a small light in the lamp. In this case, disconnect one of the small wires from No. 111, Fig. 2, then when

Names and Numbers of Parts. Fig. 4.

28	Binding Post, large hole.	69	Top Lever Screw.
28½	Binding Post Nut.	74	Set Screw.
29	Binding Post, small hole.	78a	Clutch Rod Weight.
40	Reflector Clamp, bottom.	78b	Clutch Rod.
40½	Reflector Clamp, top.	79	Thumb Nut.
41	Reflector Support.	81a	Thumb Screw.
44	Clutch.	87	Carbon Clamp, male.
49	Extension Base.	88	Carbon Clamp, female.
50½	Lamp Base.	90	Magnet Yoke.
51½	Lamp Column.	91	Carbon Holder Spring.
52	Bottom, large clamp.	92a	Top Clutch Spring.
53	Bottom, small clamp.	93	Tension Spring
54	Hand Nut.	96	Insulation Fibre.
55	Hand Washer.	97	Insulation Washer.
57	Top Bracket.	98	Vertical Adjusting Screw.
58	Spring Tension Screw.	99	Vertical Adjusting Nut.
58½	Spring Tension Nut.	100	Upper Carbon Holder.
59	Top Lever.	102	Clutch Foot.
60	Small Lever.	102a	Clutch Foot Rod.
61a	Dash Pot.	106	Lower Electrode Holder.
61b	Dash Pot Plunger.	107	Adjusting Screw.
62	Magnet Insulation.	108	Lock Nut.
63	Magnet, Long Link.	109	Copper Electrode.
63½	Magnet, Short Link.	120	Solenoid Screw.
64	Magnet.	121	Reflector Clamp Screw.
65	Solenoid.	122	Clutch Weight Screw.
66	Binding Post Screw.	200	Electrode Holder, complete.
		300	Top Carbon Holder, complete.

sufficient time is had the cause of the trouble may be located.

Most of the troubles are traceable to the adjustment of the lamp.

If the carbon feeds too fast, the clutch rod (No. 78 *b*) should be adjusted so it will not have so much lost motion, or travel, before the clutch (No. 44) grips the carbon. Sometimes this trouble can be overcome by making the clutch spring (No. 92 *a*) stronger. To do this, remove cotter pin from No. 100 *a* and remove spring No. 92 *a* from the casing. Then pull it out a little, thereby giving it more "set". Again, by shortening wire No. 63, the magnet (No. 64) is held further out of the solenoid (No. 65) giving it more strength to clutch the carbon, and will prevent the jar of the locomotive from jarring the carbon through the clutch faster than it burns.

If the wire (No. 63) is too short the lamp will jump.

If the light burns green it is burning upside down, and the binding posts (Nos. 28 and 29, Fig. 2) must be reversed on the dynamo. To do this, remove binding posts No. 28 and No. 29, in lower brush holder (No. 11), then put No. 29 where No. 28 was and No. 28 where No. 29 was, being careful not to disturb insulator (No. 97 and No. 97½, Fig. 2).

The lamp may be moved in all directions for focusing. To get the proper vertical focus on the track, either to have the light close or to strike the track far ahead, loosen the set screw No. 74 on the side, and by turning the adjusting screw (No. 98) the lamp can be raised or lowered as desired. To move it sideways, backwards or forwards, loosen the hand nuts (No. 54) and the lamp is free to move.

When once in focus, there is no need of changing it again. Tighten all screws.

The back of the reflector is supported by an adjustable step, with screw to raise or lower it, so the volume of the light will come out in parallel lines.

To Focus the Lamp.—1. Adjust back of reflector so front edge will be parallel with front edge of case.

2. Have point of copper as near center of reflector as possible.

3. Have carbon as near center of chimney hole in reflector as possible.

4. Have locomotive on straight track and move lamp until obtaining best results on track. The light should be reflected in parallel rays and in as small a space as possible.

To lower light on track, raise lamp. To raise light on track, lower lamp.

If the light throws any shadows it is not focused properly.

If the light is focused properly and does not then strike center of track do not change focus, but shift the entire case on base-board.

Suggestions in the Care of this Headlight.—Have a few strips of No. 0 sand paper about $1\frac{1}{2}$ inches wide on hand to clean up the commutator.

A special and superior carbon made expressly for this apparatus is furnished by the manufacturers.

If the light fails to burn when turning on steam, see that all screws are tight, and that the point of copper electrode is clean. Push down on lever No. 90 and see if the carbon lifts up and falls freely. Put a carbon

across both binding posts, No. 28 and No. 29, Fig. 2, and if there is a flash when it is removed, the dynamo is all right and the trouble is in the lamp. If a flash is not observed when carbon is removed, take out the brushes and clean the commutator with sand paper (not emery paper), put the brushes back and try the carbon again. If no flash is then obtained, there is a "short" circuit. This is probably caused by wires touching each other and the dynamo must not be run until this is remedied.

Keep all screws tight.

If the light goes out momentarily on the road, the fault is probably in the carbon, and another carbon should be tried.

After putting in a new carbon, always push down on lever No. 90 and notice if carbon lifts and falls freely. If it does not lift, it is not in the clutch, No. 44. If it does not fall down freely, turn it partly around and find the freest place.

The carbon should burn from eight to nine hours.

Engineers should be held responsible for the proper care of the equipment unless some one is appointed to examine and care for them at round houses.

Before leaving for a trip the apparatus should be started and the brushes examined as to tension of the brush springs (No. 113, Fig. 2), and adjusted if necessary before getting out on the road.

This apparatus is not automatic, and as there are quite a number of enemies to electricity on the locomotive such as grease, dirt, jar, heat, etc., it is necessary to give it a few minutes' attention every day. If this be done failures on the road will be infrequent.

Attempt should not be made to remove the reflector from the case until after removing the top carbon holder (No. 100) by loosening thumb nut No. 79, Fig. 4.

If the copper electrode burns off, the equipment is running too fast, and the speed should be reduced by turning screws No. 117, Fig. 2, to the left until the trouble is stopped. Care should be exercised to adjust all screws (No. 117) the same, as nearly as possible. One-half turn of screws will change speed about 100 revolutions per minute.

It is best to adjust tension spring (No. 93) as loosely as possible and not have the light go out while the locomotive is standing still.

If the light dies down when the locomotive is running fast, the tension spring (No. 93) may be too tight, which prevents solenoid (No. 65) from separating carbons sufficiently to form proper arc, or spring (No. 92) may be too loose, allowing back edge of clutch (No. 44) to be jarred up and release the carbon.

An oval, bent glass for the headlight case is especially recommended.

ELECTRICAL TERMS EXPLAINED.

As there are many men who have no definite idea of what electricity really is, and as a slight knowledge is necessary to properly care for electric headlight equipment, and to get the best results therefrom, a few *extracts from the A B C of electricity, in simple language and terms familiar to nearly all, are here given, so they may be very readily understood, and will be of interest to those using electric headlights.

*These extracts are taken from the Pyle instruction book, and are necessarily very brief. For a full explanation of electrical terms the reader is referred to "The Science of Railways."

DEFINITIONS.

The three first measurements in electricity are:

The volt. The ampere. The ohm.

These are explained as follows:

THE VOLT—This term may be better understood by making a comparison with something you all know of. Suppose we have a tank containing 100 gallons of water and we want to discharge it through a half-inch pipe at the bottom of the tank. Suppose, further, that we want to make the water spout upward, and for this purpose the pipe is bent upward as in Fig. 5.

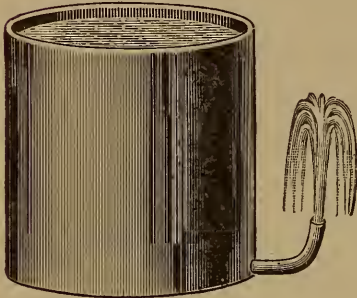

FIG. 5.

If you opened the tap the water would spout out and upward as in

Fig. 5. The cause of its spouting upward would be the weight or pressure of the water in the tank. This pressure is reckoned as so many pounds to the square inch of water.

Now, if the tank were placed on the roof of a house and the pipe brought to the ground, as shown in Fig. 6, the water would spout up very much higher, because there would be many more pounds of pressure on account of the height of the pipe.

So the force or pressure of water is measured in pounds, and therefore a pound is the unit of pressure or force of water. Now, in electricity the unit of pressure or force is called a volt. This word "volt" does not mean any weight, as the word "pound" weight does. If you have a pound of water you must have something to hold it, because it has weight, and consequently occupies some space. But electricity itself has no weight, and therefore cannot occupy any space.

When we desire to carry water into a house or other building we do so by means of pipes, usually made of iron. The principal supply

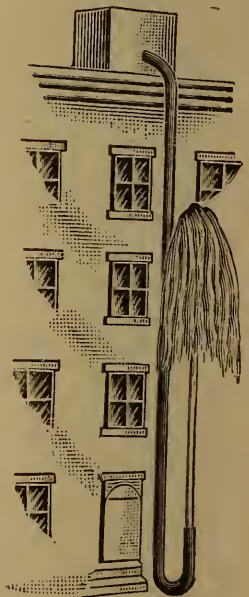

FIG. 6.

usually comes from a reservoir which is placed on high ground so as to give the necessary pounds of pressure to force the water to the upper part of the houses. If some arrangement of this kind were not made we could get no water in our bedrooms, because water will not rise above its own level unless by force.

The water cannot escape as long as there are no holes or leaks in the iron pipes; but if there should be the slightest crevice in them the water will run out.

In electricity we find similar effects.

The electricity is carried into houses by means of wires, which are covered or insulated with various substances—such, for instance, as rubber. Just as the iron of the pipes prevents the water from escaping, the insulation of the wire prevents the escape of the electricity. If we were to cause the pounds of pressure of water in pipes of ordinary thickness to be very greatly increased the pipes could not stand the strain and would burst and the water would escape. So it is with electricity.

If there were too many volts of pressure the insulation would not be sufficient to hold it, and the electricity would escape through the covering or insulation of the wire.

It is a simple and easy matter to stop the flow of water from an ordinary faucet by placing your finger over the opening. As the water cannot then flow, your finger is what we would call a non-conductor, and the water will be retained in the pipe.

The same effect is obtained in the case of electricity. If you place some substance which is practically a non-conductor or insulator, such as rubber, around an electric wire, or in the path of an electric current, the electricity acted upon by the volts of pressure cannot escape, because the insulation keeps it from doing so, just as the iron of the pipe keeps the water from escaping. Thus the volt does not itself represent electricity, but only pressure which forces it through the wire.

There are other words and expressions used in connection with electricity which are sometimes associated with the word volt. These words are pressure and intensity. You might say, for instance, that a certain dynamo machine had an electro-motive force of 110 volts, or that the intensity of a cell of battery was two volts, etc.

We might mention, as another analogy, the pressure of steam in a boiler, which is measured or calculated in pounds, just as a pressure

of water is measured. So you might say that 100 pounds of steam pressure used through the medium of a steam engine to drive a dynamo could thus be changed to electricity at 110 volts pressure.

THE AMPERE—In comparing the pounds pressure of water with volts of pressure of electricity we used as an illustration a tank of water containing 100 gallons, and we saw that this water had a downward force or pressure in pounds. Let us now see what this pressure was acting upon. It was forcing the quantity of water to spout upward through the end of the pipe. The pounds pressure of water acting upon the 100 gallons would force it out at a certain rate, which, let us say, would be one gallon per minute.

This would be the rate of flow of water out of the tank. Thus we find a second measurement to be considered in discharging the water tank. The first was a force or pounds of pressure, and the second the rate at which the quantity of water was being discharged per minute by that pressure.

This second measurement teaches us that a certain quantity will pass out of the pipe in a certain time if the pressure is steady, such quantity depending, of course, on the size or friction resistance of the pipe. In electricity the volts of pressure act so as to force the quantity of current to flow through the wires at a certain rate per second, and the rate at which it flows is measured in amperes. For instance, let us suppose that an electric lamp required a pressure of 100 volts and a current of the ampere to light it up, we should have to supply a current of electricity flowing at the rate of one ampere, acted upon by an electro-motive force of 100 volts.

You will see, therefore, that while the volt does not represent any electricity, but only its pressure, the ampere represents the rate of flow of the current itself.

You should remember that there are several words sometimes used in connection with the word ampere. For instance, we might say that a lamp requires a current of one ampere or that a dynamo would give a "quantity" of twenty amperes.

THE OHM—You have learned that the pressure would discharge the quantity of water at a certain rate through the pipe. Now, suppose we were to fix two discharge pipes to the tank, the water would run away very much quicker, would it not? If we were to try and find a reason for this, we should see that a pipe can only, at a given pressure, admit so much water through it at a time.

Therefore, you see, this pipe would present a certain amount of resistance to the passage of the total quantity of water, and would only allow a limited quantity at once to go through. But if we were to attach two or more pipes to the tank, or one large pipe, we should make it easier for the water to flow, and therefore the total amount of resistance to the passage of water would be very much less and the tank would be quickly emptied.

Water has substance and weight, and therefore occupies some space, but electricity has neither substance nor weight, and therefore cannot occupy any space; consequently to carry electricity from one place to another we do not need to use a pipe which is hollow, but a solid wire.

These solid wires have a certain amount of resistance to the passage of electricity, just as the water pipe has to the water, and (as it is in the case of the water) the effect of the resistance to the passage of electricity is greater if you pass a larger quantity through than a smaller quantity.

If you want to carry a quantity of electricity to a certain distance and for that purpose use a wire, there would be a certain amount of resistance in that wire to the passage of the current through it; but if you use two or more wires of the same size, or one large wire, the resistance would be very much less and the current would flow more easily.

Suppose, instead of emptying the water tank from the roof through the pipe, we just turned the tank over and let the water pour out at once down to the ground. That would dispose of the water very quickly and by a short way, because there would be no resistance to its passage to the ground. Suppose we had an electric battery giving a certain quantity of current, say five amperes, and we should take a large wire that offered no resistance to that quantity, and put it from one side of the battery to the other, a large current would flow at once and tend to exhaust the battery. This is called a short circuit because there is little or no resistance, and it provides the current with an easy path to escape. Electricity always takes the easiest path. It will take as many paths as are offered, but the largest quantity always takes the easiest. As the subject of resistance is one of the most important in electricity, we will give you one more example, because if you can obtain a good understanding of this principle it will help you to comprehend the whole subject. We

started by comparison with a tank holding 100 gallons of water, discharging through a half-inch pipe, and showed you that the pounds of pressure would force the quantity of gallons through the pipe. When the tap was first opened the water would spout up very high, but as the water in the tank became lower the pressure would be less, and consequently the water would not spout up so high; so if it were desired to keep the water spouting up to the height it started with, we should have to keep the tank full so as to have the same pounds pressure all the time. But if you wanted the water to spout still higher we should have to use other means, such as a force pump, to obtain a greater pressure.

If we should use too many pounds pressure it would force the quantity of water more rapidly through the pipe and would cause the water to become heated because of the resistance of the pipe to the passage of that quantity acted upon by so great a pressure. It is the same with electricity, except that the wire itself would become heated, some of the electricity being turned into heat and lost. If the wire were too small for the volts pressure and amperes of current of electricity, the resistance of such wire would be overcome and it would become red-hot and perhaps melt. Electricians are therefore very careful to calculate the resistance of the wires they use before putting them up, especially when they are for electric lighting, in order to make allowances for the amperes of current which flows through them, so that but little of the electricity will be turned into heat and thus render it useless for their purpose.

The unit of resistance is called the "OHM."

All wires have a certain resistance per foot, according to the nature of the metal used and the size of the wire, that is to say, the finer the wire the greater the number of ohm resistance it has to the foot. Water and electricity flow under very similar conditions, that is to say, each of them must have a channel or conductor, and each of them requires pressure to force it onward. Water, however, being a tangible substance, requires a hollow conductor, while electricity being intangible will flow through a solid conductor. The iron of the water pipe and the insulation of the electric wire serve the same purpose, viz. that of serving to prevent escape by reason of a pressure exerted.

There is another term which should be mentioned in connection with resistance, as they are closely related, and that is opposition.

There is no general electrical term of this name, but as it will be most easily understood from the meaning of the word itself, we have used it.

Let us have an example of what opposition would mean if applied to water. Probably every one knows that a water wheel is a wheel having large paddles or blades around its circumference. When the water in trying to force its passage rests against one of these paddles it meets with opposition, but overcomes it by pushing the paddle away. This brings around more opposition in the shape of another paddle which the water also pushes away, and so this goes on, the water overcoming this opposition and turning the wheel around, by which means we can get the water to do some work for us.

You must remember, however, that it is only by putting opposition in the path of a pressure and quantity of water we can get this work. The same principle holds good in electricity. We make electricity in different ways, and in order to obtain useful work we put in its path the instruments, lamps or machines which offer the proper amount of resistance or opposition to its passage, and thus obtain from this wonderful agent the work we desire to have done. You have learned that the three important measurements in electricity are as follows:

The volt is the practical unit of measurement of pressure.

The ampere is the practical unit of measurement of the rate of flow.

The ohm is the practical unit of measurement of resistance.

PRESSURE REGULATORS OR REDUCING VALVES.

To reduce from a high initial pressure such as is carried on a modern locomotive boiler to a required minimum for steam heating or other similar purposes, and to always maintain this same minimum pressure regardless of the varying conditions on either side of the valve, has always been a problem difficult of solution.

Pressure regulators employing pistons have largely been superseded by those wherein flexible diaphragms are used. The pistons are more liable to stick and clog up, and require to be frequently taken apart and cleaned.

The most perfect regulators thus far constructed are those wherein diaphragms and balanced valves are employed. By making these of proper proportion a comparatively uniform reduced pressure may be maintained, provided the supply and demand are not too suddenly and widely changed.

The reason why a uniform pressure is required in train heating systems is not so much on account of maintaining a uniform temperature (for steam at 30 pounds pressure is but little hotter than steam at 10 or 20 pounds pressure) as it is to keep a constant pressure sufficient to drive out all the condensation from the rear as well as the front cars of a train, and to prevent a high accumulation of pressure which is likely to burst hose, wherever used, or strain the couplings, fittings, etc.

DIRECTIONS FOR THE MANAGEMENT OF STEAM
HEATING ON RAILROAD TRAINS.

Rules for Making up Trains.--When a train is made up, all steam hose should be coupled, and all the cocks in the steam train pipe the whole length of the train should be opened.

When signal is given, steam should be turned on at the cab, not to exceed sixty-five pounds, and allowed to blow through the entire length of the steam train-pipe.

After steam issues at the rear end of the train-pipe, the rear cock of last car should be closed, and reducing valve in cab set to forty pounds pressure. If more than eight cars are in the train, add five pounds for each additional car. In very cold weather, the rear train-pipe cock should be left open enough to allow a little steam to pass, and escape through the rear coupling.

Regulation of Temperature.--To heat cars, open steam inlet valves on each car, and when live steam appears at the drips, set each drip so that a little steam escapes with the water. If a trap be used, see that it is adjusted to allow a little steam to escape with the water.

Frequently examine traps and drip valves to see that they are operating properly. They should be as hot as can be borne by the hand. If cooler, or cold, they should be opened a trifle, or if steam is blowing, closed a little.

Never close steam inlet valves entirely without first opening drip valves or blow-off valve, and allow all water to blow out before closing steam inlet valve.

When steam is required on a car again, open steam inlet valve, and afterwards close drip valves or blow-off valve.

Changing Engines.—When approaching stations where engines are to be changed, or terminals where cars are to be laid up, five minutes before arriving at such stations the rear train-pipe cock must be opened wide, and before coming to a stop at such stations, the engineer must shut off steam at boiler valve. Do not use reducing valve for this purpose.

If engines are to be changed, trainmen must satisfy themselves that steam is shut off at engine before uncoupling cars.

In freezing weather, if cars are to be laid up, or stand thirty minutes after engine is uncoupled, the hose throughout the train must be uncoupled, and all drip valves or blow-off valves opened.

THE MASON LOCOMOTIVE REDUCING VALVE.

This valve is designed to automatically reduce and maintain an even steam pressure for heating cars from the locomotive. It is placed in the steam supply pipe leading from the boiler to the heating system* and regulates the amount of steam passing to the system, allowing only sufficient steam to maintain the desired pressure.

The principle upon which the Mason reducing valve works is that of an auxiliary valve, 11, controlled by the low pressure in the heating system through the medium of a metal diaphragm (23), and admits steam

* The reader is referred to the excellent chart "The American Locomotive" contained in "The Science of Railways."

from the initial side of the valve, through a port (NN) to operate a piston (17), which in turn opens the main valve (16) and admits steam to the heating system.

By referring to the sectional view here shown, it

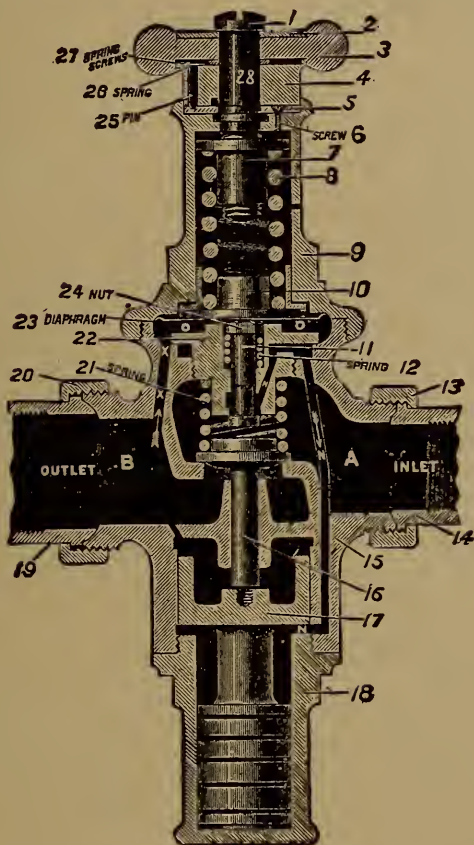

FIG. 1.

Mason Locomotive Pressure Reducing Valve.

will be seen that the steam enters the valve at the side marked "inlet," a small portion of it passing up through the auxiliary valve (11).

This valve (11) is forced open by the compression of the large spiral spring (8), acting on the button (10)

through the diaphragm (23), so that, in opening the valve (11), the diaphragm is also forced down. As soon as the valve (11) is opened, steam passes through and into ports (*NN*) to the under side of piston (17). By raising piston (17), the main valve (16) is opened against the inlet pressure, since the area of valve (16) is only half that of piston (17). Steam is thus admitted to the system. When the pressure in the heating system has reached the required point, which is determined by the spring (8), the diaphragm (23) is forced upward by the low pressure which passes up through port (*X*) to chamber *OO*, under the diaphragm, thus allowing auxiliary valve (11) to close, thereby shutting off steam from the under side of piston (17). The main valve (16) is now forced down to its seat by the inlet pressure, shutting off steam from the heating system and pushing piston (17) down to the bottom of its cylinder. The steam beneath piston (17) exhausts freely around it (the piston being fitted loosely for this purpose) and passes off into the system.

It will be seen from this that when the pressure in the heating system has reached the point at which the governing spring (8) is adjusted, the flow of steam is automatically checked, and when the pressure in the system (and that in chamber *OO*, under the diaphragm,) is slightly reduced, the valve will again open and supply the required amount of steam.

Piston (17) is fitted with a dashpot (18), which prevents chattering or pounding when the pressure is suddenly reduced.

Directions for Attaching, Regulating and Repairing.—Place the valve vertically in the steam supply

pipe. The steam should flow through the valve in the direction indicated by the arrow cast in the side. Before connecting the valve, the pipes should be thoroughly blown out, in order to expel all dirt and chips. If the piping is new, steam should be allowed to flow through for some little time, so as to burn off all the oil or grease which may be in it.

When ready to let on steam, turn the wheel at top of the valve in the same direction as you would to open a globe valve; that is, turn to the left to open or admit more steam and to the right to close or reduce the pressure. Time must be allowed for the system to fill, before the required pressure is obtained.

If the valve should not maintain a low pressure, it will probably be due to the fact that some dirt or chips from the piping have lodged in the seat of the valve (16).

To take the valve apart, the tension on the diaphragm spring (8) must first be removed by turning the wheel as far as it will go, in the direction taken by the hands of a watch. Then unscrew the spring-case (9), and remove the button (10) and the diaphragm; also remove the cap (22), which contains the auxiliary valve. The threaded rod which accompanies each valve can then be screwed into the valve disc (16), which should work easily. Pull out this valve and clean the seat. Then insert the rod through the valve-stem hole, screw it into the piston (17), and see if it works up and down easily. It will not be found possible to raise and lower the piston (17) suddenly, as the dashpot (18) will restrain it. If the piston (17) is found to be stuck fast, remove the dashpot (18) at the bottom of the valve, pull out the piston

and clean it with fine emery cloth; being careful to wipe off all emery before replacing. Before replacing the cap (22), examine the small auxiliary valve (11) and see that it is tight and free from dirt. Be sure that the diaphragm (23) is perfectly clean, also that there is no dirt where it makes its seat.

The wheel is made self-locking in any position, by means of a steel locking pin (25), which is forced by a spring into any one of twelve recesses in a hardened steel plate (5). The valve should be removed during the summer. Before replacing, thoroughly clean and oil all the parts.

THE GOLD PRESSURE REGULATOR.

Fig. 2 shows a sectional view of the Gold steam heating regulator. It will be readily seen that this is of the diaphragm type with a nearly balanced valve.

The diaphragm is made of a solid sheet of thin phosphor bronze, slightly corrugated at the outer edge, with an enlarged flange (*O*), so that the diaphragm will always keep its original shape. The dome (*M*) of the regulator is solid so that no steam would escape into the cab should the diaphragm break. The recess shown at *S S* provides a water seal in order to prevent any chattering of the valve.

The regulator is set by means of the handle (*I*), which is perforated in order to keep it cool for easy handling by the engineer. The handle (*N*) is an extension of a lock nut which holds the regulating screw firmly in any given position. The set screw (*R*) is provided as a check on the maximum or minimum amount of pressure required as it can be seen

that the play of the spring (*L*) is controlled by this set screw (*R*). Spring (*F*) helps to guide the spindle (*D D*) and also tends to more nearly balance the valves and make up for any possible gumming of valves or spindle.

Main valve *D D* is opened and closed by the movement of the diaphragm. Spring *L* forces

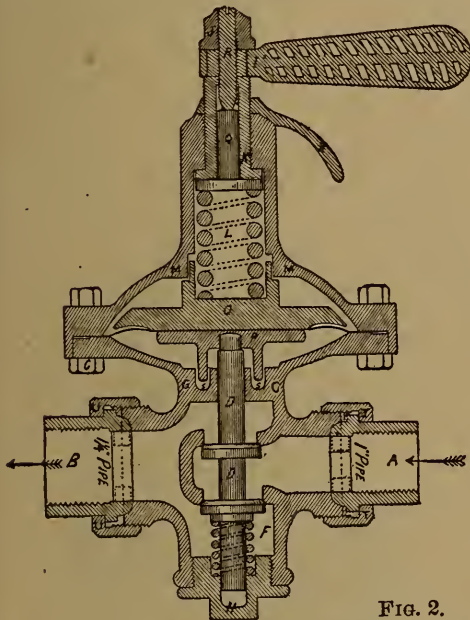

PARTS OF REGULATOR.

- A*.—1 inch Inlet Union Nipple.
- B*.— $1\frac{1}{4}$ inch Outlet Union Nipple.
- C*.—Bolts and Nuts for Dome and Body.
- D*.—Balance Spindle with Hard Seats.
- F*.—Bottom Spring.
- G*.—Body of Regulator.
- H*.—Bottom Plug.
- I*.—Handle.
- J*.—Top Nut.
- K*.—Hollow Screw.
- L*.—Top Spring.
- M*.—Dome of Regulator.
- N*.—Lock Nut.
- O*.—Top Flange.
- P*.—Bottom Flange.
- Q*.—Top Spindle.
- R*.—Set Screw.
- T*.—1 inch Inlet Union Nut.
- U*.— $1\frac{1}{4}$ inch Outlet Union Nut.

FIG. 2.
Gold Pressure Regulator.

the diaphragm down and the main valve opens and remains thus until steam from the outlet side of the valve, some of which passes the loose stem *D* to the under side of the diaphragm, closes the main valve.

CLIMAX STEAM PRESSURE REGULATING VALVE.

Description.—Steam enters at *A*, surrounds main valve (1), passes the water packing grooves around this valve, and bearing against the shoulder carries

this valve (1) upward, allowing steam to pass through the now raised valve to *B*, as shown by the arrows. The reduced pressure steam from *B* also acts upward through ports (3 and 11) upon the under side of regulating piston (6). If spring (7) were set for say 100 pounds, as soon as the pressure on the under side

1. Main Valve.
2. Opening in Main Valve.
3. Port Leading to the Regulating Piston 6.
4. Solid Disc, held in place by cap 12.
6. Regulating Piston.
7. Regulating Spring.
8. Regulating Screw.
10. Auxiliary Valve Spring.
11. Ports in Disc 4.
12. Governor Cap.
13. Controlling Steam Chamber.
14. Body.
16. Auxiliary Valve.

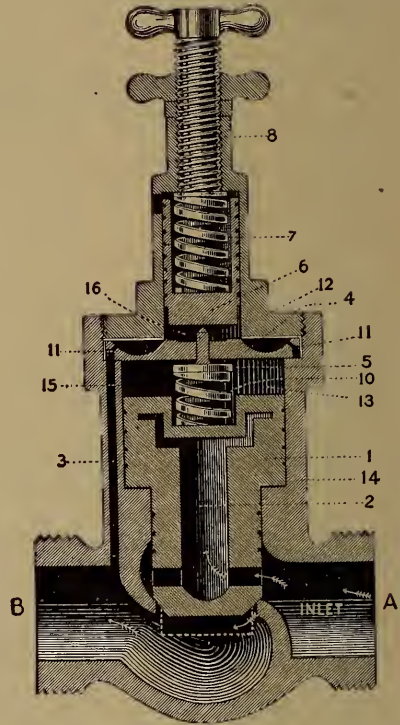

FIG. 3.
Climax Steam Pressure Regulating Valve.

of regulating piston (6) reached that amount, it would move slightly upward and away from its former contact with the auxiliary valve (16), thus allowing 16 to seat in disc (4), thereby preventing the further escape of steam from the controlling chamber (13). Steam from inlet (*A*) passing through the grooves or water packing of valve (1) to chamber (13), now seats

valve (1) until the pressure at *B* and consequently that below piston (6), drops slightly below 100 pounds. Then spring (7) forces down piston (6) and opens auxiliary valve (16), thereby permitting the escape of pressure from chamber (13) through valve (16), ports (11 and 3) to *B*. The conditions are such now, as in starting, that valve (1) is raised for a further supply of steam from *A* to *B*. In actual operation, where a continuous flow is being used, valves (1 and 16) are held just sufficiently off their seats to maintain a uniform pressure at *B*.

The valve shown in the cut is intended for use where a large and continuous supply of steam is needed, as for running dynamos for train lighting, etc. When this valve is to be used for train heating only, a projection is made on the bottom of valve (1), as shown by the heavy dotted line, so that only a small annular opening is made as the valve starts from its seat.

To obtain greater pressure screw down on the spring (7) by means of the regulating screw (8). To obtain less pressure screw up on the regulating screw.

ECLIPSE REDUCING VALVE.

Description.—Before starting, spring (*A*) and the stem below it have forced down piston (*B*) and opened valves (*E E*). When steam is turned on at the steam heat throttle valve on the boiler head and as soon as the reduced pressure at the left hand or outlet side which also acts on the under side of piston (*B*) has reached a sufficient amount to over-balance the tension in spring (*A*), the piston (*B*) will raise and pull

with it the valves (*E E*), thereby shutting off any further supply of steam until the pressure under piston (*B*) again falls below the tension of spring (*A*). In action this valve does not open wide and then close, but assumes a position open only enough to admit a uniform supply of steam needed to maintain the desired pressure.

- A.* Regulating Spring and Stem.
- B.* Regulating Piston.
- C.* Exhaust Pipe to Atmosphere.
- D-D.* Relief Ports.
- E-E.* Double Seated Valve.
- F.* Regulating Screw.
- G.* Lock Nut.
- I.* Inlet.
- O.* Outlet.

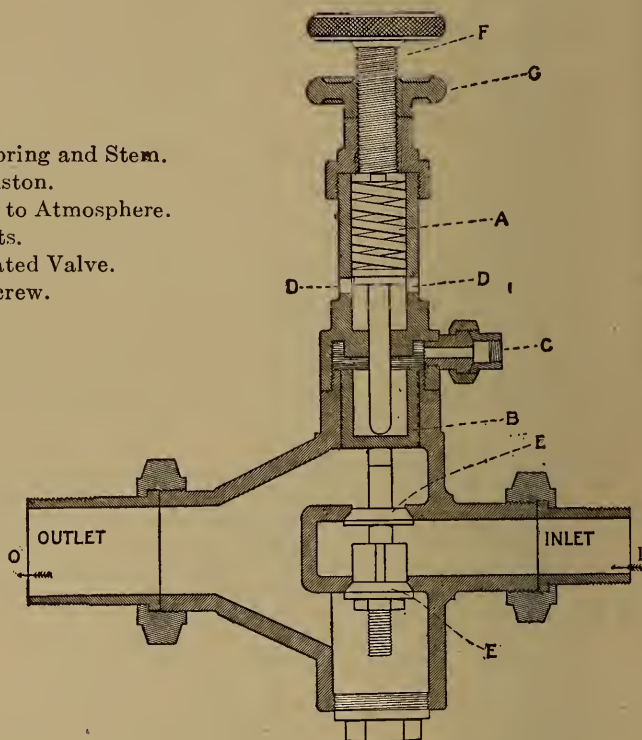

FIG. 4.
Eclipse Reducing Valve.

This reducing valve is also made with a double piston valve in place of the double bevel seated valves (*E E*), but the latter, as shown in the engraving, is more satisfactory, especially for short trains requiring but small supply of steam.

To obtain greater pressure screw down on *F* and lock with *G*, or do the reverse if less pressure is desired.

THE TAAFEL PRESSURE REGULATOR.

This regulator, sometimes called the "Leslie" regulator, is used largely on locomotives for train heating.

The engraving here shown gives a sectional view through the center of the valve, whose operation is as follows:

Steam from the inlet side (*R*) enters from the right

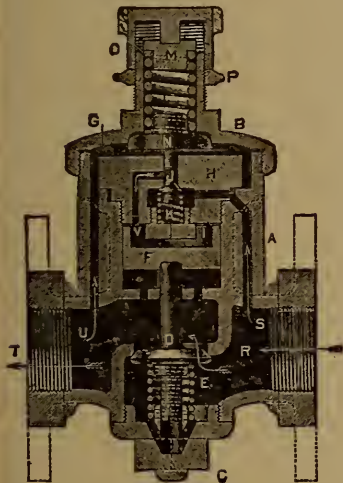

- A. Main Body.
- B. Top Cap of Main Body.
- C. Bottom Cap of Main Body.
- D. Main Valve.
- E. Main Valve Spring.
- F. Piston.
- G. Diaphragm.
- H. Body of Regulating Valve.
- I. Cap of Regulating Valve.
- J. Regulating Valve.
- K. Regulating Valve Spring.
- L. Adjusting Spring.
- M. Top Seat of Adjusting Spring.
- N. Bottom Seat of Adjusting Spring.
- O. Regulating Cap.
- P. Lock Nut of Regulating Cap.
- Q. Wood Handle and Nut.
- R. Inlet.
- S. Inlet Port to Reg. Valve Chamber.
- T. Outlet.
- U. Port to Diaphragm Chamber.
- V. Port from Regulating Valve Chamber to Piston Chamber.

FIG. 5.

Taafel Pressure Regulator.

hand side, as shown in the cut. A portion of the steam passes up through port (*S*) to the regulating valve (*J*) which it finds open, due to the downward pressure of the adjusting spring (*L*) on the diaphragm (*G*), which in turn bears upon the small valve (*J*). This small regulating valve being open allows the steam to pass as shown by the arrow to chamber (*V*) where it forces piston (*F*) downward, thus opening

the main valve (*D*) and allowing steam from the locomotive boiler to pass to the train heating system at the outlet (*T*). Port (*U*) connects the under side of diaphragm (*G*) with the heating system, and when the pressure there reaches whatever amount the adjusting spring (*L*) is set to withstand, the slightest additional pressure will cause diaphragm (*G*) to bend upward enough to release regulating valve (*J*), thus allowing the latter to be seated by the force of its spring (*K*), just beneath it. No further supply of steam from the inlet side can now reach chamber (*V*) and what pressure remains therein can pass around piston *F* (which is for this purpose but loosely fitted in its cylinder) and equalize with the system pressure underneath. Piston (*F*), being equally balanced, permits the main valve spring (*E*) to close the main valve (*D*), thereby shutting off further supply of steam to the heating system.

As soon as the pressure of the steam in the heating system under diaphragm (*G*) becomes the least amount less than that of the adjusting spring (*L*), the diaphragm will bulge downwards, unseating regulating valve (*J*), which, as before described, again produces a supply of steam to the system.

For attaching and adjusting this regulator the following directions should be observed:

When possible place regulator in a vertical position on a horizontal pipe, but always arranged so the steam will pass through in the direction indicated by the arrow cast on the side of the valve body.

Before attaching the regulator put a stop valve on inlet pipe and blow out pipes thoroughly; after the regulator has been attached and before pressure is

turned on, unscrew cap (*O*) to take all pressure off the adjusting spring (*L*). Open the stop valve, then screw down the regulating cap (*O*) until the desired pressure is reached, when the cap should be locked in position by lock nut (*P*). A very slight turn of the cap either way will change the pressure.

The regulating cap (*O*) can be removed while pressure is on, if so desired.

The top cap (*B*) of main body can be removed while pressure is on, providing steam is released from the outlet pipe (*T*).

The diaphragm must always be set with bead up.

To take out main valve (*D*), unscrew the bottom cap (*C*) of the main body.

To remove the regulating valves, first unscrew top cap (*B*) of main body, then unscrew the regulating valve body (*H*), and also cap (*I*).

When repairing, care should be taken to see that all joints, seats and piston are thoroughly cleaned and a little heavy oil used on the joints before screwing them up tight.

Never use oil of any kind on the piston, valves, valve seats or valve stems.

When the regulator is in working order all parts should work freely.

All parts of each size regulator are interchangeable.

THE ROSS STEAM PRESSURE REDUCING VALVE.

This reducing valve shown in the accompanying cut is of the diaphragm-piston type. The regulating screw at the top produces the required pressure through a double coil spring upon a flexible metallic

diaphragm having a stem extending down by a loose fit through the regulating piston and supply valve to an adjusting nut.

This adjusting nut regulates the maximum opening of the supply valve, which opening should not be over $\frac{1}{8}$ inch, and the stem serves as a guide to the piston and valve, which are in one piece. As the stem is a loose fit in the latter, the pressure beneath the supply valve. (that of the heating system) and that in the small chamber between the diaphragm and the piston are always the same. Hence, when steam from the locomotive boiler (entering from the right as shown in the engraving) strikes the upper side of the valve

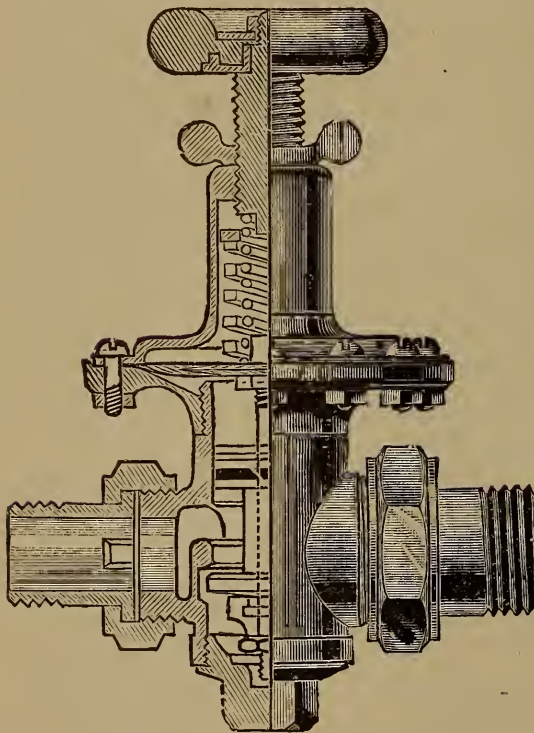

FIG. 6.

Ross Steam Pressure Reducing Valve.

and the under side of the piston, as there is no pressure on top of the latter due to the asbestos packing (shown in the illustration by dark lines) therein, the valve is forced down and open, admitting steam to the heating system. When the pressure in the heating system, passing by the stem to the under side of the diaphragm, becomes great enough, it causes the dia-

phragm to raise sufficiently to clamp the valve to its seat and shut off further supply until the system pressure reduces below the set limit. When that condition again exists, the diaphragm springs downward allowing the supply valve to again open.

Adjustment and Repairs.—The piston should always be kept well packed with asbestos, the diaphragm joint kept tight, and the adjusting nut on the bottom of the stem set so that valve cannot open more than $\frac{1}{8}$ inch.

If steam in large quantities passes the valve when it should not, take off the bottom cap, unscrew the adjusting and yoke nuts, pull out the valve and piston.

If the valve has a good seat and no scale or dirt is found under it, the trouble was due to the valve having too much lift. Hence, in replacing the parts, screw the adjusting nut up until the valve is clamped to its seat, first having relieved tension on the diaphragm from the top regulating screw; then slack off the nut about a turn and a half or two turns and the trouble will be overcome.

If the valve regulates well on long trains, or where much steam is used, but allows the pressure to become too great on short trains, or where the steam requirements are small, the piston packing has become hardened or worn out and should be replaced.

SPECIAL AUTOMATIC RELIEF VALVE.

The Consolidated Car Heating Company employ the Mason regulator or reducing valve, which has been fully described elsewhere, and also, for addi-

tional safety, the special relief valve shown sectioned in the accompanying cut, Fig. 7.

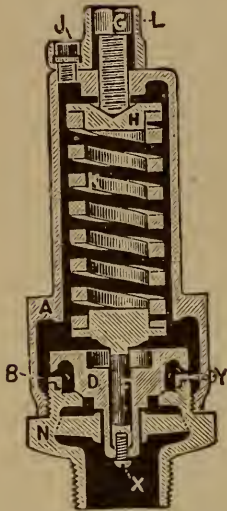

FIG. 7.
Special Automatic
Relief Valve.

This relief valve is set at 50 pounds and is for the purpose of relieving the pressure in system heating pipe and at the same time signaling the engineer, should the pressure become too great.

By its use the not infrequent delays due to hose burst from over-pressure may be reduced to a minimum.

To take valve apart: Use the key to unscrew lock-screw (*J*), take off the shield (*L*), and relieve the load on spring by unscrewing the set-screw (*G*). Then loosen set-screw (*Y*), and unscrew the casing.

To set valve at a higher pressure: Screw set-screw (*G*) down; at a lower pressure, screw set-screw up.

To regulate pop: The pop or action of the escaping steam is regulated by the externally threaded ring (*B*) in the base of the valve, which is easily accessible without taking valve apart, and is held securely in place when set, by means of set-screw (*Y*) on the side of the valve body. If the valve pops too suddenly and reduces the pressure too much, turn ring (*B*) down (further away from the valve disc), and if it does not pop enough, opening and closing only gradually, turn ring (*B*) up (nearer to the valve disc). When the desired adjustment is obtained, secure the ring by means of the set-screw (*Y*); whenever set-screw (*G*) is changed, the pop regulating ring must in most cases be changed to suit.

To insure proper working: Pop safety valves should be attached immediately upon the boiler, or as close to same as possible; otherwise the connecting pipe should be at least one size larger in diameter than the size of the pop valve.

Caution: Before attaching valve, blow out pipe and avoid the use of too much lead or pipe grease. This valve is sensitive, and any foreign substance lodging in it will prevent its perfect working.

The location of the automatic relief valve and the other locomotive cab attachments connected with the train steam heating apparatus are clearly shown in Fig. 8.

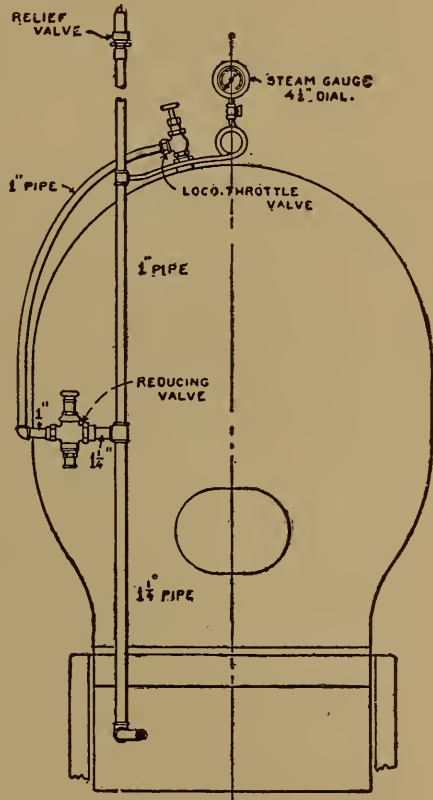

FIG. 8. Location of Steam Heating Cab Attachments.

RULES FOR ENGINEERS.

The following rules are applicable to all forms of direct train steam heating apparatus :

1. Engineers must give for heating trains on the road a steam pressure of twenty pounds, on heating gauge in cab, for trains of five cars, and an additional three pounds for each additional steam-heated car.

2. Give extra pressure up to forty-five pounds, if desired, to heat cold trains, and to blow out at terminal points, before shutting off.

3. Steam must not be shut off from heating apparatus or turned down while on the road.

4. Pressure should always be regulated by the reducing valve, the throttle valve being wide open when using steam for heating. If at any time the reducing valve fails to hold the pressure steady, report same and see that the valve is cleaned.

5. See that the throttle valve of heating apparatus is closed about three minutes before entering stations, where engine is to be disconnected or additional cars to be placed in train, and at terminal points. This is important to prevent scalding train men in uncoupling hose while pressure is on.

6. When not using steam on train, allow sufficient steam to pass through steam pipe to prevent freezing steam pipe under tank.

7. Get signal that steam is through train line before leaving terminal point or changing station.

AIR BRAKE APPARATUS.

THE DUPLEX AIR PUMP—NEW YORK AIR BRAKE COMPANY.

The air pump is one of the most important attachments to the locomotive; it furnishes the motive power for the operation of the automatic air brake.

Fig. 1 shows the No. 2 Duplex air pump of the New York Air Brake Company, which is adapted for large locomotives. It works with a smoothness and ease of operation in strong contrast to the ordinary single cylinder pump, the absence of jarring and noise being particularly noticeable, and will supply air rapidly.

The action of this pump in compressing air is similar to the use of steam in a compound engine, but the air is compounded in this case and not the steam. Both steam cylinders are seven inches in diameter. The high-pressure air cylinder is also seven inches in diameter, but the low-pressure air cylinder is larger, its diameter being ten inches and its capacity therefore exactly twice that of the steam cylinder actuating it. Both air cylinders are filled with free air at every stroke. The first operation is to force the air from the largest cylinder into the smaller one in addition to the free air already in the smaller cylinder. The smaller cylinder then contains three times its volume of free air, compressed to about forty pounds. The high-pressure piston then completes the compression and forces the air into the reservoir. In this way,

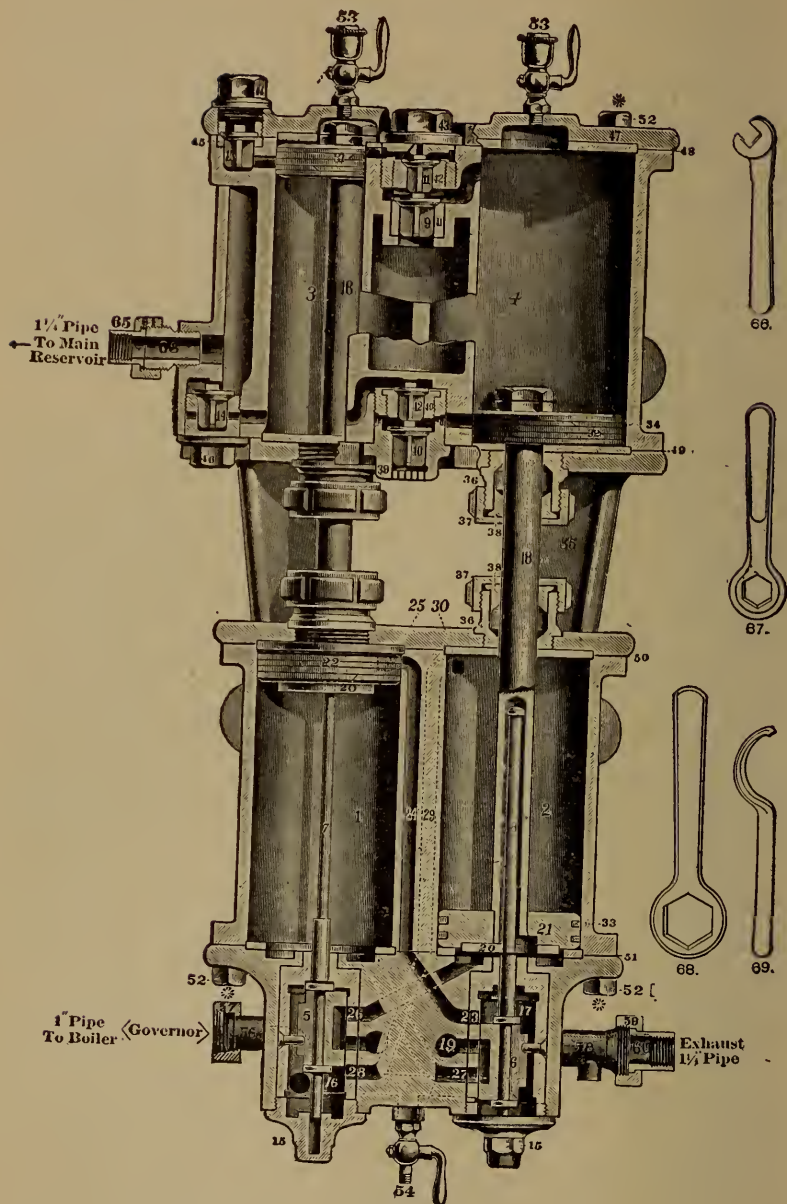

FIG. 1.

New York Air Brake Co.'s Duplex Air Pump.]

the two seven-inch steam pistons are caused to actuate the equivalent of three seven-inch air pistons (the area of a ten-inch piston being exactly double that of a seven-inch), or, in other words, two measures of steam are made to compress three similar measures of air.

The valve gear is very simple. For the steam cylinders it consists of two plain slide valves (5) and (6), moving in steam chests (16 and 17), and operated by small tappet rods (7 and 8), which extend into the hollow piston rods of the steam cylinders. As is shown, the valve on one side controls the supply of steam to the opposite side. The air valves are simple poppet or check valves, which seat by gravity while the pistons wait, and therefore are not liable to pound themselves to pieces. (The pistons of one side rest while the pistons of the other side are in motion.) The operation is as follows:

In the position shown, the air piston in cylinder (4) has completed its downward stroke and compressed

Parts of Duplex Air Pump.

- | | |
|---------------------------------------------------------|-------------------------------------------|
| 1-2 Combined Steam Cylinders. | 44 Upper Discharge Valve Cap. |
| 3-4 Combined Air Cylinders. | 45 Upper Discharge Valve Seat. |
| 5-6 Slide Valves. | 46 Lower Discharge Valve Seat. |
| 7-8 Valve Stems. | 47 Top Head. |
| 9-10 Receiving Air Valves. | 48 Upper Air Cylinder Gasket. |
| 11-12-13-14 Discharge Air Valves. | 49 Lower Air Cylinder Gasket. |
| 15 Steam Chest Caps. | 50 Upper Steam Cylinder Gasket. |
| 16-17 Steam Chest Bushings. | 51 Lower Steam Cylinder Gasket. |
| 18 Piston Rods. | 52 Cylinder Head Bolts. |
| 19 Lower Steam Cylinder Head, with Valves and Bushings. | 53 Oil Cups for Air Cylinders. |
| 20 Piston Plates for Actuating Valve Stems. | 54 Drain Cock. |
| 21-22 Five-Inch Steam Pistons. | 55 Piston Plate Bolt. |
| 31 Five-Inch Air Piston. | 56 Steam Union Stud for Governor. |
| 32 Seven-Inch Air Piston. | 57 Steam Union Nut for Governor. |
| 33 Five-Inch Piston Packing Rings. | 58 Exhaust Pipe Union Stud. |
| 34 Seven-Inch Piston Packing Rings. | 59 Exhaust Pipe Union Nut. |
| 35 Centre Piece. | 60 Exhaust Pipe Union Swivel. |
| 36 Piston Rod Stuffing Boxes. | 61 Quarter-Inch Nipple. |
| 37 Piston Rod Stuffing Box Nuts. | 62 Quarter-Inch Union. |
| 38 Piston Rod Stuffing Box Glands. | 63 Air Union Stud. |
| 39 Lower Receiving Valve Chamber. | 64 Air Union Nut, $\frac{3}{4}$ -inch. |
| 40 Lower Intermediate Valve Seat. | 65 Air Union Swivel, $\frac{3}{4}$ -inch. |
| 41 Upper Receiving Valve Seat. | 66 Cylinder Head Bolt Wrench. |
| 42 Upper Intermediate Valve Seat. | 67 Cap and Discharge Valve Wrench. |
| 43 Upper Intermediate Valve Chamber. | 68 Upper and Lower Valve Chamber Wrench. |
| | 69 Piston Packing Nut Wrench. |

its contents through valve (12) into cylinder (3). The plate (20), on steam piston (21), has moved valve (6) to its lowest position. This admits steam through port (23, 24, 25) to upper side of piston (22), and will cause that piston to descend and expel the partially compressed air in cylinder (3) through valve (14) and passage shown into the reservoir. Meanwhile, the cylinder (4) has become filled above the piston with air at atmospheric pressure through valve (9), and the cylinder (3) will be filled with air at atmospheric pressure through valves (9 and 11), both of which open inward and are seated by gravity. When piston (22) reaches the end of its downward stroke, the plate (20) strikes the tappet on valve stem (7) and moves valve (5) to its lowest position, thus uncovering port (26) and admitting steam through port (26) to the lower side of piston (21), thus causing piston (21) to rise and compress the air which is in cylinder (4) through valve (11) into upper part of cylinder (3). Just as piston (21) completes its stroke, its plate (20) strikes the tappet on valve stem (8) and moves valve (6) to its highest position, uncovering port (27) and admitting steam through port (27) to the lower side of piston (22), causing that piston to rise and expel the partially compressed air in cylinder (3), through valve (13) into passage shown, and thence into the reservoir. While the pistons are compressing the air above them into the reservoir, the air cylinders below the pistons will be filled with air at atmospheric pressure through valves (10 and 12), ready for another cycle of operation.

The construction is very durable, and all valves can be examined or removed by unscrewing plugs, with-

out taking the pump down. The steam cylinders are placed underneath the air chambers to allow natural drainage and insure clean air.

TRIPLE VALVES—NEW YORK AIR BRAKE COMPANY

The triple valve plays a vital part in the operation of the automatic air brake, the purpose it serves being to provide a way by which the stored pressure in the reservoir may be automatically admitted to the brake cylinder whenever the pressure in the train-pipe escapes.*

PLAIN TRIPLE VALVE.

Fig. 1 shows a section of the Plain Triple valve, which is used only on engines and tenders. The parts are few, simple and durable, and their operation is not easily affected by dirt.

Connections are made with the auxiliary reservoir, the brake cylinder, and the train-pipe, as shown; slide valve (38) controls the exhaust of air from brake cylinder, to release brakes, and graduating valve (48) controls the admission of air from auxiliary reservoir to brake cylinder, for applying brakes. Piston (40) actuates slide valve (38) and graduating valve (48), and in such a manner that valve (38) will close exhaust port before graduating valve (48) is opened. The slide valve (38) can remain stationary while the piston (40) returns part way and closes graduating

*The principle of the triple valve and the details of other forms thereof are fully described in "The Science of Railways," and the reader is referred to the General Index of that work for information in regard thereto.

valve (48), as the abutments that move valve (38) are farther apart than the length of the valve.

The operation is as follows: Air from the train-pipe passes to cylinder (A), through charging groove (B) and passage (C) to chamber (D), and thence through passage (E) into the auxiliary reservoir. When the train-pipe pressure is reduced, the piston (40) moves its full stroke, first shutting off the auxiliary reservoir from the train pipe by closing the connection between passage (B) and cylinder (A), next closing exhaust

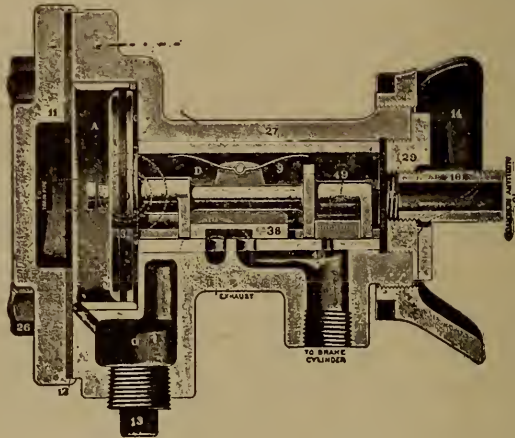

FIG. 1.
Plain New York Triple Valve.

valve (38) and opening graduating valve (48), thus admitting air into the brake cylinder; the amount admitted being in proportion to the reduction of the train-pipe pressure. If the train-pipe pressure is reduced but little, the pressure in the reservoir is soon reduced to less than that in the train-pipe, and the piston (40) starts back and closes graduating valve (48), without disturbing slide valve (38), which is held with some force by the air pressure, aided by spring (9), and checks the return stroke when valve (48)

is closed. A further reduction of train-pipe pressure would repeat the same action and apply the brakes a little harder. If the train-pipe pressure is reduced five to eight pounds, the brakes will be applied with but moderate force, but if the train-pipe pressure is reduced twenty pounds, the graduating valve (48) will remain open and the brakes go full on, as the auxiliary reservoir pressure will then continue to flow into the brake cylinder until the pressure in each has become equalized.

An increase of pressure in the train-pipe will cause all the valves to move back to the position shown in the plate, thus releasing the brakes and allowing the reservoir to be re-charged. Passage (*F*) allows moisture from the train pipe to collect in chamber (*G*), where it can be readily drained by unscrewing plug (13).

THE NEW YORK IMPROVED QUICK ACTION TRIPLE VALVE.

Fig. 2 shows a sectional view of this triple valve. Figs. 2, 3 and 4 are ideal sketches with all working parts drawn on the same plane, in order to render an explanation more readily understood. In the actual construction some of the moving parts are placed at right angles to the main piston, so that all the inside parts can be removed without detaching the valve from the reservoir or the train-pipe. This valve has the same connections and is interchangeable with the Westinghouse quick action triple valve.

The work it does is known as "service" and "emergency," the first being its ordinary action, and the second giving the very strong and instant application

for emergency use. To accomplish the latter throughout a long train, pressure from the train-pipe is discharged at each car in addition to the reduction by the engineer. As elsewhere explained, the ordinary

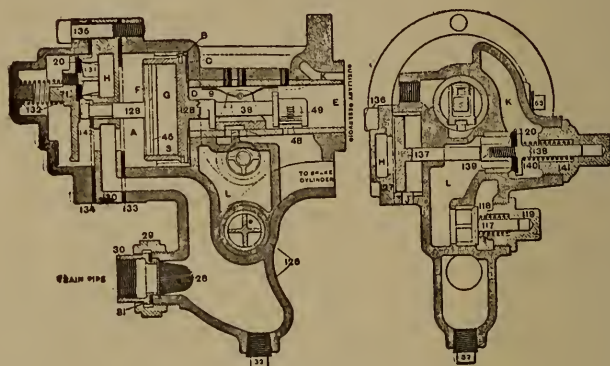

FIG. 2.
New York Quick Action Triple Valve.

service application is made by letting from six to eight pounds pressure out of the train pipe, and emergency application by a sudden reduction of ten or more pounds. In either case, the reduction causes an impulse of air to travel through the train-pipe and operate the triple valve of each car as it passes along. The service reduction is not powerful enough to affect the emergency parts and travels through the train with moderate speed. The emergency reduction, however, is so much more powerful that it also sets the emergency parts in motion and, as they exhaust the train-pipe pressure in their immediate vicinity, this impulse is transmitted from car to car with great rapidity.

The "service" parts occupy the central portion of Figs. 3, 4 and 5. The auxiliary reservoir is charged through the usual groove (B). Exhaust valve (38)

and graduating valve (48) cover the usual ports, and are moved by the main piston (128) for applying and releasing the brakes for service stops, in the manner already familiar in plain and quick action triple valves.

The "quick action" parts occupy the left and top por-

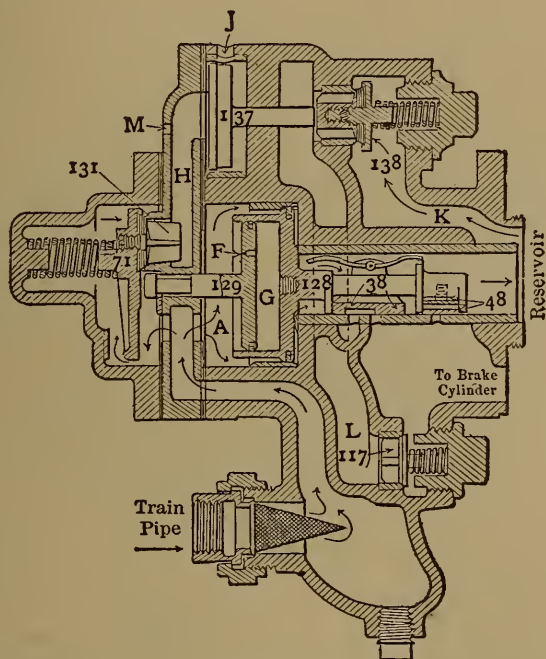

FIG. 3.

Illustrative Model of New York Quick Action Triple Valve.
(All valves in normal positions).

tions of the drawing, and are inoperative under ordinary conditions. Vent valve (71) is held to its seat by spring (132), assisted by train-pipe pressure, and can only be opened when piston (129) is forced to the left. Quick action valve (138-139) is held to its seat by spring (140), assisted by reservoir pressure, and can only be opened when piston (137) moves to the

right. All parts are simple and durable, and the valves are so located that no oil from the brake cylinder can possibly reach a rubber valve seat.

Fig. 3 shows the triple with all valves in their normal positions; Fig. 4 shows the position of the valves in service application; and Fig. 5 shows the

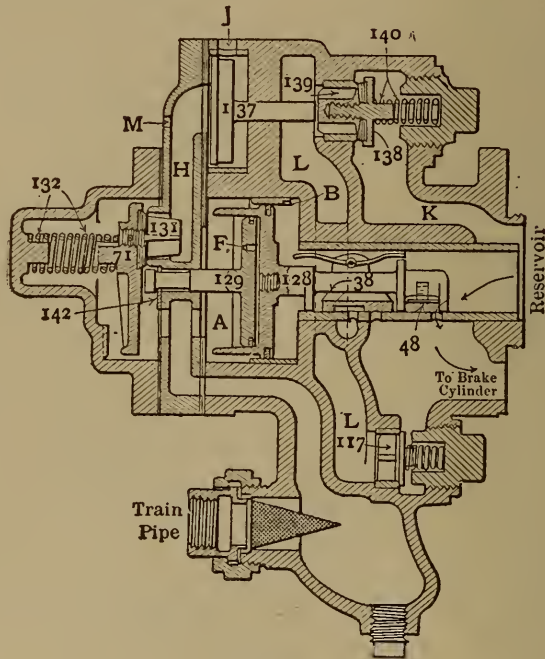

FIG. 4.

Illustrative Model of New York Quick Action Triple Valve.
(Position of valves in service application).

valves in emergency position. The arrows indicate the course of the air in each position.

The triple valve proper consists of the triple piston valve (128), the exhaust valve (38) and the graduating valve (48). The graduating and exhaust valves are of the slide valve pattern, and in their arrangement on the triple piston stem are independent

of each other. The triple piston valve is of the cup or extended pattern, and forms a cylinder for the vent valve piston (129). These three valves, combined, of course, constitute the triple valve, and the triple valve is the part that gives the brake its automatic action.

The quick action part of the triple consists of the

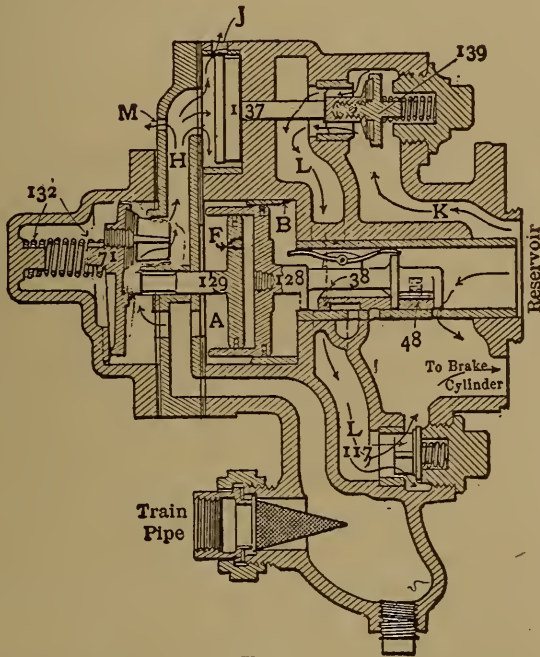

FIG. 5.
Illustrative Model of New York Quick Action Triple Valve.
(Valves in emergency position!)

vent valve piston (129), the extended cup or cylinder of piston (128), vent valve (71), vent valve spring (132), emergency piston (137), emergency valve (139), and brake cylinder check valve (117). To these parts we may add the vent ports (*M* and *J*) and the passages (*H*, *L*, *L* and *K*).

In the normal position, that of charging the auxiliary reservoir, as shown in Fig. 3, the air comes in

from the train-pipe, as indicated by the arrows, passes by the triple piston (128) through the feed groove (*B*) to the auxiliary reservoir. At the same time it charges chamber (*G*), between the vent valve piston (129) and the triple piston (128) through the very small port (*F*) drilled through the vent valve piston (129.)

Main piston (128) has the same stroke for both service and emergency application. The small port (*F*) is of such a size that when triple piston (128) moves slowly to the left, as in service application, Fig. 4, the air in space (*G*) will be pressed through opening (*F*) without disturbing piston (129) from its normal position.

In the service application (Fig. 2) only the triple valve proper operates. The triple piston moves to the left until it rests against, and forms an air-tight joint on the leather gasket (133); then the exhaust valve (38) is moved into a position covering the exhaust ports from the brake cylinder to the atmosphere, and the service port is uncovered by the graduating valve (48), so that the auxiliary pressure may expand into the brake cylinder and apply the brake.

The sharp reduction of the train-pipe pressure for an emergency stop will cause main piston (128) to move rapidly to the left. In this case, the air in space (*G*) cannot escape through passage (*F*) fast enough to prevent a momentary pressure upon piston (129), strong enough to overcome its resistance and cause valve (71) to be pushed from its seat, as shown in Fig. 5. This allows train-pipe air to enter, momentarily, the passage (*H*) and escape to the atmosphere through small port (*M*) and the larger opening (*J*). In doing this latter piston (137) is forced to the right

enough to uncover port (*J*), and this movement unseats emergency valve (139) and allows the full power of the auxiliary reservoir pressure to pass rapidly to the brake cylinder, there to be instantly effective, on account of the large annular passage (*L L*) and check valve (117). Meanwhile, as passage (*F*) is always open, the temporary pressure exerted by air in chamber (*G*) has rapidly lost its effect by escaping through port (*F*), and spring (132) has returned valve (71) to its seat, thus checking the further escape of air when the train-pipe pressure is sufficiently reduced to apply the brakes to quick action on adjoining cars. As valve (71) closes, it returns piston (129) to its original position, its travel to the right being limited by the stop (142), shown in Fig. 2. Valve (139) and piston (137) have also been returned to their former positions, as shown in Fig. 3.

Releasing brakes after an emergency position is accomplished in the same manner as previously described under the plain triple. All other parts having automatically returned to their original positions (Fig. 3), there is only the main triple piston (128) to be acted upon. Restoring the train-line pressure causes this piston to return slide valve (38) and graduating valve (48) to the position shown in Figs. 2 and 3, allowing the brake cylinder pressure to escape to the atmosphere underneath the slide valve (38), at the same time the auxiliary reservoir is being replenished through the feed groove (*B*).

This triple valve has no communication between the train-line and the brake-cylinder, and hence no defective check valve can allow the brake-cylinder to escape back into an open train pipe.

One of the advantages of this valve lies in the fact that it is so constructed, as shown in Fig. 2, that, if any one of the valves leaks, it can be detected from the outside and the defect remedied without disturbing any of the pipe joints.

Moisture from the train-pipe collects in the drain cup at the bottom of the valve where it can be drained by unscrewing the plug.

While the parts are similar for passenger and freight triple valves, the ports in the former are larger, and therefore they should not be interchanged. Passenger triples have a letter "P" cast on the outside.

WESTINGHOUSE "1900" FEED-VALVE OR TRAIN-LINE GOVERNOR. SLIDE VALVE PATTERN.

This form of feed-valve attachment to the "1892" Engineers' Brake Valve was designed to embody all the advantages of the old form and at the same time govern the train-line within closer limits, be less liable to derangement from gum and dirt, and be so arranged that it can be easily taken apart and cleaned without the slightest interference with the adjustment.

The method of attachment of this new device is identical with that of the older form, the two being interchangeable.

As clearly shown in the cuts, Figs. 1 and 2, the supply-valve chamber *F* and the ports and passages marked *f* are in direct communication with the main reservoir through port *f* of the engineers' brake valve,* when the handle of the latter is in "running

*For full particulars of the principle and operation of the Engineer's Brake Valve the reader is referred to "The Science of Railways," where they may be found by reference to the General Index.

position." The passage lettered *ii* is an extension of the corresponding train-line passage in the brake valve. Chamber *E* is separated from chamber *F* by supply-valve piston 54.

It will readily be seen that if chamber *E* is connected with the train-line, piston 54 (See Fig. 2) would be forced to the right by the greater main reser-

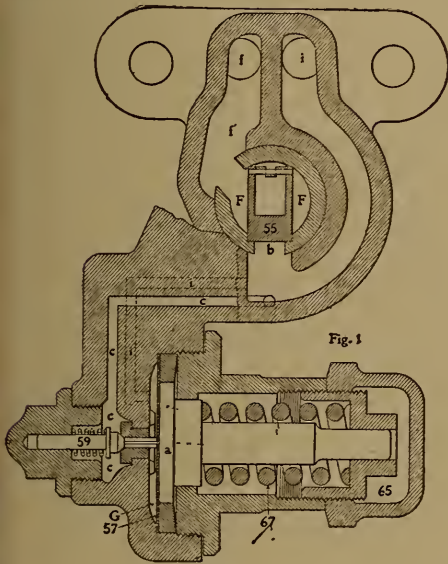

Fig. 1

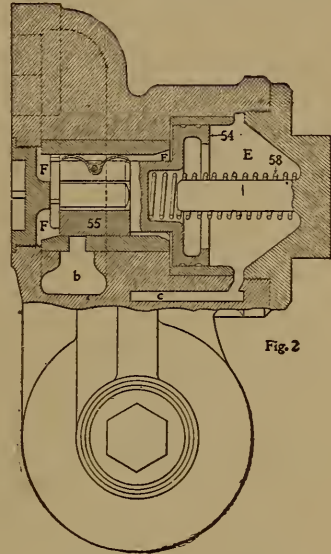

Fig. 2

Fig. 1.

Fig. 2.

Westinghouse "1900" Feed Valve or Train Line Governor.
Slide Valve Pattern.

- | | |
|--------------------------------|----------------------|
| 54—Supply Valve Piston. | 59—Regulating Valve. |
| 55—Supply Valve. | 65—Regulating Nut. |
| 57—Diaphragm. | 67—Regulating Spring |
| 58—Supply Valve Piston Spring. | |

voir pressure in chamber *F* acting on the other side of this piston. However, if chamber *E* were shut off from all communication with the train-line, it will be equally apparent that, as there are no packing rings in piston 54, the main reservoir pressure from chamber *F* would soon form an equal pressure in chamber *E*, thus allowing the supply-valve piston spring 58 to force piston 54, and with it the slide-

valve supply valve 55 to the left, closing port *b*, as shown in Fig. 2.

Now it is in order to explain how chamber *E* may or may not be in connection with the train-line.

By referring to Fig. 1, it will be seen that regulating valve 59, when open, connects passage *c c* leading from chamber *E* (consult both Figs. 1 and 2 to see the connection) with diaphragm chamber *G*, which in turn is connected by invisible passages *ii* (dotted lines, Fig. 1) with the train line at port *i* at the top. Regulating valve 59 is normally held open by diaphragm 57, which is acted upon by regulating spring 67, whose tension of seventy pounds is adjusted by regulating nut 65.

When the handle of the engineer's brake valve is placed in "running position," main-reservoir air is admitted to chamber *F*, forces supply-valve piston 54 forward, carrying supply valve 55 with it, uncovers port *b*, and gains entrance directly into the train line through passage *ii*. The resultant increase in train-line pressure likewise increases the pressure in chamber *G* under diaphragm 57 until it overcomes the tension of regulating spring 67, previously adjusted to yield at seventy pounds or some other desired pressure. The consequent movement of diaphragm 57 allows regulating valve 59 to be seated by its spring, closing port *a* and cutting off all communication between chamber *E* and the train-line. The main-reservoir pressure in chamber *F* then equalizes with the pressure in chamber *E*, by leakage past supply-valve piston 54, and supply-valve piston spring 58, previously compressed by the comparatively higher pressure in chamber *F*; now

reacts and forces supply valve 55 to its normal position, closes port *b*, and cuts off the communication between the main reservoir and the train-line. The reduction of train-line pressure below seventy pounds, or other set limit, reduces the pressure in chamber *A*, thereby permitting regulating spring 67 to react to the left and forcing regulating valve 59 from its seat, thus allowing the accumulated pressure in chamber *E* to exhaust into the train line through ports *cc* and *ii* (dotted), as previously described.

The main-reservoir pressure in chamber *F* now readily overcomes that now in chamber *E*, and hence forces piston 54 and with it the supply valve 55 to the right, and recharges the train-line through port *b*, as before described.

With this form of valve it is readily seen that the train-line is charged more quickly than with any of the former designs, because it maintains a wide open port until the full train-line pressure has been reached.

HIGH-PRESSURE CONTROLLING APPARATUS.

The high-pressure controlling apparatus was originally designed for the high-speed braked trains,* but has become adopted and quite useful in service on mountain grades, for which its utility will be easily recognized. It should be noted that the new slide valve feed-valve attachment, fully illustrated and described elsewhere in this volume, is now a standard part of this high-pressure controlling apparatus.

* For further details of the High-Speed Brake apparatus the reader is referred to "The Science of Railways," where, in the General Index, he will find several references to descriptions and illustrations of the special mechanism connected therewith

In high-speed brake service the same locomotive does not always haul the same train, and hence such locomotives must be so equipped that they may be ready in a moment's time to work in either high-speed or ordinary service pressures. While this would ordinarily require a change in the adjustment of the pump governor and feed

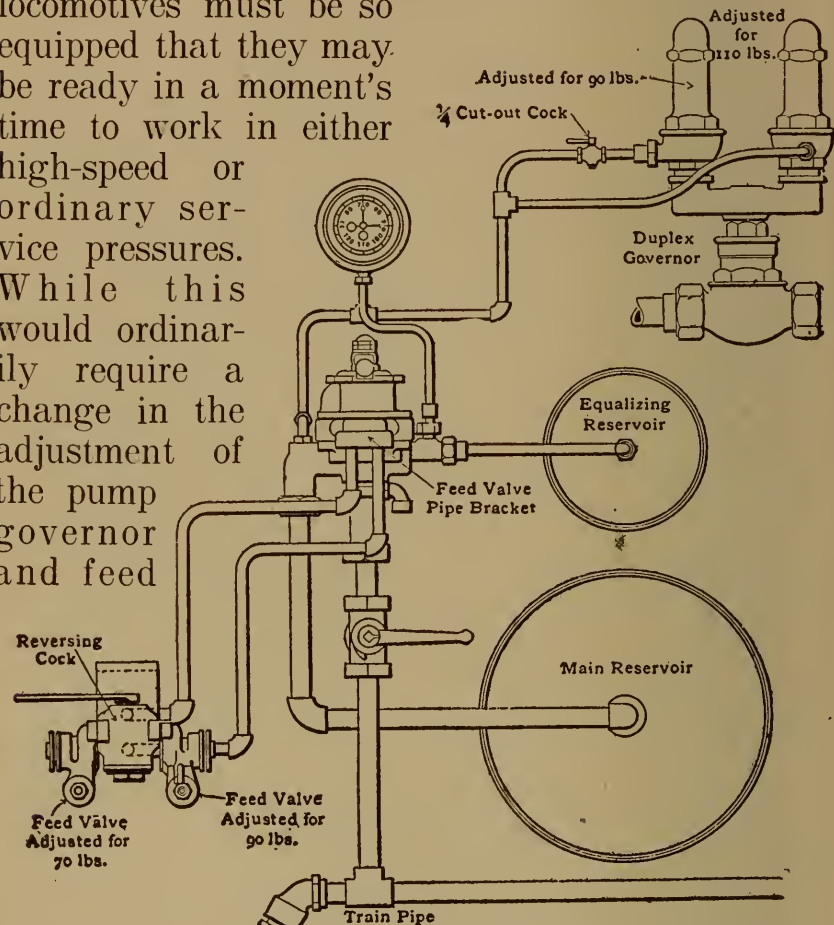

FIG. 3.
High-Pressure Controlling Apparatus.

valve attachment in changing from one service to the other, yet the controlling apparatus here shown makes it possible to throw the low-pressure governor and the low-pressure feed-valve attachment out and the similar high-pressure parts in by the mere turning of two valves.

As will be seen by the cut, the duplex governor consists of a single body and two tops or heads, one of which is adjusted at 90 and the other at 110 pounds pressure. Each governor head is connected to the main reservoir pressure, which it is their duty to control. The reversing cock is placed in some convenient and secure place, generally under the running board on the engineer's side of the locomotive. This cock has two feed-valve attachments, one set at 70 and the other at 90 pounds train line pressure, and either of these may be thrown into use and the other cut out by merely turning the handle of this reversing cock. It should also be noted that there is a small $\frac{1}{4}$ -inch cut-out cock in the air pipe leading to the low-pressure (90 pounds) governor. Thus, by turning the reversing cock handle to the left, the 70-pound feed-valve is thrown into operation, and by opening the $\frac{1}{4}$ -inch governor cut-out cock, the 90-pound governor is operative, thereby giving the low-pressure system. If it be desired to change to the high-pressure system, reverse the position of both cocks, that is, turn the reversing cock handle to the right, thereby cutting out the low-pressure feed-valve and throwing the high-pressure feed-valve into use; close the $\frac{1}{4}$ -inch governor cock, thereby cutting out the low-pressure governor and allowing the air pump to compress air into the main reservoir until the high-pressure governor acts.

When the above described apparatus is used in connection with the high-speed brake, it is customary to set the high-pressure feed-valve at 110 pounds and the high-pressure governor at 120 pounds pressure.

BRAKE SHOES.

The subject of shoes is ordinarily considered a prosaic one; but as foot wear for mankind must be adapted to the various requirements to be met with, so must the brake shoe "fit" the service required. The man with sharp nailed logging boots would be no more handicapped in wearing them in the ball-room than would be the dancer with his patent leather "pumps" in a log-rolling contest.

The same air pressure applied to the various wheels of a locomotive or train where brake shoes of different hardness are used will produce a widely different friction as well as tire-dressing effect on the various wheels. Before the maximum braking power could be obtained from the friction of the hard cast iron shoes, the wheels having softer shoes applied would be sliding. Sliding wheels not only cause damage to themselves but while sliding reduce the retarding effect for which the brake exists. Hence the only way to obtain the fullest degree of brake efficiency is to have a uniform hardness of brake shoe on each wheel.

Brake shoes are made for three kinds of service, namely:

(1) Steel-tired driving wheels, (2) chilled cast iron and (3) steel-tired car, engine truck, and tender wheels.*

* For further information on brake shoes and the various degrees of cast iron best adapted thereto, the reader is referred to "The Science of Railways," General Index, Vol. XII.

The brake shoe for locomotive driving wheels must be one that not only will produce the necessary friction for braking purposes but also dress off that portion of the tire which is not worn down by contact with the rail. Small-wheeled freight and suburban passenger engines necessarily require a brake shoe that will cause greater tire dressing than that necessary for the large driving wheels of express locomotives.

It has been said with reason that work on driver and tender brakes that will enable them to wear out brake shoes is more to be desired than quick-acting triple valves, and it is safe to assume that the brake which does not wear out shoes in a reasonable time is doing but little work; before all other considerations the brake should have proper holding power.

The primary point in the consideration of a brake shoe is friction, and next to this the effect of the shoe upon the tire. The experience of railroad men in general and the results of various tests show that steel acts more effectively on the tire than chilled or unchilled cast iron, and for this reason shoes of steel, or steel and iron, for locomotive service, are the most efficient and popular.

The last point to be considered in the brake shoe and

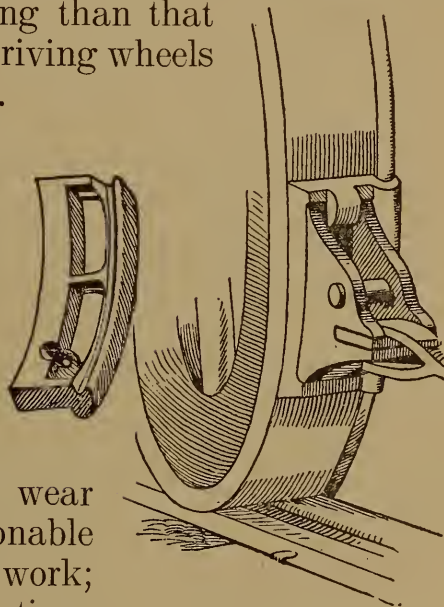

FIG. 1.
Brake Shoe and Its Application to the Driver.

one which is of the least importance in comparison with the other two (although oftentimes overlooked by the purchasing agent in his zeal for cheapness), is the life of the shoe, or its durability.

The brake shoe which lasts the longest is liable to be the one which does the least work. It can be shown that by reducing the brake pressure, the same result is accomplished as would occur from making the shoe very hard.

The shoes for locomotive service are:

First, the driving brake shoes, which are required not only to hold the wheel but also to cut down the tire where it is not acted upon by the rail.

Second, the leading truck and tender shoes, which while giving good frictional effect should not act so severely upon the tires, because of the reduced action of the rail in wearing into the tires. However, the shoes for the leading truck should cover not only the outer tread but the flange also of the wheel in order to reduce to a minimum the tendency to sharp flanges. The tender shoes, if used on steel tires, should preferably be made of the same design, although the tendency toward wearing the wheel flanges sharp is not so great as in the case of the engine truck. The shoes in each case should have good frictional effect consistent with the proper action on the tires.

THE SARGENT BRAKE SHOES.

The Sargent brake shoes, made under license from the American Brake Shoe Company, are described as follows:

Locomotive Driving Brake Shoes. — First, the

skeleton steel brake shoe, Fig. 2, is a casting of mild steel, the metal of which is so disposed as to cover as much as possible those parts of the wheel tread which are not acted upon by the rail. Steel is the most effective metal for wearing down the tire and in the skeleton steel brake shoe the right metal is properly designed for the service required. The material possesses high frictional power and a strong wearing action on the tire, and, as distributed in the skeleton design, cuts away the outer tread and top of flange, thus tending to maintain the original tire outlined. Shopping engines for tire turning is largely prevented or delayed by the use of the steel shoe, and the expense of locomotive maintenance considerably reduced. The skeleton steel brake shoe is strongly recommended for freight, switching and suburban service, and where tires are rapidly worn into by the action on the rail.

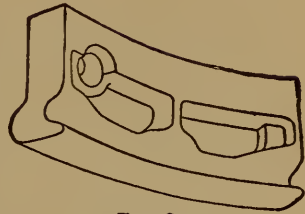

FIG. 2.
Skeleton Steel Brake Shoe.

The Skeleton Steel Insert Shoe, Fig. 3, is recommended for general locomotive service. It is not so severe a tire dresser as the all-steel shoe, but is more generally used. It consists of a body of cast iron having inserts of a special crucible steel disposed along the face of the shoe where it contacts with the tire outside of the limits of rail wear. These inserts remain constant, being unchanged by the heat of friction, presenting hard and uniform cutting edges

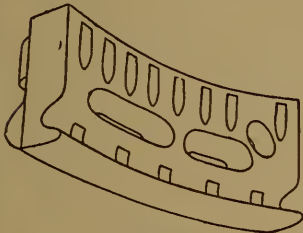

FIG. 3.
Skeleton Steel Insert Shoe.

which are exposed by the grinding away of the cast iron between them, and act like milling tool cutters in dressing down the tire. The skeleton design removes much of the shoe metal from against the throat of the wheel flange and over the line of rail wear; the broad surfaces of soft cast iron at each end of the shoe and the large area surrounding the inserts afford ample holding power, while the inserts by their hardness insure durability and cutting action on the tire.

The skeleton steel insert shoe is designed for all classes of locomotive service and its use insures increased engine mileage between tire turnings and increased brake efficiency.

The Improved Combination Brake Shoe, Fig. 4, is designed for those who desire great durability combined with wearing action on the tire.

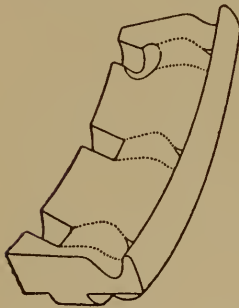

FIG. 4.

Improved Combination
Driving Brake Shoe.

It consists of a body of cast iron having high chilling properties; diagonal grooves along the outer tread, and depressions in the flange-bearing portions made by metal chill blocks, provide sharp edges for cutting down the tire; across the face of the shoe and over the limits of the rail wear upon the tire, are alternate areas of chilled and soft metal, the former to reduce to a minimum the abrading action of this portion of the shoe face upon the tire, and the latter to provide frictional effect. The combination of cutting edges and hard and soft surfaces of contact being such as to provide an equality of brake shoe action upon the tire, so as to prevent uneven wear. This brake shoe is in extensive use and proves a most durable and economical shoe.

Engine Truck and Tender Brake Shoes.--The Skeleton Diamond "S" Brake Shoe consists of a body of soft cast iron surrounding and permeating a bundle of expanded sheet steel, as shown by Fig. 5. The shoe is especially designed to give a mild uniform dressing action upon the outer tread and the top of the flange in order to keep up with the wear of the rail into the tire and to perpetuate as long as possible the original shape of the wheel tread. The combined structure of steel and cast iron makes a very strong shoe with a composite face in which strands of mild steel bind the cast iron in all directions. The toughness of the steel retards the rapid grinding away of the cast iron without materially reducing the frictional effect, with the result of increasing the life of the shoe over that of plain cast iron without sacrifice of holding power.

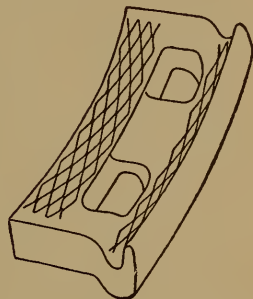

FIG. 5.
Skeleton Diamond "S"
Brake Shoe.

The use of this brake shoe on truck and tender wheels, as well as the steel-tired coach wheels, means greater mileage from the tires, increased efficiency in brake action, together with a reduction in the total cost of operation.



FIG. 6.
Unflanged
Diamond "S"
Brake Shoe.

The Unflanged Diamond "S" Brake Shoe is a reinforced cast iron shoe, as shown by Fig. 6. It is simply a block of soft, strong iron cast about a bundle of strips of expanded sheet steel. The combination forming a solid, homogeneous mass in which the steel is not fused by the iron, but retains its toughness and strength, and on account of

the bonded structure of the shoe, holds it together so that it can be worn down much thinner than the plain cast iron shoe without danger of fracture. The durability and strength of the Diamond "S" shoe insure a reduction in cost with an improvement in the brake efficiency.

The "U" Brake Shoe, as shown by Fig. 7, is designed to provide a shoe with the maximum dura-



FIG. 7.
The "U" Shoe.

bility with a constant and uniform action throughout its entire life, without injurious effect on the wheel; and to secure this extra endurance at as little expense of holding power as possible.

The idea is to take a soft cast iron shoe and add metal to the ends beyond the limits of the ordinary M. C. B. shoe, hardening these ends from the back in such a manner that the chilled or unchilled portion merges into the softer iron before reaching the surface of the shoe exposed to wear against the wheel at the beginning of service. So that at the start the whole area of contact of the "U" Shoe is of soft, unchilled iron equal to the face of the Standard M. C. B. Shoe. As the shoe wears down the hardened ends come into play to increase its life and these hardened ends, while delaying the rapid wear of the soft cast iron, increase the bearing surface of the shoe upon the wheel, making up somewhat for the decrease in frictional effect.

The location of the hardened ends of the "U" Shoe are outside the limits of the M. C. B. brake head and in no way diminish the strength of the shoe. The

ordinary type of chilled brake shoe is very liable to break in service on account of the strained condition of the metal, due to the chilled sections or inserts. This strained condition is entirely removed in the construction of the "U" Shoe; which is used on tender, coach and car wheels where great durability is desired.

THE LAPPIN BRAKE SHOES.

The recent development in the line of improvement in brake shoes has been, not so much in the creating of new forms or types, as in the modification of existing types to insure the practical wearing out of all or nearly all of the metal in the shoe, and thereby eliminating the brake shoe scrap that has in the past contributed so large a proportion to the waste of metal that makes up the scrap heap in railroad yards.

The first marked advance made in this direction was with the steel or malleable metal back shoe patented by H. B. Robischung in 1893, and since acquired by the Lappin Brake Shoe Company. In addition to this malleable metal back this shoe is now being furnished with malleable hooks and lugs on types of shoes where they form part of the device for attaching the shoe to the brake head.

Fig. 8 illustrates a driver brake shoe having malleable or steel back

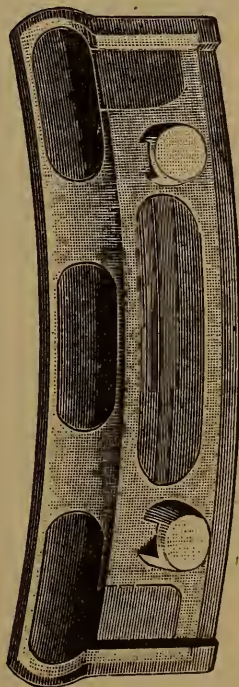

FIG. 8.
Lappin Driver Brake
Shoe, with Malleable
Back and Lugs.

and lugs, as described. With this construction, the shoe can be worn down with perfect safety to this back which is about one-fourth of an inch thick, thereby reducing the scrap loss by more than fifty per cent., and the hooks or lugs, being of malleable metal, cannot break, as sometimes happens when they are of common cast iron or of the same material as the body of shoe.

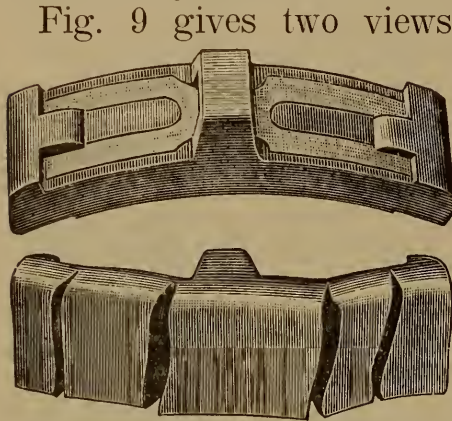

FIG. 9.

Lappin Car or Tender Brake Shoe.

back that if the shoe from any cause should crack or break, in several pieces, it can still be worn out with entire safety.

Fig. 10 shows a malleable metal or steel back extending over the lug on back of shoe, and through which passes the key that secures the shoe to brakehead. This lug, when formed of the cast metal integral with the body of the shoe, is liable to break, in which case the shoe is at once detached from brake head and falls off; but with the malleable metal back extending over

Fig. 9 gives two views of the now standard Lappin car shoe of the M. C. B. type with steel back, one showing the back of an unbroken shoe and the other a face view of shoe broken in pieces to show the grip of the metal in body of shoe on the metal back. The pieces are held so firmly to the

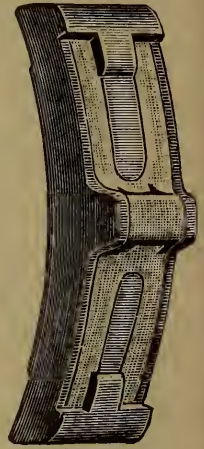
FIG. 10.
Lappin Brake Shoe.

and forming the lug, it is impossible for the shoe to break at this point and fall off.

Fig. 11 shows the back and face view of the interlocking shoe, the latest development in brake shoe improvements, which it is claimed will *entirely* eliminate the brake shoe from the scrap heap, as this shoe wears entirely out in the service, leaving no scrap that can be found. It can be furnished in the ordinary soft iron brake shoe mixture, to roads that so prefer it, or it can be furnished with inserts in the face for use on chilled wheels, or it can be chilled in sections in conformity with the Lappin standards for use on either chilled or steel tired wheels, the inserts of the chills very greatly increasing the life or wearing qualities of the shoe.

When first applying this type of shoe, what is known as the plain-faced type without any interlocking recesses cored in the face is used, and when this shoe has worn down to about five-eighths of an inch in thickness, or to the point at which ordinary cast iron shoes are scrapped, it is removed, and by the interlocking device on its back it is secured to the face of a new pocket-faced shoe, and the whole is then again reapplied to the brake head with the new pocket faced shoe next to the brake head, and the remaining unworn part next to the wheel, as shown in Fig. 12.

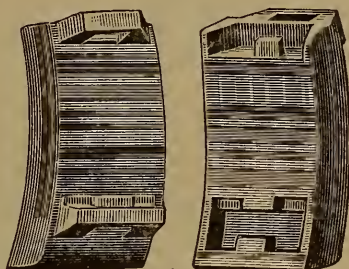

FIG. 11.

Interlocking Brake Shoe.

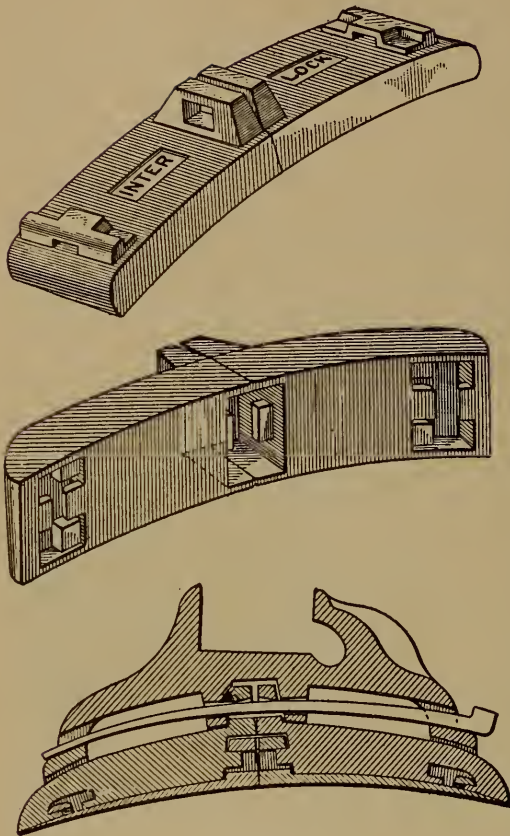

FIG. 12.

The Interlocking, Divided, Brake Shoe.

with the radius of the wheel against which it had been previously applied.

This shoe is cast in two parts, each about seven inches in length, and these short segments at once adjust themselves equally well to wheels from thirty-three to thirty-six inches in diameter, and thus obviate the necessity of carrying a stock of shoes for these different sizes of wheels. The remaining unworn part of the old shoe, when again attached to the face of a new shoe, always presents a surface exactly conforming

with the radius of the wheel against which it had

THE CORNING BRAKE SHOE.

As the result of an extended study of the requirements of a brake shoe suitable for both steel-tired and chilled wheels, the Corning Brake Shoe Company presents another type of brake shoe. The materials used in its construction, soft cast iron and chilled iron,

were selected as being the only common metals which do not injure steel tires. No steel or wrought iron is used in Corning brake shoes.

Reference to the accompanying engravings will show the Corning brake shoe for locomotive driving wheels and the plain shoes for cars and tender wheels. These are all similar in having the main body of the shoe of tough, hard iron cast about a



FIG. 13.
Corning Soft
Gray Iron
Insert.

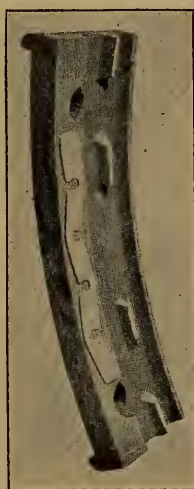

FIG. 14.
Corning Driver,
Brake Shoe.

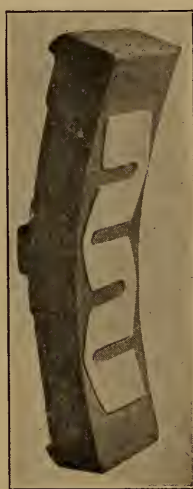

FIG. 15.
Corning Plain
Brake Shoe.

soft gray iron core, shown in Fig. 13; the body of the shoe has a chilled face. The sides of the soft iron inset are so tapered from the back to the face of the shoe that, after the body is cast about it, a section through the shoe shows a dove-tail joint. The advantage gained by this combination is that the long life of the chilled iron is obtained, while at the same time the soft iron gives to the shoe frictional qualities equal to those of the ordinary cast

iron so commonly used in service. The wearing qualities of this combination of materials have repeatedly been shown by service tests made on many railroads, while recent laboratory tests have established the claims made for the frictional qualities of these shoes. It is claimed that one of these shoes such as shown in Fig. 15, will outwear six plain cast iron shoes of ordinary hardness.

FLEXIBLE METALLIC JOINTS.

It has long been customary to convey steam and air by rubber hose when flexibility of construction has been required. In regard thereto it should also be stated that such hose has been perfected in quality to a very great extent. However, the combined effects of the pressure within and the weather without ultimately require its renewal, and the length of time during which it may safely be used is very indeterminate.

With the advent of the air brake on all classes of trains, and steam heating on passenger trains, came a demand for some flexible metallic joint or coupling to be used between the vehicles.

While the air brake train-pipe has normally a greater pressure than the train steam heating pipe, the latter is not only larger but is frequently subject to undue pressures, sometimes approaching the full boiler pressure carried on the locomotive; this might be caused from improperly closing valves near the head end of the train, or more usually from defective pressure regulators on the locomotive. Then, too, more danger and delay are attendant upon the bursting of a steam hose than that of an air hose.

Considerable difficulty has been experienced in designing a satisfactory flexible coupling for all purposes, that should of necessity be easy of coupling and uncoupling. Inasmuch as the locomotive and tender require to be less frequently disconnected than

other parts of the train, it is but natural that a satisfactory metallic connection between these should have first been put into extensive practice.

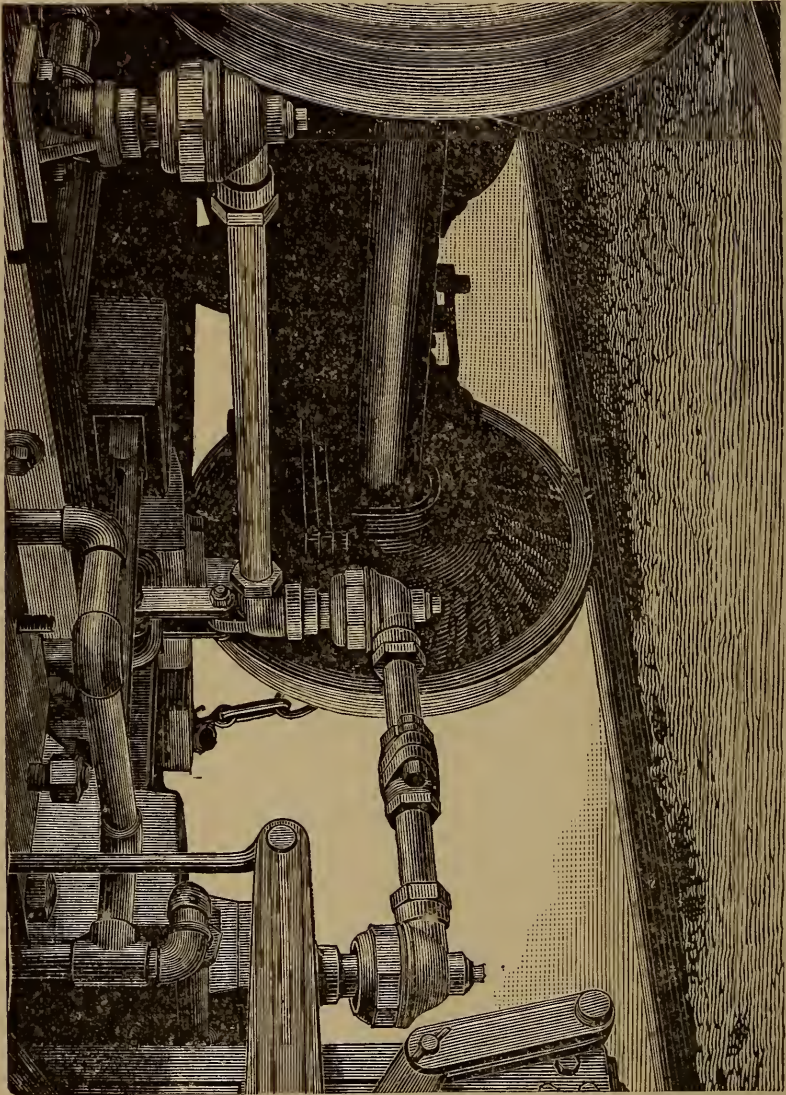

FIG. 1.
Moran Flexible Joint.

Although a large number of such devices have been used locally on various railways, it will be the inten-

tion to here describe only those which have been used extensively in all parts of the country.

THE MORAN FLEXIBLE JOINT.

Fig. 1 clearly illustrates the application of this joint for steam heating connection between engine and tender. It will be noticed that, to give the best results, all three joints should stand square with the piping when the engine is on a straight track.

By reference to Fig. 2, which shows a sectional view of one of the three joints, the arrangement of the automatic relief trap may be clearly seen. It consists of a small steel ball held off from its seat by a spring whose tension is only sufficient to withstand about 15 pounds per square inch. Hence as soon as the pressure exceeds this amount the ball seats and prevents all escape of steam or water. However, when the steam is shut off and the pressure drops below 15 pounds, the automatic drip is opened and all condensation escapes. This automatic action of the traps will thus effectually prevent all freezing and bursting of pipes under engine and tender providing the piping is properly done, that is, sloped from each way toward these joints in order that they may be at the lowest point and consequently drain off all water of condensation.

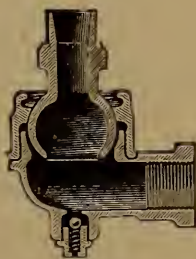

FIG. 2.
Sectional View Moran
Flexible Joint.

These joints require no care and attention as long as they have steam for lubrication, but in warm weather when not in use and sand and grit works into the joints, it is most advisable to either constantly

keep a slight pressure of steam on them by closing the cock at the back of the tank or else to remove the joint from the locomotive until cold weather.

The former practice is that advised by the manufacturer.

Fig. 3 shows this same metallic coupling as made for connecting steam piping between cars or between



FIG. 3.

Metallic Coupling for Steam Piping.

the rear of the tender and the train. Should the train break in two, the chains automatically disengage the steam coupling without damage thereto.

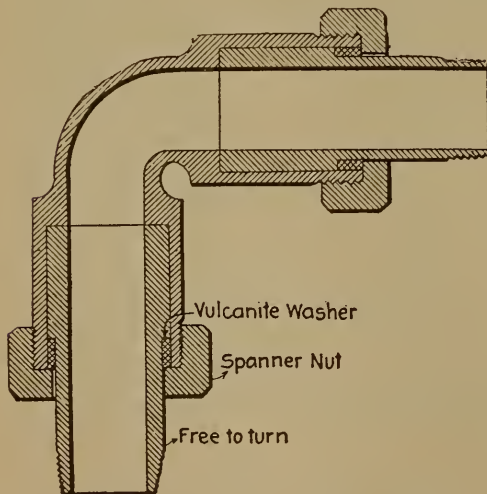

FIG. 1. Section of Swivel Joint.

McLAUGHLIN'S
FLEXIBLE
METALLIC
CONDUIT.

For conveying steam or air between locomotive and tender.

The joints in the pipe are made by swiveling elbows.

A nipple, with an enlarged end, is inserted in the bore of the elbow, and is free to turn therein, but is held in place by a cup nut, against which the shoulder, or enlargement of the elbow, bears. A ring of vulcanized rubber is inserted between these surfaces to make a tight joint and to provide for taking up wear.

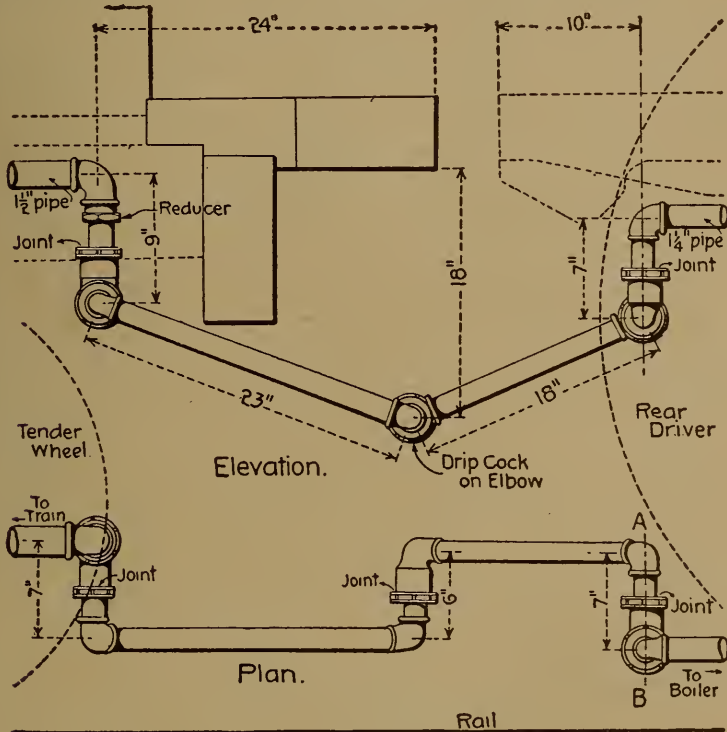

FIG. 2.
Plan and Elevation of Steam Heat Conduit as applied between Locomotive and Tender.

While adapted to and used for a large number of purposes requiring flexible connections, the most severe test has been made in connecting locomotives and tenders for steam heating. In this exacting service the arrangement has given excellent satisfaction for a period of three years. It wears well and does not leak. The construction is shown in the engravings.

Any couplings used by any railroad can be used with the joint the same as if it were hose.

This conduit has been adopted by a number of the large railway systems of the country.

CLIMAX FLEXIBLE METALLIC JOINT.

Fig. 1 shows the general construction and arrangement with a pet cock at the lowest point of the coupling for drainage of all water when not in use. There is a double or universal joint at each side and a single or swivel joint in the center.

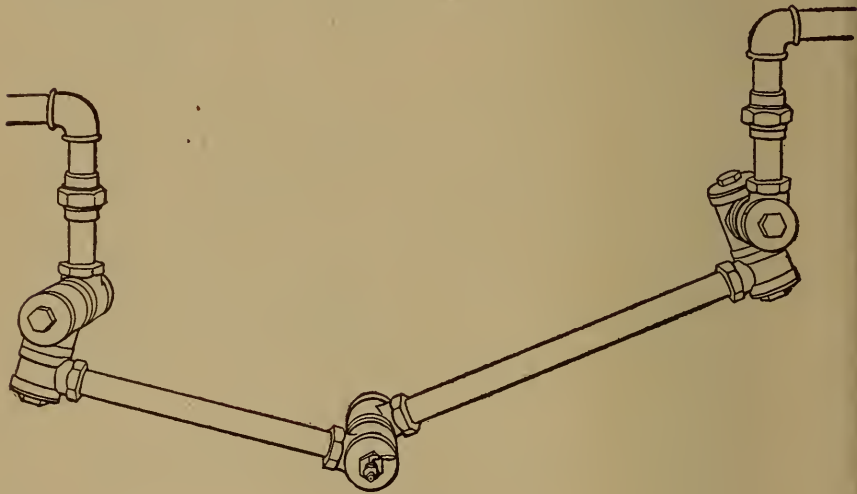

FIG. 1.
Climax Flexible Metallic Joint.

Fig. 2 shows a sectional view of one of the universal joints. They are made entirely of steam metal, and the two glands (*G-G*) are each surrounded by three Jenkins discs screwed down to a joint by the nuts (*E-E*). These nuts have holes in their faces to per-

mit their removal whenever the discs require renewal. To do this the caps (*C-C*) may be taken off.

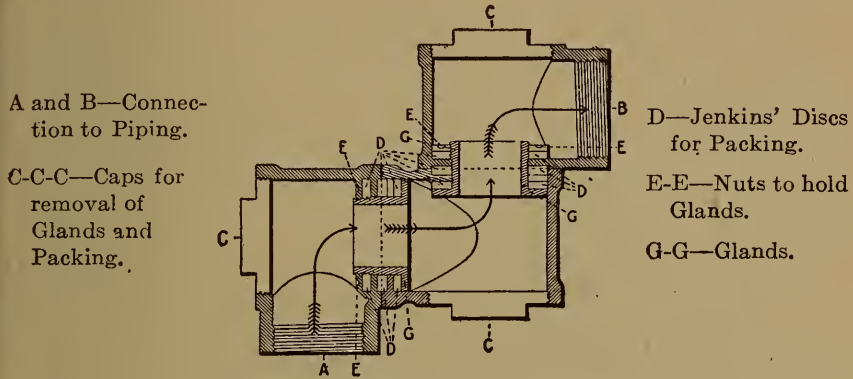

FIG. 2.

Climax Flexible Metallic Joint—Double Joint.

The center swivel joint shown in Fig. 1 has a single gland and set of packing similar to those shown in Fig. 2.

PRESSURE GAUGES.

The first devices for indicating the varying changes of pressure were extremely crude, although the absolute standard is and always has been the weight of mercury (quicksilver) expressed in pounds pressure per square inch.

One of the first pressure gauges used was a simple "U"-shaped glass tube partly filled with mercury; the pressure admitted to one side lowering the level in that side and raising it in the other. The difference between the two levels determined the pressure—2 1/32 inches (approximately) being equal to one pound per square inch at a temperature of 60 degrees Fahr.

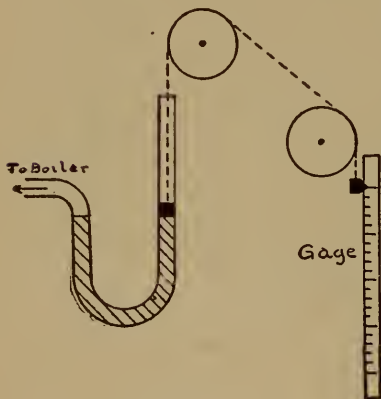

FIG. A.
Mercury Column and Gauge.

When it was not convenient to graduate directly upon the glass tube, recourse was had to a metal tube with a float and independent scale in some convenient location. The engraving Fig. A shows such a U-shaped tube with float transferring the indications to a scale by means of a cord over pulleys.

While the mercury gauge has been greatly perfected it is, as before stated, still the standard gauge to this day. The most accurate test is a perpendicular iron tube, immersed in a sealed pot of mercury at its

base and running high in the air (see Fig. 1). The pressure from the test pump is applied to the surface of

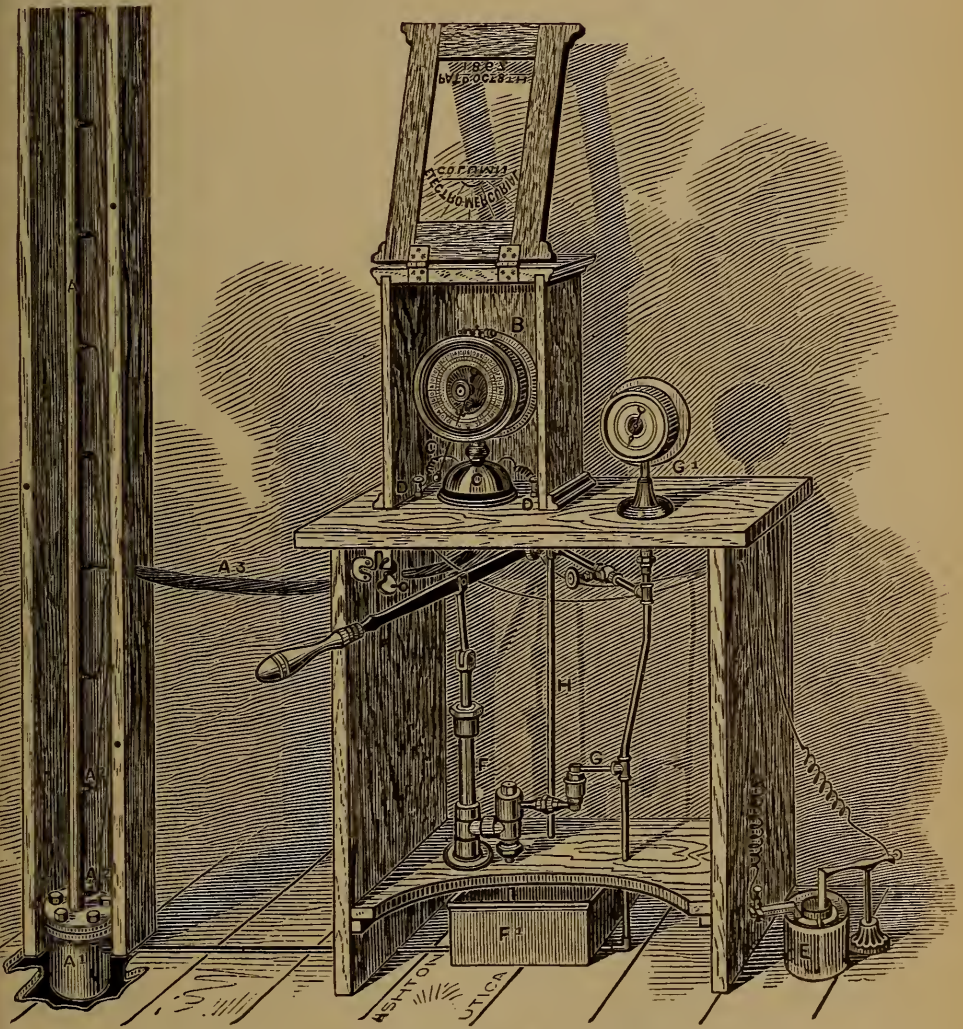

FIG. 1.
Electro-Mercurial Gauge Tester.

the mercury and causes the latter to rise in the tube to a height proportionate to the pressure applied. At

each point of graduation on the tube, an insulated platinum wire point is inserted and connected with an electrical register. By means of battery connections to the mercury and to each platinum point, when the two come in contact at each graduation, the electrical register is formed.

Although the sealed tube was allowed on higher pressures, yet as late as 1843 the French government required the open tube to be used for engines under sixty pounds and steamboats under thirty pounds pressure per square inch.

On account of its defects and disadvantages for ordinary pressure measurement, the tube of mercury gradually gave way to gauges of mechanical construction, more suitable for practical use. The designs and modifications of such mechanical gauges are now quite numerous, but for years there were two principal types, viz.: the "Bourdon" tube and the "diaphragm."

The single spring Bourdon gauge as shown in Fig. 2, is dependent for its action upon the fact that pressure admitted to a bent tube has a tendency to straighten it; however, it was found to be open to objection from two main causes—(1) The end of the tube, after passing the top center, became a pocket for water of condensation, and hence became liable to damage by frost. (2) As the tube was long and sensitive to motion, it was found not

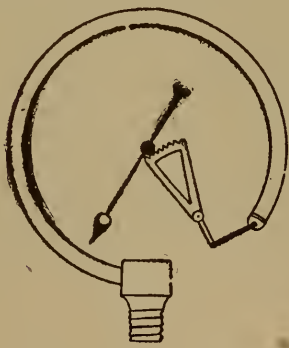

FIG. 2.

Single Bourdon Spring Gauge.

accurate on a locomotive, or any moving machinery, as the jolt and jar kept the pointer in such a constant vibration as to prevent a correct reading of the pressure being obtained.

Each improvement upon this single Bourdon tube gauge consisted mainly in cutting off a piece of the tube, until finally the tube did not pass the top center. The vibration and pocket features were thus overcome, but at a sacrifice of the motion of the spring. This finally resulted in the introduction of the double

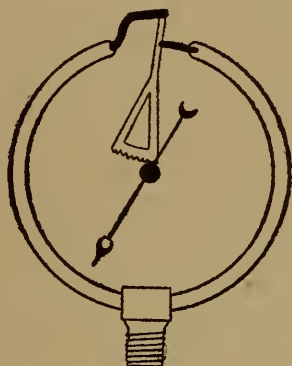

FIG. 3.
Double Bourdon Spring Gauge.

Bourdon tube gauge, which is shown in Fig. 3. This was found to be more satisfactory and free from the two former prime objections to the Bourdon tube. The principle of this double Bourdon tube is the same as of the single tube style, and this principle can readily be understood by noticing the tendency of a coil of hose to straighten out when pressure is admitted within it.

The other type referred to is the diaphragm gauge, invented in about the year 1849. One of the earlier

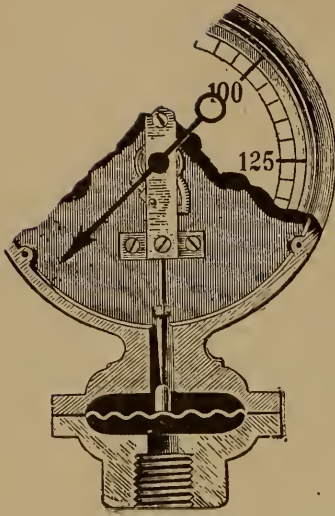

FIG. 4.
Early Form of Diaphragm
Gauge.

forms of this gauge is shown in Fig. 4, having the diaphragm located in a compartment below the gauge. The objection to this gauge, as originally designed, was in the use of the flat diaphragm fastened rigidly at the circumference. It was impossible to make allowance for the drawing in toward the center when pressure was applied. The diaphragm made of a corrugated plate has finally been used to reduce this tendency.

Fig. 5 clearly illustrates another and different form of diaphragm gauge. In this gauge there were several corrugations on one side and none on the other; the pointer was fastened perpendicularly, as shown, at the center of the diaphragm. Thus the extra movement on the corrugated side, produced by the applied pressure, moved the pointer or hand of this gauge along the graduations.

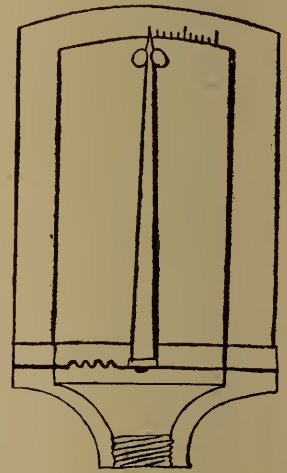

FIG. 5.
Early Form of Diaphragm
Gauge.

Siphons and Siphon Cocks.—Wherever a pressure gauge is to be used for steam, siphons are indispensable.

For very small gauges bulb siphons or "traps," three styles of which are shown in

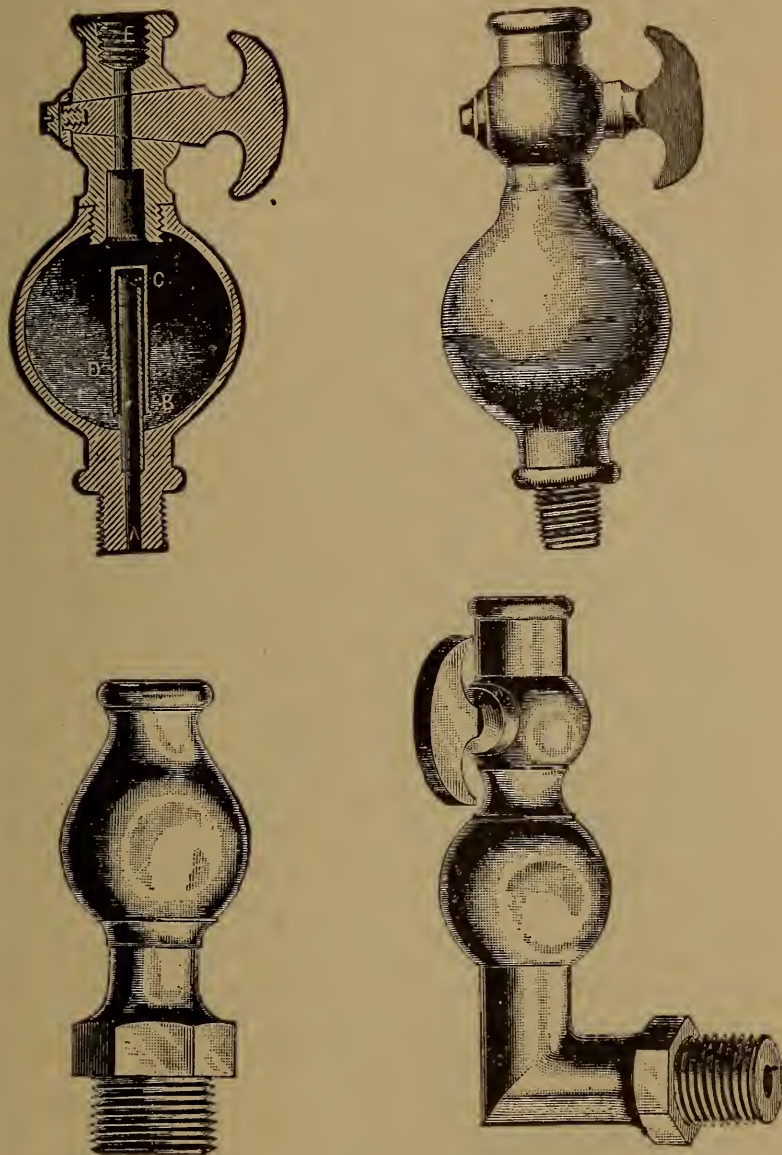

FIG. 6.
Bulb Siphons or Traps.

Fig. 6, are often used, but for larger gauges a pipe siphon, as illustrated in Fig. 7, is used, as it can be made of such size as necessary to hold sufficient water.



FIG. 7.
Coil Pipe
Siphon.

It should be particularly understood by those using pressure gauges of the types hereinafter shown that none of the manufacturers warrant these gauges for steam use unless a siphon is attached that will supply sufficient water to fill the tubes and springs, otherwise they become heated by steam and cannot be depended upon for accurate indications of pressure.

The principle of the siphon is readily understood by reference to steam heating pipes in any house, or in the pits of a roundhouse, with which all are familiar. It is well known that pipes gradually sloping will permit steam to pass throughout their length, but that when there is a low place anywhere the water will settle at that point and remain unless there is an outlet beyond through which the steam pressure behind can force the water. These siphon pipes are used to form such traps for steam gauges, and it should be borne in mind that any leak, no matter how slight, between the siphon and gauge, will permit the steam to force the water out and itself enter the gauge.

All gauges used on a locomotive, whether to indicate steam or air pressures, should be placed as far from the boiler as possible, and, while rigidly secured to prevent vibration, they should be mounted on brackets insulated as well as may be from the heat radiating from the boiler or by conduction through the bracket. To minimize this conducted heat,

gauges should preferably be fastened to wooden blocks, and the latter to the boiler gauge bracket itself.

CROSBY LOCOMOTIVE PRESSURE GAUGE.

This gauge has the double Bourdon tube springs, as shown in the engraving, Fig. 9. The tube springs are connected at each end with their respective parts by screw threads without the use of any soldering material whatever, thus insuring tight joints under extreme conditions of heat and pressure. The lever



FIG. 8.



FIG. 9.

Crosby Locomotive Pressure Gauge.

mechanism, which transmits the free movements of these Bourdon tube springs to the index, has been designed with great care, and so that it may be easily renewed in case of repairs.

These gauges for locomotive use are graduated to any pressure not exceeding five hundred pounds per square inch.

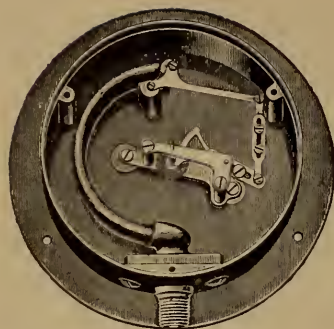

FIG. 10.
Crosby Single Tube Gauge.

Fig. 10 shows the internal arrangement of a single Bourdon tube spring Crosby gauge. This gauge is designed to meet the demand for a cheaper gauge than the more accurate double tube form before illustrated.

The thermostatic water back gauge shown with single and double Bourdon tube springs in Figs. 11 and 12, is particularly adapted for use on high-pressure locomotives, especially compound locomotives, which frequently carry a boiler pressure of two hundred pounds, or over.

It is well known that when a steam gauge in use, on account of its location, is heated to a temperature of 100° Fahr., and upwards, that there is an expansion of its parts, due to the heat, to such an extent that it will be erroneous in measuring the pressure which it should record. In such cases the parts which materially affect the correct operation of the gauge are the tube springs. It occurs thus: The tube springs having been tested and adjusted to a certain movement under pressure in the ordinary temperature of the factory, or where it takes place, will when the same are heated in use to a high temperature lengthen by expansion to such an extent that, when they are subjected to the same pressure, their free ends will move through a larger arc than when they were tested. This movement multiplied by the ordinary mechanism of a steam gauge for transmitting it, causes this increased pressure to appear upon the dial. In such

a heated condition of the tube springs, the error produced is sometimes considerable, being several per cent. greater than the true pressure, thus deceiving the user of steam into the belief that he is getting a less result, in work, from the indicated pressure than he ought. This error can be corrected by suitable mechanism in the steam gauge. Such an one, it is claimed, is internally shown by Figs. 11 and 12. In the ordinary steam gauge, the bar which transmits the movement of the free ends of its tube springs is



FIG. 11.



FIG. 12.

Single Bourdon Tube Spring.

Double Bourdon Tube Springs.

Crosby Thermostatic Water-Back Gauges.

made of a homogeneous metal, and when the tube springs are affected under heat as above stated, it transmits the increased movement just in the same way that it would transmit the intended or designed movement when the tube springs are cold. Thus the error arises. In the improved gauge above shown, this bar is made of brass and steel brazed together, forming a thermal bar, so that, under the influence of high temperatures, it will compensate for the expansion or lengthening of the tube springs and their greater movement thereby under pressure, by retarding

simultaneously the motion of the index which records such movement on the dial. The action of this thermal bar is, that its end remote from that where it is attached to the tube springs will droop, or deflect, or move oppositely to the tube springs on account of the action of the temperature upon the two metals composing it, as is commonly understood. This opposite movement retards the index proportionately to the lengthening of the tube springs, as they are both influenced by the same temperature, and thus compels it to keep back to the notation of pressure on the dial where it correctly should be.

In addition to this thermal bar, this gauge has a chamber, so constructed that when filled with water or other liquid it not only supplies the Bourdon tube springs, connected to it with all that is required, but serves to equalize the temperature about them. This is important. For unless the tube springs are subjected to a heat greater than 212° Fahr., they do not set when in use; and as it is impossible, as made, under ordinary conditions of use, for heat to be transmitted by conduction to such an extent, they are secure from this danger.

This chamber is located in the gauge case so that it has its connection to it and with the boiler at the bottom. Attached to it are the tube springs, the index mechanism, and the dial, the latter upon the bosses; and all are independent of the case and are free from any influence of it under heat, excepting at its immediate point of attachment, which is unimportant.

The chamber of this gauge is filled with a liquid which is not seriously affected by exposure to cold, nor is it injurious to the operation of the gauge. Upon

the removal of the cork which is inserted in the inlet of the gauge connection to prevent leakage during transportation, it may be attached to the boiler in the usual manner without a siphon or other device for furnishing water to it.

Should it become necessary again to fill the chamber with water or other liquid, remove the small screw located in the case by the side of the gauge connection, to provide a free course from the inlet in the gauge connection, around through the chamber and tube springs to the open air. Then, holding the gauge so that the inlet will be uppermost, pour the liquid used into it, occasionally shaking and turning it to expel the air and assist the flow of the liquid into all parts of the chamber and tube springs. When they have received about two fluid ounces of the liquid, and it appears at the aperture of the screw removed, they will then be filled. Close this aperture tightly with the screw and the gauge will be ready for use.

THE LANE PRESSURE GAUGE.

This gauge is shown by Fig. 13. The improvement in this gauge consists of a bent lever provided with an adjustable link at its head, to which one of the tube springs is attached, the other tube spring being directly connected with this lever. By this plan the movements of the lever and rack, relatively to the two tube springs, can be more readily and perfectly adjusted than by any other method in use in this style of gauge.



FIG. 13.
Lane Pressure Gauge.

STAR GAUGES.

In designing a spring tube that will not retain any permanent set after repeated bending back and forth with varying pressure, the manufacturers of this gauge make use of a corrugated tube, as shown in the accompanying engraving. These makers also lay special stress upon the point that they have for many years manufactured a non-corrosive movement in their gauges, thus avoiding the injurious results of smoke and gases.



FIG. 13-A.

Star Corrugated Spring.

STAR NON-CORROSIVE AND NON-SETTING
LOCOMOTIVE STEAM GAUGES.

Two styles of these gauges are illustrated by Figs. 14 and 15. The former (the standard) known as the double spring Bourdon type and Fig. 15 shows the double spring Lane type.

Each style of gauge is fitted with their non-corrosive movement and corrugated spring tubes.

It is a well known fact that in all branches of mechanical engineering where lightness, rigidity and

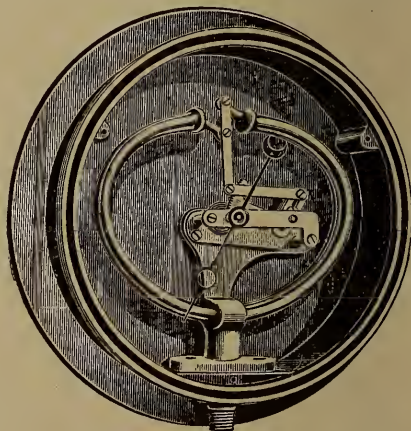

FIG. 14.

Star Double-Spring Gauge—Bourdon Style.

strength are required, corrugation is adopted where practicable, in order to give the necessary stiffness without increasing the weight. Hence it is claimed that the corrugated spring tube is superior to the plain forms. These gauges are fitted with hair springs to take up all lost motion, after the approved practice of all accurate pressure gauges.



FIG. 15.
Star Double-Spring Gauge—Lane Style.

THE ASHCROFT GAUGES.

These gauges have non-corrosive movements and are constructed of Bourdon springs of seamless drawn tubing.



FIG. 16.
Ashcroft Single Bourdon-Spring Steam Gauge.

Fig. 16 shows the interior mechanism of the single Bourdon spring steam gauge, and Fig. 17 the same of the double Bourdon spring gauge with the addition of the Lane improvement in attachment of springs to movement as referred to hereinbefore.



FIG. 17.
Ashcroft Double Bourdon-Spring Steam Gauge, with Lane's Improvement.

In order to provide a gauge that should be accurate, durable and exempt from the annoyance of permanent set of the Bourdon

springs, these manufacturers provide a locomotive steam gauge having an auxiliary spring, as shown



FIG. 18.
Ashcroft Auxiliary Spring
Locomotive Steam Gauge.

in Fig. 18. The auxiliary spring feature consists of an independent co-operating spiral spring (A) applied to the free end of the single Bourdon tube, which dispenses with the necessity of a second tube, and reduces the number of joints subjected to wear and friction between the tube and the segment of the

recording movement to two. The Bourdon tube, it should be noticed, is short enough to drain itself and thus prevent damage by freezing.

Figs. 19 and 20 illustrate the Ashcroft double spring standard locomotive gauge, the internal arrangement being clearly shown.



FIG. 19.
Ashcroft Double-Spring Standard Locomotive Gauge.



FIG. 20.

THE UTICA GAUGE.

In construction, this gauge differs from those previously described chiefly in its spring, which is, of course, the essential part of any gauge, as all movements of good gauges are constructed with great care.

The "capsular" spring is the style of spring employed

and is made in two sizes for large and small gauges, as shown in Figs. 21 and 22. It consists of a spring



FIG. 21.
Utica Capsular Spring.



FIG. 22.
Utica Capsular Spring.

box, capsular in form, with the circumferences of the two heads (A A) flanged and locked together (in the larger form) in an elastic band (B) at a point above and below the spring heads themselves. This fastening thus acts as a hinge joint. It should be noticed that this Utica spring has two heads, while the old style diaphragm spring, as described in the introductory remarks on gauges, has but one. Thus, the former gives double the motion for the same movement of the spring. Inasmuch as the manufacturers agree to replace any steam gauge which shows a cracked spring-head, it need scarcely be said that great care is taken in the selection of metal and in the making of these springs.

Fig. 23 shows a Utica locomotive steam gauge partially sectioned in order to illustrate its internal

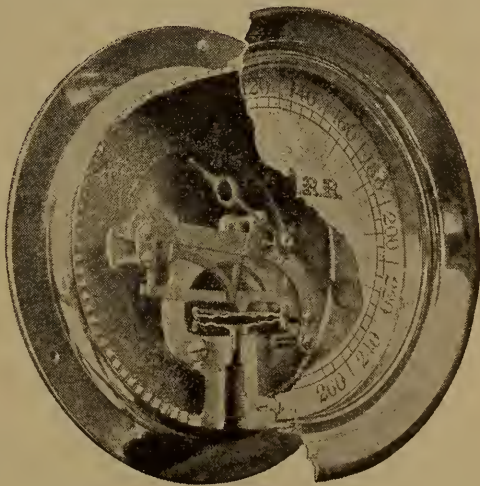

FIG. 23.
Utica Locomotive Steam Gauge.

mechanism. A bell crank bears against the top of the upper spring head. The pressure within the spring causes the heads to bulge and bear against this crank, which is joined by means of light lever connections with the pointer, thus indicating the pressure.

THE DUPLEX AIR BRAKE GAUGE.

The Air Brake Gauge is an essential part of the automatic brake system. It records two pressures, namely, that in the main reservoir and that in the train line. It will be noted that the hands indicating these pressures are of different colors, that for the reservoir pressure being red and that for the train line pressure black. The difference between these two pressures is the excess pressure in the reservoir over that in the train line, and it is important that this excess should always be at least twenty or twenty-five pounds. The location of the air gauge on the locomotive is shown in the plate "The American Steam Locomotive," part numbered 207.*

The duplex air brake gauge is usually so designed and constructed that each spring, while acting entirely independent, registers its movement through its own index hand upon the same circle of figures. These air brake gauges are subject to such wide and rapid variations that their construction must be of the very best.

* The Air Gauge is described and illustrated in "The Science of Railways," in connection with the exposition therein of the Air Brake, and the reader is referred to the general index of that work for reference to further information on the subject.

The standard "Westinghouse" type of duplex air gauge, as manufactured by the Ashcroft Manufacturing Company, is shown in Figs. 24 and 25. From the



FIG. 24.



FIG. 25.
Sectional View.

Westinghouse Duplex Air Gauge.

latter figure it will be seen that each pointer or gauge hand is acted upon independently of the other pointer by double Bourdon tube springs.

A later style of duplex air gauge, called the "Sema-



FIG. 26.

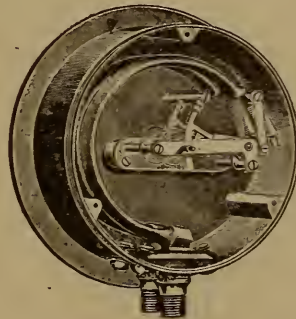

FIG. 27.
Sectional View.

Semaphore Duplex Air Gauge.

phore" gauge, is shown in Figs. 26 and 27. The points of difference in this gauge are the use of single Bourdon springs with auxiliary springs (as described

more fully under Steam Gauges) and the black dial with white figures so arranged that their positions for the three pressures, fifty, seventy and ninety pounds per square inch (the most important pressures to the engineer for operating the air brake) enable him to instantly and accurately observe the variations of pressures in his air brake system; for the two extreme pressures of fifty and ninety always stand at right angles with the seventy pounds pressure point which is at the top of the dial. On this dial a much wider space is allowed for each five pounds pressure, so as to insure closer and more accurate reductions in train braking. The glass over the dial is an oval crystal like a watch, and while the case does not extend in front of the glass as usual to afford protection from breakage, yet this arrangement enables the engineer to read the gauge when it stands at a considerable angle to him.



FIG. 28.



FIG. 29.

Crosby Duplex Air Gauge.

The interior mechanism of the Crosby duplex air gauge is clearly shown in Figs. 28 and 29. These cuts show the double attachments of this gauge so

located that in Fig. 28 the two pressures are connected to the gauge nipples, one before the other, in a line with the center of the gauge, while in Fig. 29 these connections are one at each side of the center of the gauge. The words "train line" or "reservoir" are stamped on the gauge nipples so that they can be distinguished in connecting pipes to the gauges.

The dial of this gauge is the same as that shown in Fig. 24.

The Star duplex air gauge differs from the gauges last described mainly in the use of corrugated Bourdon springs, as shown in Fig. 13-A.

A very useful gauge for assistance to Air Brake Inspectors or others testing the air pressure carried by a locomotive, is shown in Fig. 30.

By means of the adjustable thumb screw at the bottom this gauge may be applied to either the train line or air signal hose on the rear of an engine or train.

The exception above noted to the usual form of dial where both hands indicate their pressures from the same

figures is the Utica form of duplex air gauge, as shown in Figs. 31 and 32.

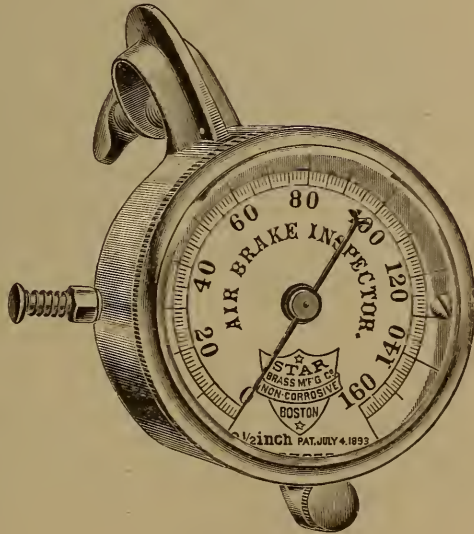

FIG. 30.

Star Air Brake Inspectors' Gauge.



FIG. 31.
Utica Duplex Air Gauge.

It is virtually two gauges in one, as but half of the dial is used for train-line pressure and the other half for main reservoir pressure.



FIG. 32.
Utica Duplex Air Gauge.

The interior of this gauge may be seen from Fig. 32 to consist of two "capsular" springs, each actuating its own pointer.

PRESSURE RECORDING GAUGES.

In order to have a graphic record showing every variation of pressure and the time of day or night, the pressure recording gauge is sometimes applied to a locomotive. While it is usually used to record the steam pressure, the more recent introduction of the recorder for the air brake train-line pressure is liable to institute a greater use for this latter purpose.



FIG. 33.
Pressure Recording Gauge:



FIG. 34.
Star Pressure Recording Gauge.

Both the Crosby and the Star pressure recording gauges are similar in appearance, hence Fig. 33 will indicate the external appearance of either one. Fig. 34 shows a Star recording gauge that has an ordinary gauge dial and pointer outside of the recording disc. In all these gauges, by the aid of suitable mechanism, not shown, the pressure which is to be recorded is brought to bear upon the lever (seen on the left hand side of the cut) in such a way as to move it away from or toward the center, according as the pressure is increased or reduced in the boiler or train brake pipe.

At the end of this lever is carried a pen charged with

red ink, and the point of this pen rests lightly upon the paper chart which has curved radial lines coinciding with the pressure movements of the point of the pen, were the paper chart itself held stationary. The circular lines on the chart serve as graduations to mark the degree of pressure, and are numbered by four columns of figures. The paper charts shown in Figs. 33 and 34 are designed to be rotated once every twenty-four hours by a clock movement of great accuracy.

Thus it will be seen that with the chart steadily rotating any variation of pressure will cause the pen to move across the line of movement of the chart, producing a more or less zig-zag red line, and thus recording accurately the pressure at the exact time of day or night that it occurred.

The chart must be set right according to the time of day before the thumb screw in the center is tightened. The reading of the two charts here shown in Figs. 33 and 34 is the same and would be 110 pounds pressure at 6:30 o'clock A. M.

The Crosby Air Brake Recording Gauge is of the same construction and has the same appearance as that used for steam, as shown in Fig. 33, except that it is graduated for five pounds to each circular line and the highest pressure shown is ninety pounds.

It is well known that in the use and operation of air brakes there exist certain negative conditions, which, as a whole, tend to reduce their efficiency, and are thereby opposed to safety and economy. Very great importance, we believe, is attached to carrying a standard pressure—no more nor less—at all times; that the brakes are in perfect working order; and,

above all, that proper discretion is exercised in their manipulation, otherwise the power of the brakes is either over or under developed. The former is conducive to delay, waste of fuel, overheating and cracking of wheels and wheel flattening; the latter to loss of control, from which arises the gravest and most serious of possibilities—that of accident. That it is important and desirable that these conditions should be overcome, every one, we think, will admit; but that it may be done, it is first necessary to know where and how they exist. This information may be obtained by using an air brake recording gauge, an instrument designed for continuously recording the pressure of air used in the operation of air brakes.

In using these recording gauges for indicating steam pressure the same care, as heretofore explained, should be exercised to prevent live steam from entering and heating the gauge.

GAUGE HAND OR "POINTER" PULLERS.

Three styles of hand or pointer pullers are shown in Figs. 35, 36 and 37, either one of which is a very

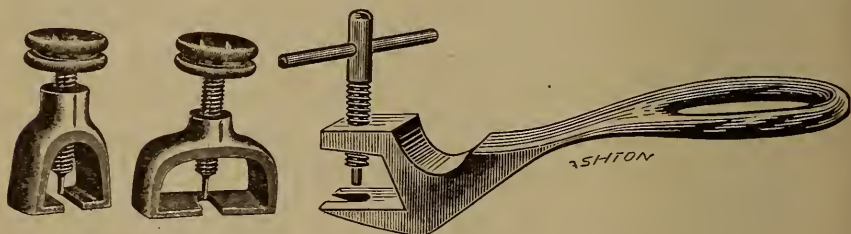

FIG. 35. FIG. 36.
Gauge Hand or "Pointer"
Pullers.

FIG. 37.
Gauge Hand or "Pointer" Pullers.

handy tool for use in removing gauge hands with the least liability of damage to either the gauge, movement, or the hands themselves.

TESTING GAUGES.

Engineers and firemen depend almost entirely upon the steam and air gauges to know the pressure under which the locomotive in their charge is working, and yet they are fully aware that these gauges do many times get out of order. Knowing full well that the locomotive is not pulling what it should, they report the gauge out of order.

When the engine arrives at the terminus, the practice too frequently is to remove the gauge from the engine, take it to the shops and have it tested, that is, tried in comparison with an accurate gauge, known to be correct, which gauge is called a test gauge.

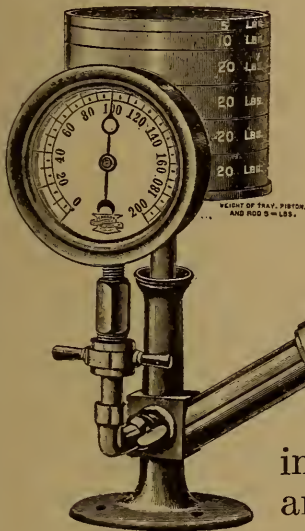

FIG. 38.
Crosby Test Gauge.

Three of such testing devices are shown in Figs. 38, 39, 40 and 41, which are known as the Crosby, Ashcroft, and Star, respectively, and will be described hereafter.

There is no question but that this test will determine if the gauge itself is defective at the time and under the existing temperature of the testing room, but it does not by any means follow that this same gauge will correctly indicate the pressure when placed in the cab of a locomotive. At the beginning of this chapter the instructions regarding proper piping, insulation and location of gauges were called to the attention of the

reader, but these precautions are not always observed even by designers and builders who make the finest locomotives and equip them with the most modern devices.

It is possible, owing to the location of a gauge, to have it in error from one to twenty pounds (and even more, in extreme cases) and yet have the gauge

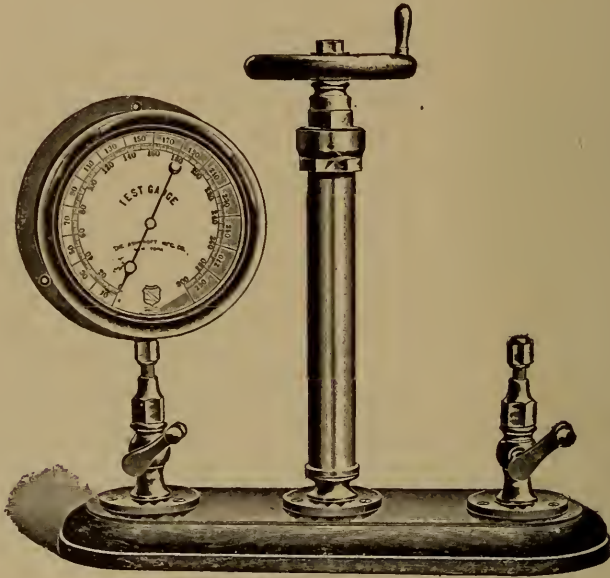

FIG. 39.
Ashcroft Test Gauge.

show correct every time it is removed and tested. All gauges are adjusted cold and the fine mechanism therein will correctly indicate pressures when all parts are at this moderate temperature. Almost all metals weaken as their temperature becomes higher. Hence the springs in the gauges will have a greater deflection than normal when heated above a moderate temperature, and will thus indicate a greater pressure

than that actually existing in the boiler or other receptacle to which they are attached.

For the reasons hereinbefore given, it is strongly advocated by those with extended experience in such matters that it is much better to allow the gauge to be tested to remain upon the locomotive, in its usual location. If the steam gauge is to be verified, attach an accurate test gauge with a large siphon pipe (as shown in Fig. 7) to some convenient connection at the steam dome and compare the readings of this test gauge with that of the gauge in the locomotive cab, manip-

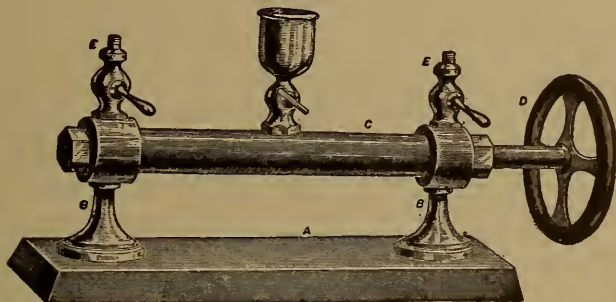

FIG. 40.
Star Test Gauge.

ulating the fire and injectors sufficiently to cause the pressure to pass through the ordinary variations that exist in service. Incidentally, there is considerable of an advantage aside from the time it saves and the accuracy thereby secured in not removing the gauge, in that no couplings or connections are disturbed, and hence no leaks produced; for leaks anywhere above the gauge siphon are very injurious to a steam gauge.

To test the air gauge, couple an ordinary gauge which is known to be accurate, or the gauge shown

in Fig. 30, to the train brake hose at the rear of the tender, or some convenient but cool place in the cab; cause the pressure to vary through its usual range, and compare the attached gauge with the one located on the boiler head.

Steam gauges on a locomotive sometimes show less pressure than that actually in the boiler, on account of their being attached to the steam turret or fountain instead of deriving their pressure directly from the boiler itself. This difference can readily be detected by noting a sudden drop or rise in the pressure indicated by the gauge when the injectors, air pump, steam-heat, electric headlight, etc., which take steam from the fountain, are suddenly opened or closed, as the case may be.

The Description of Gauge-Testing Devices here illustrated is as follows:

The Crosby Gauge Tester, shown in Fig. 38, consists of a stand from which rises a cylinder having accurately fitted into it a piston with an area of exactly one-fifth of a square inch. This piston moves freely up and down, and has attached to the top of the piston rod a disc for supporting the weights. Each weight is marked with the number of pounds per square inch it will exert on the gauge. From the bottom of the cylinder two tubes project; one forms a stand for holding the gauge to be tested, the other rises at an inclined angle and forms the oil reservoir having within it a screw plunger for forcing the oil inward or outward. Screw down on the plunger until the weights are lifted, and then note the reading of the gauge as compared with the weights, counting the weight of piston, piston rod and tray equal to five

pounds. The piston should be carefully cleaned of all oil and gum after each test.

The Ashcroft Gauge Tester is shown in Fig. 39, and its operation is very similar to that last described, except that instead of known weights being used a

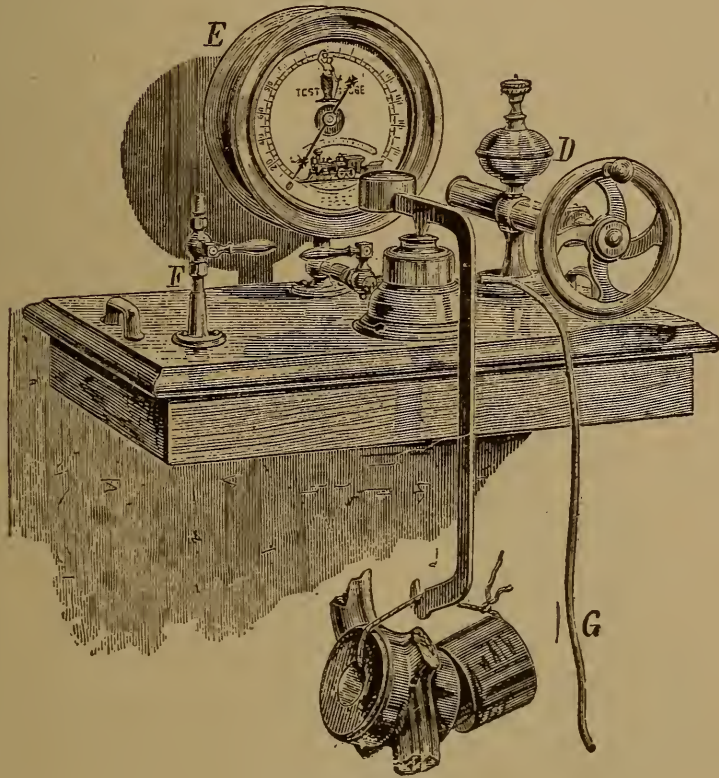

FIG. 41.
Utica Gauge Tester.

test gauge is attached to the nipple to left of the vertical screw plunger, while the gauge to be tested is attached to the nipple on the right. By screwing down the screw-feed the pressure is gradually increased up to the desired limits of the reading of the gauge to be tested.

The Star Gauge Tester, as illustrated in Fig. 40, is used precisely the same as that shown in Fig. 39, but in the cut the test gauge is not shown and the screw plunger is placed horizontally. An accurate test gauge is attached to one of the nipples (*E E*) and the gauge to be tested to the other nipple. Screwing in on the plunger wheel (*D*) increases the pressure of oil to any amount desired.

The Utica Gauge Tester is clearly illustrated by Figs. 41 and 42. The latter engraving shows the

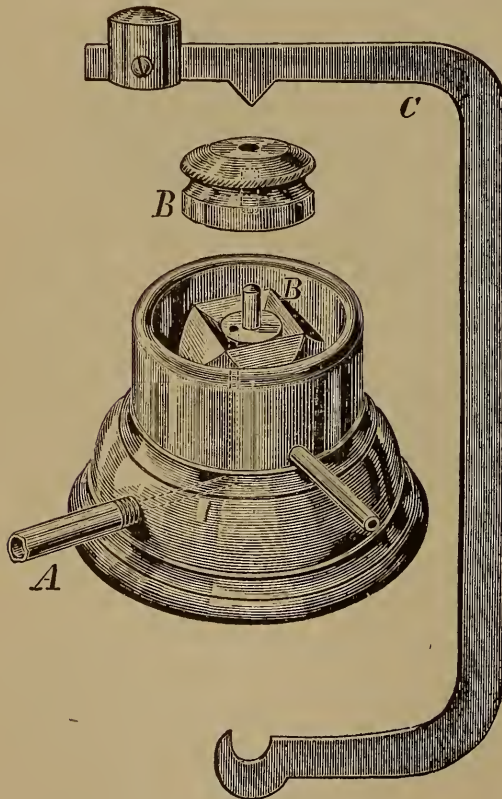

FIG. 42.
The Utica Gauge Tester.

square-inch test valve, which consists of a brass disc provided with a pipe (*A*) to be connected with a plunger (*D*), as in Fig. 41. At *B* is a hardened steel valve and seat, the latter having knife edges for the valve (*B*) to rest upon, and being made exactly one square inch in area. The pipe (*A*) opens directly under the valve, as shown by the dotted lines. Fig. 41 is intended to show the use of this square inch valve in connection with an

ordinary screw plunger (*D*) and a test gauge at *E*. The gauge to be tested is attached at *F*. The pieces of iron attached to the bottom of the yoke, together with the valve and yoke itself, have been previously weighted, so that the valve must lift and the water escape by the overflow pipe (*G*), the moment such known weight is exceeded by the water pressure. The gauge to be tested should then indicate a pressure per square inch equal to the combined weights of the valve, yoke, and weight attached.

LOCOMOTIVE POP SAFETY VALVES.

While there are a great many styles of pop safety valves used on locomotives, only the types especially designed for this use are here described.

The cause of boiler explosions is excessive pressure, and the fact that such disasters are of not infrequent occurrence, whether arising from neglect or otherwise, points forcibly to the necessity of providing against them in every possible way. There are safeguards against the danger of explosion which manufacturers and owners have in their power to use that may be relied upon to largely diminish the danger. The first is in the use of a perfect automatic pop safety valve, absolutely certain in its action, prompt in opening and closing, and fully sufficient in capacity to relieve the boiler from any excessive pressure beyond the amount intended to be carried as a safe limit. For its location see plate "The American Steam Locomotive," part numbered 201.*

While steam gauges may become deranged from improper care or a wrong method of connection to the boiler, the pop safety valve is generally very reliable and its adjustment should never be changed without the proper authority from someone who absolutely knows, from the application of a test gauge, that the valve requires change of adjustment.

* The Safety Valve is described, and another illustration thereof given, in "The Science of Railways," and the reader is referred to the "Description of the Locomotive" given in that work for further particulars in relation thereto.

THE COALE POP SAFETY VALVE AND MUFFLER.

This is a distinct design of safety valve and is largely used. Its form of construction makes it responsive to and restrictive of steam under variable pressures. Though possessed of large discharging power it gives adequate warning before blowing hard, thus enabling the fireman to control his fire or regulate the supply of feed water before strong "popping" occurs. Used on high pressure boilers, it opens and closes gradually, thus preventing excessive strains upon the boiler.

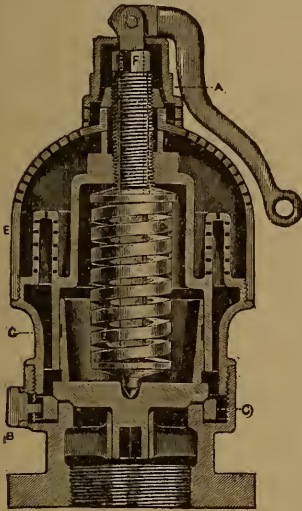

FIG. 1.
The Coale Pop Safety Valve
and Muffler.

By means of the spring bolt and adjustable ring both the points of opening and closing may be changed without removing the valve or reducing the steam in the boiler. The construction of the muffler reduces the noise of the escaping steam to a minimum. This feature frequently prevents the frightening of horses and also the annoying interruptions to telegraph orders at stations, should the locomotive be blowing off.

The valve is guarded above and below the seat; at the latter point by a central sectional hub.

The guide wings are removed as far as possible, to allow for contraction and expansion, and also to prevent grooving of the valve seats by steam passing by the guide wings.

The central sectional guide bearing for the valve stem consists in dividing the ring bearing into arc sections between the arms, in order to overcome the effect of uneven expansion and contraction of metals. By this method the guide bearing insures vertical reciprocation of the valve.

To Adjust the Valve.—If a change of pressure be desired, unscrew the cap (*A*) and screw down or up the adjusting screw (*F*), according to whether more or less pressure is desired. To regulate the opening and closing action of the valve, unscrew the bolt (*B*), and by means of any pointed instrument the adjustable screw ring (*C*) may be readily moved either to the right or left. Should the valve close with too much drop of boiler pressure, move the screw-ring (*C*) to the left, a notch or two at a time, until sufficient change has been accomplished. To increase the pop, move ring (*C*) to the right. After the valve is adjusted to suit the requirements, replace bolt (*B*) and cap (*A*).

To examine the inside of the valve, unscrew the cap (*A*) and spring-bolt (*F*), so as to relieve the spring's tension, remove the set screws, and the dome (*E*) and case (*G*) may then be unscrewed and the internal parts of the valve are exposed.

STAR LOCOMOTIVE POP SAFETY VALVES.

An efficient form of "open" or plain locomotive pop safety valve is shown in Figs. 2 and 3. As will be seen from the latter (the sectional view) the spring is encased in a chamber, thereby being protected from the escaping steam. The spring discs or seats, both top and bottom, are pivoted, in order to overcome all

liability of an imperfect bearing of the spring upon its valve.



FIG. 2.
Exterior View.

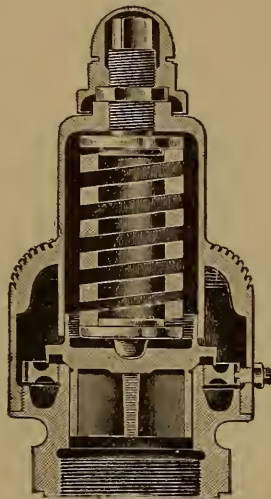

FIG. 3.
Sectional View.

The Star Improved Open or Plain Locomotive Pop Safety Valve.

Figs. 4 and 5 illustrate the muffled Star pop safety valve, which is seen to be similar in construction, with the addition of the top hood, or "muffler," which tends to greatly reduce the noise of the escaping steam, and hence is of considerable advantage. Both the plain and the muffled valves have large relief powers, and are made to withstand the highest pressures used on locomotives. The slotted domes and mufflers have their real aim in preventing dirt and cinders from entering the interior of the valve and clogging its free action. All liability of back pressure on top of valve, which causes continual chattering, is removed.

By removing the small set screw, shown at the right

of both types of valves shown, and turning the ring within to the right or left with a pointed instrument,

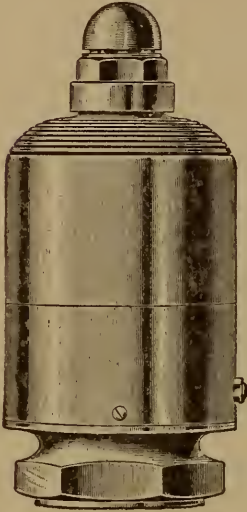

FIG. 4.
Exterior View.

The Star Improved Locomotive Muffled Pop Safety Valve.

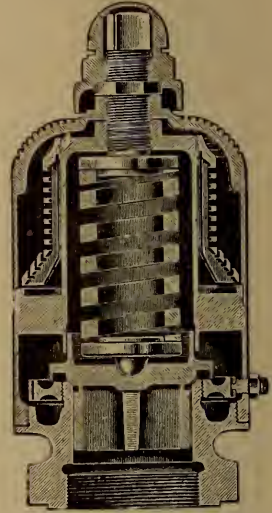

FIG. 5.
Sectional View.

the discharge when the valve "pops" will be greater or less correspondingly.

MEADY MUFFLED LOCOMOTIVE POP SAFETY VALVE.

The cut, Fig. 6, represents the Meady muffled locomotive pop safety valve, showing its internal construction. It will be observed that the valve proper projects upward through the perforated casing of the valve, enclosing within it the spring which holds it to its seat; and the upper or outward side of the valve is open to the air at all times, so that when

the valve is discharging it is free from any pressure of the out-going steam, which escapes through the perforated casing into the open air without a disturbing noise.

By this design there is no back pressure on the valve, and its component parts so co-operate that the valve rises when it opens to a greater height than is usual in valves of this character.

For tension of the spring and the adjustment of the parts, means are conveniently arranged and provided. A lever is furnished when desired. In size and utility it is believed to afford all the advantages which are demanded, and to meet all the requirements of an exacting railroad service.

Directions.—It should never be meddled with unless it becomes necessary to reset it. In such case, first loosen or remove the acorn check nut (*K*) above the spring bolt (*F*); then holding with a wrench the hexagonal top (*B*) of the valve, with another wrench turn the nut (*J*) downward to increase, and upward to reduce the pressure, until the valve opens at the desired point as indicated by the steam gauge. To modify the loss of pressure in blowing, slightly withdraw the screw bolt (*M*) in the base of the valve until it ceases to engage with the ring (*L*) encircling the valve seat (*C*), then with any pointed instrument

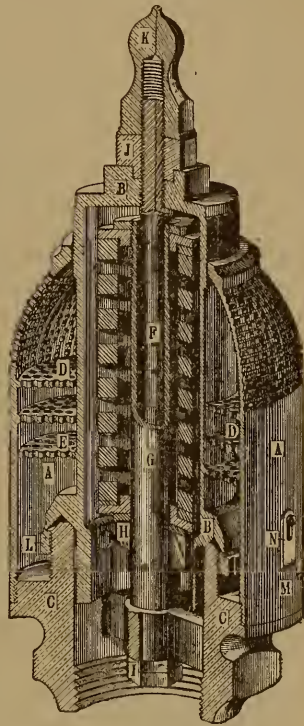

FIG. 6.
Meady Muffled Locomotive
Pop Safety Valve.

inserted into the small opening (*N*) near the screw bolt, turn the ring (*L*) downward for diminishing, and upward for increasing the loss.

CROSBY LOCOMOTIVE POP VALVES.

Fig. 7 shows in section a Crosby plain pop safety valve. The valve proper (*B B*) rests upon two flat annular seats (*V V*) and (*W W*) on the same plane, and is held down against the pressure of steam by the steel spiral spring (*S*). The tension of this spring is increased by screwing down the threaded bolt (*L*) at the top of the cylinder (*K*). The area contained between the seats (*W*) and (*V*) is what the steam pressure acts upon ordinarily to overcome the resistance of the spring. The area contained within the smaller seat (*W W*) is not acted upon until the valve opens.

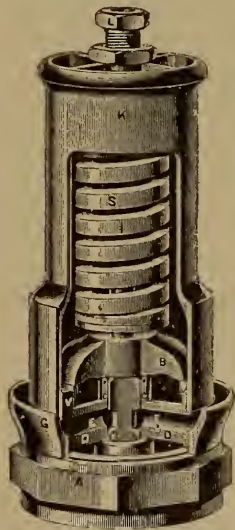

FIG. 7.
Sectional View
Crosby Locomotive Pop
Safety Valve.

The larger seat (*V V*) is formed on the upper edge of the shell or body (*A*) of the valve. The smaller seat (*W W*) is formed on the upper edge of a cylindrical chamber or well (*C C*), which is situated in the center of the shell or body of the valve, and is held in its place by arms (*D D*), radiating horizontally, and connecting it with the body or shell of the valve. These arms have passages (*E E*) for the escape of the steam or other fluid from the well into the air when the valve is open. This well is deepened so as to allow the wings

(*X X*) of the valve proper to project down into it far enough to act as guides, and the flange (*G*) is for the purpose of modifying the size of the passages (*E E*) and for turning upward the steam issuing therefrom.

Action of the valve when working under steam is as follows: When the pressure under the valve is within about one pound of the maximum pressure required, the valve opens slightly, and the steam escapes through the outer seat into the cylinder and thence into the air; the steam also enters through the inner seat into the well, and thence through the passages in the arms to the air. When the pressure in the boiler attains the maximum point, the valve rises higher and steam is admitted into the well faster than it can escape through the passages in the arms, and its pressure rapidly accumulates under the inner seat; this pressure, thus acting upon an additional area, overcomes the increasing resistance of the spring and forces the valve wide open, thereby quickly relieving the boiler. When the pressure within the boiler is lessened the flow of steam into the well also is lessened, and the pressure therein diminishing, the valve gradually settles down; this action continues until the area of the opening into the well is less than the area of the apertures in the arms, and the valve promptly closes.

The point of opening can be readily changed while under steam by screwing the threaded bolt (*L*) up for diminishing, or down for increasing the pressure.

The seats of this valve are flat, and do not cut or wear out and leak so readily as bevelled seats. The valve is made of the best gun metal.

Directions for Setting.—Screw the head-bolt (*L*),

Fig. 7, which compresses the spring, up for diminishing, or down for increasing the pressure until the valve opens at the pressure desired, as indicated by the steam gauge; secure the head-bolt in this position by means of the lock-nut; for regulating the loss of escaping steam, turn the screw ring (*G*) up for increasing, or down for decreasing it.

Directions for Repairing.—This valve having flat seats on the same plane is very easily made tight if it leaks by following these directions, viz.: With an ordinary lathe slightly turn off the two concentric seats of the valve and valve shell or base, respectively, being careful that this is done in the same plane, and perpendicular to the axis of the valve. The valve will then fit tightly on the valve shell. If no lathe is at hand then grind the valve proper on a perfectly flat surface of iron or steel, until its two bearings are exactly on a plane and with good, smooth surfaces; then take the shell and grind its seats in precisely the same manner; rinse both parts in water and put together, and the valve will be found to be tight; to ascertain when the bearings are on the same plane, use a good steel straight edge. Do not grind the valve to its seats on the shell by grinding them together, but grind each part separately, as above stated.

Other types of Crosby plain and muffled pop safety valves are shown in the four next succeeding engravings. Figs. 9 and 11, both sectional views, also show the lever with which these valves are supplied when so desired. It is quite customary to supply a cap which may be locked over adjusting nut (*L*), Fig. 7, so that no one without a key can alter the adjustment of the valves.

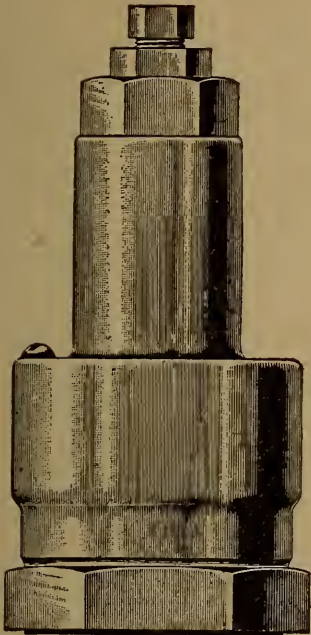

FIG. 8. External View.
Crosby Plain Locomotive Pop Safety Valves.

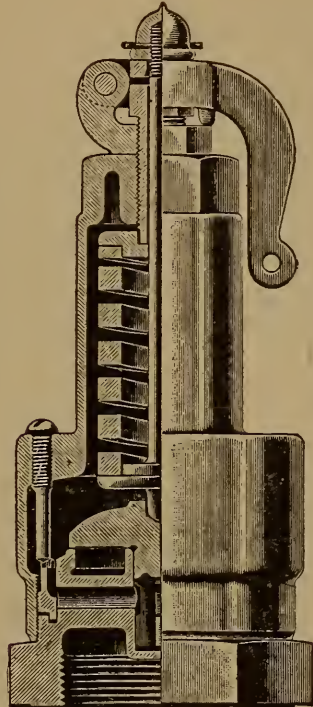

FIG. 9. Sectional View with Lever.
Crosby Plain Locomotive Pop Safety Valves.



FIG. 10. External View.

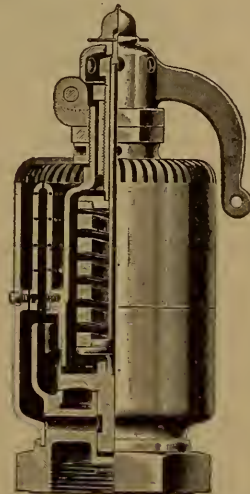

FIG. 11. Sectional View with Lever.
Crosby Muffled Locomotive Pop Safety Valves.

THE CONSOLIDATED LOCOMOTIVE POP SAFETY VALVES.

Figs. 12 and 13 represent two different types of muffled safety valves, made especially for locomotive use. These valves were formerly known as the Richardson pop safety valves.

The advantage to be derived from the use of this muffled valve in place of the ordinary "open" or plain

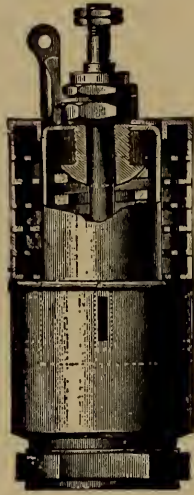

FIG. 12.
Flat Top Muffler Valve
with Lever.

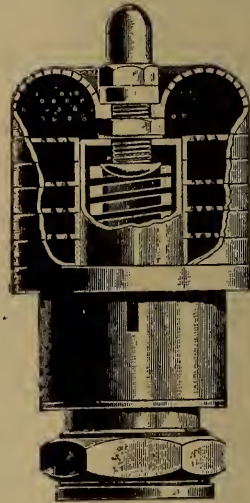

FIG. 13.
Round Top Muffler Valve
without Lever.

pop valve is that the noise of the escaping steam is reduced to the lowest possible minimum; the steam is discharged upwards and with sufficient force to direct the current above the top of the locomotive cab, so that it does not trail on to the engine or in train windows.

The muffler parts are of simple construction and readily replaced from the shops of a railroad company at small cost.

Fig. 14 shows the Consolidated plain pop safety valve for locomotives. This valve is identical in construction and operation with that just described, excepting that it is not equipped with a muffler. On some roads it has been found an economy to equip each engine with one encased and one muffler valve; when this is done the muffler valve is generally set at a lower pressure than the plain encased valve, and thus

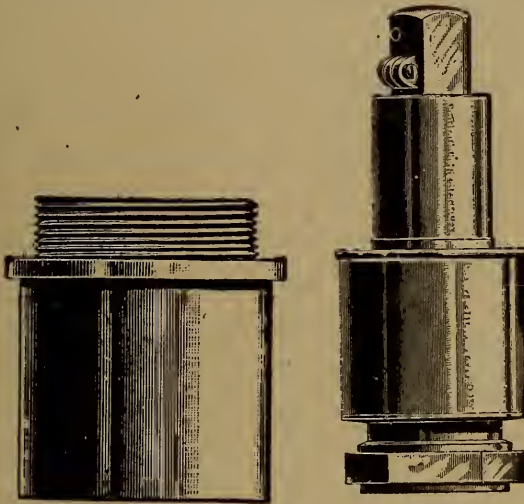

FIG. 14.

The Consolidated Plain Locomotive Pop Safety Valve.
Fitted with Richardson's Adjustable Screw Ring.

performs all the work required; the plain encased valve can thus be used as an auxiliary and to blow down the pressure when such is required.

Directions for Changing the Pressure and Altering the Closing Pressure of any of the Consolidated Pop Safety Valves.—Remove the lock-up cap, then slack up check-nut. If it is desired to increase the pressure, turn the compression screw down or to the left about one square of the hexagon nut for each five pounds

pressure, then secure the check-nut and let the valve blow, noting the increase of pressure by a correct steam gauge after the valve "pops." If the pressure is reduced too much before the valve closes, remove the brass pin or screw from the side of case, and with any pointed instrument inserted through the hole from which the pin or screw was taken, turn the notched adjustable ring inside the case down or to the left, one or two notches at a time, until the valve closes at the desired pressure. In changing the position of the adjustable ring, care should be taken to lock it with the pin or screw each time before blowing the valve, and to replace all parts securely after valve is satisfactorily adjusted.

If the pressure is to be reduced, reverse the operations described above.

Always connect valves as close to the boiler as possible, and when pipe connections to inlet of valve must be used, have them the full diameter of the valve or larger, and as short and free from bends as possible.

Great care must be used in making joints with red lead, as it is apt to settle on the valve seat, and thus prevent its closing tight.

For a variation of more than 10 per cent. in the original opening pressure of a valve, a different spring should be used.

THE ASHTON POP SAFETY VALVE.

This valve is made both open and with muffler. It is a particularly efficient valve and used very extensively on locomotives throughout the country.

These valves may be regulated from the outside

top of the pop and are ordinarily provided with a lock for securing the cap and thus preventing the adjustment being tampered with by irresponsibles.

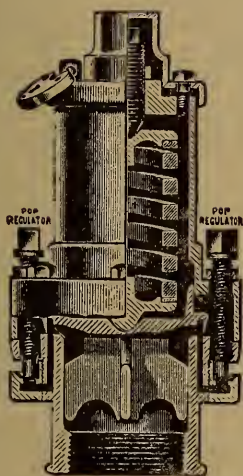

FIG. 15.
Ashton Open Pop Safety Valve.

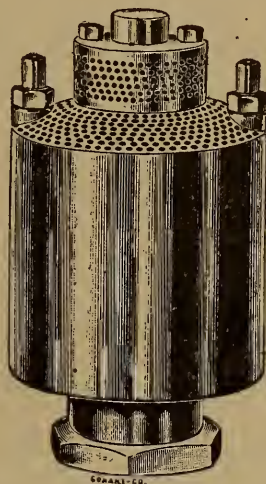

FIG. 16.
Ashton Muffler.

LOCOMOTIVE INJECTORS.

This chapter, while devoted to locomotive injectors, does not pretend to treat of them in their entirety; it does, however, contain brief descriptions and practical information on various types in common use on locomotives.

The injector was patented in 1858 by Giffard, an eminent French engineer, and was introduced into this country in 1860.

There is a great diversity of opinion as to the theory of how an injector works, yet that generally accepted is that an injector works because the great velocity of escaping steam has the power to impart sufficient velocity to the feed water to overcome the pressure of the boiler. In other words, a jet of steam, under a high velocity, strikes the column of water, and, mingling with it, carries it on into the boiler, the water in the boiler being a passive body.

Technically speaking, the *kinetic*, or moving, energy of the jet of combined steam and water overcomes the *static* energy, or state of rest, that exists within the boiler. A stone suspended from a cliff has stored within itself the same energy as that of the boulder which has just gone crashing into the chasm below; the former is said to have static energy, the latter kinetic.

It may here be permissible to use a rude comparison to show the effect of moving force upon standing force. Imagine two cars of equal weight on level track, one at rest and the other moving. When they come

together, as any practical railroad man knows, the result will be that the moving car will push the other ahead of it, and itself move on beyond the point where they struck. If necessary we could even see that should the moving car be much lighter in weight than the other, the effect would be the same to a degree. Thus, at the boiler check we again have the place of coming together of two forces—the stationary force from within acting simply on top of the check, beyond which it cannot escape, and the moving force of the jet of combined water and steam from the injector, which can and does not only crowd back the standing pressure, but itself passes beyond the check and enters the boiler.

It has long been a general belief that the fact that the check was below the water level of the boiler accounted for the working of the injector, but this has been proven to be untrue. An injector will work with the check above the water in a boiler, but the circulation in the boiler will be less perfect by reason thereof, and more difficulty will be experienced in keeping the check from leaking.

Inasmuch as some injector makers prefer to retain the piston theory of an injector's working, it is but fair that it should be given and the reader permitted to select that most compatible with his own line of reasoning. The piston theory is that the steam flowing into the large end of the steam tube is condensed by the water, the combined mass practically forming a piston, against which the steam acts, and as the area of the large steam end of the tube is greater than the area of the throat of the discharge tube, the water is forced into the boiler.

Specially constructed injectors used for boiler testing or for washing out boilers are sometimes made to deliver a pressure four or five times as great as the pressure of steam used in operating them. To accomplish this the steam end of the tubes have a larger area than with an ordinary injector.

There are many different classes of injectors, the principal types used differing in having a single or double set of tubes, fixed or adjustable tubes, and open or closed overflow. Each one of these classes may be either lifting or non-lifting, re-starting automatically or not.

Injectors in General.—The locomotive injector, no matter of what type or style, is a delicate apparatus requiring care in operation and immediate attention when its work is defective, if the best results are to be obtained. While the majority of injectors in use and those here shown and described are lifting injectors and capable of working with a high temperature of feed water, yet it is not desirable to heat the feed water much in excess of 90 or 100 degrees Fahrenheit. Besides the injury to the paint on the tank, it has been found by careful tests that the hotter the combined delivery of steam and water from the injector, the more quickly the injector nozzles and tubes and the delivery or "branch" pipe will become filled with lime and its proper action become impeded.

With each form of injector, and with the different qualities of feed water used, the length of time an injector should be allowed to work before it is given attention will vary. However, it is safe to say that there are few localities where it would not be advantageous to remove the injector and place it in a bath

of ten parts of water to one part of muriatic acid once a month, and between these periods run a quart of acid through the injector without removing it from the locomotive.

Instructions General to All Injectors on locomotives carrying steam pressure above 180 pounds:

Set the injector just above the top of the tank. At eight feet lift and 200 pounds pressure, the capacity is about ten per cent. less than normal.

Cold water in the tank is best for the injector. Hot water reduces its life and efficiency. At 120 degrees temperature the capacity is about one-third below the normal. The range of capacities is reduced and no injector lifts as promptly with feed water at temperatures above this.

Use large suction pipe and tank valve connections. If the diameter is increased one size, the gain in capacity is from five to ten per cent. Use large strainers with small holes. Small strainers require frequent cleaning. If the holes are large, cinders and coal pass through and wear the injector tubes. If the strainer is too small, the injector does not give full capacity. Be sure that the gasket between hose and suction pipe is not squeezed so as to close the opening. The suction pipe must be absolutely tight; any leak of air reduces the capacity and makes the overflow valve jump.

Delivery pipe and main check valve must be of ample area. If an injector gives high back pressure it is using too much steam. If the delivery opening is too small, the power of the injector is wasted in increased friction in the pipes.

Causes for Various Injector Defects.—Waste at

the overflow when the steam pressure drops.--Because the tubes are designed for higher pressures, and too much water enters for the steam to force into the boiler.

When an injector delivers more water at low steam pressures.--The tubes are designed for the lower pressure and not enough water can enter the combining tube to condense the steam--the vacuum inside this tube is less strong, and not as much water is lifted.

When an injector will not take hot water.--The opening of the combining tube is too small to permit sufficient water to enter to condense the steam.

When an injector breaks if the valve is throttled.--The steam is not condensed and the overflow is too small to allow it to discharge freely, so that it is compelled to blow back into the suction pipe.

When an injector works better with the steam valve throttled.--The steam nozzle is too large; throttling the steam reduces the amount to be condensed and increases the vacuum in the combining tube, increases the capacity and enables the engine to steam better.

When an injector gives a very high back pressure.--The steam nozzle is larger than necessary to do the work of forcing the water into the boiler, and live steam is taken away from the cylinder to heat the delivered water.

It is so self-apparent as to require no reasoning, that every engineer placed in charge of a locomotive, and whose safety and that of the lives in his charge depends so largely upon a proper supply of water to

the powerful boiler he is operating, should thoroughly understand the construction and manipulation of the injectors on his locomotive, or on other locomotives which he may be called upon to run any day. He should also be prepared to proceed intelligently and promptly in case his injector fails to do its work perfectly.

SELLERS' CLASS N IMPROVED SELF-ACTING INJECTOR.

This self-acting injector is designed especially for locomotive use. It operates equally well when supplied with water under pressure or when it is placed above the level of the water supply, provided the height of lift does not exceed fifteen or eighteen feet.

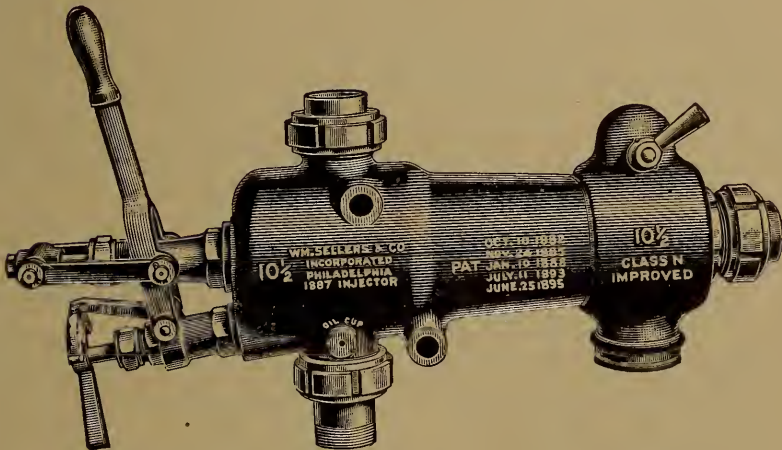

FIG. 1.

Sellers' Class N Improved Self-Acting Injector.

It is mainly on account of its efficient positive action and very wide range of capacities at 200 pounds steam pressure, that it is especially applicable to high-pressure locomotive boilers. It should work

well from the highest steam pressures used on locomotives down to thirty-five pounds steam pressure without adjustment and without wasting at the overflow, and by regulating the water supply valve on the injector, it is claimed to work at ten to fifteen

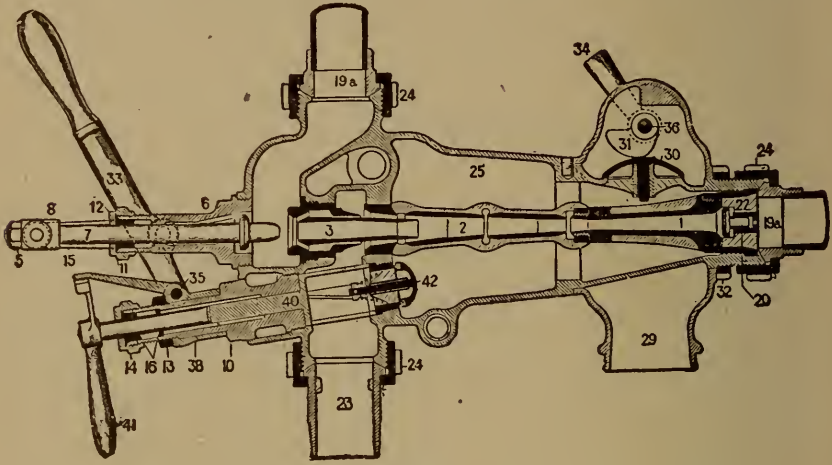

FIG. 2.

Seller's Class N Improved Self-Acting Injector.—(Sectional View).

LIST OF PARTS.

- | | | | |
|------|-----------------------|------|----------------------|
| 1. | Delivery Tube. | 23. | Plain. } Unions for |
| 2. | Combining Tube. | 23a. | Reduc. } Iron Pipes. |
| 3. | Steam Nozzles. | 24. | Coupling Nuts. |
| 5. | Spindle Nut. | 25. | Injector Body. |
| 6. | Steam Stuffing Box. | 27. | Wrench. |
| 7. | Spindle. | 29. | Waste Pipe. |
| 8. | Crosshead. | 30. | Waste Valve. |
| 10. | Water Stuffing Box. | 31. | Waste Valve Cam. |
| 11. | Follower. | 32. | Jam Nut for No. 29. |
| 12. | Packing Ring. | 33. | Starting Lever. |
| 13. | Lock Nut. | 34. | Cam Lever. |
| 14. | Follower for No. 10. | 35. | Pin, Nos. 9 and 33. |
| 15. | Links. | 36. | Cam Shaft. |
| 16. | Packing Ring. | 37. | Washer on 36. |
| 19. | Plain. } Rings for | 38. | Collar and Index. |
| 19a. | Reduc. } Copper Pipe. | 39. | Funnel. |
| 20. | Check Valve. | 40. | Plug Water Valve. |
| 22. | Guide for No. 20. | 41. | Regulating Handle. |
| | | 42. | Inlet Valve. |

pounds. As this injector restarts instantly under all conditions of service, it can well be depended upon.

Its construction is quite simple and it is easy and economical to repair.

This injector has shown most excellent results when the feed water is strongly impregnated with lime. The tubes of all classes of the same size of this injector are interchangeable, thus greatly reducing the extra parts to be kept on hand.

While this injector may be placed wherever it is most convenient for the engineer, it is generally located within the cab or part way through the cab frame.

The action of this injector is as follows: Steam from the boiler is admitted to the lifting nozzles by drawing the starting lever 33 about one inch, without withdrawing the plug on the end of the spindle 7 from the central part of the steam nozzle 3. Steam then passes through the small diagonally-drilled holes and discharges through the outside nozzle, through the upper part of the combining tube 2 and into the overflow chamber, lifts the overflow valve 30, and issues from the waste pipe 29. When water is lifted the starting lever 33 is drawn back, opening the forcing steam nozzle 3, and the full supply of steam enters the combining tube, forcing the water through the delivery tube into the boiler.

At high steam pressure there is a tendency in all injectors having an overflow to produce a vacuum in the chamber 25. In the improved self-acting injector this is utilized to draw an additional supply of water into the combining tube by opening the inlet valve 42, which is forced by the jet into the boiler, increasing the capacity about twenty per cent.

The water-regulating valve 40 is only to adjust the capacity to suit the needs of the boiler. The range is unusually large.

The cam lever 34 is only used to prevent the opening of the overflow valves when it is desired to use the injector as a heater, or to clean the strainer. The joint between the body 25 and the waste-pipe 29 is not subject to other pressure than that due to the discharging steam and water during starting; the metal faces should be kept clean and the retaining nut 32 screwed up tight.

To tighten up the gland of the steam spindle, push the starting lever 33 to end of stroke, remove the little nut 5 and draw back the lever 33. This frees the cross-head 8 and links 15, which can be pushed out of the way, and the follower 12 tightened on the packing, to make the gland steam tight.

Operation.—Open wide the valves in the steam and water supply pipes (not shown). Draw the starting lever 33 slowly all the way back; this lifts the feed water and forces it into the boiler with a single movement. Adjust the capacity with the water-regulating valve 40, by means of the handle 41, to suit the needs of the boiler. If the water in the tank is warm or the suction pipe is hot, or if the injector has not been used for some time and condensed water has accumulated in the steam supply pipe, draw the starting lever 33 back about an inch and wait for the water to appear at the overflow before bringing the lever 33 way back. However, in all ordinary cases the injector should be started without the loss of a large amount of water at the overflow.

To obtain the minimum capacity, adjust the water-regulating valve 40 by means of handle 41 until puffs of steam appear at the overflow, and then open slightly.

The following rules for procedure when this injector fails to do its work perfectly will be found of especial advantage to those handling locomotives equipped with this injector:

When the Injector Will Not Lift.—(1) The suction pipe may be filled with boiling water.—Draw the starting lever 33 back about one inch, close lever over waste valve 34 and when the suction pipe is clear, open quickly, and water will appear at the overflow.

(2) Strainer stopped up.—Use same method as above, and, if not effective, uncouple pipe and clean out strainer.

(3) Obstruction in lifting combining tube.—Uncouple the delivery pipe from the injector and unscrew the tubes; carefully examine all holes and pass a light brass wire through the combining tube 2 and the delivery tube 1 until it strikes the check valve. (The obstruction may have dropped out during the removal.)

(4) Obstruction in the lifting steam nozzle.—Unscrew spindle nut 5 and pull starting lever 33 back, drawing off crosshead 8; remove follower 11 and pull out spindle; unscrew stuffing box 6, slacken lock nut 13 and rotate starting lever out of the way. Unscrew steam nozzles 3 and hold lightly in vise by the square on taper end, using a box wrench on the upper hexagon. When separate, clean very carefully with fine emery cloth until the metal is bright, without altering diameters. If the surfaces are much grooved or cut, substitute new parts.

(5) Inlet valve 42 may be open.—Remove pin 35, unscrew lock nut 13 and swing starting lever 33 out of the way; unscrew water stuffing box 10 and remove

water valve 40; insert light wire to see if inlet valve 42 seats freely; if not, remove with a wrench made of a piece of flat iron. The spring on the valve stem should just close valve when horizontal.

When the Injector Will Lift, But Will Not Deliver the Water into the Boiler.—(1) Suction pipe choked.—This may be shown by steam appearing at the overflow when the starting lever is opened wide, or by the delivery being too hot. The tank valve may be partially closed or hose lining loose. Blow out the suction pipe as described before.

(2) Main check valve stuck on seat.—Shown by a heavy, or by a continuous light overflow. Tap the check valve lightly with a lead hammer; if not effective, cap of valve will have to be removed when engine is not under steam.

(3) Main check valve too small.—Shown by a continuous light overflow or drip. All valves should have openings and pipe connections at least as large as those of the injector. It is usually advantageous to have the suction pipe one size larger.

(4) Obstruction in the tubes.—Uncouple the delivery end of the injector and remove and examine the combining and delivery tubes as before.

(5) Steam nozzle 3 stopped up.—Remove the steam stuffing box 6 and the steam nozzle 3 as before described, and see if the main nozzle is choked.

(6) If the overflow valve 30 vibrates on its seat, and the injector works noisily, look for a leak in the suction pipe. Draw starting lever 33 back about one inch, close waste valve lever 34 and close the tank valve sufficiently to produce slight pressure in suction pipe; examine all joints and seams carefully for leak,

which, with large injectors, may be below the water line.

General Instructions.—(1) Blow out all pipes carefully with steam before attaching the injector, tapping the pipe with a hammer in order to loosen all the scale.

(2) When drip pipe is attached close to overflow of injector, it must be of ample size required.

(3) Always use a dry pipe attachment to insure perfectly dry steam.

(4) The diameter of the strainer should be large enough to give an ample supply of water even when some of the holes are choked.

(5) Keep all valves steam tight; all leaks tend to increase rapidly owing to the velocity with which steam passes through the smallest opening.

(6) A leak at the overflow valve 30 diminishes the capacity of the injector and draws air into the boiler; this valve can be ground without removing the injector from the engine. Unscrew the coupling nut 24 and the jam nut 32 at the delivery end; slide both parts over the boiler feed pipe and follow with the overflow sleeve 29; this uncovers the valve, which may then be ground to a bearing, using only fine sand or powdered quartz.

Repairs.—The parts most liable to wear depend upon the condition of the steam and the feed water. Wet steam cuts out the lifting steam nozzle without affecting the other tubes, while grit or dirt in the supply water wears the outside of the forcing steam nozzle and roughens the tubes. Every injector should work as before described, and, if the steam is dry and the water supply clean, will give long and

satisfactory service. When new combining and delivery tubes are required, remove old tubes from body by means of a special wrench provided for that purpose; hold the delivery tube in a vise and remove piece No. 22 with same wrench; note if shank of check valve or bearing in piece No. 22 are worn too much for use. Screw new parts together without bending, always holding them in vise as close to the threads as possible; then place them between lathe centres and tap lightly with a lead hammer until the hole in the end of the combining tube runs perfectly true. See that the seats on the body and the shoulders of the tubes show clean bright metal; put a little black lead and oil on threads and screw firmly in place.

(2) Keep the steam pipe and chamber free from dirt and chips from the threads on the pipes, and the steam nozzles perfectly clean. The steam nozzle is the life of an injector, and should be maintained in best condition. If the injector is new and the lifting nozzle should fill up, remove from body as previously described and push a piece of card-board down through the annular nozzle, so as to drive out the dirt; it will probably not be necessary to take the nozzles apart.

(3) When grinding the steam valve, screw the steam stuffing box rather tightly against its shoulder to insure its proper alignment, after placing a rubber washer over the holes leading to the lifting nozzle to prevent the sand from working into the lifting jet; this washer should, of course, be provided with a hole large enough to admit the plug on the end of the spindle. Keep the steam valve perfectly tight.

(4) To remove lime and scale, immerse the tubes

or the whole injector in a bath composed of ten parts of water to one part muriatic acid. Remove as soon as scale is dissolved.

(5) It is essential that the tubes and nozzles be maintained in good condition, and that the proportions be correct, in order to obtain the best results from an injector. The body of this injector will last a lifetime, but the tubes require occasional replacing. As these can now be purchased or made at a very low cost, it is not good policy to allow the condition of the injector to run down.

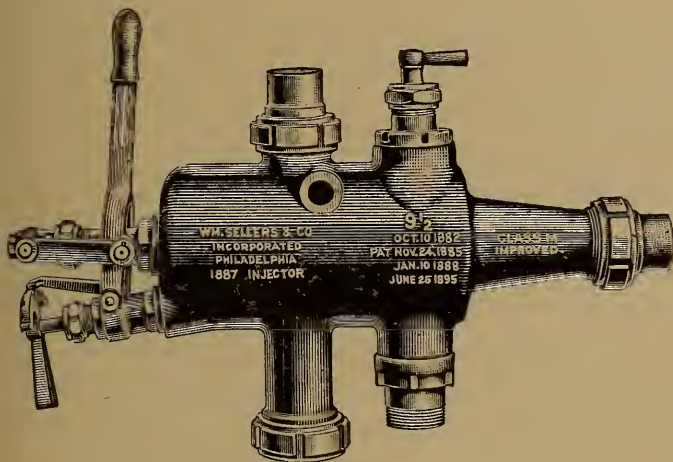

FIG. 3.

Seller's Class M Improved Self-Acting Injector.

The Sellers improved self-acting injector known as "Class M" is of special form and is interchangeable with the "Monitor," "Ohio," and other injectors having connections standard therewith.

This form is shown by a general view in Fig. 3 and by sectional view in Fig. 4. Its principle and operation are so nearly identical with the "Class N" injector as to need no special description.

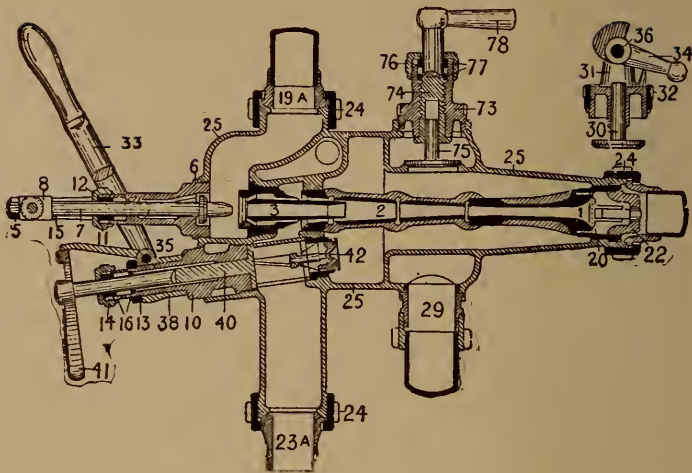

FIG. 4.

Seller's Class M Improved Self-Acting Injector.—(Sectional View).

LIST OF PARTS.

- | | |
|---------------------------|----------------------------------|
| 1. Delivery Tube. | 25. Injector Body. |
| 2. Combining Tube. | 27. Wrench. |
| 3. Steam Nozzles. | 29. Waste Pipe. |
| 5. Spindle Nut. | 30. Waste Valve. |
| 6. Steam Stuffing Box. | 31. Guide for No. 30. |
| 7. Spindle. | 32. Jam Nut for 31. |
| 8. Cross Head. | 33. Starting Lever. |
| 10. Water Stuffing Box. | 34. Cam Lever. |
| 11. Follower. | 35. Pin, Nos. 9 and 33. |
| 12. Packing Ring. | 36. Pin through 31 and 34. |
| 13. Lock Nut. | 38. Collar and Index. |
| 14. Follower for No. 10. | 39. Funnel (Extra). |
| 15. Links. | 40. Plug Water Valve. |
| 16. Packing Ring. | 41. Regulating Handle. |
| 19. Plain } Rings for | 42. Inlet Valve. |
| 19a. Reduc. } Copper | 73. Guide for Overflow Valve 75. |
| | 74. Heater Stem. |
| 20. Check Valve. | 75. Overflow Valve. |
| 22. Guide for No. 20. | 76. Follower. |
| 23. Plain. } Unions for | 77. Pack Ring in 73. |
| 23a. Reduc. } Iron Pipes. | 78. Heater Lever. |
| 24. Coupling Nut. | |

NATHAN "SIMPLEX" INJECTOR.

The *Simplex* injector is what is termed an automatic instrument and will restart, picking up the water after interruption from any cause such as water surging in the tank when the supply is low. It is also self-regulating, controlling the water without waste at the overflow with a varying pressure of steam

from 200 pounds down to 50 pounds without any manipulation on the part of the engineer.

Below 50 pounds pressure the water must be regulated by the water valve. It will start readily, even with a hot suction pipe. This injector is provided with an extra water way which is controlled by an inlet valve 9, which valve serves to increase the injector's capacity at steam pressures above 150 pounds.

Should this valve 9 leak or stick off its seat, the key 35 above may be turned one-half turn and thus this extra water way shut off. The injector will then start and work as an ordinary injector.

The range of reduction in this injector is nearly sixty per cent. and is obtained by means of the water valve. The steam valve is supposed to be wide open at all times.

The thumb screw on the lever guide is simply to keep the lever in a slightly open position whenever the injector is used as a heater, so that the entire pressure may not be put on the hose alone.

The only parts liable to need attention are the steam valve and the inlet valve. Should the injector get hot every time when out of use, it is evident the steam valve leaks and should be ground in. In case there is any difficulty in starting the injector, it may be the inlet valve is out of place (or unseated), and in such a case turn the key 35 a half turn, with the letter *S* on the upper face of the square spindle end, and the injector will go to work. At the end of the run this valve may be given the necessary attention.

To use this injector as a heater, close the heater cock check and draw out the starting lever.

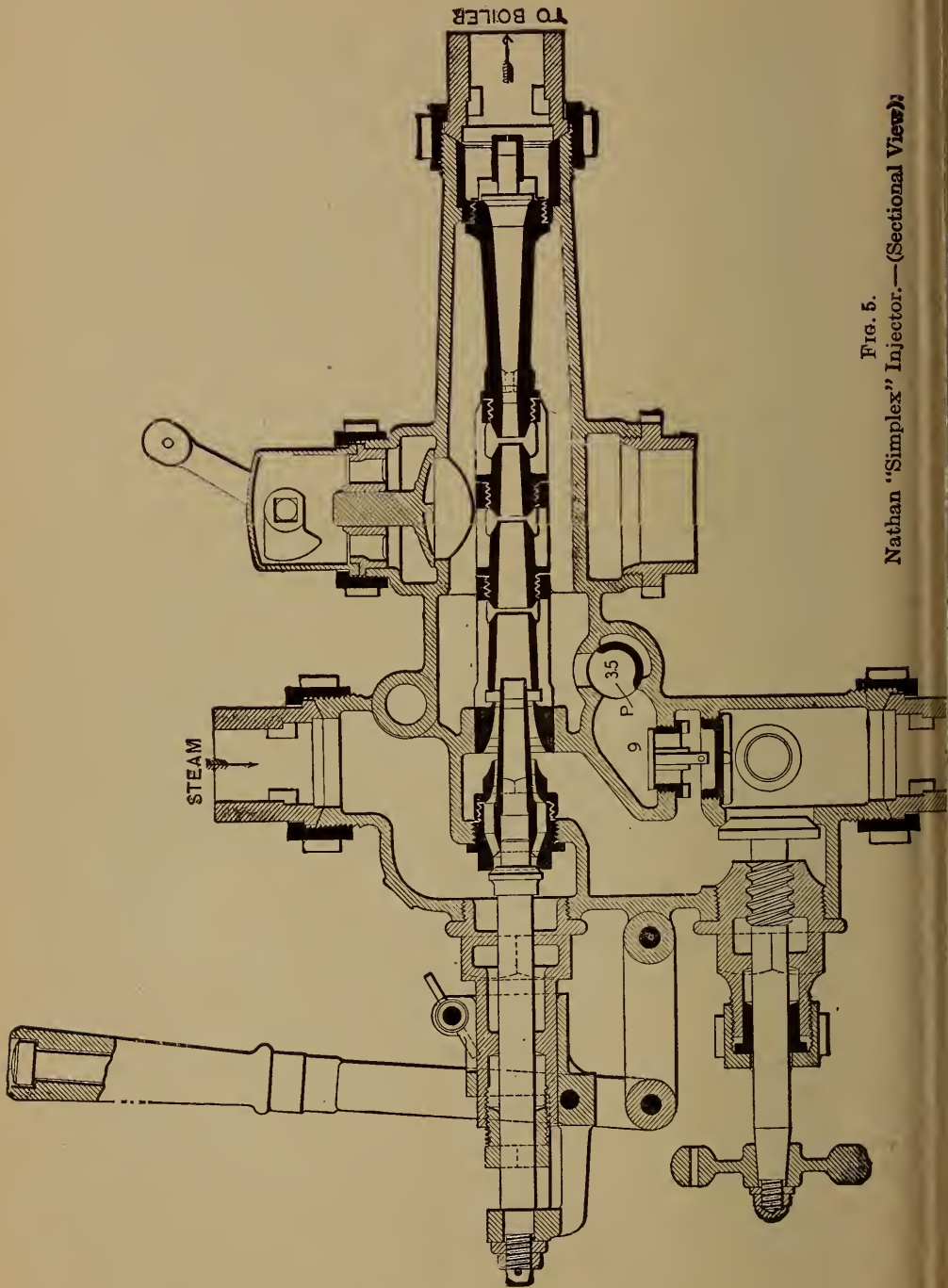

FIG. 5.
Nathan "Simplex" Injector.—(Sectional View.)

In starting on high lifts and in lifting hot water, pull out the starting lever slowly.

To start the injector, pull out the lever; to stop, push in the lever.

NATHAN "MONITOR" INJECTOR.

While this type of injector is not of such recent design as the "Simplex" there are a great many in use.

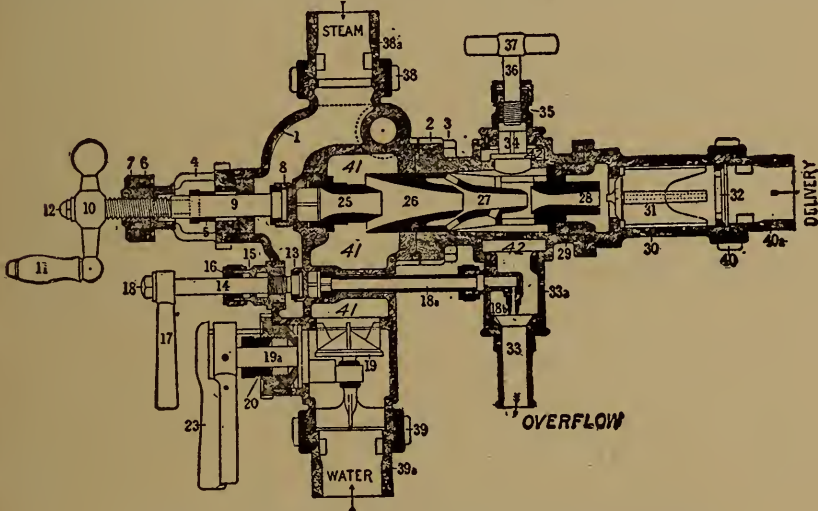

FIG. 6. Nathan "Monitor" Injector (Sectional View.)

LIST OF PARTS:

- | | |
|--------------------------------|---------------------------------|
| 1. Body (back part). | 23. Water Valve Lever Handle. |
| 2. Body (front part). | 25. Steam Nozzle. |
| 3. Body Screw. | 26. Intermediate Nozzle. |
| 4. Yoke. | 27. Condensing Nozzle. |
| 5. Yoke Gland. | 28. Delivery Nozzle. |
| 6. Yoke Packing Nut. | 30. Line Check. |
| 7. Yoke Lock Nut. | 31. Line Check Valve. |
| 8. Steam Valve Disc and Nut. | 32. Stop Ring. |
| 9. Steam Valve Spindle. | 33. Overflow Nozzle. |
| 10. Steam Valve Handle. | 33a. Overflow Chamber with Nut. |
| 11. Steam Valve Rubber Handle. | 34. Heater Cock Check. |
| 12. Steam Valve Top Nut. | 35. Heater Cock Bonnet and Nut. |
| 13. Jet Valve Disc and Nut. | 36. Heater Cock Spindle. |
| 14. Jet Valve Spindle. | 37. Heater Cock T Handle. |
| 15. Jet Valve Bonnet and Nut. | 38. Coupling Nut—Steam End. |
| 16. Jet Valve Gland. | 38a. Tail Piece—Steam End. |
| 17. Jet Valve Lever Handle. | 39. Coupling Nut—Water End. |
| 18. Jet Valve Top Nut. | 39a. Tail Piece—Water End. |
| 18a. Jet Tube. | 40. Coupling Nut—Delivery End. |
| 18b. Lifting Nozzle. | 40a. Tail Piece—Delivery End. |
| 19. Water Valve. | 41. Water Chamber. |
| 19a. Eccentric Spindle. | 42. Vacuum Chamber. |
| 20. Water Valve Bonnet. | |

Its method of operation and a description of its parts are therefore given here.

Operation.—Valve 19 is opened by means of lever 23, which admits water into chamber 41. Valve 13 is then opened by means of lever 17, which admits steam into tube 18a, escaping into overflow, thus creating a partial vacuum in chamber 41 by means of communication, through chamber 42, with valve 34 open, drawing water from tank into chamber 41, nozzle 26, and escaping at overflow. When water thus appears, valve 8 is opened by means of lever 10, admitting steam into nozzles 25, 26, 27 and 28, forcing check valve 31 open and forcing the water already in chamber 41 into delivery pipe, thus supplying the boiler. Water is regulated by valve 19. To shut the injector off, valve 8 is closed.

METROPOLITAN LOCOMOTIVE INJECTOR.

The Metropolitan "1898" Locomotive Injector is a double-tube injector, composed of a lifting set of tubes which lift the water and deliver it to the forcing set of tubes under pressure, which in turn force the water into the boiler.

The lifting set of tubes act as a governor to the forcing tubes, delivering the proper amount of water required for the condensation of the steam, thus enabling the injector to work without any adjustment under a great range of steam pressure, handle very hot water and admit of the capacity being regulated for light or heavy service under all conditions.

This injector will start with 30 to 35 pounds steam pressure, and, without any adjustment of any kind will work at all steam pressures up to 300 pounds. It

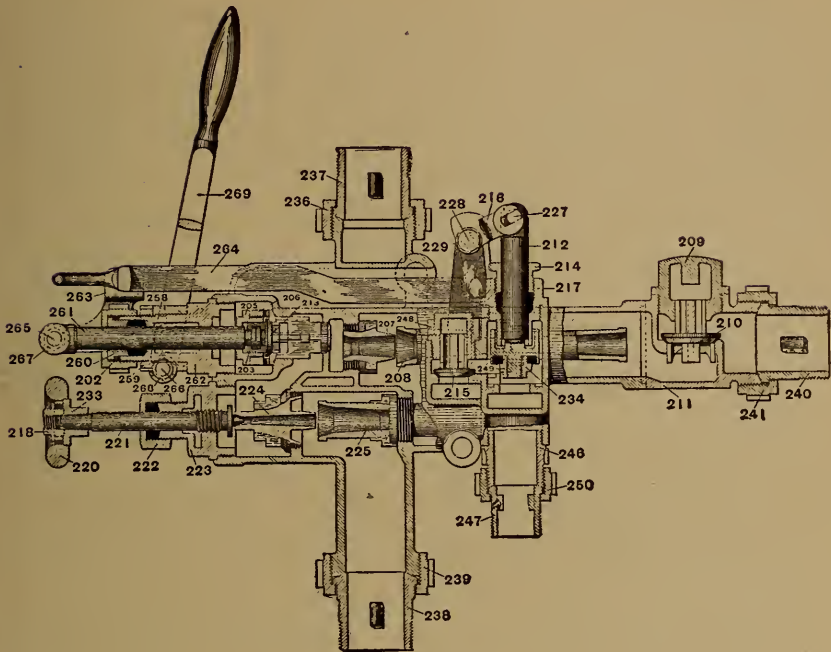

FIG. 7.

The Metropolitan "1898" Locomotive Injector.

LIST OF PARTS.

- | | |
|-------------------------------------|-------------------------------------|
| 202. Packing Nut for 261. | 233. Regulating Valve Wheel Disc. |
| 203. Champ Ring. | 234. Nut for Overflow Disc. |
| 205. Steam Swivel Ring. | 236. Union Nut, Steam End. |
| 206. Steam Valve. | 237. Tail Pipe, Steam End. |
| 207. Forcing Steam Jet. | 238. Tail Pipe, Suction End. |
| 208. Forcing Combining Tube. | 239. Union Nut, Suction End. |
| 209. Check Valve Cap. | 240. Tail Pipe, Delivery End. |
| 210. Check Valve. | 241. Union Nut, Delivery End. |
| 211. Check Valve Casing. | 245. Nut for Stud Bolts in Flange. |
| 212. Overflow Valve Stem. | 246. Union Overflow Nozzle. |
| 213. Auxiliary Steam Valve. | 247. Union Nut for Overflow Nozzle. |
| 214. Packing Gland for No. 212. | 248. Overflow Valve Cap. |
| 215. Overflow Valve. | 249. Disc for Overflow Valve. |
| 216. Overflow Valve Lever. | 250. Tail Pipe for Overflow Nozzle. |
| 217. Overflow Center Piece. | 258. Fulcrum Collar. |
| 218. Regulating Valve Handle Nut. | 259. Fulcrum Nut. |
| 220. Regulating Valve Wheel. | 260. Steam Packing Gland. |
| 221. Regulating Valve Stem. | 261. Steam Valve Stem. |
| 222. Packing Nut for No. 221. | 262. Steam Center Piece. |
| 223. Regulating Valve Center Piece. | 263. Side Links. |
| 224. Lifting Steam Jet. | 264. Overflow Connecting Bar. |
| 225. Lifting Combining Tube. | 265. Bolt for Steam Valve Stem. |
| 227. Overflow Valve Pin. | 266. Fulcrum Bolt. |
| 228. Overflow Bolt. | 267. Nut for Bolt No. 265. |
| 229. Nut for Bolt No. 228. | 268. Nut for Bolt No. 266. |
| 231. Stud Bolt. | 269. Lever. |

is claimed that at all steam pressures and under all conditions its operation is the same. When working, all the water must be forced into the boiler. It is impossible for part or all the water to waste at the overflow should the steam pressure vary.

The independent lifting apparatus produces a strong, powerful vacuum, which enables the injector to promptly lift the water when subjected to the severe conditions of a hot suction pipe, leaking check valves, and hot water supply.

This injector will handle very hot feed water. It starts readily, taking feed-water at 140° Fahr. with steam pressures up to 150 pounds, and 135° Fahr. with a steam pressure of 175 pounds, and 130° Fahr. with a steam pressure of 200 pounds.

Regulation of capacity is an important, in fact indispensable, feature of the perfect locomotive injector. With this injector the capacity can be regulated for light or heavy service under all steam pressures and with hot as well as with cold feed water.

To Connect and Operate.—Place the injector above the level of the water in the tender within reach of the engineer. Take steam from the dome through a dry pipe; should the injector be placed outside the cab, extension fittings must be used.

To Start the Injector.—Pull the lever back slightly until the resistance of the main steam valve is felt. This lifts the water. As soon as the water is lifted, pull the lever back steadily as far as it will go. The injector will then be feeding. Do not push lever in to regulate the feed; it must be pulled back as far as it will go.

To Regulate the Feed.—To increase the capacity

turn the wheel to the left. To decrease the capacity turn the wheel to the right.

To Use as a Heater.—Close the overflow valve by disconnecting the connecting bar and pulling it back. Admit steam by pulling the lever slightly.

General Suggestions for Piping and Making Repairs.—The Injector is preferably located inside the cab thus being directly under control of the engineer. It is necessary that the steam pipe and the opening in the main steam valve be as large as the steam connection so that the injector will receive a full supply of steam. If it does not receive a full supply of steam it will be sensitive or refuse to work at all. The suction and delivery pipes must also be large.

Repairing.—The forcing combining tube 208 is subject to the greatest wear, also to incrustation from limy or impure water. When this tube shows signs of wear, if but little, the roughened part can be smoothed. If the wear is considerable a new tube should be inserted. In time the forcing steam jet 207, the lifting steam jet 224, and the lifting combining tube 225, will wear and should be renewed. The automatic overflow valve 215 must be tight, and if it does not seat tight it should be promptly reground. If this valve leaks it will allow the water discharged from the forcing combining tube 208 to flow back and heat the water between the lifter and the forcer so that the injector will break.

The final overflow valve is made with a special disc 249, which is soft. This prevents any damage being done to the valve seat. These discs are inexpensive, easily renewed, and do away with the

grinding of the valve to its seat. Should the steam valve, 206 and 213, leak, it should be reground promptly.

The sectional view shows the injector with the vertical form of check valve. If the feed water is limy or impure, a swing check valve, as illustrated and described elsewhere, should be used. The lever movement as shown in the diagram is the improved lever attachment. The first Metropolitan "1898" locomotive injectors made had a different form of lever attachment.

THE "HANCOCK" LOCOMOTIVE INSPIRATOR.

The difference between an inspirator and an injector is that the former is a double apparatus having both lifting and forcing jets and tubes combined, and operating with a closed overflow, while the lifting injector has these two parts independent one from the other.

The type of Hancock inspirator of which Fig. 8 is a general and Fig. 9 a sectional view, is designed to meet the demand for an instrument of the class which is operated by one lever or handle. The regulating valve 105, which is directly under the lever, throttles the steam supply to the lifter steam nozzle only, thereby reducing the capacity of the inspirator from the maximum to the minimum without the use of a "lazy cock."* This arrangement neither disturbs the suction by creating an increased vacuum in the pipe, nor impairs the effectiveness of the forcing apparatus.

* "Lazy Cock" was the term applied to the valve formerly located in the feed-water pipe, by the opening and closing of which the regulation of the amount of feed-water supplied was effected.

Pipe Connections.—To obtain the best results, locate the inspirator with the overflow nozzle 108 about four inches above the water in the tank. Take the steam direct from the dome or highest part of the boiler, and not from a pipe which furnishes steam for

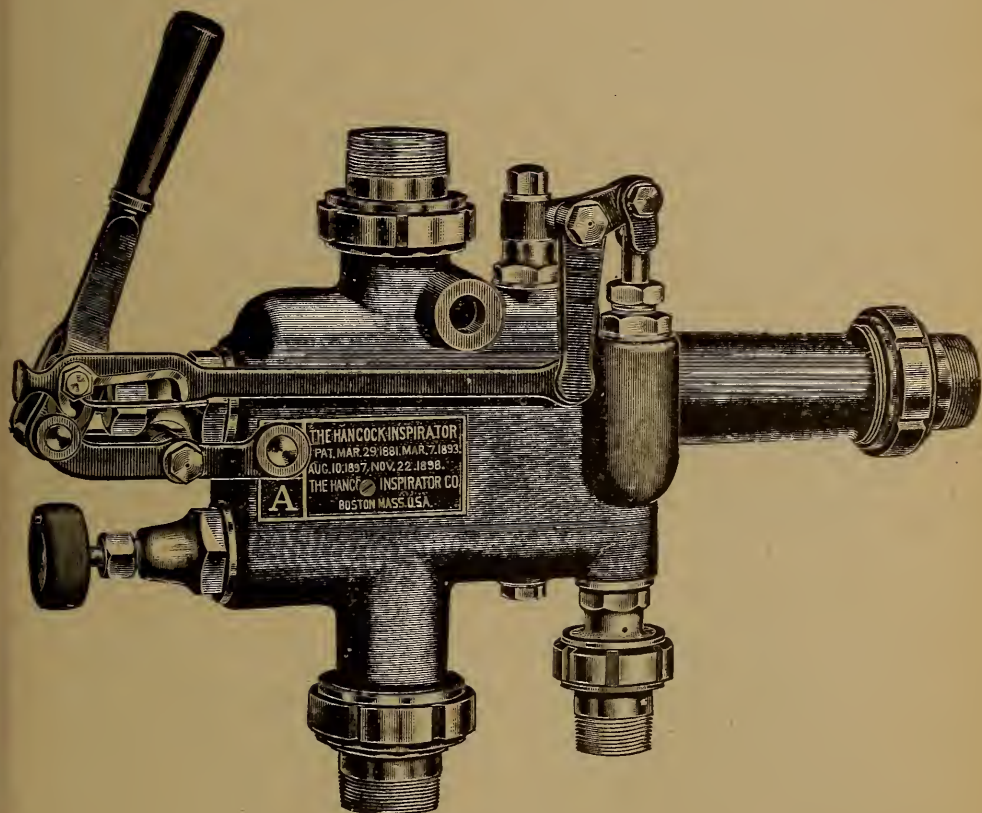

FIG. 8.

Hancock Locomotive Inspirator.

other purposes. Place a globe valve in the steam pipe, and blow it out thoroughly before connecting the inspirator, to remove any redlead, chips, etc.

All openings in the steam connections from the inspirator to the dome and the openings in the suction

or feed-pipe connections from the inspirator to the tank must be of ample size. The overflow pipe should be the full size of the inspirator connection and as nearly straight as possible. The end of the overflow pipe must be open to the air, and not piped below the surface of the water.

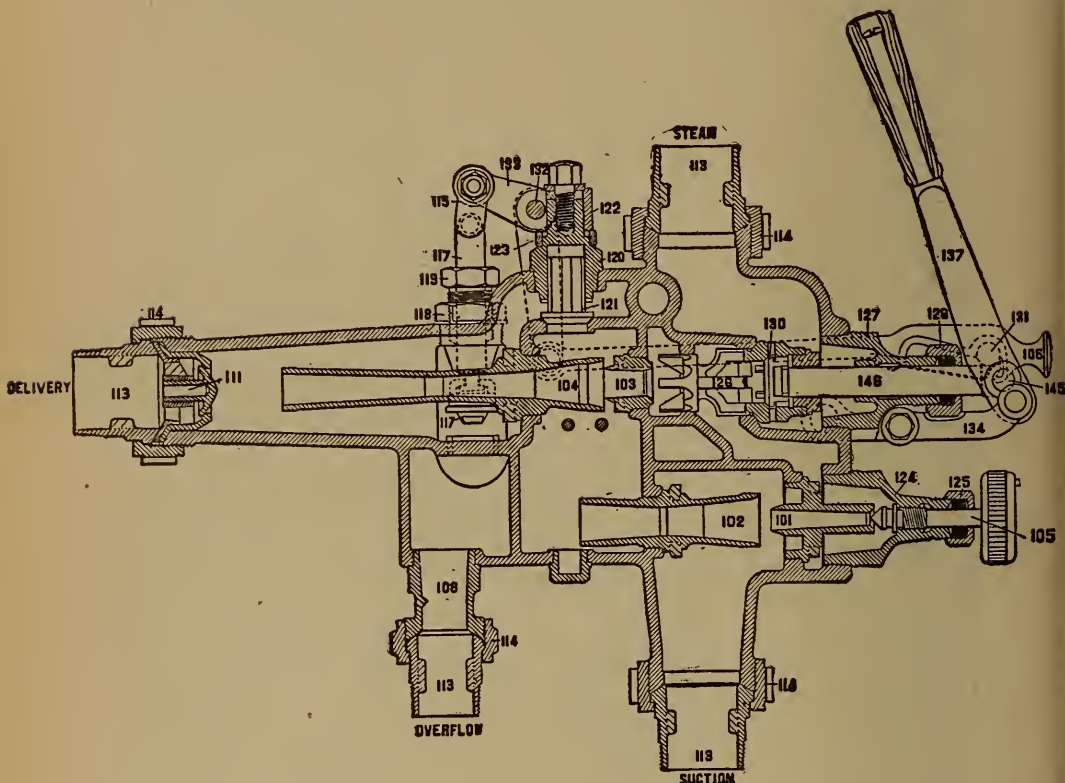

FIG. 9.

Hancock Locomotive Inspirator.

Operation.—To start the inspirator draw the lever back to lift the water, then draw it back *slowly* to the stop. When the lever 137 is drawn back slightly, steam is admitted to the lifter steam valve 130 through the forcer steam valve 126 to the lifter steam nozzle 101. The velocity of the steam into the lifter com-

binning tube 102 creates a vacuum, and causes the water to flow through the lifter combining tube 102, condensing the steam, and out through the intermediate overflow valve 121 and through the final overflow valve 117 in the delivery chamber. A further movement of the lever 137 opens the forcer steam valve 126 admitting steam to the forcer steam nozzle 103 and to the forcer combining tube 104, and creating a pressure in the delivery chamber sufficient to close the inter-

LIST OF PARTS FIG. 9.

- | | |
|------------------------------------------------|-----------------------------------------------|
| 101. Lifter Steam Nozzle. | Tobin Bronze Nut for Bolt for 115. |
| 102. Lifter Tube. | 117. Final Overflow Valve Stem. |
| 103. Forcer Steam Nozzle. | Disc for 117. |
| 104. Forcer Combining Tube. | Nut for 117. |
| 105. Regulating Valve Spindle. | 118. Bonnet for Final Overflow Valve. |
| Rubber Wheel for 105. | 119. Packing Nut for Final Overflow Valve. |
| Back Plate for 105. | 120. Bonnet for Intermediate Overflow Valve. |
| Brass Washer for 105. | Tobin Bronze Cap Screw for 120. |
| Screw for 105. | Iron Washer for 120. |
| 106. Connecting Rod. | 121. Intermediate Overflow Valve. |
| Spring for 106. | 122. Holder for Overflow Valve Crank. |
| 108. Overflow Nozzle. | 123. Adjusting Ring. |
| 111. Line Check Valve. | 124. Bonnet for Regulating Valve. |
| Case for 111. | 125. Packing Nut for Regulating Valve. |
| Cage for 111. | 126. Forcer Steam Valve. |
| 113. Brazing Nipple for Steam Connection. | Coupling Nut for 126. |
| Brazing Nipple for Suction Connection. | 127. Bonnet for Steam Valve. |
| Brazing Nipple for Delivery Connection. | 128. Packing Nut for Steam Valve. |
| Brazing Nipple for Overflow Connection. | 130. Lifter Steam Valve. |
| Threaded Nipple for Steam Connection. | 131. Tobin Bronze Stud for Connecting Rod. |
| Threaded Nipple for Suction Connection. | 132. Tobin Bronze Stud for 122 and 133. |
| Threaded Nipple for Delivery Connection. | Tobin Bronze Nuts for 122 and 133. |
| Threaded Nipple for Overflow Connection. | 133. Crank for Overflow Valve. |
| 114. Coupling Nut for Steam Connection. | 134. Side Strap—right hand. |
| Coupling Nut for Suction Connection. | Side Strap—left hand. |
| Coupling Nut for Delivery Connection. | Tobin Bronze Bolt for 134. |
| Coupling Nut for Overflow Connection. | Tobin Bronze Nuts for Bolt for 134. |
| 115. Connecting Link for Final Overflow Valve. | 137. Lever. |
| Steel Pin for 115. | Wood Handle for 137. |
| Tobin Bronze Bolt for 115. | Screw for 137. |
| | 145. Tobin Bronze Pin Connecting 137 and 146. |
| | 146. Steam Valve Stem. |

mediate overflow valve 121 and open the intermediate or line check valve 111.

The final overflow valve 117 will be closed and the inspirator in full operation when the lever is drawn back to the stop. When the pin in the wheel of the regulating valve is at the top, the inspirator will deliver its maximum quantity of water; to reduce the feed, turn the regulating wheel to the right.

To use the heater attachment lift the connecting rod until disengaged from the stud in the lever, then draw back the connecting rod to close the overflow valve. Regulate the quantity of steam by the lever without throttling the main steam valve on the boiler.

If the inspirator "breaks" or will not start promptly, see if there is a leak in the suction connections. If the openings into the tank are too small, or the hose strainer clogged, or the hose kinked or its lining collapsed, the inspirator will not get a sufficient supply of water.

If the inspirator will lift the water, but will not deliver it into the boiler, see that the main (boiler) check valve is in proper working order. If the opening in the main steam valve or its connections is not of the required size or there is a leak in the dry pipe, the supply of steam will be insufficient.

If the overflow pipe is smaller than the overflow nozzle there will be back-pressure, which will interfere with the proper working of the inspirator.

Injectors sometimes fail to operate when the water is low in the tank, but an inspirator will continue to operate when properly supplied with steam and water, and will not "break" unless the water is taken from the

suction. An engineer will quickly know by the sound when an inspirator "breaks."

THE HANCOCK "COMPOSITE" LOCOMOTIVE INSPIRATOR.

The "composite" is a compound Hancock inspirator, consisting of two separate and individual inspirators within one body, which can be operated separately or simultaneously, as desired.

Each and every part of a "composite" type inspirator that is subject to wear and renewal is identical in

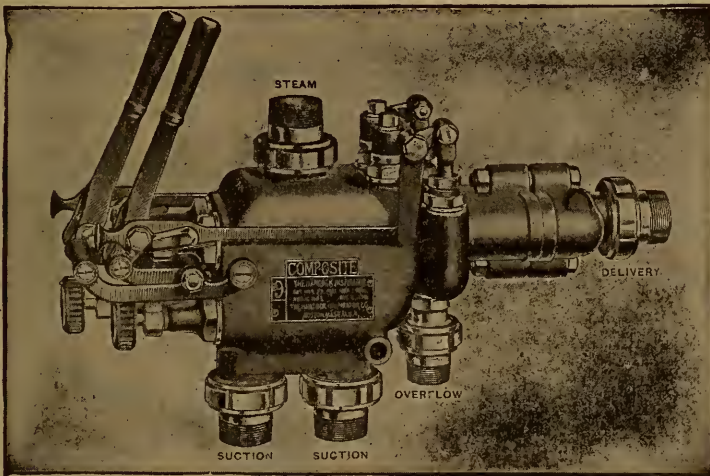

FIG. 10.

Hancock "Composite" Locomotive Inspirator.

design and interchangeable with the corresponding part of the standard locomotive inspirator of the same size.

This instrument enables two inspirators to be connected with practically the expense of connecting one, thus giving two independent ways of feeding the

boiler. By making practice of operating one instrument one time, and the other the next, both are constantly kept in perfect working order. The "composite" takes up practically no more room than a single instrument.

Where it may be desired to locate both injectors on one side of the locomotive convenient to either the engineer or fireman who has charge of pumping the engine, or on the boiler butt available to both, the advantages of the "composite" are apparent.

This instrument can be used and a steady feed kept when there is a great variation in the power used. With the various combinations of nozzles used it is possible to keep a steady feed when using but eighteen per cent. of the maximum horse power of the boiler. For example, take the special size of the "composite," arranged with size 40 nozzles in one side and size 55 nozzles in the other; when both instruments are working simultaneously the water delivered is sufficient to supply 1150 H. P. of boilers; by shutting off the size 55 inspirator, and reducing the feed of the size 40 inspirator, steady feed for 200 H. P. can be maintained. Engineers will appreciate the advantages of this instrument where there is a great variation of power used.

By removing the delivery connection, which is joined to the body by a flanged joint, the forcing tubes of each inspirator are easily removed for cleaning or repair. The valve mechanism of each instrument is independent, the same as the Hancock inspirator, previously shown. The capacity of each inspirator can be regulated by the regulator. The minimum capacity is obtained by using the smaller inspirator

with reduced feed. The maximum capacity by working both inspirators full.

Operation.—The Hancock “composite” inspirator is operated the same as the Hancock inspirator, type “A.”

When it is desired to use both inspirators at the same time, start one, and after it is going start the other.

The arrangement of the different connections to the “composite” inspirator are somewhat varied. All have one each steam and overflow connections and a double suction connection—one to the left and the other to the right tank valve. The delivery connections can be combined, as shown in Fig. 10, to feed through a single boiler check, or entirely separate, supplying the boiler independently through each boiler check.

THE LUNKENHEIMER LOCOMOTIVE INJECTOR.

The Lunkenheimer '99 model standard injector is claimed by the manufacturers to be especially suitable for high-pressure work. The machine is of the double tube positive closing overflow type, but the lifting and forcing tubes are all in one line, and, in this respect, it differs in construction from the Metropolitan, Hancock and other machines, where the lifting tubes are situated below the forcing set.

This injector also differs in several other particulars; for instance, the regulation of the water discharge is accomplished in a different manner from any other injector. In the Lunkenheimer injector the amount of steam required to lift the forcing water is reduced in direct proportion to the amount of water

discharged. In other forms of injectors the amount of forcing steam remains constant, while only the lifting steam and water are decreased. The effect of this reduction of all three items in proportion results in causing the discharge to be cooler at minimum than in other injectors of this class.

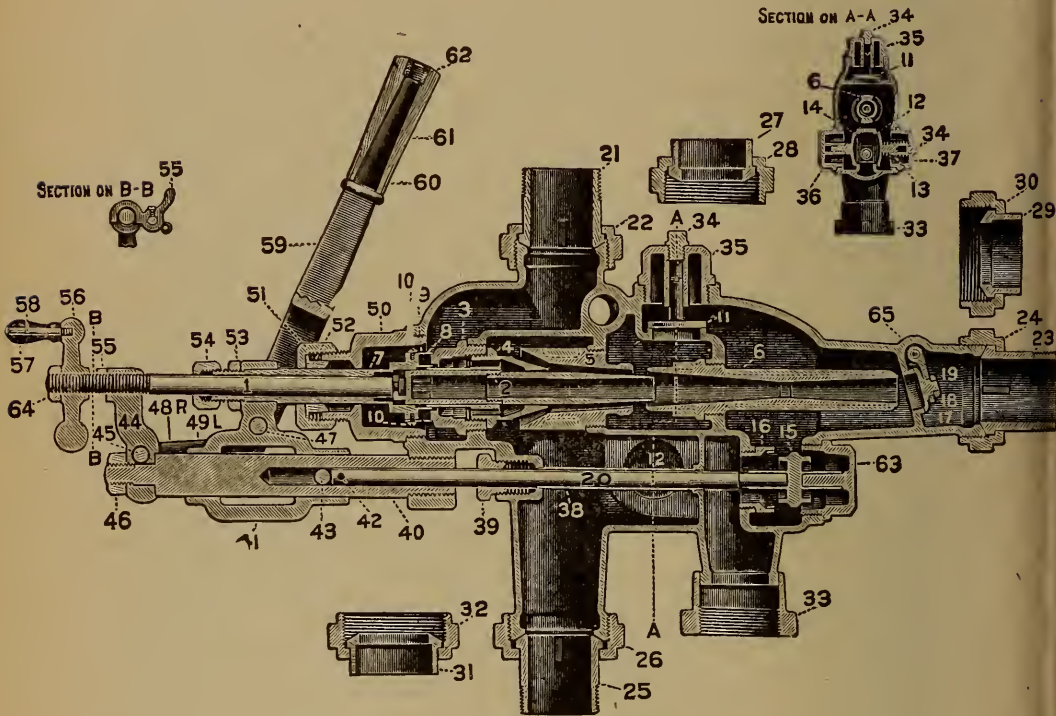

FIG. 11.

Lunkenheimer "99" Model Injector.

The grading, as described in detail below, is accomplished by moving the steam tube (2) in and out by means of the crank handle (56) situated at the back end of the machine.

Mode of Action.—In starting, lever (59) is drawn

back slightly. This movement draws the steam valve (7) back and unseats same partially, which admits the lifting steam through passages in cap (3) and huddler (4), out around steam tube (2), into the water lifting tube (5), opening valve (11) and exhausting partially through the valve (4) and also through the tube (6) and out through overflow valve (15) into the atmosphere. The steam thus exhausted exerts a strong draught in the suction branch, discharges the air, and the water is "lifted." When water appears at the overflow, lever (59) is drawn all the way back. This movement uncovers the ports in the movable steam tube, admitting the jet of forcing steam, which drives the water through the forcer combining tube (6). By the same movement of the lever (59) the rod (20) is withdrawn and valve (15) is seated by the increasing pressure in the delivery chamber. Valve (11) is also seated by the pressure on top of same, and all water is forced through the tube (6), overcomes the boiler pressure on line check valve (17) and passes into the feed pipe. The amount of water delivered is regulated by the movable steam tube (2). This tube moves longitudinally through the other tubes in the machine and is actuated by the threaded stem (1) and crank (56). To deliver the maximum amount of water the tube is withdrawn to its limit. This admits the maximum amount of steam around the outside of the tube to lift the water, and also to the interior of same to force the jet of water into the boiler. The withdrawal of tube (2) also increases the passageway around same and through tubes (5 and 6). When it is desired to reduce the capacity, the crank (56) is turned from left to right, which forces the tube (2)

into the openings in tubes (4, 5 and 6). The effect of this is :

First. To cut off the amount of forcing steam passing through the ports in the end of tube (2) as same is moved into the tubular extension of huddler (4).

Secondly. It decreases the passage of lifting steam around tube (2) and through huddler (4), due to the tapering diameter of tube (2) approaching the fixed internal diameter of huddler (4).

Thirdly. The passage ways through tubes (5 and 6) are decreased as the tube (2) is passed into same.

The amount of steam required is decreased proportionately to the quantity of water discharged. In other injectors the discharge of steam remains constant, while the water alone is decreased in quantity. The result of this method is that this injector delivers water, when working at minimum, at a low temperature. As scale only forms when water is heated to high temperatures, there is less liability of trouble from this cause than with machines where the discharge is very hot.

The auxiliary water valve (12) is situated at the side of the machine and controls the port between the suction branch and the intermediate chamber of the injector, see sectional cut. The function of this valve is to make the injector self-adjusting and unaffected by variations of steam pressure. At certain pressures the water lifting tube does not deliver a sufficient quantity of water to condense the steam, and at such times the vacuum formed in the chamber causes the valve (12) to open and admit the additional amount of water required.

This machine is claimed to be very economical and

efficient, and will work at all pressures from seventy to two hundred and fifty pounds without any adjustment whatever.

THE OHIO LOCOMOTIVE INJECTOR.

The Ohio injector is noted for its simplicity, having few parts and those arranged conveniently for repairs. It will be noted from the sectional view here shown

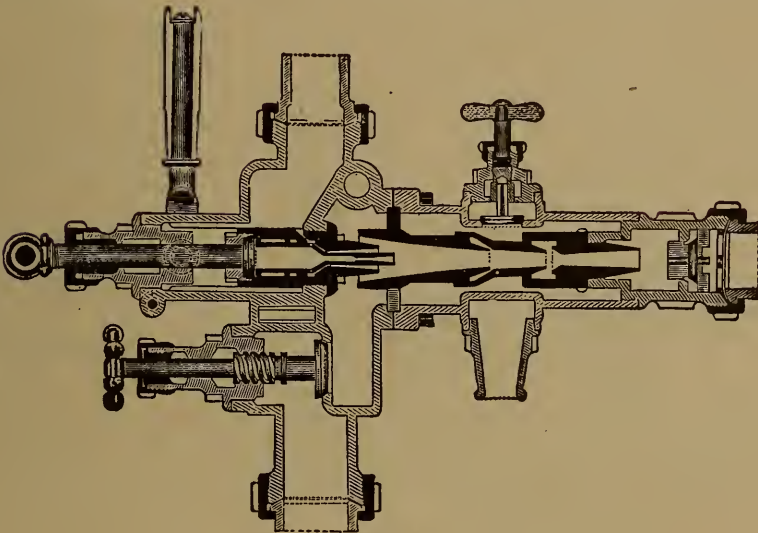

FIG. 12.
The Ohio Locomotive Injector
(Sectional View).

that the combining tube and the delivery tube are screwed directly to the delivery end connection on the right in the cut, and can be taken out with an ordinary wrench without disturbing the other tubes; the lifting tube, instead of being screwed to the injector body, is held in place between the two flanges which are bolted together, as shown. This design lessens the liability of marring or breaking the tubes in their removal for inspection or repairs.

This injector is interchangeable with the other principal injectors used, the size and location of its connections being the same.

THE NIAGARA LOCOMOTIVE INJECTOR.

This injector is of the double tube type, strongly built, and is thoroughly balanced, requiring but little effort to operate it.

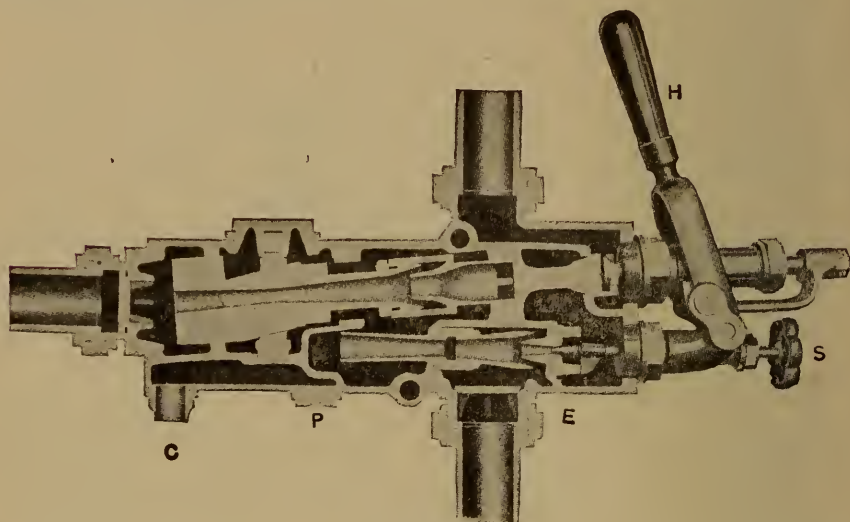

FIG. 13.

The Niagara Locomotive Injector.
(Sectional View.)

The forcing water and steam nozzles are both connected directly with the spindle operated by the handle (*H*). The overflow valve is in a vertical position. The regulation is effected by the spindle (*S*) reducing the quantity of steam supplying the suction steam nozzle, thereby diminishing the quantity of water delivered to the forcing nozzle.

The cut shows the injector adapted to the Sellers pipe connection. By interchanging overflow nozzle

(C) with plug (P) and replacing the water connection (E) with a longer leg, the Monitor pipe connections are obtained.

Operation.—To start, pull the handle slightly until water appears at overflow (C), then draw handle completely back.

To stop, push handle forward through its full stroke.

To regulate its capacity, turn wheel (S).

To Use as a Heater.—Pull handle back with a quick motion, through its full stroke. When used as a heater a full head of steam cannot blow back into the tender, and thus the water hose are protected against being blown off.

“LITTLE GIANT” LOCOMOTIVE INJECTOR.

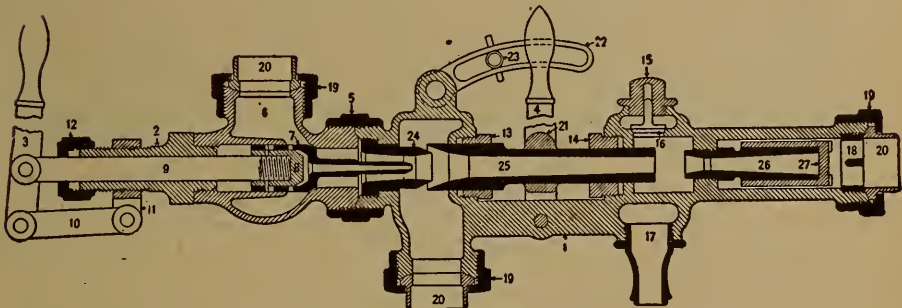

FIG. 14.
Little Giant Locomotive Injector.
(Sectional View.)

LIST OF PARTS.

- | | |
|--------------------------|---------------------------|
| 1. Body. | 15. Overflow Cap. |
| 2. Stuffing Box. | 16. Overflow Valve. |
| 3. Starting Lever. | 17. Overflow Nozzle. |
| 4. Injector Lever. | 18. Check Valve Stop. |
| 5. Right and Left Nut. | 19. Coupling Nut. |
| 6. Starting Valve Body. | 20. Swivel. |
| 7. Main Valve. | 21. Combining Tube Clamp. |
| 8. Jet Valve. | 22. Quadrant. |
| 9. Jet Valve Stem. | 23. Thumb Screw. |
| 10. Starting Valve Link. | 24. Steam Tube. |
| 11. Fulcrum. | 25. Combining Tube. |
| 12. Stuffing Box Nut. | 26. Discharge Tube. |
| 13. Large Packing Nut. | 27. Check Valve. |
| 14. Small Packing Nut. | |

This injector is fitted with a movable combining tube (part numbered 25 in sectional view) operated by a lever which allows it to be adjusted to work correctly at different pressures of steam and under the many conditions required of a locomotive injector.

To Operate.—Have the combining tube in position to allow sufficient quantity of water to condense the steam when the starting valve is full open, then open

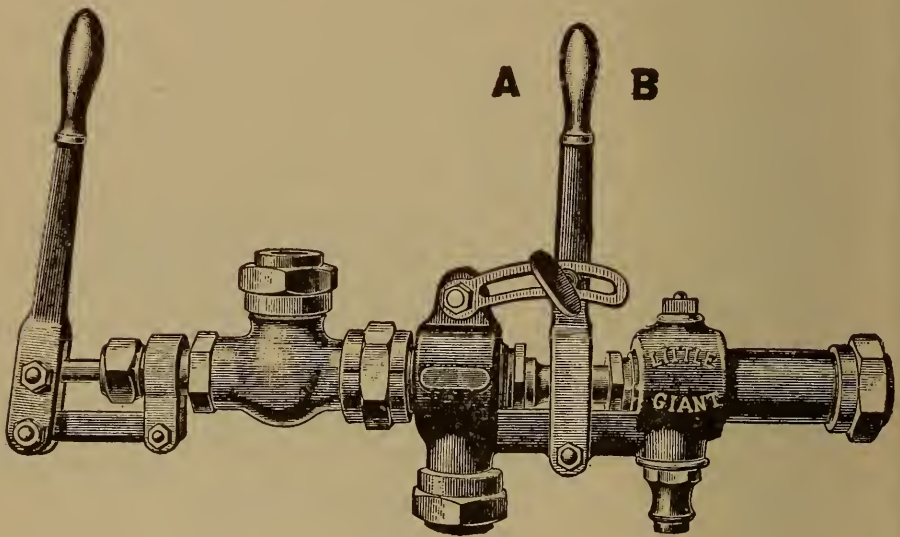

FIG. 15.

Little Giant Locomotive Injector.

the starting valve slightly; when water shows at the overflow, open full. Regulate the water by moving the combining tube—toward *A* for less water, and toward *B* for more water.

To Use as a Heater.—Close the overflow by moving the combining tube toward *B* until the tubes 25 and 26 come together, then open the starting valve enough to admit the quantity of steam required.

BOILER WASHING AND TESTING APPARATUS.

The accompanying engraving shows a washing and testing apparatus, which will wash out, fill, and apply pressure to a boiler, with hot water. It has a capacity of 5,000 gallons per hour. When this apparatus is used, the boilers are washed much more effectually than can be done with cold water, and their temperature is not materially reduced, which is injurious to flues and fire-box. It enables one to blow out, wash and fill with hot water and have a locomotive ready for service within one hour, without injury to the boiler.

This apparatus has connection for 2-inch pipes, and must be located where the water will flow to it.

When applying pressure this apparatus will produce and maintain from three to five times the amount of steam pressure used in operating it.

To Attach.—Connect steam pipe to swivel No. 1; water supply No. 2, and discharge to No. 3.

To Wash Out Boiler.—Close overflow (*O*) by moving tube (*C*) over to the discharge. Open water supply, then steam valve (*A*), until the required force is obtained.

To Apply Pressure.—When boiler is filled with hot water, the same as when washing, shut steam valve (*A*); open overflow (*O*) by moving combining tube (*C*) to about midway of its travel; when water shows at overflow (*O*), open steam valve (*B*) slowly

until full open; then adjust combining tube so as to allow the least quantity of water possible to show at (O). Relief valve (R) can be adjusted as desired.

Keeping the cock to the pressure gauge partly closed will prevent the hand from unduly vibrating.

One of the Many Ways It May Be Located, is so to take cold water to the apparatus from, and put hot water back into the pipe that supplies water for

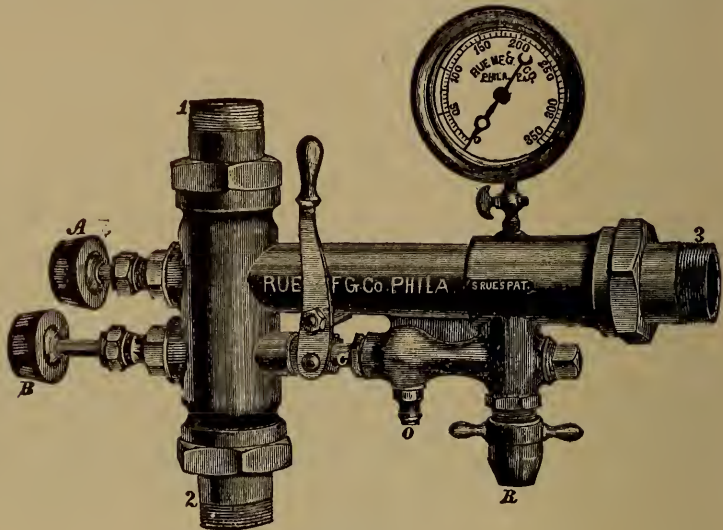

FIG. 1.

Boiler Washing and Testing Apparatus.

washing with cold water—always putting in a stop valve or cock between the connections. The hot water from the apparatus will pass with great force through the same pipe, hose, nozzles, etc., as are used with cold water.

“SWING” INTERMEDIATE OR LINE CHECK VALVE.

The check shown in the accompanying engraving can be applied to the “branch” pipe or injector delivery pipe of any locomotive injector.

Experience has proved that a hinged or swinging movement of the valve is more reliable and its action more certain than either the horizontal or vertical types with a sliding movement, especially where trouble is caused by incrustation from limy or impure water.

There are no wings or guides to become incrustated with scale or deposit while the valve is open and to prevent its closing, and the liability of damage or delay caused by the valve sticking or failing to close is obviated.

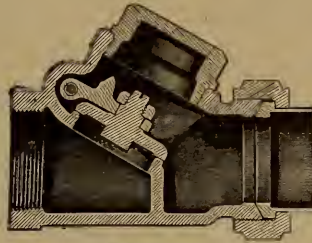

SECTIONAL VIEW.
 FIG. 1. Swing Intermediate or Line Check.

No matter how efficiently a boiler check is used, there is no question as to the double advantage gained by the use of a line check valve, and few modern equipped locomotives are now without them.

OIL CUP—FOR INJECTORS AND INSPIRATORS.

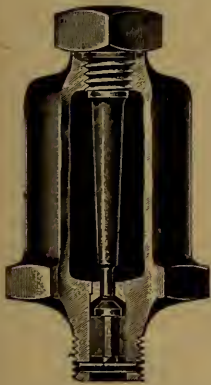

FIG. 1.
 Injector Oil Cup.
 (Sectional View.)

For lubricating the internal parts of any injector or inspirator it is very desirable to have a suitable oil cup, as shown in the engraving (Fig. 1), attached to the injector or steam pipe.

It is considered that the introduction of oil into the steam chamber is more effectual than its admission into the water chamber. Hence the oil cup should be arranged to discharge directly into the steam chamber, thereby lubricating the nozzles, tubes and other parts subject to wear, and preventing the adhesion of scale formed by impurities in the water.

When the filling plug is unscrewed sufficiently to allow the steam to escape, the valve in the bottom closes and the oil cup can be readily filled without closing the main steam valve. When the filling plug is again screwed into position the valve in the bottom is opened and the oil feeds out.

THE EJECTOR OR JET PUMP.

The "ejector" or jet pump is designed for use at railroad water stations, on construction trains, for emptying wheel pits and similar railroad service.

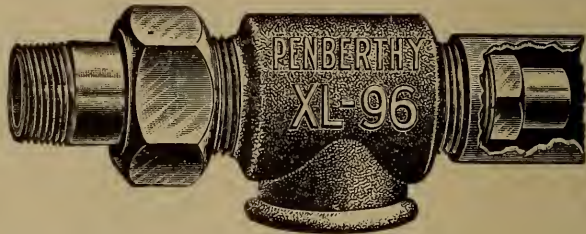

FIG. 1.

Penberthy Ejector.

It is a device, simple in construction, compact in form, convenient to handle, has no movable parts and cannot get out of order.

Fig. 2 shows the position in which an ejector should be placed for high elevations. For lifting only the ejector can be placed at the boiler level.

Where it is required to lift water ten feet or over it is advisable to place a foot-valve on the lower end of the suction pipe.

All ejectors, if properly constructed, will lift water to a height of twenty-five feet, but for elevating

over twenty-five feet the ejector should be placed near the water level and a delivery pipe one size larger than the connections used. In this man-

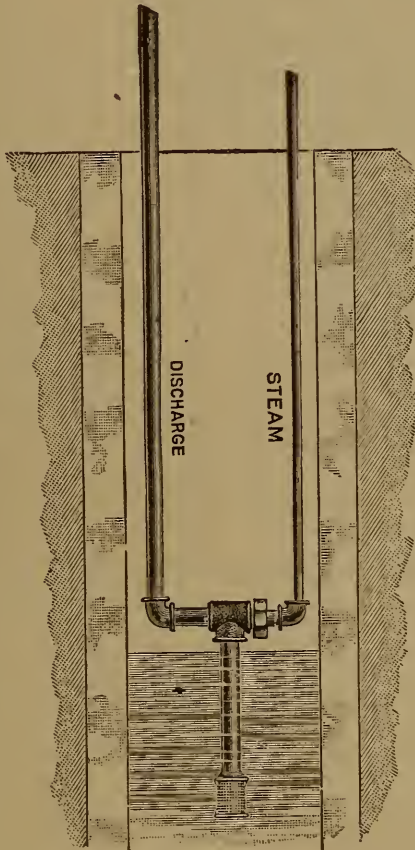
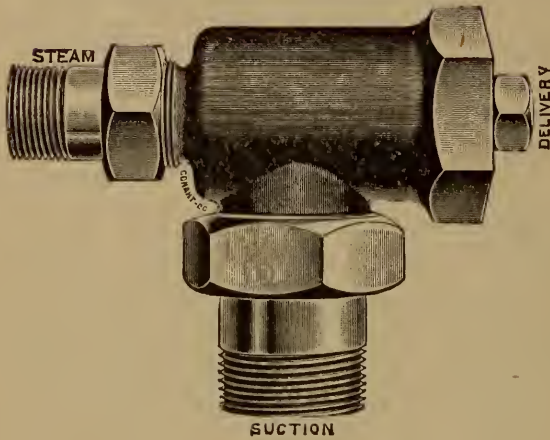

FIG. 2.

Ejector, showing connections for
Elevating.

ner water can be lifted about fifty feet with seventy-five pounds steam pressure, and about seventy feet with one hundred pounds steam pressure.

Fig. 3 is a general view of the Hancock ejector. The "steam," "suction" and "delivery" connections are as illustrated.



SUCTION
FIG. 3.

Hancock Ejector or Jet Pump.

The suction connections must be perfectly tight. Before operating the ejector blow out the steam pipe to remove any iron chips, red lead, etc.

To use an ejector economically, regulate the quantity of steam with the starting valve.

This ejector is furnished to operate with either steam, air or water.

LOCOMOTIVE BOILER CHECKS.

Too great care and attention cannot be given this important part of the locomotive.*

Leaky boiler checks are always a source of great annoyance and no injector, no matter how good it may be, will give satisfactory service under these conditions. The check valve must have sufficient "lift," that is, be allowed to raise sufficient distance from its seat, and when the injector is shut off the check valve must close; if it does not, but sticks or cocks to one side, the steam from the boiler has a tendency to blow back through the injector and cause the latter to become heated beyond its proper working condition, and also causes the injector and branch pipe to become incrustated with lime or other deposits.

The object of the boiler check is to prevent a return flow of water from the boiler when the injector is shut off; the valve is automatically closed by the pressure from the boiler acting upon its upper surface.

Fig. 1 gives three views of a commonly used locomotive boiler check valve, the casing being made of heavy cast iron; the advantage of this form of casing is that any ordinary amount of pounding and rapping that usually occurs when a check "sticks up" will not spring the body and cage of the check and thereby render the valve inoperative.

* For the location of the locomotive boiler check, see the chart "American Steam Locomotive," parts numbered 120 and 121.

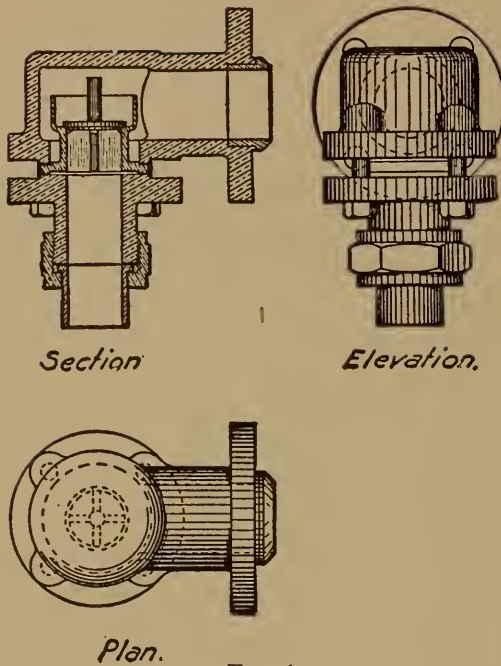

FIG. 1.

Boiler Check Valve, with Cast Iron Casing.

depends a great deal upon the size of both check and injector, but should not be less than one-fourth of an inch nor rarely over three-eighths of an inch.

A combined main boiler check and stop valve is shown in Fig. 2.

The main check valve and its seat can be removed for grinding or repair while the boiler is under steam. This is often of great advantage when a railroad is taxed

The check valve itself is generally but a small part of the boiler check, as the whole attachment is termed. Most check valves have three or four lugs or "wings" which extend below the valve seat and serve as guides to the proper re-seating of the valve.

The proper "lift," that is, the amount the valve can raise, to give a boiler check

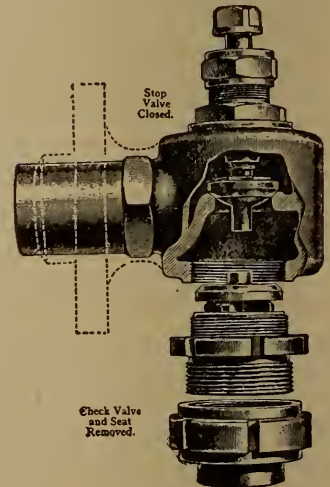

FIG. 2.

Sellers' Combined Boiler Check and Stop Valve.

to the limit for locomotives and often effects a saving of several hours. The illustration shows the stop valve (which is adjusted from the top outside) closed, and the check valve and seat removed. When the check valve is replaced it is evident its lift can be regulated by the amount the stop valve is raised.

Another ingenious form of combined check and stop valve is shown in Fig. 3.

As will be seen, there is a main body (D) in which is the conical plug-like cage (B), held in place by the cap (C) and ring (F). Inside the cage (B) is the usual check valve (E), the lift of which is controlled by the "stop" or projection on the cap (A).

Should the check valve become stuck or leaky, the whole cage (B) can be turned like a plug cock, closing the opening to the boiler and thereby acting like a stop valve between the injector and the boiler. The cap (A) can then be removed and the valve (E) re-ground with a screw-driver, turning the cage back into its original position after the repairs are effected.

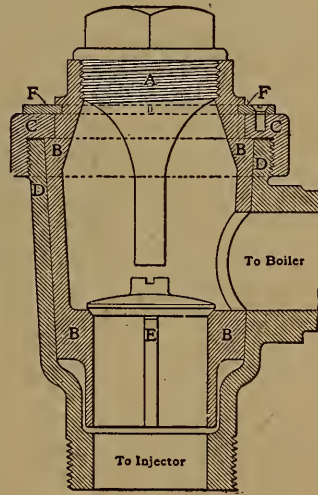

FIG. 3.
Combined Check and Stop Valve.

With the boiler check shown in Fig. 4, the rotary movement of the seat while closing (by the effort of the inclined turbine wings under the seat) on passage of fluid, makes a clean and sure closing check. This may be used with or without an adjustable top, shown

at the left of the stem, which allows the volume of passage to be varied, and thereby proves valuable for very careful adjustment in the working of injectors.

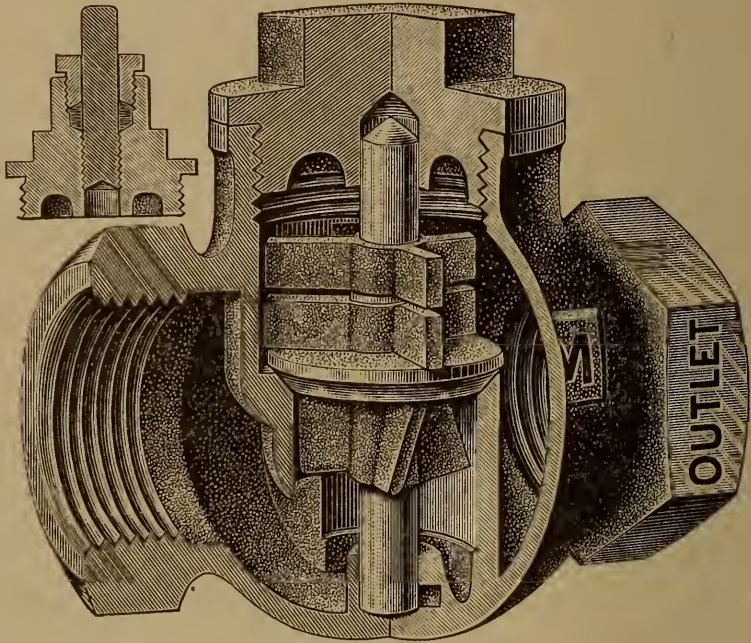

FIG. 4.

Müller Turbine Boiler Check Valve.

The rotary seat insures an even wear and long life, and the mode of passage of fluids insures a clean valve at all times.

LOCOMOTIVE SLIDE VALVES.

The valve is the device which admits steam to, and allows it to exhaust from the cylinder of every steam engine. The form of valve having a flat seat upon which it slides backward and forward is termed a slide valve. The slide valve was used as a means of distributing steam in a cylinder before the locomotive was invented, and has ever since been an important factor therein. *

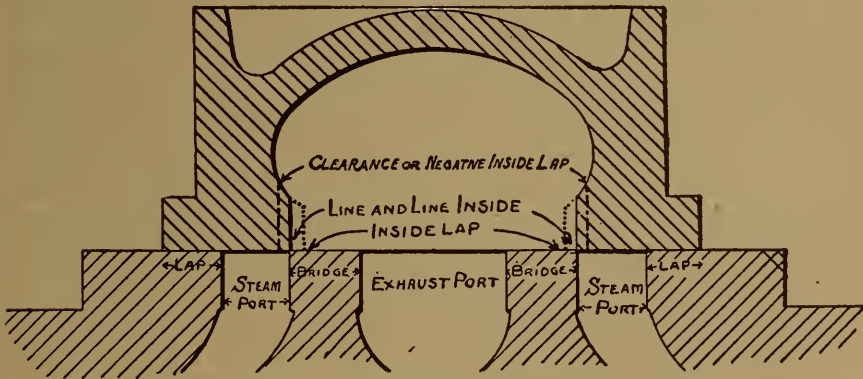

FIG. A.
Graphic Definitions of Valve Dimensions.
Plain Slide Valve.

The plain slide valve was long the standard for locomotive practice, but in more recent years with the increased size of locomotives and their correspondingly larger ports, together with the advent of the

*"The Science of Railways" contains many illustrations and much information relative to the distribution of steam by the slide valve and the eccentrics and link motion which give the movement thereto; also information concerning valve dimensions, etc.

present era of high steam pressure, the friction between valve and valve seat became excessive. These strains must be borne by all parts of the valve gear, which increased greatly the frictional resistances therein, and also taxed to the limit the power of the engineer in reversing the engine. Reversing cylinders were invented and applied to many locomotives, to the relief of the engineer, but not in any way reducing the frictional resistance, which was a large portion of the engine's entire power.

Finally it was found that by relieving much of the steam pressure from the top of the valve—that is, partially balancing it—the friction could be greatly reduced. Of the many means devised to balance the slide valve but few have attained that point of usefulness to merit special description herein, but those widely used throughout the country are here given.

The engraving given of the plain slide valve (Fig. A) gives graphic definitions of the various valve dimensions as they are technically known.

THE RICHARDSON BALANCED SLIDE VALVE.

Referring to the illustrations, Figs. 1 and 2 are longitudinal and transverse sections through the centre of an ordinary locomotive steam-chest fitted with this valve. Fig. 3 is a plan of the valve, and Fig. 4 is an elevation of one of the end packing strips and springs. The only alteration made in the plain valve is the addition of the balance plate (*A*), and the substitution of a valve suited to receive the four packing strips (*p, p, p, p.*)

In these engravings the balance plate is shown bolted to the steam-chest cover, but it is obvious that

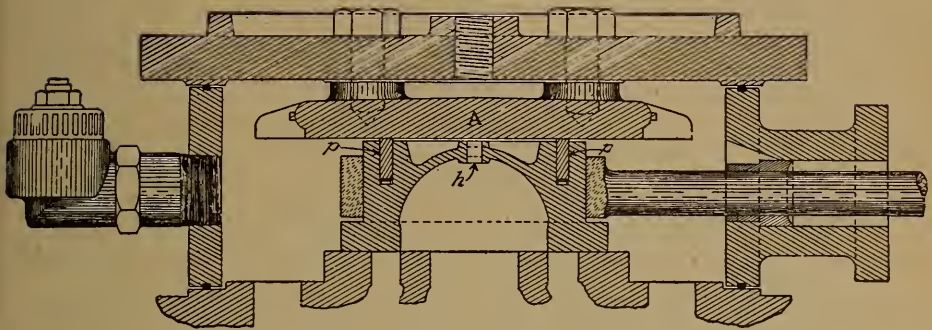

FIG. 1.
Richardson Balanced Slide Valve.
Longitudinal Section.

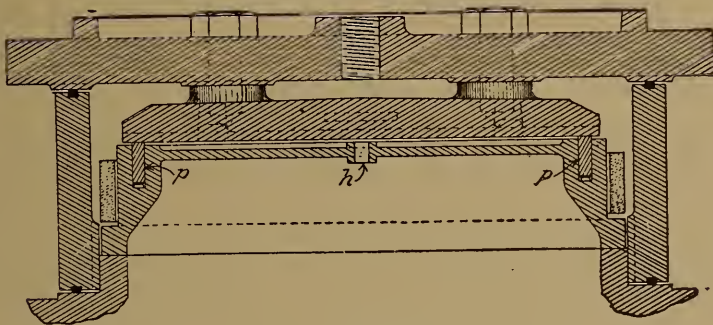

FIG. 2.
Richardson Balanced Slide Valve.
Transverse Section.

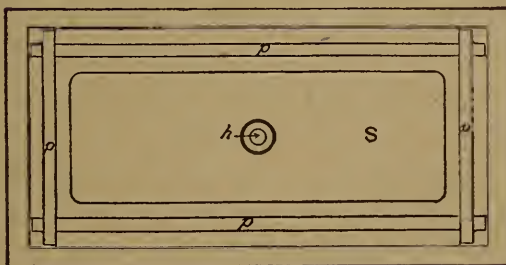

FIG. 3.
Plan.
Richardson Balanced Slide Valve.

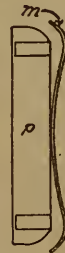

FIG. 4.
Elevation of End
Packing Strips
and Springs.

they may be cast in one piece if desired. As will be noticed, the four sections of packing enclose a rectangular space (*ss*, Fig. 3), which is made equal in area to the amount of valve surface which it is desirable to relieve of pressure; the packing strips preventing steam from entering this space and its communication with the exhaust port in the valve, through the small hole (*h*), relieving it from any pressure that might otherwise accumulate. These packing strips, four in number, as previously noticed, are: the two longer ones, plain, rectangular pieces of cast iron, while the shorter ones, as shown in Fig. 4, are made with gib-shaped ends to retain them in place.

Under each packing strip is placed a light semi-elliptic spring—one of which is shown at *m*, Fig. 4—which serves the purpose of holding the packing strips against the balance plate when steam is shut off. While in operation, the different sections are held in steam tight contact, by direct steam pressure, with the balance plate and with the inner surfaces of the grooves cut to receive them, the joint being made complete by the abutting of the ends of the long sections against the inner surfaces of the gibbed sections at the four corners.

The Richardson form of balanced valve is used more extensively than any other balanced valve in the country.

THE ALLEN-RICHARDSON BALANCED SLIDE VALVE.

The purpose of the Allen valve is to prevent, in part, wire-drawing of steam when running at high speed

with the valve cutting off early in the stroke. The Allen ports furnish an additional passage for the admission of steam at such times; thus, when the steam port is open one-half inch in the ordinary

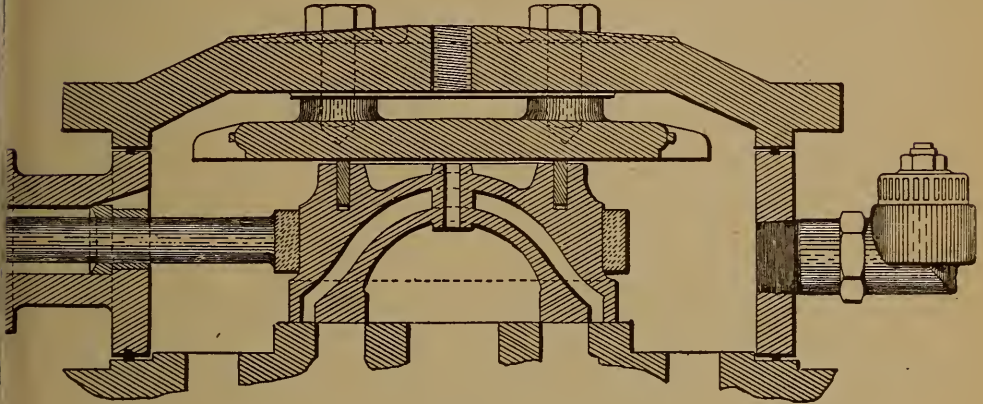

FIG. 5.
Allen-Richardson Balanced Slide Valve.
Longitudinal Section.

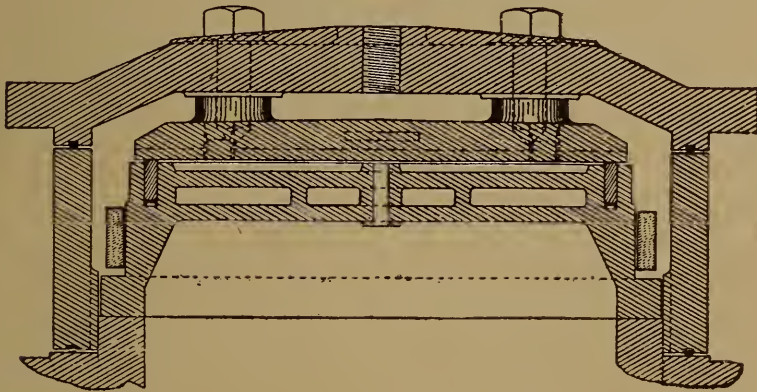

FIG. 6.
Allen-Richardson Balanced Slide Valve.
Transverse Section.

manner, the port of the cored passage is also open to the same extent on the other side of the valve and consequently the effective area of the steam port is doubled and becomes equal to a single port open of one inch.

The wire-drawing which takes place when an engine is running at high speed with the valve cutting off early in the stroke is thus much diminished and the consequent economy of steam and coal is obvious. The lessened wire-drawing implies a higher average pressure on the piston when working at the same cut-off and, therefore, the usual average pressure can be obtained with a shorter cut-off, thus effecting an appreciable economy. Hence the unbalanced Allen valve effects a better and more economical distribution of steam; but its use is attended with certain disadvantages. The bearing surface on the face of a slide-valve is never sufficiently large to enable it to wear well under the heavy pressure of steam, and this wearing surface is still further reduced in the Allen valve, owing to the internal steam-ports. The internal passage virtually divides the valve into two parts and the pressure of steam acting on the outer part springs and bends its working face below that of the internal or exhaust part of the valve. The useful wearing face thus becomes reduced to a space about half as wide as the outside lap of the valve. It is, therefore, not surprising that the Allen valve when unbalanced wears very rapidly and the trouble and expense of constantly facing valves and seats and the loss of steam in blowing through leaky valves, counterbalances the advantages gained by the diminished amount of wire-drawing. These disadvantages are entirely overcome by properly balancing the valve, and then are gained, not only all the advantages of the Richardson balancing device, but also the increased steam economy from using the Allen ports.

To be sure of getting the very best results from the

use of the balanced Allen valve, the ports and bridges should exceed the full travel of the valve by at least one-eighth of an inch. The radius of the link should always be as long as permissible, to avoid an excessive increase of lead when cutting off early in the stroke.

THE AMERICAN BALANCED VALVE.

Two forms of this valve are illustrated, together with a longitudinal sectional view of the valve in the

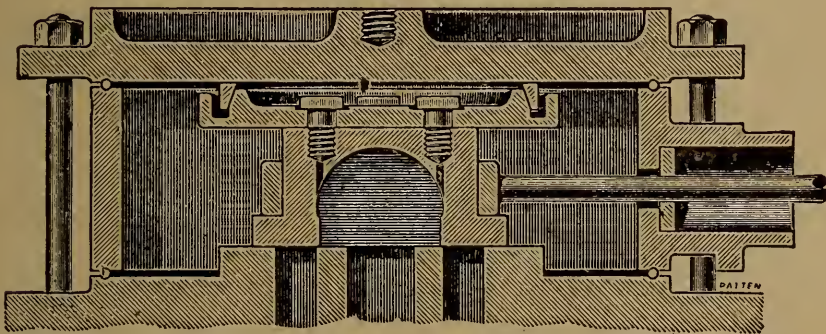

FIG. 1.
The American Balance Valve.
Single Disc Longitudinal Section.

steam chest. Experience proves this balance to be a very successful form of balance valves. This is due to the simplicity of construction, positive action and very large area of balance. The beveled ring is self-adjusting—no springs being required—hence not liable to get out of order.

This form of balance may be applied to almost every form of slide valve.

The American balance valve is used by a great many railroads in this country, consequently details of its construction are here given, believing they will

be interesting to a large number of railroad men. It has also attracted the attention of foreign builders and is now in use upon many locomotives in foreign countries.

The claims of advantage for this valve are, first of all, an absolutely steam-tight joint, not only when newly fitted, but all the time. Second, greater area of balance. The formula for figuring the area of balance differs from many others, and yet this valve will not raise from its seat under all ordinary conditions of service. It should be explained that this valve is balanced in what is presumably its heaviest position, and with the steam pressure acting on the circumference of this taper ring, it will be observed that for the valve to lift it is necessary to force the cone up into this taper ring; and since the ring is held by the steam chest pressure from opening, the valve cannot lift without first overcoming the friction of the beveled face, besides opening the ring against the steam chest pressure. The lighter positions of the valve, where a straight wall balance would allow the valve to go off its seat, need not be considered. It should not, however, be assumed that this taper will crowd the valve down on its seat, which would appear to be a natural conclusion to draw, from its manner of preventing the valve from leaving its seat. If the degree of taper was made great enough—forty-five degrees or greater—the action of the steam chest pressure on the circumference of the ring would, of course, wedge it in between the cone and the chest cover and exert an enormous pressure on the valve. In fact it would not work satisfactorily at all; the friction would be too great. This, however, is not the case. Experiments

have been made with this taper from nine degrees to twenty-four degrees, and the proper degree of taper has been found with which the ring is certain to rise under all conditions, and yet not crowd itself against the upper bearing more than necessary. This is demonstrated by the fact that rings have been reported to have run 190,000 miles with only one thirty-second of an inch wear off their face.

This form of balance is extremely simple, has no delicate parts, is little likely to be broken, has positive automatic adjustment, self-supporting feature of the ring, and entire absence of springs. Its cost of construction is low, and it can be maintained at small expense. It might be stated in explanation of this, that the only repair necessary is to put on a new ring when the old one has worn out from the top downward. As the new rings are one inch deep they can easily wear three-eighths of an inch and still adjust themselves; and to wear a ring three-eighths of an inch, assuming that it is made of proper metal, will, it is claimed, require from four to eight years in continual service. When the old ring is taken off the cone and a new one from stock placed on the old cone, the balance is just the same as when all is new. This is explained by the fact that since the steam pressure on the circumference of the ring holds it firmly against the beveled face of the disc or cone while in operation under steam (its own tension holding it when not under steam), there is absolutely no lateral wear on the ring or disc; hence, a new ring fits an old disc at any future time.

Since these rings are all lathe work (it does not require more than twenty minutes' hand work to fasten

on the L-shaped piece for covering the cut of the ring), it will, therefore, readily be seen that the expense in taking a stock ring and renewing the balance is small.

It would appear that the disadvantages of other valves are removed in this valve by the taper feature of the ring. A variation of one-thirty-second of an inch in the diameter of a ring either way from the sizes

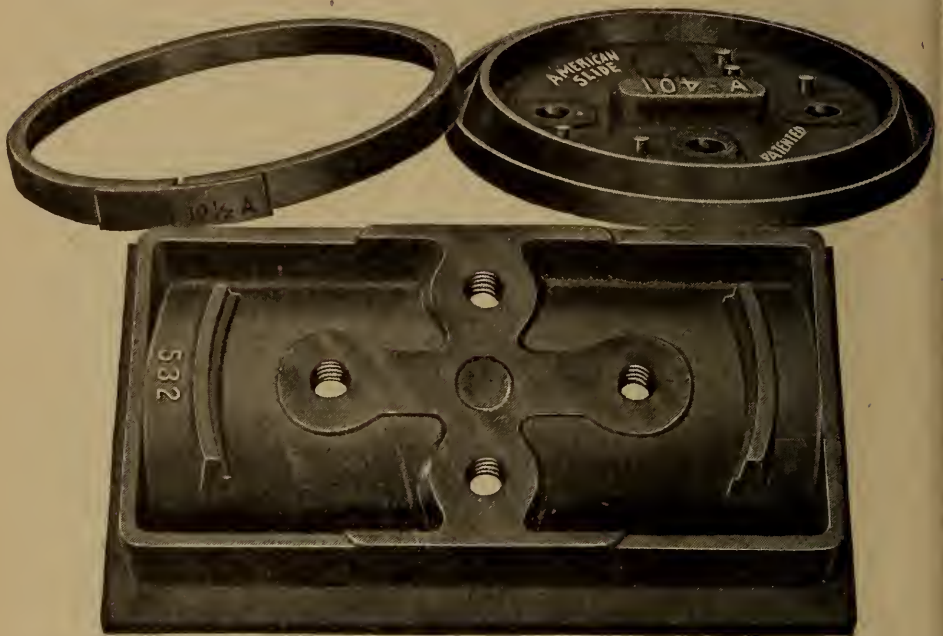

FIG. 2.

Single Disc American Balance Valve.

required would not in any wise interfere with the service of the valve, since the ring is turned one-fourth of an inch smaller than its working diameter.

The ring is expanded over the cone and thus receives a tension which makes it self-supporting when not under steam; the steam on its circumference supports it when in operation. The outside rim or

flange, as shown, extending outside the taper ring, is to prevent pieces of the ring from falling in the path of the valve in the event of accident to the ring.

Several forms of this balance are used, the simple disc (Figs. 1 and 2) and the double disc (Fig. 3) being more fully described.

Single "Disc" American Balanced Valve.—The single disc balance should always be used where chest room will permit it, as one ring and disc is simpler than two, but it will be noticed that in this form the ring and cone extend beyond the sides of the valve.

Rule.—For length of steam chest for single balance, add the extreme travel of the valve to the outside diameter of disc, and to this sum add not less than one-half inch for clearance—one-fourth inch at each end of chest. If a little more clearance is desired, the rims of disc may be cut one-eighth inch, *i. e.*, just flattened on two sides in line of valve travel; but in no case are they to be cut beyond their inside diameter. If sufficient clearance cannot be obtained by cutting the rims one-eighth inch each side in line of valve travel, then double balance must be used.

The ring must be protected by the disc, and when figuring outside diameter of ring one-fourth inch must be added for the joint plate and the ring must be figured when expanded on the cone until its top face is flush with top of cone, or at its greatest possible diameter.

Fig. 2 shows the single disc balance valve with cone and ring removed.

Double "Disc" American Balanced Valve.—When the steam chest is too short to leave clearance for the outside diameter of the disc or cone of single balance

at extreme travel of valve, then double balance is used. If the yoke fit (or box) of valve is large enough, two cones are cast on the valve, as shown in Fig. 3, but if the yoke fit is not large enough to cast cones on, then two discs are used. If the distance across the two discs, when they are side by side on top of valve, is greater than width of steam chest, the rims on each disc may be cut one-eighth inch at center of valve,



FIG. 3.
Double Cone American Balance Valve.

thereby drawing the discs one-fourth inch closer together; and if more clearance is necessary, the rims may also be cut one-eighth inch at ends of valve, giving one-fourth inch more or a total of one-half inch. But in no case shall the rims be cut more than one-eighth inch, or to their inside diameter.

If discs thus cut will not clear the sides of chest, less balance must be used.

Repair of These Valves—Discs Bearing on Valve.—

In all cases where possible the height adjustment should be made by lowering the chest cover, or bearing plate, but when chest cover cannot be lowered the discs may be raised. When it is found necessary to raise the disc on the valve longer bolts should be used and the liners placed between the disc and the valve must be true, and large enough to give a solid bearing for disc on the valve. If found necessary to raise the disc to clear the top of valve yoke, the same rules must be observed. The bolts which fasten the disc to the valve should be steam-tight on threads and steam-tight under the heads, a copper washer being used under the heads, forming a bolt lock. The interior of each disc or cone is relieved to the exhaust cavity of the valve, as shown by the several holes in Fig. 3.

In "cone" balance, holes are drilled through the top of valve, but in "disc" balance the relief holes pass through the bolts, one-fourth inch hole being drilled through each bolt, as shown in Fig. 1.

The Single "Cone" Balanced Valve must be cast flangeless if a valve yoke extending all around the valve (as in locomotives) is used, but need not be flangeless, when made for center rod to drive the valve (as in stationary engines). In case of the locomotive yoke, it is recommended that the yoke be carried on the steam chest at the ends of the valve. Where old chests have rubbing strips wide enough they can be planed on top and the yoke allowed to ride on them, and in new work this can be done cheaper than to put on a front carrying horn and is more efficient than to support the yoke on the valve stem packing and the valve itself. A valve need not be flangeless to thus

support the yoke; it can be carried with any valve, and it insures the free upward movement of the valve at all times, which is very essential in obtaining the best results.

The outside rim on disc or cone is merely a safeguard to the ring in case of accident—preventing broken portions of the ring from getting under the valve—it performs no other duty. The required inside diameter of this rim must allow the ring to be expanded on the cone until the top face of the ring is flush with top of cone and still clear the one-eighth inch joint plate on the outside of ring. In single balance the rims may be cut one-eighth inch front and back, giving one-fourth inch more clearance, when the disc runs too close to steam chest at full travel of valve.

Proper Height Adjustment.—When the valve is in position and the chest cover has been screwed down there should be one-eighth inch between the face of the bearing plate (sometimes called balance plate) and the top of disc or cone. The rings are bored for this position and in this position have their proper tension. This allows the valve to lift off its seat one-eighth inch, which it will do as soon as steam is shut off while the engine is in motion or drifting, provided it is not held down by the valve yoke. The valve yoke must not interfere with this upward movement of the valve.

Proper Tension on Ring.—Rings are all bored smaller than the diameter at which they are to work; therefore, when a ring is set on its proper cone it will stand higher than its working position. The face of bearing plate must not be closer than one-eighth inch

to top of cone after chest cover has been screwed down. In placing the cover in this position the ring is expanded over the cone until its inside diameter at bottom is the proper balancing diameter.

Owing to the natural elasticity of the ring and its expansion over the cone, a tension is placed on the ring, the action of which is (the same as the steam pressure) to close the ring on the cone, which necessarily causes the ring to move upwards. The ring is, therefore, self-supporting and self-adjusting. All rings are interchangeable on discs and cones of respective sizes, whether standard or special.

American balances are known under the following heads:

Single Disc Balance—one ring and one disc.

Double Disc Balance—two rings and two discs.

Single Cone Balance—one ring, with cone cast on the valve.

Double Cone Balance—two rings, with cones cast on the valve.

Necessary Cylinder Relief.—The valve should always be free to lift one-eighth inch off its seat, to allow the free passage of air from one end of the cylinder to the other between valve and valve seat when the engine is running without steam. The tops of all American balance discs, or cones, show a polish, giving positive evidence of their contact with the bearing plate or cover, and that they, therefore, do float. The explanation is: At the first stroke of the piston, after the engine has been shut off, air is compressed in one end of the cylinder while the valve is traveling a distance equal to its outside lap; at an early stage of this compression the valve is thrown

off its seat and the escaping air rushes under the valve into the opposite end of the cylinder to relieve the suction which is taking place in that end; this operation is repeated so rapidly that the valve is kept floating until a slow speed has been reached.

The Formula of Balance Used on the American balance valve is as follows:

(1) Area of balance for plain valves.--Area of one steam port, two bridges, and the exhaust port, plus eight per cent. if for *single* balance and plus fifteen per cent. if *double* balance.

(2) For *Allen* valves use the same formula as above; then from the area derived subtract the area of one side of the *Allen* port.

THE PISTON VALVE FOR LOCOMOTIVES.

The advantages gained by large ports and diminished frictional resistance supposed to be co-relative with the piston valve have been a subject of grave dissension among practical locomotive designers.

The piston valve is an old device, yet of rare use on the locomotive until recent years. The large and successful introduction of the Vauclain* type of com-

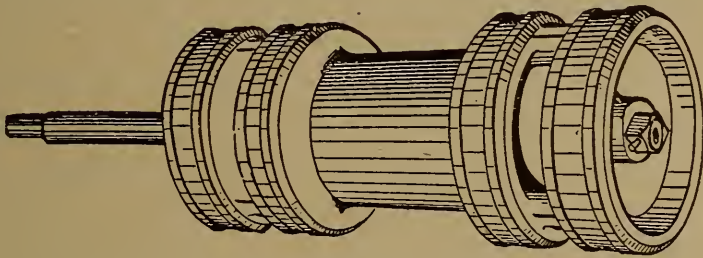

FIG. 1.
Piston Valve for Baldwin Four-Cylinder Compound Locomotives.

pound locomotives, employing a double piston valve, as shown in Fig. 1, is undoubtedly accountable for the much experimenting now going on and the many styles—too numerous to mention—of piston valves in use in a limited number of locomotives on almost every railroad system of any size in this country

It was for some time erroneously supposed that a piston valve was a perfectly balanced valve; this, however, has been proven not to be so, as the unbalanced portion is largely dependent upon the width of

*For complete description of this piston valve, the reader is referred to Compound Locomotives in Vol. XII, "The Science of Railways."

the packing rings. Therefore it is not surprising to find that the principal difference between the various forms of locomotive piston valves lies in the varied designs of packing rings.

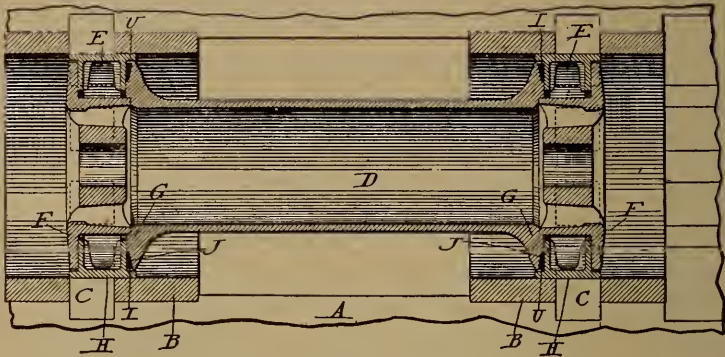

FIG. 2.
Locomotive Piston Valve.

The American piston valve with wide packing rings wedged in such a manner as to prevent their great outward pressure against the walls of the valve chamber, is shown in Fig. 2, as it has been applied to several locomotives of modern and complete design.

WATER GAUGES AND GAUGE COCKS.

In order to determine the height of the water in the boiler, a glass water gauge is attached to the boiler (see plate "American Steam Locomotive," part No. 251) by which the engineer can see at a glance the water level.

The plain water gauge is so familiar to the ordinary practical man that it will be sufficient here to illustrate and describe a few of the improved forms which automatically shut off the flow of steam should the water glass break while in service.

Fig. 1 shows a combined drip-cock and automatic water gauge. The automatic device or ball (D) is moved and agitated every time the handle is turned and gauge glass blown out through the

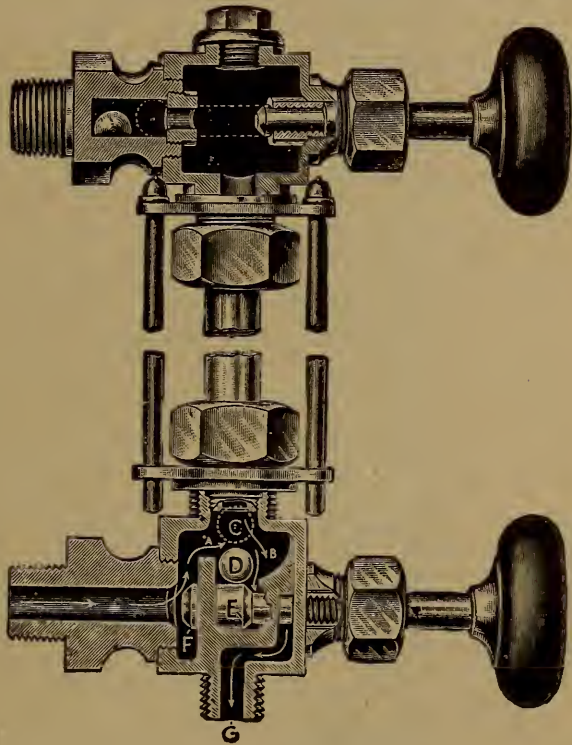

FIG. 1.
Pemberthy Automatic Water Gauge.

valve (*E*) to waste pipe at *G*, and cannot, therefore, become stuck fast by lime or other sediment. It will readily be seen that it is impossible for the two little

balls to go to their seats except when the glass breaks and they take the positions shown by dotted lines.

To blow off, the lower handle is turned a half turn to the right, or toward the closed position for valve (*F*).

E is a double-seated valve shown by Fig. 1 as off from both seats, its position when the gauge is being blown off, which is accomplished by simply turning the lower handle, no pet cock being used. The steam follows the course shown by the arrows (*B*) to the outlet (*G*), the steam pressure being *down on the ball*. In closing, the partition at the left of the ball (*D*) prevents the action of the boiler pressure from suddenly moving the ball to its seat. If, however, the glass break, the rush of steam to the glass, via arrows (*A*), causes an eddy or vacuum which immediately throws the ball to its seat, shown by ball *C* (dotted lines). The ball (*D*) resting on valve (*E*) is rolled about and agitated every time the

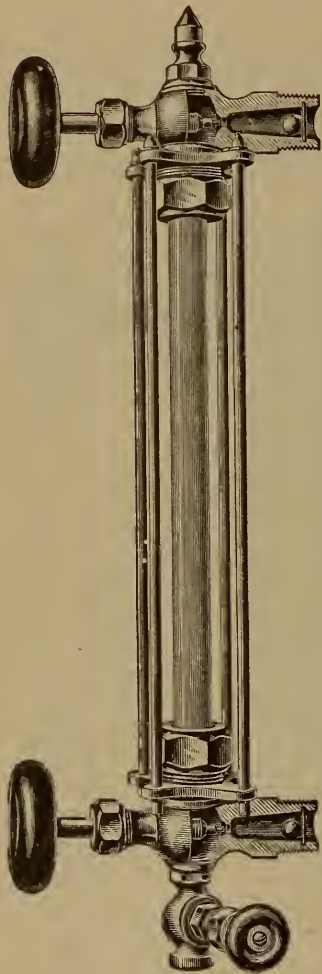

FIG. 2.
Star Self-Closing Water Gauge.

immediately throws the ball to its seat, shown by ball *C* (dotted lines). The ball (*D*) resting on valve (*E*) is rolled about and agitated every time the

handle is turned to blow out the gauge, and cannot become stuck fast and fail to work at a critical moment. The upper half works on the same principle, but of slightly different construction.

Fig. 2 shows a slightly different form of automatic water gauge. Should the glass accidentally be broken, the steam and water rushing out will force the balls up, and close the passages.

After a new glass has been put in place, slowly screw in the wood wheels; the needle projections on the stems will force the ball away from the openings, and leave the passages free and unobstructed again.

In the Crosby water gauge, shown in Fig. 3, both the upper and lower passages to the boiler are instantly and automatically closed by the ball valves on the sudden breaking of the glass, avoiding all danger to life and all inconvenience and waste of steam and water.

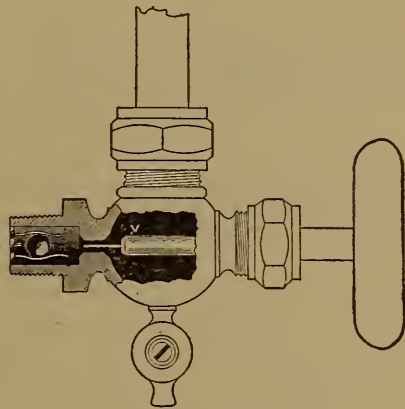

FIG. 3.
Crosby Safe Water Gauge.

When the water gauge is open to the boiler the ball rests within the cage away from the valve seat, where it will remain until it is propelled to it by the sudden breaking of the glass.

When this happens, upon closing the water gauge the ball is pushed back into this cage by means of the pin in the end of the valve *V* (see cut). Care should be exercised upon again opening the water gauge

that the valve (*V*) is turned out as far as it will go, in order to withdraw the pin from the seat and not obstruct the ball valve from seating itself when called into use.

The purpose of the cage is to hold the ball away from the shell of the cock to which corrosion or sediment might otherwise cause it to adhere.

Gauge Cocks.—In addition to the general use of glass water gauges, gauge cocks are used supplementarily for the same purpose. There are generally

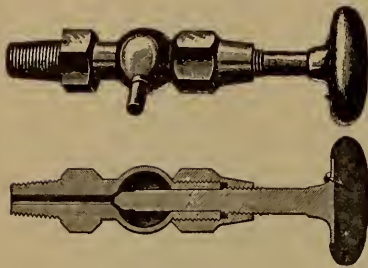

FIG. 4.
Regrinding Locomotive Gauge Cock.

three, sometimes four. The top and bottom ones are placed on the boiler at about a level with the top and bottom of the glass gauge and are used to determine the water level when the glass gauge is out of use from breakage or otherwise. If, when the upper cock is opened it continues to discharge water, there is too much water in the boiler; if, on the contrary, when the lower cock is opened, only steam issues forth, it is an evidence of too little water. Fig. 4 shows a standard pattern of locomotive gauge cock, so constructed that it can be separated for the purpose of re-packing or re-grinding the working parts without detaching it from the boiler while the necessary repairs are being made. It is substantially made and largely used on railroads.

THE MASON AIR BRAKE PUMP REGULATOR OR GOVERNOR.

This regulator is designed to automatically control the air pressure in the brake system for operating the brakes on railroad cars. It is placed in the steam supply pipe leading to the air pump, and regulates the amount of steam passing to pump, and allowing the pump to run just sufficiently to maintain the desired air pressure in the train service pipe.

Description.—The principle on which the Mason Air Brake Regulator works is that of an auxiliary valve (8), controlled by the air pressure from the train service pipe, through the medium of a metal diaphragm (24), and admits steam from the initial side of regulators through a port to operate a piston (19), which in turn opens the main valve (21), and admits steam to the pump. By referring to the sectional view, it will be seen that the steam enters the regulator

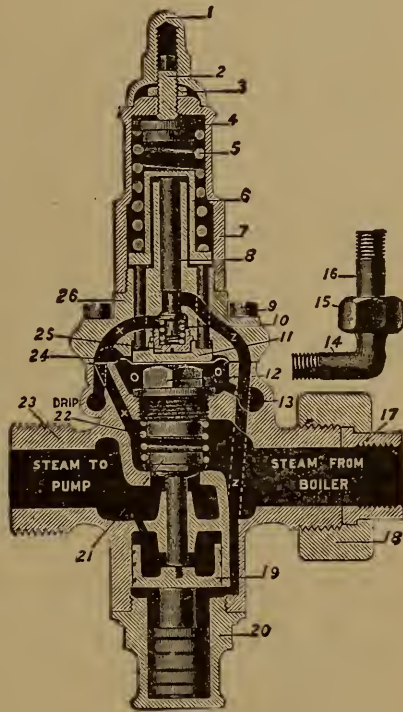

FIG. 1.
Mason Air Brake Pump Regulator.

at the side marked "steam from boiler." a small portion of it passing up through the passage (XX) to the auxiliary valve (8). This valve (8) is forced open by the compression of the large spiral spring (5) acting on the cricket through the diaphragm. This cricket (6) has three studs projecting down from the rim, which pass through three loosely fitting holes in the bonnet, the lower ends resting on a button (11) which sits on the diaphragm, so that in opening the valve (8) the diaphragm is also forced down. As soon as the valve (8) is opened, steam passes through and into port (Z), down under piston (19.) By raising this piston (19) the main valve (21) is opened against the initial pressure, since the area of valve (21) is only one-half of that of piston (19). Steam is thus admitted to the pump. A connection with the main air pipe is made as indicated; and, by a passage, air enters the chamber below the diaphragm, which carries the cricket (8), as before stated. When the pressure in the air pipe (16) and chamber (O) has risen to the required point, which is determined by the tension of the spring (5), the diaphragm is forced upward by the air pressure in the chamber, carrying with it the cricket (6), and allowing valve (8) to close, shutting off the steam from piston (19). The main valve (21) is now forced to its seat by the initial pressure, shutting off steam from the pump and pushing the piston (19) down to the bottom of its stroke. The steam beneath this piston exhausts freely around it—the piston being fitted loosely for this purpose—and passes off into the pump. The leakage past the auxiliary valve (8) passes up under the cricket and out into the spring case, where it

makes its escape down through the cricket holes to the upper side of the diaphragm and into the drip. It will be seen from this that, when the pressure in the brake pipe has reached a predetermined point, the pump will be automatically stopped; and, when the pressure in the brake pipe is reduced by applying the brakes, the pump will quickly produce a surplus pressure in the main reservoir to insure the speedy release of the brakes and recharge the auxiliary reservoirs. The piston (19) is fitted with a dashpot, which prevents chattering or pounding when the air pressure is suddenly reduced.

Directions for Attaching and Repairing the Regulator.—Place the regulator in the steam supply pipe to the pump and so that steam will flow through it in the direction indicated by the arrow cast on the body. With a small pipe make a connection from the train pipe to the air pressure connection (15 and 16) on regulator. The one-eighth inch tapped hole marked "Drip" must be left open, but it may drip from either side by reversing the plug.

Before connecting the regulator to pump, the steam pipe should be thoroughly blown out, in order to expel all dirt. If the piping is new, steam should be allowed to flow through slowly for some little time, in order to burn off all glummy oil and grease, which would otherwise be carried into the regulator and thus clog the working parts.

When ready to start, open both steam and air valve wide, then remove the cap (1) which screws over the screw (2), slack off the jam nut (3), and with the key gradually screw down the adjusting screw (2) until the desired air pressure is obtained. The regulator is

then properly set. Screw the jam nut (3) down firm and replace the cap (1).

If the regulator should fail to hold the desired pressure, it will probably be due to the fact that some dirt or chips from the pipe have lodged on the seat of the main valve (21); or possibly under the auxiliary valve (8). To open the regulator proceed as follows: Shut off both steam and air pressure from the regulator. Remove the cap (1), and with the key unscrew the adjusting screw (2), until all tension is removed from spring (5). Then take out the screws (9), and remove bonnet (7), diaphragm (14) and button (11). Take out the plug (12) and the spring (22). The threaded rod which accompanies each regulator can then be screwed into valve (21) which should work easily. Pull out this valve and examine both valve and seat, cleaning them thoroughly. Then insert the rod through the valve stem guide, screw it into the piston (10), and see if it works up and down easily. It will not be found possible to raise it suddenly, as the dash-pot piston (20) will restrain it. After pulling up, let go of the rod suddenly, and, if the piston drops easily, it is all right. In case it does not, unscrew the dash-pot cap (20), from bottom of the regulator, pull out the piston (19), and clean it with kerosene or spirits. If it seems somewhat tight, rub it with fine emery cloth, being very careful to thoroughly wipe it off before replacing. Before screwing on the bonnet, examine the auxiliary valve (8). To do this, remove the slot-headed plug (25) in bottom of bonnet, also the small spring (10). The valve (8) can then be taken out and examined. This valve should work perfectly free. In taking out the plug (25), there may be a burr,

caused by the screw driver, which should be dressed down before replacing, as this plug forms a guide to centralize the diaphragm button (11), which should fit over it freely. In replacing the bonnet (7), be sure that the zero marks on the side and those on the body correspond; also see that the diaphragm (24) is replaced so that the port holes in it correspond with the holes in the body. Carefully clean the diaphragm as well as the place where it makes its seat. Do not use washers or gaskets of rubber, or any other compound, in making connections. They will burn, and the pieces will get into the regulator. Two copper gaskets for making the steam connections are sent with each regulator.

NOTE.—The reader will find the several forms of Westinghouse Standard Air Pump Governors fully illustrated and described in "The Science of Railways."

LOCOMOTIVE STEAM WHISTLES.

The locomotive steam whistle, aside from its more ordinary uses, is distinctly a safety appliance and a danger signal as well. The tone should be such as not to be disagreeable to the ear of passengers and others, and yet clearly audible to all whom it would

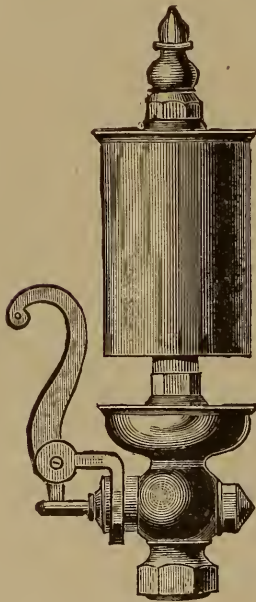

FIG. 1.
Bell Whistle.

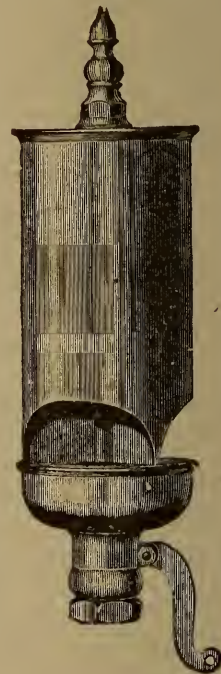

FIG. 2.
Chime Whistle "Locomotive Style."

warn or to whom it would convey signals. Fig. 1 shows the ordinary bell whistle with steam valve and lever attached. As an improvement in tone, various types of chime whistles were made at different railroad

shops. They were, many times, a bunch of pipes of such different lengths as to cause a harmony of sound. The manufacturers have improved on this type, making a chime whistle out of a single bell, as shown in Figs. 2, 3, 4 and 5. This is done by dividing the bell into three or four sections whose depth varies, thus producing different but harmonious tones. Fig. 2 shows what is termed the "locomotive style" because of its upright valve. The slide valve type is clearly shown by Fig. 3, which illustrates this style of Crosby whistle, used on a large number of locomotives and said to be the original single bell chime whistle marketed.

This whistle is fully adapted to severe railway service. In the distribution of material and the uniting of the several parts great care has been exercised in the designing and making of it, so that it shall resist successfully the jars and concussions which may arise in use on a locomotive. In all whistles whenever the valve is badly worn the cup is of little or no value. To meet this condition the valve has been made so that the seats are the same as are employed in the Crosby spring-seat valve, shown elsewhere in this volume, and are seen in the above mentioned cut marked (A) and (B).

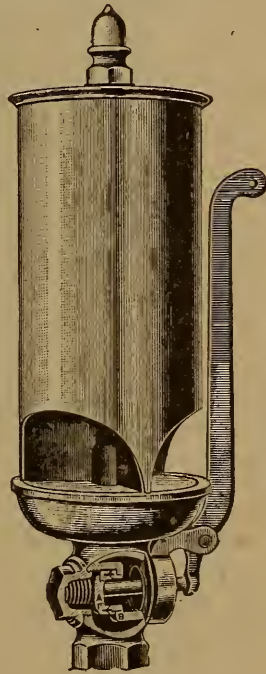

FIG. 3.

Crosby Chime Whistle,
Slide Valve Type.

These seats can be renewed at a small expense whenever they are injured or worn, thus preserving the entire whistle for a very much

longer time than formerly when in constant service. This applies only to the sizes five-inch and six-inch diameters of bell, which are the ordinary ones for locomotives.

Fig. 4 represents the Crosby single bell chime whistle. It differs from the whistle last illustrated in having a compound automatic whistle valve incor-

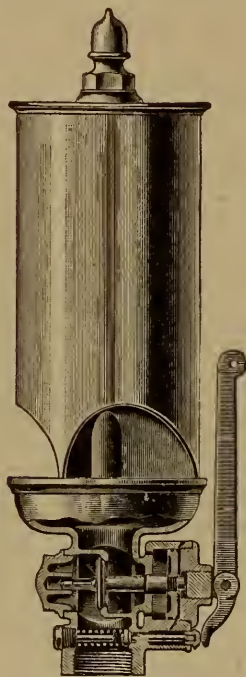

FIG. 4.
Crosby Single Bell Chime
Whistle.



FIG. 5.
Ashcroft's Four-Tone Chime
Whistle.

porated as a part of its construction, in the place of the ordinary whistle valve. It has been found by experience that whistles, when used under the high pressures which are to-day in almost general use, are sounded or operated with difficulty and great exertion. To meet this difficulty, that is, to sound whistles of any size, no matter what the pressure is,

with little effort, this whistle was designed. The ease of operation can be readily seen by an examination of the cut. The only valve which must be operated by force is the small one which is held closed by a spiral spring pressed to the foot of the lever. A slight pull on this lever pushes inward the valve and permits the steam to flow into a chamber and to open automatically the large valve and sound the whistle. By this device the largest whistles under the highest pressure of steam are operated with ease and rapidity.

The Ashcroft four-tone chime whistle is shown in Fig. 5. These whistles are pitched to first, third and fifth of the common musical scale, which harmonizes the sound and gives an agreeable musical chord.

The chime whistle has proved much more penetrating than the single bell whistle, as shown in Fig. 1, and can be heard at a greater distance, without the harsh, disagreeable noise.

Many railroads have adopted a chime whistle for passenger runs, in order to distinguish passenger from freight trains, but new locomotives are being added so rapidly, and are of such size as to haul very long trains, and thus require a whistle of maximum penetrating qualities to be heard at the rear end of the train.

STAY BOLTS.

The corrugated fire box for locomotive use being only in the experimental stage, it may be said that practically every locomotive has several hundred stay-bolts which form the connecting and strengthening link between the fire-box and the outer shell of the boiler. (For the description and construction of the locomotive boiler, the reader is referred to Vol. I, "The Science of Railways," where he will find many engravings relating thereto; also to Plate I, "The American Steam Locomotive.")

The great expense to railroad companies caused by the frequent breaking of stay-bolts, requiring renewals of same and the consequent laying up of the engine out of service, have led motive power men to consider the means of remedying this evil. A number of different devices have been used in the effort to accomplish this end. Some of them have proven fairly satisfactory; others have failed and been abandoned. In soft water districts where the breakage of stay-bolts is not so frequent and is, therefore, not such a serious matter, some of these devices have apparently given good results; at least the mechanical construction of the device has received credit where it is more than likely the credit was due to soft water and careful handling of engine by the engine crew. But on roads not so favorably situated, where the water is heavily impregnated with lime, sulphur and other ingredients which deposit a hard scale on

the fire-box sheet, stay-bolts and flues, the conditions are very much more severe; the frequent leaking of the flues making it very difficult for the engine crews to handle their fire and water supply with the regularity desired and the incessant rising and falling of the temperature in the fire box causes a corresponding expansion and contraction of the fire-box sheets.

The sheets being covered with scale of greater or less thickness become overheated, and this causes excessive expansion of the sheets. This constant movement of the fire box while the shell of the boiler is comparatively rigid, the two being firmly riveted together at the foundation ring, all movements of the fire box must be accommodated by the stay-bolts and the importance of flexibility in the stay-bolts has been recognized as an absolute necessity. A great many roads have tried the expedient of reducing the diameter of the stay-bolts in the water space; others have milled out the stay-bolt longitudinally in the water space, and while these and similar attempts have accomplished some good, the urgent necessity for something more flexible and durable has been felt to be a necessity by the motive-power department of our railroads, especially in those sections using bad water. It has been observed that about ninety-nine per cent. of all stay-bolts which break give way just inside of the outer sheets; this being fully recognized by locomotive builders and locomotive superintendents, it has become an almost universal practice to drill a small hole in the outer end of each stay-bolt for the purpose of detecting broken stay-bolts. While this has worked satisfactorily in soft water districts, it has been the experience of

motive-power men in bad water districts, that, after the stay-bolts have become partially broken, the fracture extending from the outer surface to this small hole drilled in the stay-bolt, the lime and other scaling matter contained in the water, works its way into the hole, so completely stopping it up as to prevent any escape of steam or water. In such cases the method of detecting broken stay-bolts is by the insertion of a steel wire or other suitable pointed instrument into the detector holes.

Many theories have been advanced as an explanation for the breaking of stay-bolts, and as to the cause of their breaking invariably next to the outside sheet. It is conceded that the expansion and contraction of the fire-box sheets is principally responsible for the fracture of the stay-bolts—due to the repeated change in position of the fire-box.

This same action goes on in the fire-box of every locomotive, whether the water used is what is known as soft water or hard water, and it has been somewhat of a puzzle to account for the much larger number of broken stay-bolts in those engines using hard water.

The following explanation has been suggested as the true cause of this trouble, where hard water is used: In the first place, scale forms more rapidly on the fire-box sheets; the sheets become much hotter, and the expansion is much greater than where no scale is formed.

These strains brought upon the stay-bolts due to the expansion and the contraction of the sheets, open the fibre of the metal in the stay-bolts near the outer shell of the boiler, and a thin film of scale is immediately deposited, and when the stay-bolts are forced in

the opposite direction, this film of scale, occupying the space, offers resistance to the fibre of the metal resuming its normal position. In the meanwhile scale is deposited in the open fibre of the metal on opposite side of stay-bolt, and as this process continues, the film of scale being deposited in this ever increasing opening has the effect of wedging the metal apart alternately on one side and then on the other, finally causing the stay-bolt to part at that point. The stay-bolt does not break next to the fire-box sheet. Due to the fact that this end of the bolt is kept at such a temperature that the metal is more elastic and yields to the change of position without opening the fibre and exposing it to the entrance of this deposit of scale.

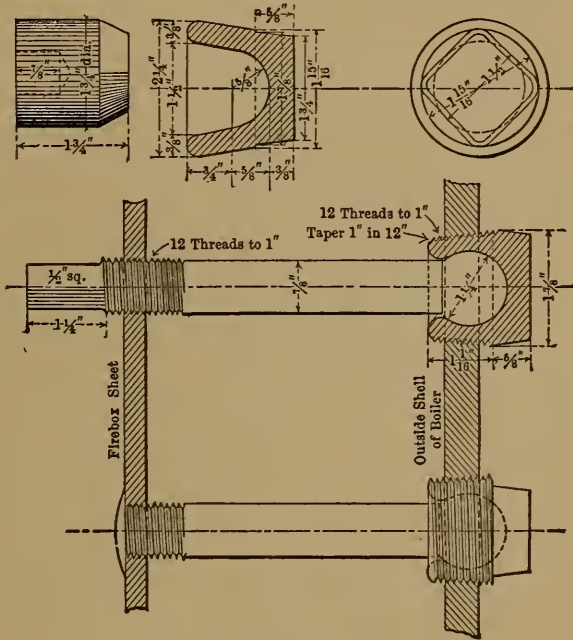

FIG. 1.
Johnstone Flexible Stay Bolt.

To overcome this difficulty many other mechanical devices have been designed, one of which, known as the Johnstone flexible stay-bolt, derives its name from the designer, a mechanical superintendent of a large American railway.

It will be seen by reference to the accompanying engraving (Fig. 1) that this device is composed of two parts; the plug is made of mild steel, while the stay-bolt proper is made of any of the standard brands of iron generally used for the purpose, or of steel, which is much cheaper and has a greater tensile strength. The plug is first made as a drop forging; the ball on end of stay-bolt is formed in an upsetting machine; the ball is then inserted into the cup or plug, and the metal of the plug folded down around the ball.

The method of applying this stay-bolt is as follows: The plug is screwed into the outer sheet while the stay-bolt proper is screwed through the inner or fire-box sheet, the square end of the stay-bolt enabling the man on the inside of fire-box to screw in the stay-bolt, while the man on the outside screws in the plug. After the stay-bolt is screwed into place, it is cut off on the inside and hammered over in the usual way (as shown in the lower bolt of the engraving), while a holding-on bar is held against the back of the plug.

The upper figure in the cut shows the bolt as screwed in and before being cut off; the lower figure shows the bolt cut off and hammered over ready for service.

It is claimed that this is a perfectly flexible stay-bolt and no amount of movement of the fire-box can have any effect to break it.

In renewing stay-bolts in old fire-boxes, where it becomes necessary to put in a larger stay-bolt---this is done by enlarging the end of the stay-bolt where it is screwed into the fire-box sheet. The ball on the end of the stay-bolt and the neck of the stay-bolt adjacent

to the ball retain their standard dimensions, and are the same for all sizes of bolts.

The practice adopted by one large railroad in renewing old stay-bolts of the ordinary form and replacing them with these flexible bolts, is as follows. The outer end of the stay-bolt is drilled through the outer sheet with a one and five-eighths inch twist drill. A piece of gas pipe is then inserted through the water space, so that the old stay-bolt to be removed is inside of the pipe; the stay-bolt is then cut out or drilled out of the inside sheet, and is knocked out through the pipe. This prevents it from falling into the water leg of the boiler. The outer sheet is then tapped out, pieces of gas pipe or suitable mandrel passing through the tap or through the inner sheet of the fire box, guiding the tap. The fire box sheet is tapped out in the usual way. All of this work is done by the use of pneumatic tools, and is thus rapidly performed. These stay-bolts have been tested to ascertain what pull would be necessary to open up the plug, or pull the ball out of the plug. Tests have been made where the plug was screwed through the outer sheet, so that the center of the ball was inside the inner surface of the sheet, thus removing any re-inforcing effect which the sheet might have on the plug; and under these conditions it was found that it required from twenty thousand to twenty-five thousand pounds to pull the ball out of the plug, and where the plug is screwed into the sheet, as shown in the engraving, the sheet re-inforcing the plug, the bolts broke in the thread under a pull of from twenty-eight thousand to thirty thousand pounds, without so much as loosening the ball in the plug. As these bolts in service have only to resist a

strain of about three thousand pounds, it will be seen that they have a factor of safety under the worst conditions of six, and under normal conditions of nearly ten.

As the usual brands of standard stay-bolt iron are simply valuable on account of their ductility or drawing-out property, this quality being unnecessary in the Johnstone flexible stay-bolt, the manufacturers thereof strongly recommend the use of steel in the bolt proper, not only on account of its less cost but also because of its greater tensile or pulling strength and greater durability.

It is not urged that these bolts be used throughout the entire boiler. Different people have different ideas and varied experience as to where staybolts break most frequently, hence the flexible bolt should be applied as the experience and the judgment of the user dictate.

Inspection of Stay-Bolts.—As a result of long experience, it has become the general practice of most railroad companies in this country to have a careful test and stay-bolt inspection made each month, of every locomotive in service. To this practice is undoubtedly due the great decrease in locomotive boiler explosions, for the stay-bolt has been the hidden source of these disastrous occurrences, more than any other. In conclusion, it should be said that even with drilled or hollow stay-bolts, no inspection should be allowed to pass without its being absolutely known by the insertion of a wire or other pointed instrument into the hole for a distance greater than the thickness of the shell, that the hole itself is not stopped up.

LOCOMOTIVE ECCENTRICS.

The reason the eccentrics of a locomotive should be considered of great interest to the practical railroad man is perhaps not difficult to explain, if we take into consideration the frequent delays due therefrom, and the fact that there are, in number, four of them on every locomotive, that they are of great size and weight, and that their speed is the highest at times when inspection is impossible until some stopping point is reached. While they should be provided with a set-feed oil cup (besides the usual oil hole filled with hair or wool), still on the locomotive they are not readily accessible and can only be well inspected by getting under the engine in the roundhouse.

The accompanying engraving of Linstrom's improved eccentric for locomotives will be of interest from the fact that it would seem to solve some of the difficulties attendant upon the usual construction of locomotive eccentrics.* The eccentric set screw is done away with, the U-shaped bolt *D* not only holding the two segments *A* and *B* together, but also clamping them to the shaft. While there is no objection to the use of keys with this eccentric, it is said to be unnecessary, as its construction prevents its slipping on the shaft. It is claimed to allay the running hot of the eccentric, which often occurs on the ordinary form, on account of tightening the set

* For illustrations and description of the ordinary locomotive eccentric, the reader is referred to "The Science of Railways," General Index.

screws and thereby forcing the eccentrics away from the shaft and causing them to bind in the straps, producing excessive friction.

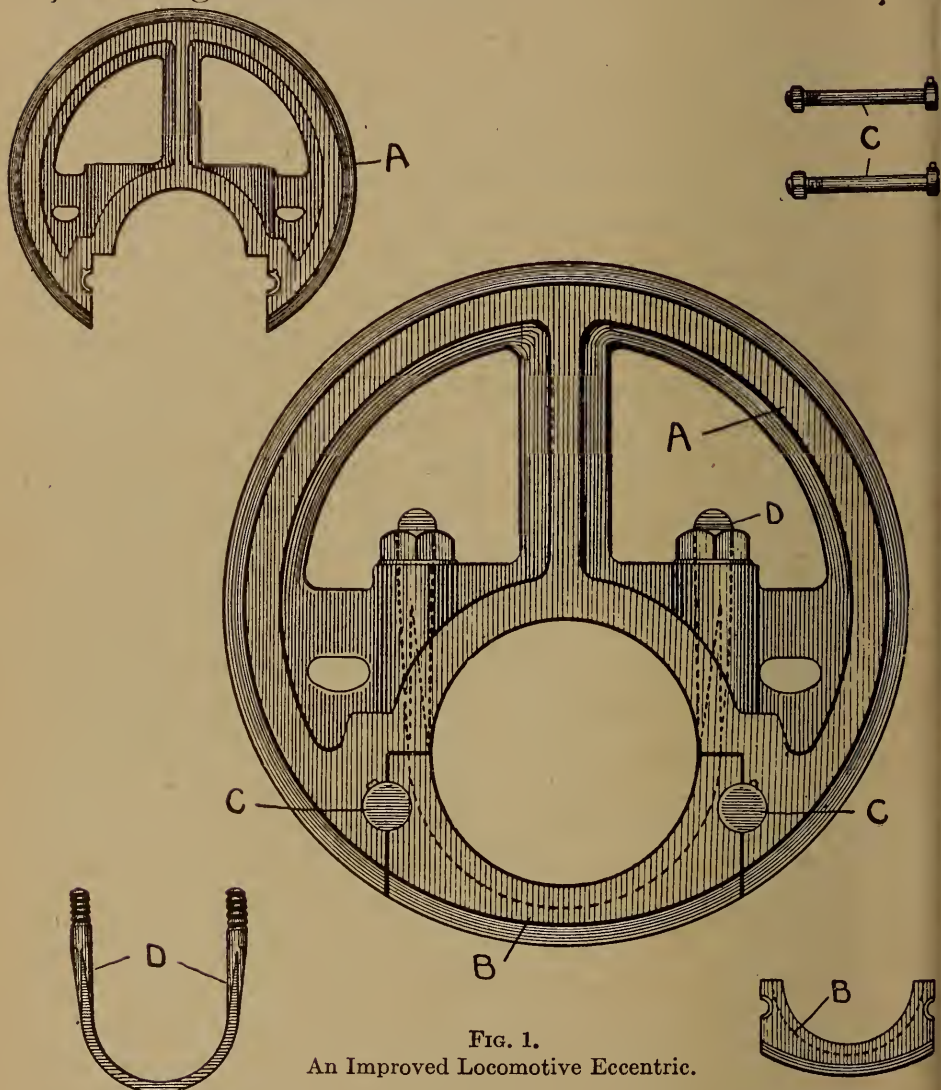

FIG. 1.

An Improved Locomotive Eccentric.

The two bolts *C C* serve as dowel pins to hold the two halves of the eccentric rigidly together, even if nuts on U-bolt *D* should become loosened.

ROD PACKING FOR LOCOMOTIVES.

In early locomotive practice all the glands and stuffing boxes were packed with hemp, cotton or other fibrous packing, occasionally some ingenious engineer buying a little tea-lead when he became too tired of renewing the packing almost daily. And it is perhaps this latter practice that furnished the idea of metallic packing now so generally used on valve stems and piston rods.

There still remains, however, a considerable number of locomotives, especially on logging or other

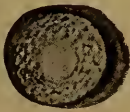

CLASS A.
Round or Square.

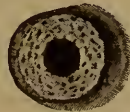

CLASS C.
Round or Square.



CLASS K.



CLASS L.

Rubber Wound Cloth Packing.

small railways not conveniently situated with reference to machine shops, where some kind of packing other than metallic is used on these parts; but instead of hemp or cotton, some of the forms shown in the accompanying illustration, as *A*, *C*, *K*, and *L*, being those most used. The packing here shown is made from layers of asbestos cloth or canvas coated with rubber. This makes a very strong and elastic packing, suitable for joints of all kinds. A mixture of

plumbago or graphite is often intermixed with the layers of cloth and rubber, and tends to reduce the friction to a considerable extent and insure greater life to the packing.

The first metallic packing for locomotives simply furnished metal rings in place of the fibrous ones formerly used. It failed to provide all the essentials that have since been found necessary to success.

Fibrous packing had at best more or less elasticity. It was possible to compress it between its gland and the bottom of the stuffing box enough to make it contract on the rod and make a joint. If the rod moved out of the center of the stuffing box when at work, it pushed the packing aside, and when it moved back its packing followed it or else there was a leak. Some means had to be provided to make the soft metal rings fit the rod and be free to move with it. They must fit tighter on the rod when the steam is on than when it is off.

The first improvement was in adopting a cone cup on the gland end of the packing and fitting the soft metal rings into it. These rings were kept into the cone by a spring. This kept the rings in contact with the rod, and the steam itself increased the pressure when the piston was doing work.

UNITED STATES METALLIC PACKING.

By reference to Figs. 1 and 2 it will be seen that this packing consists of three babbitt rings, numbered 2.

The parts referred to by number in these cuts are: 2—three babbitt rings, known as one ring; 3—flange follower; 4—ball joint; 5—swab holder; 6—vibrating cup; 7—gland; 8—preventer.

It will be seen that all the parts other than the babbitt rings are simply for the purpose of properly securing these in a steam-tight position against the piston rod, with the exception of the ball joint 4, which is to prevent the escape of steam from around the



FIG. 1.

United States Piston Rod Packing.

packing. The babbitt rings 2 are made each in two halves in order to avoid the necessity of disconnecting the crosshead from the rod, and they are placed in a vibrating cup, 6, whose interior form is that of a double angle cone. The face of this cup 6 bears against the

therefor, namely: the flange follower 3 and the vibrating cup 6 are composed of two rings, the inside one of which in each case is made in two halves.

This packing should always be lubricated by an oil cup supplying oil to a swab cup.

Fig. 3 shows the Gibbs vibrating cup, designed for engines having an enlarged end on rod. It is recommended as an improvement over the regular vibrating cup for this purpose. This cup has an inner ring, in halves. In designing new work, using this cup, it is desirable to increase the diameter of stuffing box one-half of an inch.

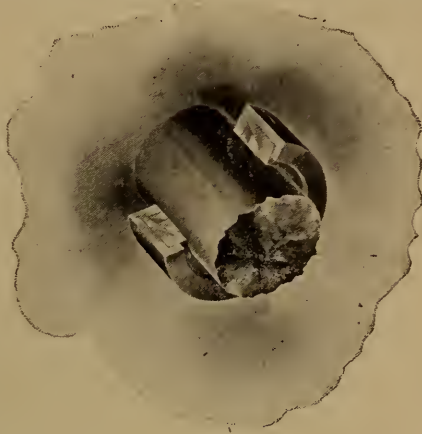

FIG. 3.
Gibbs' Vibrating Cup for Pistons with Enlarged Ends.

UNITED STATES VALVE-STEM PACKING.

It will be seen by reference to Fig. 4 that this packing is very similar to the piston packing of the same manufacture. A bushing or support, 9, is placed in the stuffing box to carry the weight of the valve stem. This support wears the valve stem less than the neck of the cylinder head formerly did, yet it is certain to wear some flat place on the under side of the valve stem the length of the valve travel when the reverse lever is hooked up in the position most used. Then when the valve is full stroked this flat place would travel farther into the packing rings, and cause

a bad leak. This has been overcome in the design of this packing, by the use of the long, extended gland 7 and preventer 8, which render the distance between the support 9 and the babbitt rings 2 slightly greater than the full valve travel.

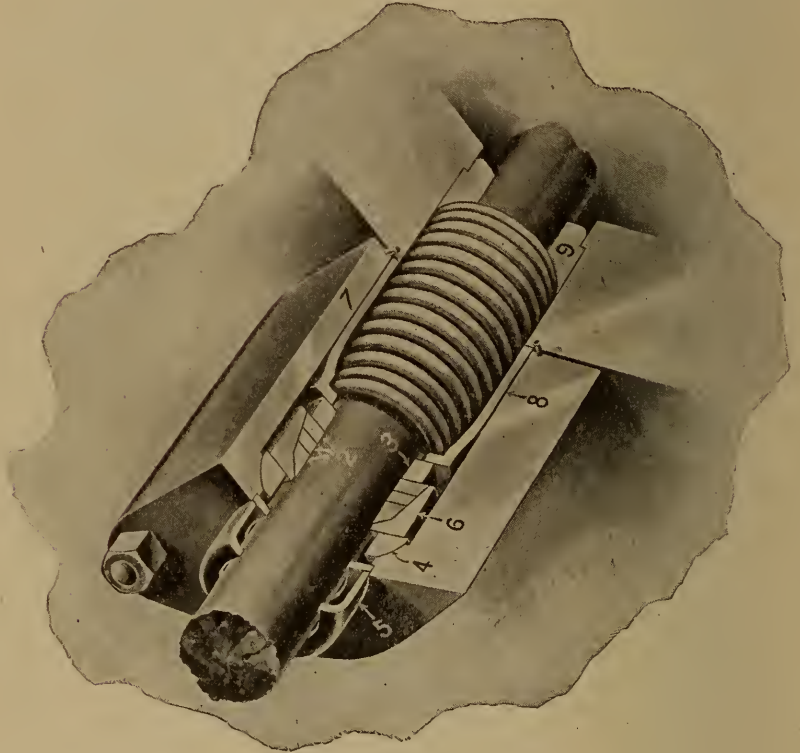

FIG. 4.

United States Valve Stem Packing.

Parts referred to by numbers, in Fig. 4, are as follows: 2—three babbitt rings in halves, known as one ring; 3—follower; 4—ball joint; 5—swab cup; 6—vibrating cup; 7—gland; 8—preventer; 9—support.

JEROME METALLIC PACKING.

Fig. 1 represents the Jerome piston rod packing, embracing all the new improvements used therewith. The parts designated by letter are: A--piston rod; B--the cone; C--the gland; D--the stuffing box; E--the packing rings; F--the follower; G--the coil spring; H--the bushing ring; J--stud bolts; K--sliding ground joint; L--cap screws, to hold the swab

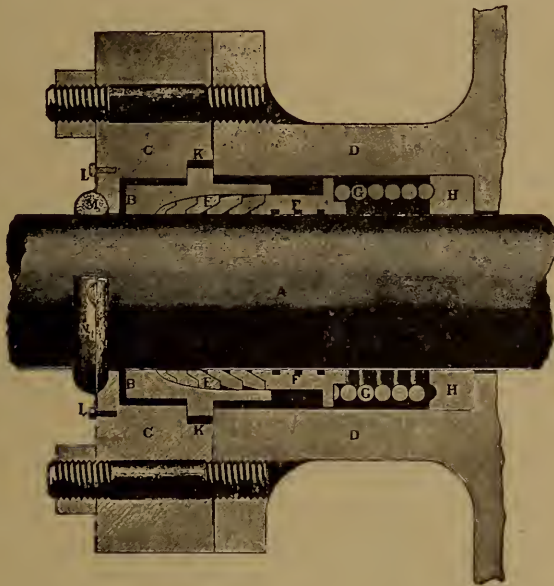

FIG. 1.

Jerome Piston Rod Packing.

holder; N--swab holder; M--the swab. The swab holder N is one of the best devices for oiling the piston rod and valve stem of an engine yet invented, and is now applied to all of the Jerome packing.

Fig. 2 shows in detail the Jerome standard piston packing for rods with enlarged ends. B represents the gland; C, the rear portion of the cone which is

ground to a joint in the gland *B*; *D*, the outer portion of the cone or packing case, which is made in halves,

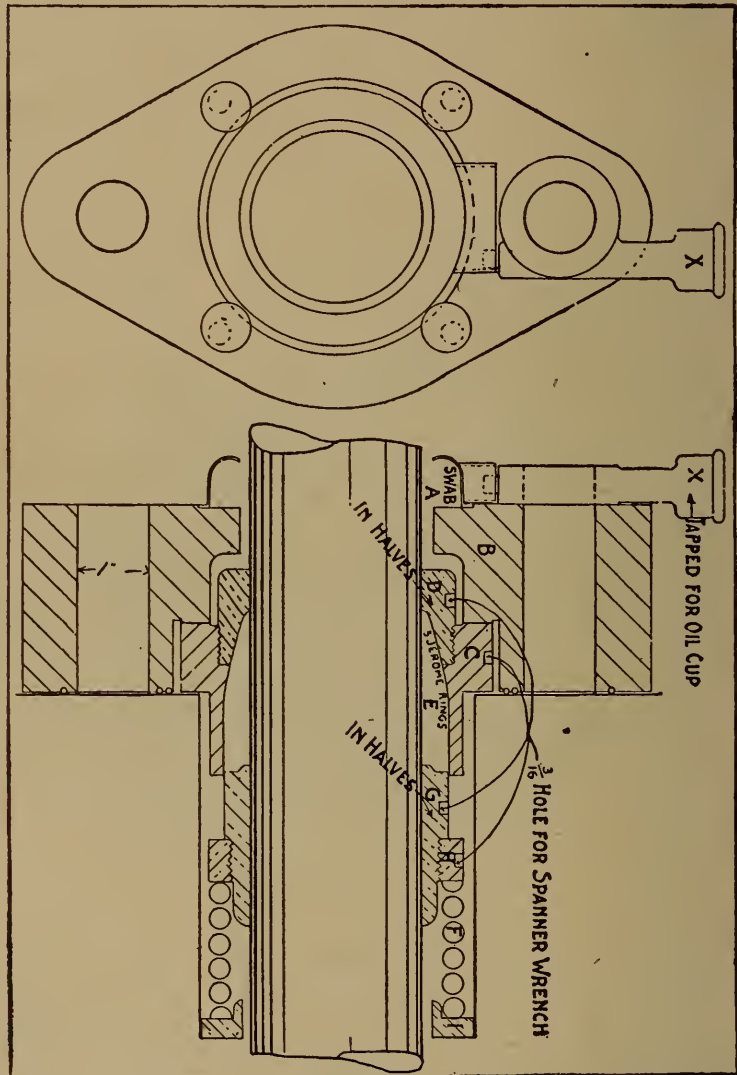

FIG. 2.

Jerome Piston Rod Packing for Pistons with Enlarged Ends.

of gun metal, and fitted with dowel pins to hold it rigidly in place when applied. The two halves of *D*

are held together by *C* screwing over them. *E* shows the space where the packing rings shown in Fig. 1 are to go; *F* is a coil spring; *G* is a follower, which is also made in halves and held in place by the ring *H*, which screws over it from the inside; *I* is a ring placed in the bottom of the stuffing box, where it cannot rub on the rod, and is used to make a seat for the spring *F*; *X* is a pipe, or tube, leading to the swab, and *A* is the oil cup, fed from the pipe *X*, which screws into it.

When desired, cone *C* is made in two parts, the outer ring being in the form of a ball joint, but in most cases this is said to be unnecessary.

After the piston rods have become worn and are turned down, it is only necessary to make a smaller cone, *D*, and reduce the size of the packing rings by cutting out a portion of each ring, so that it will close upon the smaller rod.

The babbitt packing rings used in this packing are each partly severed, as shown in Fig. 3, which represents a set of rings with one ring above opened in open position, ready to close around the rod without the necessity of disconnecting the rod from the crosshead. As the packing wears it ordinarily only requires the addition of another of the larger rings.



FIG. 3.
Packing Rings
for Jerome Pis-
ton Rod Packing.

JEROME VALVE-STEM PACKING.

Fig. 4 shows in a similar manner the application of Jerome metallic packing to a valve stem. It will be seen that the cone *D*, or vibrating cup, has a straight sliding joint at *C* to compensate for any lateral play

in the valve stem. This is found to be satisfactory, except where there is a great deal of rolling motion, due to the valve stem being very short, in which case a

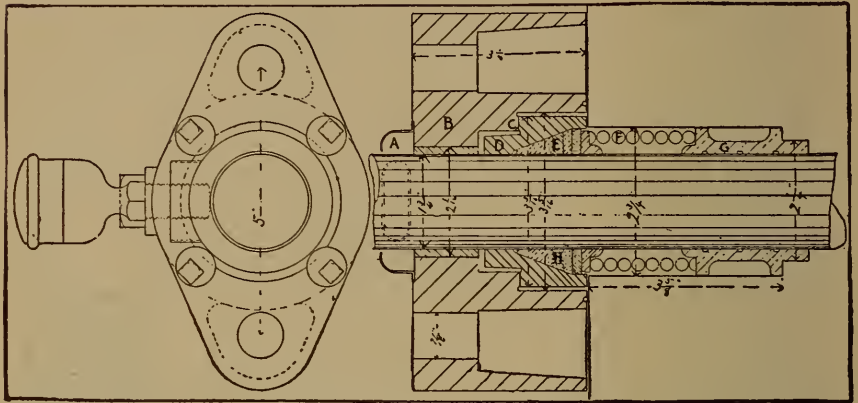

FIG. 4.

Jerome Valve Stem Packing.

ball joint is made at *C* by the addition of another ring, as before described for piston packing where desirable.

When the valve stem wears or is turned down, it is

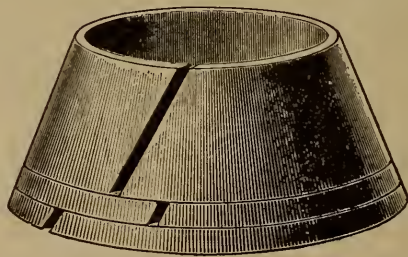

FIG 5.

Jerome Valve Stem Packing Rings.

only required to make a smaller cone *D*, and add new packing rings.

Fig. 5 shows the babbitt rings for one valve stem,

turned up to proper size, ready for application. In case it is not convenient to disconnect the valve stem, the rings may be sawed in half, and applied in this manner. In applying new rings to either the piston rods or valve stems, be sure that all joints are properly broken.

AIR PUMP METALLIC PACKING.

As the air brake is now almost wholly relied upon to handle trains--both passenger and freight--a failure to obtain sufficient air pressure usually results in serious delays to trains, as well as rendering their operation less safe.

Air pumps are one of the hardest things to pack well with fibrous packing, and yet one of the easiest to pack with metallic packing. Several large railroads use shot and graphite, which in time hardens into a state similar to babbitt packing; many other railroads use a metallic packing of their own design; hence it will suffice to here show the two forms of metallic air pump packing most frequently used when purchased from manufacturers.

UNITED STATES AIR PUMP PACKING.

This form of packing is shown in Fig. 1 as applied to the regular stuffing box standard to air pumps. It should be noted that the cone is made enough smaller than the stuffing box to allow some vibration. The cone also has a shoulder fitting over the stuffing

box, thereby preventing the gland being screwed in far enough to close up the coil spring.

The form of the babbitt rings is seen to be quite

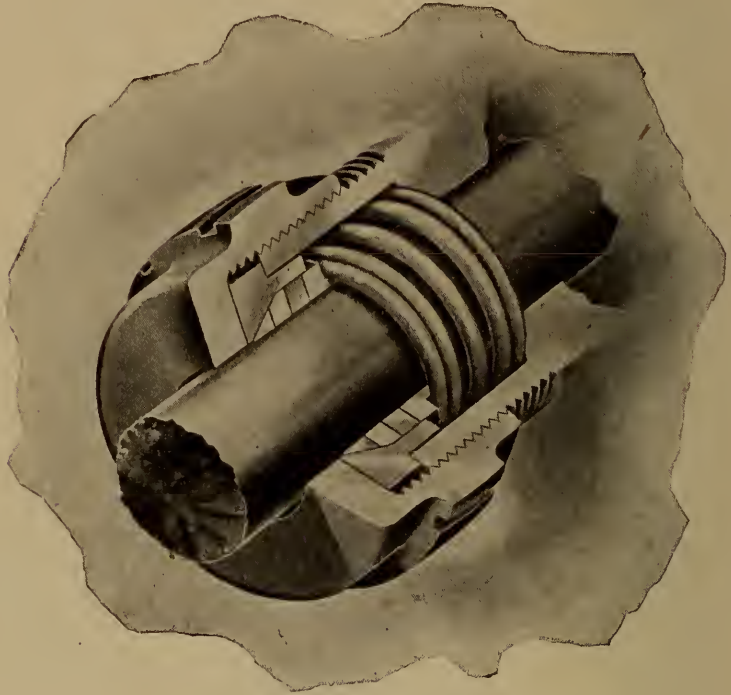

FIG. 1.

United States Air Pump Packing.

similar to those furnished for piston rods and valve stems by the same manufacturers.

JEROME AIR PUMP PACKING.

This form of metallic air pump packing is shown in Fig. 2, which clearly illustrates its use.

No air pump should be used on a locomotive without some form of metallic packing, as it is much less

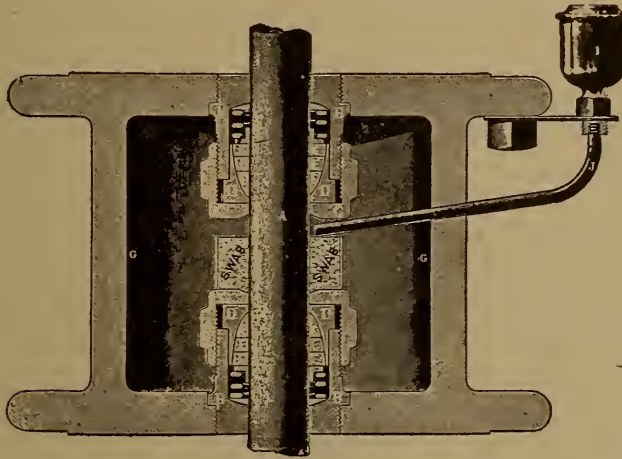

FIG. 2.

Jerome Air Pump Packing.

likely to burn out than fibrous packing, and will thus prevent many a delay or engine failure

SWAB HOLDERS.

It should be remembered that metallic packing is a babbitted bearing and needs oil and attention just as much as it would if the shaft turned around



FIG. A.

Swab Holder and Swab for Lubricating Valve Stems and Piston Rods.

The engraving shows a not uncommon form of swab holder and swab used on piston rods and valve stems. The air pump packing needs a swab no less, and is very easy of application by any engineer. Any engineer can bend a piece of copper or sheet iron, wind with candle wicking, and in short order have a very effective air pump swab.

LOCOMOTIVE LUBRICATION.

Next in importance to the proper design of the various parts of a locomotive may be considered the care and lubrication of the many bearings, pins, etc., where movement between the parts takes place.

It is needless here to enumerate these parts; suffice it to say that all locomotives use cylinder oil and some grade of machine oil (usually termed "engine" oil). A cheaper grade of machine oil, termed "car" oil, and some form of solid or pasty grease are also employed as lubricants on many classes of locomotives.

To properly distribute these different grades of lubricants, we will consider first the locomotive lubricator, not only on account of its great relative importance, but because of its embodiment of the greatest ingenuity, subsequently illustrating and describing many of the various styles of oil and grease cups used upon the bearings and pins not surrounded by and subjected to the heat and pressure of steam.*

THE LOCOMOTIVE LUBRICATOR

Although many engines (notably marine engines using distilled feed water) have been run successfully without cylinder lubrication other than that of the

* In "The Duties and Responsibilities of Locomotive Engineers, Vol. XII of The Science of Railways," the reader will find many valuable points of information relative to the proper lubrication of locomotives.

steam that is condensed about the walls of the chamber, as higher boiler pressure became used in locomotive practice, it was found advisable to employ oil in the lubrication of the cylinders.

The boiler of a locomotive is probably forced more at times and more steam is taken from it in a given time than from that of any other boiler of the same size. This causes priming, and more or less of the water is carried with the steam into the cylinders. Hence, if the water has much of any incrustating matter in solution, much of it reaches the valves and valve seats, the pistons and cylinders, and results in cutting these surfaces to a considerable extent, even with the most approved methods of lubrication.

The original method employed for oiling the valves and cylinders was by means of an oil cup located on top of the steam chest, through which cup oil could be supplied to the valves and cylinders below whenever steam was shut off.

This necessitated the engineer or fireman going to the front end of the engine and pouring oil in these two cups—one on either side. This was neither convenient nor always safe. About the year 1864 the next improvement made was in the placing of these oil cups in the cab and connecting them by sloping pipes to either steam chest. Thus the oil could be supplied by the enginemen without their leaving the cab.

After many designs of hand oilers had been used, the necessity for an even flow of oil to valves and cylinders of locomotives was met in the year 1872 by the introduction of the steam-chest oiler that could be filled, and an adjustment made whereby a constant and controllable flow of oil was had.

In 1883 the first *down drop-feed* lubricator made its appearance, one being provided for each cylinder. These lubricators were located in the cab with pipes leading to each steam chest.

In 1885 this was changed to the *up drop-feed*, one lubricator for each cylinder being used, however, until 1886, when the *double sight-feed* lubricator was put in use. From the time of the introduction of the air brake and consequent use of the air pump up to 1888 a separate lubricator was used for air pump lubrication. In that year, however, another feed attachment was added to the cylinder lubricator for this latter purpose, making it a *triple sight-feed* lubricator, as at present used, several varieties of which it is the purpose of this chapter to illustrate and describe.

With the high pressure of steam, now quite general in modern locomotives, there has been in some instances a disturbing element developed in valve oiling, which, with reason, excites the attention of enginemen and others interested therein. It has been demonstrated that, with a high steam pressure and a cut-off of one-quarter or less, there is a holding of oil within the oil pipes in case the locomotive is worked with wide open throttle. How much of this withholding of oil is due to an improper supply of steam to the lubricator, and how much to improper arrangement of oil pipes, over which the lubricator manufacturers have no direct control, is a matter of considerable speculation.

Any change decreasing the size of pipes or of their location, preventing a free flow of oil along the pipes in a constant and downward course by an upward

turn of current or by bad bends in the pipe, will surely pocket the oil and hold it back until the strength of the draft at the steam chest outlet increases sufficiently to overcome it. Decreasing the pipe opening at any one point between or at the steam inlet valve on the boiler and the oil outlet at the steam chest will doubtless pocket the oil.

With the original sight-feed lubricators and a boiler pressure of 130 pounds or less there was no trouble experienced in connecting up with piping 5-16 inch inside diameter. A change to higher pressures, with complaints of trouble in their proper lubrication, has induced the majority of makers to advise the use of pipe having an inside diameter of not less than $\frac{1}{2}$ inch, and to issue explicit instructions as to the manner of applying the steam and oil pipes. It is a well known fact that, next to initial condensation of steam, friction causes the greatest loss of power that occurs in the steam engine. The idea of employing sight-feed lubricators is not faulty, as these instruments are the fruits of a vast amount of study and experiment, and they are very successful in performing their duty of delivering regularly a small amount of lubricant, which may be nicely controlled. The trouble is probably outside of the lubricator, and lies in the method of sending the oil to the steam chest; it lies in the pipe system employed, through which the oil is expected to pass in a downward sloping course from the lubricator to a point six or seven feet below it to the steam chest. The oil feeds well enough when the throttle is closed and it is aided by a vacuum in the steam chest, and the difficulty begins when the throttle is opened and

steam, but little lower than boiler pressure, is admitted at the steam chest end of the pipe.

The results are more noticeable and more troublesome with high pressures, which are used to assist in meeting the vastly increased duty expected of modern locomotives, but it is not believed to be true that the high boiler pressures cause the lack of regular feeding of oil to the steam chest. Accompanying the use of increased pressures, longer locomotive runs are now the rule, which makes it more important to lubricate properly. The complaint was also made by engineers that the valves used the oil, and the cylinders did not get enough. The reason that the oil does not go through the pipes regularly is interesting. It is reasonable to suppose that, at the opening of the throttle, steam under or very near boiler pressure is forced up into the long oil pipes, where it condenses, nearly filling the pipes with water, and the lighter oil cannot get through the water under these conditions. Some of it may get through on account of the churning it receives.

Engines working slow and hard with long cut off will get their oil all right as the steam chest pressure will fluctuate with the opening of the ports by the valve, in which case the boiler pressure will force the oil down. It must be understood that boiler pressure must be maintained on the lubricator for good results, and hence the aforesaid recommendations regarding the piping of lubricators are strongly urged.

Location of sight-feed lubricators.—The best location for the lubricator to secure good results will largely depend on style of boiler, and on location of other cab fittings. On engines with large foot plate, prob-

ably the best location is over the middle end of boiler. In this position the feeds are in plain view of both engine men, and irregular working and stoppage will be noticed at once. Upon engines, where the boiler extends well into or through the cab and the engineer's seat is at the side of the boiler, the cup should be placed with the cylinder feed glasses in line (lengthwise) with the boiler, with air pump feed and oil glass facing the engineer. This arrangement brings the feed glasses under the supervision of the engineer at all times in daylight, and by placing the gauge light on the same standard that holds the lubricator, it will bring the feeds out distinctly at night. The bracket supporting the lubricator should be sufficiently heavy to prevent vibration of the cup, this action tending to loosening of pipes and joints.

Steam supply and piping.--It has been the general practice to attach the steam connection for the lubricator to the turret, where a turret is used. In a number of instances, where the lubricator was not working satisfactorily, it was found that the dry pipe, supplying the combination stand, was not sufficiently large to supply all drains made upon it, and to maintain full boiler pressure in the lubricator. In cases of this kind it will be found beneficial to change the steam connection to the highest point of the boiler in the cab and, if necessary, to use a separate pipe for dry steam. Full $\frac{1}{2}$ -inch openings in pipes and fittings should be had to secure best results. It is also very important to see that the oil delivery pipe should have a good steady fall from the lubricator to the steam chest. Oil will float upward

through water, but not downward. Do not connect to turrets, as the pressure is not uniform when so connected.

Cleaning.—In cleaning out the lubricator, it will be necessary to occasionally immerse it in a lye bath.

This is especially true when care is not taken to strain oil. Some grades of oil leave a residue behind that, under the high temperature, seems to bake into scale. A practice of blowing out by steam tends to prevent this accumulation, but will not always remove it after it has once been formed. This will also be apparent on the glasses, and can be avoided and removed by a small amount of glycerine swabbed through the glasses.

Filling.—The greatest care should be exercised in the filling of the oil tank to prevent foreign matter of any kind passing into the reservoir with the oil, as the passages for same in all lubricators in use are very small (about 1-32 inch opening), and a small particle in the right place stops the feed and prevents the cup from working, on whichever side it may occur, until removed. To obviate this difficulty, it is recommended that all filling cans be provided with a strainer, believing that in this case an ounce of prevention is worth a pound of cure. With some makes of lubricator, it will be found best not to fill the oil tank entirely full, as there is a likelihood of a small quantity being forced over into the boiler, this action being brought about by the expansion of the oil in the reservoir.

When the principle of the lubricator is thoroughly understood by engine men, defects and peculiar actions will be easily detected and remedied. Partic-

ular attention should be paid to the matter of opening steam and water valves immediately after filling the oil tank, the opening of the water valve to avoid bulging of the oil reservoir and bursting of glasses, due to expansion of oil when heated. The steam valve should always be opened full to maintain as nearly as possible the boiler pressure in the lubricator all the time, whether steam is shut off from the cylinder or not. The steam valve should always be opened first, and closed last. By so doing, it will be found that nearly all of the trouble will disappear, as there will be no muddying up of water in sight-feed glasses, no siphoning of oil, and no irregular feed, for the equalization of pressures will protect the lubricator against those things---provided, of course, the lubricator is in working order.

If the sight-feeds get stopped up, shut the water valve at back of cup between condenser and oil tank, open the drain cock at bottom of cup, and the steam pressure will blow everything in the sight-feed glass up into the oil tank, carrying the obstruction out with it. In the same way the steam feed or chokes can be cleaned. In this case, shut the steam feed from the boiler and open the throttle, so the steam chest pressure will come into the cup. This will blow the obstruction in the choke down into the sight-feed glass, and leave this passage clear. In case of a broken feed glass close the valves above and below the break; use hand oiler until such time as new glass can be put in. Proceed as follows: Close water valve; then steam valve. Take off packing nuts on broken glass, unscrew box of the valve on top of the feed arm, where glass is broken,

drop glass in from top through packing nuts, using new gaskets. Do not tighten packing nuts too tight, replace valve box on top of upper feed arm and open steam valve, and when glass fills with condensation open water valve.

Equalizing feature.—The successful working of the modern lubricator as applied to locomotives of to-day is almost entirely dependent on the equalizing feature. It will be found that in the majority of cases of irregular action this feature has been destroyed, either by insufficient opening from boiler to lubricator, equalizing pipes partially or wholly stopped up, or choke plugs worn larger, or becoming loose. The opening in choke plugs should bear a certain relation to the amount of steam delivered through the equalizing pipe, in order to hold up boiler pressure in upper feed arm. As one writer has said: "On account of small opening in choke plug the steam is huddled up, and not allowed to pass out freely into the oil pipe, whereby a pressure equal to the full boiler pressure is maintained on top of sight-feed glasses, irrespective of whatever pressure may or may not prevail on the opposite or cylinder side of the choke plug." It will be apparent, from what has been said, that the feed will be regular, irrespective of pressure in oil pipes, as this equalization of pressures in the lubricator is brought about by reducing the opening at the point of oil delivery. This is especially true where full throttle and short cut-off is used. When throttle is opened wide in starting, the oil pipes fill up from the steam chest end first. If the engine is cut back, the steam chest pressure is very nearly the same as the lubricator pressure, and the current of oil and steam

through the chokes is very slow, no doubt being delayed sometimes several minutes or until such time as the throttle is eased off. Reducing the steam chest pressure below the lubricator pressure, establishing a live steam current through the oil pipe from the lubricator to the steam chest, will always tide an engine over this difficulty.

Siphoning.—Instances of siphoning from oil tanks, when feed valves were closed, steam and water valves open, and boiler allowed to cool off, are so rare that they may safely be said not to occur with the modern lubricator as constructed to-day. When cases of oil disappearance are met with, investigation will usually prove one or more mechanical defects present in the lubricator. The following are a few causes for loss of oil:

1. Pipe leading from condenser to bottom of oil tank being split, or bad joint where screwed into water passage.

2. Blow hole in casting, allowing oil to pass into steam channel or upper feed arms.

3. Imperfect joint made with the plug in opening, through which the oil supply pipe is sometimes inserted, has been followed by a loss of oil.

Mileage.—This is a feature that cannot be disposed of without many considerations of conditions and surroundings. It is an admitted fact that one man will use less oil on one engine than he could possibly get along with on another engine of the same class. It is largely, therefore, a matter of judgment of the engine man in charge how much oil is to be used or is required on that particular engine, without regard to the mileage made by some other engine under what

would almost seem similar conditions. The lubricator should be set to afford good and sufficient lubrication to valves and cylinders, and feeds should not be closed unless stops exceed ten minutes.

Instruction for the use of valve oil.—In one pint of valve oil there are, when fed through a lubricator in good repair, not less than 6,600 drops. A feed of five drops per minute will ordinarily be found sufficient for the largest engines and heaviest service; for smaller engines, or light service, a comparatively slower feed of oil will be found sufficient. A feed of one drop per minute is sufficient for an air pump.

At a feed of five drops per minute for each cylinder, and one drop per minute for air pump, ten hours' steady service can be obtained from one pint of valve oil.

Intelligent and economical results cannot be obtained unless engine men know the rate at which oil is being fed through the lubricators. If a small quantity of oil is put in a lubricator, time must be allowed for the condensation to fill the cup, and raise the oil to the top of the feed pipes before the feed valves are opened.

Immediately after the oil is put in the lubricator the steam and condenser valves should be opened; the steam valve should always be opened first and opened full, and should be shut last. By bearing this in mind, as before stated, most trouble with lubricators will disappear, water in feed glasses will remain clear, and there will be no loss of oil by siphoning.

The feed valves should be opened and set a few minutes before starting on the trip, and if the lubri-

cator is in good repair there will be little or no variation in the feed between using steam and when the throttle of the engine is shut.

Irregularity in feed of lubricators is usually due to enlarged opening in choke plugs. The holes in choke plugs should not exceed 1-32 of an inch.

Great care should be taken when filling the lubricator that no foreign substance be allowed to get into it. Owing to the smallness of the openings through which the oil passes, it does not take much to clog them.

If engine or other oil is mixed with valve oil, its fire test is reduced, and its value as a lubricant for valves and cylinders is gone.

Extravagant use of valve oil results in clogged-up exhaust, pipes, and a consequent increase in coal consumption.

Working water or damp steam, or slipping an engine to get water out of cylinders, is considered bad practice, and has a bad influence on valve and cylinder lubrication.

While engine is standing it may be ascertained whether openings in choke plugs are too large or not by closing cylinder cocks, placing lever in center, blocking driving wheels, and opening throttle valve of engine, then open feed valves of lubricator. After determining by the watch the rate of feed per minute, close throttle valve and open cylinder cocks; if feed of lubricator increases, it can usually be charged to enlarged choke plug openings; if either or both equalizing steam pipes to lubricator are clogged, the result will be the same, but the latter condition is rarely found.

TABLE.
SHOWING PERFORMANCE OF LUBRICATORS WITH GOOD VALVE OIL.

Capacity of Lubricators.	Total Number of Drops Contained in Lubricator.	Number of Drops for Each Cylinder per Minute.	Hours Consumed in Feeding-out 1 Lubricator.	Total Miles Run on a Basis of		Number of Miles Run to One Pint of Oil on a Basis of	
				Passenger, 30 Miles per Hour.	Freight, 18 Miles per Hour.	Passenger, 30 Miles per Hour.	Freight, 18 Miles per Hour.
2 Pints.	13,200	5 Drops	22 Hours	660 Miles.	396 Miles.	330 Miles.	198 Miles.
3 Pints.	19,800	5 Drops.	33 Hours.	990 Miles.	595 Miles.	330 Miles.	198 Miles.
Triple Feed, 3 Pints. }	19,800 }	5 Drops, and 1 Drop for Air Pump.	30 Hours. }	900 Miles.	540 Miles.	300 Miles.	180 Miles.

Explanation of the Hydrostatic Principle of sight-feed lubricators.—It will be of advantage to those who would come to a complete understanding of the modern sight-feed lubricator to carefully note how simple is its working, as described by a well-known lubricator manufacturer.*

“A common double connecting hydrostatic sight-feed lubricator, if detached from all steam sources and set upon a table, its oil reservoir completely filled with oil and its condenser and sight-feed glasses filled with water, will feed perfectly when set to operate—the hydrostatic principle being then most perfectly illustrated, because there is an absolute equality of pressure (an atmospheric pressure of about 15 pounds per square inch) at the steam intake and oil outlet ends of the lubricator, in which case we have a liquid body suspended between two equal and, therefore, non-opposing forces, the oil being actuated or moved out of the oil-feed nipple by the heavier weight of water suspended over it.

“When the oil drop has left the nipple the hydrostatic feature has performed its function, the oil being floated out of the sight-feed glass by the difference between the specific gravity of the oil and the water in the glass. If we increase the pressure at the condenser end only, the lubricator will increase its feed, being actuated then not only by the weight of water, but also by this additional condenser pressure. On the other hand, if we increase the pressure at the oil delivery arm only, the feed of the lubricator will be retarded in a corresponding ratio, and, if the pressure

* F. W. Marvin.

is sufficiently increased, it will overcome the hydrostatic pressure and cause the lubricator to stop feeding altogether.

"Hence it is obvious that a perfect equality of pressure at the top of the condenser and at the oil delivery pipes is absolutely necessary to a common hydrostatic, or the feed will not be uniform.

"It is for this reason that when applied to a stationary engine its condensing tube and oil delivery arms are both connected to a steam pipe on the boiler side of the engine throttle in order that closing the throttle shall not affect the steam pressure at either end of the lubricator. Thus such a lubricator requires no equalizing tubes or chokes, and feeds its oil perfectly and steadily, regardless of pressure or whether the throttle is open or closed. Change the connections of this same lubricator, leaving the condenser tube still connected on the boiler side of the engine throttle, but remove the oil delivery connection to the cylinder side of the throttle (that is, straddle the throttle), and note the results: As long as the throttle is wide open the lubricator continues to feed hydrostatically; but the moment we close the throttle we have removed all the pressure from the oil discharge arms and left the pressure on the condenser, and immediately the lubricator feeds with the weight of water plus the boiler pressure, thus racing and emptying itself rapidly. Hence it will be seen that straddling the throttle produces conditions analogous to those of a locomotive, and consequently the necessity of locomotive lubricator requirements, as follows:

"(1) An equalizing tube is added, which is simply a by-pass around the throttle to replace to the oil dis-

charge arm of the lubricator the pressure that was lost when the throttle was closed; and still we have not bettered conditions, because the oil discharge pipe is so large that it permits an outflow of steam as fast as the equalizing tube can supply it. Therefore it is necessary to also add a choke between the equalizing tube and the oil outlet in order to maintain boiler pressure within the lubricator feed arm at all times."

While most locomotive lubricators have the choke plugs located within the lubricator, others place them at or near the steam chest in order to avoid a flow of steam *up* the oil supply pipes.

DETROIT TRIPLE-FEED LOCOMOTIVE LUBRICATOR WITH AUTOMATIC STEAM CHEST VALVES.

The 1900 pattern of the Detroit locomotive lubricator is fully illustrated and the various valves described in what follows:

The automatic steam chest valves furnished with this lubricator are to be connected directly above the steam chests, and are sent out blank so they can be threaded to fit the plugs already in the steam chests. It is claimed they are so constructed that a continuous, uninterrupted feed of oil is maintained to the steam chests and cylinders under all conditions of throttle position, *and there is no danger of their becoming inoperative through the lodging of dirt or sediment in restricted passages.*

The use of the old style auxiliary oilers is necessarily accompanied by a good deal of spilling and general waste of oil, and in order to avoid this, this

lubricator is equipped with by-pass valves for auxiliary oiling. The by-pass valve is shown in section on the right-hand side of plan view, Fig. 3. These by-pass valves are intended to be used only when, on account of a broken glass or other cause, the oil cannot be fed through the sight-feed glass. At all other times these by-pass valves should be kept closed tightly on their seats. The stems of the by-pass valves are graded to feed at exactly the same rate as the regular regulating feed valves *EE*, so that an eighth turn opening or a quarter turn opening of the by-pass valve will allow the same quantity of oil to be fed as an eighth turn opening or a quarter turn opening of the regulating feed valve *E*.

Each sight-feed glass is provided with an automatic safety valve, a sectional view of which is shown in Fig. 2, and on a larger scale in Fig. 5. Each drop of oil has to pass through this safety valve, and in doing so it pushes the check, No. 17b, open. After the drop passes out this check seats again until the next drop appears. Should the glass be broken from any cause, the check No. 17b remains tightly closed and prevents the escape of any steam or oil to injure those in the cab. This safety valve also protects the glass from the steam passing through the equalizing pipes. Where the steam has free access to the sight-feed glasses, the upper parts of these glasses soon become worn thin and break, being cut away by the eddying motion of the steam as by a sand blast. Hence an advantage is claimed for this design.

This lubricator has only two external equalizing tubes, one for each steam cylinder. The equalizing tube for the air pump feed is located inside the

condenser, and is shown in Fig. 1, part No. 11. The gauge glass is provided with an automatic check valve in both upper and lower gauge arms, so that in case it should be broken no oil or water can escape. One of the checks is shown in Fig. 3, part No. 27c.

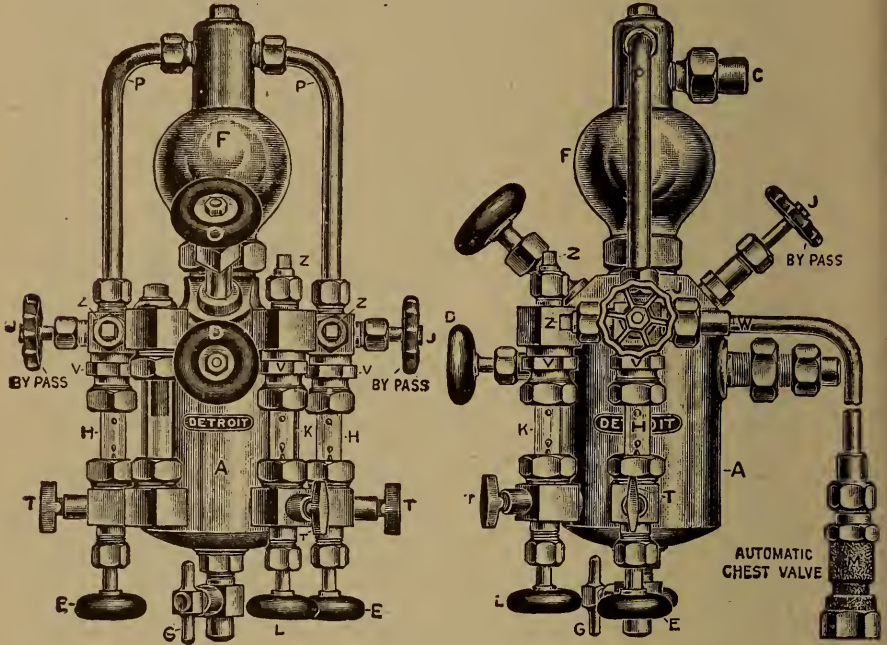

FIG. A.
(Front View.)

FIG. B.
(Side View.)

Detroit Triple Feed Locomotive Lubricator.

F—Condenser.
A—Oil Reservoir.
O—Filler Plug.
G—Drain Plug.
D—Water Feed Valve.
EE—Feed Regulating Valves to Right and Left Hand Cylinders.
L—Feed Regulating Valve to Air Pump.

ZZZ—Automatic Safety Valves.
JJJ—By-Pass Valves to Right and Left Hand Cylinders and to Air Pump.
WW—Coupling to Right and Left Hand Cylinders.
R—Coupling to Air Pump.

Directions for application.—1st. Secure the Lubricator to boiler-head or to top of boiler by strong bracket.

2nd. Connect Lubricator at coupling C to boiler

space, using copper pipe of 13-16 outside diameter or its equivalent, and a $\frac{3}{4}$ inch valve at boilers.

3rd. Connect with tallow pipes at couplings *WW*, and with air pump at coupling *R*.

4th. Automatic chest plugs furnished with the Lubricator can be threaded to fit plugs already on steam chests.

5th. The fitting to which our steam chest valve is attached should be bored to $\frac{1}{4}$ inch hole.

Directions for operating.—When the lubricator is first applied, blow out thoroughly, then close all the valves.

To fill.—Remove filler plug *O*, and fill the reservoir full with clean, strained oil.

To start lubricator.—1st. Open boiler valve gradually until wide open, and allow sufficient time for condenser and sight-feed glasses to fill with water. Keep wide open while lubricator is in operation.

2nd. Open water-feed valve *D*.

3rd. Regulate the flow of oil to right and left hand cylinders by valves *EE*, and to air pump by valve *L*.

To refill.—Always close valves *EE* and *L* in advance of valve *D*. Open drain plug *G*, then filler plug *O*. Refill and proceed to operate as before.

It is important that valves *ZZZ* contain automatic safety valves, and should be kept closed when the lubricator is in operation.

To clean glasses.—Open valve *T*, unseat safety valve *Z*, and when glasses are cleaned close valve *T*, and after the glasses have filled with water screw valve *Z* tight to its seat and leave in that position.

No hand oiler is attached to this lubricator, and none is required. The by-pass valves *JJJ* control

this feature, and are to be operated as follows: Always keep closed unless the sight feed glass becomes broken. In that event, close the feed regulating valve under the broken glass and use the by-pass valve as a hand

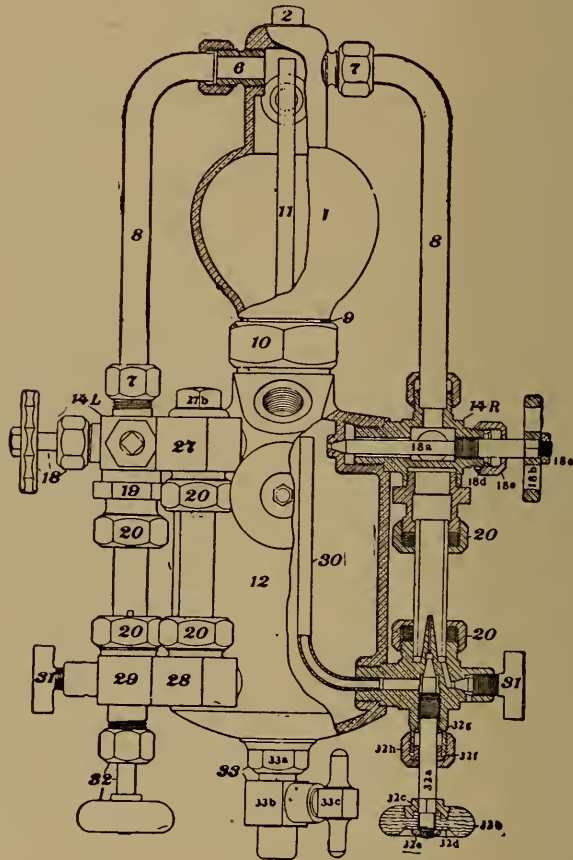

FIG. 1.

Detroit Triple Feed Locomotive Lubricator.
(Front Elevation.)

oiler. Regulate the feed identically the same as with a regulating valve, remembering always that an opening corresponding with that of the feed-regulating valve will give an equal quantity of oil through

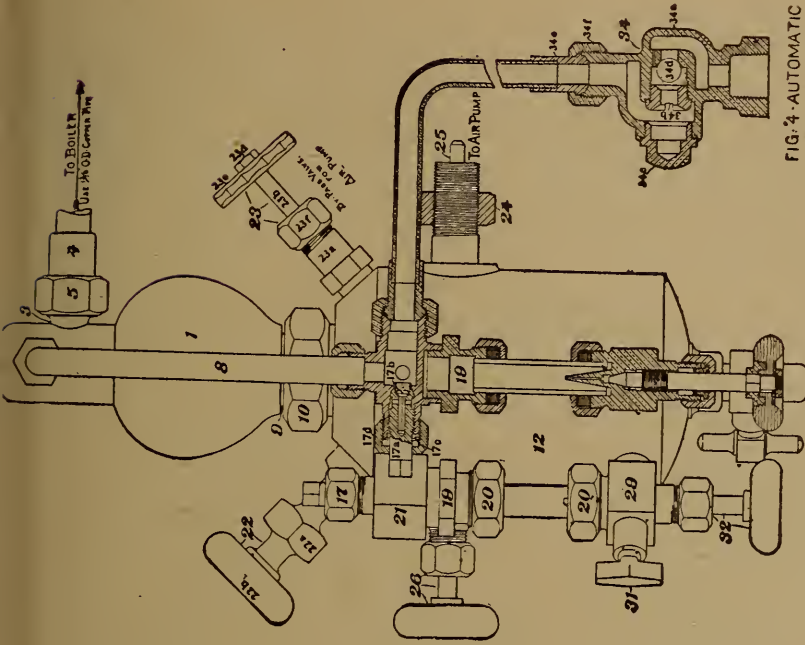

FIG. 4.—AUTOMATIC
STEAM CHEST VALVE

Fig. 2. Detroit Triple Feed Locomotive Lubricator.
(Side Elevation.)

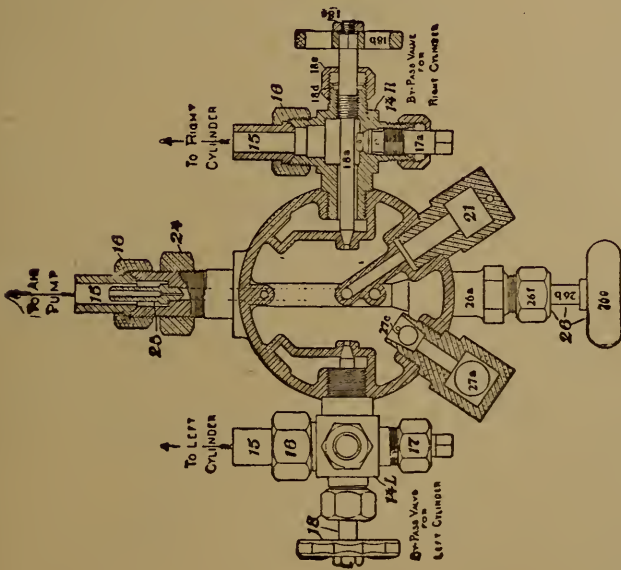

Fig. 3. Detroit Triple Feed Locomotive Lubricator.
(Plan View.)

Showing cross-section view, as though lubricator was
cut open horizontally on the line of
upper sight feed arms.

the by-pass, guarding against too great an opening of the by-pass valve and consequent waste of oil. In no event is it necessary to close the locomotive throttle or any valve of the lubricator, excepting the regulating valve under the broken sight-feed glass, to use the by-pass valve as an auxiliary oiler.

LIST OF PARTS FOR DETROIT TRIPLE LOCOMOTIVE LUBRICATOR.

Figs. 1, 2 and 3.

No.	No.
1. Condenser.	23d. Handle Nut.
2. Condenser Plug.	23e. Gland.
3. Boiler Nipple.	23f. Packing Nut.
4. Boiler Nipple Tail Pipe.	24. Support-Arm Nut.
5. Boiler Nipple Tail Pipe Nut.	25. Air-Brake Nozzle.
6. Equalizing Tube Nipple.	26. Water Valve, Complete.
7. Equalizing Tube Nipple Nut.	26a. Center Piece.
8. Equalizing Tube.	26b. Stem.
9. Condenser Tail Pipe.	26c. Handle.
10. Condenser Tail Pipe Nut.	26d. Handle Nut.
11. Air Brake Equalizing Tube.	26e. Gland.
12. Oil Reservoir.	26f. Packing Nut.
13. Water Tube Complete.	26g. Handle Washer.
14r. Upper Feed Arm, Right.	27. Upper Gauge Arm, Complete.
14l. Upper Feed Arm, Left.	27a. Upper Gauge Arm.
15. Tail Pipe.	27b. Upper Gauge Arm Plug.
16. Tail Pipe Nut.	27c. Upper Gauge Arm Ball Check.
17. Automatic Safety Valve, complete.	28. Lower Gauge Arm, complete.
17a. Stem.	28a. Lower Gauge Arm.
17b. Check.	28b. Lower Gauge Arm Ball Check.
17c. Bush Ring.	29. Lower Feed Arm.
17d. Packing Nut.	30. Oil Tube.
18. By-Pass Valve, R. or L. Cylinder, Complete.	31. Vent Stem.
18a. Stem.	32. Regulating Valve, Complete.
18b. Stem Handle.	32a. Stem.
18c. Stem Handle Nut.	32b. Handle.
18d. Stem Bush Ring.	32c. Handle Plate.
18e. Stem Packing Nut.	32d. Handle Washer.
19. Extension Sleeve.	32e. Handle Washer Nut.
20. Packing Nut.	32f. Gland.
21. Upper Air Brake Arm.	32g. Bush Ring.
22. Filler Plug, Complete.	32h. Packing Nut.
22a. Filler Plug.	33. Drain Valve, Complete.
22b. Filler Plug Handle.	33a. Drain Valve Seat.
22c. Filler Plug Handle Plate.	33b. Drain Valve Body.
22d. Filler Plug H'dle Washer.	33c. Drain Valve Stem.
22e. Filler Plug H'dle Washer Nut.	34. Automatic Steam Chest Valve, Complete.
22f. Filler Plug Copper Seat.	34a. Body.
23. By-Pass Valve for Air Brake, Complete.	34b. Seat.
23a. Centre Piece.	34c. Plug.
23b. Stem.	34d. Ball Check.
23c. Handle.	34e. Tail Pipe.
	34f. Tail Pipe Nut.

To insert the sight-feed glass.—Place the gland nuts and the extension sleeve *V* around the glass in the order shown. Then pass the lower end of the glass over the point of the nozzle, as indicated in the left-

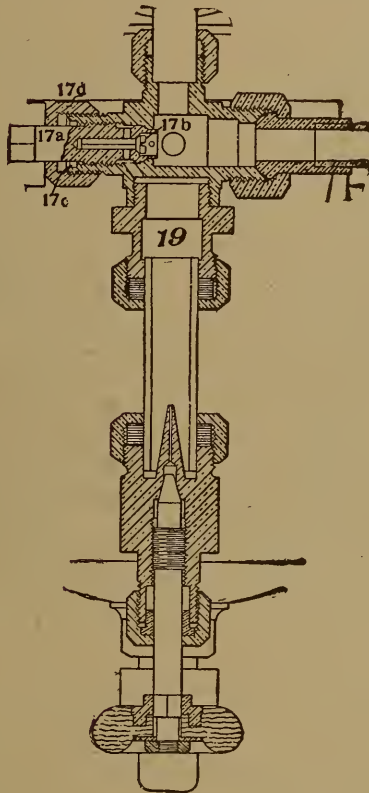

FIG. 5.

Detroit Triple Feed Locomotive Lubricator.

Sectional view of feed—showing automatic safety valves above the glasses.

hand cut, and place the glass in position. Then screw the sleeve *V* in place, and tighten up the gland nuts.

To remove the glass, first unscrew the gland nuts and push the upper one down until it touches the

lower one. Then unscrew the sleeve *V*, pushing it down slightly on the glass also, and the whole will pass out easily.

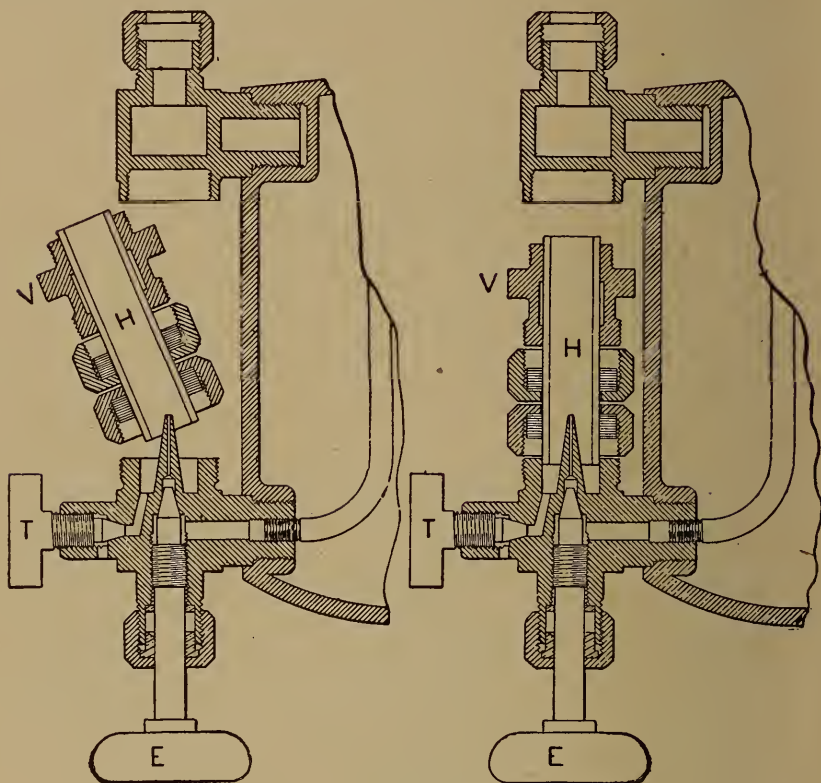

FIG. 6.

Detroit Triple Feed Locomotive Lubricator.
Showing manner of inserting and removing sight-feed glass.

THE DETROIT TRIPLE-FEED LOCOMOTIVE LUBRICATOR WITH TIPPETT ATTACHMENT.

The tippett attachment has been designed to insure the regular delivery of the oil to the wearing parts by overcoming the back pressure from the steam chests. It consists of a pipe leading to the dry-pipe within the

boiler and communicating with the two tallow pipes, as shown in Fig. As soon as the throttle is opened, an extra current of steam from the dry pipe is admitted into the tallow pipes. This, it is claimed,

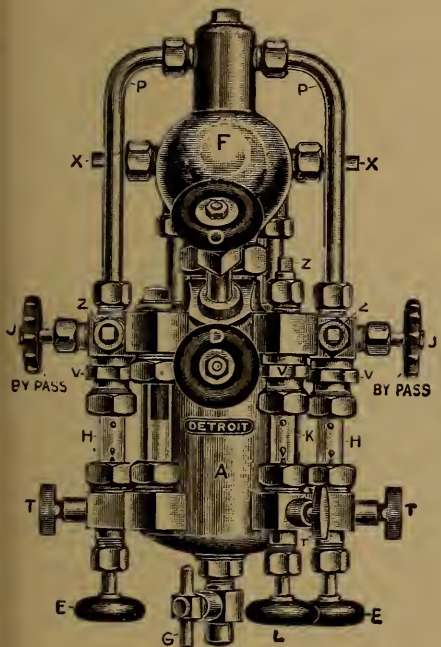

FIG. A.

Detroit Triple Feed Locomotive Lubricator with Tippet Attachment. (Front View.)

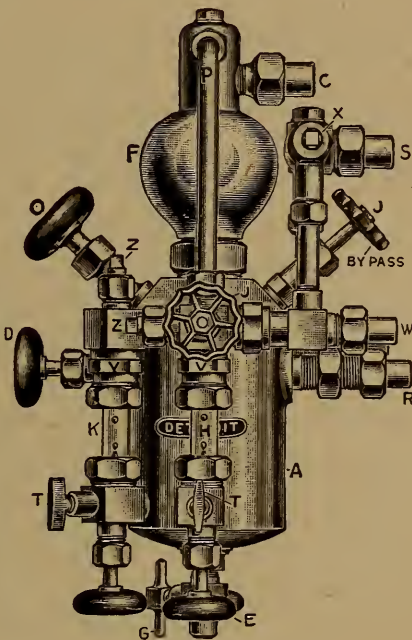

FIG. B.

Detroit Triple Feed Locomotive Lubricator with Tippet Attachment. (Side View.)

- C—Boiler Connection.
- F—Condenser.
- A—Oil Reservoir.
- O—Filler Plug.
- G—Drain Plug.
- D—Water Feed Valve.
- EE—Feed Regulating Valves to Right and Left Hand Cylinders.
- L—Feed Regulating Valve to Air Pump.

- ZZZ—Automatic Safety Valves.
- JJJ—By-Pass Valves to Right and Left Hand Cylinders and to Air Pump.
- WW—Coupling to Right and Left Hand Cylinders.
- R—Coupling to Air Pump.
- S—Dry-Pipe Connection.
- XX—Valves in Yoke of Tippet Attachment.

overcomes the back pressure from the steam chests and creates a circulation of steam in the tallow pipes towards the cylinders. Hence, as soon as the drop of oil rises through the sight-feed glass, it is carried at

once to the wearing parts, as intended, and a steady delivery of the oil to the cylinders is assured under all conditions of throttle position. In connecting the tippett attachment, a copper pipe 13-16 inch outside

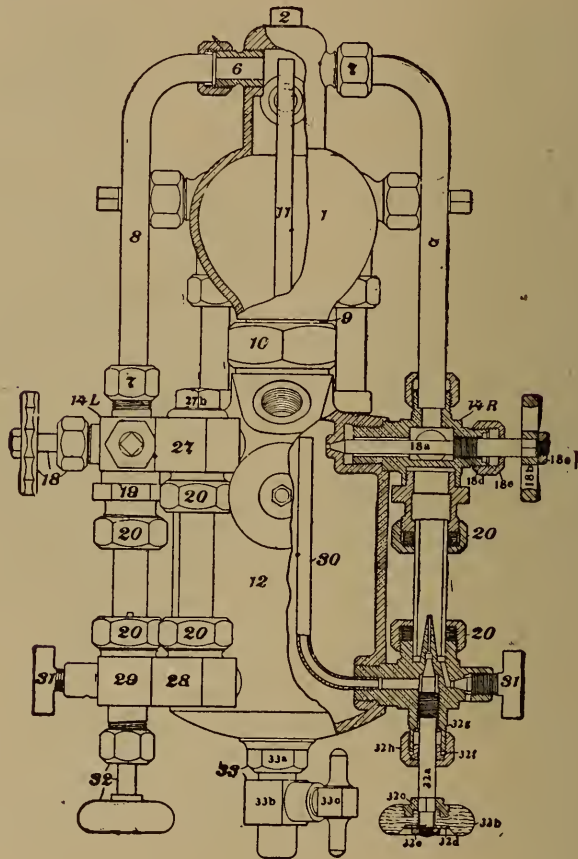

FIG. 1.

Detroit Triple Feed Locomotive Lubricator with Tippett Attachment.
(Front Elevation.)

diameter should be used, as shown in cut, and it is recommended that this pipe be brazed to the swivel *N* instead of being screwed into same. The pipe used for connecting the condenser to the boiler should be $\frac{5}{8}$ -inch outside diameter copper pipe.

Directions for application.—1st. Secure the Lubricator to boiler-head or to top of boiler by strong bracket.

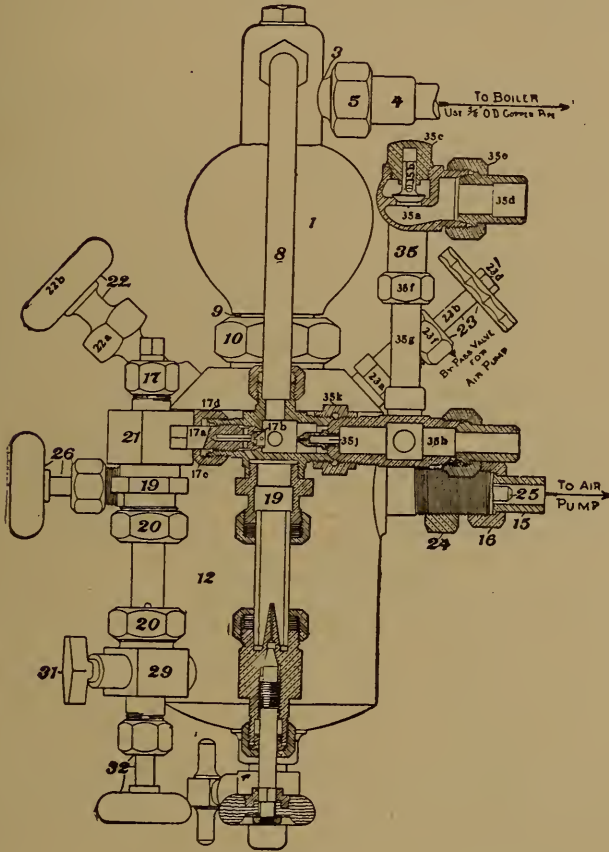

FIG. 2.

Detroit Triple Feed Locomotive Lubricator with Tippet Attachment.
(Side Elevation.)

2nd. Connect Lubricator at coupling *C* to boiler space, using copper pipe of $\frac{5}{8}$ outside diameter or its equivalent, and a $\frac{1}{2}$ inch valve at boiler.

3rd. Connect coupling *S* with Dry Pipe as shown

in cut on opposite side using copper pipe 13-16 in. (outside) diameter.

4th. Connect with tallow pipes at couplings WW and with air pump at coupling R.

5th. Reduce the opening at steam chest plugs to 3-16 in.

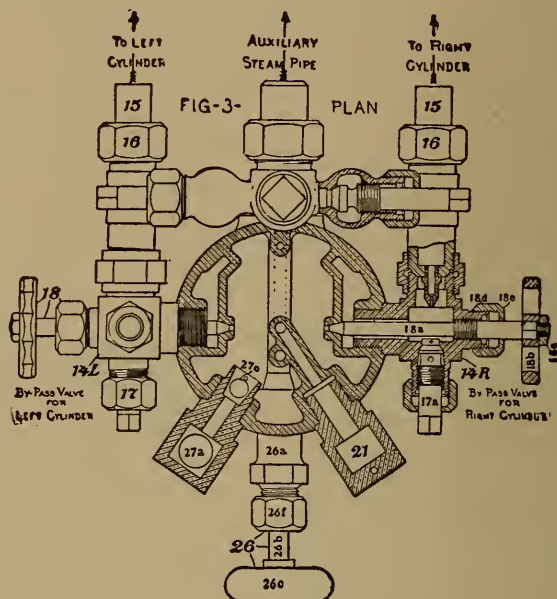

FIG. 3.

Detroit Triple Feed Locomotive Lubricator with Tippet Attachment.
(Plan View.)

The above cut shows cross section view as if Lubricator were cut open horizontally on the level of the upper sight feed arms.

The steam chest oil pipe plug should be of the pattern shown in Fig. 5, having a hole 3-16 inch in diameter at the bottom.

When lubricator is applied to simple engine, open full both valves *XX*, and leave in that position.

When application is made to Cross Compound

Engines, open full valve X on side to high-pressure steam chest, and close tight valve X on side to low-pressure steam chest, and leave in that position.

LIST OF PARTS FOR DETROIT LOCOMOTIVE LUBRICATOR WITH TIPPETT ATTACHMENT.

Figs. 1, 2 and 3.

- | No. | No. |
|-------------------------------------------------|---------------------------------------------|
| 1. Condenser. | 26c. Handle. |
| 2. Condenser Plug. | 26d. Handle Nut. |
| 3. Boiler Nipple. | 26e. Gland. |
| 4. Boiler Nipple Tail Pipe. | 26f. Packing Nut. |
| 5. Boiler Nipple Tail Pipe Nut. | 26g. Handle Washer. |
| 6. Equalizing Tube Nipple. | 27. Upper Gauge Arm, Complete. |
| 7. Equalizing Tube Nipple Nut. | 27a. Upper Gauge Arm. |
| 8. Equalizing Tube. | 27b. Upper Gauge Arm Plug. |
| 9. Condenser Tail Pipe. | 27c. Upper Gauge Arm Ball Check. |
| 10. Condenser Tail Pipe Nut. | 28. Lower Gauge Arm, Complete. |
| 11. Air Brake Equalizing Tube. | 28a. Lower Gauge Arm. |
| 12. Oil Reservoir. | 28b. Lower Gauge Arm Ball Check. |
| 13. Water Tube Complete. | 29. Lower Feed Arm. |
| 14r. Upper Feed Arm, Right. | 30. Oil Tube. |
| 14l. Upper Feed Arm, Left. | 31. Vent Stem. |
| 15. Tail Pipe. | 32. Regulating Valve, Complete. |
| 16. Tail Pipe Nut. | 32a. Stem. |
| 17. Automatic Safety Valve, Complete. | 32b. Handle. |
| 17a. Stem. | 32c. Handle Plate. |
| 17b. Check. | 32d. Handle Washer. |
| 17c. Bush Ring. | 32e. Handle Washer Nut. |
| 17d. Packing Nut. | 32f. Gland. |
| 18. By-Pass Valve, R. or L. Cylinder, Complete. | 32g. Bush Ring. |
| 18a. Stem. | 32h. Packing Nut. |
| 18b. Stem Handle. | 33. Drain Valve, Complete. |
| 18c. Stem Handle Nut. | 33a. Drain Valve Seat. |
| 18d. Stem Bush Ring. | 33b. Drain Valve Body. |
| 18e. Stem Packing Nut. | 33c. Drain Valve Stem. |
| 19. Extension Sleeve. | 35. Tippett Yoke, Complete. |
| 20. Packing Nut. | 35a. Tippett Yoke. |
| 21. Upper Air Brake Arm. | 35b. Tippett Yoke Check. |
| 22. Filler Plug, Complete. | 35c. Tippett Yoke Plug. |
| 22a. Filler Plug. | 35d. Tippett Yoke Tail Pipe. |
| 22b. Filler Plug Handle. | 35e. Tippett Yoke Tail Pipe Nut. |
| 22c. Filler Plug Handle Plate. | 35f. Tippett Yoke Con'g Nut. |
| 22d. Filler Plug H'dle Washer. | 35g. Tippett Yoke Con'g Tail Pipe. |
| 22e. Filler Plug H'dle Washer Nut. | 35h. Tippett Arm, Right. |
| 22f. Filler Plug Copper Seat. | 35i. Tippett Arm, Left. |
| 23. By-Pass Valve for Air Brake, Complete. | 35j. Tippett Arm, Nozzle. |
| 23a. Centre Piece. | 35k. Tippett Arm, R. and L. Connecting Nut. |
| 23b. Stem. | 36. Dry-Pipe Fitting, Complete. |
| 23c. Handle. | 36a. Dry-Pipe Fitting. |
| 23d. Handle Nut. | 36b. Dry-Pipe Fit'g Tail Pipe. |
| 23e. Gland. | 36c. Dry-Pipe Fit'g Tail Pipe Nut. |
| 23f. Packing Nut. | 37. Expansion Joint. |
| 24. Support Arm Nut. | 37a. Expansion Joint. |
| 25. Air-Brake Nozzle. | 37b. Expansion Joint Nut. |
| 26. Water Valve, Complete. | 37c. Expansion Joint Gland. |
| 26a. Center Piece. | |
| 26b. Stem. | |

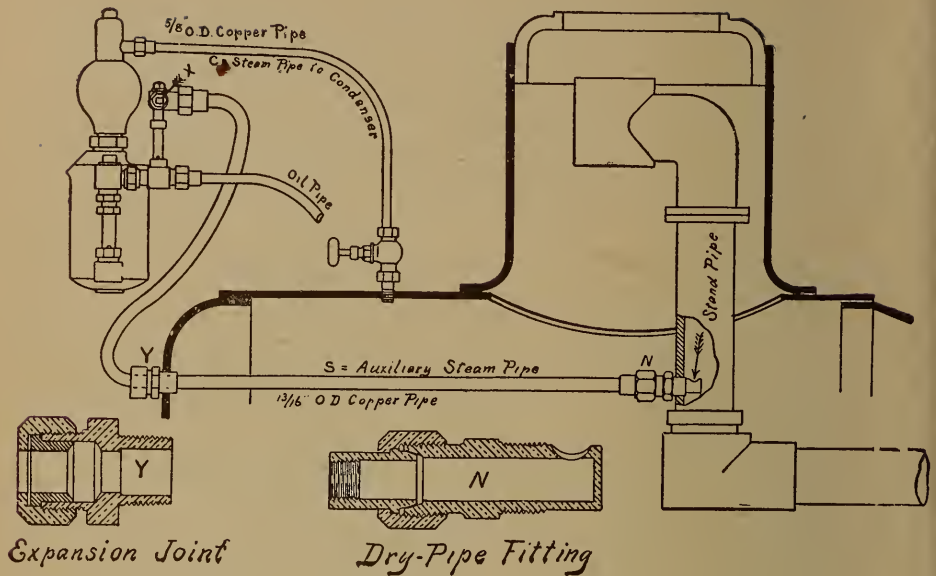

FIG. 4.

Detroit Triple Feed Locomotive Lubricator with Tippet Attachment.
Showing method of connecting Tippet Attachment to Locomotive.

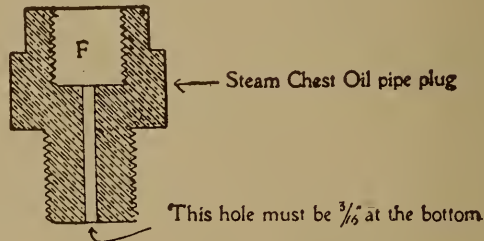

FIG. 5.

Steam Chest Oil Pipe Plug.

MICHIGAN SIGHT-FEED LUBRICATOR.

The manufacturers of this lubricator claim to overcome the "hold-up" of oil in the tallow pipes, and to insure a delivery of oil direct to the steam chest with wide open throttle and any position of reverse lever.

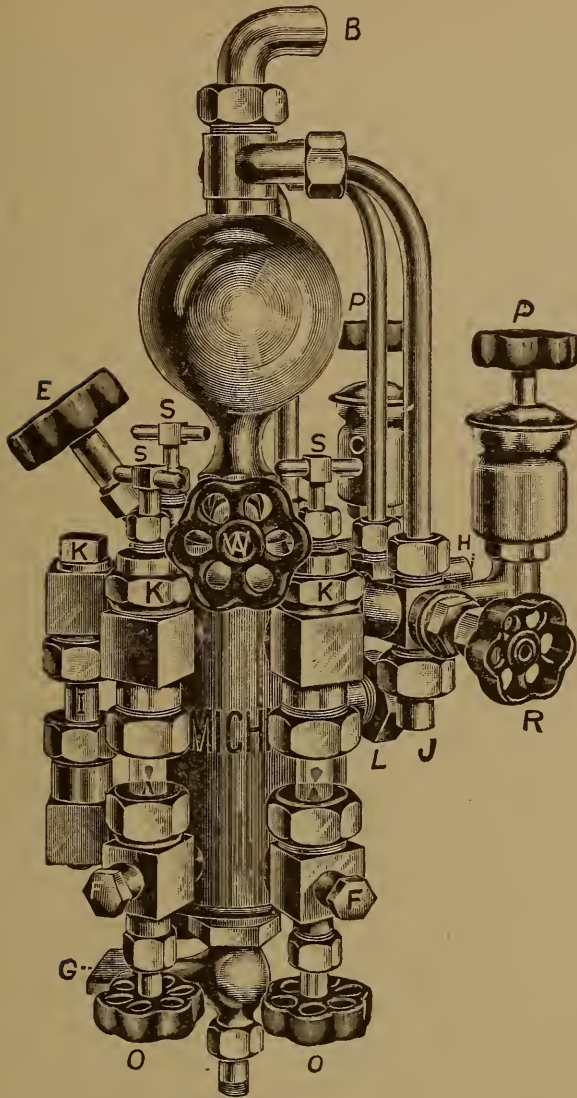

FIG. 1. Michigan Sight Feed Lubricator.

L-L-L—Lock Nut to secure Lubricator to Angle Iron.
B—Union to connect Pipe for admission of steam.
J-J—Unions to connect Cylinder Feeds to Tallow Pipes.
H—Union to connect Air Pump Feed.
N—Steam Valve for Boiler Pressure. (Not shown.)
E—Filler Plug.
W—Valve to admit water from Condenser to Oil Reservoir.
O-O-O—Regulating Feed Valves.
C-C—Auxiliary Oilers operative with Throttle open or closed.

P-P—Auxiliary Oiler Filler Valves.
R-R—Auxiliary Oiler Feed Valves.
S-S-S—Lifting Stems to hold Automatic Check Valves off their Seats so Glasses will fill with Water of Condensation when empty.
F-F-F—Valves to drain Sight-Feed Glasses without emptying Oil Reservoir.
K-K-K—Removable Plugs for renewing or cleaning Sight-Feed Glasses.
I—Gauge Glass.
G—Valve to drain Oil Reservoir.

The principle by which it is claimed that this "hold-up" of oil in the tallow pipes is prevented is shown in Fig. 2, which illustrates the automatic

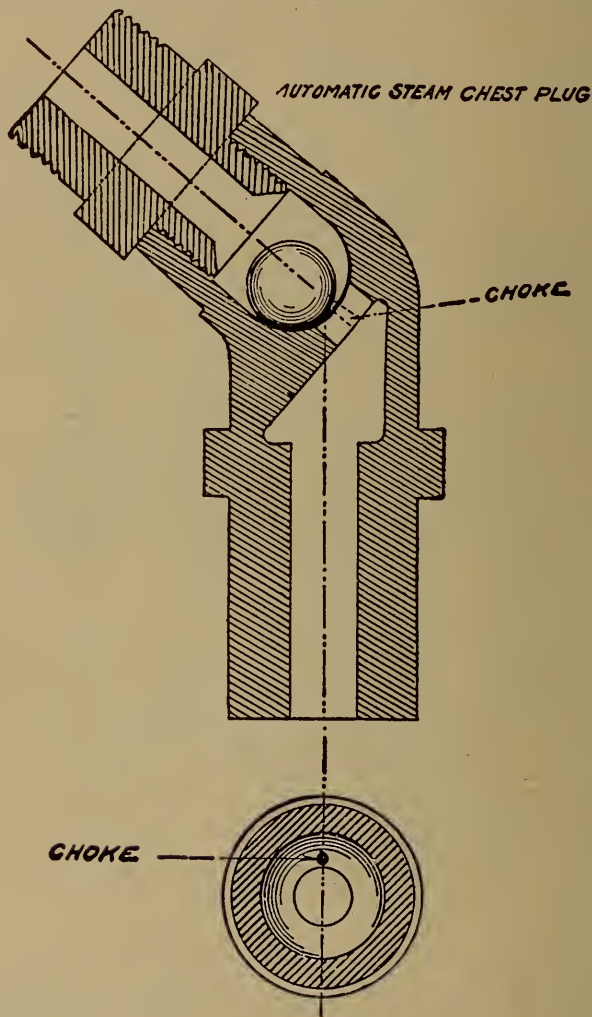

FIG. 2.

Vertical longitudinal section of Michigan automatic steam chest plug, showing the large area and its ball valve, associated with a constant choke at the side thereof.

steam chest plug. This device has a ball valve, the seat of which is about equal in area to the inside of the

tallow pipes of the locomotive, and having at one side of this seat the choke opening. The cylinder feeds *JJ*, Figs. 1 and 3, have no chokes within the lubricator. Hence a full current of steam is delivered from the boiler through the steam tube, condenser, equalizing tubes and tallow pipes to these automatic plugs at each steam chest, thus giving a complete steam area from the boiler to the steam chest about equal to that of the tallow pipes. Consequently, when the locomotive throttle is wide open, the forward pressure from the lubricator practically equalling the back pressure from the steam chest, the ball in the steam chest plug drops by gravity from its seat to the position shown in Fig. 2.

All pressures now being equal, oil will flow by gravity into the steam chest at the same intervals it is seen feeding in the sight-feed glass.

The instant the boiler (or forward) pressure becomes greater than the steam chest pressure, as when the engine throttle is closed, the ball valve in the steam chest plug is forced to its seat, leaving only the small choke at the side of the ball seat open, and thus maintaining a balance of pressure in the intake and outlet pipes of the lubricator. These steam chest plugs should always be screwed perpendicularly into the top of the steam chest.

Another special feature of this valve is the arrangement whereby oil may be supplied through the auxiliary oilers (*CC*, Figs. 1 and 3) without closing the locomotive throttle, as clearly shown in Fig. 3.

Another noticeable feature of this lubricator is the automatic check valves at the top of each sight-feed glass, as shown in Fig. 4. These valves are

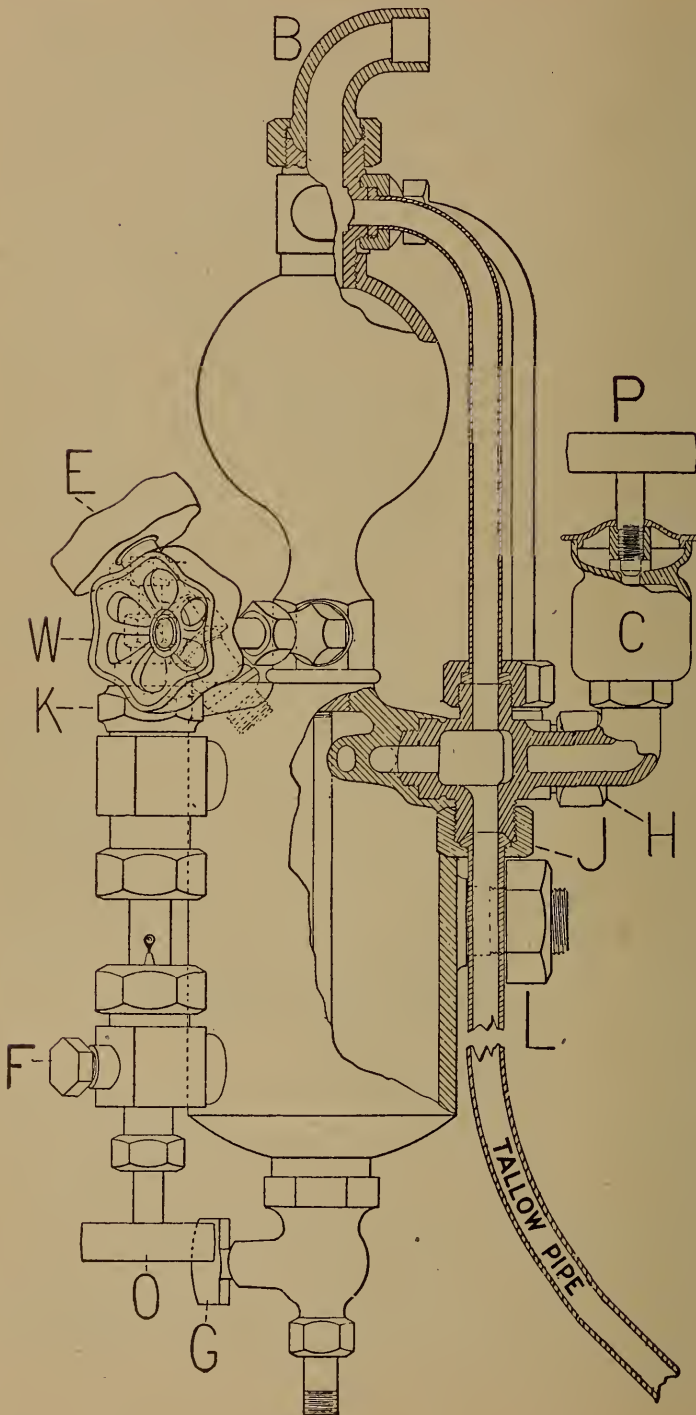

FIG. 3.

Michigan Sight Feed Lubricator.

Side elevation, part in vertical longitudinal section.

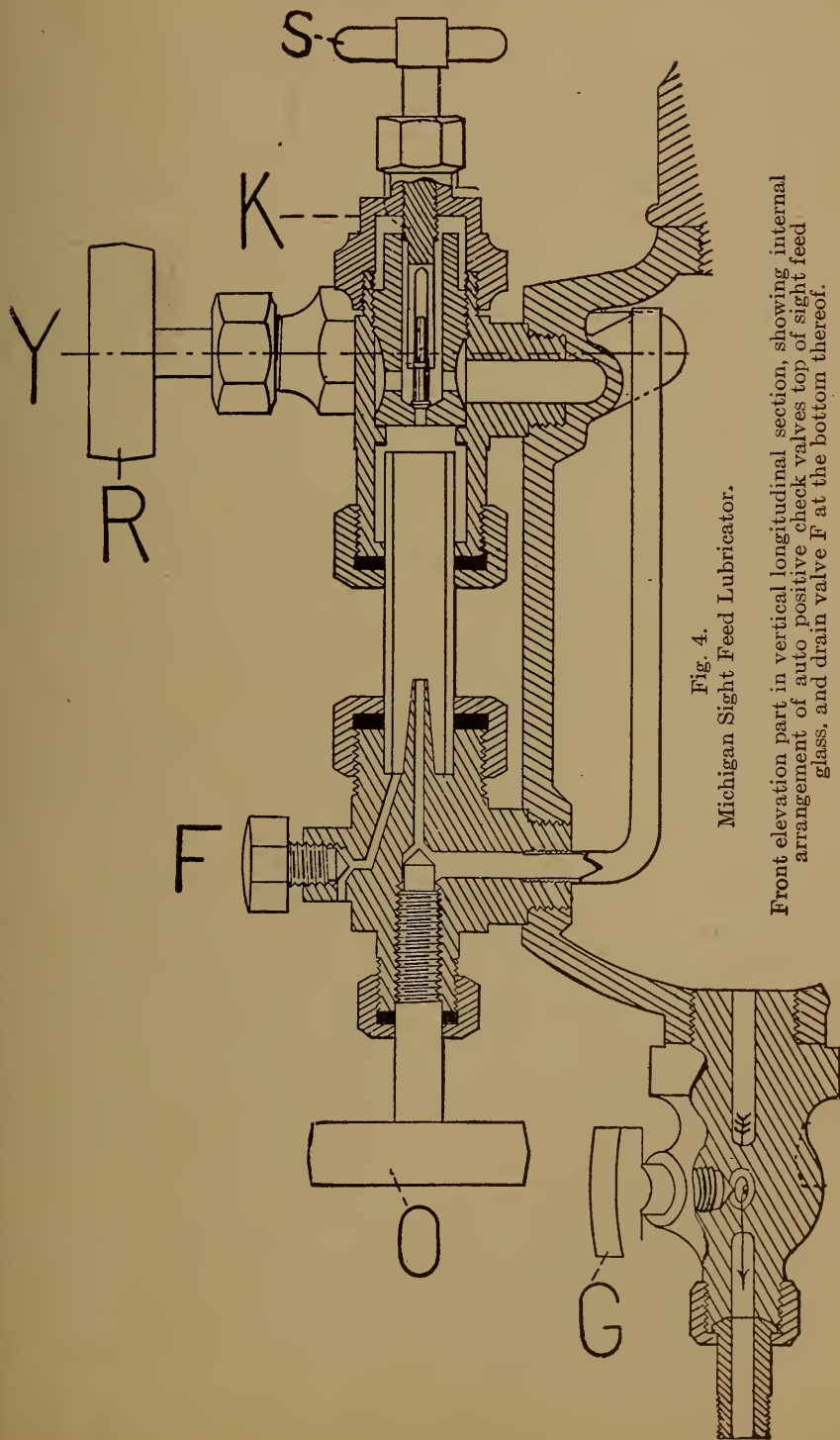

Fig. 4.
Michigan Sight Feed Lubricator.

Front elevation part in vertical longitudinal section, showing internal arrangement of auto positive check valves top of sight feed glass, and drain valve F at the bottom thereof.

suspended in the stems *S**S**S* (see also, Fig. 1), which, when screwed down, leave the check valves free to close automatically should the sight-feed glasses break. When it is desirable to open the sight-feed drain valves *FFF* to renew the water of condensation in any one glass while the others are still operating, unscrew the lifting stem *S* a few turns, thus holding the check valve off its seat and permitting steam to blow through. As soon as the glass is blown out, close the valve *F*, and fresh water will immediately fill the glass; then screw down on the lifting stem *S*, and the check is again automatic.

To operate.—Open steam valve *N* full for boiler pressure, then open valve *W*, and regulate feed of oil by valves *OOO*, observing not to start feeding until the condenser and sight-feed glasses have had time to condense full of water.

Shutting off lubricator.—In leaving engine after a trip, close the sight feeds first and the steam valve last, leaving water valve *W* open, in order that the expansion caused by heating freshly filled oil will ease off through the tallow pipes, thus preventing the expansion, strain or bulging of the lubricator.

To operate the auxiliary oilers.—Close the auxiliary feed valve *R* perfectly tight, and open its oil feeder valve *P* a turn or two, fill the cup with oil, close tightly valve *P*, and finally open valve *R*, thus permitting the oil to pass directly into tallow pipes, as shown in Fig. 3.

Blowing out lubricator.—The method of renewing the water of condensation in the sight-feed glasses has already been given.

Should the passage from the top of the sight-feed

nipple to the top of the internal oil delivery arm (in reservoir) become clogged, this can be blown out with live steam by emptying the oil reservoir and leaving the feed valve *O* and reservoir drain valve *G* open. (See Figs. 1 and 4.)

THE SEIBERT SIGHT-FEED LUBRICATOR.

This lubricator has three sight feeds for oiling independently each cylinder and air brake. After placing in position and connecting as directed steam enters at *C*, a portion passing through the small outside pipes leading from the top of the bulb or condenser to each cylinder through *O* on both sides, taking oil at the discharge from the lubricator at the top of the sight feeds, and for the air brake pump cylinder at the connection just below the auxiliary oiler *G* to the different cylinders to be lubricated. The other portion of steam condenses in bulb *F*, forming the water column; this water is conducted to the bottom of the lubricator under the oil, which is forced out through sight feeds *E E E* in drops regulated by valves *K K K*. Thus it can be readily understood that exactly the quantity of oil allowed to feed up through each sight-feed must go to each cylinder as desired.

At the auxiliary oiler *G* on back of lubricator connections are made with the air brake pump cylinder, and the quantity of oil feeding is indicated by sight-feed *E* on the front of the lubricator.

To attach the lubricator.—Remove valves from plugs over the steam chests. Fasten the lubricator to the boiler head with bracket at the proper height, and have the outside pipes now in use attached to unions

O O, similar to that shown in cut. Make pipe connection to supply the lubricator with steam pressure from any convenient point on the boiler to the union

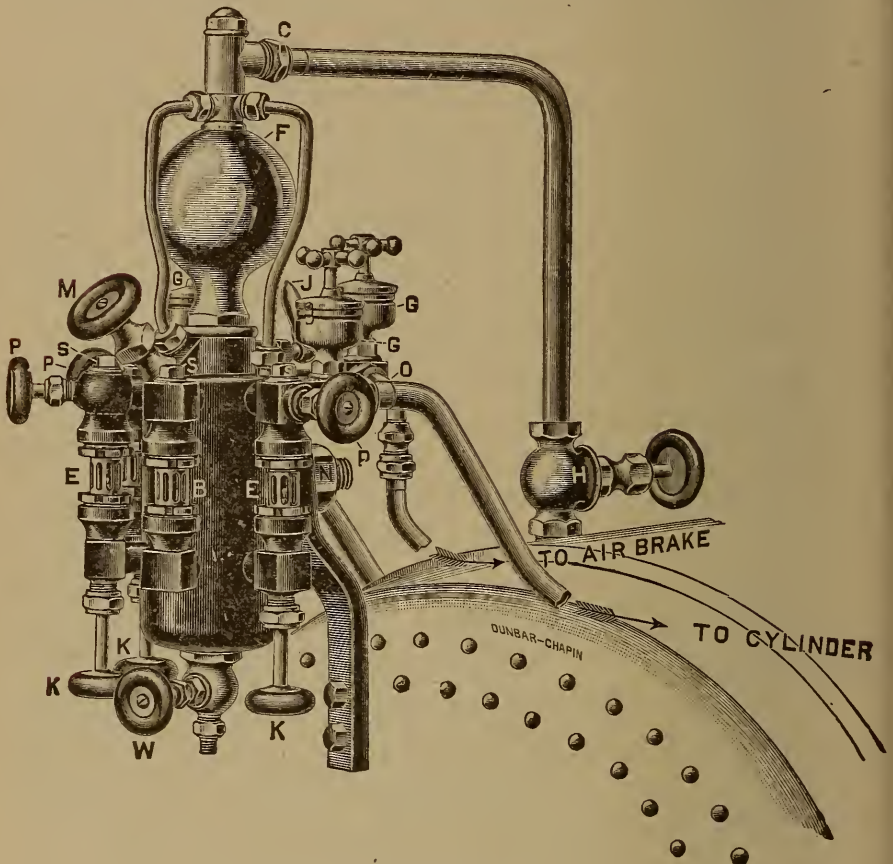

FIG. 1.
Seibert Triple Sight Feed Lubricator.

M—Filling Plug.
H—Steam Valve.
K-K-K—Regulating Valves.
J—Water Valve.
F—Condenser.
G-C-C—Auxiliary Oilers.
W—Draw-off Valve.
O-O—Connections to Cylinders.

N—Lock Nut to fasten Lubricator to Bracket.
E-E-E—Sight-Feeds.
E—Gauge Glass.
S-S-S—Plugs over Glasses.
C—Union.
P-P-P—Valves to shut off at top of Glass when broken.

at *C*. A globe valve should be put in at boiler end of this pipe as shown at *H*. Place a small globe valve in the pipe marked "to air brake," near the steam pipe

of the air pump, for the purpose of shutting off that portion when desired.

To operate the lubricator.—Close valves *W*, *K*, *K*, *K*, *J*, small valve in the air brake pipe, and boiler valve *H*. When first starting the lubricator, to facilitate matters, fill the sight-feed glass with clean water by removing plugs *S* at the top of the several feeds and then replace the plugs; afterwards the glass will be kept full by condensation. Fill the lubricator at plug *M* completely full with good strained oil and screw the plug down; then open boiler valve *H* a very little, and wait a few moments until the pipe or condenser *F* is full of water from condensation; then open water valve *J*, also open the small valve in air brake pipe. The valves *P*, *P*, *P*, should always be kept open, except when glass breaks; then valves *P* and *K* on that particular sight feed should be closed and use the auxiliary oiler *G* at that point same as common cab boiler. Regulate the drops of oil by opening feed valves *K*, *K*, *K*, more or less, as required for each cylinder.

To refill the lubricator, shut valves *H*, *J*, *K*, *K*, *K*, also small valve in air brake pipe, and draw off the water at valve *W*; then close it and fill the lubricator as before. Upon starting it again, open water valve *J* first, the boiler valve *H* a little, also open small valve at air brake steam pipe, and regulate by valves *K*, *K*, *K*.

If the lubricator becomes disabled, the auxiliary oil cups *G*, *G*, *G*, can be used the same as common cab oilers.

FORCE-FEED LUBRICATORS.

For many years past individual unit, force-feed lubricating devices have come to supersede all others in power plants where modern and economical practice prevails.

At the present time of very fast trains, making long runs between stops, the question of facilities for thorough and positive lubrication of all journals, eccentrics and links of the fast moving engine becomes very important.

CORY'S FORCE-FEED LUBRICATOR.

The introduction of the device herewith illustrated and described marks a distinct advancement in secur-

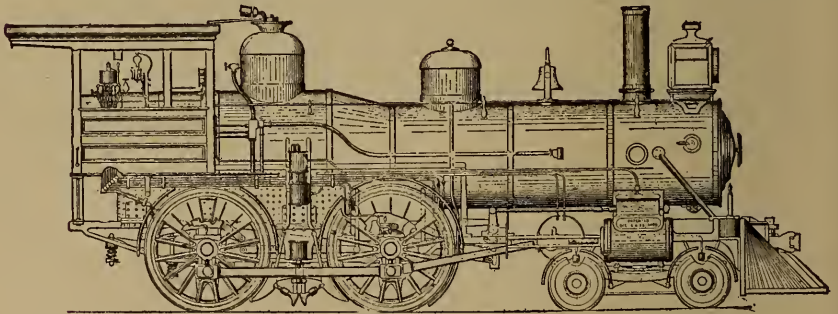

FIG. 1.

Cory's Force Feed Lubricator for Oiling all Journals, Eccentrics and Links While Engine is Running Full Speed.

ing the highly desirable means of oiling all important bearings of the locomotive, while it is running at full speed, and this is fully accomplished direct from the cab, from where it is possible to oil each bearing successively, or any particular bearing repeatedly, that may be giving temporary trouble by heating.

The lubricator is placed, conveniently of access, in the cab (as shown in Fig. 1), and consists of an oil supply reservoir of one gallon capacity; at the lower part of this reservoir is seated a hollow conical valve *A* (Fig. 2); the cavity in this conical valve will hold about one-eightieth of a gallon. This space inside of

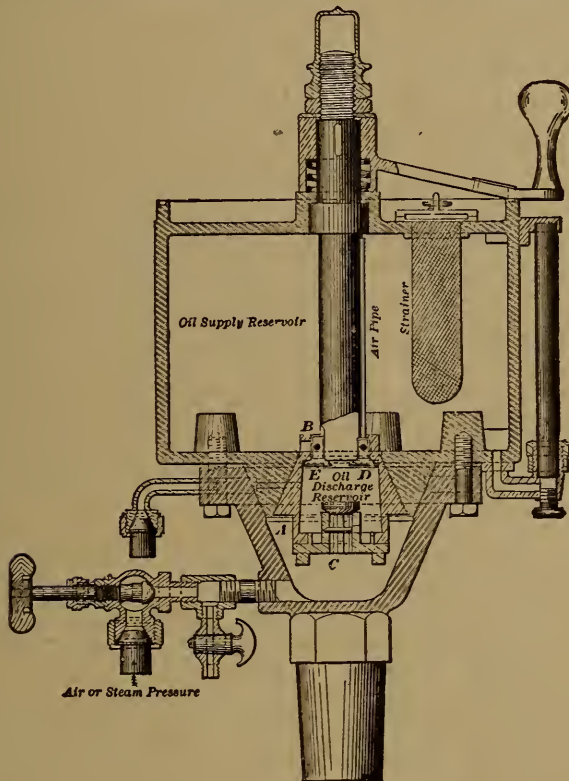

FIG. 2.

Cory's Force Feed Lubricator.

conical valve is termed the oil discharge reservoir, and connects to oil supply reservoir by small valve *B*, seated in upper part of hollow valve. The side of the hollow valve is perforated by a hole, *E*, one-eighth inch diameter, that can be brought to coincide with any one of the 16 outlet holes at the base of oil supply

reservoir, that each connects with a line of pipe to a given bearing. There are 16 notches on the upper rim of the lubricator, that when lever is brought to engage with any one of these notches the hole in the side of conical valve then coincides with a given hole, in base, to outlet pipe. When the lever is thus placed for any bearing desired to supply with oil, the valve shown attached to base, and connected to either steam or air pressure, is opened, and pressure enters through small valve *C*, into the oil discharge reservoir, closing valves *B* and *D*, and forcing contents of oil discharge reservoir through hole *E*, and through line of pipe connecting with bearing that it is desired to oil. This requires but a moment, when pressure should be shut off, and lever placed midway between any two notches and in about ten seconds the discharge reservoir will again be filled and ready for discharging to any desired bearing when the lever is placed in the notch corresponding to the bearing to be oiled, and pressure again turned on.

For all main journals three way tips are furnished for ends of pipe; thus the wedges and jaws are oiled as well as the journal.

Thus the engineer has at his command a positive means of oiling all parts of his engine, however fast the engine may be running, and however long distances he is obliged to run without stops, thus preventing any dangerous and destructive heating and cutting of bearings, delays of trains and possible accidents that might occur from rear end collisions, by being obliged to stop, cool off and pack hot journals.

The use of this device is not intended to relieve the engineer from the responsibility of adjusting his

present oil cups, and inspecting and oiling by hand, when first taking engine out from terminal station, the same as if engine was not equipped with the force feed lubricator.

There is simply placed at the disposal of the engineer a gallon of oil that can be forced from the cab to any desired bearing, as occasion requires.

While this lubricator was originally designed for emergencies and long distance runs, it is now being used for oiling at all times, all bearings having pipes leading thereto, and is showing saving in oil over hand oiling. It has also been found a great convenience in winter to be able to blow steam to the various parts of the running gear, and thereby melt accumulated snow and ice, and thus have cups and bearings in condition for oiling.

The piping may be done with either one-eighth inch wrought iron or copper pipe.

MCCANNA FORCE-FEED LUBRICATOR.

This system of lubrication consists of a reservoir filled with the oil to be used as lubricant and many small oil pumps operated by a single ratchet wheel connected with the valve stem or some other portion of the engine having a reciprocal motion of from 3 to 5 inches. The discharge pipe from each of these small pumps leads to the journal, guide, steam chest cylinder or other part to be lubricated. As each of these parts requires a different amount of lubrication, provision is made whereby the length of stroke of each pump may be readily and quickly altered while the machine is in motion.

There are a great many difficulties due to the weather and other causes to be overcome in applying such a device to the locomotive engine; but that it has many advantages must be readily conceded.

When the feeds are once set the amount of oil supplied any given part varies automatically with the speed of the locomotive, and will cease altogether with the engine at rest. Thus the lubrication is directly in proportion to the requirements.

The accompanying engraving shows a large express locomotive equipped with force-feed cylinder lubricators. The oil reservoir *G* is placed at a convenient point in the cab, with pipe *D* leading to the oil pump *B* located in a protected position back of the steam chest to which it is attached. A clamp, *A*, is fastened to the valve stem and connected by a suitable rod to the pump ratchet arm *C*. Thus it takes several movements of the valve stem backward and forward to cause one stroke of the small pumps, which can be adjusted to deliver but a drop or less at a stroke. The pump here shown has two delivery pipes leading to either steam chest, one of them being shown at *F*.

To set the pump to feed more oil, move the set-nuts closer together on the pump plunger, thus making less lost motion. To set the pump to feed less oil, move the set-nuts farther apart, making more lost motion. Adjustments can be made for each five to fifty turns of the driving wheels to produce but one stroke of the pumps. Each stroke of the pumps can in turn be independently adjusted to deliver from ten drops to one-fiftieth of a drop of oil. This would indicate that a very wide range of requirements can be met by the engineer.

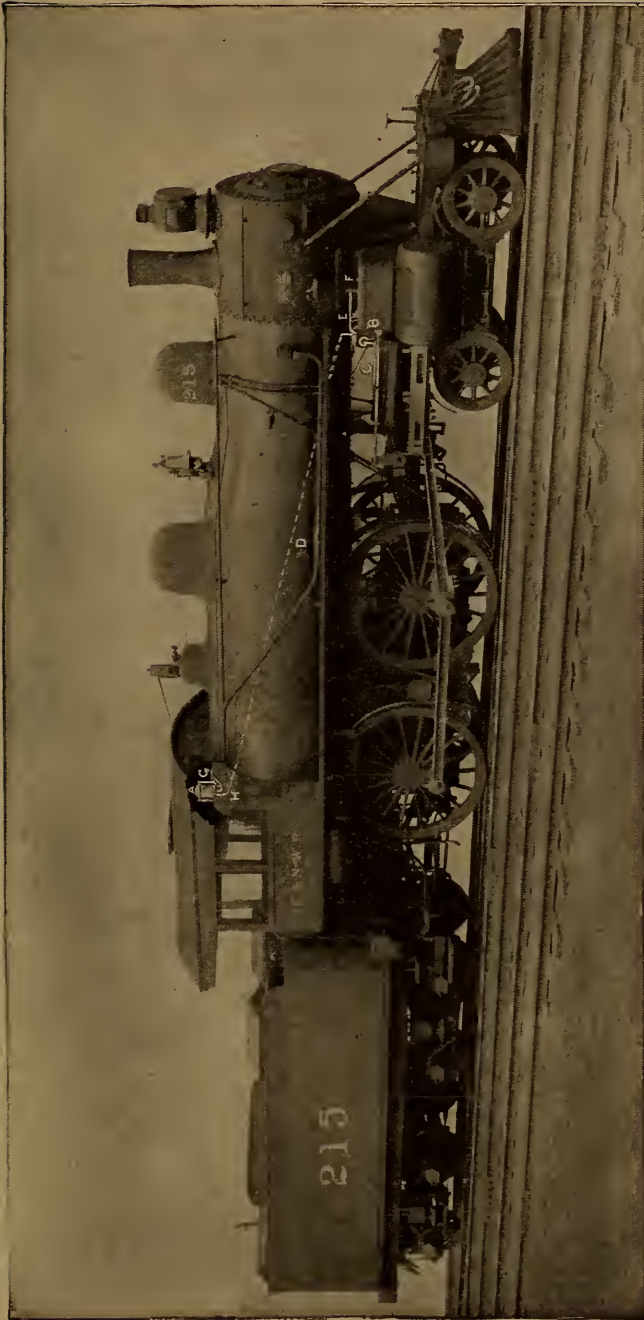

FIG. 1.
McCanna Locomotive Force Feed Cylinder Lubricator.

ENGINE TRUCK OIL CELLAR AND SIGHT-FEED OIL CUP.

The "Acme" combined cellar and oil cup is designed especially for engine trucks to overcome the friction, journal wear, and that bane of the railroad man's

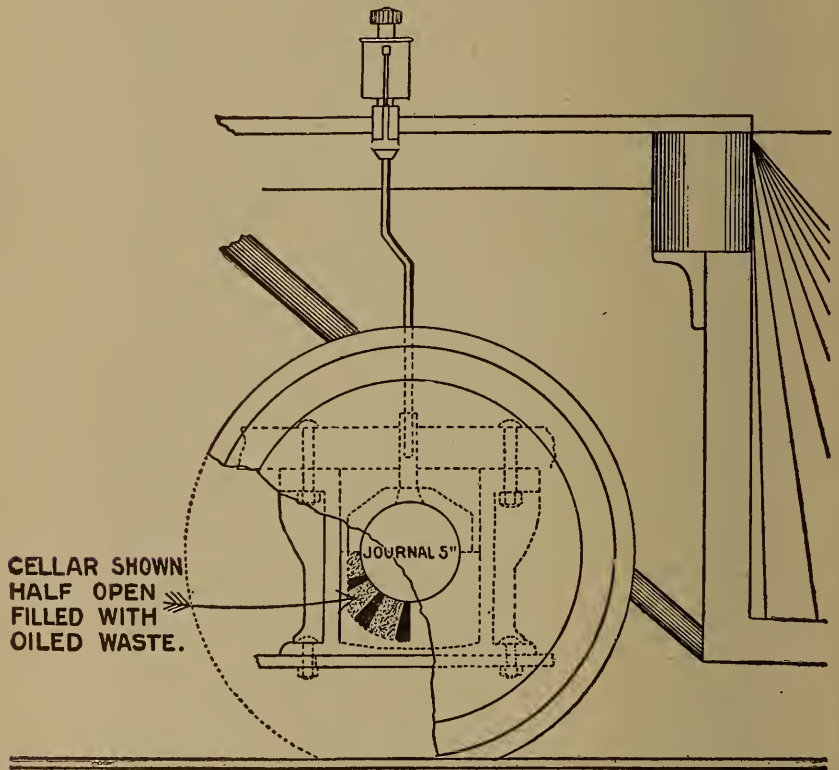

FIG. 1. Acme Engine Truck Cellar and Oil Cup.

existence, hot boxes and thereby to prevent unnecessary stopping of fast trains and to permit of long distance runs between stopping points. By giving a

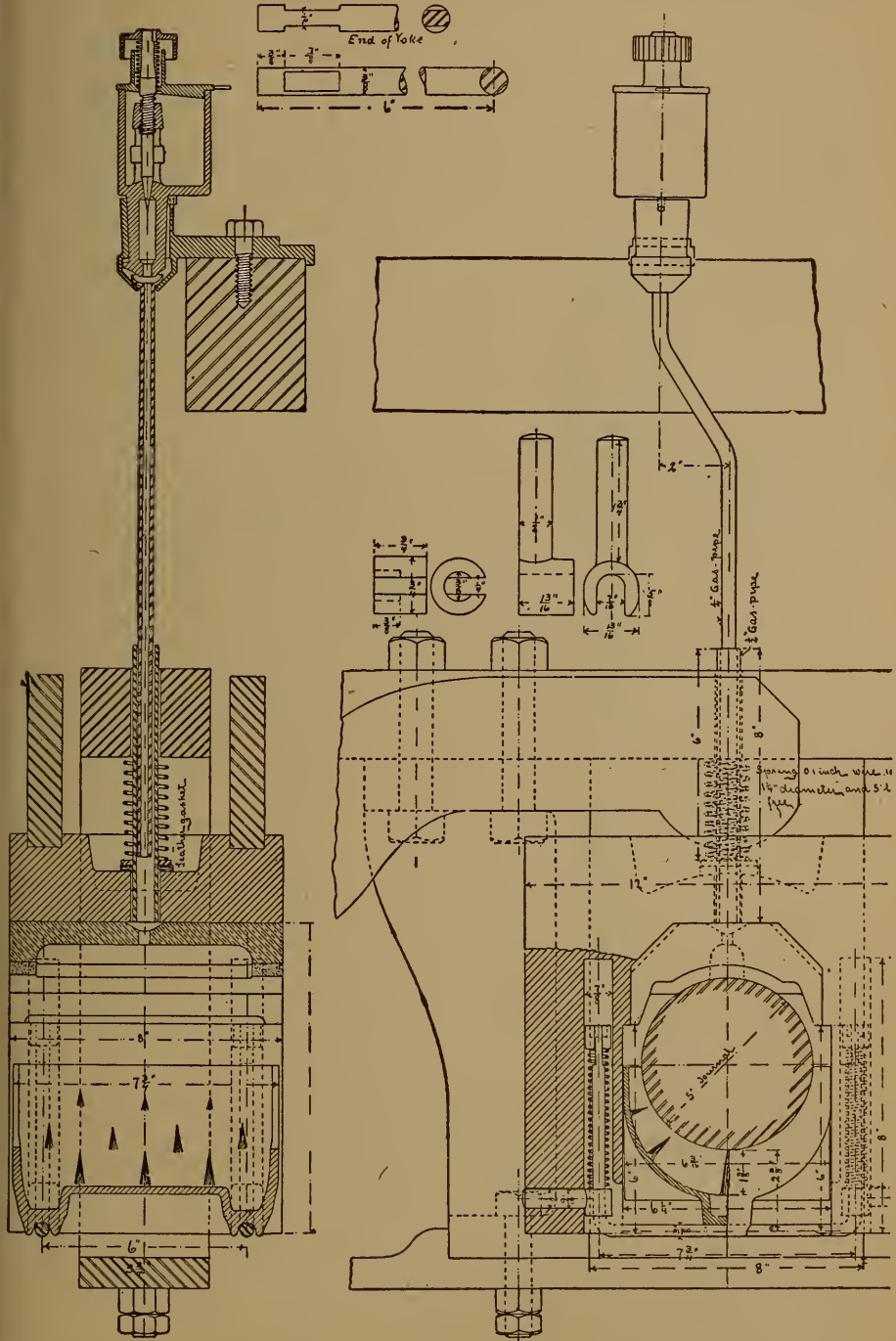

FIG. 2. Acme Automatic Engine Truck Cellar with Acme Sight-Feed Cup.

regular feed of oil to the bearings it is claimed to effect considerable saving of oil.

Fig. 1 gives a general view of these devices as applied to the leading wheel of an engine truck; Fig. 2 shows the details of both the cellar and the oil cup.

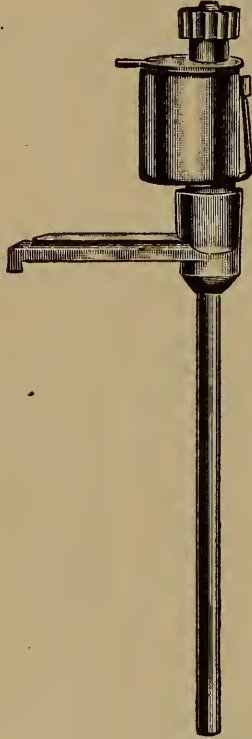

FIG. 3.

Acme Oil Cup.

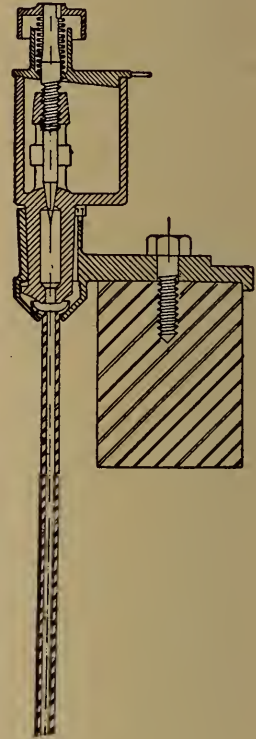

FIG. 4.

Acme Oil Cup.
(Sectional View.)

From the latter engraving it will be noted that no cellar-bolts are required, and hence none can be lost, as frequently occurs on the road with the ordinary form, but that the cellar is held up to the journal by four coil springs. By this arrangement the cellar may be pulled down and removed instantly without a

wrench, and yet cannot be lost from the truck box when replaced.

Fig. 3 shows the oil cup and supply pipe. When in place, the bottom end of the pipe is connected to the engine truck by a short piece of rubber hose.

Fig. 4 is a sectional view, from which the internal arrangement of the cup is seen to be that of a "needle feed" oil cup adjustable from without. The cup is detachable by simply turning it half around and lifting it out when necessary to clean, but its shape prevents its being jarred out and lost while the locomotive is running.

OIL CUPS.

There is no more important requisite for the proper running of a locomotive than adequate provision for the proper lubrication of those parts wherein it is necessary to overcome the deterrent effects of friction.

One of the devices for accomplishing this is the oil cup, the aim of which is to continually supply

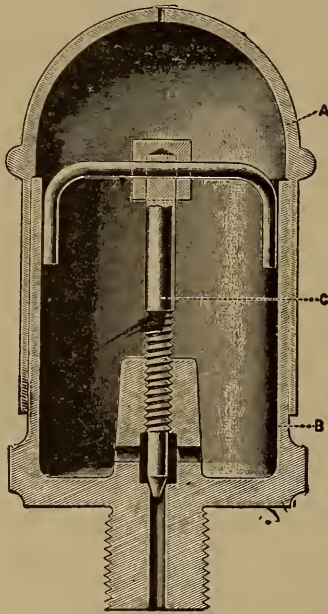

FIG. 1.
Guide Cup.

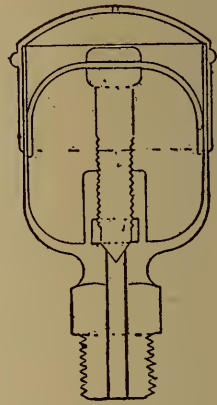

Fig. 2.
Guide Cup.

the bearing with lubricant while in motion, to feed little or no oil when standing still, and to feed copiously when the bearing gets hot.* There are so many

* The subject of lubrication and lubricants is referred to in "The Science of Railways," and the reader is referred to the General Index of that work for further information in regard thereto.

different kinds of oil cups in use, many of them patented, that it would be impossible to describe them all. The following examples will, however, serve in a general way to indicate the various types and the uses to which they are put:

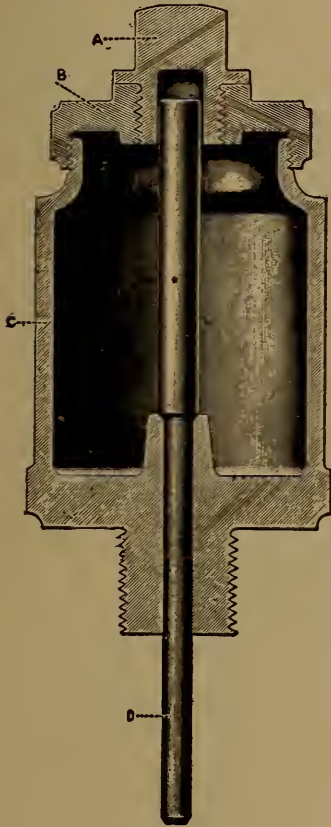

FIG 3.
Spindle Feed Rod Cup.

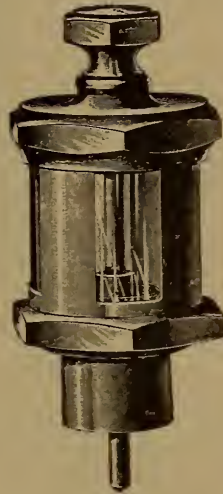

FIG. 4.
Locomotive Bearing Cup
for Connecting Rods.

Guide cups are used to lubricate the guides (see plate "American Steam Locomotive," parts numbered 89), and Figs. 1 and 2 illustrate a common type used for this purpose.

A is the cap or cover, B the body and C the adjust-

able feeder (Fig. 1). By turning the screw feed to the left the needle feed is opened to any extent desired, and by turning to the right it may be entirely closed, as, for instance, when the engine is not running.

Spindle feed cups are used on revolving parts. An example is shown in Figs. 3 and 4. These cups can be filled through the hole in the top without dis-

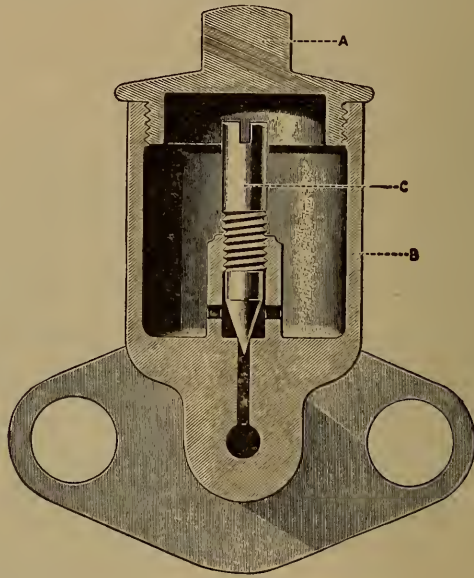

FIG. 5.

Oil Cup for Front End Main Rod on Cross Head.

turbing the regulating device, and will not feed except when the engine is in motion.

The spindle *D*, Fig. 3, is thrown up and down again with each revolution of the pin, and a small amount of oil is churned down to the bearing. As the bottom end of the spindle *D* is on or near the bearing, any heat in the latter is quickly carried up the spindle, thereby causing a greater flow of oil downwards to the pin or bearing.

Fig. 5 shows a needle-feed oil cup for the front end

of main rod on the cross-head. (See plate "American Steam Locomotive," part numbered 96.) By removing the cap the needle may be raised to regulate the amount of feed.

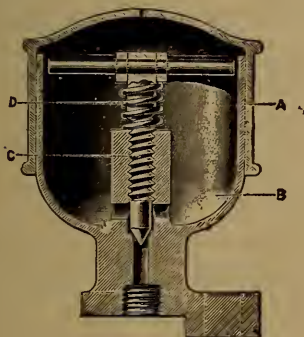

FIG. 6.

Valve Stem Oil Cup.



Fig. 7.

Main Rod, Front End, Oil Cup.

Fig. 6 shows an adjustable needle-feed cup sometimes used on valve stems, although an open cup similar to Fig. 9 with a pipe from the bottom to a swab on the valve stem is perhaps more often used.

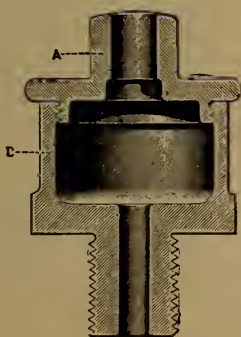

FIG. 8.

Oil Cup for Rocker Box on Cross Head.



FIG. 9.

Oil Cup for Link Hanger.

Open cups.—Fig. 7 shows a style of open cup sometimes used on the front ends of main rods, although needle-feed cups similar to Fig. 5 are in more general use for this purpose. When an open cup like

Fig. 7 is used it is filled with waste, hair or wicking to hold the oil and prevent its being thrown out of the cup.

Figs. 8 and 9 show two styles of open cups which serve as reservoirs for oil for other locomotive bearings. These cups may be packed with waste or hair to longer retain the oil.

GREASE CUPS.

While grease has been very successfully used as a lubricant on shop and mill machinery, its use

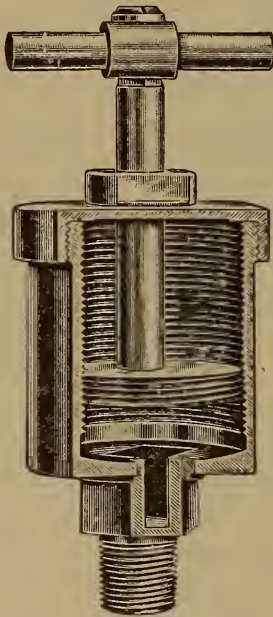

Fig. 10.

Grease Cup for Rods.

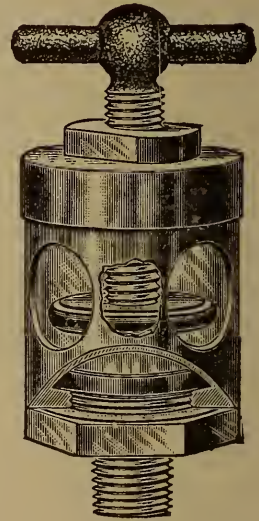

FIG. 11.

Glass Grease Cup for Rods.

on locomotive bearings has never been extensive. However, those railroads that have adopted the use of grease on main and side rods of very heavy

locomotives are very pronounced in its favor from an economical, as well as a beneficial, standpoint, and give the following as an excellent formula: One box of concentrated lye in one quart of warm water, and let stand over night. Mix thoroughly by warming eight pounds of tallow and two pints of good valve oil; then add the lye and water, and stir until it becomes thick. In winter it is best to use one pound less of tallow and three pints of valve oil.

HAND OILERS.

While there are a great many different varieties of hand oilers in use on the various railroads, their construction and operation are quite similar, and it will suffice to illustrate two of them.

The objection to the plain oiler having no valves is that oil is wasted while the engineer is getting the snout of the can to the oil cup or bearing, and also after it is removed therefrom until the can is tipped right side up again.

The closer the valve is located to the end of the "snout" of the can (as shown in Fig. 2) the less will be the loss of oil.



FIG. 1.
Crosby Hand
Oiler.



FIG. 2.
McVicar Hand Oiler.

PROPER LUBRICATION OF JOURNALS.

The increase in size of locomotives and tenders, as well as cars, necessitates the carrying of greater weight upon each journal. To accommodate these great weights the engineering department has progressed from light iron rails of 35 pounds per yard to heavy steel rails of 100 pounds per yard.

From a weight on each driving wheel of eight to ten thousand pounds formerly, we now find an increase barely escaping twenty-five thousand pounds.

The locomotive tender has also kept pace with the engine itself, but with no addition in the number of wheels carrying this greater weight. Even though track tanks* are used on many trunk lines, still the miles of railroads thus equipped would bear a very small ratio to the total American railroad mileage. Hence it is necessary to carry a large supply of water in the tender to supply the immense locomotive boilers of present construction. Where 2,000 to 2,500 gallons was formerly considered ample, we now find tenders of 5,000 to 7,000 gallons capacity on fast express and heavy freight locomotives. The coal capacity has been increased proportionately and we no longer find a coal space provided for five or six tons, but for twelve to fifteen tons. Thus it is that we have come to the requirements of carrying a tender which, loaded, weighs considerably in excess

* The reader is referred to "The Science of Railways" for description and illustration of track tanks.

of one hundred thousand pounds, all to be supported by two bogie trucks, or eight wheels and the same number of journals.

The proper method of packing the driving boxes and their cellars is very important, and a matter with which every railroad man in the mechanical department should be familiar; yet when the exercise of great care is enjoined upon those whose duties it is to clean off the top of the driving boxes, keep the oil holes open and see that the cellars are well packed with clean, spongy waste, and similar instructions are given in the care of the engine truck cellar, it still remains that the proper care and packing of journal boxes on the tender and cars of the train is less understood than it should be from a scientific standpoint.

Hence it is believed that the careful discussion of this subject will be not only interesting, but exceedingly instructive, to every practical railroad man.

THE PROPER CARE OF PACKING IN JOURNAL
BOXES.—ITS IMPORTANT RELATION
TO SUCCESSFUL LUBRICATION.*

“An attempt to curtail the proper care of journal boxes at once affects the service and its successful and thoroughly safe operation, the effects of which extend from the president down through the entire management until it reaches the men assigned the duty of the care of packing and oiling the journal boxes. It would, therefore, be a reasonable claim that this branch of the work on railroads is one of the most important, if not the most important, as a car

* From a paper presented before the Central Railway Club.

or locomotive can be run that has not been thoroughly cleaned or repainted or varnished, but it cannot be run with a hot journal, which may be due in a great measure to the neglect in this branch of the work.

“Too much importance cannot be attached to this branch of railway work, in having systematic meth-

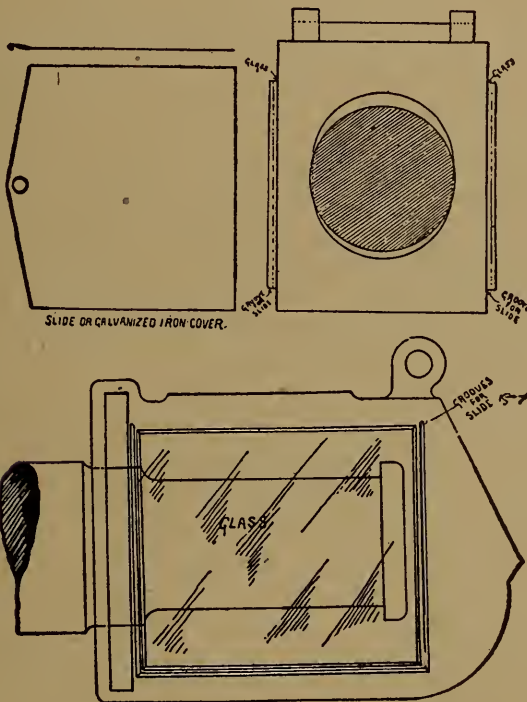

FIG. 1.

Galvanized Iron Box for Demonstrating Effect of Various Methods of Loosening Up Packing.

ods and intelligent and reliable men to perform this service. To accomplish these ends it would appear as a wise and up-to-date policy to make a specialty of following up all the details of this work, as well as the care in the selection of intelligent men, as in all branches of the mechanical sphere the most successful

are those that make a specialty of some one of the several branches.

“In this connection, it would seem proper to refer to the volume of the work in the care of packing in journal boxes. When we refer to recent statistics which show that the number of cars in the United States at the present time has reached 1,300,000, making 10,400,000 journal boxes to maintain, a general idea of the magnitude of this work can possibly be realized, and in view of this the officers of the railways who can give more than passing attention to this branch of the service by fully providing the best known facilities for the work, and rendering such assistance to the men responsible in this department, will, it is certain, find it greatly to the interests of the railway with which they are connected.

“As a better means of interesting the men directly engaged in the care of packing and oiling cars and locomotives, especially at terminals, yards and engine houses, where opportunity is given to give special attention to the packing prior to oiling, I desire to call attention to a model journal box which is shown here (see Fig. 1), the special object of which is to educate the men up to the most efficient means of thoroughly maintaining the packing in boxes, which is of greater importance than the mere adding of oil to the box without regard to the condition of the packing. The principle of the box is such as to enable the men to make a practical demonstration of the exact effect of their method of stirring up the packing in a box, and if their methods are in any respect deficient, they may also observe the effects of a proper treatment of the packing, especially on the

sides and rear of box, which portions are quite commonly neglected, and by thus practically demonstrating the bad and good effects with suitable packing tools, the interest of the average man may be awakened and the effects of his work greatly im-

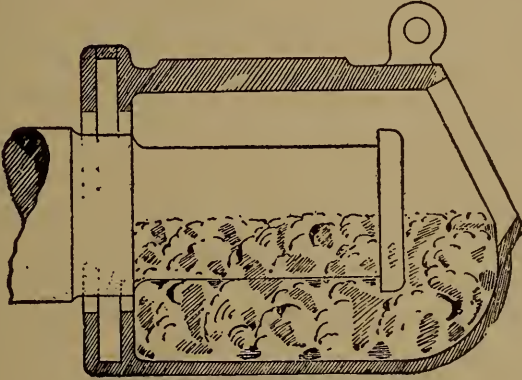

FIG. 2.

Showing Proper Height of Packing.

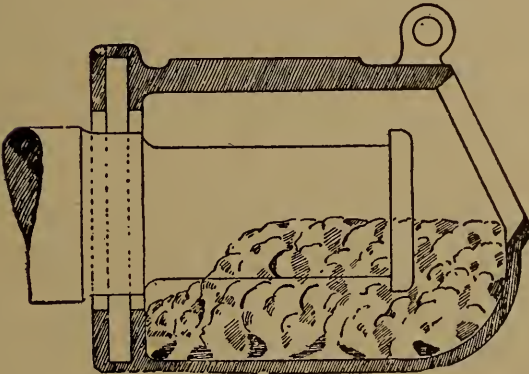

Fig. 3.

Showing Bad Condition of Packing at Back End.

proved. Efforts in this or some direction of this kind are a necessity if we may hope to improve and secure more satisfactory service, as it is feared that on many roads the details of this work have not been given sufficient serious and personal attention.

"Fig. 2 illustrates the height of packing in a box that has been found to produce the most satisfactory results. It will be seen that this illustrates the top line of packing to correspond about with the center line of the journal, thus leaving the packing entirely clear of the lower edges of the brass, which is also a desirable condition, and it also shows the packing in the front end of the box to be slightly below the opening in the box, the object being to prevent waste of oil out the front of the box; and, further, any additional packing in excess of this in the front of the box will be practically of no value.

"Fig. 3 illustrates the shape packing will assume in the rear of the box when not properly maintained at terminals where opportunity is given for this work. From this it will be seen that the packing is not in contact with journal at rear end of same; this is caused, in some cases, by not packing the back end of box firmly enough, and also, more especially, owing to improper treatment of the packing on the sides and rear portions of box at terminals prior to oiling, in combination, also, in some cases, with a lack of packing tools well adapted for accomplishing effective results in the least possible time. This condition of packing is further shown in the model box, the object of which, as previously stated, is to demonstrate beyond question the effects of proper and improper treatment of the packing, and serve as a better means of interesting and educating the men engaged in this work. It will be observed that by the use of glass sides in the model box the entire journal is exposed to view, and also clearly shows the condition of the packing the entire length of the journal and at the

back of the box. A more important feature, however, is that it clearly shows to the man to be instructed in this work the exact effect of his method of stirring up the packing prior to oiling. If the practice he has followed does not restore the packing on the sides and rear of box to proper relation with the journal, this will be clearly and positively demonstrated to him, as well, also, as the effect of such slight change that may be necessary in his methods to produce desirable results, and effect the most elastic condition of the packing, so that the oil in the box may be freely conveyed to the journal. As this is a practical demonstration, I think it will be conceded that it will serve as a superior means of interesting the men in their work, as compared to verbal or written instructions concerning the same. If this is the case, it is quite logical that the men will become more expert in the performance of this work, and better results can be reasonably looked for.

“The necessity for treating the packing in this or a similar manner, we think will be quite apparent to any one who will make the most casual observations of the solid, non-elastic condition the packing assumes through a failure to give it proper attention at the back end of the box, as previously described; and when in this condition it not only fails to convey oil to the journal, but actually becomes in time hardened and glazed, the effect of which is to wipe or scrape off any oil that may reach the journal from the forward part of the box. The lubrication, therefore, is so retarded as to, in a short time, result in the heating of the journal. At the same time that this condition exists in the back of the box, the appearance of the

packing near the front of the box may be very good, and a man that gave attention to the packing just prior to journal heating would be under the impression that the treatment he gave it was all that possibly could be done. It is, therefore, considered that the treatment of the packing as demonstrated by the model box, and also described, is of much greater importance than the mere adding of oil to the box.

“Fig. 4 illustrates a journal box having an excessive quantity of packing, which is not only a wasteful practice, resulting in a loss of oil out of the ends of the

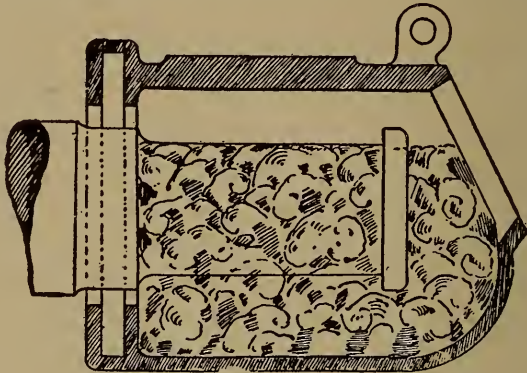

FIG. 4.

Showing Excessive Quantity of Packing.

box, but is also detrimental to good results, as by this method of so completely filling up the box with packing a condition is caused that frequently results in threads or small particles of packing becoming caught between brass and journal. This occurs by violent shocks produced in switching and application of brakes when the relation between brass and journal is sufficiently disturbed to permit small particles of waste being caught under the edge of brass and journal. This is particularly true when the packing is pressed up close around the brass, as in Fig. 4.

This is not an infrequent cause of very serious cases of hot driving boxes on engines. The effect is that the oil is wiped off the journal and the surface thus becomes dry, resulting in heating in a comparatively few minutes. It is therefore apparent that in stirring up packing, the top portion should be entirely below the edge of the brass. In stirring up packing as described it should be understood clearly that all that is required is a slight loosening up of the top surface of the packing on each side of the journal, keeping the back of the box well closed up by maintaining packing at the proper height. The top layer of packing will thus be kept in a light, elastic condition next to the journal, which is most desirable in order that the oil may be freely conveyed to the journal from the more solid portions of packing underneath. A general disturbance of the packing should be avoided, as no good results can be secured by this method.

“As suitable tools for this work are as essential as competent and skillful men, a packing tool (see Fig. 5) is here shown, made of steel, that has been found well adapted for the work of slightly stirring up packing in journal boxes at terminals where time is given for this work. This will apply to both passenger and freight cars and locomotive tenders. By reason of the custom of some men with other forms of packing tools they may not at first appreciate the value this form of tool will be to them, but it is thought that by some consideration and trial it will be found very efficient. Its efficiency depends in a great measure in following out the practice of stirring up packing as described. For illustration: It will not be desirable for the practice of placing it down under

the entire bulk of the packing at the sides of the box, as some men follow. This practice is questionable for the reason that when this is done the entire bulk of packing on the side of the box is raised bodily from the bottom of the box, and it should be considered carefully, if this is the case, how long it will likely remain

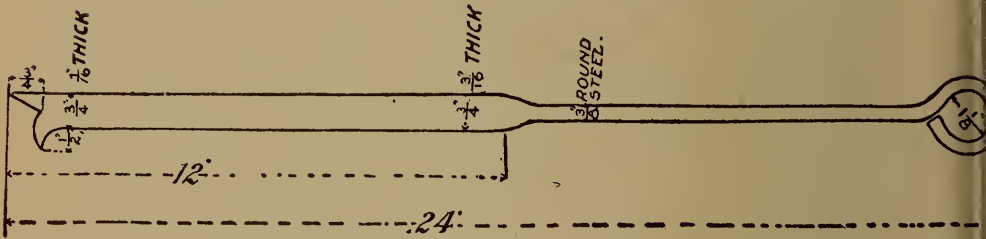

FIG. 5.

Tool for Loosening Up Packing in Journal Boxes.

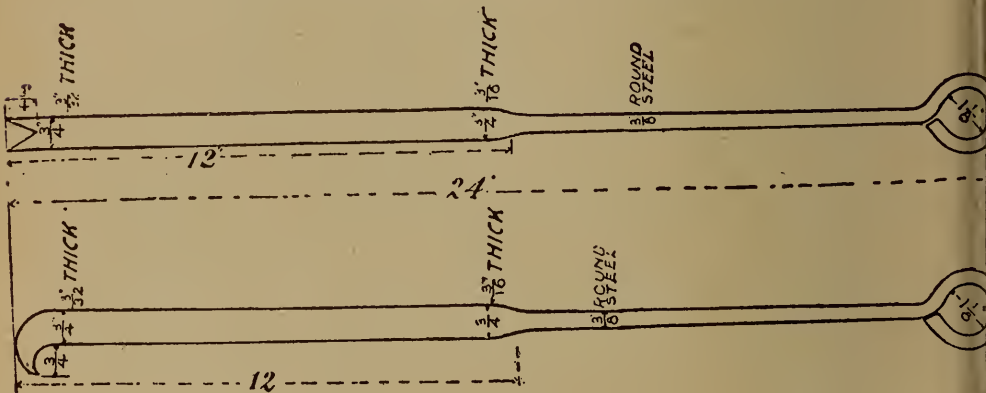

FIG. 6.

Tool for Packing Journal Boxes in Shops and Shop Yards.

up in that condition after the train is in motion, when the journal box is subjected to innumerable blows from frogs and switches. It is quite logical reasoning that it will all settle back in a short time in a non-elastic condition. This tool can be known as the combination packing tool, as it combines the features

of the commonly known packing iron and hook. It is, therefore, only necessary for the men to carry the one tool in performing this work at terminals, the hook side of the tool being necessary to remove particles of dry packing when found, or, in many cases, surplus packing.

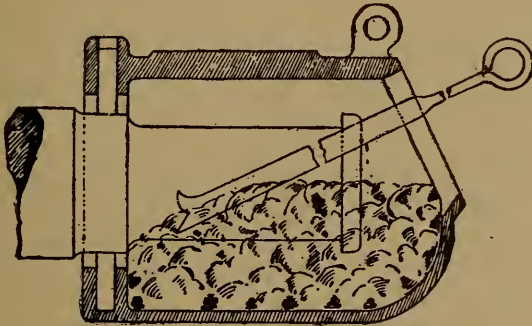

FIG. 7.

Showing Position of Packing Tool When Used to Loosen Up Packing in Each Side of Journal.

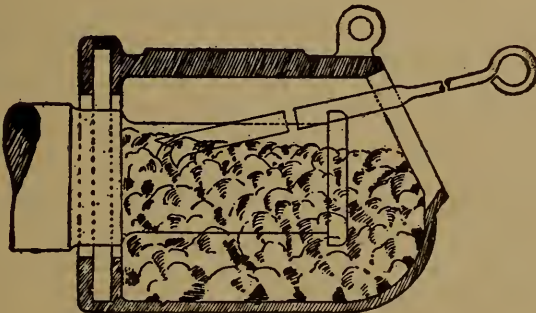

FIG. 8

Showing Position of Packing Tool When Used to Remove Surplus Packing.

“In Fig. 6 there is shown a set of packing tools intended for use in shops or shop yards, where the entire repacking of boxes is done, and we therefore consider this operation entirely distinct from that of stirring up packing by inspectors at terminals, and consequently a slightly different form of tool for the

work will be found desirable, as is the case with the great variety of tools required by skilled mechanics in their various occupations. As the practice of some is to have a hook about eight inches from the handle end of the packing tool] to facilitate the opening and closing of box lids, it should, of course, be understood that when this feature is a desirable one, it should be added to the tool. The "V" shaped end of these tools affords a ready and effective means to lightly loosen up the top layer of packing, which is the end most desired, so that this portion of the packing may be in the most elastic condition possible. Figs. 7. and 8 show the position of packing tool when used as described.

"In this connection it is well to consider the quantity of waste and oil in a journal box when packed in the usual manner. Each box contains from $1\frac{1}{4}$ to $2\frac{1}{4}$ pounds of waste and from $4\frac{1}{2}$ to 10 pints of oil, depending upon the size of box, varying from $3\frac{3}{4}$ x 7 inches up to the $5\frac{1}{2}$ x 10 inch box. It will thus be seen and appreciated, I believe, that to properly utilize the oil that is in the box, the packing next to the journal should be maintained in as elastic condition as possible. It should be further understood that the oil as it passes between the surfaces of the brass and journal is not actually consumed, but is deposited to a degree again on the opposite side of journal from which it ascended for use again an indefinite number of times.

"In numerous tests made by various responsible railways a very unusual high mileage has been made from the one re-packing of the box or boxes without the addition of any oil during the test. In some of

these tests the mileage has been from six to twenty thousand miles. During the test the packing was examined daily and maintained in an elastic condition, as previously described, no oil, however, having been added during the test. Reference to these tests and results is only for the purpose of illustrating the possible mileage in the oil contained in a journal box when subjected to a special test as referred to, and is not for the purpose of conveying the idea that such results are obtainable under the average conditions and treatment on the best regulated roads, but, instead, to indicate under reasonable conditions, which are readily obtainable through careful and systematic methods, results far superior to what are now being obtained under the average practices."

It should be enjoined upon those whose duty it is to inspect and care for journal boxes that in stirring up the packing or in pushing the packing down in the front of the box, where there is always a tendency for it to work out, the top waste (which contains more or less sand and dirt) should be crowded first toward the front of the box, and then down under the cleaner oily waste, which latter will thus be brought up to the journal.

One who has given much time and study to the subject strongly advises the following practice in the packing of a journal box on either a car or locomotive tender: The first packing put into the box should be twisted up into a roll and shoved clear to the back of the box and up against the axle, thus forming an effective dust guard, as well as a preventive to oil running out of the back of the box. Then small bunches of waste, that have been saturated in oil for at

least twenty-four hours and subsequently drained of superfluous oil, should be packed under the journal until the box is filled the whole length of the journal. Complete the operation as begun by a twisted roll having no fibre connection with the other packing, placed in the front of the box for the purpose of preventing the good packing from working out from under the journal.

It is desired, in conclusion, to emphasize the fact that the most important part of the work of lubrication is the skillful and proper maintenance of the packing in the box, so that the most elastic condition may be secured and maintained.

JOURNAL BOX DUST GUARDS.

In order to retain the oil in the journal box and at the same time exclude the dust, sand and dirt it has long been customary to employ some form of wooden or metal dust guard, the former being frequently faced with plush or felt. Many improvements upon this older form of solid board guard have been devised, one of the best known being here illustrated.

HARRISON DUST GUARD.

The Harrison dust guard is constructed from hard wood, well oiled, and made in two sections. Through

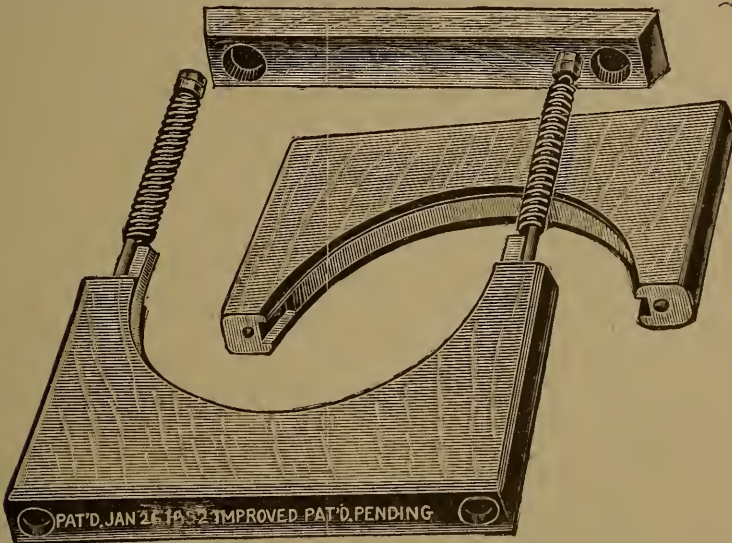

FIG. 1.
Harrison Dust Guard.

each of these sections there is formed an orifice adapted to receive bolts. In the upper section of the

top part the orifices are enlarged in order to receive springs. Said springs are compressed with jammed hexagon nuts whereby the sections are held yieldingly together, constantly encircling the car axle journal at all times, and in both of the sections there is three-sixteenths of an inch taken out of the center, thereby allowing three-eighths of an inch wear before sections are closed together.

In each of the sections there is formed a groove three-eighths of an inch wide and three-sixteenths of an inch deep. Into this groove there is inserted packing strips. The packing strip in the upper section is sufficiently shortened to allow the packing strip in the lower section to telescope into groove in the upper section, thereby closing the joints between the two sections, not only making this guard dust proof, but, as the packing is cut out of heavy belting leather, insuring great service owing to the fact that under tests of upwards of fifty-five thousand miles no indication of wear was observable.

THE LOCOMOTIVE BELL RINGER.

On locomotives traversing thickly settled portions of the country, and those engaged in suburban and switching service, running long distances within the limits of cities, mechanical bell ringers are no longer a novel luxury—they are a judicious investment of capital. Railways using them extensively or adopting them as a standard for all locomotives would as soon think of discarding the injector and going back to the old feed pump as they would of doing away with the bell ringer.

The duties of a locomotive fireman, who used to ring the bell, have increased with the increased size and speed of locomotives and the rules governing the avoidance of black smoke, because of its being classed as a nuisance about cities, if for no more economical reasons. A man furnishing coal to a ten-foot firebox developing from five hundred to fifteen hundred horsepower, has little time to do much else when the locomotive is in motion—the time when it is necessary to ring the bell.

THE GOLLMAR BELL RINGER.

This bell ringer is preferably so arranged as to automatically start the bell ringing whenever the locomotive whistle is sounded. This arrangement is clearly shown in Fig. 1. Thus connected, it is claimed to afford valuable evidence in case of grade-crossing accidents. A small chain connected to the whistle

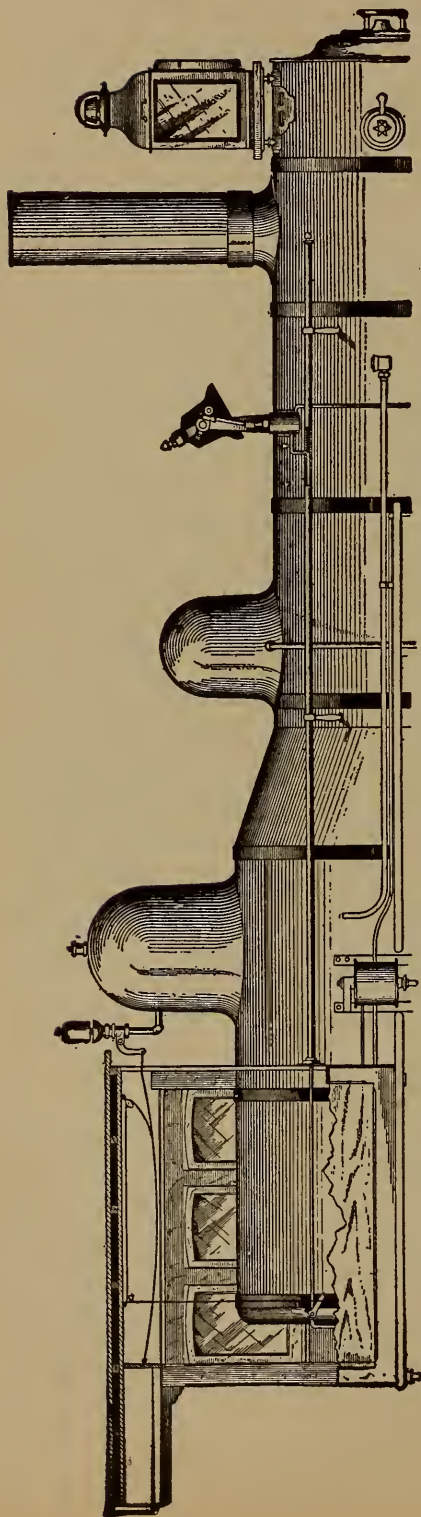

FIG. 1. Shows Whistle Connection and Application of Golmar Bell Ringer.

rigging automatically opens a small valve in the cab, which valve admits steam or air pressure to the bell ringer. This cab-operating valve is close to the engineer's hand, and may readily be opened without pulling the whistle cord.

While steam pressure may be used to operate this and other bell ringers, air pressure is much preferable, especially in cold climates.

The construction and its action are as follows, as may be seen by reference to Fig. 3: There are two openings near the bottom for pipes; the upper one is the inlet, the lower is the exhaust. Pressure is admitted through the upper opening, opposite an annular groove in valve 18, through which four holes are drilled, admitting the pressure under the single acting piston

10 ; this causes piston 10 to rise, forcing the bell to swing. Piston 10 has a stroke of one and one-fourth inches when at its extreme travel; crank 2 has a stroke of four inches. The connecting rod is in two sections, 6 and 7 , which allows the crank 2 to make a complete revolution without causing piston 10 to move. When the ringer is started to work the piston 10 will be driven upward, causing the bell to



FIG. 2.

Full View of Bell Ringer.

swing, and valve stem 17 will raise valve 18, closing inlet port, and use pressure expansively by traveling the length of the lap before the lower edge of valve 18 will open the exhaust port. The bell, having received an impulse, will continue its motion after the piston 10 has reached the upper end of its stroke, the crank box 6 sliding on rod 7. The impetus which the bell receives being expended, it will fall; the set bolt 4 will

strike the end of rod 7, and piston 10 will be forced downward (being open to the exhaust below), coming in direct contact with valve 18, thereby closing exhaust port and opening inlet port after cushioning on the pressure remaining under piston 10 subsequent

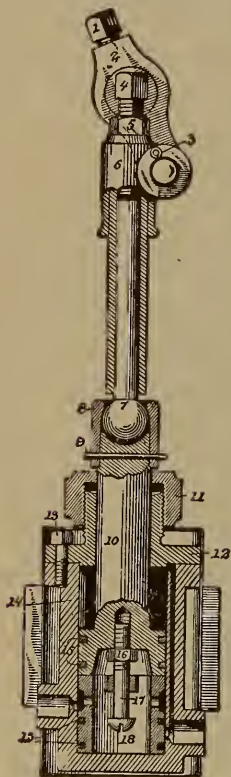

FIG. 3.
Gollmar Bell Ringer.
(Sectional View.)

to the closing of the exhaust on account of the exhaust port being placed slightly above the bottom of the cylinder. It will be seen that valve 18 is only operated at the terminations of the piston 10 stroke. Packing rings 15 on the piston and on the main valve are packing rings standard to the Westinghouse eight-inch air pump reversing valve. As the rings are kept in stock by all railroads using air-brakes, no extra supply need be carried by them.

The bell ringer can be easily adjusted to use pressure in proportion to the power required. This is accomplished by means of valve stem 17, which is secured in its adjusted position by jamb nut 16. No change in length of connecting rod is required in making this adjustment. These bell ringers have been used successfully when cutting off pressure after the piston has moved but three-eighths of an inch of its stroke. This arrangement makes it so economical in use of pressure that air is always used in preference to steam, and it has never caused any trouble with train brakes.

This little machine has no outward moving parts except the rod. Its valve is attached to the piston.

THE SANSOM BELL RINGER.

The Sansom bell ringer is operated by the admission of compressed air pressure under the piston, which forces piston upward and carries a connecting rod attached to a crank on the bell shaft, as shown in Fig. 1. When an arm, extending on the left of the

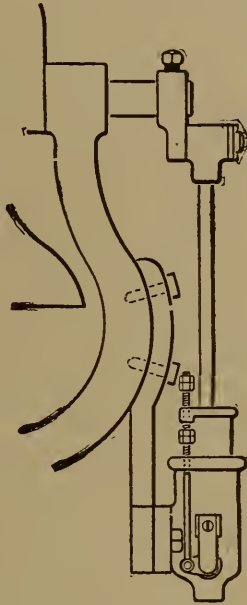

FIG. 1.
The Sansom Bell Ringer.

piston, has traveled to the upper set of lock nuts on reversing rod, the admission port begins to close and the exhaust port to open, thus allowing the air to escape from the cylinder and the weight of bell to force piston to bottom of cylinder.

When the arm on the left has traveled to the lower set of lock nuts, the exhaust port begins to close and

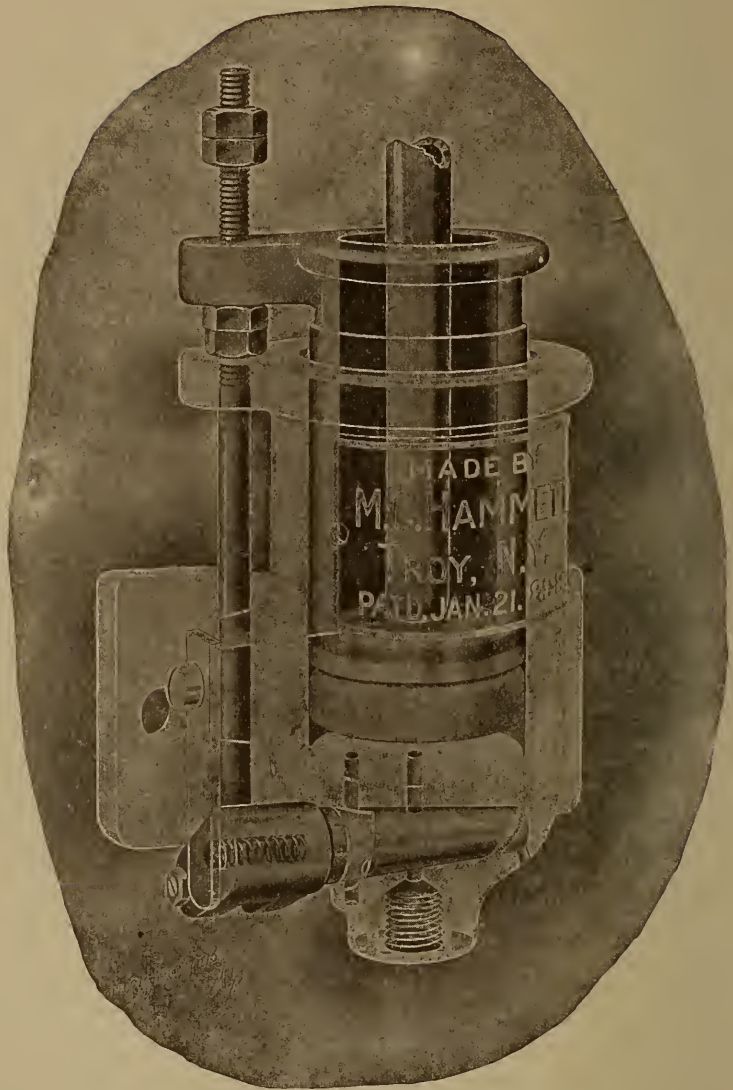

FIG. 2.

The Sansom Bell Ringer, Showing Internal Mechanism.

the admission port to open, thus again forcing the piston upwards, as before described. Fig. 2 is a transparent view of the bell ringer, showing the working of the valve within.

The variation in the stroke of the ringer is made by adjusting lock nuts on reversing rod. To increase the throw of bell, raise the upper set of lock nuts; to decrease throw, lower them.

THE CHICAGO LOCOMOTIVE BELL RINGER.

The Chicago Locomotive Bell Ringer, as shown in Fig. 1, is so nearly similar in operation that the

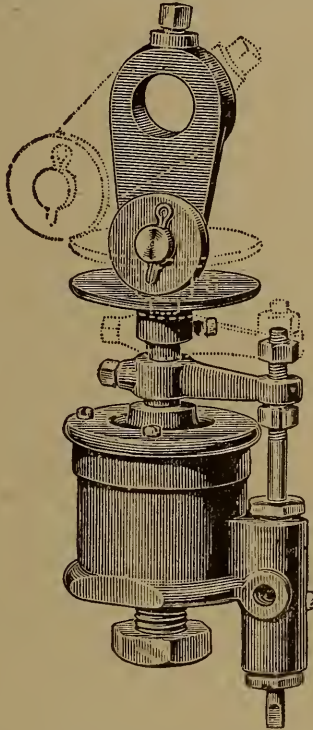

FIG. 1. Chicago Locomotive Bell Ringer.

engraving suffices for an explanation after the principles of the foregoing devices have been described.

AUTOMATIC STEAM BLOWERS.

THE HUFF AUTOMATIC STEAM BLOWER.

This automatic steam blower is a simple and novel device inserted in the blower pipe immediately over the steam chest, and auxiliary to the regular blower valve in the cab. By its use the blower automatically goes to work whenever the throttle is closed, and automatically ceases blowing whenever the throttle is opened, the force of the blower blast being regulated by the blower valve in the cab.

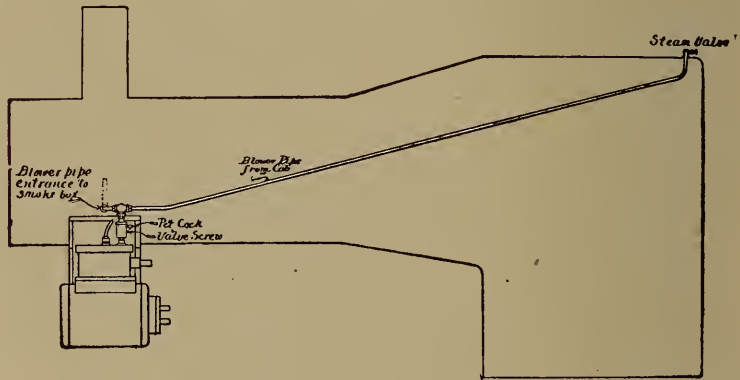

FIG. 1.

Huff Automatic Steam Blower.

It is well known that the proper and regular use of the present hand blower for the purpose of preventing the smoke and gases trailing back over the train and coming out into the cab when the engine is shut off requires much care and attention on the part of the fireman, and that it is seldom accomplished in practice.

The location and connections of this device are shown by Fig. 1. It will be noticed that it can be easily and quickly installed. The arrangement and working of the internal parts are shown by Fig. 2, and the external appearance of the complete device, ready for installation, is shown by Fig. 3.

To install this device, a piece of the blower pipe about four inches long is cut out at a point directly over the steam chest; the ends of the two remaining parts are threaded, the device inserted, and a one-inch pipe connection made between the bottom of the cylinder *A A* (at the point *N*, Fig. 2) and the top of the steam chest.

It is assumed that the blower valve in the cab is always kept open to some extent; under these circumstances, steam at full boiler pressure always fills the blower pipe from the cab down to the valve *F*. When the throttle is opened, the steam in the steam chest (see part numbered 44, plate "The American Steam Locomotive") exerts an upward pressure on the piston *EE*; the area of the piston *EE* being much greater than the area of the valve *F*, the excess of upward pressure on the piston *E E* over the down-

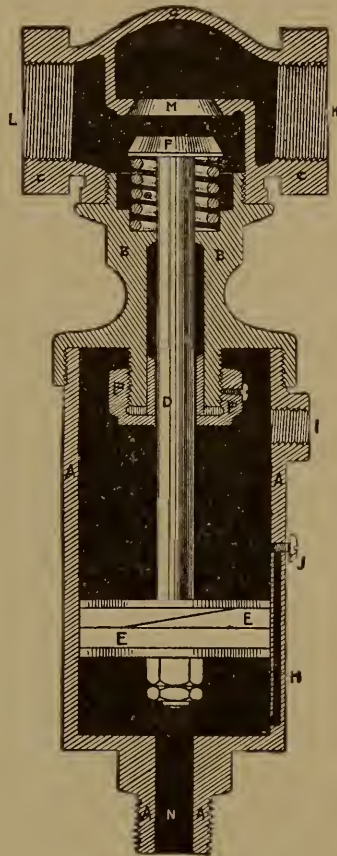

FIG. 2.
Huff Automatic Steam Blower.
(Sectional View.)

ward pressure on the valve *F* results in the seating of the valve *F*, so that as long as these conditions continue the blower cannot blow. When the throttle is closed the boiler pressure acting downward on the small area of the valve *F* is nevertheless greater than the atmospheric pressure (in the steam chest) acting upward on the piston *E E*, and the valve *F* is, therefore, forced down from its seat *M* (being cushioned by the spring *G*), and the blower goes to work automatically.

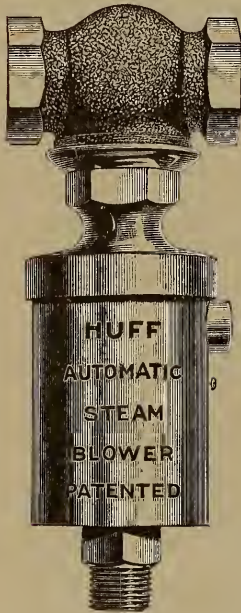

FIG. 3.
Huff Automatic Steam
Blower.
(External View.)

In the rare emergency of wishing to keep the blower at work when the engine is using steam it is only necessary to open the screw valve *J* and plug the exhaust opening *I*, under which circumstances the piston *E E* will be in equilibrium with the same steam pressure above and below it, and the boiler pressure in the blower pipe will open the valve *F*, and the blower will go to work and remain at work (whether the throttle is open or shut) as long as the blower valve in the cab is left open.

This automatic steam blower thus provides a means by which the judicious and economical use of the old blower valve may be accomplished—the smoke and gases from a passenger engine may be largely prevented from trailing over the train when the engine is shut off—thus greatly increasing the comfort of passengers, and particularly those who use trains which are running in local and suburban service.

The crews of all engines, whether passenger, freight or shifting, may be relieved of the annoying and harmful effects of smoke and gases coming into the cab when engines are shut off; this is very annoying even when coal is used as a fuel, but almost intolerable when coke is used; besides this, it seems to be necessary to make some provision for keeping a coke fire bright when the engine is not working, and this device provides a positive and automatic means of accomplishing this. Finally, the automatic action of this

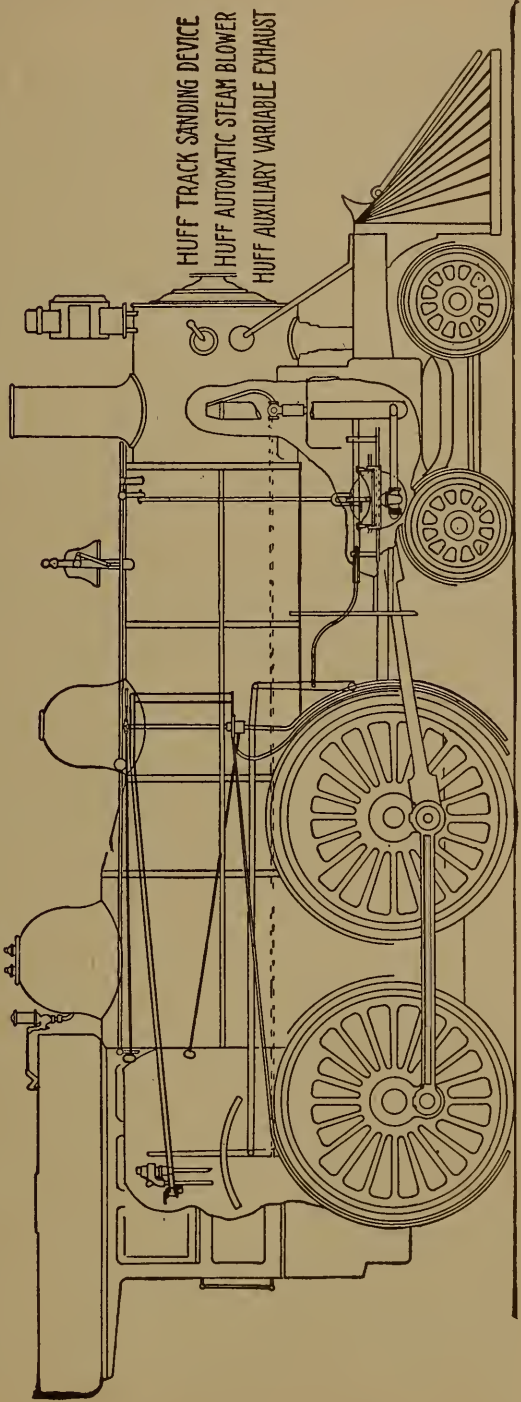

FIG. 4. Huff Locomotive Attachments.

device would relieve the fireman of much of the work of "hooking" or stirring up the fire.

Fig. 4 shows the application of this and other locomotive attachments by the same manufacturer.

CHICAGO & NORTH-WESTERN R'Y BLOWER VALVE.

The automatic blower valve used by the Chicago & Northwestern Railway on suburban locomotives to prevent black smoke is a valve operated by compressed air, which is admitted mechanically by the opening and closing of the locomotive throttle in the cab.

Fig. 5 shows a view of the boiler head with the arrangement of the device employed for this purpose. The air controlling valve with connections to the

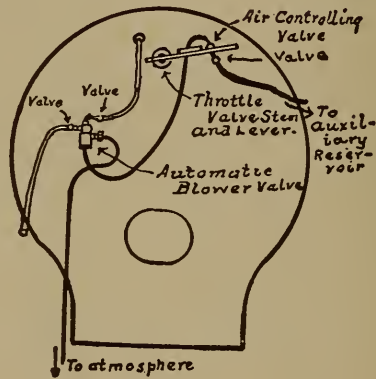

FIG. 5.

C. & N-W. R'y Automatic Blower Valve.

auxiliary reservoir of the driver brake and to the automatic blower valve is shown located just back of the throttle lever. When the throttle is closed all communication between the two is closed, but when

the throttle is opened the air pressure automatically unseats the small controlling valve and passes to the blower valve where it acts upon a piston, closing off the steam from the blower pipe in the smoke box. In case it is not desired to have the blower work when the locomotive is standing, the usual blower valve is closed. It is by the amount of opening given this latter valve that the severity of the automatic blower is regulated.

VARIABLE EXHAUST NOZZLES.

The history of expanding exhaust nozzles is nearly as old as the locomotive itself. Ever since the locomotive was first constructed there has been a feeling among practical men that there should be some means of controlling the exhaust opening to a certain degree in accordance with the amount of steam being used in the cylinders. Experience has shown that when a stationary nozzle is used the various conditions under which a locomotive is worked produce, at times, wasteful results in fuel economy, and under many conditions the contracted opening of the nozzle gives too great a back pressure in the cylinder, thus decreasing the speed and efficiency of the locomotive.

The stationary nozzle must be made small enough to get the desired draft on the fire when the engine is working the least practical amount of steam in the cylinders, and when it becomes necessary to "drop the lever" and work more steam in the cylinders the increased velocity of the exhaust through a restricted opening of the nozzle tears the fire on the grates, thus rushing the gases and finer coal unconsumed through the flues and causing wasteful results. The holes torn in the fire also admit cold air through the grates, cooling the flues and fire-box suddenly, and causing them to leak. There is no doubt but what many engine failures due to leaky flues may be attributed to this cause.

To overcome these difficulties many forms of

expanding nozzles have been devised, most of them, however, being designed to be operated manually by the engineer, but the neglect of the latter to properly and constantly use them caused them to quickly become inoperative by corrosion and gumming up due to the heat and gases of the front end.

WALLACE & KELLOGG'S VARIABLE EXHAUST NOZZLE.

The automatic variable exhaust nozzle here shown has been in use for several years, and is claimed to have overcome by its automatic action many of the

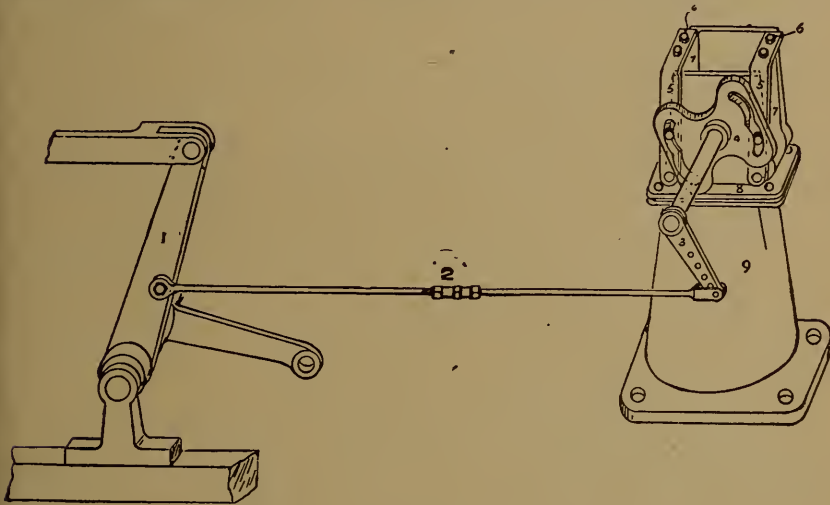

FIG. 1.

Wallace & Kellogg's Automatic Variable Exhaust Nozzle.

serious objections to former devices. The movable wings are connected to a rotating cam, which in turn is connected to a shaft extending through the smoke-box. To this latter shaft, by means of a crank *I* and adjustable rod *2*, connection is made with the reverse lever or lifting arm *1*. Therefore the operating of

the nozzle is automatically adjusted to correspond with the amount of steam that is being used in the cylinders at all times. When the reverse lever is hooked up toward the center of the quadrant the nozzle is the smallest. When the lever is in either forward or back extreme position of the quadrant the nozzle is the largest.

The adjustment of the nozzle may be altered in a moment's time by simply moving the front end of the connecting rod 2 up or down on the crank *I*, thereby giving it correspondingly less or increased travel, as desired.

On account of the frequent changes of the reverse lever this nozzle, it is claimed, cannot become gummed or corroded so as to render it inoperative.

THE HUFF AUXILIARY VARIABLE EXHAUST.

The exhaust nozzles of locomotives are made small enough in diameter to give sufficient blast to stimulate the fire and generate the necessary amount of steam when the valves are cutting off short and the steam is being used expansively; this results in the blast being too strong at certain other times, when the valves are cutting off later, and the terminal pressure is higher; this excess force of blast is detrimental in two ways: first, by increasing the back pressure in the cylinders; second, by tearing the fire and causing excessive coal consumption. The Huff automatic variable exhaust provides a means by which these objections are overcome.

In applying the device to a locomotive the exhaust passages are tapped at convenient points between the

cylinders and the smoke-box and pipes led back through the saddle; these pipes (which should be at least two inches in diameter and larger, if possible) are connected with a reservoir or drum located immediately back of the saddle, as shown in Fig. 4; this drum is provided with a vent and valve, which preferably should be operated by a connection from the lift shaft, so that the vent opening will be greater when the reverse lever is at either end of the quadrant, and

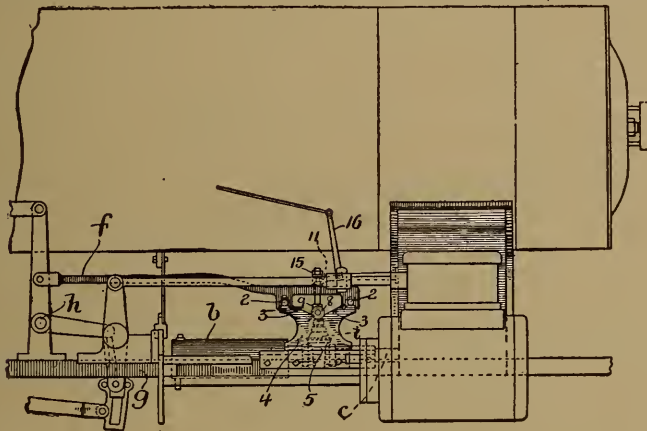

FIG 1.
Huff Automatic Variable Exhaust.
(Side View.)

less when the reverse lever is in mid-gear. The escaping steam from the vent may be piped to any convenient discharge point, as, for instance, up the back of the stack.*

The application of the apparatus to a locomotive, and the relative arrangement of the parts, is shown by Figs. 1, 2, 3 and 4. Figs. 1, 2 and 3 show the application to a locomotive fitted with double exhaust nozzles,

* The reader is referred to the plate of the "American Steam Locomotive," to arrive at a clear understanding of the location of the ordinary locomotive parts herein referred to.

while Fig. 4 shows a possible alternative application to a locomotive fitted with a single exhaust nozzle; in the former case, however, two small drums were used instead of one large drum, owing to the fact that the intervening space was already occupied by the main reservoir of the air brake system. The arrangement of parts for the double exhaust locomotive (Figs. 1, 2 and 3) is as follows:

The openings in the top of the cylinder saddles, marked *e e*, Fig. 2, are the points where the exhaust

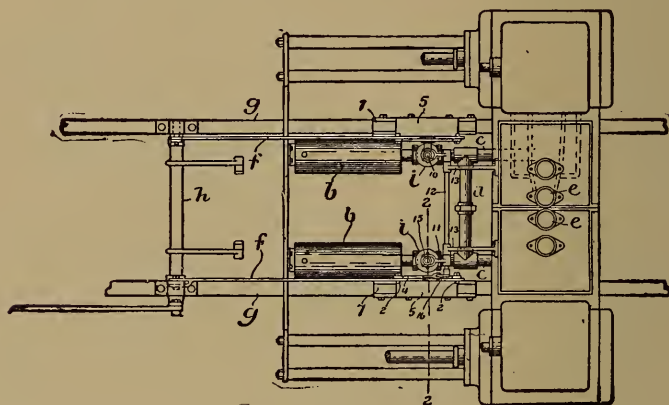

FIG. 2.
Huff Automatic Variable Exhaust.
(Plan View.)

base and nozzles are attached; *c c* are the pipes which are tapped into the exhaust; *d* is a cross-pipe connecting the two; *b b* are the drums; *i i* are gate valves inserted into the pipes *c c* back of the cross-pipe *d*. The mechanism for operating the gate valves from the lift shaft in this case involves the use of special slides working in guide bases which are attached to the frames, the slides being made with inclined slots which engage rollers attached to the vertical stems of the gate valves. As the slides have a horizontal

motion, imparted by connections from the lift shaft, the gate valves have their maximum opening when the reverse lever is in either extreme position, and their minimum opening when the reverse lever is in mid-gear. The several parts comprised in this mechanism for working the gate valves from the lift shaft are shown in Fig. 1 and marked *f*, *g*, *h*, 2, 3, 4, 5, 6, 7, 8 and 9. An auxiliary apparatus is also provided,

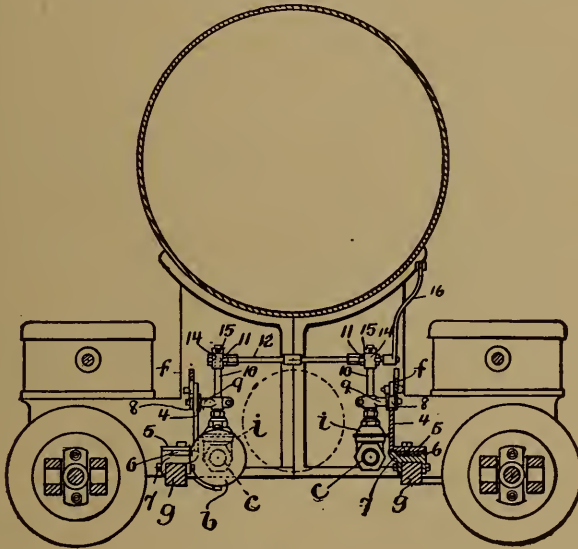

FIG. 3.
Huff Automatic Variable Exhaust.
(Front View.)

by which the gate valves may be operated from the cab independently of their control by the reverse lever when the engine is cut back. The parts of this auxiliary apparatus are shown in Fig. 3, and marked 11, 12, 13, 14, 15.

It has been stated that the drum or drums should be fitted with a vent and valve to control the discharge of surplus steam to the atmosphere; in the particular

application shown by Figs. 1, 2 and 3 this vent and valve were located on the lower side of one of the drums (which was the only available point) and the valve was adjustable by hand only; the lift shaft connection was, therefore, made with the gate valves *i i* instead.

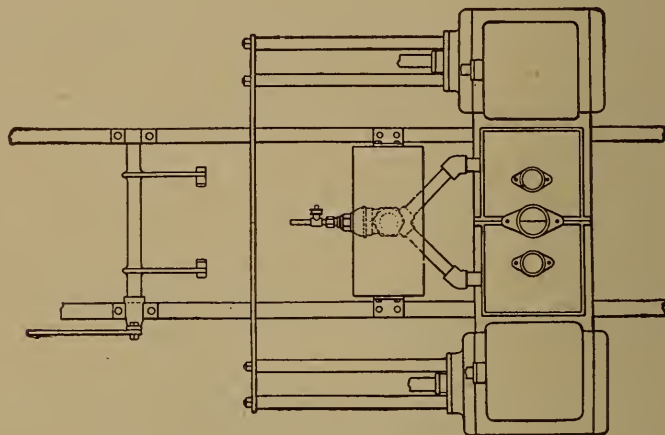

FIG. 4.

Huff Automatic Variable Exhaust.
(View from Under Side of Locomotive.)

Service trials of the Huff variable auxiliary exhaust on a double exhaust locomotive have shown a coal saving of about sixteen per cent. on the ton mile basis. It is probable that this result was attributable to two influences: first, a portion of each exhaust was by-passed around to the other side and discharged into the stack through the nozzle which was not in action at that time, thus both relieving the back pressure and making the exhaust into the stack more regular and uniform than it otherwise would have been; second, by venting to the atmosphere through the vent on the under side of the drum any excess of

steam over and above what was necessary to develop sufficient blast under the particular circumstances and conditions then existing.

THE WALLACE & KELLOGG AIR-PUMP EXHAUST FEED-WATER HEATER AND CYLINDER LUBRI- CATOR.

The construction of this appliance is as follows: A three-way cock is used in connection with exhaust port of air pump. It is placed near the air pump. Attached to this cock is a lever that extends into the cab and is operated by the engineer. Also two exhaust pipes are connected to this cock, one extending over cab and exhausting directly into the feed water in the tender, the other pipe extending to the smoke box and live steam ports or steam chests. The branch pipes to the steam ports are provided with check valves. A check valve is also placed in the pipe leading to the smoke box.

The three-way valve is for the purpose of conducting exhaust steam into the feed water or otherwise at the will of the engineer. When opened in opposite direction, and the engine is working steam, the exhaust is conducted to the stack, but when the engine is shut off, the exhaust is admitted to the two steam chests and cylinders by the automatic opening of the checks in the two branch pipes. The check in the pipe leading to the stack prevents smoke and cinders from being drawn into the cylinders when the engine is drifting.

The live steam ports are provided with automatic drip valves situated at the lowest point in cylinder

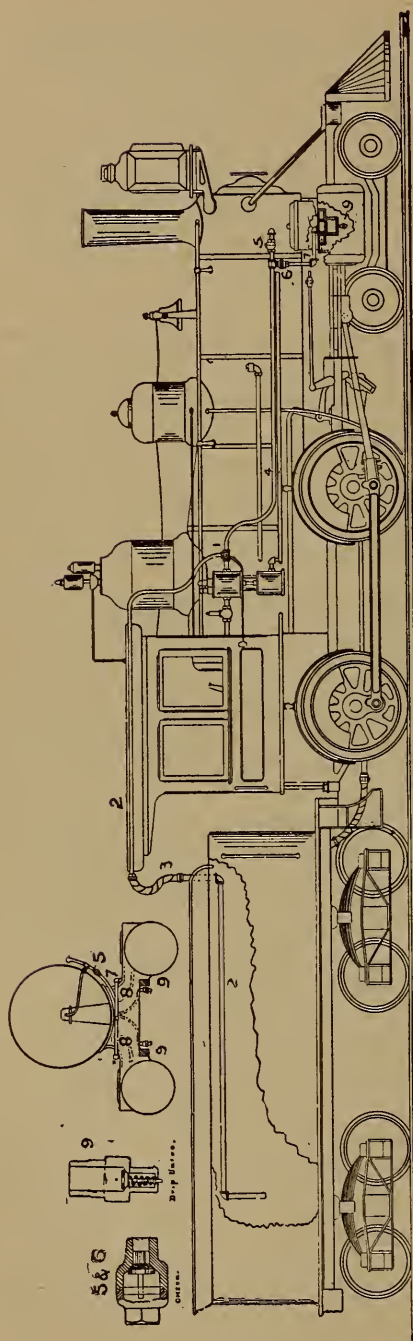

FIG. 1. Air-Pump Exhaust Feed-Water Heater and Cylinder Lubricator.

saddles for the purpose of draining condensation when the engine is at rest.

The small sectional cuts shown above the locomotive tender in the accompanying engraving clearly illustrate the details of the check valves, drip valves, etc., and their location.

Among the many advantages claimed for this device are the following:

It is noiseless. This avoids the frightening of teams or the annoyance to passengers around stations. It does not create a draft on the fire when the engine is at rest, as does the old method.

This advantage results in the saving of fuel. It acts as a lubricator to the valves and cylinders when the engine is not working steam. The exhaust

steam from air pump circulates through the steam chests and cylinders, keeping them at a uniform temperature, not allowing them to chill in cold weather when engine is at rest, or overheating or cutting of cylinders while drifting down grade due to the friction of the piston traveling to and fro. The relief valves on the steam chests can be dispensed with, as the air pump exhausting into same performs their functions to a large degree. There is a large saving of fuel effected by the heating feed water to as high a temperature as injectors will work. This also makes a better steaming engine. It also reduces wear on valves, valve seats, cylinders, etc., to a minimum by perfect lubrication. It is beneficial to the working of the air pump, as there is a partial vacuum formed in the exhaust pipe from the pump to the live steam ports when the engine is drifting shut off, as on heavy grades when the air pump is working the hardest. The water in the tank being warmer than the atmosphere, the tank never sweats, thus preserving the life of the paint on the tank and keeping it bright and fresh. The device is simple, cheap in its construction and is claimed to effect a saving of fifty per cent. in cylinder oil and two per cent. in fuel.

BOILER CLEANERS.

It has been said that the saving to be effected in power generations to-day consists more in the overcoming of simple practical difficulties in the use of that which we already have than in any revolutionary invention. The man who could supply a simple, inexpensive means of furnishing steam boilers with pure water, which, when evaporated, would leave nothing behind it, would do more to decrease the average cost of power production than the man who develops the compound engine. Such a process would have to be so cheap in first cost as to warrant its use in comparatively small plants, and so simple as to require attendance of no higher order than that found about the ordinary boiler plant.

THE MCINTOSH PNEUMATIC BLOW-OFF COCK.

It is now generally conceded that when the water used for locomotives is bad and cannot be purified before entering the boiler the best way to dispose of the impurities is to keep them loosened up with soda-ash or some other kind of boiler purge, and remove them by washing out or blowing off the water from the boiler before they have opportunity to incrust upon the flues or sheets.

The frequent washing out of boilers has two disadvantages: first, it consumes considerable time, which may seriously interfere with transportation in busy times; and, second, bad results follow the frequent

cooling down and reheating of boilers, causing undue expansion and contraction, with the accompanying cracking of sheets and leaking of flues.

The more frequent and thoroughly the water in a boiler is blown out, the longer can be the interval between washings-out. To accomplish this, it is desirable to have several cocks easy of manipulation in the lowest parts of the boiler for getting rid of the heavier impurities, and a surface cock for removing from the surface of the water any light animal or vegetable matter that would tend to cause foaming or the water raising in the boiler. To accomplish this many styles of blow-off cocks have been used. One device, quite general in its use, is the McIntosh pneumatic blow-off cock.

Fig. 1 shows a side and sectional view of this cock, which will be seen to consist of two check valves (*A* within the shell of the boiler and *B* without), and a piston operated upon by air and released by a spring. Fig. 2 gives a view of the boiler head in the cab of a locomotive, indicating the air piping and operating valves, with large detail of the latter. When air or steam (preferably air) from a small valve in the cab (see Fig. 2) is admitted to the outward or top side of the

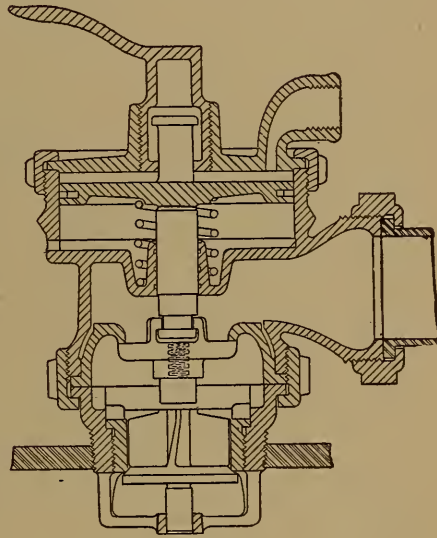

FIG. 1.

McIntosh Pneumatic Blow-Off Cock.
(Sectional View.)

piston, as it appears in the engraving, Fig. 1, it acts against the piston, which shoves both check valves open and holds them open against the pressure in the

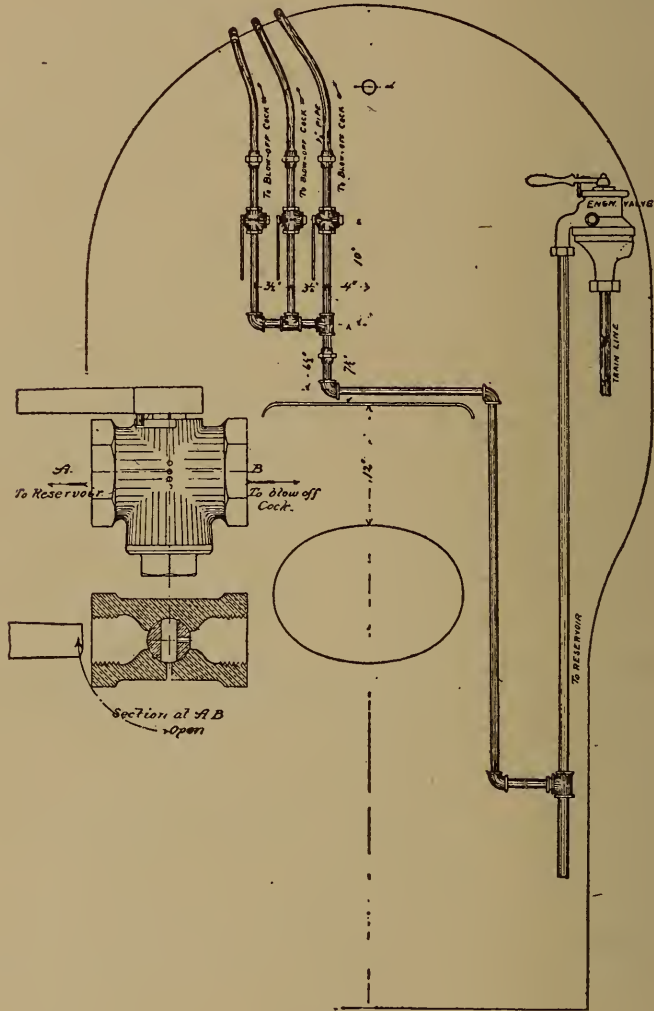

FIG. 2.

Cab Operating Valve Arrangement, McIntosh Blow-Off Cock.

boiler, on account of the area of the piston being the greater. When the air is exhausted from the piston the boiler pressure, aided by the spring, causes the

piston to assume its normal position as shown in the engraving.

Each blow-off cock has a discharge pipe leading either to the side of the locomotive or toward the back, in order to blow the impurities away from the machinery and boiler itself.

Should there be no air pressure on hand with which to operate the pneumatic cocks on an engine, the cock may be opened by screwing down (or in) on the outer handle *C*, which acts the same as the pressure on the piston, namely, forces the valves in and opens them. On the contrary, although both the check valves require to be held open before any discharge or leakage can occur, should dirt or grit get into the cylinder portion in which the piston works, or should no oiling be given the piston for a long time, the latter might stick in open position, in which case the handle of the screw should be turned back, thereby permitting the check valves to reseat themselves.

Should scale hold either or both check valves from their seats, it is generally advisable to open the valves wide several times and let them close suddenly. This will usually crush the hardest scale.

When locomotives are supplied, as shown in Fig. 3, with both surface and lower blow-off cocks, it is considered the best practice to use the surface cock *A* when the locomotive is working hard and the water is in a state of violent ebullition, carrying the impurities to the surface. At terminals, and if the boiler is foul occasionally on the road after steam has been shut off long enough for the sediment to settle, the lower blow-off cocks should be opened while both injectors are working and two or three gauges of water blown out.

While there is no packing of any kind about this cock, to keep it in perfect order the cap of the air cylinder should be removed about once a month and the

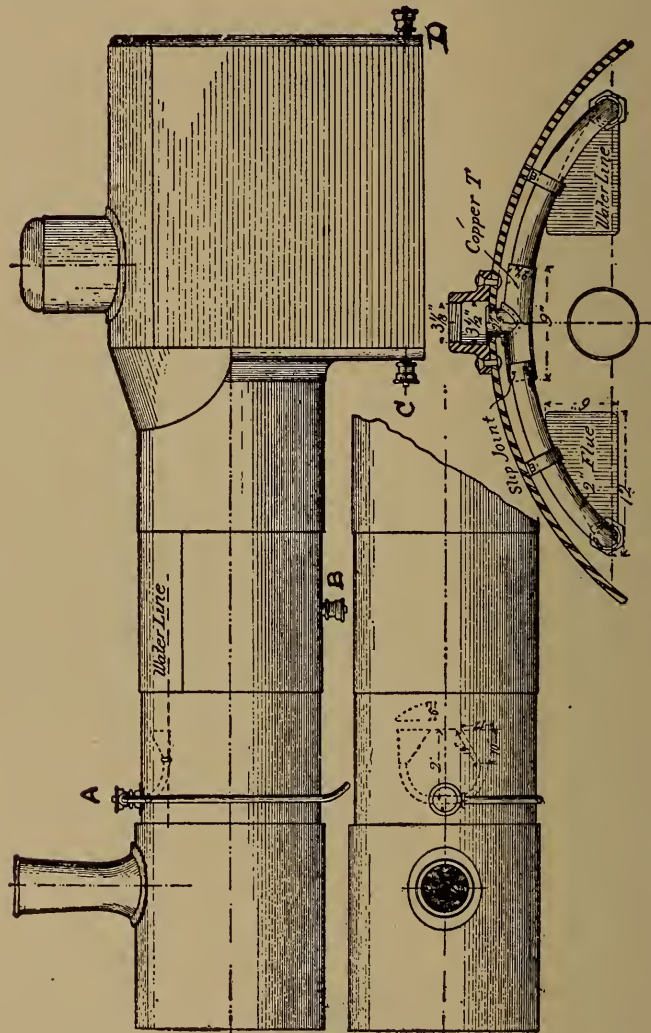

FIG. 3.
McIntosh Pneumatic Blow-Off Cock, Showing Arrangement of Blow-Off Cocks on a Boiler.

cylinder wiped out and oiled. By leaving a plug in some convenient tee of the air pipe in the cab oil may be injected therein more often if desirable.

Fig. 2 shows a convenient cab arrangement for three blow-off cocks on a locomotive. As shown, the air is taken from the main reservoir connection of the engineer's brake valve, and each operating valve consists of a one-half inch air stop cock with a small hole drilled through one side to form a three-way cock for exhausting the air from the cylinder of the blow-off cock after the cab operating valve is closed.

Should it require considerable supply of air to operate any one of the blow-off cocks, it will be found that there is a leak in the air pipe between the cab operating valve and the blow-off cock, or a bad leak by the packing ring of the latter. Its correction is obvious.

A boiler equipped as shown in Fig. 3 may be kept clean by frequently blowing out; it will develop fewer cracked firebox sheets and leaky flues, and will require washing out less often. The engine will work dryer steam and carry less scale and dirt through the valves and cylinders, thus requiring less cylinder oil and producing less wear to the valve motion; it will use less water, make more ton-miles than a locomotive not so equipped, and the loss of water and heat occasioned by blowing out will be compensated for several times over.

THE HORNISH MECHANICAL BOILER CLEANER.

This cleaner is in two parts, all inside the boiler, except the air valve and the blow-off pipe and cocks. One part is in the forward end of the boiler and reaches from side to side, using the front head as a back to which it is riveted. It extends under the dry pipe*,

* See part numbered 191, plate "The American Steam Locomotive," in "The Science of Railways."

and is also riveted to the sides of the boiler, as shown in Figs. 1 and 2.

The space between the flues and the dry pipe is used

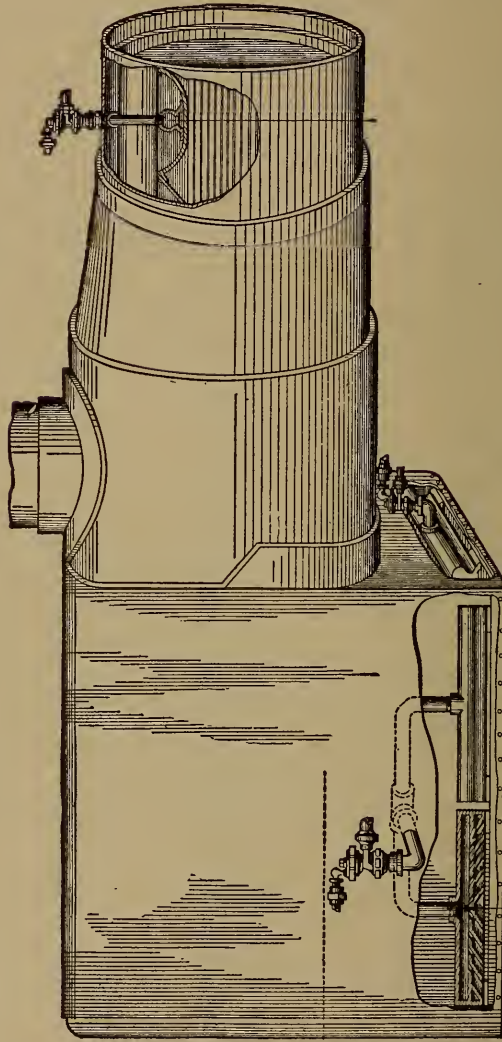

FIG. 1.
Hornish Mechanical Boiler Cleaner.

for the skimmer, see Fig. 2. It makes a perfect surface skimmer the full width of the boiler, and, at the same time, forms a basin holding from twenty to

thirty gallons. This makes a large storage capacity in which to collect and settle all the impurities that the skimmer takes from the surface. The basin holds the skimmings and settlings which can be blown off at the will of the engineer. The impurities are carried to the skimmer by the natural circulation in the boiler. The fluctuations of the water line do not affect the proper working of this device.

Within the skimmer is an arrangement for blowing off what solid matter it catches, thus practically preventing any waste of water when the skimmer is blown off, and between these times it is claimed that there is a continuous automatic drawing off.

The other part is in the leg of the boiler, as shown in Fig. 1, and cannot be put in except when the boiler is first built, or when a new fire box is put in. It is the same kind of a device that empties the skimmer as just described. It sits on top of the mud ring, the "suckers," which are raised one inch above the mud ring by legs on the draw-off head, facing down. The openings of all the suckers are the same size, but their small ends vary in size. If they were all the same size, the openings nearest the center would pass all the sediment, and those further along the head would not pass their share. (This is due to the fact that all liquids under pressure will seek the nearest outlet first.) To overcome this, the small end of the sucker nearest the opening in the center of the draw-off head is made the smallest, and the size of the others increases with the distance from the center. The matter surrounding this is always water soaked, and is a soft slush, which is easily removed by the pressure in the boiler.

As the impurities are over and around the draw-off head in front of the water and steam, the pressure in the boiler pushes them out through the suckers into the blow-off pipe before any water or steam can pass through. There is no waste of water, as the blowing off is stopped as soon as the water shows clear. This is what reduces the waste of water to a minimum. The draw-off head here shown is a great improvement over the old head formerly used; even if they should stop up from neglect, they can be cleaned from the outside

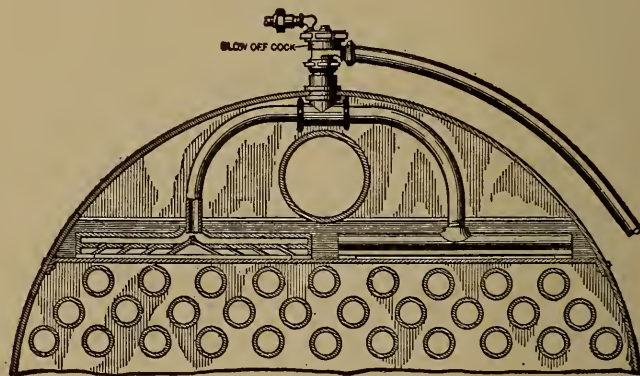

FIG. 2.

Hornish Mechanical Boiler Cleaner.
(Sectional View Through Front of Boiler.)

by forcing water through them. They cannot scale up, since there is no heat next to them from the fire box. Each part of the cleaner is a companion to the other, and what one leaves undone the other does. The two must be used together to obtain perfect results.

When the water is boiling the impurities come to the surface in a boiler the same as in an open vessel. The proper circulation in a locomotive boiler is down to the belly of the boiler after water leaves the check, then

down the forward leg along the side and up the back leg over the crown sheet, and forward over the top of the flues, striking the front head of the boiler, from which point it starts to repeat the same course over again. It is here at the front end of the boiler and at the surface that the skimmer intercepts the impurities, settling and removing them before they have time to touch the hot flues or hot sheets. This not only prevents foaming, but leaves nothing in the boiler to make scale and lessens the accumulation in the leg of the boiler.

Nothing but water will make steam, so keep grease and compounds out of the boiler. Heat is the best agency known for separating solid matter from water. A boiler is the best contrivance yet devised by man for heating water; as most of the solid matter

contained in the feed water comes to the surface when steam is up, that is the best place to remove it. It is claimed that the surface skimmer does this before it starts to make the second round with the circulation, and what little is left goes to the leg of the boiler and is removed by the mud ring device; this prevents foaming, reduces the number of washings out, prevents incrustation and corrosion, and is claimed to have been found more practical than purifying the water before entering the boiler.

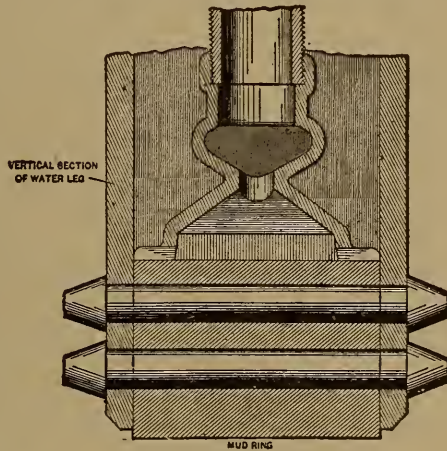

FIG. 3.
Hornish Mechanical Boiler Cleaner.
(Section Through Mud Ring.)

It is the soft matter in the boiler that is dangerous; the removing of that part removes the danger.

This device does not interfere in the least in cleaning out the old way, or in the use of compounds. If scale should form from neglecting to use the cleaner, or any other cause, compounds can be used, and what they dissolve and throw down the cleaner will remove at the surface and at the leg. As both cleaners are blown off before entering the round house, there is little or nothing left in the water, and what there is it catches while the engine is idle, to be blown out again as soon as it leaves the roundhouse. This makes a clean boiler at all times.

If boilers are allowed to become cold before removing the water, very little scale will form on the flues and sheets. It is removing the water for washing out while hot, to save time, that causes them to scale so fast and also makes them leak.

As foaming is eliminated, no solid matter goes over with the steam to cut the valves, valve seats, valve stems or packing. The cylinders, too, are kept smooth, and when free from grit their wearing surface soon acquires a gloss that insures easy working and long wear, together with a minimum use of oil. This is of great value for balanced valves, which are now coming into use with high pressure.

It is the effective heating surface that counts, and not the large amount. The more rapid the circulation is the more times it will pass over the heated surface in a given time, and a smaller heating surface with a rapid circulation is better than a larger heating surface with a more sluggish movement of the water. The thinner the liquid is the more rapidly it will circu-

late, and as it becomes thicker its movements will become slower. It is the impurities left in the boiler instead of being removed that causes the water to thus thicken.

Directions for its use upon locomotives.—Use surface blow-off after leaving and before entering roundhouse at each end of the division, also once or twice between terminals on each trip, blowing from one to one and a half minute each time. The best time to blow off the surface cleaner is when the engine is doing the hardest work. Should boiler foam from any cause, use surface blow-off for instant relief. The mud ring device is used only at each end of terminals, just before and after leaving the roundhouse.

CLIMAX BLOW-OFF COCK.

To Open the Blow-Off Cock.—When a three-way cock in the cab is turned, air or steam (the former is more desirable, especially in cold climates) is admitted through a pipe at port *C* to the upper side of piston *P*. As the upper side of piston *P* is more than twice as large as the bottom end of valve *V*, which is exposed to boiler pressure of chamber *G*, piston *P* and its valve *V* will be moved down by a pressure of air somewhat less than half what is in the boiler at the time. When this movement has taken place it will be seen that water in the enlarged cavity *G* can pass through the ports *D-D* up through the inside of valve *V*, out the ports *E-E* into the annular opening *F* leading to the atmosphere at *B*.

To Close the Blow-Off Cock.—Turn the three-way cock in the cab to its original position, which exhausts

all pressure from *C* and the top of piston *P*. The boiler pressure from *A* now acts against the bottom of valve *V* and forces valve and its piston up to position shown in cut, and the valve makes a joint at *W-W*, thereby preventing any further wastage of water. Scale or dirt caught in the ports *D-D* or *E-E* would be sheared off when the valve closes, and scale on seat

- A*—Connection to Boiler.
B—Blow-Off to Atmosphere.
C—Air or Steam Connection.
D-D—Intake Ports of Valve *V*.
E-E—Outlet Ports of Valve *V*.
F-F—Annular Opening to Blow-Off at *B*.
G—Annular Opening to Intake Ports *D*.
H-H—Vent Ports of Spring Chamber.
P-P—Piston.
K—Cap for removing Piston, Spring and Valve.
S—Spring.
V—Valve and Piston *P*, combined.
W-W—Valve Seat when closed.

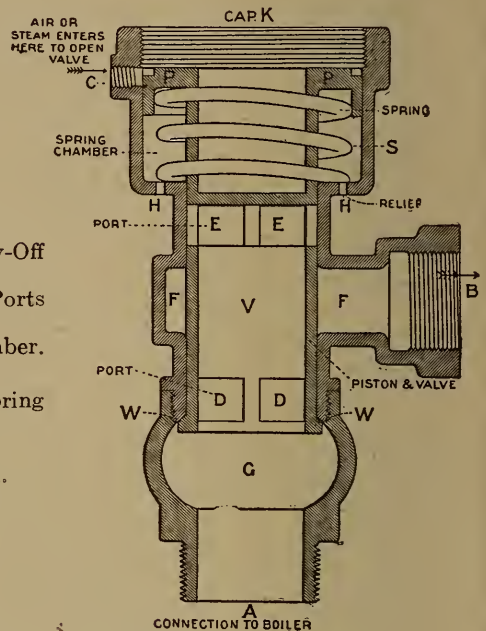

Climax Blow-Off Cock.

W-W ordinarily crushed. If the valve fails to close tight, open and close it quickly a few times until it forms a tight seat at *W-W*.

The spring *S* is for the purpose of preventing the valve opening from any vacuum formed when the boiler is cooling down. Hence, if the valve leaks at such time, cap *K* should be removed and this spring examined.

THE "LITTLE GIANT" PNEUMATIC BLOW-OFF COCK.

The accompanying engraving shows clearly by arrows the flow of pressures and fluids when this blow-off valve is in operation. Air pressure has entered the air cylinder and forced the piston, with its attached valve inside the boiler, to the right, allowing the water and the sediment in the boiler to escape.

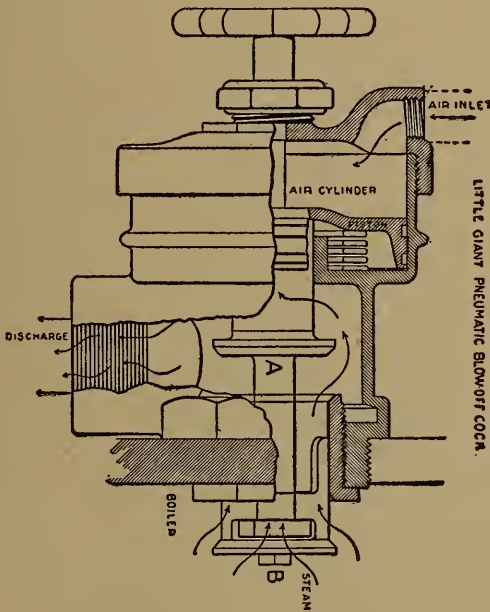

Little Giant Blow-Off Cock.

When the air pressure is withdrawn the spring behind the air piston returns it and the boiler pressure against the valve assists in the return to its seat. Should some scale or other substance remain beneath the valve *B*, by screwing in on the hand wheel, valve *A* may be forced to a seat, thus rendering this valve remarkably safe against failure to close.

THE JOHNSTONE BLOW-OFF VALVE.

This is a form of gate valve operated by a suitable lever at the will of the engineer. These valves have been largely used on locomotives, and are much superior to an ordinary globe valve for this purpose, as particles of scale will not prevent their proper closing.

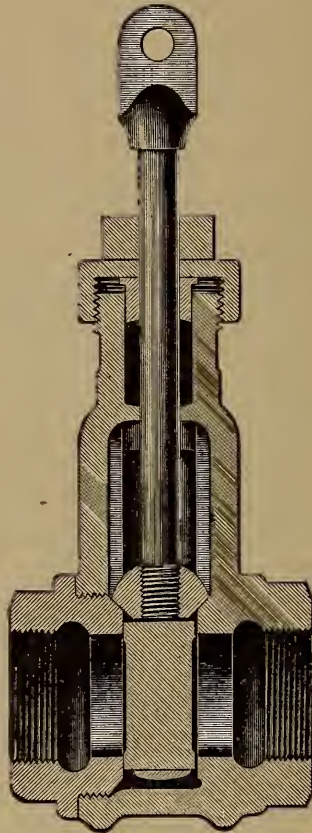

Johnstone Blow-Off Valve.

The sliding valve is attached to the stem by means of a stirrup, shown just under the valve, and which loosely encloses it, and thus permits it to freely adjust

itself to the seat it forms at the side opposite the attachment to the boiler.

By a lever connected to the stem the valve can be raised entirely from its seat, so that there is a full straight-way opening through the valve body. The sliding of the valve under pressure maintains its surface and its seat in close contact, and if any scale or other foreign matter tending to impair such contact intervenes, it is destroyed or displaced by the attrition of the parts when so operated.

THE HOMESTEAD BLOW-OFF VALVE.

This valve serves a purpose similar to that last described. A long wrench extending up through the running board or deck permits its use while the locomotive is in motion.

While the cut here shown gives an exterior view, its internal arrangement is identical with that of the "Homestead Straight-Way Valve," shown elsewhere. One-quarter turn opens the valve wide, and the reverse movement not

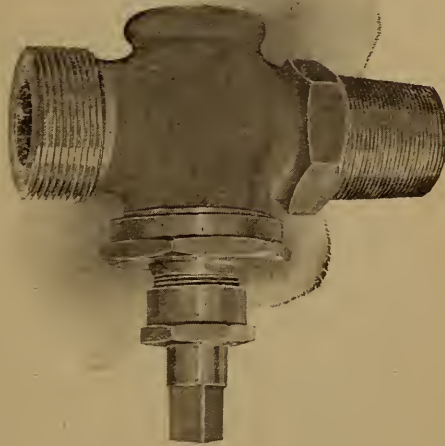

Homestead Blow-Off Valve.

only closes the valve, but locks it tightly upon its seat, thereby preventing all leakage.

AUTOMATIC AIR AND STEAM COUPLER.

The illustrations here given show a device that automatically couples and uncouples the air brake pipes on freight trains, and the air signal and steam heating pipes as well on passenger trains. This device has been in successful operation on a number of passenger and freight trains. Figs. 1 and 2 show a plan and a side view of the device.

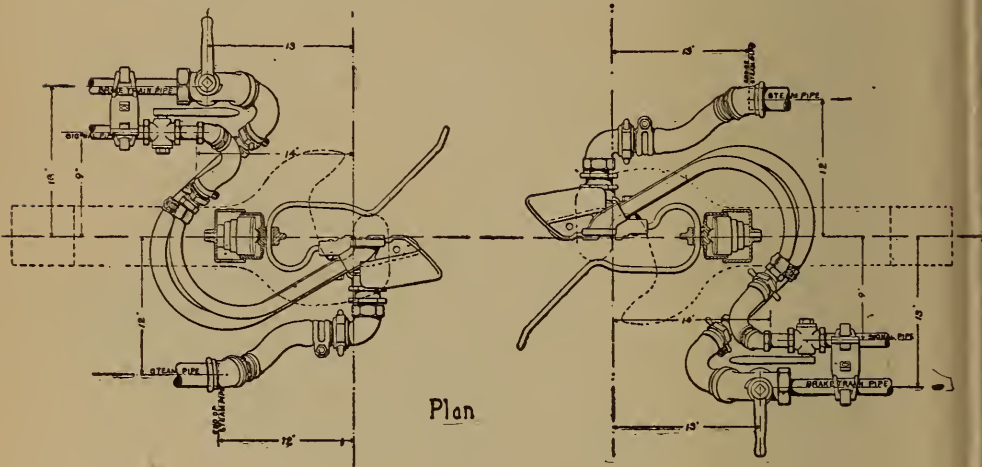
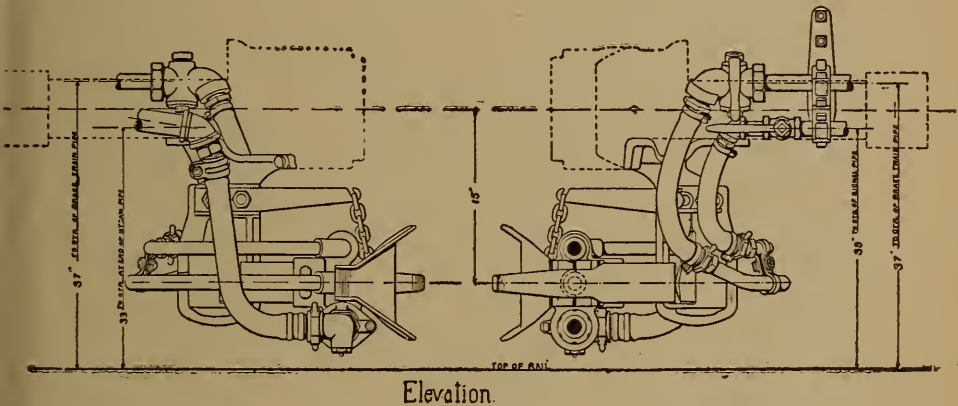

FIG. 1.
Automatic Air and Steam Coupler.

The construction, manner of attaching and operation of this device may be described as follows: The apparatus is interchangeable, there being no rights and lefts. The coupling head consists of a casting with openings on its face to receive the registering gaskets, and a coupling spring riveted thereto, as shown on the plan view (Fig. 1). On the elevation

view (Fig. 2) is shown a cast-steel bracket riveted to the under side of the drawbar, to which a slotted hanger, in which the coupling spring rests, and a chain arm to support the coupling head, are bolted.

The gaskets are so placed in the head that neither is touched by the opposite one until the coupling is made. This protection is effected by a tongue and groove, on which tongue the face rides until the gaskets are in position to register, when the tongue drops into the groove.



Elevation.

FIG. 2.

Automatic Air and Steam Coupler.

The outer end of the coupling head, having "V" and wedge-shape guides, is directed both vertically and horizontally by the outwardly bent spring on the opposing members. This coupling spring performs the double function of guide and clamp to hold the head firmly together when coupled.

As will be seen on the elevation views, the heads are tapped to receive the air pipes, to which connection is made to the train and signal pipes by a short hose.

The steam attachment is so arranged that it can

be readily removed or attached without affecting the air connections. An automatic drip at the lowest point of the steam attachment provides for all condensation.

As will be seen on the plan views, the slotted hanger is provided with a spring buffer which positively insures the air coupling under all conditions where the car couplers will operate, and which maintains the coupling point of the air coupler in advance of the car coupling. The spring resting in this slotted hanger; the head being suspended by the chain, and the flexibility of the short hose permit the free movements required by the variations in the heights of cars, as well as the movements on curves, and also permit the free coupling in all such cases.

An interchange is provided in such a way that coupling may be effected with the ordinary hand hose coupler.

The coupling and uncoupling takes place automatically and simultaneously, as well as with the same degree of certainty, as does the car coupling.

THE LINSTROM SYPHON PIPE.

This is a decided improvement over the old form of tank valve which too frequently becomes disconnected from the spindle, requiring the draining of the tank and reconnecting.

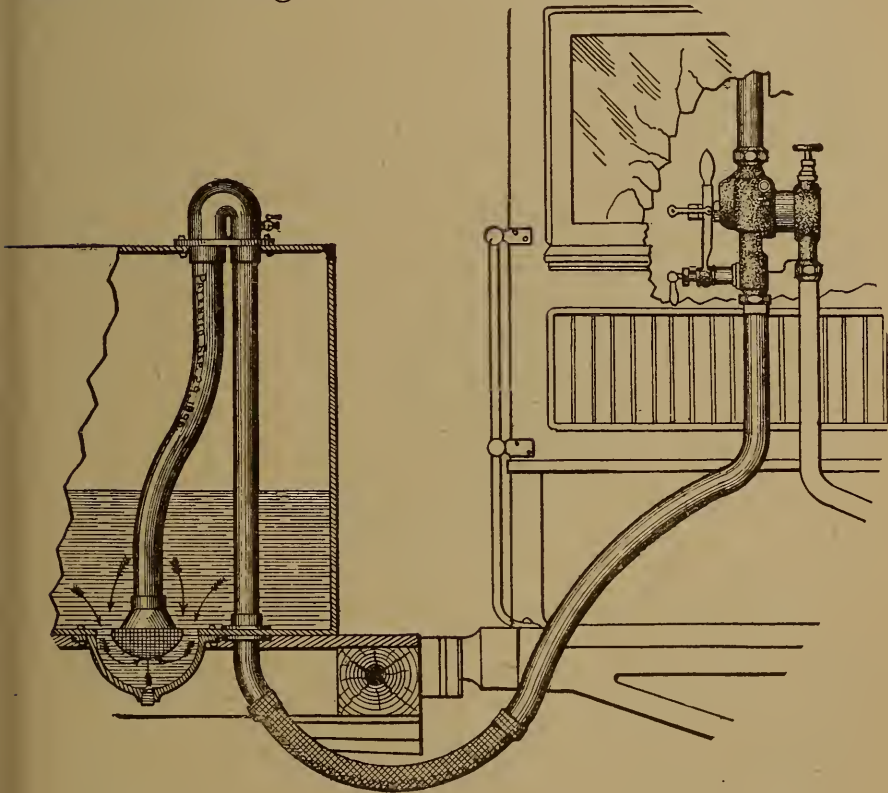

FIG. 1.

Linstrom Non-Freezing Syphon Pipe.

The syphon is said to be more easily and cheaply applied than the ordinary tank valve and hose strainer, with which it does away. With this device

there can be no flooding of the gangway by the leakage of the tank valve which is, of course, dangerous in cold weather.

As soon as the injector is started the priming fills the syphon, which remains full. It is impossible for the hose to freeze, for by simply permitting the injector to blow steam back into the tender the hose and feed pipe are immediately emptied of water, leaving nothing in the exposed pipe or hose to freeze.

To clean any sediment from the tank, remove the small plug in the bowl shown below the strainer. To disconnect the tank hose when there is no steam to blow the water out of feed pipe, open the small pet cock shown at the top (or return bend), thereby admitting air and breaking the action of the syphon. This air cock should be closed at all times when working the syphon.

This device also permits the use of a large strainer with small openings.

LOCOMOTIVE FEED-WATER STRAINERS.

THE SELLERS' STRAINER.

The Sellers' strainer, herewith illustrated, from long continued service has shown many special advantages to recommend it.

The strainer has standard pipe and hose connections, and is coupled directly to the end of the injector suction pipe. It occupies but little more space than the ordinary hose nut and cone strainer, and can be usually applied without alteration of the length of

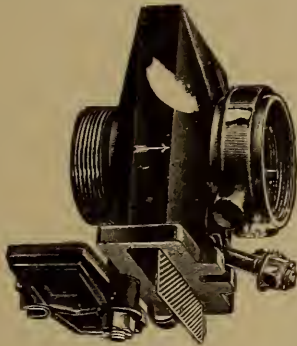

FIG. 1.

View of Strainer from Under Side Showing Straining Plate
Partially Removed.

the hose or of the pipe. The metal straining plate is of large area, and is provided with holes so small that fine particles, which pass through the ordinary strainer, are excluded from the injector; the dirt trap is large and admits of a considerable accumulation before cleaning is required; among other advantages claimed are the certainty of a continuous and plentiful supply of water to the injector, less wear of the

injector, combining and delivery tubes, a considerable saving of time over the ordinary method in removing and cleaning the strainer, and a convenient and mechanical arrangement of all the parts.

This strainer can be cleaned in a few minutes without breaking the pipe or hose joints. Fig. 1 gives a view from the under side, with the nuts slackened, the T-head bolt swung upward, the cap

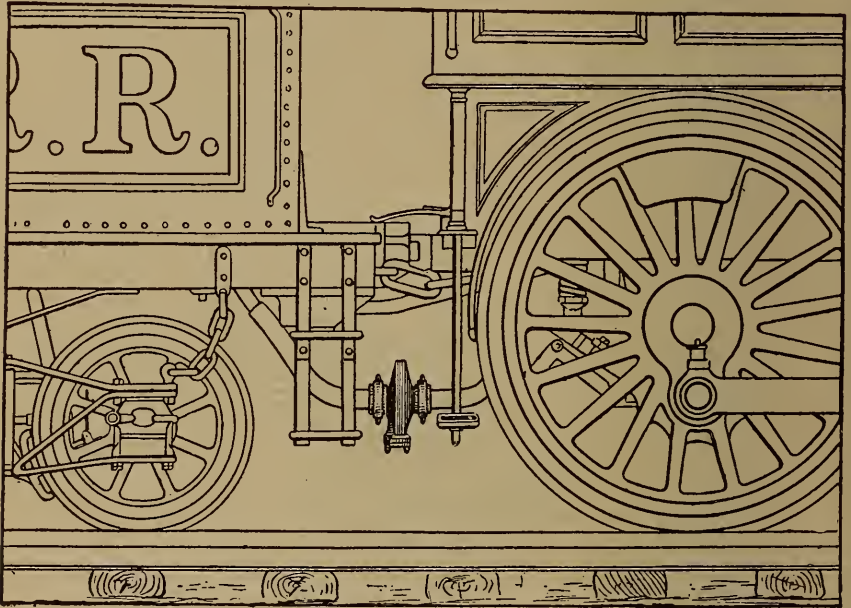

FIG. 2.

Position of Strainer on Locomotive.

rotated on the fixed stud clear of the opening, and the straining plate partially removed. The ends of both bolts are provided with split pins to prevent the complete removal or accidental loss of the attaching nuts and washers. All other parts are made of strong brass, the strainer plate being of copper. An arrow on the side of the strainer body indicates the direction

of the flow of water. This strainer may be used without change on either the right or the left side, and is adapted for use with any style of injector, and gives ample capacity for any size up to and including No. 12.

HEATH FEED-WATER STRAINER.

Fig. 3 illustrates another convenient form of hose strainer. The strainer itself is of such shape and size as to permit of a large number of small perforations, giving ample opening and still excluding much dirt from the injector. The large drain cup below the strainer forms a pocket to catch cinders and sediment from the tank, which can be readily and quickly discharged by removing the plug at the bottom.

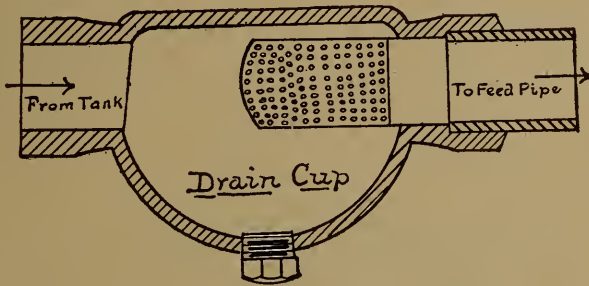

FIG. 3.

Heath Feed-Water Strainer.

H-D LOCOMOTIVE STRAINER.

The H-D locomotive strainer is an improved form of hose strainer giving full area, and can be used for either the right or left hand side of the locomotive. The screen is circular in form and rigidly attached to

the cap or bonnet, which forms a receptacle for all dirt and sediment. By removing the cap or bonnet the dirt or sediment is removed with the screen, which can easily be cleaned.

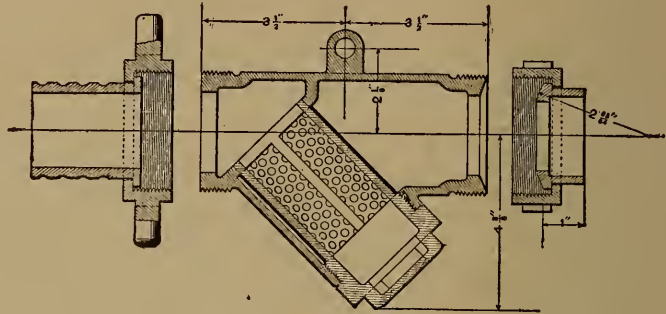

FIG. 4.

The H-D Locomotive Strainer.

THE HANCOCK LOCOMOTIVE HOSE STRAINER.

The hose strainer illustrated by Fig. 5 consists of a perforated copper plate in a metal frame which fits into slides in the body. The perforated copper plate

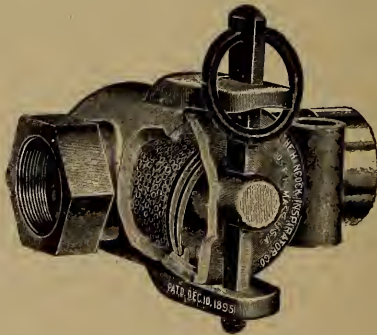

FIG. 5.

Hancock Hose Strainer.

rests at such an angle that coal or other sediment from the tank will drop below the plate and not interfere with the water-way. By removing the tapered

key, the bonnet or cap can be easily taken off and the copper plate removed and cleaned. The bonnet is fitted with a ground joint, and the seat is so located as to be protected from damage. This strainer is furnished either right or left hand.

The simplicity of its construction and its great convenience to locomotive engineers will readily be seen.

When it is considered that a large capacity injector suitable for large modern locomotive boilers delivers approximately one gallon of water each second, it will readily be seen why such importance is placed on having a good-sized, effective feed-pipe strainer that will not become quickly stopped, and when so deranged can be removed and cleaned without serious loss of time.

SNOW FLANGER.

THE Q & C-PRIEST SNOW FLANGER.

This flanger is supported directly on the engine truck boxes, a few inches in front of the forward wheels. Being thus supported, it does not rise and fall with the movement of the engine on the springs, nor swing sideways across the rail on curves. This feature enables it to do regular and uniform work. As it follows the movement of the engine truck, it conforms to all the irregularities of the track, giving an even depth of cut, the same on curves as on tangents.

The knives are placed one inch above the top of the rail and make a cut twelve inches wide by two inches deep inside of the rails, and twelve inches wide and one-half inch deep outside of the rails.

While the knives are constructed strong enough to remove hard packed snow and sand, they are purposely designed so as to break when striking guard rails or any obstructions without damage to the other parts, and can be readily and quickly replaced.

This flanger is operated by compressed air by means of a cylinder located on or near the running board, and is under full control of the engineer by means of an air cock in the cab.

It may thus be raised instantly to clear crossings, guard rails, etc. There is also a hand lever arrangement running to the cab, so that the engineer may operate it by hand or hook it up out of use in case the air pump should fail.

It is claimed that torpedoes may be used with no

danger of their displacement by this flanger in operation through the hardest snow. It is further claimed that its use prevents derailments caused by engine truck wheels mounting hard packed snow or sand, and also prevents loss of hauling power of locomotives

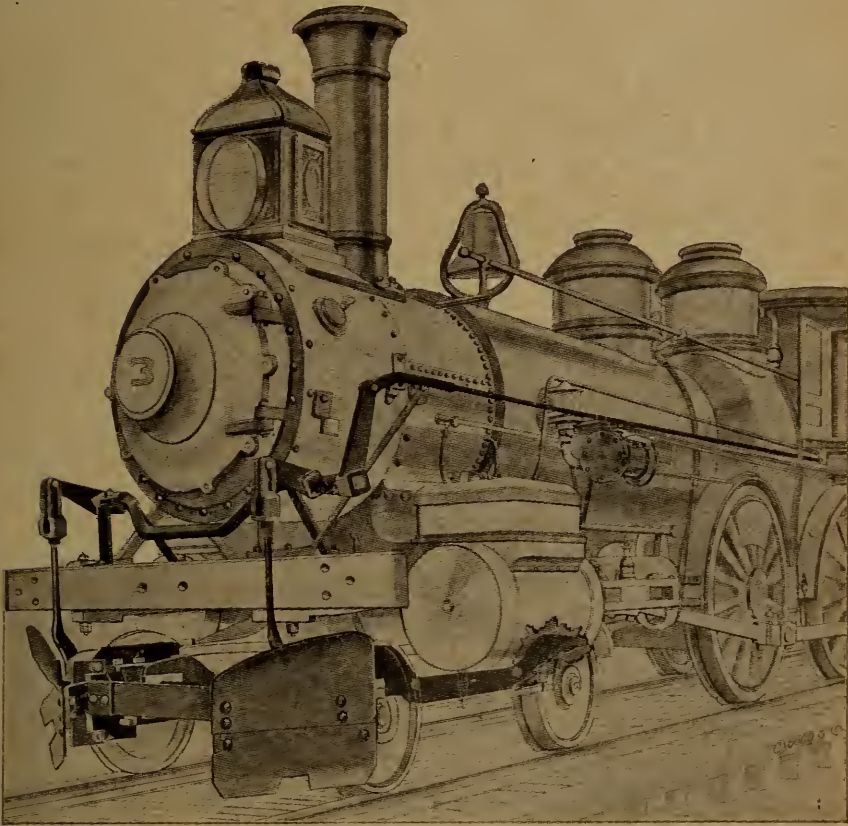

FIG. 1.

The Q & C-Priest Snow Flanger as Attached to Locomotive.
(Pilot Removed to Show Working Parts of Flanger.)

caused by the intervention of snow and ice between the driving wheels and rails. It avoids tire and rail cutting due to slipping in snow.

A pilot plow of any size can be carried in the usual manner without interference with this device.

NEW ENGINEER'S BRAKE VALVE—NEW YORK AIR BRAKE CO.

The engineer's brake valve (for its location see plate "The American Steam Locomotive," part numbered 218), which, as its name implies, is operated by the engineer, opens communication between the main

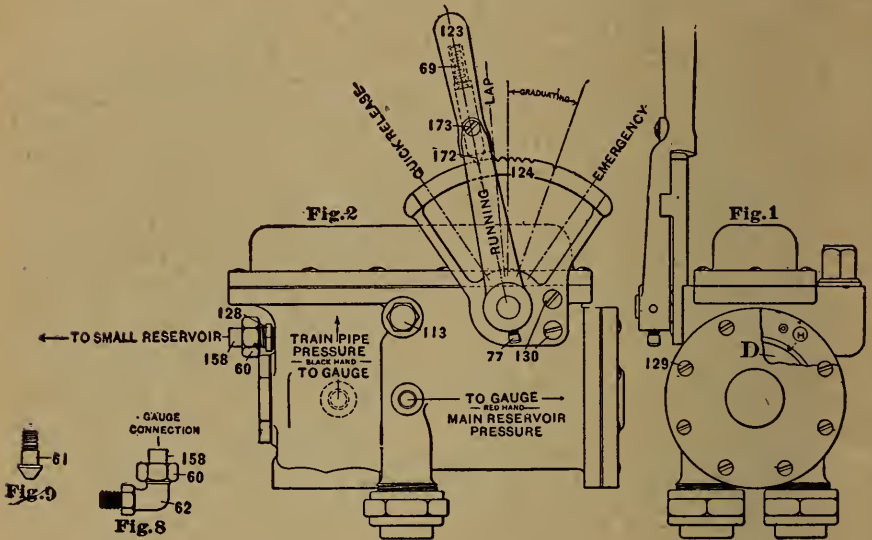

Positive Discharge Engineer's Brake Valve.
New York Air Brake Co.

air reservoir and the train pipe for the purpose of charging cars or releasing brakes, closing the connection and opening the train pipe to the atmosphere when the brakes are to be applied.*

*The principle of the engineer's brake valve and the details of another form thereof are fully described in "The Science of Railways," and the reader is referred to the General Index of that work for information in regard thereto.

The above engraving shows the outside appearance and inside construction of the valve when seen from different points of view. Figs. 1 and 2 are external views, rear end and side, respectively. Fig. 3 is a cross-section through the feed valve (rear view). Fig. 4 is a section through the side, showing travel of slide valve 114 and how graduating valve 110 is controlled by piston 104. Fig. 5 is a cross-section through the slide valve (front view). Fig. 6 is a plan of the

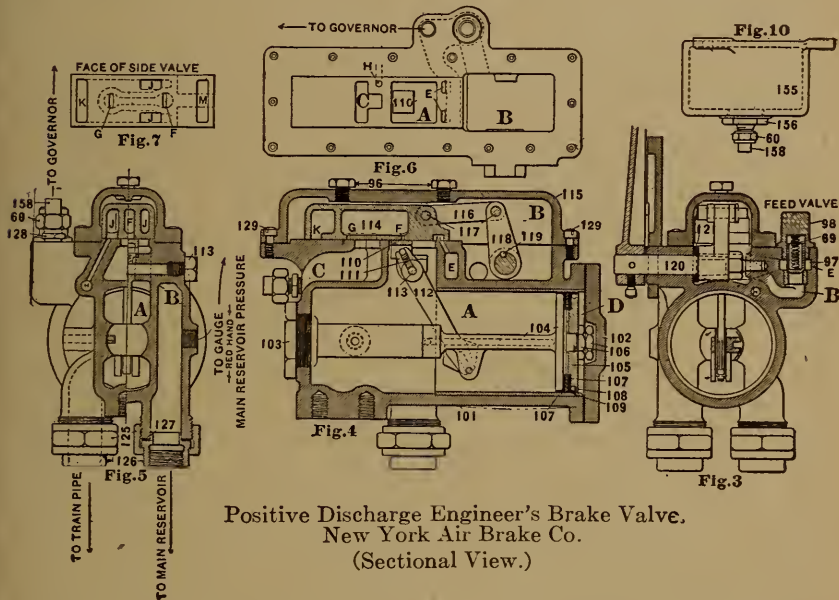

Positive Discharge Engineer's Brake Valve.
New York Air Brake Co.
(Sectional View.)

valve seat. Fig. 7 shows the face of the slide valve. Fig. 8 is the gauge connection.

The Principal Parts and Their Duties.—Referring to Fig. 4, the chamber B is connected to the main reservoir. The chamber A is connected to the train pipe. Discharge of train pipe air to the atmosphere for service application occurs through ports F, G, and passage C. Main slide valve 114

controls the flow of air from the main reservoir to the train pipe, and from the train pipe to the atmosphere. In the drawing the slide valve occupies "running position." To "release," it moves to the extreme left. To "apply," it moves to the right; a service application uncovering small ports *F* and *G*; an emergency application uncovering the large ports *K* and *J*. (See Figs. 5 and 7.)

Small slide valve 110 is a cut-off or graduating valve, operated by piston 104. Its function is to stop the discharge of air to the atmosphere when the train pipe pressure has fallen to the desired amount.

Piston 104 is exposed on one side to train pipe pressure in chamber *A*, and on the other side to pressure from a small auxiliary reservoir (connected to space *D*). Its function is to cause valve 110 to automatically move whatever distance is necessary to close port *F*. Decrease of train pipe pressure in chamber *A* allows the pressure in small reservoir *D* to expand, and thus move piston 104 to the left, which, through the agency of lever 112, causes valve 110 to close port *F* by moving as far to the right as port *F* has been carried by slide valve 114. If the slide valve has moved only a short distance, piston 104 will have to move but a short distance to close port *F*, and consequently only a slight reduction of train pipe pressure will occur. If the slide valve carries port *F* a considerable distance, then piston 104 must move a considerable distance to close it, and a corresponding reduction of train pipe pressure occurs. Thus, the discharge of train pipe air is greater or less, according to the distance which cut-off valve 110 is required to travel.

Port *H* (Fig. 6) connects with a passage running lengthwise of the valve (Figs. 1, 3 and 5), one end of which leads to the small reservoir (as shown by Fig. 2), while the other end leads to the space *D*, back of piston 104 (Figs. 1 and 4). In "running position," port *J* in the face of slide valve 114 (Figs. 5 and 7) connects chamber *A* with port *H* in the *seat* of the slide valve (Fig. 6), thus permitting train pipe air to flow into the small reservoir and to the rear of piston, as shown. When the handle is moved to apply brakes, however, ports *J* and *H* no longer connect, and therefore the stored up air in the reservoir *D* acts as an independent force on piston 104.

The operation is as follows: With handle in "running position," the valves occupy the position shown in Fig. 4. Discharge ports *F* and *G* and *K* are closed, and direct communication from the main reservoir to the train pipe is cut off by the slide valve. By means of the feed valve described below, however, the train pipe will continue to receive air through small ports *E* and *M* until the normal pressure of seventy pounds has been obtained therein.

For "service" application, place the handle in one of the "service" or "graduating" notches and *leave it there*. This carries slide valve 114 far enough to the right to uncover small ports *F* and *G*, thus permitting train pipe air to escape from chamber *A* to the atmosphere, through the exhaust passage *C*. Small cut-off valve 110 automatically stops the discharge as soon as the train pipe pressure in chamber *A* reduces enough to allow piston 104 to move, as previously explained. For light applications, use the first of the graduating notches on short trains, or the second notch with five

or more cars. For heavier applications move the handle one or two notches further.

For an "emergency" application, move the handle to position marked "emergency." This will carry slide valve 114 to the extreme right, permitting rapid discharge of train pipe air from chamber *A* to passage *C* and the atmosphere, through ports *J* (Figs. 5 and 7), the passage in slide valve, and the large port *K* (Figs. 4 and 7).

With handle in position of "quick release," slide valve 114 is moved to the extreme left, thus admitting main reservoir pressure direct from chamber *B* to train pipe chamber *A* through the large opening which the end of the slide valve uncovers. At the same time, air contained in the small reservoir is discharged to the atmosphere through passage *H*, ports *J* and *K*, and passage *C*, thus allowing train pipe pressure to return piston 104 and cut-off valve 110 to the position shown in Fig. 4 in readiness for another service application. When releasing brakes, always place the handle in "quick release" position long enough to permit discharge of air from the small reservoir, before moving the handle back to the "running" position.

With the handle in "running position," the small reservoir is charged to the same pressure as the train pipe. If the handle, when in full release position, is moved to a service notch too quickly, a full service application will result; but if it is moved slowly, or stopped in either "running" or "lap" position for a second or two, the small reservoir will become charged and automatically cut off the exhaust as usual.

With the handle in "lap position" all communica-

tion is cut off between the main reservoir and the train pipe, as well as between the train pipe and the atmosphere.

The air pump governor is connected to the passage in which the well known excess pressure valve or feed valve is located. (Figs. 3, 5 and 6.) This passage has a port *E* in the valve seat, which, by movements of the slide valve, is connected either with the main reservoir, with the train pipe, or is closed entirely. The governor is set at seventy pounds, and will shut off steam in any position of the slide valve when either the train pipe pressure reaches seventy pounds, or main reservoir pressure reaches eighty-five pounds. The pump cannot, therefore, produce undue pressure when the brakes are set, and the train pipe cannot become overcharged when they are released. When the handle is in running position, a recess *M* in the slide valve (Fig. 7) connects the port *E* (Figs. 4 and 6) to the train pipe, and air from the main reservoir has to pass through the feed valve on its way to the train pipe.

The small reservoir furnished with this valve can be placed in any convenient position, but we advise attaching it to the roof of the cab, and connecting the pipe between the reservoir and the engineer's valve in such a way that water cannot accumulate in the reservoir, but will drain out of it through the engineer's valve. Copper pipe must be used for this purpose, as it can be readily bent into place, and lessens the danger from leakage by avoiding the elbows and joints that are necessary with iron pipe. All piping must be absolutely tight.

Remarks—Do not allow the seat of the main slide

valve to become dry. If the handle pulls too hard, remove oil plugs 96 (first letting air out of the main reservoir) and oil the seat both in front and back of the slide valve. Before putting back the oil plugs move the handle back and forth several times to spread the oil over the seat. It is also a good plan to occasionally remove cover 115 and lubricate slide valve 114 and its seat with a compound or grease such as vaseline. The lever shaft 120 should be oiled occasionally, through the oil hole made for that purpose in the flange of the cover, back of the quadrant.

THE AUTOMATIC EMERGENCY RECORDER.

Ever since the advent of the quick action automatic air brake into railway service, there has been continually sought a means whereby the unnecessary use by the engineer of the emergency position, of his equalizing discharge valve, could be recorded against him.

Any device employed to record the emergency applications made by an engineer in handling either air-brake trains or light engines must be considered unreliable or worthless that does not fulfill the following conditions: (1) It should not interfere or impede in the least the application of the brakes to either light engine or train; that is, it must not affect the sensibility of the brakes by impeding either the preliminary or emergency exhaust. (2) It should be automatic. (3) It should record each emergency application made, whether engine is attached to train or handled light. (4) It should not operate when service applications only are made. (5) It should not make a record of the times the engineer's valve handle is placed in emergency position when there is no air on the engine. (6) It should not operate when a hose bursts or the conductor applies the brakes from rear of train. (7) It should make its record in such a manner as to defy its being destroyed. (8) It should be so constructed as to evade any attempt on the part of the person in charge of engine to change the record when once made, or to prevent a record being made when once

the forbidden position is reached. (9) It should be easily applied, simple and durable; and (10) it should be capable of being applied to all engineer's valves on the market without having to alter their design.

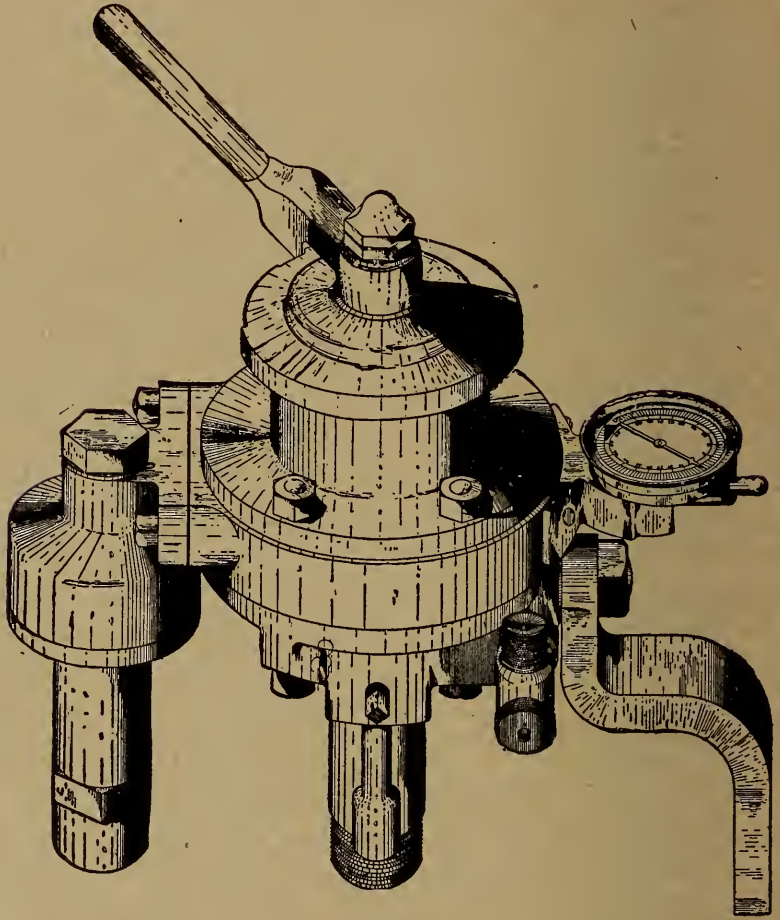

FIG. 1.

The Automatic Emergency Recorder as Applied to an 1892 Westinghouse Engineer's Brake Valve.

This recorder here illustrated (Fig. 1) registers accurately each and every time the engineer's valve handle is placed in that position familiarly known as the "emergency position." The record is not made

upon paper or a sensitized film, which may be removed and destroyed, but is permanently marked by a hand or pointer, similar to the manner of registering fares on street cars. It may be so constructed as to admit of its registering an indefinite number of applications. The device shown ranges in capacity from one to five thousand. It will readily be seen by reference to Fig. 1 that from the very construction of this device no interference whatever can come to the successful operation of the air brakes by its attachment to the engineer's valve. It works automatically and records every emergency application, but none made in service position. No record will be made unless there is air in the reservoir, nor where a hose bursts while engine is carrying air. It will admit of no tampering in order to falsify its record; is simple, cheap, easily applied, and durable. It will fit any valve, with a slight change of base.

The indicator is moved by the sudden flow of air from the emergency port of the engineer's valve compressing a spring, as shown in the details of the engraving.

The device is extremely simple of construction, consisting of a ratchet wheel or plate with one hundred teeth actuated by a pawl connected to the top of a small rocker arm giving proper motion to the ratchet plate when the piston makes the forward stroke by means of a bevel at the end of the piston rod, throwing the bottom of the rocker arm back and the top forward. A spring pin is also fixed in the ratchet plate, actuated at a fixed point in its revolution with another plate placed over the ratchet, whereon each one hundred revolutions of the needle is recorded. The face plate

is graduated into one hundred parts, from which each movement of the needle is read. The exhaust port for service or preliminary applications of the air brake is placed at the end of the cylinder, and is one-eighth of an inch in diameter as against one-sixty-fourth of an inch in diameter of the same port in an 1892 Westinghouse engineer's brake valve, thus giving a high factor of safety for service exhaust. The ports for emergency exhausts are in the sides of the cylinder, and the needle makes its record the instant the piston follower clears the ports. The device will record 4,999 applications of the emergency, and then return to zero, and begin all over again. No movement of the needle takes place when service applications are made.

AUTOMATIC BRAKE-SLACK ADJUSTER.

While there have been many types of brake-slack adjusters used on cars and locomotive tenders, that adjuster formerly known as the McKee, but now made by the Westinghouse Co., and called by the latter name, has been used more extensively than any other.

The accompanying engraving shows a coach or tender brake cylinder and levers with the Westinghouse slack adjuster applied to the back head. As

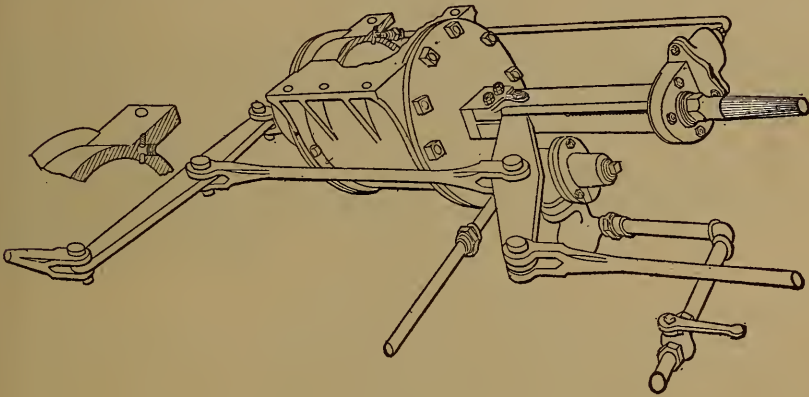

FIG. 1.

The Westinghouse Latest Improved Slack Adjuster.

will be seen, a very small air pipe is tapped into the brake cylinder at a point to clear the piston when the latter has traveled seven and one-half inches. Thus, when the brake piston passes beyond this point a small quantity of air is conveyed through this pipe to a very small cylinder wherein it forces a piston against a heavy spring engaging a pawl in a ratchet wheel attached to the screw holding the back cylinder

lever. When the brake is released, the spring, by means of the pawl and ratchet wheel, turns the screw, thereby moving outward the inside end of back cylinder lever, which takes up about one-thirty-second of an inch of piston travel. When new brake shoes are applied the screw should be turned back sufficiently to let out the travel to about what it was before the new shoe was applied.

The Gould slack adjuster is also a mechanical device which works, however, on the ratchet principle and without any use of the air pressure, as will clearly be seen by reference to the accompanying engraving.

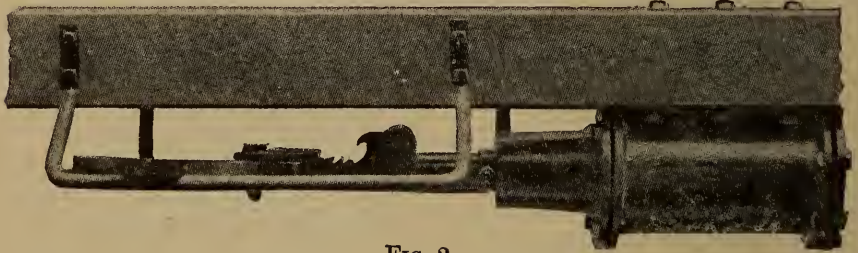

FIG. 2.
Gould Brake-Slack Adjuster.

The advantages to be gained by the application of any efficient brake-slack adjuster to cars or locomotive tenders are of considerable importance.

Their use will keep the piston travel of all the brake cylinders uniform, thus insuring maximum pressure of the brakes and permitting better stops to be made and preventing serious shocks which usually cause damage of some nature. Anything which tends toward the efficiency of the brakes reduces the waste of air and accordingly reduces the requirements placed upon the air pump, thereby lessening the cost of pump repairs.

LOCOMOTIVE GLOBE VALVES, RELIEF VALVES, ETC.

Fig. 1 shows the ordinary construction of either globe or angle valves for locomotive use. The particular valve here shown is designed for service where an all-metal valve is required, and is claimed to be especially adapted for high steam pressures and to withstand "wire drawing," being made with a flat



FIG. 1.

Standard Heavy Locomotive Globe Valve.

seat. The projection under the disc protects the seat from dirt and from the cutting action of the steam when the valve is partly open, and also serves as a guide when re-grinding is necessary.

To re-grind one of these valves, remove the disc from the stem and grind it with a temporary holder screwed into it.

THE CROSBY SPRING SEAT VALVE.

This valve is shown in Fig. 2, which represents the valve with a section of the body removed in order to show its internal design. *A* is the upper disc, in which *a a* represents the seat with its conical depression terminating in an annular groove of considerable depth. *C* shows the valve body, whereon at *b b*, in the valve seating *B*, is constructed a conical seat having in the center a similar

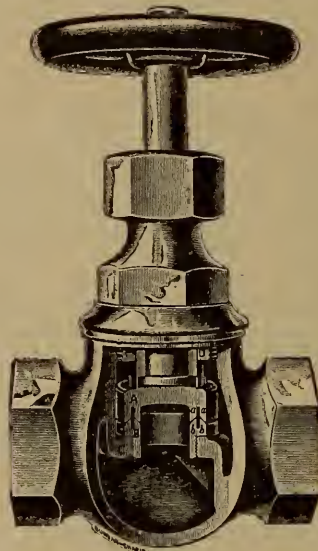

FIG. 2.
Crosby Spring-Seat Valve.

groove. These seats have greater contact surface, and by means of the central grooves have greater resilient action, which permits them to shut tight and remain so. This novel characteristic prevents them from jamming when the valve is closed, and leaves them free to accommodate themselves to any variation of temperature. When partially open, it is claimed that the out-rushing steam or water does not abrade

their surfaces, as ordinarily happens with ordinary valves.

THE HOMESTEAD STRAIGHT-WAY VALVE.

This valve is so constructed that when it is closed it is at the same time forced firmly to its seat. This result is secured by means of the traveling cam *A* through which the stem passes. The cam is prevented from turning with the stem by means of the lugs *B*, which move vertically in slots. Supposing the valve to be open, the cam will be in the lower part of the chamber in

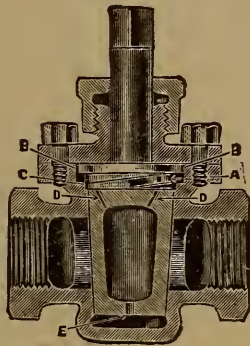

FIG 3
Homestead Straight-Way Valve.

which it is placed, and the plug will be free to be easily moved. A quarter of a turn in the direction for closing it causes the cam to rise and take a bearing on the upper surface of the chamber, and the only effect of further effort to turn the stem in that direction is to force the plug more firmly to its seat. A slight motion in the other direction immediately releases the cam and the plug turns easily, being arrested at its proper open position by contact of the fingers of the cam at the other end of its travel. *E*, *D*, *D*, are balancing parts. This valve forms a very efficient blow-off

valve where an automatic valve is not desirable (see chapter on Boiler Cleaners).

STEAM CHEST VACUUM VALVES.

The purpose of these valves is to permit air to enter the steam chest and thence the locomotive cylinder when the engine is "drifting" or running with steam shut off.

These valves are often termed "relief valves," but should more properly be known as *vacuum* relief

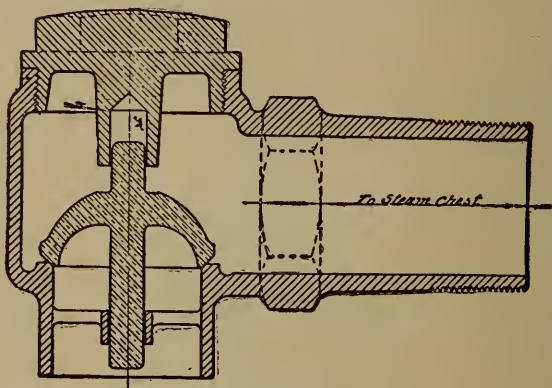

FIG. 4.
Steam Chest Vacuum or Air Relief Valve.

valves or suction valves, one type of which is shown in the engraving, Fig. 4.

Inasmuch as it is well known that the steam chest pressure may at times become very great when a locomotive at speed is reversed and the throttle not opened, many railroads use a combined *vacuum and pressure relief valve*, as shown in Fig. 7, on all steam chests. It is hardly necessary to describe in detail the pressure relief valve thus used, as its principle is identical with that of the locomotive pop safety valve, which is fully described and illustrated elsewhere in this volume. If, in place of the cap shown in the vacuum relief

valve here illustrated, a pop safety valve should be screwed, the result would be a combined vacuum and pressure relief steam-chest valve. The pressure spring is usually adjusted to an amount slightly in excess of the boiler pressure to avoid its blowing when the locomotive is working hard and under full pressure.

Two forms of *pressure relief valve* are shown in Figs. 4 and 5.

RICHARDSON RELIEF VALVE.

In order to obtain the best results from valves (especially balanced valves) on locomotives, a relief valve should be placed in the steam chests for the

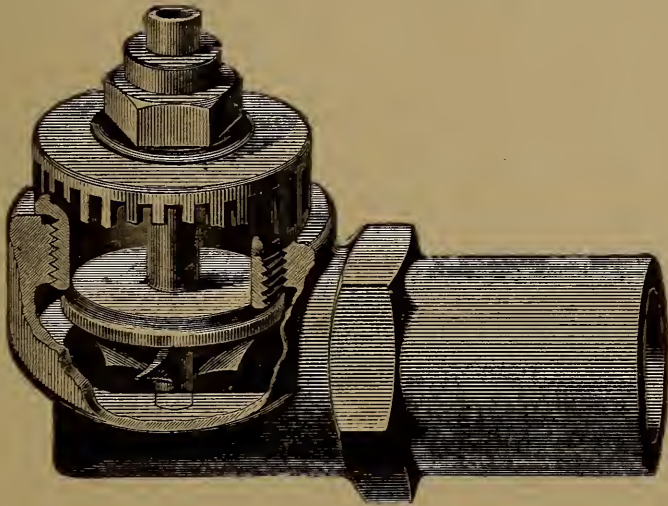

FIG. 5.

The Richardson Vacuum Relief Valve.

purpose of admitting clean air from the outside atmosphere, and thereby preventing a vacuum being formed in the steam chests and cylinders when the engine is running with steam shut off; otherwise air from the

smoke-box, charged with hot gases, dust and cinders, will be drawn into the chests and cylinders through the exhaust ports, burning up all oil and cutting and grinding the valves and valve seats.

The valve here shown by Fig. 5 can be used with much benefit with any slide valve. It is made extra heavy, to stand wear, and the curved valve wings are so arranged that the valve in closing always finds a new seat, thus keeping itself tight.

BLACKALL RELIEF VALVE, FOR USE ON LOCOMOTIVES.

This valve is placed on a locomotive at any point between the throttle valve and slide valve, preferably upon the steam chest, where it will have a free and open communication with the steam pipes of the engine only. It is designed to prevent the accumula-



FIG. 6.
Blackall Relief
Valve for Use on
Locomotives.

tion of pressure in the pipes or boiler of a locomotive if engine is suddenly reversed while moving forward, as is frequently the case. The valve is adjusted to open at a slightly higher pressure than the maximum pressure carried on the boiler, but below the pressure required to produce a rupture of parts, and will permit the excess of air pressure to escape from the steam pipes, and thereby prevent any undue pressure being generated by the cylinders. A uniform pressure of air will be maintained within the limit of safety, which will supply resistance to the pistons and overcome the momentum of the train, and perform the functions of an

automatic air brake on the drivers, and stop the train. By the use of this device engines can be reversed suddenly while running at a high rate of speed, without strain or damage to any portions of the machinery or boiler.

RICHARDSON COMBINED PRESSURE AND VACUUM RELIEF VALVE.

This valve (Fig. 7) is designed to be placed in the steam chest to automatically supply clean air to the cylinders through the air-valve *A* when engine is

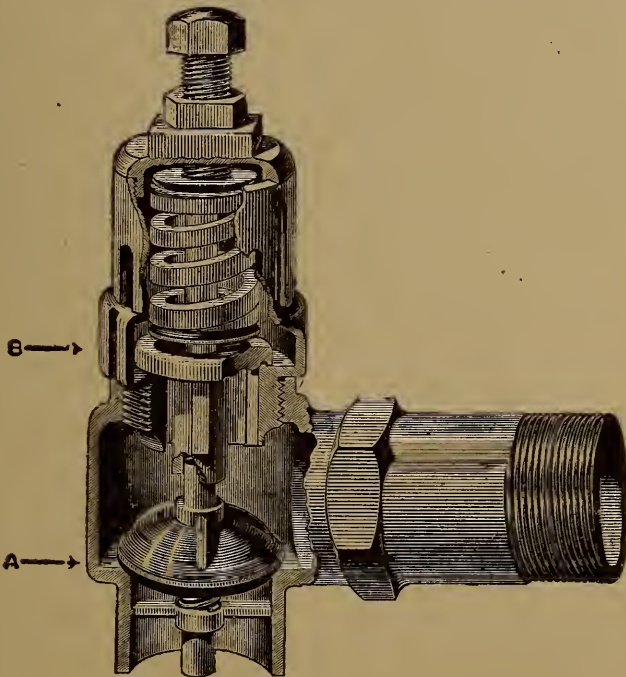

FIG. 7.

Richardson Combined Pressure and Vacuum Relief Valve.

running shut off, and thus furnishes a free supply of air from the outside instead of its being sucked in

from the smoke-box laden with hot gases and cinders which lap all oil from the valves and seats.

The pressure relief valve *B* performs a very valuable function in preventing the dangerous accumulation of pressure in the steam chest and dry-pipe and oftentimes the breaking of same when the engine is suddenly reversed. The valve is set to open at a pressure slightly above the maximum boiler pressure, and will allow any excess of pressure to escape to the atmosphere, yet will maintain in the cylinders a uniform pressure of air within the limits of safety when running forward after reversing, and thus supply resistance to the pistons and overcome the momentum of the train, and perform the functions of an automatic air brake in assisting to stop the train. By using this valve an engine may be suddenly reversed while running at high speed without strain or damage to any portion of the machinery or boiler.

LOCOMOTIVE BOILER COVERINGS.

The extent of heat losses occurring by radiation from a modern locomotive boiler under service conditions has long been a matter of speculation. There have been investigations to determine the radiation from pipes and other steam-heated surfaces, usually within buildings, but, until recently, there have been no tests which would disclose the effect of the air currents such as, at speed, circulate about the boiler of a locomotive.

From such service tests it has been determined that a perfectly bare boiler would lose about ten per cent. of the total power of the machine, which would amount to nearly one thousand dollars per year on a large high-pressure locomotive, but that by properly covering about two-thirds of the exposed surface of boiler and fire-box over sixty per cent. of this loss may be prevented.

Thus it would appear to be a matter not undeserving the attention of practical railroad men to know that by this means alone over half a million dollars per year may be saved on a railway system having one thousand locomotives.

An eminent professor states that "the best insulating substance known is air confined in minute particles or cells, so that heat cannot be removed by convection." He also states that "no covering can equal or surpass that of perfectly still and stagnant air, and the value of most insulating substances

depends upon the power of holding minute quantities in such a manner that circulation cannot take place."

The covering used on a boiler is often termed lagging, from the custom when wood covering was used.

Wood lagging when first applied, and if the workmanship is good, is a good heat insulator; but it is quite impossible to obtain thoroughly dry lumber for this purpose, and the result is that after it has been subjected to the temperature of the boiler for a longer



FIG. 1.

Manner of Covering a Locomotive Boiler with Sectional Lagging.

or shorter time the wood shrinks and the joints open, and the wood is charred and rattles from place and soon becomes of little use as an insulator. For this reason the use of wood lagging, long so universally practiced in this country, is being largely abandoned for other more fibrous material which does not warp and shrink, but retains its original form after continued use.

A large number of manufactured boiler coverings are composed in part or whole of asbestos or magnesia.

Asbestos is a fibrous mineral, and one of Nature's unique products. It is found in various parts of the world and usually occurs in narrow veins or seams. When treated mechanically it yields soft, white,

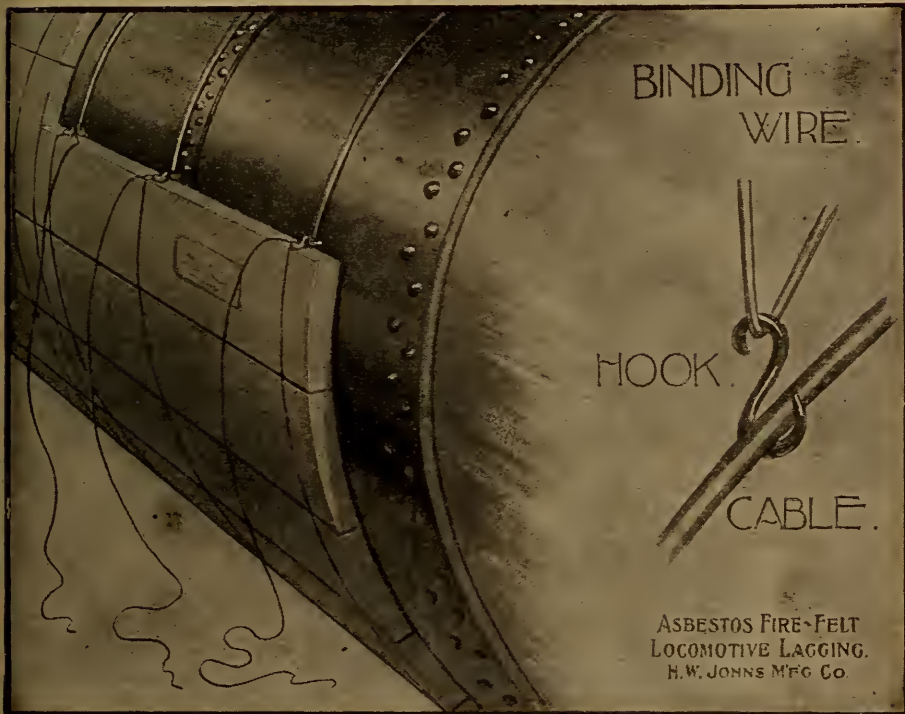

FIG. 2.
Method of Securing Sectional Lagging to the Boiler.

delicate and exceedingly strong fibres, which can be spun, woven and otherwise manufactured into many useful articles. In addition to its fire-proof qualities, it is also acid proof and practically indestructible except from abrasion.

Fig. 1 shows a locomotive boiler undergoing the process of covering with a form of manufactured

covering known as sectional lagging. From Fig 2 the details of its application may be readily understood.

When it is such general practice in stationary and marine engineering to cover every particle of exposed steam pipe it would seem much more important to do so on a rapidly moving locomotive where the resulting radiation is very much greater.



FIG. 3.

Asbestos Covering for Steam Pipes.

Asbestos covering, as shown in Fig. 3, for steam supply pipes to the air pump, train heating system, electric headlight, etc., is gradually but surely coming into use.

THE STEAM ENGINE INDICATOR.

The degree of excellence to which the locomotive and other steam engines has been brought is very largely due to the use of the indicator. A careful study and comparison of indicator diagrams taken under different speeds, pressures, and with various cut-offs furnishes the only means of showing the action of steam in the cylinder and of gaining a definite knowledge of the various changes of pressure that take place therein.

An indicator diagram is the result of two motions, namely: a horizontal movement of the paper in exact correspondence with the movement of the piston, and a vertical movement of the pencil in exact ratio to the pressure exerted in the cylinder of the engine. Consequently, it represents by its length the stroke of the engine on a reduced scale, and by its height at any point the pressure on the piston at a corresponding point in the stroke. The shape of the diagram depends altogether upon the manner in which the steam is admitted to and released from the cylinder of the engine. The variety of shapes given from different engines, and by the same engine under different circumstances, is almost endless, and it is in the intelligent and careful measurement of these that the true value of the indicator is found; and no locomotive or stationary engineer should be without a knowledge of the principles and uses of this ingenious device and able to properly read an indicator diagram.

A diagram shows the pressure acting on one side of the piston only during both the forward and return stroke, whereon all the changes of pressure may be properly located, studied and measured. To show the corresponding pressures on the other side of the piston, another diagram must be taken from the other end of the cylinder. When the three-way cock is used, the diagrams from both ends are usually taken on the same paper.

To obtain trustworthy results on high-speed engines, an indicator must have extreme lightness, a nice adjustment of all the moving parts and fine workmanship; to these indispensable qualities should be added simplicity of construction and convenience of manipulation.

THE CROSBY STEAM ENGINE INDICATOR.

This indicator is designed to meet the requirements of modern steam engineering practice. The high-speed system of construction in locomotives and steam engines which greatly prevails to-day renders the older type of indicator well-nigh useless. Many details which gave little trouble at low speeds cause errors under the present requirements which seriously affect the results.

Fig. 1 shows a general view of the Crosby indicator, while the illustration in Fig. 2 is a sectional view showing the design and arrangement of the parts.

Referring to Fig. 2, part 4 is the cylinder proper, in which the movement of the piston takes place. It is made of a special alloy, exactly suited to the varying temperatures to which it is subjected, and secures to

the piston the same freedom of movement with high pressure steam as with low; and as its bottom end is free and out of contact with all other parts, its longitudinal expansion or contraction is unimpeded and no distortion can possibly take place.

Between the parts 4 and 5 is an annular chamber, which serves as a steam jacket; it will always be filled with steam of nearly the same temperature as that in the cylinder.

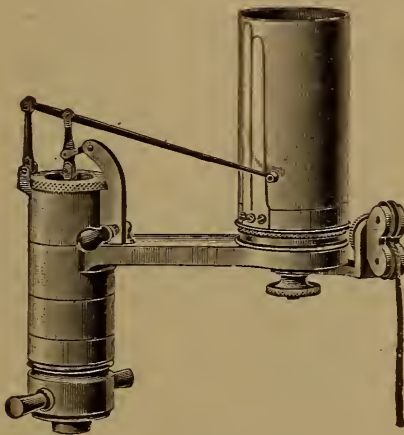

FIG. 1.
The Crosby Indicator.

The piston 8 is formed from a solid piece of the finest tool steel. Its shell is made as thin as possible consistent with proper strength. It is hardened to prevent any reduction of its area by wearing, then ground and lapped to fit (to the ten-thousandth part of an inch) a cylindrical gauge of standard size. Shallow channels in its outer surface provide a steam packing, and the moisture and oil which they retain act as lubricants and prevent undue leakage by the piston. The transverse web near its center supports a central

making this connection the piston rod should be screwed into the socket as far as it will go; that is, until the upper edge of the socket is brought firmly against the bottom of the channel in the piston rod. This is very important, as it insures a correct alignment of the parts and a free movement of the piston within the cylinder.

The swivel head 11 is threaded on its lower half to screw into the piston rod more or less; according to the required height of the atmospheric line on the diagram. Its head is pivoted to the piston rod link of the pencil mechanism.

The cap 2 screws into the top of the cylinder and holds the sleeve and all connected parts in place. Its central hole is furnished with a hardened steel bushing which forms a durable and sure guide to the piston rod. On its under side are two threaded portions. The lower and smaller projection is screw-threaded outside to engage with the like threads in the head of the spring and hold it firmly in place. The upper and larger projection is screw-threaded on its lower half to engage with the light threads inside the cylinder; the upper half of this larger projection—being the smooth, vertical portion—is accurately fitted into a corresponding recess in the top of the cylinder, and forms thereby a guide by which all the moving parts are adjusted and kept in correct alignment, which is very important, and is impossible to secure by the use of screw threads alone.

The sleeve 3 surrounds the upper part of the cylinder and supports the pencil mechanism. It turns around freely, and is held in place by the cap. The handle for adjusting the pencil point is threaded

through the arm and in contact with a stop-screw in the plate 1 may be delicately adjusted to the surface of the paper on the drum. It is made of hard wood, in two sections; the inner one may be used as a lock-nut to maintain the adjustment.

The pencil mechanism is designed to afford sufficient strength and steadiness of movement with the utmost lightness, thereby eliminating as far as possible the effect of momentum, which is especially troublesome in high speed work. Its fundamental kinematic principle is that of the pantograph. The fulcrum of the mechanism as a whole, the point of attachment to the piston rod and the pencil point are always in a straight line. This gives to the pencil point a movement exactly parallel with that of the piston. The movement of the spring throughout its range bears a constant ratio to the force applied and the amount of this movement is multiplied six times at the pencil point.

Springs.—In order to obtain a correct diagram, the movement of the pencil of the indicator must be exactly proportional to the pressure per square inch on the piston of the steam engine at every point of the stroke; and the velocity of the surface of the drum must bear at every instant a constant ratio to the velocity of the piston. These two essential conditions have been attained to a great degree of exactness in the Crosby indicator by a very ingenious construction and nice adaptation of both its piston and drum springs.

The piston spring is of unique and ingenious design, being made of a single piece of the finest spring steel wire, wound from the middle into a double

coil, the spiral ends of which are screwed into a brass head having four radial wings with spirally drilled holes to receive and hold them securely in place.

Adjustment is made by screwing them into the head more or less until exactly the right strength of spring is obtained, when they are there firmly fixed. At the bottom of the spring—in which lightness is of great importance, it being the part subject to the greatest movement—is a small steel bead firmly attached to the wire. This reduces the inertia and momentum at this point to a minimum, whereby a great improvement is effected. This bead has its bearing in the center of the piston, and in connection with the lower end of the piston rod and the upper end of the piston screw 9 (both of which are concaved to fit), it forms a ball and socket joint which allows the spring to yield to pressure from any direction without causing the piston to bind in the cylinder, which is liable to occur when the spring and piston are rigidly united.

The testing of the spring.—The rating or measurement of the springs is determined with great care and accuracy by special apparatus. The pressure test is made by the direct action of the steam in the cylinder of the indicator and in a mercury column, simultaneously operating with a capacity of three hundred pounds pressure per square inch. Suitable and ingenious electrical apparatus is so combined with these mercury columns that the ordinary division in inches of vacuum and in pounds pressure, respectively, are automatically marked on the test card on the indicator drum as the test of the spring proceeds. Each spring is tested in pressure to twice the capacity

marked on the same. This method of testing pressure springs has been in use for several years and has been demonstrated to be the best system for accuracy.

The drum spring 31 is a short spiral spring, thus greatly reducing the frictional resistance.

If the conditions under which the drum spring operates be considered, it will readily be seen that at the beginning of the stroke, when the cord has all the resistance of the drum and spring to overcome, the latter should offer less resistance than at any other time; in the beginning of the stroke in the opposite direction, however, when the spring has to overcome the inertia and friction of the drum, its energy or recoil should be greatest.

This drum spring, being a short spiral having no friction, has a quick recoil. At the beginning of the forward stroke it offers to the cord only a very slight resistance, which gradually increases by compression until at the end its maximum is reached. At the beginning of the stroke in the other direction its strength and recoil are greatest at the moment when both are most needed, and gradually decrease until the minimum is reached at the end of the stroke. Thus, a nearly uniform stress on the cord is maintained throughout each revolution of the engine.

The drum 24 and its appurtenances, except the drum spring, are similar in design and function to like parts of other indicators and need not be particularly described. All the moving parts are designed to secure sufficient strength with the utmost lightness, by which the effect of inertia and momentum is reduced to the least possible amount.

The Crosby indicator is made with a drum one and

one-half inches in diameter, this being the correct size for high speed work, and answering equally well for low speeds. If, however, the indicator is to be used only for low speeds and a longer diagram is preferred, it can be furnished with a two-inch drum.

All improved Crosby indicators are changeable from right-hand to left-hand instruments, if occasion requires.

TABOR STEAM ENGINE INDICATORS.

The steam engine indicators that have come into prominent use have one essential plan of construction. There is a steam cylinder and a paper drum. The steam cylinder is designed to connect with the interior of the engine cylinder and to receive steam whenever the engine receives it. A piston, which is enclosed in the indicator steam cylinder, communicates motion to a pencil arranged to move in a straight line, the amount of movement being limited by the tension of a spiral spring against which the piston acts. The paper drum is a cylindrical shell mounted on its axis, and is made to turn forward and backward by a motion derived from the cross-head of the engine. A sheet of paper or card, as it is named, is stretched upon the drum, and the pencil is brought to bear upon it. In this manner the instrument traces upon the paper a figure outline, termed the indicator diagram, which is the object sought. Since the motion of the paper drum is made to coincide with that of the piston of the engine, and the height to which the pencil rises varies according to variations in the force of the steam, the indicator diagram presents a record of the

pressure of steam in the engine cylinder at every point of the stroke.

To obtain well-defined diagrams with instruments of this description, it has been found desirable to employ a spring of high tension, so as to permit but a small movement of the piston. That a suitable height of the diagram may be obtained, this plan requires the multiplication of the movement of the piston. In the means that are employed for accomplishing this result, still preserving a straight line movement, the various forms of indicators that have been extensively used find their essential differences.

The Richards indicator, the first instrument of this kind that came into use, depended for the multiplication of the movement upon two levers, pivoted at opposite ends, and connected by a bar carrying the pencil. One of the levers at a point near the pivoted end received the motion of the piston. The use of this indicator upon engines running at high speed showed that the momentum of the multiplying device produced a disturbance in the action of the instrument which made the diagram inaccurate.

The object sought by the inventor of the Tabor indicator was to better adapt the instrument to the attainment of smooth and accurate diagrams at high speeds. He endeavored to provide a movement having such few parts, and those of such light weight, that a quick response to the action of the steam pressure should occur at any speed liable to be met in practice. The employment of high speeds is now of frequent occurrence on stationary and marine engines, and suitable provisions for indicating in those cases have become a recognized necessity.

Description.—A prominent feature of the Tabor indicator lies in the means employed to communicate a straight-line movement to the pencil. A stationary plate containing a curved slot is firmly secured in an upright position to the cover of the steam cylinder. This slot serves as a guide and controls the motion of the pencil bar. The side of the pencil bar carries a

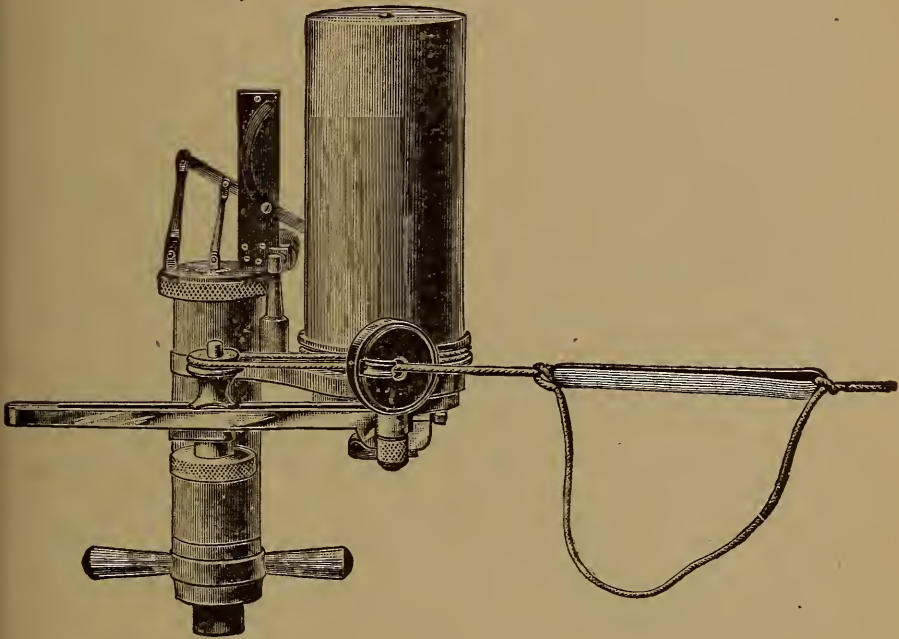

FIG. 1.

Tabor Indicator Fitted with Drum Stop Attachment.

roller which turns on a pin, and this is fitted so as to roll freely from end to end of the slot. The curve of the slot is so formed, and the pin attached to such a point, that the end of the pencil bar which carries the pencil moves up and down in a straight line when the roller is moved from one end of the slot to the other. The curve of the slot just compensates the tendency of

the pencil point to move in a circular arc, and a straight-line motion results. The outside of the curve is nearly a true circle, with a radius of one inch.

The steam cylinder and the base of the paper drum are made in one casting. Inside the steam cylinder is a movable lining cylinder within which the piston of the indicator works. This cylinder is attached by means of a screw-thread at the bottom, and openings on opposite sides at the top are provided for the introduction of a tool for screwing it in or out. Openings through the sides of the outer cylinder are provided to allow the steam which leaks by the piston to escape.

The pencil mechanism is carried by the cover of the outside cylinder. The cover proper is stationary, but a nicely fitted swivel plate, which extends over nearly the whole of the cover, is provided, and to this plate the direct attachment of the pencil mechanism is made. By means of the swivel plate the pencil mechanism may be turned so as to bring the pencil into contact with the paper drum, as is done in the act of taking a diagram; this pencil mechanism is attached to the swivel by means of the vertical plate containing the slot which has been referred to, and a small standard placed on the opposite side of the swivel for connecting the back link. The slotted plate is backed by another plate of similar size, which serves to receive the pressure brought to bear on the pencil bar when taking diagrams, and to keep the pencil bar in place. The pencil mechanism consists of three pieces: the pencil bar, the back link, and the piston rod link. The two links are parallel with each other in every position they may assume. The lower pivots of these links and the pencil point are

always in the same straight line. If an imaginary link be supposed to connect the two in such a manner as to be parallel with the pencil bar, the combination would form an exact pantograph. The slot and roller serve the purpose of this imaginary link; the connection between the piston and the pencil mechanism is made by means of a steel piston rod. At the upper end, where it passes through the cover, it is hollow, and has an outside diameter measuring three-sixteenths of an inch. At the lower end it is solid, and its diameter is reduced. It connects with the piston through a ball-and-socket joint. The socket forms an independent piece, which fits into a square hole in the center of the piston, and is fastened by means of a central stem provided with a screw, which passes through the hole and receives a nut applied from the under side. The nut has a flat-sided head, so as to be readily operated with the fingers. A number of shallow grooves are cut upon the outside of the piston to serve as a so-called water packing.

One of the most important features of an indicator is its parallel motion. The correctness of the parallel motion of the Tabor indicator is such that at all times, and at every point on the diagram within the reach of the pencil point, the extreme end of the pencil bar will record a vertical travel or movement of just five times that of the indicator piston.

The springs used are of the duplex type, made of two spiral coils of wire, strongly held at their ends in brass fittings. The wires are so mounted that the ends of each coil are connected on opposite sides of the fitting. This arrangement equalizes side strain on the spring, and insures the piston moving central in

the cylinder, thus avoiding excessive friction caused by a single coil spring, in forcing the piston against the side of the cylinder. The threads by which the spring is connected are cut on the inside of its fittings, and suitable threaded projections on the under side of the cover and on the upper side of the piston, respectively, are provided for securing the spring in place. These springs are adjusted under steam pressure, and are, consequently, correct only when used with steam.

The paper drum turns on a vertical steel shaft, secured at the lower end to the frame of the indicator. This drum is supported at the bottom by a carriage, which has a long vertical bearing on the shaft. It is guided at the top by the same shaft, which is lengthened for this purpose, the drum being closed in at the top and provided with a central bearing. The drum is held in place by a close fit in the usual manner, and is easily removed by the hand when desired. Stops are provided on the inside of the drum at the bottom, with openings in the outside of the carriage to correspond, so as to prevent the drum from slipping. These are so placed that the position of the drum may be changed so as to take diagrams in the reverse position of the pencil mechanism, when so desired. The drum is made of thin brass tubing, so as to be extremely light. Spring clips are attached to the drum for holding the paper.

The drum carriage projects below the lower end of the drum, where it is provided with a groove for the reception of the driving cord. This groove has sufficient width for two complete turns of the cord. The drum spring, by which the backward movement

of the drum is accomplished, consists of a flat spiral spring of the watch spring type, placed in a cavity under the drum carriage encircling the bearing. It is attached at one end to the frame below, and at the other end to the drum carriage. In its normal position the drum carriage is kept against a stop by means of the pull of the spring. The lower hub of the drum carriage rests directly on the spring case, while the opposite hub is in contact with a knurled thumb nut screwed and pinned to the central drum shaft. This thumb nut serves as a convenient means for winding or unwinding the paper drum spring, as by loosening the thin hexagon nut on the under side of the arm to which the spring case is secured by it, the thumb nut can then be turned in either direction until just the desired tension of the spring is obtained, when the thin nut should again be firmly tightened.

A simple form of carrier pulley serves to guide the driving cord on to the drum from any direction. A single pulley is mounted within a circular perpendicular plate, and the hole in the center of which coincides with the center of the driving cord with the periphery of the pulley. The plate can be turned about its center so as to swing the pulley into any desired angular position, and thereby lead the cord off in any desired direction. The plate is held by a circular frame, which serves also as a clamp, and the pulley is fixed in position by the use of the same nut which secures the frame to the pulley arm.

The instrument is attached by means of a coupling having but one thread. It is simple, like a common pipe coupling, and is operated by simply turning it in the proper direction, without exercising that care

which the use of couplings having double threads requires. The indicator cock is provided with a stop so as to turn only the ninety degrees needed for open and shutting. A complete revolution of the cock is impossible.

The pressure of the pencil on the paper drum is regulated by means of a screw which passes through a projection on the slot plate, and strikes against a small stop provided for the purpose and secured to the frame. This screw is operated by a handle of sufficient size to be readily worked by the fingers, which also serves as a handle for turning the pencil mechanism back and forth, as is done in the act of taking diagrams. The screw, with handle, may be introduced and worked from either side, so as to use the pencil mechanism on either side of the paper drum.

The end of the pencil bar is shaped in the form of a thin tube for the reception of the pencil lead or metallic marking point. The tube is split apart on the side and yields to the slight pressure required to introduce the pencil from either side, so as to mark on either side of the paper drum desired.

Ashcroft Reducing Wheels.—To insure an accurate reduction of the stroke of an engine to the desired length of the indicator diagram to be taken therefrom, a reliable reducing motion is essential. Various modifications of the pendulum lever, pantographs and other combinations are employed to accomplish this result, often with accuracy when they are used under favorable conditions. The "wheel" has proved a much more reliable and satisfactory reducing motion than any of the other kinds, and during the

last few years it has, to a great extent, superseded all other devices for the same purpose.

The illustration herewith, Fig. 2, represents an independent reducing wheel motion, so made that it can be applied not only to Tabor but other indicators.

The device consists of a base *K*, with two standards for the bearings for the worm shaft *R*. The base is

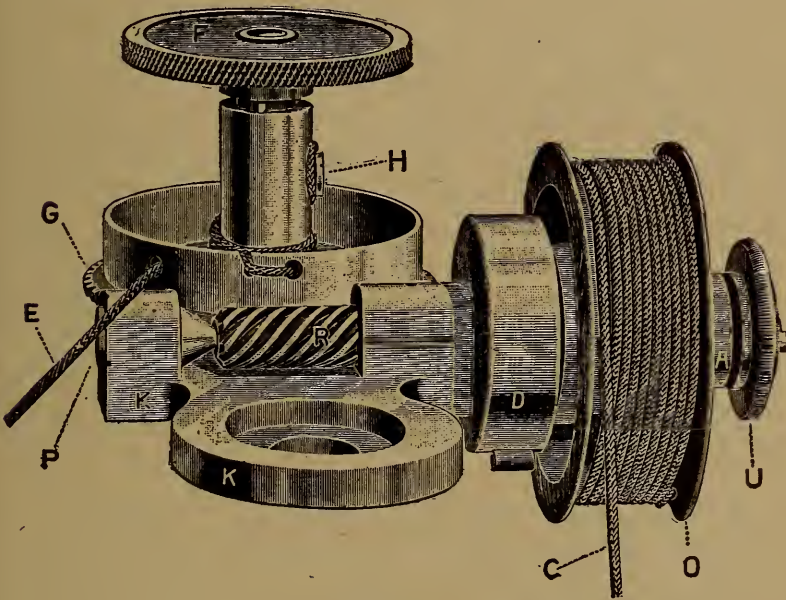

FIG. 2.
Ashcroft Reducing Wheel.

extended to provide a support for the worm gear disc *G*, to which the cord *E* from the indicator paper drum is secured in a manner as illustrated. A pulley *O*, of suitable diameter for the stroke of the engine, is loosely mounted on the worm shaft *R*, to which pulley one end of the separate driving cord *C* is secured, the other end of the cord being connected either direct to the engine cross-head to a standard bolted thereto, or

to any other part of the engine having a coincident motion. From whatever point selected for attaching the cord, it is necessary that the cord run in a line practically parallel with the travel of the engine cross-head for a distance of at least the length of the engine stroke.

A small flat coil spring, located in the spring case *D*, is connected to the pulley *O* by means of a disc (not shown in illustration) for the sole purpose of rewinding upon the pulley the slack cord that would otherwise occur during the inward stroke of the engine. When in operation the entire mechanism is returned to its normal position at the termination of the inner stroke of the engine at each revolution, by the action of the spring inside the paper drum of the indicator. When ready to operate, and just before engaging the clutch by means of swivel collar *U*, the knurled disc on top should be turned around slightly to advance the paper drum of the indicator sufficiently to avoid the drum striking against its stop upon its return motion.

Drum Stop Attachment.—This attachment is shown in Fig. 1, and is for the purpose of starting and stopping the indicator paper drum at all times without unhooking the actuating cord. It consists of an arm attached to a part of the indicator by a screw. A slide is adjustable on the arm, and upon it is mounted a cord pulley for directing the actuating cord around the paper drum of the indicator. Said slide can be instantly secured in any desired position on the arm by the thumb nut and washer.

The manner of connecting and operating the attachment is as follows: The actuating cord from

any ordinary form of reducing motion connected with the engine is passed around the cord pulley, thence on the paper drum of the indicator. When the slide is at its inner position no motion will be transmitted to the paper drum, but by taking hold of the thumb nut and moving the slide outward on the arm, it will cause the paper drum to rotate back and forth in the usual way while taking a card. At any convenient position on the actuating cord there is superposed a rubber band for the purpose of taking care of any slack in the cord when the slide is at its extreme inner position and paper drum at rest, thus avoiding any unhooking of the actuating cord during the time of operating the indicator in making tests.

Electric Attachment.—In making complete and reliable tests of steam power from any and all classes of engines, wherever it is necessary to use two or more indicators for the purpose, it requires some convenient and rapid means of operating them so that all cards taken at any particular stroke of the engine will commence and leave off in the same interval of time. The cut represents a simple electrical attachment as it is applied to the Tabor indicator for this purpose to enable the operator to produce diagrams from one or more indicators simultaneously during the same stroke of the engines, and from any number of cylinders by simply pressing a button arranged to close the electrical circuit.

The attachment consists of a magnet support *S*, which is clamped to the body of the indicator and held in place by the set-screw *E*. A magnet *M* is secured to the support, also binding screws *C* and spring *D*. An armature *A* is mounted on the rod *B*, and adjusted

to coincide with the magnet *M*, and then secured to the rod *B* by the small set-screw in the armature for that purpose. The rod *B* is screwed into the upright on the swivel plate of the indicator, and any movement of the armature *A* produces a similar movement of the pencil toward or from the paper drum. The spring *D*

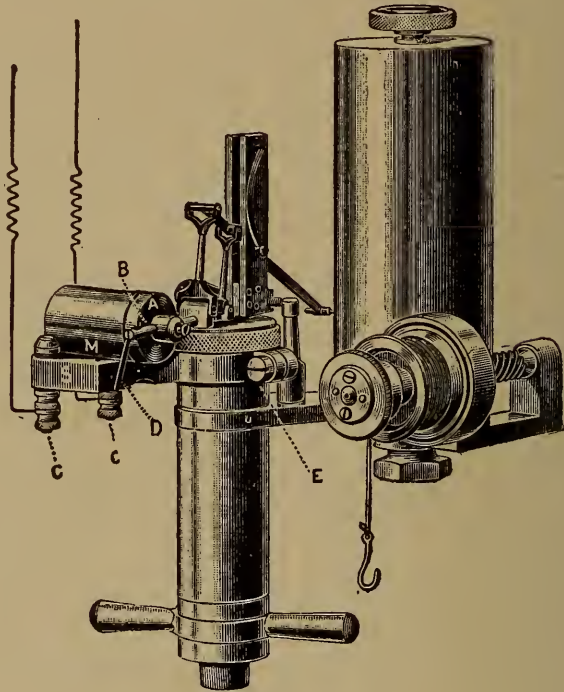

FIG. 3.

Tabor Indicator Fitted with Houghtaling Reducing Motion and Electric Attachment.

is for the purpose of holding the armature within the field of the magnet before the current is established, and also to quickly release it when the current from the battery is broken.

The improved device is easily attached to or detached from the indicator in a few seconds. By

removing the cap that supports the pencil movement of the indicator and slackening the set-screw *E* of the support *S*, the attachment is readily removed. Its connection with the indicator does not in any way interfere with the usual speedy and convenient means of adjusting the diagram paper to, or removing it from, the paper holding drum, or the changing of a spring in the instrument. It can be used on either right-hand or left-hand indicators with equal facility by reversing the magnet support *S* and the magnet *M*, the latter being secured to its supporting shelf by two small screws. Any one of the well-known batteries in the market (either dry or liquid) will be ample to operate a single indicator where the circuit is short.

THE THOMPSON STEAM ENGINE INDICATOR.

The original Thompson indicator was patented in 1875, but has been considerably improved upon from time to time.

The radical improvements, as made in the old style Thompson indicator, consist of lightening the moving parts, substituting steel screws in place of taper pins, using a very light steel link instead of a large brass one, reducing the

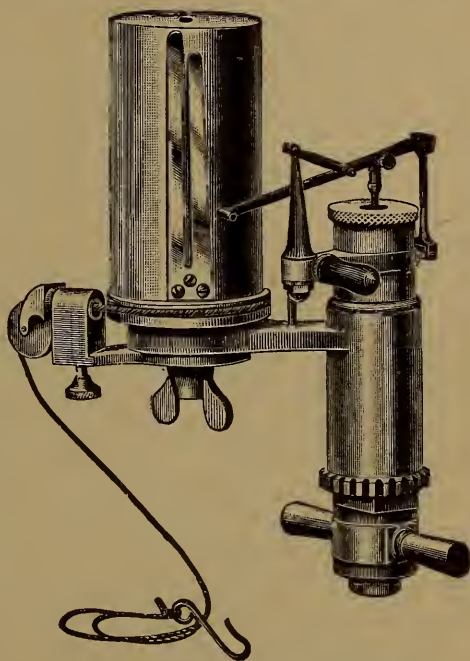

FIG. 1. The Thompson Indicator.

weight of the pencil lever, also weight of squares on trunk of piston and lock-nut on end of spindle, and increasing the bearing on connection of parallel motion. By shortening the length and reducing the actual weight of the paper cylinder just one-half, and by shortening the bearing on spindle, also lowering the spring casing to a nearer

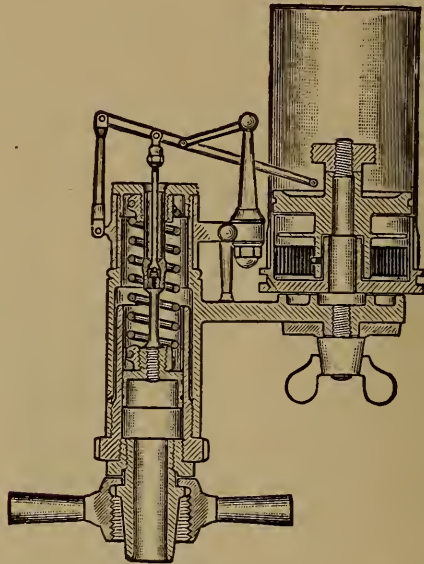

FIG. 2.

The Thompson Indicator.
(Sectional View.)

plane to that in which the cord runs, the momentum of the paper cylinder has been reduced to a very small amount. All of these improvements have lessened the amount of friction, which was heretofore very small, but is now reduced to a minimum; and furthermore, they tend to improve, on the whole, an instrument whose principle has always been of undoubted correctness.

READING INDICATOR DIAGRAMS.

While the diagram is solely a graphic representation of the pressure in the cylinder, and only one side of the cylinder, still by a knowledge of the various operations of the locomotive slide valve much valuable information is gained.

In the diagram, Fig. 1, the line DD is the atmospheric line, and is made by setting the indicator drum in motion when there is no connection open between the locomotive cylinder and the indicator piston. The pressures indicated by lines above and below this line from which measurements are taken are those above

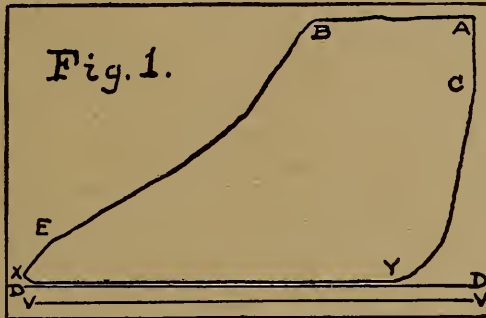

or below atmospheric pressure. The line VV is the zero line fourteen and seven-tenths pounds below line DD , and drawn by hand after the card is taken. AC is the "admission line." Steam is first admitted to the cylinder at C , hence that is called the "point of admission." AB is the "steam line." B is the "point of cut off," after which the pressure in the cylinder drops in expanding; hence, BE is the "expansion line." At point E the exhaust port begins to open and is thus called the "point of initial exhaust," or "point of release." The exhaust continues to the end of the stroke at X . XY is the line of "back pressure." The

exhaust port closes at *Y* and compression begins, *Y C* being the compression line.

The slightest irregularities in the steam distribution of a valve may thus be readily detected by taking an indicator card at a not too great speed.

It is customary to take an indicator diagram from each end of the cylinder, upon the same card. The taking of the second card follows the first as quickly as the three-way cock can be moved. Having the two indications on one card enables the variations between the steam distribution in the two ends of the cylinder to be readily detected.

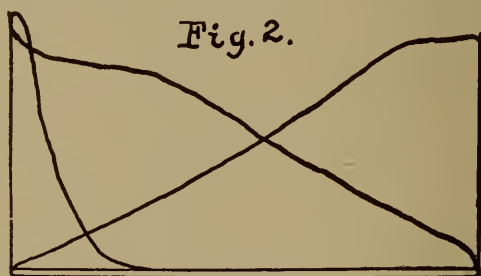

The diagram, Fig. 2, shows unequal steam distribution in the two ends of the cylinder. Looking at card *H* we can see that the exhaust port closes too early and compression exceeds the steam chest pressure (as shown by the loop), which causes the valve to raise off its seat. This card of itself would indicate too great inside lap, but by noting card *O* it is seen that there is no compression at the other end of the cylinder. Hence before any change is made the blades should be adjusted to equalize the two cards. It is always advisable to equalize the distribution in both ends of the cylinder before altering the eccentrics or the valve itself.

THE BOYER SPEED RECORDER.

The principal parts of this machine consist of a rotary pump, a cylinder and a piston. Oil is used as a circulating medium, the pump chambers and cylinder being entirely filled. While the machine is at rest the piston to which the gauge wire and pencil are attached is retained in its lowest position by two coil springs, but when given motion the pump produces a pressure of oil beneath the piston, causing it to rise to a point where an equilibrium is established between the pressure of oil and the tension of the springs, this point being determined by the speed at which the pump is moved—each thirty-second of an inch rise of the piston indicating a speed of one mile per hour. Moving around a drum in the upper part of the machine, at the rate of one-half inch to the mile, is a ribbon of paper, having thereon horizontal and perpendicular lines, each horizontal line from the base or zero line representing five miles per hour, and each perpendicular line a mile post along the road.

If the locomotive is moving at the rate of twenty miles per hour the pencil will trace its mark on the fourth line from the base or zero; and for every mile traveled the paper will move under the pencil one-half inch, or the exact distance from one perpendicular line to another.

By examining the chart, the exact speed at which the train passed any point on the road, the number and location of stops, the distance, speed and location of any backward movement that may have been made, can be determined at a glance.

In the cab of the locomotive, in view of the engineer,

is placed a gauge similar in appearance to a steam gauge, the needle of which points to the number of miles per hour the locomotive is moving. This is connected to the piston of the machine by a small wire

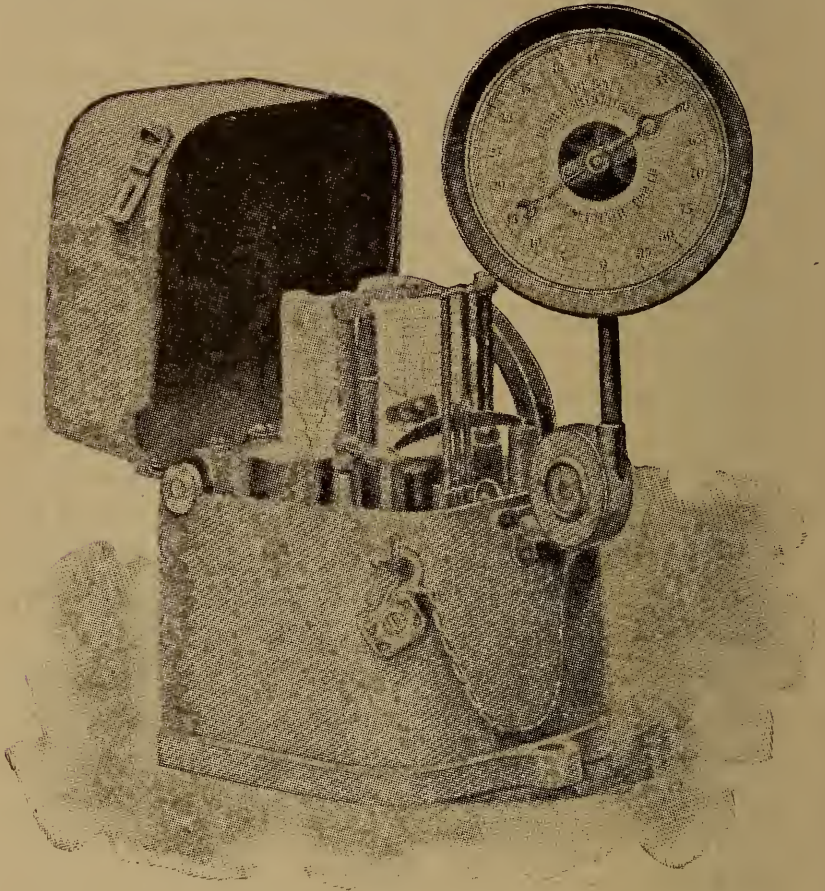

FIG. 1.

Boyer Railway Speed Recorder.

enclosed in a one-eighth inch gas pipe. This pipe runs straight, except where necessary to make a distinct bend, when an elbow of suitable angle, containing a sheave for the wire to run over, is inserted.

THIS CUT IS ABOUT ONE-THIRD ACTUAL SIZE, AND WAS TAKEN FROM A RECORD MADE ON A RAILWAY RUNNING WEST FROM ST. LOUIS.

FIG. 2.

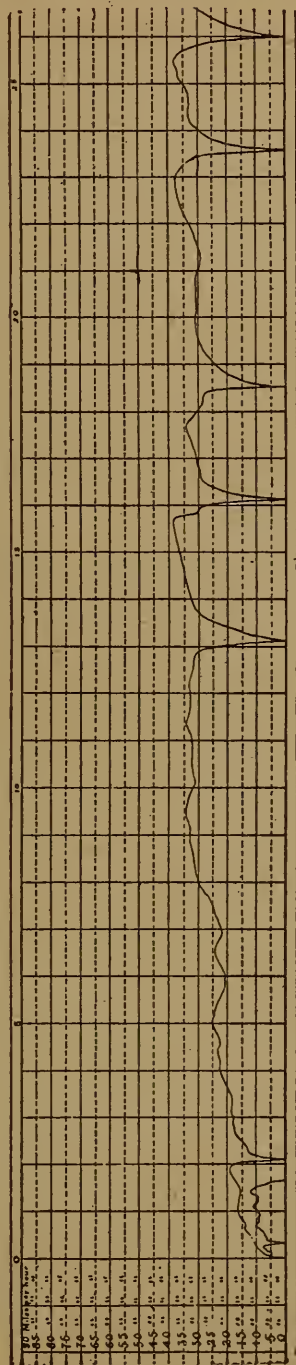

The chart shown in the accompanying cut was placed in recorder while the engine was at the round-house, in such a position as to bring the mile-post, marked zero, under the pencil at the Union Depot, which is about 1½ miles from the round-house. It will be noticed that the engine made one stop on its way backing down to the Depot.

After pulling out with the train the first stop was made at a point a little more than 2 miles from the Depot; the second stop was made at Kirkwood, somewhat more than 13 miles distant from the Depot. The highest speed attained between the first and second stops was 35 miles per hour.

The recorder can be placed in a special car or caboose when desired.

The size of recorder is nine inches long, seven and one-half inches wide and nine and one-fourth inches high. All the parts are made with the greatest accuracy, and are interchangeable.

Every machine is set up at the factory and accurately adjusted up to ninety miles per hour.

The charts are wound on wooden spools, and are made in various lengths up to one thousand miles.

If the recorder is properly applied, the chart will show the actual mileage made, as well as the speed at all points on the run.

Application of recorder.—In applying a Boyer speed recorder to a locomotive with a four-wheel truck, it should be bolted on the frame over the rear-truck axle, with wheel inward. It is usually necessary to bolt a plate of iron on the frame and to set the recorder on that in order to get it far enough in for the belt to pass the truck-box. The pulley to drive the machine should be clamped on the axle, in line with the machine pulley.

This pulley is in two pieces, with a liner between at one side, and should be bored to fit loosely on the turned part of the axle, and when clamped around the axle, the liner should be left out.

When necessary to move the pulley along the axle there need be only one bolt loosened.

In applying recorder to an engine with a pony truck, a disc of suitable diameter, with groove in edge for the belt, should be fastened to the end of the axle, with a cap-screw in center. The recorder, in this case, may be placed on the wheel-guard.

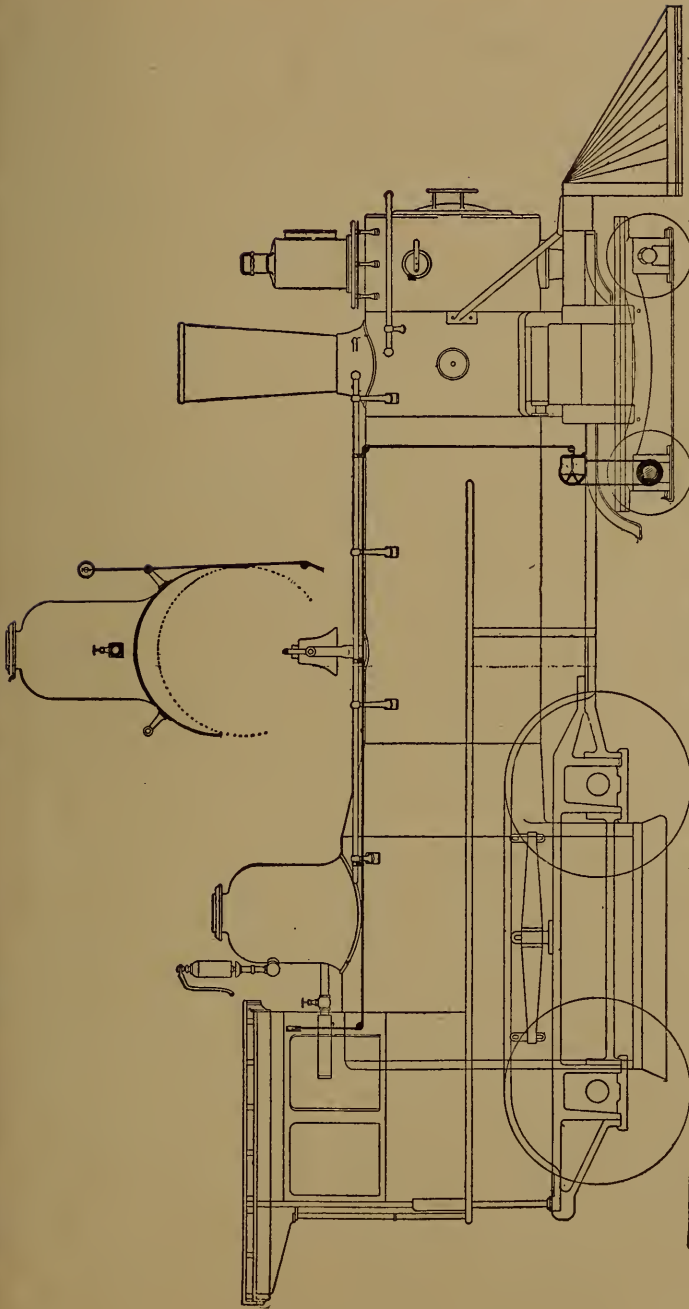

THE BOYER RAILWAY SPEED RECORDER
AS APPLIED TO A LOCOMOTIVE
HAVING A FOUR WHEEL TRUCK

After the machine has been secured in position, place the gauge in the cab where it may be easily seen by the engineer. (It may be fastened on the same bracket that holds the steam-gauge.)

Before the gauge can be fastened it is necessary to remove the dial, in order to put the screws for fastening through the countersunk holes in back.

(The dial can be removed from the gauge by loosening the screws and turning it around until the notch will pass one of the screw heads.)

After fastening the gauge, run a one-eighth-inch gas pipe from it to the recorder. Get it straight as possible, using the elbows containing sheaves wherever necessary. The pipe may be carried along directly under the hand rail and firmly secured thereto by clamps or fastened on the running-board.

Before the pipe is screwed together there should be a thread or small cord passed through each piece, the ends tied together and drawn in. After the pipe, recorder and gauge are in position, the needle of the gauge should be connected with the machine by means of the fine phosphor-bronze wire accompanying the recorder. Take a piece of this wire, long enough to make the connection, with about fifteen inches of silk cord attached to one end and stretch the wire about four per cent.; attach the silk cord to the thread, which is in the pipe at the gauge, and draw the wire through, being careful not to get it kinked.

Place the loop in end of cord on the cross-head hook after passing under the small sheave in the front of machine; then pass the wire around sheave in the gauge out through the notch at the side and around the small screw; then turn the sheave to the left about

half an inch so as to bring tension on the wire, and fasten the end by tightening down the screw, around which the wire is drawn. This done, take the silk cord from the hook on the recorder, move it up and down, and if it moves perfectly free return it to the hook, then put the hand on the gauge with the point at zero.

It will be well to note the manner in which the temporary piece of wire is attached to gauge, which is left there for the purpose of showing the mode of fastening and should be removed before attaching the permanent wire.

It is very important to have the inside of the pipe free from loose scale and dirt, as it may lodge in the ells and prevent the free movement of the sheaves.

In replacing the dial, zero can be placed at lowest point and the head put on to suit.

If, after the recorder has been run for a time, and the hand does not come to zero when the machine is at rest, the hand should be taken off and placed right without disturbing the wire.

When not convenient to put the machine on frame of engine, it may be placed in front of the cylinder and power taken from a thin pulley screwed on the end of the front axle outside of wheel—the same as on engine with pony truck.

The recorder when put in a car is usually placed on the floor, the gauge at a convenient height to be seen, and the belt run down through the floor to the pulley on the axle. In this case the belt and recorder pulley should be boxed on the inside of the car to prevent dust from coming up.

It is usually found necessary to place the machine

within eighteen inches of the center of the car, so as to get the belt around the axle inside of the truck timbers. The recorder may be placed just behind the door, almost against the end of the car, allowing enough space to open the case.

If it is more convenient to have the pulley on the opposite side of machine, as in case of its application to engine with pony truck, it can be so placed by removing the spool plate and loosening the set screw that holds the clutch in center of shaft, then remove the shaft and end bearings and reverse them. The

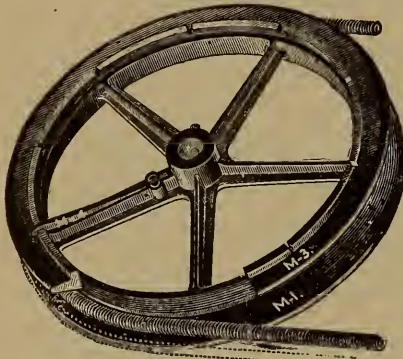

FIG. 3.
Recorder Pulley—Boyer Speed
Recorder.

worms and clutch collar should be left in position.

Recorder pulley.—The flange *M-3* is screwed onto the main part *M-1*, and is held in position by latch *M-4*. The diameter is adjusted, or the point at which the belt runs is varied, by moving the flange to or from

the main part. This adjustment is enough to allow for a change of about three inches in the diameter of a car wheel.

The belt should be coupled by means of the plyers furnished, similar to the manner in which the coupling is fastened in one end of the belt sent with the recorder.

Cut the belt of such a length that it will require stretching about eight per cent. to put it in place.

Speeding.—The pulley on recorder should make six hundred revolutions per mile. The diameter of this

pulley is determined by dividing 63,360 (the number of inches in a mile) by the circumference of the car wheel in inches, which gives the number of revolutions of the car wheel per mile; this result, multiplied by the circumference of the axle pulley in inches and the product divided by 600, will give the circumference of the adjustable pulley on the recorder.

Example.—Suppose the wheel be 94 inches in circumference and the axle pulley $17\frac{1}{2}$ inches in circumference, then $63,360 \text{ in.} \div 94 \text{ in.} \times 17\frac{1}{2} \text{ in.} \div 600 = 19.66$ inches, the circumference of recorder pulley.

To set this pulley to the proper size, take a piece of wire belt the exact length the circumference should be, and adjust the flange of the pulley by raising the latch and turning it until the ends of the piece of belt when passed around will just meet. Be careful not to stretch the belt in measuring. The axle pulley should be measured the same way. (It would be well to measure the axle pulley before putting on axle.)

To ascertain the circumference of the car wheel, a steel tape, or, in the absence of this, a piece of gauge wire may be used, the size being taken at the bearing point of the wheel.

If the measuring of these wheels is carefully done, the record will show a mileage of within one per cent. of the actual distance traveled, and this discrepancy can be rectified by a final adjustment of the recorder pulley.

Care of recorder.—To fill the machine, lift it out of the case and remove the lower spool-plate, which is

fastened by a screw in the center between the spool spindles. The filler-hole will be found directly back of the drum, plugged by a large-headed screw; remove this and fill from the can of circulating oil accompanying the machine. The spout of oil-can should be screwed on loosely, so as to admit air to the can while pouring therefrom. See that the spout is clean, and no dirt gets in the machine.

When the machine is filled to overflow the oil will appear in the bottom of the worm-wheel chambers, and this excess will run out through holes at either side.

It is important to have the machine entirely filled, and to insure this the wheel should be turned while the oil is being poured. After the oil appears in the bottom of the worm-wheel chambers, the wheel should be turned vigorously for a moment to churn out the air which may be in the machine, after which it will take more oil.

A small quantity of oil should be added every six months to replace any that may have evaporated; because, after a length of time; should the oil get below a certain line in the pump chamber, the machine will record low.

In replacing the machine in the case, be careful and keep it as near level as possible, so as not to spill the oil.

Worm-wheels, shaft and bearings should be cleaned about every six months.

The interior of the recorder should not be disturbed, as it is important that the joints remain sealed.

Description and care of oiler.—The inner part of the paper drum is arranged to contain lubricating

oil, and also to gradually feed it to the working parts as the machine moves. The construction is this:

A small tube *J-3* passes through the bottom of the drum and extends half way up on the inside, to which point the drum is filled with oil. The space above the oil line contains a plunger *J-4*, which is gradually lowered by the slow movement of a screw *J-5*, the latter being operated through a ratchet *J-7*, from an

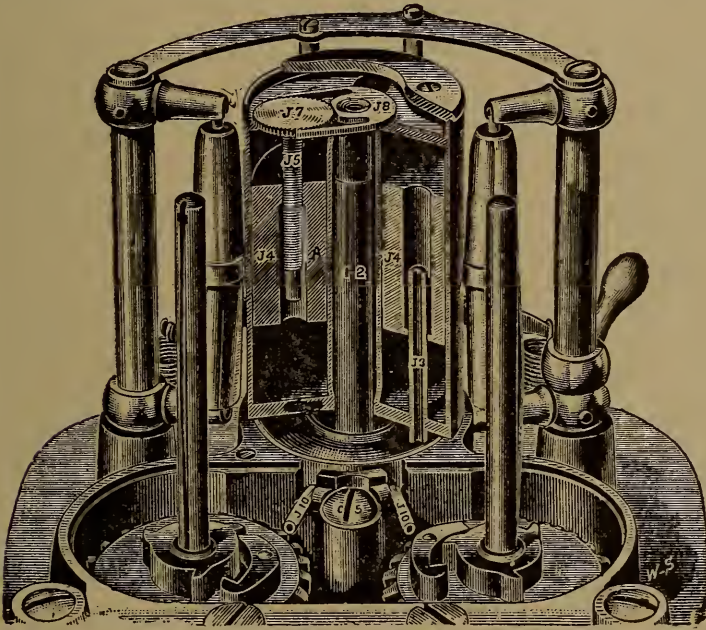

FIG. 4. Oiler—Boyer Speed Recorder.

eccentric on the upper end of the stationary shaft *I-2*, around which the drum revolves. The plunger does not force the oil, it simply displaces and keeps it high enough to run into the top end of and out through the tube. When the plunger stops moving the flow of oil ceases.

To fill the oiler.—Remove the cover by taking out the four screws in the top, then take off the yoke

J-8 that operates the ratchet wheel *J-7*. Turn the ratchet wheel to the right until the plunger within is drawn to the top, when the wheel will stop turning; next, pour the full contents of the bottle of lubricating oil furnished into the large hole. The spout of the circulating oil-can will serve as a funnel.

When the oiler is filled raise it out of its position so that the small tube *J-3*, out of which the oil flows, can be seen; then slowly turn the ratchet wheel in the direction that it will be driven (to the left) until the oil starts to flow from the lower end of the tube; then return the oiler to position, put on the yoke, right side up, and screw the cover on.

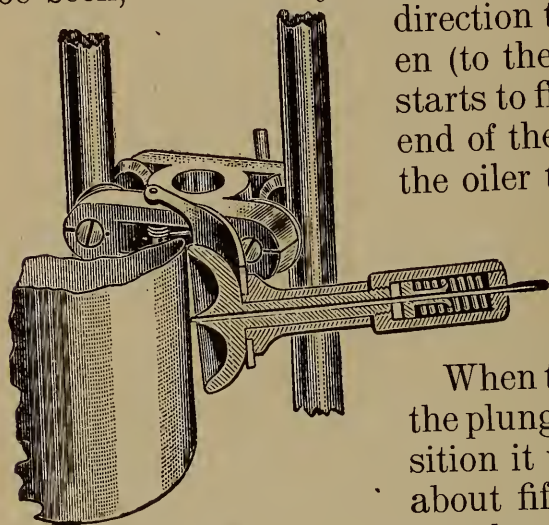

FIG. 5.
Pencil Mechanism Boyer Speed Recorder.

When the oiler is filled and the plunger in its highest position it will require a run of about fifty thousand miles to exhaust the supply of oil. At this time the plunger will have run off the lower end of the screw and will be in its lowest position. In order to again raise the plunger it will be necessary to remove the oiler from the machine and invert it, so as to start the screw into the plunger, to raise it, preparatory to refilling.

It would probably be best to refill the oiler every six months, thereby insuring the mechanism against failure from want of lubrication.

The pencil.—The pencil is brass wire and when in

good condition makes a distinct line on the prepared surface of the paper. It is held by friction and forced against the paper by a spring within the holder.

The pencil should project far enough through the disc on the end of the holder to bear with sufficient pressure on the paper to make a line. Should it project too far through, it will withhold the disc from contact with the paper and will not revolve, which is necessary in order to get a clear line.

To be sure that the pencil is properly adjusted, withdraw the operating lever enough to remove the gripping rolls from contact with the paper, but not enough to remove the pencil, then turn one of the paper spools so as to draw the paper under the pencil; if it is correctly adjusted the pencil will revolve and make a clear line.

Should the pencil not mark distinctly it can be improved by slightly rounding the end on a smooth file, emery or sand paper. The pencil is soft and easily bent, but can readily be straightened by rolling between two flat surfaces of wood or iron. It should be straight as possible in order to enable the spring to hold it against the paper.

To put on the paper.—Loosen the end of the paper and start it on the empty spool by putting the end into the saw cut in the direction that it will not easily come out; wind two or three turns of the paper around the spool, then swing out the operating lever as far as it will go, which will remove the gripping rolls and pencil from the paper drum and place the paper around the drum, putting the two spools of paper on the spindles, with the supply on the left-hand spindle, when facing the direction the loco-

motive or car is to move, then return the operating lever to its former position.

Axle pulley required for application of recorder on a

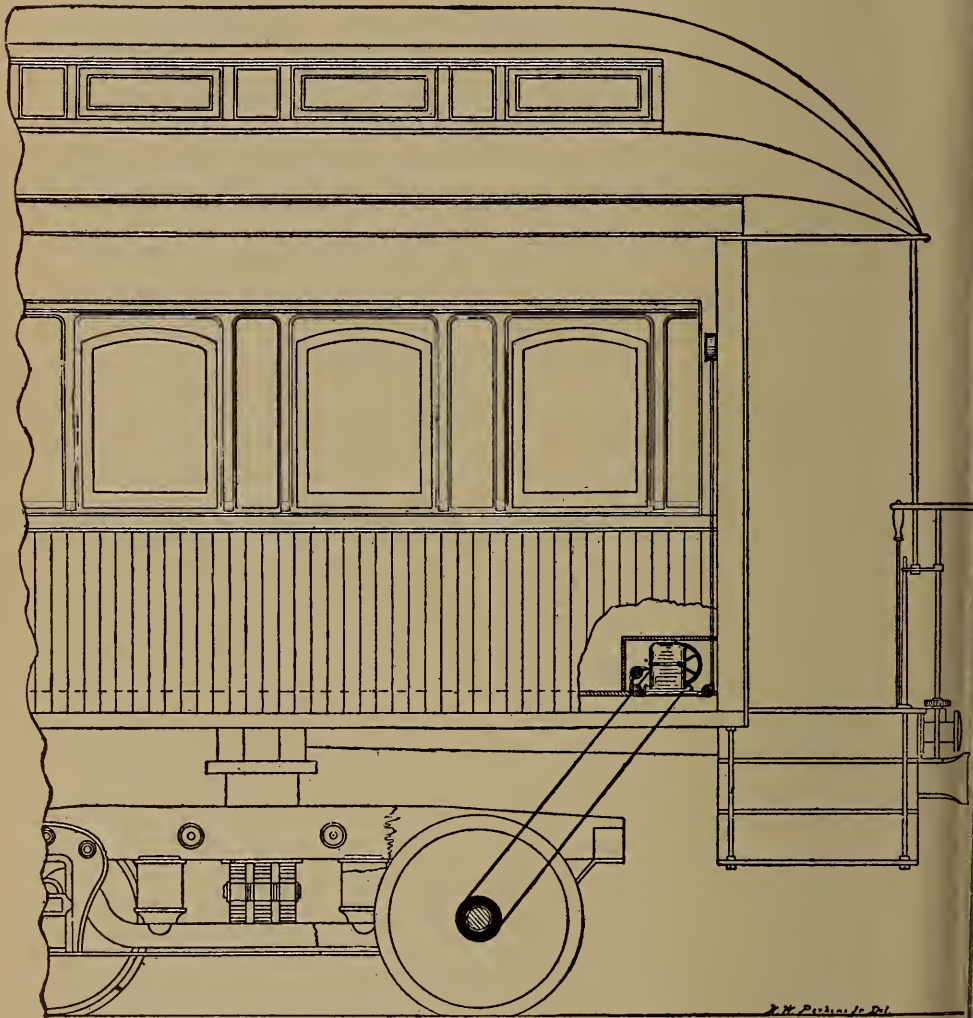

FIG. 6.

Boyer Speed Recorder as Applied to a Passenger Car.

car should be split and secured and adjusted to position on the axle by means of six set screws dividing the circumference into thirds, disposed in pairs.

The bore or inner surface of pulley need not be turned out, but should be large enough to clear the rough surface of axle at all points. The length of bore should be about four inches.

LOCOMOTIVE REVOLUTION COUNTER.

The accompanying cut illustrates the Crosby locomotive counter. It is designed particularly for use on locomotives and high-speed engines, and is a valuable

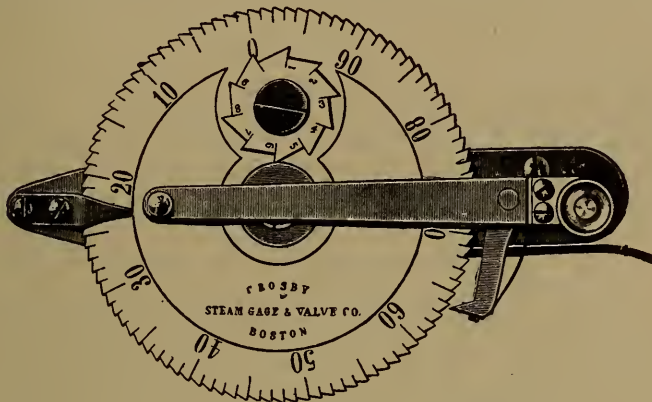

FIG. 1.
Crosby Locomotive Counter.

auxiliary to the steam engine indicator. The arm which moves the ratchet is connected by a cord with some reciprocating part of the engine, or with the drum motion of the indicator, so as to give it about one and one-half inches swing back and forth during each revolution of the shaft. It is provided with a convenient starting and stopping device, so that it can be made to begin or stop counting at any instant.

AUTOMATIC COUPLERS FOR LOCOMOTIVES.

The long "push-bar" pilot coupler has been displaced by the pilot coupler, the construction and attachment of which differs with shape of the pilot used by each railroad company. Hence no attempt will be made to illustrate the pilot coupler; suffice it to say that the contour lines of the coupler itself are

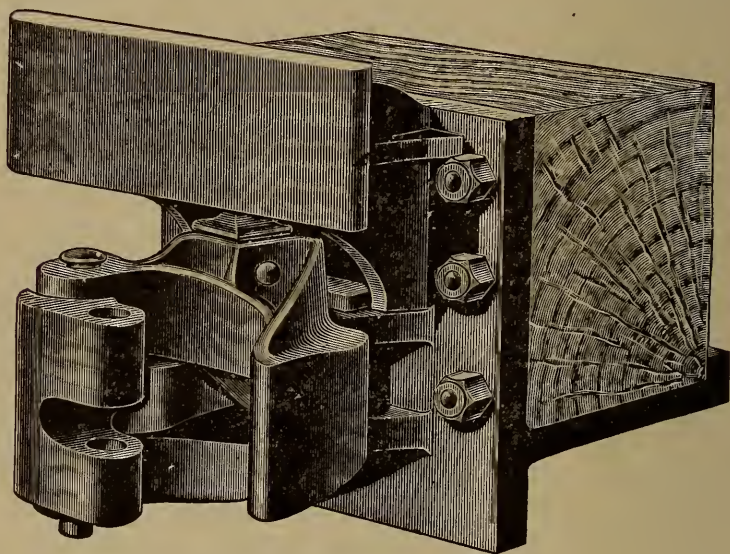

FIG. 1.
Talbot Automatic Coupler for Tenders.

standard with the Master Car Builders' coupler on all cars.

The couplers for the back of the locomotive tender are, however, of not so great a variety. Where the construction of the tank frame will permit, it is quite customary to apply an automatic coupler quite similar to that on a freight car, but there are a large number of

tenders in this country equipped with a plate coupler like that shown in the accompanying engraving, or quite similar thereto. The coupler here shown is pivoted on the outside of the end sill of the tank by a concentric pin, which gives to it the same circular path it would have if it were pivoted four feet back from head, thus permitting it to have the required three-fourths inch side play without the liability of uncoupling. When tension is put upon it, it centers itself in line of draft and conforms to all the movements of the service. This form of coupler is also made with an elliptic buffing spring.

On locomotives engaged in switching service only, this form of plate coupler is attached to the front timber and the pilot, usual with road engines, omitted.

COUPLER EMERGENCY KNUCKLE.

The M. C. B. automatic draw bar has come into general use on American railroads, and its adoption has greatly increased the safety and facility of train handling; but the parts of the draw bar, the knuckle and lock, necessarily give way in service from wear and tear, and cause trouble by reason of trains parting. When this occurs, if there is a spare knuckle or locking part at hand to replace the defective one, there is little delay in moving the train. But usually the spare part is missing, because it is hardly practicable to carry the assortment necessary to insure having the one wanted, there being about ninety different types of draw bars in use. In case the piece is missing, a link and pin or chain is used, and this means a very unsafe and unsatisfactory connection, and probable injury to draft rigging.

The Gilman-Brown emergency knuckle, as shown by Fig. 1, will go into ninety-five per cent. of the draw bars in service and make a rigid coupler, into which any automatic coupler will lock securely if in good order. By simply removing or raising the locking pin or locking parts and inserting this emergency knuckle, replacing the knuckle pin, which is seldom injured, a safe and complete connection is assured.



Fig. 1.

Gilman-Brown Emergency Knuckle.

The chances are enormously in favor of the emergency being safely and satisfactorily met if there is one of these knuckles close at hand.

It is essentially a repair tool which could well be considered part of the equipment of every freight engine, switch engine and way car, as it is a practical and economical insurance against delay on the road in consequence of defective knuckle or locking parts.

CAST STEEL FOR LOCOMOTIVE PARTS.

The use of cast steel in place of wrought or cast iron is of quite modern practice. The object accomplished thereby is a reduction of cost over wrought iron and a lightening and strengthening of parts formerly constructed of cast iron.

The first locomotive parts to be made of cast steel were the centers of driving wheels. As cast steel is ordinarily considered about three times as strong as cast iron, the section of all parts of the wheel center

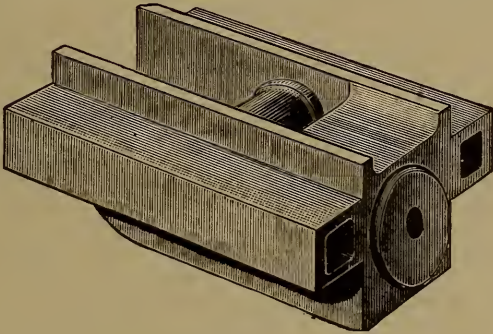

FIG. 1.
Hollow Cast Steel Cross-Head for 4-Bar Guides.

was thus safely reduced, making them more symmetrical, lighter, and still much stronger.

The weight on driving wheels being such a governing factor in determining the size and design of new locomotives, this practice of effecting a reduction of from two thousand to three thousand pounds in the driving wheels of a locomotive, and permitting the same weight to be added to the boiler, is a very important one in American practice.

Subsequently the substitution of cast steel for wrought iron in locomotive cross-heads came into

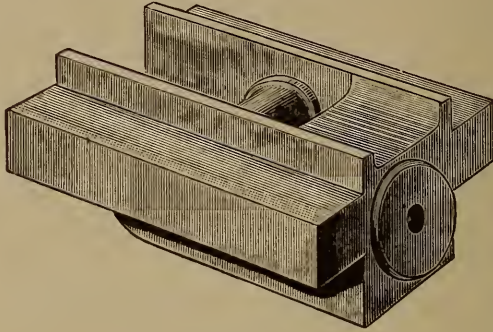

FIG. 2.

Solid Cast Steel Cross-Head for 4-Bar Guides.

quite general practice. Figs. 1 and 2 show hollow and solid cast steel cross-heads for four-bar guides. Fig. 3 is a cast steel cross-head for two-bar guides.

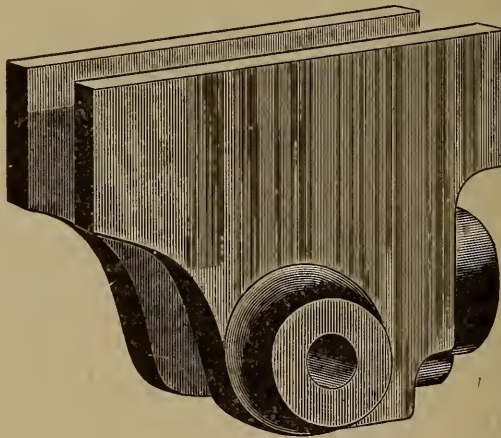

FIG. 3.

Cast Steel Cross-Head for 2-Bar Guides.

These can be made lighter than wrought iron cross-heads, are less liable to flaws in their manufacture, and are much less in first cost.

Fig. 4 shows another substitution of cast steel for wrought iron in the rocker arm. (For the location of the rocker arm see plate "American Steam Locomotive," part numbered 116.)

Until quite recently all locomotive driving boxes were made of cast iron. Although they were of very great weight and thickness, their breakage was of frequent occurrence. Fig. 5 shows a light driving

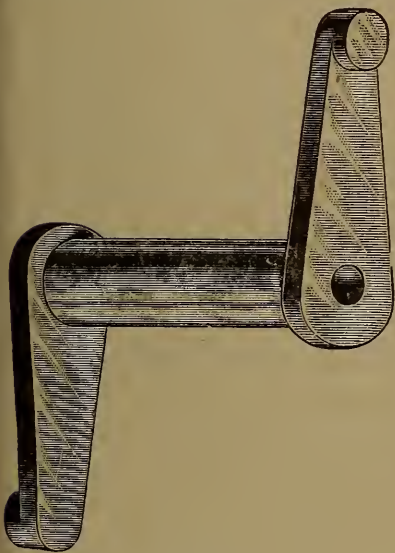

FIG. 4.
Cast Steel Rocker Arm.

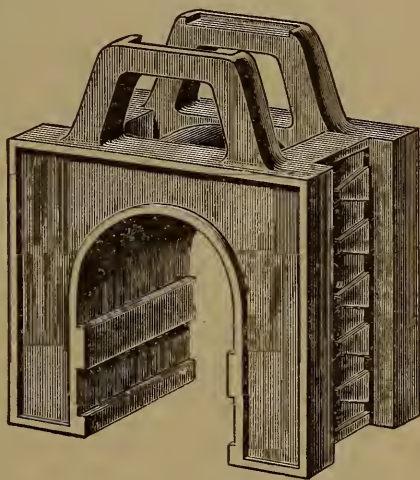

FIG. 5.
Cast Steel Driving Box.

box made of cast steel, thereby reducing considerable unnecessary weight from the driving wheels.

Many locomotive parts formerly made of wrought iron, malleable iron and brass are now cast of steel. Perhaps the most notable of these are the engine frames, which have been found to give excellent satisfaction, and at a saving of from three to four cents a pound effected by the time they are ready to put into the engine.

HEATING ENGINE HOUSES.

It has been a long established practice to heat engine houses by steam. The coils of pipe are securely fastened to the sides of the pits of each "stall" or roundhouse track. A supply pipe leads around the house, in a trench at one end or the other of the pits, and each coil of pit pipes is connected thereto with a shut-off valve intervening.

This location of heating pipes not only is economical of wall and floor space in the engine house, but also causes the greatest heat directly below the locomotives, a matter of great advantage in cold climates where engines come in all covered with snow and ice, which must be thawed off before a thorough inspection can be made, the necessary work done, and the various parts properly oiled for the next trip.

It is considered good practice to use at least two-inch pipe in the pit coils, so that wherever possible to use exhaust steam for this heating it can be done with the least back pressure possible.

If the shops are located near the engine house, the exhaust steam from the stationary engine, steam pumps, and air pumps or compressors, should be utilized for heating the roundhouse.

Hot Air Heating for Engine Houses.—As the adaptation for roundhouses of the Sturtevant system of hot air heating is quite recent, a description of this method of heating, as installed in the roundhouse of the Chicago & Northwestern R'y, at Clinton, Iowa

(probably the largest engine house in the world), presents an interesting study.

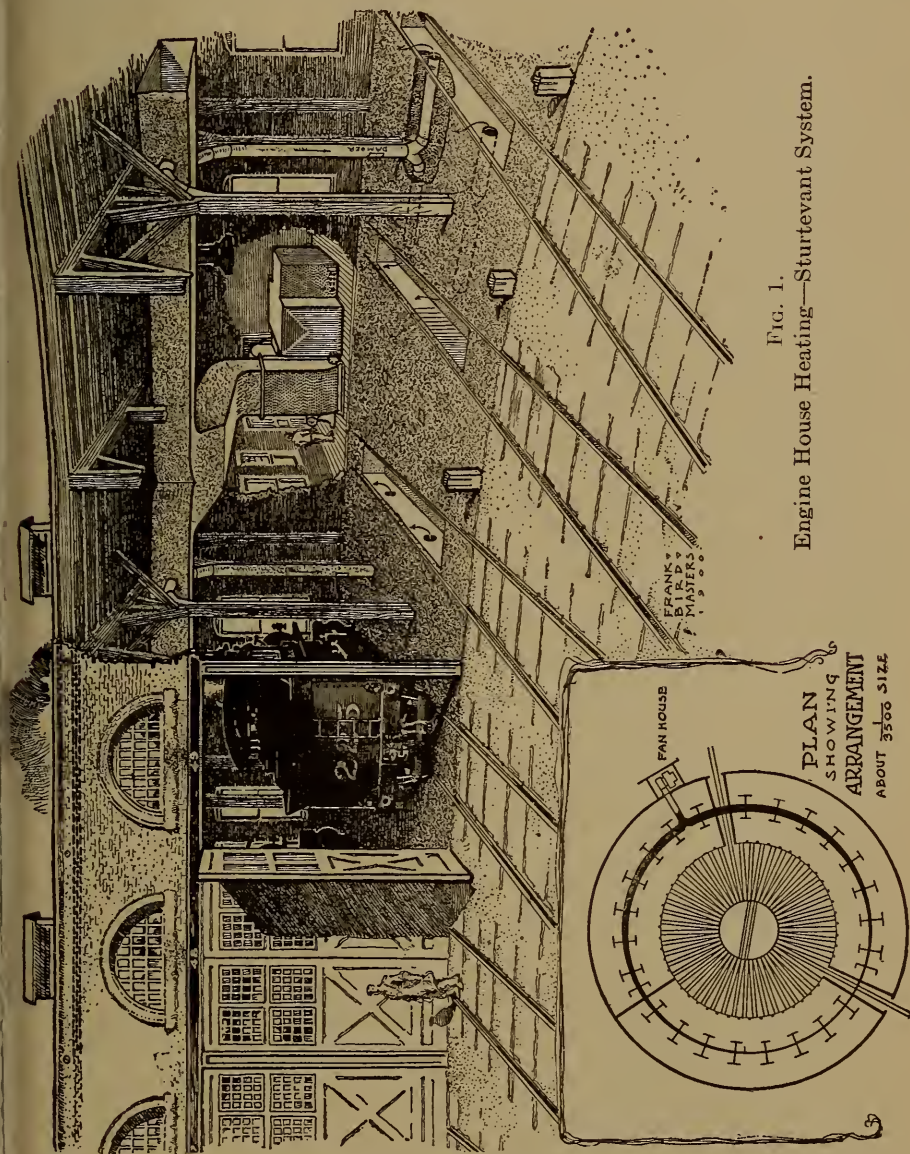

FIG. 1.
Engine House Heating—Sturtevant System.

The house is three hundred and seventy-five feet in outside diameter, the interior circle being two hundred

and twelve feet in diameter. The inside clearance between walls is eighty-one feet and six inches, and provision is made for forty-eight stalls, or, including entrance and exit, fifty. As the length of the longest locomotive, at the time this house was built, was sixty-two feet eight and one-half inches, ample space was thus left around either end of the engine.

In selecting the system of heating the desirability was recognized of combining both the means of maintaining proper temperature in the building and of rapidly melting snow and ice from the locomotives during the winter season. Upon the rapidity with which the latter process can be accomplished must of course depend the length of time during which a locomotive must remain out of service.

As most effectually combining the advantages required to meet these conditions, the Sturtevant blower system of combined heating and ventilation was selected and installed in accordance with the plans and elevation shown in the accompanying engraving.

Located outside of the house, and filling the space between it and the nearby machine shop and store room, is the apparatus, consisting of a steel plate fan-wheel twelve feet in diameter, enclosed in a steel plate housing with upward discharge. To the fan shaft an eleven and one-half by sixteen horizontal engine is directly connected. This arrangement makes it possible to operate the fan at any desired speed, and with entire independence of any other source of motive power.

The air is, by means of the fan, drawn through a heater having a capacity of twenty thousand lineal

feet of one-inch pipe built of sections in three groups and enclosed in a steel plate casing, rendering the apparatus at once fire-proof and directing the current of air to the fan under whose action it moves.

Passing upward from the fan, the air enters a large horizontal galvanized iron duct, which extends to a position midway between the inner and outer circumferences of the engine house, and there branches into separate pipes extending in either direction entirely around the house until they meet at the opposite end of the same diameter. Being carried overhead, they in no wise encroach upon valuable space.

Distribution of air is secured through branching pipes, which are led downward along the sides of the vertical posts and branch beneath the ground level, so as to connect with the pipes extending to the pits upon either side. The vertical pipes, fitting closely to the posts as they do, are protected from injury, and do not occupy effective floor space. Just above the floor line each is provided with a slide damper, as shown, by means of which heated air may be admitted to the building. There being over fifty of these branch pipes with these openings, it is evident that the circulation of air is all that can be desired.

Each branch pipe to a pit is provided with a damper operated from floor level, so that air may be locally discharged in large volumes. The result is that an excessive amount of hot air is delivered to the pit and rises evenly across the running gear of the locomotives. The high temperature rapidly melts the snow and ice, while the air, with the greediness due to high temperature, rapidly absorbs all moisture and carries it away. A hot, dry condition is therefore assured,

and the time during which a locomotive must be kept out of service is usually reduced by fully two-thirds—a most important feature in locomotive practice.

It is also evident that the large volume of air admitted plays an important part in the process of ventilation. Individual roof ventilators are provided for every other stall, thus insuring positive upward movement of air from floor level and its escape when its duty is completed.

One of the most essential advantages of this method of heating lies in the fact that the entire heating surface (far less than would be required for direct heating) is massed in a fire-proof casing in the adjoining building. The volume and temperature of the air is immediately under the control of a single individual, while local requirements can be met by the adjustment of dampers, as shown and described. The exhaust steam from the fan engine is utilized in the heater, so that the cost of operating the fan is greatly reduced. Live steam is supplied to the remainder of the heater. It is, however, customary in ordinary mill practice where there is ample quantity of exhaust steam to utilize it in the heater, as can always be readily done without producing back pressure on the main engine.

SMOKE JACKS FOR ENGINE HOUSES.

Although of comparatively recent adoption, there are but few engine houses of any importance not now equipped with some form of "drop" jack; that is, with telescope pipe which permits its being lowered to completely cover the locomotive stack. If properly constructed, such a jack not only prevents the escape of all smoke and gases into the engine house and

THE BRUYN AUTOMATIC SWINGING SMOKE JACK.

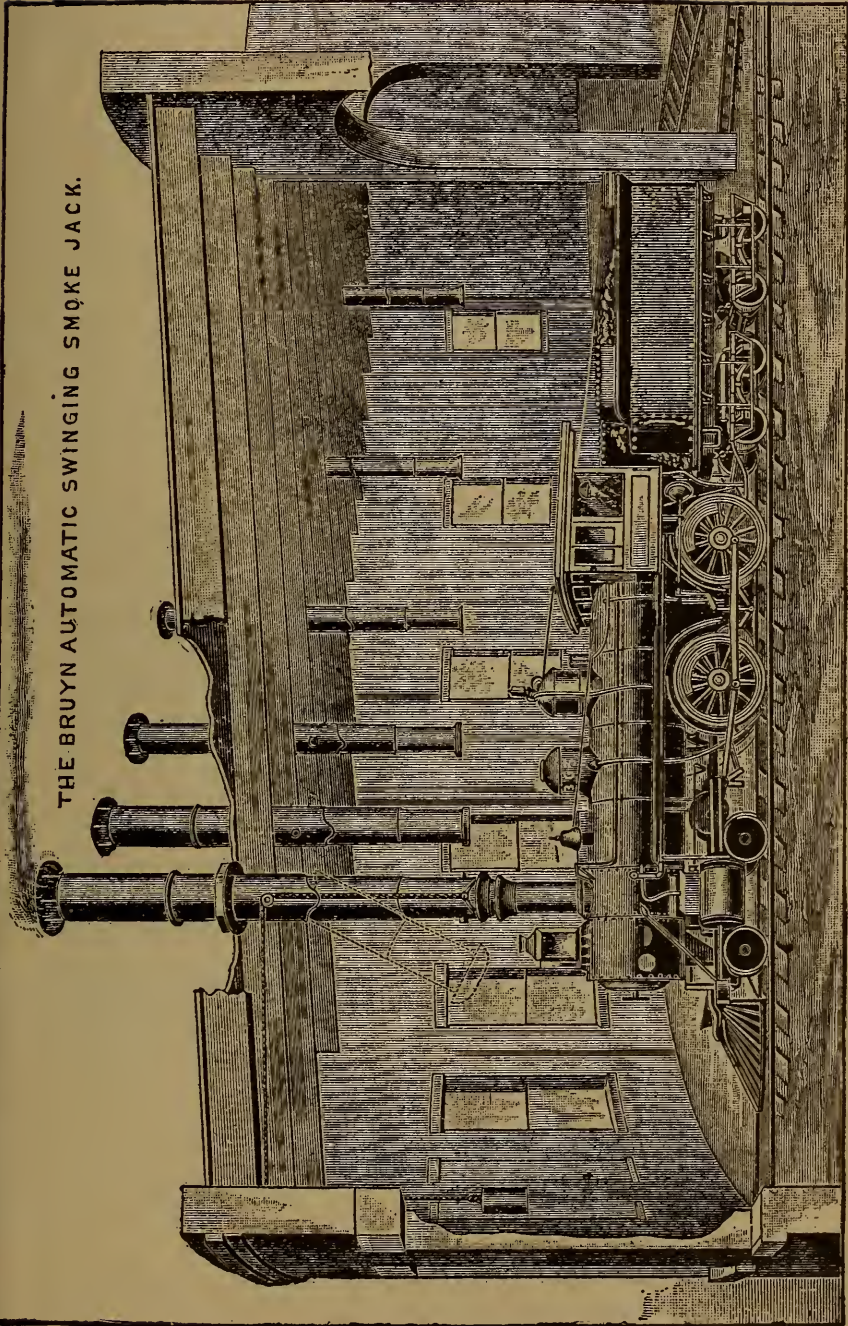

FIG. 1.

locomotive cab, but also increases the natural draft and prevents creosote or drippings from falling on the front end and headlight.

Proper inspection and repair work cannot be accomplished on locomotives where the engine house is so full of smoke and noxious gases, as was often the case with the old form of stationary non-dropping smoke jacks.

The smoke jack should also be provided with a damper, so that the draft may be shut off when an engine is without fire, for a strong draft at such times produces a sudden cooling of the flues, flue sheet and fire-box, and often causes them to leak.

The accompanying engraving shows one design of telescoping smoke jack.

It will be seen that the telescope portion is counter-balanced by suitable weights hung near the wall. The damper is located just above the ball-bearing hood, which fits tightly into the locomotive stack. The smoke jack here shown has a swinging joint, so that no breakage could occur by moving the engine from under it without first raising the jack.

By an ingenious arrangement the damper is automatically closed whenever the jack is raised, thus saving heat in the round house which would otherwise escape through the jack.

LOCOMOTIVE FIRE KINDLERS.

The Ferguson locomotive fire kindler consists essentially of a tank to contain oil, a hose coupling for connection with the compressed air system or with the main reservoir of another locomotive, a hose terminating in a nozzle for spraying the mingled oil and air, and a valve for controlling the relative pro-

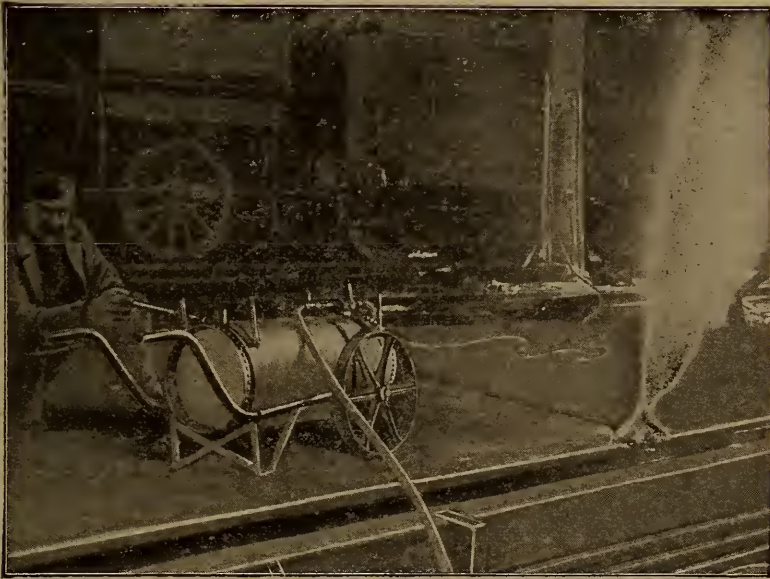

portions of oil and air. The tank is most conveniently mounted on a truck, by which means it may be easily removed from one part of the roundhouse to another.

The valve is the principal feature of novelty. Turning the cock regulates the proportions of air and oil admitted into the tube. Turned one way, air alone

passes through and oil adhering to the inside of the hose is removed.

The tank holds twenty-five gallons of oil, which is sufficient to kindle fires in forty engines, on an average. About fifteen minutes of one man's time and three quarts of cheapest crude oil are required to start a fire. The kindler is very easy to operate. The nozzle, which is at the end of a long tube, and to which is attached a small piece of lighted waste, is thrust into the ash-pan, and the flame passes up through the fuel previously placed upon the grates until it is wholly ignited.

The same apparatus can also be used as a blow-pipe for heating tires, straightening frames or other bent work that may require removal and which ordinarily has to be sent to the blacksmith shop to be straightened.

LOCOMOTIVE JACK SCREWS AND POWER HOISTS.

The enormous increase in the weight of locomotives and tenders has naturally been followed by very powerful and efficient jacks, which are required for the purpose of lifting the engine itself or some of its parts.

No one knows as well as the old railway mechanic and his helper the vast amount of time expended every day in raising and lowering even the lighter engines of his day, while with a good set of either geared or hydraulic jacks the heaviest locomotive can be raised a foot in less than a minute and a half, and again lowered with equal or greater celerity.

Before illustrating and describing several forms and designs of jacks now in general use on American railroads, and here mentioned on account of their especial adaptation to locomotive requirements, it would be well to say that no jack, be it ever so powerful, can render efficient service unless it has a firm, unyielding foundation to stand upon. Hence great care should be exercised in the design and construction of a stone or concrete wall on each side of every track in engine houses.

To the uninitiated, let it be said that one or more jacks must be used every time it is necessary to pack a journal, change a spring, spring hanger or equalizer, remove a pair of wheels, or change the driving wheel tires, etc. Thus, there is scarcely a day but what

from some cause some part or the whole of an engine or tender must be raised.

Fig. 1 shows a screw jack with the bottom end enclosed, forming an oil receptacle. The screw being thus lubricated and protected, does not become rusted and is always ready for service. As two or more screw jacks are usually carried on every locomotive



FIG. 1:

Chapman Screw Jack.

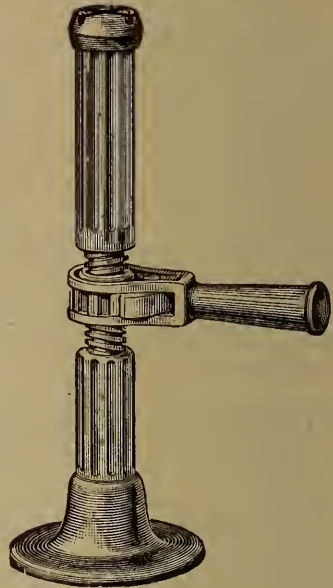

FIG. 2.

Joyce Double Movement Screw Jack.

for instant use in case of break-down on the road, and unless the screw portion is properly protected, they soon rust and become unfit for service.

Fig. 2 shows a double movement screw jack, which lifts twice as rapidly as a single screw, and, it is claimed, requires no more power on account of there being no friction under the cap, as in the case of the latter.

The rapid moving jack shown in Fig. 3 is so called because, when the load is off, it can be raised immediately to any desired point, and when up can be as quickly let down, thus saving the tedious operation of turning the screw up and down without load. The two segmental nuts are supported on steel pins moving in angular slots, so as to allow them to move in and out of gear. To raise the screw to any desired height for work, it is only necessary to lift it by taking



FIG. 3.

Joyce Rapid Moving
Screw Jack.

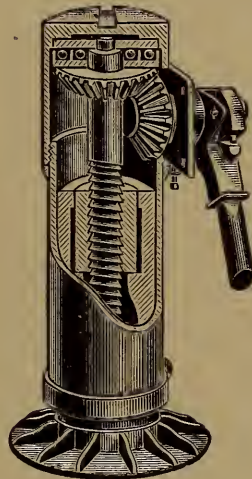

FIG. 4.

Norton Ball-Bearing Ratchet
Screw Jack.

hold of the lever. To lower it take hold of one of the handles with the left hand, and inclining the jack to an angle of about forty-five degrees, with the other hand holding the lever, let the screw down.

The jack shown in Fig. 4 has a stationary standard and a sliding sleeve fitting over the same. The standard has a removable nut (usually phosphor-bronze) fitted within it and resting on a shoulder, in which the screw turns. The standards are hollow and

can be filled with oil, thus keeping the screw constantly lubricated. To the upper end of the screw is fastened a steel gear; a hardened tool steel plate encircles the hub, and rests on the body of said gear, on which are placed circular trains of hardened steel balls, held in place by rings between the rows (as shown in the cut). In the top or head of the sliding sleeve, which is bored to fit standards, is placed another hardened tool steel plate with a hole in the center, through which the end of the screw projects.

When the jack is assembled the sleeve slides down over the screw and standard, the bearing plate in the head resting on the balls on the plate on the gear, so that the whole weight is carried by the balls (between the steel plates), which act as a thrust-bearing between the screw and head of sleeve, reducing the friction and increasing the lifting power of the jack.

The sleeve which revolves on the standard, allowing the lever to be used from either side, carries the load, and is raised or lowered by the screw, which is turned by means of a gear on the ratchet shaft engaging with the gear on the screw, and operated by a reversible ratchet and lever having the up-and-down, or "pump-handle," motion. The sleeve at the lower end is provided with a "stop-dog" or pawl, which prevents the screw from being run out of the nut. This sliding sleeve takes all the side strain off the screw, preventing it from bending, and also protecting all the working parts from sand, coal-dirt and water, making it an efficient jack for carrying on locomotives or for use in engine houses.

Fig. 5 gives a general idea of the Joyce geared jack. A wooden handle fits into the socket shown. The

bar has strong, heavy teeth operated by a pinion, which in turn is operated by a wheel mounted on the same shaft with it. The wheel is operated by a lever and pinion. This mechanism gives the advantage of a fine-toothed bar for power without the weakness of fine teeth, as both bar and wheel have strong and durable teeth. The jack raises one-fourth inch per stroke of the lever, and yet the pitch of teeth on the bar is one and nine-sixteenths inches and on the wheel one inch.

To adjust the jack for raising the load, turn the small crank in the frame near the lever straight up; for lowering the load, turn this crank straight down.

For shop or wrecking purposes, especially in confined quarters, where a screw jack or a pumping jack could not be well operated, the hydraulic jack is most rapid, powerful and efficient.

There are several designs of hydraulic jacks, each differing from the others in no essential feature; hence it will suffice to illustrate but one or two designs.

The principle upon which the hydraulic jack works is that of a pump. The lowering is done by a movement of the handle reversed, or, as in the case of the jack shown in Fig. 6, by a thumb screw, the location of which is indicated. These jacks can be lowered steadily and to any extent, without the slightest jar, even when loaded to their greatest capacity.

In the jack shown the valves are all on the end of the



FIG. 5.
Joyce Geared Locomotive Jack.

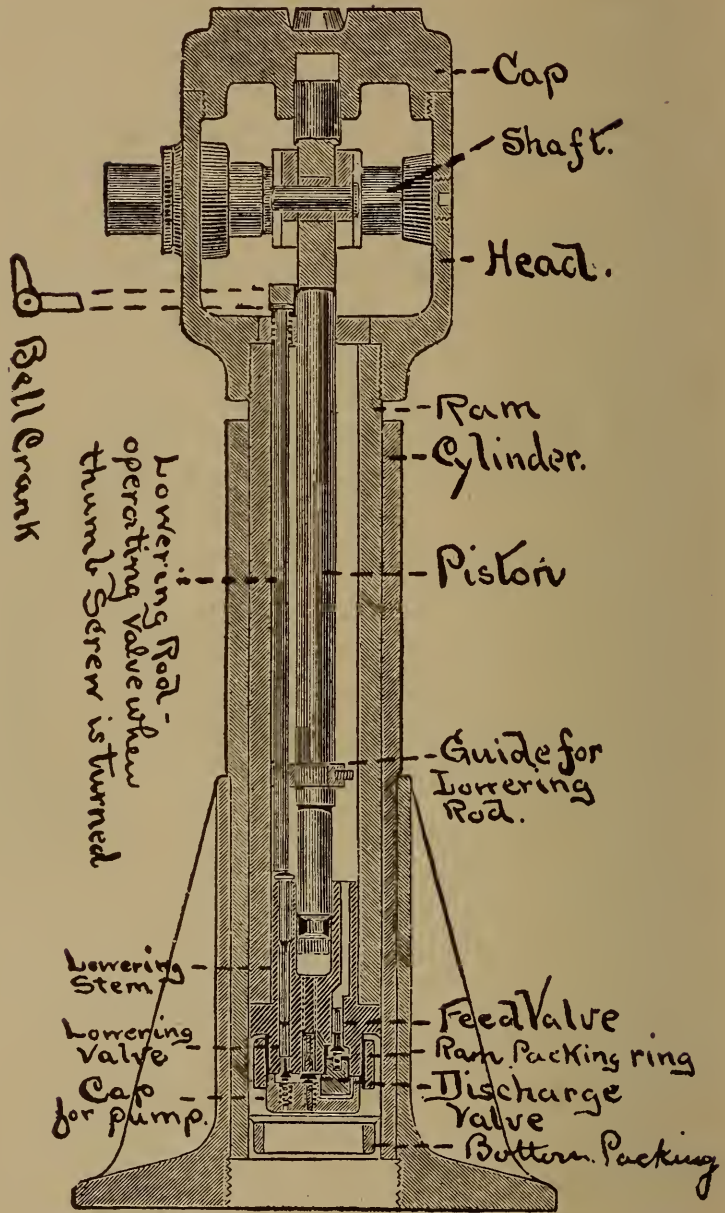

FIG. 6.

Sectional View of Justice Hydraulic Jack.

ram, and are accessible by simply withdrawing the ram from the cylinder, and removing a small cap. This enables a person of ordinary intelligence to examine the valves and remove any obstructions that may interfere with the working of the jack. This is a great advantage, as none of the working parts need be disturbed to examine the valves and repair same when necessary.

These jacks will work horizontally to two-thirds of their run-out limit.

The "rocker shaft" which operates the pump rod passes through a stuffing-box to prevent leakage, and terminates in a square boss.

This permits of the lever being applied in any one of four positions, which is frequently of great advantage when working in cramped quarters, clearing away wrecks, etc.

Directions.--To fill the jack, remove slotted screw in the head.

The best fluid for filling is made one part water, six parts alcohol and one-half part of good oil (sperm preferred), well shaken together before putting in the jack. Never use coal oil, wood alcohol nor water only in filling, as the two former destroy the packing, and the latter may burst the cylinder in freezing weather and rusts the metal.

In using the jack, press the lever with a quick surge, and move the handle upwards suddenly, in order to give the valves a chance to react quickly.

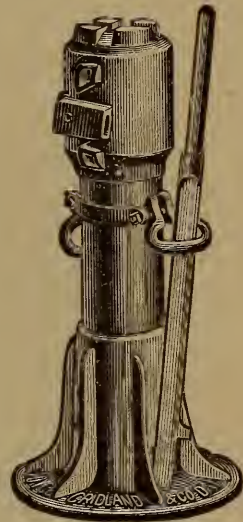

FIG. 7.
Joyce Hydraulic Jack.

The thumbscrew valve should be screwed outwards a few turns when raising a load. In lowering, screw this valve inwards slowly. This valve, being independent of the pumping mechanism, gives absolute control over the speed or distance of the lowering weight, and a half turn of the thumbscrew will stop the load at any point without the slightest jar.

Should the jack refuse to work on account of the valves sticking to their seats or from air entering the pump, by striking the lever a few sharp blows, up and down, the valves will be jarred loose and the air expelled.

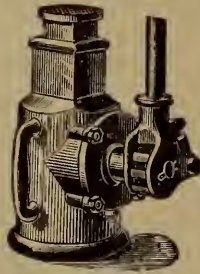

FIG. 8.
Geared Journal Jack.

The levers are all made the proper length for one man (of about one hundred and fifty pounds weight) to lift the full capacity of the jack. In no case must more than one man work the lever, nor must the handle be lengthened, as damage to the jack will be the result.

The jack will work to best advantage if the slotted filling screw in head is slightly loosened when in use; this allows the escape of air in the jack, and prevents the "springy" motion to the lever.

Fig. 8 shows a small-geared jack of fifteen tons capacity, for jacking-up the box of a tender or engine truck.

Compressed air has played so large a part in economical shop practice, and hence it is not surprising

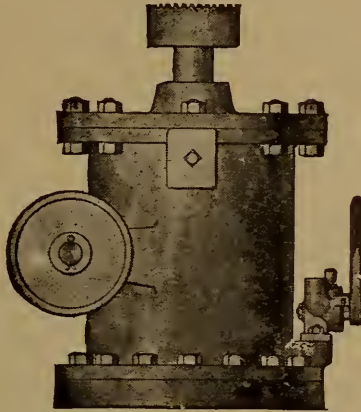

FIG. 9.
Portable Air Jack.



FIG. 10. Air Jack and Carriage.

to see large, portable air jacks, as shown in Figs. 9 and 10, in use for raising locomotives and tenders, where the engine house and shops have compressed air.

Fig. 11 shows a general view of a chain hoist with a pneumatic motor as an actuating medium.

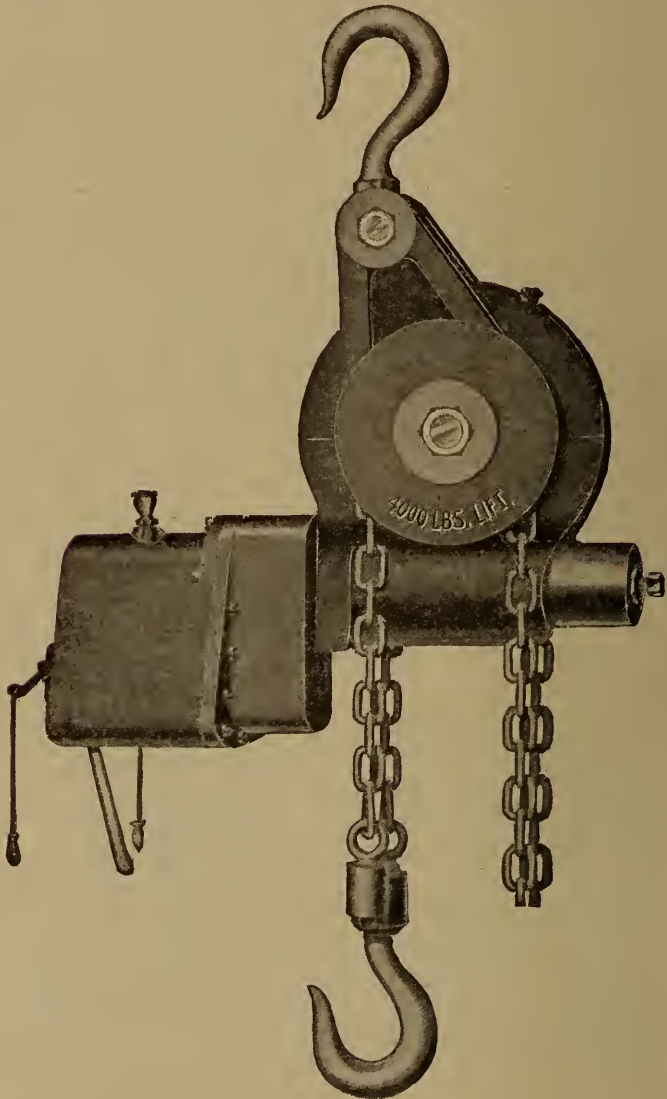

FIG. 11.

"Little Giant" Pneumatic Motor Chain Hoist.

Will replace hand chain tackle at any place without extra fittings and works with low head room. It lifts two tons eight feet per minute. Weight, 80 pounds.

LOCOMOTIVE OR CAR PUSHER.

The pusher shown in Fig. 1 is designed to take the place of the ordinary iron pinch bar, and is much lighter, gives a much more powerful pushing effect, and on account of the steel knife-edge *D* holding to a

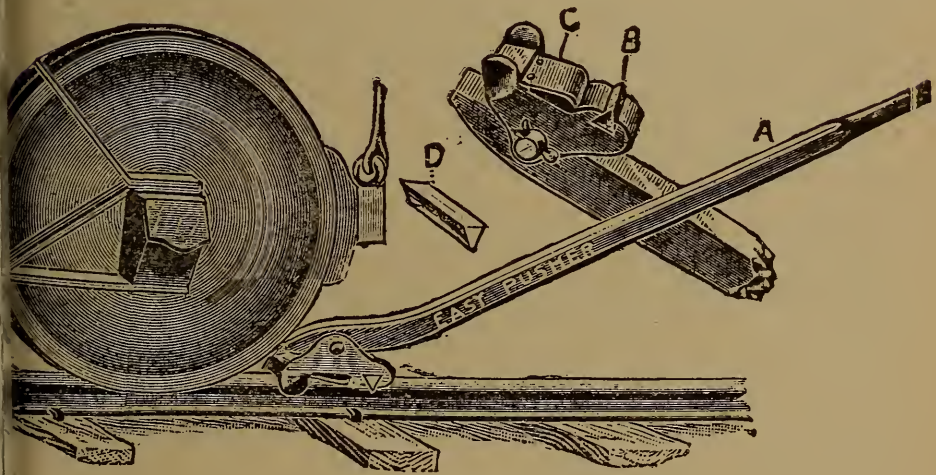

FIG. 1.

slippery rail such a bar is particularly useful about shops and roundhouses, where the rails are usually more or less greasy and slippery.

Many devices of a nature similar to the one here shown are used in pushing cars and locomotives short distances.

LOCOMOTIVE TRACK SANDERS.

Many of the objections that obtained with the hand sanders are overcome with the advent of pneumatic track sanding devices.

There was, perhaps, but one advantage in the old hand sander--that it would deliver more sand in a given time--but this was offset by its many points of disadvantage. Too much sand on the rails makes a train pull hard and, too, most of the sand delivered by gravity at the mouth of the pipe falls or is blown off the rail, and is wasted, and the locomotive, after a very few miles of continuous sanding, is entirely out of sand. To apply the hand sanding device efficiently to both front and rear of driving wheels (as on switching engines) required two sand boxes instead of one, while with many of the pneumatic sanders the single sand box may be used and the sand delivered to any part of the locomotive equally well.

Not a few of the pneumatic track sanders still retain the hand lever and valve as an auxiliary, in case the air pump should fail and there be no compressed air with which to operate the pneumatic device.

Heretofore the matter of sanding has received but scant attention; any gravity system which would deliver sand somewhere on the rail seemed to be equal to all needs.

Gravity sanding devices have no part in to-day's progressive railroading for the following reasons: Such systems are unreliable; they will not deliver

sand promptly and at the point where it will be of the utmost use; they are wasteful of sand, fully fifty per cent. of the sand leaving the rail before the driving wheels reach it, and at times so seriously as to interfere with the working of the present interlocking switch system. The use of more sand than is absolutely necessary tends to excessive tire and rail wear; they are wholly out of the line of progressive railroad improvements.

The gains sought and accomplished by pneumatic sanders are: An economy in the quantity of sand used, amounting to something like a saving of sixty per cent.; the use of just enough sand to bring the best results and no more; the placing of the sand where it is most needed and so that each grain does its share of the work; the instantaneous application of sand when needed; the automatic application of the sand when needed without special effort on the part of the engineer, allowing his attention to other duties when sander is in operation; a great reduction of tire and rail wear and an increased hauling capacity for the locomotive.

In the operation of any locomotive pneumatic sander the air pressure should always be taken from the main reservoir and not from the train line, which might affect the train brakes.

THE LEACH "D" SANDER.

This is one of the most modern and efficient devices used for this purpose. Among the many points of advantage it possesses may be given the following:

It is outside of sand box, accessible at all times for

inspection or when making repairs, and where engineers and shopmen can, at a glance, understand its operation.

The resistance of the column of sand always above the trap, prevents air-pressure from escaping up through the sand box and therefore a high pressure



FIG. 1.

Leach "D" Sander, Showing Adjustable Air Nozzle with Check Valve.

is available through discharge pipes for removing obstructions at their lower ends.

The adjustable air nozzle used with this style device can be so adjusted as to regulate the amount of sand discharged to the rail. This nozzle is fitted with a small check valve, preventing air passages from becoming plugged with sand.

Fig. 1 shows this type of pneumatic sander as applied to a locomotive, the trap located just under the running board being sectioned. It will be noticed that the discharge pipes are bent up fifteen degrees, to prevent sand from jarring out of the traps when the engine is running. A 1-inch plug at *E* is thus located in order to remove small stones, etc., which may get into traps.

To regulate the amount of sand delivered, increase or decrease the distance *A* by loosening jamb nut *C* and moving the adjusting tube *D* in or out. The greater the clearance *A*, the greater the sand delivery.

Care should be taken to have the nozzles on opposite sides of an engine adjusted alike.

Fig. 2 shows the application to a locomotive with six driving wheels, of the double type of this sander. Care should be taken to rigidly clamp the pipes at the bottom, and they should be so bent as to deliver sand direct to the point of contact between the driving wheels and the rail.

Fig. 4 shows the detail parts of the Leach "D" sanders. This type of pneumatic locomotive sander is used more extensively than any other in this country.

The Leach "A" sander, as shown in Fig. 5, was in very extensive use previous to the introduction of the later "D" style. With this type, the blast is used simply for economy in the use of sand and for convenience in operating. The sand traps are attached to the sand box in the most convenient manner, the sand is supplied thereto through independent outlets from the box, and is discharged therefrom into and through the usual hand lever controlled pipes to the

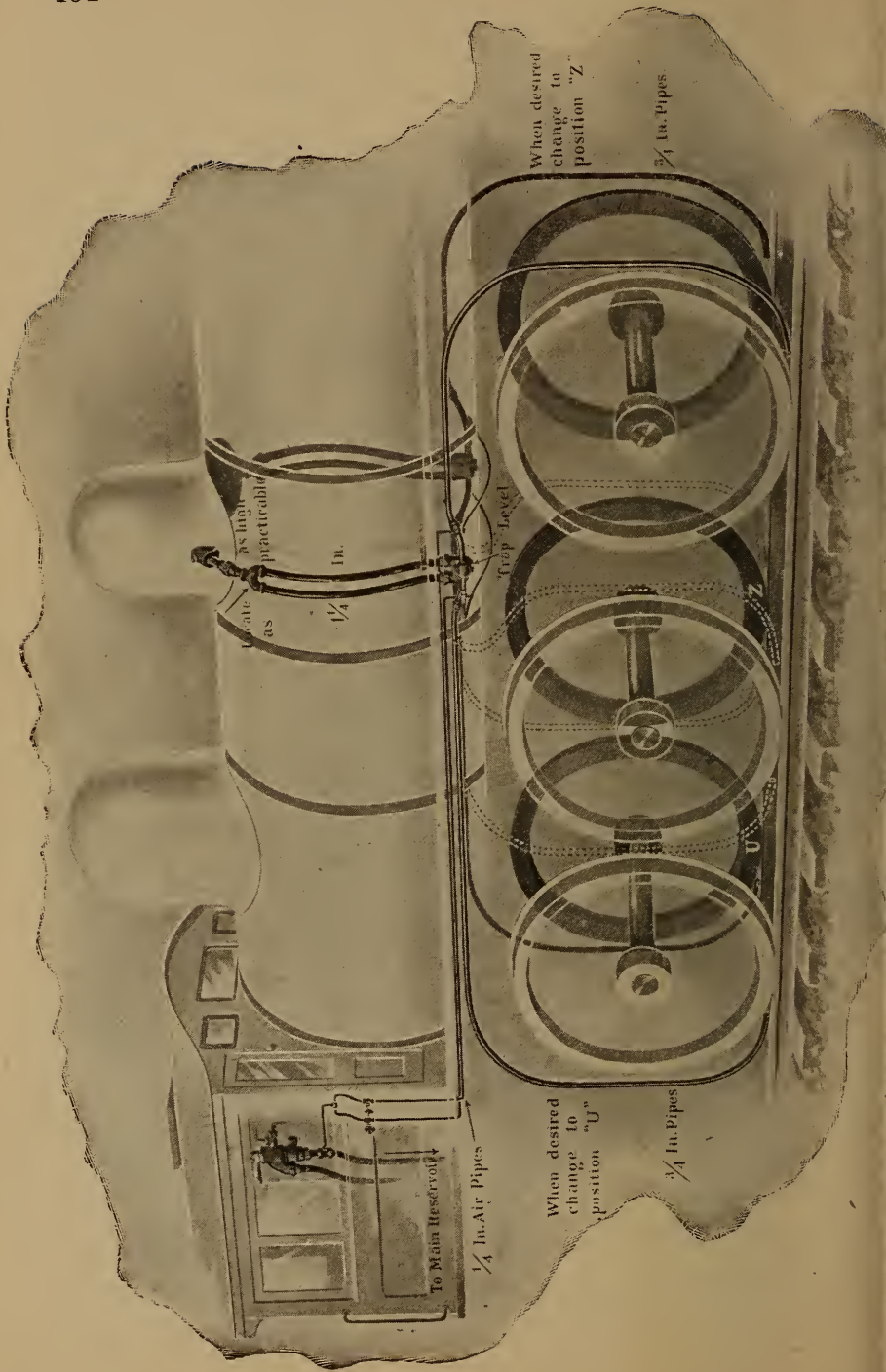

locate as high as practicable as

1/4 in.

Trap Level

When desired change to position "Z"

3/4 in. Pipes

To Main Reservoir ↓

1/4 in. Air Pipes

When desired change to position "U"

3/4 in. Pipes

rail, the lever attachments being available for use as desired.

The discharge pipes, usually one and one-fourth

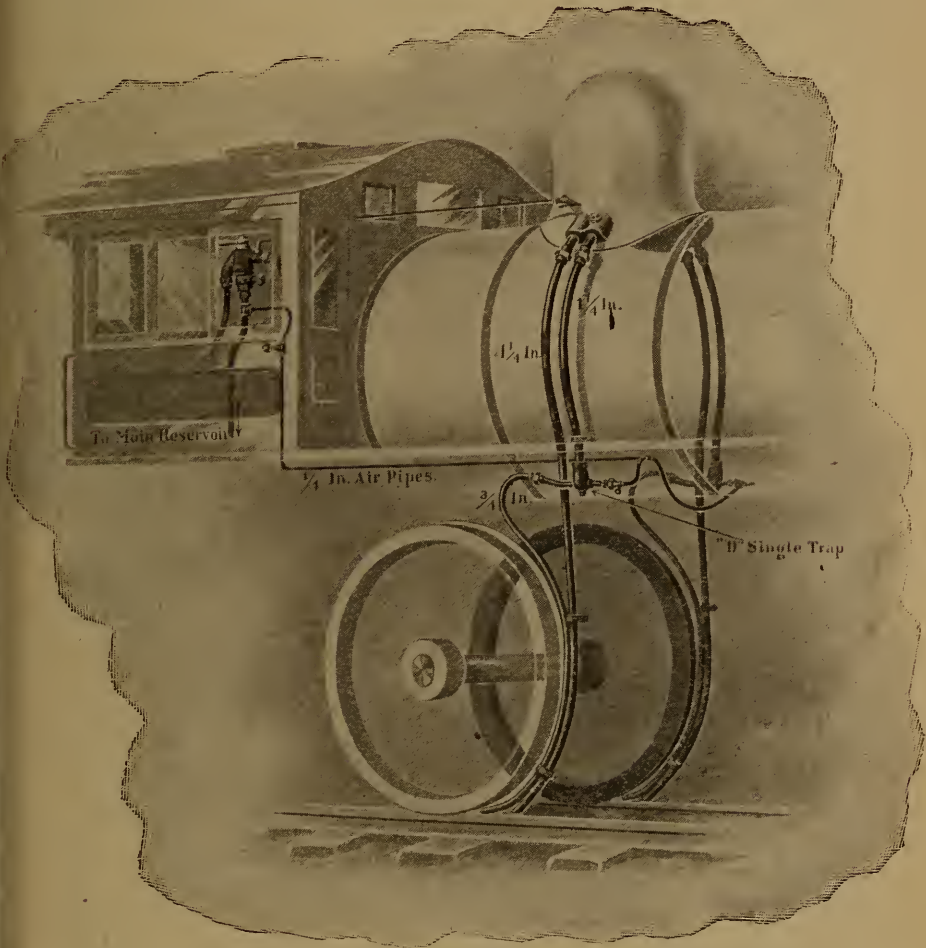

FIG. 3.

Leach "D" Single Sander, Showing Application to an Eight-Wheel Locomotive for Sanding the Rail Going Ahead Only.

inch, must be fitted at such a pitch that sand will flow through them by gravity when the lever is used. The



1/4 In. Triple "Y" Connection.



"D" Triple Trap.



"D" Double Trap.



"D" Single Trap.



1/4 In. Union Tee With Plug.



SPECIAL ATTACHMENT When Required.



1/4 In. A Connection.



3/4 In. Discharge Pipe.

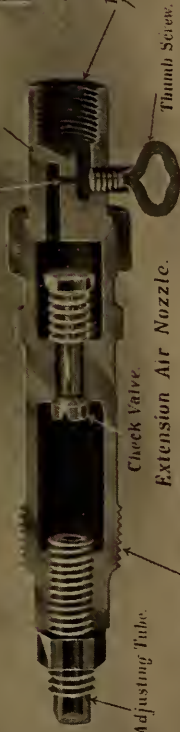

Extension Air Nozzle.

3/4 In. Pipe Thread.



1/4 In. 45° or 55° Elbow.



Warning Port



1/4 In. Cab Valve.

3/4 In. Air Jet Union Tail Piece.

Thumb Screw.

Adjusting Tube.

Check Valve.

amount of sand discharged is controlled by the adjustment of cab valve. Hardened caps receive the wear of the sand blast.

Being easily applied and maintained, conveniently



FIG. 5.
Leach "A" Sander.

located for cleaning and very economical in the use of air, they are deservedly popular on many roads where the service conditions do not require the special features peculiar to the "D" type.

THE "SHE" SANDER.

This device is an improvement on the Houston sander (not here shown), and will interchange with the Houston device in every particular.

The action of the "She" sander, as shown in Fig. 6, is that of a syphon and ejector. The syphon used in connection with this device is especially designed to

carry the sand through the pipes to the rail with great velocity, and uses only a small amount of air to accomplish this result.

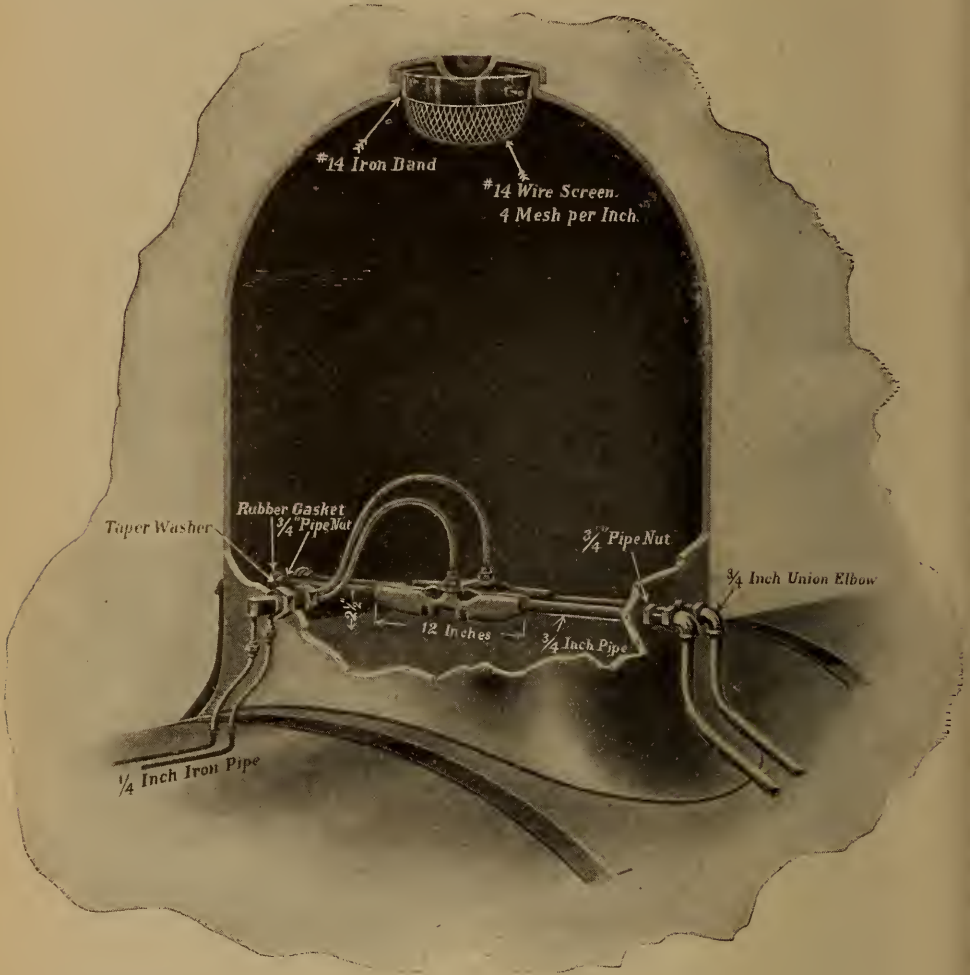

FIG. 6.

The "She" Sander, Showing Application to Sand Box.

It is simple in construction, being so arranged that the air nozzles are always out of the sand, and therefore they cannot become clogged when not in use.

The siphon being in the center of the sand box, where the sand is always the driest, it can be recommended for service where sand is apt to become damp and bake in the box.

The sand-pipes can be run around the brake heads, or inside of the engine frames, getting close contact to the drivers.

Fig. 7 shows the detail parts of the "She" locomotive sander.

While it is only when the rail conditions are bad that the use of sand may be desired in making service stops, its use in emergency stops is very important as an additional means of securing a shorter stop.

Under emergency conditions it is especially important that every part of the brake or stopping equipment be applied at once and by one movement of the controlling brake mechanism.

SHERBURNE'S ARRANGEMENT FOR AUTOMATIC SANDING.

The simultaneous application of brakes and sand is best accomplished by use of the Sherburne automatic port placed in the Westinghouse engineer's valve and arranged as shown in Fig. 8.

This positively insures the application of sand during every emergency stop and without additional thought or action on the part of the engineer.

This automatic port can be used in connection with any pneumatic sanding device and can be applied at a small cost.

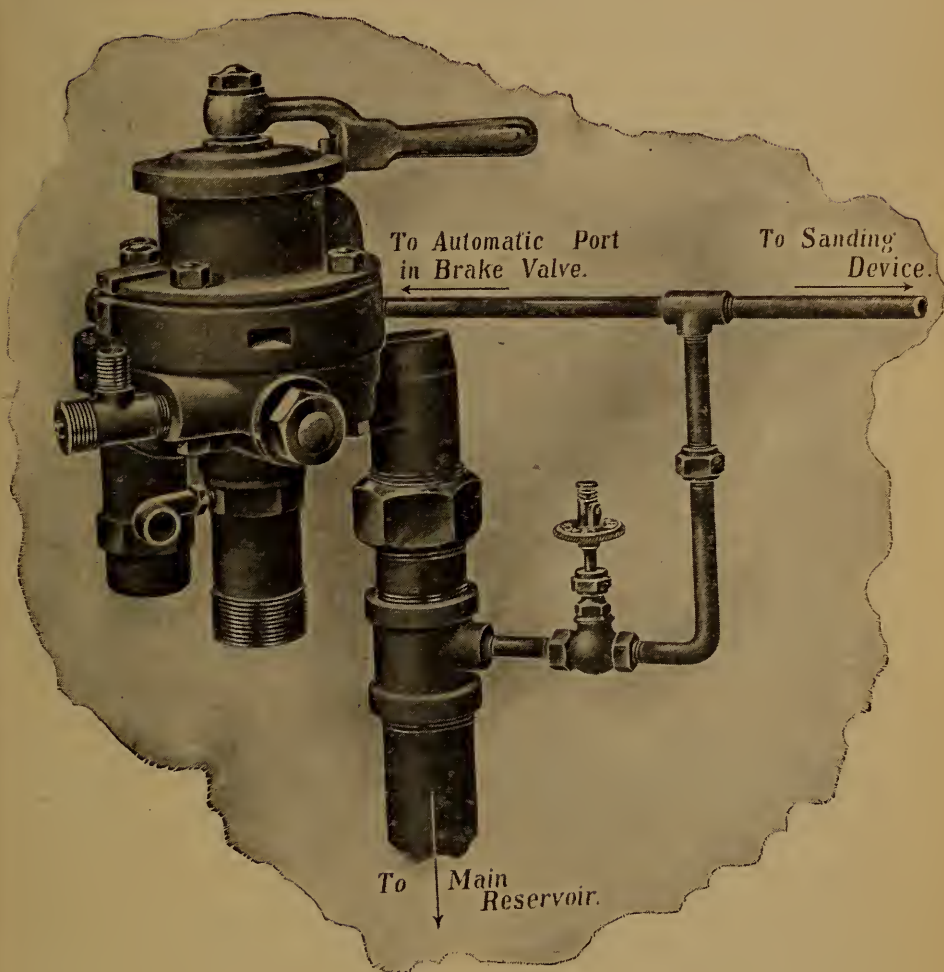

FIG. 8.

Sherburne's Arrangement for Automatic Sanding.

THE HUFF PNEUMATIC TRACK SANDER.

The Huff track sander is the invention of a locomotive engineer of long experience, and embodies new features suggested to him by his personal knowledge of many track sanders which have preceded this one.

The construction and operation of this sander are illustrated by Figs. 1, 2, 3 and 4, in which Fig. 1 shows the device as a whole; Fig. 2 each part separate of which it is composed; Fig. 3 its application to a locomotive and pipe connections thereto; and Fig. 4

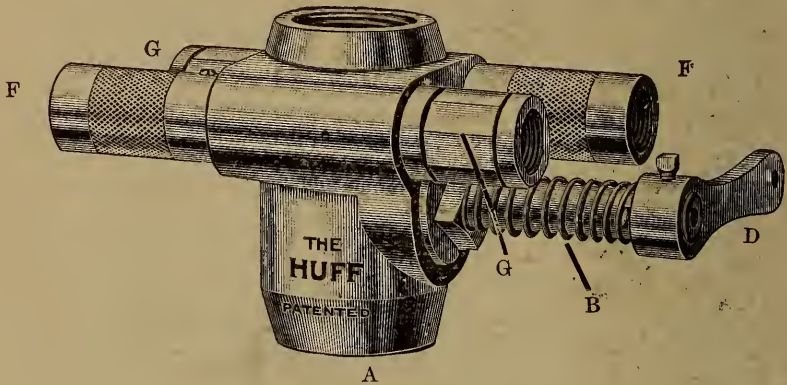

FIG. 1.

Huff Pneumatic Track Sander.

the engineer's valve in the cab, by which the mechanism is operated.

The body *A* is inserted into the old gravity sand pipe (which is otherwise undisturbed) at any convenient point, either above or below the running board. The compressed air supply pipes are connected at *F F*, and the sand delivery pipes are led off at *G G*. The lever *D*, operating the foot valve *B*, should be connected, by suitable means, to the cab, so that it may be under control of the engineer. A thin

sheet steel partition is inserted into the old sand pipes, extending from the dome down to the Huff device, forming a junction with a bridge in the device; this is to facilitate blowing out possible obstructions in the sand delivery pipes, as will be referred to later. Each of the two feed tubes *F* contains an air adjusting tube *H*, which, in turn, contains in one end the bridge

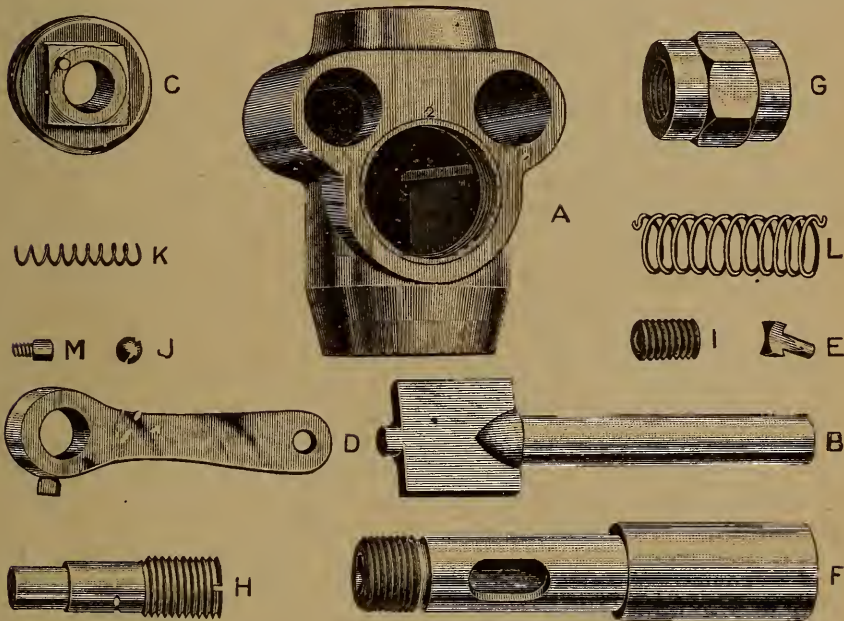

FIG. 2.

Detail Parts, Huff Pneumatic Track Sander.

E, in the opposite end the adjusting screw *I*, and between them the ball valve *J* and the spring *K*. This tube *H* is kept from turning in the feed tube *F* by the set screw *M*. The body *A* is fitted with a foot valve *B*, forming its floor, and so connected, as has already been said, that it can be worked from the cab. The stem of this foot valve *B* passes out through the nut *C*, and is encircled by the spring *L*, which tends to

keep the foot valve normally closed. When the device is being used as a double sander the slots in the feed tubes *F* should face each other. When in use as a single sander one tube may be revolved until its slot is blanked against the wall of body *A*; the tubes *F* may be firmly held in any position by the hexagon nut *G*.

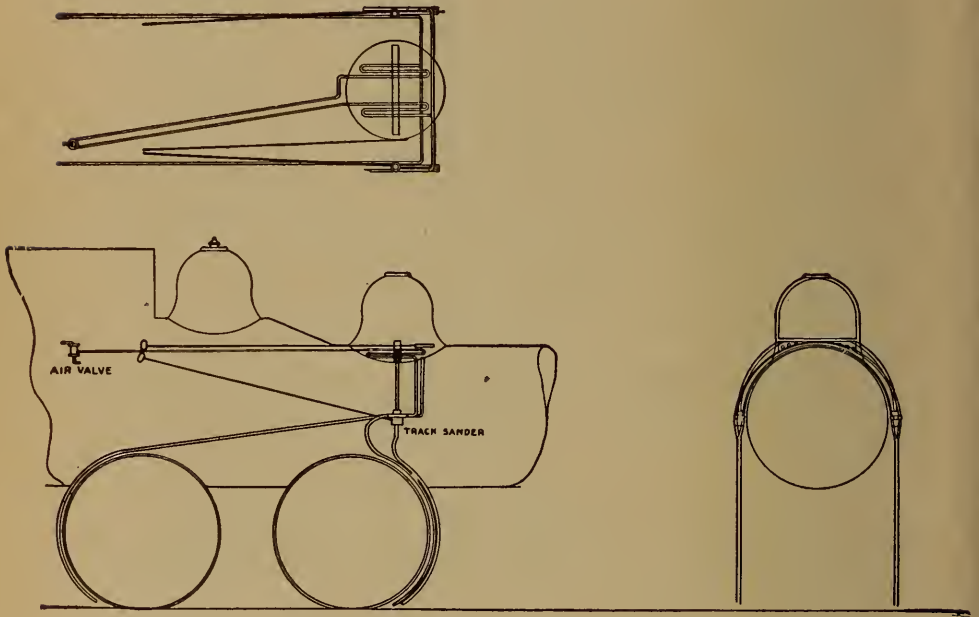

FIG. 3.
Huff Pneumatic Track Sander.
(Showing Application and Pipe Connections.)

The method of connecting the compressed air supply pipes from the engineer's sanding valve (see Fig. 4) to the feed tubes *F F* in body *A* is ordinarily the same as in other pneumatic track sanders; but, if it is desired to employ heated compressed air (which would be a great advantage in cold countries), the air pipes may be led to coils located over the boiler, under

the sand box (as shown by Fig. 3), and thence to the feed tubes *F F* of the body *A*.

The ordinary current use of the Huff track sander does not call for any further explanation, but it is desirable to refer to some of the methods of working in the emergency of one or another of the sand pipes becoming inoperative on account of obstructions. In that event the engineer may, while the engine is still running, close the main valve in the sand box, and open the foot valve, thus discharging the contents of body *A*, including any small obstructions which may have collected there; then by closing the foot valve and working the engineer's sand air-valve (in the cab) he may thoroughly blow out all the sand delivery pipes. In the case of an exceptionally obstinate obstruction in one of the pipes, which could not be dislodged by this treatment when the engine was running, it would still be possible, when the engine had stopped, to follow another course, by plugging the mouths of the free pipes, and concentrating the full force of the air pressure on the obstruction in the remaining pipe.

Summarizing, it is claimed that this track sander embodies in its construction and operation the following advantages:

1. Minimum cost of application, and exemption from necessity of making any changes in the sand box itself or in the old hand-sanding apparatus under the sand box.

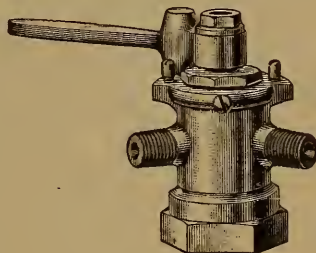

FIG. 4.
Engineer's Valve—Huff Pneumatic Track Sander.

2. Feed adjustments so arranged as to secure both a minimum and a regular delivery of sand at the rail.

3. The foot valve feature results in a slight inward suction of external air through its joints, when air is applied (as such application creates a slight vacuum in body *A*); this tends to keep the sand loose in the body *A*, and to reduce the danger of clogging.

4. The reasonable probability of being able to blow out any ordinary obstruction while the engine is running; the possibility of being able to blow out and thoroughly dry all pipes after an engine comes in from off the road, and to insure everything being in working order for the next trip; the feature of being able to use heated compressed air in cold countries, or elsewhere, when desired.

5. In case of failure of the air supply, the foot valve may be fastened open, and the old hand sander used.

THE A-B-C TRACK SANDER.

A sander composed of but few parts is shown in Fig. 1. *A* is the connection to the sand box. *C* is the air connection leading from a small operating valve in the cab. *B* is the ordinary delivery pipe leading to the rail, and *D* is a loose tube at the opening of delivery pipe *B*.

Directions for Applying.--Cut the sand pipe just above the running board, or where sanders can be gotten at conveniently.

To Clean Out.--Remove plug in the top and pull out the loose tube *D*. Should air fail while on the

road, remove the loose tubes *D* and leave them out, using the ordinary hand sand lever.

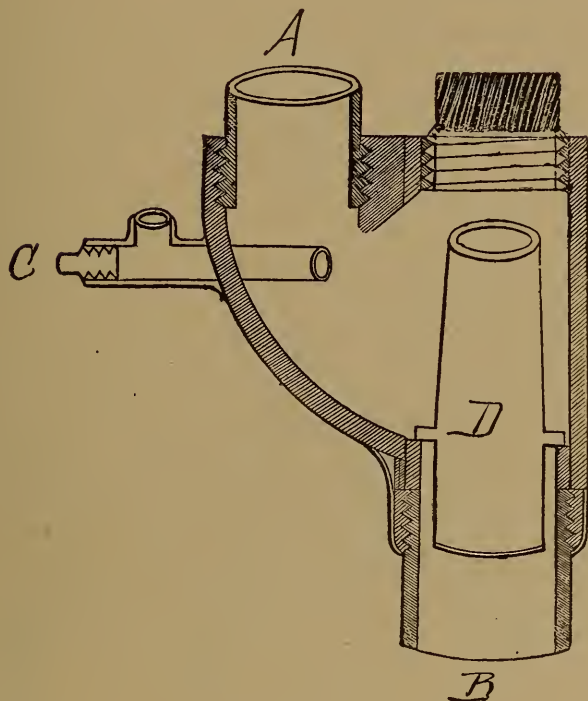

FIG. 1.
A-B-C Track Sander.

THE "MUDD" AIR SANDER.

This device is shown in detail by Figs. 1, 2 and 3, and is seen to be operated in conjunction with the original slide valve sand-lever device. One-inch standard pipe should be used for the forward delivery pipes, and one-half inch standard for the back-up.

For the forward motion, drill a one-half inch pipe tap hole through the base of the sand-box into the sand cavity to which the original pipes are attached,

the hole to be drilled between the original slide valve and the outer casing. This hole should be tapped out with one-half inch pipe tap, and one of the short

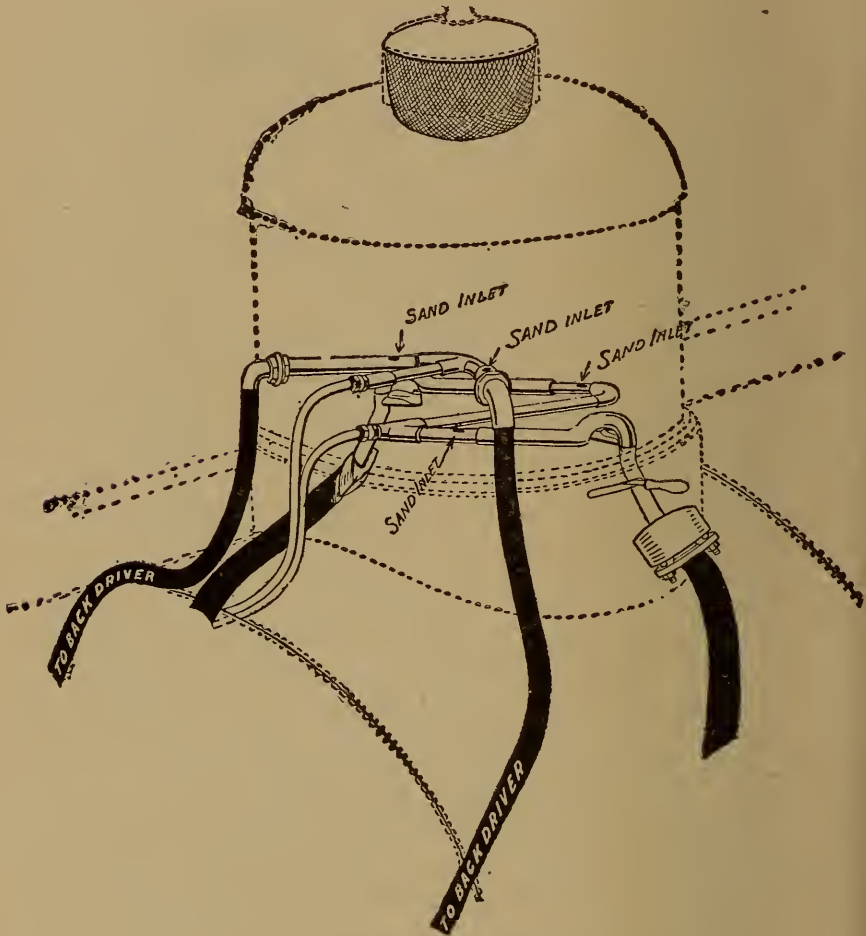

FIG. 1.
The Mudd Track Sander.

nipples screwed in. Then drill a hole in the casing directly back of the center of the sand box, and as near the bottom as possible, through which place the air-pipe connection. The pipe that runs from the

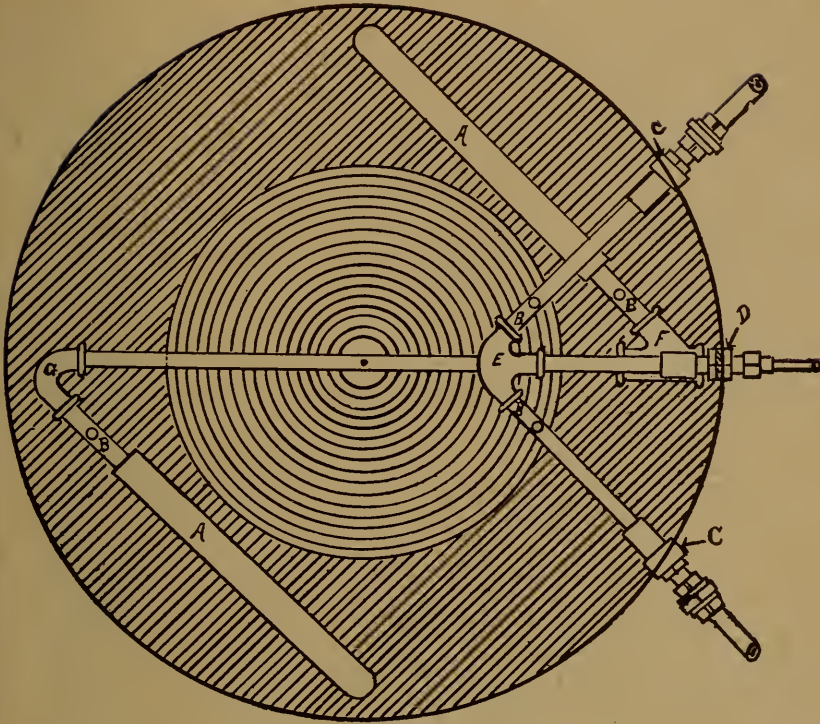

FIG. 2.
The Mudd Track Sander.
(Plan View.)

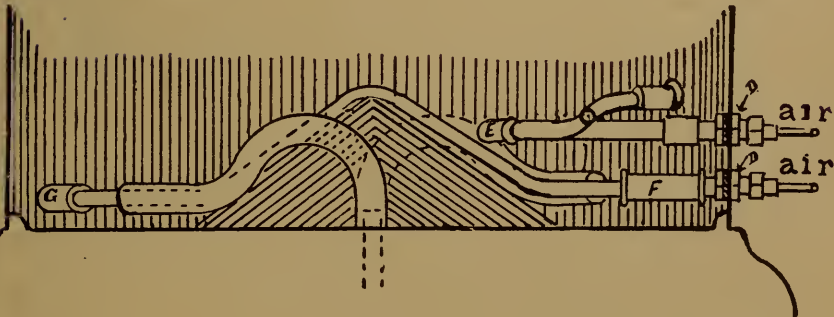

FIG. 3
The Mudd Track Sander.
(Side View.)

engineer's valves should be one-quarter inch copper pipe, and placed under the jacket.

There should be placed in the top of the sand box, as shown in Fig. 1, a one-quarter inch mesh netting to insure screened sand at all times.

The back-up sander should be placed directly over the forward delivery apparatus, and as near the bottom of the box as it is possible to get it.

The air pressure should be taken from the reservoir pipe attached to the engineer's valve.

PNEUMATIC TOOLS AND THEIR USE FOR LOCOMOTIVE WORK.

There is undoubtedly a dividing line between tools and appliances used on a locomotive and those used in *building* and *repairing* locomotives, yet it cannot fail to interest practical railroad men if this volume conveys some idea of the various uses of pneumatic tools,

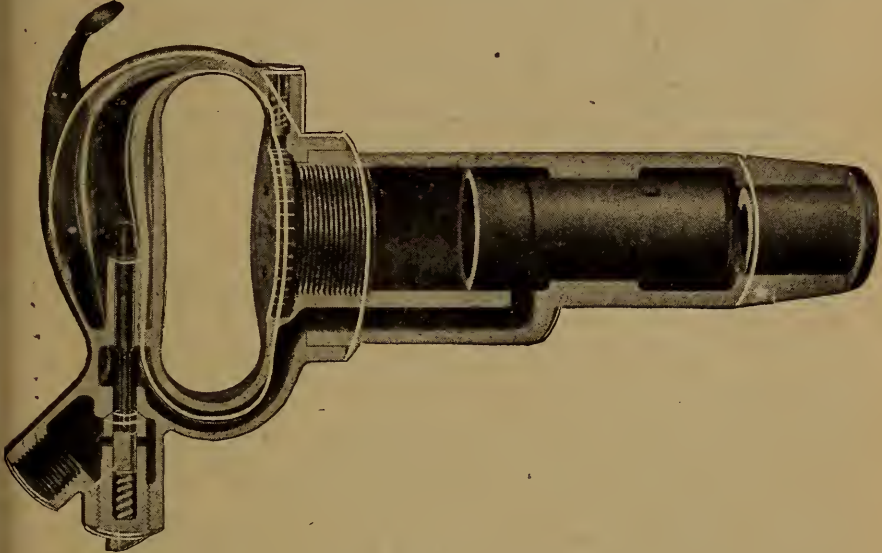

FIG. 1.

Pneumatic Hammer, Strikes 5,000 to 7,000 Blows Per Minute.
(Weight, Various Sizes, 5 to 9 Pounds.)

used in almost every railroad shop and roundhouse in the United States to-day.

The engravings herein will tell the story of usefulness and expediency of the various pneumatic tools shown more explicitly than any lengthy description thereof. †



FIG. 2.
Pneumatic Hammer Chipping Steel Casting.



FIG. 3.
Pneumatic Hammer Beading Flues—Will Bead 150 Locomotive Flues in One Hour.



FIG. 4.

Flue Expander Pusher—This attachment, which can be applied to any class of roller expander, forces the pin inwards by air pressure, only requiring one man to handle it when used with a pneumatic drill. It expands every flue with the same force and avoids all distortion of the flue sheet.

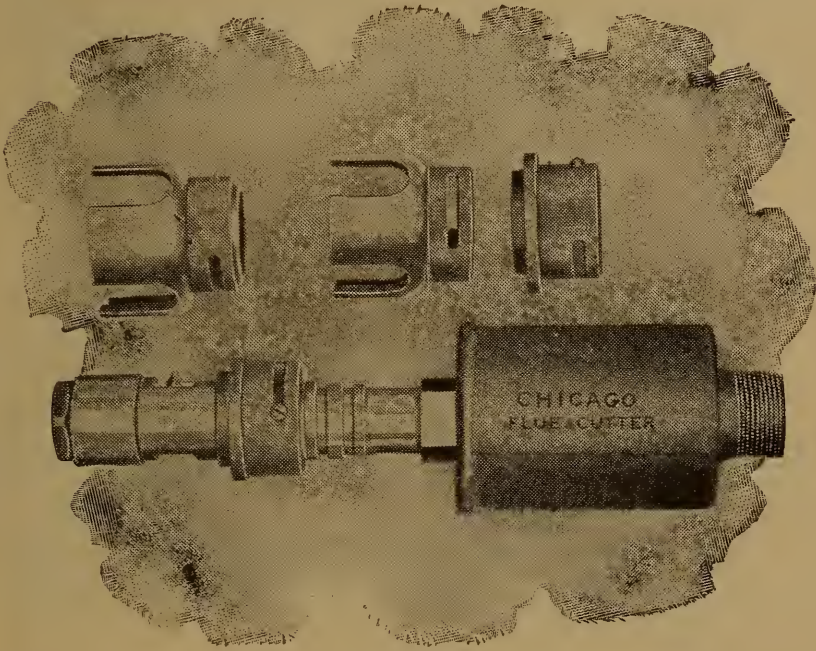

FIG. 5.

Chicago Pneumatic Flue Cutter—Each machine is adapted to three different sizes of flues and will cut flues both inside and outside of sheet.

Pneumatic Hammer Boring and Saw Hammer
 Patent of the U.S.A. and Foreign
 J. H. B. & Co. Ltd. London, E.C. 4, England

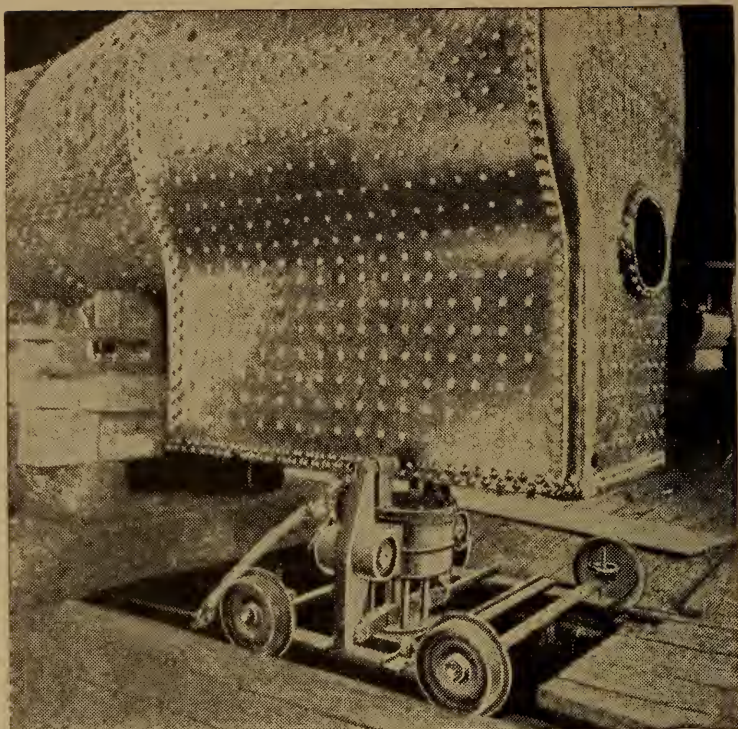

FIG. 6. Chicago Pneumatic Mud Ring Riveter Mounted on Truck.

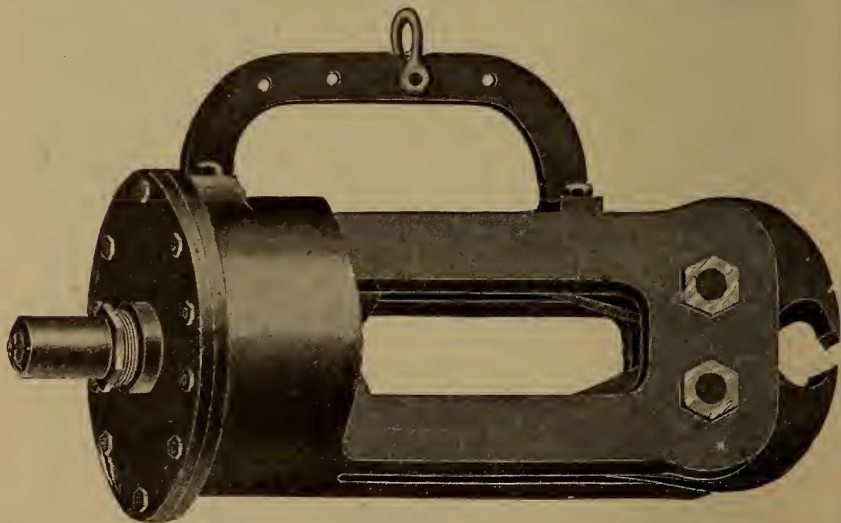

FIG. 7.

"Little Giant" Stay Bolt Nipper—The stay bolt may be cut off at any length desired, as the bolt passes through the cylinder. Will cut stay bolts up to $1\frac{1}{4}$ inches in diameter.



FIG. 8.

Pneumatic Drill.

(Weight, Various Sizes, from 13 to 40 Pounds.)

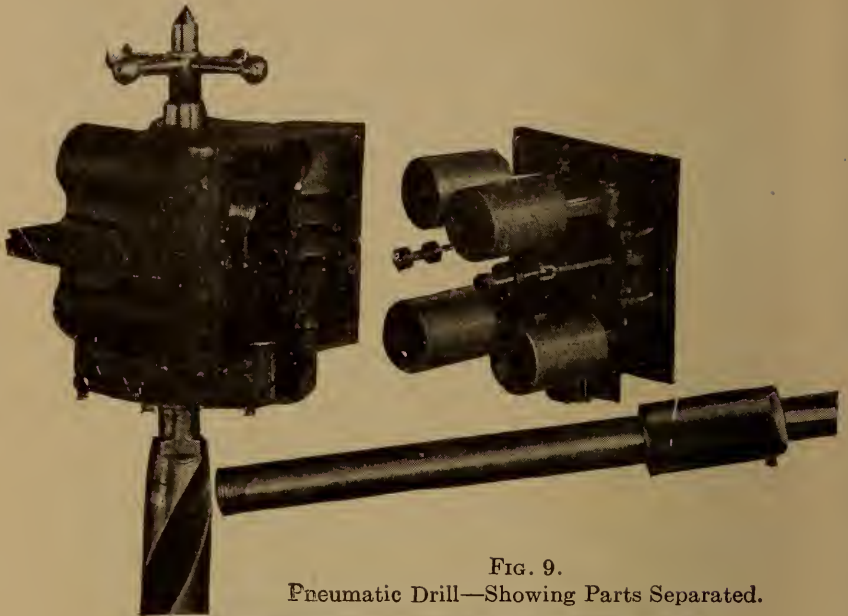

FIG. 9.
Pneumatic Drill—Showing Parts Separated.

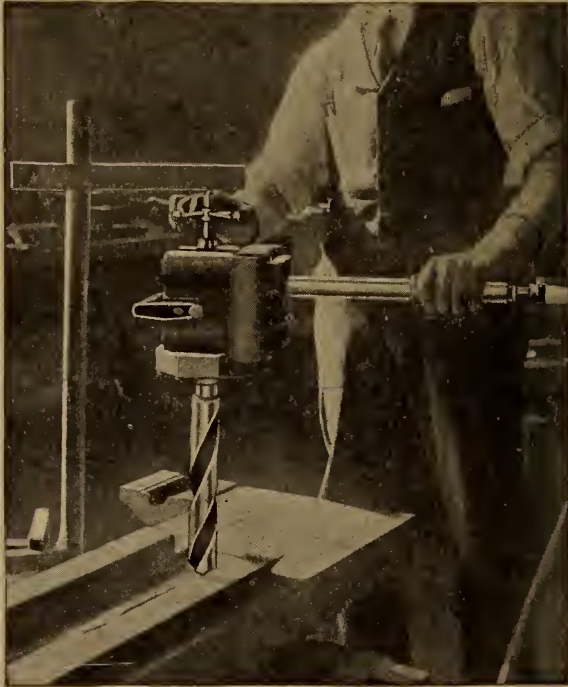

FIG. 10.
Pneumatic Drill at Work in the Machine Shop.

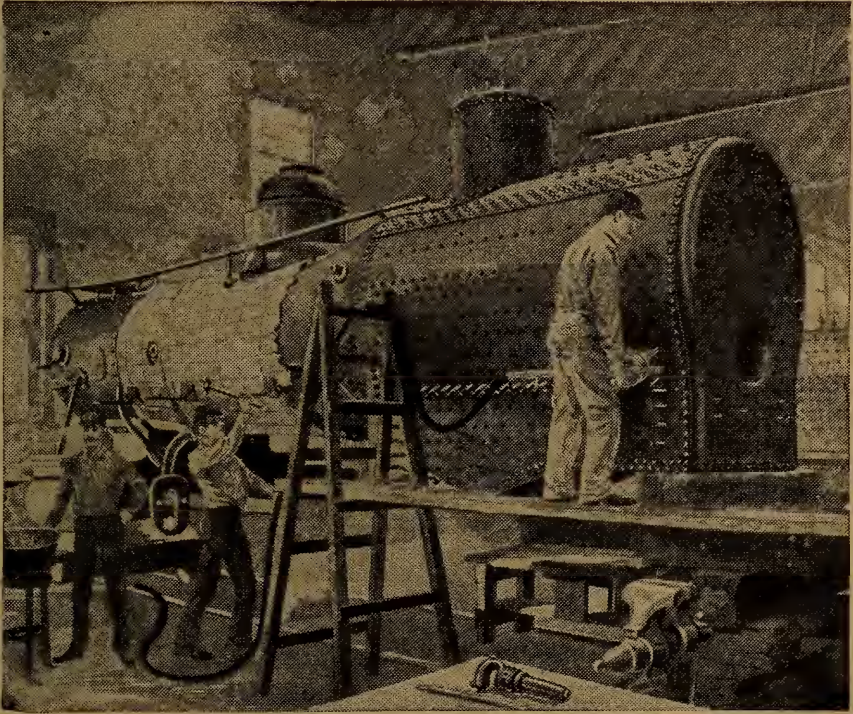
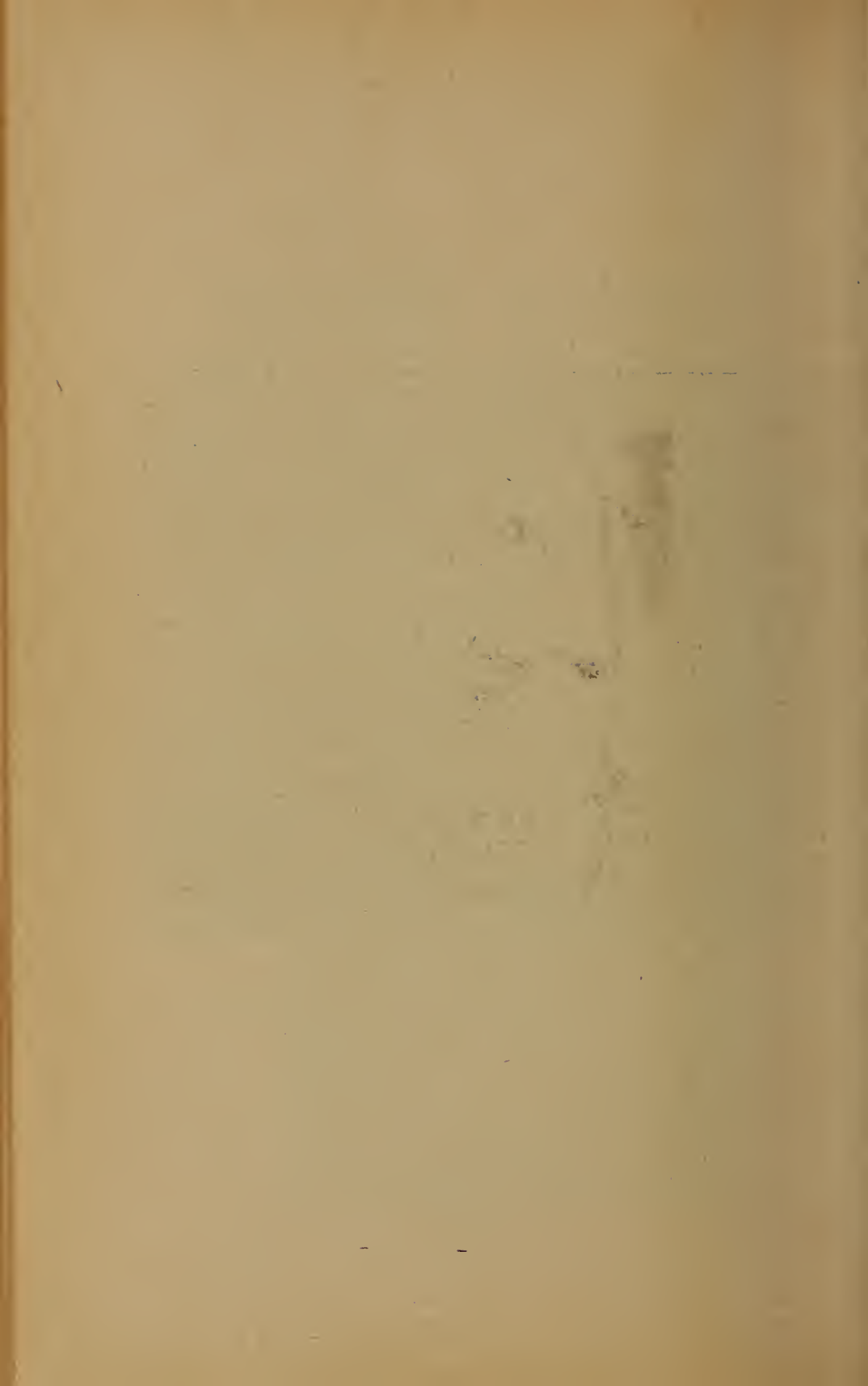

FIG. 11.

Piston air drill for drilling, reaming and tapping on locomotive work—It is operated with one-third the amount of air used by a rotary motor and develops 50 per cent. more power.



ILLUSTRATIONS.

	PAGE.
The American Steam Locomotive, Plate I—opposite.....	8
Location of Pyle national electric headlight on locomotive	10
Electric headlight engine	12
Electric headlight—Lamp B	16
Electric headlight—Lamp C	18
Illustrations of electrical measurements	24
Mason locomotive pressure reducing valve	33
Gold pressure regulator	37
Climax steam pressure regulating valve	38
Eclipse reducing valve	40
Taafel pressure regulator	41
Ross Steam pressure reducing valve	44
Special automatic relief valve	46
Location of steam heating cab attachments	47
New York Air Brake Co.'s duplex air pump	50
Plain New York triple valve	54
New York quick action triple valve	56
Illustrative model of New York quick action triple valve (all valves in normal positions)	57
Illustration of New York quick action triple valve (position of valves in service application)	58
Illustrative model of New York quick action valve (valves in emergency position)	59
Westinghouse "1900" feed valve or train line governor—slide valve pattern	63
High pressure controlling apparatus	66
Brake shoe and its application to the driver	69
Skeleton steel brake shoe	71
Skeleton steel insert shoe	71
Improved combination driving brake shoe	72
Skeleton diamond "S" brake shoe	73
Unflanged diamond "S" brake shoe	73
The "U" shoe	74
Lappin driver brake shoe, with malleable back and lugs	75
Lappin car or tender brake shoe	76
Lappin brake shoe	76
Interlocking brake shoe	77
Interlocking, divided, brake shoe	78
Corning soft gray iron insert	79
Corning driver brake shoe	79
Corning plain brake shoe	79
Moran flexible joint	82
Sectional view, Moran flexible joint	83
Metallic coupling for steam piping	84

	PAGE.
Section of swivel joint.....	84
Plan and elevation of steam heat conduit, as applied between locomotive and tender.....	85
Climax flexible metallic joint.....	86
Climax flexible metallic joint—double joint.....	87
Mercury column and gauge.....	88
Electro-mercurial gauge tester.....	89
Single Bourdon spring gauge.....	90
Double Bourdon spring gauge.....	91
Early form of diaphragm gauge.....	92
Early form of diaphragm gauge.....	92
Bulb siphons or traps.....	93
Coil pipe siphon.....	94
Crosby locomotive pressure gauge.....	95
Crosby single tube gauge.....	96
Crosby thermostatic water-back gauges.....	97
Lane pressure gauge.....	99
Star corrugated spring.....	100
Star double-spring gauge—Bourdon style.....	100
Star double-spring gauge—Lane style.....	101
Ashcroft single Bourdon spring steam gauge.....	101
Ashcroft double Bourdon spring steam gauge, with Lane's improvement.....	101
Ashcroft auxiliary spring locomotive steam gauge.....	102
Ashcroft double spring standard locomotive gauge.....	102
Utica capsular spring.....	103
Utica capsular spring.....	103
Utica locomotive steam gauge.....	103
Westinghouse duplex air gauge.....	105
Westinghouse duplex air gauge (sectional view).....	105
Semaphore duplex air gauge.....	105
Semaphore duplex air gauge (sectional view).....	105
Crosby duplex air gauge.....	106
Crosby duplex air gauge.....	106
Star air brake inspector's gauge.....	107
Utica duplex air gauge.....	108
Utica duplex air gauge.....	109
Pressure recording gauge.....	110
Star pressure recording gauge.....	110
Gauge hand or "pointer" pullers.....	112
Crosby test gauge.....	113
Ashcroft test gauge.....	114
Star test gauge.....	115
Utica gauge tester.....	117
Utica gauge tester.....	118
Coale pop safety valve and muffler.....	121
Star improved open or plain pop safety valve—exterior view... ..	123
Star improved open or plain pop safety valve—sectional view.. ..	123
Star improved locomotive muffled pop safety valve—exterior view.....	124

	PAGE.
Star improved locomotive muffled pop safety valve—sectional view	124
Meady muffled locomotive pop safety valve	125
Crosby locomotive pop safety valve—sectional view	126
Crosby plain locomotive pop safety valves	129
Crosby muffled locomotive pop safety valves	129
Flat top muffler valve, with lever	130
Round top muffler valve, without lever	130
Consolidated plain locomotive pop safety valve, fitted with Richardson's adjustable screw ring	131
Ashton open pop safety valve	133
Ashton muffler	133
Sellers' class N improved self-acting injector	139
Sellers' class N improved self-acting injector (sectional view)	140
Sellers' class M improved self-acting injector	147
Sellers' class M improved self-acting injector (sectional view)	148
Nathan "simplex" injector (sectional view)	150
Nathan "monitor" injector (sectional view)	151
Metropolitan "1898" locomotive injector	153
Hancock locomotive inspirator	157
Hancock locomotive inspirator	158
Hancock "composite" locomotive inspirator	161
Lunkenheimer "'99" model injector	164
Ohio locomotive injector (sectional view)	167
Niagara locomotive injector (sectional view)	168
Little Giant locomotive injector (sectional view)	169
Little Giant locomotive injector	170
Boiler washing and testing apparatus	172
"Swing" intermediate or line check valve	173
Oil cup for injectors and inspirators	173
Penberthy ejector	174
Ejector, showing connections for elevating	175
Hancock ejector or jet pump	176
Boiler check valve, with cast-iron casing	178
Sellers' combined boiler check and stop valve	178
Combined check and stop valve	179
Müller turbine boiler check valve	180
Graphic definitions of valve dimensions—plain slide valve	181
Richardson balanced slide valve (longitudinal section)	183
Richardson balanced slide valve (transverse section)	183
Richardson balanced slide valve (plan)	183
Richardson balanced slide valve (elevation of end packing, strips and springs)	183
Allen-Richardson balanced slide valve (longitudinal section)	185
Allen-Richardson balanced slide valve (transverse section)	185
American balance valve (single disc, longitudinal section)	187
Single disc, American balance valve	190
Double cone American balance valve	192
Piston valve for Baldwin four-cylinder compound locomotive	197
Locomotive piston valve	198

	PAGE.
Pemberthy automatic water gauge.....	199
Star self-closing water gauge.....	200
Crosby safe water gauge.....	201
Regrinding locomotive gauge cock.....	202
Mason air brake pump regulator.....	203
Bell whistle.....	208
Chime whistle "locomotive style".....	208
Crosby chime whistle—slide valve type.....	209
Crosby single bell chime whistle.....	210
Ashcroft four-tone chime whistle.....	210
Johnstone flexible stay-bolt.....	215
An improved locomotive eccentric.....	220
Rubber wound cloth packing.....	221
United States piston rod packing.....	223
United States piston rod packing for pistons with enlarged ends.....	224
Gibbs' vibrating cup for pistons with enlarged ends.....	225
United States valve stem packing.....	226
Jerome piston rod packing.....	227
Jerome piston rod packing for pistons with enlarged ends.....	228
Packing rings for Jerome piston rod packing.....	229
Jerome valve stem packing.....	230
Jerome valve stem packing rings.....	230
United States air pump packing.....	232
Jerome air pump packing.....	233
Swab holder and swab for lubricating valve stems and piston rods.....	234
Detroit triple feed locomotive lubricator (front view).....	252
Detroit triple feed locomotive lubricator (side view).....	252
Detroit triple feed locomotive lubricator (front elevation).....	254
Detroit triple feed locomotive lubricator (side elevation).....	255
Detroit triple feed locomotive lubricator (plan view).....	255
Detroit triple feed locomotive lubricator (sectional view of feed showing automatic safety valves above the glasses).....	257
Detroit triple feed locomotive lubricator (showing manner of inserting and removing sight-feed glass).....	258
Detroit triple feed locomotive lubricator, with tippett attachment (front view).....	259
Detroit triple feed locomotive lubricator, with tippett attachment (side view).....	259
Detroit triple feed locomotive lubricator, with tippett attachment (front elevation).....	260
Detroit triple feed locomotive lubricator, with tippett attachment (side elevation).....	261
Detroit triple feed locomotive lubricator, with tippett attachment (plan view).....	262
Detroit triple feed locomotive lubricator, with tippett attachment showing method of connecting tippett attachment to locomotive.....	264
Steam chest oil pipe plug.....	264
Michigan sight feed lubricator.....	265
Vertical longitudinal section Michigan automatic steam chest plug.....	266

	PAGE.
Michigan sight-feed lubricator, side elevation.....	268
Michigan sight-feed lubricator, front elevation.....	269
Seibert triple sight-feed lubricator.....	272
Cory's force-feed lubricator for oiling all journals, eccentrics and links while engine is running full speed.....	274
Cory's force-feed lubricator.....	275
McCanna locomotive force-feed cylinder lubricator.....	279
Acme engine truck cellar and oil cup.....	280
Acme automatic engine truck cellar, with acme sight-feed cup..	281
Acme oil cup.....	282
Acme oil cup (sectional view).....	282
Guide cup.....	284
Guide cup.....	284
Spindle feed rod cup.....	285
Locomotive bearing cup for connecting rods.....	285
Oil cup for front end main rod on cross-head.....	286
Valve stem oil cup.....	287
Main rod, front end, oil cup.....	287
Oil cup for rocker box on cross-head.....	287
Oil cup for link hanger.....	287
Grease cup for rods.....	288
Glass grease cup for rods.....	288
Crosby hand oiler.....	290
McVicar hand oiler.....	290
Galvanized iron box for demonstrating effect of various methods of loosening up packing.....	293
Showing proper height of packing.....	295
Showing bad conditions of packing at back end.....	295
Showing excessive quantity of packing.....	298
Tool for loosening up packing in journal boxes.....	300
Tool for packing journal boxes in shops and shop yards.....	300
Showing position of packing tool when used to loosen up pack- ing in each side of journal.....	301
Showing position of packing tool when used to remove surplus packing.....	301
Harrison dust guard.....	305
Whistle connection and application of Gollmar bell ringer.....	308
Gollmar bell ringer.....	309
Gollmar bell ringer (sectional view).....	310
Sansom bell ringer.....	311
Sansom bell ringer (showing internal mechanism).....	312
Chicago locomotive bell ringer.....	313
Huff automatic steam blower.....	314
Huff automatic steam blower (sectional view).....	315
Huff automatic steam blower (external view).....	316
Huff locomotive attachments.....	317
C. & N.-W. R'y automatic blower valve.....	318
Wallace & Kellogg's automatic variable exhaust nozzle.....	321
Huff automatic variable exhaust (side view).....	323
Huff automatic variable exhaust (plan view).....	324

	PAGE.
Huff automatic variable exhaust (front view).....	325
Huff automatic variable exhaust (view from under side of locomotive)	326
Air pump exhaust feed water heater and cylinder lubricator...	328
McIntosh pneumatic blow-off cock	331
Cab operating valve arrangement, McIntosh blow-off cock....	332
McIntosh pneumatic blow-off cock, showing arrangement of blow-off cocks on boiler.....	334
Hornish mechanical boiler cleaner	336
Hornish mechanical boiler cleaner (sectional view through front of boiler).....	338
Hornish mechanical boiler cleaner (section through mud ring) .	339
Climax blow-off cock	342
Little Giant blow-off cock	343
Johnstone blow-off valve	344
Homestead blow-off valve	345
Automatic air and steam coupler (plan)	346
Automatic air and steam coupler (elevation)	347
Linstrom non-freezing syphon pipe	349
Sellers' strainer (view from under side showing straining plate partially removed)	351
Sellers' strainer (position of strainer on locomotive)	352
Heath feed-water strainer	353
H-D locomotive strainer.....	354
Hancock hose strainer	354
Q and C—Priest snow flanger (as attached to locomotive).....	357
Positive discharge engineer's brake valve—New York Air Brake Co	358
Positive discharge engineer's brake valve—New York Air Brake Co.—(sectional view)	359
Automatic emergency recorder, as applied to an 1892 Westinghouse engineer's brake valve	366
Westinghouse latest improved slack adjuster.....	369
Gould brake-slack adjuster	370
Standard heavy locomotive globe valve.....	371
Crosby spring seat valve	372
Homestead straight-way valve	373
Steam chest vacuum or air relief valve.....	374
Richardson vacuum relief valve	375
Blackall relief valve for use on locomotives.....	376
Richardson combined pressure and vacuum relief valve	377
Manner of covering a locomotive boiler with sectional lagging..	380
Method of securing sectional lagging to the boiler	381
Asbestos covering for steam pipes.....	382
Crosby indicator	385
Crosby indicator (sectional view).....	386
Tabor indicator, fitted with drum stop attachment	393
Ashcroft reducing wheel.....	399
Tabor indicator, fitted with Houghtaling reducing motion and electric attachment.....	402

	PAGE.
Thompson indicator	403
Thompson indicator (sectional view)	404
Indicator diagram	405
Indicator diagram	406
Boyer railway speed recorder	408
Record of speed	409
Boyer railway speed recorder, as applied to a locomotive	411
Recorder pulley—Boyer speed recorder	414
Oiler—Boyer speed recorder	417
Pencil mechanism—Boyer speed recorder	418
Boyer speed recorder, as applied to passenger car	420
Crosby locomotive counter	421
Talbot automatic coupler for tenders	422
Gilman-Brown emergency knuckle	424
Hollow cast-steel cross-head for 4-bar guides	425
Solid cast-steel cross-head for 4-bar guides	426
Cast-steel cross-head for 2-bar guides	426
Cast-steel rocker arm	427
Cast-steel driving box	427
Engine house heating—Sturtevant system	429
Bruyn automatic swinging smoke jack	433
Ferguson locomotive fire kindler ..	435
Chapman screw jack	438
Joyce double movement screw jack	438
Joyce rapid moving screw jack	439
Norton ball-bearing ratchet screw jack	439
Joyce geared locomotive jack	441
Sectional view of Justice hydraulic jack	442
Joyce hydraulic jack	443
Geared journal jack	444
Portable air jack	445
Air jack and carriage	445
Little Giant pneumatic motor chain hoist	446
Locomotive pusher	447
Leach "D" sander, showing adjustable air nozzle with check valve	450
Leach "D" double sander	452
Leach "D" single sander, showing application to an eight-wheel locomotive for sanding the rail going ahead only	453
Leach "D" sanders—detail parts	454
Leach "A" sander	455
"She" sander, showing application to sand box	456
"She" sander—detail parts	457
Sherburne's arrangement for automatic sanding	459
Huff pneumatic track sander ..	460
Huff pneumatic track sander—detail parts	461
Huff pneumatic track sander, showing application and pipe con- nections	462
Engineer's valve—Huff pneumatic track sander	463
A. B. C. track sander	465

	PAGE.
Mudd track sander	466
Mudd track sander (plan view)	467
Mudd track sander (side view)	467
Pneumatic hammer	469
Pneumatic hammer, beading flues	470
Pneumatic hammer, chipping steel casting	470
Flue expander pusher	471
Chicago pneumatic flue cutter	471
Chicago pneumatic mud ring riveter, mounted on truck	472
Little Giant stay-bolt nipper	472
Pneumatic drill ..	473
Pneumatic drill (showing parts separated)	474
Pneumatic drill (at work in machine shop)	474
Piston air drill for drilling, reaming and tapping	475

INDEX.

	PAGE.
A. B. C. track sander.....	464
Adjuster, automatic brake-slack.....	369
Air brake apparatus.....	49
“ pump regulator or governor, Mason.....	203
“ valve, new engineer's—N. Y. Air Brake Co.....	358
Air pump exhaust, Wallace & Kellogg's.....	327
“ metallic packing.....	231
Air and steam coupler automatic.....	346
Allen-Richardson balanced slide valve.....	184
American balanced valve.....	187
Ashcroft pressure gauge.....	101
“ reducing wheels.....	399
Ashton safety valve.....	132
Automatic air and steam coupler.....	346
“ brake-slack adjuster.....	369
“ couplers.....	422
“ emergency recorder.....	365
“ steam blowers.....	314
“ track sanding.....	458
Bell ringers.....	307
Blackall relief valve.....	376
Blowers, steam, automatic.....	314
Blower valve, C. & N.-W. R'y.....	318
Boiler checks.....	177
“ cleaners.....	330
“ coverings.....	379
“ testing apparatus.....	171
“ washing and testing apparatus.....	171
Boyer speed recorder.....	407
Brake, air, apparatus.....	49
Brake-slack adjuster, automatic.....	369
Brake shoes.....	68
“ valve, new engineer's—N. Y. Air Brake Co.....	358
C. & N.-W. R'y blower valve.....	318
Checks, boiler.....	177
Check valve, swing intermediate.....	172
Chicago bell ringer.....	313
Cleaners, boiler.....	330
Climax blow-off cock.....	341
“ flexible metallic joint.....	86
“ steam pressure regulating valve.....	37

	PAGE.
Coale safety valve	121
Cocks, blow-off	330
" gauge	199
" siphon	92
Consolidated safety valve	130
Corning brake shoe	78
Cory's force-feed lubricator	274
Counter, revolution—Crosby	421
Couplers, automatic	422
Coupler, automatic air and steam	346
Coverings, boiler	379
Crosby locomotive revolution counter	421
" pressure gauge	95
" safety valve	126
" spring seat valve	372
" steam engine indicator	384
Cups, oil	284
Cylinder lubricator, Wallace & Kellogg's	327
Detroit triple feed lubricator	235
" " " " with Tippett attachment	258
Diagrams, indicator, Reading	405
Duplex air brake gauge	104
" " pump—N. Y. Air Brake Co	49
Dust guards, journal box	305
Eccentrics	219
Eclipse reducing valve	39
Ejector, the	174
Electric headlight	9
Emergency recorder, automatic	365
Engine houses, heating	428
" " smoke jacks for	432
Exhaust nozzles, variable	320
Feed valve, Westinghouse "1900"	62
Feed-water heater, Wallace & Kellogg's	327
" strainers	351
Fire kindlers	435
Flanger, snow—Q and C—Priest	356
Flexible metallic joints	81
Force-feed lubricators	274
Gauge cocks	199
" hand or "pointer" pullers	112
Gauges, pressure	88
" pressure recording	110
" testing	113
" water	199
Globe valves	371
Gold pressure regulator	36
Gollmar bell ringer	307
Grease cups	288
Guards, dust	305

	PAGE,
Guide cups	285
Hancock "composite" inspirator	156
" feed-water strainer	354
" inspirator	156
H and D feed-water strainer	353
Hand oilers	290
Harrison dust guard	305
Headlight, electric	9
Heath feed-water strainer	353
Heating engine houses	428
High pressure controlling apparatus	65
Hoists, power	437
Homestead blow-off cock	345
" straight-way valve	373
Hornish mechanical boiler cleaner	335
Huff automatic steam blower	314
" pneumatic track sander	460
" variable exhaust nozzle	321
Indicator diagrams, Reading	405
Indicators, steam engine	383
Injectors	134
Injector oil cup	173
Inspirator, Hancock	156
" oil cup	173
Intermediate check valve, Swing	172
Jack screws	437
Jerome air pump packing	232
" metallic packing	227
" valve stem packing	229
Jet pump	174
Johnstone blow-off cock	344
Joints, flexible metallic	81
Journal boxes, dust guard	305
" " packing in	292
Journals, lubrication of	291
Kindlers, fire	435
Knuckle, coupler, emergency	423
Lane pressure gauge	99
Lappin brake shoe	75
Leach "D" track sander	449
Line check valve, Swing	172
Lunkenheimer injector	163
Linstrom siphon pipe	349
Little Giant injector	169
" " pneumatic blow-off cock	343
Lubrication	235
" journals	291
Lubricators	235
Lubricator, cylinder—Wallace & Kellogg's	327
Mason reducing valve	32

	PAGE.
McCanna force-feed lubricator	277
McIntosh pneumatic blow-off cock	330
McLaughlin's flexible metallic joint	84
Meady safety valve	124
Metallic joints, flexible	81
Metropolitan injector	152
Michigan sight-feed lubricator	264
Moran flexible metallic joint	83
Mudd track sander	465
Nathan "Monitor" injector	151
" "Simplex" injector	148
New York air brake, duplex air pump	49
" " " " triple valves	53
Niagara injector	168
Nozzles, exhaust, variable	320
Ohio injector	167
Oil cellar, engine truck	280
Oil cups	284
Oil cup, injector	173
" inspirator	173
Oilers, hand	290
Open cups	287
Packing journal boxes	292
Packing, metallic	221
" rod	221
Piston valve	197
Pneumatic tools	469
Pop safety valves	120
Power hoists	437
Pressure gauges	88
Pressure, high, controlling apparatus	65
Pressure recording gauges	110
" regulators	30
Pullers, gauge hand or "pointer"	112
Pump, duplex air—N. Y. Air Brake	49
" jet	174
" regulator—Mason air brake	203
Pusher, locomotive or car	447
Recorder, emergency automatic	365
" speed, Boyer	407
Reducing valves	30
" wheels, Ashcroft	399
Regulators, pressure	30
Regulator, pump, Mason air brake	203
Relief valves	371
Revolution counter, Crosby	421
Richardson balanced slide valve	182
" combined pressure and vacuum relief valve	377
" relief valve	375
Ringers, bell	307

	PAGE.
Rod packing	221
Ross steam pressure reducing valve	43
Safety valves, pop	120
Sanders, track	448
Sansom bell ringer	311
Sargent brake shoe	70
Screws, jack	437
Seibert sight-feed lubricator	271
Sellers' feed-water strainer	351
" injector	139
"She" track sander	455
Sherburne's arrangement for automatic sanding	458
Shoes, brake	68
Siphons	92
Siphon pipe, Linstrom	349
Slide valves	181
Snow flanger—Q and C—Priest	356
Special automatic relief valve	45
Speed recorder, Boyer	407
Spindle feed cups	286
Star pressure gauge	100
" safety valve	122
Stay-bolts	212
Steam and air copuler, automatic	346
" blowers, automatic	314
" chest vacuum valves	374
" heating, directions for management of, on trains	31
" engine indicators	383
Steel, cast, for locomotive parts	425
Swab holders	234
Swing intermediate or line check valve	172
Taafel pressure regulator	41
Tabor steam engine indicator	391
Tender brake shoe	73
Testing boiler apparatus	171
" gauges	113
Thompson steam engine indicator	403
Tools, pneumatic	469
Track sanders	448
Trains, heating by steam	31
Triple valves—N. Y. air brake	53
Truck brake shoe	73
" oil cellar	280
United States air pump packing	231
" " metallic packing	222
" " valve stem packing	225
Utica pressure gauge	102
Valve, blower, C. & N.-W. R'y	318
" brake, new engineer's—N. Y. Air Brake Co.	358
" check, swing intermediate	172

	PAGE,
Valve, feed, Westinghouse "1900".....	62
" globe	371
" piston.	197
" reducing	30
" relief	371
" safety, pop	120
" slide.....	181
" triple, N. Y. air brake.....	53
Variable exhaust nozzles.....	320
Wallace & Kellogg's air pump exhaust, feed-water heater and cylinder lubricator.....	327
Wallace & Kellogg's variable exhaust nozzle.....	321
Washing, boiler, apparatus.....	171
Water, feed, strainers	351
Water gauges.....	199
Westinghouse air brake—Westinghouse "1900" feed valve....	62
Whistles, steam	208

THE SCIENCE OF RAILWAYS

By MARSHALL M. KIRKMAN.

"THE SCIENCE OF RAILWAYS" DESCRIBES THE METHODS AND PRINCIPLES CONNECTED WITH THE ORGANIZATION, LOCATION, CAPITALIZATION, CONSTRUCTION, MAINTENANCE, OPERATION AND ADMINISTRATION OF RAILROADS.

IN TWELVE VOLUMES, COMPRISING BOOKS ON

Railway Equipment.	Fiscal Affairs; Collection of Revenue.
Railway Organization.	Fiscal Duties of Agents and Conductors.
Financing, Constructing and Maintaining.	Principles Governing Collection of Revenue.
Train Service.	General Fiscal Affairs.
Passenger, Baggage, Express and Mail Service.	General Fiscal Affairs and Statistics.
Freight Business and Affairs.	Payment of Employes of Railroads.
Disbursements of Railways.	Treasurer's Office.
Economical Purchase, Care and Use of Material.	The Relief Department of Railroads.
Fiscal Affairs; Expenditures.	Origin and Evolution of Transportation.
Economic Theory of Rates; Private versus Government Control of Railroads.	Engineers' and Firemen's Manual—General Index.

"Officers and employes of railway companies and the students of this form of transportation owe you much. . . ." MARVIN HUGHITT, President Chicago and North-Western Railway.

"To railroad men, whose duties so frequently run in a groove, they afford most useful information that could not otherwise be obtained, and they suggest improved methods that must be highly beneficial to railway management."—C. C. HARVEY, President New Orleans and North-Eastern Railroad.

"The Science of Railways' shows a work of labor and thought. The subject is treated as none but a practical railroad man could treat it. The illustrations showing the modes of transportation from the primitive days to the present time are necessarily quaint and instructive. His delineations of character required to make a good and efficient railway officer are clear and pointed. His reference to the construction of railways, operation, maintenance of roadway and rolling stock are discussed with a clear head and hold the reader's attention. It is a work that should be in the hands of every railroad man, young and old. There is something in every volume interesting, and it is well adapted to the wants of young and ambitious railroad men, and it should be in the hands of those employes whose aim is advancement."—JOHN M. TOUCEX, General Manager New York Central and Hudson River Railroad Company.

"A curriculum eminently adapted for the employe in any sphere of labor. It is of inestimable value as a book of reference."—ROBERT DUDGEON, Superintendent Minnesota Transfer Railway Company.

"I hope your work may be spread wide amongst railroad men as well as investors."—J. L. TEN HAVE, Frzn, Capitalist, Amsterdam, Holland.

"Written with a grace and facility of diction which fairly entitle them to be received as literature of the first class."—*Noah's Sunday Times*.

"The author's long experience, his great opportunities for acquiring accurate knowledge, his careful and thorough study of railway administration, make his books authoritative, studious, thoughtful and enlightened."—*Chicago Evening Journal*.

PUBLISHED BY
THE WORLD RAILWAY PUBLISHING COMPANY,
CHICAGO, ILL.

THE SCIENCE OF RAILWAYS

BY MARSHALL M. KIRKMAN.

"THE SCIENCE OF RAILWAYS" DESCRIBES THE METHODS AND PRINCIPLES CONNECTED WITH THE ORGANIZATION, LOCATION, CAPITALIZATION, CONSTRUCTION, MAINTENANCE, OPERATION AND ADMINISTRATION OF RAILROADS.

IN TWELVE VOLUMES, COMPRISING BOOKS ON

- | | |
|---------------------------------------------------------------------------|------------------------------------------------|
| Railway Equipment. | Fiscal Affairs; Collection of Revenue. |
| Railway Organization. | Principles Governing Collection of Revenue. |
| Financing, Constructing and Maintaining. | Fiscal Duties of Agents and Conductors. |
| Train Service. | General Fiscal Affairs. |
| Passenger, Baggage, Express and Mail Service. | General Fiscal Affairs and Statistics. |
| Freight Business and Affairs. | Payment of Employes of Railroads. |
| Disbursements of Railways. | Treasurer's Office. |
| Economical Purchase, Care and Use of Material. | The Relief Department of Railroads. |
| Fiscal Affairs; Expenditures. | Origin and Evolution of Transportation. |
| Economic Theory of Rates; Private versus Government Control of Railroads. | Engineers' and Firemen's Manual—General Index. |

"Replete with valuable information and suggestions pertaining to the construction, operation and maintenance of railroads. The author's large experience in the service has eminently qualified him for the authorship of these practical and didactic volumes."—GEORGE W. PARKER, President and General Manager, St. Louis, Alton & Terre Haute Railroad Company.

"An able and interesting work. . . . I am not at all surprised at the thoroughness with which the work has been done, coming from the pen of Mr. Kirkman, as it is only in harmony with the completeness manifested in all his efforts and in all he does."—A. N. TOWNE, late Vice-President and General Manager, Southern Pacific Railway Company.

"It is to be hoped that Mr. Kirkman's works will find not only a place in the library of every railroad man who wishes to be well informed in connection with his business, but will also reach the general public. Mr. Kirkman's long connection with railway service eminently constitutes him an authority on such subjects. I hope 'The Science of Railways' will meet with a widespread circulation."—J. M. WHITMAN, General Manager, Chicago & North-Western Railway.

"The work . . . ought to be in the hands of every progressive young man in the railway service. Each volume treats fully and completely its subject, and the work as a whole is an encyclopaedia of railway methods and principles."—GEORGE A. COE, Superintendent, Chicago & Erie Railroad.

"A great work, clearly and intelligently set forth, with . . . enough elasticity to make it perfectly practicable to be adapted to local surroundings of every railroad. . . . Any man who has practical knowledge sufficient to handle any part of a railroad system can work in harmony with it." . . . —A. A. SHARP, Superintendent, Yazoo & Mississippi Valley Railroad.

"The author has had forty years' experience as an employe and executive officer of railways, and has been engaged thirty-four years in writing this work. It embraces the literature of the world on the subject, coupled with his own vast experience and research. Railroad men have long recognized the need of such a work. While it treats of specific things, it does not reflect the methods of any particular property or country. It portrays truly and vividly the principles and practices of the great art of transportation, under the general head of 'The Science of Railways.' Representative railroad men, without distinction, commend the work for its thoroughness, vast research and impartial representation."—*Brotherhood of Locomotive Engineers' Journal*.

PUBLISHED BY
THE WORLD RAILWAY PUBLISHING COMPANY,
CHICAGO, ILL.

THE SCIENCE OF RAILWAYS

BY MARSHALL M. KIRKMAN.

"THE SCIENCE OF RAILWAYS" DESCRIBES THE METHODS AND PRINCIPLES CONNECTED WITH THE ORGANIZATION, LOCATION, CAPITALIZATION, CONSTRUCTION, MAINTENANCE, OPERATION AND ADMINISTRATION OF RAILROADS.

IN TWELVE VOLUMES, COMPRISING BOOKS ON

Railway Equipment.	Fiscal Affairs; Collection of Revenue.
Railway Organization.	Fiscal Duties of Agents and Conductors.
Constructing, Financing and Maintaining.	Principles Governing Collection of Revenue.
Financing.	General Fiscal Affairs.
Constructing and Maintaining.	General Fiscal Affairs and Statistics.
Train Service.	Payment of Employes of Railroads.
Passenger, Baggage and Mail Service.	Treasurer's Office.
Freight Business and Affairs.	The Relief Department of Railroads.
Disbursements of Railways.	Origin and Evolution of Transportation.
Economical Purchase, Care and Use of Material.	Engineers' and Firemen's Manual—
Fiscal Affairs; Expenditures.	General Index.
Economic Theory of Rates.	

"The titles of the several volumes will show the extent of the ground covered. The merit of the work will be found in the fact that it is the product of an expert in active railway service."—ALDACE F. WALKER, Chairman of Board of Directors, Atchison, Topeka and Santa Fe Railway.

"I find the books most interesting. It is a work that ought to be in the library of every railroad man. My wonder is, how the author, with all his business, could find time and courage to write and publish such a complete and elaborate work. He is certainly entitled to very great credit for it, as well as the thanks of all practical railroad men."—AUSTIN CORBIN, late President, Long Island Railroad Company.

"The books are the recognized standard on the subjects treated of in this country."—JAMES McCREA, Vice-President, Pennsylvania Company.

"These books are of great value to railway employes and to investors and others interested in railway properties."—WILLIAM H. NEWMAN, Vice-President, Great Northern Railway Company.

"Of high educational value, because of the interest excited from the outset in a subject of paramount importance to civilized man. . . . The illustrations are impressive object lessons. The varied subjects discussed are treated in a most interesting and instructive way, and cannot fail to leave a deep and lasting impression on all thoughtful readers."—J. C. WELLING, Vice-President, Illinois Central Railroad.

"The work is a remarkable one, very interesting and valuable to railway men, and students generally. It contains information that has not been compiled heretofore, together with the practical ideas of a practical railway man applied to current operations of railroads. I commend the work most highly."—C. G. WARNER, Vice-President, Missouri Pacific Railroad.

"No young man in the railroad service, with the intention of pursuing that branch of commerce as a profession, can better equip himself than by a patient and careful reading of these volumes. I think Mr. Kirkman has rendered the profession and the public a valuable service by producing this work."—J. C. STUBBS, Third Vice-President, Southern Pacific Company.

"Should be read by every man who is interested in railway affairs, and by those employes who intend to make railroading their life work, and who are ambitious for advancement therein. Strange as it may seem to some, these books, instead of being dry and tiresome reading, are as interesting as classical works of fiction; yet, at the same time, the knowledge derived from their perusal is of incalculable value—not alone to railroad men, but to all who are studiously inclined."—THEO. LOW, Superintendent, Norfolk & Western Railway.

"It is equally valuable to the general reader and to the railroad man. It is a vast storehouse of information in relation to the history, construction and operation of railroads and the duties and obligations of railroad companies as common carriers."—HENRY C. CALDWELL, United States Circuit Judge.

"Mr. Kirkman has won very high distinction as an expert and reliable authority in railway management."—*Report of Government Directors, Union Pacific Railway.*

PUBLISHED BY
THE WORLD RAILWAY PUBLISHING COMPANY,
CHICAGO, ILL.

U 619

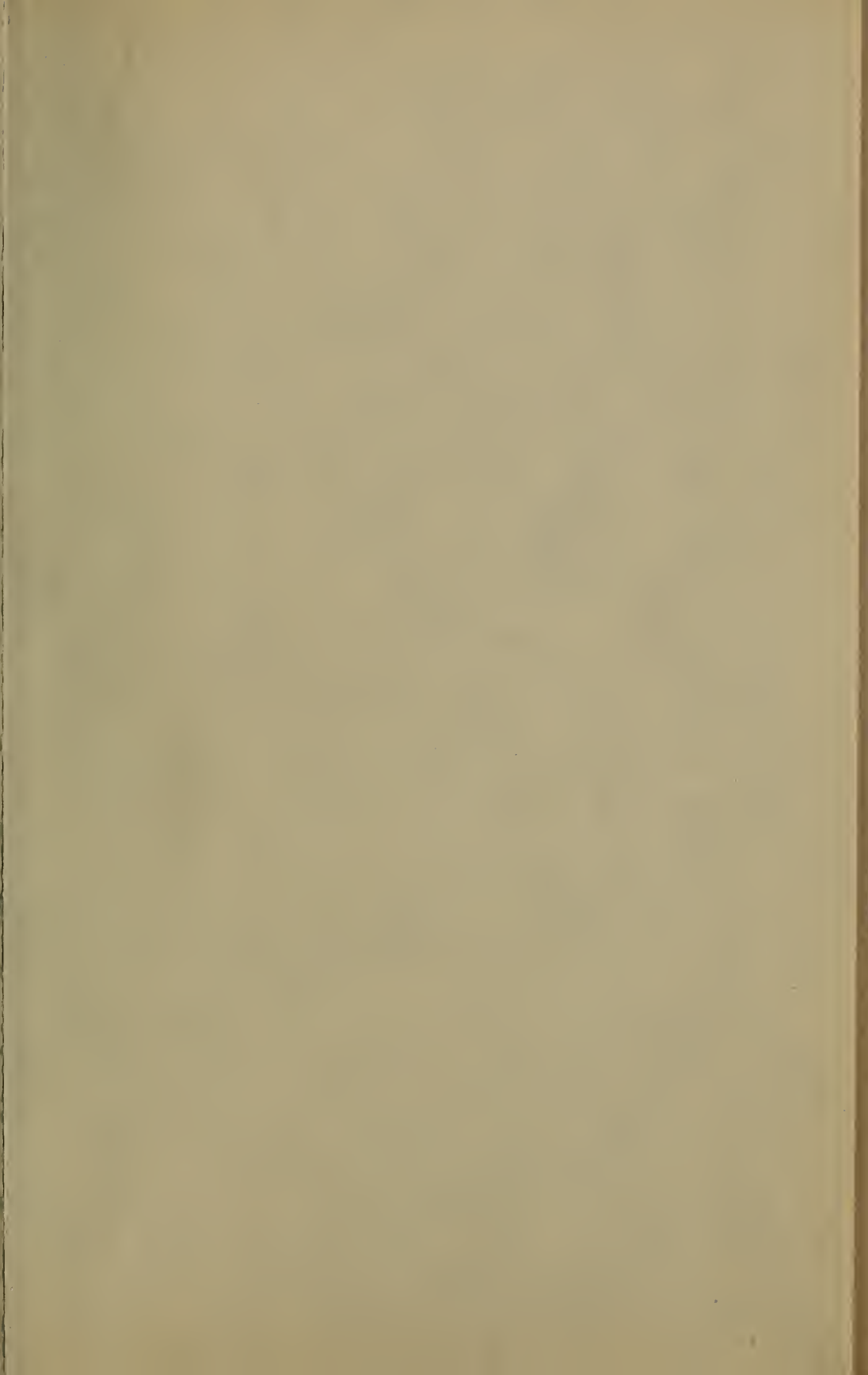

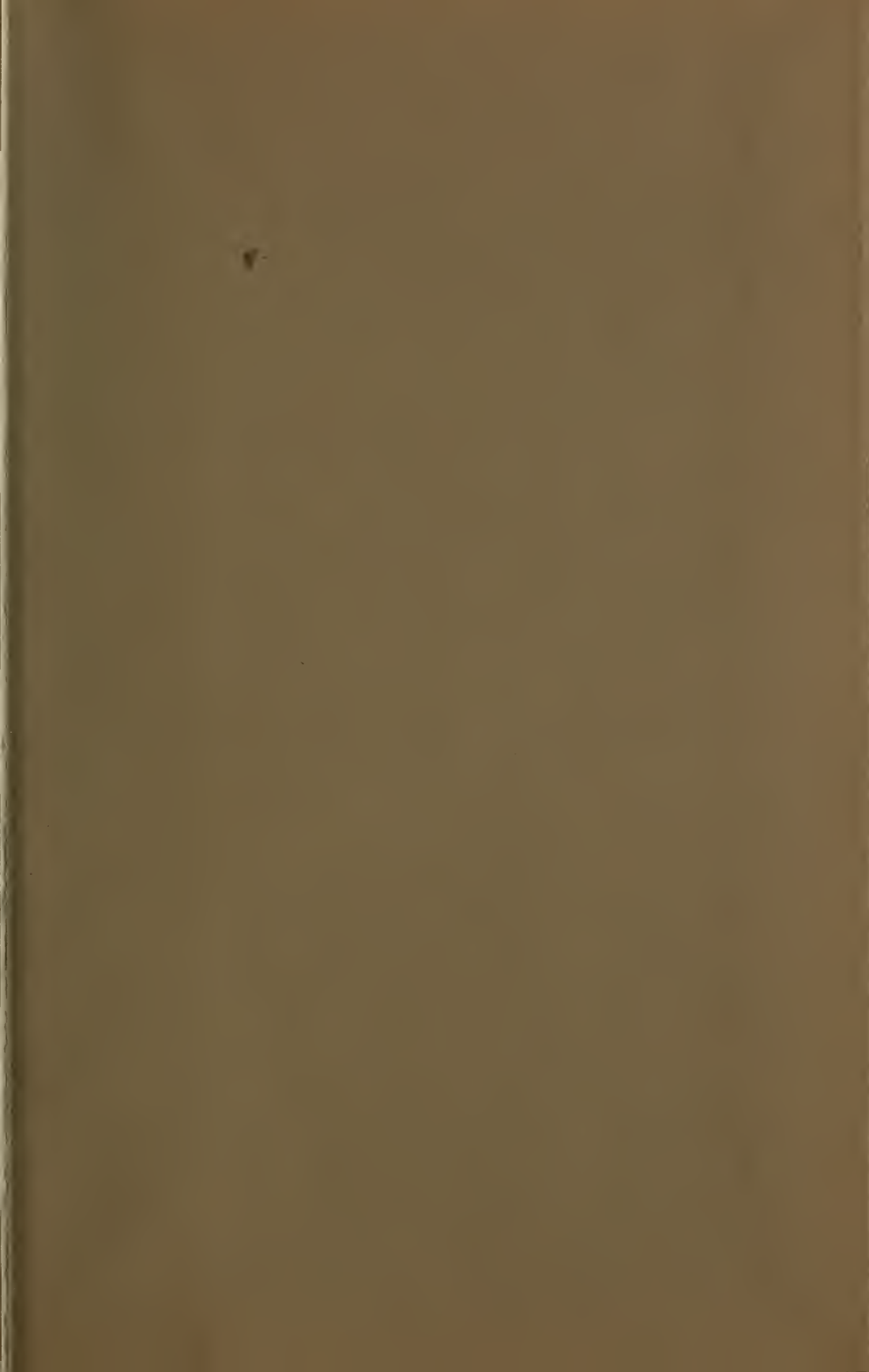

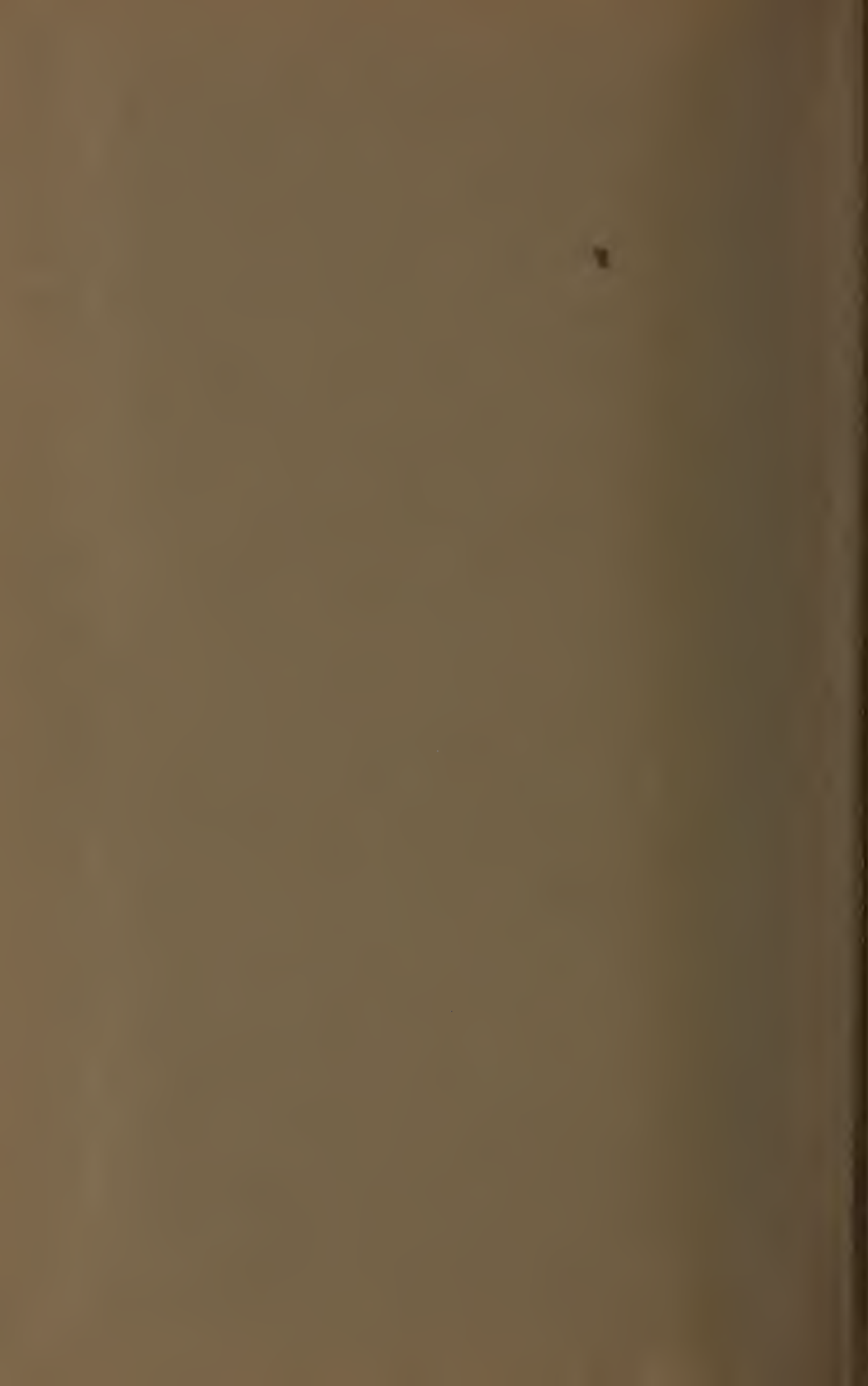

LIBRARY OF CONGRESS



0 029 827 630 6