



Class TS 253

Book 187











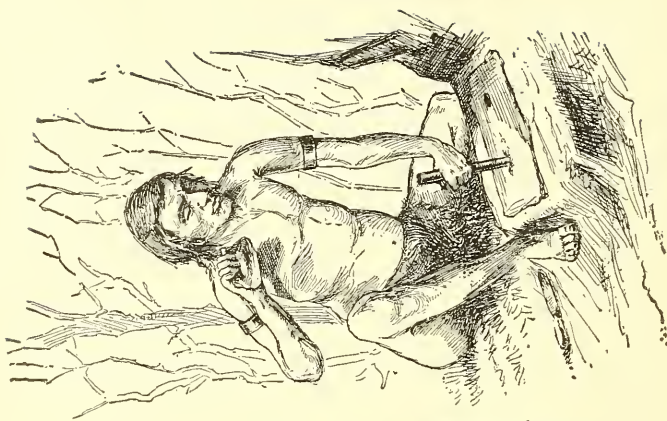

*Frontispiece.*

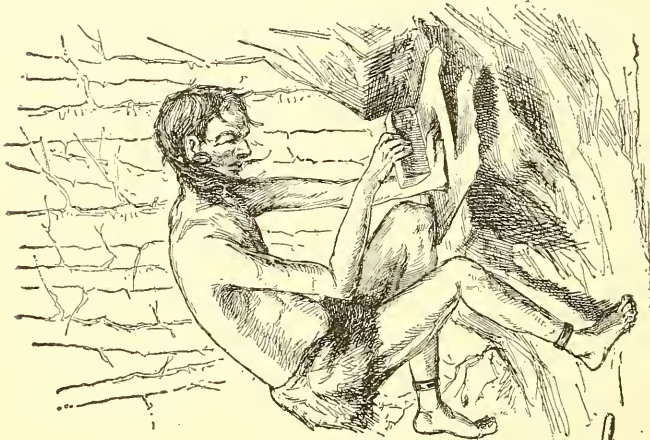

**SOME PRIMEVAL METHODS.**

See page 15.

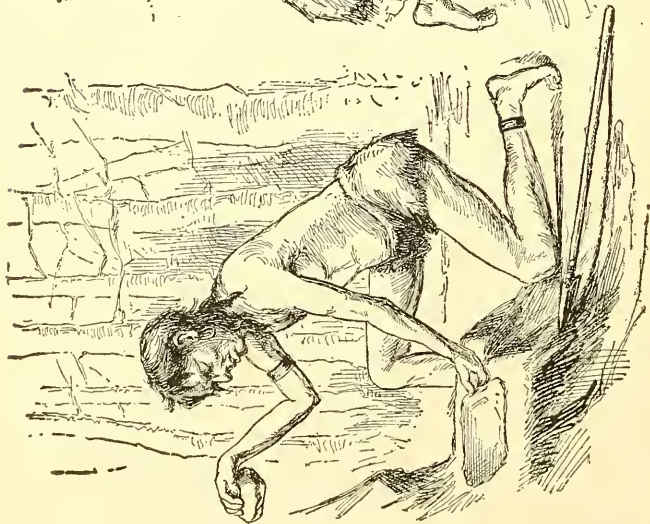



# PRESS-WORKING OF METALS.

*A TREATISE UPON THE PRINCIPLES AND PRACTICE OF  
SHAPING METALS IN DIES BY THE ACTION OF  
PRESSES, TOGETHER WITH A DESCRIPTION  
OF THE CONSTRUCTION OF SUCH IMPLE-  
MENTS IN THEIR VARIOUS FORMS,  
AND OF THE MATERIALS  
WORKED IN THEM.*

BY

OBERLIN SMITH,

*Member American Society of Mechanical Engineers;  
Member American Society of Civil Engineers;  
Member American Institute of Mining Engineers;  
Associate Member American Institute of Electrical Engineers.*

Illustrated with 433 Engravings.

FIRST EDITION.  
SECOND THOUSAND.

NEW YORK:  
JOHN WILEY & SONS.  
LONDON: CHAPMAN & HALL, LIMITED.

1901.

5

Copyright, 1896,  
BY  
OBERLIN SMITH.

51289  
-04

D	A	C	O	G	P	A	T	E	C	C	C	C	S	A	S	E	R
C	E	E	U	F	C	A	C	S	G	E	-	C	S	C	B		
T	E	C	O	C	H	E	B	C	C			C	E	C	E		
E	E	E	L	A	O	F	C	E	L			C	L	O	E		
C	E	E	E	B	C	C	O	E	E			M	E	C	E		

C	E	E	C	C	E	C	E	C	E	C	E	C	E	C	E	C	E	C
E	E	E	E	E	E	E	E	E	E	E	E	E	E	E	E	E	E	E
E	E	E	E	E	E	E	E	E	E	E	E	E	E	E	E	E	E	E
E	E	E	E	E	E	E	E	E	E	E	E	E	E	E	E	E	E	E

ROBERT DRUMMOND, ELECTROTYPYER AND PRINTER, NEW YORK.

4-10622

TO

**Prof. J. Burkitt Webb,**

THE AUTHOR'S EARLY ASSOCIATE IN THOSE PRACTICAL RESEARCHES  
AND PEEPS BEHIND THE SOMETIMES RELUCTANT CURTAIN  
OF NATURE'S ARCANA WHICH HAVE LED, AMONG  
OTHER THINGS, TO THE WRITING OF ITS  
PAGES, THIS BOOK IS AFFECTIONATELY  
DEDICATED.



## PREFACE.

---

DID there already exist an extensive literature upon the subject treated of in these pages, their somewhat meager information might in some cases prove superfluous. Failing, however, to find upon record many of the facts and principles which seem necessary to the successful design, construction, and operation of presses and dies, I have drawn upon a personal experience of many years in this line of work, and prepared a treatise which, as far as it goes, may perhaps be of value to the makers and users of the interesting class of tools which serve as its subject-matter. The use of these tools is very rapidly increasing in recent years, an almost marvelous variety of articles now being pressed out of sheet- or bar-metals which a few years ago were hand-forged or cast, or were non-existent.

Such cut, pressed, stamped, and drawn articles are found in all departments of our modern civilized life, often forming integral parts even of the cradle and the coffin—not to speak of the wedding-ring between. The system by which they are manufactured appears as a large factor in the creation of civilization itself, by making possible the cheap and uniform production of much of our hardware, our cooking utensils, and plate, and jewelry; our timepieces, and sewing-machines, and typewriters; our reapers, and wagons, and bicycles—to say nothing of the numberless other tools pertaining to our complex life, from a button even to a steamship.

The number and variety of these press-begotten devices is

so enormous that the maker of any one of them should but gently criticise my book if haply he finds not therein full instruction for the production of his specialty. Many of the articles produced in dies, if of a difficult form, can be perfected only by careful, and sometimes perplexing, experimentation. It often takes a good while to find out into what shapes the Creator intended a piece of metal to flow, and what are His eternal limitations. The general principles governing all this work I have, however, attempted to set forth—at any rate to a hint-giving extent.

A portion of the matter herein contained was written over two years ago at the request of the editor of the "Metal Worker" of New York, and was published as a serial in that journal, and also in the "Iron Age." Several new chapters, however, have since been introduced, together with over a hundred additional engravings, and the whole has been subjected to a careful revision and amplification. No attempt has been made to limit the language to the rigid brevity and technicality of a text-book on mathematics or chemistry, a freer style, rhetorically speaking, being perhaps more acceptable to the general reader.

*Oberlin Smith.*

BRIDGETON, N. J.,  
January 1, 1896.

# CONTENTS.

---

## CHAPTER I.

### INTRODUCTORY.

	PAGE
Beginnings of the Art—Fundamental Principles—Probable Origin—Rotary Operations—Press Definitions—Press Qualifications—Nomenclature . . . . .	II

## CHAPTER II.

### PRESS CLASSIFICATION AND ANATOMY.

Classification by Motions—Classification by Position—Classification by Frame Design—Composite Frames—Classification by Method of Support—Classification by Kinetic Construction—Classification by Power Applied—Classification by Functions—Classification by Materials Worked—Name Guessing—Points for a Press-buyer—Artistic Design—Some Power Press Problems—Clutches—Sub-presses . . . . .	20
--	----

## CHAPTER III.

### A "MUSEUM" OF PRESSES.

Press Literature—A Pictorial Collection—Hand Presses—Foot Presses—Drop Presses—Power Cutting Presses—Power Double Crank Presses—Power Embossing Presses—Power Punching Presses—Power Punches and Shears—Power Curling and Horning Presses—Power Drawing Presses—Power Re-drawing Presses—Coining Presses—Hydraulic Presses—Hammering Machines .	42
---	----

## CHAPTER IV.

### DIES.

Definitions and Evolution—Classification by Functions—Interchangeability—Bolsters—Attaching Dies—Accuracy and Durability	
--	--

	PAGE
ity—Some Specimen Dies—Composite Die Construction—Heights of Ram and Dies—Die Lubrication—Nomenclature. . . . .	73

## CHAPTER V.

### MATERIALS AND MEASUREMENTS.

Commercial Materials—Wire Gauges—A Proposed New Gauge—Micrometers—Annealing . . . . .	95
---	----

## CHAPTER VI.

### CUTTING PROCESSES.

Explanatory—Chiseling—Shearing—Dip or Shear—Punching—Deep Punching—Punching Tapering Holes—Imperfect Sheared Surfaces—Drifting or Repunching—A Museum of Blanks—Gang-cutting—Combination Cutting—Successive Cutting—Successive Gang-cutting—Cutting Die Qualifications—Hardness of Dies—Bevels of Cutting Edges—Strippers, Hold-downs, etc.—Die Gauges—Cutting Speeds—Cutting Pressures—Adaptation of Presses . . . . .	123
---	-----

## CHAPTER VII.

### BENDING PROCESSES.

Bending—Forming—Embossing—Cutting-Forming-Embossing—Knockouts—Speed and Pressure—Assembling—Involuntary Processes—Soft Punches—Fluid Punches—Presses Suitable . . . . .	154
---	-----

## CHAPTER VIII.

### CURLING AND SEAMING PROCESSES.

Curling or Wiring—Outward Curling—Inward Curling—Assembling by Curling—Principles of Curling—Straight Curling—Horn-ing or Side-Seaming—Speeds and Pressures—Suitable Presses . . . . .	167
--	-----

## CHAPTER IX.

### DRAWING PROCESSES.

Drawing Historically—Drawing Defined—Mechanics of Drawing—Flow of Metals—Conical Drawing—Depth of Drawing—Body-wrinkles—Flange Wrinkles—Proportions of Work—Multiple Drawing—Condition of Dies—Cutting-Drawing-Embossing—	
---	--



	PAGE
Specimen Drawn Work—Spring-drawing—Blank Dimensions— Blank Formulæ—Trimming Edges—Roller Spinning—Roller Curl- ing—Speeds and Pressures—Kinds of Presses Desirable . . .	184

CHAPTER X.

RE-DRAWING PROCESSES.

Re-drawing — Inverted Re-drawing — Broaching—Vee Blank- holders—Rim-forming—Neck Reducing—The Speed and Pressure —Presses most Suitable—Drawing, Prophetically . . . . .	214
--	-----

CHAPTER XI.

COINING PROCESSES.

Drop Forgings—Coining Coins—Riveting—Compressing Plas- tic Substances—Tube “Squirting”—Speed and Pressure—Presses Used . . . . .	223
--	-----

CHAPTER XII.

PRESS FEEDING.

Definitions—Hand Feeding—Roller Feeding—Reel Feeding— Grip Feeding—Carriage Feeding—Dial Feeding—Friction Dials— Indexing—Gravity Feeding—Knockouts—Pushouts—Feeding Speeds—Special Automatic Machines . . . . .	233
---	-----

CHAPTER XIII.

MISCELLANEOUS.

Manifolding Work in Dies—Paper-working—Hammer Blows— Effective Pressure in Drop Presses—Testing Pressures—Electric Driving—Power Required for Presses—Future Development . . . . .	249
INDEX OF SUBJECTS—Alphabetical . . . . .	263



# PRESS-WORKING OF METALS.

---

## CHAPTER I.

### INTRODUCTORY.

#### BEGINNINGS OF THE ART.

OF the origin and history of the art of metal work as performed in dies, operated by presses, we know but little. The numberless wonderful and beautiful operations of to-day, most of which it must be acknowledged, however, tend rather to cheapening and unifying than to beautifying the articles produced, are merely the results of a long course of evolution, tending constantly to a survival of the fittest methods. Regarding the progress of the art as a whole, it cannot be said that any one age shines out upon the pages of history, or that any one inventor has made himself immortal. Processes identical in principle with many of our modern ones were undoubtedly practiced by that master metallurgist and machinist, Tubal-Cain, and by the long line of skilled artificers who have been his disciples and followers adown through all the ages which have gradually created civilization.

This civilization in its modern glory, and its far greater glory yet to come, may be regarded as almost wholly dependent upon the noble art of metal working in its various branches; for we cannot conceive of the existence of the constructions

and instruments of modern engineering and other sciences if we were limited to such primitive materials as wood and stone.

### FUNDAMENTAL PRINCIPLES.

In choosing the specific subject of this book, differentiating the general theme of metal-working by selecting sheet- and bar-metals, and this again by limiting himself to the operations of a particular class of tools, the author realizes that he must not lose sight of certain fundamental principles which underlie the art as a whole; considering the important divisions of casting, forging and finishing, as well as press-working, but omitting reference to purely chemical and electrical processes.

It may be well in this connection to say that the four process-defining verbs employed near the end of the last sentence are used in a commercial and technical sense rather than in a scientific one, as they somewhat overlap each other in exact meaning. This is readily seen when we consider that casting, which generally means the running of molten material into a mold by the force of gravity merely, sometimes also means the forcing of the same thereinto by means of a pump, or its equivalent, as in type casting and the Whitworth pressure system of steel casting. From this it is but a step to the drop-forging of white-hot iron in the dies of the drop press or (in other materials) to the pressing to shape of semi-molten glass, or of cold soap and candy. The differences are chiefly those of the degree of plasticity in the substance treated. We thus find no very distinct line of demarcation between casting and forging, for much of the ordinary blacksmith's work is analogous to drop-forging, except that his tools are not as highly specialized, and do not so completely give their own form to the work. Again, we find that finishing (in the sense here used of paring and scraping or abrading the surface of the metal to more accurate shape,

as in machine shop processes) is partly included in a blacksmith's work, as in chiseling, filing, etc. Still again, we shall see that press-working may, and sometimes does, include all of the processes referred to—*e.g.*, forcing into molds, as in casting; cutting, shearing, punching, smashing, bending, stretching, compressing, etc., as in forging; and paring, etc., as in finishing.

In general, however, it may be said that press-work has much more in common with forging than with the other processes in question, and that it bears the same relation to the blacksmith's or the coppersmith's work that printing does to the scrivener's art, or chromo making to oil painting, or a knitting machine to one's grandmother. In any of these cases we have on the one hand a mechanico-reproductive process wherein the brain of the designer has been expended upon specialized tools which will produce predetermined articles, all exactly alike, for the benefit of the millions—in many cases, unfortunately, with but little embodiment of the æsthetic. On the other hand, we have much more expensive products, each made singly as the individual child of the artisan's brain, and each differing in some degree from its brethren. Should the artisan happen to be also an artist, as were the stone cutters of Greece and of mediæval Europe, the gold, bronze and iron workers of old Italy and Spain (but as are not, alas! the most of our metal workers of today), then his beauty-loving individualism in mechanical work serves as a leaven to leaven the lump of ugliness that tends to crush down all love of the beautiful in this intensely utilitarian age.

Referring again to certain general principles underlying the mechanical working of metals (at any rate, in all the processes mentioned except finishing), we have as one necessary condition a molecular structure which will enable the particles to flow among themselves when the proper force is

applied. In the case of *casting* this occurs at a temperature at which the particular metal in question happens to become a perfect liquid or nearly so. In *forging* the flow usually takes place at a bright red heat, although sometimes the metal is cooler than this, or even entirely cold—this latter term meaning here (and throughout this treatise) the ordinary temperature of the atmosphere. In *press-work* the metal is sometimes heated as in forging, but in the great majority of cases it is handled cold.

The other necessary condition, besides a capability of approximately non-elastic flow in the material worked, is the employment of certain tools that will first cause this flow and that will then limit it, so as to produce the predetermined shapes required. In ordinary casting these tools consist of the molds to inclose and limit the shape, together with a proper pouring tube (wherein the sprue or gate is formed) to give "head" or pressure to the metal. In forging, they consist of the surfaces and corners of hammers and anvils, together with horns, swages, fullers and other more specialized tools. In that modification of a forge-shop called a rolling mill, the tools in question, of course, consist of the surfaces of the rolls, whether they be cylindrical to produce sheet metal, or grooved in various ways to produce bars. In press-working the forcing tools are the press rams, while the limiting and shaping operations are performed by the dies.

#### PROBABLE ORIGIN.

Before proceeding to a practical analysis of the press-working art as we find it existent to-day, it will be well to recur once more to the historical aspect of the subject, that we may trace its probable beginnings back in the primitive ages of the world's history. The first man who chanced to dig up a little nugget of native gold or copper, or some other man who found a piece of malleable metal in the ashes of

his fire as a result of the accidental smelting of certain ore happening therein, may very probably have pounded it out thinner between two stones, and thus have become the first sheet-metal manufacturer. If he then cut it in two by lapping it over the sharp edge of a stone and sliding another one down past it, he had invented the first shearing press. If he pushed the end of a sharp-edged cylindrical stone through it into a hole in a stone underneath he was doing the first punching. If the upper tool was rounded off so as not to cut through, being perhaps a hard-wood stick, he was making a little cup by the process of forming or stamping. In the frontispiece a hint at such performances is attempted, but it is only fair to state that no photographs of the figures or landscape were available.

Thus simple, however, in principle, are most of the operations that we still perform in sheet-metal work. We have improved them only in detail, gradually evolving better and better tools, to the end of obtaining more and more accuracy, uniformity and rapidity of production. The transition from a punch or upper die, held in and guided by the hand, to a simple machine wherein the same was guided by being attached to a moving ram, was but a natural one and something that required no great inventive ability. The great economic and epoch-making advance which followed later was the specialization of a part of this work into certain

#### ROTARY OPERATIONS.

It is evident that the action of a pair of rolls, such as are used in ordinary rolling mills, for reducing the thickness and increasing the length, and sometimes the width, of a piece of metal, as well as in some cases bending it to a different form, as, *e.g.*, in the case of corrugating, is somewhat analogous to the action of dies approaching each other in a press—in the processes of mashing, forming, embossing, coining,

etc. The shearing action of a press also has its analogue in the rotary cutters mounted upon parallel shafts which are often used for slitting and trimming sheet-metals. All this rolling work is of course but a specialized specimen of the general operations of forging, of which press-work is another specimen.

#### PRESS DEFINITIONS.

A general definition of the word "press," as used for the purposes with which we are concerned in this treatise, might be written as follows: A machine in which a bed or anvil is approached by a ram or hammer, having a reciprocating motion in a line approximately at right angles to said bed, and the said ram being suitably guided in the framework of the machine so that it may always move in the same path. It will thus be seen that the two important members in any ordinary press are the bed and the ram, and that they are only a more highly specialized form of the blacksmith's anvil and hammer or of the still more primitive large stone and small stone used by the predecessors of Tubal-Cain.

Such a generic form is shown in the pictures, Figs. 1 and 2, wherein *F* is the frame, *b* the part thereof serving as a bed and *R* the ram, the views being side and top respectively. The ram is arranged with a handle at the top for the most primitive method of operation possible.

#### PRESS QUALIFICATIONS.

The general essentials in such a machine are a massive and rigid bed with a flat and true surface upon which to fasten one of the dies; a rigid framework extending toward and surrounding the ram that it may slide, or sometimes swing, therein with a considerable degree of accuracy; means for taking up lost motion caused by original looseness of fitting or by subsequent wear; and a somewhat massive and rigid



ram, carrying proper means for fastening and securely holding the other die. The surface of the ram nearest the bed is usually flat and parallel thereto, although for some shearing work and occasionally for rough punching a ram is allowed to swing in the arc of a circle, usually being itself in such case a part of one arm of its operating lever. In the vast majority of cases, however, a ram is of cylindrical or prismatic form, sliding accurately in true bearings in the frame of the press. These bearings should, if the machine is of correct

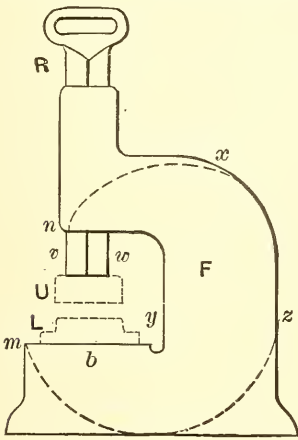

FIG. 1.

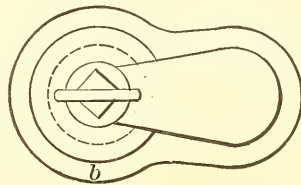

FIG. 2.

design, be of great length in proportion to the thickness of the ram, the object of thus maintaining the ram rigidly in its predetermined path of motion being to always bring the dies together with the same relation to each other, that they may not be injured and that the work may be uniformly shaped thereby.

The causes which tend to destroy this accuracy of motion are: 1. The springing of the ram itself, when made too slim and when projecting too far out of its bearings. 2. False motions (sidewise) in its bearings, either by their not embracing it tight enough or by their being so short as to magnify by means of the leverage the slight looseness which

is necessary in any working bearings. 3. The springing of the frame out of its normal shape at points between its bed and the ram bearings. It may therefore be said, in general, that it is almost impossible to make these parts of a press too clumsy, and that the more metal they contain, within reason and consistently with the space available, the better they are, especially as they want not only the strength to keep them in position, but all the inertia possible to prevent vibration when acted upon by the powerful and often rapidly applied forces necessary to move the ram.

#### NOMENCLATURE.

Hereafter in this treatise certain parts shown in the illustrations will be uniformly referred to by the following letters: *F* for press-frame; *b* for the bed thereof, which is usually but not always a part of the same casting; *R* for ram; *P* for plunger; *a* for axis of ram; *L* for lower-die; *U* for upper-die; *U'* for drawing-punch or inner-upper-die; *M* for matrix; *K* for knock-out; *S* for stripper; *G* for gauge; *p* for pressure between ram and bed in the line of ram's axis; *t* for throat, and *M* for metal or other material to be worked in the dies. The meaning of such of the above names as are not self-explanatory will be made clear further on, except perhaps the somewhat indefinite word "throat." This (with its derived adjective "throated") will refer to the gap or space containing the dies in that type of press where the main body of the frame extends back of the vertical axis or center-line of the ram, rather than at each side of it as in most "columnar" frames. "Throat" is sometimes used to express the distance, in inches or some other unit, from axis *a* back to frame, as shown in Figs. 11 and 13. This, however, does not conflict with its meaning the whole gap when no dimensions are affixed.

The other essential parts pertaining to presses and dies

are so numerous that no definite system can be maintained in referring to them. The nomenclature herein used will follow conventional practice as far as is feasible, but in names with a number of synonyms the word which seems the most in accordance with common sense will be selected. A case in point is the ram of a press, which, called by this name, seems to be expressed in a short, crisp manner which almost explains itself (because of its ramming functions) even to a layman. Other names frequently used for this member are slide, slide-bar, bar; mandrel, gate, head, platen, drop, hammer, plunger, etc. The last-named word will be herein used for the inside ram of double-action presses, the outside one being called simply a ram.

In dealing with locations, relative positions and directions the simple and definite words, top, bottom, right-side, left-side, front, back; and up, down, right, left, forward, backward, will be respectively used—it being understood that they are governed by the operator's anatomy as he faces the working side of the machine, which is its *front*. Thus "forward" is toward him, "right" to his right, etc.

## CHAPTER II.

## PRESS CLASSIFICATION AND ANATOMY.

## CLASSIFICATION BY MOTIONS.

A STRICTLY logical classification of presses seems impossible, as almost any given kind of press can be grouped by many different systems, some of which will inevitably interfere with and overlap each other. One important general distinction is that between single and double action machines—that is to say, between those having a plain ram with a simple uniform motion, and two rams, one inside the other, with perhaps different amounts of motion and moving at different times, as is the case with the ordinary drawing press. In some rare cases even more than two rams are used, but machines containing them may be justly ranked with special machinery, and need not be considered here.

## CLASSIFICATION BY POSITION.

Another conventional classification is by position. Whether a press is upright, as in Figs. 1 and 11, or inclined, as in Fig. 12, or horizontal, as would be the case if Fig. 1 was fastened with its base against a vertical wall, determines its "position" and perhaps one of its names. In Figs. 11 and 12 is shown a common form of press where the frame can be set at any desired angle between the two extremes shown, by swinging, rocking or otherwise revolving it, in relation to its legs. Such presses are usually called "inclinable," in distinction from the term "inclined," in which latter case

the frame is supposed to be permanently fastened in such position. The object of this inclination is that work which is

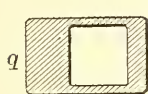

FIG. 3.

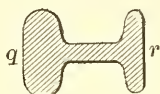

FIG. 4.

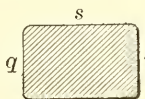

FIG. 5.

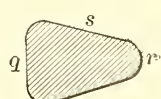

FIG. 6.

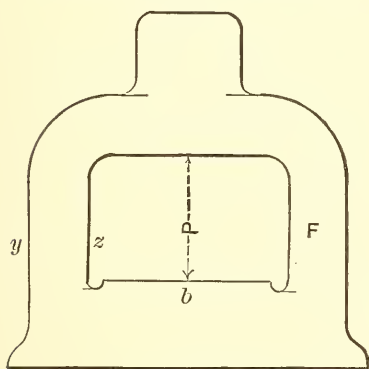

FIG. 7.

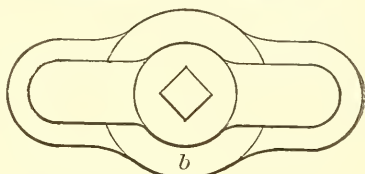

FIG. 8.

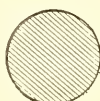

FIG. 9.



FIG. 10.

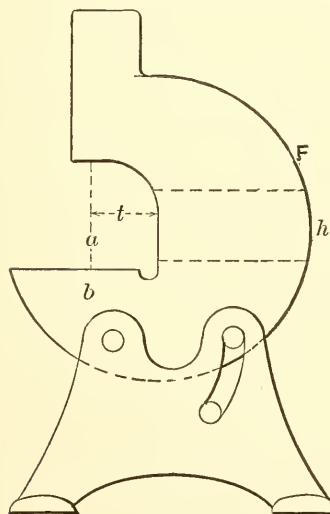

FIG. 11.

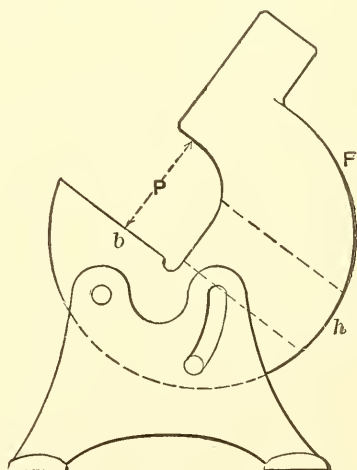

FIG. 12.

knocked up from the lower die, and delivered between it and the upper die, may slide away from said dies by the force

of gravity, usually passing through a hole,  $h$ , indicated by the dotted lines, and thence descending into a proper receptacle.

#### CLASSIFICATION BY FRAME DESIGN.

Another classification is by the kind of frame used, of which there are many types. The most common among these is the throated frame shown in side view in Figs. 1, 11, 12 and 13, where the throat measurement is counted from

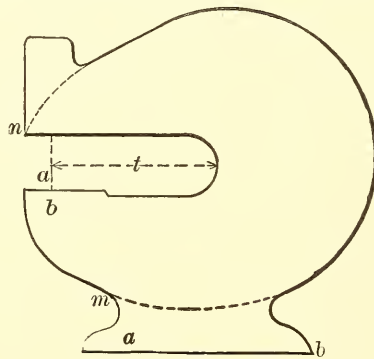

FIG. 13.

the axis  $a$  of the ram backward to the front surface of the frame, as at the dimension measurement  $t$ , generally expressed in inches. Such presses are usually cast with the frame in one piece. The general form is obviously that of a parabolic beam bent somewhat into the shape of the letter C. Such a beam, of course, has its ends of much less depth than its middle portion, according to the well-known laws governing the strength of beams, when so constructed as to put equal stress upon the material at all points in their lengths. The ideal outside contour for such a beam is approximately shown by the dotted line in Figs. 1 and 13, which starts at  $m$  and ends at  $n$ . The parts of the frame exterior to this line are added at the bottom to give a flat base and at the top to give ram bearings, but the parts neces-

sary for strength lie within said dotted line. In Figs. 3 and 4 are shown possible cross-sections of the back part of the press frame in Fig. 1, cut at  $Wx$  or at  $y z$ , where the tensile member  $q$  is connected with the compressive member  $r$  by two thin webs at the sides, or one web in the middle, as the case may be. Figs. 3 and 4 are equally good as regards the normal vertical strains of the press, but Fig. 3 has the well-known advantage of any tubular construction in regard to torsional strains, and is, therefore, better for a press frame, as there is less chance of the ram bearings springing sidewise. In both figures the member  $q$  is shown much heavier than the member  $r$ , because the usual material, cast-iron, is supposed to be employed, and this metal has a tensile strength much less than its compressive. In Fig. 5 is shown a cross-section sometimes used, where there is evidently a considerable waste of material, both in the middle,  $s$ , and at the back,  $r$ . In Fig. 6 another section sometimes used is shown. The relation of  $q$  and  $r$  is correct, but there is waste material at  $s$ . In some cases press frames of the general C-shaped type in question are made with the projecting bed detachable, and perhaps adjustable up and down. Witness an ordinary horn press, where the horn really constitutes the bed, but is interchangeable with other horns.

Perhaps the next most common form of press frame is shown in front view by Fig. 7 and in top view by Fig. 8, where the bed is connected to the ram bearings by two vertical posts or columns, forming a part of the same casting. In these figures a form often used for screw presses is shown, but the same general construction is more often embodied in much taller and narrower presses, which are frequently run by power and used for embossing, punching, etc., particularly in cases where there is no need for passing through a wide sheet of metal, as is done in throated presses. In Fig. 13 is shown a common type of press frame with an excep-

tionally deep throat, which is used especially for heavy punching and shearing work.

It is evident that in Fig. 7 the frame  $F$  consists essentially of a double-ended beam forming the bed, connected to another double-ended beam across the top by the two upright columns, which are subjected to tensile strains mostly. Any shape of cross-section is, therefore, suitable for columns of this kind (providing the beams are stiff enough), the most common forms being those shown in Figs. 9 and 10.

### COMPOSITE FRAMES.

Besides the numerous family of seamless press frames there are a variety of composite constructions in which the frame proper is built up of several pieces. Among these a common form, which may be called a pillar press, is shown in partial front section in Fig. 14. In this case a heavy

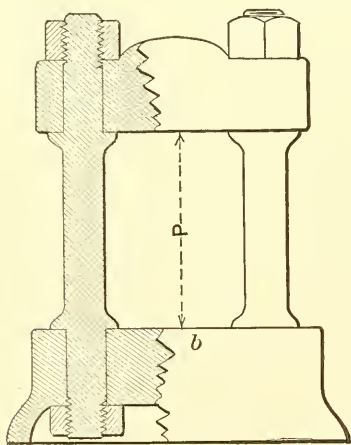

FIG. 14.



FIG. 15.



FIG. 16.



FIG. 17.

cross beam forming the bed, and usually also the base of the machine, is connected to the cross beam at the top by two or more cylindrical columns or pillars, which are usually turned and accurately fitted to bored holes in the afore-



mentioned beams, being held securely therein by large nuts screwed on at the top and bottom ends thereof. This is a common construction in hydraulic presses, and also in ordinary power presses of very large size. No attempt has been made in the cut to show the ram or its driving mechanism. It will be noticed that the pillars of this press are subjected to tensile stresses only, and that it is of a convenient form for cheaply making these members of forged metal, which, of course, makes them much safer against breakage. A design of this kind always strikes the observer as being more archi-



FIG. 18.



FIG. 19.



FIG. 20.

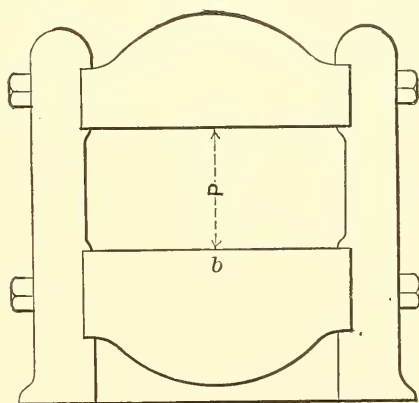

FIG. 21.

tectural in its nature than the forms previously described, as we have here some of the prominent elements of a Greek temple—the stylobate, the columns with base and capital and the entablature all being clearly discernible. Its structural principle, however, is evidently very different from the temple in question, the stresses upon whose columns are purely compressive.

Another composite form of press frame is shown in Fig. 21, where the columns are usually of cast metal and where the cross beams forming the bed and what, for want of a better name, we will call the head, are notched into the columns and secured therein by heavy bolts from the outside. The stresses upon these columns are largely tensile, but strongly approach lateral stresses at the points of junction with the cross members.

Still another form of frame is shown in Figs. 22 and 23,

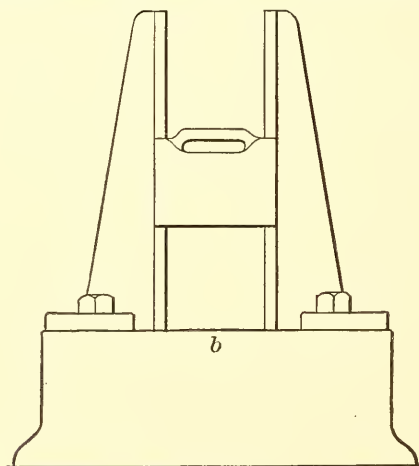

FIG. 22.

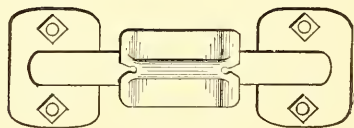

FIG. 23.

where the portraits, in front and partial top views, respectively, are of a somewhat corpulent member of the genus drop press, the ram being shown half way up, but without its lifting devices. Such a method of fastening the columns to the bed is sometimes used in other than drop presses, but is not well calculated to resist tensile stresses. This feature

is, however, of no importance in the case shown, where the ram falls by gravity and is not pushed downward from any part of the frame as an abutment. This same remark in regard to an upper frame not needing strength, except for ram guiding purposes, when gravity actuates the ram, will, of course, also apply to such constructions as Figs. 1 and 7. In Fig. 24 is shown one of the forms of swinging ram previously referred to. In this way are built the well-known lever or alligator shears used in rolling mills, etc. The same principle is obviously employed in ordinary scissors, belt punches and other such tools. In one sense the ram may be

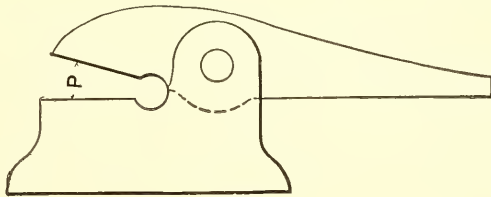

FIG. 24.

said to form the upper arm of the frame. Numerous other frame constructions might be described, but the instances given will cover the majority of those in use.

#### CLASSIFICATION BY METHOD OF SUPPORT.

Another classification in commercial use is founded upon the fact that some presses stand upon the floor, either upon legs attached to the frame, as in Figs. 11 and 12, or with a base extending downward from the frame proper and resting upon the floor, as in Fig. 13, or in cases like Figs. 14, 21 and 22, where the bed is thick enough up and down to nearly or quite reach the floor, and does not need to be artificially raised up therefrom.

In contradistinction to these floor presses, whose peculiarity is usually not mentioned as such, are the bench presses, so-called, which are often set with their bases resting upon

an ordinary work-bench, or in some cases upon one made lower than usual. The type of frame usually employed in such presses is shown in side and top views in Figs. 1 and 2, and in front and top views in Figs. 7 and 8. Drop presses, as in Fig. 22, are often used in this way also when they happen to be of small size. It is obvious that press frames can be so mounted directly upon a bench only when the depth of the bed is considerably less than the usually convenient height for setting the top of the press bed above the floor, which is generally about 32 inches.

Obviously other classes analogous to these might be established, as, for instance, wall, ceiling and suspension presses. As a practical matter, however, the former two of these are rarely used. An instance of the latter is seen in the portable steam, pneumatic and hydraulic "crabs" which are used for punching and riveting, mostly upon boiler and ship work, and which are usually suspended from a trolley above and driven through the medium of a fluid-conveying hose, or an electric conductor.

#### CLASSIFICATION BY KINETIC CONSTRUCTION.

The next general method of classifying presses is by their kinetic construction, and they are often named after some important member of the driving mechanism, as for instance lever presses, screw presses, toggle presses, crank presses, etc. Before analyzing the kinematics of the subject more in detail (when, by the way, I will for convenience include drop presses, considering the center of the earth as pulling the ram down by an imaginary cord) it will be well to look for a moment at Fig. 1 and consider again the primal principle involved in all machines of this character. I have here shown the simplest possible form of press which would properly guide and strike together the two dies  $U$  and  $L$ , shown in dotted lines. It is, of course, but an amplification of the

round stick of the primeval savage, slid by the pressure of one hand through the other hand closed around it as a guide, and pushed down over a hole in a flat stone, as imagined in the early part of the last chapter. In this case the ram  $R$  is shown of a rectangular cross-section at  $vw$ , that it may not revolve and alter the relation of the dies to each other. It can obviously perform, within certain limits of pressure, all the functions of a press if the ram is simply pushed down by the hand of the operator. Indeed, such presses, with a spring added to lift the ram, are frequently seen upon office desks for embossing documents of various kinds. If it is worked upon a somewhat different principle, by the ram being lifted and allowed to do its work in falling, it then becomes a true drop press.

In Figs. 15 to 20 are shown cross-sections of various rams in common use, Fig. 18 being perhaps the most popular, its wear and that of its bearings being easily "taken up" by the adjustment of a single "gib." Fig. 20 is obviously arranged to slide upon round columns.

In Figs. 25 to 46 are shown, diagrammatically, a series of rams,  $R$ , with the press frames which guide them omitted, and with the various driving mechanisms crudely indicated by mere lines, which will, however, serve to show the principles involved. At  $f$  are shown the lever fulcrums which abut upwardly within some part of the frame structure. At  $S$  are shown the respective shaft bearings used in the case of power presses. These in Figs. 36, 37, 38 and 39 evidently also abut upwardly.

Describing these diagrams: Fig. 25 shows, in side view section, a hand lever press; Fig. 26, a foot pendulum press; Fig. 27, a foot lever press; Fig. 28, a hand lever toggle press; Fig. 29, a foot pendulum toggle press; Fig. 30, a foot lever toggle press; Fig. 31, a power crank lever press; Fig. 32, a power cam lever press; Fig. 33, a power crank

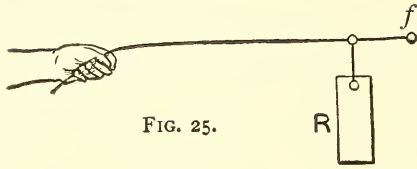

FIG. 25.

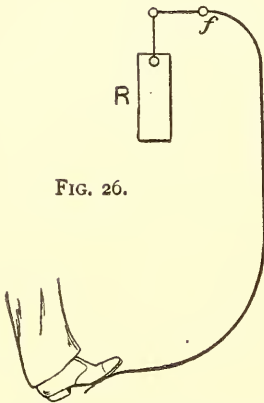

FIG. 26.

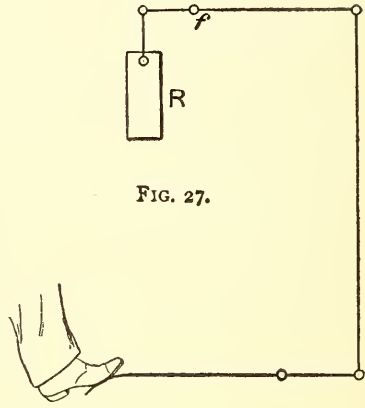

FIG. 27.

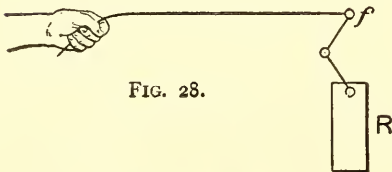

FIG. 28.

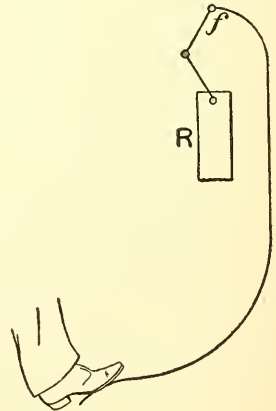

FIG. 29.

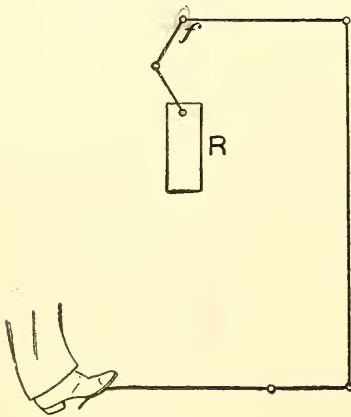

FIG. 30.

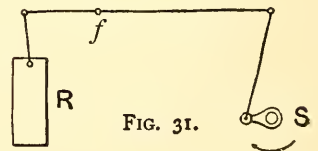

FIG. 31.

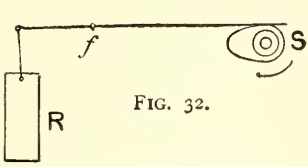

FIG. 32.

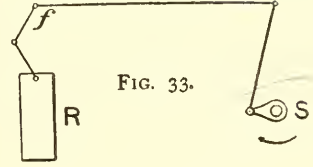

FIG. 33.

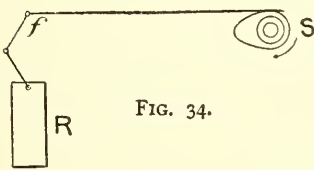

FIG. 34.

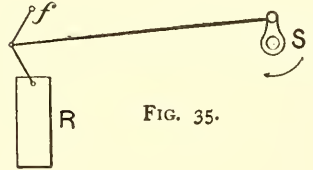

FIG. 35.

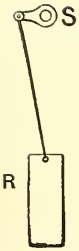

FIG. 36.

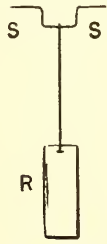

FIG. 37.

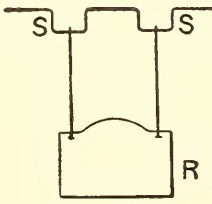

FIG. 38.

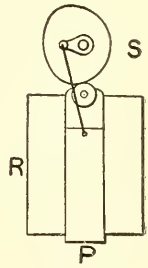

FIG. 39.

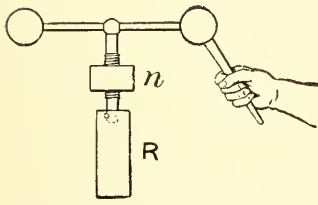

FIG. 40.

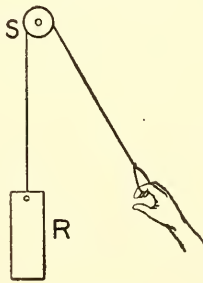

FIG. 41.

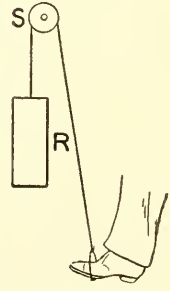

FIG. 42.



FIG. 43.

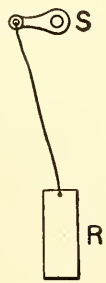

FIG. 44.



FIG. 45.

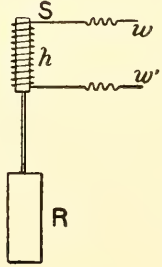

FIG. 46.

lever toggle press; Fig. 34, a power cam lever toggle press; Fig. 35, a power toggle press; Fig. 36, a power crank press, ordinarily known simply as a power press. Fig. 37 is a front view of the same, with the ram at down stroke; and Fig. 38 a front view of a power double crank (sometimes called a double pitman) press. These latter are often used for large work, where the ram needs to be very long from right to left, and would not very well maintain its parallelism with the bed were it driven down at one point only. In Fig. 39 is shown the ram of a double-action press, driven down by cams working upon rollers, and a plunger, *P*, sliding inside of it, driven by a crank and pitman. Sometimes, in a nearly similar press, the ram is driven by cranks instead of cams, these being of shorter stroke than the plunger crank and set to move in different "time." Fig. 40 shows a hand screw press, with the nut *n* abutting upward in the press frame. Such presses are sometimes driven by power also, by means of any appropriate arrangement of reversible gearing connected with the screw. Fig. 41 shows a hand drop press, wherein muscular action stores up the energy developed by gravity rather than performs direct work, and in Fig. 42 is a foot drop press. In both of these cases the ram is lifted by a downward pull upon a cord or strap running over a sheave at *S*. In some cases such muscular action is assisted by a pulley at *S* being made to constantly revolve by power, the tightening of the cord giving sufficient friction to raise the ram, which, however, falls and slides the cord over the pulley when no downward pull occurs at the other end. In Fig. 43 is shown a drop press with a roller-lifter for the ram; and in Fig. 44 a crank-lifter drop press. The rollers and crank are respectively driven by power, the rollers being separated when the ram is to drop, or, in the other case, the crank being thrown out of gear with its driving shaft. Fig. 45 shows a pneumatic, steam, or hydraulic press, the



ram being driven in one or both directions by a piston in cylinder, *C*. In Fig. 46 is represented one form of a magnetic press, where the ram is actuated by a solenoid, consisting of a bar of iron, *S*, which is drawn into a helix, *h*, or its equivalent, when a current of electricity is passed through the wires *w w'*.

#### CLASSIFICATION BY POWER APPLIED.

Press nomenclature enjoys another system of classification, which has, perhaps, been sufficiently indicated in the last paragraph, consisting of the kind of power applied. Thus we have various members of the family christened as hand presses, foot presses, power presses, hydraulic presses, etc. It is sometimes the case, however, that a foot press is supplied with a power attachment, and that a power press is equipped so that it can be worked by hand, usually by fastening a crank to the fly-wheel thereof. Again, a hydraulic or magnetic press is really a power press, because power, in the conventional sense of the term as derived from a revolving shaft, driven by steam or otherwise, has been used to force the water or electricity through the pipes or wires connected with the press. On the other hand, a hydraulic press might have its water supplied by a hand pump or even by a device supplied with a foot treadle.

It will thus be seen that press names are still somewhat indefinite when derived from power-supply conditions, as well as others that we have considered or are to consider.

#### CLASSIFICATION BY FUNCTIONS.

Still another classification is commonly used in the commercial baptism of the useful machine which we are studying, viz., that of functions. Thus we have the word press prefixed with the adjectives shearing, punching, cutting, form-

ing, bending, embossing, coining, stamping, drawing, deepening or reducing, broaching, etc., almost *ad infinitum*.

These names too are often misnomers, as any one of the presses named will upon occasion perform more or less perfectly some or all of the other functions in question. Usually, however, the majority of its work is as indicated by its name.

#### CLASSIFICATION BY MATERIALS WORKED.

Whether or not the classifications which we might elect to use are infinite in number it matters not; the fact remains that there seem to be an inconveniently great quantity. I will, however, mention but one more, which is derived from the material worked upon, thus giving us such names as tin presses, leather presses, soap presses, pill presses, brick presses, etc., the last three being, perhaps, distant cousins of the sheet-metal press family, although much like them in many points of construction, and in the employment of the general principle of compressing and embossing the material used, very much after the manner of an ordinary coining press. Such machines as hay, cotton, and cloth presses are still more distant relations, but yet show a family resemblance in both gait and features, so to speak.

#### NAME-GUESSING.

From the foregoing it may be inferred that when a metal-worker tries to solve some of the conundrums suggested by this subject, by going forth to select a press from among the numerous kinds and sizes so freely advertised in the market, he will find them classified and named by their motions, their position, their shape of frame, their method of support, the kinetic principle of their driving mechanism, their mode of obtaining power, their functions, and the material worked in them. Furthermore, these distinctions are

overlapped and interwoven with each other in every imaginable direction, as, for instance, when any one of a half dozen distinctly classified presses may with equal facility be sold him for a cutting press, or where all sorts of functions may be performed by a power press, etc. His only recourse is to have a general knowledge of the whole subject. This he must use judiciously, in connection with the advice furnished him by the press-maker, so as to get a machine to suit him, regardless of what particular string of adjectives (as numerous, perhaps, as the Christian names of a Spanish duke) may be tacked on to the particular article which he will finally select.

#### POINTS FOR A PRESS-BUYER.

In general, a few of the most important points to be considered by the purchaser of a press are as follows: 1. A great excess of strength and rigidity, that it may not break down or spring unduly from its normal shape. 2. Great length to the ram and ample surface of the proper shape upon its bearings and the parts of the frame which confine and guide it. 3. Accuracy of workmanship, especially in regard to the ram and its relations to the bed. 4. Durability, as secured by ample proportions in the smaller details and by sufficient bearing surfaces upon all the wearing parts, together with proper material, properly hardened where necessary. 5. All the "clumsiness" possible in the bed, ram, and parts adjacent thereto, to give plenty of the "anvil principle"; that is to say, plenty of inertia to resist sudden blows without undue vibration. 6. Convenience of manipulation, both in operation and adjustment. 7. Ample length of adjustment in the ram and other members having variable positions, together with plenty of die room in general. 8. Beauty and harmony of general design. This latter point may be sneered at as of no practical consequence by some

non-esthetic Philistines whose souls are but part way civilized. Such men, however, must sometimes buy presses. For their financial benefit I will say that, in the long run, those machines which are most artistically proportioned will, necessarily, have their materials so located in detail as to do the most good for the least money. They will, therefore, be the strongest and most durable.

### ARTISTIC DESIGN.

True art in machinery, however, does not consist in imitating the façade of a Gothic cathedral upon the side of a frame casting; or in making it look like a grape arbor, vines, leaves, grapes, and all—both of which I have seen done by prominent makers. Neither does it manifest itself by painting birds and flowers and beautiful things upon an innocent press frame in all the colours of an autumn forest, as, some years ago, used to be so much the fashion. Real art is practical, and it is truthful. It does not allow an iron casting to imitate a wood molding or a stone carving, but only, merely, to be, honestly, *a casting*.

This, for strength and cheapness as well as beauty, should be of the simplest shape possible, consistent with its functions and the position and direction of the stresses within it. It should have simple rather than complex contour lines, and should, as far as practicable, be made bulky and hollow rather than with disfiguring external strengthening ribs. Sharp corners should be avoided where not actually required, and the whole surface should have a “rounded up” appearance in general. Bosses, lugs, and other projections from the main body of a casting should look as if they *grew out of it*, as do the branches from a tree trunk, instead of seeming as if they were stuck-on afterthoughts. Forged work should follow the same rule, as far as is consistent with forging

operations. To sum up, every member of a machine should appear to be what it is, without shams or imitations.

### SOME POWER-PRESS PROBLEMS.

Such of my readers as are interested in analyzing more closely some of the various points involved in the mechanism of ordinary power presses I will refer to a paper read by me before the American Society of Mechanical Engineers some years ago, entitled "Power-press Problems," which will be found in Vol. IX., page 161, of its "Transactions." From this paper I quote a few paragraphs, as follows:

"To the maker and user of machine-tools, which are often quite complicated in their construction and action, the machine commercially known as a 'power press' may seem too simple to require any literature of its own. If the motions are analyzed which are required in the two general classes—machine-tools and presses—it will be found, in machines of the planer type, for instance, that it is necessary to move either the work or the cutting tool in an accurately straight line to a considerable distance against a cutting pressure, and in two other straight lines, both at right angles to this first line, and one of which has its direction adjustable to make an infinite number of angles with the other. For the necessary feeds and adjustments these motions must be in both directions, and in the case of the first-mentioned one the backward or return motion must be much faster than the forward motion.

"In machines of the lathe type, in which may be included screw machines, milling machines, boring and drilling machines, etc., there is frequently a similar set of motions to the last two described for the planer; while for the first-named rectilinear movement is substituted a rotary one, so as to produce cylindrical and conical surfaces instead of

planes. In both types of machines many of the motions must be reversible, intermittent, and variable in speed. These requirements, together with all the adjustments necessary, and the great strength and rigidity which ought to be, but are not always, embodied in such tools, make them ponderous as well as complicated, and consequently expensive. This ponderosity or clumsiness for the stationary and slowly moving parts the writer has elsewhere advocated in writing of the 'anvil principle' vs. the 'fiddle principle' when criticising the extreme flimsiness of many of the machine-tools in the American market. . . .

"A power press, to a casual mechanical observer who had not studied it as a specialty, would seem to be far easier to design than the machine-tools proper, mentioned above, but after taking it up as a specialty his judgment would be reversed, and he would find several knotty problems to keep him awake at night while the builder of lathes or planers was quietly sleeping the sleep of the just. This difference arises partly from the fact that power-press building is both a newer and a smaller industry than the making of machine-tools. It has not been so fully experimented with, either in point of time or in regard to the number of experiments—in other words, these machines have not arrived at the same stage of development in the evolution of their race as have the older and more numerous tribe of lathes and planers.

"A more important difference, however, lies in the fact that machine-tools are subjected to very little percussive action, while all the parts of a power press are constantly endeavoring to hammer themselves and each other to pieces. This is due chiefly to the fact that the work in the dies offers a sudden resistance to the moving parts when it is struck, and, incidentally, to the sudden stopping and starting of several heavy members of the machine while the wheel which drives them revolves at a constant speed.

“As a consequence of these conditions one of the problems arising is, how to fasten the parts together so that nothing will jar loose or come apart while in action. . . .”

A study of the above-mentioned conditions, and of presses themselves doing actual work, will convince the knowledge-seeker in this field that a press is a *suicidal organism* which is constantly trying to do itself serious, if not fatal, damage. It naturally, therefore, requires more of the doctor's care than do ordinary tools, and is oftener in hospital. These facts should make its owner more lenient in regard to its periodic disabilities than is often the case in press-working shops, where “swearing matches” at the press-makers are not an uncommon event.

#### CLUTCHES.

The most unhealthy organ, so to speak, pertaining to the anatomy of a power press is the automatic-stop-clutch. The function of this device is, at the will of the operator, to suddenly make a driving connection between the constantly revolving fly-wheel and the temporarily stationary main shaft. Its further duty is to disconnect these members again automatically—usually after the shaft has made exactly one revolution, and when the ram has reached its up, or open, position.

There are many forms of these clutches in use, some better than others, but it is safe to say, in general, that there are no perfectly good ones.

This is because of the great difficulty of making a device of the kind which will meet the widely varying conditions to which presses are often subjected after the maker has lost sight of them. Among these conditions are considerable variations in speed, in brake adjustment, in lubrication, in tightness of running parts, in shaft load and ram load, in nature of feed and other attachments, in the resilience of the

work between the dies and of the dies themselves, etc., etc. These differences cause "over-running" and "under-running" of the shaft, more or less difficulty of disconnection, etc., and, altogether, make a clutch more suicidal in its tendencies than is the press as a whole. The most destructive action of all is usually the instantaneous starting of the shaft and appurtenances from a state of rest, at their maximum rate of speed, instead of allowing a gradual acceleration. This is sometimes avoided by the use of friction clutches, but with these certain other difficulties are apt to appear, especially with non-gearred, fast-running presses.

#### SUB-PRESSES.

For various kinds of work of a small and delicate nature a device called a sub-press, mounted upon a press proper, between the bed and the ram, is in rather extensive use, especially for jewelry, watch- and clock-work, etc. Such a tool usually consists of the frame and ram of a small press, somewhat resembling Fig. 1, page 17, or, more frequently, as far as its frame is concerned, a columnar type of machine such as is shown in Figs. 7 and 8, page 21, but usually of a more compact design. Its base is firmly clamped or otherwise secured to the bed of the main press, while the top end of its ram is coupled somewhat loosely to the bottom of the main ram. Thus the up and down motion of the latter is transmitted to the sub-ram, and the punch attached thereto, while a lateral freedom of motion is allowed which prevents the little ram suffering by any inaccuracies of the comparatively clumsy big one. The coupling together is usually done by a tee-shaped head entering a groove of like conformation.

The object of using a sub-press is twofold, the first reason being that the delicate and expensive little dies which



it generally operates may be accurately located, and fastened once for all in a machine which will maintain their alignment better than can be done with frequent resettings, and with the springiness and lost motion, due to a large press whose ram is at a considerable distance above its bed, and which, moreover, has not as a usual thing the near together columns and closely fitted ram easily attainable upon the sub-press.

The second reason referred to is the general convenience, and adaptability for quick setting, incident to a device which keeps its dies always ready set in relation to each other, and which needs but to be roughly attached to a big press that does not have to be kept in such transcendently good order as would otherwise be necessary. The type of press employed for this work may vary considerably, but should usually comprise a rather short stroke, and a considerable height between bed and ram, together with a delicate down adjustment of the latter. Great accuracy of ram fit, etc., as before intimated, is not essential, this being provided for in the simple, but highly organized, little sub-machines, each of which belongs, for the time being, to its own pair of dies alone.

## CHAPTER III.

## A "MUSEUM" OF PRESSES.

## PRESS LITERATURE.

AS far as the writer knows, the literature of this subject, outside of press-makers' catalogues, is extremely limited. It is, however, to be hoped that in the not too far off future somebody will give to the world a comprehensive biography of a family of machines which are far too useful to remain much longer in the realms of literary oblivion.

In commencing this treatise there was no intention of making it a natural history of the press family, although it has seemed necessary to treat the different varieties somewhat in detail in order that subsequent descriptions of dies, together with the materials worked in them and the operations thereupon, may be clearly understood. Were it a thorough-going treatise upon the machines in question, it might well of itself occupy a bulky volume, which should properly include several hundred portraits in perspective of the various types of these interesting tools. There might seem to be, however, another reason besides lack of space for omitting such a set of pictures, viz., because it would be difficult to so limn them as not to make apparent some of the designs of well-known makers which are in the market, and thus lead to a suspicion of invidious distinctions, unless indeed it were possible to take composite photographs of all the good presses of each particular kind.

This somewhat sentimental view of the case would, however, keep all the good actual presses, with their time-proved

virtues, entirely out of sight, and would limit the pictorial literature of the subject to figments of the imagination, so to speak. There is therefore shown in the illustrated pages of this chapter a number of groups of characteristic presses, each group representing an important type, but not, of course, attempting to show a complete list of all possible varieties.

### A PICTORIAL COLLECTION.

The majority of the pictures in question are taken, by permission, from the catalogues of eight or nine leading American press-makers, two or three makers in England, and one or two in Germany. The English pictures are marked "E," the German "G," and the remainder, which are left unmarked, are American. No other European pictures happened to be available, but they would not vary much from those shown.

It will be noticed that some of the foreign designs shown resemble closely certain of the American ones. In some cases this is due to foreign makers having imitated something which they found in this country; indeed, the writer knew of a case where one of his own machines, of a new and unique design, was absolutely reproduced abroad. Such copying obviously cannot be prevented without having comprehensive foreign patents, but in the absence of these it is of course perfectly legal and may be considered in the light of a compliment to the designer.

To balance alleged grievances of this kind, where Americans are sometimes apt to grumble at their ideas being appropriated, we must remember that very much of our American machinery is directly descended from European models, although perhaps in some cases considerable revision and improvement has been made.

The pictures shown upon the various pages in this chapter

do not in all cases give a sample from each of the makers above mentioned in any given group, although most of the pages contain a considerable variety of different people's designs. The individual presses in each group have been selected as best representing a general type, with all the minor variations possible, so that a comparison can be made between several perhaps equally good methods. The nomenclature used is as unsystematic as might be expected from the explanations in the previous chapter, being sometimes derived from the anatomy, sometimes the functions, and sometimes other circumstances connected with the machine in question. On the whole, however, it adapts itself as nearly as possible to the popular names commercially used in the engineering world. Just what such a collection of machines as the one in question should be called in the aggregate is a question to be considered. In lieu of a better name perhaps the title of this chapter, "A Museum of Presses," may answer as well as anything available. In view of the variety of families shown and the variations among their individual members, it is probably a sufficiently suggestive one.

These press portraits are drawn to an approximate scale of  $\frac{1}{4}$  inch to the foot, and are therefore about  $\frac{1}{8}$  of real size.

#### HAND PRESSES.

On page 45 are shown a number of presses worked by the hand of the operator, Figs. 47 to 49 having the common feature of being throated screw presses standing upon the floor, but Fig. 48 being different from the others in having the frame inclinable upon its legs, the handle adjustable around the screw, and the screw incased. Fig. 49 is arranged as what is called a sprue-cutter, having mounted in it chisel-like upper and lower dies for cutting "sprues" off from castings.

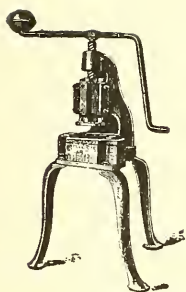

FIG. 47.

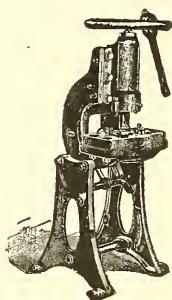

FIG. 48.

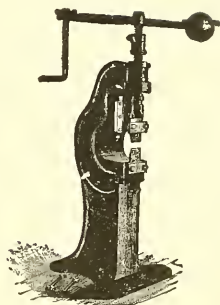

FIG. 49.

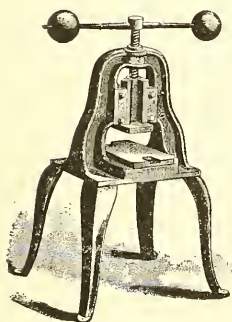

FIG. 50.

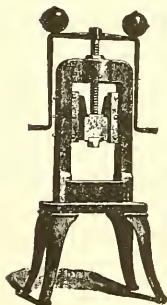

FIG. 51.

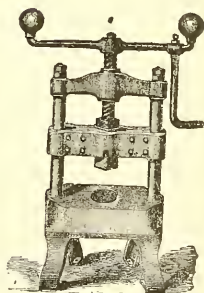

FIG. 52. E

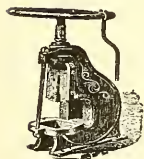

FIG. 53.

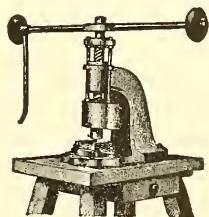

FIG. 54. G



FIG. 55. E



FIG. 56.

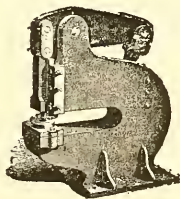

FIG. 57.

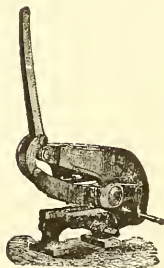

FIG. 58. G

Figs. 50 to 52 show columnar screw presses, the first mentioned being sometimes called an arch press, from the general shape of its frame.

Figs. 53 and 54 show throated bench screw presses, the first mentioned being provided with a stay-rod, one or two of which members are often added to any sort of a throated press to make it approximately resemble a columnar press in point of stiffness.

Figs. 55 and 56 show throated portable screw presses such as are usually employed for punching boiler sheets, etc., which cannot easily be moved to a stationary press.

Figs. 57 and 58 show hand-lever presses arranged for punching and shearing respectively. In the former the lever has been removed from its socket and does not appear in the picture. Such machines were formerly more extensively used than now, in this day of hydraulic pipes and electric wires.

### FOOT PRESSES.

On page 47 are shown in Figs. 59 and 60 inclinable lever foot presses by different makers, both of which happen to be mounted with bolsters equipped with special die-clamps for quickly gripping the lower die.

Fig. 61 shows an upright lever foot press which might be considered either of the bench or floor type, according to whether the wooden table is really counted as a part of the machine.

Fig. 62 shows a lever foot press with adjustable bed, and with its frame extending down in the form of a pedestal to the floor. Fig. 63 represents a pendulum foot press with removable pedestal, so that it can be arranged as a bench press.

Fig. 64 shows a lever bench press of small size, and Figs.

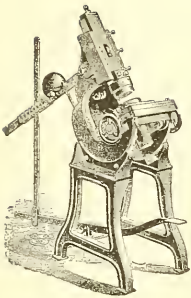

FIG. 59.

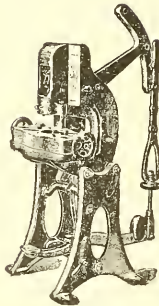

FIG. 60.

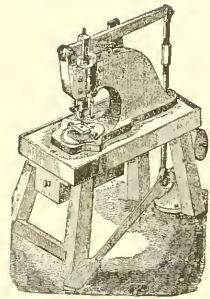

FIG. 61. G

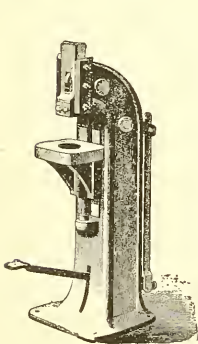

FIG. 62.

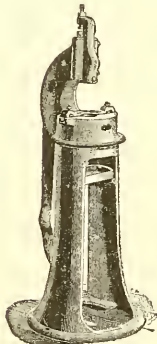

FIG. 63.

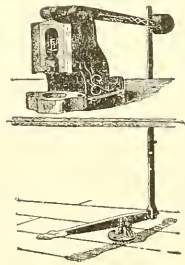

FIG. 64.

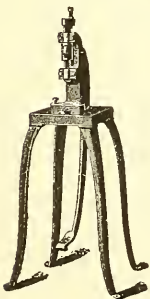

FIG. 65.



FIG. 66.

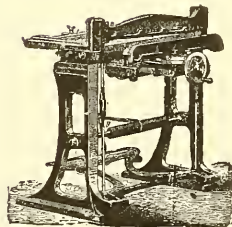

FIG. 67. G

65 and 66 pendulum presses, the latter being mounted as a bench press.

Fig. 67 pictures a lever "squaring-shear" which, although not usually termed a press, is as much so in reality as are many others which happen to be provided with shearing rather than punching tools.

The term pendulum is generally used, instead of the word lever, which it might logically be called, to designate the main operating lever of a press which extends direct to the pedal, rather than being connected therewith by a pitman and a separate treadle-lever, as in the so-called lever presses.

#### DROP PRESSES.

On page 49 is shown in Fig. 68 a hand or foot bench drop press, where the hammer is lifted by muscular power applied by the hand or foot in the respective stirrups attached to the rope.

In Fig. 69 is shown a much larger machine, where a revolving pulley at the top gives sufficient friction to raise the hammer when the free end of the belt is tightened by the hand of the operator, which follows its motion as it descends.

In Fig. 70 is shown a portable crank "lifter" for lifting and suddenly letting go of the hammer in almost any drop press, such as, for instance, in Fig. 72 or 73.

In Fig. 71 is shown a large drop press with its ram lifted by rollers pinching a board attached thereto. Fig. 72 illustrates another columnar, and Fig. 73 a throated, drop press, either of which might have its ram lifted by the same kind of rollers, or otherwise, as desired. It will be noticed that the last-mentioned machine is equipped with a dovetailed die chuck, while most of the others hold the lower die with set screws in lugs projecting up from the bed. These are



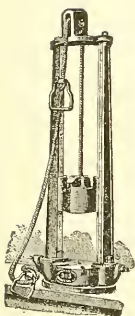

FIG. 68.

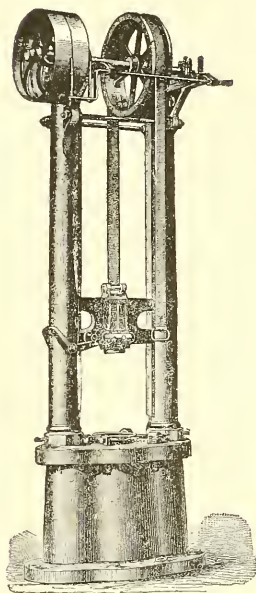

FIG. 69. G

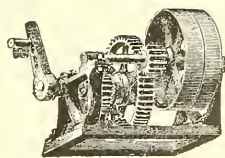

FIG. 70.



FIG. 72.

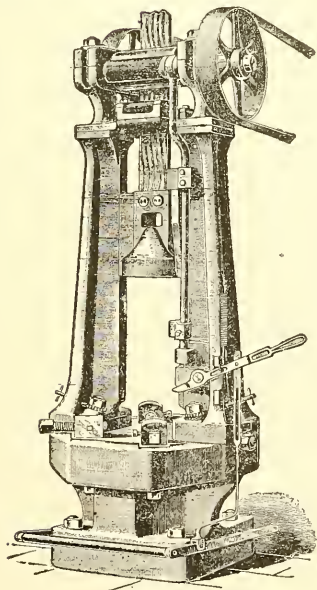

FIG. 71



FIG. 73.

technically called "poppets." The upper die is usually dovetailed into the ram; or, if of soft metal, it is held by casting it into or onto some undercut recess or projection of proper shape.

In Fig. 146 (at the end of this chapter) is shown a large steam drop press, which might or might not have the force of gravity augmented by allowing steam to enter the top of the cylinder, as well as the bottom. Its principal function, however, is to merely lift the ram. This much resembles a regular steam hammer in general design, and has been separated from its fellow drop presses that it may appear with the other members of its fluid-operated family.

#### POWER CUTTING PRESSES.

On page 51 are shown in Figs. 74 to 82 a number of throated so-called cutting presses, their chief characteristics being that they are of a type which is considerably *spread out*, as it were, in lateral directions, so as to take large dies and give room for large bed-holes. They are chiefly used for "blanking," and are generally built lighter in proportion to their extreme dimensions than are some other types of machine intended for heavier work.

Without describing these in detail it may be remarked that the collection is somewhat unique, as showing no less than nine distinct methods of inclining the frame upon the legs. All of these but one have the common fault of requiring a different length of belt for different degrees of inclination. This one is Fig. 78, which, on the other hand, has the disadvantage of requiring much more metal in the legs, on account of their extra height, than do the others. It is, however, a convenient machine.

It will be noticed that the axis of oscillation in some of these presses is a considerable distance back of the ram axis,

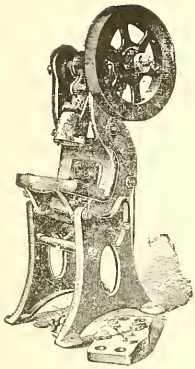

FIG. 74.

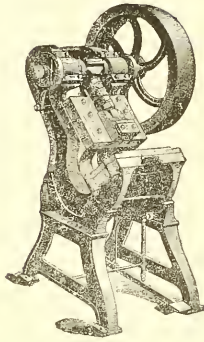

FIG. 75.

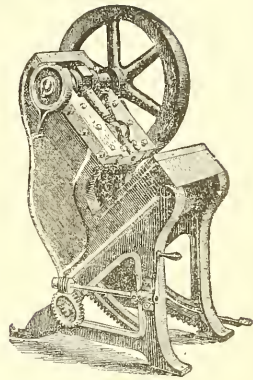

FIG. 76. E

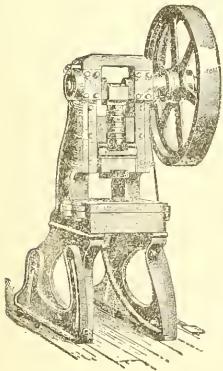

FIG. 77.

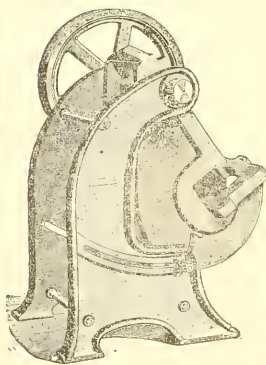

FIG. 78.

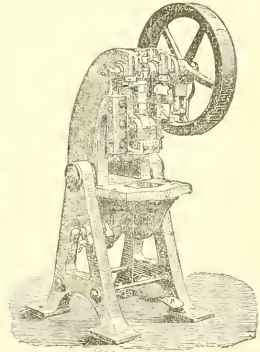

FIG. 79. G

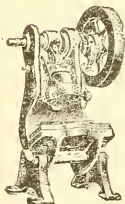

FIG. 80.

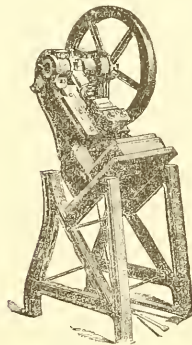

FIG. 81.

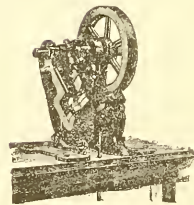

FIG. 82.

which causes the front of the bed to rise unduly when it is inclined. The further forward this swinging point can be placed, within reason, the more convenient is the height for the operator.

#### POWER DOUBLE-CRANK PRESSES.

On page 53 are shown in Figs. 83, 84, and 85 various designs of so-called double-crank presses which will at a glance explain themselves. It will be noticed that two of these are what are technically termed "geared" presses, in contradistinction to the "non-geared" kind, which constitute the majority of the press family. The difference consists in interposing a train of gearing (usually a small driving and a large driven cog-wheel) between the fly-wheel shaft and the main shaft, instead of mounting the fly-wheel upon the latter shaft direct. The machines here shown are sometimes functionally designated stamping presses, to distinguish them from smaller types of cutting presses which have but a single crank and pitman. They are sometimes also called double-pitman presses. The ram adjustment is usually arranged with some coupling of the pitmans, that they may lengthen and shorten in unison.

Fig. 86 shows a "twin" press, which is really nothing but two machines mounted upon a common table and set of legs, although its appearance is that of one machine, somewhat resembling the ones referred to in the paragraph above.

In Fig. 87 is shown a power squaring-shear very similar to the one operated by foot-treadle before referred to, but in its general kinetic construction strongly resembling the double-crank presses which appear above.

In Fig. 88 is shown an entirely different form of double machine where each individual twin approaches toward or recedes from his fellow, so as to shear off both ends of the work at once to a predetermined length.

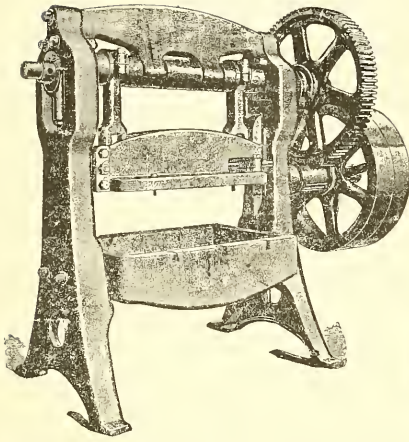

FIG. 83.

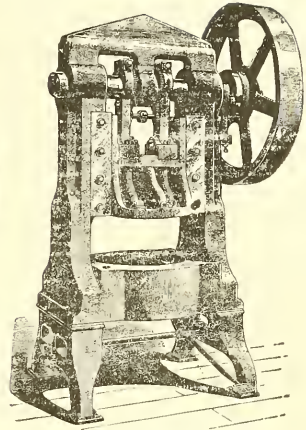

FIG. 84.

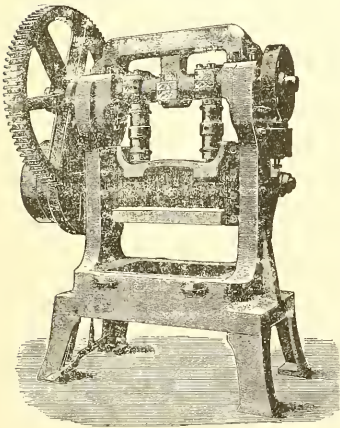

FIG. 85. E

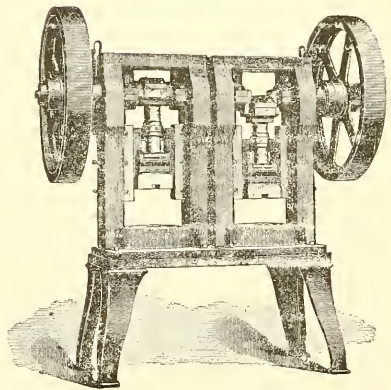

FIG. 86. E

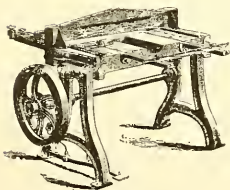

FIG. 87.

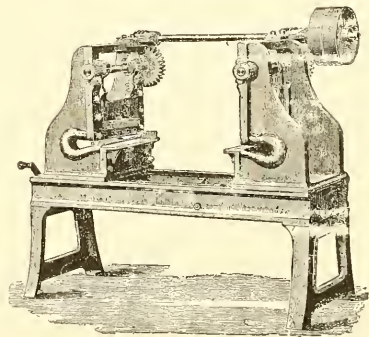

FIG. 88. E

## POWER EMBOSSING PRESSES.

On page 55, in Figs. 89, 90, 91 and 92, is shown an ordinary type of columnar embossing press, being so called on account of their unusual rigidity and strength, in comparison to their size. This does not mean, however, a limitation to the function of embossing, but only that these machines are specially adapted for such work. The principal variations from the common type in the group mentioned are the wedge ram adjustment in the case of Fig. 89, and the eccentric ram adjustment in Fig. 92. The last named, it will be noticed, is a geared press, while the others have the fly-wheel upon the main shaft.

In Figs. 93 and 94 are shown embossing presses of a more powerful type, having the ram driven up from the bottom by toggles. One of these is double-geared, as it is termed—that is, there are two pairs of gears and an intermediate shaft embodied.

## POWER PUNCHING PRESSES.

On page 56, in Figs. 95 to 97, are shown different makes of the ordinary type of punching press, so called, with the fly-wheel at the back, and with a bed-hole large enough to allow for other work than the mere punching of rivet-holes and such. It will be noticed that the ram adjustment, clutches, etc., vary considerably in these machines, as they do in many others yet to be set forth. There is scarcely, however, an opportunity to here describe these devices in detail.

In Figs. 98 to 100 are shown machines intended for small-diameter punching only, the latter being geared, and also being arranged so that it can be run by hand as well as power. The little machine pictured in Fig. 99, unlike the others, is a

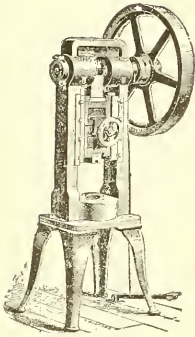

FIG. 89.

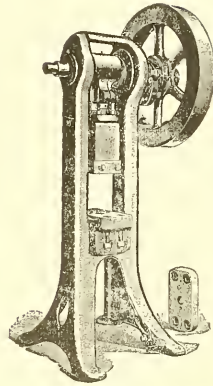

FIG. 90.

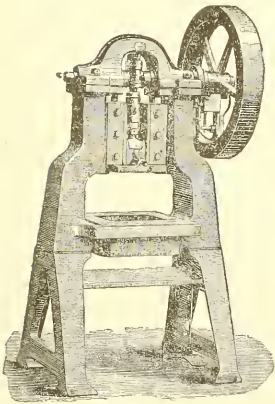

FIG. 91. G

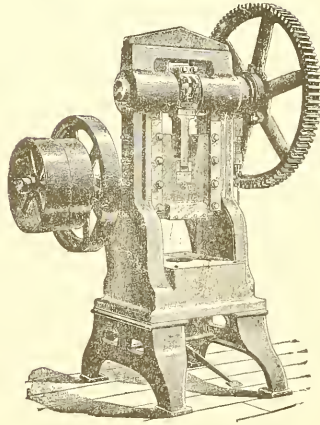

FIG. 92.

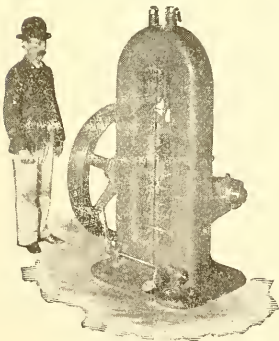

FIG. 93.

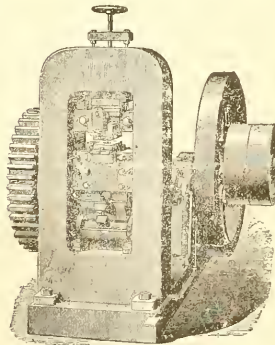

FIG. 94.

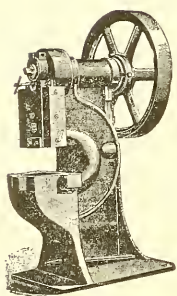

FIG. 95.

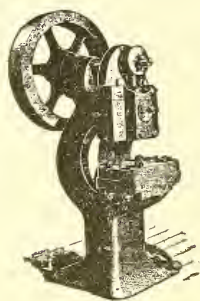

FIG. 96.

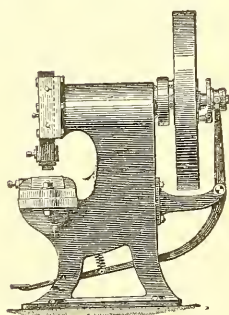

FIG. 97. E

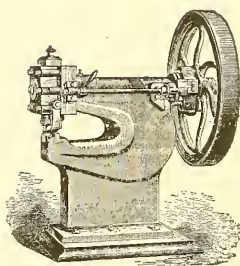

FIG. 98.



FIG. 99.

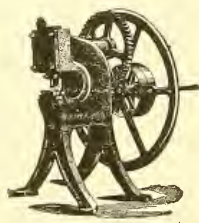

FIG. 100. E



bench press, of a type often used for making buttons, steel pens, and such work.

#### POWER PUNCHES AND SHEARS.

On page 58 Figs. 101 to 106 show a variety of different makes of punching and shearing machines of the well-known type used in boiler and ship-building shops, etc. It will be noticed that these are all powerfully geared, and that some of them are twin, or double, machines, being arranged to punch at one end and shear at the other. In the case of Figs. 105 and 106, both of which happen to be of foreign construction, it will be observed that the ram is arranged to punch at one end and shear at the other so as to do work while running in both directions instead of only one, as in more common forms.

Fig. 107, page 59, illustrates a machine which is really, as far as its functions go, more like those mentioned as "punching presses," save that it is started and stopped with a hand-lever instead of a foot-treadle, and is not so near the average of conventional design.

In Fig. 108 is shown a double machine with the rams sliding in an inclined position and arranged with special shear-blades for cutting angle-iron. This happens to be provided with an engine mounted directly upon it instead of being driven by belts, as is the case with the other machines on the same page.

Fig. 109 shows a peculiar type of machine used for scarfing or beveling the edges of boiler plates, etc., wherein the ram is inclined somewhat from a vertical position, while the bed remains horizontal.

Fig. 110 represents a heavy punching press of the horizontal type, the ram being in a recumbent position, so to speak, rather than upright as usual.

In Fig. 111 is shown a heavy punching machine having

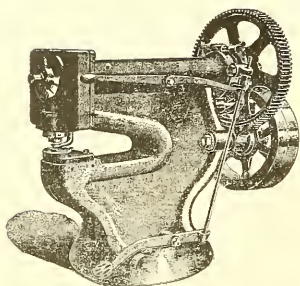

FIG. 101.

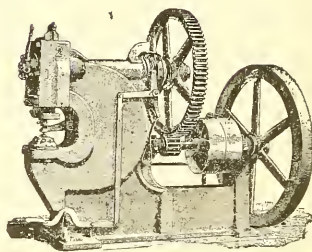

FIG. 102.

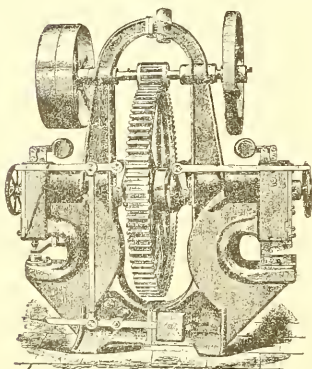

FIG. 103.

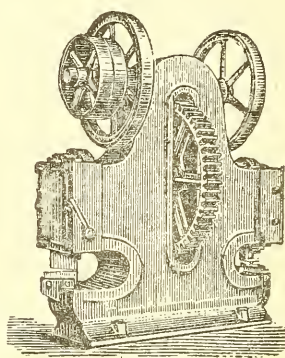

FIG. 104. E

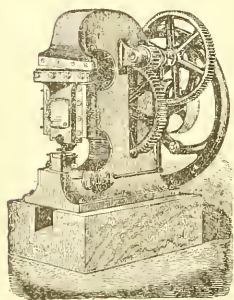

FIG. 105. G

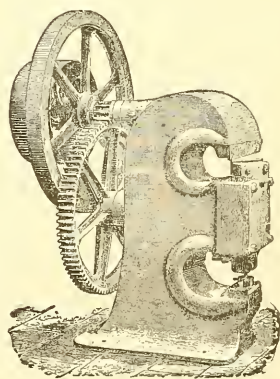

FIG. 106. E

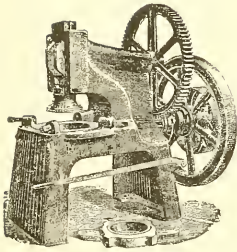

FIG. 107 E.

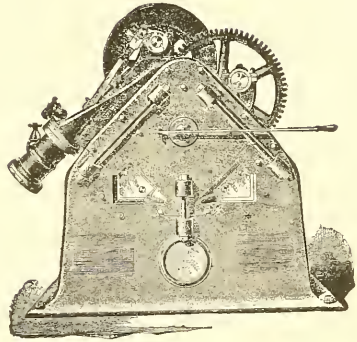

FIG. 108.

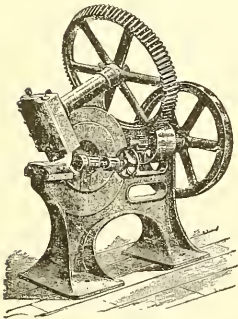

FIG. 109.

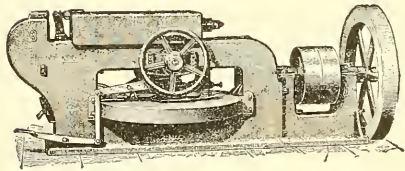

FIG. 110.

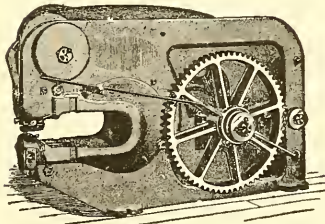

FIG. 111.

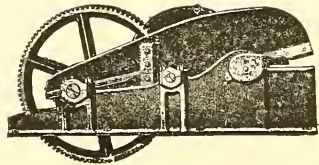

FIG. 112.

its ram driven through the medium of a lever rather than direct from the main shaft, as with most of the others.

Fig. 112 shows what is popularly known as an alligator shear, obviously so named from its resemblance to that long-bodied, strong-jawed animal. In this machine is shown an instance, referred to in an earlier chapter, where the ram of the machine swings upon an axis instead of sliding, and where it really serves to form a part of the main framework.

The name "punches," as applied to many of the above machines, is a commercial one and is somewhat of a misnomer, as the little pieces of steel forming the upper dies are also called punches. This confusion of terms can hardly perhaps be avoided at present, until that hoped-for time when the mechanical world shall be blessed with some good dictionary-making. The machines really should be called "presses," just as much as should any of those we are considering.

One special feature noticeable in these heavy punches and shears is the usual (although not universal) absence of the automatic-stop-clutch so generally used in other types of power presses. In many of them an ordinary clutch, which can be thrown in or out of gear at almost any point of the up or down stroke, is operated by a hand- or foot-lever. In others, especially in England, the "gag" system is used. In these the main shaft runs all the time, and the ram normally stays in up position, except when made to descend by the pushing in beneath the crank-pin box of the so-called gag, which is a wedge-like or other block of suitable shape, usually operated by a hand-lever.

#### POWER CURLING AND HORNING PRESSES.

On page 61, in Figs. 113 and 114, are shown different makes of adjustable-bed presses which are, as arranged in the pictures, equipped for curling or wiring thin sheet-metals,

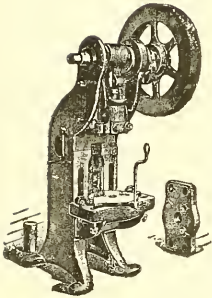

FIG. 113.

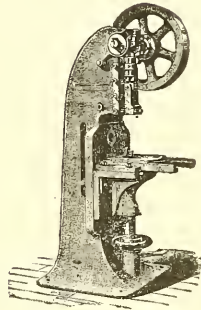

FIG. 114.

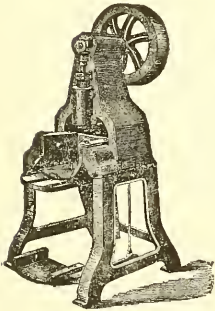

FIG. 115. E

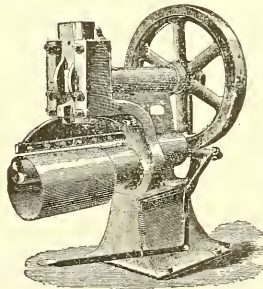

FIG. 116. E

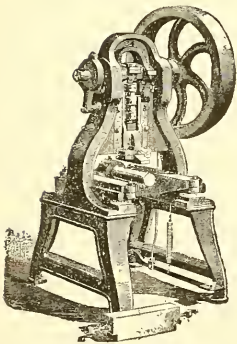

FIG. 117.

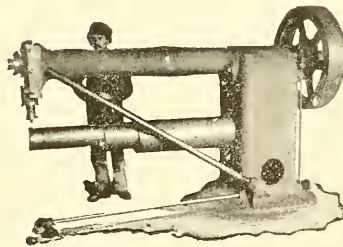

FIG. 118.

but which can, by the lowering or removal of the bed and the insertion of a horn in the large hole shown above the same, be quickly converted into horning presses.

In Fig. 115 is shown a curling press with the bed non-adjustable, with no provision for horning and cutting work, etc.

In Fig. 116 is shown, *per contra*, a horning press pure and simple, having no provision for curling or other work.

Fig. 117 shows a press arranged for horning which can, by the removal of the horn-carrying bolster, and the reinsertion of the loose portion of the bed, shown on the floor removed from the front thereof, be converted into an ordinary cutting press.

Fig. 118 shows a large horning press of a type used for punching and riveting small boiler shells and similar hollow cylindrical work. Such machines usually have the upper arm of the frame, which carries the shaft and ram, strongly braced from the main body of the frame. The lower arm, forming the hornlike bed, cannot be so braced, as it must receive over its whole length the shell to be worked. It must therefore be made of the stiffest material available, and then be allowed to spring what it will.

### POWER DRAWING PRESSES.

On page 63, Figs. 119 to 124, are shown six different makes of large geared power drawing presses, three of them of foreign construction. They are of the usual type, with a plunger moving separately inside of the ram, this plunger in all these cases being driven by cranks or eccentrics upon the main shaft. It will be noticed that in Fig. 119 the ram is driven and held in its "dwelling" position by a system of toggles rather than by cams, as is the case with all the others of this group. Certain interesting variations in the

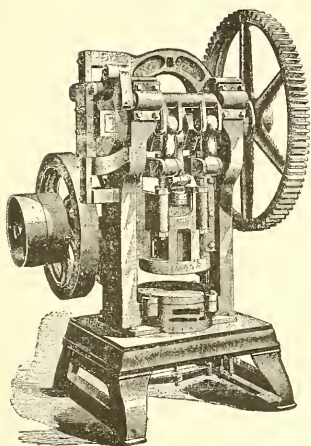

FIG. 119.

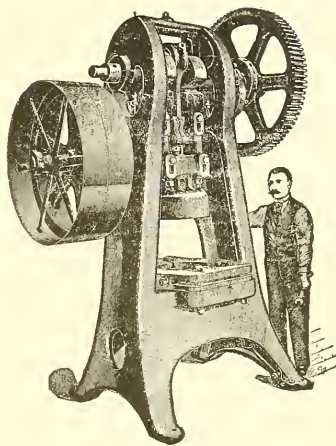

FIG. 120.

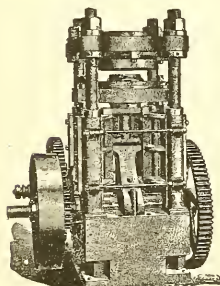

FIG. 121.

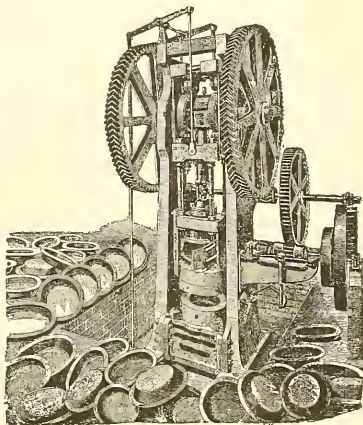

FIG. 122. E

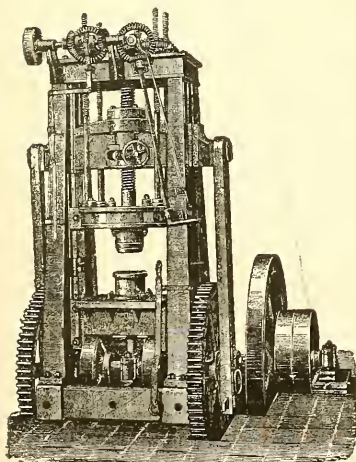

FIG. 123. G

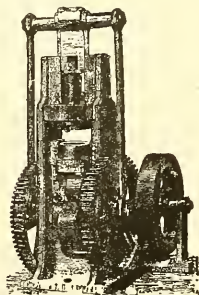

FIG. 124. E

ram and plunger motions may, however, be observed. In Figs. 119, 120, and 122 the ram and plunger both do their work while moving downward from above. In Fig. 121 the effective stroke is upward for both ram and plunger, while in Figs. 123 and 124 the ram moves upward, while the plunger comes down to meet it. The last-named machine is of a design that has been built in America as well as England, but I am not sure as to which country originally gave it birth. Fig. 122 pictures a press so big that it has to be partly sunk in a pit. It is surrounded by its own good works, in the shape of a number of milk-pans that it has drawn from flat blanks.

On page 65 Figs. 125 and 126 show inclinable, non-geared, double-action drawing presses, the frames being both throated and adjustable upon their legs.

Fig. 127 shows the same sort of a machine without the inclinable feature, and Fig. 128 something nearly similar, but set permanently inclined and provided with an embossing attachment. This is of similar design to a certain American press, and one was probably copied from the other. Another feature in the latter machine, different from the others, is the positive lifting of the ram by means of the cams, while two of the others have spring-lifted rams, or a combination of a spring and plunger lift. The first mentioned of all has a toggle-actuated ram. Ram lifting upon large presses of this sort is sometimes performed by special auxiliary cams and levers. In other cases it is done by counterbalance weights, and in still others by the piston of a steam cylinder.

#### POWER RE-DRAWING PRESSES.

On page 66 are shown, in Figs. 129 to 133, several characteristic specimens of geared "re-drawing" or "reducing" presses, whose chief peculiarity is an extra long stroke, their



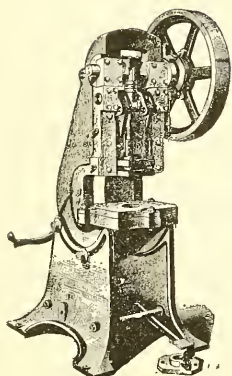

FIG. 125.

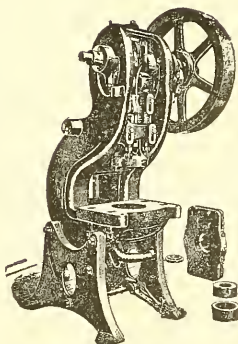

FIG. 126.

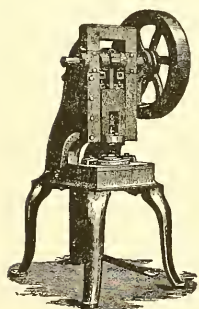

FIG. 127. G

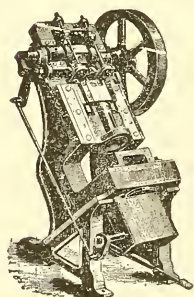

FIG. 128. E

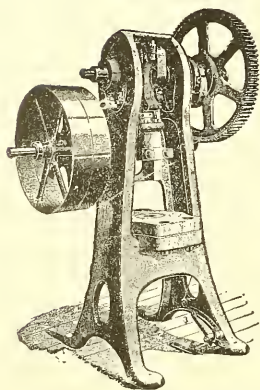

FIG. 129.

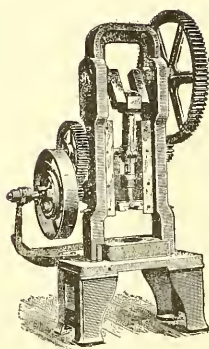

FIG. 130.

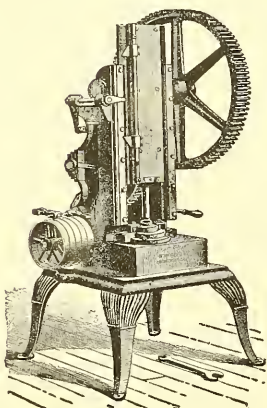

FIG. 131.

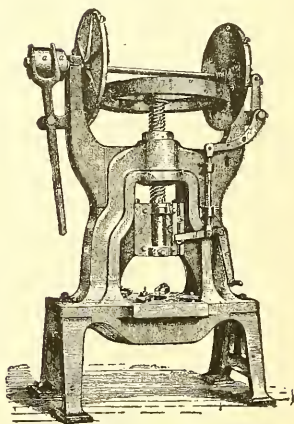

FIG. 132. G

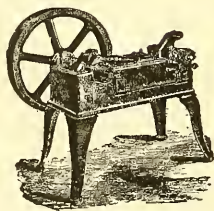

FIG. 133.

motion being single-action. Their function is usually the "re-drawing," or reducing," or "deepening," or "broaching," or "drawing," as the operations are variously termed, of "cups" which have been made from flat blanks of sheet-metal in double-action drawing presses proper, as before described. Obviously their functions need not be limited to work of this sort, however. In Fig. 131 the ram has a variable stroke of considerably greater amplitude than usual, and is operated by a rack and gearing rather than by a crank, as in most of the other ones. The press in Fig. 132 is of the power screw type, having the unique feature (in this country at least) of a screw-actuated ram, where a friction wheel mounted upon the top of the screw is driven by the adjustable friction disks upon the horizontal main shaft, the motion downward being, obviously, an accelerated one. These machines are used in France and Germany to a considerable extent (and for a variety of purposes), but not much, as yet, in this country. Fig. 133 pictures a horizontal re-drawing press with an automatic feeding attachment, such as is used for reducing and deepening cartridge shells, etc.

#### COINING PRESSES.

On page 68 is shown in Fig. 134 an ancient coining press of unknown date. For the representation of this and the next picture I am indebted to the kindness of Mr. Evans of Philadelphia, who published them some time ago in a book describing the Mints of the United States. The lower arm, forming the bed, and the upper arm, serving as the ram, were evidently intended to be brought together by being placed between an anvil and a hammer. Its crude form and cruder method of operation, together with its roughly coined products, speak clearly for themselves.

On the same page, in Figs. 135 to 138, are shown auto-

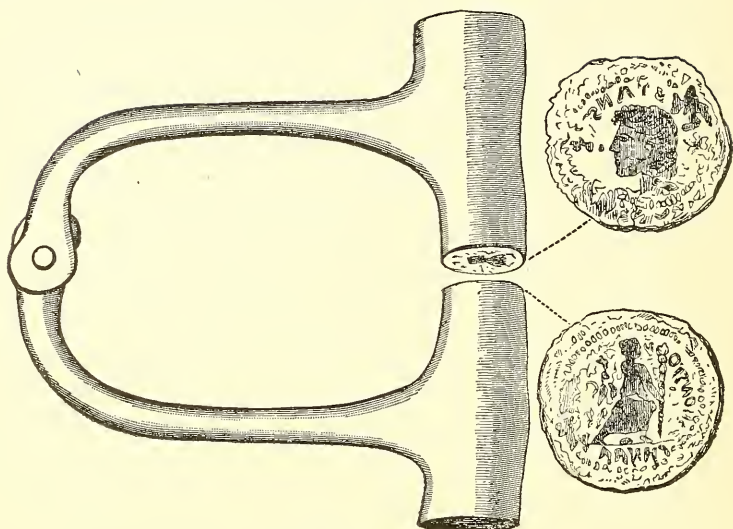

FIG. 134.

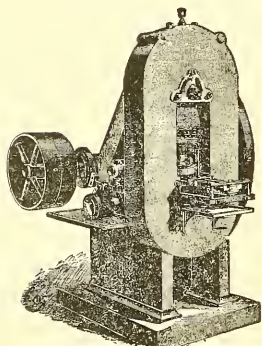

FIG. 135.

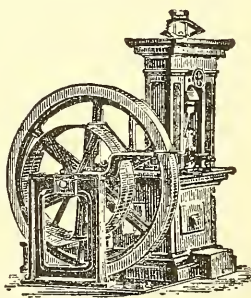

FIG. 136. E

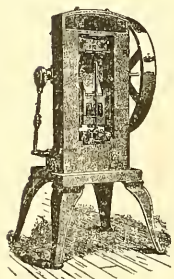

FIG. 137.

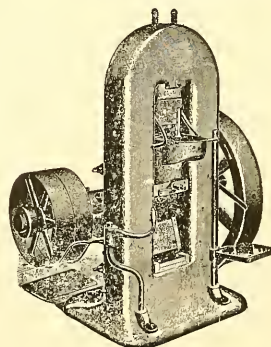

FIG. 138.

matic coining presses with tube feeds, such as are used in the mints of the United States and elsewhere. The last-mentioned one has the ram driven from below, but all of them are operated by powerful toggles, and are provided with a tube in which the blanks, or "planchets," for the coins are placed, the same descending by gravity until pushed in by feeding "fingers" to a position between the dies. Provision is of course made for automatically ejecting the coin from the ring into which it is expanded, and for pushing it laterally away from the machine. Fig. 136 is an English design.

### HYDRAULIC PRESSES.

On the upper part of page 70, in Figs. 139 and 140, are shown respectively a throated and a columnar hydraulic press, the latter being provided with pumping apparatus as an attachment thereof. Such a machine is sometimes used for the heavy coining of medals, etc.; although, as is well known, its additional functions are almost infinite in number, in regard to metal-work and for other purposes. The first-named press is shown equipped for ordinary punching work.

In Fig. 141 is shown a horizontal hydraulic press such as is used for deepening rather large cartridge shells and other similar work. All these liquid-driven machines are very powerful, but comparatively slow in their action.

In Fig. 142 is shown a horizontal hydraulic press wherein the ram is mounted at the top of a high arm, forming a part of the frame, with the bed serving as an abutment and forming another arm, also projecting upward to the same height. The function of such a machine is usually the punching and riveting of steam-boiler shells at a considerable distance from the ends thereof, one wall of the shell being slipped down between the arms mentioned.

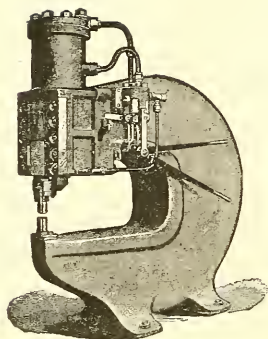

FIG. 139.

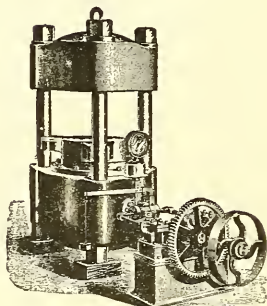

FIG. 140.



FIG. 141.

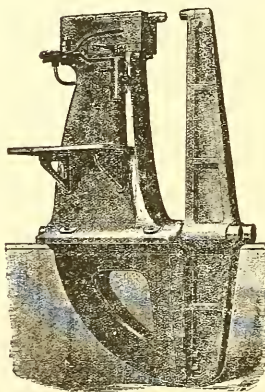

FIG. 142.

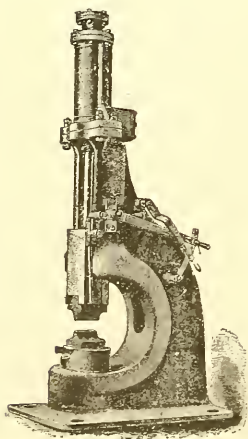

FIG. 143.



FIG. 144. E

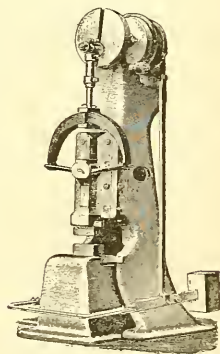

FIG. 145.

## HAMMERING MACHINES.

In Fig. 143 is shown a throated-frame gas hammer, which may be considered as a closely related cousin of the steam-hammer family. The chief differences in construction are due to the requirements of gas rather than steam as the driving fluid. Although it may be objected that a hammer is not, strictly speaking, a press, and therefore that it does not belong in this collection, there is really no essential difference in the *motif* of these two machines.

In Fig. 144 is shown a small steam hammer with the throated style of frame usually employed upon small and medium sizes. The columnar style used for very large hammers is represented in Fig. 146, as applied to a big steam

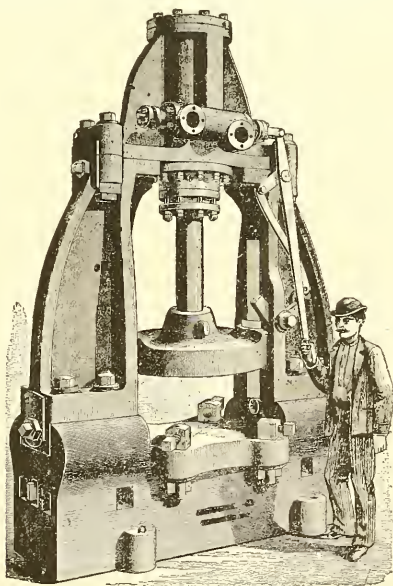

FIG. 146.

drop press. This is nearly like a hammer in general style and has been further described under the head of drop presses on page 50.

In Fig. 145 is shown what is termed a power hammer, the ram of which is actuated by a crank, very much in the same way as in an ordinary press, except that there is an elastic spring connection in the pitman between, thus not making the ram's motion positive in relation to the crank, and giving a quicker and more hammerlike blow. This has an action much like that of a steam hammer and is used for the same general work, chiefly forging. Hence its place in this part of the chapter.



## CHAPTER IV.

## DIES.

## DEFINITION AND EVOLUTION.

HAVING in the previous chapters attempted to define, briefly describe, and to some extent classify presses of various kinds, it will now be in order to describe the tools complementary thereto, which are commonly known as *dies*. Such dies, considering any one unit of their quantity, may be defined in a general way as: a pair of special tools so related to one another that when properly guided and approached toward each other, with sufficient pressure, they will produce a definite, uniform, and permanent change upon each one of certain similar pieces of suitable material placed between them.

The history of dies is doubtless hidden still farther back in the dim obscurity of the long ago than is that of the primeval presses referred to in the first chapter. A beginning of putting the die-using principle into practice was made when Adam sewed together his fig leaves—that is, if, as seems rather probable, he punched holes in them with a big thorn, letting it penetrate the leaf and enter the space between his fingers beneath as it lay flat upon his hand. A pair of fingers and a thorn were thus an analogue of early punching dies, these tools, like more modern dies, being capable of producing “duplicate work” upon a great number of pieces. After the same fashion we may trace the action of forming dies in the corrugating of a leaf or a piece of bark placed

between the hands, with the fingers of one partly entering the inter-finger spaces of the other. When a lump of clay or a snowball (if snowballs were climatically practicable in primeval times and places) was firmly grasped between the two intaglios of a pair of hands the resulting double-faced cameo, with its reversed finger contours, and its "lines" of "heart," of "fortune," and of "fate," as the palmist calls them, was a product of an early style of coining dies—as truly, indeed, as is a "pat" of butter the product of a later style.

We have no record of the actual beginnings of metal-working dies, but we know that at a period some seven centuries before the Christian era the Greeks made rather good coins and medals with tools of this kind. The manner of their gradual development from the crude hints given by the finger-compressed ball of clay must forever be left to the imagination only. A curious thing in history is the fact that the art of printing, which is only in reality a specialized form of die-work, plus the inking, should have been perfected but so recently. Perhaps this is merely because the world was not earlier ready for it.

The construction of some of the commoner forms of metal-working dies would seem not to have been blessed with much improvement during the last two thousand years or so, except perhaps in accuracy of dimension and shape. There have been, however, especially in the present century, many new processes invented, for which special dies have been contrived—particularly combination and gang dies of various kinds. Much has of course been gained in the way of elaboration of detail upon finely engraved surfaces, etc., since the microscope has been available as an instrument of precision.

In the methods of making dies wonderful improvements have been developed in modern times, chiefly in the way

of cheapening and increasing the efficiency of die-makers' tools.

The operating of all sorts and conditions of dies has obviously been enormously cheapened and improved by means of the presses considered in the preceding chapters.

#### CLASSIFICATION BY FUNCTIONS.

Like presses, dies are somewhat difficult to classify, but not to so great a degree. It will here be sufficient to classify according to their functional character only, without attempting to do so by the material they are made of, by the kind of press they are fitted to, by their method of construction, or any other of a dozen systems that might be contrived. In each class, as, for instance, cutting dies, there will be necessarily a number of varieties, based somewhat upon the material to be worked and the condition in which it is to be put. No attempt will be made at a disquisition upon the art of die-making, as such might well occupy a complete volume in itself. The chief purpose of these chapters is to describe the operations practiced by the metal-worker as he views them from his standpoint, or, rather, as he should view them. In carrying out this idea it has been necessary to refer to the different forms of presses, without going into the details of their mechanical design. Dies will be herein treated the same way, only such details of their construction being given as are necessary to illustrate their action, both in theory and practice. In describing each general class some advice may be given as to certain good points in these tools which should be looked after by their users, but the methods of manufacturing them and their exact design, as far as concerns the best modes of putting together, etc., will be left to the unknown makers thereof.

## INTERCHANGEABILITY.

While speaking of dies in a general way, and before entirely leaving the subject of variations in presses, it will be well to show by illustrations a few of the most common methods of fastening dies to the beds and rams, respectively, of the presses in which they are to be used. Some of these varying methods are equally good, but an important point with the user of such tools is to arrange for *interchangeability* to the greatest possible extent—not only that certain given dies may fit as many presses as possible, as far as the kind and size thereof will permit, but especially that the numerous dies which he very probably has on his shelves (either actually or in prospect) may, as far as can be, fit in common a given press. Too much importance cannot be attached to the attainment of a strict system of uniformity in these fastenings, so that certain dies can be quickly taken out of a press and others substituted, and also that there may be as few changes as possible in the adjustments of the press itself.

## BOLSTERS.

In Fig. 147 is shown, in vertical axial cross-section, a bolster, *B*, on which is fastened by tap-bolts screwed into the same a lower die, *L*, it being understood that this bolster is, as usual, simply a flat plate bolted or otherwise secured to the bed of the press to which it belongs, in the customary way, such bolsters being generally furnished by the press-makers either as a standard part thereof or especially to order. They often have a hole of some size and shape through them, as in Fig. 147, but are sometimes solid, as in Figs. 148 and 154. The bolster, *B*, Fig. 148, is shown with a truss or boss, *s*, projecting below its bottom surface and extending downward into the bed of the press. Such trussed

bolsters are often useful for heavy work that happens to be concentrated near the center.

The general object of a bolster is to occupy some of the spare room, up and down, which is usually allowed in case extra high dies should be required for some special purpose; and also to partly cover up and bridge over the large hole which is generally made through a press-bed, that work of a maximum size may sometimes be dropped through. Both of these objects are obviously to enable smaller and cheaper lower dies to be used for average work than would be the case were each die required to be thick enough and to have its flange or plate spread out far enough to reach the bed-bolts of the press which usually secure the bolster.

#### ATTACHING DIES.

In Fig. 147 *R* represents the lower part of a press ram, in which is inserted the upper die *U*, it being shown in this

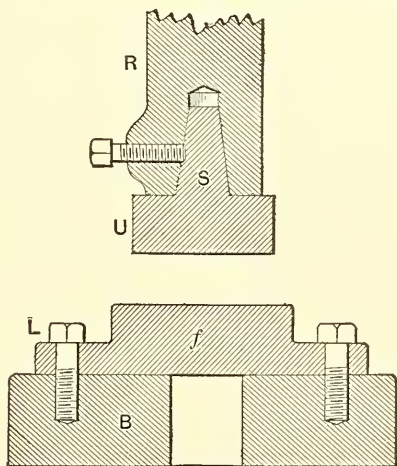

FIG. 147.

case with a tapering shank, *S*. This drives tightly into the socket of said ram and is prevented from slipping out by a

set-screw, which, for better security, is usually made with a point, countersunk into the shank. To save complication these dies are shown perfectly flat upon the faces which come together, and in this shape may be regarded as flattening dies, such as are frequently used for straightening and compressing small articles. Almost any variety of dies can obviously be secured by this and the other methods to be described.

Fig. 148 shows shank of die *U* cylindrical instead of conical. In this case the set-screw does not need, neces-

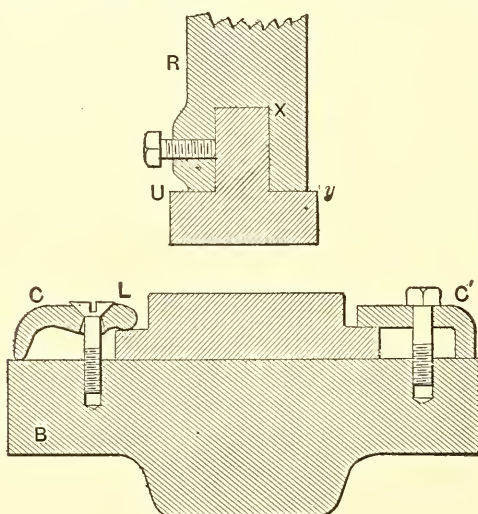

FIG. 148.

sarily, to be countersunk therein. The top end of shank *x* is shown as having a bearing against top of ram-hole, as well as the top surface of the die proper at *y* having its bearing upon the bottom of the ram, it being better in all cases to have as much contact of solid metal as possible, to carry the heavy compressive stresses incident to all work of this kind. In the same picture the lower die *L* is shown fastened by tail-clamps, *C C'*, the latter being of a crude form often used, where a piece of bar-iron is simply bent at right angles

and a bolt-hole is thrown at it, so to speak, almost anywhere, instead of being put as close to the die as possible. Such a construction not only enables the clamp to bend down, but loses a good deal of the leverage that may be gained by arranging the proportions as in clamp *C*, where the bolt is put near the die. This clamp is of better design for withstanding bending-strains, being thickened at the bolt-hole. It is also rounded upon its lower surfaces at each end, and provided with a spherical-headed screw (sunk below the surfaces out of the way of work catching against it), all of which

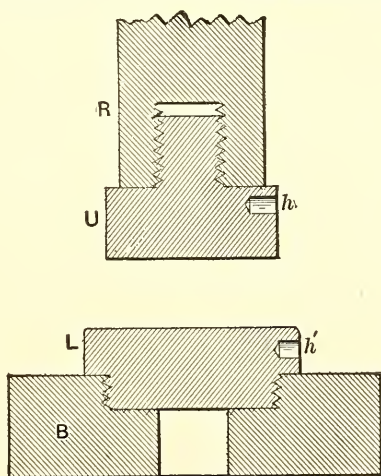

FIG. 149.

allows it to accommodate itself to die-plates of somewhat varying thicknesses.

In Fig. 149 is shown a bolster and ram into each of which the dies are screwed, being revolved by a straight wrench in holes *h h'*, or by making the dies polygonal in shape, or otherwise. Oftentimes with shanks of this kind the die *U* is made higher, as in Fig. 150, with a squared or hexagonal portion to the shank at *S'*. This construction is very common with round dies of small size, such as are used for can-making, etc.

In Fig. 151 is shown a horizontal cross-section, at a point just below  $x$ , of a ram like those in Figs. 147 and 148, the common form of dovetail slide-bearings being embodied. This, however, is sometimes varied to some of the other forms shown in Figs. 15 to 20, Chap. II. Incidentally a

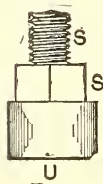

FIG. 150.

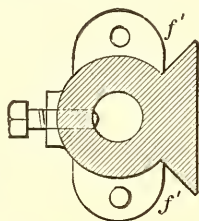

FIG. 151.

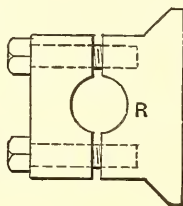

FIG. 152.

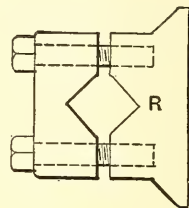

FIG. 153.

flange,  $f' f'$  (shown also in Fig. 154), is embodied in this ram, although it might be omitted as far as the other features described are concerned. In Fig. 152 is shown a similar section of a ram fitted with a separate clamp, as in Fig. 155, but with

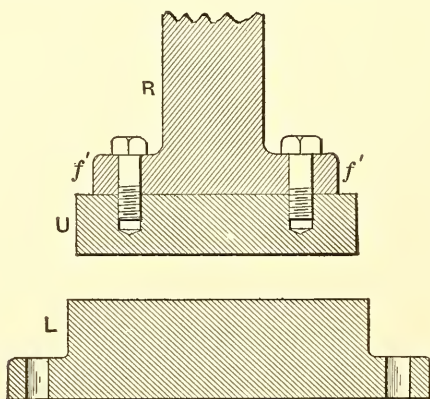

FIG. 154.

tap-bolts to pinch it tightly upon the die-shank when inserted in the round hole, or punch-socket, shown. In Fig. 153 is shown a modification of the latter form where the hole or socket is of rectangular form, set diagonally, the clamp being in this case mounted upon studs and tightened by nuts run-



ning thereon. This is perhaps, upon the whole, the best of all methods for holding shanks, especially when the socket is chambered out at the top, as at *x*, Fig. 155, so that if desired the shank can have a flange or projection entering into this chamber, and thus be held against any downward pull caused by stripping, etc. Such a socket will at the same time hold flangeless shanks just as well, and will accommodate those of round, round slightly flattened, octagonal, or square sections. Furthermore, the size of these shanks need not be accurate, as the clamp can be screwed up to various points in its path so as to grasp sizes of somewhat varying diameters.

Fig. 154 shows at *L* an extra large and heavy lower die, intended to be bolted directly to the press-bed without a bolster; also an upper die which is perfectly flat on the top and is secured to ram *R* by tap-bolts through flanges *f' f'* (shown also in top view at Fig. 151) which are provided thereon. This is an excellent method for large cutting dies, which might slightly shift in a rotary direction, on a vertical axis, if fastened with a shank only. Sometimes, however, they are secured with both shank and tap-bolts.

In Fig. 155 is shown a bolster, *B*, to which is fastened a chuck, *C'*, by means of countersunk tap-bolts, although it might be fastened in various other ways, or might even be a part of the bolster itself, as in the next figure. In this chuck is secured a small cylindrical disk- or ring-shaped die, *L*, by means of a set-screw. This is a common form, especially where there happens to be a large number of small dies which are of the same size outside, it evidently being much cheaper to mount them all in a common chuck in this way than to provide each one separately with a plate of its own. At *C* is shown an upper chuck, secured in the ram *R* by the method previously mentioned in discussing Fig. 153, although such a chuck may be mounted according

to any of the systems above described. It is shown that upper die *U* is secured by a pointed set-screw entering its shank, which latter, however, might be either tapering, as

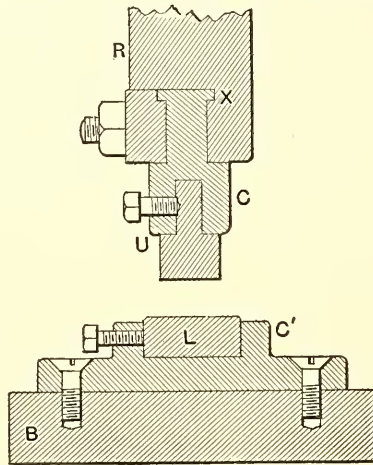

FIG. 155.

in Fig. 147, or screwed, as in Fig. 149. The same reasons in favor of the chuck system apply here as have just been mentioned for the lower die.

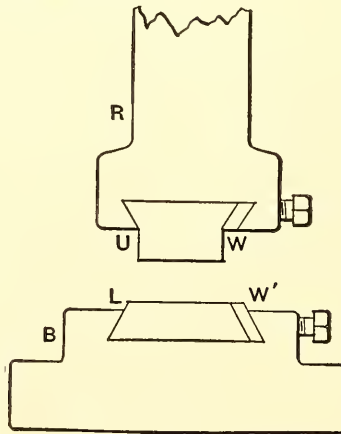

FIG. 156.

In Fig. 156 is shown another chucking system in common use, where the lower die *L* is dovetailed into the chuck *B*,

which in this case is shown as made in one piece with the bolster, although it evidently might be separate, as in Fig. 155. The upper die *U* is shown as secured to the ram by the same dovetailed method, although when such dies are small they are sometimes dovetailed to an upper chuck, which is fastened to the ram by any of the methods shown. As here given, these dies are gripped by a wedge-shaped gib, *W*, and also by set-screws bearing thereupon. These set-screws are, however, generally omitted, dependence being placed upon the wedge only. In some cases the wedge is omitted, the set-screws alone doing the work. In Fig. 157 is shown, at *B*, another form of bolster-chuck, which is also represented in top view at Fig. 158. In this case the dies fit

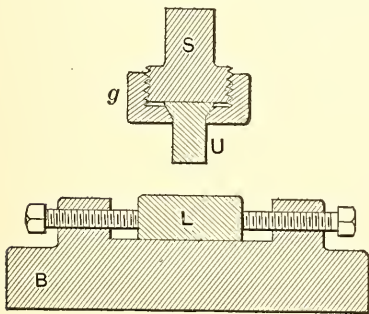

FIG. 157.

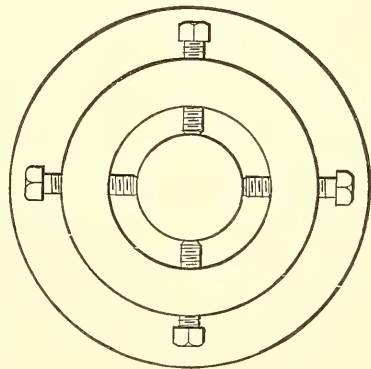

FIG. 158.

loosely inside of an upwardly projecting ring upon the chuck (or its substitute, four, or three, separate lugs) carrying the set-screws shown. Such a die may be varied in position by running each set-screw in or out to a more or less amount. It is one of the oldest methods for gripping dies, and is still used in many cases, but more especially upon drop-presses, where the die is solid and heavy and there is no other method provided for adjusting it laterally in place. It is, however, very objectionable for thin, ring-shaped dies for accurate cutting or forming work, as the die itself is generally sprung

more or less out of its normal shape by the pressure of the screws. In this case the upper chuck is shown as a shank, *S*, provided with an enlarged screw-thread at its lower end, upon which a gland, *g*, is screwed. The gland forces the upper die *U* upward by means of its conical head, and at the same time holds it rigidly in lateral directions. This form is much used for round punching work not exceeding 2 or 3 inches in diameter, and is very convenient and cheap, as the " punches " themselves, which have to be frequently renewed, are of the simplest possible form.

In Fig. 159 is shown a pair of shear-blades, the lower one, *L*, fastened to a chuck, *C*, or in some cases to a bolster

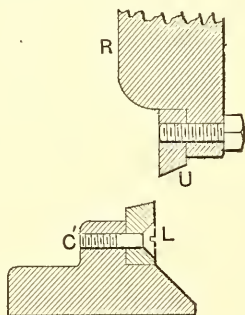

FIG. 159.

of similar shape, or in still other cases to the bed of the press itself, as made especially to receive it. At *U* is shown the upper blade, fastened directly to the ram, although in some cases an upper chuck is used. Two ordinary methods of fastening are shown, the upper one consisting of tap-bolts tapped into the blade, and the lower one of countersunk screws loose through the blade. In some cases such screws are made longer and mounted with nuts instead of screwing directly into the chuck.

At Fig. 160 is shown one of the common methods of fastening double-action dies, for drawn-work, to the ram of a double-action press, *R*, which is usually provided with

projecting flanges through which tap-bolts run down into the flanged upper die  $U$ . As shown, this die is centered by a tenon projecting upward into the ram, the bolts being somewhat loose in their holes. The inner upper die (sometimes called a drawing-punch)  $U'$  is shown as fitting and guided by the interior of the die  $U$ . Its shank at  $S$  is shown as fitting loosely in plunger  $P$  of press, so that if there are any inaccuracies due to wear or other causes it may be rigidly kept in alignment by the die itself. A common method of holding  $U'$  from dropping out of plunger embodies a small sliding bolt or other device, not here shown, engaging in an annular groove running around  $S$  near its upper end.

In Fig. 161 is shown a die not guided by a tenon, but

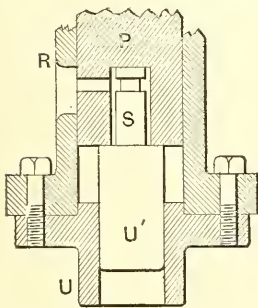

FIG. 160.

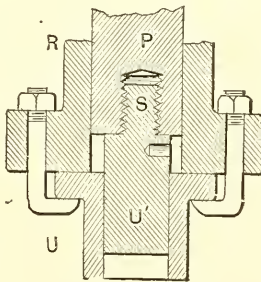

FIG. 161.

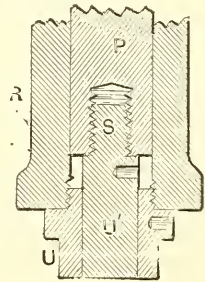

FIG. 162.

resting with its flat surface against ram  $R$ , being secured by sliding hook-headed clamps. The inner die  $U'$  is screwed into the plunger, the same as in Fig. 149, and the outer die is supposed to find its own position before being clamped to place. In Fig. 162 is shown the same arrangement as regards the plunger, but with a threaded socket in the ram, into which the upper die is screwed. Sometimes a chuck, the upper part of which is fitted to the ram in the same manner as is the die itself in Figs. 160 or 161, is used, thus getting the advantage of one chuck which will answer for several small dies. The lower dies are not shown in the last three

figures mentioned, as they are fastened by some of the various methods shown for single-action dies.

In general, it may be said that a mode of fastening dies which will fulfill the following conditions in any particular case will be found most satisfactory: 1. Great rigidity and absolute security against displacement. 2. Quickness of manipulation, so that dies can be rapidly set and unset. 3. (For some kinds of dies) capability of revolving the dies about their vertical axis to various desired positions in the ram or upper chuck; and below, either directly upon the bolster or by revolving the bolster itself, or any lower chuck that may be used. 4. Interchangeability, as previously referred to. 5. Cheapness of design in one or both dies. There are in common use various methods besides the ones shown in the pictures. These, however, will give a general idea of the most usual methods. The fastenings for upper and lower dies, as shown in the various pictures, do not necessarily go together respectively, as, for instance, the lower die in Fig. 147 might accompany the upper die in Fig. 148 or 149, etc.; and almost any of them could be freely changed about at will. Hereafter in this treatise the simple form of upper and lower dies shown in Fig. 148, each consisting of a small cylinder surmounting a large one, will be used, wherever suitable, as a conventional diagram representing a pair of dies.

#### ACCURACY AND DURABILITY.

In making or purchasing dies, after considering what general mechanical forms as above mentioned are best suited to his case, the die-user should pay especial attention to getting the proper—not necessarily high—degree of accuracy and durability to suit his particular work. In some cases the accuracy must be very great, as, for instance, where certain pieces of work produced by various dies must assemble to-

gether and properly fit each other. In this case the durability of certain working surfaces is very necessary in order that the sizes dependent thereon should be maintained as nearly uniform as possible. In other cases accuracy is not necessary, as, for instance, with various kinds of ornamental work, where mere appearance is the chief desideratum. Such dies may, perhaps, be required to have certain surfaces durable for the sake of maintaining the proper artistic effect or of avoiding wrinkles, etc. In other cases, however, there may not be any good reason for special durability, except avoidance of too frequent repairs or renewals. How frequent is a matter which depends wholly upon the required production. If, for example, only 1000 pieces of a certain soft-brass ornament are wanted in a year, as is the case in some gas-fixture manufactories, it would be foolish to make accurate hardened steel dies, because dies of the softest, cheapest material would run without any apparent wear for the hour or two required to make this quantity.

If, on the other hand, these dies were required to run every day and all day, making many millions of pieces each year, then the greater the first cost, with its consequent durability, the cheaper, as a rule, the dies would be in the long run.

#### SOME SPECIMEN DIES.

In Figs. 163, 164, and 165 are shown perspective views of various lower chucks. In Figs. 166, 167, 168, 169, 170, and 171 certain forms of fruit-can dies are pictured, this whole group, as well as the above-mentioned chucks, being assembled at random from cuts in the catalogues of various die-manufacturers. They are given here simply to show some of the designs in practical use—not necessarily as things of beauty and joys forever.

In Fig. 172 is shown in one group a complete set of dies

for manufacturing such parts as could be made with dies of a certain design of lantern, used by one of our large railway companies. They are given merely as an illustration of the appearance such tools may assume in practice, and to give an idea to the uninitiated of the large quantity of dies required to produce a comparatively simple-looking article. Such a group represents a great many hundreds of dollars for the actual cost of the dies included therein. Each pair

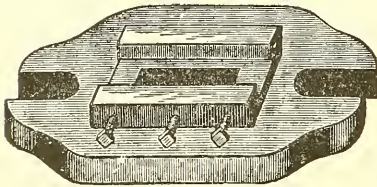

FIG. 163.

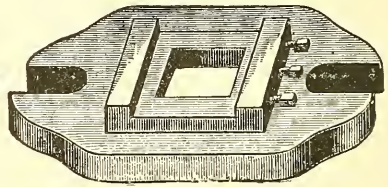

FIG. 164.

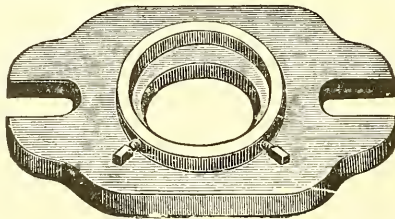

FIG. 165.

of dies, nevertheless, will cheaply produce millions upon millions of pieces, all practically alike, and each having a value perhaps of only a fraction of one cent.

#### COMPOSITE DIE CONSTRUCTION.

Although many dies are made of one piece of metal, especially if of a simple shape, such as round and square cutting dies, etc., yet it is often desirable, in the interests of original economy of construction as well as durability, to make a die more complex in itself, by building it up with a number of parts. This not being a treatise upon die-making, the details of various constructions of the kind in question can hardly be here described. An instance, however, may



be mentioned, which carries this principle to rather an extreme point. With the tools used for cutting armature-disks for electric motors it is often necessary to cut say from 10 to 300 deep narrow notches around the edge of a disk of sheet-iron, varying anywhere from six inches to four feet in diameter. These are sometimes cut separately in an "indexing" machine, but when it happens that dies are required for producing a complete disk at one stroke, including the pe-

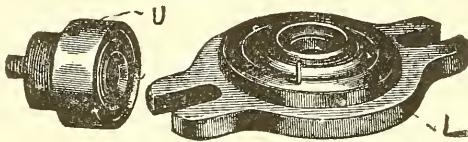

FIG. 166.

FIG. 167.

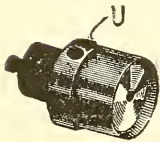

FIG. 168.

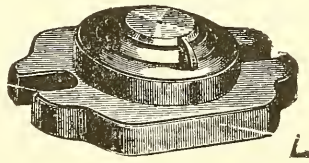

FIG. 169.

riphery itself, the central hole, certain key-seats and bolt-holes, as well as all the notches, it is obvious that the difficulty of making either a punch or a die in one piece would be very great, to say nothing of the impossibility of keeping everything exactly in shape, without warping, during the process of hardening, together with the strong probability of some of the teeth or other delicate parts being cracked at the same time. Even if finished successfully, the after breakage of a single tooth would, with such construction, ruin the whole die. It is therefore customary to insert all the hardened-steel teeth, and other cutting-edges, in iron or

soft-steel plates, fastening them in some way so that any one tooth may be removed, for repair or replacement, if desired.

Other cases of built-up construction are seen in gang

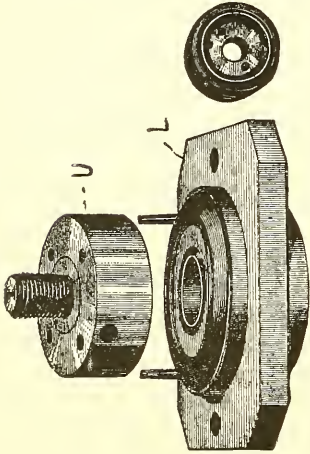

FIG. 170.

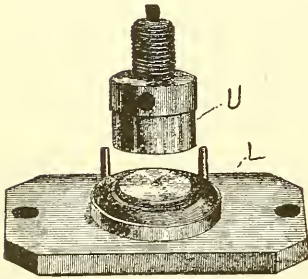

FIG. 171.

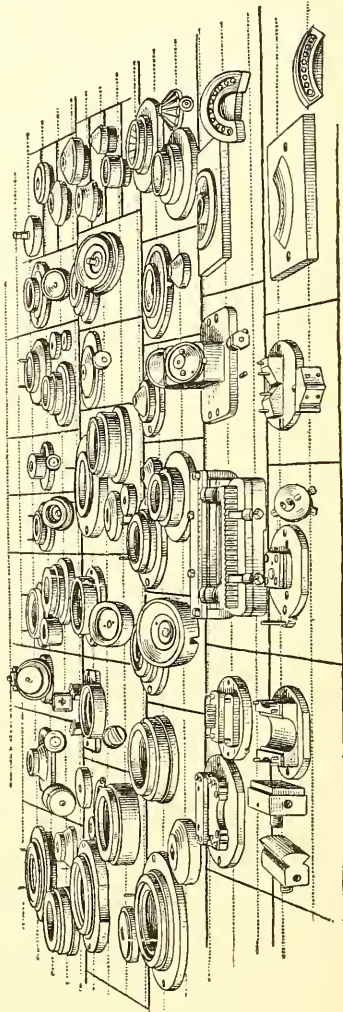

FIG. 172.

punching tools of various kinds—also in the combination cutting-forming dies used to produce fruit-can tops and such like work.

Changeable gang-dies are sometimes made with each individual punch or die, or both, removable so that others can be substituted. Following such a method embossing punches (as for stamping letters, etc.) are in some cases clamped together in a "form," after the manner of printer's type.

#### HEIGHTS OF RAM AND DIES.

In adapting dies to a given press which is known to be of the right kind and size, after finding that the lower die will lie upon the bolster (or perhaps upon the bed, direct) properly fastened thereto; and that the upper die can be secured under or into the ram, with or without a special chuck or bushing; the next most important consideration is the matter of working ram height. The first condition to ascertain is the "shut height" of the dies (let us call it  $h$ ) and also the "open height" ( $H$ ), in cases where it is definite, which it usually is not. If not, the minimum height that will answer, to receive and deliver the work, may be taken ( $H'$ ).

The measurements should be reckoned from the main top surface of the upper die—without counting knockups, shanks, or other projections that enter into the bed, bolster, or ram. Calling the bolster thickness  $B$ , the press-stroke  $S$ , and the working ram height, up from bed, when at top of stroke,  $R$ , we obviously have  $R=B+h+S$  and  $R=B+H$  or  $H'$ . If then the specification of a press shows an "open height from bed to ram" equal to  $R$ , or, if greater, with the excess covered by the ram's adjustment, then it may be supposed to receive the dies. Some little of the excess just mentioned is desirable, to avoid the need of accurate heights in making and repairing dies.

In cases where there is no bolster  $B$  of course becomes zero in the formula. With punching-dies  $h$  is obtained by

giving the proper "lap" of punch into die. With double-action dies the ram height and plunger height should be considered separately.

#### DIE LUBRICATION.

Many dies are run without any lubrication whatever, but they will obviously last longer if treated in the same way as are other wearing surfaces. It is difficult to apply oil directly to the dies themselves, but it is sometimes customary to run a sheet of metal, which is being worked, under a felt roller, or a brush, or a pad of some soft material, which is kept saturated with oil or other lubricant. This is especially necessary in the case of drawing-dies, where the metal is forced between the punch and die through a considerable distance, with a rubbing action, often under considerable pressure. The material used for such lubricants is frequently sperm-oil, or almost any kind of grease having a good body. It is often objectionable, however, to have the finished work coated with grease, which is difficult to remove, to say nothing of the expense of the lubricant itself. It has been found that for working sheet-brass in certain ways soap-suds, which is both cheaper and cleaner than oil, answers a very good purpose. There are also various liquids in the market which are made purposely, and which probably consist of some modification or mixture of grease, soap, water, etc. For drawing steel tubes a thin mixture of whitelead and grease, preferably tallow, has proved an excellent lubricant.

In some cases an occasional blank, or other piece of the metal being worked, is greased (say one out of every two or three dozen), the rest being fed dry into the dies. This of course keeps them somewhat lubricated. In many other cases no lubrication at all is practiced—especially with shallow work, and when the metal is of a so-called "greasy" nature, like tin-plate, for instance. Even with the latter, however,

a lower percentage of breakage may be attained by occasionally rubbing the surfaces of the dies or the metal with a lump of paraffine, which of course deposits but a very thin film—not sufficient to soil the work.

#### NOMENCLATURE.

As before stated, the various dies herein treated will be named functionally, but it must be remembered that the functions themselves are not commercially named with much regard to uniformity or good logic. Such inconsistencies as may appear will doubtless be condoned by the charitable reader, in consideration of the present “state of the art” of lexicography as applied to mechanics.

Regarding the individual membership of a “pair of dies,” it may be remarked that the word “punch” is very generally used to designate an upper die, whether cutting, forming, drawing, or otherwise, but this practice is not universal. In many cases “upper die” is the better term—for one reason, because the word punch is also used as a verb to denote the operation of punching and as a noun to designate the press itself, which is often called a “punch,” especially if used for small holes in thick metals. As applied to one of two coining-dies, or to certain forms of upper combination-dies, etc., the word is entirely a misnomer. To avoid ambiguity, therefore, the term “upper die,” when used herein, will designate the die which is usually attached to the press ram—that is, in cases where the ram is not inverted. In the latter contingency, and in the case of horizontal presses, etc., some additional definitions might become necessary. Where there are three, rather than two, dies in a set, as with ordinary drawing-dies, it will be proper to term the inner upper one a punch, while the one surrounding it (sometimes called a blank-holder) will be known as the upper die.

Another pair of terms frequently used are “male die”

and "female die"—meaning conventionally, of course, the one that enters and the one that is entered, respectively. These are convenient names as applied to punching, cutting, and some sorts of forming dies, etc., but, being thus restricted, they can hardly be used in a general sense. Applied to certain kinds of embossing-dies they are respectively synonymous, perhaps, with the terms "cameolike" and "intaglio-like."

## CHAPTER V.

**MATERIALS AND MEASUREMENTS.**

## COMMERCIAL METALS.

HAVING analyzed to some extent the tools used in the art of special metal-working of which we are treating, it will now be well to glance at the general nature of the materials worked by these tools. Although my title speaks of "metals" as the general name for these materials, the term may be qualified somewhat by occasionally including certain forms of non-metallic substances in the forms of sheets and bars, which are often treated by the presses and dies in question in an exactly similar manner to the metallic ones. These substances are mostly pasteboard, paper, cloth, leather, thin slabs of wood, and a variety of other artificial fabrics resembling them in general characteristics—that is, so far as the most ordinary press operations are concerned. By processes analogous to coining a great number of plastic materials may be worked in dies, but to some of these further reference will be made in a later chapter.

It will hardly be necessary to give here a list of all the press-worked metals in common use, nor to deal with the origin and metallurgy thereof. The most common (perhaps about in the order named) are Iron, Steel, "Tin-plate," Brass, Aluminum, Copper, Zinc, "Britannia," Silver, Lead, Nickel, Gold, and Platinum. They are all ductile and work well when in proper condition. Not the least so is our new and beautiful aluminum, which seems to be destined to a marvelous future development, but which only a very few years ago would have appeared at the end of the above list. Its behavior under the action of dies is admirable.

The various alloys analogous to brass, such as the bronzes, "german silver, etc., are too numerous to specify in detail. Any of the metals mentioned can usually be procured in the form of sheets, bars, or wire.

In Figs. 173, 174, 175, and 176 are shown a few of the most ordinary various forms of bar-metal in common use, their cross-sections being circular, semicircular, and rectangu-

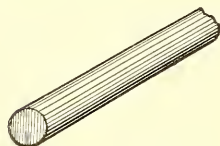

FIG. 173.

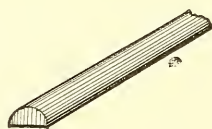

FIG. 174.

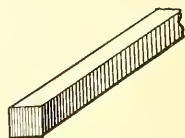

FIG. 175.

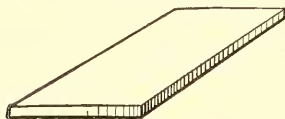

FIG. 176.



FIG. 177.

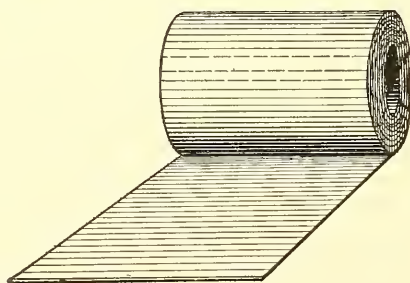

FIG. 178.

lar, respectively. In Fig. 177 is shown part of a sheet of tinplate and in Fig. 178 a roll of sheet-brass. These latter, and in fact all sheet-metals, are obviously but very thin, wide bars, and there is, therefore, no vital distinction between them and any other flat bar, like Fig. 176, the difference being only in degree, and not in kind. As a practical matter we shall find that such bars as are here shown (and others) are frequently worked in the same machinery as are the sheets, which differ



from them only by being thinner and wider in their general proportions. In addition to the above and other common forms of bars, triangular, hexagonal, octagonal, etc., have been developed in recent years a great many special cross-sections for iron and steel bars which come under the general category of "construction iron" and "shapes," their most general use being for the frame-work of ships, buildings, and bridges. The above terms are obviously not very logical, as all the other forms mentioned are also used for construction, and they all have some *shape*.

The most used cross-sections for the metal in question are as follows: **I, T, L, C, Z**, their respective commercial names being I-beams, tees, angles, channels, and Z-bars. Their degree of commonness is probably about as in the order given.

Besides the above types, there is the analogous and still more familiar tee-rail, with its various modifications, which is used in such enormous quantities upon all the railways of the world. There are also wrought-metal pipes of many sizes, usually of circular section, but not always. Then, too, there is wire of almost every size, shape, and material, which of course is really of the same nature as bar-metal.

The above-mentioned metallic forms, which it is hardly necessary to here describe in further detail, are all, in common, frequent victims of the rapacious jaws of some member of the press "menagerie" exhibited in the previous chapter.

A buyer of any of the materials in question should of course familiarize himself with the exact commercial names pertaining to their different kinds, qualities, sizes, and methods of measurement *at* the time and place of his proposed purchases. This warning is uttered because of the considerable variations occurring in different locations and times in the nomenclature of both the articles themselves and the gauging-tools by which they are measured.

In this country and in Great Britain the English inch, and the fractions thereof in common use, are almost always used to designate the larger sizes of bar- and sheet- iron, steel, and copper, as well as brass. Thus, for instance, bar-iron is known as  $\frac{3}{4}$ -inch round, 1-inch square,  $4 \times \frac{1}{2}$  inch, and so on. The wider bars, usually called plates, such as are used for boiler-making, ship-building, etc., are also usually designated by their dimensions in inches. When, however, round bars become so small as to be called wire, which is generally under  $\frac{1}{2}$  inch in diameter, and of a length sufficient to coil, and when sheets become too thin to be described by ordinary inch fractions, then trouble commences. This trouble arises from the innate foolishness of the human heart, which cleaves to that which is old, no matter how absurd, and hesitates long about adopting the new, however permeated with common sense.

#### WIRE-GAUGES.

The last remark refers to the vexed question of the so-called wire-gauges, which might occupy the whole of this book if treated exhaustively. The only reason for devoting the next few pages to so apparently trivial a subject is the desirability of a metal-worker making himself fully acquainted with the pitfalls into which he is liable to tumble when buying his materials by a *numbered* thickness.

It was Carlyle, if I remember aright, who said that the population of England were so many millions—mostly fools. However indignantly we may repudiate the descriptive portion of the distinguished cynic's remarks as applied to the people of our mother country in general, we can scarce but admit the partial foolishness of that portion of the population who have been engaged at various times during a century past in the industry of inventing wire-gauges. In America, too, we find that either heredity or example, or both, has

caused a further development of this pernicious industry, and that the crowning absurdity of all its products has been legalized in the United States by an act of Congress taking effect July 1, 1893.

One of the chief points about this remarkable latest "standard" is that it is almost everything it should not be, and fails to be almost anything that it should be, utterly ignoring many attributes that should be embodied in a good gauge, some of which are as follows:

(*a*) The popularity and universality which are necessary to secure definiteness of measurement in the commercial world. (*b*) Suggestiveness, preferably by making its unit of measurement in harmony with some other well-known unit, as, for instance, the English inch or convenient fractions thereof. (*c*) A logically progressive scale, with the smaller numbers for the smaller sizes, rather than a retrogressive one. (*d*) Uniformity of names or numbers, as, for instance, from unity upward, rather than mixing in a number of ciphers having no meaning in themselves. (*e*) A uniform or uniformly increasing increment in each successive size. (*f*) Capacity for additional sizes, either smaller or larger than the original ones, or interpolated between the same, as requirements at first unthought of may afterward occur.

In the table on page 103 are given the dimensions, in thousandths of an inch, of 13 different American gauges, whose nominal size or number is shown in column A. On page 105 will be found a table giving in like manner the dimensions of 12 different foreign gauges, with the numbers in its column A. These numbers are not continued beyond 50, although in a few cases the gauges themselves extend to a distance which might too far trespass upon the reader's patience. In giving the inch values the decimals have not been carried out beyond three places of figures, although some of the gauge numbers run to millionths and even billionths of

an inch. In cases where these transcendental figures have been dropped a plus sign has been inserted, the third figure remaining normal, although the quantity would really have been better expressed in some cases (where followed by a figure larger than five) had such third figure been increased by one. For the practical purpose, however, of comparing the degrees of foolishness embodied the three figures in question will doubtless be sufficiently accurate. The values given in the tables have been carefully compiled from a variety of sources, including both English and American engineering handbooks, catalogues of gauge-, screw-, wire-, and sheet-makers, etc.

Some similar work has been recorded in a chart gotten up by Dr. S. S. Wheeler, in which he has plotted a graphical comparison of all the principal gauges. This is a valuable addition to the literature of the subject.

An inspection of column A will show the absurdity (for any new gauge at any rate) of using groups of ciphers in advance of unity. The first group given can easily be remembered by thinking of Wordsworth's *We-are-seven*, *Con-way-dwelling*, *cottage-girl*, and has the advantage of requiring counting to identify it—thus preventing undue haste. In practical use it is probably pronounced *number seven-naught*. In column B we see again our new national standard, as referred to upon a previous page. In column C we have the real "American gauge," so called, which is largely used for measuring sheet-brass and sometimes for brass wire. The best thing that can be said of it is that it is the least bad of the whole lot, being scientifically designed so that its measurements will plot a parabolic curve with a uniform reduction of 11 per cent between each consecutive size. It is thus better proportioned to meet the generality of sizes required than are the other ones, but it has many of the faults common to them, as, *e.g.*, being retrogressive, starting with four

naughts, being expressed in odd thousandths, and even millionths, of the English inch, etc. The notch gauge in actual use for measuring these values is a beautiful tool—as might be expected of a product of the eminent engineering firm who designed it and whose name it bears.

In columns D, E, F, and G we have other arbitrary standards, the first three of which seem to bear a close relation to each other. Possibly they may have, long ago, been evolved from some common source by the interesting copying process of measuring old worn-out gauge-notches to make new ones by. The music-wire gauge shows a decided change of tune, being the first with progressive numbers yet brought to our notice, though apparently being just as unsystematic as all the rest.

In column H we have another progressive gauge whose figures, regarding  $\frac{1}{1000}$  inch as a unit, are the respective square roots of 1000 times the gauge number in column A. This probably may be convenient to electricians, some of whom compare all cross-sections of their wires by a special unit, the “mil,” which is a denomination of a sort of special “circular square measure,” so to speak. The particular gauge numbers selected, however, do not appear to run up with a uniformly increasing increment, as is shown by the series 3, 5, 8, 12, 15, etc. This gauge, as will be seen in the lower half of the column, advances by fives to 50 and goes beyond in the same way to 100; thence to 200 the advance is by tens, and after that by twenties up to 360.

In column I we have another progressive gauge which appears to be a little more systematic than some of the others, as the sizes are expressed in whole thousandths, and run with a not wholly crazy series of increments, though why near the end of the table the measurements should jump suddenly from  $\frac{1}{2}$  inch to 1 inch between two consecutive numbers, and this for measuring sheets as thin as zinc is

usually made, is not quite comprehensible. Neither is it apparent why it starts where it does, or for that matter, why it goes on, or stops, or is.

In columns J and K we have two more arbitrary and retrogressive gauges with no special features of interest. They both continue onward in the same style to No. 60. The drill-rod gauge is thereafter continued further, as a sort of supplement, in a progressive form, with letters for names instead of numbers, A representing .234 inch and Z .413 inch. The increments between are neither uniform nor uniformly increasing, but run in a sort of a "wild-cat" series somewhat thus: 4, 4, 4, 4, 7, 4, 5, 9, 5, 14, 7, 11, 7, etc., with various other numbers interpolated.

In column L we have a progressive gauge for measuring American screws which seems to be founded upon nothing and to start nowhere, except that its increments are approximately .013 each. In column M we have a retrogressive gauge used by some of the large sheet-iron manufacturers, but, like most of the others, the question why it did not die before it was born will remain one of the conundrums of the ages. Its comparatively slight difference from the Birmingham gauge in common use must make it extremely inconvenient in practice. The next gauge, in column N, is a progressive one, and is, as far as I know, the only one used by glass manufacturers. Its numbers, like several of the others, are not consecutive, and certainly seem to skip around in a rather lively fashion. They appear to be without any particular definiteness, either in position or in relative measurements.

In column O in the next table, page 105, we have a retrogressive gauge which is, I believe, the only legally standardized one in England, it having been adopted by the Board of Trade some years ago. It seems to be founded upon the older gauges somewhat evened up, so to speak, but appears

A	B	C	D	E	F	G	H	I	J	K	L	M	N
Gauge Number.	American, New Legal Standard.	Brown & Sharpe, or B. & S., "American Standard."	Washburn & Moen Mfg. Company.	G. W. Prentiss, Holyoke.	Trenton Iron Co., Trenton.	For Music-wire in America.	Edison, for Copper Wire.	For Zinc Sheets in America.	For Twist - drills and Steel Rods.	For Drill- and Pin- rods.	For Screws in America.	For Sheet-iron in America.	For Glass Panes in America.
0000000	.500												
000000	.468+		.460										
00000	.437+		.430										
0000	.406	.460	.393		.450								
000	.375	.409+	.362		.360								
00	.343+	.364+	.331		.328+								
0	.312	.324	.317		.299+	.305					.031+		
1	.281+	.280	.283		.277+	.285		.002	.228	.227	.071		
2	.265+	.257	.263		.259+	.265		.004	.221	.219	.084+		
3	.250	.229+	.244		.240+	.245	.054+	.006	.213	.212	.097+		
4	.234+	.204	.225	.223	.225			.008	.200	.207	.110+		
5	.218+	.181+	.207	.204+	.205		.070+	.010	.205+	.204	.123+		
6	.203+	.162+	.192	.188+	.190			.012	.204	.201	.136+		
7	.187+	.144+	.177	.175	.175			.014	.201	.199	.150		
8	.171+	.128	.162	.160+	.160		.089+	.016	.199	.197	.163+		
9	.156+	.114+	.148	.147+	.145			.018	.196	.194	.176+		
10	.140+	.101	.135	.135+	.130			.020	.193+	.191	.189		
11	.125	.090+	.120	.120	.117+			.024	.191	.188	.202+		
12	.109+	.080	.105	.106	.105	.020+	.109+	.028	.180	.185	.215+		.059
13	.093+	.071+	.092	.092	.092+	.031+		.032	.185	.182	.228+		.063
14	.078+	.064+	.080	.081+	.080	.032+		.036	.182	.180	.242+		
15	.070	.057+	.072	.072	.070	.034+	.122+	.040	.180	.178	.255+		.071
16	.062	.050+	.063	.062	.061	.035		.045	.177	.175	.268+	.062+	.077
17	.056+	.045+	.054	.054	.052+	.037		.050	.173	.172	.281+		.083
18	.050	.040+	.047	.047	.045	.039+		.055	.160+	.168	.294+	.046+	
19	.043+	.035+	.041	.041	.040	.041		.060	.166	.164	.307+		.091
20	.037+	.031+	.035	.035	.035	.043	.141+	.070	.161	.161	.321	.038+	
21	.034	.028+	.032	.032	.031	.046+		.080	.159	.157	.334+	.035	.100
22	.031	.025+	.028	.029	.028	.048+		.090	.157	.155	.347+	.031+	
23	.028	.022+	.025	.026	.025	.050+		.100	.154	.153	.360+	.028+	
24	.025	.020+	.023	.023	.022+	.054		.125	.152	.151	.373+	.025	.111
25	.021+	.017+	.020	.021	.020	.058+	.158+	.250	.149+	.148	.386+	.022+	
26	.018	.015+	.018	.019	.018	.062+		.375	.147	.146	.400	.020	.125
27	.017	.014+	.017	.018	.017	.066+		.500	.144	.143	.413+	.018	
28	.015	.012+	.016	.017	.016	.071+		1.000	.140+	.139	.426+		
29	.014	.011	.015	.016	.015				.136	.134	.439		
30	.012	.010	.014	.015	.014		.173+		.128+	.127	.452+		
31	.010	.008	.013	.014	.013				.120	.120	.465+		
32	.010	.007+	.013	.013	.012				.116	.115	.479		.154
33	.009	.007	.011	.011	.011				.113	.112	.492+		
34	.008	.006+	.010	.011	.010				.111	.110	.505+		
35	.007	.005+	.009+	.010	.009+		.187+		.110	.108	.518		
36	.007	.005	.009	.010	.009				.106+	.106	.531		.167
37	.006	.004+	.008+	.009	.00+				.104	.103	.544+		
38	.006+	.003	.008	.009	.008				.101+	.101	.557		
39		.003	.007+	.008	.007+				.090+	.099	.571		
40		.003+	.007	.007	.007		.200		.098	.097	.584+		
41									.096	.095			
42									.093+	.092			.200
43									.089	.088			
44									.086	.085			
45								.212+	.082	.081			
46									.081	.079			
47									.078+	.077			
48									.076	.075			
49									.073	.072			
50									.223+	.070			

The above values all in inches.

to have no special relation to anything else on earth or in the heavens.

Column P represents the well-known Birmingham, or B. W. G., or Stubs, gauge, which is almost always referred to (by some or any or all of these names), in this country, at least, when wire and iron and steel sheets are designated by number, although brass wire is sometimes, as before stated, measured by the Brown & Sharpe gauge. The gauge in question is often referred to in this country as "English standard," these words sometimes being stamped upon the gauges themselves, even in the factories of the best makers. This is evidently a misnomer, in view of the fact that England seems to have a dozen or so standards, one of them (not this one) being legalized, as before mentioned.

In columns Q, R, S, T, U, V, and W we have another pestilent brood of gauges starting and ending nowhere in particular, all different, all retrogressive, and all belonging apparently to the class of literature the reading of which might have made Carlyle so cynical. It will be noticed that no less than three of the gauges in this table enjoy the adjective "Birmingham," and the names of the others are rather uncertain, some being derived from places and some from people.

In gauge nomenclature it may be observed that, besides having one name for several different things, the same thing has several names, as is shown by more than one of the instances given. The Lancashire gauge, shown in column S, goes on beyond the figures tabulated to No. 80, which is .013 inch in size. It then has a supplementary progressive series named by letters from A to Z, the same as does the gauge already described in column K. After that, however, it indulges in a certain vagary by starting with No. A1, whose value is .420 inch, and onward alphabetically to No. H1, with a value of .494 inch.

In column X may be seen the first glimmer of common



A	O	P	Q	R	S	T	U	V	W	X	Y	Z
Gauge Number.	English Imperial Legal Standard.	Birmingham, or Stubs or "English Standard."	Birmingham, for Sheets not Iron or Steel.	Birmingham, for Iron Sheets.	Lancashire, One of Holtzapfels.	Warrington, or Rylands.	Old English, for Brass, etc.	Needle-wire in England.	Music-wire in England.	Whitworth's English Standard.	French, Jauge de Limoges.	French, for Galvanized Iron.
0000000	.500					.500						
0000000	.464					.468						
000000	.432					.437						
00000	.400					.406						
000	.372	.454				.375						
00	.348	.425				.343						
0	.324	.380				.326						
1	.300	.340	.004	.312	.227	.300		.045		.001	.015	.023
2	.276	.284	.005	.281	.219	.274		.042		.002	.022	.027
3	.252	.259	.008	.250	.209	.250		.035		.003	.026	.031
4	.232	.238	.010	.234	.204	.229		.032		.004	.031	.035
5	.212	.220	.012	.218	.201	.209		.028		.005	.035	.039
6	.192	.203	.013	.203	.198	.191		.025	.018	.006	.039	.043
7	.176	.180	.015	.187	.195	.174		.022	.019	.007	.044	.047
8	.160	.165	.016	.171	.192	.159		.020	.020	.008	.048	.051
9	.144	.148	.019	.156	.191	.146		.018	.021	.009	.053	.055
10	.128	.134	.024	.140	.190	.133		.016	.022	.010	.057	.059
11	.116	.120	.029	.125	.189	.117		.014	.023	.011	.066	.063
12	.104	.109	.034	.112	.185	.100		.013	.025	.012	.076	.070
13	.092	.095	.036	.100	.180	.090		.012	.026	.013	.075	.078
14	.080	.083	.041	.087	.177	.079	.083	.010	.028	.014	.079	.086
15	.072	.072	.047	.075	.175	.069	.072	.009	.030	.015	.084	.094
16	.064	.065	.051	.062	.174	.062	.065	.008	.032	.016	.088	.106
17	.056	.058	.057	.056	.169	.053	.058	.007	.033	.017	.112	.118
18	.048	.049	.061	.050	.167	.047	.049	.005	.035	.018	.134	.134
19	.040	.042	.064	.043	.164	.041	.040	.004	.038	.019	.156	.154
20	.036	.035	.067	.037	.160	.036	.035	.003	.042	.020	.177	.173
21	.032	.032	.072	.034	.157	.031	.031	.002			.201	.193
22	.028	.028	.074	.031	.152	.028	.029			.022	.222	.213
23	.024	.025	.077	.028	.150		.027				.244	.232
24	.022	.022	.082	.025	.148		.025			.024	.268	
25	.020	.020	.095	.023	.146							
26	.018	.018	.103	.021	.143		.020			.026		
27	.016	.016	.113	.020	.141		.018					
28	.014	.014	.120	.018	.138		.016			.028		
29	.013	.013	.124	.017	.134		.015					
30	.012	.012	.126	.015	.125		.013			.030		
31	.011	.010	.133	.014	.118		.012					
32	.010	.009	.143	.012	.115		.011			.032		
33	.010	.008	.145		.111		.010					
34	.009	.007	.148		.109		.009			.034		
35	.008	.005	.158		.107		.009					
36	.007	.004	.167		.105		.007			.036		
37	.006				.102		.006					
38	.006				.100		.005			.038		
39	.005				.098		.005					
40	.004				.096		.004			.040		
41	.004				.095							
42	.004				.091							
43	.003				.086							
44	.003				.084							
45	.002				.080					.045		
46	.002				.078							
47	.002				.076							
48	.001				.073							
49	.001				.070							
50	.001				.067					.050		

The above values all in inches.

sense yet appearing as recorded by history in the industry of gauge-inventing. Previously everything had been allowed to grow up of itself in the most haphazard manner, but here we see the work of the practical mind of Sir Joseph Whitworth, who, as soon as he tackled the subject, hit upon the obvious and only sensible way, in a country using the English inch, of designating the small sizes in question. This was, of course, to express them in inches, like other measurements used in mechanical work, which he did while retaining the old word "number" as a prefix—probably with a view of catering to the prejudices of a gauge-using people. This gauge in its complete form extends onward beyond the table to No. 100, increasing by fives; thence to 120 by tens; thence to 180 by fifteens; thence to 300 by twenties; and thence to 500 by twenty-fives. The progression, it will be noticed, is not quite uniform in character, nor is the progression in the lower part of column X, where the increment of two suddenly changes to five, beyond No. 40. This, however, may be forgiven, as a gauge of the kind in question is not limited to any particular numbers, it being perfectly logical to insert or omit, as may happen to be required for the particular work in hand. The system always remains the same, the sum expressed by the number agreeing with the quantity of thousandths of an inch involved.

In columns Y and Z we have two French gauges, both of which are progressive, but which have the usual non-relation to each other, or to any other principle, person, or thing. It is but fair to state, however, that when expressed in millimeters (which are not given in this table, in the interests of uniformity) they do not have so much of the "ragged-edge" effect as appears in the table. The progression, though, is not very uniform, and the actual sizes are in two places of decimals—that is, in hundredths of a millimeter

No. 0 being, in the Jauge de Limoges, .39 mm.; No. 5, .90 mm., etc.

In addition to the 25 gauges given in the tables there are a few odd ones, not so much used, which need not be given in detail. One of these is the French so-called millimeter gauge for iron rods, etc., which starts at No. P, equaling 5 mm.; followed by No. 1, 6 mm.; No. 2, 7 mm.; and thence onward, numerically, to No. 30, equaling 100 mm. The increments, however, are not uniform, being represented by 1 mm. up to No. 16, and then increasing by steps of various sizes. Another gauge, also French, is used for zinc sheets, and is almost like the zinc gauge given in column I, varying, however, in some of its higher numbers.

Still another gauge is the German millimeter, so called. This is founded upon the same correct idea as is the Whitworth, No. 1 representing one mm., No. 2 two mm., No. 3 three mm., etc. Practically, however, its sizes would obviously be too large and too far apart for ordinary thin sheet-metals or wire. Besides those above cited, there are a German, a French, and an English screw-gauge, and a German rivet-gauge, about which little is known here. Among the curiosities of gauge literature may be cited a hoop-iron gauge, the specification of which has been mislaid. It, as I remember, playfully runs its numbers in reverse order part way through the scale, each having a small circle (like a degree-mark) printed after it. It then duplicates these numbers in natural order without the mark. Just what the sizes are I do not recollect, but practically hoop-iron is, I believe, nowadays sold by the B. W. G. Another curiosity in the gauging business is to have no gauge at all, as is the case in measuring tin-plate, whose thickness is commercially known by such names as Taggers when anywhere from .004 inch to .008 inch, as IC from .008 inch to .014 inch, as IX from .013 inch to .017 inch, as IXX from .015 inch to .019 inch,

etc. It will be noticed that these numbers lap each other in most cases, so that the same sheet might be called by either of two of the names given. There is, however, no attempt to measure this thickness, either by makers or users, it being guessed at by weighing a box of plates and knowing the number of sheets therein, these usually varying individually to a considerable degree in any one box. The sorting, which is generally necessary, is done by shaking each sheet flatwise and judging of the thickness by the stiffness and weight.

Another yet more foolish method of defining the thickness of sheet-metal, especially copper and lead, is to specify the weight in pounds or ounces per some unit of surface area, as so many ounces per square foot, etc. The solving of such puzzles as are involved in measuring operations of this kind requires either long experience or a mathematical mind of a high order.

A supplementary set of sizes, lying between any of the gauge numbers of any of the 25 gauges mentioned, are in practical use, and are known by the following names: No. so-and-so easy, or bare, or scant, or loose, or light. Also No. so-and-so full, or tight, or heavy. Still another set of sizes are represented by these same adjectives with the word "rather" as a prefix; and still another set by the use of fractions, No.  $15\frac{1}{2}$ , etc., the  $\frac{1}{2}$  serving as a suffix to, and in some way modifying, a regular gauge number. Furthermore, the people who use the above adjectives, with or without their qualifying adverb, and who use the fraction spoken of, do not generally make it very clear as to whether the scantiness, or fullness, or increase expressed by the fraction, refers to the actual size of the gauge-notch in question or to the numbers designated. Such indefiniteness in the case of retrogressive gauges may of course reverse the meaning intended, and therefore the occupation of receiving and filling

orders for sheet-metal, rods, nails, rivets, and wire becomes a somewhat puzzling one, to say the least. A customer merely states that it is to be No. so-and-so, qualified occasionally perhaps by the adjectives, etc., just mentioned, but says nothing about what gauge is meant, and how the adjectives and fractions are intended to be applied, nor whether he is depending upon duplicating material which has been measured by some old gauge with worn-out notches. This is no fancy picture, but merely a portrayal of some of the misery daily occurring in commercial life.

It is a noteworthy fact that with nearly all the gauges in common use the scale is retrogressive, having the smaller numbers for the larger sizes, which is manifestly an absurdity. The only excuse for this arrangement is that the numbers are given in the order of the operations of the wire-drawer, who originally adopted the ingenious and really somewhat scientific idea of calling his rolled-iron rod No. 0; his wire, after once being pulled through the drawing-plate, No. 1; after twice, No. 2; after thrice, No. 3, etc. This was all very well from his point of view, until he commenced to use larger rods, when he was obliged to lose sight of the beautiful numbering of his operations, or rather to accept a false numbering, and to adopt a group of naughts for his starting-point. Furthermore, as different kinds of wire and different kinds and qualities of metal were afterward introduced, different gradations in drawing-plates were necessary, and thence probably arose some of the various other gauges which are shown in the tables on the preceding pages. This was a sort of natural evolution, based as usual upon ignorance of the future, and one which perhaps led the poor wire-drawer to think life hardly worth living, as the numerous gauges adopted from time to time gradually got mixed up, and when gauges of this sort were used for sheets and bars, as well as for round wire, etc.

In Fig. 179 is shown a side view, actual size, of the familiar B. & S. gauge. It is made of sheet-steel about  $\frac{1}{16}$ " thick, and is a very accurate tool—when new. This will serve also as a representation of the various other old gauges. They are usually thus circular, or else of an elongated octagonal contour.

A thorough discussion of some possibly successful and popular remedy for the evils indicated in this chapter, and a remedy, moreover, that should be international rather than merely American, might well require a volume to itself. In

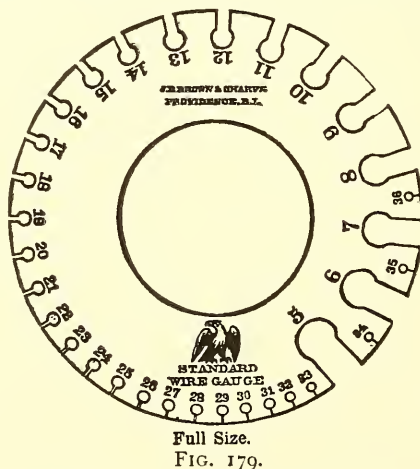

the limited space herein at command it is enough to say that the subject is constantly attracting more and more interest among engineers and other scientific men, with a probable result of some definite standard methods of dealing with the measurements in question being settled upon in the not too far-off future. Were it an Anglo-American question only there would be but little difficulty in popularizing the Whitworth gauge, this being the only logical system where the English inch is the unit of measurement. Such gauges should be made not only for all varieties of sheet-metals, wire, rods and bars, but for paper, cloth, leather, glass, etc., one sys-

tem answering perfectly for all. The apparent unnecessary magnitude of a gauge comprising every  $\frac{1}{1000}$  inch, say, from 1 to 1000, can be easily overcome by preparing notched gauges for particular trades and industries, containing only such sizes as are in common use therein. Each industry or group of industries needing about the same range could thus have as small and simple a gauge as possible, with all superfluous numbers omitted; and any gauge would absolutely agree with any other, whenever they happened to have any numbers in common.

The real difficulty in this matter, however, looms up when we attempt to contrive an international gauge, which will be equally welcome to the peoples of the earth using the English inch and the French meter. It has been suggested that a gauge founded upon a hundredth of a millimeter as a unit, each number to express the quantity of these units embodied, would answer perfectly well for the whole world's use, and this view is advocated by a number of scientists in this country as well as abroad. Such a scheme has the disadvantage for England, America, and Australia of not being easily translated into and compared with our standard measurements. It has, however, the advantage of having a unit of about  $\frac{1}{2500}$  inch, which for very small sizes is better than the  $\frac{1}{1000}$  inch unit of the Whitworth gauge. Whichever of these two most feasible schemes may be adopted, the commercial and engineering world will certainly be happier and better therefor. One strong point in favor of the general principle herein advocated is that any of the notched gauges (which form seems to be popularly demanded) founded thereupon can be easily calibrated and kept in order by the ordinary micrometers such as are now in use in all machine-shops, measuring by thousandths up to 1 inch, or similar ones arranged for the metric system.

This very important subject is now being looked into by

a committee of the American Society of Mechanical Engineers, which will probably co-operate with committees from the other great national engineering societies. Interesting discussions have for some years past taken place in the various society conventions, in one of which the adoption of a  $\frac{1}{1000}$ -inch unit for a numbered gauge was proposed and strenuously advocated by the present writer, he at that time (May, 1889) not knowing just how far Whitworth had previously gone in the same direction. Nobody appears to have ever seriously opposed this scheme, but there seems yet to be the inertia of a heavy mass of conservatism and indifference to overcome. Active forces have, however, been set in motion and it is earnestly to be hoped that before the twentieth century shall have dawned the civilized world will have forgotten its past incomprehensible foolishness in regard to the measuring of its smaller dimensions, and that some gauging system as simple and definite as it is universal will have been adopted as merely the embodiment of common sense applied to common things.

#### A PROPOSED NEW GAUGE.

In following up and amplifying the Whitworth idea of notching it is very desirable that the gauge should be of some distinctive shape, which will not be confounded with any of the old gauges, thus preventing many mistakes. Fortunately none of the notched gauges in the market have been made of an elliptical contour, as shown in Fig. 180, which might be uniformly adopted as the only shape for such new gauges as are based upon the system in question. Among other advantages are general beauty of form and convenience for the pocket. This scheme was recently proposed by me before a joint committee of the American Railway Master Mechanics' Association and the American Society of Mechan-



ical Engineers, with an offer to freely assign any rights to a design patent which I might be entitled to. It was unani- mously, though unofficially, approved by all the members thereof, who decided that a desirable method of marking the notches in such a gauge was as shown in the picture, viz., by the three figures expressing the decimal of thousandths of

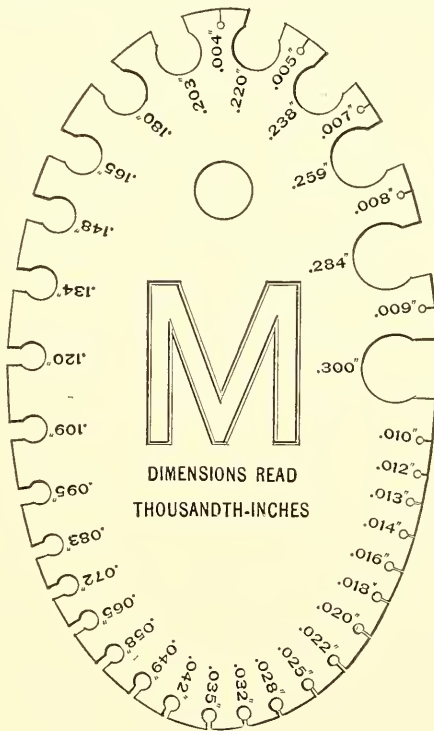

FIG. 180. \*

an inch, with a very definitely marked decimal-point to the left of the same, and with the usual "inch-mark" (") above and to the right. This uniform use of three figures will tend to prevent mistakes in speaking of the sizes in question, which would not be the case if final ciphers were omitted and certain measurements were allowed to be expressed in tenths or hundredths by the use of one or two figures respectively.

In such case were a measurement, for instance, twenty-one hundredths, it would very likely be spoken of as "twenty-one thick" or "twenty-one gauge," in which contingency it could, of course, not be known whether twenty-one hundredths or twenty-one thousandths was intended. By the uniform system mentioned, however, such a measurement would, of course, be known as "two hundred and ten" rather than "twenty-one."

A difficulty has been suggested as apt to arise in cases where measurements must be finer than in any given number of thousandth inches, this being that sometimes four figures would have to be used. Such cases will rarely happen in commercial life, but when they do the system will not be at all thrown out of gear by the use of an additional figure, provided that the decimal expresses it as ten-thousandths. This is for the reason that such gauges are limited to sizes under 1 inch in thickness, and that therefore there are never more than three figures in practical use when working upon the thousandth basis. The use of four figures at once indicates, therefore, that the ten-thousandth basis has been adopted for the particular case in question.

In regard to a name for this proposed gauge there is perhaps no definite consensus of opinion yet formulated. It was proposed as one scheme that such a tool be stamped with a large letter "M," as shown in the picture. This, being the Roman symbol for 1000, would give the general idea that such a number was used as a base of operations. This scheme might not be as logical as would one involving a definite name, but it has the merit of being new, so that there will be no danger of mixing the "M" in question with "B. & S." or "B. W. G." or any of the other names; and it also has the very important feature of being short and simple, and therefore easy to speak and write. This brevity (as is shown in the popular naming of the elevated railways

in New York by the single letter "L" and by numerous other instances of the kind) is, in our rapid modern life, an extremely important factor of popularity. There would seem to be but little difficulty in introducing a gauge of this kind where its shape, either to the eye or to the touch, would be absolutely distinctive, either in light or darkness, as would also the large M deeply stamped upon it. In ordering goods it would be necessary merely to say, "Send" so many "pieces of brass, M gauge .087." It would not be important to write the inch-marks, and in verbal orders neither they nor the point nor the cipher would appear. Instead of the big M possibly a big D, the initial of the word "decimal," would be better, this adjective seeming so far to be the most popular.

Referring more in detail to the picture, there is shown therein, drawn to real size, a gauge embodying somewhat the above ideas, and one, moreover, which could be notched and graduated to any desired set of sizes without upsetting the system involved. It would (wherever it happened to have any sizes in common with it) agree absolutely with the Whitworth gauge—and with common sense. The particular graduations shown in this case are not ideal, the sizes not running in a proper series. It is made as it is merely to show how the ordinary B. W. G. gauge would look with the proposed new system applied to it, the notches being a copy of the same from "No. 1" to "No. 36," in actual size.

In general, it may be said that the committees above referred to, as well as various other would-be reformers who have taken an interest in this question, have not publicly committed themselves to the advocacy of a national legal gauge of this sort. They think that such a tool is needed in the present emergency, and that its use is only in the line of carrying out the system of measuring that they are already doing with the ordinary micrometer gauge. These

gentlemen are, presumably, perfectly willing to consider in future an international gauge for the use of the whole civilized world, which may or may not be founded upon the English inch or the French millimeter, or something else not yet worked out.

Some of the desirable qualities to be sought for in selecting a good series of numbers for a commercial gauge of the kind in question are as follows:

1. The increments in the series should be uniform or should increase with a considerable degree of regularity, not decreasing at some points and abnormally increasing at others, etc. In other words, the numbers used as ordinates should plot as smooth and graceful a curve as possible, without re-entrant angles, and preferably approximating a parabola.

2. The measurements in question should, as far as possible, agree with the fractions of an inch in common use in our draughting-rooms and machine-shops, especially those founded upon the binary divisions thereof, as sixty-fourths, thirty-seconds, sixteenths, eighths, etc.

3. They should also agree, as far as is consistent with other conditions, with the old gauges in common use, for the reason that metals measured by such old gauges are already now in the market in large quantities, and are more likely to be produced in future than are those measured by any new set of sizes. This is on account of the prejudice and force of habit of the makers thereof, and on account also of the special tools they have in use, such as dies for wire-drawing, etc.

4. The numbers used should be as easily remembered as possible, and therefore the preference should be given to "round numbers," so called—that is, those ending in ciphers and fives.

Keeping in view the principles above enumerated, and referring to the chart, Fig. 181, there will be seen in the

first column a series of 38 numbers (about enough to comfortably fill an ordinary pocket-gauge), which, measured from

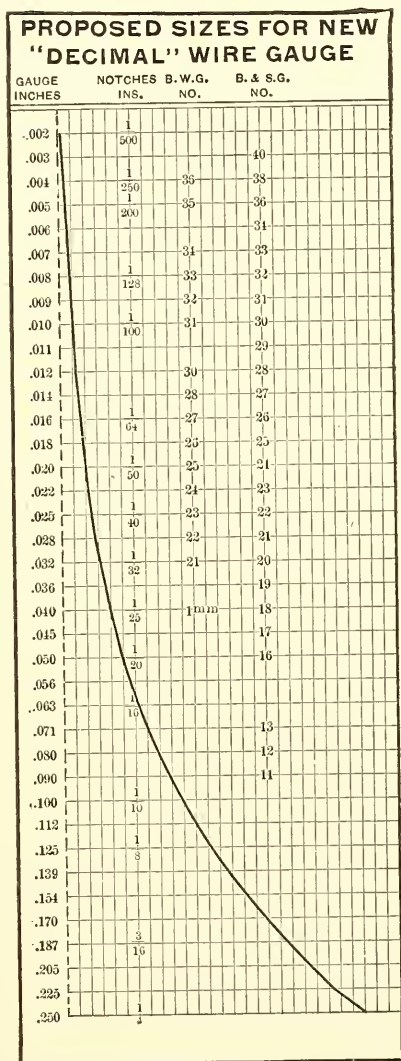

FIG. 181.

the vertical dotted line respectively as abscissæ, will produce the curve shown. This is reasonably smooth and approximates a parabola.

Furthermore, certain of these numbers are respectively equivalents, within a fraction of less than  $\frac{1}{1000}$  inch in each case, of the popular draughting-room and machine-shop measurements  $\frac{1}{28}$ ,  $\frac{1}{4}$ ,  $\frac{1}{32}$ ,  $\frac{1}{16}$ ,  $\frac{1}{8}$ ,  $\frac{3}{16}$ , and  $\frac{1}{4}$  inch, and also incidentally of  $\frac{1}{80}$ ,  $\frac{1}{60}$ ,  $\frac{1}{40}$ ,  $\frac{1}{30}$ ,  $\frac{1}{20}$ ,  $\frac{1}{15}$ ,  $\frac{1}{10}$  inch and 1 millimeter.

It will be noticed also that the Birmingham wire-gauge is represented by 15 equivalents, many of them exact. Better than this, the Brown & Sharpe gauge is represented by no less than 25 approximate equivalents, 22 of them being in a continuous series. These all agree within a fraction of less than  $\frac{1}{1000}$  inch, and all but one of them within less than  $\frac{1}{2000}$ , it being impossible in most cases to make them entirely exact, as the Brown & Sharpe gauge is scientifically founded upon a parabolic curve and is expressed in full by decimals of the inch running as far as millionths. Such agreement with this gauge, which is undoubtedly the best of the arbitrary retrogressive gauges in use, is an important feature, as large quantities of sheet-brass and brass wire are commercially measured with it, and it is well known as the "American gauge." A departure from its measurements is made only at 0.050 inch and above, it being very desirable to embody the  $\frac{1}{4}$  inch with the natural divisions thereof, and furthermore, it is usually unnecessary for a notched gauge to embrace any larger sizes than this, as the measurements of our plates and rods are, perhaps, most frequently expressed in thirty-seconds, sixteenths, etc., when above  $\frac{1}{4}$  inch. Besides the old gauge numbers given in the chart, there are other omitted ones which approximate the proposed new sizes within a limit of from  $\frac{1}{1000}$  to  $\frac{9}{1000}$ . In most cases the difference is not so great but what the new numbers would practically cover all ordinary commercial requirements, never departing over 5 per cent from either gauge—the B. & S. or the B. W. G.—from some one of the notches. This is nearer than the average measuring is usually done.

In regard to the fourth desirable qualification above mentioned, the series of numbers given is not, of course, an ideal one, although pains has been taken to embody such easily remembered numbers as .005, .010, .020, .025, .040, .050, .080, .090, .100, .125, .170, and .250. The odd numbers between seemed necessary—in some cases to agree with desirable vulgar fractions, and in others to complete the series with a proper rate of progression so as to strike upon an average the greatest number of probable marketable thicknesses of metal.

In general, if anybody planning a set of numbers (to suit perhaps some particular industry) will arrange them as on the chart, measuring off their values to some desirable scale, and if, furthermore, he will see that the resulting curve plotted therefrom is an ordinarily decent one, pleasant to the eye and satisfying to the conscience, he may feel sure that he has gotten a useful gauge, and that no harm will be done by certain notches which may appear superfluous. These may seem interpolations for his present purpose, but in adding other sizes to his products in future these neglected notches will, by the law of probabilities, be likely to prove the "missing links" he was unconsciously looking for.

### MICROMETERS.

In Fig. 182 is shown, real size, an adjustable gauge, commonly known as a "micrometer." It has a capacity for measuring thicknesses up to 1 inch—of course near the edge of the sheet only. Similar ones are made for  $\frac{1}{2}$ " , 2" , and 3" work. They are graduated to read direct up to .025" , and further by adding revolutions of the screw, each of which counts another .025" . They are usually very accurately made, and some of them have a vernierlike graduation which reads to ten thousandths.

In Fig. 183 is shown in real size, side and top views, a micrometer design contrived by the writer for a gauge to be carried in the vest pocket, and to be instantly read without the calculation required in those now in use. Obviously it has not their capacity, being intended for thin metals only, as, *e.g.*, tin-plate, light sheet-iron, etc. It has, however,

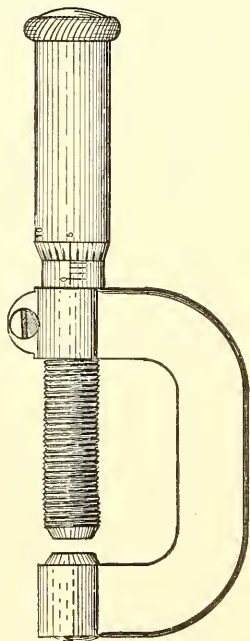

FIG. 182.

the advantage of measuring some 2'' from the edge of the sheet. It is not patented, and it is to be hoped that some gauge-maker will recognize its good points, if it has any, and put it upon the market.

#### ANNEALING.

It is taken for granted that the materials employed for press-working, especially in processes of distortion, which are more difficult than mere cutting, must be to some con-



siderable degree in a malleable or ductile physical condition. In the case of many metals when worked hot this freely flowing condition exists as a matter of course. When worked cold, however, it is frequently necessary to have them annealed before beginning operations.

For cutting or punching, most commercial metals are in

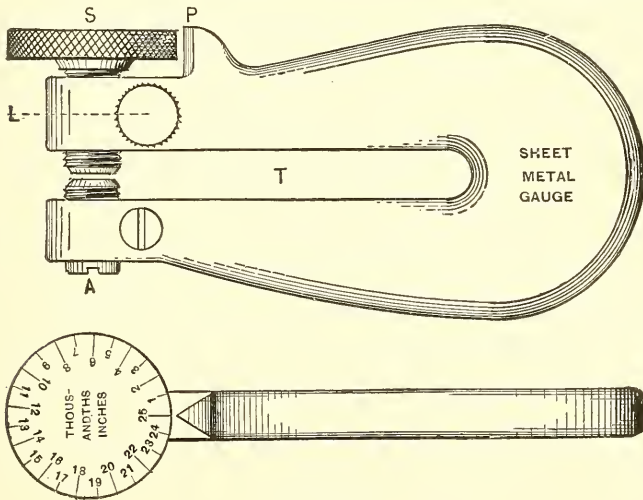

FIG. 183.

a suitable state as found in the open market, except perhaps tool-steel, which is generally sold unannealed.

For forming, drawing, coining, and analogous processes, especially where there is to be considerable distortion, and with such metals as steel, brass, nickel, aluminum, etc., which rapidly harden by the action upon them of hammers, dies, rolls, and other tools, care should be taken that they are in their "soft" rather than "hard" condition when purchased. This softness and ductility, however, is apt to disappear during certain operations performed in dies, and should be restored by re-annealing when the metal becomes so brittle as to be cracked or torn. In the case of drawing cups, shells, tubes, and such like this necessity for annealing often happens after the first one, two, or three operations.

Where many pieces of work are to be made, which thus require annealing, it is best to have special apparatus for the purpose, with a view of heating the metal without oxidizing it to such an extent as to form a scale upon its surface. Such scale not only wastes it away, but acts in many cases as a grinding material to wear off the surfaces of the dies, to say nothing of its effect in marring the surface of the work.

One of the newer annealing processes (which I believe is patented) enables highly polished metal to be brought from the furnace with no scale of oxide whatever, the original brilliancy, if polished, being maintained throughout. This result is ingeniously attained by keeping the metal while being heated in a *bath of gas* containing no oxygen, the practical arrangement being the forcing of ordinary heating or illuminating gas into the air-tight receptacle in which the heating is done. Usually the fuel is this same gas, a small portion of which is shunted off, as it were, for bathing purposes, as above mentioned.

## CHAPTER VI.

## CUTTING PROCESSES.

## EXPLANATORY..

HAVING more or less accurately formulated the ideas of writer and reader regarding tools and materials, we will now deal with actual processes, showing in such diagrams as may be necessary only conventional forms for shear-blades, dies, etc., and omitting as far as possible, for the sake of simplicity, pictures of the presses themselves or of the methods of fastening dies thereto. The details treated of will generally require only certain views of the working surfaces of the respective dies and of the materials worked therein. The letters *U* and *L* will represent upper and lower dies respectively in their conventional sense, although it must be remembered that the respective positions of these are, in practice, sometimes reversed, or in some cases turned at right angles or at some other angle to their usual vertical position—as in horizontal shearing-machines, inclined presses, etc. The metal or other material when shown between the dies will usually be represented by dotted lines and will be marked *M*. It will be referred to as “the material,” “the metal,” or, oftener, perhaps, “the work,” as may in each case seem appropriate. These remarks will apply also to subsequent chapters dealing with other processes.

## CHISELING.

If we analyze cutting processes as performed in presses, we find a most primitive idea to be that of the chisel, or

knife, as shown in Fig. 184. This is in a certain sense a form of coining or forcing the tool bodily into the metal. Practically it is an application of the wedge, which was prob-

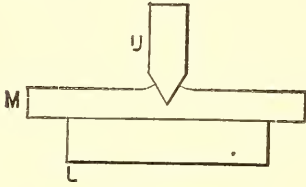

FIG. 184.

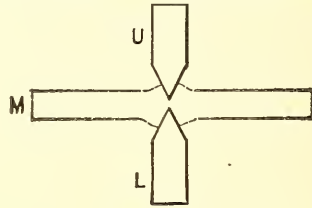

FIG. 185.

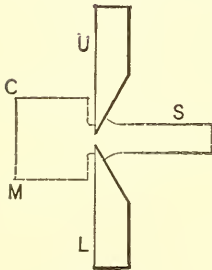

FIG. 186.

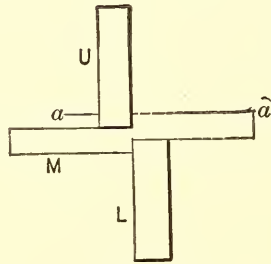

FIG. 187.

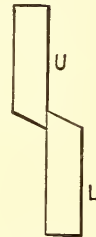

FIG. 188.

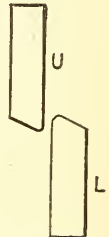

FIG. 189.

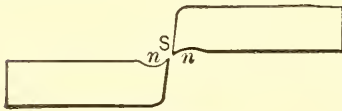

FIG. 190.



FIG. 191.

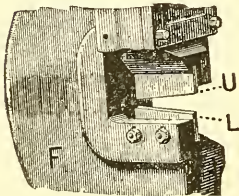

FIG. 192.

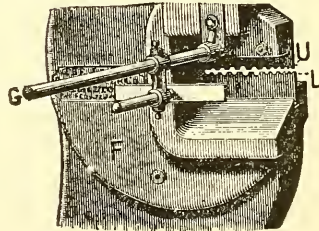

FIG. 193.

ably carried out in antediluvian times, when the primeval metal-worker found a particularly sharp-edged stone and pressed it hard down upon his piece of copper or lead, that he might separate it and make the one twain. In modern

practice this principle is carried out in the blacksmith's chisel, in the tinman's punch, in various sharp-edged dies for cutting shoe-soles or other articles of leather, paper, etc., and in that form of foot or power press known as a "sprue-cutter," which is usually made with two chisels meeting each other, as in Fig. 185, or more often with one-sided chisels, as in Fig. 186, these leaving less of a lump upon the casting, *C*, when the sprue, *S*, is removed.

In all chiseling processes there is, of course, a tendency to raise a bur upon each side of the knife, as shown, exaggerated, at the sides of *U* and *L*. Usually, however, this is partly crushed down by the sliding of the knife against it.

#### SHEARING.

The next and most usual process for cutting materials embodies the principle of shearing, shown in its most primitive form in Fig. 187, where a certain part of the material is pushed away from a plane represented by one of its surfaces, as *aa*, Fig. 187, into another plane parallel thereto, by being slid past the other part of the material, which remains in its normal position. This sliding of certain of the particles or molecules past certain other ones constitutes the stress known in engineering by the general term of "shear," and is governed by well-known laws as to the resistance of the material itself. These laws it is not necessary now to define or formulate further than the reference which will be found near the end of this chapter to the pressures required for such shearing.

In Fig. 188 is shown, in end view, a more usual form of shear-blades, the cutting-edges being made at an angle of about  $75^\circ$  between their two limiting surfaces, instead of  $90^\circ$ , as in Fig. 187. In Fig. 189 is shown the same blades as they often appear after practical use, with their edges rounded off and their adjustment altered so that their vertical faces

do not touch one another. In Fig. 190 is shown the appearance of a bar of metal as sheared apart at *s* with the dull blades just mentioned. In the left-hand piece the lower corner is rounded, while the upper corner runs into a sharp bur that has crept up between the blades. Just to the left is an indentation, *n*, caused by the compressive action of the blade itself. The other piece of metal is, of course, the same, but reversed in position.

In Fig. 191 is shown, in vertical cross-section, a piece of sheared sheet-metal with the same rounded corner and the same bur at the top, but with a cleaner cut, as made by sharper and well-set blades. The bur and round corner are exaggerated, but they are usually present in some degree in all kinds of shearing and punching work. They must be allowed for even in working thin metals with sharp dies, as it is often a matter of consequence on which side of the work this slight bur shall appear, and which side shall have a slightly rounded corner.

In Fig. 192 is shown a part of the frame of a press with a pair of plain shear-blades mounted directly upon the bed and the ram respectively. In Fig. 193 is a similar view, with shear-blades made for cutting off round iron, there being a series of semicircular notches in each blade adapted to the sizes of iron to be worked. Upon this view there is also shown an adjustable gauge, *G*, such as is often used for pushing a bar against, to regulate the length of the piece cut off. The two views shown are copied from various machines commercially in the market, and fairly represent good average design. The same may be said of the mounted punch and die shown in Fig. 196.

#### DIP OR SHEAR.

In Fig. 194 is shown a face view of the blades in Fig. 187, the same being made parallel, so that all points along

their cutting-edges will come into contact with the metal at the same time. This form is best (properly "beveled," as in Fig. 188) where the metal must not be twisted or otherwise disturbed, and is good enough in any case where it is quite narrow in comparison with its thickness, as with square bars. With such proportions it obviously is not practicable to much lessen the pressure required to do the cutting by dividing it up and extending it over a longer time. Such

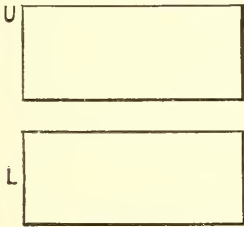

FIG. 194.

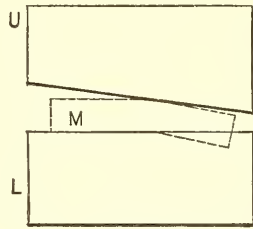

FIG. 195.

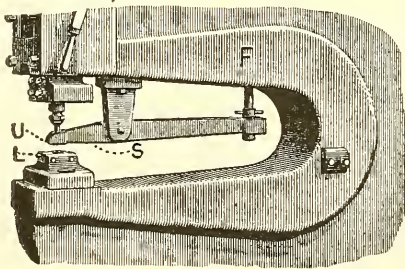

FIG. 196.

an extension of time and lessening of the pressure at any particular moment may sometimes be obtained, however, by making one of the blades, like the upper blade in Fig. 195, with an inclination of the edge, commonly known as "dip" or "shear." This evidently is useful only where the width of metal cut is considerable. It is obvious that in such case one edge of the piece of bar- or sheet-metal is pushed down by the upper blade and depressed in advance of the other edge, thus producing a bending action across

the sheet which distorts it more or less from its original flat condition, as at *M*. This action is seen in the curling up and twisting of a narrow strip cut from a piece of paper with a pair of scissors, or a sheet of tin-plate with a pair of snip-shears. In many cases it does no harm, and we therefore see the great majority of shearing-machinery made in this way. This inclination of one blade to the other is usually somewhere between  $5^{\circ}$  and  $15^{\circ}$ . If the angle is too great, the tendency of the work is, obviously, to slide lengthwise of the blades, or toward the left, in Fig. 195. The greater the angle the easier the work is done by the machine and the more the sheet is distorted, and *vice versa*.

It is very desirable that the word "shear," as designating the angle of inclination referred to, and also the act of mechanically producing such inclination, should be changed for a less confusing term, as this word is already used in many cases for the press itself which does the shearing, and for each of the blades which are mounted thereupon, and for the act of doing the cutting-work itself. Thus in this connection we may easily have such an awkward and misleading sentence as the following:

"Tom, shear half an inch the upper shear in the two-ton shear, that it may shear more easily by having more shear—and, I say, Tom, leave a sheer opening of an inch and a half."

The quoted sentence reads like sheer nonsense. It is, of course, given as an extreme case of the evil referred to, but I have heard orders uttered which were nearly as confusing. The word in question is above used the first time as a verb, denoting the act of grinding more inclination upon one of the blades; the second time as a noun, meaning the blade itself; the third time as a noun, meaning the machine in which the blades are mounted; the fourth time as a verb, denoting the act by the machine of shearing the material worked upon; the fifth time as a noun, designating a detail



of construction of the blades, and the sixth time (differently spelled) as an adjective, defining the space between said blades. In my own practice I am endeavoring to use the term "dip" as a substitute for "shear" in this connection, but perhaps may not succeed in inducing the public to accept it. This word is given by Webster as a synonym for "slope" and "pitch," and has in its favor brevity and crispness, together with no danger of confusion with other terms apt to be used in the same connection. It also is correct from an engineering point of view (at any rate in the case of ordinary upright shearing-presses) as representing some angle of inclination with the horizon, and it is already applied to such angles in mining parlance when speaking of mineral veins. It would also seem somewhat appropriate in speaking about gangs of punches as shown in Fig. 200, which are set with their lower ends in a series of different heights, that they may not enter the work all at once but may bring the pressure required for each cumulatively upon the press. In this case certain of the punches have a dip, so to speak, below the other ones, in the sense of reaching downward. A word often used in connection with such punches is "lead," meaning that one has the lead of some other one in first striking the work. To tools of this kind the word "shear" is hardly applicable at all, but the word "dip," if it could be generally introduced, would answer for all cases of punches as well as shear-blades.

#### PUNCHING.

In speaking of the important operation of punching as a companion with shearing, both of them coming under the head of shearing processes when the term is used in its broader sense, and shearing, in its turn, being but one subdivision of the general class known as cutting processes, we again find ourselves in a state of disgust with word-inventors. This is

because the word "cutting" is used by practical men in a specific sense also, when defining certain dies, as an adjective almost synonymous with "punching." It is difficult to draw the line between dies known by these two names, but the former is usually applied to large sizes of "cut" in thin sheets of metal and the latter to small sizes in thick bars or sheets. Roughly drawing a line of demarcation, it might do to call the operation cutting when the thickness of metal is less than  $\frac{1}{10}$  of the longest diameter of blank, and punching when more than  $\frac{1}{10}$  of the same. The former term would cover most of the press-work on thin sheet-metals and the latter on boilers, bridges, ships, etc. In this treatise no definite distinction will be made except as an approximation to the proportions above mentioned.

In Fig. 196 appears a partial view of a deep-throated press frame, with a small round punch and die mounted in chucks set therein, and supplied with an adjustable stripper, S.

In Fig. 197 is shown, in vertical axial section (which, by the way, is the kind of view given in most of the previous pictures where circular work has been represented, and which will be usually understood hereafter unless otherwise specified), a pair of ordinary round cutting dies, without dip, both working surfaces lying in planes parallel to each other. It is evident that such a pair of dies are in principle simply a pair of shear-blades, like Fig. 188, bent around into a circle, and that the same principles involved in ordinary shearing hold good. This statement may be somewhat modified where the diameter of the blank (this term "blank" meaning in general a flat piece of any shape cut from a sheet) is quite small in comparison with its thickness, as for instance in punching boiler-plate, etc. In such cases a little more force must be required to do the shearing, on account of the blank being tightly confined in the hole from which

it is pushed; while in doing the same amount of shearing in a straight line the piece cut off usually falls freely away without friction. A thick blank of small diameter is sometimes called a "punching"—also a "wad." The metal around it is in some cases termed the "margin."

Fig. 198 purports to show an upper die or punch, such as is often used for boiler-work, etc., with its lower end made in a spiral form instead of lying in a plane normal to its

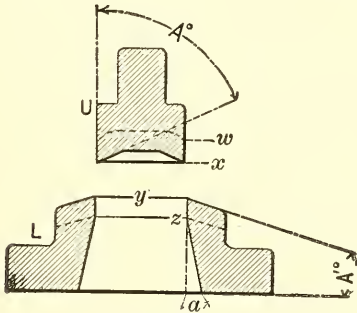

FIG. 197.

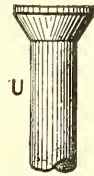

FIG. 198.

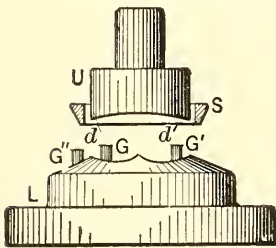

FIG. 199.

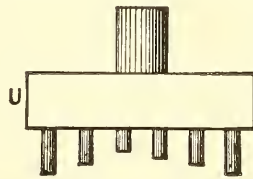

FIG. 200.

axis. Various experiments with such punches have shown them to require somewhat less force to drive them through than in the case of the ordinary flat-bottomed ones. In Fig. 199 the same principle of dip is shown in the upper die *U* with its two "high-points" *d d'*. These strike the metal first, the bottom of this die being scooped out as if it had been held against a cylindrical grindstone. For large diameters this is much better than a single high-point, as in Fig.

198, because the pressure upon the press ram is balanced, whereas with one point striking the metal first there is a tipping action which tends to spring the ram and upper part of the press frame out of a vertical position, and consequently to slide the upper die sidewise over the lower one. Such action often occurs in practice, to the considerable detriment of the cutting-edges, and great care should always be taken, where a die is over 2 or 3 inches in diameter at any rate, to see that it strikes the metal at two or more points equally balanced about the vertical axis of the ram. Of course this cannot always be done, and in such cases a more rigid press will be required than in the other case. The lower die *L* in Fig. 199 is also shown "dipped," having in this case four high-points. In practice, however, one die is usually made flat, all of the dip being put upon the other. Which die should be flat depends upon the nature of the work. With a thin material, such as tin-plate, and with diameters, say, above 2 inches, this point is of little consequence, as both the blank and the sheet outside of it, if sprung out of flat while the die is going through, will readily be restored to a flat condition by their own elasticity. If, however, the metal is thick and rather non-elastic and the diameter small, it is evident that an upper die scooped out, as in Fig. 199, would bend the blank, perhaps beyond its elastic limit. In such cases, therefore, the upper die should be perfectly flat, that is, if no damage will be done to the sheet outside by its being bent as it rests on the dipped lower die. Usually in these cases this sheet outside is only "scrap" (the conventional term for all the waste metal), and such bending will make no difference. If, however, it too must remain flat, the only recourse is to make both dies without dip and use more pressure to drive them. In cases where mere perforating is done, that is, where the sheet outside the blank is the article required for use and the blank is regarded

as scrap, the upper die should always be the dipped one—unless indeed their size is so large in proportion to the thickness of metal as not to signify.

In general, it is better theoretically to have only two high-points upon cutting dies, either round or otherwise, as the metal which is sprung out of flat by reason of the dip is, in such case, simply bent into an approximately cylindrical shape, while with more than two points it is distorted in more than one direction into a dished shape or otherwise, which may permanently warp it beyond power of recovery. The reason is, because certain parts of the metal are then actually stretched while others remain normal. That this is true can be vividly demonstrated by merely bending a thick sheet of writing-paper, which does not hurt it, and then by pushing it a little way into one's hat, which ruins it. Practically, with thin metals this action may be neglected, and it is often best to put a high-point at each angle of the contour line of the blank, as, *e.g.*, three in a triangular die, four in a square one, etc. These points entering into or over the other die first serve to guide their relative motion during the rest of the stroke, and thus to protect such parts of the cutting-edges as follow after into contact.

For similar reasons it is obviously better to let the longest punches in an upper gang-die be located near the outer ends, as in Fig. 200, especially if the die is long in a lateral direction; and the outer ones should strike the work at the same time.

### DEEP PUNCHING.

In ordinary punching presses a rough limit to the thickness which can be worked cold is usually found for such metals as iron and mild steel in a dimension but little greater than the diameter of the punching. Beyond this there is apt to be trouble in the way of punches crushing themselves

down, or being torn apart in the act of stripping. If, however, special precautions are taken in the way of very slow ram motion, so as to give the metal time to flow, and especially in the way of guiding the punches all the way down, so that they cannot buckle (spring out of a right line), some remarkable results may be, and have been, obtained. The most curious specimen I have seen was made by Messrs. Hoopes & Townsend, of Philadelphia, and consists of a block of iron nearly 2'' thick, with a  $\frac{7}{16}$ '' hole punched through it, cold, the bottom end of the hole being only about  $\frac{1}{8}$ '' greater diameter than the top. I believe, however, that work even somewhat proportionately thicker than this has been punched.

The "wads" from this thick work are much shorter than the hole. As their density is but little increased, it follows that some of the metal under the punch must flow sidewise into the walls surrounding the hole, thereby increasing the bulk of the object being punched. In holes of less length than their diameter, *e.g.*, in boiler-work, this thinning of the blank or wad is noticeable, but to a much less degree.

#### PUNCHING TAPERING HOLES.

In general, for thin metals, and particularly for paper, cloth, and such like materials, it is necessary that a punch should fit a die closely, so as to allow none of the material to creep down between. Indeed, a rule frequently used by the writer for accurately testing such dies has been to see that they would cut wet tissue-paper, cleanly, all around. In the practical punching of metals of some considerable thickness, however, say  $\frac{1}{8}$ '' and over, it is customary to make the hole in the die larger than the punch, the object being to reduce the pressure upon said punch, thereby adding to its durability, and also to save some of the power required for the performance of its work. The result of such a con-

struction is of course a conical, or other tapering, blank removed from the hole, its upper end being the diameter of the punch, and its lower end that of the die. It is obvious that this can be pushed out of a sheet or bar of metal more easily than would be the case if it were parallel, chiefly on account of the reduction of friction where the sides of the blank slide down against the walls of the hole—or, in common parlance, because it has better clearance.

I have not at hand accurate records of the relative power required for different amounts of this clearance between punch and die, but I remember that in some interesting experiments made some years ago by Messrs. Wm. Sellers & Co. the minimum power was found to be required when the clearance amounted to  $\frac{1}{8}$  of the thickness of the sheet being punched. When the blank was either more or less conical than this, the power had to be increased. As a matter of fact, however, such proportions represent an extreme case beyond that generally used in practice, where the clearance is generally not over from  $\frac{1}{16}$  to  $\frac{1}{12}$  of the thickness. For instance, in punching  $\frac{3}{4}$ " thick bars a 1" punch will often be run with a die  $1\frac{1}{16}$ " in diameter, which gives a ratio of  $\frac{1}{12}$ . In general, the clearance in ordinary work will vary from  $\frac{1}{64}$ " to  $\frac{1}{16}$ ". In some cases, with round holes, the conical shape in question may perhaps happen to be an advantage, as when the large end can be turned outward in riveted joints, etc., but in other cases it may, on the contrary, happen to be detrimental.

#### IMPERFECT SHEARED SURFACES.

In considering the question of whether to shear and punch a given piece of work, rather than to mill it and drill it perhaps, it must be remembered that sheared surfaces are necessarily rough and lacking in accuracy. More than this, the contiguous metal is somewhat disintegrated, having its

fibers sent downward by the tearing away of the removed metal and the sliding past of the shear-blade or punch. This weakens its structure to such an extent that many modern boiler specifications insist upon all holes being reamed larger to remove the damaged wall of metal. Others allow no punching, but require drilling from the solid.

#### DRIFTING OR RE-PUNCHING.

The word "drifting" is used in a number of different senses, but in press-work is usually applied to a system of what may be termed re-punching. This consists of enlarging a hole already punched, or possibly drilled, or even cast, by forcing a punch through it, to shave off the walls to a larger diameter. The operation is thus more nearly akin in principle to the action of a planing- or slotting-tool rather than to ordinary punching. The operation is a partial remedy for the evil mentioned in the last paragraph, inasmuch as it lightly shaves off the wall of disturbed metal.

Sometimes a drifting-tool consists of an elongated bar, of the required cross-section to suit the shape of the hole, which is equipped with a succession of teeth, one above the other, its general form being slightly tapered so that as each set of teeth follow they will shave out a little more metal until the largest diameter is reached. A tool like this is usually dropped through the work when it has finished its stroke, to save time and to avoid any damage to the teeth that might occur by pulling it up again through the aperture that it has scraped out. Such an operation is sometimes called "broaching." In this book, however, the term will be reserved as appertaining to certain conditions of the process of drawing—to be mentioned further on.

#### A MUSEUM OF BLANKS.

In Figs. 201 to 233, 235 to 250, and 255 to 260, all inclusive, are shown top views of various blanks, each of which



has been cut from the sheet at one stroke of an ordinary pair of cutting-dies. They are mostly of such shapes as are

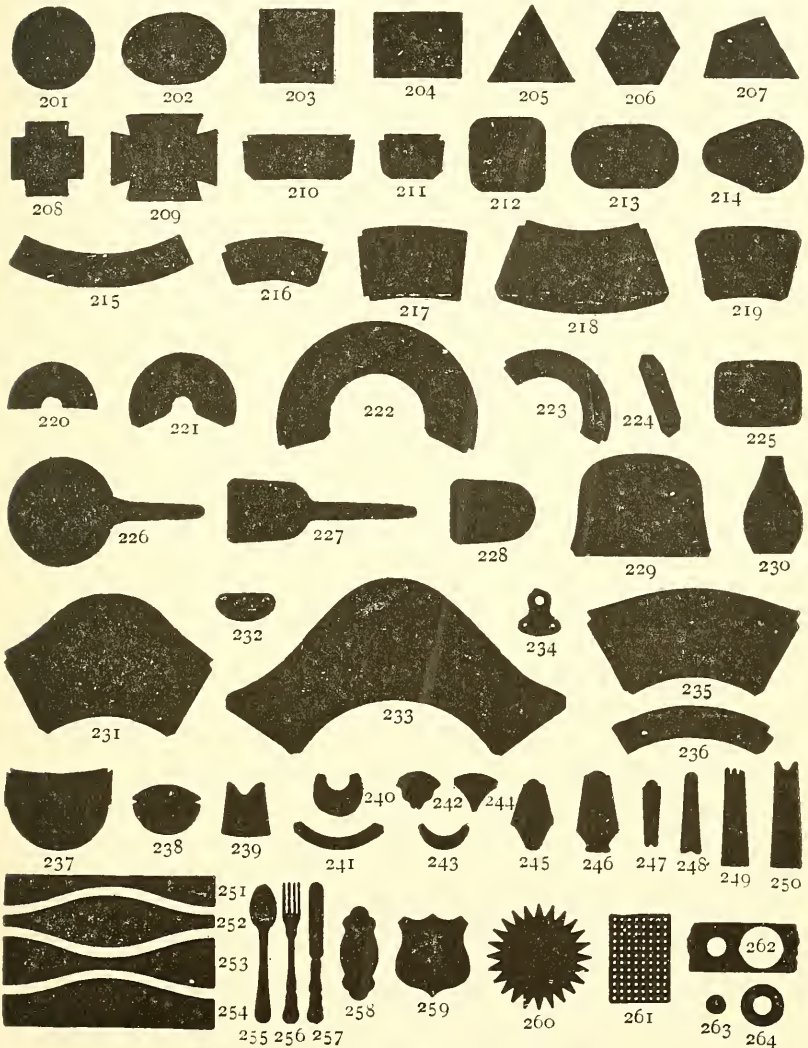

FIGS. 201-264.

produced in regular tinware factories, and consist chiefly of parts of "pots, kettles, and pans," together with shovels, table-platè, badges, etc. Figs. 251 to 254 show blanks

that have been merely sheared apart from a rectangular sheet by a gang of curved shear-blades, thus producing at one blow the necessary pieces for a stovepipe-elbow. Such work as Figs. 234 and 261 is usually perforated in gang-dies, where a number of punches are set in an upper plate, as shown in Fig. 200, and where the lower die usually, but not always, consists of a single plate of steel containing proper holes for the punches to enter. The remaining pieces from Fig. 262 onward have been cut by the "successive" system.

#### GANG-CUTTING.

The mere grouping of dies and punches, as indicated in Fig. 200 and referred to in the last paragraph, the object generally being rapidity of work and uniformity of spacing, is so simple and obvious as to require but little mention. The process involved may be termed gang-cutting or gang-punching, according to circumstances. It is employed for making "perforated metal" so called, for rows of rivet-holes in boiler-sheets, for ornamental-work in brass and paper, etc., etc. The perforations as well as the spacing may of course be either alike or different. Sometimes all the holes required are punched at once, and in other cases one or more rows are produced at each stroke, the sheet being fed along intermittently—automatically or by hand. In some cases the sheet is the required product, in others the blanks.

#### COMBINATION-CUTTING.

A common method of producing completed pieces at a single operation is by "combination-cutting" dies, wherein one or more male dies are usually set inside of a female die, and *vice versa*. The sexual terms just used have been before mentioned, and are generally understood as designating respectively any punch, such as *U*, Fig. 197—the male—

which enters a die, and any die, such as  $L$ —the female—which is entered by a punch.

In Fig. 265 is shown a typical form of combination dies of the kind referred to, which will produce any perforated work like Figs. 234, 261, or 264, at the same time cutting the outside contour. As shown, it is arranged for cutting simply a circular ring or washer,  $M$ . Such ring, of course, remains upon top of the lower die  $L$ , the small blank cut from it dropping through as usual. An inspection of the picture will show that  $L$  consists of a male die at the outside and a female die in the center, while  $U$  consists of a female die outside and a male die in the center. The rings  $K K'$  are used as knockouts or strippers and are usually driven by springs, the function of  $K$  being to drive the finished ring out of the upper die and of  $K'$  to lift the surrounding remainder of the sheet from the lower die. The work is, of course, shoved out sidewise or backward, either by means of the surrounding sheet itself, or by means of gravity, when the press happens to be in an inclined position. Such dies as these are largely used for cutting armature disks and similar accurate work, oftentimes being built with a large number of teeth or notches around the outer edge, which obviously makes them very expensive. They are, however, usually built up in sections, so that if one piece needs repairing or renewing the whole die need not be thrown away. Sometimes dies of the kind just described are turned upside down from the position shown. The objection to this, however, is that the blanks from the perforations have to be driven upward through a hole or tube which usually curves over and delivers them at one side of the upper die, or of the ram, should they be pushed so far up.

#### SUCCESSIVE CUTTING.

Fig. 262 illustrates a system of gang-punching used for producing washers like Fig. 264, and other perforated articles.

A pair of dies for such work are shown in Fig. 266, where the metal  $M$ , being fed in the direction of the arrow, is advanced to the point  $a$  at first stroke of the press so that the punch  $u$  will perforate it and drop through the punching or blank  $M'$  (or Fig. 263). It is then advanced to the point  $b$ , so that at the second stroke the punch  $u'$  will make the large hole around the small one. The pintle  $p$ , projecting below the same and set centrally therewith, enters the small hole and serves to guide the metal more accurately than would otherwise be done by ordinary gauging, so that a completed washer  $M''$  (or Fig. 264) drops through the lower die  $L$ . At the same time the punch  $u$  is punching a second hole and dropping through another blank  $M'$ , which again is advanced at the next stroke to have another washer punched from around it, etc. Thus is produced a complete piece of work at each stroke, except the first and last at the respective ends of the bar or sheet. This method can of course be amplified so as to punch any number of holes, of any shape, and in any relative position, at the first stroke, and then, at subsequent strokes, to punch around each one separately, or around or between any of them or any groups of them that may be desired. In this way are cheaply produced many small articles, such as keys, parts of locks, etc.

#### SUCCESSIVE GANG-CUTTING.

In making ordinary gang-punching dies for producing work, or rather scrap, of the general character shown in Figs. 261, 267, and 269, it is evident that in some cases the holes might be so near together that the little isthmuses, as we may call them,  $i, i, i$ , etc., would be too narrow (so as to avoid waste of metal) in the female die to secure the requisite strength for it to hold together. The remedy in such case is to so set the gang of punches and corresponding holes in the lower die that certain alternating holes may be punched in the metal,

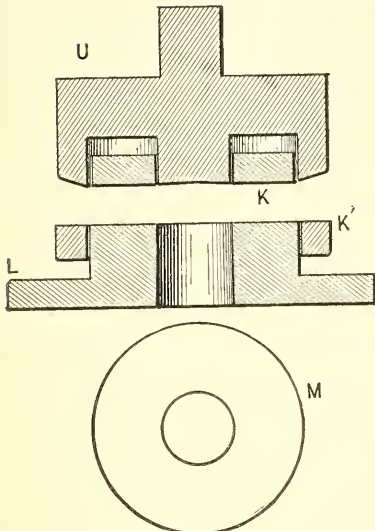

FIG. 265.

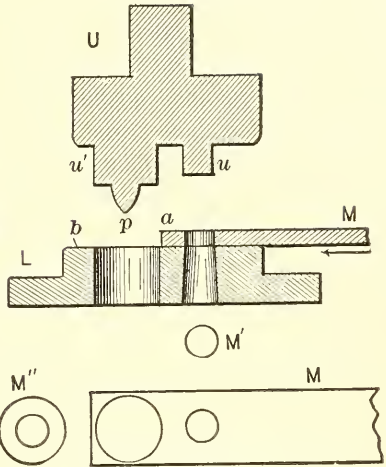

FIG. 266.

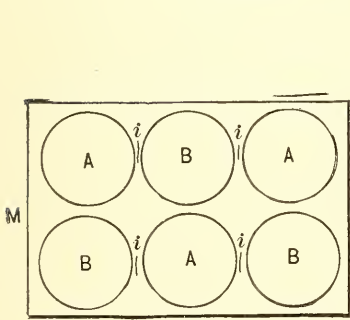

FIG. 267.

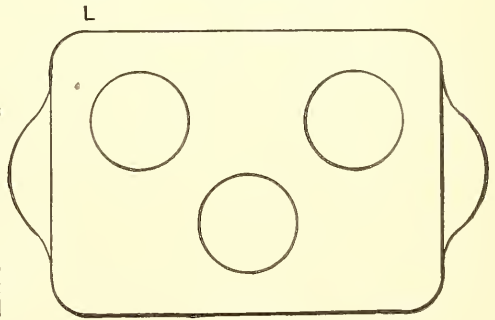

FIG. 268.

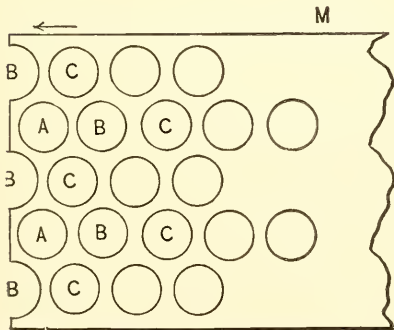

FIG. 269.

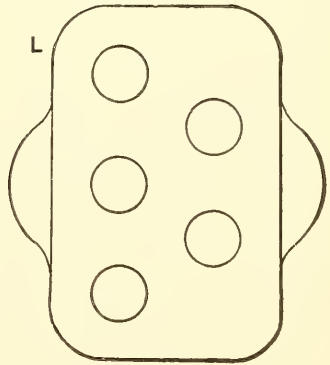

FIG. 270.

omitting the ones between, as for instance in Fig. 267, where those marked *A* are thus punched first. This diagram represents a sheet of tin-plate from which six fruit-can tops have been made in gang combination cutting-forming dies. The lower die is shown in top view in Fig. 268. After the first stroke the sheet is either turned around or turned over so that at the second stroke all those holes marked *B* will be punched, and so on. In feeding a long strip of metal by this system (see Fig. 269), there is no lost time except at the ends of the strip, where, for instance, in the case shown, only two holes, *AA*, could be punched at the first stroke, two whole ones and three halves, *BB*, etc., at the second stroke, but the five complete ones, *CC*, etc., as located in the lower die, Fig. 270, at the third and subsequent strokes.

A great deal of work is done upon this system in brass-factories and other places producing small articles from long rolls of metals, the feeding usually being automatic. It is a curious fact that this principle of interspacing dies has recently become the subject of a patent, which, of course, is an absurdity, as the system is very old.

#### CUTTING DIE QUALIFICATIONS.

In general, some of the important points desirable to secure in cutting dies are first-rate material of proper hardness; great rigidity against distortion by springiness, especially in lateral directions; and durability, by having ample length of bearing-surfaces, as from *w* to *x* and *y* to *z*, in Fig. 197. Each die between these points should be perfectly parallel, so that when sharpened by grinding off the top surface of *L* and the bottom surface of *U* they will still fit each other as tightly as at first, or as nearly so as is consistent with what their cylindrical or prismatic surfaces, as the case may be, which slide against each other, have actually worn away. It is, therefore, very bad practice to make the hole in a round

lower die conical all the way through and to make the upper die conical, decreasing from the bottom upward. Such dies will work well at first, but have very little "life," whereas if made as in Fig. 197 they can be ground away gradually (upon their horizontal surfaces) to the points  $w$  and  $z$ , as shown by the dotted lines. Below  $z$  it is necessary to have the size of the hole somewhat increased to give clearance to the blank, that it may not clog therein. Sometimes this is made conical, as shown, and sometimes it is enlarged bodily and left parallel, with a small step at  $z$ . It is well, however, to have this clearance quite small. On ordinary dies about 2 inches thick it has been found good practice to make the clearance-distance  $a$  from  $\frac{1}{32}$  to  $\frac{1}{16}$  inch. In the upper die there is no need of giving any clearance, and some die-makers even go so far as to make  $U$  slightly larger at the top, so that as the lower surface is ground off the bottom diameter is slightly increased, thus maintaining a tighter fit in the lower die than would otherwise be the case. It is generally easier, however, to make the sides parallel all the way up.

#### HARDNESS OF DIES.

While in the case of punching and shearing thick metals the upper and lower dies or shear-blades, as the case may be, are both made hard, there is a large variety of work where one of the dies is made moderately soft, the other one being as hard as possible, consistently with not having the sharp edges crack off in working. Such dies can usually be worked upon all metals no harder than iron or very mild steel which are less than  $\frac{1}{16}$  inch thick. The object is that the dies may be quickly and cheaply repaired, as far as maintaining sharp cutting-edges is concerned, by hammering up the top or bottom surface, as the case may be, of the soft die, thus spreading out or riveting such die sidewise, making it larger if it be the male, and smaller if it be the female. This can often be

done without unsettling either of them from the press. After the proper amount of hammering the dies are oiled and forced together, the hard one shaving or drifting off the surplus metal from the soft one, thus leaving them again a good fit, one within the other. It is, of course, necessary that the hard die should in such case have a reasonably sharp edge. In most instances it is best to have it freshly ground. The grinding should, obviously, be done on the bottom of an upper and the top of a lower die—not upon the sides where the size would be affected.

The vexed question of which die shall be hard—male or female—is not of very much consequence, although many people take it for granted that it should be the female, simply because they have always been accustomed to that method. One good reason exists for this, however, viz., the presence of a hard surface, which will not wear away so fast, over which to slide the sheets, these sometimes being covered with scale, and therefore doing a good deal of grinding on their own account. Under some conditions, where great accuracy of shape and size is required, it is difficult to make the female die hard, because of the trouble of grinding it out to exact dimensions after hardening, ordinary grinding-machinery not being made for sliding through small holes of irregular shapes. If, on the other hand, the male die is hard, it usually can be ground exactly as wanted, because such grinding is on the outside, where accessible. The reason for such after-grinding being necessary is, of course, the warping or shrinking, or both, of the steel, which often happens after hardening to an extent great enough to spoil the accuracy with which the die was originally made. The difficulty of grinding above spoken of obviously does not occur with round and elliptical dies, as the female ones can be ground out inside in ordinary grinding-lathes, using common and “oval” chucks respectively.



## BEVELS OF CUTTING EDGES.

The bevel of shear-blades has been already referred to as being usually about  $75^{\circ}$ . This angle, of course, appears in cutting dies, as *A* and *A'*, Fig. 197. Its object is chiefly to facilitate the grinding and hammering-up practiced in repairs, although it is supposed that the metal is cut easier, with a little less power, than when the edges are at an angle of  $90^{\circ}$ , as in Fig. 187. Just how much power is saved thereby I have at present no data regarding. In some cases, however, it is better to make the surface of dies perfectly flat, with a  $90^{\circ}$  angle, to avoid the little notch that is left in the work, as shown at *nn*, Fig. 190, or the analogous bevel occurring when the dies are sharp.

## STRIPPERS, HOLD-DOWNS, ETC.

It is usually necessary to supply a male cutting-die with a "stripper," which in general consists of a stationary ring surrounding it and extending slightly below it when in upper position, as shown at *S*, Fig. 199. This is usually secured either to the press-frame back of the ram or to the lower die or bolster, it being bent downwardly in such case to meet the place of fastening. The latter method serves a good purpose where the downwardly-extending portion is not in the way of the sheet, as for instance where the sheets are narrow. If, however, it is desirable to move the sheet back a considerable distance, as for cutting another row of holes forward of the first row, etc., a stripper is apt to be in the way if mounted as last mentioned. Sometimes a stripper is a ring sliding upon the male die and driven down by springs abutting there-against. In still other cases it slides in this way, but is struck upon the up-stroke by stationary abutments fastened to the press-frame.

The stripper shown in Fig. 196 gets its adjustment by

swinging upon a pivot and does not therefore always maintain its lower surface in a horizontal plane. This feature endangers small, slim punches by "cramping" them when the metal tries to tip into a different position from that in which it was punched during the process of "stripping"—that is, having the punch pulled out of it. Such a stripper, however, serves a good purpose for heavy work. An alternative device, which does not cramp, is made to slide vertically up and down to attain its adjustment.

When work is punched without any stripper at all it is generally the case that the punch is tangent to the edge of the sheet at one or more points—thus allowing the scrap surrounding it to spring away, or partly fall away in pieces, so as to relieve itself and slip off. This method is often practiced with tin-plate and other thin metals.

A "hold-down" is apparently of the same nature as a stripper, but is used in connection with a shear-blade rather than a punch, and for a different purpose. Its function is to keep that part of the work from tipping-up which rests upon the lower blade, during the down stroke of the upper blade as it cuts off and pushes down the severed portion. It usually consists of a fixed bar extending across and immediately above the work a few inches from the upper blade. Did it appear in Fig. 187, it would be located at the right side of the picture a little above and to the left of the point *a*. It is not needed in cutting off long bars where their own weight, supplemented perhaps by the pressure of the operator's hand, acts with sufficient leverage to keep them down. Obviously this device is more necessary with dull blades (as in Fig. 189) than with sharp ones.

Analogous to an ordinary hold-down is the "clamping-pad" used on some shearing-machines, especially for slitting large sheets. This consists of a stiff bar lying against the face of the upper blade and over the lower one, having the

same length as the blades themselves. It is automatically operated by cams or springs so as to firmly clamp down the sheet just before the shearing commences and release it as soon as, or before, the ram gets up, so that it may be slid to another position or removed altogether. This pad is frequently mounted upon the ram—sliding up and down thereon. Its function is not only to keep the work from sliding out of place, but to prevent its being warped and bent by the action of the blades.

A ring- or disk-shaped pad is often used in certain cutting and forming dies—for similar reasons to the above—also, in some cases, to prevent “buckling,” where metal is forced downward and inward, edgewise upon itself, so to say.

#### DIE-GAUGES.

In regard to gauges, they are too numerous in design to be described in detail here. In their simplest form they are merely round pins, projecting upward from the lower die, as at  $G$ ,  $G'$ , Fig. 199, for back-gauges, and  $G''$  for an end-gauge, so called. Sometimes, however, gauges are so arranged as to confine a strip of metal at both front and back, and in many cases the end-gauge  $G$  is arranged as a “finger-gauge,” so that it will move up and down automatically by the action of the press at the proper time. When the feeding and gauging is done by hand, however, the work is lifted so as to slide over the top of  $G''$ . The “pin” of a finger-gauge is sometimes arranged to project downward into the work from above.

#### CUTTING SPEEDS.

In regard to the best speed for running cutting dies, but little has been accurately determined. The ordinary quick-running presses in common use, making from 50 to 200 strokes per minute and generally averaging perhaps 100, seem to

work well for shearing and punching most of the common metals which are not over  $\frac{1}{4}$  inch thick. An exception, however, should be made for cast steel, for cutting which a press should be geared so as to run very much slower than for mild steel, iron, brass, and the softer metals. The reason for this is simply to get more durability in the dies, as the edges seem to get dull very rapidly at quick speeds. For punching metals over  $\frac{1}{4}$  inch thick it is usually better to use what is known as a geared press, which generally makes from 25 to 75 strokes per minute. In the cases mentioned presses of short stroke, usually 2 inches or less, are referred to. Where a press happens to have a much longer stroke, it is of course necessary to run at a lower number of strokes per minute to secure the same actual cutting speed. This, from the above figures, will average from 8 to 60 feet per minute, which compares closely with the speeds used for the shaving or paring processes of the machine-shop.

#### CUTTING PRESSURES.

In regard to the pressure required for chiseling operations no data are at hand. It must, however, be considerably greater than in shearing and punching, for which it may be said in general that the actual force required to shear a given unit of section is somewhat less than that required to pull apart the same section by stretching—that is to say, in most of the ordinary ductile metals, such as steel, iron, brass, copper, etc. In other words, the ultimate shearing strength of these metals is a little less than their ultimate tensile strength, sometimes (as observed with certain steels) being only about 75 per cent. thereof.

This is assuming sharp cutting edges, however, which are not always present. Considering the fact that cutting tools are often dull, a safe general rule in providing a press for doing certain shearing or punching work would be to have it

capable of safely exerting and resisting a force powerful enough to tear apart 1 square inch of section of the particular metal to be used for each square inch which is required to be sheared. In the case of mild steel this may be considered roughly as about 60,000 pounds per square inch; for wrought iron, 50,000; for bronze, 40,000; for soft brass, and copper and cast iron, 30,000; for aluminum, 20,000; for zinc, 10,000; for tin and lead, 5,000; etc.—always reckoning in the same way, according to their tensile strength, which may generally be found in any engineering reference book—that is to say, in cases where the author of the book has taken the trouble to mention the particular metal which the reader happens to want, which is not always.

Unfortunately these books, even the best of them, do not give full tables of the shearing-strengths of the ordinary metals. The writer has in view the publication at a future time of some definite information in this line which he hopes to obtain from operations in actual presses with actual dies, by means of a special weighing-apparatus of his own contrivance.

To give an example of the principle above stated: Supposing a press-user wishes to shear off bars of iron 1 inch square, or bars 2 inches by  $\frac{1}{2}$  inch, or 4 inches by  $\frac{1}{4}$  inch, or to punch a hole 1 inch in diameter (which is about three inches round) in iron  $\frac{1}{8}$  inch thick, or 2 inches diameter in a sheet  $\frac{1}{8}$  inch thick, or 12 inches diameter in a sheet  $\frac{1}{16}$  inch thick. In any of these cases he will want to cut an actual section of about 1 square inch. He will, therefore, need to use a machine which will give 50,000 pounds pressure at the beginning of the cutting operation, or, more accurately speaking, a little after its beginning, when some slight crushing of the metal has taken place. This initial pressure, for instance in the case of cutting off a bar 1 inch square, will not have to be maintained during the whole 1 inch of ram descent while the cutting is going on. This is because the resistance

will soon begin to decrease, probably after the first  $\frac{3}{8}$  inch or  $\frac{1}{2}$  inch of descending, ceasing entirely after about  $\frac{3}{4}$  inch of motion, as at this time the bar will have been so disintegrated as to fall apart before being pushed entirely down to the amount of its own thickness.

The maximum pressure necessary, therefore, for shearing proper is measured by the amount of cross-section to be cut, and may be formulated thus: Taking  $P$  = pressure in pounds required from ram,  $W$  = width and  $T$  = thickness in inches of bar to be sheared off, and  $S$  = shearing strength per square inch in pounds of the material of the bar, we have:  $WT$  = area of section cut and  $SWT$  = total initial pressure.

Hence  $P = SWT$ , that is, providing there is no dip to the blades.

Applying this rule to punching, we let  $W$  = circumference, or length of contour line, of the hole, which is really the width to be sheared. For round holes, taking  $D$  = diameter in inches, we have  $W = D\pi$  (or 3.14 times  $D$ ). For square holes, taking  $D'$  = short diameter, we have  $W = 4D'$ . As before stated, a rule easily remembered and one that is on the safe side is to let  $S = 50,000$  for iron and tin-plate.

The rule just given must, of course, be modified in favor of less pressure requirement wherever it is practicable to use dip upon one of the blades or dies. Figs. 271, 272 and 273

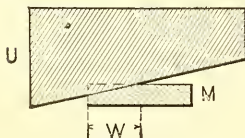

FIG. 271.

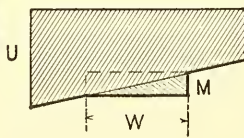

FIG. 272.

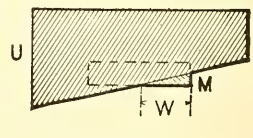

FIG. 273.

show successive stages of the descent of an upper blade,  $U$ , upon a bar of metal,  $M$ . In the first position it will be seen that the practical width of cut  $W$  is only about one half that of the bar, while in the second it has become equal to the whole width of the bar, and this is evidently the maximum

width upon which it will act. The average thickness, however, in this position is but one half that of the bar, and the area of metal yet to be cut is measured by the triangle just below the blade, which is evidently but one half the area of the bar's cross section. In the last position the width of cut has been reduced. From these diagrams it will be seen that a blade that has as much dip as that shown will require only about one half the pressure required by a blade without dip, and this is nearly correct, except that some excess would be required to bend and twist the bar, as in Fig. 195. In Fig. 274 is shown a bar twice as thick as before, and it is here evident that when the width of cut has reached that of the bar itself there remains about three quarters of the area yet to be cut. Consequently the pressure is reduced by the dip something less than one quarter only. In Fig. 275 is shown the

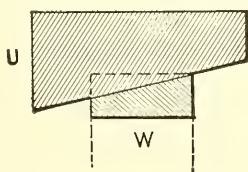

FIG. 274.

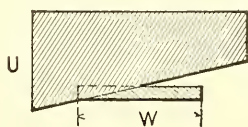

FIG. 275.

opposite extreme, where only about one half the width of the bar and one half the thickness are at the same time being contributed as factors to the area being sheared. Consequently the pressure required is only a little more than one quarter of what it would be with a dipless blade. In Fig. 276 is shown

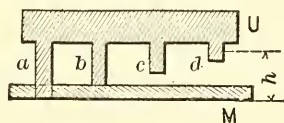

FIG. 276.

a gang of punches,  $a, b, c, d$  —  $a$  having just reached through the bar of metal  $M$  when  $b$  is ready to commence. In the same way  $b$  will reach through when  $c$  commences, etc. Thus

it is obvious that the pressure required at any time is only that due to the resistance of one punch, but that the whole height traveled by the ram while doing its work is represented by  $h$ , which is four times the thickness of  $M$ , or, in general, as many times its thickness as there are punches, providing they are set with this amount of dip. An analysis of the preceding diagrams will show that the same rule holds good—viz., that the maximum pressure required is approximately in inverse proportion to the working distance traveled by the ram.

In estimating, therefore, the necessary pressure for any given pair of dies, the pressure required for flat dies without dip should first be ascertained by the formula given above, and then a reduction should be made in proportion to the increase of time during which the dies are doing their work over that due to the thickness of the metal itself, as caused by the particular amount of dip that may be present in the dies.

The pressure data given assume an upper die or punch of the same diameter as the die which it enters, such construction insuring a parallel hole through the metal. When the clearance referred to in a previous paragraph is present the pressure-coefficient is really a little less, but hardly to an extent worth considering.

The punching pressure required is also somewhat lessened when holes are located very near the edge of a sheet or bar, on account of the spreading of the metal sidewise, but this does not amount to much in practice, and such punching should be avoided.

Regarding the pressure required for stripping metal from a punch during its ascending stroke, I have no reliable data at hand. It varies considerably with the amount of punch and die clearance, the smoothness of the punch and the squareness of the stripper therewith, together with its rigidity, etc. It is undoubtedly a good deal less than one tenth of the punch-



ing pressure, even in extreme cases. A series of experiments in this direction are certainly very desirable, and the writer hopes upon some future occasion to be able to publish an experience of this kind which he has not yet enjoyed.

#### ADAPTATION OF PRESSES.

Regarding the kinds of presses used for the cutting processes which have been described in this chapter, it may be said that, like the Scotchman's whiskey, there are no bad kinds. In other words, almost any sort of a press is sometimes suitable—the nearest approach to an exception to this statement being perhaps the drop press tribe, whose members are generally employed in other work. Furthermore, their rams are apt to be so loosely fitted to their columns as to endanger the cutting edges of delicate dies. This, however, is not necessarily the case. A more serious objection would usually be the abnormally high speed attained by the ram at the bottom of its stroke—due to acceleration by gravity.

## CHAPTER VII.

### BENDING PROCESSES.

#### BENDING.

FOLLOWING a natural order, we come next to forming or bending processes, where the metal has its surfaces pushed out of their original planes into some new shape, but where the thickness is supposed to be not materially altered, except where it is incidentally made thinner in certain spots by being stretched, etc. In Fig. 277 is shown a V-shaped pair of bend-

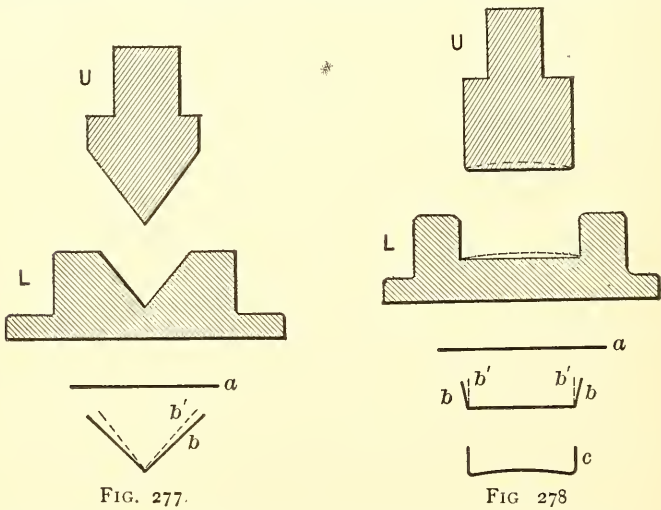

FIG. 277.

FIG 278

ing dies and beneath them a straight plate of metal, *a*, together with the same as it appears after bending, at *b*. The dotted line *b'* shows where the dies tried to bend it, and the black line *b* its final position as assumed by its own elasticity. This, of course, varies with the material, a piece of lead or even copper remaining very nearly in the same shape as the

die which forms it, while iron, mild steel, hard brass, etc., in the order named, require such a die to be of a more and more acute angle, as the metal approaches nearer the character of a spring.

In Fig. 278 is shown a pair of bending or forming dies which are removed one step further from the simplicity of the first named, giving two bends to the work instead of one. Here the same difficulty occurs in regard to the edges springing part-way toward their original shape after leaving the die, as shown again by the lines *bb*. It is not therefore possible with a die of this kind to produce edges which are exactly square with the main body of the plate. An approximation may, however, be sometimes made by bulging upward the horizontal surfaces of the dies, as shown by the dotted lines in Fig. 278, to an extent not greater than is suited to the elastic limit of the particular pieces of metal used. The die therefore attempts to make the work somewhat concave upon the bottom, as at *c*, which forms the corners at a sufficiently acute angle to approximately counterbalance the tendency to spring open; so that when the bottom has sprung back flat the edges will stand up perhaps nearly enough at right angles thereto. To place practical dependence upon this system, however, requires uniform blows by the press and uniform elasticity in the metal.

#### FORMING.

In Fig. 279 is shown a pair of round forming dies, where a flat circular blank, *a*, is laid in the recess *m*, which acts as a gauge merely for locating it centrally. It is then pushed by the upper die, or punch, *U*, through the parallel opening *n*, and falls beneath the dies—being stripped off the punch when the same is ascending by the sharp “stripping-edge” *o*. At *b* is shown the shape of the work when in a half-way stage of the operation, its final condition being as at *c*. With dies of

this kind the edge of the work cannot be very deep in proportion to its diameter, on account of the wrinkles which evidently attempt to form when the circumference is reduced. It is true that these incipient wrinkles can be somewhat smoothed out by allowing the punch and die to fit tightly

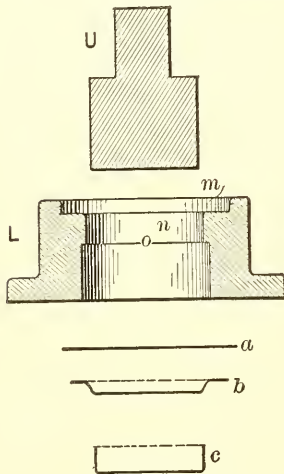

FIG. 279.

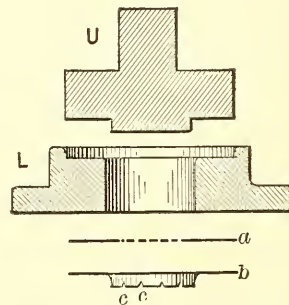

FIG. 280.

enough to confine the metal to its original thickness—providing this thickness came uniform, which it usually does not in practice. In doing this, however, the metal of the edge is lengthened in certain spots in a vertical direction, which causes a jagged edge. If the depth is too much increased, the wrinkles so fold upon one another as to tear the metal entirely away at certain places. The remedy for this will be considered later on under the head of the drawing process. With metal like ordinary tin-plate, in diameters of not less than 2 inches, a width of edge from  $\frac{1}{8}$  to  $\frac{1}{4}$  inch can usually be obtained in plain forming dies without objectionable wrinkles.

With cylindrical work like that in question, and also with elliptical work (which resembles it by having a convex contour with an edge extending all around), the outward springing of this edge does not occur to an objectionable degree, as it

does with rectangular work having two separate and unconnected edges, like that shown in Fig. 278. This is because the edge  $c$  forms itself into a hoop, as it were, to confine itself from moving outwardly, which it cannot do when released from the die without actually stretching in a circumferential direction; and this evidently can occur but in a very slight degree.

In Fig. 280 is shown a pair of forming dies for turning an edge upon an internal, instead of an external, circular contour. These take a perforated blank,  $a$ , and open out the hole, turning it downward into a cylindrical-shaped edge, as at  $b$ . If an attempt is made to get this edge too wide, certain cracks will appear, as at  $cc$ , etc., in the picture. As the edge in opening outwardly increases its circumference, it will not stand more than a certain amount of tensile strain, the stress here being of exactly an opposite character to the compressive one which forms the wrinkles in work like that in Fig. 279.

#### EMBOSSING.

In Fig. 281 is shown one type of a pair of embossing dies, so called. The word "embossing" is used in this treatise, and very generally in the sheet-metal trades, to denote a small degree of forming or bending at various points upon the surface of a piece of sheet-metal, the location of which usually

tends to show in top view a figure or design of some kind, decorative or otherwise, as, for instance, pictures, symbols, lettered inscriptions, etc. In such work the metal is pushed downward or upward more or less at various points into ridges and grooves, but not to a sufficient extent to tear it apart. The tendency is evidently to

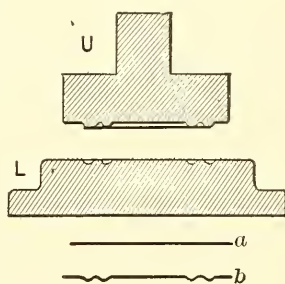

FIG. 281.

so tear it, as its outer edges are maintaining a rigid resistance against inward flow (except in

certain forms of the drawing process), and the metal has therefore to elongate where forced to take a shape whose cross-section shows a longer profile-line. This is shown by the section of the piece of embossed work,  $b$ , which is longer in profile than is the blank from which it was made,  $a$ . In the case given I have represented a pair of circular dies with two annular grooves sunk in  $L$ , corresponding ridges projecting from  $U$ . This is a design sometimes used upon the heads of tin cans, etc., its object being partly to make them stiffer, and perhaps partly for ornament. Such embossing, however, is merely typical of an infinite number of designs which may be thus stamped upon ductile metal. The word embossing, as applied to this process, should not be confounded with the same term as sometimes used to designate the process known more properly as coining, to be described further on.

In Fig. 282 is shown a broken-away vertical section of one groove and ridge of a pair of embossing-dies, where the flat surfaces have approached each other within a distance measured by the thickness of the metal, represented by  $m$ . Theoretically the space between upper and lower die might properly

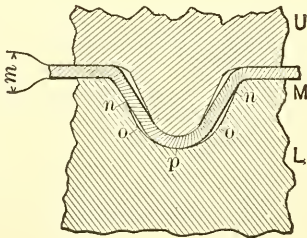

FIG. 282.

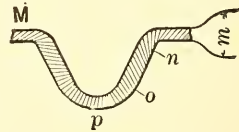

FIG. 283.

be this thickness,  $m$ , at the points  $n$ ,  $o$ , and  $p$ , as the metal would then exactly fill between at all points. Practically, however, it is better to give an embossing-die clearance at such points as  $n$  and  $o$ , letting the metal follow the "tight points" to suit itself, as in the picture. This is desirable, because some of the metal may be a little too thick, or dirt may

accumulate in the dies, in either of which cases there would be a jam between the points *n* and *o*, which would prevent the dies coming down home, or which, at any rate, would require a great deal more pressure to do the work. Another reason for this clearance is the practical difficulty of the die-maker being perfectly sure that there is space enough everywhere, unless he follows the method here given, of being sure there is enough by having too much. It is customary to give a little clearance at *p* also, but this is not of so much importance, as contact at that point would simply prevent the flat surfaces from coming together quite so tight.

A simple method devised by the writer, and long practiced by those working under his instructions, for ascertaining the clearance of forming and embossing dies is to lay pieces of small lead wire, whose diameter may be about two times *m*, across the dies at the various points requiring a test. Between these points small pieces of the sheet-metal to be used, whose thickness is *m*, are laid upon the lower die to act as blocking, so that the proper stopping-point of the upper die may be insured. The press ram is then brought hard down, with the result of the lead being smashed out to the varying thicknesses represented by the spacing of the dies, and as shown in Fig. 283. It is evident that all such points as *n* and *o* ought to be thicker than *m*, and this is generally easily determined by the eye. Such points as *p* must, of course, never be less than *m*, and may be a little more.

#### CUTTING-FORMING-EMBOSSING.

Almost all the various processes of forming and embossing may be combined with cutting, and with each other, wherever the work is of suitable shape. The tools for conducting such operations are usually called "combination dies," although the term is not very definite, being sometimes used, as before described, for the combining of two or more sets of

cutting-edges. In Fig. 284 is shown, in vertical axial section, a pair of combination-dies such

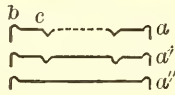
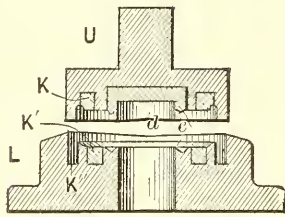

FIG. 284.

as are very extensively used for producing fruit-can "tops," as shown in section at *a*, and "bottoms," as shown with embossed groove at *a'* or plain at *a''*. In practice these dies are assembled in separate pieces to some extent, to insure cheapness, durability, and facility of repairs, but they are here depicted in conventional form. It will be seen that

the outer cutting die has the female at the bottom as well as the inner one, a result which was not obtained in Fig. 265, Chapter VI, where the work remained flat. In this case the latter part of the upper die's descent cuts the central hole while the forming of the edge at *b* and the embossing of the groove at *c* is taking place. It will be noticed that the turning upward of the inner wall of this groove causes a tendency to crack, as in *b*, Fig. 280, although in practice it is not made deep enough to produce this effect. Such action does not take place in *a'*, because the stretching action is resisted by the continuous surface in the center, which is retained in the case of this can-bottom by removing the central cutting-punch *d* from the upper die. Should a plain flat bottom be desired, as at *a''*, the embossing-punch *e* is also removed.

Sometimes combination cutting-forming, etc., is done in a double-action press with dies similar to the drawing-dies to be described in Chapter IX, Figs. 331 and 343. These dies have the advantage of strong and simple construction, and, in operation, of dropping the work through beneath the lower die.



## KNOCKOUTS.

A knockout-ring is shown in Fig. 284 in the upper die at  $K$ , and in the lower die at  $K'$ . They are unnaturally given in closed position (as they would be were the dies shut together) merely to show better the general contour of the sectional view. Sometimes what is called an "edge knockout" is used instead of the construction shown at  $K'$ , consisting of a thin ring rising in the groove  $K''$  and pushing against the edge of the work rather than underneath its flat surface. This ring at  $K''$ , if driven up by strong springs, acts in some degree as a spring-drawing attachment (to be described later on), and serves to smooth out the slight wrinkles which usually otherwise appear in the edge of the work. The knockouts described are generally driven by springs, but sometimes by pins extending through the dies and attached to or pushed by certain positive-action knockout devices. In some cases such special knockout "attachments" to a press are not positively driven, but are actuated by a strong spiral spring, or a spring made of rubber disks, etc.

## SPEED AND PRESSURE.

The speed at which forming- and embossing-work is done is of little consequence, as in practice the ram speeds of the presses in common use are none of them fast enough to tear the metal by moving it more rapidly than its molecular inertia will permit.

The pressure required for the processes above described varies too greatly to be formulated in a general way, being dependent upon the character of the work and the condition of the dies. For given pieces of metal, however, it frequently happens to be a good deal more than for the cutting operations performed upon the same. When the dies are so set as to actually squeeze the metal thinner, it is forced to flow sidewise, and a "coining" action is set up. In such case the required

pressure is very great, often exceeding the crushing strength of the metal. This, in its turn, is usually something greater per square inch of section than is the tensile strength.

#### ASSEMBLING.

Analogous to forming processes proper are various operations where the assembling of two or more pieces is done, oftentimes upon the same general principle as the riveting down of an eyelet, or a rivet, which has been passed through two pieces of paper or metal. In general, some piece of metal which has previously been brought to shape by dies or otherwise is driven tightly, or perhaps dropped loosely, into or onto some other piece or pieces, whereupon they are all fastened together by some auxiliary forming process which bends or forms certain edges or surfaces in a manner best adapted to locking the various parts permanently together.

In this way two cup-shaped pieces are connected to form a certain style of door-knob; ornamental stamped-out parts are assembled into the stem of a gas-fixture; and the base-piece is fastened onto a cuspidor or coal-scuttle. Such work will be further set forth in the next chapter, under the head of curling, etc.

#### INVOLUNTARY PROCESSES.

In addition to the humanly invented processes we have been considering there are sometimes developed others which, to a careless observer, might seem to emanate from the brain and hand of his Satanic Majesty. Among what may thus be called involuntary processes is the very annoying one known as warping, which occurs especially in the products of embossing and forming dies, as well as to some extent in drawn-work also. The most favorable conditions for its occurrence are thin metals, large diameters, and edges so shallow as not to form stiff trusses in themselves. The die-maker is often blamed for work thus coming from the press twisted and sprung, so

that it is impossible to make it lie flat upon a plane surface. Generally, however, a result of this kind is entirely owing to its design; and Dame Nature, rather than the die-maker, must be blamed for one of the most provoking and perplexing problems which the die-user is called upon to solve.

Mechanically, the cause of this warping is due to the middle of the stamped sheet of metal being too small for the outside thereof, so to speak. This occurs when the central parts have been embossed or otherwise drawn together and put under a tensile strain, while the average circumference of an outer zone, near the edges, has not been correspondingly reduced, and therefore does not assume the shortest distance around its course, which would naturally lie in a plane. A remedy is sometimes found by altering the design so that this outer zone may have various ribs and corrugations running approximately in a radial direction toward the center, such corrugations tending to take up the surplus metal in a circumferential direction. These additional features can often be added by a judicious designer in a way to serve a decorative purpose. A similar warped effect can obviously be produced by letting the middle of the metal alone and stretching or otherwise increasing too much the area near the edges. This is often done by forming-dies when turning a narrow vertical edge around a large thin blank. Such action is due to imperfect "upsetting" where the circumference is reduced, and perhaps also to a too tight squeezing of the edge between the dies, which has a stretching effect.

The converse of the conditions above mentioned occurs when the middle part of the sheet is too big for the outside, as is the case in any dished or saucer-shaped work. This is often seen in the bottoms of buckets, etc., which have been somewhat bulged, and which can be "flopped" back and forth, always staying in a position at either side of the plane of the outer zone of the metal. In such case the said outer

zone is pushed outwardly by the central parts, and is therefore in a taut condition, which tends to make it stay flat rather than otherwise. If that surpassingly skillful artisan known as the "saw-maker" were to tackle a sheet of this kind, he would soon flatten it by hammering it near the edges. If, on the contrary, he hammered it in the middle, it would be on account of converse conditions.

### SOFT PUNCHES.

Forming work, especially in drop presses, is sometimes performed by using a punch made of soft and easily fusible metal like lead, or, preferably, a mixture of lead and tin, in proportion of about two of the former to one of the latter. The object in making such a punch in this way, is: 1st, cheapness, because it can be cast directly into the die, which is usually of harder metal, and of more expensive construction; 2d, a soft punch of this sort under the influence of a quick and powerful blow will maintain its shape by reason of its particles flowing by their own momentum, in whatever direction they can go to perfectly fill the die, or rather the interior of the work, which is supposed to be a slightly smaller copy of the same. If, therefore, the punch moves down quickly enough (as is usually the case in a drop-press), it will flow out and fill the interstices of a somewhat intricate die, as, for instance, in the case of ornamental brass-work in designs of imitation carving, etc.

In drop press work these punches are sometimes used for thin metals, as in making dish-pans, wash-bowls, sauce-pans, etc.; though formerly they were employed, before the advent of the drawing-press, very much more than now. In such dies a good many successive operations are necessary, that the work may be coaxed down, so to speak, a little at a time. It is then easy to cast a punch part-way down in the die for the

first operation, and after running through a batch of work tear it off and remelt it, to pour another one a little deeper, and so on. Thus a batch of pans can be run through over and over again, the die never being removed from its position. The punches are cast blocked off at part depth by laying a diaphragm in the die part-way down, or by using one of the unfinished pans itself for the purpose. The press ram has, of course, a proper "anchorage," so to speak, to which the soft cast metal will cling.

### FLUID PUNCHES.

A rather curious modification of forming a deep article to shape by a punch entering a die is to make the former of water or other liquid. In other words, the idea is to force the work outward and down into the form of the die by means of hydraulic pressure inside of the same, proper arrangements of course being made for packing around the edges of the dies so that the fluid cannot escape. This system is chiefly used for comparatively soft metals, such as silver, britannia-metal, and other materials used for table-plate and analogous constructions. It is generally applied to a cup-like article which has already been brought nearly to shape in a drawing-press or otherwise. It is especially useful where the dies are "undercut"—that is, larger part-way down than they are at the top; such are used for producing forms like the tea-pots, sugar-bowls, etc., often seen upon our breakfast-tables. In such cases the die must of course be split into such a number of parts as to enable it to open and the work to be removed from it. It is evident, however, that such a water-punch can enter it and be withdrawn without the difficulties incident to a solid punch. In some cases metal can thus be forced out into ornamental figures sunk in the surface of the die in a way not easy otherwise to attain.

I have never heard of air or other gases being used in

this same way for metallic work, but such a pneumatic punch, entering a separable iron die, is the tool used every day by glass-blowers throughout the world. Another instance of similar work, minus the lower die, is seen in the industry of blowing soap-bubbles.

#### PRESSES SUITABLE.

For the various forming and embossing processes described in this chapter almost any type of press may or may not be suitable, according to circumstances. The type least likely to meet all conditions is, perhaps, a drop-press, which usually has the peculiarity of a faster moving and more loosely fitting ram than have other presses. These machines, however, are especially adapted to some kinds of embossing-work, and are sometimes used for forming, particularly in producing shallow pans, plates, trays, etc., in tin-plate and sheet-iron. In recent years they have been, for these latter functions, superseded to a considerable extent by drawing-presses. For heavy embossing, a short-stroke toggle press, similar to those used for coining, is sometimes a very effective tool.

## CHAPTER VIII.

## CURLING AND SEAMING PROCESSES.

## CURLING OR WIRING.

SOMEWHAT analogous to forming processes, but involving a new principle not yet herein touched upon, is the operation of "curling" or "wiring," with its various modifications. This consists of bending the end of each element of a cylinder, or truncated cone, or analogous hollow curvilinear-contoured object, with sheet-metal walls, either outward or inward into an approximate circle lying in an axial plane of the object itself. With outward curling the axial section of the object may therefore resemble a short column surmounted by a torus, as in Fig. 288. The two words quoted as names for this process are used synonymously, although it would be more correct to confine the term "curling" to the operation of putting a curled edge upon the top of a pan, cup, or other vessel without any wire inside of it, this empty curling being often spoken of as "imitation wiring." Real wiring is the same process when done around a ring of wire, which, of course, stiffens the vessel very much more than does the bastard process before mentioned. The latter, however, is cheaper and easier to perform, and often answers a sufficiently good purpose.

## OUTWARD CURLING.

In Fig. 285 is shown, in vertical axial section, a pair of outside-wiring dies for cylindrical work, such as tin cups, dinner-pails, etc. This process, it should be mentioned, is usually confined to thin metals like tin-plate, sheet-iron, and some-

times brass and copper, all of which are usually less than  $\frac{1}{8}$  inch thick. In such tools the lower die *L* serves mostly as a receptacle for the work, while the upper die *U* does the actual

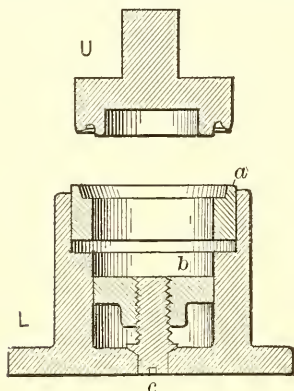

FIG. 285.



FIG. 286.



FIG. 287.

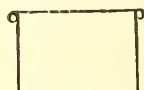

FIG. 288.

curling. Were the dies in question for curling only, the loose ring *a* (which is driven to the upward position shown by suitable springs and limited therein by proper stops) might be omitted, the top of the die being solid, as in Fig. 289. As it is, this ring is used to support a ring of wire (usually bent around without joining), shown in Fig. 286. This is laid loosely around the top of the uncurled work, Fig. 287, and creeps down as the ring *a* descends by the action of *U*. The upward projecting wall at the top of the ring is to confine the wire loosely against its tendency to expand, perhaps irregularly, to such a degree that the down-curling edge of the sheet-metal would not be able to embrace it. This wall is tapered out larger at the top to allow the wire ring to enter more easily, and also to enable the curling edge to more surely penetrate between it and the wire. At *b* is shown an adjustable bottom upon which the work rests, and which is regulated by the screw *c* or its equivalent. This construction enables the same die to be used for various heights of work. In cases where but one height is required this bottom is made in a solid



piece with the rest of the die, as in Fig. 289. In Fig. 288 is shown the finished work, as curled without containing the wire ring, such dies being available for making it either with or without the same.

In Fig. 289 is shown a pair of curling dies for outside curling upon the large end of conical or tapered work, such as is

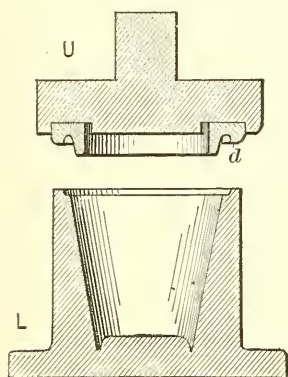

FIG. 289.

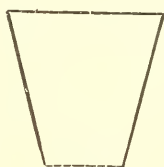

FIG. 290.

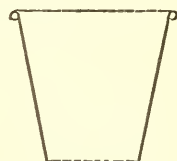

FIG. 291.

shown uncurled in Fig. 290 and curled in Fig. 291. It is suitable for dish-pans, milk-pans, sauce-pans, buckets and such like work. Should it be desired to put in a real wire, the top of the die *L* is supplied with a "floating" ring, as at *a*, Fig. 285. This ring is, in some cases, made to contract or expand, to suit the changing diameters of conical work, in a manner similar to that of the sectional curling-rings to be described.

In the tapered work we are considering it is evident that the curling, as it successively passes through the different stages shown in Figs. 318 to 321, inclusive, must grow smaller in its general diameter as it creeps down the cone to smaller and smaller diameters of the tapered work. It is therefore necessary that the curling-ring *d* should be detached from the remainder of the upper die, so that it can gradually decrease its diameter as it goes downward in doing its work. That it may thus become a contracting ring it is made in a number of sec-

tions, usually being sawed apart radially into perhaps six or eight pieces. These are, of course, properly supported in the main body of *U*, and are supplied with springs to drive them outward as they ascend, so that they will be ready for the next piece of work. It is found in practice that such rings are sufficiently elastic to approximate nearly enough to a true circle as they are forced into the lower die, and that the slits, if narrow enough, do not injuriously mark the work. The work shown in Fig. 291 fairly represents the "body" of an ordinary sheet-iron bucket. These bodies are usually made up of one or two, or more, sections, seamed together in lines forming elements of the cone.

In Fig. 292 is shown a pair of dies which are the exact reverse of those just described. They are for curling the small end of conical work, as shown in uncurled and curled conditions in Figs. 293 and 294, respectively. In general, it is found better to confine the work outside for outside curling, and it is therefore placed within the lower die, as a receptacle, in the two former cases above mentioned. In this case, however, it is evident that the work could not be gotten into and out of such a die unless it opened in halves, but experience has proved that work of the kind here shown (which, by the way, fairly represents coffee-pot bodies and such like articles) can be successfully curled after being slipped over the hornlike lower die pictured in Fig. 292, which seems to brace the body against "buckling" better than with straight work, etc. This and other dies of the same bulky character are often made hollow merely to save metal and make them lighter to handle. They could, obviously, however, just as well be solid, as far as their functions are concerned. The curling-ring *d* has in this case an expanding rather than a contracting action, and is forced inward by springs, instead of outward, as in Fig. 289. It of course expands automatically as it is driven down upon the work.

## INWARD CURLING.

In Fig. 295 is shown a pair of dies for the inward curling of a plain cylindrical body, Fig. 296, into the condition shown

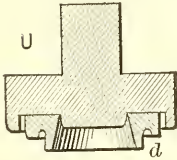

FIG. 292.

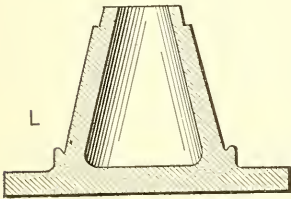

FIG. 293.

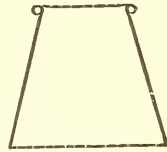

FIG. 294.

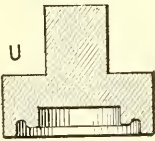

FIG. 295.

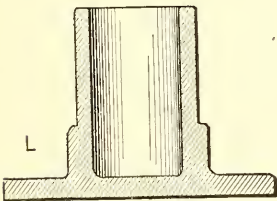

FIG. 296.



FIG. 297.

in Fig. 297. Sometimes this process is practicable at both ends of the work at once by the use of double curling-dies. In this way it is well adapted for certain forms of napkin-rings, etc. Such dies can, of course, be arranged for real wiring if desired.

In Fig. 298 is shown a pair of dies for the inward curling of the large end of conical work, as shown in Figs. 299 and 300,

respectively. In this case the curling-ring is, of course, a contracting one.

In Fig. 301 is shown a pair of dies for the inward curling of

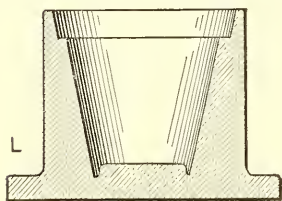
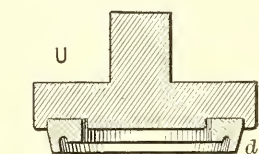

FIG. 298.

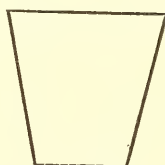

FIG. 299.

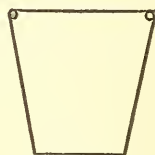

FIG. 300.

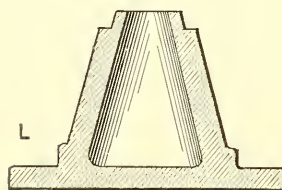
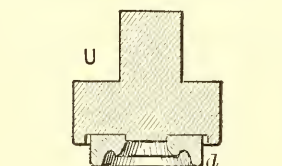

FIG. 301.

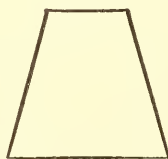

FIG. 302.

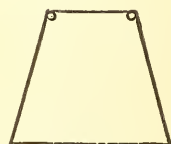

FIG. 303.

the small end of conical work, as shown in Figs. 302 and 303, respectively. In this case the curling-ring *d* expands.

#### ASSEMBLING BY CURLING.

In Figs. 304 to 312, and also in Figs. 314 and 315, are shown specimens of what might be called the curiosities of curling. They are combination processes, where two or more pieces previously made of the proper shape are assembled and

fastened together, as well as given a suitable finish by various operations of curling, etc.

In Fig. 304 are shown the uncurled body, bottom, and base ring of a patent coal-scuttle, one side only being given, and that in "slice-section." In Fig. 305 the same are shown, in complete section, after being curled at one operation, the dies at the same stroke curling the top rim *e*, the triple joint *f*,

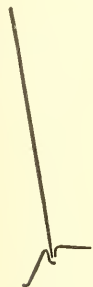

FIG. 304.

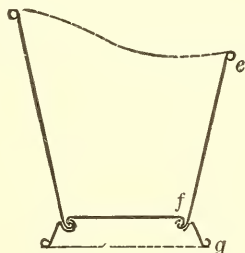

FIG. 305.

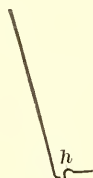

FIG. 306.

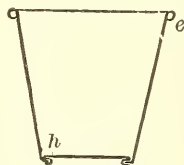

FIG. 307.

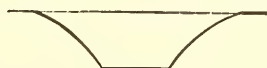

FIG. 310.

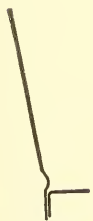

FIG. 308.

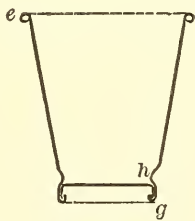

FIG. 309.



FIG. 311.

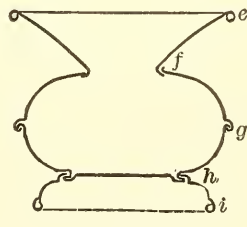

FIG. 312.

and the bottom rim *g*. Dies for such work are, of course, very difficult to make, especially as the top of the vessel does not lie in a normal plane, nor in a plane at all, being of the double spiral shape shown. It is, moreover, necessary to use self-acting outside clamps to clamp the body securely to the horn, and also to embody certain vertical motions of the horn itself, and of a clamping device to hold the bottom and base ring in place.

In Figs. 306 and 307 are shown two similar stages of the operation of curling the top of a bucket and putting a bottom thereon, the latter, however, not being a curling operation, but rather a peculiar style of forming, where an upwardly projecting bead in the bottom, *h*, is forced to bulge and bend over outwardly by the pressure brought upon it at the same time that the top curling is being done.

In Figs. 308 and 309 are shown similar stages of the operation of putting the bottom in a bucket by a different method, consisting of double-curling them together at *g*, while the top curl is being made at *c*. In this case a depression, *h*, has been made in the body in some kind of a roller forming-machine.

In Figs. 311 and 312 are shown similar successive stages in the operations of putting together a sheet-metal cuspidor. The curling at *e*, however, has in this case been done in a lathe, because the taper of the cone (see, also, Fig. 310, as before curling) was too great for curling-dies to work properly.

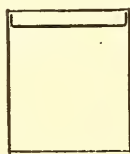
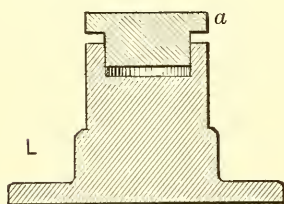
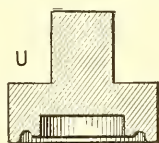

FIG. 313.

FIG. 314.

FIG. 315.

The operations at *f* and *h* consist of a sort of a combined curling and smashing, somewhat similar to that shown in Fig. 307. At *g* and *i* the action is true curling, done in an inward direction.

In Fig. 313 is shown a pair of dies for putting together by the process of inside curling a body and a bottom, as shown in its

successive stages in Figs. 314 and 315, respectively. The function of the spring-driven-up plate *a* in the lower die is to support the bottom when first laid upon it, but it of course descends therewith as the curling proceeds.

### PRINCIPLES OF CURLING.

In analyzing the principles of the curling process we will find that, with the dies under consideration, it cannot be practiced upon the edge of a flat sheet of metal, and that said metal must not lie in a plane, but in the surface of a cylinder, or approximately so. It is, therefore, not practicable, with ordinary curling-dies, to curl or wire rectangular utensils or other articles having a prismatic or pyramidal rather than a cylindrical or conical form. It is true that a curling action might take place at the angles of such pyramids or prisms if they were somewhat rounded off to a curved contour, but at the sides, where the edge followed straight lines, it would simply be bent, as at the top of *M*, Fig. 316, instead of being truly curled.

In Figs. 316 to 321 are shown at *U*, in partial vertical

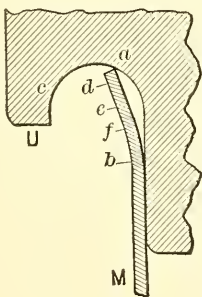

FIG. 316.

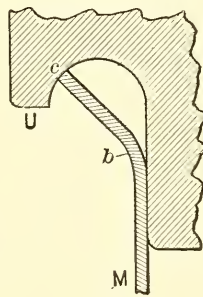

FIG. 317.

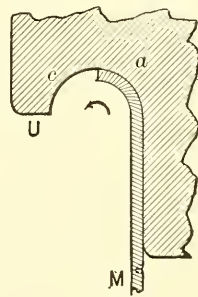

FIG. 318.

axial section, one side of a broken-away curling-ring, and at *M*, in Figs. 318 to 321, similar sections of a piece of plain cylindrical work near its upper end, these latter pictures show-

ing various successive stages as the die  $U$  descends in the operation of true curling.

In Fig. 316 is shown the bending action before referred to, where the edge of the work lies in a straight line. Or, for the

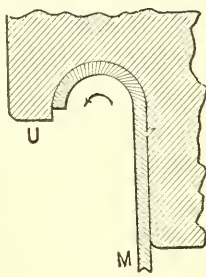

FIG. 319.

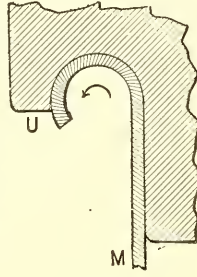

FIG. 320.

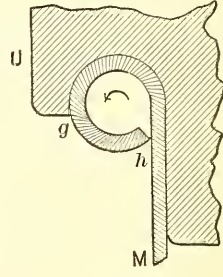

FIG. 321.

sake of illustration, let us suppose that  $M$  is a little bar of metal, standing on end, and say  $\frac{1}{8}$  inch thick by  $\frac{1}{4}$  inch wide, shown in edge view. It is evident that when this straight vertical bar is struck by the inclined surface of  $U$ , at the point  $a$  and below, it will be bent outward, but with a long bend, as shown, instead of a short one, as in Fig. 318. This is by reason of the ordinary principles of leverage, which cause a bar to bend as far as possible from the end where the force is applied so as to obtain more leverage for such bending, its starting-point being determined in this case by the outside resistance at  $b$ , which is supposed to be the confining part of the lower die. If the operation is carried a little further, the top end of the bar reaches a point in the die at  $c$ , where it stands at right angles to the surface of the same and can be coaxed no further sidewise, but only buckled. The result is a general smash, or perhaps it is carried down in some irregular and undesired form. If, however, when it first starts to bend outward it could be confined at the point  $d$  on its surface, and after the extreme end is bent into a short curve it could be again confined at  $e$ , and still later at  $f$ , it is evident that it would assume the proper shape and approximately follow the



semicircular curvature of the die at *ac*. To illustrate more plainly: Supposing that we have a vessel composed of a number of the small bars, *M*, arranged in a circle like the staves of a barrel, and supposing that we have a hoop at *d* which will confine them all until a bend is started at each of their ends, and that then it will expand and another hoop at *e* will hold them until they are again bent, when this hoop in its turn expands—and so on. Such an arrangement would evidently develop a curling operation, and the action described is what really takes place, the sheet of metal itself being at the same time its own staves and its own hoops. To prove that a square can not be properly curled along its flat sides it is only necessary to imagine a square barrel, in which, obviously, the hoops would have but an infinitely small resistance to the initial expansion of the staves, except at the corners and in their near vicinity.

With inside curling the holding-in action at *d*, *e*, *f*, etc., is due to the compressive instead of the tensile resistance of the metal in a circumferential direction, as before. Then, by analogy, we have the arch instead of the hoop principle, and our little staves become the arch-stones.

When the top of a piece of metal has once been set into a curve of small radius at the extreme edge, and when the forming of the incipient curl thus commenced is gradually continued, as in Figs. 319, 320, etc., there is no action tending to straighten it out again, except (in the case of outside curling) the resistance of the edge of the metal to compression as it travels inward from *g* to *h*, Fig. 321. This resistance is not, however, as has been proven in practice, sufficient to spoil the curl, which consequently progresses inward until it strikes the main body of the metal; or, indeed, if the process be continued long enough, until it goes on around in a spiral form, as shown in Fig. 322. With internal curling the circumferential stresses in the edge of the metal as it travels from

$g$  to  $h$  are of course tensile instead of compressive, but, again, are not sufficient to balk the curling propensities existing.

It is evident that as the edge of the metal travels outward from  $a$  to  $c$  in external curling it must be stretched or made longer circumferentially. This, in some cases, is sufficient to crack it in a radial direction at numerous points around it. To guard against this the diameter of the curl must not be too large in proportion to the diameter of the vessel operated upon. Its behavior in this respect depends also upon the thickness and toughness of the metal. If, again, the curl

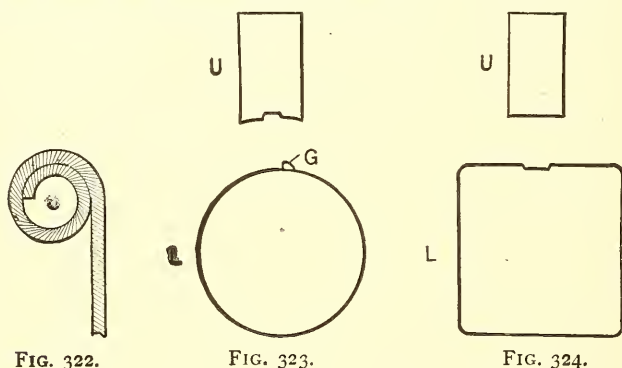

FIG. 322.

FIG. 323.

FIG. 324.

If itself is too large in relation to the metal's thickness, the edge does not go in properly from  $g$  to  $h$ , according to a tendency that was predicted for it in the last paragraph. Sometimes, indeed, with the large curling used with real wire, it is necessary to roll the edge down afterward in some kind of a "burring" machine. Especially is this apt to be the case with external curling upon work with considerable taper, like dish-pans. The large diameter of the pan, the largeness of the wire which is usually put in, the greater distance from  $g$  to  $h$  on account of the taper, and the proportionate thinness of the metal, all serve to present bad conditions for true curling.

With internal curling there is less trouble in regard to the points above mentioned, but as the edge of the metal is first compressed and becomes smaller in traveling from  $a$  to  $c$ , it

must be expanded and stretched in completing its journey from *g* to *h*, this being exactly the converse of the other case. If tough enough it will go all right; if not, otherwise.

In practical work it is found that with ordinary tin-plate and sheet-iron a curl of from  $\frac{3}{32}$  to  $\frac{3}{16}$  inch in diameter can be obtained, according to various conditions above indicated. For larger curls to be successfully made, much thicker metal might be required.

#### STRAIGHT CURLING.

An exception to the working of the general principle above mentioned, which prevents the curling of an edge of sheet-metal standing up in a straight line, may be arranged for by a peculiar form of die, where the wall of metal at *fb*, Fig. 316, is held from bending away from the upper die's vertical working surface by a special supporting plate forming part of the lower die, which confines and supports the metal, but which slides down out of the way, as the upper die descends. This construction is not very common, but has sometimes been used for curling the straight sides of a square dinner-pail, and similar work.

Another exception to our somewhat elastic rule is found in the case of very shallow work, like *a''*, Fig. 284, for instance, where the rigidity of the flat bottom, or web, of the article, together with the stiffness of the low standing-up edge, serve to hold the metal at the beginning of the curl nearly to its original position—at any rate for inward curling.

#### HORNING OR SIDE-SEAMING.

Somewhat germane to the subject of curling and wiring, inasmuch as it is used in preparing utensil bodies for that process, is the operation of horning or side-seaming. This also is an assembling process, where two or more pieces are fastened together by press work, and is analogous to some of

the putting-together operations described a few paragraphs back.

In Fig. 323 is shown a front view of a round "horn," *L*, which is, of course, in reality a lower die, and of an upper die, or so-called "force," *U*. These, as shown, are adapted for closing down a side seam upon a cylindrical or conical "body" with an outside projection, as in Fig. 327. At *G* is a row of disappearing gauge-pins, against which one edge of the metal is placed. These are pushed down by the other overlapping edge as it is depressed by the force *U*, and rise again by springs placed beneath them.

In Fig. 324 are shown a horn and force adapted for square work rather than round. In this case the horn is grooved and the face of the force is flat, thus adapting it for an internally

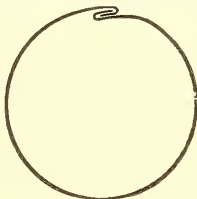

FIG. 325.

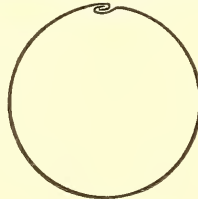

FIG. 326.

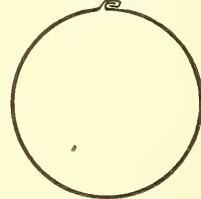

FIG. 327.

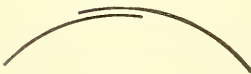

FIG. 328.



FIG. 329.



FIG. 330.

projecting seam like that in Fig. 326. Either form of seam can, of course, be made in either round or square work, these horns being shown as random specimens merely, representing two common forms of contour and both kinds of seams. In some cases a seam is made at one corner of a rectangular horn, instead of at the side.

In Figs. 325 and 326 are shown the successive stages of an ordinary "lock-seam," the first showing it loosely hooked together, the hooks having been previously formed separately; and the second showing it after being struck and smashed

down solidly together in the press. In Fig. 327 the same thing is shown, but with the seam projecting outwardly, as before mentioned.

The articles requiring these lock-seams are very numerous. A few among them are spice- and mustard-boxes, some fruit- and meat-cans, biscuit-boxes, petroleum-cans, powder-“kegs,” stove-bodies, etc., together with a variety of pans, pails, and pots. The class represented by the last three mentioned, when not drawn from a single blank, is known as “pieced ware.” A vessel like a large bucket or a dish-pan is sometimes made with several side seams at various points around its body. The bottoms of these utensils are usually fastened on by “double-seaming” in a special rotary machine. All the seams are, in the case of tin-plate, reinforced with solder, and in the case of “black-iron,” by tinning or enameling the article all over. In boxes and canisters for holding dry substances the seams are usually left untouched, as they come from the machine.

In Figs. 328, 329, and 330 are shown, more as a curiosity than anything else, three successive stages of a peculiar patented seam which I once designed a special press for, the ram being supplied with three different dies, each putting itself in position, successively, during three quick blows which the press gave before stopping. The horn also was provided with an automatically-changing lower die. The work was placed in the machine without hooks, as in Fig. 328, the three successive blows putting it first into the shape 329, then into 330, and finally smashing it so that it looked pretty much the same as Fig. 326. This seam was a success mechanically, especially for thin sheets, although somewhat wasteful of metal. For some reason unknown to me the owners have never put it upon the market.

There are numerous other forms of special seams which do not appear to have come into practical use, and there are also

some patented machines for making automatically the ordinary locked seam first described. These, however, it will hardly be worth while to describe here.

#### SPEEDS AND PRESSURES.

The ram speed in running curling dies is immaterial, there being no limitations in this respect as presses are ordinarily operated.

The speeds used in seaming work are also indefinite, although, with a given size of press, a quick hammer-like blow would be likely to prove most effective.

The pressure needed for curling is usually small, it being quite possible to use a foot press upon tin-plate worked up to, say, about 12 inches in diameter. In the lack of accurate data a safe pressure allowance would probably be from 100 to 200 pounds per lineal inch of curl, or circumference of utensil. This is counting the metal not over  $\frac{1}{8}$ " thick. In general, the pressure would most likely have to be increased approximately as the square of the thickness.

The pressure required for seaming is much greater, and can hardly be too much, if kept well within the crushing strength of the metal. Again we have no accurate records of what is needed for each particular set of conditions; but, roughly speaking, an allowance should be made of from 2000 to 4000 pounds for each inch of seam length—that is with ordinary tin-plate and sheet-iron.

#### SUITABLE PRESSES.

The kind of press used for curling is not of much consequence except that it must have height enough for the depth of the dies, which is usually much greater than for work of other kinds, plus the depth of the work itself, so that it may be inserted between them and then dropped into or on to the lower die. This is assuming the lower die to be fastened to

the press-bed in the ordinary way, and would, of course, involve an extra long stroke to the ram. In practice, however, except for very shallow work, the lower die is generally mounted upon a sliding or swinging table, which is brought forward each time the work is to be removed and replaced. It is then pushed backward (by hand, usually) under the upper die, which need have but an ordinary stroke of from 1 to 2 inches, according to the character of the particular dies in question. In this case the height from the bed, or rather the bolster, to the ram, with ram up, need be but the "shut-height" of the dies plus the stroke, as usual. Obviously, however, such dies are apt to average higher than do cutting dies, etc.

The presses used for horning are usually made on purpose for the work, with the projecting bed omitted from the frame, and in lieu thereof special means for inserting or otherwise fastening on horns of various sizes and shapes. For certain small work ordinary presses can be used, with horns mounted upon properly adapted bolsters.

## CHAPTER IX.

## DRAWING PROCESSES.

## DRAWING, HISTORICALLY.

THE drawing process for sheet-metals, by which deep cylindrical, conical, and other cup-shaped articles are made seamless from a flat sheet, is very different from the ordinary forming process used for shallow articles of like general nature; or, to speak more accurately, it is an amplification of the same, embodying certain new and entirely different principles. It is in its nature as interesting as it is unique. It is, moreover, a comparatively new process, probably dating back not more than 50 or 60 years. As near as I can learn it was first used in America by Mr. Grosjean of New York, who informs me that he thinks it was practiced in France over half a century ago. I am informed by Mr. Neidringhaus of St. Louis that the Prussian system of metal-drawing, as it is called, was invented at Saarlouis, Rhenish Prussia, by the Strouvelle Brothers. It probably was not practiced on a large commercial scale in this country much earlier than 1866, and the first presses were made here by a Mr. Marchand, who had been employed by Mr. Grosjean and his associates.

This process is sometimes called "stamping," which term, however, is a misnomer, being improperly used to designate something which is the successor of the old stamping process, but entirely different from it. The latter was practiced for many years in the production of various seamless utensils, such as pans, bowls, plates, cups, etc., which were gradually



coaxed down into shape, so to speak, by frequently repeated blows in a drop-press.

## DRAWING DEFINED.

Sheet-metal drawing, proper, consists in so confining a certain outer zone of a blank (which is to be drawn into a cup-like shape) between two rigid flat surfaces that the metal cannot wrinkle when pulled radially inward, which it attempts to do on account of the constantly decreasing circumference of its edge. In Fig. 331 is shown, in vertical axial section, a pair of combination push-through drawing-dies, of the sort

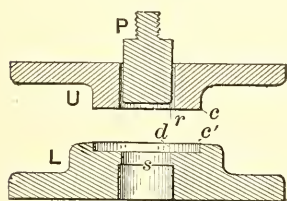

FIG. 331.

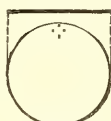

FIG. 332.

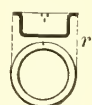

FIG. 334.

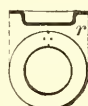

FIG. 333.

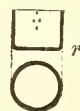

FIG. 335.

used for any plain cylindrical articles of medium depth, such as blacking-boxes, can-covers, clock-cases, etc. They consist of a lower die, *L*, an upper die, *U*, and a drawing-punch, *P*. They are shown with cutting-edges, *c*, *c'*, for which reason they are termed "combination-dies"—as a sheet laid between them when *U* descends is first cut into a blank, as shown in two views in Fig. 332. They could, however, just as well be used for blanks already cut, the edge *c'* being in such case somewhat rounded off to facilitate easy entrance of the blank, and remaining to serve the purpose of a gauge merely. Where blanks rather than whole sheets are used, this gaugering may be omitted and gauge-pins substituted therefor, as in Fig. 340, at *G G*. In some kinds of work no gauges are used except the fingers of the operator, the top surface of the

die being made of exactly the same size as the blank, to facilitate adjusting in this way.

### MECHANICS OF DRAWING.

The operation of these tools is as follows; The die *U* descends until the blank is firmly clamped between it and the die *L*, at which time *U* stops, the ram of the press being provided with a proper "dwell" until the punch *P* has had time to descend, forming the work gradually to shape, as shown by its successive stages in Figs. 333, 334, and 335. The punch then ascends, the work being prevented from rising by the sharp, hard stripping-edge *s*. The slight expansion of the

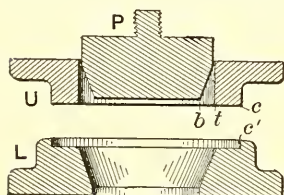

FIG. 336.

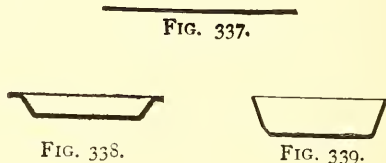

FIG. 337.

FIG. 338.

FIG. 339.

top edge of the work by its own elasticity is usually sufficient to prevent its pulling up through the die again. In some cases, however, there is a tendency to do so, which can be prevented by three or more spring-pawls inserted in the die at a point below *s*.

In all work of this kind it is important to vent the punch by an air-hole of ample size, somewhat as shown in Fig. 343, as otherwise there is a tendency for the work to be drawn upward by suction. This vent has been omitted from the other engravings.

It is evident that if the die *U* remains stationary during the drawing of the work the thickness of the flange thereof—that is to say, the flat part from the edge inward, which would be the rim of the inverted "straw hat," so to speak, represented by Fig. 333—must remain of the same thickness

as the original blank. Consequently the sides of the finished cup, Fig. 335, as well as its bottom, will remain of uniform thickness—that is, if there happens to be sufficient room between the sides of punch and die, so that the metal is not squeezed thinner. It may be said that the die *U* might be easily forced upward by the attempted thickening of the metal, the press springing open to allow for the same. This is true, but in practice the fact is that the thickness is changed but little. We have, therefore, in this process an interesting action taking place in the flange, viz., the crowding together—in blacksmith's parlance the "upsetting"—of the metal in a circumferential direction, while a pulling apart or stretching action is going on in a radial direction, and that to an amount, as experience proves, just about sufficient to balance the other.

This action is very prettily shown by a graphic method. Four small dots arranged in a square are marked upon the blank, as in Fig. 332, and this square will be seen to have

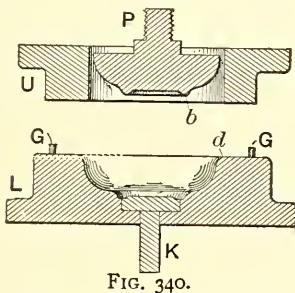

FIG. 340.

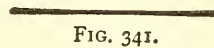

FIG. 341.

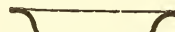

FIG. 342.

elongated itself radially and shortened itself circumferentially into the form of a diamond during different stages of the work, becoming a very elongated one at the last. The same action is shown in Figs. 349 and 350, which were photographed from an actual piece of drawn-work about 5 inches in diameter by something over 2 inches deep, the blank for which was made of "decorated tin," upon which were ruled cross-lines, as shown. The new relations of these lines to

each other upon the sides of the cylindrical cup tell the story far better than mere words can do.

#### FLOW OF METALS.

There is evidently here an interesting instance of the cold flow of metals, the molecules thereof being obliged to move freely among themselves and arrange themselves in new positions. Such flow takes place, as experience proves, without weakening the metal, it merely growing somewhat harder, in the same way as it would in any hammering or rolling operations. This subject has been previously treated by the writer in a lecture delivered by him before the Franklin Institute, entitled "Flow of Metals in the Drawing Process," which was published in the *Journal of the Institute* for November, 1886. The following paragraphs are quoted therefrom :

"Common instances of elastic flow may be found in the wonderful stretching of a piece of india-rubber to perhaps ten times its normal length and its indignant return to exactly its original form, or in the bending or twisting of any wooden or metallic springs, etc.

"Instances of non-elastic flow are observed most frequently, perhaps, in connection with semi-solids, such as the clay upon the potter's wheel, the dough in the hands of the housewife, or the putty under the glazier's knife. In the apparently rigid solids such action is not popularly conceivable, but a little observation will show that the cold-forging of a piece of iron, or, indeed, any bending or other permanent distortion of any piece of metal, could not occur without this flowing of its molecules among themselves. Such flowing is shown on the grandest scale known to our present experience (whatever may have happened in the mighty workshops of geological science) in the glaciers of the Alps, where great masses of solid ice flow slowly down their confining channels, changing

their shape of cross-section as needs be, without being crushed or suffering any disintegration of their substance. This has been well described by Professor Tyndall, and it is, if I remember rightly, the same distinguished prowler about Nature's portals who tried the very interesting experiment regarding the flow of foreign objects through solid pitch without leaving any holes in it. I could not find the description of this experiment the other day in any books that I had at hand, but I believe it was as follows: A number of stones were placed upon the top of, and a number of corks underneath, a mass of pitch several inches thick, and abandoned to their fate. After several months of silent disappearance the corks arrived at the top and the stones at the bottom of the pitch, having floated and sunk respectively to their natural destinations.

“In looking for the flow of solids in the metallic arts it will be well to omit all hot processes as dealing with semi-fluids; but familiar examples of cold flow may be seen in wire-drawing, tube-drawing, cold-rolling, and -hammering, lead-pipe making, sheet-metal spinning, etc.

“The first two mentioned are obviously analogous, about the only difference being that the tube is hollow, usually with a mandrel inside of it, while the wire is solid. Very similar to these operations, as respects the direction of flow of the particles of metal, is the reducing of a rod in grooved rolls, the chief difference being that the metal is coaxed along by friction, so to speak, instead of being pulled by its finished end. In hammering a bar the tensile stresses are entirely omitted and the action is wholly compressive, in a lateral direction, of course.

“In lead-pipe making we have also an entirely compressive action, but one very different from that in the last-named process. Here the lead is squirted out, as it were, much after the manner of a syringe, or a sausage-stuffer, or

one of those curious but really excellent squirting brick-machines. . . .”

### CONICAL DRAWING.

In Fig. 336 is shown a pair of conical drawing-dies, the blank and successive stages of the work being shown respectively in Figs. 337, 338, and 339. Perspective views of finished work from dies of this sort are shown in Figs. 354 to 359. Large-sized dies of this kind are usually made of cast-

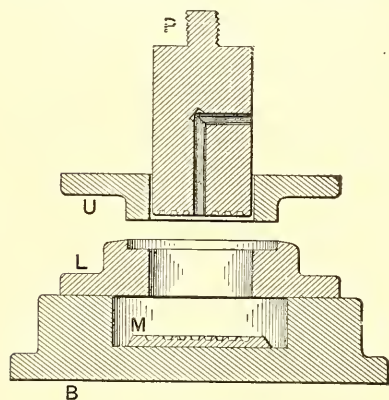

FIG. 343.

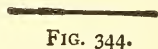

FIG. 344.

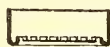

FIG. 345.

iron, without cutting-edges, the gauging being done by hand, as before mentioned. Where there is considerable taper to the work, it is removed by the hand of the operator grasping it inside and lifting it merely by friction as he pulls it upward and sidewise. The presses for doing this are run very slowly (sometimes not over 8 or 10 strokes per minute) with continuous strokes, not stopping by the clutch with the ram in up position, as is usual with smaller presses. This is, of course, somewhat dangerous, as a man's arms would be crushed to a jelly were he to fail in keeping time with the motions of the press, even perhaps by the fraction of a second. It is rarely, however, that accidents of this sort happen.

In Fig. 340 is shown a somewhat similar pair of dies, ex-

cept that they are nearer hemispherical than conical, and are provided with a knockout, *K*, which rises at the proper time by a spring, or automatically by the motion of the press.

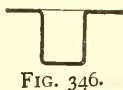

FIG. 346.



FIG. 347

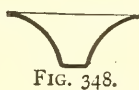

FIG. 348.

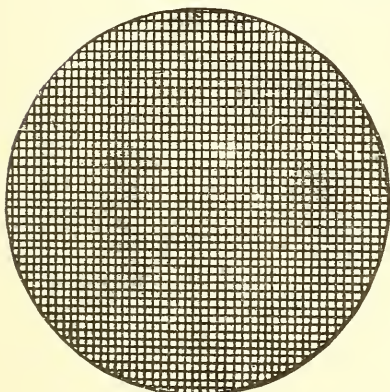

FIG. 349.

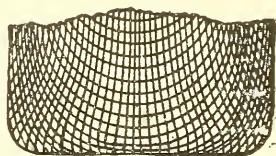

FIG. 350.

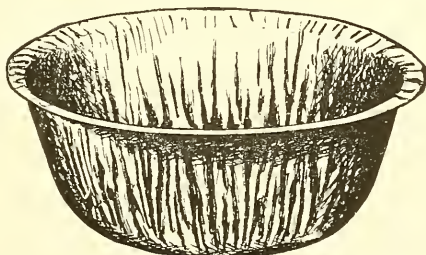

FIG. 351.



FIG. 352.

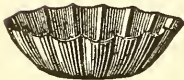

FIG. 353.



FIG. 354.

Such knockouts are of course used in dies of either of the forms described, and they are sometimes omitted in the bowl-shaped work (see Fig. 342) made in the dies now under dis-

cussion. The necessity of such a knockout is of course dependent upon whether the work is steep enough at any place to cause it to stick fast and thus prevent a free delivery. In Figs. 358 and 359 are shown perspective views of a bowl and cup made in dies of this sort.

#### DEPTH OF DRAWING.

The depth of work attainable by the drawing process depends upon various conditions, among which are the kind and toughness of metal, the thickness thereof in proportion to the diameter, the smoothness of the dies, etc. I have known small articles to be drawn at one operation from a good quality of "one-cross" tin-plate, which is about  $\frac{1}{64}$  inch thick, to a depth equal to one half their diameter. Occasionally this proportion has reached two thirds, as, for instance, a 3-inch round box 2 inches deep, etc.; but such would be an extreme case. Brass, german-silver, and copper can usually be drawn somewhat deeper, while zinc, on account of its tensile weakness, has limitations of shallowness which are sometimes very provoking. Silver and gold are well adapted for deep work, but I cannot learn of the latter metal having been tried for anything as large as a churn. Recent experiments in the drawing of aluminum show it to be well adapted to the process. It is especially convenient on account of working without so frequent annealing as is necessary with brass, iron and steel, etc. Its tensile strength, however, being somewhat less than brass, prevents, in some cases, so great a depth being obtained at one operation. In various experiments conducted by the writer in drawing cartridge-shells of this metal it showed itself most excellently adapted to the purpose, as it is also to all sorts of cooking-utensils, which are drawn without difficulty in the ordinary forms. These, on account of their healthfulness, lightness, and beauty, are, I think, destined to undergo an enormous development.



It may be asked why some of the weaker metals cannot be drawn as deep as stronger ones, considering that their compressive resistance to upsetting is probably somewhere nearly in proportion to their tensile strength. An explanation may perhaps be found in the flange-friction, between the die-holding surfaces, remaining nearer a constant than do some of the other conditions. There are, however, a good many things in the physical structure of the various metals regarding which we must, for the present at least, retain an agnostic attitude.

To quote again from the lecture before mentioned, and referring to Fig. 331:

“A little study of the work which is being done in a die like this will show why a limit of depth is soon reached. The actual work done consists, firstly, in overcoming molecular friction, or causing to flow among themselves the particles of metal in the flange before and while it turns the corner  $d$ ; and secondly, in overcoming the friction between the upper and lower sides of the metal and the surfaces of the dies. If we imagine the part of the work which has become cylindrical to be a series of little ropes (forming the elements of the cylinder) which are attached to the punch by running across under the bottom of it and thence up its sides to the corner  $d$ , we will see that all the resistance offered in the flange is being overcome by the punch pulling these ropes downward over the corner  $d$ , it acting as a stationary pulley-block, as it were. Hence if the united tensile strength of all these little ropes is great enough to overcome the resistance at its maximum, which is soon after the metal begins to flow, when the flange is at its widest, perfect work will be the result. If, however, there are not enough ropes to do this work, which is the case when the diameter at  $s$  is too small, the flange will not start to move, but the punch will simply go down and tear the bottom out of the work. Thus if we try for too great a depth relatively to the proposed diameter the work will be spoiled,

because this means a wide flange, to furnish more metal—and, consequently, more resistance.

“It is evident that the little ropes spoken of will render more easily about a large corner than a small one, and that therefore a better result may be obtained by increasing the radius of the “drawing-corner”  $d$ . If, however, this is carried too far, a considerable part of the flat holding-surface of the lower die is lost, and a new evil arises, known as body-wrinkles, which will be explained further on. Practically, for working tin-plate, the radius of the corner  $d$  is made from  $\frac{1}{8}$  to  $\frac{1}{4}$  inch. The curvature of the corner  $r$  upon the punch also affects the result. If it is made perfectly sharp, it tends to cut the metal which is pulled around it, and practically ought not to be less than  $\frac{1}{16}$  inch radius. It is often much larger than this to suit shape of work desired, but if made very large it causes the trouble of body-wrinkles before referred to, on account of there being a certain zone of the blank which is unconfined by the flat holding-surfaces.”

In conical work the difficulty in regard to getting enough tensile strength of metal to pull in the flange is often greater than in cylindrical, as the hypothetical little ropes spoken of in the above quotation are still fewer in number around the small circle whose perimeter is at  $b$ , Fig. 336, than they would be in the larger one at  $t$ , with a cylindrical punch. In general, therefore, work with a diameter at the bottom small in proportion to the extreme diameter of the flange is difficult to draw. This is shown in Figs. 346, 347, and 348, where there is a great deal of work going on in the vicinity of the flange in comparison to the amount of strength around the point of the punch to do the pulling.

#### BODY-WRINKLES.

In conical work like Fig. 339, or with approximately spherical shapes like Fig. 342, the blank is evidently uncon-

fined over a certain annular zone lying between the lower corner of the punch  $b$  and upper corner of the lower die  $d$ , represented in general by the distance  $b t$ , Fig. 336. As the inner portions of the flange enter this zone and pass inward over its surface they are obliged to become smaller in circumference. There are here no clamping die-surfaces to prevent wrinkles, which are therefore naturally formed and carried down into the conical portion of the work, as shown in Fig. 351, which was photographed from an actual washbowl about 10 inches in diameter, just as it left the dies. These are known as "body-wrinkles," in contradistinction to the "flange-wrinkles," which sometimes occur when the upper and lower dies are not set tightly enough together. The former are usually removed by roller-spinning in a special lathe. They are apt to occur in almost any of the utensils shown, except perhaps in work like the pie-plate, Fig. 354. This is so shallow that they only barely begin to form, especially as the flange can be clamped very tightly in proportion to the depth, so that there is a tendency to pull out these incipient wrinkles by the actual stretching of the conical body of the work. There are other cases where wrinkles do not form objectionably on account of the work having very little taper, as in Fig. 357.

In Figs. 352 and 353 are shown common forms of cake-pans, which illustrate body-wrinkles when *systematized* and intended purposely to remain. These are the easiest made of all forms of deep work, and do not require a holding-die at all, being made without trouble in a single-action press.

#### FLANGE-WRINKLES.

The absence of wrinkles in the flat flange of metal between the dies, which represents what remains of the original blank, is obviously due to sufficient die-pressure being maintained throughout the operation. Conversely, their presence (always as a nuisance) is due to the upper die being insufficiently forced

down, or to the press springing open afterward. If they once begin to form, it is almost impossible to smooth them out again. In straight work they are apt to show permanently in the walls of the article produced, while in conical or other tapering work they go down and aggravate the evil of body-wrinkles.

In general, therefore, any "blank-holder" (as the upper die is often called) should be set down as *firmly* as the metal will stand without tearing. Furthermore, it should be set *evenly*, ascertaining the average of such a condition by repeated trials, as some irregularity in the thickness or hardness of the blank may prove misleading at first. All good drawing-presses are provided with some sort of a "tipping" adjustment, either in the ram or bolster, by which the above-named result may be obtained.

#### PROPORTIONS OF WORK.

Obviously, large diameter, in proportion to depth of draw, ensures less tendency to wrinkles and breakage, and is a condition requiring less power to make the metal flow.

Thick blanks are less liable to breakage than are thin ones, for the same reasons, connected with friction in its proportion to cross-section, that are given further on in relation to multiple drawing—and, too, because less "holding"-pressure is needed.

There is with thick blanks also less tendency to wrinkle because of the reluctance of the stiffer metal to bend or buckle out of its original plane, in obedience to the circumferential upsetting action we have been considering. This stiffness is approximately as the square of the thickness, and hence we find that in drawing "clumsy" articles, so to speak, such as some forms of cartridge-cups, gong-bells, heavy boiler-heads, etc., we do not need any flange-pressure at all. In such case the process becomes really a forming one, notwith-

standing the use of a double-action press and dies. The latter are referred to in Chapter VII; and certain double-action crank-presses which are sometimes used for such dies are mentioned in Chapters II and III.

From the analysis given it will be seen that, in general, the least difficult articles to draw, with a given metal, are those which are comparatively thick, flangeless, shallow, flat-bottomed, and cylindrical rather than conical or irregular.

#### MULTIPLE DRAWING.

It has been seen that the resistance to be overcome in drawing is due to both surface-friction against the dies and to molecular friction, or resistance to flow. With such conical articles as bowls, pans, etc., which do not require to be absolutely of uniform size, advantage is taken of this division of resistance by drawing two or more together—sometimes as many as four. In such a case the surface-friction is no greater for four than for one, as there are but two surfaces sliding against the dies. The molecular friction is, of course, four times as great as with one, but the sum of these frictions is obviously less in proportion to the tensile strength of the wall of metal surrounding the punch, which is as the number of thicknesses involved. There is, therefore, a considerable gain in strength, and deeper work may be made than where one is drawn at a time.

Formulating the above, with a view of showing the principle merely without introducing actual values, letting  $T$  = total tensile strength of wall of metal around punch,  $R$  = total resistance of flange against being pulled down into the formation of said wall,  $S$  = total surface-friction,  $M$  = molecular friction, and  $x$  = such amount of  $R$  as is due to the friction of one surface, we have  $R = S + M$ , and  $S = 2x$ , due to the two sliding surfaces. We will assume  $T = 4x$  and  $M = 3x$ , as being a rough approximation of the truth—

at any rate with some metals, some dimensions, and some ram-pressures. Hence, regarding the drawing of one blank at a time as Case 1, two blanks as Case 2, etc., we have in

(Case 1)  $R = 2x + 3x = 5x$ , and  $T = 4x$ , which is  $< R$ ,

(Case 2)  $R = 2x + 6x = 8x$ , and  $T = 8x$ , which  $= R$ ,

(Case 3)  $R = 2x + 9x = 11x$ , and  $T = 12x$ , which is  $> R$ .

It is obvious that if  $R$  exceeds  $T$ , as in Case 1, the blank cannot be drawn at all, but must be burst through by the descending punch. With Case 2 the results would be doubtful; but when  $T$  exceeds  $R$  by a small percentage, as in Case 3, only a few breakages will occur. With greater excess, such as would be attained with four blanks (and these other hypothetical conditions), there would be practically none at all. The safety limit, here occurring between one and three blanks, may of course happen at some other point when the various conditions are different.

It is customary to remove the several thicknesses together from the press, sometimes spinning them in this condition, after which they more or less easily drop apart. Obviously this could not well be done with cylindrical articles, as the difference in diameter would be too apparent, and, moreover, they could not be easily separated.

#### CONDITION OF DIES, ETC.

Referring again to the condition of the dies, it is very necessary, in order to avoid surface-friction, that they be made exceedingly smooth and that the flat surfaces should be truly parallel, thus giving a space of uniform thickness between them. It is better to polish the clamping-surfaces radially rather than to leave a "lathe polish" upon them—a quite perceptible difference in preventing the metal from cracking sometimes appearing under such conditions.

Lubrication, which in certain cases is needed with various other kinds of dies referred to in this treatise, as mentioned

in Chapter IV, is always necessary, to a more or less degree, in drawn-work. Sometimes oil is the best material—either applied occasionally to the dies, or smeared in a thin coat over the sheets or blanks, or some of them. Paraffine, applied in the same way, is good for tin-plate. Soap-suds works well for brass, and there are a variety of special preparations in the market. Zinc draws better if warmed as well as lubricated.

Iron and other metals are sometimes drawn hot. Among the curiosities of heating may be mentioned a method (which I think has been patented) of passing a current of electricity through the strip of metal as it goes through the press, thus heating it locally at the right time and place.

#### CUTTING-DRAWING-EMBOSSING.

In Fig. 343 are shown in axial section, rear view, a pair of triple-action dies, and in Figs. 344 and 345 a blank and a finished box-lid made therein. The action of these is the same as in Fig. 331, except that the punch has relatively a longer stroke and carries the work down onto the embossing-“matrix” *M*, which is fastened at the bottom of a special bolster, *B*, made with an opening at the back through which the work is removed instead of dropping downward in the ordinary way. The object of this is to emboss panels, beads, lettering, or other devices upon the bottom of the work, and yet not be obliged to knock it up through the die, which is difficult with cylindrical-shaped articles. The removal spoken of is usually performed by gravity, the press being set in an inclined position, so that the work may freely slide out. Sometimes, however, an automatic push-out is provided. This is safer, as gravity occasionally fails to do its duty at a critical moment. Presses built especially for such work usually have a shorter ram-stroke than usual, as room is not required between the dies for knockout work, and a relatively longer plunger-stroke is

needed, so that the die *L* may be made unusually thick (to give it strength where it bridges across the open space in the

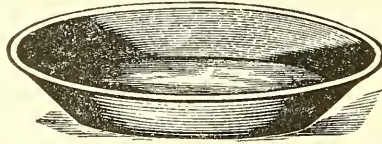

FIG. 355.

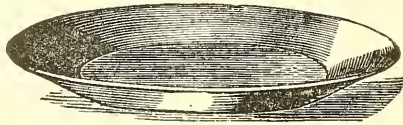

FIG. 356.

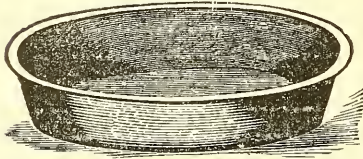

FIG. 357.

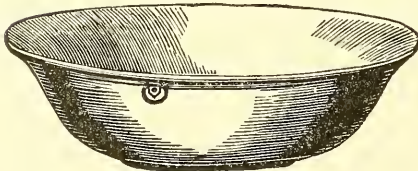

FIG. 358.

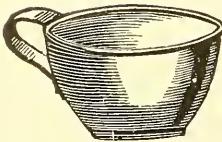

FIG. 359.

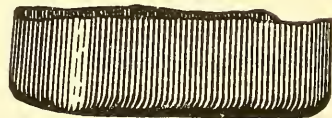

FIG. 360.

bolster), and yet that the punch may descend far enough to reach through it and downward to *M*. The punch itself is of course unusually long.



## SPECIMEN DRAWN-WORK.

It is evident that other shapes (looked at in top view) than round may be treated by the drawing process. In Fig. 360 is shown a rectangular sardine-box, whose sides are straight and corners rounded to about  $\frac{3}{4}$  inch radius. This is quite difficult to draw, because the action upon the metal at the corners is approximately the same as in drawing a cylindrical box with the same radius, or  $1\frac{1}{2}$  inches in diameter, which is very small considering the depth attained. There is in such case a violent flow of metal, modified somewhat as it extends outward from a rounded corner into the two adjacent straight sides. The



FIG. 361.

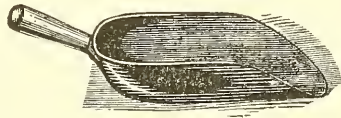

FIG. 362.

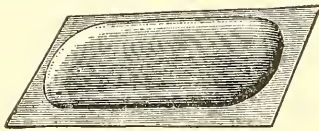

FIG. 363.

shape of the blank for work of this kind is rather peculiar, the corners being very much cut away in comparison with the sides, to allow for the great radial stretch of metal at those points. The turning up of the sides along near the middle thereof is obviously a bending action merely.

In Fig. 361 is shown an oblong pan with rounded ends, which is of somewhat the same nature as the box just mentioned.

In Fig. 362 is shown a grocers' scoop, which was drawn in an irregular die, the flange and a part of the body being trimmed off afterward.

In Fig. 363 is shown an ordinary washboiler-bottom, illustrating a case where no special blank is purposely prepared, but where the so-called "well" or depression is drawn in an ordinary rectangular sheet of metal, the holding-surfaces of the dies of course being large enough to cover it. This system is sometimes used in producing certain tin toys, where the two

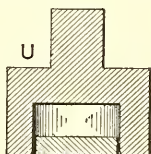

FIG. 365.

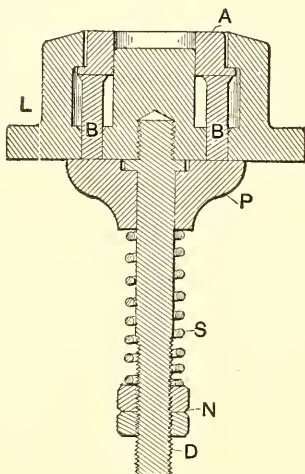

FIG. 364.



FIG. 366.



FIG. 367.

halves of an animal are thus drawn and trimmed and then soldered together along the spinal column, etc.; also for various other similar shallow work. Its advantage is that no cutting dies are needed except for trimming off a part, or all, of the flange after drawing, which dies would have to be furnished in any case.

The various utensils shown in Figs. 354 to 359 have already been referred to. They represent average tinware, or, equally well, the enameled ironware which is coated with a

baked-on porcelain-like skin, and which enjoys a number of fanciful names—as christened by the makers thereof.

### SPRING-DRAWING.

In Fig. 364 is shown a pair of combination spring-drawing dies, so called, with the blank they cut shown in Fig. 365 and other stages of the work shown in Figs. 366 and 367.

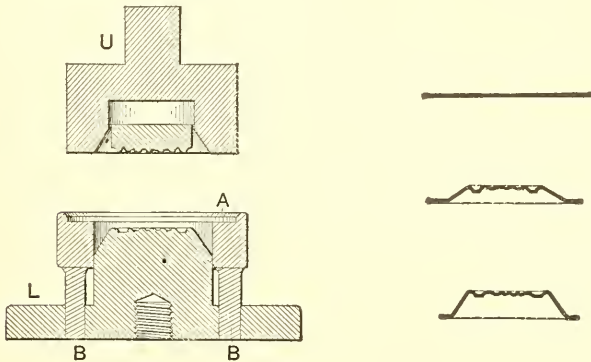

FIG. 368.

In Fig. 368 is shown a pair of similar dies, arranged to work from a pre-cut blank, and not supplied with cutting-edges. The blank, the part-way drawn, and the completed work are respectively shown at the side of the dies. In this case the combination is one of drawing-embossing.

Such dies are used in single-action presses, the flange-pressure being supplied by the drawing-ring *A*, which is driven up and against the die *U* by a powerful spring *S*, working against a sliding plate *P*, through the medium of a series of pins *B B*. The stem *D*, together with its plate *P*, nuts *N*, spring *S*, etc., form a portable device sometimes known as a "spring-drawer," which can be screwed into any die adapted for it. Work done in this way is generally limited to thin metals and in depth to about 1 inch, as the pressure with

anything much deeper would be so great as to waste considerable pressure, the descending ram having, of course, to compress the spring to the same number of pounds as are afterward given out by it upon its ascent—and this in addition to its legitimate work.

Another disadvantage of this strong upward pressure is its reaction upon the press-ram and connected parts. This sometimes causes the ram of a power-press to “fly up,” carrying the shaft around at a higher speed than the fly-wheel and making a disagreeable jerk. The remedy is a closely locked clutch or an unusually tight brake.

A series of rubber disks is in some cases substituted for the spiral spring *S*. In other cases, especially for shallow work, local springs are inserted under the ring *A*, making each die complete in itself and independent of the spring-drawer as a separate attachment. The knockout-plate in the upper die is driven down by springs, or otherwise, as usual.

Obviously the ring *A*, in addition to acting as a knockout, performs the function of a blank-holder—the same as does the upper die itself in double-action work.

#### BLANK DIMENSIONS.

In regard to the important matter of blank dimensions it will be pertinent to again quote from my Franklin Institute lecture, as follows:

“It will naturally occur to the student of this subject that some easy method is desirable for determining the diameter of the blank for any given piece of drawn work, especially if its dies are to cut, as cutting-edges are expensive to make—and to alter, if guessed at and made wrong at first. Aside from lucky guessing, somewhat guided, perhaps, by analogies from other approximately similar work that dies have been made for before, I have in my own practice used

three principal methods to obtain this measurement of blank diameter.

“The first of these methods is the tentative one. It is the surest, but in many cases the most expensive. It consists in cutting blanks of as near as possible the right size and shape by guess and trying them successively, modifying the shape of each to suit circumstances until the proper shape of drawn-work is produced. For dies that do not cut this is not difficult, as the flat holding-surfaces can be made plenty large enough, and whatever gauging arrangements are to guide the blank can be put on afterward, when its correct proportions are decided upon. In cutting-dies the female cutting-ring must be made separately, and left unfinished until the size and shape are ascertained. The male cutting-ring, which forms part of the upper holding-surface, must of course be made, but can be left plenty large enough until this trial has been completed.

“The second method referred to may be called the ‘gravitative.’ It depends for its accuracy upon the principle that the thickness of the metal in a piece of drawn-work is the same as it was in the original blank, which is in fact usually the case. My plan is to carefully weigh the sample piece of drawn work which is to be reproduced, and then, knowing the weight of 1 square inch of a piece of similar sheet-metal of exactly the same measured thickness, to calculate the number of square inches necessary in the blank and make its diameter to suit this given area. This system can obviously be practiced only where a sample of the work is at hand, and where the blanks are circular in form. Certain inaccuracies may arise in the practice of this method, where there are sundry beads, corrugations, etc., near the center of the piece of drawn work, which tend to let the metal stretch when the punch comes home in the die. Such action is properly embossing rather than drawing, and stretches the metal thinner

in certain places, which, of course, invalidates the accuracy of the result. It is, however, often useful for work whose contour is simple in form near the central portions, where a drawing action does not take place.

BLANK FORMULÆ.

“ The third method spoken of may be called the ‘ mensurative.’ This, too, depends upon equal areas and upon the thickness of the metal remaining the same. In the case of plain cylindrical work a very simple formula which I have worked out for the purpose may be used. This is given in

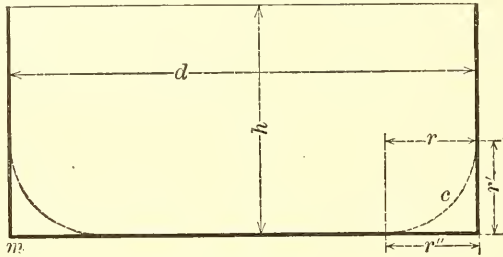

FIG. 369.

Let (in inches, at middle of sheet's thickness)

- $d$  = diameter of cup.  $a$  = area of bottom + sides.
- $h$  = height of cup.  $a$  = area of blank, also.
- $r$  = radius of corner.  $x$  = diameter blank is to be cut.
- $c$  = arc of  $90^\circ$ , with radius  $r$ .

$$a = .785d^2 + \pi rh \dots \dots \dots (1)$$

$$x = \sqrt{\frac{a}{.785}} = \sqrt{\frac{.785d^2 + \pi dh}{.785}} \dots \dots \dots (2)$$

$$x = \sqrt{d^2 + 4dh}, \text{ for sharp-cornered cup.} \dots \dots \dots (3)$$

$$r' + r'' - c = \frac{r}{2}, \text{ about.} \dots \dots \dots (4)$$

$$2(r' + r'') - 2c = r, \text{ about.} \dots \dots \dots (5)$$

$$x = (\sqrt{d^2 + 4dh}) - r, \text{ about, for round-cornered cup; with small corner, say where } r < \frac{h}{4} \dots \dots \dots (6)$$

Fig. 369, equation 3, for a box or cup whose corner at  $m$  is sharp, or nearly so, and in equation 6 for a round-cornered

box. The latter formula is not theoretically accurate as regards equal areas, but serves an excellent practical purpose where the corner is not of too large a curvature—say with a radius not more than one fourth the depth of the cup. The diagram given in Fig. 369 is a vertical axial section of a cylindrical box or cup, the same as was shown in Fig. 335. It is not worth while here to give the working out of the formulæ, as by a close inspection the figures will explain themselves.

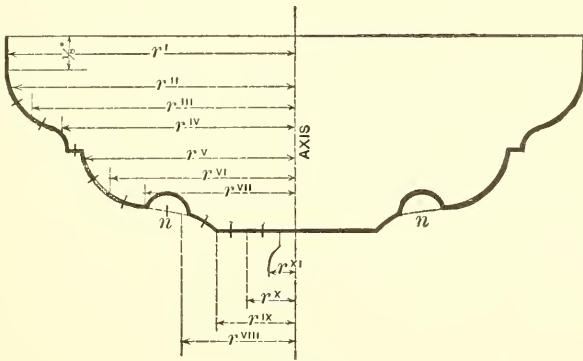

FIG. 370.

Let (in inches):

$r^I, r^{II}, r^{III}, r^{IV},$  etc., = radii drawn to axis from centers of gravity of  $\frac{1}{8}$ -inch segments of contour-line.

$s = r^I + r^I + r^{III} + r^{IV},$  etc.; that is, the sum of the radii.

$a$  = area of bottom + sides.

$a$  = area of blank, also.

$a'$  = area of one zone whose average radius is  $r^I, r^{II},$  or  $r^{III},$  etc.

$x$  = diameter blank is to be cut.

$$a' = 2r^I \pi \frac{1}{8}, \text{ etc.} \dots \dots \dots (7)$$

$$a = 2s \pi \frac{1}{8} = .785s \dots \dots \dots (8)$$

$$x = \sqrt{\frac{a}{.785}} = \sqrt{\frac{.785s}{.785}} = \sqrt{s} \dots \dots \dots (9)$$

“ In Fig. 370 is shown a system which I have devised for ascertaining the area of a piece of drawn-work of irregular contour as regards its vertical axial section. This method is a graphic one, an exact profile of the work being drawn to a

scale of real size, and this contour-line being laid off from its axis outward into sections, each exactly  $\frac{1}{8}$  inch long. From the centers of these sections horizontal measurements are taken to the axis as indicated by  $r^i$ ,  $r^{ii}$ ,  $r^{iii}$ ,  $r^{iv}$ , etc. These measurements, of course, represent various radii of the piece of drawn work in question. If we let the sum of them be called  $s$ , we then get the very simple formula given in equation 9. The reason that just  $\frac{1}{8}$  inch was taken for the length of these segments of the contour-line was that it happened to reduce the equation to the simple form given, while any other length would have made it more complicated. The principle here involved is obviously that of the area of any zone being its width multiplied by its circumference at a point representing the center of gravity of its single cross-section. The points marked by  $r^i$ ,  $r^{ii}$ , etc., are, of course, not accurately in the center of gravity of each of the little segments, but they are practically near enough so. The same principle occurs in this method as in the last-mentioned one regarding places in the metal which will stretch thinner when formed to shape, like deep beads or other indentations. This trouble may be mostly neutralized, however, by bridging over them, so to speak, in making the contour-line—that is, by running the latter across from point to point of the corrugations, instead of following their curves, wherever it is judged that stretching will take place. This amended contour is shown at  $n$ ,  $n$ , Fig. 370, by dotted lines, and on it the segments should be laid out.

“In making drawn-work whose top view is elliptical instead of round the formulæ above given may be used with some modifications.

“To do this the ellipse is treated separately as regards its short and long axes, and values for  $d$  are inserted in the two equations which would be used for circles that approximately coincide with the sides and ends of the ellipse at the termini of its respective axes.



“In making rectangular work with round corners some idea of the shape of the blank may be obtained by treating the corners as belonging to a circle of the proper diameter, while the sides of the rectangle, which properly are not drawn at all, but only bent to shape, may be treated nearly by actual measurement, as in them very little stretching takes place. As regards the corners, however, the tentative method is the safest wherever it is possible to use it.”

An empirical rule (which has been used for a common quality of steel about  $\frac{1}{10}$  of the blank diameter in thickness) for getting as deep a cylindrical cup as practicable from a given blank is to let the cup diameter be  $\frac{2}{3}$ , or 60 per cent., of the blank diameter. This obviously might prove too much or too little when conditions of thickness and quality were changed.

#### TRIMMING EDGES.

In Figs. 351 and 363 it will be noticed that the edge of the flange is somewhat irregular, and Figs. 350 and 360 show that certain defects in symmetry which start in the flange are carried down into the “wall” of the work, often aggravated in degree, with the effect of a rough and jagged edge. In other words, it is difficult, except with very shallow work, to get either flanged or non-flanged articles with edges true enough for practical use without a trimming operation.

Flanged work can be thus trimmed in cutting-dies or with rotary shearing-cutters in a “trimming”-lathe. Such lathes are usually made so that they will answer also for “spinning” and “wiring”—sometimes all successively at one chucking.

Flangeless work is usually trimmed in a special machine by the use of rotary shearing-cutters. Sometimes, however, a “turning-tool” is used, as in a lathe, paring away chips as it

goes through. This process is applied to small thick-walled articles, as some sorts of cartridges, etc.

The chief causes of irregular edges are, first, lack of parallelism in press beds and rams and in the dies mounted thereon, both in original construction and as temporarily induced by distortions due to stresses while working; and, second, lack of parallelism, homogeneity of structure, and uniform hardness and smoothness in the sheets of metal worked. None of these defects can be wholly remedied, and very minute doses of them sometimes cause alarming symptoms in the way of non-uniform radial distances traveled by various portions of the flange. Hence, unconquerable raggedness, especially in square and irregular work.

#### ROLLER-SPINNING.

The object of spinning is to smooth out the wrinkles, a result which may be attained, either before or after trimming, by passing a hard roller, mounted in a slide-rest or otherwise, over the surface as the article revolves. This may be done inside or outside, but in either case the metal of the chuck forms a "backing" to take the roller pressure.

#### ROLLER-CURLING.

Wiring, as it is usually termed for this sort of work, is in most cases merely curling, and is done, after trimming, by pressing a grooved roller against the revolving edge. Pans as shown in Figs. 354 to 358 have been thus served. Elliptical and other shapes not round can obviously be treated in lathes especially adapted to follow the proper contours.

#### SPEEDS AND PRESSURES.

In regard to the maximum limit of punch-speed in drawing we have but few reliable data. The number of strokes per minute of drawing presses in commercial use varies say

from 8 to 200, with perhaps a rough general average of 50 or 60 per minute. At these rates the various metals used seem to flow properly without tearing fracture, although it may be that in some cases a slower speed would produce better results. Evidently some systematic experiments are very desirable.

But few available data exist, or at any rate have been made public, regarding the pressure per square inch necessary for holding the various kinds of metal between the surfaces of drawing dies. Neither do any proper testing instruments exist which will fill all the conditions present. These must be originated, and it is certainly desirable that somebody should make a series of experiments in connection with this matter, as well as in relation to the pressures in general that are used in sheet- and bar-metal work. Such experiments, if properly performed, are tedious and expensive, but the writer hopes at a future time to be able to publish something definite upon the subject. Some fragmentary experiments which he made a few years ago show about 200 pounds per square inch for holding the flange of a small milkpan, over 300 pounds upon a blacking-box in one case and nearly 500 pounds in another. One such box, with less than  $1\frac{1}{2}$  square inches of drawing-surface, stood over 4000 pounds without the bottom being punched out, showing that in such shallow work there is often a great excess of flange strength. In general, for small tin-plate work, etc., the pressure will probably run between 200 and 400 pounds.

The greatest possible plunger-pressure that can be used in any given case, without breakage, is, of course, measurable by the tensile strength of the cross-section of the work at the smallest diameter of the punch. This strength is obviously found by multiplying the circumference of the work at that point by the thickness of the metal (both in inches) and by its ultimate tensile strength per square inch. Or,  $P = SWT$ ,

our old formula with a new application,  $P$  being pounds,  $W$  width of metal (circumference),  $T$  thickness of the same, and  $S$  strength in pounds per square inch—in this case tensile.

If the plunger of a press will give this pressure (counting its maximum work), and the ram nearly or quite as much more, and all without too much springing, it is suited for its vocation.

#### KINDS OF PRESSES DESIRABLE.

In regard to the kinds of presses used for such work the general motion required has been before described. The plunger motion is almost always produced by means of a crank and pitman. The ram motion also is sometimes obtained this way in the case of certain kinds of shallow work, especially in brass factories. The “dwell” for the purpose of holding the flange of the work is obviously in such case but an approximate one, but if the metal is not too thin it seems to answer the purpose in the cases referred to. The majority of drawing presses are arranged to work the ram during its downward stroke by means of cams. These, if properly made with enormously strong shafts and rollers, with amply large bearing-surfaces and of proper material, are very efficient and durable. The lifting of the ram is sometimes positively done by cams, and sometimes by non-positive devices, such as springs and weights, or steam-, air-, or water-pistons working in appropriate cylinders, etc. Any of these devices, if properly designed and adapted to the speed of the press, are sufficiently good for the purpose. In cases where the ram carrying the upper die, or blank-holder, is reversed, doing its clamping in an upward instead of a downward direction (as is the case in some large bottom-ram presses), the direct action of gravity is used to return it. This gives excellent results, and an exceedingly simple construction can be obtained. Another device which has come into rather extensive use

consists essentially of a system of toggle-joints intervening between the ram and the press frame, which hold the ram securely clamped, with its die against the flange of the work, without bringing a running-pressure upon the shaft and roller-bearings, as is the case with cam-presses. This is obviously an advantage, but there is considerable difference of opinion among press makers and users as to whether any such advantage compensates for the additional complication required, especially after several years' wear has taken place. In general, it may be said that any of the plans mentioned are practically good enough if properly designed.

## CHAPTER X.

## RE-DRAWING PROCESSES.

## RE-DRAWING.

FOLLOWING the drawing process proper, as described in the last chapter, is the process of "deepening," "reducing," or "re-drawing," by any one of which terms it is designated. It depends in general upon the same principles, but differs somewhat in detail. The chief difference is that instead of drawing a comparatively shallow cup-shaped article from a flat blank it deepens the cups already made into other and deeper cups, at the same time reducing their diameter.

In Fig. 371 is shown, in vertical axial section, a pair of dies for performing such operations. In Fig. 372 is a section of a

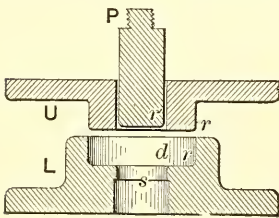

FIG. 371.

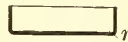

FIG. 372.

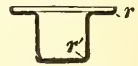

FIG. 374.

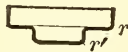

FIG. 373.



FIG. 375.

cup-shaped piece of work, which, by the way, is often technically called a "cup" by the makers of cartridges and such like articles, its name after re-drawing being a "shell." It has previously been drawn from a blank, as described in Chapter IX, and is placed in a recess in the lower die *L*, made to fit it, so as to guide it centrally into place. The upper die *U* is of such a diameter as to fit inside of it, the rounded cor-

ners at  $r$  and  $r$ , Fig. 371, being made of such curvature as to fit each other. Successive stages, during the progress of the punch at one down stroke, of the work as thus re-drawn are shown respectively in Figs. 373, 374, and 375. The rounded corner of the drawing-punch  $r'$  obviously governs the corner of the finished work, as shown by the same letter.

After the first re-drawing the deepened cup or tube can of course be again drawn, with another reduction of diameter, and then again, and so on *ad infinitum*, within certain practical limits. These limits are chiefly governed by the condition of the metal, which tends to harden in more or less degree, just as it does with other forging operations. With iron, steel, brass, copper, etc., annealing is necessary after each two or three draws. With such annealing, however, almost any increase of length can be obtained, as is shown in the case of an ordinary cartridge-shell, penholder-tube, or similar article. A series of successive stages of such re-drawing are shown in Figs. 376 to 380. In the case of tin-plate or other metal



FIG. 376.



FIG. 377.



FIG. 378.

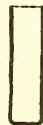

FIG. 379.



FIG. 380.

which cannot be annealed without spoiling the coating, not more than one or two re-drawings can usually be made; and then the metal is apt to be so brittle near the edge, where most of the flow has taken place, as to render it unfit for other bending operations, such as curling, etc. By one re-drawing it is practicable to obtain a tin-plate cup or box of a depth about equal to its own diameter. Here, again, the proportions depend, of course, upon the quality of the metal and its thickness in relation to its diameter.

A somewhat empirical rule for steel shells whose thickness

approximates say  $\frac{1}{30}$  of their final diameter is to reduce the diameter from 20 per cent to 30 per cent at each draw. As the literature of this subject increases we shall doubtless find available more numerous and more definite rules and tables which will eliminate many of the "cut-and-try" methods now so prevalent.

In Fig. 381 is shown a square steel box with rounded corners, as drawn in its first operation. In Fig. 382 is shown a

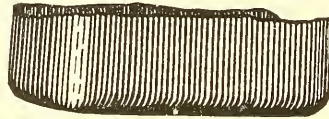

FIG. 381.

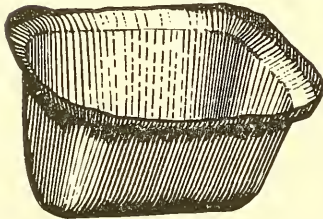

FIG. 382.

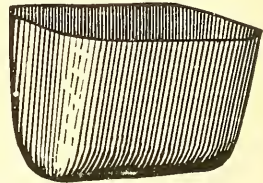

FIG. 383.

second operation, as it was re-drawn, and in Fig. 383 a third, making it into a complete elevator-bucket. In this case the last operation was not, properly speaking, drawing, as the edge was trimmed and at the same time turned upward by being forced through a die, without reducing the diameter of the body, and therefore with no chance to use a blank-holder. This is very difficult work to make, as the writer discovered some years ago when developing for a client various sizes of these buckets, as a new article of manufacture.

#### INVERTED RE-DRAWING.

In Fig. 384 is shown a pair of re-drawing dies, where the cup, Fig. 385, is placed over the lower die in an upside down



position. It is therefore turned partially inside out in being brought to the form shown in Fig. 386. In Figs. 387 and 388 are shown subsequent deepening, which will explain themselves. With plain shapes of this kind there does not seem to be any particular advantage in thus reversing the work, although in some cases it is desirable for special reasons. One disadvantage, where the reduction in diameter is small, is that the lower die must be thin radially, and is therefore liable to burst should an extra thick sheet get in.

An amusing, though annoying, circumstance connected with this last-named process is that after being in common use in various factories for a number of years somebody pat-

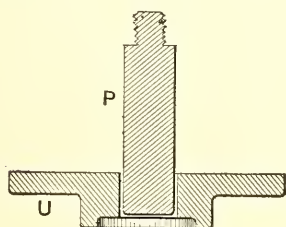

FIG. 384.

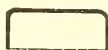

FIG. 385.



FIG. 386.



FIG. 387.



FIG. 388.

ented it. It is true we cannot expect the Patent Office officials to know everything that is happening in the mechanical world, but this fact suggests that possibly an occasional tour, at the Government's expense, among such plants belonging to the great industries of the country as pertained to each visiting examiner's particular kind of work, would be an excellent investment of the people's money.

The case just mentioned is not unique, there being frequent blunders of the same sort. A number of others might be cited which pertain to sheet-metal work. One of these patents is upon cutting sheets, as already mentioned in connection with Figs. 267 and 268, for another old process.

In Figs. 389 to 391 are shown the different stages of the work performed in a similar die to that last described, but with the difference that the cup, Fig. 389, was left with a flange upon it in its first operation. This flange could not, obviously, be very wide, there being nothing to prevent its wrinkling as it gradually crawls inward and upward upon the lower die. The process is sometimes useful with thick metals and small diameters to produce such work as the "castor socket," Fig. 391, in the final operation.

#### BROACHING.

A modification of a deepening operation proper is shown in Fig. 392, where the "broaching" process is combined with the re-drawing. The word broaching has here a very different meaning from that given it by the machinist, who applies it to the process of forcing a piece of male work through a lower cutting-die, or pushing a cutting-punch through a hole in female work, thereby shaving it to a given size, and really performing an operation analogous to planing or slotting. In cases where he uses male or female broaching-cutters having a series of teeth following each other, and each taking off its own chip, his work more nearly resembles milling.

In relation to sheet-metals the word broaching means smashing the work thinner by forcing it through a space between the punch and die which is too small for it. This in itself is, of course, very similar to some kinds of tube-drawing, which again is the same as wire-drawing, if we imagine the mandrel to be a part of the tube. In the case in question a reduction of diameter is being made at the same time as the thinning of the metal is taking place. This is much practiced in cartridge-drawing, especially where it is desirable to keep the end or bottom of the work of the original thickness, as shown in the picture. When done, the bottom remains of as much greater thickness than the sides as happens to be

required, and as has been arranged for in choosing the thickness of the sheet. In small work of this kind the use of a blank-holder, or upper die, *U*, is abandoned after the first one or two draws, as the metal is reduced so little in diameter in proportion to its thickness that the wrinkles have no chance to form. Even if incipient wrinkles do form they are quickly

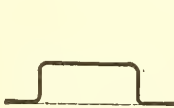

FIG. 389.



FIG. 390.

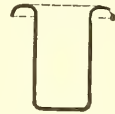

FIG. 391.

crushed out again as the metal is squeezed somewhat thinner. In this, as in all drawing, however, the wrinkles must never be allowed to get big enough to fold over upon one another.

#### VEE BLANK-HOLDERS.

In some large work, such as various kinds of pans having considerable taper, a kind of upper die termed a "vee blank-holder" is sometimes used in a re-drawing operation. This blank-holder outside is of the same shape and size as the punch which drew the first operation, but is cylindrically hollow inside, for the punch of the second operation to pass through it. Thus the wrinkles are held from forming in a conical zone constituting the upper part of the body of the future completed pan, rather than in a flat flange, as is usually the case.

A press is said to have been built several years ago with a series of these blank-holders inside of one another, each being as above—a ring with its exterior periphery in the form of a truncated cone. Outside of these was an ordinary flat blank-holder, which descended first as usual. The outer ring descended next, drawing a depression in the blank so shallow as not to have body-wrinkles. This, of course, acted as a

punch, its central aperture surrounding the nest of other rings, not interfering with its functions for flat-bottomed work. It then stopped and served as a vee blank-holder for the next contained ring, which, in the same order, performed the same functions respectively. Thus all acted in succession, the result being a conical pan without wrinkles or need of spinning, all parts of its surface having been "held" as much as necessary at all stages of the operation.

This machine probably had no relatives or descendants. It was theoretically very beautiful in principle, but the prac-



FIG. 392.



FIG. 393.

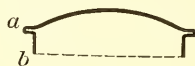

FIG. 394.

tical difficulty of driving all the rings with just the right motions, and of keeping them in order, together with the complications incident to changing frequently from one-sized pan to another, must have soon ended its career—and without much hope of posterity. For several billions of one-sized pans the scheme would be a good one, however.

#### RIM-FORMING.

In Fig. 393 is shown the first operation (being ordinary drawn-work), and in Fig. 394 the second operation, of what is known as a "rim-cover," such as is used as a lid for pots and other utensils. The bead or rim *a* has been "bulged" outward by the simple process of pushing the top down with a plain concave die, the lower edge of the metal being properly confined in a lower die. This is, of course, not a process of drawing at all, but is simply given here to illustrate an interesting operation following the work of the drawing-press. It is usually necessary to trim the edge true before bulging, especially if the depth is considerable relatively to the diameter. Otherwise the ragged edge causes irregularities in the rim.

## NECK-REDUCING.

Another useful after-process applied to a deep-drawn shell, of comparatively thick metal, of the shape of Fig. 395 is practiced by reducing the upper ends and thus forming it into the similitude of a metallic bottle, as in Fig. 396. This reduction is sometimes done entirely by spinning, but can also be done by a series of dies forced over the neck one after another, the body of the work being properly confined. Some cartridge-shells are reduced in this way at the open end. In Fig. 397



FIG. 395.



FIG. 396.

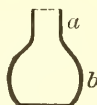

FIG. 397.

is shown a somewhat similar reduction of the neck at *a*, together with the bulging out of a part of the body at *b*, thus forming a pitcherlike utensil, as shown. This bulging outward might be done with certain forms of expanding dies, or with a fluid punch, as described in Chapter VII. It is, however, usually performed by a spinning operation from inside.

## THE SPEED AND PRESSURE

required for re-drawing are so nearly the same as for primal drawing, mentioned near the end of Chapter IX, that no further data need be here given.

## PRESSES MOST SUITABLE.

In regard to the kind of presses best adapted for the reducing and deepening operations just treated of it may be said that such machines for many of the processes in question are usually supplied with single-action rams, the chief characteristic being an unusually long stroke. Of course, where the stroke and power are sufficient, any ordinary press will do, and no very great accuracy is required. In some cases such presses are made with an abnormally long stroke,

arranged to adjust to any amount desired, after the manner of a planer-table, the ram being driven through the medium of a rack, screw, or other suitable mechanism. The horizontal-ram type of press is frequently used instead of the vertical, especially for large cartridge-drawing and tube-making.

#### DRAWING, PROPHETICALLY.

The future possibilities of the interesting process of drawing and re-drawing metals seem to me very great. Much has been done in comparatively recent times in the way of developing the various operations involved.

It is a somewhat curious fact that small thin steel tubes for bicycle-frames are now drawn in 12- or 15-foot lengths, starting with a thick flat blank but a few inches in diameter, and that this seemingly tiresome process can commercially compete with the simpler plan of drawing down a hollow ingot.

In the direction of general bigness we can, even now, manage articles as large as soda-water fountains and kitchen-boilers, drawing them cold, by the processes above described, from ordinary flat sheets. To draw large steam-boilers in the same way would be only a matter of enormous first cost for the plant. Many irregular-shaped articles are also now drawn, such as wheelbarrow-bodies, sinks, mangers, etc. These processes simply need amplifying to produce bath-tubs and boats. How large objects it will pay to attempt in this way I will not venture to predict. The commercial and mechanical sides of the question will no doubt, as usual, adjust themselves finally into a condition of stable equilibrium.

In general, it may be said that the beautiful processes in question have already proved themselves boons to mankind, especially in the way of cheapening household utensils, and putting more and better ones within reach of the masses. The future will doubtless see further and still more wonderful developments.

## CHAPTER XI.

## COINING PROCESSES.

## DROP-FORGING.

THE process of coining, as has been indicated in earlier chapters, is analogous to drop-forging; or pumping melted metal into a type-mold; or squeezing a piece of soap or clay in the palm of one's hand; or molding a pat of butter. In it we see illustrated the principle of the flow of solids, even more vividly than in the drawing process.

In Fig. 398 is shown, in vertical axial section, a pair of ordinary drop press dies, arranged for drop-forging a small

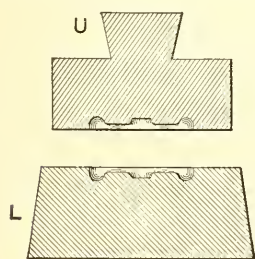

FIG. 398.

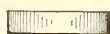

FIG. 399.



FIG. 400.

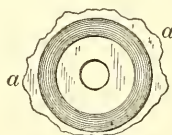

FIG. 401.

hand-wheel, as shown in axial section in Fig. 400 and in top view in Fig. 401. It is possible to do such work as this cold where copper, lead, and other soft metals are used. In practice such dies are more often employed for iron or steel, heated almost to a white heat. In Fig. 399 is shown a blank from which the wheel is made, which may be of any appropriate form. In this case it is merely a round punching, made from flat bar-iron. The process is, of course, simply one of

molding, the die *L* being rigidly secured to the bed of the press and the die *U* to the ram. The latter descends from a considerable height, and with a force far greater than is usually employed in sheet-metal work.

A distinguishing characteristic of freshly drop-forged products is the irregular little fin, surrounding the work like a halo at *a a*. This is evidently due to the surplus metal creeping out between the dies—the only path of escape open to it. It is true this fin might not occur, but it generally does. Its absence is attainable only by the blank being placed exactly in the right position, remaining there during the blow, and containing exactly the right amount of metal. These fins, as before intimated, are always present in some degree, but are trimmed off afterward in a “trimming-press,” in which are mounted dies that are, of course, nothing but ordinary cutting-dies—with the punch hollowed out, as far as practicable, to fit the upper surface of the work. Obviously, by this process such articles only can be made as will deliver freely from the dies, by reason of having considerable taper and no high vertical walls. Extremely irregular contours present no special difficulties.

The practical applications of the art in question are far too numerous to be scheduled here. By it thousands of small tools and parts of machinery, hardware, cutlery, etc., are rapidly made, with the uniformity of punched-out work, but of far better quality as regards smoothness and density. Most of them, moreover, are of rounded-up forms, so to say, which could not be made at all from flat sheet-metal with punching dies. Such forgings are usually better than the best hand-made forgings, as well as vastly cheaper and more uniform. They are often cheaper than castings of like form, and for most purposes a great deal better.



## COINING COINS.

The process of coining, as employed for manufacturing medals and metallic money, embodies the same general principles as drop-forging work, but is carried out very differently in detail. Furthermore, the metals used are generally worked cold, and there is much more uniformity in the general design of the product than in the drop-forging art, whose products embrace almost every conceivable kind of article adapted to the processes employed.

In Fig. 402 are shown, in vertical axial section, a pair of coining-dies, *U* and *L*, together with their "collar" *C*, such as are used in the mints of all the principal civilized nations of the earth for stamping the coins of the realm, from so-called "planchets" or "milled" blanks, as shown in axial section

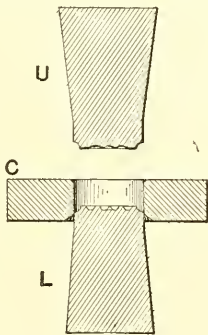

FIG. 402.

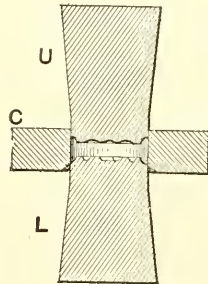

FIG. 403.

in Fig. 406. These dies are shown in open position, ready for the planchet to be fed into them by sliding it over the face of the collar and allowing it to drop into the same and over the lower die. In Fig. 403 the same dies are shown in closed position, as when giving pressure to the embryo coin. In Fig. 404 they are shown when the upper die has risen out of the way and when the lower die has risen in its collar to eject the coin; or, as is often the case with an alternative device in press motions, when the collar has descended for the same purpose, the lower die remaining stationary.

In Fig. 405 is shown, in edge view, a blank as punched by ordinary round-cutting dies from a strip of metal of the proper thickness; and in Fig. 408 an enlarged partial section of the same appears. At *ab* are shown, exaggerated, the characteristic rounding on one side and burring on the other incident to all punching operations. These, however, do not signify, as the "milling" machine kindly takes care of them.

In Fig. 406 is shown in section, as before mentioned; and in Fig. 410 in partial section a planchet which has been made from a blank by the "milling process," so called. This consists of rolling the edges in a special machine, the radial com-

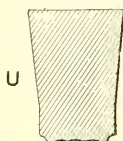

FIG. 407.

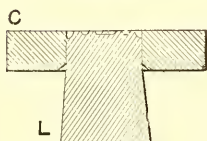

FIG. 404.



FIG. 406.

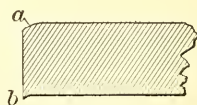

FIG. 408.

pression thus obtained upsetting or thickening them into the form shown, while at the same time the corners are rolled down to a rounded shape, preferably more like *c* than *d*. In Fig. 407 is shown the face of a finished medal which has received upon both sides at once reversed impressions from the respective upper and lower dies employed.

In some cases a coin or medal is "reeded," or fluted upon the edges, as is the case with our American silver and gold coins, the so-called reeding consisting of a number of fine teeth, or cogs, running parallel with the axis of the coin. These are formed by fluting the internal surface of the collar *C*, which is usually made very slightly conical, to facilitate easy deliverance.

It is evident that in this kind of work, as well as in drop-forging, there is a tendency to produce unwelcome fins, should there be a surplus of metal to the slightest degree. These fins of course tend to form as at *e* and *f*, Fig. 409, in the only place available for the metal to escape, which is in the joints between the dies and collar. Manifestly they must be avoided, and great care is therefore taken, for mechanical as well as financial reasons, that the weight, and consequently the approximate mass, of metal in all the planchets shall be uniform, at least to within a very small limit of error. Even with this accuracy of bulk there would sometimes be minute fins, especially as the dies cannot be depended upon to always come exactly the right distance apart, were an attempt made to produce perfectly sharp corners at *c* and *d*. For this rea-

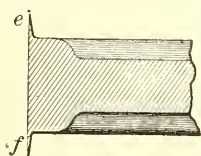

FIG. 409.

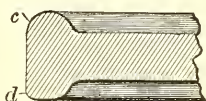

FIG. 410.

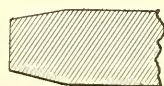

FIG. 411.

son, as well as for convenience and beauty in the coin, these corners are rounded, an attempt being made to leave them of nearly as great a radius of curvature as was given to them by the milling process. This, of course, can only be done by not pressing the planchet hard enough in the middle to make the edge flow out violently and force itself into the interstices of the mold, as in Fig. 409. Fortunately, with the metals ordinarily used, this can be done successfully, and yet a sufficiently deep, sharp, cameo impression obtained upon each face of the coin. The changing conditions above referred to, however—viz., some slight difference in bulk, a non-uniform descent of the upper die owing to springiness in the machinery, and certain trifling variations in the density of the metal—cause a different amount of edgeward flow. Conse-

quently upon some coins, and upon one face more than the other of some certain coin, and perhaps at certain places around the edge of a given coin-face, the metal will flow outwardly scarcely at all, thus leaving a considerably rounded corner at *c*. At other times and places the circumstances mentioned will cause a greater flow edgeward, with the result of a much sharper corner, as shown at *d*. The constant effort of the coiner, however, is to prevent *d* from ever becoming entirely sharp. A casual examination of any new coin will show, without a magnifying-glass, these inaccuracies as to the relative sharpness of corners, even in different places upon the same coin.

Within a short time past, and since the production of aluminum has been so wonderfully cheapened, it has become fashionable to coin this metal into medals of all imaginable designs, and all degrees of beauty and ugliness. Some of the makers of these have attempted an excessively deep cameo effect. The metal, however, has proved itself too prone to flow wheresoever it listeth, with the practical result of a finned edge like Fig. 409, the metal near the periphery not proving itself to be a sufficiently strong hoop to hold in against the radial flow outward started by the central expanding forces. The makers, who attempted but a small production, dressed the obnoxious fins off in a lathe, which, of course, was a slow and wasteful process. In one case these difficulties were brought to the attention of the writer, who suggested the use of a planchet made thinner around its edge instead of thicker, and also considerably tapered off, as in Fig. 411. Such a shape is easily made in a pair of special dies after cutting the blank; or in the sheet, before cutting the same, by compressing dies set in a gang with the cutting die, on the "successive" plan, so as to produce the blanks at one operation.

This form of planchet proved successful, as the surplus flow from the center was, by the time the impressions were

made, none too great to properly fill the edges of the mold—by which term is meant the group formed by the dies and collar, closed as in Fig. 403. In general, as the flow can be outward easier than inward, there should always be thickness enough in the middle to suit the particular coin being made.

### RIVETING.

Riveting is really a coining process, inasmuch as the metal is caused to flow from the old shape of the rivet-body (usually cylindrical) to a new and different shape of larger diameter, forming the head, which is approximately conical or hemispherical. The body also is oftentimes upset, that it may closely fill the hole, and thus a coining-flow is set up throughout the structure. Sometimes the metal is hot and sometimes cold. In any case the details of riveting are too well known to need further description herein. It should be mentioned, however, that there is in modern practice a tendency to more and more substitute a single press-stroke for the numerous hammer-blows formerly so much used, especially in hot work, as boiler-riveting, etc.

### COMPRESSING PLASTIC SUBSTANCES.

In Fig. 412 is shown a pair of dies and a collar, such as is used for making the ordinary medicinal tablets, or disk-shaped pills, shown in Fig. 413. These work precisely upon the same

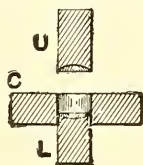

FIG. 412.



FIG. 413.

principle as do the dies in a coining-press, and are sometimes made of other shapes than round, such as square, triangular, etc. The material in this case is usually a dry powder which

adheres by compression. Any fins that may occur are so fragile as to rub off in handling, and are not noticed.

Soap-presses also work upon precisely the same principles above described, and all the cake-soap in common use is simply the product of coining the crude pieces of irregular shape, which are usually placed in the lower die by hand.

The same process is sometimes used for compressing cakes of salt and other materials, usually in the form of rectangular bricks. The ordinary brick press of commerce is another illustration of a coining apparatus, the dies or molds being usually set in gangs of several together in a row. That form of brick press which uses dry powdered clay is almost as elaborately built as is a smaller coining press, but is, of course, relatively immense in its proportions and strength, as very great pressure is required to properly compact the clay.

#### TUBE-SQUIRTING.

An interesting modification of coining proper is seen in the process of making from soft metal (cold) the thin-walled, thick-ended, collapsible tubes used for painters' colors, toilet-pastes, and a variety of other purposes. Not only do these tubes find their active vocation in squirting forth these semi-liquid substances, when pressed to do so, but they are themselves squirted into existence, so to speak.

This process consists in squeezing a thick flat disk of metal so tightly in a deep female die that its particles flow outward and upward around the punch. This is made enough smaller than the die to allow room for the desired thickness of wall. The result obtained is evidently an amplification of the *fin* shown at *c*, Fig. 409. Any desired shape of neck can obviously be formed at the same time, and a proper hole can be perforated therein. Such tubes are usually made, a considerable number at a time, in gang-dies, set in a hydraulic press.

Somewhat akin to the process just described is the squirt-

ing of continuous lead and tin pipes through a die and around a mandrel, from an annular mass of metal to which enormous pressure is applied.

#### SPEED AND PRESSURE.

The speed employed in the operations we have been considering should not be too fast to obtain the fine impressions usually required. It is probable that the ordinary speed of a drop press ram might in some cases give the metal scarcely time enough to flow, but there is no difficulty in practically running such machines at a speed of from 100 to 200 strokes per minute, 120 being the usual standard for small coins in the United States mints, and 100 for the larger ones. Such limit as exists seems to be a matter of press-jerking rather than slow-flowing. In a machine designed by the writer (see Fig. 138, page 68) the customary 6'' feeder-stroke and 1½'' ram-stroke were replaced with strokes of ¾'' and ⅙'', respectively. The result was a speed of 200, with scarcely perceptible jar or noise.

Regarding the pressure required for ordinary coining but few data are available. The force applied to any given coin, however, of course considerably exceeds the ultimate compressive strength of that particular piece of metal, otherwise it would not flow. The approximate pressures supposed to be used in the U. S. mints are as follows: For dimes, 30 tons; quarter-dollars, 60 tons; half-dollars, 100 tons; dollars, 160 tons—all of 2000 pounds each.

#### PRESSES USED.

The presses used for medals, of which but small quantities are usually required, are generally hand-fed, and are either of the screw- or toggle-driven type. Drop presses sometimes come into play, but are more difficult than others to keep in

a condition conducive to the accurate working and maintenance of dies—to say nothing of their too fast speed.

For regular coinage in government mints, and in some cases in the factories of medal- and badge-makers, automatic presses are used in which the planchets are simply piled by hand into a long vertical tube, the machine doing the rest upon its own responsibility.

In general, coining machines must be of much stiffer design than the average run of presses, and of comparatively enormous power. They are usually made with two straight columns, placed as near together as possible, and with very deep cross-members—all with a view of preventing “springiness” to the greatest possible degree.



## CHAPTER XII.

**PRESS-FEEDING.**

## DEFINITIONS.

THE terms "feed" or "feeder" or "feeding-attachment" refer, in this connection, to the various devices that are sometimes mounted upon presses, the object of which is to move into place between the dies the material to be worked thereby. The word "feed" is also used to designate the motion of the material, as well as the device by which such motion is produced. "Feeding" applies to the operation of supplying "work" to the press and dies, whether in the form of the original sheets or bars of commercial materials, as a primary operation, or of partially made articles as secondary and tertiary operations, etc. This feeding may be manual or mechanical. In the latter case it is usually automatic.

## HAND-FEEDING.

The primitive, and by far the most usual, method of feeding a sheet or bar of metal to a press is by hand, the operator's muscles sometimes being guided and assisted by certain fixed gauges, as heretofore mentioned, although it is often the case that he depends upon his eye or hand alone. In some cases, particularly in heavy punching work, the holes to be punched are marked upon the sheet or bar with white paint, usually through a stencil. In other cases the centers of such holes are marked with a center-punch. In the latter case the punch terminates in a small conical point, projecting

in the line of its axis, which enters the impression previously formed by the center-punch. Such feeding is adopted only for slow-going work, where there is time to properly adjust it. It requires, moreover, constantly vigilant attention on the part of the operator, and does not always produce very accurate results, especially when the press ram runs continuously, as is often the case. The feeding of tin-plate to cutting or combination dies is usually performed by hand. This is naturally the case, as the sheets are of small size, and not well adapted for automatic devices, because they would have to be replaced too often. It is earnestly to be hoped that our modern inventors will soon supersede the antiquated methods used in producing this useful metal by some process that will give it to us in long strips from a reel. We can then double or treble the speed of our press-work upon it.

In connection with hand-feeding the melancholy fact must be looked in the face that many of the best press-operators in this and other lands may be found with mutilated hands, or, as past-masters of the art, with no hands at all. There seems to be a peculiar fatality in this respect, which perhaps is not so strange after all, when we consider the enormous number of operations performed by these faithful men and women and boys and girls, in some cases amounting to 10,000, 20,000, and (with certain work) even over 100,000 per day of ten hours. The worst danger is not usually, as might be supposed, with "continuous feeding," but occurs in cases where a power press is stopped each time by an automatic clutch, and started by the operator with the usual foot-treadle. The dies and the gauging therein are often so arranged that his hand must pass between the upper and lower die each time, to locate and remove the work. He is apt to get into the habit of moving his foot and his hands rhythmically with each other, which is all right so long as his attention is not attracted by pretty girls passing the window,

a pack of fire-crackers exploding in the street, or, worse, by an accidental failure of the press ram to stop as usual at the top of its stroke.

It is too often the case that when some of these things happen a die descends before the fingers are out of the way, and that one or more of them is crushed or cut off. It has so far seemed to be impossible either to make presses that will not get out of adjustment (usually either through the failure of proper attention or from lack of lubrication), or to prevent operators from becoming careless. The only real remedy is to so design dies, with automatic and other safeguards, that it is impossible for any part of an operator's person to enter between them. It is, for instance, perfectly practicable to make a stripper so deep as to inclose a cutting punch entirely at all points of its stroke, to extend so low that no fingers can enter beneath it, and to be so thin at its bottom edge as not to be in the way of feeding. With forming dies, etc., there is somewhat more difficulty, but nothing which cannot be overcome with sufficient ingenuity.

Such providing of safeguards has been carried out in the form of a thoroughly practical system in certain factories known to the writer, but there seems to be a lamentable lack of interest in the matter by employers generally, as well as by the employés, who suffer the most. The fact is that a perfect system of such safeguards is difficult to install, and is apt to be quite expensive. The experience of press- and die-makers is that their customers are not willing to pay for more than enough tools to actually do the work, the extra appliances required for safety not being absolutely necessary. In many cases such devices are difficult to design, as any particular die may perhaps require a new system contrived especially for it. For gradual improvements in this important field it is to be feared we can only look to the future, in the same way as we must for the expensive safeguards needed to

protect our much smashed-up railway employés. Public sentiment, and its consequential legislation, doubtless will, after a while, do these things so necessary to an era of decent civilization.

### ROLLER-FEEDING.

Automatic roller- (or roll-) feeding is mostly applicable to very long sheets or bars, especially to those which are thin enough to be wound upon a reel. In this case an operator can attend to a number of presses at once, only replacing the rolls of material as they are exhausted. For such work a pair of "feed-rolls," operating after the same manner as a clothes-wringer, is usually employed, or sometimes two pairs, working "in time" with each other, one on each side of the dies. This double arrangement is in order that no unfed places shall occur at the ends of the sheet. The feed-rolls mentioned have, of course, an intermittent motion, pushing or pulling the material forward while the dies are out of contact, and stopping while the work is being done upon it.

In Fig. 414 is shown a single roller-feed mounted in a wide press in which is also mounted a long gang of dies. In this way the so-called perforated metal, or paper, is produced,

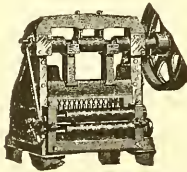

FIG. 414.

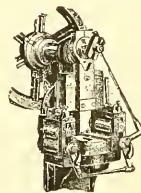

FIG. 415.

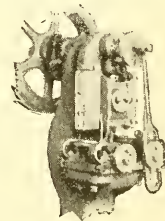

FIG. 416.

although double-feeds are more frequently used for this purpose. The presses, in this and some following views, are shown partially broken away—particularly at the fly-wheel and at the legs or pedestal.

In Figs. 415 and 416 are shown double roller-feeds, where the strip of work is both pushed toward the dies and pulled away from them on the other side. It will be noticed that in the first two feeds mentioned the pitmans connecting the adjustable crank upon the press shaft with the rolls, and the rolls with each other, respectively, are pivoted to levers upon the roll shafts. In the last-named picture the pitmans carry racks which drive by meshing into spur gears. The intermittent motion is obviously obtained by pawls and ratchets.

### REEL-FEEDING.

Another popular device giving an intermittent linear motion is known as a "reel-feed." This is often used for thin metals, with single punching, or where a number of pieces are to be cut from the sheet at once, providing the scrap remains strong enough to hold itself together after being perforated. This scrap is wound upon a reel at one side of the machine as the uncut metal is unwound from another reel upon the other side. The spacing of the feed is in this case performed by a finger-gauge, which automatically enters one or more of the cut perforations, making them do their own gauging, and then rises out of the way whilst the feeding occurs. It of course enters again before the arrival of the latest edge of the hole which is to abut against it. The pulling reel attempts an excess of motion, the pull yielding when the fixed distance has been moved through, by means of a friction-slip arrangement. The supplying reel is, of course, controlled by a brake against too rapidly delivering.

In Fig. 417 is shown a reel-feed, mounted upon a double-action crank press—together with strip of brass which is being fed. In this case the feeding is from back to front, but it is often arranged in a right-and-left direction. It is also just as likely to be equipped upon a single-action press

## GRIP-FEEDING.

Another form of linear feeding is what may be called the step-by-step, where the sheet of material is intermittently fed by being successively gripped, pushed forward, clamped to hold in place, let go of by the gripper and, later, unclamped, the grippers meanwhile being returned to their original position ready to repeat the operation *ad libitum*. Such a feed is often used for sheets of cardboard in cutting playing-cards, either singly or in gangs. It is especially useful for this purpose where great accuracy is required and where no finger-

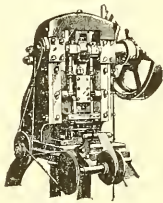

FIG. 417.

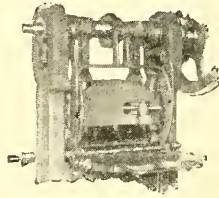

FIG. 418.

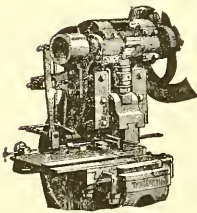

FIG. 419.

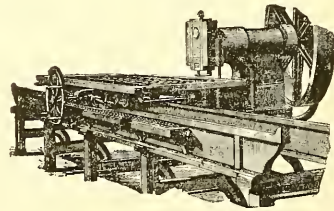

FIG. 420.

gauge arrangement can be used against the edge of the paper itself, on account of its inherent weakness. The same remarks will sometimes apply to certain thin and fragile metallic work.

In Fig. 418 is shown a grip-feed, operated on the above-named step-by-step principle and arranged for cutting a gang of seven playing-cards at each stroke of the press upon which it is mounted, which in this case happens to be of the double-crank variety.

In Fig. 419 is shown, mounted upon a small press, a feed-

attachment of the same sort, but operating upon only one card at a time. Such machines are, of course, applicable for metal work as well as paper and other soft materials.

#### CARRIAGE-FEEDING.

In Fig. 420, attached to a punching-press, is shown another form of intermittent linear feed, such as is used for punching holes along the edge of boiler-sheets, and work of like character. This is usually done one hole at a time, but sometimes with a gang of a few punches set in a row. The distinctive feature appearing in this device is a table-like carriage to which the sheet of material is clamped, and which is moved bodily in two directions, at right angles to each other. This movement can be automatic, and obviously may be made as accurate as that of a lathe-carriage.

A positive feed of this sort is sometimes used for playing-cards, instead of the kind shown in Fig. 418. This is the best system, for such work must be cut very accurately, "registering" by the printing which is already upon the sheets. Otherwise, too much temptation might fall in the path of those gentlemen who like to read the face of a card by an irregular margin upon the back.

In general, a carriage-feed may be made much more positive and uniform than can any of the others described. *Per contra*, the roller-feeds are the least so, and for accurate spacing must be supplemented by finger-gauge or "pintle" devices. For a specimen of the latter see Fig. 266, Chapter VI.

#### DIAL-FEEDING.

Various automatic devices are in use for feeding partly made articles to dies whose functions are the performing of secondary or tertiary operations, etc. These are sometimes reciprocating, a sliding or swinging receptacle coming forward to receive the work and then carrying it back and holding it

between the dies during their operation upon it. Much oftener, however, these devices are rotary in their motion, the most common form being an intermittently revolving wheel which, with its appurtenances, is commonly known as a dial-feed. This is much used in re-drawing cartridges, as, for instance, where the "cups" made in the first operation are placed by hand into recesses in a horizontal dial-wheel revolving upon a vertical axis, the machine running continuously at a speed consistent with thus placing the articles manually. There is plenty of room at the front of this dial, which is several inches in diameter, for the operator to vary somewhat from an automaton and yet get a cup in every hole. Should one occasionally be missed, it of course does no harm. Each cup is brought in succession under the deepening punch, the dial stopping for a sufficient length of time for it to be pushed down through the die and for the punch to be returned above the upper plane of the dial, which then revolves through another stage of its progress while the punch goes still further upward and returns part of the way down.

In Figs. 421 and 422 are shown ordinary types of dial-feeds mounted respectively upon a double-action cam press and a re-drawing press. Fig. 423 shows a special combination of an intermittent dial-feed, together with a number of different kinds of dies treating the work successively and a roller-feed for introducing a different material (in this case paper) into the metallic work placed in the dial.

It may be interesting to notice the three very different methods shown for driving the dials above referred to, the last-mentioned one being simply a "drunken worm," as it may be termed, meshing into a special gear, where the worm threads are arranged in a spiral position a part of the way around, and are nothing but simple collars, lying in normal planes throughout the remainder of the periphery. The second dial mentioned is driven by a device resembling the



venerable stop-winder used on music-boxes, watches, etc. The dial first shown is operated by the well-known pawl and ratchet so often employed for intermittent motions. This latter is generally subject to the uncer-

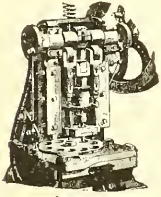

FIG. 421.

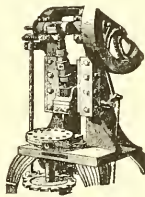

FIG. 422.

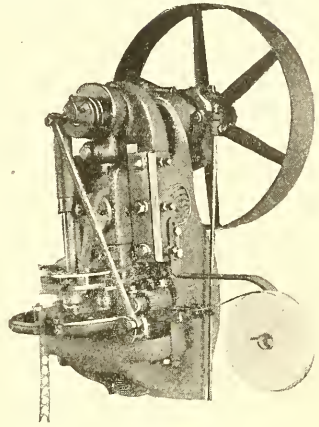

FIG. 423.

tainties incident to a dependence upon springs, friction, and inertia. Sometimes, however, a locking device is provided.

#### FRICTION-DIALS.

In certain cases such work as has been mentioned is performed by what is known as a "friction-dial," whereon a number of cups, or such like, are stood up together in an irregular group alongside of each other, at the large end or opening of a curved wedge-shaped recess, whose walls are stationary and whose bottom is the flat, continuously-moving horizontal disk or dial. The question as to which of the pieces of work shall get in first is somewhat a matter of chance, as they are simply all hustled onward miscellaneously—on something the same principle as a crowd trying to enter a gate at a football game. The one who happens to be ahead is pushed into the gate first, which gate, in the case of the machine in question, is a definite opening leading to a space above the lower die. When it is pushed downward, sufficiently operated upon, and left beneath the die, then the next one is, by the same frictional action, pushed into its place. This process is adapted only to shallow articles with flat bottoms, as tall slim ones would be apt to upset and try

to enter the dies in a wrong position. Obviously, very broad thin objects, like buttons for instance, would also be unsuitable, as they would have a tendency to slip over one another. They should therefore be approximately of the same height as width, and should be cylindrical rather than conical.

In Fig. 424 is shown a friction dial-feed which thus revolves continuously, carrying a group of pieces of work back in the massed condition described. As fast as they can get to their desired final position they are, of course, checked by

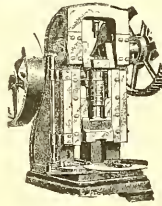

FIG. 424.

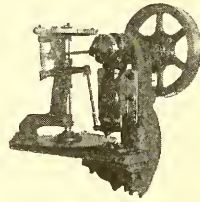

FIG. 425.

a proper stop. The punch then pushes each one through the die beneath, and this gives room for the next one to take its place.

#### INDEXING.

In Fig. 425 is shown a rotary "step-by-step," or intermittent, feed for punching notches or holes in armature-disks and similar work. As mounted upon a small press it is sometimes called an "indexer," and sometimes a "notching press." The thin disc to be punched is clamped between two circular gripping-chucks, which are governed in their motion by the ratchet-dial at the top, containing the desired number of teeth. This is driven by a pawl operated from the press shaft. In some cases the dial is placed below the work.

Sometimes the axis of an indexing-feed is placed horizontally or in an inclined position. This adapts it for cutting holes or notches, or groups of the same, in the sides of cylindrical or conical objects respectively. Lamp-burners and such like, are often perforated in this way.

## GRAVITY-FEEDING.

It is evident that with a horizontal press, long straight bars of metal might be stood up end-wise and fed into the dies by gravity—if governed by a proper finger-gauge or its equivalent. In practice this is not often done, a vertical position not being convenient for handling such bars. With an inclined press, however, this scheme might well be adopted oftener than it is.

A common application of gravity for delivering work to dies is seen in the "tube-feed," in coining presses, where a pile of blanks, guided in a tube, descend of themselves as fast as the lower one is pushed automatically from under the rest. This device appears in Figs. 135 to 138, Chapter III.

In certain cases an inclined trough, with the blanks edge to edge, is used as a gravity-feed. Indeed, small cups, or other regular objects of almost any kind may be thus fed, under favorable conditions.

Many other curious feeds might be added to the ones above mentioned, but those given will answer as sufficient samples illustrating the general principles involved.

## KNOCKOUTS.

In addition to the feeding devices proper which have been described, many of which feed the work in rather than out, there is a distinct class of ejecting press- or die-attachments known by the general name of "knockouts," or sometimes and if limited to the lower die, as "knockups." "Ejectors" would probably have been a better name, had fate so willed it—and had men more logical minds.

Some of these devices have been described in former chapters as integral parts of the dies themselves. In such cases they are usually, although not always, operated by springs, and may be situated either in the upper or lower die, or both.

In other cases, the "pads" that do the pushing out are set loosely in the dies and are operated by a special device, sometimes known as a portable knockout, which is attached to the press as temporarily a part thereof. Such attachments are often operated by springs, but in many cases are mechanically connected to some moving part of the press. In certain instances this connection is a mere attachment to the ram by rods or otherwise, so that the stem of the knockout will rise with it, either to the full extent of its stroke or with some "lost motion." In other cases the device is connected with a cam upon the main shaft, so as to move properly at a pre-determined time, independently of the ram.

In Fig. 426, at *CD*, is shown a portable spring-knockout mounted beneath a pair of dies. The stem upon which the spring *C* slides is screwed in below. This spring is supported and regulated by the nuts *D*, and pushes up the flanged sleeve against a group of loose pins projecting below the die. These run up under the ejecting pad thereof, and slide upward when the downward pressure is relieved by the ascent of the ram. In some cases the knockout stem is screwed into the bolster instead of the die, the push-pins extending down through the same. The construction of this device is almost identical with the spring-drawer shown in Fig. 364, page 202.



FIG. 426.

A device similar in principle, but more compact, is sometimes inserted in the ram, to give a downward thrust. At other times a slot running through the ram receives a stationary beam attached to some part of the press frame. In other cases this beam becomes a lever, which changes the amount of the motion, the effect with either method being to drive downward a plate acting upon pins set in the upper die.

An advantage of either of the last-named attachments is that when once applied to a press they will answer for any

number of suitable dies that may be interchangeable therein, without requiring the extra complication of a set of springs, etc., mounted in each individual die.

The knocking-out of work is occasionally performed by an air-blast—as is also the pushing down home into a die of certain small pieces which happen to be unperforated and which fit tight enough to serve as pistons.

#### PUSHOUTS.

Certain other ejecting devices, known sometimes as “push-outs,” are closely akin to the knockouts just described. These are generally used for pushing pieces of work horizontally out through an opening in the back or side of the lower die, the punch having delivered it only so far down, on account of there being an anvil-like matrix beneath to do embossing, or for some other analogous reason. The pushing member of the device is usually automatic, but is occasionally arranged to work by hand.

Sometimes an air-blast is used to thus eject work sidewise. While mentioning such blasts, it may be said that they are more frequently used to eject “scale,” or other dirt that has fallen from, or that has been scraped off, the metal. Especially is this needed in working red-hot iron in forming dies.

#### FEEDING SPEEDS.

In hand-feeding, expert operators learn to move the work synchronously with the press ram's motion, even at as high a speed in some cases as 240 times a minute, in such work as cutting small blanks from a strip of metal, etc. Usually, however, the speed is much slower, averaging perhaps 100 strokes a minute for continuous running and fewer where the press is started each time with the clutch. With foot or hand presses, as a general rule, still less speed is attained.

With automatic feeds of various kinds there is no definite limit in regard to speed. In general, it may be said that a

feeding device will run as fast as will the press in which it is mounted, the limitations in the case of both being due chiefly to the conditions of weight and inertia happening to be present. These conditions vary greatly, however, in individual cases. With gravity-feeds Dame Nature has of course exhibited her law of falling bodies and uttered her interdict, "Thus far shalt thou go and no further."

#### SPECIAL AUTOMATIC MACHINES.

In addition to the thousands, if not millions, of members composing the army of presses in active service, an army which is constantly mustering in new recruits for newly invented purposes, to an extent almost inconceivable to the past generation, there are in use a number of modifications and amplifications of the power press proper. These may, in general, be denominated automatic metal-pressing machines, and they are of almost every conceivable design and degree of complexity. Many of them are hidden in their own lairs, never coming forth in the light of public gaze. Others, again, can be seen in metal factories of all sorts—in the domains of pin-making, hook- and eye-making, button-making, etc.

Such machines usually turn out so enormous a product that they themselves are comparatively few in number. Being so few and so highly specialized, it naturally follows that they generally have not become regular articles of manufacture, but are worked out, one at a time, by a series of experiments. In many cases such a machine is but the perfected descendant of a line of ancestors, each of which has, in the course of its evolution, contributed new facts to the problem whose solution is sought—only to die in its turn and be buried in a scrap-heap, giving place to some still further perfected child or grandchild. The final outcome of such heredity is, in certain cases, so marvelous a something that it seems to outvie human brains and fingers in the perfection and rapidity of its work.

Naturally, enormous sums of money have been spent upon developing machinery of this kind, and many wise and skillful mechanics have been tempted to contract, for a fixed sum of money, to produce a perfected machine which proves, in the end, to cost perhaps ten times as much. Such money is generally well spent for somebody when the final result has been obtained, but is ill spared by the unlucky originator.

Pertinent to these facts a piece of advice may be given to all inventors of special machines, which is to allow the owners thereof to furnish all the capital, while the designer (for pay) furnishes the knowledge and experience. If the latter individual furnishes the money himself, as is too often the case, he will find in the end that he has not only furnished experience, but has received a great deal that he did not expect.

Any mechanical explanation of the machines referred to is here, of course, out of the question, as they are too infinite in variety. It may be said, in general, that many of them are modifications of power presses, having not only the normal vertical ram motion, perhaps duplicated above, below, and at the sides, but also various other rams, levers, etc., moving in other directions, as horizontally backward and forward, right and left, and diagonally. These motions are usually obtained by special cams, which move some given member to place, keeping it there as long as required and returning it home. Perhaps by this maneuver a cutting operation will be performed, leaving the cut blank in a certain position with a "dwell" for a certain time, while some other member approaches and does something else to it, in the way, probably, of perforating it, bending or forming certain parts of it, etc. Perhaps then some third member will approach and do another thing, either in the way of operating upon it further or moving it to some other position. Finally, in most cases, a humble member known as a knockout or a pushout will act as a hall-porter and usher it forth beyond

the portals of the machine. In most instances a complex automatic organism of this sort has one main shaft which governs the motions of all the other members, and which revolves once for each complete cycle of "time."

In certain special machines, as well as in some ordinary presses, the material used has to be brought to a given fixed temperature. This has been before treated of to a certain extent, but the apparatus for doing the heating, uniformly and at the proper time, must obviously be considered as pertaining to the automatic machines here under consideration. A case in point would be the interesting process (which, I think, somebody has patented) of automatically heating the metal by passing a current of electricity through it as it approaches the critical position where it must be worked. This is in principle analogous to some of the other electrical processes pertaining to welding and forging which are so rapidly being worked out. It is difficult to foresee what the development of this electrical pressing may prove to be in future, but it is evidently only one of the many heretofore unsuspected uses to which electricity may be applied.



## CHAPTER XIII.

## MISCELLANEOUS.

## MANIFOLDING WORK IN DIES.

IT has been taken for granted, in describing various press-working operations in which the use of dies is involved, that but one thickness of metal was to be worked at a time, although in describing the drawing process reference was made to working two or three pieces at once. It is obviously possible, however, to thus manifold work, as it may be termed, in various bending and forming operations, providing the same condition is admissible as in drawing conical pans inside of one another, viz., that the inner ones shall be smaller than the outer. In coining-work a duplication of pieces in the dies at one time is of course out of the question. In cutting and punching flat sheets or bars we obviously have the most favorable conditions for going through several thicknesses at once, as all the blanks thus cut would be practically of the same size. As a matter of fact, two or three thicknesses of thin metals, such as tin-plate, sheet-iron, etc., are often cut at a single stroke of the dies by being piled one upon another when fed. The writer has recently made some definite experiments as to how many layers it is possible to thus cut, and has succeeded in making as many as a dozen blanks at a time.

It is evident that under such conditions the upper blank which touches the punch must act as the punch for the next one, and that for the one below it, and so forth. Thus the metal is being cut by a tool no harder than itself, with the

result that might be expected, a certain crushing and tearing around the edges which gives a very uncouth effect. The lower blanks and the upper " margins " are not only extremely rough where cut apart, but are somewhat bent up around the edge into a little conical flange, thus making the blanks slightly cup-shaped. This bad effect of course increases with the number worked at once, getting worse and worse on the blanks as they are removed farther from the punch, and on the margins as they are farther from the top of the lower die.

In practice two or three layers of metal are probably about as many as it is worth while to attempt to cut at one time, although if smoothness and flatness are of no consequence more might be worked in some cases. It may be asked why several layers of thin metal will not punch as well as with the same total thickness aggregated into a thicker plate. It is true that in the latter case the pushing down of all the lower parts of the blank have to be done by portions of its own material above, but in the former case, of a number of separate plates, we have a laminated structure in which each layer can slide somewhat over the adjacent one, as the fibres are bent out of their normal plane.

In working paper it has been found that very many more layers can be cut at a time than in the case of metal.

#### PAPER-WORKING.

The greater portion of the ensuing remarks upon paper-cutting are extracts from an article published by me in *The American Machinist*, giving the results of certain experiments which, though not exactly germane to the subject of this book, may be of interest as showing some of the doings of an ordinary press and dies originally made for metal working.

" The object of the experiments referred to was: 1st, to ascertain the best angle of cutting edges for ordinary male and female dies, when used in cutting paper and pasteboard; 2d,

to see how many thicknesses could be successfully cut under various conditions; 3d, to note the pressure required. For this purpose a pair of round dies, cutting to a diameter of  $1\frac{1}{2}$  inches was used, a section and top view of the same being shown in Fig. 427.

“ In the first batch of experiments the punch and die were both made perfectly flat with the angles *A* and *B* each 90 degrees, the edges being sharp and the punch fitting the die with a close but easy sliding fit, say, not over one five-thousandth of an inch loose.

“ The second condition of the dies was as in Fig. 428, with the lower die still flat, and the punch beveled out so as

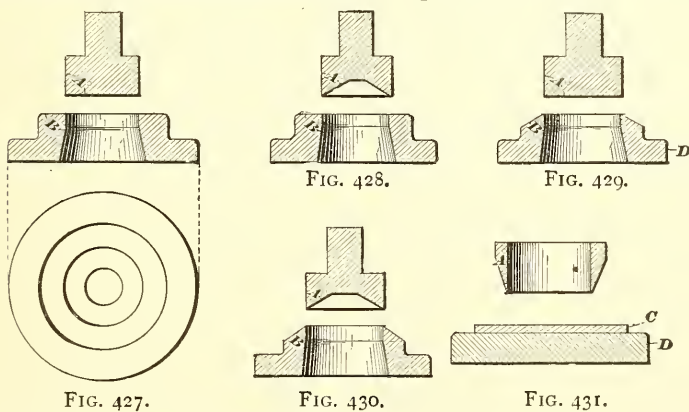

to make the angle of cutting edge at *A* 60 degrees, which angle seemed to be (after a few trials with other inclinations) the most appropriate for the purpose.

“ Under condition third, the punch was flat and the die beveled to an angle of 60 degrees, as in Fig. 429.

“ Under condition fourth, both punch and die had their edges beveled at *A* and *B*, to angles of 60 degrees, as in Fig. 430.

“ With dies in condition first, from one to five sheets of manilla paper, .012" thick, could be cut at a time when piled together, the cutting being reasonably smooth. When ten

were cut at a time some of them were rough and ragged, and with twenty at once the roughness was too great for any ordinary purposes, both with the "blanks" and "margins." With pasteboard .057" thick (one sheet at a time), the cutting was very good, and with two sheets at a time, slightly ragged. With pasteboard of a softer quality, .105" thick (one sheet at a time) the cutting was fairly good only, being slightly ragged.

"In all these cases, as might be expected, both blanks and margins remained flat.

"Under condition second, much smoother edges were produced when cutting a number of sheets at a time, on account of the sharp angle of the punch—work almost smooth being produced ten at a time, and fairly good twenty at a time, the pasteboard also showing better results than before. As might be expected, however, the paper blanks were bent upward into the concave recess of the punch, when cutting more than about five or six at a time, to an extent calculated to render them useless for ordinary purposes. This was especially the case when cutting twenty at once, a number of the uppermost blanks in the pile being very much wrinkled, and the pasteboard blanks showing a raised bead near the edge caused by the radial compression. As might also be expected in this case, the margins remained flat, without injurious wrinkles.

"Under condition third, with the punch flat, and the die having an edge whose section was an acute angle, the expected again happened, the paper blanks being flat and smooth all the way through, and the margins being permanently bent and wrinkled when cut in piles of more than five or six sheets at a time—so much so as to render them unfit for ordinary use. With twenty sheets at a time the lowermost margins were embossed out to a cup-shape where they were forced over the conical portion of the lower die to about  $\frac{3}{16}$  inch

deep, while the central ones of the pile had a depressed flange something on the counterbore order, the uppermost ones being nearly flat, but slightly wrinkled. In the case of the pasteboard something of the same effect occurred, but not to so great an extent.

“ Under condition fourth, the cutting was still smoother than in any of the other cases, with less of the ragged-edge effect, even twenty sheets at once being cut in fairly good shape. As might be supposed, however, the evils cited in the last two paragraphs, viz., cupping and wrinkling of the blanks, in the one case, and of the margins in the other, were here united as twin evils, although the distortions did not seem to be quite as great in either case as with the other dies.”

In regard to the actual and relative pressures required for paper-punching under the various conditions named, no accurate records were made, but the figures varied from 3000 to 6000 pounds per square inch of section cut. The lower pressures were attained with the sharpest angles, as in Fig. 430.

“ In Fig. 431 are shown the tools for a more usual method of cutting paper, pasteboard, cloth, leather, etc., than by the use of the male and female dies just under consideration. These work upon the chiseling principle, and consist of a hollow cutter with its angle *A* at the cutting edge about 20 degrees, and its depth from 1 inch to  $1\frac{1}{2}$  inch, together with a matrix or anvil, *C*, upon which the cutting is done—usually a sheet of copper, soft-brass, lead or pasteboard, the latter being probably the most frequently used. This rests upon an iron plate, *D*, set upon the bed of the press. In some cases, however, a wooden anvil, preferably with the end grain toward the cutters, is used in place of the plate *C*. The cutter is usually placed by hand upon the pile of paper sheets, which are slid under the ram-driven platen of the press. This of course descends upon the top of the cutter, and pushes it down exactly in contact with *C*. The blanks are generally removed

by hand, although in some cases the cutter is reversed, and so mounted upon a lower die-plate (something after the fashion of Fig. 429) that the blanks may fall through of themselves as they are pushed down by the following blanks in succeeding operations. In still other cases they are pushed upward by an automatic knockup, worked by springs or otherwise. In either of these last-named cases a spring-stripper is sometimes furnished for pushing the pile of margins off from the outside of the cutter, instead of removing them by hand."

In some recent experiments I found that a cutter of this kind would cut smoothly some 300 thicknesses of ordinary printing-paper at a time, the whole pile being about 1 inch thick. The pressure per square inch of section cut was, roughly speaking, some 2000 to 3000 pounds, the larger diameters naturally taking the least force per inch, on account of less stretching of the margins, proportionately, being required.

The purposes for which paper is cut into definite shapes are of course very numerous. Among them are playing- and photograph-cards, labels, valentines, and so-called paper dolls of every imaginable complexion and every degree of beauty and ugliness.

The forming and drawing processes are also practiced upon paper and other soft substances—usually when in a dampened condition, with the dies kept hot upon a bolster having a steam-coil inside. Similarly, an operation analogous to coining is performed upon thick pasteboard and sometimes on leather.

In nearly all these cases the presses are the same as those used for metal-working.

#### HAMMER-BLOWS.

In comparing the efficacy and general desirability of a quick hammer-like blow, as given by a drop press, with the

slower pressure given by a crank-driven ram or the ram of a hydraulic press, there are various circumstances to be taken into account. In general, where hard work is to be done through a very short distance, as in smashing out wrinkles or embossing a shallow design in sheet-metal, etc., a given pressure can be obtained for less money with a drop press than with its more expensive rivals. This is because of its simplicity as an agent for storing power, there being, as with other members of the hammer family, no kinetic mechanism through which heavy pressures must be conveyed from a power-storing fly-wheel. The lifting of a weight by any rough device that is strong enough for its work, with no particular accuracy of motion, and the subsequent letting go of it, so that gravity may do the rest, gives us an ideal simplicity, the only accurate mechanism necessary being a pair of columns to guide the hammer-like ram so that it will fall in its proper place.

The varying circumstances above referred to are too numerous to be scheduled here. Among them are the temperature of the metal, its thickness, its capacity for quick flow among its particles, etc. One important point in favor of a slow, positive, action is that the metal is affected uniformly, or nearly so, all the way through, while with a quick hammer-blow it is, on account of the inertia of its own particles, affected mostly upon the outside. This causes variations of density, and in heavy forgings an openness of internal structure not conducive to the greatest strength. Witness the "piping," or central cavities, sometimes occurring in large shafts which do not get pressure enough to squeeze them together.

In the case of small articles of hot metal the chilling of the surfaces by the action of dies which are massive in proportion to the work is a serious objection to the use of a slow-moving ram. It is, however, more important to attain a quick opening of the dies than a quick closing together, as a com-

paratively slow closing has the advantage above mentioned of allowing the metal to flow properly, while every moment that they remain closed upon the work gives a clear loss of heat. This is especially the case where a number of successive blows are to be given, and for such action the drop press is not a suitable machine, as the lifter does not act immediately, or with great initial rapidity. For such work a trip-hammer has been found a very useful tool, although the accuracy of its motion is not all that can be desired.

A heavy, geared, toggle press might seem to be a good machine for the hot squeezing of small articles weighing but a few ounces. This is not the case, however, as the terminal closing and initial opening are so slow with a toggle-motion that the work is as cold as the dies before it is fully squeezed. A non-geared, rather fast-moving machine is evidently desirable, and it is quite possible to construct a big, special, press whose kinetic arrangement shall give the ram a moderately quick closure and a more rapid opening,—at the same time retaining some of the advantages of a toggle-motion in the way of avoiding friction under heavy pressure. The general characteristics of such a machine were well described by a friend of mine with the analogies, “As strong as an elephant, and as quick as a cat.”

#### EFFECTIVE PRESSURE IN DROP PRESSES.

A mysterious efficiency is sometimes claimed for a drop press blow, as having some wonderful inherent property not attainable by an ordinary ram pressure. There is, however, nothing in such a blow but what can be resolved into the simple elements of force measured in pounds and motion measured in feet or inches. In estimating the actual pressure attained it is not even necessary to go into the mathematics of the laws of gravitation, as a simple calculation which will resolve



the action of the hammer into foot-pounds is all that is required.

If, for instance, a one-hundred-pound ram is lifted ten feet there must necessarily be (disregarding for the time being the friction of the guiding columns as of little account) 1000 foot-pounds of stored energy, which is bound to be given out during the time that the ram is being stopped by its action upon the work. If this action takes place during the last one foot of its fall, then the average pressure through that foot will be 1000 lbs., dying away to nothing as it reaches the bottom of its stroke. If the distance through which work is done is one inch, then the average pressure will be 12,000 lbs. If, as is more likely in sheet-metal work, the actual pressure is required through, say, one tenth inch, then the average pressure will be 120,000 lbs. In other words, the total foot-pounds divided by the distance in feet through which the ram is doing effective work will give the average number of pounds pressure exerted upon the same. In practice some 10 per cent may be deducted from these figures for friction and motion wasted in heat, etc.,—the amount varying with circumstances.

This, however, is assuming that the anvil or bed of the press is of ample weight, so that much of the force of the blow will not be wasted in moving it and its supports. The latter should not be of springy timber-work, as of old, but of solid masonry, extending down to bed-rock where feasible.

As compared with a drop press a slow-running mechanical or hydraulic press is better for cold metals, which usually will flow better to a new form if treated slowly than when called upon for a violent and sudden disarrangement of their particles. The same thing may be said in regard to hot metals of such large bulk that there is little danger of the chilling of the surfaces by contact with the dies. The truth of this statement may be verified by citing the fact that within a few years past

many of the great steel-works in this country and Europe are substituting hydraulic presses of enormous power (10,000 tons pressure being considered nothing remarkable) for the big steam-hammers formerly used. The action thus obtained upon great ingots of white-hot steel used for forging cannon, steamer-shafts, and such work, is found to be both quicker and better.

### TESTING PRESSURES.

The pressure required for doing any sort of die work, from cutting to coining, is often a desirable thing to know, but is generally with press-users a sadly unknown quantity. The most accurate method of obtaining this knowledge is to use a regular testing-machine, arranged for compression, preferably equipped for giving an automatic record of the pressures at each instant of the closing of the dies, which are temporarily mounted therein. Such tests are usually not available in a press-working shop, but a rough test used in my own practice for ascertaining what a press ram would do has been to place between two flat, hardened, plates, one mounted upon the bed and the other upon the ram, certain pieces of bar-iron, of the same size and quality as certain other ones which had been previously tested for compression in a regular laboratory. The value of this of course depends upon the uniformity of the metal, but for approximate work it has been found sufficient to use  $\frac{1}{2}$ " square American iron—annealed and cut up in short pieces, 1", 2", 3", 4", and 5" long, etc.

These pieces, when laid on their sides and smashed to about  $\frac{7}{16}$ " thick, so as to widen to  $\frac{9}{16}$ " wide, represent somewhere near one ton (of 2000 pounds) pressure for each  $\frac{1}{20}$ " in length. 1" would therefore represent 20 tons; 2", 40 tons; 4", 80 tons, etc. For lighter pressures, smaller sections of iron could be used and the system could be carried out with various other modifications. Doubtless copper would be more uniform and

give better results than iron, but might not be as cheap and convenient to get hold of. At a future time I hope to make public more accurate records in regard to the behavior of different qualities of iron, and to give a more definite rule for reading results.

I also hope to further develop a certain device to which I have given considerable study, but have not yet perfected. This is a portable, recording, compression-testing machine, in the form of a bolster which can be placed upon the bed of any ordinary press. To its upper surface will be secured any die in which work is to be tested. By allowing sufficient resistance between the dies the capacity of the press can of course be tested also. The difficulties to be overcome are chiefly due to the small available space at command and to the great range of pressures requiring to be weighed with the same instrument.

#### ELECTRIC DRIVING.

Until recently power presses have been driven with belts from countershafts or from line-shafting, but it is now becoming the fashion, to some small extent, to equip each press with an individual electric motor. It is to be hoped that this fashion will increase and multiply, as the advantages of such driving are too numerous to be mentioned in detail here. Obviously, the convenience of standing a machine anywhere, in any position, and connecting to it by a pair of wires dropping from the ceiling, or, preferably, coming up through the floor, are manifest, especially as the speed can be accurately controlled, and the power is used only at the exact time, and to the exact amount needed, without waste from shaft-friction, belt-resistance, etc. Furthermore, the advantages of clear overhead shop-room, with its incidental increase of light, cleanliness, and safety, are almost beyond computation, when compared with the methods of our grandfathers and our

fathers—and of ourselves, in those ancient times some four or five years ago, before we knew about these things.

The above remarks do not refer to an electric or magnetic press proper, as mentioned in an earlier chapter. Such direct driving of a press ram by electro-magnets has not as yet been developed very far, except in the analogous case of rock-drills, and perhaps occasionally an electric hammer.

#### POWER REQUIRED FOR PRESSES.

The horse-power required to drive a press is usually quite small in comparison with that absorbed by many other machines of about the same general size. This is because the speeds are comparatively slow, and the down-strokes, which do the hard work, are intermittent. Again, we have in literature few, if any, definite data based upon dynamometrical tests of actual work.

An approximate estimate of the power that a mediumly tight driving-belt of a power press can supply may be made by the old rule of multiplying the diameter of the driven pulley (which oftentimes is the fly-wheel also) by belt-width, both in inches, and by revolutions per minute, dividing the product by 3000, the quotient from which will be the horse-power. Such result may be discounted quite freely by guess—say from 25 to 75 per cent. This is to allow for the half-cyon moments of waste time, so to speak, between the down strokes of the ram, when the belt is doing almost nothing, except, indeed, at certain times to restore the depreciated speed of the heavy fly-wheel that is (or ought to be) present in every such machine in order that a part of the power may be freely stored therein for each critical time of need. The discount referred to will be greater in instances where the main shaft is stopped after each stroke by its clutch, because in such case the ram will be actually at work during a less proportion

of its total time than with a continuously running shaft. The observer must judge in each particular case as to how much of the time actual work is being done in overcoming friction or otherwise. Of course much better than all this would be the use of a good recording dynamometer (could a suitable one be obtained), from whose records the power used could be averaged.

An excellent substitute for the above-mentioned instrument, in cases of electric driving, is the presence of an ampère-meter or watt-meter in the circuit. The voltage being known, a little mental translation will enable the observer to read the greatly varying horse-power at each individual instant.

#### FUTURE DEVELOPMENT.

The wonderful evolution of some of the various processes involved in the art which is the subject of this treatise has before been referred to. It is a well-known fact that our commercial metals are all the time being developed into a more suitable quality and form for being acted upon by dies, and that hundreds of inventors are busily at work contriving new devices for the household, the ship, the farm, the road, and every other department of human activity. Moreover, the tendency is constantly to cheapen and unify various parts of these devices, striking them out in dies from malleable material rather than producing them by the older processes of hand-forging and casting. It is impossible to predict how far this line of evolution may go in the future, but at present the prospects seem to point toward a more and more thorough and frequent use of the processes in question as the years go on.

Unquestionably very many articles of common and necessary use, which serve to add to the pleasure, convenience, and consequent happiness of mankind, and womankind, too, have been increased in number and improved in quality by the

facility with which they can be produced in presses and dies. Truly, if the man is to be commended who can "make two blades of grass grow where grew one before," how much can be said of those men whose toiling brains and hands are providing the means by which not two only, but two thousand, useful and beautiful things can be furnished to the waiting multitude for a price at which but one could be obtained by their fathers and their grandfathers! Shall not the Recording Angel say of each of these busy workers, like Abou Ben Adhem, he "loves his fellow-men"?

# INDEX.

## A

	PAGE
Accuracy in dies.....	86
Aluminum.....	95
for cooking utensils.....	192
coins and medals.....	228
American gauges.....	99, 103
Railway Mast. Mech. Asso.....	112
Soc. of Mechanical Engineers.....	112
Anatomy of presses.....	20
Annealing metals.....	120
for drawing.....	192
Anvil principle.....	38
and hammer.....	16
Armature disks.....	139
Artistic design in presses.....	36
metal-working.....	13
Art of metal-work, origin and history.....	II, 14
Assembling work in dies.....	162
by curling.....	172, 173, 174
Attaching dies.....	77
Automatic machines.....	246

## B

Bar metals.....	65
Belts, horse-power of.....	260
Bending processes.....	154
in dies.....	154
Bevel of cutting-edges.....	145
Blank dimensions.....	204
formulæ.....	206, 207
Blank-holders.....	196
vee.....	219
multiple.....	219
Blanks, a museum of.....	136, 137

	PAGE
Blanks and margins.....	131
Blank sizes, mensurative finding.....	206
gravitative finding.....	205
tentative finding.....	205
Blows, hammer.....	254
Body-wrinkles.....	194
systematized.....	195
Bolsters for presses.....	76
Brass.....	95
Brick presses.....	230
Britannia.....	95
Broaching.....	218
Brown & Sharpe gauge.....	110
Bubble-blowing.....	166
Burs in shearing and punching.....	126
Buying metals.....	97
presses.....	35

## C

Cartridge re-drawing.....	240
Carlyle, Thomas.....	98
Carriage-feeding.....	239
Casting punches in place.....	164
under pressure.....	12
Chart of gauges, Wheeler's.....	100
Cheapening utensils by drawing processes.....	222
Chiseling.....	123
cutters for paper, angle of.....	253
dies.....	124
Chucks, for dies.....	81
Clamping pads in shearing.....	146
dies.....	78, 85
Classification of presses.....	20
Clearance in cutting dies.....	143
Clutches.....	39
Coining coins.....	225
presses.....	67, 68
flow in.....	227
presses.....	231
press, quick-running.....	231
pressures.....	231
processes.....	223
speeds.....	231
Coins of aluminum.....	228
reeding of.....	226



	PAGE
Coins, ejecting.....	225
fins upon.....	227
milling of.....	226
Cold flow of solids.....	188
Columnar presses.....	24
Combination cutting.....	138
Commercial metals.....	95, 96, 97
Composite press frames.....	24
Compressing plastic substances.....	229
Conical drawing.....	190
Copper.....	95
Corks rising through pitch.....	189
Cranks and cams.....	64
Curling and seaming processes.....	167
assembling by.....	172, 173, 174
by rolling.....	210
dies.....	168
in horning presses.....	60, 61
inwardly.....	171
irregular.....	173
or wiring presses.....	182
outwardly.....	167
pressures.....	182
principles of.....	175
processes.....	167
speeds.....	182
straight work.....	179
tapered work.....	169, 170
<b>Cutting</b> die qualifications.....	142
dies.....	130
-drawing-embossing.....	199
edge bevels.....	145
-forming-embossing.....	159, 160
presses.....	50, 56
pressures.....	148
processes.....	123
speeds.....	147
with gang-dies.....	138

## D

Dangers of press-feeding.....	234
Decimal-gauge notch sizes proposed.....	177
Deepening process.....	214
Deep punching.....	133

	PAGE
Depth of drawing.....	192
Design in machinery, artistic principles.....	192
Diagrams of press motions.....	29, 30, 31
Dial and roller feed combined.....	240
Dial-feeding.....	239
Die chucks.....	81
clamps.....	78, 48
gauges.....	177
hardness.....	143
interchangeability.....	76
knockouts.....	161
lubrication.....	92
nomenclature.....	93
pressures in cutting.....	148
sexes.....	93
sharpenings.....	142
specimens, pictures of.....	87, 88, 89, 90
speeds in cutting.....	147
work manifolding.....	249
Dies, accuracy and durability.....	86
attaching to pieces.....	77
classified by functions.....	75
comparative cost of.....	87
composite construction of.....	88
cutting-forming-embossing.....	159, 160
definitions and evolutions.....	73
for cutting and punching.....	131
for cutting successively.....	131, 149
for curling or wiring.....	168
for double curling.....	171
for shearing... ..	124, 125
for assembling work.....	162
for bending... ..	154
for chiseling.....	124
for embossing.....	158
* testing fit of.....	159
for forming.....	155, 156
functions.....	93
height of.....	91
Dip or shear.....	126, 127
Double-action presses.....	62, 63, 65
-crank presses.....	52, 53
curling dies.....	171
Drawing, annealing for.....	172
conditions of dies for.....	198
conical.....	190

	PAGE
Drawing, defined.....	185
depth of.....	192
historically.....	184
mammoth work.....	222
mechanics of.....	186
presses.....	62, 63, 65, 212
pressures.....	210
process analogies.....	189
processes.....	184
prophetically.....	222
speed.....	210
of.....	190, 217
springing of tools in.....	210
spring.....	203
with cutting and embossing... ..	199
Drawn-work, lubrication of.....	199
manifolded.....	197
proportions.....	196
specimens of.....	201
temperature of.....	199
Drifting or re-punching.....	136
tools.....	136
Driving by electricity.....	259
Drop forging.....	223
fins on.....	224
trimming of.....	224
presses.....	26, 47, 48
press pressure, effective.....	225
Drop-presses, stored energy.....	257
Duplication in die-work.....	73
by press-work.....	13
Durability in dies.....	86

## E

Ejecting coins.....	225
Ejectors.....	243
Electric driving.....	259
Embossing in dies.....	157
presses.....	54, 55
with cutting and drawing.....	199
speeds.....	161
pressures.....	161
Energy, stored.....	257
English presses.....	43

	PAGE
European gauges.....	102, 105
Evans, Mr.....	67

## F

Feeding attachments.....	233
by grip devices .....	238
by gravity.....	243
by hand.....	234
by rollers.....	236
by reels.....	237
by revolving dials.....	239
by sliding carriages.....	239
presses .....	233
speeds .....	234, 245
Feeders.....	233
Feeds.....	233
indexing.....	242
Fins in coining.....	227
on drop forgings.....	224
Fiddle principle.....	38
Flanges, internal.....	157
Flange wrinkles.....	195
Flatness of work after punching.....	132
Flow of glaciers.....	188
of solids, elastic.....	188
of solids.....	13, 161
of metals.....	188
in coining.....	227
of solids, not elastic.....	188
Fluid punches.....	165
Foolishness in wire-gauges.....	100
Foot-presses.....	46, 57
Foreign presses.....	43
Forging processes.....	12
by slow pressure.....	257
forming in dies.....	155, 166
pressures.....	161
speeds.....	161
Frame design of presses .....	22
Franklin Institute.....	188
Friction-dials.....	241
Fruit-can tops.....	142
Functions of presses.....	34
of dies.....	75
Future development of press-work.....	261

## G

	PAGE
Gang cutting or punching.....	138
Gas-hammers.....	71
Gauge, a proposed new.....	112, 113
decimal.....	112, 113
nomenclature.....	104
numbers, qualifications of.....	116
modifications.....	108
micrometer.....	119, 120, 121
Gauges for metals.....	98
Gauging in dies.....	147
German presses.....	43
Glass-blowing.....	166
Glacial flow.....	188
Gold.....	75
Graphic analysis in drawing.....	187
Gravity-feeding.....	243
Grip-feeding.....	238
Grosjean, Mr.....	184

## H

Hammer-blows.....	254
Hammering machines.....	70, 71
Hand feeding.....	233
presses.....	44, 45
Hardness of dies.....	143
Hold-downs and strippers.....	145
Hoopes & Townsend.....	134
Horning or side seaming.....	179
and curling presses.....	60, 61
Horse-power of belts.....	260
Hot forging, rapidity of.....	255
Hydraulic presses.....	69, 78

## I

Indexing feeds.....	242
Inclined presses.....	47, 50, 51
Internal forming.....	157
Inventing wire-gauges.....	98
Inverted, re-drawing.....	216
Involuntary processes.....	162
Inward curling.....	171
International gauges.....	111
Irregular curling.....	173
Iron.....	95

## K

	PAGE
Kinetic construction of presses.....	28
Knockouts .....	243
portable.....	244
in dies .....	161

## L

Lead.....	95
pipe squirting.....	230
Lever presses.....	46, 47
Limit in depth of drawing .....	192
Literature of presses.....	42
Lock-seams .....	180
Lower and upper dies.....	93
Lubrication of dies and materials.....	92

## M

Machines, automatic.....	246
Machine-tool analogies.....	37
Mammoth drawing processes.....	222
Manifolding in paper-cutting.....	254
work in dies.....	249
Marchand, Mr.....	184
Margins and blanks .....	131
Materials and measurements.....	95
worked in presses.....	34
Measurement of materials.....	95
Mechanics of drawing .....	186
Medals.....	226
Metal buying.....	97
Micrometer gauges .....	119, 120, 121
Milling coins.....	226
Mints.....	67
Motions of presses.....	20
Multiple drawing.....	197
Museum of blanks.....	136, 137
presses.....	42
Mutilation by press-feeding.....	235

## N

Name-guessing for presses.....	34
Neck-reducing .....	221

	PAGE
Neidringhaus, Mr.....	184
Nickel.....	95
Nomenclature of dies.....	93

## O

Outward curling.....	167
----------------------	-----

## P

Paper cutting manifolded.....	254
working.....	250
working pressures.....	253
Patenting old processes.....	217
Pendulum presses.....	46, 47
Perforated metal.....	138
Pictorial collection of presses.....	43
Piping in forgings.....	255
Planchets for coins.....	225
Plastic substances, compression and molding of.....	229
Platinum.....	95
Power applications to presses.....	33
press problems.....	37
required for presses.....	260
Position of presses.....	20
Portable knockouts.....	244
Press bolsters.....	76
buyers, points for.....	35
classification and anatomy.....	20
classification by functions.....	33
by frame design.....	22
by kinetic construction.....	28
by materials worked.....	24
by method of support.....	27
by motions.....	20
by position.....	20
construction, primal principles.....	17
definitions.....	16
feeding, definitions of.....	233
literature.....	42
nomenclature.....	18
work, future development of.....	261
working, principles of.....	12
Presses, coining.....	67, 08
cutting.....	50, 51

	PAGE
Presses, drawing.....	62, 63, 65, 212
double-action.....	62, 63, 64
double-crank.....	52, 53
drop.....	48, 49
embossing.....	54, 56
foot.....	46, 57
for brick.....	230
for curling or wiring.....	182
for cutting.....	153
for forming and embossing.....	166
for re-drawing.....	221
for seaming.....	182
for horning.....	183
for soap.....	230
hand.....	44, 45
hydraulic.....	69, 70
inclined.....	47, 50, 51
lever.....	46, 47
pendulum.....	46, 47
power for.....	260
punching.....	54, 56
qualifications.....	16
re drawing.....	64, 66
reducing.....	64, 66
safety devices.....	234, 235
screw.....	44, 45
toggle.....	62, 63, 65, 67, 68
twinned.....	52, 53
wiring.....	60, 61
Pressure for coining.....	231
for drawing.....	210
for cutting dies.....	148
for paper-working.....	253
in drop presses, effective.....	251
in forming and embossing.....	161
with loose punches.....	135
Primeval methods.....	I, 14
Principles of curling.....	175
Proportions for drawn-work.....	196
Prussian system of drawing.....	184
Punches.....	93
and shears.....	57, 58,
fluid.....	165
of soft metal.....	164
Punching.....	129
presses.....	54, 56
pressure reduced.....	135



	PAGE
Punching tapering holes.....	134
Punchings or wads.....	131
Pushouts.....	245

## Q

Quick-running coining-presses.....	231
------------------------------------	-----

## R

Rams of presses.....	19
heights from beds.....	91
cross-sections.....	24, 25
Rapidity in hot forging.....	255
Re-drawing presses.....	64, 66, 221
pressures.....	221
processes.....	214
speeds.....	221
upside down.....	216
Reducing necks.....	221
presses.....	64, 66
processes.....	214
Reeding coins.....	226
Reel-feeding.....	237
Re-punching or drifting.....	136
Rim-covers.....	220
forming.....	220
Riveting.....	229
Roller and dial feed combined.....	240
curling.....	210
feeding.....	236
spinning.....	210
Rotary operations.....	15

## S

Safety devices for presses.....	235
Screw-presses.....	44, 45
Seams, special.....	181
Seaming or horning presses.....	183
pressures.....	182
processes.....	167
speeds.....	182
Sexes of dies.....	93
Shapes of bar metals.....	97

	PAGE
Sharpening dies by hammering.....	143
Shear-blades.....	84
Shear or dip .....	126, 127
Sheared surfaces, imperfect.....	135
Shearing as affected by dies....	150
dies.....	124, 125
presses .....	27
strength of various metals.....	149
Shears and punches.....	57, 58
squaring .....	47, 48, 52, 53
Sheet-metal gauged by weight.....	108
Sheet-metals.....	96
Side-seaming or horning.....	179
Silver.....	95
Soap-presses .....	230
Soft punches.....	164
Special automatic machines.....	246
machinery.....	246
machines, inventors of.....	247
seams.....	181
Specimen drawn-work.....	201
Speed in forming and embossing.....	161
Speed of drawing.....	190, 210
Speeds for cutting-dies.....	147
for seaming.....	182
in coining .....	231
for curling.....	182
for re-drawing .....	221
in drawing.....	210
Spinning by rolling.....	210
Spring-drawing.....	203
Springing of work after bending.....	154
of tools in drawing.....	210
Sprue-cutting.....	125
Squaring shears.....	47, 48, 52, 53
Squirting of soft metals.....	230
Stamping process.....	184
Steam-hammers.....	71
Steel.....	95
Stones sinking through pitch .....	189
Stored energy in drop-presses.....	257
Straight curling .....	179
Strength of metals, shearing.....	149
of materials in drawing .....	193
in drawing comparative.....	198
Strippers and hold-downs .....	145
Strouvelle Bros.....	184

	PAGE
Sub-presses.....	40
Successive cutting .....	139
dies.....	139, 141
gang-cutting.....	140, 141
Suicidal press tendencies.....	39
Supporting presses, methods of.....	27

## T

Tapering holes, punched.....	134
Temperature of material.....	248
Tensile strength in drawing.....	193
Testing die sharpness.....	134
fit of embossing dies.....	159
pressures.....	258
Thickness of tin-plate.....	107
Throats of presses.....	18
Tin-plate.....	95
thickness.....	107
Toggle-presses.....	62, 63, 65, 67, 68
Topography of machinery .....	19
Trimming drop-forgings .....	224
edges.....	209
Trip-hammer work .....	256
Tubal Cain and disciples.....	11
Tube feeds.....	243
squirting.....	230
Twin presses.....	52, 53
Tyndall, Prof.....	189

## U

Upper and lower dies.....	93
---------------------------	----

## V

Vee blank-holders.....	219
------------------------	-----

## W

Warping in forming and embossing.....	162
Weighing-bolsters.....	259
Wet-paper test.....	134
Wheeler, Dr. S. S., gauge charts by.....	100

	PAGE
Whitworth, Sir Joseph .....	12, 106
William Sellers & Co.....	135
Wire.....	96
Wire-drawing sizes .....	109
Wire-gauges.....	98
foolishness of.....	98
function of.....	98
qualifications of.....	99
standards for .....	99
tables of.....	103, 105
Wiring presses.....	60, 61
processes.....	167
Wrinkles, body.....	194
flange .....	195

## Z

Zinc.....	95
-----------	----





# SHORT-TITLE CATALOGUE

OF THE

## PUBLICATIONS

OF

# JOHN WILEY & SONS,

NEW YORK.

LONDON: CHAPMAN & HALL, LIMITED.

ARRANGED UNDER SUBJECTS.

Descriptive circulars sent on application. Books marked with an asterisk are sold at *net* prices only, a double asterisk (\*\*) books sold under the rules of the American Publishers' Association at *net* prices subject to an extra charge for postage. All books are bound in cloth unless otherwise stated.

### AGRICULTURE.

Armsby's Manual of Cattle-feeding.....	12mo,	\$1 75
Principles of Animal Nutrition.....	8vo,	4 00
Budd and Hansen's American Horticultural Manual:		
Part I.—Propagation, Culture, and Improvement.....	12mo,	1 50
Part II.—Systematic Pomology.....	12mo,	1 50
Downing's Fruits and Fruit-trees of America.....	8vo,	5 00
Elliott's Engineering for Land Drainage.....	12mo,	1 50
Practical Farm Drainage.....	12mo,	1 00
Green's Principles of American Forestry. ( <i>Shortly.</i> )		
Grotenfelt's Principles of Modern Dairy Practice. ( <i>Woll.</i> ).....	12mo,	2 00
Kemp's Landscape Gardening.....	12mo,	2 50
Maynard's Landscape Gardening as Applied to Home Decoration.....	12mo,	1 50
Sanderson's Insects Injurious to Staple Crops.....	12mo,	1 50
Insects Injurious to Garden Crops. ( <i>In preparation.</i> )		
Insects Injuring Fruits. ( <i>In preparation.</i> )		
Stockbridge's Rocks and Soils.....	8vo,	2 50
Woll's Handbook for Farmers and Dairymen.....	16mo,	1 50

### ARCHITECTURE.

Baldwin's Steam Heating for Buildings.....	12mo,	2 50
Berg's Buildings and Structures of American Railroads.....	4to,	5 00
Birkmire's Planning and Construction of American Theatres.....	8vo,	3 00
Architectural Iron and Steel.....	8vo,	3 50
Compound Riveted Girders as Applied in Buildings.....	8vo,	2 00
Planning and Construction of High Office Buildings.....	8vo,	3 50
Skeleton Construction in Buildings.....	8vo,	3 00
Briggs's Modern American School Buildings.....	8vo,	4 00
Carpenter's Heating and Ventilating of Buildings.....	8vo,	4 00
Freitag's Architectural Engineering. 2d Edition, Rewritten.....	8vo,	3 50
Fireproofing of Steel Buildings.....	8vo,	2 50
French and Ives's Stereotomy.....	8vo,	2 50
Gerhard's Guide to Sanitary House-inspection.....	16mo,	1 00
Theatre Fires and Panics.....	12mo,	1 50

Hatfield's American House Carpenter.....	.8vo,	5 00
Holly's Carpenters' and Joiners' Handbook.....	18mo,	75
Johnson's Statics by Algebraic and Graphic Methods.....	.8vo,	2 00
Kidder's Architect's and Builder's Pocket-book.....	16mo, morocco,	4 00
Merrill's Stones for Building and Decoration.....	.8vo,	5 00
Monckton's Stair-building.....	.4to,	4 00
Patton's Practical Treatise on Foundations.....	.8vo,	5 00
Siebert and Biggin's Modern Stone-cutting and Masonry.....	.8vo,	1 50
Snow's Principal Species of Wood.....	.8vo,	3 50
Sondericker's Graphic Statics with Applications to Trusses, Beams, and Arches. ( <i>Shortly.</i> )		
Wait's Engineering and Architectural Jurisprudence.....	.8vo,	6 00
	Sheep,	6 50
Law of Operations Preliminary to Construction in Engineering and Architecture.....	.8vo,	5 00
	Sheep,	5 50
Law of Contracts.....	.8vo,	3 00
Woodbury's Fire Protection of Mills.....	.8vo,	2 50
Worcester and Atkinson's Small Hospitals, Establishment and Maintenance, Suggestions for Hospital Architecture, with Plans for a Small Hospital.		
	12mo,	1 25
The World's Columbian Exposition of 1893.....	Large 4to,	1 00

## ARMY AND NAVY.

Bernadou's Smokeless Powder, Nitro-cellulose, and the Theory of the Cellulose Molecule.....	12mo,	2 50
* Bruff's Text-book Ordnance and Gunnery.....	.8vo,	6 00
Chase's Screw Propellers and Marine Propulsion.....	.8vo,	3 00
Craig's Azimuth.....	.4to,	3 50
Crehore and Squire's Polarizing Photo-chronograph.....	.8vo,	3 00
Cronkhite's Gunnery for Non-commissioned Officers.....	24mo, morocco,	2 00
* Davis's Elements of Law.....	.8vo,	2 50
*    Treatise on the Military Law of United States.....	.8vo,	7 00
*	Sheep	7 50
De Brack's Cavalry Outpost Duties. (Carr.).....	24mo, morocco,	2 00
Dietz's Soldier's First Aid Handbook.....	16mo, morocco,	1 25
* Dredge's Modern French Artillery.....	.4to, half morocco,	15 00
Durand's Resistance and Propulsion of Ships.....	.8vo,	5 00
* Dyer's Handbook of Light Artillery.....	12mo,	3 00
Eissler's Modern High Explosives.....	.8vo,	4 00
* Fieberger's Text-book on Field Fortification.....	Small 8vo,	2 00
Hamilton's The Gunner's Catechism.....	18mo,	1 00
* Hoff's Elementary Naval Tactics.....	.8vo,	1 50
Ingalls's Handbook of Problems in Direct Fire.....	.8vo,	4 00
*    Ballistic Tables.....	.8vo,	1 50
* Lyons's Treatise on Electromagnetic Phenomena. Vols. I. and II.	.8vo, each,	6 00
* Mahan's Permanent Fortifications. (Mercur.).....	.8vo, half morocco,	7 50
Manual for Courts-martial.....	16mo morocco,	1 50
* Mercur's Attack of Fortified Places.....	12mo,	2 00
*    Elements of the Art of War.....	.8vo,	4 00
Metcalf's Cost of Manufactures—And the Administration of Workshops, Public and Private.....	.8vo,	5 00
*    Ordnance and Gunnery.....	12mo,	5 00
Murray's Infantry Drill Regulations.....	18mo, paper,	10
* Phelps's Practical Marine Surveying.....	.8vo,	2 50
Powell's Army Officer's Examiner.....	12mo,	4 00
Sharpe's Art of Subsisting Armies in War.....	18mo, morocco,	1 50



* Walke's Lectures on Explosives. . . . .	.8vo,	4 00
* Wheeler's Siege Operations and Military Mining . . . . .	.8vo,	2 00
Winthrop's Abridgment of Military Law . . . . .	12mo,	2 50
Woodhull's Notes on Military Hygiene . . . . .	16mo,	1 50
Young's Simple Elements of Navigation . . . . .	16mo, morocco,	1 00
Second Edition, Enlarged and Revised . . . . .	16mo, morocco,	2 00

### ASSAYING.

Fletcher's Practical Instructions in Quantitative Assaying with the Blowpipe. . . . .	12mo, morocco, <sup>1</sup>	1 50
Furman's Manual of Practical Assaying . . . . .	.8vo,	3 00
Miller's Manual of Assaying . . . . .	12mo,	1 00
O'Driscoll's Notes on the Treatment of Gold Ores . . . . .	.8vo,	2 00
Ricketts and Miller's Notes on Assaying . . . . .	.8vo,	3 00
Ulke's Modern Electrolytic Copper Refining. . . . .	.8vo,	3 00
Wilson's Cyanide Processes . . . . .	12mo,	1 50
Chlorination Process . . . . .	12mo,	1 50

### ASTRONOMY.

Comstock's Field Astronomy for Engineers. . . . .	.8vo,	2 50
Craig's Azimuth . . . . .	.4to,	3 50
Doolittle's Treatise on Practical Astronomy. . . . .	.8vo,	4 00
Gore's Elements of Geodesy . . . . .	.8vo,	2 50
Hayford's Text-book of Geodetic Astronomy . . . . .	.8vo,	3 00
Merriman's Elements of Precise Surveying and Geodesy . . . . .	.8vo,	2 50
* Michie and Harlow's Practical Astronomy . . . . .	.8vo,	3 00
* White's Elements of Theoretical and Descriptive Astronomy . . . . .	12mo,	2 00

### BOTANY.

Davenport's Statistical Methods, with Special Reference to Biological Variation. . . . .	16mo, morocco,	1 25
Thomé and Bennett's Structural and Physiological Botany. . . . .	16mo,	2 25
Westermaier's Compendium of General Botany. (Schneider.) . . . . .	.8vo,	2 00

### CHEMISTRY.

Adriance's Laboratory Calculations and Specific Gravity Tables. . . . .	12mo,	1 25
Allen's Tables for Iron Analysis. . . . .	.8vo,	3 00
Arnold's Compendium of Chemistry. (Mandel.) ( <i>In preparation.</i> ) . . . . .		
Austen's Notes for Chemical Students. . . . .	12mo,	1 50
Bernadou's Smokeless Powder.—Nitro-cellulose, and Theory of the Cellulose Molecule . . . . .	12mo,	2 50
Bolton's Quantitative Analysis. . . . .	.8vo,	1 50
* Browning's Introduction to the Rarer Elements . . . . .	.8vo,	1 50
Brush and Penfield's Manual of Determinative Mineralogy. . . . .	.8vo,	4 00
Classen's Quantitative Chemical Analysis by Electrolysis. (Boltwood.) . . . . .	.8vo,	3 00
Cohn's Indicators and Test-papers. . . . .	12mo,	2 00
Tests and Reagents. . . . .	.8vo,	3 00
Copeland's Manual of Bacteriology. ( <i>In preparation.</i> ) . . . . .		
Craft's Short Course in Qualitative Chemical Analysis. (Schaeffer.) . . . . .	12mo,	2 00
Drechsel's Chemical Reactions. (Merrill.) . . . . .	12mo,	1 25
Duhem's Thermodynamics and Chemistry. (Burgess.) ( <i>Shortly.</i> ) . . . . .		
Eissler's Modern High Explosives. . . . .	.8vo,	4 00

Effront's Enzymes and their Applications. (Prescott.)	8vo,	3 00
Erdmann's Introduction to Chemical Preparations. (Dunlap.)	12mo,	1 25
Fletcher's Practical Instructions in Quantitative Assaying with the Blowpipe.	12mo, morocco,	1 50
Fowler's Sewage Works Analyses	12mo,	2 00
Fresenius's Manual of Qualitative Chemical Analysis. (Wells.)	8vo,	5 00
Manual of Qualitative Chemical Analysis. Part I. Descriptive. (Wells.)	8vo,	3 00
System of Instruction in Quantitative Chemical Analysis. (Cohn.)	2 vols. ( <i>Shortly.</i> )	
Fuertes's Water and Public Health	12mo,	1 50
Furman's Manual of Practical Assaying	8vo,	3 00
Gill's Gas and Fuel Analysis for Engineers	12mo,	1 25
Grottenfelt's Principles of Modern Dairy Practice. (Woll.)	12mo,	2 00
Hammarsten's Text-book of Physiological Chemistry. (Mandel.)	8vo,	4 00
Helm's Principles of Mathematical Chemistry. (Morgan.)	12mo,	1 50
Hinds's Inorganic Chemistry	8vo,	3 00
* Laboratory Manual for Students	12mo,	75
Holleman's Text-book of Inorganic Chemistry. (Cooper.)	8vo,	2 50
Text-book of Organic Chemistry. (Walker and Mott.)	8vo,	2 50
Hopkins's Oil-chemists' Handbook	8vo,	3 00
Keep's Cast Iron	8vo,	2 50
Ladd's Manual of Quantitative Chemical Analysis	12mo,	1 00
Landauer's Spectrum Analysis. (Tingle.)	8vo,	3 00
Lassar-Cohn's Practical Urinary Analysis. (Lorenz.)	12mo,	1 00
Leach's The Inspection and Analysis of Food with Special Reference to State Control. ( <i>In preparation.</i> )		
Löb's Electrolysis and Electrosynthesis of Organic Compounds. (Lorenz.)	12mo,	1 00
Mandel's Handbook for Bio-chemical Laboratory	12mo,	1 50
Mason's Water-supply. (Considered Principally from a Sanitary Standpoint.)		
3d Edition, Rewritten	8vo,	4 00
Examination of Water. (Chemical and Bacteriological.)	12mo,	1 25
Meyer's Determination of Radicles in Carbon Compounds. (Tingle.)	12mo,	1 00
Miller's Manual of Assaying	12mo,	1 00
Mixer's Elementary Text-book of Chemistry	12mo,	1 50
Morgan's Outline of Theory of Solution and its Results	12mo,	1 00
Elements of Physical Chemistry	12mo,	2 00
Nichols's Water-supply. (Considered mainly from a Chemical and Sanitary Standpoint, 1883.)	8vo,	2 50
O'Brine's Laboratory Guide in Chemical Analysis	8vo,	2 00
O'Driscoll's Notes on the Treatment of Gold Ores	8vo,	2 00
Ost and Kolbeck's Text-book of Chemical Technology. (Lorenz—Bozart.)		
( <i>In preparation.</i> )		
* Penfield's Notes on Determinative Mineralogy and Record of Mineral Tests.	8vo, paper,	50
Pictet's The Alkaloids and their Chemical Constitution. (Biddle.) ( <i>In preparation.</i> )		
Pinner's Introduction to Organic Chemistry. (Austen.)	12mo,	1 50
Poole's Calorific Power of Fuels	8vo,	3 00
* Reising's Guide to Piece-dyeing	8vo,	25 00
Richards and Woodman's Air, Water, and Food from a Sanitary Standpoint	8vo,	2 00
Richards's Cost of Living as Modified by Sanitary Science	12mo,	1 00
Cost of Food, a Study in Dietaries	12mo,	1 00
* Richards and Williams's The Dietary Computer	8vo,	1 50
Ricketts and Russell's Skeleton Notes upon Inorganic Chemistry. (Part I.—Non-metallic Elements.)	8vo, morocco,	75
Ricketts and Miller's Notes on Assaying	8vo,	3 00
Rideal's Sewage and the Bacterial Purification of Sewage	8vo,	3 50

Ruddiman's Incompatibilities in Prescriptions.....	8vo,	2 00
Schimpf's Text-book of Volumetric Analysis.....	12mo,	2 50
Spencer's Handbook for Chemists of Beet-sugar Houses.....	16mo, morocco,	3 00
Handbook for Sugar Manufacturers and their Chemists.....	16mo, morocco,	2 00
Stockbridge's Rocks and Soils.....	8vo,	2 50
* Tillman's Elementary Lessons in Heat.....	8vo,	1 50
* Descriptive General Chemistry.....	8vo	3 00
Treadwell's Qualitative Analysis. (Hall.).....	8vo,	3 00
Turneaure and Russell's Public Water-supplies.....	8vo,	5 00
Van Deventer's Physical Chemistry for Beginners. (Boltwood.).....	12mo,	1 50
* Walke's Lectures on Explosives.....	8vo,	4 00
Wells's Laboratory Guide in Qualitative Chemical Analysis.....	8vo,	1 50
Short Course in Inorganic Qualitative Chemical Analysis for Engineering Students.....	12mo,	1 50
Whipple's Microscopy of Drinking-water.....	8vo,	3 50
Wiechmann's Sugar Analysis.....	Small 8vo,	2 50
Wilson's Cyanide Processes.....	12mo,	1 50
Chlorination Process.....	12mo,	1 50
Wulling's Elementary Course in Inorganic Pharmaceutical and Medical Chem- istry.....	12mo,	2 00

## CIVIL ENGINEERING.

### BRIDGES AND ROOFS. HYDRAULICS. MATERIALS OF ENGINEERING. RAILWAY ENGINEERING.

Baker's Engineers' Surveying Instruments.....	12mo,	3 00
Bixby's Graphical Computing Table.....	Paper, 19½ × 24½ inches.	25
** Burr's Ancient and Modern Engineering and the Isthmian Canal. (Postage, 27 cents additional.).....	8vo, net,	3 50
Comstock's Field Astronomy for Engineers.....	8vo,	2 50
Davis's Elevation and Stadia Tables.....	8vo,	1 00
Elliott's Engineering for Land Drainage.....	12mo,	1 50
Practical Farm Drainage.....	12mo,	1 00
Folwell's Sewerage. (Designing and Maintenance.).....	8vo,	3 00
Freitag's Architectural Engineering. 2d Edition, Rewritten.....	8vo,	3 50
French and Ives's Stereotomy.....	8vo,	2 50
Goodhue's Municipal Improvements.....	12mo,	1 75
Goodrich's Economic Disposal of Towns' Refuse.....	8vo,	3 50
Gore's Elements of Geodesy.....	8vo,	2 50
Hayford's Text-book of Geodetic Astronomy.....	8vo,	3 00
Howe's Retaining Walls for Earth.....	12mo,	1 25
Johnson's Theory and Practice of Surveying.....	Small 8vo,	4 00
Statics by Algebraic and Graphic Methods.....	8vo,	2 00
Kierstedt's Sewage Disposal.....	12mo,	1 25
Laplace's Philosophical Essay on Probabilities. (Truscott and Emory.).....	12mo,	2 00
Mahan's Treatise on Civil Engineering. (1873.) (Wood.).....	8vo,	5 00
* Descriptive Geometry.....	8vo,	1 50
Merriman's Elements of Precise Surveying and Geodesy.....	8vo,	2 50
Elements of Sanitary Engineering.....	8vo,	2 00
Merriman and Brooks's Handbook for Surveyors.....	16mo, morocco,	2 00
Nugent's Plane Surveying.....	8vo,	3 50
Ogden's Sewer Design.....	12mo,	2 00
Patton's Treatise on Civil Engineering.....	8vo, half leather,	7 50
Reed's Topographical Drawing and Sketching.....	4to,	5 00
Rideal's Sewage and the Bacterial Purification of Sewage.....	8vo,	3 50
Siebert and Biggin's Modern Stone-cutting and Masonry.....	8vo,	1 50
Smith's Manual of Topographical Drawing. (McMillan.).....	8vo,	2 50

Underdicker's Graphic Statics, with Applications to Trusses, Beams, and Arches. ( <i>Shortly.</i> )	
* Trautwine's Civil Engineer's Pocket-book	16mo, morocco, 5 00
Wait's Engineering and Architectural Jurisprudence	8vo, 6 00
	Sheep, 6 50
Law of Operations Preliminary to Construction in Engineering and Architecture	8vo, 5 00
	Sheep, 5 50
Law of Contracts	8vo, 3 00
Warren's Stereotomy—Problems in Stone-cutting	8vo, 2 50
Webb's Problems in the Use and Adjustment of Engineering Instruments	
	16mo, morocco, 1 25
* Wheeler's Elementary Course of Civil Engineering	8vo, 4 00
Wilson's Topographic Surveying	8vo, 3 50

## BRIDGES AND ROOFS.

Boiler's Practical Treatise on the Construction of Iron Highway Bridges	8vo, 2 00
* Thames River Bridge	4to, paper, 5 00
Burr's Course on the Stresses in Bridges and Roof Trusses, Arched Ribs, and Suspension Bridges	8vo, 3 50
Du Bois's Mechanics of Engineering. Vol. II	Small 4to, 10 00
Foster's Treatise on Wooden Trestle Bridges	4to, 5 00
Fowler's Cofferdam Process for Piers	8vo, 2 50
Greene's Roof Trusses	8vo, 1 25
Bridge Trusses	8vo, 2 50
Arches in Wood, Iron, and Stone	8vo, 2 50
Howe's Treatise on Arches	8vo, 4 00
Design of Simple Roof-trusses in Wood and Steel	8vo, 2 00
Johnson, Bryan, and Turneaure's Theory and Practice in the Designing of Modern Framed Structures	Small 4to, 10 00
Merriman and Jacoby's Text-book on Roofs and Bridges:	
Part I.—Stresses in Simple Trusses	8vo, 2 50
Part II.—Graphic Statics	8vo, 2 50
Part III.—Bridge Design. 4th Edition, Rewritten	8vo, 2 50
Part IV.—Higher Structures	8vo, 2 50
Morison's Memphis Bridge	4to, 10 00
Waddell's De Pontibus, a Pocket-book for Bridge Engineers	16mo, morocco, 3 00
Specifications for Steel Bridges	12mo, 1 25
Wood's Treatise on the Theory of the Construction of Bridges and Roofs	8vo, 2 00
Wright's Designing of Draw-spans:	
Part I.—Plate-girder Draws	8vo, 2 50
Part II.—Riveted-truss and Pin-connected Long-span Draws	8vo, 2 50
Two parts in one volume	8vo, 3 50

## HYDRAULICS.

Bazin's Experiments upon the Contraction of the Liquid Vein Issuing from an Orifice. ( <i>Trautwine.</i> )	8vo, 2 00
Bovey's Treatise on Hydraulics	8vo, 5 00
Church's Mechanics of Engineering	8vo, 6 00
Diagrams of Mean Velocity of Water in Open Channels	paper, 1 50
Coffin's Graphical Solution of Hydraulic Problems	16mo, morocco, 2 50
Flather's Dynamometers, and the Measurement of Power	12mo, 3 00
Folwell's Water-supply Engineering	8vo, 4 00
Frizell's Water-power	8vo, 5 00

Fuertes's Water and Public Health.....	12mo,	1 50
Water-filtration Works.....	12mo,	2 50
Ganguillet and Kutter's General Formula for the Uniform Flow of Water in Rivers and Other Channels. (Hering and Trautwine.).....	8vo,	4 00
Hazen's Filtration of Public Water-supply.....	8vo,	3 00
Hazlehurst's Towers and Tanks for Water-works.....	8vo,	2 50
Herschel's 115 Experiments on the Carrying Capacity of Large, Riveted, Metal Conduits.....	8vo,	2 00
Mason's Water-supply. (Considered Principally from a Sanitary Stand-point.) 3d Edition, Rewritten.....	8vo,	4 00
Merriman's Treatise on Hydraulics. 9th Edition, Rewritten.....	8vo,	5 00
* Michie's Elements of Analytical Mechanics.....	8vo,	4 00
Schuyler's Reservoirs for Irrigation, Water-power, and Domestic Water-supply.....	Large 8vo,	5 00
** Thomas and Watt's Improvement of Rifiers. (Post., 44 c. additional),	4to,	6 00
Turneure and Russell's Public Water-supplies.....	8vo,	5 00
Wegmann's Design and Construction of Dams.....	4to,	5 00
Water-supply of the City of New York from 1658 to 1895.....	4to,	10 00
Weisbach's Hydraulics and Hydraulic Motors. (Du Bois.).....	8vo,	5 00
Wilson's Manual of Irrigation Engineering.....	Small 8vo,	4 00
Wolff's Windmill as a Prime Mover.....	8vo,	3 00
Wood's Turbines.....	8vo,	2 50
Elements of Analytical Mechanics.....	8vo,	3 00

## MATERIALS OF ENGINEERING.

Baker's Treatise on Masonry Construction.....	8vo,	5 00
Roads and Pavements.....	8vo,	5 00
Black's United States Public Works.....	Oblong 4to,	5 00
Bovey's Strength of Materials and Theory of Structures.....	8vo,	7 50
Burr's Elasticity and Resistance of the Materials of Engineering. 6th Edition, Rewritten.....	8vo,	7 50
Byrne's Highway Construction.....	8vo,	5 00
Inspection of the Materials and Workmanship Employed in Construction.....	16mo,	3 00
Church's Mechanics of Engineering.....	8vo,	6 00
Du Bois's Mechanics of Engineering. Vol. I.....	Small 4to,	7 50
Johnson's Materials of Construction.....	Large 8vo,	6 00
Keep's Cast Iron.....	8vo,	2 50
Lanza's Applied Mechanics.....	8vo,	7 50
Martens's Handbook on Testing Materials. (Henning.) 2 vols.....	8vo,	7 50
Merrill's Stones for Building and Decoration.....	8vo,	5 00
Merriman's Text-book on the Mechanics of Materials.....	8vo,	4 00
Strength of Materials.....	12mo,	1 00
Metcalf's Steel. A Manual for Steel-users.....	12mo,	2 00
Patton's Practical Treatise on Foundations.....	8vo,	5 00
Rockwell's Roads and Pavements in France.....	12mo,	1 25
Smith's Wire: Its Use and Manufacture.....	Small 4to,	3 00
Materials of Machines.....	12mo,	1 00
Snow's Principal Species of Wood.....	8vo,	3 50
Spalding's Hydraulic Cement.....	12mo,	2 00
Text-book on Roads and Pavements.....	12mo,	2 00
Thurston's Materials of Engineering. 3 Parts.....	8vo,	8 00
Part I.—Non-metallic Materials of Engineering and Metallurgy.....	8vo,	2 00
Part II.—Iron and Steel.....	8vo,	3 50
Part III.—A Treatise on Brasses, Bronzes, and Other Alloys and their Constituents.....	8vo,	2 50

Thurston's Text-book of the Materials of Construction	8vo,	5 00
Tillson's Street Pavements and Paving Materials	8vo,	4 00
Waddell's De Pontibus. (A Pocket-book for Bridge Engineers.)	16mo, mor.,	3 00
Specifications for Steel Bridges	12mo,	1 25
Wood's Treatise on the Resistance of Materials, and an Appendix on the Preservation of Timber	8vo,	2 00
Elements of Analytical Mechanics	8vo,	3 00

## RAILWAY ENGINEERING.

Andrews's Handbook for Street Railway Engineers. 3×5 inches.	morocco,	1 25
Berg's Buildings and Structures of American Railroads	4to,	5 00
Brooks's Handbook of Street Railroad Location	16mo, morocco,	1 50
Butts's Civil Engineer's Field-book	16mo, morocco,	2 50
Crandall's Transition Curve	16mo, morocco,	1 50
Railway and Other Earthwork Tables	8vo,	1 50
Dawson's "Engineering" and Electric Traction Pocket-book	16mo, morocco,	4 00
Dredge's History of the Pennsylvania Railroad: (1879)	Paper,	5 00
* Drinker's Tunneling, Explosive Compounds, and Rock Drills	4to, half mor.,	25 00
Fisher's Table of Cubic Yards	Cardboard,	25
Godwin's Railroad Engineers' Field-book and Explorers' Guide	16mo, mor.,	2 50
Howard's Transition Curve Field-book	16mo, morocco,	1 50
Hudson's Tables for Calculating the Cubic Contents of Excavations and Embankments	8vo,	1 00
Molitor and Beard's Manual for Resident Engineers	16mo,	1 00
Nagle's Field Manual for Railroad Engineers	16mo, morocco,	3 00
Philbrick's Field Manual for Engineers	16mo, morocco,	3 00
Pratt and Alden's Street-railway Road-bed	8vo,	2 00
Searles's Field Engineering	16mo, morocco,	3 00
Railroad Spiral	16mo, morocco,	1 50
Taylor's Prismoïdal Formulæ and Earthwork	8vo,	1 50
* Trautwine's Method of Calculating the Cubic Contents of Excavations and Embankments by the Aid of Diagrams	8vo,	2 00
* The Field Practice of Laying Out Circular Curves for Railroads	12mo, morocco,	2 50
* Cross-section Sheet	Paper,	25
Webb's Railroad Construction. 2d Edition, Rewritten	16mo, morocco,	5 00
Wellington's Economic Theory of the Location of Railways	Small 8vo,	5 00

## DRAWING.

Barr's Kinematics of Machinery	8vo,	2 50
* Bartlett's Mechanical Drawing	8vo,	3 00
Coolidge's Manual of Drawing	8vo, paper,	1 00
Durley's Kinematics of Machines	8vo,	4 00
Hill's Text-book on Shades and Shadows, and Perspective	8vo,	2 00
Jones's Machine Design:		
Part I.—Kinematics of Machinery	8vo,	1 50
Part II.—Form, Strength, and Proportions of Parts	8vo,	3 00
MacCord's Elements of Descriptive Geometry	8vo,	3 00
Kinematics; or, Practical Mechanism	8vo,	5 00
Mechanical Drawing	4to,	4 00
Velocity Diagrams	8vo,	1 50
* Mahan's Descriptive Geometry and Stone-cutting	8vo,	1 50
Industrial Drawing. (Thompson.)	8vo,	3 50
Reed's Topographical Drawing and Sketching	4to,	5 00

Reid's Course in Mechanical Drawing.....	8vo,	2 00
Text-book of Mechanical Drawing and Elementary Machine Design..	8vo,	3 00
Robinson's Principles of Mechanism.....	8vo,	3 00
Smith's Manual of Topographical Drawing. (McMillan.).....	8vo,	2 50
Warren's Elements of Plane and Solid Free-hand Geometrical Drawing..	12mo,	1 00
Drafting Instruments and Operations.....	12mo,	1 25
Manual of Elementary Projection Drawing.....	12mo,	1 50
Manual of Elementary Problems in the Linear Perspective of Form and Shadow.....	12mo,	1 00
Plane Problems in Elementary Geometry.....	12mo,	1 25
Primary Geometry.....	12mo,	75
Elements of Descriptive Geometry, Shadows, and Perspective.....	8vo,	3 50
General Problems of Shades and Shadows.....	8vo,	3 00
Elements of Machine Construction and Drawing.....	8vo,	7 50
Problems, Theorems, and Examples in Descriptive Geometr.....	8vo,	2 50
Weisbach's Kinematics and the Power of Transmission. (Hermann and Klein.).....	8vo,	5 00
Whelpley's Practical Instruction in the Art of Letter Engraving.....	12mo,	2 00
Wilson's Topographic Surveying.....	8vo,	3 50
Free-hand Perspective.....	8vo,	2 50
Free-hand Lettering. ( <i>In preparation.</i> )		
Woolf's Elementary Course in Descriptive Geometry.....	Large 8vo,	3 00

## ELECTRICITY AND PHYSICS.

Anthony and Brackett's Text-book of Physics. (Magie.).....	Small 8vo,	3 00
Anthony's Lecture-notes on the Theory of Electrical Measurements.....	12mo,	1 00
Benjamin's History of Electricity.....	8vo,	3 00
Voltaic Cell.....	8vo,	3 00
Classen's Quantitative Chemical Analysis by Electrolysis. (Boltwood.)..	8vo,	3 00
Crehore and Squier's Polarizing Photo-chronograph.....	8vo,	3 00
Dawson's "Engineering" and Electric Traction Pocket-book..	10mo, morocco,	4 00
Fletcher's Dynamometers, and the Measurement of Power.....	12mo,	3 00
Giibert's De Magnete. (Mottelay.).....	8vo,	2 50
Holman's Precision of Measurements.....	8vo,	2 00
Telescopic Mirror-scale Method, Adjustments, and Tests....	Large 8vo,	75
Landauer's Spectrum Analysis. (Tingle.).....	8vo,	3 00
Le Chatelier's High-temperature Measurements. (Boudouard—Burgess.)	12mo,	3 00
Löb's Electrolysis and Electrosynthesis of Organic Compounds. (Lorenz.)	12mo,	1 00
* Lyons's Treatise on Electromagnetic Phenomena. Vols. I. and II.	8vo, each,	6 00
* Michie. Elements of Wave Motion Relating to Sound and Light.....	8vo,	4 00
Niaudet's Elementary Treatise on Electric Batteries. (Fishback.).....	12mo,	2 50
* Parshall and Hobart's Electric Generators.....	Small 4to. half morocco,	10 00
* Rosenberg's Electrical Engineering. (Haldane Gee—Kinzbrunner.)...	8vo,	1 50
Ryan, Norris, and Hoxie's Electrical Machinery. ( <i>In preparation.</i> )		
Thurston's Stationary Steam-engines.....	8vo,	2 50
* Tillman's Elementary Lessons in Heat.....	8vo,	1 50
Tory and Fitcher's Manual of Laboratory Physics.....	Small 8vo,	2 00

## LAW.

* Davis's Elements of Law.....	8vo,	2 50
* Treatise on the Military Law of United States.....	8vo,	7 00
* .....	Sheep,	7 50
Manual for Courts-martial.....	16mo, morocco,	1 50

Wait's Engineering and Architectural Jurisprudence.....	8vo,	6 00
	Sheep,	6 50
Law of Operations Preliminary to Construction in Engineering and Architecture.....	8vo,	5 00
	Sheep,	5 50
Law of Contracts.....	8vo,	3 00
Winthrop's Abridgment of Military Law.....	12mo,	2 50

## MANUFACTURES.

Bernadou's Smokeless Powder—Nitro-cellulose and Theory of the Cellulose Molecule.....	12mo,	2 50
Bolland's Iron Founder.....	12mo,	2 50
"The Iron Founder," Supplement.....	12mo,	2 50
Encyclopedia of Founding and Dictionary of Foundry Terms Used in the Practice of Moulding.....	12mo,	3 00
Eissler's Modern High Explosives.....	8vo,	4 00
Effront's Enzymes and their Applications. (Prescott.).....	8vo,	3 00
Fitzgerald's Boston Machinist.....	18mo,	1 00
Ford's Boiler Making for Boiler Makers.....	18mo,	1 00
Hopkins's Oil-chemists' Handbook.....	8vo,	3 00
Keep's Cast Iron.....	8vo,	2 50
Leach's The Inspection and Analysis of Food with Special Reference to State Control. ( <i>In preparation.</i> ).....		
Metcalf's Steel. A Manual for Steel-users.....	12mo,	2 00
Metcalf's Cost of Manufactures—And the Administration of Workshops, Public and Private.....	8vo,	5 00
Meyer's Modern Locomotive Construction.....	4to,	10 00
* Reisig's Guide to Piece-dyeing.....	8vo,	25 00
Smith's Press-working of Metals.....	8vo,	3 00
Wire: Its Use and Manufacture.....	Small 4to,	3 00
Spalding's Hydraulic Cement.....	12mo,	2 00
Spencer's Handbook for Chemists of Beet-sugar Houses.....	16mo, morocco,	3 00
Handbook for Sugar Manufacturers and their Chemists.....	16mo, morocco,	2 00
Thurston's Manual of Steam-boilers, their Designs, Construction and Operation.....	8vo,	5 00
Ulke's Modern Electrolytic Copper Refining.....	8vo,	3 00
* Walke's Lectures on Explosives.....	8vo,	4 00
West's American Foundry Practice.....	12mo,	2 50
Moulder's Text-book.....	12mo,	2 50
Wiechmann's Sugar Analysis.....	Small 8vo,	2 50
Wolff's Windmill as a Prime Mover.....	8vo,	3 00
Woodbury's Fire Protection of Mills.....	8vo,	2 50

## MATHEMATICS.

Baker's Elliptic Functions.....	8vo,	1 50
* Bass's Elements of Differential Calculus.....	12mo,	4 00
Briggs's Elements of Plane Analytic Geometry.....	12mo,	1 00
Chapman's Elementary Course in Theory of Equations.....	12mo,	1 50
Compton's Manual of Logarithmic Computations.....	12mo,	1 50
Davis's Introduction to the Logic of Algebra.....	8vo,	1 50
* Dickson's College Algebra.....	Large 12mo,	1 50
* Introduction to the Theory of Algebraic Equations.....	Large 12mo,	1 25
Halsted's Elements of Geometry.....	8vo,	1 75
Elementary Synthetic Geometry.....	8vo,	1 50



* Johnson's Three-place Logarithmic Tables: Vest-pocket size.....paper,	15
	100 copies for 5 00
* Mounted on heavy cardboard, 8×10 inches,	25
	10 copies for 2 00
Elementary Treatise on the Integral Calculus.....Small 8vo,	1 50
Curve Tracing in Cartesian Co-ordinates.....	12mo, 1 00
Treatise on Ordinary and Partial Differential Equations.....Small 8vo,	3 50
Theory of Errors and the Method of Least Squares.....	12mo, 1 50
* Theoretical Mechanics.....	12mo, 3 00
Laplace's Philosophical Essay on Probabilities. (Truscott and Emory.)	12mo, 2 00
* Ludlow and Bass. Elements of Trigonometry and Logarithmic and Other Tables.....	8vo, 3 00
Trigonometry and Tables published separately.....	Each, 2 00
Maurer's Technical Mechanics. ( <i>In preparation.</i> )	
Merriman and Woodward's Higher Mathematics.....	8vo, 5 00
Merriman's Method of Least Squares.....	8vo, 2 00
Rice and Johnson's Elementary Treatise on the Differential Calculus.Sm.,	8vo, 3 00
Differential and Integral Calculus. 2 vols. in one.....Small 8vo,	2 50
Wood's Elements of Co-ordinate Geometry.....	8vo, 2 00
Trigonometry: Analytical, Plane, and Spherical.....	12mo, 1 00

## MECHANICAL ENGINEERING.

### MATERIALS OF ENGINEERING, STEAM-ENGINES AND BOILERS.

Baldwin's Steam Heating for Buildings.....	12mo, 2 50
Barr's Kinematics of Machinery.....	8vo, 2 50
* Bartlett's Mechanical Drawing.....	8vo, 3 00
Benjamin's Wrinkles and Recipes.....	12mo, 2 00
Carpenter's Experimental Engineering.....	8vo, 6 00
Heating and Ventilating Buildings.....	8vo, 4 00
Clerk's Gas and Oil Engine.....	Small 8vo, 4 00
Coolidge's Manual of Drawing.....	8vo, paper, 1 00
Cromwell's Treatise on Toothed Gearing.....	12mo, 1 50
Treatise on Belts and Pulleys.....	12mo, 1 50
Durley's Kinematics of Machines.....	8vo, 4 00
Flather's Dynamometers and the Measurement of Power.....	12mo, 3 00
Rope Driving.....	12mo, 2 00
Gill's Gas and Fuel Analysis for Engineers.....	12mo, 1 25
Hall's Car Lubrication.....	12mo, 1 00
Hutton's The Gas Engine. ( <i>In preparation.</i> )	
Jones's Machine Design:	
Part I.—Kinematics of Machinery.....	8vo, 1 50
Part II.—Form, Strength, and Proportions of Parts.....	8vo, 3 00
Kent's Mechanical Engineer's Pocket-book.....	16mo, morocco, 5 00
Kerr's Power and Power Transmission.....	8vo, 2 00
MacCord's Kinematics; or, Practical Mechanism.....	8vo, 5 00
Mechanical Drawing.....	4to, 4 00
Velocity Diagrams.....	8vo, 1 50
Mahan's Industrial Drawing. (Thompson.).....	8vo, 3 50
Poole's Calorific Power of Fuels.....	8vo, 3 00
Reid's Course in Mechanical Drawing.....	8vo, 2 00
Text-book of Mechanical Drawing and Elementary Machine Design..	8vo, 3 00
Richards's Compressed Air.....	12mo, 1 50
Robinson's Principles of Mechanism.....	8vo, 3 00
Smith's Press-working of Metals.....	8vo, 3 00
Thurston's Treatise on Friction and Lost Work in Machinery and Mill Work.....	8vo, 3 00
Animal as a Machine and Prime Motor, and the Laws of Energetics.	12mo, 1 00

Warren's Elements of Machine Construction and Drawing.....	8vo,	7 50
Weisbach's Kinematics and the Power of Transmission. Herrmann— Klein.).....	8vo,	5 00
Machinery of Transmission and Governors. (Herrmann—Klein.).....	8vo,	5 00
Hydraulics and Hydraulic Motors. (Du Bois.).....	8vo,	5 00
Wolff's Windmill as a Prime Mover.....	8vo,	3 00
Wood's Turbines.....	8vo,	2 50

### MATERIALS OF ENGINEERING.

Bovey's Strength of Materials and Theory of Structures.....	8vo,	7 50
Burr's Elasticity and Resistance of the Materials of Engineering. 6th Edition, Reset.....	8vo,	7 50
Church's Mechanics of Engineering.....	8vo,	6 00
Johnson's Materials of Construction.....	Large 8vo,	6 00
Keep's Cast Iron.....	8vo,	2 50
Lanza's Applied Mechanics.....	8vo,	7 50
Martens's Handbook on Testing Materials. (Henning.).....	8vo,	7 50
Merriman's Text-book on the Mechanics of Materials.....	8vo,	4 00
Strength of Materials.....	12mo,	1 00
Metcalf's Steel. A Manual for Steel-users.....	12mo,	2 00
Smith's Wire: Its Use and Manufacture.....	Small 4to,	3 00
Materials of Machines.....	12mo,	1 00
Thurston's Materials of Engineering.....	3 vols, 8vo,	8 00
Part II.—Iron and Steel.....	8vo,	3 50
Part III.—A Treatise on Brasses, Bronzes, and Other Alloys and their Constituents.....	8vo,	2 50
Text-book of the Materials of Construction.....	8vo,	5 00
Wood's Treatise on the Resistance of Materials and an Appendix on the Preservation of Timber.....	8vo,	2 00
Elements of Analytical Mechanics.....	8vo,	3 00

### STEAM-ENGINES AND BOILERS.

Carnot's Reflections on the Motive Power of Heat. (Thurston.).....	12mo,	1 50
Dawson's "Engineering" and Electric Traction Pocket-book.....	16mo, mor.,	4 00
Ford's Boiler Making for Boiler Makers.....	18mo,	1 00
Goss's Locomotive Sparks.....	8vo,	2 00
Hemenway's Indicator Practice and Steam-engine Economy.....	12mo,	2 00
Hutton's Mechanical Engineering of Power Plants.....	8vo,	5 00
Heat and Heat-engines.....	8vo,	5 00
Kent's Steam-boiler Economy.....	8vo,	4 00
Kneass's Practice and Theory of the Injector.....	8vo,	1 50
MacCord's Slide-valves.....	8vo,	2 00
Meyer's Modern Locomotive Construction.....	4to,	10 00
Peabody's Manual of the Steam-engine Indicator.....	12mo,	1 50
Tables of the Properties of Saturated Steam and Other Vapors.....	8vo,	1 00
Thermodynamics-of the Steam-engine and Other Heat-engines.....	8vo,	5 00
Valve-gears for Steam-engines.....	8vo,	2 50
Peabody and Miller's Steam-boilers.....	8vo,	4 00
Pray's Twenty Years with the Indicator.....	Large 8vo,	2 50
Pupln's Thermodynamics of Reversible Cycles in Gases and Saturated Vapors. (Osterberg.).....	12mo,	1 25
Reagan's Locomotives: Simple, Compound, and Electric.....	12mo,	2 50
Rontgen's Principles of Thermodynamics. (Du Bois.).....	8vo,	5 00
Sinclair's Locomotive Engine Running and Management.....	12mo,	2 00
Smart's Handbook of Engineering Laboratory Practice.....	12mo,	2 50
Snow's Steam-boiler Practice.....	8vo,	3 00

Spangler's Valve-gears.....	8vo,	2 50
Notes on Thermodynamics.....	12mo,	1 00
Spangler, Greene, and Marshall's Elements of Steam-engineing.....	8vo,	3 00
Thurston's Handy Tables.....	8vo,	1 50
Manual of the Steam-engine.....	2 vols. 8vo,	10 00
Part I.—History, Structure, and Theory.....	8vo,	6 00
Part II.—Design, Construction, and Operation.....	8vo,	6 00
Handbook of Engine and Boiler Trials, and the Use of the Indicator and the Prony Brake.....	8vo,	5 00
Stationary Steam-engines.....	8vo,	2 50
Steam-boiler Explosions in Theory and in Practice.....	12mo,	1 50
Manual of Steam-boilers, Their Designs, Construction, and Operation.....	8vo,	5 00
Weisbach's Heat, Steam, and Steam-engines. (Du Bois.).....	8vo,	5 00
Whitham's Steam-engine Design.....	8vo,	5 00
Wilson's Treatise on Steam-boilers. (Flather.).....	16mo,	2 50
Wood's Thermodynamics, Heat Motors, and Refrigerating Machines.....	8vo,	4 00

## MECHANICS AND MACHINERY.

Barr's Kinematics of Machinery.....	8vo,	2 50
Bovey's Strength of Materials and Theory of Structures.....	8vo,	7 50
Chase's The Art of Pattern-making.....	12mo,	2 50
Chordal.—Extracts from Letters.....	12mo,	2 00
Church's Mechanics of Engineering.....	8vo,	6 00
Notes and Examples in Mechanics.....	8vo,	2 00
Compton's First Lessons in Metal-working.....	12mo,	1 50
Compton and De Groodt's The Speed Lathe.....	12mo,	1 50
Cromwell's Treatise on Toothed Gearing.....	12mo,	1 50
Treatise on Belts and Pulleys.....	12mo,	1 50
Dana's Text-book of Elementary Mechanics for the Use of Colleges and Schools.....	12mo,	1 50
Dingey's Machinery Pattern Making.....	12mo,	2 00
Dredge's Record of the Transportation Exhibits Building of the World's Columbian Exposition of 1893.....	4to, half morocco,	5 00
Du Bois's Elementary Principles of Mechanics:		
Vol. I.—Kinematics.....	8vo,	3 50
Vol. II.—Statics.....	8vo,	4 00
Vol. III.—Kinetics.....	8vo,	3 50
Mechanics of Engineering. Vol. I.....	Small 4to,	7 50
Vol. II.....	Small 4to,	10 00
Durley's Kinematics of Machines.....	8vo,	4 00
Fitzgerald's Boston Machinist.....	16mo,	1 00
Flather's Dynamometers, and the Measurement of Power.....	12mo,	3 00
Rope Driving.....	12mo,	2 00
Goss's Locomotive Sparks.....	8vo,	2 00
Hall's Car Lubrication.....	12mo,	1 00
Holly's Art of Saw Filing.....	18mo	75
* Johnson's Theoretical Mechanics.....	12mo,	3 00
Statics by Graphic and Algebraic Methods.....	8vo,	2 00
Jones's Machine Design:		
Part I.—Kinematics of Machinery.....	8vo,	1 50
Part II.—Form, Strength, and Proportions of Parts.....	8vo,	3 00
Kerr's Power and Power Transmission.....	8vo,	2 00
Lanza's Applied Mechanics.....	8vo,	7 50
MacCord's Kinematics; or, Practical Mechanism.....	8vo,	5 00
Velocity Diagrams.....	8vo,	1 50
Maurer's Technical Mechanics. ( <i>In preparation.</i> )		

Merriman's Text-book on the Mechanics of Materials . . . . .	8vo,	4 00
* Michie's Elements of Analytical Mechanics . . . . .	8vo,	4 00
Reagan's Locomotives: Simple, Compound, and Electric . . . . .	12mo,	2 50
Reid's Course in Mechanical Drawing . . . . .	8vo,	2 00
Text-book of Mechanical Drawing and Elementary Machine Design . . . . .	8vo,	3 00
Richards's Compressed Air . . . . .	12mo,	1 50
Robinson's Principles of Mechanism . . . . .	8vo,	3 00
Ryan, Norris, and Hoxie's Electrical Machinery. ( <i>In preparation.</i> )		
Sinclair's Locomotive-engine Running and Management . . . . .	12mo,	2 00
Smith's Press-working of Metals . . . . .	8vo,	3 00
Materials of Machines . . . . .	12mo,	1 00
Spangler, Greene, and Marshall's Elements of Steam-engineering . . . . .	8vo,	3 00
Thurston's Treatise on Friction and Lost Work in Machinery and Mill Work . . . . .	8vo,	3 00
Animal as a Machine and Prime Motor, and the Laws of Energetics . . . . .	12mo,	1 00
Warren's Elements of Machine Construction and Drawing . . . . .	8vo,	7 50
Weisbach's Kinematics and the Power of Transmission. (Herrmann— Klein.) . . . . .	8vo,	5 00
Machinery of Transmission and Governors. (Herrmann—Klein.) . . . . .	8vo,	5 00
Wood's Elements of Analytical Mechanics . . . . .	8vo,	3 00
Principles of Elementary Mechanics . . . . .	12mo,	1 25
Turbines . . . . .	8vo,	2 50
The World's Columbian Exposition of 1893 . . . . .	4to,	1 00

## METALLURGY.

Egleston's Metallurgy of Silver, Gold, and Mercury:		
Vol. I.—Silver . . . . .	8vo,	7 50
Vol. II.—Gold and Mercury . . . . .	8vo,	7 50
** Iles's Lead-smelting. (Postage 0 cents additional.) . . . . .	12mo,	2 50
Keep's Cast Iron . . . . .	8vo,	2 50
Kunhardt's Practice of Ore Dressing in Europe . . . . .	8vo,	1 50
Le Chatelier's High-temperature Measurements. (Boudouard—Burgess.) . . . . .	12mo,	3 00
Metcalf's Steel. A Manual for Steel-users . . . . .	12mo,	2 00
Smith's Materials of Machines . . . . .	12mo,	1 00
Thurston's Materials of Engineering. In Three Parts . . . . .	8vo,	8 00
Part II.—Iron and Steel . . . . .	8vo,	3 50
Part III.—A Treatise on Brasses, Bronzes, and Other Alloys and their Constituents . . . . .	8vo,	2 50
Ulke's Modern Electrolytic Copper Refining . . . . .	8vo,	3 00

## MINERALOGY.

Barringer's Description of Minerals of Commercial Value. Oblong, morocco . . . . .	2 50	
Boyd's Resources of Southwest Virginia . . . . .	8vo,	3 00
Map of Southwest Virginia . . . . .	Pocket-book form,	2 00
Brush's Manual of Determinative Mineralogy. (Penfield.) . . . . .	8vo,	4 00
Chester's Catalogue of Minerals . . . . .	8vo, paper,	1 00
Cloth . . . . .		1 25
Dictionary of the Names of Minerals . . . . .	8vo,	3 50
Dana's System of Mineralogy . . . . .	Large 8vo, half leather,	12 50
First Appendix to Dana's New "System of Mineralogy." . . . .	Large 8vo,	1 00
Text-book of Mineralogy . . . . .	8vo,	4 00
Minerals and How to Study Them . . . . .	12mo,	1 50
Catalogue of American Localities of Minerals . . . . .	Large 8vo,	1 00
Manual of Mineralogy and Petrography . . . . .	12mo,	2 00
Egleston's Catalogue of Minerals and Synonyms . . . . .	8vo,	2 50
Hussak's The Determination of Rock-forming Minerals. (Smith.) Small 8vo, . . . . .	2 00	

* Penfield's Notes on Determinative Mineralogy and Record of Mineral Tests.	8vo, paper,	0 50
Rosenbusch's Microscopical Physiography of the Rock-making Minerals. (Iddings.)	8vo,	5 00
* Tillman's Text-book of Important Minerals and Docks.	8vo,	2 00
Williams's Manual of Lithology.	8vo,	3 00

## MINING.

Beard's Ventilation of Mines.	12mo,	2 50
Boyd's Resources of Southwest Virginia.	8vo,	3 00
Map of Southwest Virginia.	Pocket-book form,	2 00
* Drinker's Tunneling, Explosive Compounds, and Rock Drills.	4to, half morocco,	25 00
Eissler's Modern High Explosives.	8vo,	4 00
Fowler's Sewage Works Analyses.	12mo,	2 00
Goodyear's Coal-mines of the Western Coast of the United States.	12mo,	2 50
Ihlseng's Manual of Mining.	8vo,	4 00
** Iles's Lead-smelting. (Postage 9c. additional.)	12mo,	2 50
Kunhardt's Practice of Ore Dressing in Europe.	8vo,	1 50
O'Driscoll's Notes on the Treatment of Gold Ores.	8vo,	2 00
* Walke's Lectures on Explosives.	8vo,	4 00
Wilson's Cyanide Processes.	12mo,	1 50
Chlorination Process.	12mo,	1 50
Hydraulic and Placer Mining.	12no,	2 00
Treatise on Practical and Theoretical Mine Ventilation.	12no,	1 25

## SANITARY SCIENCE.

Copeland's Manual of Bacteriology. ( <i>In preparation.</i> )		
Folwell's Sewerage. (Designing, Construction, and Maintenance.)	8vo,	3 00
Water-supply Engineering.	8vo,	4 00
Fuertes's Water and Public Health.	12mo,	1 50
Water-filtration Works.	12mo,	2 50
Gerhard's Guide to Sanitary House-inspection.	16mo,	1 00
Goodrich's Economical Disposal of Town's Refuse.	Demy 8vo,	3 50
Hazen's Filtration of Public Water-supplies.	8vo,	3 00
Kiersted's Sewage Disposal.	12mo,	1 25
Leach's The Inspection and Analysis of Food with Special Reference to State Control. ( <i>In preparation.</i> )		
Mason's Water-supply. (Considered Principally from a Sanitary Standpoint.) 3d Edition, Rewritten.	8vo,	4 00
Examination of Water. (Chemical and Bacteriological.)	12mo,	1 25
Merriman's Elements of Sanitary Engineering.	8vo,	2 00
Nichols's Water-supply. (Considered Mainly from a Chemical and Sanitary Standpoint.) (1883.)	8vo,	2 50
Ogden's Sewer Design.	12mo,	2 00
* Price's Handbook on Sanitation.	12mo,	1 50
Richards's Cost of Food. A Study in Dietaries.	12mo,	1 00
Cost of Living as Modified by Sanitary Science.	12mo,	1 00
Richards and Woodman's Air, Water, and Food from a Sanitary Standpoint.	8vo,	2 00
* Richards and Williams's The Dietary Computer.	8vo,	1 50
Rideal's Sewage and Bacterial Purification of Sewage.	8vo,	3 50
Turneure and Russell's Public Water-supplies.	8vo,	5 00
Whipple's Microscopy of Drinking-water.	8vo,	3 50
Woodhull's Notes and Military Hygiene.	16mo,	1 50

## MISCELLANEOUS.

Barker's Deep-sea Soundings . . . . .	8vo,	2 00
Emmons's Geological Guide-book of the Rocky Mountain Excursion of the International Congress of Geologists . . . . .	Large 8vo,	1 50
Ferrel's Popular Treatise on the Winds . . . . .	8vo,	4 00
Haines's American Railway Management . . . . .	12mo,	2 50
Mott's Composition, Digestibility, and Nutritive Value of Food. Mounted chart.		1 25
Fallacy of the Present Theory of Sound . . . . .	16mo,	1 00
Ricketts's History of Rensselaer Polytechnic Institute, 1824-1894. Small	8vo,	3 00
Rotherham's Emphasized New Testament . . . . .	Large 8vo,	2 00
Steel's Treatise on the Diseases of the Dog . . . . .	8vo,	3 50
Totten's Important Question in Metrology . . . . .	8vo,	2 50
The World's Columbian Exposition of 1893 . . . . .	4to,	1 00
Worcester and Atkinson. Small Hospitals, Establishment and Maintenance, and Suggestions for Hospital Architecture, with Plans for a Small Hospital . . . . .	12mo,	1 25

## HEBREW AND CHALDEE TEXT-BOOKS.

Green's Grammar of the Hebrew Language . . . . .	8vo,	3 00
Elementary Hebrew Grammar . . . . .	12mo,	1 25
Hebrew Chrestomathy . . . . .	8vo,	2 00
Gesenius's Hebrew and Chaldee Lexicon to the Old Testament Scriptures. (Tregelles.) . . . . .	Small 4to, half morocco,	5 00
Letteris's Hebrew Bible . . . . .	8vo,	2 25













LIBRARY OF CONGRESS



0 003 320 762 1

