

DEPARTMENT OF COMMERCE

CIRCULAR
OF THE
BUREAU OF STANDARDS

S. W. STRATTON, DIRECTOR

No. 17

MAGNETIC TESTING

[3d Edition]
Issued March 18, 1916



WASHINGTON
GOVERNMENT PRINTING OFFICE
1916

CIRCULARS

2. Measurements of Length and Area, including Thermal Expansion.
3. Verification of Standards of Mass.
4. Verification of Standards of Capacity.
5. Testing of Clinical Thermometers.
6. Fees for Electric, Magnetic, and Photometric Testing.
7. Pyrometer Testing and Heat Measurements.
8. Testing of Thermometers.
9. Testing of Glass Volumetric Apparatus.
10. Legal Weights (in pounds) per Bushel of Various Commodities.
11. The Standardization of Bomb Calorimeters.
13. Standard Specifications for the Purchase of Incandescent Electric Lamps.
14. Samples of Analyzed Irons and Steels—Methods of Analysis.
15. The International Unit of Light.
16. The Testing of Hydrometers.
17. Magnetic Testing.
18. Standard Gage for Sheet and Plate Iron and Steel.
19. Standard Density and Volumetric Tables.
20. Electrical Measuring Instruments.
21. Precision Measurements of Resistance and Electromotive Force.
22. Standard Specifications for Transformers, Oil-immersed, Self-cooled, 60-cycle, 2200 Volts.
23. Standardization of Electrical Practice in Mines.
24. Publications of the Bureau of Standards.
25. Standard Analyzed Samples—General Information.
26. Analyzed Iron and Manganese Ores—Methods of Analysis.
27. The Testing and Properties of Optical Instruments.
28. The Determination of the Optical Properties of Materials.
29. Announcement of a Change in the Value of the International Volt.
30. Lime: Its Properties and Uses.
31. Copper Wire Tables.
32. Standards for Gas Service.
33. United States Government Specification for Portland Cement.
34. The Relation of the Horsepower to the Kilowatt.
35. Melting Points of Chemical Elements and Other Standard Temperatures.
36. The Testing and Properties of Electric Condensers.
37. Electric Wire and Cable Terminology.
38. The Testing of Rubber Goods.
39. Specifications for and Measurement of Standard Sieves.
40. Sodium Oxalate as a Standard in Volumetric Analysis.
41. Testing and Properties of Textile Materials.
42. Metallographic Testing.
43. The Metric Carat.
44. Polarimetry.
45. The Testing of Materials.
46. The Testing of Barometers.
47. Units of Weight and Measure; Definitions and Tables of Equivalents.
48. Standard Methods of Gas Testing.
49. Safety Rules to be Observed in the Operation of Electrical Equipment and Lines.
50. National Standard Hose Couplings and Fittings for Public Fire Service.
51. Measurement of Time and Tests of Timepieces.
52. Regulation of Electrotyping Solutions.
53. The Composition, Properties, and Testing of Printing Inks.
54. Proposed National Electrical Safety Code.
55. Measurements for the Household.
56. Standards for Electric Service.
57. United States Standard Tables for Petroleum Oils.

DEPARTMENT OF COMMERCE

CIRCULAR
OF THE
BUREAU OF STANDARDS

S. W. STRATTON, DIRECTOR

No. 17

MAGNETIC TESTING

[3d Edition]

Issued March 18, 1916



WASHINGTON
GOVERNMENT PRINTING OFFICE

1916

ADDITIONAL COPIES
OF THIS PUBLICATION MAY BE PROCURED FROM
THE SUPERINTENDENT OF DOCUMENTS
GOVERNMENT PRINTING OFFICE
WASHINGTON, D. C.
AT
15 CENTS PER COPY

MAGNETIC TESTING

CONTENTS

	Page
I. Scope of circular.....	4
II. Magnetic quantities.....	4
1. Induction.....	4
Normal induction.....	5
Hysteresis loop.....	6
Selection of test points.....	8
2. Magnetizing force.....	9
3. Core loss.....	10
III. Scope of magnetic testing.....	10
1. Normal induction and hysteresis.....	10
Rods and castings.....	10
Sheet metal.....	10
Standard data.....	11
2. Core loss.....	11
Form of specimen.....	11
Standard data.....	12
3. Susceptibility.....	12
4. Permanent magnets.....	12
5. Magnetic apparatus.....	12
IV. Measurement of normal induction and hysteresis using the Burrows permeameter.....	12
1. The magnetic circuit.....	12
2. Electrical connections.....	13
3. Ballistic galvanometer adjustment.....	15
4. Normal induction.....	15
5. Hysteresis data.....	17
6. Special switch and manipulations.....	20
Normal induction.....	22
Hysteresis.....	22
7. Form of record.....	23
V. Measurement of core loss.....	23
A. The Lloyd apparatus and procedure.....	23
1. Apparatus.....	23
2. Procedure.....	31
3. Separation of eddy-current and hysteresis losses.....	32
B. The A. S. T. M. apparatus and procedure.....	33
VI. Empirical formulas.....	36
1. Induction.....	36
2. Hysteresis loop.....	37
3. Core losses.....	37
4. Exponents and the ratio of variation.....	37
VII. Typical curves and data.....	44
VIII. Publications on magnetic subjects.....	50

I. SCOPE OF CIRCULAR

This circular deals with the fundamental magnetic quantities, with empirical formulas giving the relations between these quantities, with typical data of magnetic materials, and with the methods of magnetic measurements employed at the Bureau of Standards.

An effort has been made to include in the circular as much as possible of the general information regarding magnetic subjects which the Bureau from time to time has been called upon to furnish.

II. MAGNETIC QUANTITIES

1. INDUCTION

The induction B in a bar of iron or steel is defined in terms of the quantity of electricity which flows through a test coil closely encircling the specimen when the magnetization in the bar is removed, by the formula

$$B = \frac{QR}{AN} 10^8$$

where Q = total quantity of electricity in coulombs.

R = resistance in ohms.

A = cross section of specimen in square centimeters.

N = number of turns in test coil.

The unit of induction is called the gauss.

The induction may also be defined in terms of the emf induced in a coil when the flux encircled by the coil is changing, by the formula

$$e = AN \frac{dB}{dt}$$

when e is the emf induced in the coil by the changing flux.

If the induction varies according to the sine law, this equation reduces to

$$E = 4.44 BANn \times 10^{-8}$$

where E is the effective emf and n is the frequency. This latter formula is the one commonly used in transformer design.

The induction which a bar of iron or steel will assume under a given magnetizing force depends upon the previous magnetic condition of the specimen and upon the rate of change from one

magnetic state to another. It is modified by the presence of mechanical vibration and depends to some extent on temperature. It is therefore desirable to state the conditions under which the test is made.

All the ordinary tests on magnetic material except aging are made at a constant temperature of 25° C. This is in view of the fact that all the magnetic quantities, including the normal induction, the hysteresis loop, and the losses due to hysteresis and eddy currents, depend upon the temperature of the specimen. The relation is not a simple one and is not the same for all materials. In view of these facts it seems desirable to make all such measurements at a fixed temperature.

It is important that there be no mechanical vibration of the specimen during the test. Such vibrations tend to give an induction greater than normal for increasing magnetizing forces, and too small values for decreasing forces. Hence, the test specimen is always protected from mechanical vibrations in ballistic measurements.

The results found for rolled sheets usually depend upon whether the material is magnetized parallel to the direction of rolling or at right angles to this direction. When not otherwise specified and the dimensions of sheets submitted permit it, the test pieces will be so cut that the flux traverses half of them parallel to the direction of rolling, and half normal thereto.

The measurement of flux density requires a knowledge of the cross-sectional area of the specimen. For rods and bars the cross section is determined from the dimensions. In sheet metal, however, it is not determined by direct measurement, but from values of mass, length, and density. The density of each specimen is experimentally determined, as experience shows that the assumption of any specified value introduces an uncertainty in the result which is greater than the inaccuracy of the magnetic measurements.

NORMAL INDUCTION.—If a bar of thoroughly demagnetized iron is subjected to a magnetizing force, it experiences a certain induction. This induction will be greater if the magnetizing force is applied suddenly than for a slower growth of magnetizing current. If the magnetizing force is repeatedly applied and removed, the values of the induction obtained differ somewhat.

If the magnetizing force is reversed, a change of induction approximately twice the preceding values is obtained. For the first few reversals the change of induction is not constant, but becomes so after a large number of reversals. One-half this constant value of the change in induction on reversal of the magnetizing force is the normal induction, and the locus of such points is the curve of normal induction.

The magnetic properties of a piece of iron or steel may be considered as defined by the curves of normal induction and hysteresis. Before determining the normal induction data, it is necessary that the specimen be freed from its previous magnetization. This is accomplished by subjecting it to a cyclic magnetizing force of one period per second, which is gradually reduced from an initial value, which carries the induction well beyond the point of maximum permeability to a final value somewhat lower than the lowest induction to be studied.

After thorough demagnetization, the lowest magnetizing force to be used is applied and reversed many times, until the iron is brought to a cyclic magnetic state. The induction is then measured and the next higher value of the magnetizing force applied in the same manner. This process is repeated until the required number of points is determined. This is a somewhat laborious operation, but has been found necessary in order to obtain reliable results.

HYSTERESIS LOOP.—Before determining the hysteresis loop, the iron is demagnetized as above, and the magnetizing force is applied and increased until the iron is brought up to the maximum induction for which the loop is required. This magnetizing force is repeatedly reversed until the iron is in a normal condition. The magnetizing force is now reduced from its maximum value to a lower one, and the change in magnetic induction corresponding to the change in force is noted. After determining this pair of values, the maximum magnetizing force is again applied and the iron once more brought back to a normal magnetic condition. It is not necessary, however, to repeat the process of demagnetization. Another point is then determined in the same manner as the first. Points corresponding to negative values of the magnetizing force are obtained by simultaneously reversing and reducing

the magnetizing force. Before each determination of a point on the loop the iron is brought back to its normal condition.

This method of measuring the magnetic constants differs somewhat from the old "step by step" method, which is still employed in many of the modern commercial permeameters. It has the advantage of making the measurement under more nearly the same conditions that occur in commercial practice, and is prac-

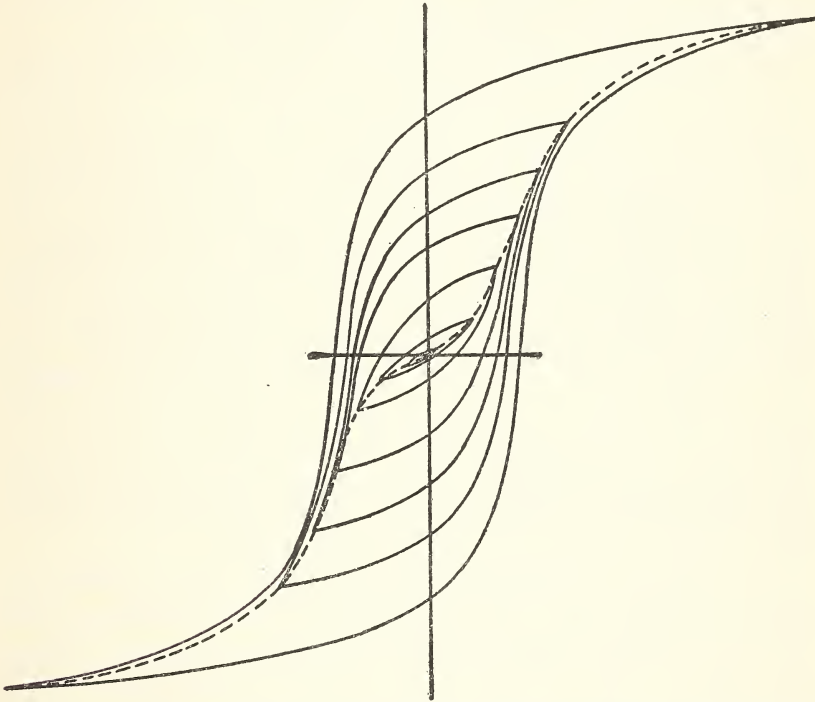

FIG. 1.—Showing that the curve of normal induction is the locus of the tips of the hysteresis loops

tically free from the effects of magnetic viscosity. Further, it is possible to get more consistent results by this method than by the older one, as the effects of imperfect initial demagnetization are not so serious. The numerical data obtained by these two methods are not identical, and in publishing results of work of the highest precision it is desirable to specify the method of measurement.

The relation between the hysteresis loop and the curve of normal induction is shown by Figure 1.

The locus of the tips of the hysteresis loops is the curve of normal induction.

SELECTION OF TEST POINTS.—In defining the magnetic properties of a bar of iron or steel, it is neither necessary nor practicable to give complete normal and hysteresis data for all values of the magnetizing force. Certain data may be chosen as characteristic and the magnetic properties inferred from these

The upper limit of the magnetizing force to be applied is determined by the heating of the magnetizing coil. The magnetic constants for high values of the magnetizing force change slowly and quite regularly, and for a considerable range may be obtained by extrapolation from the data of lower magnetizations. However, magnetizing forces up to 300 gaussses can be employed in the usual testing apparatus without undue heating of the coils. This upper limit of 300 has reference to the magnetizing force employed in the determination of normal induction data. It is not desirable to carry the cyclic induction measurements through such a wide range. A single hysteresis loop having a maximum induction of 10 000 gaussses gives a close index to the hysteretic properties at all inductions. In some cases it might be desirable to supplement these data by the residual induction and coercive force at other values of the maximum induction.

It is, of course, desirable that the number of observations be as small as possible and yet yield the required continuity of data. For most purposes the magnetizing forces required to produce inductions of 5000, 10 000, 15 000, and 20 000 indicate clearly enough the shape of the normal induction curve. If one is interested in some particular range, measurements in this region could be taken closer together—for instance, every 1000 gaussses—or the measurements may be confined to one particular region. A single pair of data may be sufficient for some purposes.

In the hysteresis data, likewise, the labor of measurement is reduced to a minimum by drawing the curve from the three principal points, namely, the tip of the magnetic cycle, the residual induction remaining when the magnetizing force is removed, and

the coercive force or the magnetizing force required to reduce the induction to zero.

Such a determination of four points on the normal induction curve and three points on the hysteresis curve gives a fair idea of the magnetic properties of a sample of iron. If several specimens are thus examined at corresponding points, it is possible to make comparisons of the different specimens and classify them into different grades without drawing complete induction curves, as would be necessary if the different specimens are tested at irregular points.

2. MAGNETIZING FORCE

The magnetizing force, or magnetic field intensity, at any point is numerically equal to the mechanical force acting upon a unit magnetic pole at that point. In magnetic testing the magnetizing force is generally produced by means of a solenoid carrying current. At the center of a very long, uniformly wound solenoid of N turns on a length L , carrying current of I amperes, the magnetizing force due to the current in the solenoid in cgs electromagnetic units is

$$H = 0.4 \pi \frac{N}{L} I$$

This is the total magnetizing force only when there are no free magnetic poles in or near the solenoid. The unit is called the gauss or the gilbert per centimeter.

Another unit in use is the ampere-turn per centimeter, which is 1.257 times the gilbert per centimeter. In ampere-turns per centimeter, $H = \frac{N}{L} I$, subject to the same restrictions as the formula above. The names, ampere-turn per centimeter, and to a less degree the gilbert per centimeter are somewhat misleading. It is only in special cases, such as within a uniformly wound and practically infinite solenoid or a uniformly wound toroid, that the "ampere-turns per centimeter" of magnetizing force are equal to the product of the number of amperes by the number of turns per centimeter. In all other cases the magnetizing force in this unit is the product of the number of amperes by the number of turns per centimeter of the infinite solenoid which produces the same magnetic field at its center that exists at the point considered.

3. CORE-LOSS

The core-loss is the power consumed within the iron when it is subjected to an alternating magnetization at a given frequency and induction. The standard core-loss is the total loss in watts per kilogram when the iron is subjected to an alternating magnetization of 60 cycles per second and an induction of 10 000 gauss.

III. SCOPE OF MAGNETIC TESTING

The magnetic testing¹ of the Bureau comprises the determination of the magnetic properties of materials and of permanent magnets, and the calibration of magnetic apparatus.

1. NORMAL INDUCTION AND HYSTERESIS

Normal induction and hysteresis involve the determination of normal induction, permeability, the hysteresis loop, residual induction, and coercive force.

RODS AND CASTINGS.—These should be submitted in the form of bars. Two bars of the same material are required, usually only one of which is to be tested and the second to be used as an auxiliary bar. The minimum length of the test piece is 25 cm (10 inches). Round rods may be 0.6 cm, 0.95 cm (three-eighths inch), 1 cm, or 1.27 cm (one-half inch) in diameter. Bars of any rectangular cross section which will pass through a hole 1 cm by 5 cm may be submitted.

For material to be used for electromagnets, field cores, etc., the usual test rod is 25 cm (10 inches) long and 1.27 cm (one-half inch) in diameter. Magnet steel is usually submitted in sizes as rolled and 25 cm long. Magnet steel may be hardened either by the submitter of the test or by the Bureau.

SHEET METAL.—Sheet metal may be submitted in either of two forms:

1. One form consists of 5 kg of strips 50 cm by 3 cm, half cut parallel and half cut at right angles to the direction of rolling.

2. The second form consists of 10 sheets approximately 30 cm (12 inches) square. These are cut at the Bureau into strips 5 cm by 25.4 cm, half parallel and half at right angles to the direction of rolling. Test material is usually submitted in this form.

¹ A schedule of fees for electric, magnetic, and photometric testing and general instructions to applicants for tests are given in Circular No. 6 of this Bureau.

The same material that is submitted for a core-loss test is also suitable for normal induction and hysteresis determinations.

In addition to the above, normal induction and hysteresis tests may be made on single strips 25 cm (10 inches) by 5 cm (2 inches). For this test, as in the case of rods, two strips of the same material are required. The final cutting to size may be made at the Bureau without extra charge. This single-strip test is intended only for investigations in which it is desired to know the characteristics of an individual strip. Core-loss determinations are not made on the single-strip sample.

STANDARD DATA.—The standard test for steel for electromagnets, etc., is the determination of the magnetizing forces corresponding to inductions of 2000, 4000, 6000, 8000, 10 000, 12 000, 14 000, 16 000, 18 000, and 20 000 gaussses, or such values as may be obtained without exceeding a magnetizing force of 300 gaussses.

The standard test for magnet steel is the determination of the magnetizing force, residual induction, and coercive force corresponding to a maximum induction of 14 000 gaussses.

2. CORE-LOSS

Core-loss tests consist of the determination of the losses due to the alternating magnetization of sheet iron and steel such as are used in transformers and armatures. They may include the separation of the total core-loss into its eddy-current and hysteresis components, and sometimes also the increase in core-loss with time, known as aging.

FORM OF SPECIMEN.—Sheet material intended for core-loss determination may be submitted in either of two forms:

1. One form consists of 10 kg of strips 50 cm by 3 cm, half cut parallel to the direction of rolling and half at right angles to the direction of rolling. These strips should be cut to size by the person submitting the material for test. It may, however, be done at the Bureau. If the cutting is to be done at the Bureau, sufficient material to allow for waste must be supplied.

2. The second form consists of 10 sheets approximately 30 cm (12 inches) square. These are cut at the Bureau into strips 5 cm by 25.4 cm, half parallel and half at right angles to the direction of rolling. Test material is usually submitted in this form.

STANDARD DATA.—The standard core-loss test is the determination of the core-loss at a maximum induction of 10 000 gaussess and a frequency of 60 cycles.

3. SUSCEPTIBILITY

Susceptibility tests involve the determination of the properties of the nonmagnetic materials such as are used in chronometers and other apparatus where magnetic material is objectionable.

4. PERMANENT MAGNETS

The testing of permanent magnets involves the determination of field strength, uniformity of field, constancy of field, and temperature coefficient.

5. MAGNETIC APPARATUS

The constants of the apparatus used in magnetic measurements are frequently incapable of calculation and even though they may be calculated should be checked up experimentally. Experimental calibrations of permeameters, fluxmeters, bismuth spirals, and test coils are made.

IV. MEASUREMENT OF NORMAL INDUCTION AND HYSTERESIS, USING THE BURROWS PERMEAMETER

Standard normal induction and hysteresis data on straight bars are obtained with the Burrows permeameter, which is described below.

1. THE MAGNETIC CIRCUIT

The magnetic circuit for this permeameter consists of two bars and two yokes joined together in the form of a rectangle. The leakage over the middle portion of one of the bars is reduced to zero by proper distribution of the magnetomotive force. With no leakage over the middle portion of the test bar, the magnetizing force may be calculated from the current and the concentration of the magnetizing winding at that point.

Fig. 2 shows the magnetic circuit in detail, together with the method of distributing the magnetomotive force. The bars should be of the same size and material. They are joined at the ends by soft-iron yokes, which make good magnetic joints, and thereby reduce the leakage to a minimum.

The magnetomotive force is applied in three sections—one over the test bar, one over the auxiliary bar, and the third distributed over the four joints. The currents in these three sections are independently adjustable. The test coils indicated by t , a , and j are each of the same number of turns and distributed as shown in the figure; t is wound over the middle of the test bar, a over the middle of the auxiliary bar, and j is wound half over one end and half over the other end of the test bar far enough away from the yokes and joints to avoid any disturbances from these causes.

2. ELECTRICAL CONNECTIONS

Fig. 3 shows diagrammatically the electrical connections both of the magnetizing and test circuits. T , A , and J refer to the

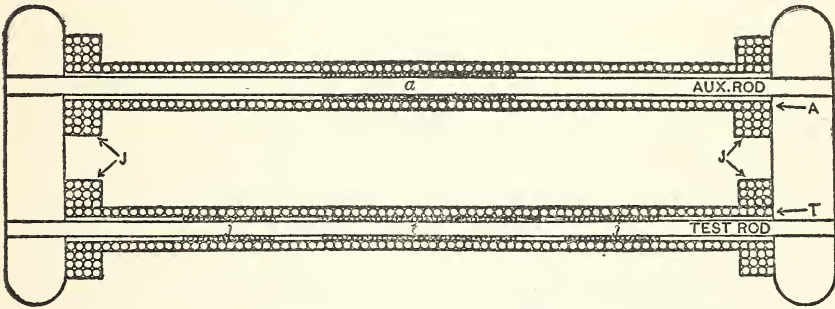

FIG. 2.—Showing the magnetic circuit of the Burrows permeameter and the relative positions of the magnetizing and test coils

magnetizing coils, and M is the primary of a variable mutual inductance; t , a , and j refer to the test coils, and m is the secondary of the mutual inductance. ST , SJ , and SM are reversing switches for the corresponding circuits. ST reverses the current in both T and A . The operation of KT is to connect the resistance $R'T$ around the contact b and then open this contact, thus inserting the resistance $R'T$ without opening the circuit. KJ and K_1A operate in a similar manner. K_2A connects the resistance $R'A$ par. in parallel with RA .

In the secondary or test circuit the dial switch SD connects the galvanometer to the test coil t in opposition to either a , j , or m . With the switch SS thrown to the right the galvanometer is at its maximum sensitivity. With this switch thrown to the left

the resistance RG ser. is placed in series with the test coils and RG par. is placed in parallel with the galvanometer, so that the

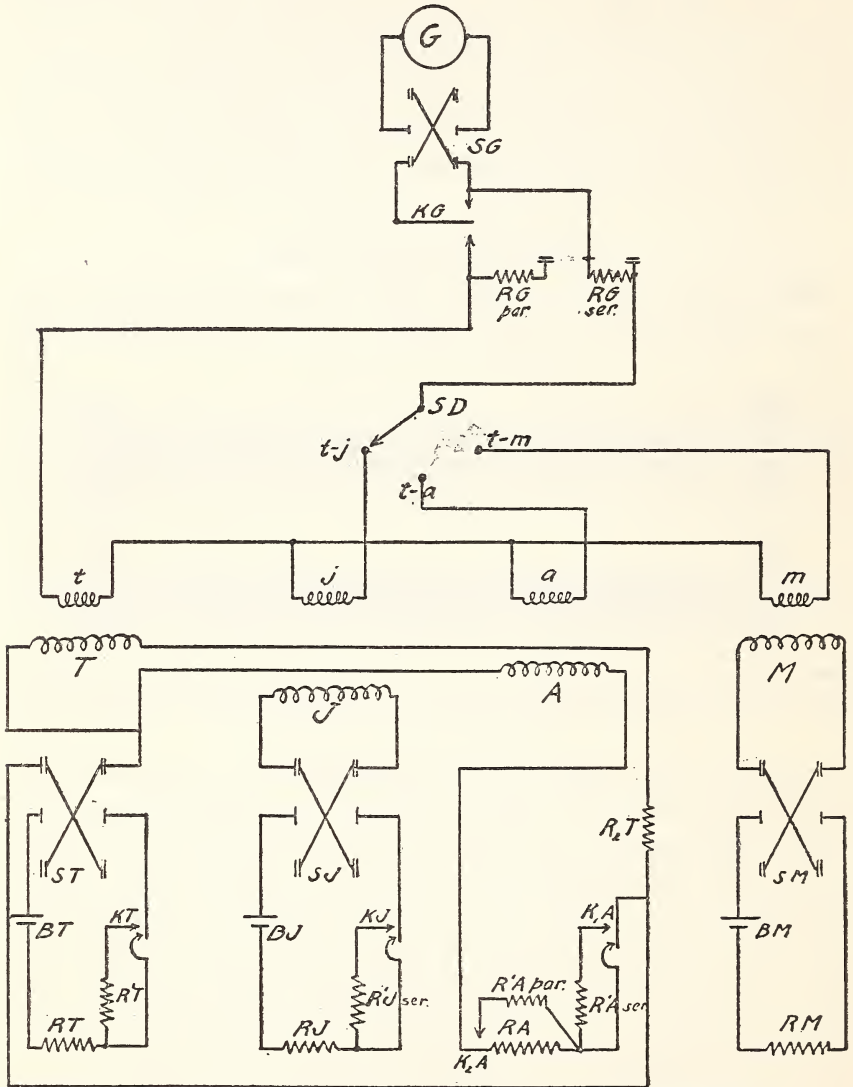

FIG. 3.—Showing electrical connections of the Burrows permeameter

galvanometer can be adjusted to work under critical damping and at a reduced sensitivity.

3. BALLISTIC GALVANOMETER ADJUSTMENT

The galvanometer is calibrated by means of a variable mutual inductance, the secondary of which is always in the galvanometer circuit. This mutual inductance can be set to such a value that the effect on the galvanometer of the reversal of 1 ampere in the primary is the same as the reversal of an induction of 10 000 gaussess through the test coil. Thus, when equal deflections are produced by the reversal of 1 ampere in the primary of the mutual inductance and 10 000 gaussess through the test coil we have the relation

$$B = 10\,000\ I$$

where I is the current in amperes in the primary of the mutual inductance and B is the induction in gaussess in the test bar that will produce the same effect. The value of mutual inductance for this relation is

$$M = AN_2 \times 10^{-4}$$

where A is the cross section of the test specimen in square centimeters, N_2 is the number of turns in the test coil, and M is the mutual inductance in henries. If the test coil has 100 turns, then

$$M = 0.01\ A$$

When the mutual inductance has been set to the proper value and with switch SS on low sensitivity the resistances RG ser. and RG par. are adjusted so that the galvanometer has approximately critical damping and the deflection is 10 cm upon reversal of 0.1 ampere in the mutual inductance primary; 1 cm deflection then corresponds to $B = 100$.

4. NORMAL INDUCTION

For the determination of normal induction the bars are inserted in the coils and the yokes clamped in place. They are then demagnetized by repeated reversals of a successively decreasing magnetizing current. This demagnetizing current is gradually reduced from a maximum value which brings the magnetization well above the knee of the curve to a point lower than the lowest value to be used. The frequency of reversal is one or two per second. There should be no current in the J coils during demagnetization. After demagnetization, the lowest magnetizing cur-

rent to be used is set and adjustments made as follows: With *SS* on low sensitivity and *SD* on $t-a$, adjust *RA* till upon reversal there is no residual deflection. When adjustment is nearly complete, *SS* is thrown to high sensitivity and adjustment completed; *SD* is then turned to $t-j$ and the current in *J* adjusted until the galvanometer shows no residual deflection when the main and compensating currents are simultaneously reversed. These two adjustments are repeated until both are in adjustment at the same time. The reversals of the magnetizing current during the adjustment are usually sufficient to reduce the iron to a magnetically cyclic state. If necessary, however, a few additional reversals may be made after the adjustment is complete.

When adjustment is obtained for $t-a$ and $t-j$, *SD* is thrown to $t-m$ and *SS* thrown to low sensitivity and a deflection is taken by reversing simultaneously the magnetizing currents and the current in the primary of the mutual inductance. The deflection should be small and in the direction due to t . The induction is then obtained by adding the value corresponding to the current in the mutual inductance primary to that indicated by the deflection. This procedure is preferable to a strictly null method because of the difference in time constants of the mutual inductance circuit and the circuit encircling the iron. The galvanometer index will always show a more or less complex kick which is difficult to interpret. The magnetizing force is given by the formula

$$H = 0.4 \pi n I$$

where n is the number of turns per centimeter along the length of the magnetizing solenoid and I is the magnetizing current in amperes. The standard magnetizing coils used at the Bureau are wound so that

$$H = 100 I$$

Since the test coil has an area somewhat greater than that of the specimen, the observed induction is too great. The correction to be subtracted is $\frac{a-A}{A} H$, where a is the area of the test coil and A is the cross section of the specimen.

Other points on the normal induction curve are obtained in a similar manner. It is not necessary to repeat the demagnetiza-

tion in the determination of successive points at magnetizing forces greater than the preceding. However, if it should be necessary to make a determination at a magnetizing force less than the preceding, demagnetization is necessary.

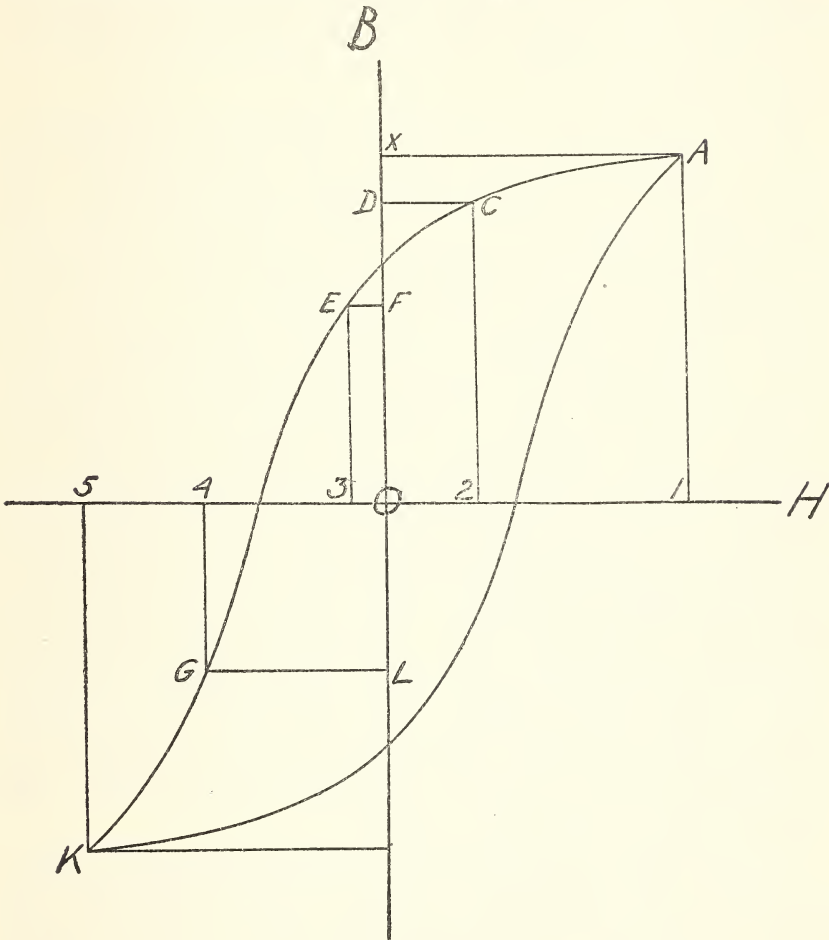

FIG. 4

5. HYSTERESIS DATA

The determination of a hysteresis loop can perhaps be best understood by reference to Fig. 4. Where the iron has been brought to the induction chosen for the tip of the loop and the

cyclic state established its condition is represented by the point A . The magnetizing force is then O_1 and the induction is OX . If the magnetizing force is reversed, the iron is carried along the magnetic path represented by $A E K$ to the point K , where the magnetizing force and induction are each of the same magnitude, but opposite in direction. The change in induction is twice the induction at the tip.

Instead of reversing the magnetizing force we may reduce it to a value represented by the point C . The reduced magnetizing force is then O_2 and the corresponding induction OD . The change in induction which is the quantity indicated by the test coil is then represented by XD . If the apparatus is calibrated to read induction in taking normal induction data by reversals, the readings in each case are to be multiplied by 2 to give the value of change in induction. The value of the induction at any point is the induction at the tip minus the change in induction. Points at the left of the OB axis are obtained by reversing the direction of the magnetizing force at the same time that it is reduced in value. If the change in induction is greater than the induction at the tip, it indicates that the flux has changed in sign as well as in magnitude as at the point G . It is obvious that if the auxiliary bar is not identical with the test bar it may have a loop quite different in shape. This means in general that the ratio of the A current to the T current will not be the same for other points on the loop as for the tip. Besides this the J compensation current will be different at other points. The compensations at the lower points will be correct when in going from the tip there is the same change in induction under the a and j test coils that there is under the t test coil.

The adjustment for compensation is accomplished in the following manner: The adjustment is first made for the tip of the loop and the iron brought to the cyclic state. With switch SD on the point $t-a$ (see Fig. 2) reduce the magnetizing current by closing the switch KT and note the galvanometer deflection. Return to the tip by opening key KT and reverse a few times to regain the cyclic condition. Adjust $R'A$ ser. and $R'A$ par. and operate K_1A and K_2A simultaneously with KT . If there is still a residual deflection, go back to the tip, bring the iron to cyclic state, and try again with a new adjustment of $R'A$ ser. and $R'A$ par. This

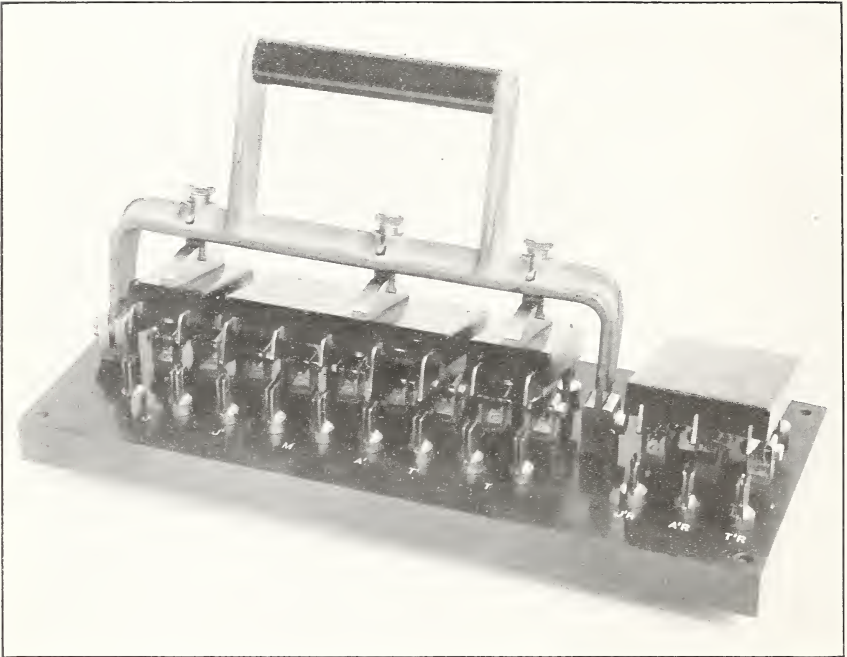

FIG. 5.—*Photograph of special gang switch for Burrows permeameter*

procedure is repeated until upon dropping from the tip there is no residual deflection. (Note that it is possible to make $R'A$ ser. = 0 or $R'A$ par. = ∞ .) Then with switch SD on the point $t-j$ follow out the same course, operating KT , K_1A , K_2A , and KJ simultaneously and making the adjustments with $K'J$. It must be noted that a change of one adjustment may change the other, and it will be necessary to check back and forth from $t-a$ to $t-j$ till both adjustments are good.

The final adjustments are always to be made with the galvanometer at its maximum sensitivity. The reading is taken with switch SD on the point $t-m$ and galvanometer on low sensitivity by operating simultaneously KT , K_1A , K_2A , and KJ and at the same time reversing SM . M should have such a current in its primary that the residual deflection is small and in the direction due to the test coil t encircling the iron. Twice the sum of the reading of the galvanometer and the reading of the mutual inductance is the change in induction. The induction at the tip minus this change is the observed induction at the lower point. The air correction is applied as in the case of normal induction by the formula

$$B_{\text{true}} = B_{\text{obs}} + R(H_1 - H_2)$$

where $R = \frac{a-A}{A}$ as before

and $H_1 = H$ at the tip

and $H_2 = H$ at the lower point

When working near the axis but still on the positive side, it may be necessary to reverse J at the same time that it is reduced. This is accomplished by reversing SJ at the same time that the other switches are operated. To go from the tip to negative values of H , ST is reversed simultaneously with the other operations. The points on a loop can be taken in any order, as each one is taken from the tip after establishing an cyclic condition. It should be noted that the residual induction can not be obtained by simply opening the switches, as in that case there are magnetizing forces acting on the test bar due to the differences in retentivity of the different parts of the magnetic circuit, and thus the magnetizing force is not zero and can not be measured.

This method, in common with all others, assumes specimens magnetically uniform along their length and for accurate work

this requirement must be met. Also for precision work where the highest accuracy is desired it is necessary to control the temperature at some value and always make measurements at that temperature. The standard temperature adopted at the Bureau is

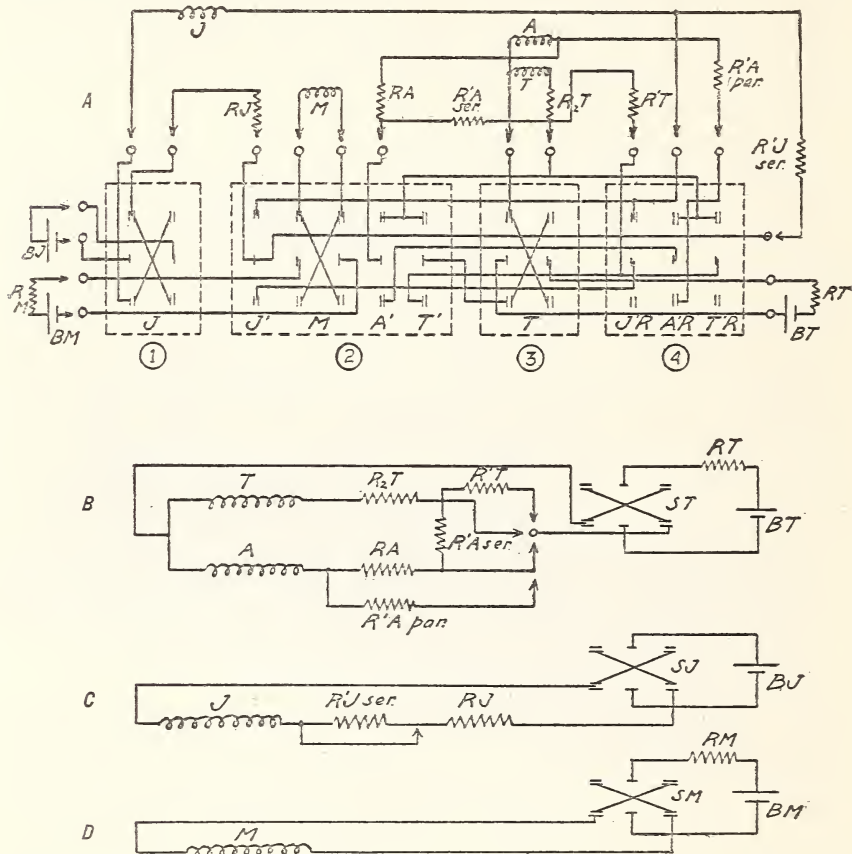

FIG. 6.—Showing diagrams of connections of gang switch for permeability and hysteresis measurements

A, Complete connections; B, main solenoid connections; C, joint coil circuits; D, mutual inductance primary circuit

25° C, which is maintained by an electrically heated and controlled oil bath.

6. SPECIAL SWITCH AND MANIPULATIONS

The switching operations for the permeameter are greatly facilitated by a specially designed switch shown in Fig. 5. The

diagram *A* of Fig. 6 shows the complete electrical connections of this switch. In diagrams *B*, *C*, and *D* the main solenoid connections, the joint coil circuits, and the mutual inductance primary circuit are shown separately for greater clearness.

During the course of a complete magnetic test the individual switches take the following positions:

Position *A*: Switches 1, 2, 3, and 4, as shown in designs *A* of Fig. 6, are all up and the corresponding electrical connections are as shown in Fig. 7.

Position *B*: Switches 2 and 4 are up; switches 1 and 3 are down. Circuits are same as *A* with currents reversed.

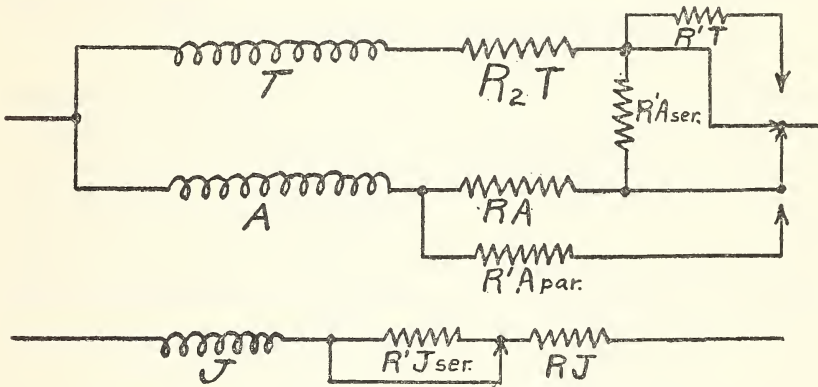

FIG. 7.—Electrical connections when gang switch is in position *A*

Position *C*: Switch 4 is up; switches 1, 2, and 3 are down. Circuits are same as *B*.

Position *D*: Switches 1, 2, 3 are up; switch 4 is down. Circuits are same as *A*.

Position *E*: Switches 1 and 3 are up; switches 2 and 4 are down. Circuits as shown in Fig. 8.

Position *F*: Switch 3 is up; switches 1, 2, and 4 are down. Circuits are same as *E*, but with current in *J* reversed.

Position *G*: Switch 1 is up; switches 2, 3, and 4 are down. Circuits are same as *E*, but with all currents except in *J* reversed.

Position *H*: Switches 1, 2, 3, and 4 are all down. Circuits are same as *E* with all currents reversed.

(NOTE.—Switch 2 also carries the reversing switch for the mutual inductance *M*.)

In the measurement of normal induction and hysteresis the switches are manipulated in the following manner:

NORMAL INDUCTION.—To adjust compensation: Throw switch from position *A* to position *B* and back repeatedly, thus reversing *T*, *A*, and *J*. At the same time adjust resistances *RA* and *RJ* until there is no residual deflection of the ballistic galvanometer on reversal with switch *SG* on either *t-a* or *t-j*.

To take reading: With switch *SG* on *t-m* and with a suitable adjustment of resistance *RM*, throw switch from position *A* to position *C*, thus reversing *T*, *A*, *J*, and *M*, and observe galvanometer deflection.

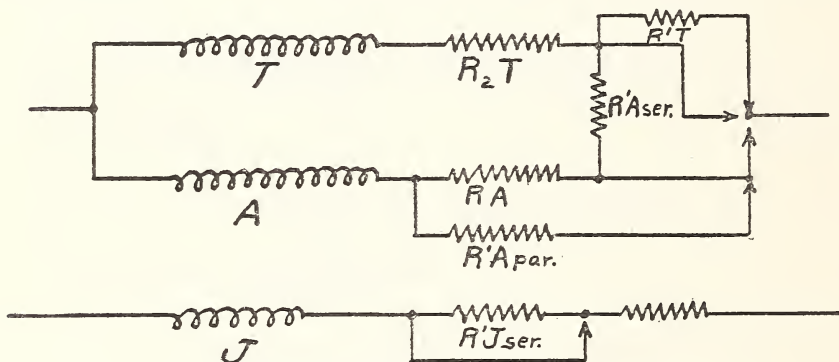

FIG. 8.—Electrical connections when gang switch is in position *E*

HYSTERESIS.—To bring to cyclic state: With resistances adjusted as for normal induction, throw switch from position *A* to position *B* and back repeatedly, thus reversing *T*, *A*, and *J*.

To adjust compensation: Adjust to cyclic state and perform one of the following operations according to the point on the loop desired, and note deflections when *SG* is on *t-a* and *t-j*, respectively. If there is a residual deflection, readjust resistances *R'A ser.*, *R'A par.*, and *R'J ser.*, and repeat the above, including the adjustment to cyclic state. When the adjustment is complete, there will be no residual deflection with switch *SG* on either *t-a* or *t-j*.

To reduce *T*, *A*, and *J*, change ratio of *A* to *T* and reverse *M*; throw switch from position *D* to position *E*.

To reduce *T*, *A*, and *J*, change ratio of *A* to *T*, and also reverse *J* and *M*; throw switch from position *D* to position *F*.

To reduce T , A , and J , change ratio of A to T and reverse T , A , and M but not J ; throw switch from position D to position G .

To reduce T , A , and J , change ratio of A to T and reverse T , A , J , and M ; throw switch from position D to position H .

The ratio of A to T is unchanged if $R'A$ ser. is 0 and $R'A$ infinite; is increased if $R'A$ ser. is 0 and $R'A$ finite; and is increased if $R'A$ ser. is greater than 0 and $R'A$ par. is infinite.

To take a reading: Throw switch as in adjusting the compensation, but with switch SG on and $t-m$ and observe galvanometer deflection. Resistance RM should be adjusted so that the deflection is small and in the direction due to the test coil.

7. FORM OF RECORD

In obtaining magnetic data for a specified set of inductions or of magnetizing forces it is generally sufficient to take observations close to each of the desired points and to scale off the desired values from the curve of observed values. Frequently it takes less time to make two observations, one on each side of the desired value, than it does to make the necessary readjustments for a specific point. The accompanying data sheets and curves illustrate the procedure of a complete set of observations.

V. MEASUREMENT OF CORE LOSS

Standard core-loss determinations at the Bureau of Standards are usually made by means of the Lloyd apparatus. Core-loss determinations are also made according to the specifications of the American Society for Testing Materials.

A. THE LLOYD APPARATUS AND PROCEDURE

1. APPARATUS

The material to be tested is usually submitted in the form of 10 sheets 30 cm (12 inches) square. This material is cut into strips 25.4 by 5 cm (10 by 2 inches). The final cutting to size is done at the Bureau. These are assembled into four bundles, in each of which adjacent strips are separated by strips of press-board of equal width and thickness, but 2 cm shorter. Each bundle is wrapped with gummed paper and is inserted in a solenoid, and the four bundles are then arranged in a square so that

the plan view shows the edges of the strips. (See Fig. 13.) The solenoids are wound upon fiber forms, which are 22.7 cm long, and have inside dimensions 5 by 1 cm. At the corners of the square

MAGNETIC OBSERVATION SHEET (1)
Form 202

Bureau of Standards

Material *Steel Bar 1/2" diam:
marked 2A*

Test No. *14626*
Date *12-24-13*
Observer. *T. L. S.*

DIMENSIONS			Magnetizing coils No. <i>6082</i>	No. of turns in test coil = <i>100</i>					
<i>Diam</i>	<i>1.270</i>		H = $100 \times I$	Mut. Ind. <i>P378S 36.27</i>					
	<i>1.271</i>		Area of test coil (a) = <i>2.15</i>	Gal. Res. <i>Par. 450 Ser. 950</i>					
	<i>1.270</i>		$k = \frac{a-A}{A} = \frac{2.15-1.27}{1.27} = .698$	Temperature <i>25°C</i>					
	<i>1.271</i>		For Normal Induction, $B_{\text{obs}} = B_{\text{th}} - kH$						
	<i>1.269</i>		For Hysteresis, $B_{\text{res}} = B_{\text{obs}} + k(H_1 - H_2)$						
Mean	<i>1.270</i>								
Area (A)	<i>1.267</i>								
MAGNETIZING FORCE			INDUCTION				<i>from curve</i>		
	$100 \times I$	$I_m \times 10^4$	Cal.	ΔB_{obs}	B_{th}	Air Cor.	B_{res}	B	H
<i>demagnetized</i>	<i>1.11</i>	<i>1704</i>	<i>305</i>					<i>2000</i>	<i>1.11</i>
	<i>1</i>	<i>1704</i>	<i>303</i>		<i>2008</i>	<i>1</i>	<i>2007</i>	<i>4000</i>	<i>1.59</i>
	<i>1.60</i>	<i>3700</i>	<i>320</i>					<i>6000</i>	<i>2.36</i>
	<i>0</i>	<i>3700</i>	<i>322</i>		<i>4021</i>	<i>1</i>	<i>4020</i>	<i>8000</i>	<i>3.41</i>
	<i>2.41</i>	<i>5714</i>	<i>397</i>					<i>10000</i>	<i>5.15</i>
	<i>1</i>	<i>5714</i>	<i>402</i>		<i>6114</i>	<i>2</i>	<i>6112</i>	<i>12000</i>	<i>6.18</i>
	<i>3.45</i>	<i>7727</i>	<i>322</i>					<i>14000</i>	<i>14.8</i>
	<i>5</i>	<i>7727</i>	<i>320</i>		<i>8048</i>	<i>2</i>	<i>8046</i>	<i>16000</i>	<i>41.6</i>
	<i>5.15</i>	<i>9676</i>	<i>332</i>					<i>18000</i>	<i>132.</i>
	<i>5</i>	<i>9675</i>	<i>337</i>		<i>10010</i>	<i>4</i>	<i>10006</i>	<i>19860</i>	<i>300.</i>
	<i>8.18</i>	<i>11720</i>	<i>281</i>						
	<i>8</i>	<i>11720</i>	<i>283</i>		<i>12002</i>	<i>6</i>	<i>11996</i>		
	<i>14.51</i>	<i>13654</i>	<i>302</i>						
	<i>1</i>	<i>13654</i>	<i>302</i>		<i>13956</i>	<i>10</i>	<i>13946</i>		
	<i>41.10</i>	<i>15727</i>	<i>280</i>						
	<i>0</i>	<i>15727</i>	<i>280</i>		<i>16007</i>	<i>29</i>	<i>15978</i>		
	<i>1279</i>	<i>17714</i>	<i>310</i>						
	<i>9</i>	<i>17710</i>	<i>310</i>		<i>18024</i>	<i>89</i>	<i>17935</i>		
	<i>380.</i>	<i>19807</i>	<i>243</i>						
	<i>0</i>	<i>19800</i>	<i>270</i>		<i>20070</i>	<i>210</i>	<i>19860</i>		

FIG. 9.—Photograph of original data sheet for normal induction measurement

short pieces of test material are bent at right angles and interleaved between the strips of adjacent bundles, as shown in the figure. There are as many of these corner pieces as there are test

pieces, and they are graduated in length so as to give a uniform lap of about 2 mm. A clamp is tightened over these laps so as to give a good magnetic joint.

MASSACHUSETTS OBSERVATORY BUREAU (1)
Form 202

Bureau of Standards

Material *Magnet Steel*
Bar 1 L

Test No. *17172*
Date *3-18-15*
Observer *T. L. S.*

DIMENSIONS		Magnetizing coils No. <i>7616</i>	No. of turns in test coil = <i>100</i>							
	<i>3.722 0.992</i>	<i>H=100 X I</i>	Mut. Ind.	<i>P378S 93.82</i>						
	<i>3.720 0.992</i>	Area of test coil (a) = <i>7.90</i>	Gal. Res.	<i>Par. 400 Ser. 3830</i>						
	<i>3.718 0.993</i>	$k = \frac{a-A}{A} = \frac{7.90-3.69}{3.69} = 1.14$	Temperature	<i>room</i>						
	<i>3.720 0.992</i>	For Normal Induction, $B_{obs} = B_{obs} - k H$								
	<i>3.720 0.993</i>	For Hysteresis, $B_{obs} = B_{obs} + k (H_1 - H_2)$								
Mesh	<i>3.720 0.992</i>									
Area (A)	<i>3.69</i>									
MAGNETIZING FORCE		INDUCTION					from curve			
	<i>mm X I</i>	$I_m \times 10^3$	Gal.	ΔB_{obs}	B_{obs}	Air Cor.	B_{obs}	B	H	
<i>for tips</i>	<i>195</i>	<i>13880</i>	<i>340</i>					<i>14000</i>	<i>±195</i>	
	<i>5</i>	<i>13880</i>	<i>340</i>		<i>14220</i>	<i>220</i>	<i>14000</i>	<i>+12000</i>	<i>+53.5</i>	
	<i>+44.2</i>	<i>966</i>	<i>233</i>					<i>+10000</i>	<i>-8.2</i>	
	<i>2</i>	<i>966</i>	<i>233</i>	<i>1200</i>	<i>2400</i>	<i>11600</i>	<i>170</i>	<i>11770</i>	<i>+8000</i>	<i>-37.2</i>
	<i>+1.6</i>	<i>1697</i>	<i>164</i>					<i>+6000</i>	<i>-57.8</i>	
	<i>6</i>	<i>1697</i>	<i>163</i>	<i>1880</i>	<i>3760</i>	<i>10240</i>	<i>220</i>	<i>10460</i>	<i>+4000</i>	<i>-58.5</i>
	<i>-34.7</i>	<i>2698</i>	<i>302</i>					<i>+2000</i>	<i>-62.3</i>	
	<i>7</i>	<i>2698</i>	<i>302</i>	<i>3000</i>	<i>6000</i>	<i>8000</i>	<i>260</i>	<i>6210</i>	<i>0</i>	<i>-64.8</i>
	<i>-52.0</i>	<i>3933</i>	<i>254</i>					<i>-2000</i>	<i>-66.7</i>	
	<i>0</i>	<i>3933</i>	<i>250</i>	<i>4165</i>	<i>8370</i>	<i>5630</i>	<i>280</i>	<i>5910</i>	<i>-4000</i>	<i>-69.1</i>
	<i>-62.3</i>	<i>5958</i>	<i>267</i>					<i>-6000</i>	<i>-72.1</i>	
	<i>3</i>	<i>5958</i>	<i>267</i>	<i>6245</i>	<i>12490</i>	<i>1510</i>	<i>290</i>	<i>1800</i>	<i>-8000</i>	<i>-76.7</i>
	<i>-59.2</i>	<i>8680</i>	<i>400</i>					<i>-10000</i>	<i>-84.2</i>	
	<i>2</i>	<i>8680</i>	<i>400</i>	<i>9080</i>	<i>18160</i>	<i>-4160</i>	<i>300</i>	<i>-3860</i>	<i>-12000</i>	<i>-109.</i>
	<i>-65.0</i>	<i>6972</i>	<i>318</i>							$B_r = 10400$
	<i>0</i>	<i>6974</i>	<i>316</i>	<i>7290</i>	<i>14580</i>	<i>-580</i>	<i>300</i>	<i>-280</i>		
	<i>-93.7</i>	<i>12559</i>	<i>140</i>							
	<i>7</i>	<i>12559</i>	<i>142</i>	<i>12700</i>	<i>25400</i>	<i>-11400</i>	<i>380</i>	<i>-11070</i>		
	<i>-119.6</i>	<i>13202</i>	<i>197</i>							
	<i>6</i>	<i>13202</i>	<i>199</i>	<i>13400</i>	<i>26800</i>	<i>-12800</i>	<i>360</i>	<i>-12440</i>		
	<i>-73.7</i>	<i>10224</i>	<i>276</i>							
	<i>7</i>	<i>10224</i>	<i>276</i>	<i>10600</i>	<i>21200</i>	<i>-7200</i>	<i>310</i>	<i>-6890</i>		

FIG. 10.—Photograph of original data sheet for hysteresis measurement

Each solenoid has two windings. The secondary consists of 121 turns of No. 14 double cotton covered wire. Over the secondary is wound 242 turns of No. 14 double cotton covered wire.

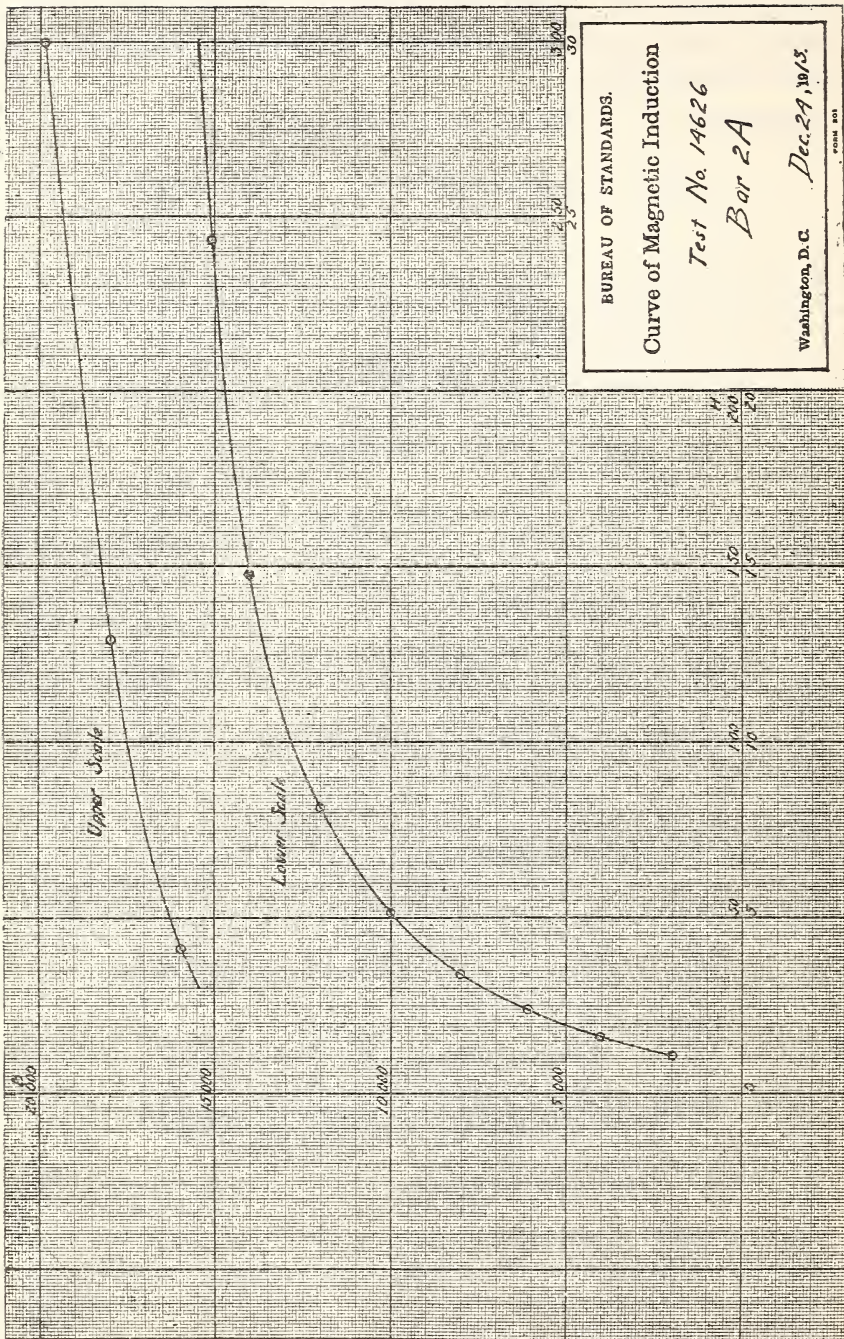

FIG. 11.—Photograph of curve of normal induction as plotted from original data

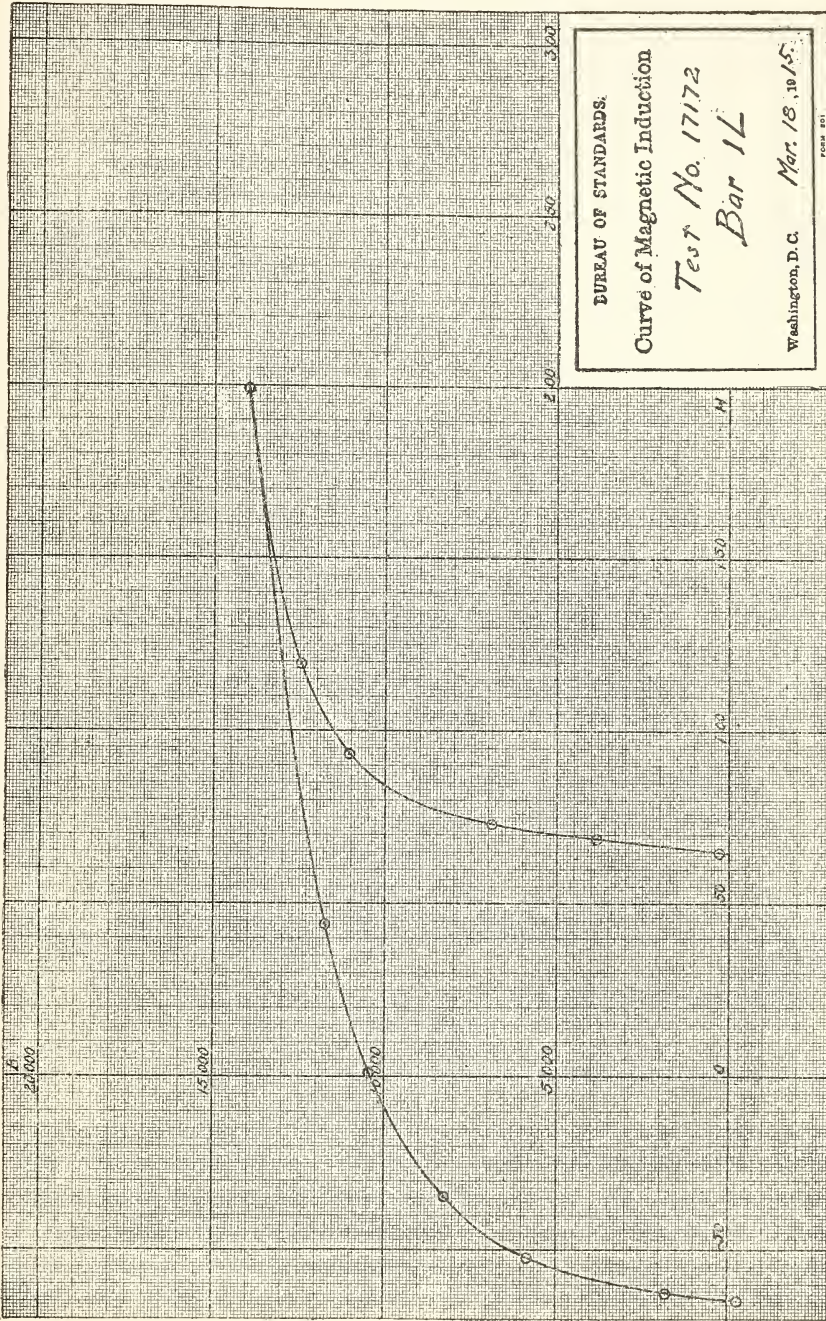

FIG. 12.—Photograph of half of hysteresis loop as plotted from original data

The four solenoids are connected in series, making a total of 968 magnetizing turns and 484 turns in the secondary. The voltmeter and wattmeter which are deflecting mirror electro-dynamometers are connected in parallel to the secondary winding. The magnetizing current traverses the field coils of this wattmeter,

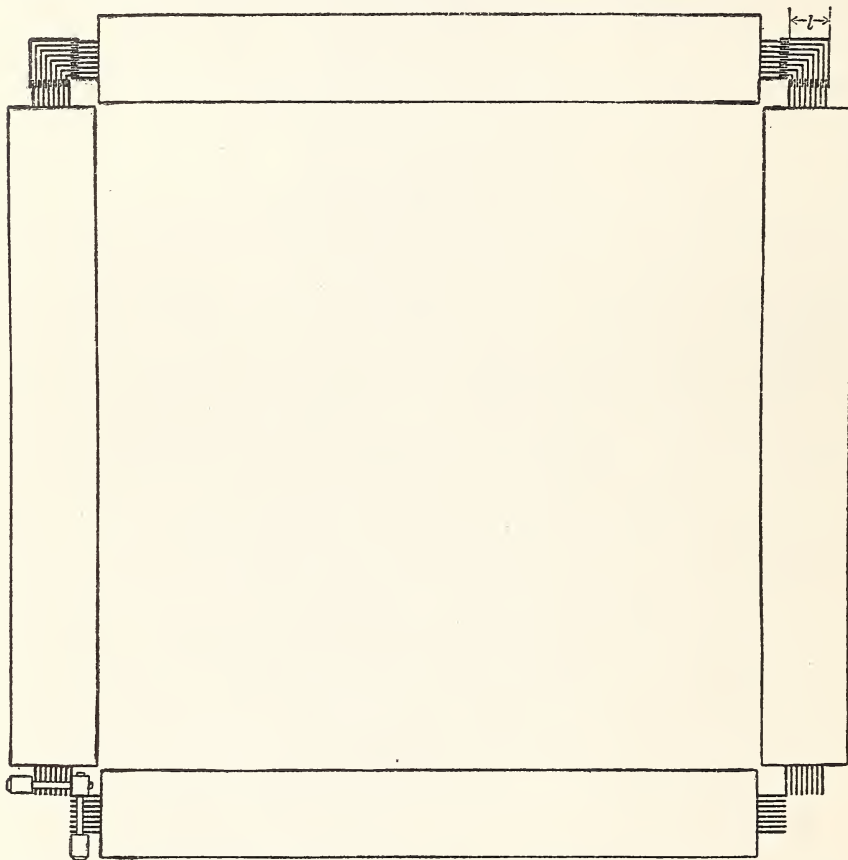

FIG. 13.—Plan of Lloyd apparatus with test pieces in position. Corner pieces have been removed from two and clamps from three corners

whose deflections are a measure of the power supplied to the core and the secondary coils. The copper loss in the primary is thus eliminated from the power measurement. Error will arise only when there is flux threading the core and linked with the primary, which is not linked with the secondary. This is avoided by winding the secondary under the primary and making the two

coextensive in length. The energy in each instrument circuit is obtained by squaring the secondary voltage and dividing by the resistance. By using a small number of turns in the secondary and sensitive instruments these corrections are kept very small and may be calculated from the resistance and voltage.

Voltmeter and wattmeter each have variable multipliers, whose resistances are adjusted to give a suitable deflection in each case. The precision of reading which is usually better than 0.1 per cent, is higher than ordinarily required.

The frequency is determined by a Hartmann and Braun frequency meter, which has been calibrated by the use of a chronograph, or where greatest accuracy is required the chronograph is used directly.

When it is desired to measure the magnetizing current, an ammeter of low resistance can be introduced into this circuit.

On account of the lapping of the corner pieces over the ends of the test pieces the flux density is low in this part of the material, and the results must be corrected therefor. The amount of lap is determined by the relative weights of corner and test pieces as compared with the relative lengths of the two parts of the circuit. When the corner pieces are of the same material as the test pieces, it is assumed that the flux density is halved in the portion of material which laps, and the energy loss is consequently only one-third normal.

B = normal (or average) maximum flux density.

B_1 = maximum flux density at ends of test pieces.

M = mass of test pieces.

m = mass of corner pieces.

l = dimension shown in Fig. 13.

W = measured loss.

$\frac{m}{M}$ = proportional increase in mass of magnetic circuit,
due to corner pieces.

$\frac{l}{25.4}$ = proportional increase in length of magnetic circuit,
due to corner pieces.

$\frac{m}{M} - \frac{l}{25.4} = c$ = mass of corner pieces which lap, expressed in terms
of mass of test pieces.

$2c$ = total material (lapped and lapping iron) in which
flux density is $\frac{B_1}{2}$

$2cW \left[1 - \left(\frac{B_1}{2B} \right)^x \right] = 2cWk = \text{correction to } W \text{ for lap, where } x \text{ expresses the law of variation of loss with } B.$

With sufficient accuracy for the purpose, K may be taken as 0.70, so that the correction becomes 1.4 cW , and the loss per unit mass is $\frac{W}{M+m} (1 + 1.4c)$ or $\frac{W}{(M+m) (1 - 1.4c)}$ with sufficient accuracy. The latter form is the most useful in practice, since a number of observations at different flux densities are usually made upon a single specimen, and the correction may be made once for all to the mass. The quantity $(M+m) (1 - 1.4c)$ may be called the "effective mass."

Corner pieces of different material but of approximately the same quality and thickness may be used with satisfactory and reliable results, providing the constants of the material are known. When using corner pieces of different material from the test pieces, it is necessary to compute the loss in the entire corner pieces and then determine the "effective mass" resulting from the lap reducing the flux in the test pieces. Since the thickness of corner pieces may be different from that of the test pieces, it is necessary to consider this, and the flux at the lap may be considered to divide evenly between the two, or in proportion to their thickness. As the results do not differ materially, we assume that in each lapped part the flux density is half the value in the rest of the material.

Let

$t = \text{thickness of test pieces,}$

$t_1 = \text{thickness of corner pieces,}$

$w = \text{loss per unit mass in corner pieces,}$

and other quantities as before. We neglect leakage which is small; c must now be computed by using for M the mass M_1 of test pieces of same material as corner pieces. The loss in the corner pieces, if there were no lap, would be $w m \left(\frac{t}{t_1} \right)^x$. Considering the effect of lap it is $w (m - 0.7 c M_1) \left(\frac{t}{t_1} \right)^x = W_c$. The correction to the loss in test pieces due to lap is 0.7 $c (W - W_c)$ and the loss per unit mass is $\frac{W - W_c}{M(1 - 0.7c)}$. If the corner pieces are of approximately

the same thickness as the test pieces, the loss in them is approximately $w(m - 0.7 cM_1)$. Here, again, the quantity $(m - 0.7 cM_1)$ can be determined once for an entire set of measurements.

2. PROCEDURE

The material is cut into strips of the given dimensions by the use of a sharp machine shear with nearly parallel jaws. The number of strips is determined by the thickness, and for gauge No. 29 amounts to 48. The strips are then weighed, bundled, and mounted in the solenoids. The effective voltage corresponding to any given flux density and frequency is computed from the following relation:

$$E = 4fNn\phi 10^{-8} = \frac{4.44 \times 484 \times 10^{-8}}{101.6\rho} Bn M$$

where n = frequency, ϕ = total flux, f = form factor of secondary emf, and ρ = density.

The dynamometer voltmeter is calibrated for one voltage as determined above, and when taking observations for watt loss, the impressed voltage is adjusted until the same deflection is obtained. For other frequencies and flux densities the resistance in the voltmeter circuit is altered until it is proportional to the product Bn , so that the same deflection is always used. For the lower values of this resistance, the slight correction due to the inductance of the instrument is also made. In computing the power supplied to the voltmeter circuit it may then be remembered that this energy is also proportional to Bn , since the same current is used throughout. An adjustable resistance is used in the potential circuit of the wattmeter, so that the power consumed here is also readily computed. This resistance is adjusted so that the deflection will remain within certain limits. These limits are so chosen that within them the deflections are proportional to the watts.

A direct-connected motor-driven generator gives an emf wave which is sufficiently close to the sinusoidal, and the form factor of the secondary emf has been determined and found sufficiently near to that assumed through the working ranges of flux density at the frequencies used.

The frequencies ordinarily used are 60 and 30 cycles, the latter being chosen because it makes the separation of hysteresis and

eddy-current losses easy to compute. The motor is supplied with power from a storage battery and the speed is controlled by field resistance. No rheostat is used in the magnetizing circuit. An autotransformer of ample capacity is used to step up or down to approximately the voltage required for the test. The final adjustment of voltage is obtained by adjusting the field resistance of the generator. The electrical connections are shown in Fig. 14. When the voltage has been adjusted to give the proper reading on the voltmeter connected to the secondary circuit the wattmeter is read. An adjustment is then made for a different flux density and readings taken as before. When the magnetizing current is desired an ammeter is included in the magnetizing circuit and its

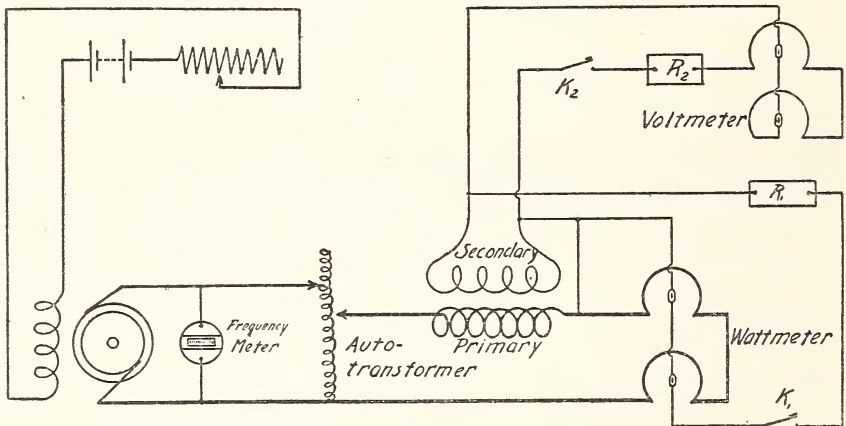

FIG. 14.—Diagram of electrical connections for core loss measurements

indications noted. Whenever a change is made from a higher to a lower flux the current is reduced gradually to the lower value in order to demagnetize the material. Whenever the magnetizing circuit has been broken it is closed through a considerable resistance, which is continuously reduced to zero in order to prevent a large first surge and consequent high magnetization, which would require subsequent demagnetization.

3. SEPARATION OF EDDY-CURRENT AND HYSTERESIS LOSSES

The total loss is separated into two components, due respectively to hysteresis and eddy currents, as follows, using the Steinmetz equation,

$$W = \eta n B^x + \zeta n^2 B^y$$

where the symbols have the same significance as before, η and ζ being constants of the material. By taking observations at two frequencies, n_1 and n_2 , we have

$$\frac{W_1}{n_1} = \eta B^x + \zeta n_1 B^y = a + bn_1$$

$$\frac{W_2}{n_2} = \eta B^x + \zeta n_2 B^y = a + bn_2$$

where a is the hysteresis loss per cycle and bn the eddy-current loss per cycle

$$a = \frac{\frac{W_2}{n_2}n_1 - \frac{W_1}{n_1}n_2}{n_1 - n_2}$$

$$b = \frac{\frac{W_1}{n_1} - \frac{W_2}{n_2}}{n_1 - n_2}$$

If $n_1 = 2n_2$, this computation is greatly simplified; for then

$$bn_2 = \frac{W_1}{n_1} - \frac{W_2}{n_2}$$

$$bn_1 = 2bn_2$$

$$a = 2\frac{W_2}{n_2} - \frac{W_1}{n_1} = \frac{W_2}{n_2} - bn_2$$

While the Steinmetz equation, and consequently this separation, is not accurately in accordance with the facts, the errors are very small in thin sheets. The exponents x and y can be determined by observations at different flux densities. Where the eddy-current loss is small, as in silicon steel, the values of y are subject to greater error.

B. THE A. S. T. M. APPARATUS AND PROCEDURE

The standard specifications of the American Society for Testing Materials for core-loss tests are as follows:

The magnetic circuit shall consist of 10 kg (22 pounds) of the test material, cut with a sharp shear into strips 50 cm ($19\frac{11}{16}$ inches) long and 3 cm ($1\frac{3}{16}$ inches) wide, half parallel and half at right angles to the direction of rolling, made up into four equal bundles, two containing material parallel and two containing material at

right angles to the direction of rolling, and finally built into the four sides of a square with butt joints and opposite sides consisting of material cut in the same manner. No insulation other than the natural scale of the material (except in the case of scale-free material) shall be used between laminations, but the corner joints shall be separated by tough paper 0.01 cm (0.004 inch) thick.

The magnetizing winding shall consist of four solenoids surrounding the four sides of the magnetic circuit and joined in series. A secondary coil shall be used for energizing the voltmeter and the potential coil of the wattmeter.

These solenoids shall be wound on a form of any nonmagnetic nonconducting material of the following dimensions:

	Cm
Inside cross section.....	4 by 4
Thickness of wall.....	Not over 0.3
Winding length.....	42

The primary winding on each solenoid shall consist of 150 turns of copper wire uniformly wound over the 42-cm length. The total resistance of the magnetizing winding shall be between 0.3 and 0.5 ohm. The secondary winding of 150 turns of copper wire on each solenoid shall be similarly wound beneath the primary winding. Its resistance shall not exceed 1 ohm.

A voltmeter and the voltage coil of a wattmeter shall be connected in parallel to the terminals of the secondary winding of the apparatus. The current coil of the wattmeter shall be connected in series with the primary winding.

A sine-wave electromotive force shall be applied to the primary winding and adjusted until the voltage of the secondary circuit is given by the equation:

$$E = \frac{4 f N n B M}{4 l D 10^8}$$

in which

f = form factor of primary emf	= 1.11 for sine wave
N = number of secondary turns	= 600
n = number of cycles per second	= 60
B = maximum induction	= 10 000
M = total mass in grams	= 10 000
l = length of strips in centimeters	= 50

VI. EMPIRICAL FORMULAS

While there are no analytical expressions by means of which exact values of the magnetic induction may be calculated from the magnetizing force, there are several approximate relations which are frequently of service.

1. INDUCTION

The relation

$$B = aH$$

where a is a constant, is sometimes useful in calculations which involve only extremely low magnetizing forces; for example, such magnetizing forces as occur in telephone loading coils. The formula

$$B = aH + bH^2$$

holds through a wider range and may generally be used for magnetizing forces less than unity.

For calculations involving high inductions the formula

$$B = \frac{H}{a + bH} + H$$

is very helpful. This relation is generally expressed in the form

$$\frac{H}{B - H} = a + bH = K'$$

whence it appears that the relation

$$K' = a + bH$$

is linear, and hence suitable for extrapolation. This relation is valuable for the calculation of inductions corresponding to magnetizing forces greater than those which can be easily measured. By it one may readily estimate the induction at a magnetizing force of 1000 gauss from observations at magnetizing forces of 200 and 300 gauss.

For still higher magnetizing forces we may make use of the fact that practical saturation is reached at 1000 gauss and that for greater magnetizing forces the increase in induction is equal to the increase in magnetizing force.

2. HYSTERESIS LOOP

A rough approximation to the area of a hysteresis loop is given by the equation

$$\text{Area of hysteresis loop} = 4 H_c \times B_{\max}.$$

The area thus indicated is too large for material of low permeability and too small for material of high permeability. The maximum error is less than 15 per cent.

3. CORE LOSSES

The formula

$$W = \eta n B^x + \zeta n^2 B^y = a n + b n^2$$

represents with a fair degree of approximation the relation between the total core loss and the quantities which determine its magnitude. This equation assumes that the induction is the same over different cross sections of the test material, that the exponents are constant, and that the frequency is not too high to permit the material to be magnetized to the same maximum value throughout the cross section.

If this formula is true and the four constants are known, one may calculate the losses at any induction and frequency.

The data required for the separation of the core loss into its eddy-current and hysteresis components (as on p. 32) involve observations under the same conditions of induction and differing only in frequency. With low frequencies of 30 and 60 cycles and the thin material usual in transformer steel, there is no appreciable error.

4. EXPONENTS AND THE RATIO OF VARIATION

The data required for the determination of the exponents, however, involve observations of different inductions and different flux distributions. In addition, the assumption that the exponents are constant requires very careful examination.

It has long been known that an equation of the form

$$W = K B^c$$

will not accurately represent either the hysteresis loss or the total iron losses, and so it has become customary to speak of the exponent as varying slightly so as to force the equation to fit the

experimental values. Numerous determinations have been published to show that the value of the exponent originally given by Steinmetz of 1.6 is only a sufficiently good mean for use over the limited range of inductions used in the design of power transformers, and that not only different kinds of iron give different values, but that for the same sample of iron the exponent varies with the induction.

Unfortunately, however, the methods that have been universally used to determine the exponent have depended upon the implicit assumption that the exponent is a true constant, and hence the values obtained are not actually exponents, but are, in most cases, the logarithmic derivative of W with respect to B , and this becomes the exponent only in the case where it is a constant. In order to make the matter clear it will be well to consider first the methods that have been used to obtain the exponent from the experimental values.²

The method most generally used at present is to plot W against B on logarithmic paper and measure the slope of the resulting curve at various values of B . Still considering c a constant, if we differentiate the equation $W = KB^c$, first taking logarithms of both sides,

$$\begin{aligned} \log W &= \log K + c \log B \\ d(\log W) &= c d(\log B) \\ c &= \frac{d(\log W)}{d(\log B)} \end{aligned} \tag{1}$$

which shows that c is the slope of the logarithmic curve. An equally accurate but less convenient method may be used with ordinary cross-section paper. Equation (1) may be written in the form

$$c = \frac{\frac{dW}{W}}{\frac{dB}{B}} = \frac{B}{W} \cdot \frac{dW}{dB} \tag{2}$$

from which the value of c at any point of the curve is seen to depend upon the values of W , B , and the slope of the curve at the

² This discussion of exponents and the ratio of variation is taken almost verbatim from a paper by P. G. Agnew on "A study of the current transformer with particular reference to iron loss," *Bull., Bureau of Standards*, 7, p. 423; 1911 (Scientific Paper No. 164).

point. These three quantities must be expressed in consistent units, as the slope $\frac{dW}{dB}$ is no longer a simple geometrical ratio as in equation (1), but has the dimensions of $\frac{W}{B}$. Another method which is often used is to solve for c from the values at two points of the curve. Thus if

$$\text{and} \quad \left. \begin{aligned} W_1 &= K B_1^c \\ W_2 &= K B_2^c \end{aligned} \right\} \quad (3)$$

$$\text{then} \quad c = \frac{\log \frac{W_1}{W_2}}{\log \frac{B_1}{B_2}} = \frac{\log W_1 - \log W_2}{\log B_1 - \log B_2} \quad (4)$$

Common logarithms may be used in either (1) or (4).

None of these methods is correct if we are dealing with a variable exponent, for then in differentiating to get (1) and (2) we should have had to take account of the variation of c with respect to B , and evidently (4) could not have been deduced at all since we should have had different values of c in (3). This will appear more clearly in an examination of the general case in which

$$W = K B^z \quad (5)$$

where the exponent z is now a variable. It may first be said that suggestions have been made that K should be considered to vary so as to fit the observations to some sort of a curve, and some writers have even treated both the coefficient and the exponent as variables, which is manifestly absurd. To consider that we have an exponent which varies slightly about a mean introduces complications, as will be shown, which greatly limits its usefulness, while any attempt to treat such a formula containing a variable coefficient can accomplish nothing since in its very simplest form the exponent would reduce to unity which merely brings us back to the measured values of B and W .

To determine, then, the relations which follow by treating the coefficient as constant and the exponent as a variable, write (5) in the logarithmic form,

$$\log W = \log K + z \log B$$

Differentiating,

$$\begin{aligned}\frac{dW}{W} &= \log B \, dz + z \frac{dB}{B} \\ \frac{dW}{\frac{dW}{dB}} &= z + B \log B \frac{dz}{dB} \\ \frac{dW}{B} &\end{aligned}\tag{6}$$

The left-hand member of this equation is the logarithmic derivative of W with regard to B , or the slope of the curve obtained by plotting W against B on logarithmic coordinate paper. If z is a constant the last term becomes zero, the curve becomes a straight line, and the slope of the logarithmic curve is the exponent. But if z is not zero the value of the exponent from equation (6) is

$$z = \frac{\frac{dW}{W}}{\frac{dB}{B}} - B \log B \frac{dz}{dB}\tag{7}$$

This shows that the logarithmic derivative is not the same as the exponent, as is tacitly assumed in the methods in common use in the determination of the exponent where the latter varies. The last term in (7) is entirely neglected in the methods which make use of either logarithmic or ordinary coordinate paper, as what is measured in these cases is merely the logarithmic derivative. Similarly the method of solving for the exponent by using values at two points of the curve will not give even the average value of the exponent over the range taken, as it is generally believed to do, for by equation (4) the quantity thus given is

$$\frac{\log \frac{W_1}{W_2}}{\log \frac{B_1}{B_2}}$$

Now, if we take B_2 very near B_1 we may replace W_1 , W_2 , B_1 , B_2 , by $W + \delta W$, W , $B + \delta B$, and B .

$$\frac{\log \frac{W_1}{W_2}}{\log \frac{B_1}{B_2}} = \frac{\log \frac{W + \delta W}{W}}{\log \frac{B + \delta B}{B}}$$

$$= \frac{\log \left(1 + \frac{\delta W}{W} \right)}{\log \left(1 + \frac{\delta B}{B} \right)}$$

and we may replace $\log \left(1 + \frac{\delta W}{W} \right)$ by $\frac{\delta W}{W}$, which is the first term in its expansion, and similarly for B .

This gives

$$\frac{\frac{\delta W}{W}}{\frac{\delta B}{B}}$$

which is the logarithmic derivative. Hence, this method gives a result which approaches that given by the other methods, namely, the slope of the logarithmic curve instead of the exponent.

The slope of the logarithmic curve is, however, of much more practical importance than the true exponent, for the greatest use of such empirical relations is as interpolation formulas. The logarithmic derivative, which is referred to hereafter as the "ratio of variation," is an exceedingly convenient form for interpolation, since for small variations it is the ratio of the percentage change in the dependent variable to the percentage change in the independent variable.

In order to bring out graphically the differences that may exist between the exponent and the ratio of variation in geometrical curves of the general parabolic form and whose exponents are of the order of magnitude of those met with in iron losses, in Fig. 16 the curve $y = x^2 + \frac{1}{x}$ together with the exponent and the ratio of variation have been plotted. This curve was chosen, as the values of the exponent and the ratio of variation are around 2 and both decrease with increasing values of x . In Fig. 17 the curve $y = x^{1+0.1x}$ together with the exponent and the ratio of variation are plotted. It will be seen that when the exponent is 2 the ratio of variation is 4.3.

Since the last term in equation (6) is positive, it follows that the ratio of variation will be greater than the exponent when the latter is increasing, and less when the exponent is decreasing.

Consequently the exponent curve lies above in Fig. 16 and below in Fig. 17.

If in the case of a curve whose exponent is changing slowly we choose two points of reference and solve for the exponent as if it were constant, one might expect to get a value somewhere near the mean of the actual values at the given points, but such is not the case. It may be either greater or less than the actual value at either limit, according to circumstances. A more surprising result of the variation of the exponent is the effect that such a method has in making large changes in the coefficient. For example, if

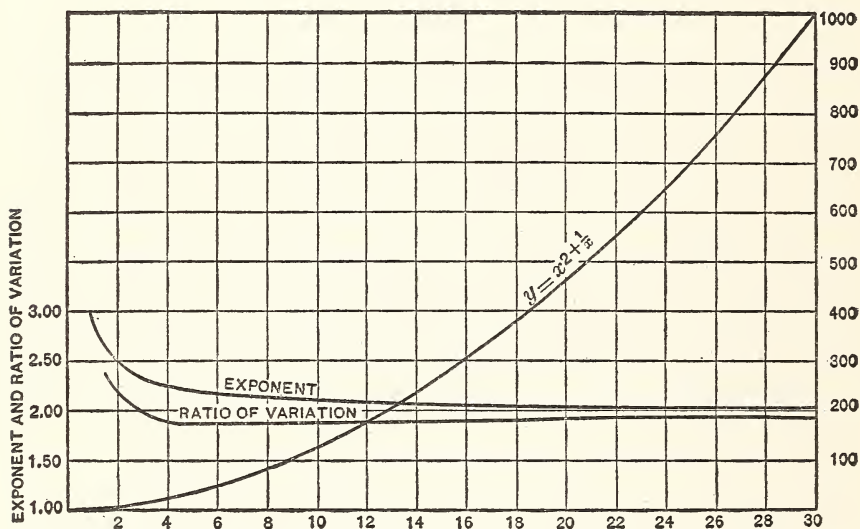

FIG. 16.—Showing the difference between the exponent and the ratio of variation in the curve $y = x^{2 + \frac{1}{x}}$

we consider the curve of Fig. 16 as an experimental curve and attempt to determine the coefficient and exponent by this method, which is the one that has been most frequently used in discussing changes in the Steinmetz exponent, we get the following results. The computed exponents are nearly identical with the ratio of variation.

Limits used	Actual curve at midpoint of range	Computed equation
$x = 6$ to $x = 8$	$y = x^{1.7}$	$y = 0.075 x^{3.05}$
$x = 8$ to $x = 10$	$y = x^{1.8}$	$y = 0.0137 x^{3.86}$

The matter is not, however, so serious as these results indicate at first sight, for while the exponents have increased the coefficient has changed from unity to the small fractions, and either of the computed curves will give fair approximations throughout the small range for which it is computed. Yet it does emphasize the

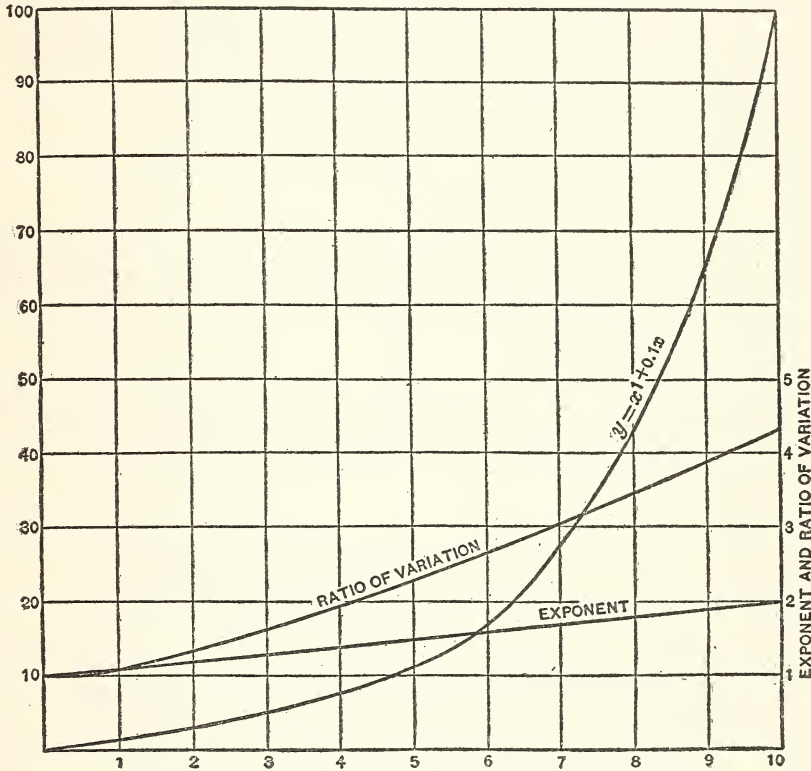

FIG. 17.—Showing the difference between the exponent and the ratio of variation in the curve $y = x^{1+0.1x}$

desirability of abandoning the use of the word “exponent” as applied to the results of such processes.

On the whole, the determination of the actual exponent is of little practical importance. It is much more difficult to determine than the ratio of variation, it depends upon the unit in which the independent variable is expressed, and after it is once determined its use, as in interpolation, requires logarithms even for small intervals. The ratio of variation, that is, the slope of

the logarithmic curve, is much more convenient to use in interpolating over small intervals. The fact that a constant exponent is the same as the ratio of variation has led to a failure to distinguish between them when the exponent is not constant, and this has introduced considerable confusion, not only in the literature of iron losses, but in the other fields in which the same ideas are made use of. Many attempts have been made to measure the variation of the exponent by methods which assume a constant exponent.

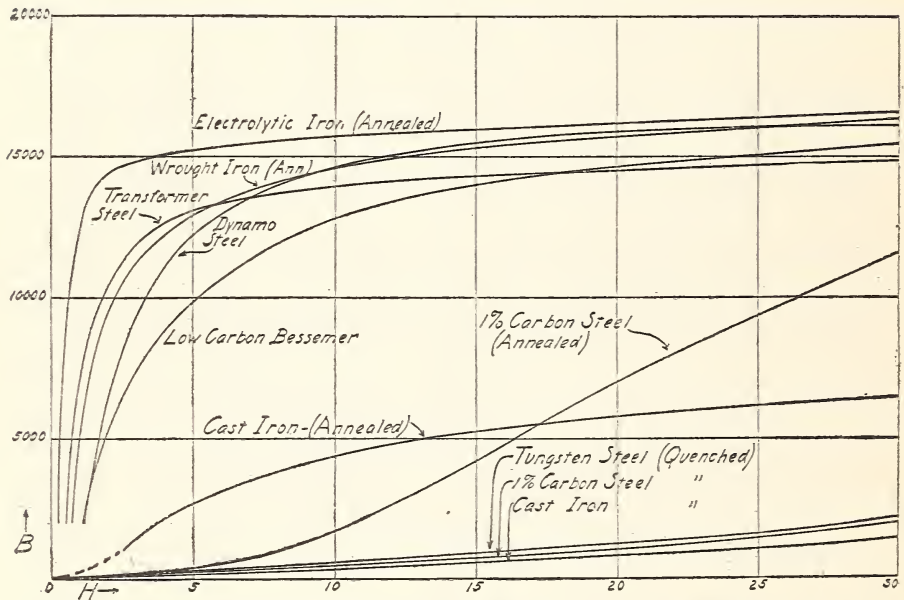

FIG. 18.—Showing typical normal induction curves for the usual commercial magnetic materials for magnetizing forces less than 30 gausses

VII. TYPICAL CURVES AND DATA

The following curves are given to show the characteristics which are commonly obtained in ordinary commercial magnetic materials. Figs. 18, 19, and 20 show the magnetic characteristics of some of the materials which are commonly employed in the construction of magnetic and electromagnetic apparatus. These include electrolytic iron, wrought iron, ordinary dynamo sheet, low-carbon bessemer (about 0.17 per cent C), high-silicon sheet (about $3\frac{1}{2}$ per

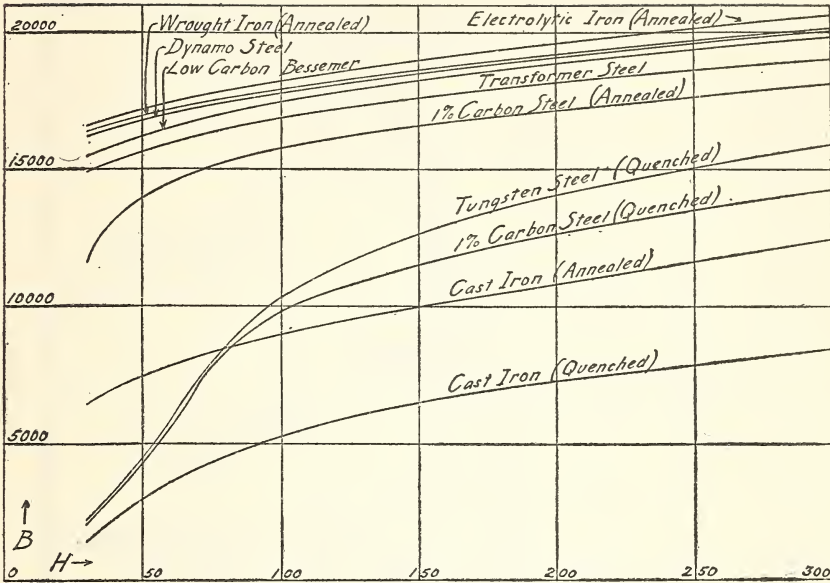

FIG. 19.—Showing typical normal induction curves for the usual commercial magnetic materials for magnetizing forces between 30 gauss and 300 gauss

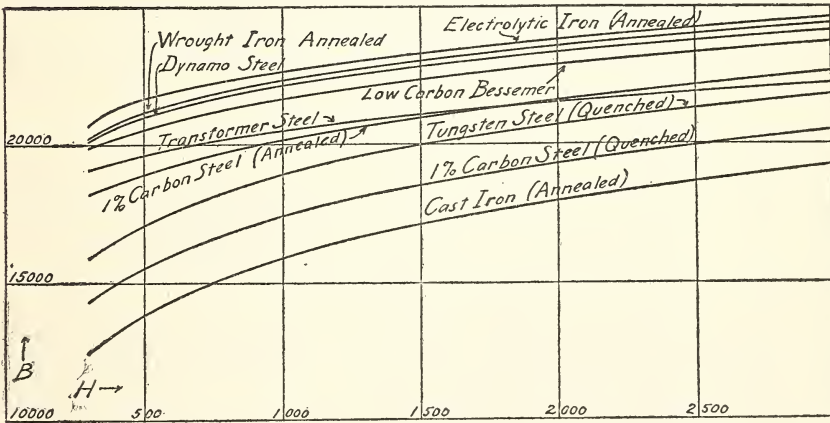

FIG. 20.—Showing typical normal induction curves for the usual commercial magnetic materials for magnetizing forces between 300 gauss and 3,000 gauss

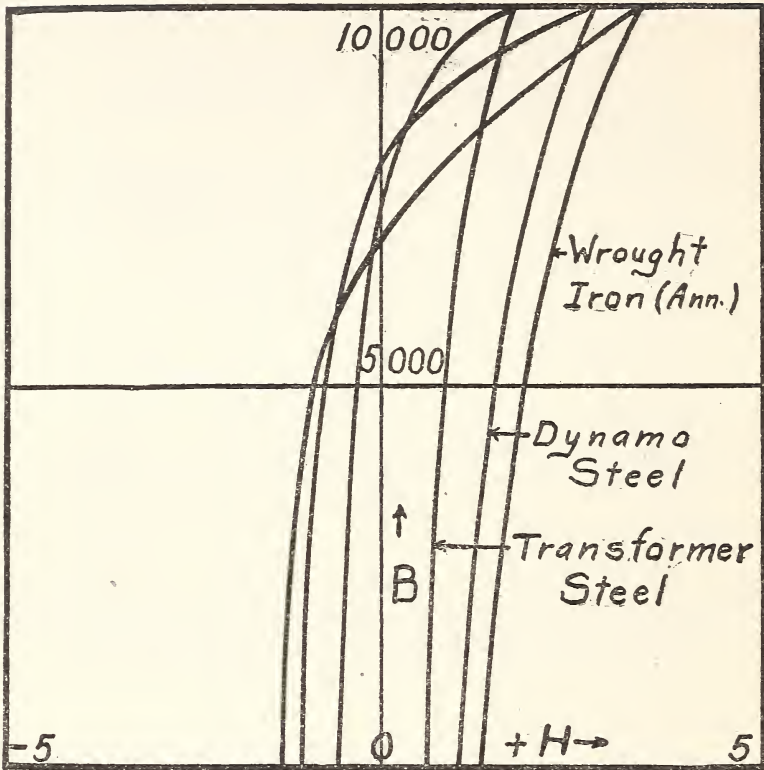

FIG. 21.—Showing typical hysteresis half loops for the usual commercial magnetic materials used in transformer and armature construction

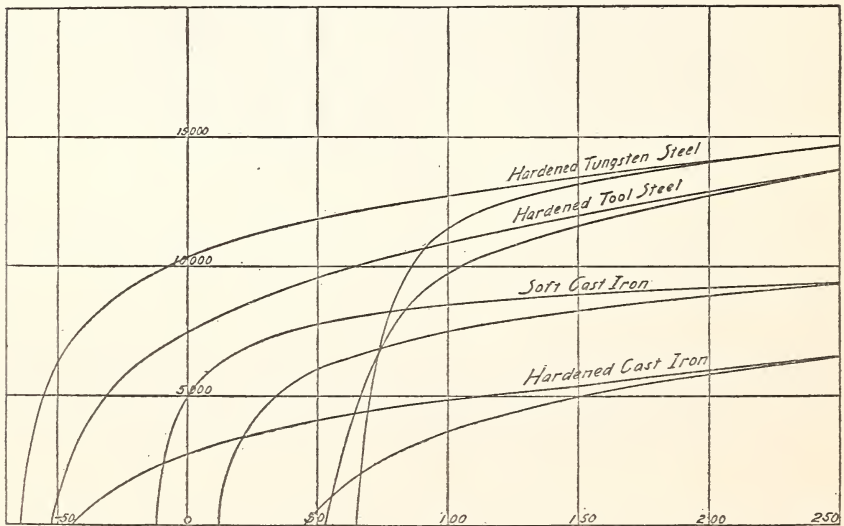

FIG. 22.—Showing typical hysteresis half loops for the usual commercial magnetic materials used for permanent magnets

cent Si), annealed and hardened high-carbon steels (about 1 per cent C), tungsten steel, and cast iron. Fig. 21 shows hysteresis loops from a tip of 10 000 gaussers for dynamo steel, high-silicon steel, and wrought iron, which materials are largely used in electromagnetic cores, transformers, and armatures. Fig. 22 gives hys-

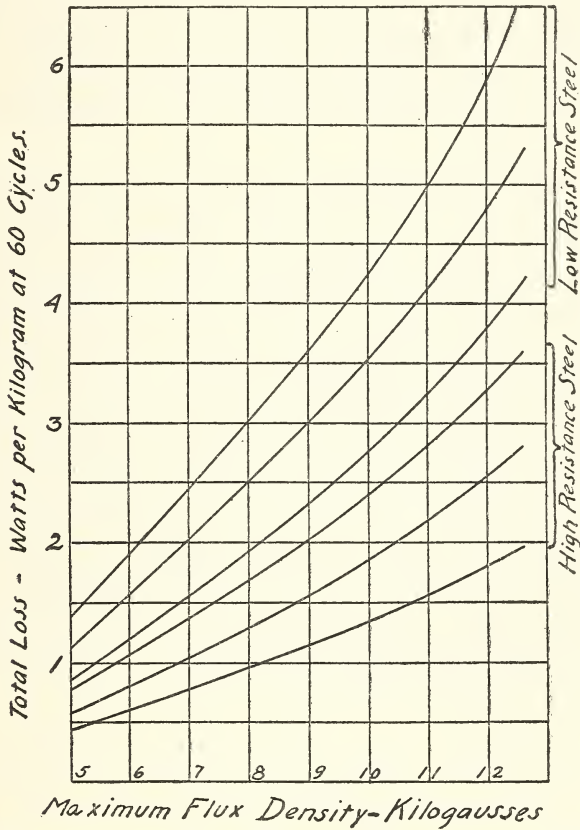

FIG. 23.—Showing typical curves of total core losses for the usual materials used in transformer and armature construction

teresis loops for cast iron both in the hardened and in the soft state and for tungsten magnet steel. Fig. 23 gives the values of the total core loss at 60 cycles for different values of the maximum induction for the steels ordinarily used in alternating-current apparatus. These steels are generally grouped as high-resistance steels and low-resistance steels. High-resistance steels have a

resistivity of between 3 and 5 ohms per metergram. Low-resistance steels have a resistivity more nearly 1 ohm per metergram. We may assume a value of 2 ohms per metergram as the dividing point between high and low resistance steels. This makes a very useful distinction for commercial steels. High-resistance steels contain about 3 per cent of silicon and have a low specific gravity (about 7.5) and a low core loss. Low-resistance steels are relatively pure iron and have a higher specific gravity (about 7.7) and a core loss approximately double that of the high-resistance materials.

The magnetic susceptibility of the so-called nonmagnetic materials is very small. The most convenient unit is one-millionth as large as the usual cgs unit. In terms of this unit the values of susceptibility extend from about +400 for solid oxygen to -14 for the diamagnetic bismuth. The susceptibilities given by different observers differ quite widely. This is probably due to the difficulty in getting pure materials. Traces of iron which are too small to be measured by the regular chemical methods will frequently mask entirely the true magnetic properties of the pure material, and consequently an investigator may report a substance as paramagnetic and a later investigator working with purer materials may report it as diamagnetic. The accompanying table gives the most probable values of susceptibility available at the present time. The susceptibility as usually defined is κ_v , sometimes called the volume susceptibility. The mass susceptibility κ_m is this value divided by the density.

Magnetic Susceptibilities

Name	Symbol	10 ⁶ k _v	10 ⁶ k _m	Name	Symbol	10 ⁶ k _v	10 ⁶ k _m
Aluminium.....	Al.....	+ 1.8	+ 0.6	Mercury.....	Hg.....	- 2.3	- 0.2
Antimony.....	Sb.....	- 4	Molybdenum.....	Mo.....	+ 0.04
Argon, 1 atm.....	A.....	- 0.10	Nickel.....	Ni.....
Arsenic.....	As.....	- 0.3	NiCl ₂	+35
Barium.....	Ba.....	- 0.3	Niobium.....	Nb.....	+ 1.3
Beryllium.....	Be.....	+ 0.8	Nitrogen, 1 atm.....	N.....	+ 0.001
Bismuth.....	Bi.....	-14	- 1.0	Osmium.....	Os.....
(Temp. 270° C).	Bi fluid.....	- 0.01	Oxygen, 1 atm.....	O.....	+ 0.12
Boron.....	B.....	- 0.7	O liquid.....	260
Bromine.....	Br.....	- 1.4	- 0.4	O solid.....	400
Cadmium.....	Cd.....	- 0.16	Palladium.....	Pd.....	+60	+ 5
Cæsium.....	Cs.....	- 0. (?)	- 0. (?)	Phosphorus.....	P white.....	- 0.9
.....	CsCl.....	- 0.28	P red.....	- 0.7
Calcium.....	Ca.....	Platinum.....	Pt (pure).....	1
.....	CaO.....	- 0.27	Potassium.....	K.....	+ 0.5
.....	CaCl ₂	- 0.39	KCl.....	- 0.5
Calcium carbon- ate (marble)	CaCO ₃	-0.6 to -0.9	Praseodymium.....	Pr.....
.....	PrCl ₃	+14
Carbon.....	- 8	Rhodium.....	Rh.....	+13	+ 1.5
Arc carbon.....	- 2	Selenium.....	Se.....	- 0.5
Diamond.....	- 0.4	Silicon.....	Si.....	- 0.1
Carbon dioxide 1 atm.	CO ₂	+ 0.017	Quartz.....	SiO ₂	- 1.2
.....	Glass.....	-0.9 to -1.3
Cerium.....	Ce.....	Silver.....	Ag.....	- 1.5	- 0.2
.....	CeCl ₃	+5 to +10	Sodium.....	Na.....	+ 0.52
.....	NaCl.....	- 0.41
Chromium.....	Cr.....	+ 4	Strontium.....
Chlorine.....	Cl.....	- 0.007	- 0.59	SrCl ₂	- 0.44
Cobalt.....	Co.....	Sulphur.....	S.....	- 0.8	- 0.5
.....	CoCl ₂	+90	Tantalum.....	Ta.....	+ 0.9
Copper.....	Cu.....	- 0.7	- 0.09	Tellurium.....	Te.....	- 1.5	- 0.3
.....	CuO ₂	+ 0.73	Thorium.....	Th.....	+ 0.2
.....	CuSO ₄ Crys.....	+ 6.5	Tin.....	Sn.....	- 0.35	- 0.03
.....	Sn gray.....	- 0.4
Gold.....	Au.....	- 3.1	- 0.15	Sn fluid.....	- 0.04
Helium, 1 atm.....	He.....	- 0.002	Titanium.....	Ti.....	+ 3
Hydrogen, 1 atm.....	H.....	+ 0.005	Tungsten.....	W.....	- 0.33
Indium.....	In.....	+ 0.1	Vanadium.....	V.....	+ 1.7
Iodine.....	I.....	- 0.35	Zinc.....	Zn.....	- 0.9	- 0.1
Iridium.....	Ir.....	+ 4.9	+ 0.2	Zirconium.....	Zr.....	- 0.4
Iron salts.....	FeCl ₂	+90	Air, 1 atm.....	+ 0.032
.....	FeCl ₃	+90	Ebonite.....	+ 1
.....	FeSO ₄ + 7H ₂ O.....	+80	Paraffin.....	- 0.9
Lead.....	Pb.....	- 1.1	- 0.1	Shellac.....	- 0.4
Lithium.....	Li.....	+ 0.38	Water.....	H ₂ O.....	- 0.8
Magnesium.....	Mg.....	+ 0.56	Wood.....	-0.2 to -0.5
Manganese.....	Mn.....	+15

Most organic compounds are diamagnetic and have a mass susceptibility between -0.5 and -0.9 .

VIII. PUBLICATIONS ON MAGNETIC SUBJECTS

The following papers on magnetic subjects have been published by the Bureau. They are issued in pamphlet form as Scientific Papers and will be sent upon request. They may be designated by the numbers which precede the titles in the list. A complete list of the technical publications of the Bureau, with brief abstracts of contents, will also be sent upon application.

SCIENTIFIC PAPERS

- No. 38. Experiments on Heusler magnetic alloys; by K. E. Guthe and L. W. Austin.
No. 78. On the best method of demagnetizing iron in magnetic testing; by C. W. Burrows.
No. 87. Apparatus for the determination of the form of a wave of magnetic flux; by M. G. Lloyd and J. V. S. Fisher.
No. 88. Effect of wave form upon the iron losses in transformers; by M. G. Lloyd.
No. 106. Dependence of hysteresis upon wave form; by M. G. Lloyd.
No. 108. Errors in magnetic testing with ring specimens; by M. G. Lloyd.
No. 109. The testing of transformer steel; by M. G. Lloyd and J. V. S. Fisher.
No. 117. The determination of the magnetic induction in straight bars; by C. W. Burrows.
No. 164. A study of the current transformer with particular reference to iron loss; by P. G. Agnew.
No. 228. An experimental study of the Koepsel permeameter; by C. W. Burrows.
No. 245. Temperature coefficient of magnetic permeability within the working range; by R. L. Sanford.

CIRCULAR

- No. 6. Fees for electric, magnetic, and photometric testing.

