

REFERENCE

NIST
PUBLICATIONS

Federal Standard 1063 has been redesignated as Federal Information Processing Standards Publication (FIPS PUB) 148. Issued by the National Institute of Standards and Technology pursuant to Section 111(d) of the Federal Property and Administrative Services Act of 1949 as amended by the Computer Security Act of 1987, Public Law 100-235.

FEDERAL STANDARD 1063

PROCEDURES FOR DOCUMENT FACSIMILE TRANSMISSION

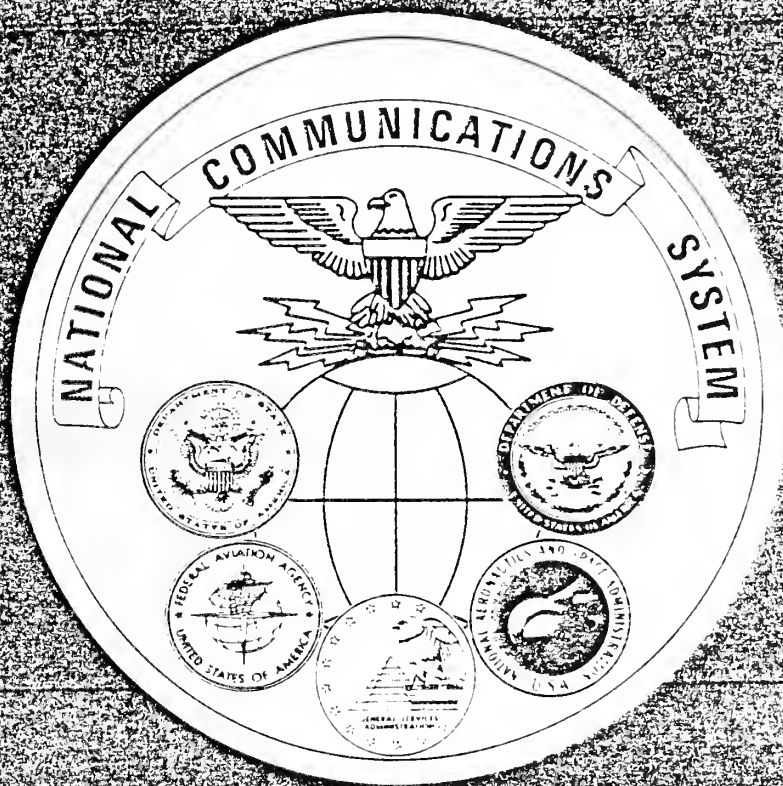
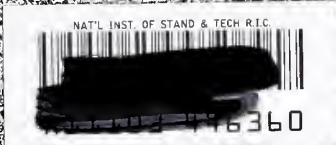

ISSUED BY GENERAL SERVICES ADMINISTRATION

JK

468

.A8A3

#148

1982

APRIL 14, 1982

EIA RS-466

EIA STANDARD

PROCEDURES
FOR
DOCUMENT FACSIMILE TRANSMISSION

RS-466



MAY 1981



Engineering Department

ELECTRONIC INDUSTRIES ASSOCIATION

NOTICE

EIA Engineering Standards and Publications are designed to serve the public interest through eliminating misunderstandings between manufacturers and purchasers, facilitating interchangeability and improvement of products, and assisting the purchaser in selecting and obtaining with minimum delay the proper product for his particular need. Existence of such Standards and Publications shall not in any respect preclude any member or non-member of EIA from manufacturing or selling products not conforming to such Standards and Publications, nor shall the existence of such Standards and Publications preclude their voluntary use by those other than EIA members, whether the standard is to be used either domestically or internationally.

Recommended Standards and Publications are adopted by EIA without regard to whether or not their adoption may involve patents on articles, materials, or processes. By such action, EIA does not assume any liability to any patent owner, nor does it assume any obligation whatever to parties adopting the Recommended Standard or Publication.

This Standard is based upon full agreement with the technical content of CCITT Recommendation T.30 for RS-466. Additionally, it is considered to have standardization implications and interest within ISO.

Published by

ELECTRONIC INDUSTRIES ASSOCIATION
Engineering Department
2001 Eye Street, N.W.
Washington, D.C. 20006

Copyright 1981
ELECTRONIC INDUSTRIES ASSOCIATION
All rights reserved

PRICE: \$15.00

Printed in U.S.A.

FEDERAL GOVERNMENT ADOPTION NOTICE

This EIA Recommended Standard RS-466 PROCEDURES FOR DOCUMENT FACSIMILE TRANSMISSION has been adopted as Federal Standard 1063.

EIA RS-466
3 April 1981

ACCEPTANCE NOTICE

This non-Government document was adopted on 3 April 1981, and is approved for use by the DoD. The indicated industry group has furnished the clearances required by existing regulations. Copies of the document are stocked by the DoD Single Stock Point, Naval Publications and Forms Center, Philadelphia, PA, 19120, for issue to DoD activities only. Contractors and industry groups must obtain copies directly from EIA, 2001 Eye Street, NW, Washington, DC 20006.

Title of Document: Procedures for Document Facsimile Transmission

Document No.: EIA RS-466

Date of Specific Issue Adopted: 3 April 1981

Releasing Industry Group: Electronic Industries Association

NOTICE: Certain provisions of this standard are the subject of international standardization agreement STANAG 5000, Interoperability of Tactical Facsimile Equipment, implemented by MIL-STD-188-161, Design Standards for Common Long Haul and Tactical Facsimile Equipment. When reaffirmation, amendment, revision, or cancellation of this standard is proposed, the military coordinating activity shall take appropriate action through military international standardization channels, including Departmental Standardization Offices, as required.

NOTICE: When reaffirmation, amendment, revision, or cancellation of this standard is initially proposed, the industry group responsible for this standard shall inform the military coordinating activity of the proposed change and request participation.

Custodians:

Army -- CR
Navy -- EC
Air Force -- 90

Military Coordinating Activity:

DCA -- DC
(Project SLHC-5003)

Review Activities:

Army -- CR, SC
Navy -- EC
Air Force -- 90
NSA -- NS
DCA -- DC
TRI-TAC -- TT

PROCEDURES FOR DOCUMENT FACSIMILE
TRANSMISSION

INDEX

		PAGE
1.0	Scope	1
2.0	Description of Phases	4
3.0	Description of a Facsimile Call	5
4.0	Tonal Signalling for Facsimile Procedure	15
5.0	Binary Coded Signalling for Facsimile Procedure	25

APPENDICES

Appendix 1	Example of Non-Standard Manual-to-Manual Basic Facsimile Operation	46
Appendix 2	Index of Abbreviations Used in EIA Standard #RS-466	47
Appendix 3	List of Commands and Appropriate Responses	48
Appendix 4	Called Station Procedures (Alternating Method)	49
Appendix 5	Signal Sequence Examples	50
Appendix 6	Related EIA Standards	62

PROCEDURES FOR DOCUMENT FACSIMILE TRANSMISSION

(From EIA Standards Proposal No. 1302-A, formulated under the cognizance of EIA TR-29 Committee on Facsimile Systems and Equipment.)

1.0 Scope

1.1 Procedures for Document Transmission

This Standard is concerned with the procedures which are necessary for document transmission between two facsimile stations operating on voice band analog circuits. These procedures essentially comprise the following:

- call establishment and call release
- compatibility checking, status and control command
- checking and supervision of line conditions
- control functions and facsimile operator recall
- both recognized optional functions as well as other (non-standard) options

In this Standard two separate signalling systems are described; first a simple tonal system using single frequency tones, and second a binary-coded system offering a much wider range of signals for more complex procedures. For simplicity of implementation as well as immunity to channel perturbations, the binary-coded system modulates between two of the tonal system's frequencies to designate the binary digit 1 and 0 information.

Thus, tonal signalling is to be utilized within simple terminals with limited functions and binary-coded signalling is to be utilized in terminals capable of more comprehensive automatic functions.

Only the procedures with their corresponding signals are specified in this Standard.

1.2 Classification of Operating Methods

For the purpose of originally establishing the facsimile connection, four operating methods are defined herein. Thus, depending on whether the called or calling party is operating in a manual or automatic mode of operation and whether it intends to transmit or receive, a particular operating method will be chosen. The particular operating method will determine the procedures to begin the interchange of signals between the two terminals. This interchange of signals is commonly referred to as handshaking.

The various operating methods are shown in Table 1.

TABLE 1

METHOD NO.	DESCRIPTION OF OPERATING METHOD	DIRECTION OF FACSIMILE TRANSMISSION	OVERALL DESIGNATION	HANDSHAKING MODE TONAL (T)/BINARY CODED (BC)
1	<u>Manual</u> operation at CALLING station	CALLING station <u>transmits to</u> CALLED station	1-T	T/BC
	<u>Manual</u> answering at CALLED station	CALLING station <u>receives from</u> CALLED station	1-R	T/BC
2	<u>Manual</u> operation at CALLING station	CALLING station <u>transmits to</u> CALLED station	2-T	T/BC
	<u>Automatic</u> answering at CALLED station	CALLING station <u>receives from</u> CALLED station	2-R	BC
3	<u>Automatic</u> operation at CALLING station	CALLING station <u>transmits to</u> CALLED station	3-R	T/BC
	<u>Manual</u> answering at CALLED station	CALLING station <u>receives from</u> CALLED station	3-R	See Note
	<u>Automatic</u> operation at CALLING station	CALLING station <u>transmits to</u> CALLED station	4-T	T/BC
4	<u>Automatic</u> answering at CALLED station	CALLING station <u>receives from</u> CALLED station	4-R	BC

NOTE: Beyond the scope of this specification

1.3 Related Standards

This Standard defines the procedures to be followed by Group 1, 2 and 3 machines as described in EIA Standard RS-465, and CCITT Recommendations T.2, T.3 and T.4. Thus, all facsimile terminals operating over the General Switched Telephone Network may utilize the procedures defined by this Standard.

1.4 Station Identification

For the purpose of classifying an automatic facsimile station as a non-speech terminal, signals are transmitted upon answering a call. As both automatic calling and called facsimile stations transmit such signals during call establishment, a normal telephone user who becomes inadvertently connected will receive signals for a period of sufficient duration to indicate clearly to him that he is incorrectly connected.

1.5 General Provisions

If any malfunction of the facsimile procedures described in this Standard is detected, the call shall be released.

Where the called station has automatic facsimile apparatus which is not ready or not able to operate, the call shall not be answered automatically.

This Standard includes procedures for not only the mandatory functions required to achieve a compatible facsimile transmission, but also numerous optional features. The procedures to obtain such proprietary manufacturer's options, the ability to switch from facsimile to speech, and the ability to define unique security passwords, are an example of the facilities which may be realized by terminals operating in accordance with this Standard.

2.0 Description of Phases

A facsimile call is made up of five phases. These phases are shown in Figure 1.

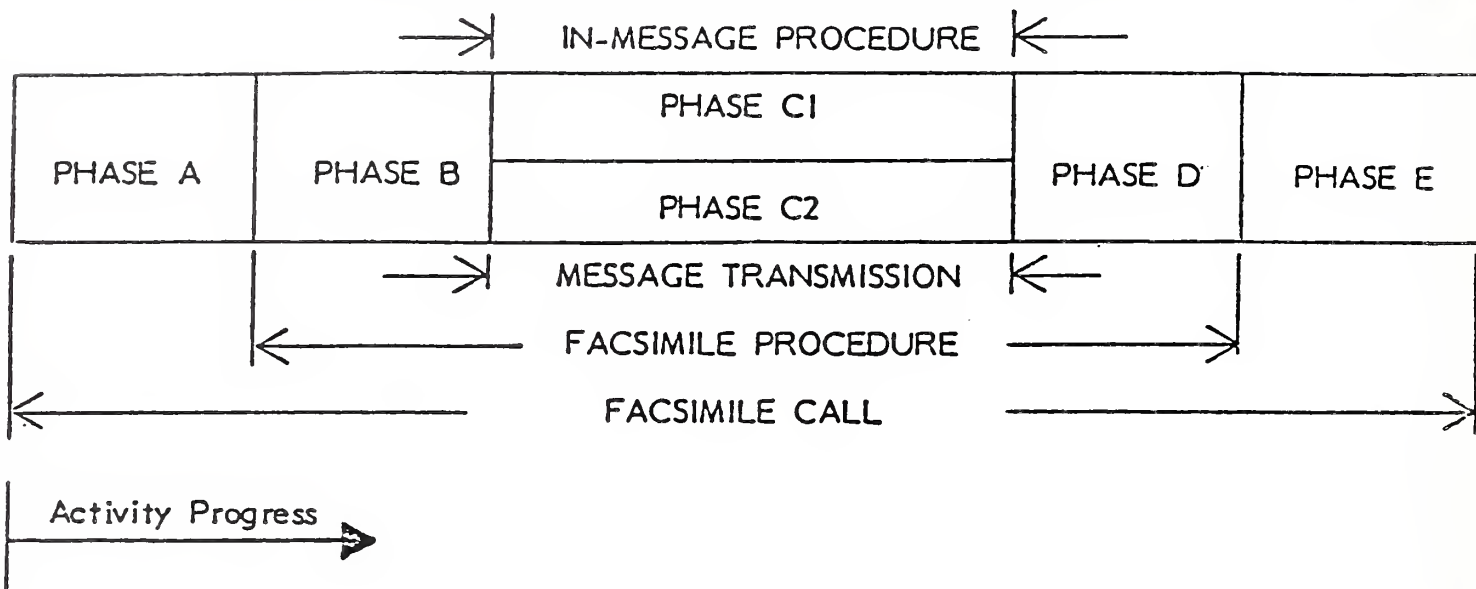

FIGURE 1

A description of each phase follows:

2.1 Phase A - Call Establishment

Call establishment can be accomplished manually and/or automatically.

2.2 Phase B - Pre-Message Procedure

The pre-message procedure consists of the identification of capabilities and the commanding of the chosen conditions as well as the confirmation of acceptable conditions.

When connection is established between apparatus operating in accordance with this standard and apparatus operating in a non-standardized manner, the equipments should disconnect before the in-message procedure unless both equipments include optional, compatible, procedures.

2.3 Phase C - Message Transmission

Message transmission procedure is covered by the appropriate Standard for the equipment. (Reference RS-465 and/or CCITT Recommendations T.2, T.3, and T.4).

2.4 Phase D - Post-Message Procedure

Post-message procedure includes information of end-of-message, confirmation of the reception of the message, and transmission of further message information.

2.5 Phase E - Call Release

Call release shall be accomplished manually and/or automatically.

3.0 Description of a Facsimile Call

3.1 Phase A - Call Establishment (Note)

The establishment of a facsimile call may be realized either manually, if an operator is in attendance, or automatically. To accomplish this, four operating methods have been defined.

Note: See Appendix 2 for abbreviations used in this Recommendation.

3.1.1 Operating Method 1

Manual operation at both the calling and called station. Figure 2 indicates the operators' actions required to establish a call.

Call Event No.	Calling Station	Called Station
1	Operator hears dial tone and dials desired number	
2	Operator hears ringing tone	Call rings and operator answers the call
3	Verbal identification	Verbal identification
4	Facsimile machine is switched to line	Facsimile machine is switched to line
5	Begin facsimile procedure (see 4. and/or 5. of this Standard)	Begin facsimile procedure (see 4. and/or 5. of this Standard)

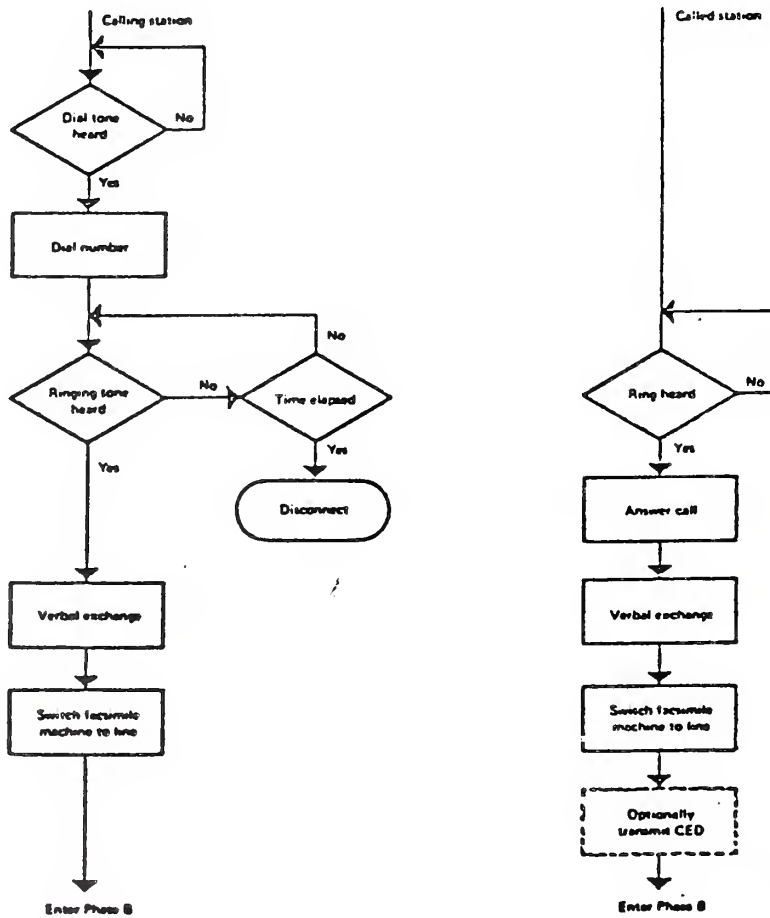

Figure 2 - Call Establishment - Operating Method 1

1.2 Operating Method 2

Manual operation at the calling station and automatic operation at the called station. Figure 3 indicates the operator's and apparatus' actions required to establish a call.

Call Event No.	Calling Station	Called Station
1	Operator hears dial tone and dials desired number	
2	Operator hears ringing tone	Equipment detects ring and answers the call.
3		Optionally, a recorded verbal announcement may be transmitted
4	Operator hears CED and facsimile machine is switched to line	Transmit CED
5	Begin facsimile procedure (see 4. and/or 5. of this Standard)	Begin facsimile procedure (see 4. and/or 5. of this Standard)

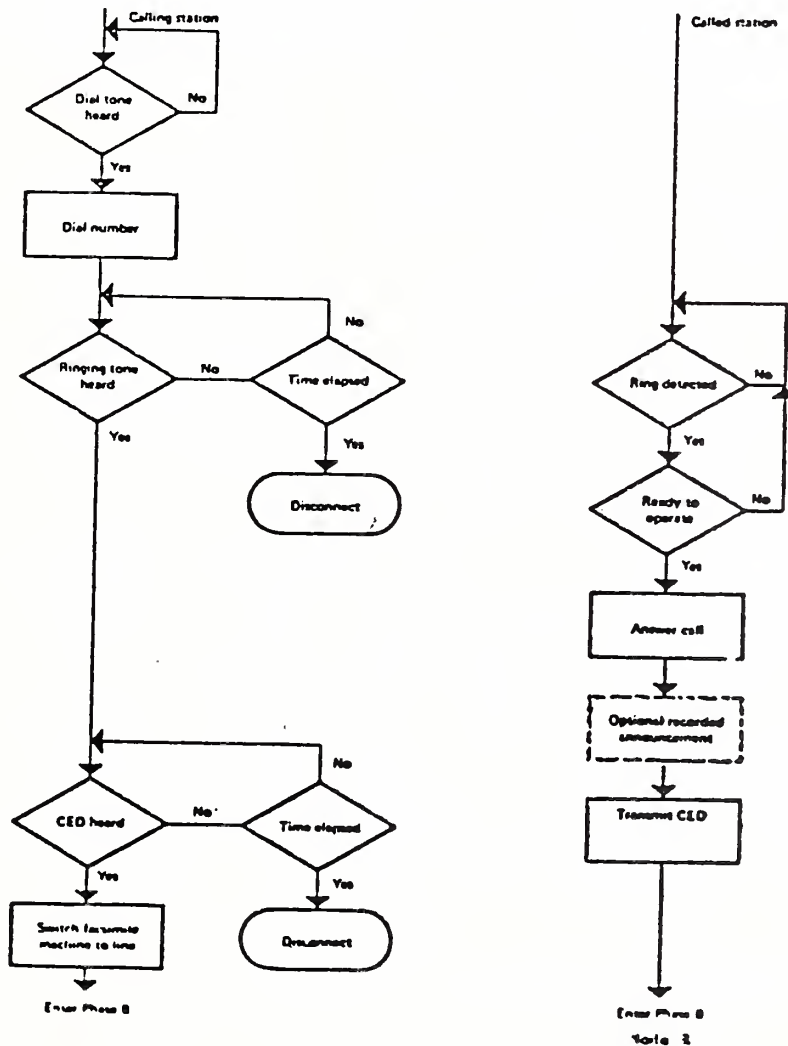

Figure 3 - Call Establishment - Operating Method 2

3.1.3 Operating Method 3

Automatic operation at the calling station and manual operation at the called station. Figure 4 indicates the operator's and apparatus' actions required to establish a call.

Call Event No.	Calling Station	Called Station
1	Equipment detects dial tone and dials desired number. To clearly indicate to a called operator that he is connected to a facsimile machine or to a normal telephone user that he is inadvertently connected, CNG will be transmitted to line during the time that signals are attempted to be detected.	
2		Call rings and operator answers the call
3		Operator detects CNG and switches facsimile machine to line (optionally CED may be generated)
4	Begin facsimile procedure (see 5. of this Standard)	Begin facsimile procedure (see 5. of this Standard)

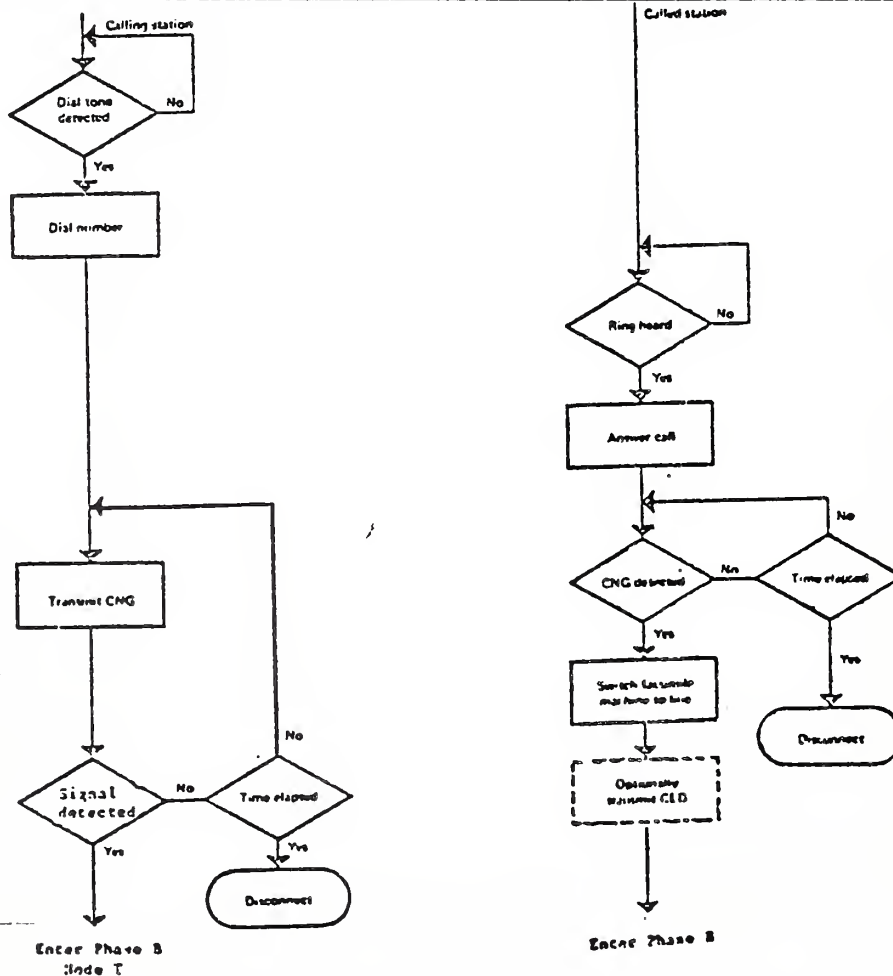

Figure 4 - Call Establishment - Operating Method 3

3.1.4 Operating Method 4

Automatic operation at both the calling and called stations. Figure 5 indicates the actions required by the apparatus to establish a call.

Call Event No.	Calling Station	Called Station
1	Equipment detects dial tone and dials desired number. To clearly indicate to a normal telephone user that he is inadvertently connected, CNG will be transmitted to line during the time that signals are attempted to be detected.	
2		Equipment detects ring and answers the call
3		Optionally, a recorded verbal announcement may be transmitted
4		Transmit CED
5	Begin facsimile procedure (see 5. of this Standard)	Begin facsimile procedure (see 5. of this Standard)

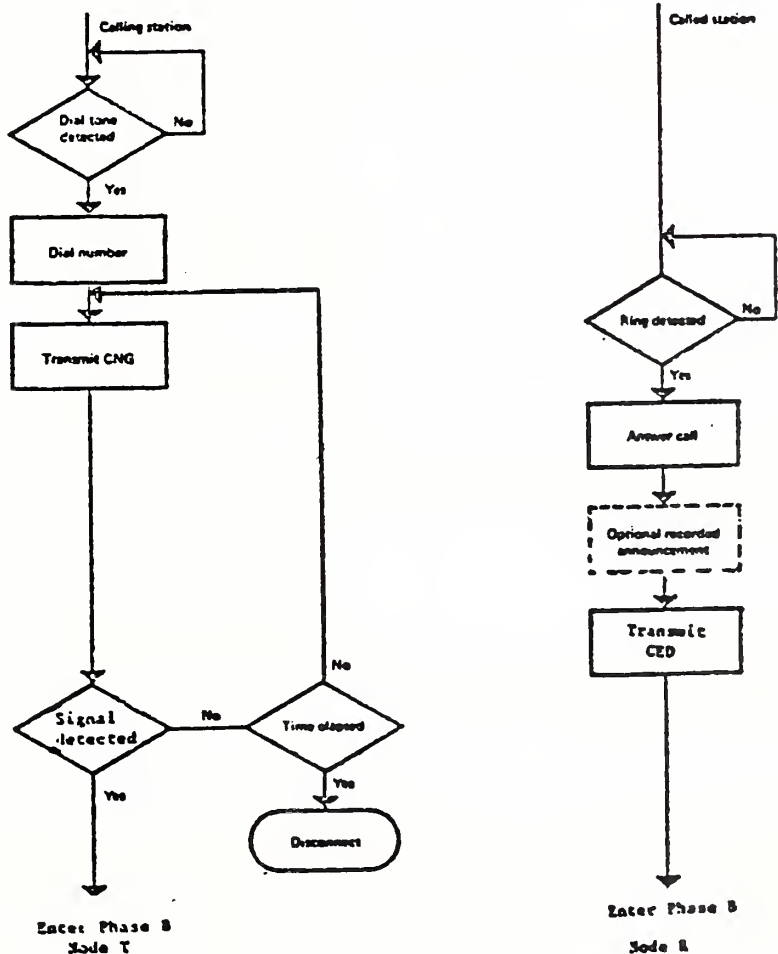

Figure 5 - Call Establishment - Operating Method 4

3.2 Phases B, C and D - Facsimile Procedure

When entering Phase B, the following rules should be adhered to:

All manual receivers and all auto-answering units must enter Phase B by identifying their capabilities (i.e. Node R of the Flow Diagram in sections 4.2 or 5.2). All manual transmitters and all auto-calling units must enter Phase B prepared to detect the capabilities and issue the appropriate mode setting command (i.e. Node T of the Flow Diagram in sections 4.2 or 5.2). To allow for operating method 2-R, the delay between the transmission of the digital identification signals shall be 4.5 seconds $\pm 15\%$ when sent from a manual facsimile receiver.

The detailed information pertaining to the tonal and binary coded facsimile procedures is contained in 4. and 5. below. The relationship between these two procedures and an overview regarding the total system operation is given in the following:

3.2.1 Interaction Between Tonal and Binary Coded Procedures

Facsimile procedures, as described in this Standard, may be realized in two different ways:

- tonally, with a limited number of tones for simple procedures (see 4. below) and
- binary coded, for more comprehensive procedures (see 5. below).

Binary coded signalling is especially desirable for machines which use:

- comprehensive automatic functions;
- digital concepts internally (e.g. redundancy reduction techniques);
- fast transmission rates (in order to keep pre and post message time short compared to total transmission time);
- special security features.

The interaction between tonal and binary coded signalling recognizes the principle of the priority of coded procedures such that, when available, binary coded signalling shall be tried first. The interaction steps are as follows:

- The unattended called station shall answer a call with the CED signal.
- The unattended calling station shall indicate a call with the CNG signal.
- Whenever it is capable of binary coded signalling, the called station will start with binary coded signalling.
- Facsimile stations being capable of tonal signalling only will start tonally.
- Facsimile stations being capable of both binary coded and tonal signalling will send a sequence of signals, the first being a binary coded signal and the second and all following signals being a composite of tonal and binary coded information.

- If the calling station reacts binary coded, then the binary coded signalling goes on through all control procedures.
- If the calling station reacts tonally, then the tonal signalling goes on through all procedures.

An example of a station having both binary coded and tonal capabilities is shown in Figure 6 for further clarification.

Called Station Procedure

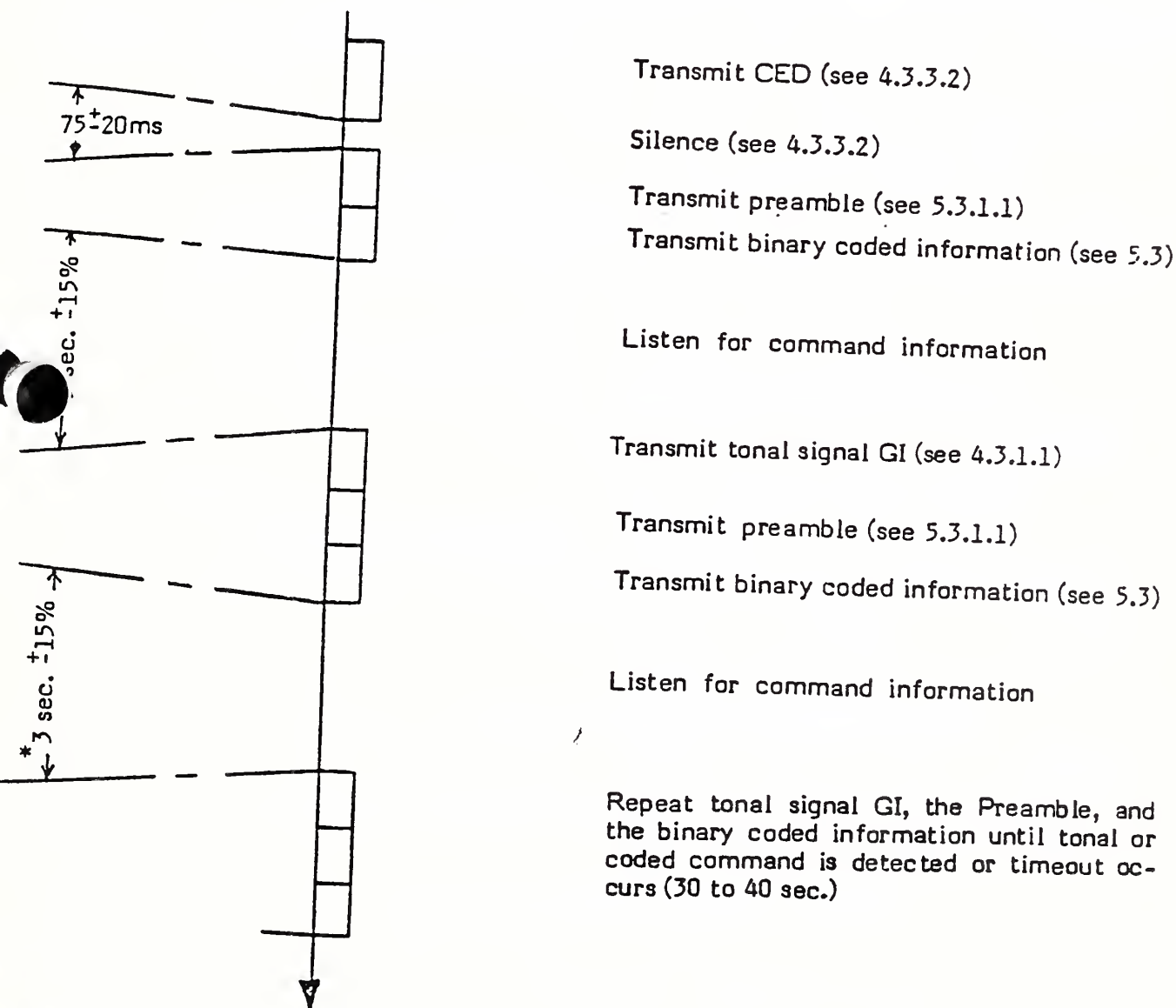

Figure 6 -- Binary Tonal Identification Signal

*Note:

For manual receivers using the binary coded procedure this delay should be 4.5 seconds $\pm 15\%$

3.2.2 Signal Sequences

This Standard utilizes the interchange of signals between the two equipments to verify compatibility and assure operation. To accomplish this end, the called station identifies its capabilities tonally (in the simplest configuration) and/or binary coded. The calling station responds to this accordingly with a command tonally or binary coded. Now the transmitter continues Phase B.

Following the transmission of the message, the transmitter sends an end-of-message signal and the receiver confirms reception. Multiple documents can then be transmitted by repeating this procedure.

The flow of signals is shown in Figure 7 for the configuration where the calling station is transmitting. These signals may be tonal or binary coded, subject to the conditions of 3.2.1 above.

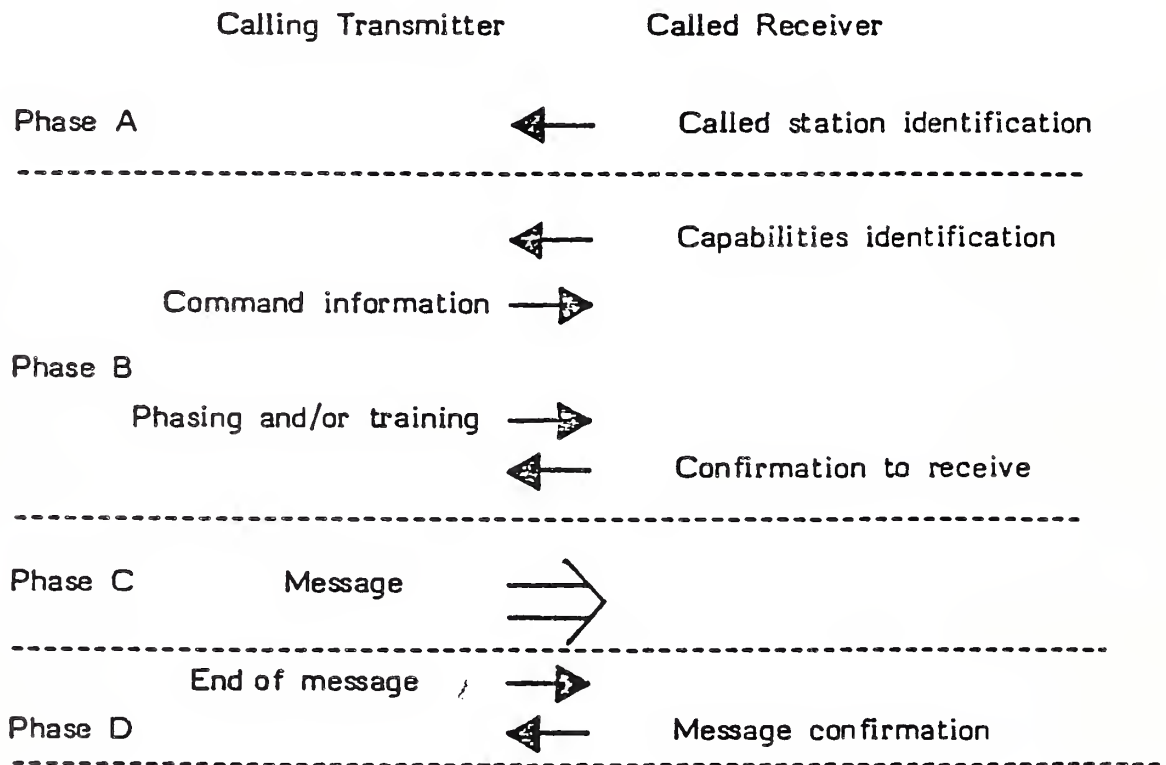

Figure 7 - Calling Station Transmitting

The condition where the calling station is to receive documents is shown in Figure 8. The simple tonal systems do not provide this capability.

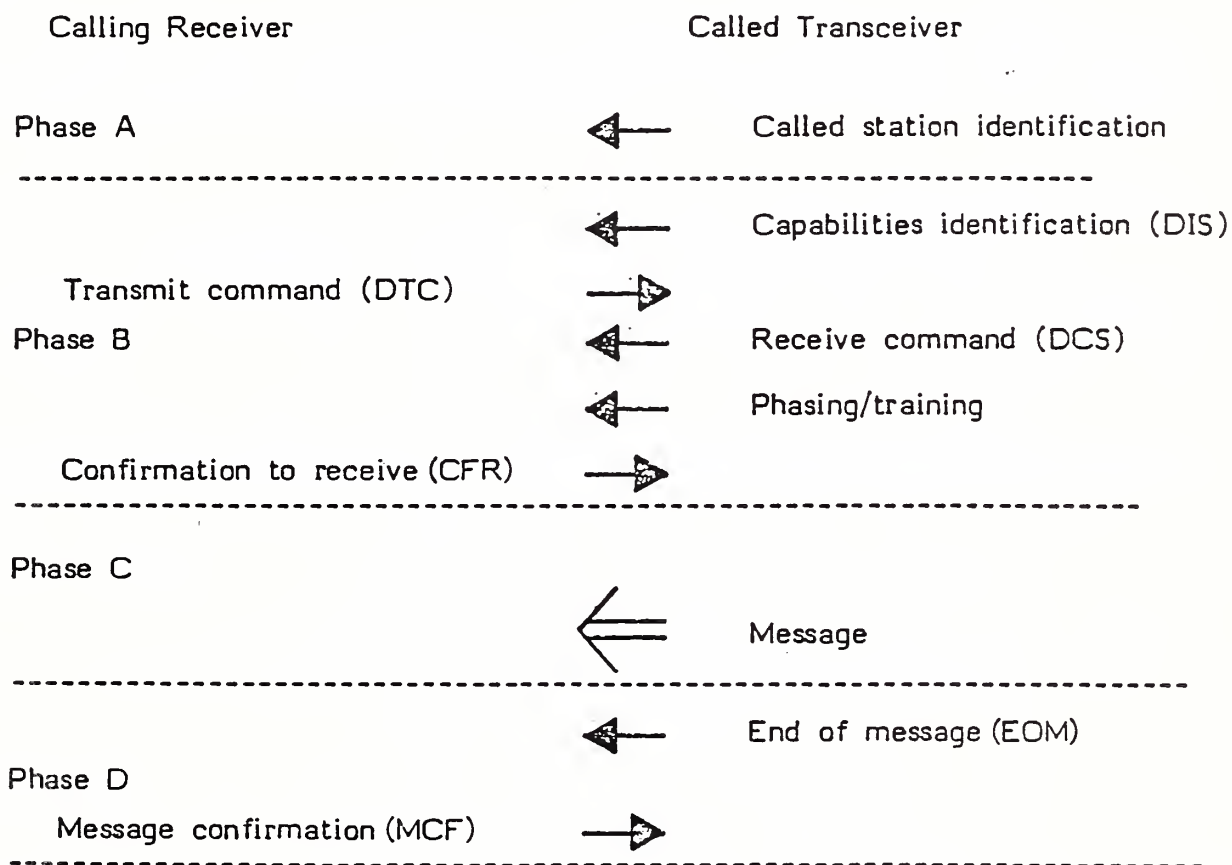

Figure 8 - Calling Station Receiving

3.3 Phase E - Call Release

Call release occurs after the last post-message signal of the procedure or under certain conditions, e.g:

3.3.1 Timeout

When a signal as specified by the facsimile procedure is not received within the specified timeout period, the apparatus may signal to operator (if one is in attendance) or disconnect the telephone connection. The appropriate timeout periods are specified in 4. and 5. below.

3.3.2 Procedural Interrupt

The facsimile procedure may be interrupted by sending a procedural interrupt signal, by notifying the attending operator or by disconnecting the connection. This signal is defined in 4. and 5. below.

3.3.3 Command

In the case where binary coded procedures are utilized, the call may be immediately terminated by the binary coded system commands as specified in 5. below.

4.0 Tonal Signalling for Facsimile Procedure

This signalling system covers operating methods 1 and 2T and has to be implemented for apparatus operating according to CCITT Recommendations T.2 and T.3 (i.e. Group 1 and 2 equipment).

4.1 Description

Phases B and C

Transmitter	Receiver
<ul style="list-style-type: none">2. GI detected3. Select appropriate Group4. Transmit GC5. Transmit Phasing 8. Detect CFR9. Transmit Message	<ul style="list-style-type: none">1. Transmit GI 6. Detect GC and Phasing. Select Group then synchronize 7. Transmit CFR

Phase D

Single-Document Transmitter	Multi-Document Receiver
<ol style="list-style-type: none">1. Transmit EOM 5. Detect MCF Switch back to telephone Operator loads document 7. Operator hears GI and switches machine to line 8. Detect GI 9. Transmit GC Continue Phases B and C	<ol style="list-style-type: none">2. Detect EOM 3. Transmit MCF 4. Prepare for next document 6. When ready to receive, transmit GI
Multi-Document Transmitter	Single-Document Receiver
<ol style="list-style-type: none">1. Transmit EOM 5. Detect MCF and prepare for next document 6. When ready to transmit, transmit CNG (optional) 9. Detect GI 10. Transmit GC Continue Phases B and C	<ol style="list-style-type: none">2. Detect EOM 3. Transmit MCF 4. Switch back to telephone Operator loads paper 7. Operator hears CNG and switches machine to line 8. Transmits GI

Multi-document transmitter to multi-document receiver and single-document facsimile apparatus operate accordingly.

Note. - It is acknowledged that there are existing equipments in the field that may not conform in all aspects to this Standard. Therefore, the decision may be made to go to a mode of operation other than specified herein. The diagram of Appendix 1 describes, as an example, one of these conditions. Other methods may be possible as long as they do not interfere with the operation standardized herein.

4.2 Flow Diagram

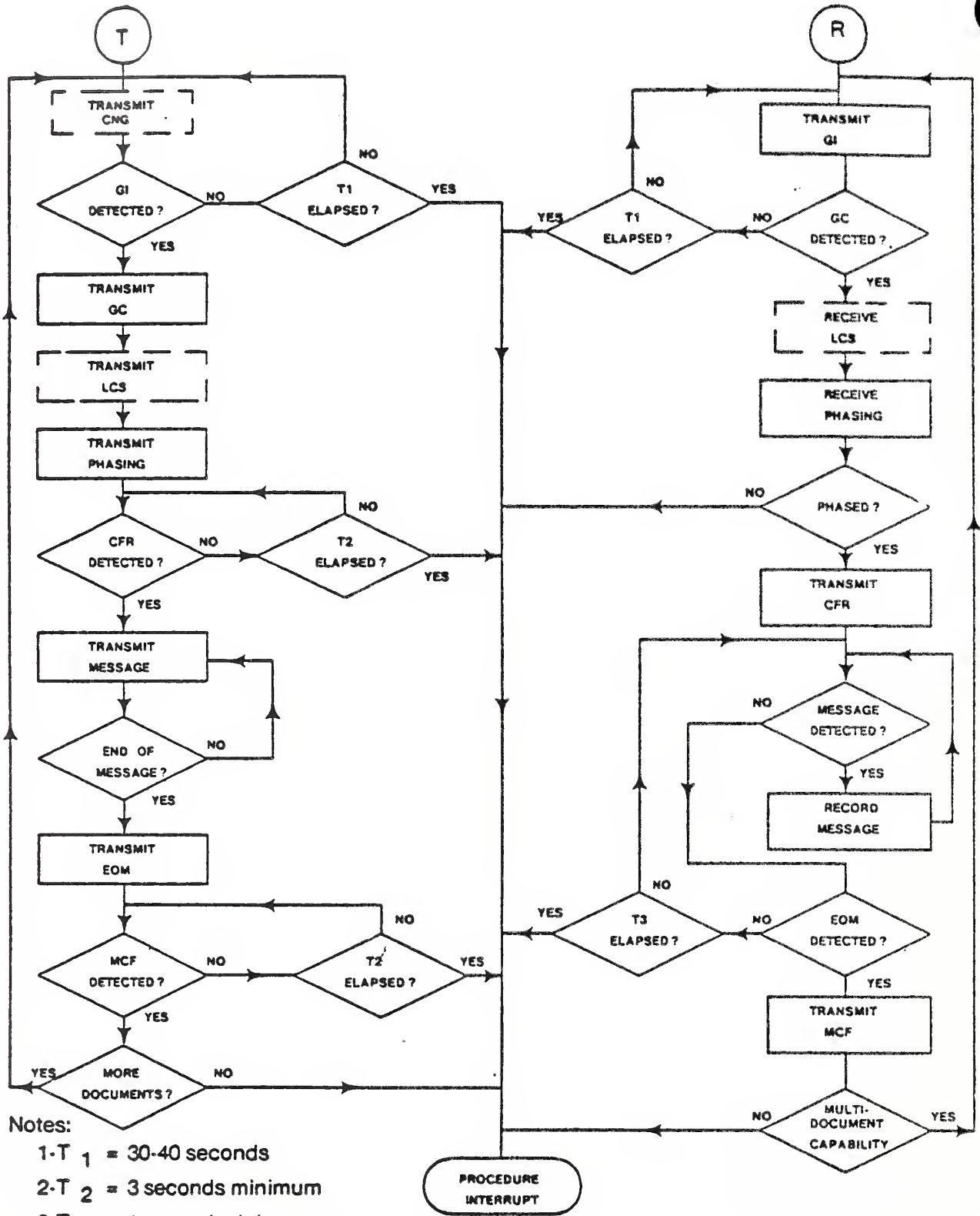

Notes:

- 1-T₁ = 30-40 seconds
- 2-T₂ = 3 seconds minimum
- 3-T₃ = 1 second minimum
- 4-Broken Boxes indicate signals not used in all methods

PROCEDURE INTERRUPT

4.3 Tonal Signal Functions and Formats

The signals used are single frequencies to line. The equipment used to detect the signal should be capable of functioning correctly with the frequency tolerances quoted plus an additional tolerance of $\pm 6\text{Hz}$ due to the line.

4.3.1 Facsimile Receiver Signals (signals transmitted by the receiver)

4.3.1.1 Group Identification Signals

GI 1 (Apparatus operating in accordance with CCITT Recommendation T.2)

Format

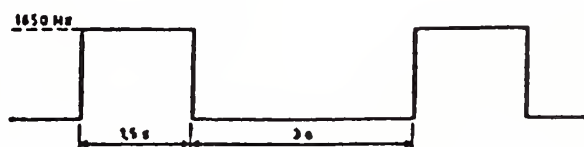

Function

1. To indicate the apparatus is in the receive mode and capable of receiving at least one page in the T.2 mode.
2. The signal is repeated until detection of GC or timer T1 elapses.
3. Tolerances: Timing $\pm 15\%$; Frequency $\pm 6\text{Hz}$.

GI 2 (Apparatus operating in accordance with CCITT Recommendation T.3)

Format

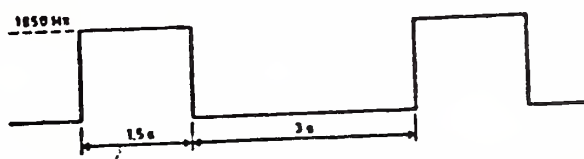

Function

1. To indicate the apparatus is in the receive mode and capable of receiving at least one page in the T.3 mode.
2. The signal is repeated until detection of GC or timer T1 elapses.
3. Tolerances: Timing $\pm 15\%$; Frequency $\pm 6\text{Hz}$.

GI 1/2 (Apparatus operating in accordance with CCITT Recommendations T.2 and T.3)

Format

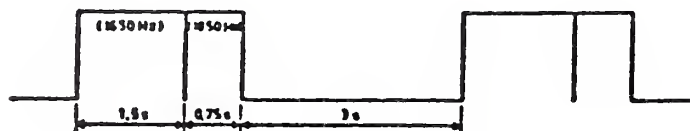

1. To indicate the apparatus is in the receive mode and is capable of receiving at least one page in the T.2 or T.3 mode. The apparatus is capable of adjusting automatically to the speed of the transmitter.
2. The signal is repeated until detection of GC or timer T1 elapses.
3. Tolerances: Timing $\pm 15\%$; Frequencies $\pm 6\text{Hz}$.

4.3.1.2 Confirmation to Receive Signals (CFR)

CFR 1 (Apparatus operating in accordance with CCITT Recommendation T.2)

Format

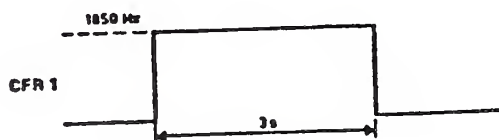

Function

1. To indicate the receiver has phased and is ready to receive at least one page in the T.2 mode. The signal must start after the completion of the phasing signal at the receiver with a maximum delay of one second.
2. Tolerances: Timing $\pm 5\%$; Frequency $\pm 6\text{Hz}$.

CFR 2 (Apparatus operating in accordance with CCITT Recommendation T.3)

Format

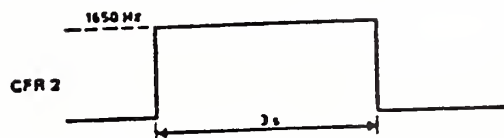

Function

1. To indicate that the receiver has phased and is ready to receive at least one page in the T.3 mode. The signal must start after the completion of the phasing signal at the receiver with a maximum delay of one second.
2. Tolerances: Timing $\pm 15\%$; Frequency $\pm 6\text{Hz}$.

4.3.1.3 Message Confirmation Signal

MCF 1 (Apparatus operating in accordance with CCITT Recommendation T.2)

Format - The same frequency and duration as for CFR 1.

Function

1. To indicate that the receiver has received one page in T.2 mode.
2. Tolerances: Timing $\pm 15\%$; Frequency $\pm 6\text{Hz}$.

MCF 2 (Apparatus operating in accordance with CCITT Recommendation T.3)

Format - The same frequency and duration as for CFR 2.

Function

1. To indicate that the receiver has received one page in the T.3 mode.
2. Tolerances: Timing $\pm 15\%$; Frequency $\pm 6\text{Hz}$.

Note. The MCF signal must start a maximum of 0.5 seconds after the completion of the EOM signal (see paragraph 4.3.2.4) at the receiver and continue for 3 seconds.

4.3.2 Facsimile Transmitter Signals (signals transmitted by transmitter)

4.3.2.1 Group Command Signals (GC)

GC1 - 1300 Hz ± 32 Hz for a duration of more than 1.5 seconds and less than 10 seconds.

GC2 - 2100 Hz ± 10 Hz for a duration of more than 1.5 seconds and less than 10 seconds.

Function

To indicate to the receiver, the Group that the transmitter has chosen. GC signal starts at the end of the Capabilities Identification signal with a maximum delay of 1 second as measured on the line at the transmitter.

4.3.2.2 Line Conditioning Signals (LCS)

Format - See 4.3.2.3 b) (Group 2 Phasing) below.

Function

1. To enable a receiver to equalize the line.
2. This is an optional signal and non-transmission should not affect compatibility.

4.3.2.3 Phasing

Format

a) Group 1

Alternating black and white signals sent through the Group 1 modulation system for 15 ± 1 seconds where the black signal is of a duration of 94-96% of the total scanning line time and the white signal occupies the remaining 4-6%. The leading edge of the white signal shall be 2 to 3% in advance of the middle of the dead sector.

b) Group 2

Alternating white and black signals sent through the Group 2 modulation system for 6 ± 0.5 seconds where the white signal is of a duration of 94-96% of the total scanning line time and the black signal occupies the remaining 4-6%. The leading edge of the black signal shall be 2 to 3% in advance of the middle of the dead sector.

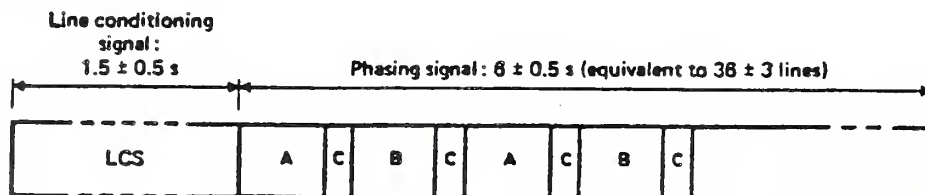

CCITT-0922

- LCS = line conditioning signal: 1100 \pm 50 Hz. Transmission of this signal is optional
- A = carrier in 0° phase for 94-96% of total scanning line length
- B = as A but may be in 180° phase
- C = no signal (at least 26 dB below the carrier) for the remaining 6-4% of scanning line length

Structure of line conditioning and phasing signal

Function

To allow the receiving apparatus to align the received image properly on the recording medium.

4.3.2.4 End-of-Message Signal (EOM)

Format

Frequency 1100 Hz ± 38 Hz. Timing 3 seconds $\pm 15\%$ immediately following the message.

Function

To indicate Phase C has been completed.

4.3.3 Common Signals

4.3.3.1 Procedure Interrupt Signal (PIS) (Applicable in both directions)

Format

462 Hz ± 1.5 Hz for 3 seconds minimum.

Function

1. To stop a distant machine
2. May be used as an operator recall.

Note 1. This is an optional signal.

Note 2. Some machines use this signal as a disconnect signal only when the receiver detects this signal immediately after transmitting MCF or transmitting MCF/GI and, in either case, before a subsequent GI.

Note 3. The satisfactory operation of the PIS signal cannot be guaranteed in, for example, the presence of echo suppressors.

4.3.3.2 Called Station Identification (CED)

At 1.8 to 2.5 seconds after the called station is connected to the line, it sends a continuous 2100 Hz ± 15 Hz answering tone for a duration of not less than 2.6 seconds and not more than 4.0 seconds.

The answering station delays for a period of 75 ± 20 milliseconds after terminating tone before transmitting further signals.

Function

To indicate a called non-speech terminal.

4.3.3.3 Calling Tone (CNG)

Format

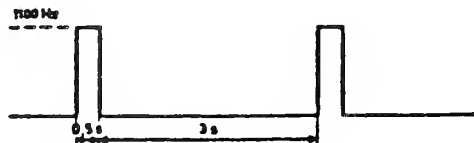

Tolerances: Timing $\pm 15\%$; Frequency $\pm 38\text{Hz}$

Function

1. To indicate a calling non-speech terminal. This signal is mandatory for automatic units and optional for manual units.
2. To indicate that the apparatus is in the transmit mode and is ready to transmit on receipt of the appropriate GI.
3. Where an apparatus is capable of sending more than one document without the necessity of operator assistance, this signal may be transmitted between documents while the transmitter is waiting for the appropriate GI. It would indicate to an operator that the transmitter was still connected to line.

5.0 Binary Coded Signalling For Facsimile Procedure

For Group 1 and Group 2 machines that require additional facilities to those provided by the procedures described in Section 4 (of this Standard), the binary coded control procedures should be transmitted in a synchronous mode at 300 bits per second.

For Group 3 machines, operating in accordance with EIA Standard RS 465, 300 bits per second is the standard signalling rate for the transmission of binary coded procedural data. Additionally, signalling of the binary coded procedural data at 2400 bits per second is allowed as an option.

Except as otherwise noted, the binary-coded control procedures should be transmitted in a synchronous mode on the general switched telephone network at 300 bits per second $\pm 0.01\%$ utilizing the following characteristics:

Symbol "1" Frequency: 1650 ± 6 Hz
Symbol "0" Frequency: 1850 ± 6 Hz

Signal generators should have a distortion not exceeding 1.0 percent and the control signal receivers should accept signals with a distortion of up to 40 percent.

Note 1. - For Group 3 machines, as defined in EIA Standard RS 465, the transmission of training, TCF, and all in-message signals, shall be at the data rate of the high-speed message channel.

Note 2.- It is acknowledged that existing equipments may not conform in all aspects to this Standard. Other methods may be possible as long as they do not interfere with the standard operation.

Note 3. - Transmission of signals utilizing the modulation system described above should be followed by a delay of 75 ± 20 milliseconds before the signalling, utilizing a different modulation system, commences. (e.g. the delay between DCS and the training sequence)

Note 4. - The transmission of signalling utilizing the signalling systems of RS 465 should be followed by a delay of 75 ± 20 milliseconds before the signalling, utilizing a different modulation system, commences. (e.g. the delay between RTC and MPS)

5.1 Description

Phases B, C and D

Case 1: Calling station wishes to transmit (see also Figure 7)

Calling Station	Called Station
	1. Transmit DIS
2. DIS detected	
3. Transmit DCS	
	4. DCS detected
	5. Select mode
6. Transmit Phasing/Training	
	7. Detect Phasing/Training
	8. Transmit CFR
9. Detect CFR	
10. Transmit message	
12. At end of message send either:	11. Receive message
a) EOM or	
b) EOP or	
c) MPS or	
d) PRI-Q	
	13. Detect EOM, EOP, MPS or PRI-Q
	14. Transmit one of the confirmation signals of post-message responses (see G.1 - G.5 of 5.3.6.1)

Note - Binary coded signals must be preceded by a preamble (see 5.3.1 below).

Case 2: Calling station wishes to receive (see also Figure 8)

Calling Station	Called Station
	1. Transmit DIS
2. DIS detected	
3. Transmit DTC	
	4. DTC detected
	5. Transmit DCS
6. DCS detected	
7. Select mode	
	8. Transmit Training/Phasing
9. Detect Training/Phasing	
10. Transmit CFR	
	11. Detect CFR
	12. Transmit message
13. Receive message	
	14. At end of message send either:
	a) EOM or
	b) EOP or
	c) MPS or
	d) PRI-Q
15. Detect EOM, EOP, MPS or PRI-Q	
16. Transmit one of the confirmation signals of post-message responses (see G.1 - G.5 of 5.3.6.1)	

Note - Binary coded signals must be preceded by a preamble (see 5.3.1 below).

Inter-working between the standard mode (300 bits per second) and the optional mode (2400 bits per second) for the binary coded handshaking procedure is provided by an alternating method.

Modifications in the main flow diagram are as follow:

Left-hand side of beginning of phase B:

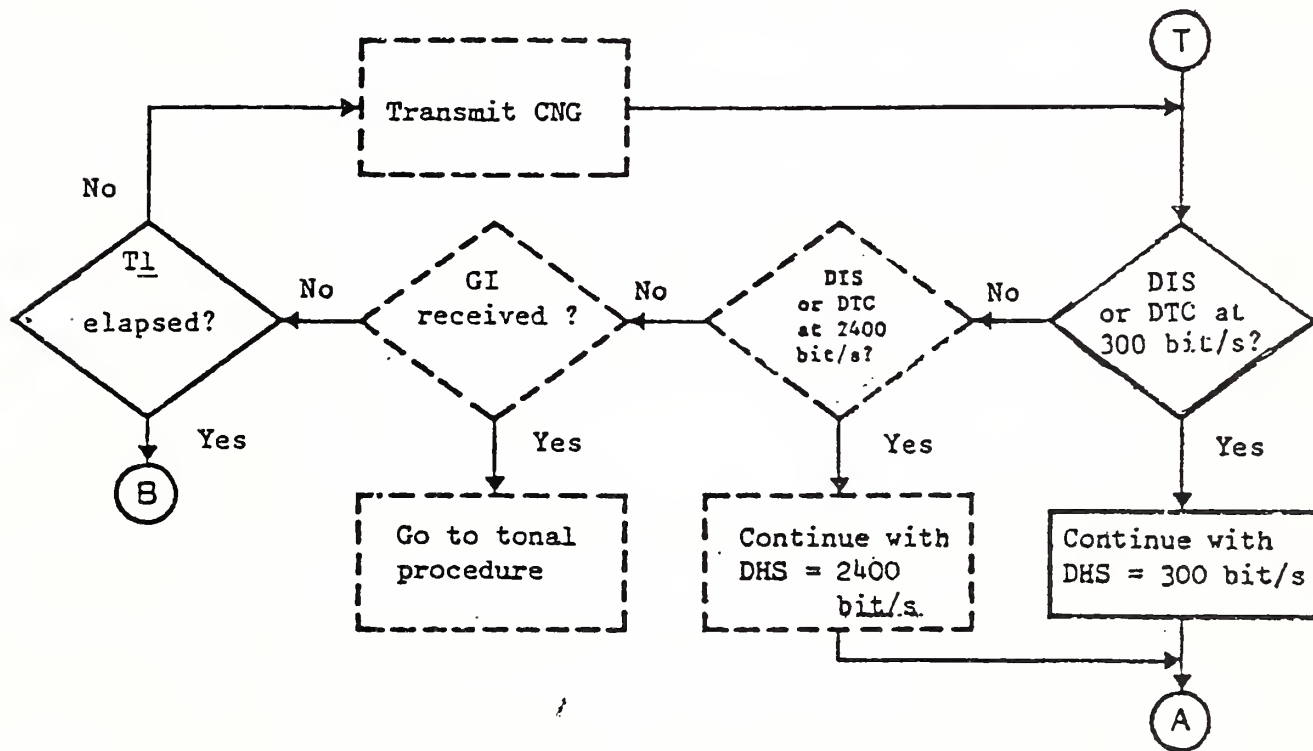

Note.

- DHS = Digital handshaking speed
- Dotted lines = optional

Right-hand side of beginning of Phase B.

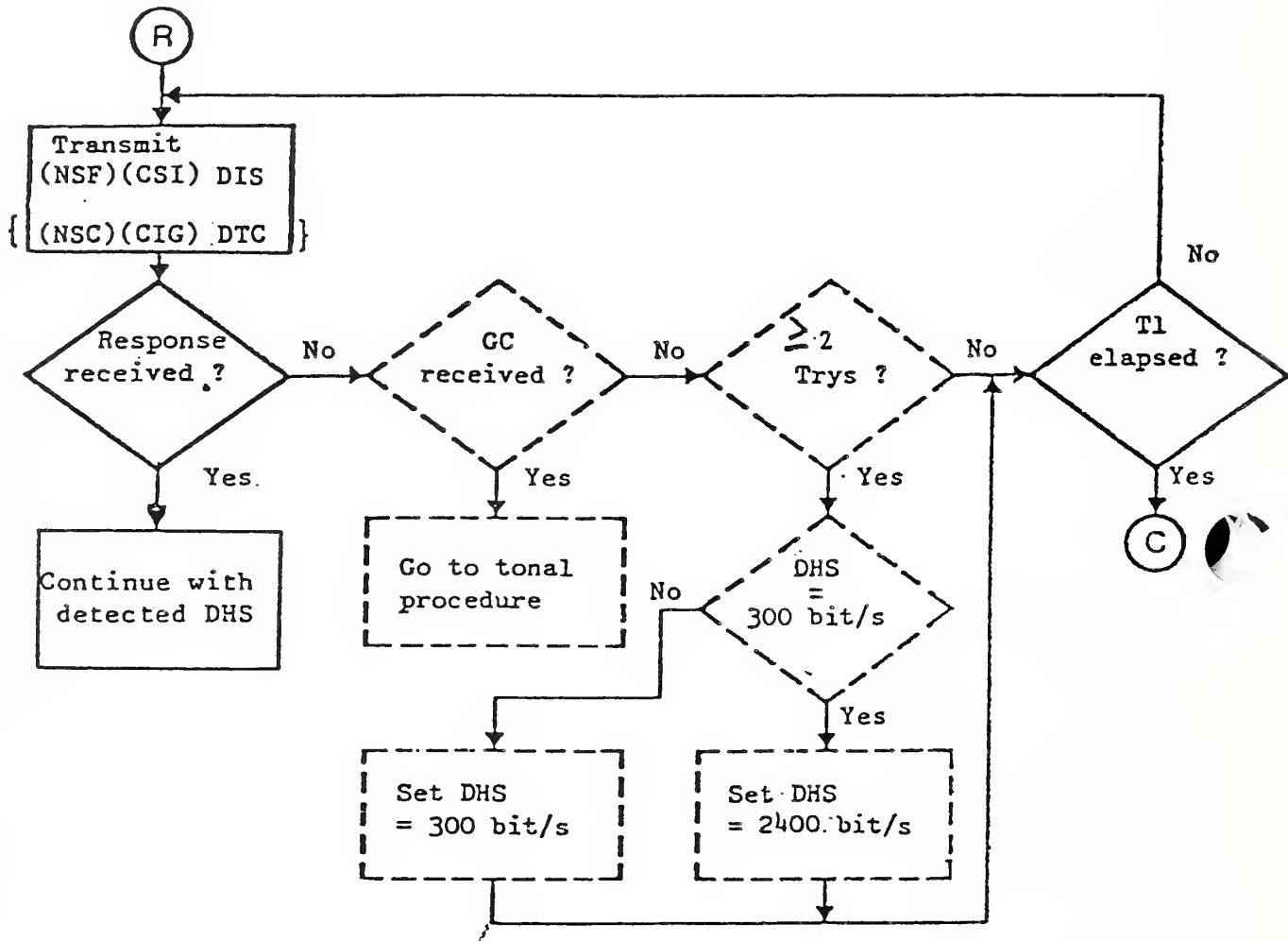

Note: The station listens to a response at 300 bps (2400 bps) after transmitting a command at 300 bps (2400 bps) and continues with the detected DHS.

5.2.1 Flow Diagram Key

COMMAND REC	The "Command Received" subroutine searches for an error-free standard command. The decision diamonds in the flow diagram refer to the most recent standard command received (e.g., EOM, MPS, etc.).
COMPT REMOTE REC	The FIF associated with the DIS has indicated a "Compatible Remote Receiver."
DOC TO XMIT	The station has "at least one document to be transmitted".
COMPT REMOTE XMTR	The FIF associated with the DIS has indicated a "Compatible Remote Transmitter" which has documents to send.
RESPONSE REC	The "Response Received" subroutine which searches for an error-free standard response.
LAST DOC	The "Last Document", for the given operating mode, has been transmitted.
SET MODE	The system controller will "set the appropriate mode" of operation.
3RD TRY	The command has been repeated three times without an appropriate response.
CAPABLE RE-XMIT	The transmitting station is "capable of retransmitting" a document which was not received with acceptable quality.
MSG CARRIER REC	The "Message Channel Carrier has been Received". This carrier is 1800 Hz for the RS 465 standard modulation scheme, 1700 Hz for the RS 465 optional modulation scheme, 2100 Hz for the Group 2 modulation scheme, and 1300-2100 Hz for the Group 1 modulation scheme.
PHASE/TRAIN OK	The Phasing/Training-TCF signal has been analyzed and the results of "Phasing/Training were OK."
CHANGE MODE	The transmitting unit desires to exit from the transmitting mode of operation and re-establish the capabilities.
NSP REQ	A "Non-Specified Procedure" has been "recognized" by a unit compatible with the station initiating that procedure.
COPY QUALITY OK	By some algorithm, the "Copy Quality was deemed OK."
REPHASE/TRAIN	By some algorithm, it is deemed desirable to transmit a new Phasing/Training signal.
FLAG	There has been the detection of a "Flag".
RECEIVE A FRAME	The unit has "Received one complete HDLC Frame."
FCS ERROR	The HDLC frame received contained an "FCS Error."

OPTIONAL RESPNS	The HDLC frame received contained one of the listed "Optional Responses."
OPTIONAL COMMAND	The HDLC frame received contained one of the listed "Optional Commands."
CRP OPTION	The facsimile unit has the "CRP Option" and can, therefore, request an immediate retransmission of the most recent command.
LOCAL INT	Either the "Local" machine or the "Local" operator wishes to generate an "Interrupt" of the standard facsimile procedures. An operator would use this as a means to request the establishment of voice contact.
LINE REQ	This means that the local operator has "Requested" that the telephone line be connected to the handset for voice contact with the remote end.
PRI-Q	A general term referring to either PRI-EOM, a PRI-MPS, or a PRI-EOP post-message command, i.e. the fifth bit of the standard post-message command is set to "1".

NOTES:

1. The Non-Specified Procedure, NSP, refers to a procedure which takes 6 seconds or less to complete. It may not necessarily be a definable signal sequence.
2. This signal pertains to Group 3 (RS-465) apparatus only.
3. The PRI-EOM, PRI-EOP, PRI-MPS post-message commands are sent when a local interrupt request is pending.
4. Where the symbol / is used, the term to the left of the slash refers to Group 1 and 2 equipment, and the term to the right of the slash refers to RS 465 equipment.
5. Where the symbols { } are used, the signals within these symbols are a response (to DIS) from the calling unit wishing to receive.
6. Where the symbols () are used, the signals within these symbols are optional.
7. At any time during the operation an interrupt may be generated which would result in a procedural interrupt. It is understood that if this interrupt happens during the transmission of the document, the EOM/RTC signal will be transmitted prior to invoking the procedural interrupt.

5.3 Binary Coded Signal Functions and Formats

An HDLC frame structure is utilized for all binary coded facsimile control procedures. The basic HDLC structure consists of a number of frames, each of which is subdivided into a number of fields. It provides for frame labelling, error checking and confirmation of correctly received information.

More specifically, the following example of a format is used for binary coded signalling. This example shows an initial identification sequence (see 5.3.6.1 A. below).

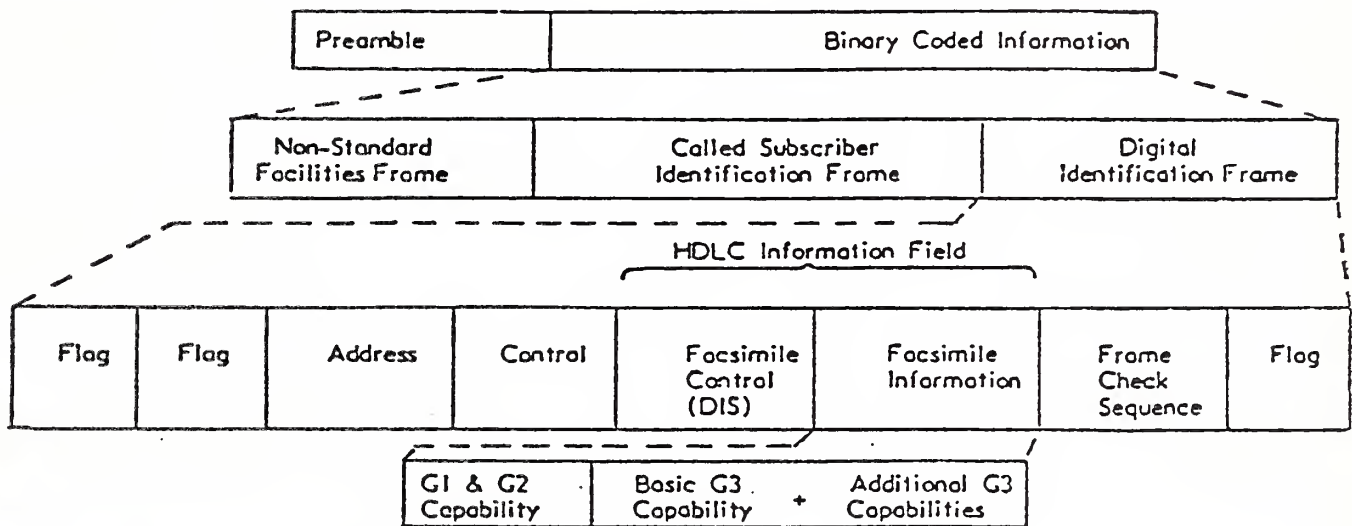

In the following descriptions of the fields it is intended that the information bits be transmitted in the order as printed, i.e. from left to right.

5.3.1 Preamble

The preamble shall precede all binary coded signalling whenever a new transmission of information begins in any direction (i.e. for each line turnaround). This preamble assures that all elements of the communication channel (e.g. echo suppressors) are properly conditioned so that the subsequent data may be passed unimpaired. This preamble may take the following forms:

5.3.1.1 Initial Identification

The preamble for binary coded signalling at 300 bit/s shall be a series of flag sequences for one second $\pm 15\%$.

5.3.1.2 Subsequent Identification

For the optional binary coded procedure at 2400 bit/s, the preamble shall be the long training modem sequence defined in RS 465.

5.3.2 Message/Signalling Delineation

5.3.2.1 Where Group 1 or Group 2 modulation techniques are employed, the delineation is obtained by the transmission of the tonal EOM signal as defined in section 4.3.2.4. This signals the CCITT T.2 or T.3 modulation system to drop off the line and be replaced by the RS-466 binary coded modulation system.

5.3.2.2 When the RS-465 modulation technique is employed, the delineation is obtained by the transmission of the RTC signal as defined in section 4.1.4 or 4.2.4 of RS-465. This signals the RS 465 modulation system to drop off the line and be replaced by the binary coded modulation system defined herein.

5.3.2.3 The transmission of the delineation signal, either the tonal EOM signal or the RTC signal, shall be followed by a delay of 75 ± 20 ms before the binary coded modulation system defined herein commences to transmit.

5.3.3 Flag Sequence

The eight bit HDLC flag sequence is used to denote the beginning and end of the frame. For facsimile procedure, the flag sequence is used to establish bit and frame synchronization. To facilitate this, the preamble defined in section 5.3.1 should be used prior to the first frame of any transmission. Subsequent frames need only one flag sequence.

Continued transmission of the flag sequence may be used to signal to the distant station that the machine remains on line but not presently prepared to proceed with the facsimile procedure.

Format: 0111 1110

5.3.4 Address Field

The eight bit HDLC address field is intended to provide identification of specific station(s) in a multi-point arrangement. In the case of transmission on the General Switched Telephone Network, this field is limited to a single format.

Format: 1111 1111

5.3.5 Control Field

The eight bit HDLC control field provides the capability of encoding the commands and responses unique to the facsimile control procedures.

Format: 1100 X000

X = 0 for non-final frames within the procedure, X = 1 for final frames within the procedure. A final frame is defined as the last frame transmitted prior to an expected response from the distant station.

5.3.6 Information Field

The HDLC information field is of variable length and contains the specific information for the control and message interchange between two facsimile stations. In this Specification it is divided into two parts, the Facsimile Control Field (FCF) and the Facsimile Information Field (FIF).

5.3.6.1 Facsimile Control Field (FCF)

The Facsimile Control Field is defined to be the first eight bits of the HDLC information field. This field contains the complete information regarding the type of information being exchanged and the position in the overall sequence. The bit assignments within the FCF are as follows:

Where "X" appears as the first bit of FCF, X will be defined as follows:

"X" is set to 1 by the station which receives a valid DIS signal

"X" is set to 0 by the station which receives a valid and appropriate response to a DIS signal

"X" will remain unchanged until the station again enters the beginning of Phase B.

A. Initial identification (from the called to the calling station)

Format: 0000 XXXX

1) Digital Identification Signal (DIS) - Characterizes the standard capabilities of the called apparatus.

Format: 0000 0001

2) Called Subscriber Identification (CSI) - This optional signal may be used to provide the specific identity of the called subscriber by its international telephone number. (See section 5.3.6.2.4 CSI Coding Format)

Format: 0000 0010

3) Non-Standard Facilities (NSF) - This optional signal may be used to identify specific user requirements which are not covered by the EIA Standards.

Format: 0000 0100

B. • Command to send (from a calling station wishing to be a receiver to a called station which is capable of transmitting).

Format: 1000 XXXX

1) Digital Transmit Command (DTC) - The digital command response to the standard capabilities identified by the DIS signal.

Format: 1000 0001

2) Calling Subscriber Identification (CIG) - This optional signal indicates that the following FIF information is an identification of that calling station. It may be used to provide additional security to the facsimile procedure. (See section 5.3.6.2.5 CIG Coding Format)

Format: 1000 0010

3) Non-standard Facilities Command (NSC) - This optional signal is the digital command response to the information contained in the NSF signal.

Format: 1000 0100

C. Command to receive (from the transmitter to the receiver)

Format X100 XXXX

1) Digital Command Signal (DCS) - The digital set-up command responding to the standard capabilities identified by the DIS signal.

Format: X100 0001

2) Transmitting Subscriber Identification (TSI) - This optional signal indicates that the following FIF information is the identification of the transmitting station. It may be used to provide additional security to the facsimile procedures. (See section 5.3.6.2.6 TSI Coding Format)

Format: X100 0010

3) Non-standard Facilities Set-up (NSS) - This optional signal is the digital command response to the information contained in the NSC or NSF signal.

Format: X100 0100

4) Training Check (TCF) - This digital command is sent through the RS 465 modulation system to verify training and to give a first indication of the acceptability of the channel for this data rate.

Format: A series of 0's for 1.5 seconds $\pm 10\%$.

Note. No HDLC frame is required for this command.

D. Pre-message response signals (from the receiver to the transmitter)

Format: X010 XXXX

1) Confirmation to Receive (CFR) - A digital response confirming that the entire pre-message procedure has been completed and the message transmission may commence.

Format: X010 0001

2) Failure to Train (FTT) - A digital response rejecting the RS 465 training signal and requesting a retraining.

Format: X010 0010

E. In-message procedure - From the transmitter to the receiver. In case of Group 3 machines, the in-message procedure formats and specific signals shall be consistent with RS 465. In-message procedures for Group 1 and Group 2 machines are defined in CCITT Recommendations T.2 and T.3 respectively.

F. Post-message commands - From the transmitter to the receiver.

Format: X111 XXXX

1) End-of-Message (EOM) - To indicate the end of a page of facsimile information and to return to the beginning of Phase B in the procedure.

Format: X111 0001

2) Multipage Signal (MPS) - To indicate the end of a page of facsimile information and to return to the beginning of Phase C upon receipt of a confirmation.

Format: X111 0010

3) End of Procedure (EOP) - To indicate the end of a page of facsimile information and to further indicate that no further documents are forthcoming and to proceed to Phase E upon receipt of a confirmation.

Format: X111 0100

4) Procedure Interrupt - End of Message (PRI-EOM) - To indicate the same as an EOM command with the additional optional capability of requesting operator intervention. If operator intervention is accomplished, further facsimile procedures shall commence at the beginning of Phase B.

Format: X111 1001

5) Procedure Interrupt - Multipage Signal (PRI-MPS) - To indicate the same as an MPS command with the additional optional capability of requesting operator intervention. If operator intervention is accomplished, further facsimile procedures shall commence at the beginning of Phase B.

Format: X111 1010

6) Procedure Interrupt - End of Procedure (PRI-EOP) - To indicate the same as an EOP command with the additional optional capability of requesting operator intervention. If operator intervention is accomplished, further facsimile procedures shall commence at the beginning of Phase B.

Format: X111 1100

G. Post-message responses (from the receiver to the transmitter).

Format: X011 XXXX

1) Message Confirmation (MCF) - To indicate that a complete message has been received and that additional messages may follow. (This is a positive response to MPS or EOM).

Format: X011 0001

2) Retrain Positive (RTP) - To indicate that a complete message has been received and that additional messages may follow after retransmission of training and/or phasing and CFR.

Format: X011 0011

3) Retrain Negative (RTN) - To indicate that the previous message has not been satisfactorily received. However, further receptions may be possible, provided training and/or phasing are retransmitted.

Format: X011 0010

4) Procedural Interrupt Positive (PIP) - To indicate that a message has been received but that further transmissions are not possible without operator intervention. Failing operator intervention and if further documents are to follow, the facsimile procedure shall begin at the beginning of Phase B.

Format: X011 0101

5) Procedure Interrupt Negative (PIN) - To indicate that the previous (or in-process) message has not been satisfactorily received and that further transmissions are not possible without operator intervention. Failing operator intervention and if further documents are to follow, the facsimile procedure shall begin at the beginning of Phase B.

Format: X011 0100

H. Other line control signals - For the purpose of handling errors and controlling the state of the line.

Format: X101 XXXX

1) Disconnect (DCN) - This command indicates the initiation of Phase E (Call Release). This command requires no response.

Format: X101 1111

2) Command Repeat (CRP) - This optional response indicates that the previous command was received in error and should be repeated in its entirety (i.e., optional frames included).

Format: X101 1000

5.3.6.2 Facsimile Information Field (FIF)

In many cases the FCF will be followed by the transmission of additional 8 bit octets to further clarify the facsimile procedure. This information for the basic binary coded system would consist of the definition of the information in the DIS, DCS, DTC, CSI, CIG, TSI, NSC, NSF and NSS signals.

5.3.6.2.1 DIS Standard Capabilities

Additional information fields will be transmitted immediately following the DIS Facsimile Control Field. The first 8 bits of this information relate to Group 1 and Group 2 apparatus and subsequent bits relate to Group 3 (RS-465) apparatus. The bit assignment for this information is given in Table 2 where a "1" indicates the condition is valid, except where specifically noted otherwise (e.g. bits 11, 12 and 21, 22, 23).

TABLE 2

BIT NO.	DIS/DTC	DCS
1	Transmitter - T.2 operation	
2	Receiver - T.2 operation	Receive - T.2 operation
3	T.2, IOC = 176	
4	Transmitter - T.3 operation	
5	Receiver - T.3 operation	Receive - T.3 operation
6	Reserved for future T.3 operation features	
7	Reserved for future T.3 operation features	
8	Reserved for future T.3 operation features	
9	Transmitter - RS 465 operation	
10	Receiver - RS 465 operation	Receive - RS 465 operation
11,12	Data signalling rate	Data signalling rate
(0,0)	V.27 ter fallback mode	2400 bits per second V.27 ter
(0,1)	V.27 ter	4800 bits per second V.27 ter
(1,0)	V.29	9600 bits per second V.29
(1,1)	V.27 ter and V.29	7200 bits per second V.29
13	Reserved for new modulation system	
14	Reserved for new modulation system	
15	Vertical resolution = 7.7 line/mm	Vertical resolution = 7.7 line/mm
16	Two-dimensional coding capability	Two-dimensional coding
17	Maximum width of paper 256mm (B4)	Maximum width of paper 256mm (B4)
18	Maximum width of paper 297mm (A3)	Maximum width of paper 297mm (A3)
19	Maximum length of paper 364mm (B4)	Maximum length of paper 364mm (B4)
20	Unlimited length of paper	Unlimited length of paper
21,22,23	Minimum scan line time at the receiver	Minimum scan line time at the receiver
(0,0,0)	20 msec. @ 3.85 lpm; $T_{7.7} = T_{3.85}$	20msec.
(0,0,1)	40 msec. @ 3.85 lpm; $T_{7.7} = T_{3.85}$	40msec.
(0,1,0)	10 msec. @ 3.85 lpm; $T_{7.7} = T_{3.85}$	10 msec.
(1,0,0)	5 msec. @ 3.85 lpm; $T_{7.7} = T_{3.85}$	5 msec.
(0,1,1)	10 msec. @ 3.85 lpm; $T_{7.7} = 1/2 T_{3.85}$	
(1,1,0)	20 msec. @ 3.85 lpm; $T_{7.7} = 1/2 T_{3.85}$	
(1,0,1)	40 msec. @ 3.85 lpm; $T_{7.7} = 1/2 T_{3.85}$	
(1,1,1)	0 msec. @ 3.85 lpm; $T_{7.7} = T_{3.85}$	0 msec.
24	Extend field	Extend field
25	2400 bits per second handshaking	2400 bits per second handshaking
26	Uncompressed mode	Uncompressed mode
27	Unassigned	
28	Unassigned	
29	Unassigned	
30	Unassigned	
31	Unassigned	
32	Extend field	Extend field

Note 1. Standard facsimile units conforming to CCITT Recommendation T.2 must have the following capability: IOC = 264

Note 2. Standard facsimile units conforming to CCITT Recommendation T.3 must have the following capability: IOC = 264

Note 3. Standard facsimile units conforming to EIA standard RS 465 must have the following capability: Paper length = 297 mm

Note 4. Where the DIS or DTC frame defines RS-465 standard modem capabilities, the equipment may be assumed to be operable at either 4800 or 2400 bits per second.
Where the DIS or DTC frame defines RS-465 optional modem capabilities, the equipment may be assumed to be operable at either 9600 or 7200 bits per second.

Note 5. $T_{7.7}$ and $T_{3.85}$ refer to the scan line times to be utilized when the vertical resolution is 7.7 lines/mm or 3.85 lines/mm, respectively (see bit 15 above). $T_{7.7} = 1/2 T_{3.85}$ indicates that in the high resolution mode, the scan line time can be decreased by half.

Note 6. The standard FIF field for the DIS, DTC, and DCS signals is 24 bits long. If the "Extend Field" bit(s) is a "1", the FIF field shall be extended by an additional eight bits.

5.3.6.2.2 DCS Standard Commands

When issuing the command, bits 1, 4 and 9 shall be set to "0". The DCS standard commands are formatted as shown in Table 2.

5.3.6.2.3 DTC Standard Command

The DTC standard capabilities are formatted as shown in Table 2.

5.3.6.2.4 CSI Coding Format

The facsimile information field of the CSI signal shall be the international telephone number including the telephone country code, area code, and subscriber number. This field shall consist of 20 numeric digits coded as shown in Table 3. The least significant bit of the least significant digit shall be the first bit transmitted.

5.3.6.2.5 CIG Coding Format

The facsimile information field of the CIG signal shall be the international telephone number including the telephone country code, area code, and subscriber number. This field shall consist of 20 numeric digits coded as shown in Table 3. The least significant bit of the least significant digit shall be the first bit transmitted.

5.3.6.2.6 TSI Coding Format

The facsimile information field of the TSI signal shall be the international telephone number including the telephone country code, area code and subscriber number. This field shall consist of 20 numeric digits coded as shown in Table 3. The least significant bit of the least significant digit shall be the first bit transmitted.

DIGIT	FILL BIT MSB	LSB
0	0	011 0000
1	0	011 0001
2	0	011 0010
3	0	011 0011
4	0	011 0100
5	0	011 0101
6	0	011 0110
7	0	011 0111
8	0	011 1000
9	0	011 1001
SPACE	0	010 0000

TABLE 3

5.3.6.2.7 Non-Standard Capabilities (NSF, NSC, NSS)

When a non-standard capabilities FCF is utilized, it must be immediately followed by a FIF. This information field will consist of at least two octets. The first two octets will contain the unique registered members' code. Additional information could then be transmitted within the FIF field. This information is not specified and can be used to describe non-standard features, etc.

5.3.7 Frame Check Sequences

The FCS shall be a 16-bit polynomial sequence. It shall be the ones complement of the sum (modulo 2) of:

- 1) The remainder of $x^k (x^{15} + x^{14} + x^{13} + \dots + x^2 + x + 1)$ divided (modulo 2) by the generator polynomial $x^{16} + x^{12} + x^5 + 1$, where k is the number of bits in the frame existing between, but not including, the final bit of the opening flag and the first bit of the FCS, excluding bits inserted for transparency, and
- 2) The remainder after multiplication by x^{16} and then division (modulo 2) by the generator polynomial $x^{16} + x^{12} + x^5 + 1$ of the content of the frame, existing between, but not including, the final bit of the opening flag and the first bit of the FCS, excluding bits inserted for transparency.

As a typical implementation, at the transmitter, the initial remainder of the division is preset to all ones and is then modified by division by the generator polynomial (as described above) on the Address, Control and Information fields; the ones complement of the resulting remainder is transmitted as the 16-bit FCS sequence.

At the receiver, the initial remainder is preset to all ones and the serial incoming protected bits and the FCS when divided by the generator polynomial will result in a remainder of 0001110100001111 (x^{15} through x^0 , respectively) in the absence of transmission errors.

The FCS shall be transmitted to the line commencing with the coefficient of the highest term.

5.4 Binary Coded Signalling Implementation Requirements

5.4.1 Commands and Responses

Whereas section 5.2 of this Standard defines a flow diagram to give an accurate example of the typical use of the binary-coded procedures, these procedures are defined specifically in terms of the actions that occur on receipt of commands by the receiving station (reference section 5.3).

A response must be sent, and only sent, upon detecting a valid command. Upon receiving a valid response, a new command must be issued within 3 seconds.

5.4.1.1 Optional Command and Response Frames

If optional frames (e.g., NSF or NSF, CSI) are sent they must directly precede any mandatory command/response frame which is sent. In this case, bit 5 of the control field is "0" for the optional frames and is "1" only for the final frame (refer to section 5.3.5).

5.4.1.2 Options Within Standard Frames

Certain optional portions of standard signals (e.g. the fifth bit of the PRI-Q signal) need not be utilized at either the transmitting unit or the receiving unit. However, the use of these optional portions of standard signals shall not cause erroneous operation.

5.4.2 Line Control Procedures and Error Recovery

Once the transmitting and receiving stations have been identified, all commands are initiated by the transmitting station and solicit an appropriate response from the receiving station (see Appendix 3, List of Commands and Appropriate Responses). Furthermore, the transmission of a response is permitted only when solicited by a valid command. If the transmitting station does not receive an appropriate valid response within 3 seconds $\pm 15\%$, it will repeat the command. After three unsuccessful attempts, the transmitting station will send the Disconnect, DCN, command and terminate the call. A command or a response is not valid and should be discarded if:

- i) Any of the frames, optional or mandatory, have an FCS error.
- ii) Any single frame exceeds 3 seconds $\pm 15\%$ (see Note below).
- iii) The final frame does not have the control bit 5 set to a binary 1.
- iv) The final frame is not a recognized standard command/response frame (see Appendix 3).

The delay of 3 seconds before retransmission of the command can be shortened by the use of the optional Command Repeat, CRP, response. If the transmitting station receives a CRP response, it may immediately retransmit the most recent command.

During the initial pre-message procedure, neither station has a defined role (i.e., transmitter or receiver). Therefore, the station transmitting the DIS command will continue to retransmit it until, according to the procedures, each station has identified itself and the normal line control procedures may be followed.

Note: The implications of a maximum frame length of 3 seconds, $\pm 15\%$ are:

- a) No transmitted frame should exceed 2.55 seconds (i.e., 3 seconds, -15%).
- b) Any frame which is received and is detected as greater than 3.45 seconds shall be discarded (i.e., 3 seconds, +15%).
- c) A frame received which is between 2.55 and 3.45 seconds duration may be discarded.

5.4.3 Timing Considerations

5.4.3.1 Time Outs

Time Out T1 defines the amount of time two stations will continue to attempt to identify each other. T1 is 35 \pm 5 seconds, begins upon entering Phase B, and is reset upon detecting a valid signal or when T1 times out.

Time Out T2 makes use of the tight control between commands and responses to detect the loss of command/response synchronization. T2 is 6 \pm 1 seconds and begins when initiating a command search, (e.g. the 1st entrance into the "Command Received" subroutine, reference 5.2 Flow Diagram). T2 is reset when an HDLC flag is received or when T2 times out.

Time Out T3 defines the amount of time a station will attempt to alert the local operator in response to a procedural interrupt. Failing to achieve operator intervention, the station will discontinue this attempt and shall issue other commands or responses. T3 is 10 \pm 5 seconds, begins on the first detection of a procedural interrupt command/response signal (i.e., PIN/PIP or PRI-Q), and is reset when T3 times out or when the operator initiates a Line Request.

APPENDIX 1

EXAMPLE OF NON-STANDARD MANUAL-TO-MANUAL BASIC FACSIMILE OPERATION

It is acknowledged that there are existing equipments in the field that may not conform in all aspects to this Standard. Therefore, the decision may be made to go to a mode of operation other than specified herein. This diagram describes, as an example, one of these conditions. Other methods may be possible as long as they do not interfere with the standard operation.

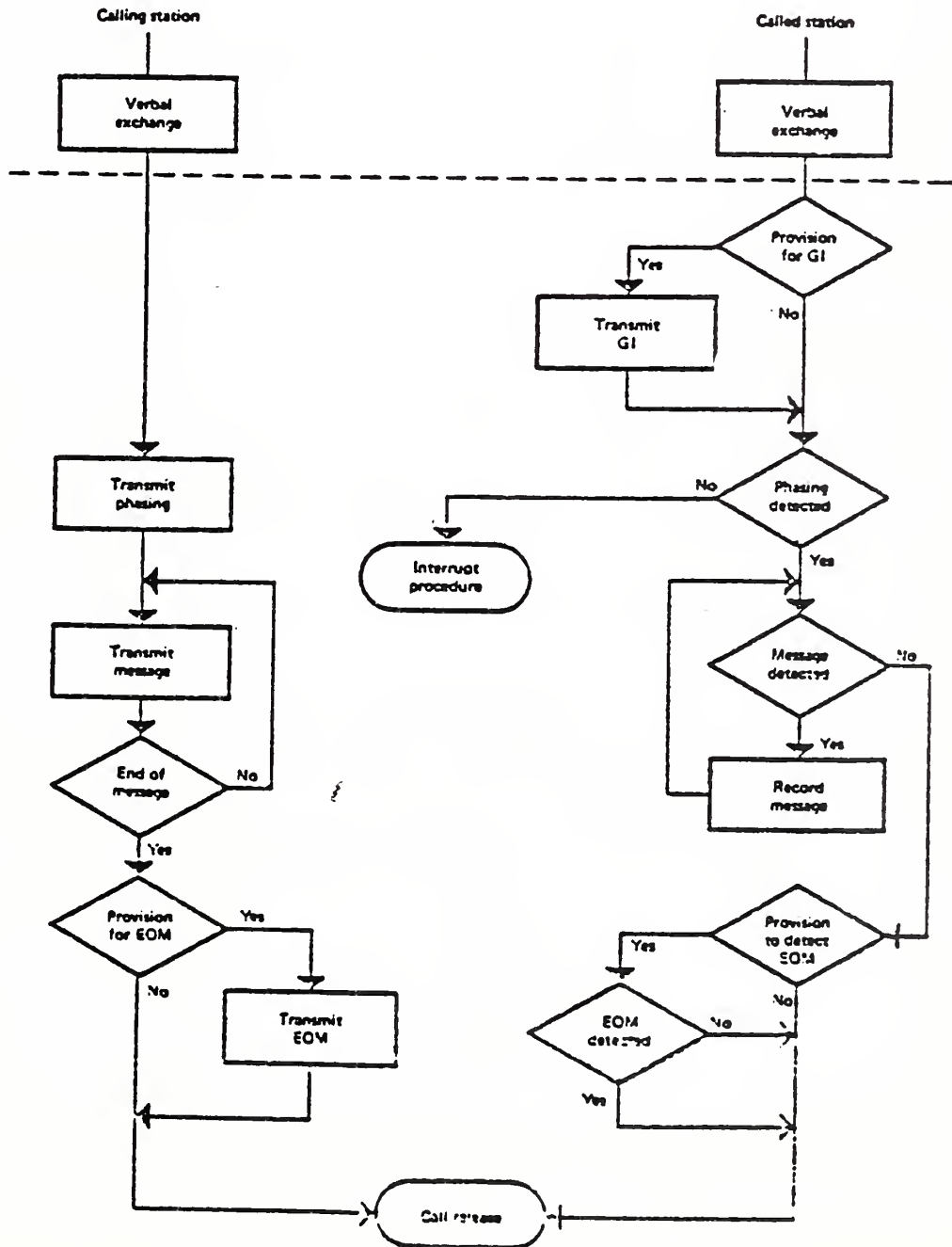

INDEX OF ABBREVIATIONS USED IN EIA STANDARD RS-466

ABBREVIATION	FUNCTION	SIGNAL FORMAT	REFERENCE
CED	Called Station Identification	2100 Hz	4.3.3.2
CFR	Confirmation to Receive	X010 0001 1850 or 1650 Hz for 3 sec.	5.3.6.1 D1) 4.3.1.2
CRP	Command Repeat	X101 1000	5.3.6.1 H2)
CIG	Calling Subscriber Identification	1000 0010	5.3.6.1 B2)
CNG	Calling Tone	1100 Hz for 500 ms	4.3.3.3
CSI	Called Subscriber Identification	0000 0010	5.3.6.1 A2)
DCN	Disconnect	X101 1111	5.3.6.1 H1)
DCS	Digital Command Signal	X100 0001	5.3.6.1 C1)
DIS	Digital Identification Signal	0000 0001	5.3.6.1 A1)
DTC	Digital Transmit Command	1000 0001	5.3.6.1 B1)
EOM	End of Message	X111 0001 1100 Hz	5.3.6.1 F1) 4.3.2.4
EOP	End of Procedure	X111 0100	5.3.6.1 F3)
FCF	Facsimile Control Field	-	5.3.6.1
FIF	Facsimile Information Field	-	5.3.6.2
FTT	Failure To Train	X010 0010	5.3.6.1 D2)
GC	Group Command	1300 Hz for 1.5 - 10.0 sec. 2100 Hz for 1.5 - 10.0 sec.	4.3.2.1
GI	Group Identification	1650 and/or 1850 Hz	4.3.1.1
HDLC	High-Level Data Link Control	-	5.3
LCS	Line Conditioning Signals	1100 Hz	4.3.2.2
MCF	Message Confirmation	X011 0001 1650 or 1850 Hz	5.3.6.1 G1) 4.3.1.3
MPS	Multi-Page Signal	X111 0010	5.3.6.1 F2)
NSC	Non-Standard Facilities Command	1000 0100	5.3.6.1 B3)
NSF	Non-Standard Facilities	0000 0100	5.3.6.1 A3)
NSS	Non-Standard Set-Up	X100 0100	5.3.6.1 C3)
PIN	Procedural Interrupt Negative	X011 0100	5.3.6.1 G5)
PIP	Procedural Interrupt Positive	X011 0101	5.3.6.1 G4)
PIS	Procedure Interrupt Signal	462 Hz for 3 sec.	4.3.3.1
PRI-EOM	Procedure Interrupt-EOM	X111 1001	5.3.6.1 F4)
PRI-EOP	Procedure Interrupt-EOP	X111 1100	5.3.6.1 F6)
PRI-MPS	Procedure Interrupt-MPS	X111 1010	5.3.6.1 F5)
RTN	Retrain Negative	X011 0010	5.3.6.1 G3)
RTP	Retrain Positive	X011 0011	5.3.6.1 G2)
TCF	Training Check	0's for 1.5 sec.	5.3.6.1 C4)
TSI	Transmitting Subscriber Identification	X100 0010	5.3.6.1 C2)

APPENDIX 3

LIST OF COMMANDS AND APPROPRIATE RESPONSES

COMMANDS	COMMENTS	APPROPRIATE RESPONSES
(NSF) (CSI) DIS	Identifying capabilities: from a Manual Receiver or an Auto Answer Unit	(NSC) (CIG) DTC (TSI) DCS (TSI) (CRP) (NSS)
(NSC) (CIG) DTC	Mode setting command: from the Calling Unit. This is a poll operation.	(TSI) DCS (NSF) (CSI) DIS (CRP) (TSI) (NSS)
(TSI) DCS (TSI) (NSS)	Mode setting command: from Manual Transmitter or Automatic Transceiver. This command is always followed by phasing/ training.	(NSF) (CSI) CFR (CRP) FTT DIS
MPS or EOP or EOM or (PRI-MPS) or (PRI-EOP) (PRI-EOM)	Post-message commands	MCF RTP RTN PIP PIN (CRP)
DCN	Phase E command	None

Note: Where the symbols () are used, the signals within these symbols are optional.

APPENDIX 4

EXAMPLE OF STANDARD AND OPTIONAL PROCEDURES

An example of a station having the standard binary coded, recognized optional binary coded and tonal capabilities is shown in this Appendix.

CALLED STATION PROCEDURES
(Alternating Method)

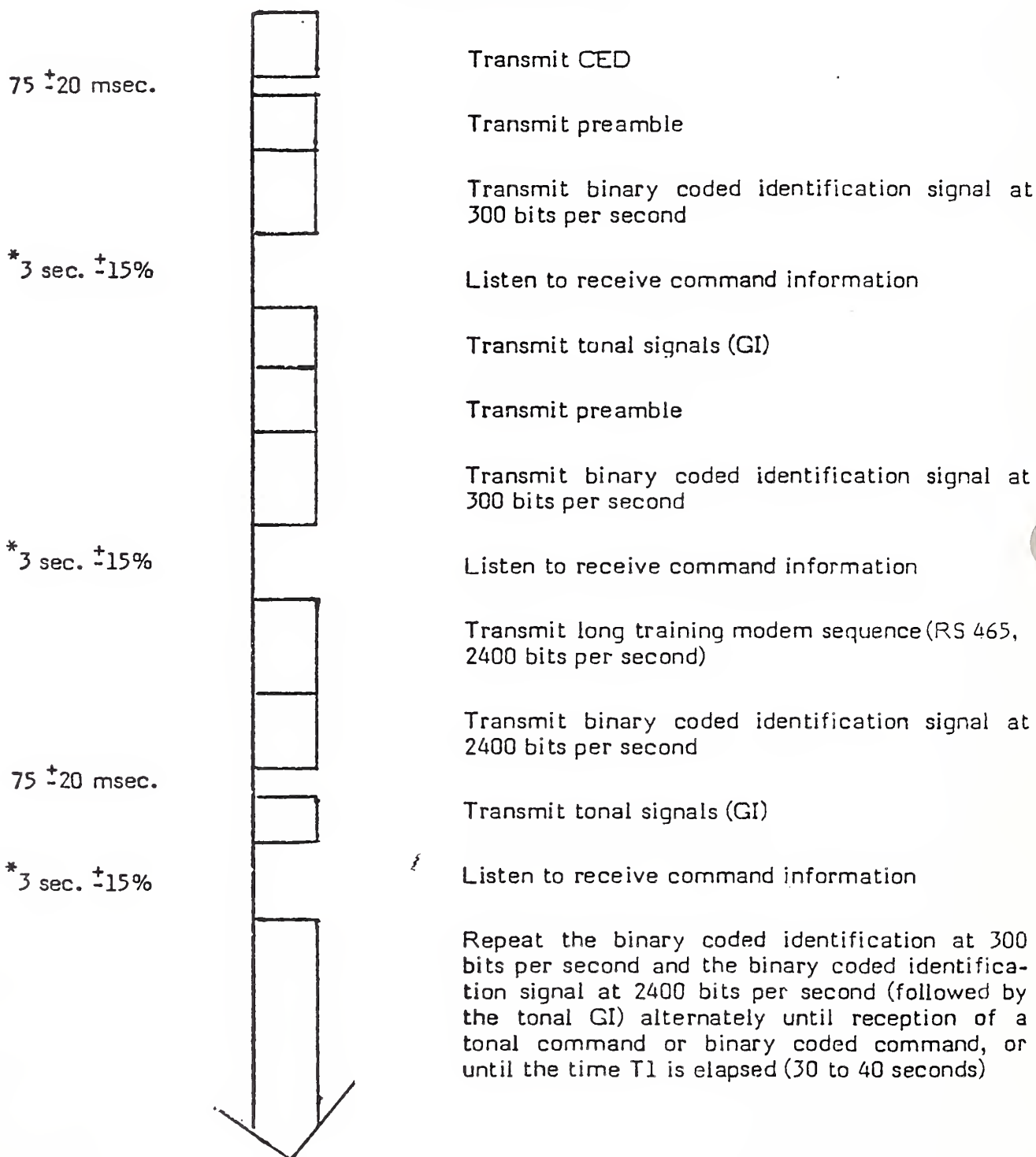

* For manual receivers using the binary coded procedure, this delay should be 4.5 seconds ±15%

APPENDIX 5

Signal Sequence Examples

The examples below are based on the flow diagrams and are offered for illustrative and instructional purpose only. They should not be interpreted as establishing or limiting the protocol. The exchange of the various commands and responses is limited only by the rules specified in this Standard. (Reference sections 5.3 and 5.4).

The notations used in these diagrams are as follows:

- An arrowhead signifies the receiver of the signal.
- A solid line indicates transmission of the signal at the data rate of 300 bits/s.
- A dashed line indicates transmission at the message data rate per RS-465.
- A lightning bolt (⚡) indicates an invalid frame.
- A bold solid line indicates the transmission of tonal signals.

The following examples assume that DIS will be repeated for T1 seconds unless responded to by a valid signal.

Example 1: An auto calling unit wishing to transmit to an auto answer unit:
Example of Post-Message Commands.

CALLING UNIT

CALLED UNIT

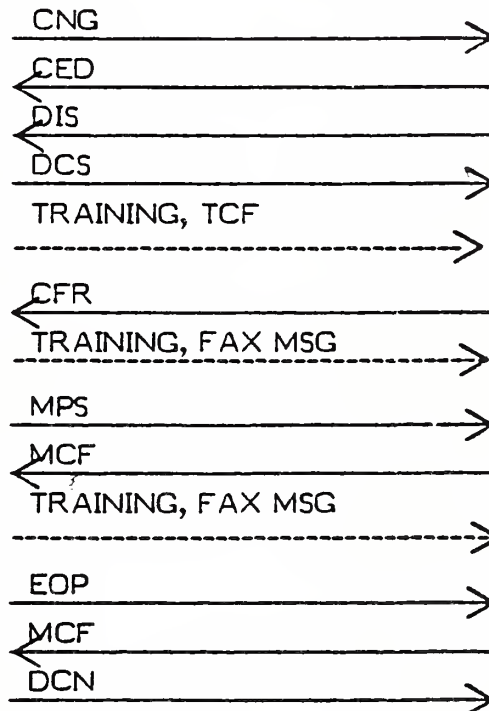

Example 2: A single page transmitter wishing to transmit to an auto answer unit:
Example of EOM

TRANSMITTING STATION

CALLED UNIT

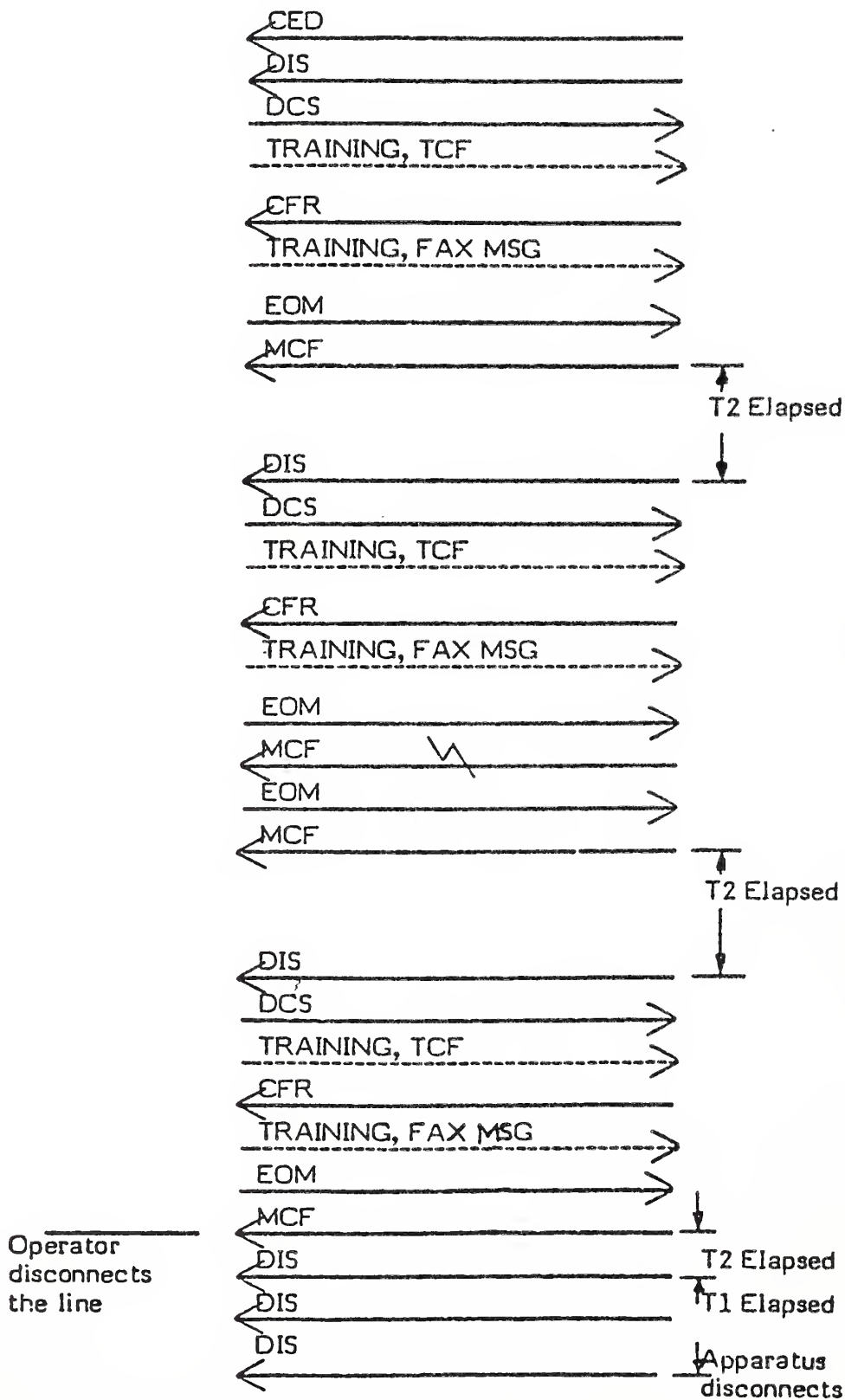

**Example 3: An auto calling unit wishing to transmit to an auto answer unit:
Example of Post-Message Responses**

CALLING UNIT

CALLED UNIT

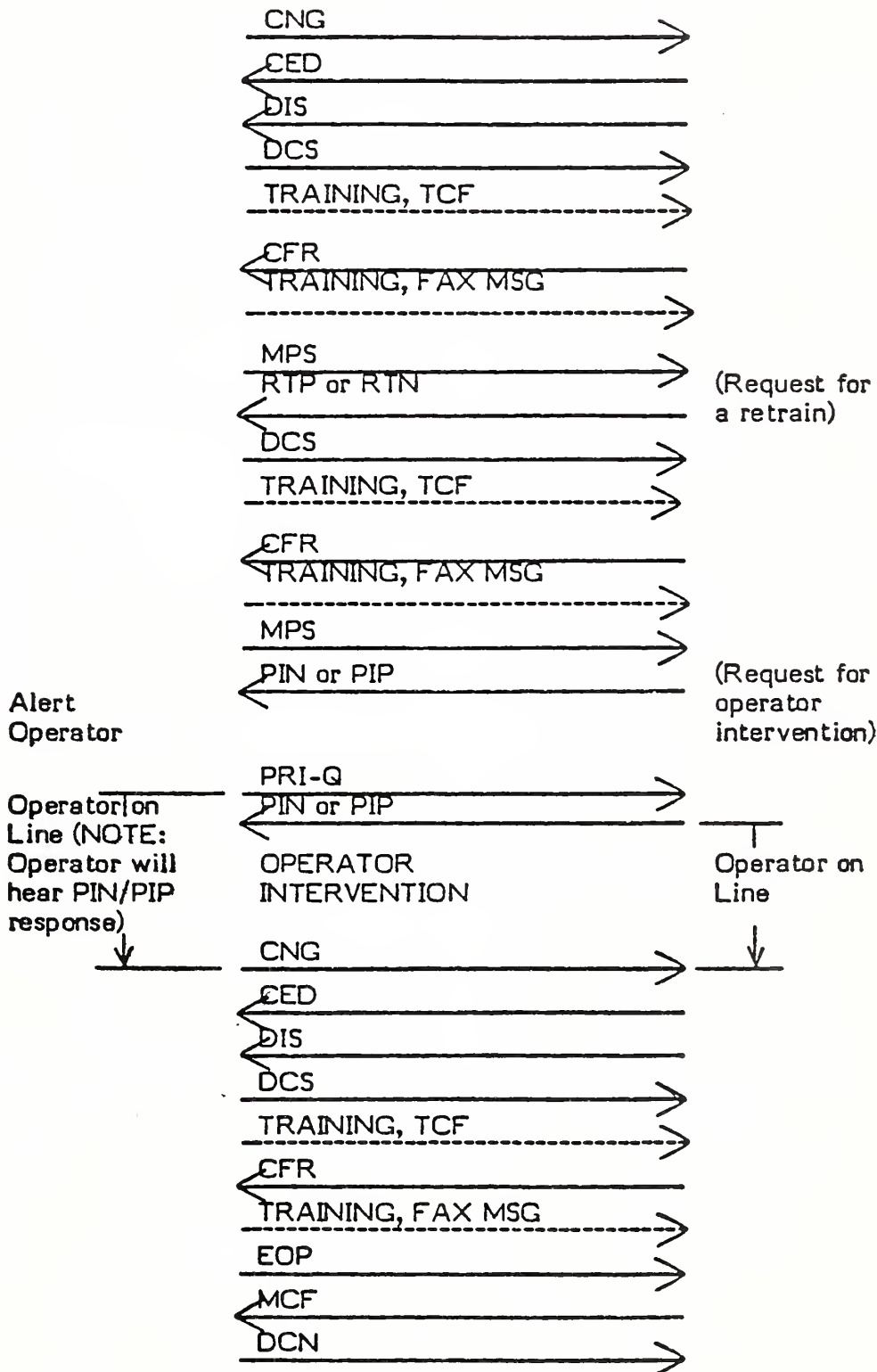

Alert Operator

Operator on Line (NOTE: Operator will hear PIN/PIP response)

(Request for a retrain)

(Request for operator intervention)

Operator on Line

Example 4: Manual transmitter wishing to transmit to an auto answer unit:
Example of initial training failure and procedural interrupts.

TRANSMITTING STATION

CALLED UNIT

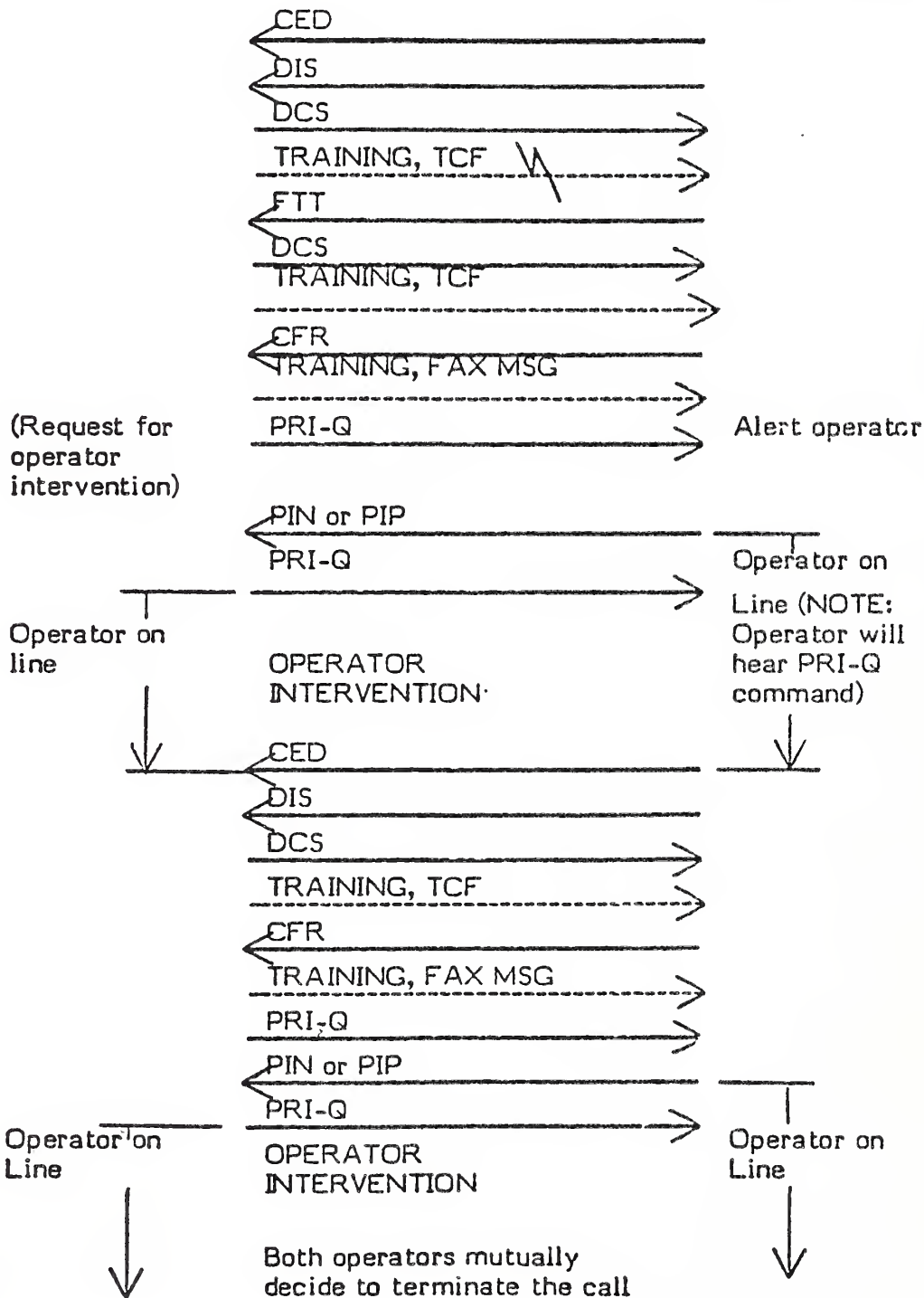

Example 5: Auto calling unit wishing to first receive from, then transmit to an auto answer unit.

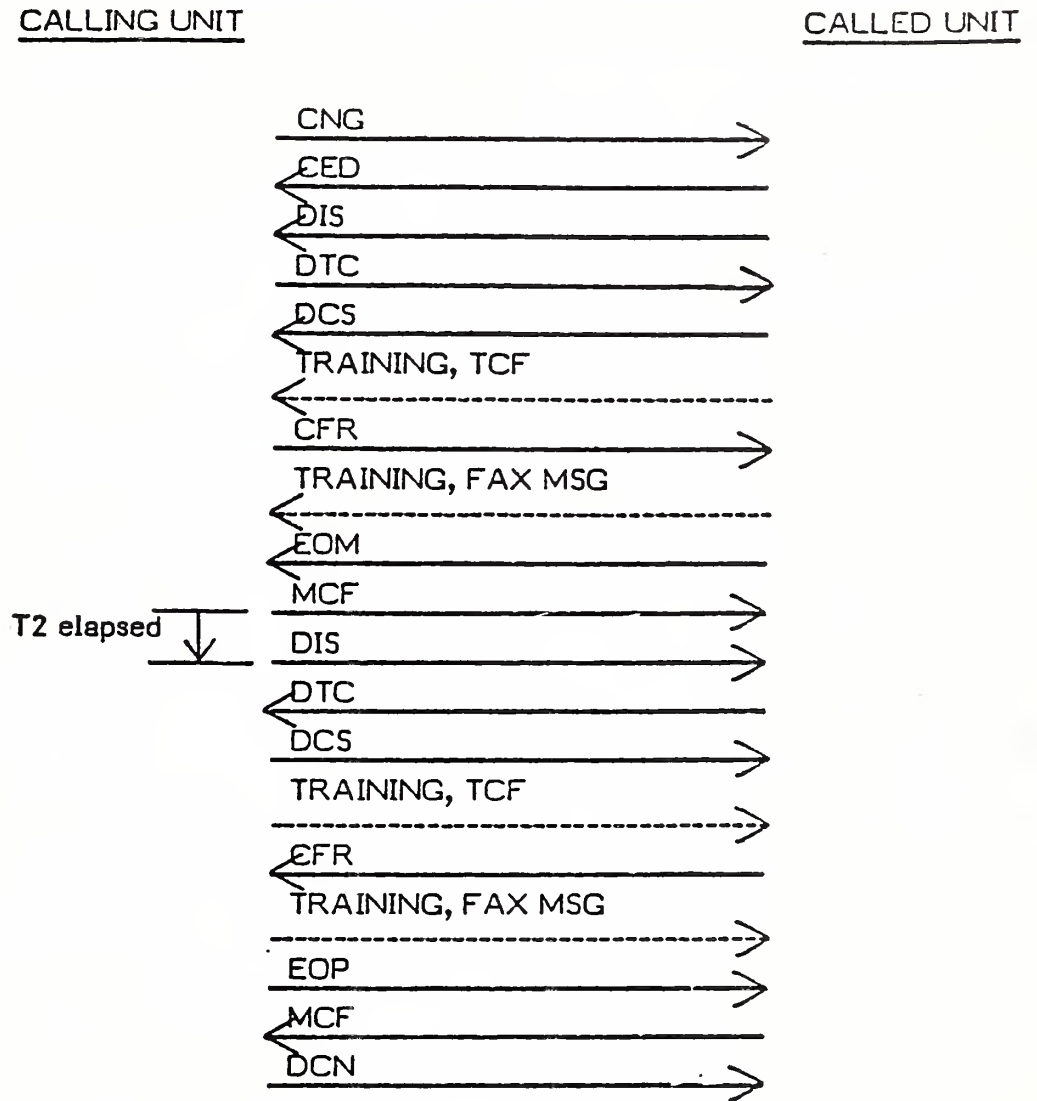

Example 6: Auto calling unit wishing to receive from an auto answer unit: Example of polling and of optional as well as non-standard signals.

CALLING UNIT

CALLED UNIT

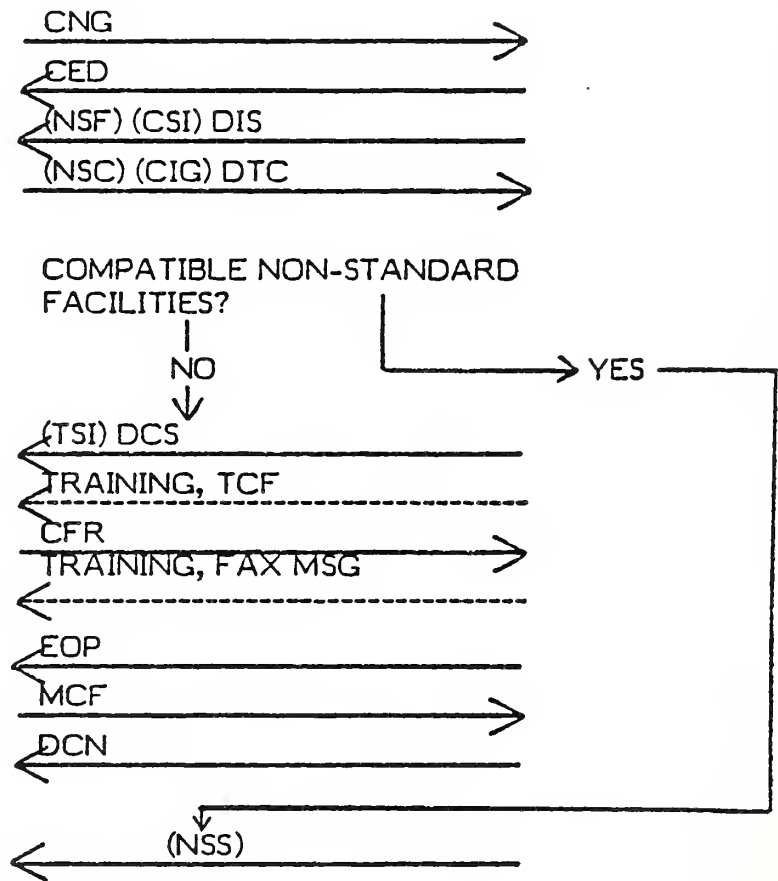

PROCEED WITH NON-STANDARD OPERATION

Example 7: An auto calling unit wishing to transmit to an auto answer unit:
Example of standard error recovery techniques

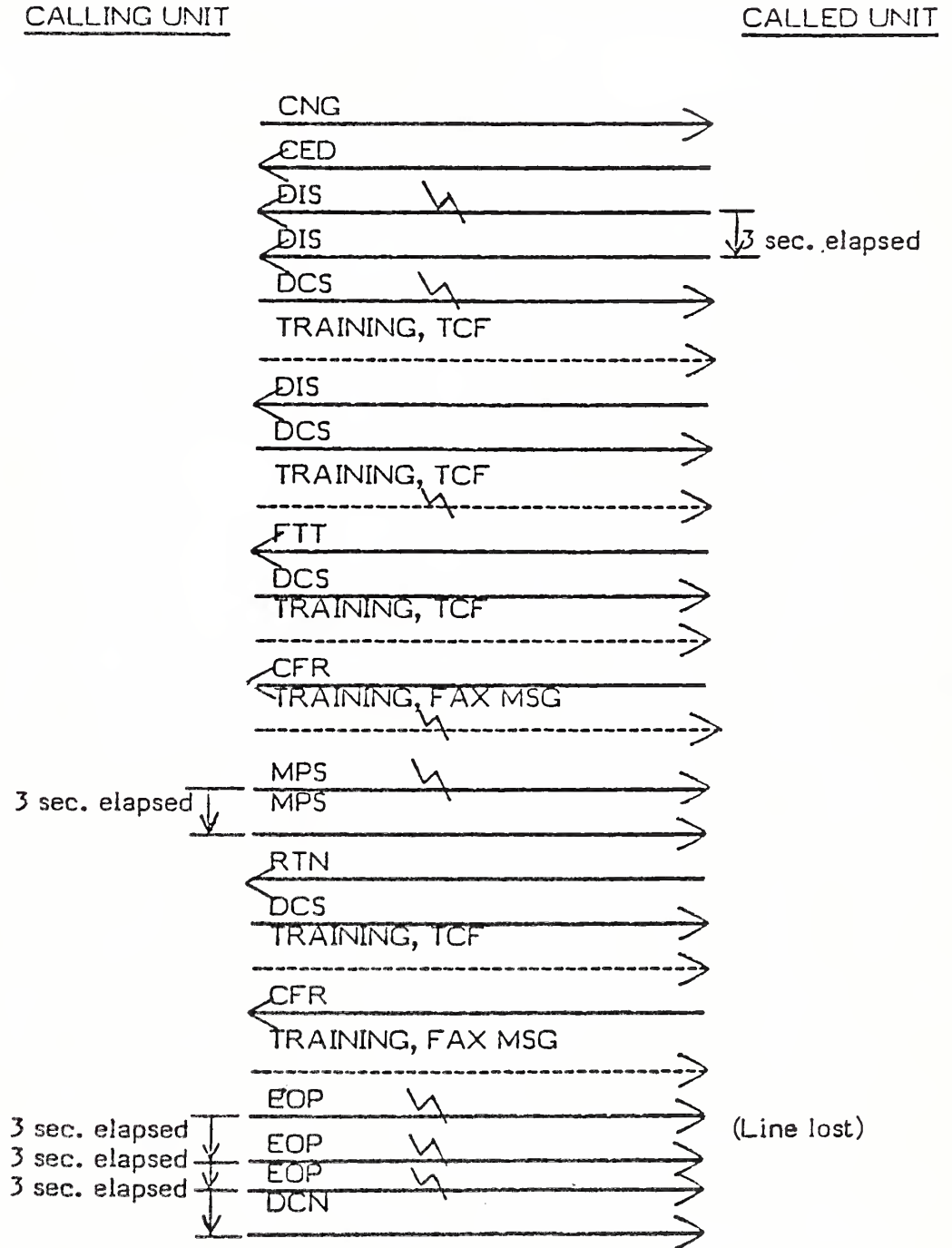

Example 8: Manual transmitter wishing to transmit to a manual receiver; Example of error recovery technique using the optional CRP response.

TRANSMITTING
STATION

RECEIVING
STATION

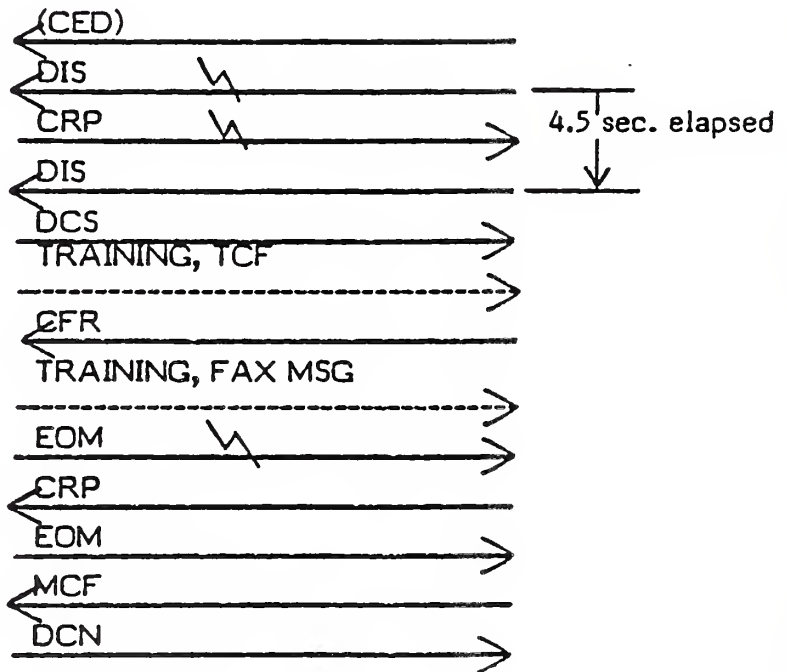

Example 9: A 2400 bps only machine wishing to transmit to a standard machine including the recognized option for binary coded handshaking procedure.

CALLING UNIT
(2400 bps only)

CALLED UNIT
(Standard +2400 bps option)

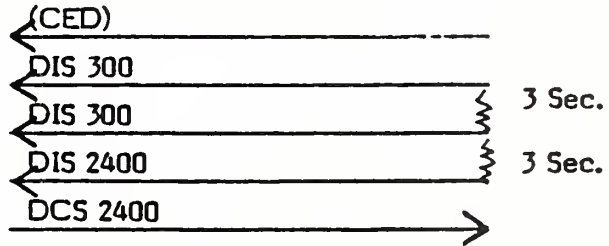

Example 10: A standard machine including the recognized option for binary coded handshaking procedure wishing to transmit to a 2400 bps only machine.

CALLING UNIT
(Standard +2400 bps
option)

CALLED UNIT
(2400 bps only)

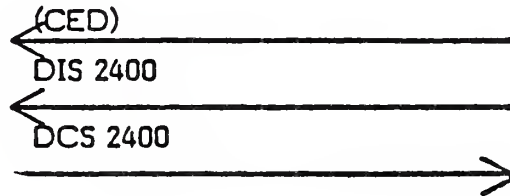

Example 11: A standard machine including the recognized option for binary coded handshaking procedure wishing to transmit to a standard machine (not including the optional mode).

CALLING UNIT
(Standard +2400 bps
only)

CALLED UNIT
(Standard)



Example 12: A standard machine (not including the optional mode) wishing to transmit to a standard machine including the recognized option for binary coded handshaking procedure.

CALLING UNIT
(Standard)

CALLED UNIT
(Standard + 2400 bps
option)

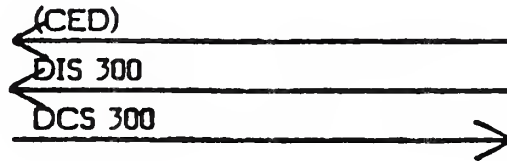

APPENDIX 6
RELATED EIA STANDARDS

RS-465 Group 3 Facsimile Apparatus for Document Transmission

RELATED CCITT RECOMMENDATIONS

- T.0 Classification of Facsimile Apparatus for Document Transmission over Telephone-Type Circuits
- T.2 Standardization of Group 1 Facsimile Apparatus for Document Transmission
- T.3 Standardization of Group 2 Facsimile Apparatus for Document Transmission
- T.4 Standardization of Group 3 Facsimile Apparatus for Document Transmission
- T.30 Procedure for Document Facsimile Transmission in the General Switched Telephone Network

RELATED U.S. MILITARY STANDARDS

MIL STD 188-161 Design Standards for Common long haul and Tactical Facsimile Equipment (Draft)

RELATED U.S. FEDERAL STANDARDS

- 1006 Telecommunications: Coding and Modulation Requirements for 4800 Bit/Second Modems
- 1061 Telecommunications: Group 2 Facsimile Apparatus for Document Transmission
- 1062 Telecommunications: Group 3 Facsimile Apparatus for Document Transmission
- 1063 Telecommunications: Procedures for Document Transmission

FEDERAL STANDARD
TELECOMMUNICATIONS: PROCEDURES FOR DOCUMENT FACSIMILE TRANSMISSION

This standard is issued by the General Services Administration pursuant to the Federal Property and Administrative Services Act of 1949, as amended. Its application to telecommunications systems is mandatory on all Federal agencies to the extent specified herein.

1. SCOPE

1.1 Description. This standard establishes the procedures for document facsimile transmission for use over voiceband analog circuits.

1.2 Purpose. This standard is to facilitate interoperability between and among facsimile terminals within telecommunication facilities and systems of the Federal Government.

1.3 Application

1.3.1 All Federal departments and agencies shall comply with this standard in the design, development, and procurement of facsimile terminals/systems.

1.3.2 For application of this standard within the Department of Defense, tactical users shall comply with the requirements contained in Military Standard 188-161. EIA Standard RS-466 has been adopted by the Department of Defense for nontactical use.

2. REQUIREMENTS AND APPLICABLE DOCUMENTS

Procedures for document facsimile transmission shall conform to the specifications set forth in Electronic Industries Association Recommended Standard 466 (RS-466).

3. CONFLICT WITH REFERENCED DOCUMENTS

Where the requirements stated in this standard conflict with any requirements in a referenced document, the requirements of this standard shall apply. The nature of the conflict between this standard and a referenced document shall be submitted in duplicate to the General Services Administration (C), Washington, D.C. 20405.

4. CHANGES

When a Federal department or agency considers that this standard does not provide for its essential needs, a statement citing inadequacies shall be sent in duplicate to the General Services Administration (C), Washington, D.C. 20405, in accordance with provisions of Federal Property Management Regulations 41 CFR 101-29.3. The General Services Administration will determine the appropriate action to be taken, and will notify the agency.

PREPARING ACTIVITY

National Communications System
Office of Technology and Standards(NCS-TS)
Washington, D.C. 20305

MILITARY INTEREST

Military Coordinating Activity

DCA - DC

Custodians

Army - CR
Navy - EC
Air Force - 90

Review Activities

Army - CR, SC
Navy - EC, NOSC
Air Force - 90, XOKC

U.S. GOVERNMENT PRINTING OFFICE

This document is available from the General Services Administration (GSA), acting as agent for the Superintendent of Documents. A copy for bidding and contracting purposes is available from GSA Business Centers. Copies are for sale at the GSA, Specification Unit (WFSIS), 7th and D Street, SW., Room 6039, Washington, D.C. 20407; telephone (202) 472-2205. Please call in advance for pickup service.

FSC TELE

