

**HANDBOOK
FOR
HEATING AND VENTILATING
ENGINEERS**

HOFFMAN



Class JH 7012

Book H 7

1913a

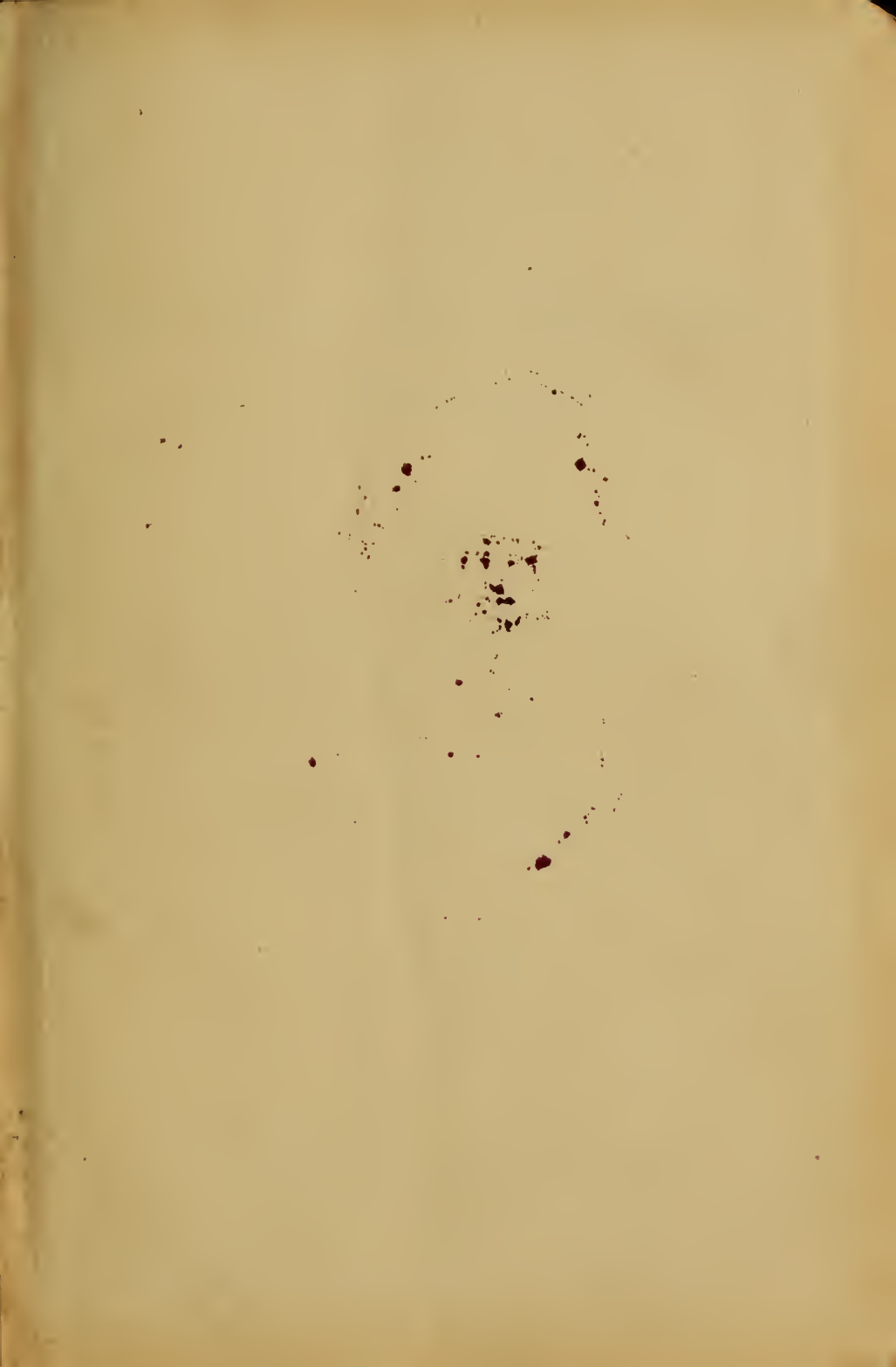

HANDBOOK
FOR
HEATING AND VENTILATING
ENGINEERS

BY

JAMES D. HOFFMAN, M. E.

PROFESSOR OF MECHANICAL ENGINEERING AND PRACTICAL
MECHANICS, UNIVERSITY OF NEBRASKA

MEMBER AND PAST PRESIDENT A. S. H. & V. E.

MEMBER A. S. M. E.

ASSISTED BY

BENEDICT F. RABER, B. S., M. E.

ASSISTANT PROFESSOR OF MECHANICAL ENGINEERING
UNIVERSITY OF NEBRASKA

THIRD EDITION

THIRD IMPRESSION, CORRECTED

McGRAW-HILL BOOK COMPANY

239 WEST 39TH STREET, NEW YORK

6 BOUVERIE STREET. LONDON. E. C.

1913

TH 7012
.H7
1913a

COPYRIGHT, 1913
BY
JAMES D. HOFFMAN

(First Edition: Copyright, 1910.
By James D. Hoffman)

Library of Congress
By transfer from
War Department
MAR 29 1928

1913-1914

1, D. C. C. 11, 31.

EXTRACT FROM PREFACE TO FIRST EDITION.

In the development of Heating and Ventilating work, it is highly desirable that those engaged in the design and the installation of the apparatus be provided with a hand-book convenient for pocket use. Such a treatise should cover the entire field of heating and ventilation in a simplified form and should contain such tables as are commonly used in every day practice. This book aims to fulfill such a need and is intended to supplement other more specialized works. Because of the scope of the work, its various phases could not be discussed exhaustively, but it is believed that all the fundamental principles are stated and applied in such a way as to be easily understood. It is suggestive rather than digressive. The principles presented are the same as those that have been stated many times before, but the arrangement of the work, the applications and the designs are all original. Many formulas and rules are necessarily given; but it will be seen that, in most cases, they are developments from a few general formulas, all of which can be readily understood and remembered. Practical points in constructive design have also been considered. However, since the principles of heating and ventilation are founded upon fundamental thermodynamic laws, it seems best to accentuate the theoretical side of the work in the belief that if this is well understood, practical points of experience will easily follow. A pamphlet containing suggestions and problems for a course of instruction in technical schools is included with every book.

It is hoped that the material here given will be simple enough for the beginner and, at the same time, sufficiently complete and exact for the engineer with years of experience. If it merits the approval of the reader, or if any part is defective or misleading, we trust that statements of criticism will be freely contributed. The only way to perfect such a

book is to have the good wishes and the co-operation of engineers in all branches of the work. These are solicited.

All the standard works upon the subject have been freely consulted and used. In most cases where extracts are made, acknowledgment is given in the text. In addition to this, references for continued reading are quoted at the close of each important topic. Because of these references throughout the book, we do not here repeat the names of their authors. We wish, however, to express our sincere appreciation of their valuable assistance.

J. D. H.

PREFACE TO SECOND EDITION.

The demand for copies of the first edition of the handbook was so great as to make a second edition necessary within the second year after publication of the first edition. A few corrections were made on the first edition and all the material has been revised to bring it up to date. The work on air conditioning has been amplified. The descriptions of hot water and steam heating have been improved by diagrams of the various piping systems. Two chapters have been added on refrigeration and many tables have been added in the Appendix. Many suggestions have come from men in practice and these suggestions have been considered, thus enlarging upon the practical side and the applications. It is believed now that every subject discussed within the scope of the book has been revised to meet the present state of the science.

Lincoln, Neb.

J. D. H.

CONTENTS

CHAPTER I. (Heat)

Arts.		Pages
1- 4	Introductory. Measurement of Heat and Temperatures	9- 13
5	Radiation, Conduction, Convection	14- 15

CHAPTER II. (Air)

6- 9	Composition of Air. Amount Required per Person	16- 24
10- 13	Humidity	25- 30
14- 15	Convection of Air. Measurement of Air Velocities	31- 34
16- 20	Air Used in Combustion. Chimneys.....	35- 37
	References on Ventilation	38

CHAPTER III. (Heat Losses)

21- 29	Heat Losses from Buildings	39- 47
30	Temperatures to be Considered	47- 48
31	Heat given off from Lights and Persons....	49
	References on Heat Losses from Buildings..	50

CHAPTER IV. (Furnace Heating)

32- 34	Essentials of the Furnace System.....	51- 53
35- 37	Air Circulation in Furnace Heating.....	53- 55
38- 47	Calculations in Furnace Design	56- 61
48	Application to a Ten Room Residence.....	62- 66

CHAPTER V. (Furnace Heating, Continued)

49- 51	Selecting, Locating and Setting the Furnace	67- 71
52- 57	Air Ducts. Circulation of Air in Rooms....	71- 76
58	Fan-Furnace Heating	77
59	Suggestions for Operating Furnaces.....	78- 79
60	Best Outside Temperature	79- 83
	References on Furnace Heating	84

CHAPTER VI. (Hot Water and Steam Heating)

61- 66	Comparison and Classification of Systems...	85- 90
67	Diagrams of Piping Systems	91- 95
68	Accelerated Systems	95- 99
69	Vacuum Systems for Steam	99-102

CHAPTER VII. (Ht. Water and St. Heating, Cont'd)

70- 75	Classification and Efficiencies of Radiators..	103-108
76- 79	Heaters and Boilers. Combination Systems. Fittings	108-113

CHAPTER VIII. (Ht. Water and St. Heating Cont'd)

Arts.	Pages
80- 83	Calculation of Radiator Surface114-121
83- 86	Pipe Sizes. Grate Area. Piping Connections.121-124
84	General Application to Hot Water Design...125-131
88- 89	Insulating Steam Pipes. Water Hammer...131-133
90	Feeding Return Water to Boiler.....133-137
91	Suggestions for Operating Boilers.....137-138
	References on Hot Water and Steam Heat'g 139-140

CHAPTER IX. (Mechanical Vacuum Heating)

92- 96	General. Webster, Van Auken, Automatic and Paul Systems141-151
97	References on Mechanical Vacuum Heating 152

CHAPTER X. (Mechanical Warm Air Heating)

98-104	General Discussion. Blowers and Fans. Heating Surfaces153-165
105-107	Single and Double Duct Systems. Air Wash- ing165-168

CHAPTER XI. (Mech. Warm Air Heating, Cont'd)

108-112	Heat Loss. Air Required. Air Tempera- tures169-172
113-114	Air Velocities. Area of Ducts172-173
115-120	Heating Surface in Coils. Arrangement of Coils173-183
121-122	Amount of Steam Used in the System183

CHAPTER XII. (Mech. Warm Air Heating, Cont'd)

123-129	Air Velocity and Pressure. Horse-Power in Moving Air184-195
130-133	Fan Drives. Speeds. Size of Engine. Piping Connections195-200
134	General Application to Plenum System....200-205
	References on Mechanical Warm Air Heat- ing206-207

CHAPTER XIII. (District Heating)

135-139	General. Conduits. Expansion Joints. Anchors208-222
140-142	Typical Design. Heat in Exhaust Steam...222-228
143-146	Hot Water Systems. General Discussion...229-231
147-149	Pressure and Velocity of Water in Mains...231-235
150-154	Radiation Heated by Exhaust Steam.....236-238
155-160	Reheating Calculations238-244
161-164	Circulating Pumps. Boiler Feed Pumps...244-251
165-169	Radiation Supplied by Boilers and Economiz- ers251-255
170	Total Capacity of Boiler Plant255-258
171-173	Cost of Heating from Central Station.....258-263
174	Steam System. General Discussion264-265

Arts.		Pages
175-177	Pipe Sizes. Dripping the Mains	265-267
178	General Application of Steam System to District	268-269
	References on District Heating	270
CHAPTER XIV. (Temperature Control)		
179-182	General. Johnson, Powers and National Systems	271-279
CHAPTER XV. (Electrical Heating)		
183-185	Discussion and Calculations	280-282
CHAPTER XVI. (Refrigeration)		
186-187	Discussion of Systems	283-284
188-189	Vacuum and Cold Air Systems	284
190-191	Compression and Absorption Systems.....	285-288
192	Condensers	289-291
193	Evaporators	292-293
194	Pipes, Valves and Fittings	294
195-196	Absorption System	294-297
197-198	Generators	298-299
199-203.	Condensers, Absorbers, Exchangers and Pumps	299-301
204-205	Comparison of Systems	302
206	Methods of Maintaining Low Temperatures	303-305
207	Influence of Dew Point	305
208	Pipe Line Refrigeration	306-307
CHAPTER XVII. (Refrigeration, Cont'd)		
210-212	Calculations	308-312
213-216	General Application	313-315
217	Cost of Refrigeration	316-317
	References on Refrigeration	318
CHAPTER XVIII. (Specifications)		
218	Suggestions on Planning Specifications.....	319-325
APPENDIX.		
	Tables and Diagrams	327

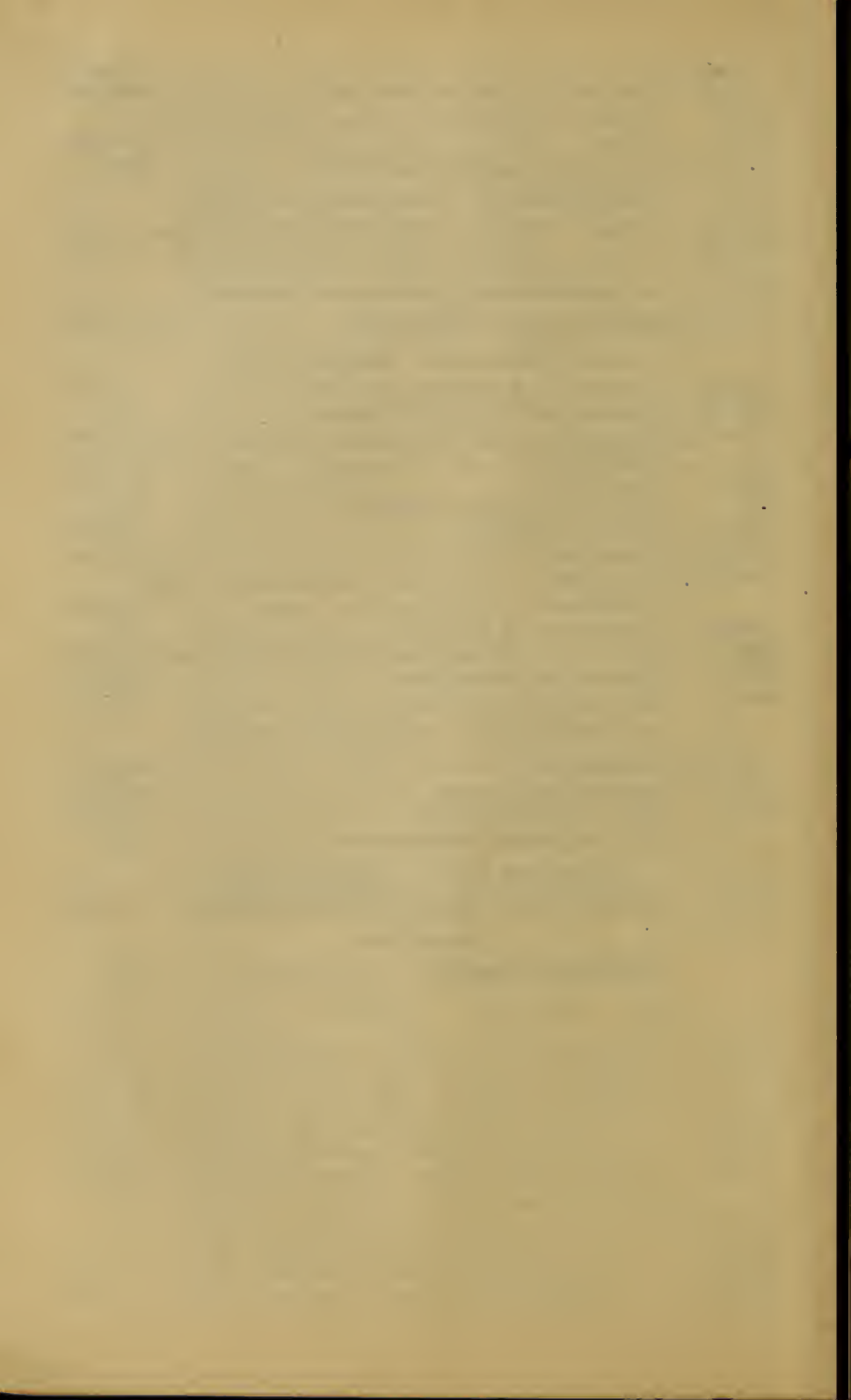

CHAPTER I.

HEAT—ITS NATURE, GENERATION, USE, MEASUREMENT AND TRANSMISSION.

1. Introductory:—In all localities where the atmosphere drops in temperature much below 60 degrees Fahrenheit, there is created a demand for the artificial heating of buildings. As the buildings have grown in size and complexity of construction, so also this demand has grown in extent and preciseness, with the general result that from the antiquated open fire-place and iron stove, there has developed a science growing richer each day from inventive genius and manufacturing technique—the science of the Heating and Ventilating of Buildings. The purpose of this hand-book shall be to outline, concisely, the fundamental principles and practical applications of this science in its various branches.

To the heating engineer of to-day, it may be that the exact nature of heat itself is of much less moment than its generation and transmission, but this fact should be impressed,—that heat is one form of energy, that it cannot be created except by conversion from some other form, and that it is infallibly obedient to certain physical laws and principles.

In generating heat to-day for heating purposes, the almost universal method is combustion. The union of such substances as coal, wood or peat with the oxygen of the air is always attended by a liberation of heat derived from the chemical action of the combination; and this heat is carried by some common carrier, such as air, water or steam, to the building or room to be heated where it is given off by the natural cooling process. In some instances this heat is converted into electrical energy, which is carried by wire to the place of use and given off by passing through a set of resistance coils, which convert it into heat; but this method is not much favored because of its inefficiency and the resulting expense. This latter objection would not hold in the case of water power installation, where the combustion of fuel is entirely eliminated.

2. Measurement of Heat:—In the measurement of heat, the most commonly accepted unit in practical engineering work is the *British thermal unit*, commonly abbreviated B. t. u., which may be defined as that amount of heat which will raise the temperature of one pound of pure water one degree Fahrenheit, at or near the temperature of maximum density, 39.1° F. (See also definition for Specific Heat). This unit value, the B. t. u., measures the quantity of heat, while the temperature measures the degree of heat. In equal masses of the same substance the two are proportional. The Fahrenheit is the more commonly used temperature scale, especially in steam engineering. The unit of this scale is derived by dividing the distance on the thermometer between the freezing point and the boiling point of water into 180 equal degrees, the freezing point being marked 32°, and the boiling point 212°. All temperatures in this work will be taken according to the Fahrenheit scale, and all quantities of heat expressed in British thermal units.

There is a second unit of quantity of heat considerably used, especially in scientific research, known as the *calorie*, commonly abbreviated cal., and defined as that amount of heat which will raise one kilogram of pure water one degree Centigrade, at or near the temperature of maximum density, 4° C. This Centigrade is a second temperature scale, the unit of which is derived by dividing the distance on the thermometer between the freezing point and the boiling point of water into 100 equal degrees, the freezing point being marked 0°, and the boiling point 100°.

It is often found desirable to change the expression for temperature or for quantity of heat from one system of terms to that of the other. For this purpose the following formulas will be found useful:

$$F = \frac{9}{5} C + 32 \quad \text{and} \quad C = (F - 32) \frac{5}{9} \quad (1)$$

where F = Fahrenheit degrees and C = Centigrade degrees. From these equations it may be seen that the two scales coincide at but one point,—40 degrees. For conversion of the quantity units the following may be used:

1 British thermal unit = 0.252 Calorie.

1 Calorie = 3.968 British thermal units.

These are for the absolute conversion of a certain quantity of heat from one system to the other. If, however, the effect of this heat is considered upon a given weight of sub-

stance and the weight also is expressed in the respective systems, the following values hold:

1 Calorie per kilogram = 1.8 British thermal units per pound.

1 British thermal unit per pound = 0.555 Calorie per kilogram.

For conversion tables from kilograms to pounds and vice versa, see Suplee's Mechanical Engineering Reference Book, page 72, or Kent's Mechanical Engineers' Pocket-Book, page 22.

3. Measurement of High Temperatures:—For the measurement of temperatures up to the boiling point of mer-

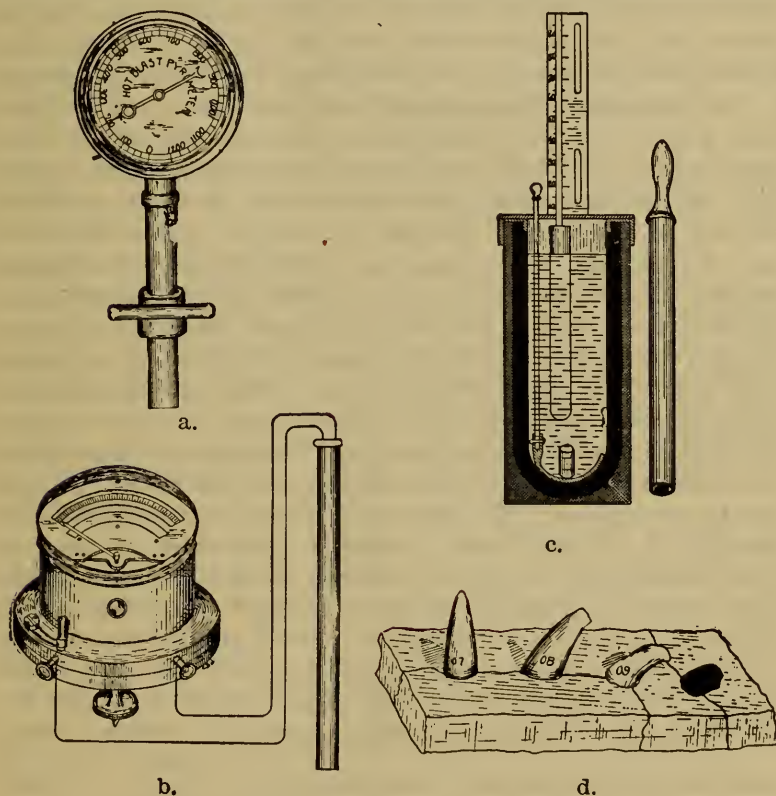

Fig. 1.

cury, or approximately 600° F., the mercurial thermometer of proper range may be employed. It is more common, however, to use some form of *pyrometer* for temperatures above 500° F., as when the temperatures of stack gases or of fire box gases are desired. Pyrometers are built upon many dif-

ferent principles, the graphite expansion stem type, shown in Fig. 1, a; the thermo-electric type, shown in Fig. 1, b; or the Siemens water calorimeter type, shown in Fig. 1, c. Various other methods might be mentioned, one of the best being temperature determination by the Seger cones, which, due to varying compositions, melt at different temperatures. A line of these numbered cones is exposed to the sweep of the gases to be measured, and their temperature determined very closely by noting the number of the last cone which melts. The cones are numbered from 022 to 39 and indicate temperatures from 590° to 1910° F., by approximate increments of 20°. Fig. 1, d, shows cones 010, 09, 08 and 07, of which only the last is unaffected, and, from the table furnished with the cones, this indicates a temperature of 1000° F.

4. Absolute Temperature:—In experiments that have been carried on with pure gases with the use of air thermometers, it has been found that air expands approximately $\frac{1}{460}$ of its volume per degree increase in temperature at zero F. or $\frac{1}{273}$ of its volume at zero C. From the same line of reasoning, by cooling the air below zero, the reverse process should be equally true, that is, for each degree Fahrenheit of cooling the volume at zero would be contracted $\frac{1}{460}$. Evidently, then, if a volume of gas could be cooled to -460° F., it would cease to exist. This theoretical point is called the absolute zero of temperature. All gases change to liquids or solids before this point is reached, however, and hence do not obey the law of contraction of gases at the very low temperatures. The fact that air at constant pressure changes its volume almost exactly in proportion to the absolute temperature, T , ($460 + t$, where t is temperature Fahrenheit) gives a starting point to be used as a basis for all air volume temperature calculations. For instance, if a volume of 20000 cubic feet be taken in at the air intake of a building at 0° , and heated to 70° , its volume, by the heating, will become greater in the same proportion that its absolute temperature becomes greater; that is, $\frac{x}{20000} = \frac{530}{460}$; $x = 23000$ cubic feet, or an increase of 15 per cent.

GAGE AND ABSOLUTE PRESSURES.—Two common ways of expressing pressures are in use. One is denoted by the expression *pressure by gage*, and refers to the total pressure in a container minus the pressure of one atmosphere. Thus the expression "65 pounds boiler pressure, by gage" means that

the boiler is carrying 65 pounds pressure, per square inch of surface, above the pressure of the atmosphere, which is, for approximate calculations, taken at the standard pressure of 14.696 pounds per square inch. Hence, the boiler carries within it a total pressure of 65 pounds plus 14.696 pounds or 79.696 pounds per square inch. This total pressure is what is known as *absolute pressure*, and when stated in pounds per square foot of area, is called *specific pressure*. Like the volume of a gas, so also the absolute pressure varies directly with the absolute temperature, other things being constant. Hence the equation $P V = R T$, where P is the absolute pressure in pounds per square foot, V is the volume of one pound in cubic feet, T is the absolute temperature, and R is a constant which for air is 53.22. From this equation, having given any two of the quantities, P , V or T , the third may be found. In very accurate calculations where the value 14.696 is not considered close enough, the barometer may be read, and its readings, in inches of mercury, multiplied by the constant .49, to obtain the pressure of the atmosphere in pounds per square inch.

MECHANICAL EQUIVALENT OF HEAT.—By precise experiment, it has been determined that, if the heat energy represented by one B. t. u. be changed into mechanical energy without loss, it would accomplish 778 foot pounds of work. Similarly, one calorie is equivalent to 428 kilogrammeters. One horse-power of work is equivalent to the expenditure of 33000 foot pounds of work per minute. Hence one horse-power of work represents 42.416 B. t. u. per minute.

LATENT HEAT.—Not all the heat applied to a body produces change in temperature. Under certain conditions, the heat applied produces internal or molecular changes, and is called *latent heat*. Thus if heat is applied to ice at the freezing point, no rise of temperature is noted until all the ice is melted; and again, heat applied to water at boiling point does not raise the temperature, but changes the water into steam. The first is called latent heat of fusion, and for ice is 142 B. t. u. per pound, while the latter is called latent heat of evaporation, and for water is 969.7 B. t. u. per pound.

SPECIFIC HEAT.—The ratio of the quantity of heat required to raise the temperature of a substance one degree, to that required to raise the temperature of the same weight of pure water one degree from the temperature of its maximum density, 39.1 degrees, is commonly called the specific heat of the substance. The above is the accepted rule among

physicists. This, however, has been modified by engineering practice so that the statement *specific heat of water* is now understood to mean the average specific heat of water between 32 degrees and 212 degrees. (Amount of heat necessary to raise one pound of water from 32 degrees F. to 212 degrees F.) $\div 180 = 1$ approximately. Table 24, Appendix, gives specific heats of substances.

5. Radiation, Conduction and Convection:—The *transmission* of heat, next to its generation, forms an item of vital interest to the heating engineer, for different forms of heating installations are based fundamentally on the different ways in which heat is transmitted. These ways are usually quoted as being three in number—radiation, conduction and convection.

RADIATION.—This transmission of heat occurs as a wave motion in the ether of space, and is the way by which the heat of the sun reaches the earth. Heat of this form, usually referred to as radiant heat, requires no matter for its conveyance, passes through some materials, notably rock-salt, without change or appreciable loss, and travels, as does light, at the rate of 186000 miles per second. In the combustion of fuel the radiant heat given off to the surrounding metal from the rays of the fire is no doubt of much greater value than has ever been credited to it. We are indebted to the noted French physicist, L. Ser, who followed Peclet in his experiments in radiant heat in fire box boilers, for a very valuable amount of information. It is to be hoped that further experimentation may soon see the relation between the "heat radiated from the incandescent surface of the fuel" and the "sensible heat in the escaping gases." This would be of great value to those engaged in the design and operation of boiler furnaces.

CONDUCTION.—The second method of transmission is more commonly evident to the senses. If a rod of metal is heated at one end, it is known that the heat is transferred, or conducted, along the rod until the other end becomes heated also. Conduction being, essentially, the way by which solids transfer heat, is hence of special significance in the calculation of heat losses through the walls of a building. *Relative conductivity* of a substance may be defined as the quantity of heat which passes through a unit thickness of the substance in a unit of time across a unit of surface of the substance, the difference of temperature between the two sides of the substance being one unit of the thermometric scale

employed. Since the complexity of our building constructions renders it obviously impossible to reduce all losses to losses per unit thickness of the structure, we are not permitted to use the term "relative conductivity" but another term, i. e., "transmission constant," or *rate of transmission*. Thus Table IV, page 40, the rate of transmission K , given for a 6 inch studded frame wall, is .25 B. t. u. per square foot of surface per degree difference of temperature for one hour. It is readily seen that this table is the basis for the heat loss calculations of buildings.



Fig. 2.

CONVECTION.—Gases and liquids convey heat most readily by this method, which is fundamental with hot air and hot water heating installations. If it is attempted to heat a body of water by applying heat to its upper surface, it will be found to warm up with extreme slowness. If, however, the source of heat be applied below the body of water as in Fig. 2; it will be found to heat rapidly; the water being distributed by circulating currents having more or less force, and follow-

ing, in general, the direction shown by the arrows. What actually happens is this:—water particles near the source of heat become lighter, volume for volume, than the colder particles near the top; then, because of the change in density, gravity causes an exchange of these particles, drawing the heavier to the bottom and allowing the heated and lighter particles to rise to the top, thus forming the circulation currents. This process is known as convection. It will never occur unless the medium expands considerably upon being heated, and unless the force of gravity is free to establish circulating currents. The hot water heating system may be considered merely as a body of water, Fig. 3, furnished with proper pipe circuits. When heated at one point, the water rises by convection to the radiators, is there cooled, hence becomes heavier, and descends by the return circuit to the point of heat application, thus completing the circuit. The warm air furnace installation works similarly, air, however, being the heat-carrying medium.

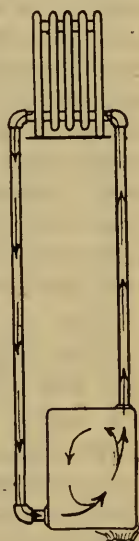

Fig. 3.

CHAPTER II.

AIR COMPOSITION—VENTILATION HUMIDITY.

6. Composition of Atmospheric Air:—The subject of ventilation as applied to buildings would naturally be introduced by a brief consideration of the properties of the air supplied. This supply is a very important factor as regards both quality and quantity. In addition to its value as a heating medium, it determines, in a large measure, the health of the occupants of the building.

The human body may be considered as a well equipped and very complex power plant. As the carbon, hydrogen and oxygen in the fuel and air supply in any mechanical power plant are consumed in the furnace, the resulting heat absorbed in the generating system and finally turned into work through the attached mechanisms, so the human body in a similar way, but at a much slower rate, absorbs the heat of combustion and turns it into work. The products of combustion in both cases are largely carbon dioxide and water. The chief requisites of the mechanical plant are good fuel, good draft and good stoking. Similarly, the human body needs pure food, pure air and healthful exercise. Of the three, the second is probably of the greatest importance, since no person can keep in health with impure air, even though accompanied with the best of food and plenty of exercise.

Air, to the average person, is made up of two elements, oxygen and nitrogen, in the volume ratio of about 20.9 to 79.1 and a density ratio of about 23.1 to 76.9, respectively. We find in making a complete analysis of pure air, that a number of other elements and compounds enter into it, making a mechanical mixture which is somewhat complex. To the heating and ventilating engineer, however, two important substances must be added to the two just stated, and a revision of the percentages will therefore be necessary. It may be said that pure air, as taken from the good open country and not contaminated with poisonous gases or the dust and refuse from the cities, would have about

the following composition. See Encyclopedia Britannica, Respiration.

Oxygen	Symbol	O	Per cent. of volume	20.26
Nitrogen	"	N	" " "	78.00
Moisture	"	H ₂ O	" " "	1.7
Carbon dioxide	"	CO ₂	" " "	.04

These values are fairly constant, except that of the moisture, which may vary according to the humidity anywhere from 0 + to 4 per cent. of the entire weight of the air. In places where the air is not pure, the following substances may be found in small quantities: carbon monoxide (CO), sulphuretted hydrogen (H₂S), ozone, argon, compounds of ammonia, and compounds of nitric, nitrous, sulphuric and sulphurous acids.

In the process of respiration, the lungs and the skin of the average person will change the composition of the air film around the person from that given above to

Oxygen	Per cent. of volume	16
Nitrogen	" " "	75
Moisture	" " "	5
Carbon dioxide	" " "	4

Comparing these values with those for pure air, it will be seen that the oxygen has been reduced about one-fifth, the nitrogen has been reduced about one twenty-fifth, the vapor has increased three times and the carbon dioxide has increased one hundred times. Oxygen has been consumed in its uniting with the excess carbon and hydrogen in the system, and is given off as carbon dioxide and water vapor. It may be seen from these ratios, that the very rapid increase in CO₂ and the accompanying impurities of animal matter, would soon render unfit for use the air in almost any building occupied by a number of people. To avoid this state of affairs, fresh air should be supplied continuously and at such points as will provide the most uniform circulation.

7. Oxygen and Nitrogen:—The oxygen of the air fills about one-fifth of the volume in atmospheric air and is the element that makes combustion possible. The other four-fifths of the space might be said to be filled with nitrogen. In a providential way, this nitrogen acts as a sort of buffer in its mixture with the oxygen and serves to control the rapidity with which the combustion takes place. Nitrogen seems to have little effect upon the respiration, except to

retard the chemical action between the oxygen and carbon and the oxygen and hydrogen. If one were to attempt to live in an atmosphere of pure oxygen, the chemical action in the lungs would be so rapid that the human body would not be able to maintain it.

S. Carbon Dioxide:—The amount of CO_2 in the air is used as an index to the purity of the air. This is not considered a poisonous gas. It has slight taste and odor but no color. It is found in many natural waters and manufactured beverages, the chief one being "soda water," which is made by forcing carbon dioxide into water under pressure. The real action of CO_2 when taken into the lungs is not well known. It has the effect of producing physical depression, and where found in sufficient quantity would even cause death by suffocation, very similar to a submergence in water. Whatever its effect upon human life may be, its presence in any room used for habitation is usually an indication of the lack of oxygen and an excess of impurities thrown off by respiration. Pure air has four parts CO_2 in 10000 parts of air, and room air should never be allowed to have more than eight to ten parts in 10000 parts of air. It becomes the problem of the heating engineer, therefore, to provide air in sufficient quantities, and to enter and withdraw the air from the room in a manner such as will not be uncomfortable to the occupants, at the same time keeping the air fairly uniform in quality, throughout the room. Carbon dioxide in the exhaled breath is about 2.5 times heavier than air of the same temperature, and therefore would have a tendency to fall. It is exhaled, however, with excessive moisture and at a temperature higher than that of the room air, both qualities giving it a tendency to rise. These latter factors probably neutralize the excessive density, and as long as the air is not absolutely quiet, would eventually result in a fair diffusion throughout the room air. In large audiences the heat given off from the occupants is sufficient to cause strong air currents which, in rising, lift this impure air to the upper part of the room. In most systems the vitiated air is withdrawn from the room near the floor line. If, as is urged by some, the ventilating air enters near the floor line and is removed from the upper part of the room near the ceiling, the problem of heating the room will be more difficult and expensive.

The circulation of air within rooms is being given much attention now and it is hoped that some conclusive results may soon be obtained. There is no doubt that less air will be needed for proper ventilation if it is entered and removed in such a manner and from such parts of the room as will keep all the air within the room constantly moving and yet free from localized air currents.

A method of determining the percentage of carbon dioxide in the air, based upon the fact that barium carbonate is nearly insoluble in water, may be performed as follows: Provide eleven bottles with rubber stoppers having two holes each, and connect them continuously by glass and rubber tubing, so that if suction be applied at the first bottle of the series, air will be drawn in at the last of the series and the same air will be passed through all. In this way a sample of the air to be tested may be drawn into each bottle. The capacities of the bottles must be made to be respectively, in ounces, $23\frac{1}{2}$, $18\frac{1}{2}$, $16\frac{1}{2}$, 14, $9\frac{1}{2}$, $7\frac{1}{2}$, $5\frac{1}{2}$, 4, $3\frac{1}{4}$, $2\frac{1}{2}$ and 2. This may readily be done by partially filling with paraffine. Into each bottle is then placed $\frac{1}{2}$ ounce of a 50 per cent. saturated solution of barium hydrate, $Ba(OH)_2$. More of the air to be tested is drawn through the system until assurance is had that each bottle contains a fair sample. Each bottle is then thoroughly shaken, so that the liquid may be brought into good contact with the air sample. If the least turbidity or cloudiness appears in the

First or largest bottle indicates	0.04 per cent. CO_2
Second bottle indicates	0.06 " " "
Third " "	0.07 " " "
Fourth " "	0.08 " " "
Fifth " "	0.10 " " "
Sixth " "	0.15 " " "
Seventh " "	0.20 " " "
Eighth " "	0.30 " " "
Ninth " "	0.40 " " "
Tenth " "	0.60 " " "
Eleventh " "	0.90 " " "

Care must be taken to have a fair sample of the air in each bottle. The glass tubes through the rubber stoppers should extend no farther than the bottom of the stoppers. Fig. 4. a, shows four of the bottles and their connections.

As an example, suppose that the air of a room was tested and that in the first, second, third, fourth, fifth and sixth bottles the liquid became turbid after vigorous shaking. Such room air would have contained 0.15 per cent. of carbon dioxide, and would have been considered quite unfit for breathing.

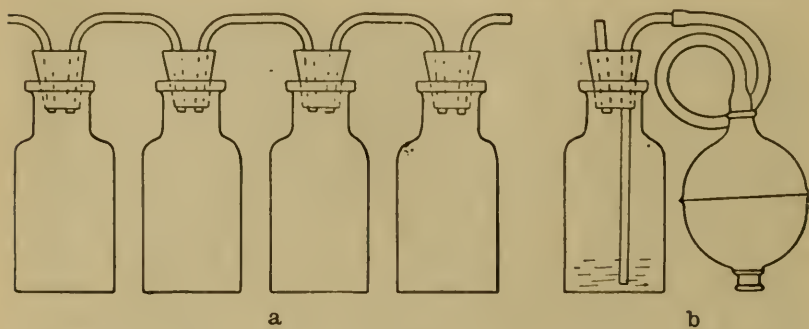

Fig. 4.

A second, less cumbersome, and more delicate method of testing for the percentage of carbon dioxide will be described, as it is the method commonly used and only requires comparatively simple apparatus, as shown in Fig. 4, b. A bottle of about 6 ounces capacity is fitted with a rubber stopper having two holes. Through one hole a glass tube is brought from the bottom of the bottle, and to the outer end of the tube is connected a valved bulb similar to those found on atomizers. Into the bottle are placed 10 cubic centimeters of a solution made by dissolving .53 grams of anhydrous sodium carbonate, Na_2CO_3 , in 5 liters of water, and adding .01 gram of phenolphthalein. The water used must have been previously boiled for at least one hour in an open vessel. With the apparatus so prepared, squeeze the bulb, thus forcing air from the room through the liquid and into the bottle. The open hole in the rubber stopper is then closed with the thumb, and the bottle shaken for twenty seconds, then another bulb-full of air is inserted, and again shaken. This process is continued and the number of bulbs of air noted until the red color of the solution, due to the phenolphthalein, disappears. This number of bulb fillings is indicative of the purity of the air according to the table below. After such an apparatus is completed, it must be calibrated

before being used. This is done by testing the number of bulb fillings of pure country air necessary to clear the liquid, which will usually vary from 40 to 70. A new table for that special apparatus is then obtained from the one given below by proportion. In the table given, this number of bulb fillings, with purest country air, is 48. If, with the apparatus made up, it is found that, say, 60 bulb fillings are required, then the proportionate table would be made by multiplying the number of bulb fillings given below by the ratio of $60 \div 48$, or 5 to 4. It is important that the bulb be compressed the same amount for each filling, and that the shaking of the bottle and contents be continued the same length of time after each filling, to obtain uniform results.

TABLE I.

Fillings	Per Cent. CO ₂	Fillings	Per Cent. CO ₂
48	.030	15	.074
40	.038	14	.077
35	.042	13	.08
30	.048	12	.083
28	.049	11	.087
26	.051	10	.09
24	.054	9	.10
22	.058	8	.115
20	.062	7	.135
19	.064	6	.155
18	.066	5	.18
17	.069	4	.21
16	.071	3	.25

The methods outlined for the approximate estimation of CO₂ are satisfactory for determining whether or not ventilating systems maintain a proper degree of purity of air. If exact percentages of CO, CO₂, O and N are required, the Orsat apparatus must be employed, for description of which see Engineering Chemistry by Stillman, page 238. See also Carpenter, H. & V. B., Chap. II, and Hempel's Gas Analysis, translated by Dennis.

9. Amount of Air Required per Person:—The need of a continuous supply of fresh air in our residences and business houses can scarcely be over-estimated. Health is probably

the greatest of all blessings and pure air is absolutely essential to health. The average adult, when engaged in ordinary indoor occupations, will exhale about twenty cubic inches of air per respiration. He will also have sixteen to twenty respirations per minute, making a total of 400 cubic inches or, say, .25 cubic foot of air exhaled per minute. If as in Art. 6, exhaled air contains 4 per cent. CO_2 , then the average person will exhale $60 \times .25 \times .04 = .6$ cubic foot CO_2 per hour, (Pettenkofer, Smith & Parker), which is constantly being diffused throughout the air of the room, thus rendering it unfit for use. If the carbon dioxide and the other impurities could be disassociated from the rest of the air and expelled from the room without taking large quantities of otherwise pure air with it, the problems of the heating engineer would be simplified, but this cannot be done. Because of this rapid diffusion, it is necessary to flood the room with fresh air in order that the purity may be maintained at a safe value. The ideal conditions would be to have it the same as that of the outside air, but the mechanical difficulties around such a ventilating system would be so great as to render it prohibitive. The standard of purity which should be aimed at, and one, as well, which may be attained with a first class system, is, .06 of one per cent. CO_2 , i. e., six parts of CO_2 in 10000 parts of air. A system, however, which maintains a standard of 8 parts in 10000 would be considered fairly satisfactory. This may be put in a simple form for calculation.

Let Q_1 = cubic feet of atmospheric air needed per hour per person; A = cubic feet of CO_2 given off per hour per person; n = the standard of purity to be maintained (allowable parts of CO_2 in 10000 parts of air); and p = the standard of purity in atmospheric air, say, 4; then

$$Q_1 = \frac{A}{n - p} \quad (2)$$

If we wish to maintain a purity in the room of seven parts CO_2 in 10000 parts of air, and pure air contains four parts in 10000, we have $Q_1 = .6 \div (.0007 - .0004) = 2000$ cubic feet of air per hour.

Another formula, quoted from Carpenter's Heating and Ventilating of Buildings, very similar to the above, is

$$Q_1 = \frac{ab}{n - 4} \quad (3)$$

where a = the purity of the exhaled breath, say 400 parts in 10000, n = the purity to be maintained in the room and b = the cubic feet of air exhaled per minute. Substituting, as above,

$$Q_1 = (400 \times 60 \times .25) \div (7 - 4) = 2000 \text{ cubic feet.}$$

Based upon .6 cubic foot of CO_2 exhaled per person per hour, Table II gives the amount of air needed to maintain the various standards of purity.

It should be understood that no hard and fast rule can be given for the air requirement per person. This, naturally, would be a different amount when considering the physical development for each person in health; it would also be different for the same person according to his occupation at the time, sleep being the least, waking rest somewhat greater, and physical exercise the greatest; but it varies decidedly with the state of the person's health, or the sanitary value of his surroundings. According as the degree of purity is demanded, the air supply must be increased to suit it.

TABLE II.

Cubic Feet of Air per Person per Hour.

n	A	Q_1
6	.6	3000
7	.6	2000
8	.6	1500
9	.6	1200
10	.6	1000

Generally, it is understood that the *average adult* subjected to average conditions will require 1800 *cubic feet of air per hour*. The amount of air needed for ventilation then in most cases can be represented by the formula $Q' = 1800 N$, where N = the number of people to be provided for.

The following table quoted from Carpenter's H. & V. B., and from Morin in Encyclopedia Britannica, gives a fair value for the amount of air per occupant per hour, that should be supplied to rooms used for various purposes.

TABLE III.

Hospitals, ordinary	2000-2400	cu. ft. per hour
“ epidemic	5000	“ “ “ “
Workshops, ordinary	2000	“ “ “ “
“ unhealthy trades	3500	“ “ “ “
Prisons	1700	“ “ “ “
Theaters	1400-1700	“ “ “ “
Meeting halls	1000-2000	“ “ “ “
Schools, per child	400- 500	“ “ “ “
“ “ adult	800-1000	“ “ “ “

Recent practice would tend to increase these values somewhat; especially those relating to school house ventilation, where a good estimate would be 800 to 1800 respectively.

One ordinary gas burner of 20 candle power, using four cubic feet of gas per hour, will vitiate as much air as three or four people. Where many lamps are used, this fact should be taken into account.

In summing up the subject of fresh air supply, it is well to call attention to the fact that the ordinary running conditions of any room cannot be absolutely determined by a single test for carbon dioxide. Trials should be frequently made and records kept. Upon one day the conditions may be unusually favorable and would show a small amount of CO₂ even though a very small amount of fresh air be admitted; while on other days, when the conditions are not so favorable, a large amount of fresh air would have to be supplied to maintain the proper purity within. If the only requirement, therefore, governing the ventilation of buildings should be that a satisfactory CO₂ test be passed, there would be a large opportunity to overrate or underrate, as the case may be, the ventilating system of the building. The only safe method in rating ventilating systems is to require a minimum air supply in addition to a maximum permissible percentage of CO₂.

The purification of air by ozonizing it has recently been advocated and by some it is claimed to be the real solution of the bad air problem. Definite scientific data are still lacking upon which to base any authoritative statements, although the invigorating effects of breathing ozonized air will be testified to by many. Ozone is an unstable form of

oxygen, probably containing a greater number of atoms per molecule, and is formed by passing air through a highly charged electric field. Because of its instability as a substance it readily breaks up and becomes more active as an oxidizing agent than oxygen itself. In its decomposition a part goes into combination with substances in the air, such as carbon impurities thrown off from the human body, and burns them up, leaving the balance which is probably pure oxygen. If in the future the purifying effects of ozone are found to substantiate the claims made by some, ventilation problems may thus be readily solved by air washing and ozonizing.

10. Moisture with Air:—Moisture with the air is a benefit to both the heating and ventilating systems in any room. With moisture in the room, a person may feel comfortable when the temperature is several degrees lower than the comfortable temperature of dry air. Dry air takes up the moisture from the skin. The vaporization of this moisture causes a loss of heat from the body, and gives to the person a sense of cold, which is only relieved when the temperature of the room is increased. Air space that is fairly saturated with moisture will not permit of much evaporation from the skin, because there is not much demand for this moisture with the air; consequently the body retains that heat and the person has a sensation of warmth which is only relieved by lowering the temperature of the air of the room. On the other hand, at low temperatures the moisture with air chills the surface of the skin by convection, a condition that is not so noticeable when the air is dry. It follows from the above statement that the range of comfortable temperatures is less for moist air than for dry air.

Concerning the effect of moisture in its relation to the heating and ventilating of the room, we may say that thoroughly dry air has not the quality of intercepting radiant heat; moisture, however, has this quality. Moist air has also somewhat less weight than dry air and is more buoyant. Because of the possibility of storing up the radiant heat within the particles of moisture, and, because of its convection qualities, it serves as a good heat carrier for the heating system.

11. Humidity of the Air:—The *actual humidity* is the amount of moisture, expressed in grains or in pounds per

cubic foot, mixed with the air at any temperature. The *relative humidity* is the ratio of the amount of moisture actually with the air divided by the amount of moisture which the same volume could hold at the same temperature when saturated. It is very important that the heating engineer be able to add to or to take away from the amount of the moisture in the air supply of any building. To find the amount of moisture that should be added or subtracted in any case, it is first necessary to determine the humidity of the air current at various points along its course. This may be obtained by the aid of the wet and dry bulb thermometer or by any one of a number

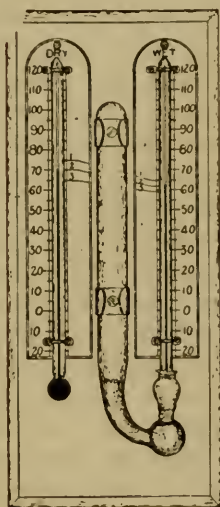

Fig. 5.

of hygrometers supplied by the trade. The wet and dry bulb thermometer has a very simple application, and is probably in most general use. The principle of its application is as follows: having two thermometers, Fig. 5, let one of them register the temperature of the room air, the other one being kept wet by a cloth which covers the bulb and projects into a vessel filled with water, shown between the two thermometers. If the air is saturated the two thermometers will record the same temperature; if, however, the air is not saturated the thermometer readings will differ an amount depending upon the humidity. It will readily be seen that the lowering of the mercury in

the wet thermometer is due to the extraction of the heat in vaporizing the moisture from the bulb to the air.

In taking readings, let the mercury find a constant level in each thermometer and then note the difference in temperature between the two. In Table 11, Appendix, at this difference and at the room temperature read off the relative humidity; then take from Table 12, Appendix, the amount of moisture with saturated air at the temperature recorded by the dry thermometer, and multiply this by the humidity. The result is the amount of moisture with the air per cubic foot of volume.

APPLICATION.—Room air, 70 degrees; difference in readings, 6 degrees. From Table 11, the humidity is 72 per cent. From Table 12, col. 7, $.72 \times .001153 = .00083$ pounds per cubic foot.

To avoid the necessity for the use of tables, various instruments have been designed, which, graphically, give the relative humidity directly. Fig. 6 shows such an instrument,

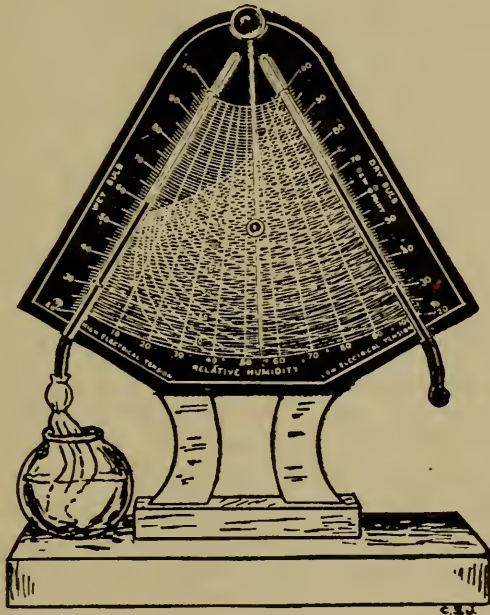

Fig. 6.

commonly known as the *hygrodeik*. To find, by it, the relative humidity in the atmosphere, swing the index hand to the left of the chart, and adjust the sliding pointer to that degree of the wet bulb thermometer scale at which the mercury stands. Then swing the index hand to the right until the sliding pointer intersects the curved line which extends downward to the left from the degree of the dry bulb thermometer scale, indicated by the top of the mercury column in the dry bulb tube. At that intersection, the index hand will point to the relative humidity on scale at bottom of chart. Should the temperature indicated by the wet bulb thermometer be 60 degrees and that of the dry bulb 70 degrees, the index hand will indicate humidity of 55

per cent., when the pointer rests on the intersecting line of 60 degrees and 70 degrees.

For accurate work any instrument of the wet and dry bulb type should be used in a current of air of not less than 15 feet per second.

Note.—A very elaborate series of experiments conducted by Mr. Willis H. Carrier of Buffalo, New York, and presented as a paper before the American Society of Mechanical Engineers in 1911, seems to show a theoretical humidity under varying conditions of temperature somewhat different from that obtained by the U. S. Weather Bureau, which has always been considered as a standard. Tables 11 and 12, Appendix, are used as reference in this book but Fig. A following Table 13, shows the variation between the results obtained by Mr. Carrier and those obtained by the Government. The two charts Fig. B and Fig. C in addition to Fig. A are extracted from Mr. Carrier's work with his permission. The completeness with which this data has been worked up permits almost any information desired to be obtained from these two charts.

12. For Close Approximations and to avoid calculations, the humidity chart, Fig. 7, may also be used in determining relative humidity, absolute humidity, dew point, temperature of wet bulb and temperature of dry bulb. On the left of the chart is a scale referring to horizontal lines giving temperatures of the wet bulb. The scale on the right hand, referring to the lines curving downward from right to left, is the scale of the room, or dry bulb, temperatures. The scale along the bottom of the chart is one of relative humidity. The scale of numbers up the center of the chart refers to the lines curving downward from left to right, and indicates the absolute humidity, i. e., grains of moisture per cubic foot with the air. The use of the chart may be most readily understood by a few applications.

APPLICATION.—Given dry bulb 70 degrees and wet bulb 60 degrees. Determine relative humidity, absolute humidity, temperature of dew point for room, etc. First, starting on the right hand scale at 70, follow down the line this number refers to until it crosses the horizontal line of 60 degrees, wet bulb temperature. From this intersection drop to the relative humidity scale and read there 55 per cent. This may be checked with the table. To obtain the absolute humidity it will be noticed that the intersection of the 70 degree and

HYGROMETRIC CHART

GIVING

HYGROMETER TEMPERATURES, RELATIVE HUMIDITY, GRAINS OF MOISTURE PER CU. FT.

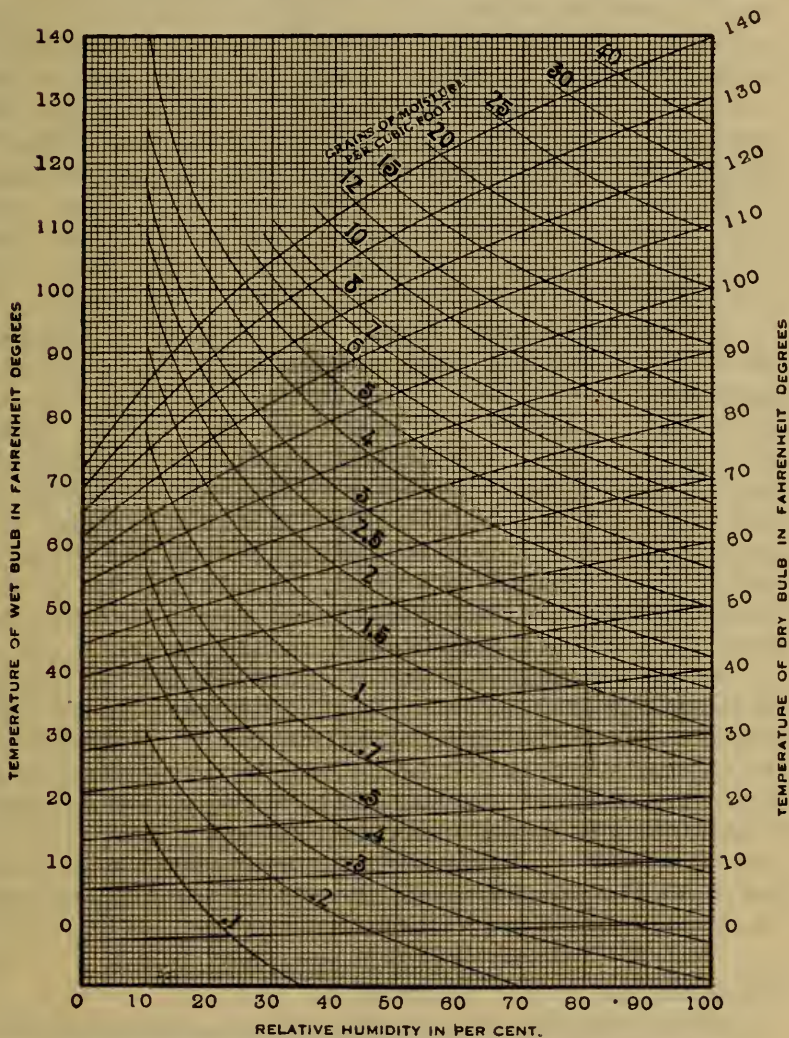

Fig. 7.

NOTE.—Fig. 7 represents two charts in one. First: the dry bulb temperature curve, which drops to the left, unites with the wet bulb and relative humidity coordinates. Second: the absolute humidity curve, which rises to the left, unites with the dry bulb and relative humidity coordinates. This makes it possible to use the two charts as one, through the relative humidity scale which is common to both.

55 per cent. coordinates shows 4.4 grains per cubic foot. If the room should cool, the absolute humidity would remain the same until the dew point is reached (neglecting air contraction), hence, following down the 4.4 grain line to 100 per cent. gives the room temperature as 52 degrees, showing that if so cooled the air would begin depositing moisture at this temperature. Again if the room should heat to 90 degrees, the relative humidity may be obtained by following the 4.4 grain line to its intersection with the 90 degree coordinate line of room temperature, and from this intersection dropping to the relative humidity scale, reading there 31 per cent. Thus, having given air under any set of conditions, the effect that a change in any one of these would have upon the remaining may be obtained without calculations.

13. The Theoretical Amount of Moisture to be Added to Air so as to Maintain a Certain Humidity:—Warm air has a much greater capacity for holding moisture than cold air. According to the law of Gay-Lussac, when air is taken at a given outside temperature and heated for interior service, the volume increases with the absolute temperature. See Art. 4. On the other hand the humidity decreases rapidly. Air thus treated becomes dry and unpleasant to the occupants, as well as being detrimental to the furnishings of the room. Some means should, therefore, be provided to supply this moisture to the air current.

In calculating the amount to be added, let Q = volume of air in cubic feet per hour entering the room at the register; t = its temperature in degrees and $T = (460 + t) =$ its absolute temperature; let Q' and $Q_0 =$ the corresponding volumes after entering and before entering, with t' and t_0 the temperatures in degrees, and $T' = (460 + t')$ and $T_0 = (460 + t_0)$ the absolute temperatures; also, let u' and u_0 be the humidities, respectively, of the room air and the outside air. Then, from the equations

$$TQ' = T'Q \text{ and } TQ_0 = T_0Q \quad (4)$$

find Q' and Q_0 .

From Table 10 or 12, Appendix, find the amounts of moisture M' and M_0 in one cubic foot of saturated air at the temperatures t' and t_0 ; multiply these by the respective humidities and volumes, and the difference between the two final quantities will be the amount of moisture required per hour as expressed by the formula

$$W = Q'M'u' - Q_0M_0u_0 \quad (5)$$

APPLICATION.—Let $Q = 5000$, $t = 130$, $t' = 70$, $t_o = 30$, $u' = .50$, $u_o = .50$, $M' = 7.98$, and $M_o = 1.935$, then

$$Q' = 5000 \times 530 \div 590 = 4490$$

$$Q_o = 5000 \times 490 \div 590 = 4154$$

$W = 13896$ grains, or 1.983 pounds per hour.

This means that approximately 2 pounds of water would be evaporated for every 5000 cubic feet of fresh air entering the register under the above conditions.

14. Velocity in the Convection of Air by the Application of Heat:—Let h_o Fig. 8, be the height of the chimney

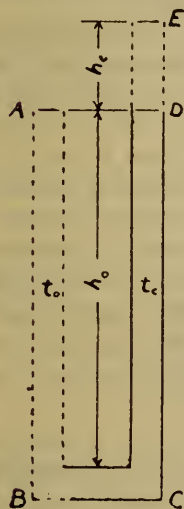

Fig. 8.

or stack. If the temperature of the gases within the chimney CD be the same as that of the entering air, then there will be no natural circulation, because the column CD , will just balance a corresponding column AB upon the outside; but if the temperature of the chimney gases CD and entering air AB be t_c degrees and t_o degrees, respectively, the chimney gases being $(t_c - t_o)$ degrees greater than that of the outside air, then, upon entering the chimney, the gases will become less dense and expand an amount proportional to the absolute temperature. With an outside column of h_o feet in height, it will then require a column within, $h_o + h_o$ feet in height to produce equilibrium; in other words, the column of gas producing motion in the chimney has a height of h_c feet.

Assume, in the system of $ABCE$, that the cross sections at all points be uniform, then the volumes of AB (imaginary column) and CE (actual column) are to each other as their respective heights, i. e.,

$V_o : V_o + V_c :: h_o : h_o + h_c$, or $h_o : 460 + t_o :: h_o + h_c : 460 + t_c$
 From this we obtain $h_c (460 + t_o) = h_o (t_c - t_o)$ and

$$h_c = \frac{h_o (t_c - t_o)}{460 + t_o} \tag{6}$$

Substituting for h in the equation $v = \sqrt{2gh}$, its corresponding value h_c , we have

$$v = \sqrt{2gh_c} = 8.02 \sqrt{\frac{h_o (t_c - t_o)}{460 + t_o}} \tag{7}$$

It is found in practice that the theoretical velocity as given by this formula is never obtained, because of the

friction of the sides of the chimney and other causes. Mr. Alfred R. Wolff quoted the actual discharge from the chimney as 50 per cent. of the theoretical. This estimate may be fairly correct for chimneys of the larger sizes, but may not be realized on the smaller ones used in residences. As the transverse area becomes smaller, the percentage of friction increases very rapidly and soon becomes the principal factor. Prof. Kent assumes a layer of gas two inches thick next the interior surface as being ineffective. This, if applied to small cross-sectional areas, increases the size of the chimney rapidly from the calculated amount.

When formula 7 is applied to hot air stacks in the heating systems, the friction is much less because of the smooth interior, and the actual velocity of the air should reach 60 to 70 per cent. of the theoretical.

15. Measurement of Air Velocities:—See also Arts. 123-125. In ventilating work it is often of the greatest importance to determine air velocities accurately. The correct determination of the sizes of air propelling fans or blowers depends upon the ability to accurately measure the velocity of delivery. In acceptance and other tests this measurement is equally important. However, no entirely satisfactory and trustworthy method of obtaining this measurement has as yet been devised.

The velocity of moving air is most commonly measured by means of a vane wheel instrument called the *anemometer*. It consists essentially of a delicately pivoted wheel holding from 6 to 15 vanes and similar to the common wind-mill wheel. See Fig. 9. To the shaft is connected a recording mechanism of some sort, the simplest being merely dials which show the velocity of the air traveling past the instrument, by the reading of which against a stop-watch, the speed per unit of time may be obtained. Since the instrument works against the friction of moving parts, its readings are subject to serious variation, and even with frequent calibration, it is not to be relied upon where results are required accurate to within 20 per cent. Various tests of anemometers by comparison to the absolute

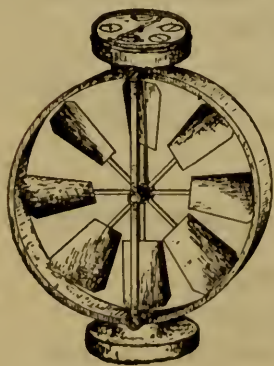

Fig. 9.

readings of a gas tank have shown errors as high as 35 per cent. slow, to 14 per cent. fast, with the discharge from pipes 8 inches to 24 inches in diameter. Hence, in general, it is very safe to say that the anemometer as an instrument for velocity measurement in precise work should be used with great care.

A second method of velocity measurement, and one applying as readily to liquids as to gases, is that of using the *Pitot tube* principle. Whenever, in a liquid or gas, a pressure produces a flow, part of this pressure, usually termed the velocity head, is considered as transformed into velocity; while a second part, usually called the pressure head, acts to produce pressure in the fluid. If now, as at A, in Fig. 10, a tube be inserted into a pipe carrying a

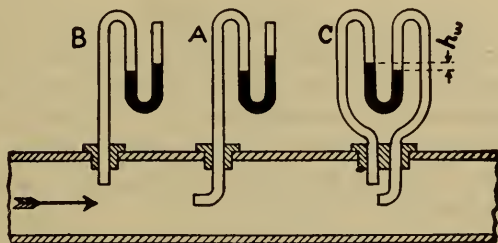

Fig. 10.

current of air or other moving fluid, and the end of this tube be bent so the plane of the opening is perpendicular to the direction of the flow, a pressure in the tube will result, due to both the velocity head and the pressure head; and the difference in levels in the connected manometer tube will indicate this sum of pressures in terms of inches of water or mercury. If, however, a tube be inserted as at B, with the plane of its opening parallel to the direction of the flow, a pressure in the tube will result, due only to the pressure head in the moving fluid; and the difference in levels in the connected manometer tube will indicate this pressure only. Then, by subtraction of the two manometer readings, the velocity head only is obtained, expressed in inches of water or mercury, whichever the manometer may contain.

At C is shown the instrument as commonly applied, with both tubes together and connected one to either leg of the manometer tube so that the subtraction is automatic

and the difference in levels read is caused by the velocity only. Having, then, the head of pressure due to velocity, to find the actual velocity apply the formula $v = \sqrt{2gh}$ where $v =$ velocity in feet per second, $g =$ acceleration of gravity in feet per second, per second, and $h =$ the velocity head of the air in feet. If the manometer contains water, then, at 60 degrees, the ratio between the specific gravity of air and water is $\frac{62.37}{.0764} = 816.4$. See Tables 12 and 8, Appendix.

Hence the above formula may be reduced to the more readily available form of

$$v = \sqrt{2 \times 32.16 \times 816.4 \times \frac{h_w}{12}}, \text{ or}$$

$$v = 66.2 \sqrt{h_w} \quad (8)$$

where $h_w =$ the difference in height *in inches* of the columns of a *water* manometer, with both legs connected as described, and a temperature of 60 degrees. By a similar method the formula may be reduced for a mercury or other manometer, or for other temperatures than 60 degrees. (See Art. 1021, Trans. A. S. M. E. Vol. XXV.)

In using the Pitot tube or the anemometer, the fact should not be lost sight of that the velocity varies from a minimum at the inner walls of the tube to the maximum at the center of the tube. It seems that the friction at the inner walls throws the moving fluid into a number of concentric layers, those toward the center moving the fastest, those toward the inner wall of the pipe the slowest. With a circular tube, the variation of velocities of these different layers may be approximately represented by the abscissae of a parabola, Fig. 11, with its axis on the axis of the circular pipe. Weisbach, on page 189 of his *Mechanics of*

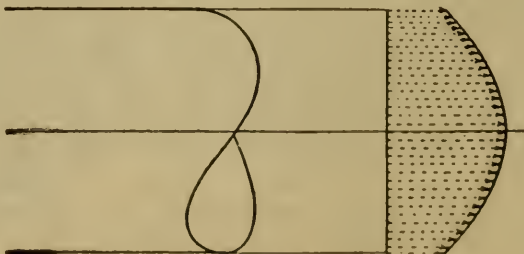

Fig. 11.

Air Machinery, quotes the *average speed* at two-thirds of the radius from the center, this value being obtained by experiments. For conduits of other shapes the position of mean velocity must be determined experimentally. This variation of velocity from the center of the stream lessening toward the walls may possibly account for the variations shown by the anemometers. It is evident that if such an instrument, with a given diameter of vane wheel, be placed at the center of a pipe of large radius it would tend to register a higher velocity than the average.

Automatic recording meters may be obtained for keeping permanent records of the flow of air and steam through pipes and ducts. The record from the meter indicates directly the cubic feet of free air or other fluid used during each hour of the day.

16. Amount of Air Required to Burn Carbon:—The chief product in the combustion of carbon with the oxygen of the air is CO_2 . The atomic weight of carbon is 12 and that of oxygen is 16, hence the chemical union of the two forming CO_2 is in the proportion of carbon 12 and oxygen 32 or as 1 : 2.66. For each pound of carbon consumed, 2.66 pounds of oxygen will be needed and the product will weigh 3.66 pounds. If pure air contains 23 per cent. oxygen, then one pound of carbon will need $2.66 \div .23 = 11.7$, say 12 pounds of air for complete combustion. One cubic foot of air at 32 degrees weighs .0807 pounds, then $12 \div .0807 = 148$ cubic feet of air necessary to burn one pound of carbon if all the oxygen of the air is burned. With volumes proportional to the absolute temperatures, this air at 70 degrees would be 160 cubic feet; at 200 degrees, 200 cubic feet; at 400 degrees, 260 cubic feet; and at 600 degrees, 320 cubic feet.

17. Probable Amount of Air Used:—It seems reasonable to assume, however, that in practice from two to three times as much air goes through a furnace as would be needed for perfect combustion. Taking this at 2.5, then the cubic feet of air found from the above would be approximately: 32 degrees, 370 cubic feet; 70 degrees, 400 cubic feet; 200 degrees, 500 cubic feet; 400 degrees, 650 cubic feet; and 600 degrees, 800 cubic feet.

18. To Determine the Transverse Area of a Chimney for Any Given Height:—Substitute h_0 and the assumed

values of t_0 and t_1 in formula 7, Art. 14. From this find the velocity of the chimney gases, and divide the total volume of air used in any given time, Art. 17, by the corresponding velocity.

19. Application to the Chimney of a 10-Room Residence:—Given: total heat loss from the building per hour, 10000 B. t. u.; coal, 13500 B. t. u. per pound; furnace efficiency, 60 per cent.; temperature at bottom of chimney, 200 degrees F.; height of chimney, 30 feet above the grate; average temperature of chimney gases, 150 degrees. (The greatest difficulty is experienced when the fire is first started before the chimney is warmed up. The temperature of the stack gases at such a time is very low.) Take the outside air temperature, 40 degrees F., and find the size of the chimney.

A heat loss of 100000 B. t. u. per hour will require $100000 \div (13500 \times .60) = 12.4$ pounds of coal per hour at the grate; then with a temperature of 200 degrees at the bottom of the chimney, this will need to pass $500 \times 12.4 = 6200$ cubic feet of air per hour. The velocity of the chimney gases, according to formula, is 20.5 feet per second or 73800 feet per hour. Assuming the real velocity to be 25 per cent. of this amount, we have approximately 18450 feet per hour; then the net sectional area is $6200 \div 18450 = .34$ square foot or 49 square inches. To fit the brick work this would probably be made 8 inches \times 8 inches.

20. All Chimneys should have a Smooth Finish on the Inside:—Probably the best arrangement that can be made is to build the chimney of hard burned brick around hard burned tiles of suitable internal size. These tiles can be had of outside sizes such that they can easily be made to work in with the brick work. Table 15, Appendix, shows chimney capacities that will be safe in average practice. Flues should preferably be made round in section, as this form presents less friction to the gases than any other. Flues should never be built less than ten inches in diameter, or eight by ten inches rectangular. The value of a flue depends very much upon the volume of passage due to area, and velocity due to height. Velocity alone is no proof of good draft for there must also be sufficient area to carry the smoke. The top of a chimney with reference

to its position relative to neighboring structures is a very important consideration. If the top is below any nearby portion of the building, eddy currents tending to enter the top of the flue may be formed and seriously reduce the draft. Under such conditions a shifting cowl, which always turns the outlet away from adverse currents, may be advisable. Good draft is very essential to the success of any type of heating system, and the purchaser of a furnace or heater should be required to guarantee sufficient draft before a maker is expected to guarantee a stated rating of his furnace or heater.

REFERENCES.

References on Ventilation and the Air Supply

TECHNICAL BOOKS.

Moore, *The School House*, p. 24. Monroe, *Steam Heat. & Vent.*, p. 99. Carpenter, *Heat. & Vent. Bldgs.*, p. 21. Hubbard, *Power, Heat. & Vent.*, p. 408. Allen, *Notes on Heat. & Vent.*, p. 91. *Ency. Brit.*, Vol. XXIV, p. 157, also Vol. XX, p. 474.

TECHNICAL PERIODICALS.

Engr. Rev., Sanitation and Ventilation in Boston School Houses, W. B. Snow, March 1908, p. 15. Subway Ventilation, J. B. Holbrook, Jan. 1905, p. 18. Ventilation of School Rooms, Nov. 1905, p. 6. *Heat. & Vent. Magazine*. A Scotchman's Notes on Ventilation, Alex. Mackenzie, May 1906, p. 15. Air Analysis as an Aid to the Ventilating Engineer, J. R. Preston, Oct. 1906, p. 11. *Domestic Engineering*. Ventilation in its Relation to Health W. G. Snow, Vol. 52, No. 4, July 23, 1910, p. 102; Vol. 52, No. 6, Aug. 6, 1910, p. 154. Ventilation of Isolated Offices, C. L. Hubbard, Vol. 45, No. 10, Dec. 5, 1908, p. 274. Humidity, Its Necessity and Benefits, W. W. Brand, July 1910. The Permanent Place of the Air Washer in Heating and Ventilating Work, Feb. 1910. *Trans. A. S. H. & V. E.* The Necessity of Moisture in Heated Houses, R. C. Carpenter, Vol. X, p. 129. Need of Ventilation in Heated Buildings, Vol. X, p. 183. Changing the Air in a Building, Vol. X, p. 285. Effect of Humidity on Heating Systems, Vol. IX, p. 323. Necessity of Ventilation, H. Eisert, Vol. V, p. 57. *The Engineering Magazine*. Humidifiers,—Their Principles and Useful Applications, S. H. Bunnell, June 1910. The Heating, Ventilating and Air Conditions of Factories, P. R. Moses, Aug. and Sept. 1910. *Engineering Record*. Ventilation of Three Basement Floors of the Marshall Field Retail Store, Chicago, Jan. 23, 1909. Ventilation of a Newspaper Photo-Engraving Plant, June 26, 1909. Ventilation of the First Church of Christ, Scientist, Boston, Sept. 19, 1908. The Ventilation of a Weave Shed, Aug. 8, 1908. Ventilation of the Battery Tunnels of the New York Subway Extension to Brooklyn, Oct. 5, 1907. Railway Tunnel Ventilation, Feb. 20, 1904. *Railway Age Gazette*. Detroit Return Trap System, July 23, 1909, p. 175. Washington Union Station Ventilation, June 12, 1908, p. 84. Heating and Ventilating the Storage Battery Stations on the New York Central & Hudson River, April 13, 1908, p. 489. Ventilation and Heating of Engine Round-houses as Adopted by the New York Central Lines, June 18, 1909, p. 1335. *The Metal Worker*. A Remarkable Theatre Ventilation Plant, Jan. 15, 1910, p. 63. An Interesting Factory Ventilation Plant, Jan. 15, 1910, p. 90. Ventilation of Factories, Auditoriums, Stores and Schools in Chicago, May 7, 1910, p. 634. Ventilation in Relation to Health, Wm. G. Snow, June 25, 1910, p. 866; July 30, 1910, p. 142. Heating and Ventilating Plant Complying with Factory Law, July 10, 1909, p. 41. Heating from a Physician's Standpoint, May 14, 1910, p. 658. Ventilating a Restaurant, Sept. 25, 1909, p. 39. *Cassier's Magazine*. The Purification of Air, Oct. 1910.

CHAPTER III.

HEAT LOSSES FROM BUILDINGS.

21. Loss of Heat by Conduction and Radiation:—In planning the heating system for any building, the first and probably the most important part of the work is to estimate the total heat loss per hour from the building. Unfortunately this is the part which is the least open to satisfactory calculations and we find little valuable theoretical data upon the subject.

Heat is lost from a building in two ways, by *radiation* and by *convection*, i. e., that transferred through walls, windows and other exposed surfaces by conduction and lost by radiation; and that carried off by the movement of the air as it passes out through the openings in the building to the outside air. The radiation loss is usually of greater importance, but the convection loss is of much more importance than is generally considered. In the average building both of these values are difficult to determine.

Radiation losses are considered under various heads, such as glass, wall, floor, ceiling and door losses. Concerning the conduction of heat through these various materials, the available data have been obtained by experimentation and do not agree very closely. Peclet in France, and Grashof, Rietschel, Klinger and Rechnagel in Germany, each carried on experimental research to determine the heat transmission through various materials and structures. These published data form the basis for a large part of the heat loss calculations of the present time. Much valuable material can be found in the more recent writings of Hood, Wolff, Box, Carpenter, Kinealy, Allen, Hogan, Hubbard and others, but many of the values quoted are only rough approximations at best. The reason for so much uncertainty in this part of the work is found in the fact that there are such great differences in methods of building construction. Conductivity tests for the various materials have been satisfactorily made, but when these same materials have been put into a building wall the quality of the workmanship often permits more heat loss by con-

vection than would be transmitted through the materials themselves. The values quoted for brick walls and glass agree fairly well. The greatest difficulty is found in the balloon-framed building with its studded walls, where the dead air space in a well constructed wall may be a good non-conductor, or where, on the other hand, the same space in a poorly constructed wall may become a circulating air space to cool the walls by the movement of the air.

Table IV has been compiled from a number of the best references as stated above, and represents a fair average of all of them. The value K (rate of transmission), in some of the references, varied for the same material, being somewhat greater for small temperature differences than where the temperatures differed widely. In general, the transfer of heat through any substance is about proportional to the difference of the temperature between the two sides of the substance. This was noticeably true for most of the quotations.

TABLE IV.

Conductivities of Building Materials.

K = B. t. u. transmitted per sq. ft. per hour per degree dif.

Materials.	K.
Brick wall, 8"4
Brick wall, 12"31
Brick wall, 16"26
Brick wall, 20"23
Brick wall, 24"21
Brick wall, 28"19
Brick wall, 32"17
Brick wall, furred, use .7 times non-furred in each case.	
Stone wall, use 1.5 times brick wall in each case.	
Windows, single glass	1.0
Windows, double glass6
Skylight, single glass	1.1
Skylight, double glass7
Wooden door, 1"4
Wooden door 2"36
Solid plaster partition, 2"6
Solid plaster partition, 3"5
Ordinary stud partition, lath and plaster on one side....	.6

Ordinary stud partition, lath and plaster on two sides..	.34
Concrete floor on brick arch2
Fireproof construction as flooring1
Fireproof construction as ceiling14
Single wood floor on brick arch15
Double wood floor, plaster beneath.....	.10
Wooden beams planked over, as flooring.....	.17
Wooden beams planked over, as ceiling.....	.35
Walls of the average wooden dwelling.....	.25 to .30
Lath and plaster ceiling, no floor above.....	.62
Lath and plaster ceiling, floor above.....	.25
Steel ceiling, with floor above35
Single $\frac{3}{4}$ " floor, no plaster beneath.....	.45
Single $\frac{3}{4}$ " floor, plaster beneath.....	.26

Occasionally it is convenient to reduce all radiating surfaces to equivalent wall surface and take account of the heat losses as a part of the wall.

The following equivalents for doors, floors and ceilings have been found to give good results:

Doors not protected by storm doors or vestibule = 200% of equal wall area.

Floor over unheated space. Air circulation = same as wall.

Floor over unheated space. Still air = 40% of equal wall area.

Ceiling below unheated space. Air circulation = 125% of equal wall area.

Ceiling below unheated space. Still air = 50% of equal wall area.

In all references from French and German authorities, one is impressed by the extreme care and exactness with which every detail is worked out, even to those minor parts usually considered in this country of no special moment.

Table IV has been reduced to chart form, Fig. 12, where the table values agree with -10° outside temperature and 0 wind velocity. The application of this chart is as follows: Assume the outside temperature -10° , still air, inside temperature 70° , south exposure. What is the heat loss from a square foot of 12 inch brick wall, also from a square foot of single glass window? Beginning at the right of the chart at -10° outside temperature trace to the left to the 0 wind velocity, then up the ordinate to the 12 inch wall

(interpolate between 8 and 16), then to the left to the line indicating 70° inside temperature, then down to the south exposure, then to the left showing 25 B. t. u. transmitted

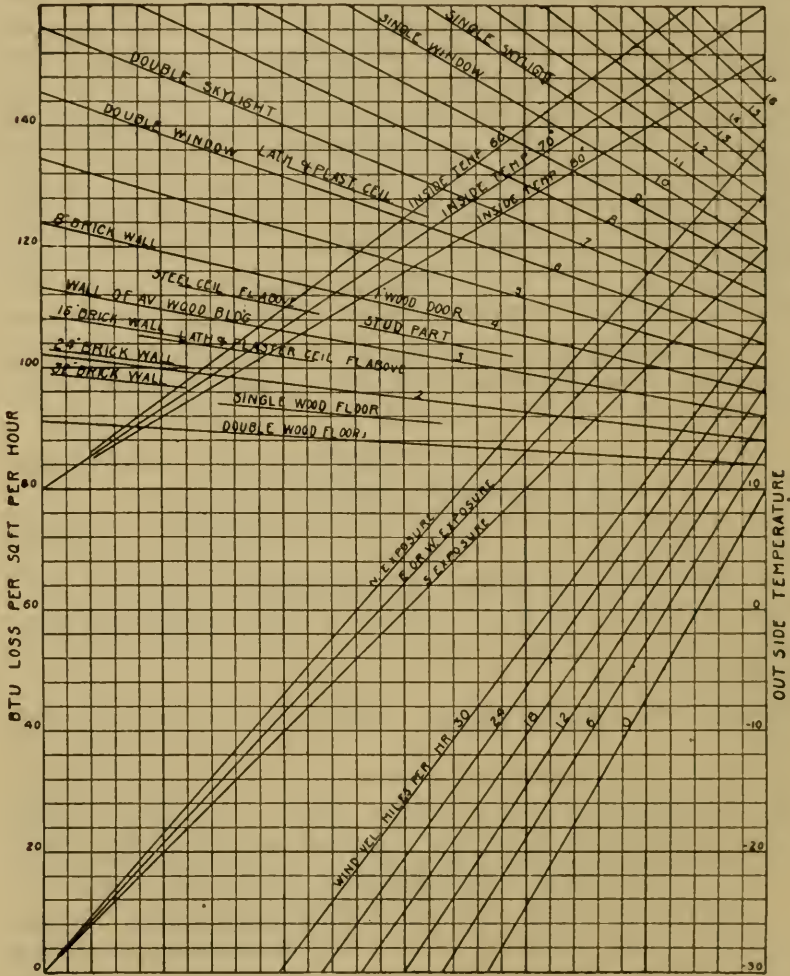

Fig. 12.

per hour. For the glass, trace from -10° to the 0 wind velocity, then up to the single window, then to the left to the inside temperature, 70°, then down to south exposure,

then to the left showing 80 B. t. u. per square foot per hour. Checking this with the table for a 12 inch brick wall we have $.31 \times 80 = 24.8$ B. t. u. For glass $1 \times 80 = 80$. The values given in the table must be increased for west, north and east exposures. The effect of the wind velocity upon the heat loss is very marked. Locations subjected to high winds should have extra allowance made. For example, take the 12 inch brick wall just mentioned. Assume the wind to be 30 miles an hour. By the same process as before we find for a south exposure, 36 B. t. u. loss as compared to 25 with 0 wind velocity.

22. Loss of Heat by Air Leakage:—The exact amount of air leaving a building by leakage is impossible to determine. Many experiments have been carried on in the last few years to determine the amount of leakage around windows and doors. These in the specific cases have been successful, but no actual values can be quoted for general use. Again, a considerable amount of air passes through the walls, thus rendering the case more complicated. In all the experiments, however, it has been found that these losses have been much greater than was supposed. In rooms not heavily exposed, or in touch with heavy winds, two changes per hour may be safely allowed for all leakage losses.

23. Exposure Losses and Other Losses:—Radiation losses are much greater on the exposed or windward side of the building. Moving air passing over the surface of any radiating material will wipe the heat off faster than would be true of still air. The north, north-west and the north-east in most sections of the country get the highest winds and have the least benefit of the sun and are therefore counted the cold portions of the building. In figuring a building it is customary to figure each room as though it were a south room, which is assumed to need no additions for exposure, and then add a certain percentage of this loss for exposure to fit the location of the room. The exact amount to add in each case is largely a matter of the judgment of the designer, who, of course, is supposed to know the direction of the heavy winds and the protection that is afforded by surrounding buildings. A wide variety of values covering the American practice might be quoted for this, but the following will give satisfactory results:

TABLE V.

North, north-east and north-west rooms heavily exposed,	10-20 per cent.
East or west rooms moderately exposed	5-10 per cent.
Rooms heated only periodically	20-40 per cent.
The German practice is somewhat more extreme than ours in this part of the work:	
North, north-east and north-west rooms heavily exposed	15-25 per cent.
East and west rooms	10-15 per cent.
Surfaces exposed to heavy winds	10-20 per cent.
Heat interrupted daily but rooms kept closed	10 per cent.
Heat interrupted daily but rooms kept open	30 per cent.
Heat off for long periods	50 per cent.
Rooms 12 to 14½ feet from floor to ceiling ..	3 per cent.
Rooms 14½ to 18 feet from floor to ceiling ...	6 per cent.
Rooms 18 feet and above from floor to ceiling	10 per cent.

24. Loss of Heat by Ventilation:—A certain amount of fresh air leaks into every building and displaces an equal amount of warm air, but this amount of fresh leakage air is not considered sufficient for good ventilation. When warm air is displaced either by leakage or by ventilation, it is exhausted to the outside air and as it leaves the room carries a certain amount of heat with it. This is a direct loss and should be taken into account.

Since the loss by leakage is practically the same for all systems of heating, it is accounted for in the ordinary heat loss formula, but losses by ventilating systems must be considered in excess of this amount. Let Q' = cubic feet of fresh air supplied per hour, $t' - t_o$ = drop in temperature from the inside to the outside air; then the heat lost by exhausting the air, Art. 27, is

$$H_v = \frac{Q' (t' - t_o)}{55} \quad (9)$$

25. Two General Methods of Estimating the Heat Loss H from a Building are in Common Use:—First, estimate all radiation losses and add to their sum a certain per cent.

of itself to allow for leakage by convection; second, estimate all radiation losses and add to their sum a certain amount which depends upon the volume of the room. The first is by *Equivalent Radiating Surfaces only* and the second is by *Equivalent Radiating Surfaces and Volume combined*.

26. Method No. 1:—Figuring by Equivalent Radiating Surface.—Let H = B. t. u. heat loss from room per hour; G = exposed glass in square feet; W = exposed wall minus glass, plus exposed doors reduced to equivalent wall surface in square feet; F = floor or ceiling separating warm room from unheated space; t_x = difference between room temperature and outside temperature; t_y = difference between room temperature and temperature of the unheated space; K , K' and K'' = coefficients of heat transmission; a = percentage allowed for exposure and b = percentage allowed for loss by leakage, varying in per cent. of other losses from 10 in the average house to 30 in the house of poor construction.

From the above, we have

$$H = (KGt_x + K'Wt_x + K''Ft_y) (1 + a + b) \quad (10)$$

(APPLICATION.—Assume the sitting room, Fig. 15, to have a total exposed wall surface, W , exclusive of glass, 242 square feet; total exposed glass, G , 38 square feet; and floor, F , 195 square feet. Assume that all the rooms are heated to 70 degrees with an outside temperature of zero degrees and that all workmanship is fair. Assume also the floor to be of the ordinary thickness and not ceiled below, with a temperature below the floor of this room of 32 degrees; and that two people are using the room. Under such conditions what is the heat loss from the room? Since this is a south room there is no exposure loss and $a = 0$. Then assuming $b = .20$ we have

$$H = (1 \times 38 \times 70 + .3 \times 242 \times 70 + .45 \times 195 \times 38) (1 + .20) \\ = 13270 \text{ B. t. u.}$$

Good judgment will be necessary in selecting the proper outside temperature for the calculation. The value of this outside temperature varies among men in the same locality as much as 20 degrees. In the above application if $t_o = -20^\circ$ and the temperature of the unheated space below the floor remains at 32 degrees, formula (10) becomes $H = 15946$ B. t. u. See discussion of this point under Art. 60.

27. Method No. 2:—Figuring by Equivalent Radiating Surface and Volume.—The general formula for this is

$$H = (KGt_s + K'Wt_s + K''Ft_y + \alpha nCt_s) (1 + a) \quad (11)$$

where H , K , G , t_s , t_y , W , F and a are as given above; C = cubic volume of the room; n = number of times the air is supposed to change in the room by leakage and convection per hour, recommended, 1 to 2; $\alpha = \frac{1}{55}$ and is usually taken .02 for convenience of calculation. This constant refers to the heat carried away by the air. The specific heat of the air at 32 degrees is .238; then the number of pounds of air heated from 32 to 33 degrees by 1 B. t. u. is $1 \div .238 = 4.2$. Now if the weight of a cubic foot of air at 32 degrees is .0807 pounds, we would have $4.2 \div .0807 = 52$ cubic feet of air heated from 32 to 33 degrees by 1 B. t. u. However, most of the heating is not done at from 32 to 33 degrees but from 32 to 70 degrees, in which case, the volume of air heated from 69 to 70 degrees by 1 B. t. u. is $52 \times 530 \div 492 = 56$ cubic feet. See absolute temperature, Art. 4. It is evident that some approximation must here be made. No exact value can be taken because of the great range of temperature change of the air, but 55 is commonly used as the best average. The difficulty of handling formula with the constant $\frac{1}{55}$ has led to the simple form .02. (See last column Table 12, Appendix.)

APPLICATION.—With the same room as used in Application 1, we have, if $a = 0$,

$$H = (1 \times 38 \times 70 + .3 \times 242 \times 70 + .45 \times 195 \times 38 + .02 \times 1 \times 1950 \times 70) (1 + 0) = 13806 \text{ B. t. u.}$$

28. Method No. 3:—Professor Carpenter reviews the work of the various authors and quotes the following formula, which is the same as that given in Method No. 2 in a more simplified form, with the terms the same as before:

$$H = (G + .25 W + .02 nC) t_s \quad (12)$$

In his opinion the very elaborate methods sometimes used are unnecessary. K may be assumed .25 for any ordinary wall surface, brick or frame, and the ceilings adjoining an attic or the floors above a cellar of the average house need not be considered. Floors above an unexcavated space where no heat is obtained from the furnace and where there

is more or less circulation of air should no doubt have some allowance. This would probably be the same as given in Art. 21. The values of n are quoted by the same authority as follows:

Values of n .

Residence heating, halls, 3; sitting room and rooms on the first floor, 2; sleeping rooms and rooms on second floor, 1. Stores, first floor, 2 to 3; second floor, $1\frac{1}{2}$ to 2. Offices, first floor, 2 to $2\frac{1}{2}$; second floor, $1\frac{1}{2}$ to 2. Churches and public assembly rooms, $\frac{3}{4}$ to 2. Large rooms with small exposure, $\frac{1}{2}$ to 1.

APPLICATION.—Assuming the same room as before,
 $H = [38 + .25 (242 + .4 \times 195) + .02 \times 2 \times 1950] 70 = 13720$.

29. Combined Heat Loss $H' = (H + H_v)$:—In buildings where ventilation is provided, the total heat loss is that lost by radiation, H , + that lost by ventilation, H_v , (see also Art. 36). Letting $Q_v =$ cubic feet of air needed per hour for ventilation, we have

$$H' = H + \frac{Q_v t_x}{55} \quad (13)$$

Rule.—To find the total heat loss from any building, add to the heat loss calculated by formula, the amount found by multiplying the number of cubic feet of ventilating air exhausted from the building per hour by one-fifty-fifth of the difference between the inside and outside temperatures.

30. Temperatures to be Considered:—The temperature maintained in heated rooms in this country is 70 degrees. Outside temperatures used in figuring heat losses are generally taken, southern part, + 10 degrees; northern part — 20 degrees; ordinary value, 0 degrees. (See Art. 60.)

The German Government requires estimates on the following temperatures, as quoted in "Formulas and Tables for Heating," by Prof. J. H. Kinealy.

TABLE VI.—Values of *t'*.

The temperatures of heated rooms are generally assumed by the German Engineers to be as follows:

Rooms in which the occupants are for the most part at rest:

Living rooms, business rooms, court houses, offices, schools	68
Lecture halls and auditoriums	61 to 64
Rooms used only as sleeping rooms	54 to 59
Bath rooms in dwellings	68 to 72
Sick rooms	72

Rooms in which the occupants are undergoing bodily exertion:

Workshops, gymnasiums, fencing halls, etc., in which the exertion is vigorous	50 to 59
Workshops in which the exertion is not so vigorous	61 to 64

Rooms used as passage rooms or occupied by people in street dress:

Entrance halls, passages, corridors, vestibules	54 to 59
Churches	50 to 54

Miscellaneous:

Prisons for the confinement of prisoners during the day	64
Prisons for the confinement of prisoners during the night	50
Hot houses	77
Cooling houses	59

Bath houses:

Swimming halls	68
Treatment rooms, massage rooms	77
Steam bath	113
Warm air bath	122
Hot air bath	140

TABLE VII.

Values of t_o When Applied to a Room.

The temperatures of rooms not heated are quoted as follows, with the outside air at 4 degrees below zero:

Cellars and rooms kept closed.....	32
Rooms often in communication with the outside air, such as passages, entrance halls, vestibules, etc.	23
Attic rooms immediately beneath metal or slate roof	14
Attic rooms immediately beneath tile, cement, or tar and gravel roof	23

31. Heat given off from Lights and from Persons

Within the Room:—As a credit to the heating system, some heating engineers take account of the heat radiated from the lights and the persons within the room. The following table by Rubner is quoted by Prof. Kinealy:

TABLE VIII.

Gas, ordinary split burner, B. t. u. per candle power hr.	300
Gas, Argand	200
Gas, Auer	31
Petroleum	160
Electric, incandescent	14
Electric, arc	4.3

According to Pettenkofer, the mean amount of heat given off per person per hour is 400 heat units for adults and 200 for children.

REFERENCES.

References on Heat Losses and Radiation.

TECHNICAL BOOKS.

Snow, *Principles of Heat.*, p. 54. Carpenter, *Heating and Ventilating Bldgs.*, p. 64. Hubbard, *Power, Heat. and Vent.*, p. 417. Allen, *Notes on Heat. and Vent.*, p. 13.

TECHNICAL PERIODICALS.

Engineering Review. Air Leakage Around Windows; Its Prevention and Effects on Radiation, Harold McGeorge, Feb. 1910, p. 64. *The Heating and Ventilating Magazine.* Austrian Coefficients for the Transmission of Heat through Building Materials, W. W. Macon, Feb. 1908, p. 36. Air Leakage through Windows and its Effect Upon the Amount of Radiation, B. S. Harrison, Nov. 1907, p. 18. Air Leakage Around Windows and its Prevention, H. W. Whitten, Dec. 1907, p. 20. Derivation of Constants for Building Losses, R. C. Carpenter, March 1907, p. 34. Methods of Estimating Heat Losses from Buildings, C. L. Hubbard, Sept. 1907, p. 1. *Trans. A. S. H. & V. E.* Heat Losses and Heat Transmission, Walter Jones, Vol. XII, p. 233. Loss of Heat through Walls of Buildings, R. C. Carpenter, Vol. VIII, p. 96. *Engineering Record.* An Investigation of the Heat Losses in an Electric Power Station, Jan. 16, 1909, p. 77. Derivations of Constants for Bldg. Losses, R. C. Carpenter, Feb. 23, 1907, p. 214. *The Metal Worker.* Humidity of Air and Its Determination, with Chart, Aug. 21, 1909, p. 56. Heating Water by Steam, Sept. 18, 1909, p. 53. Coal Consumption in Two English Hot Water Heating Plants, Sept. 19, 1908, p. 47. School House Warming and Ventilation, Serial, Jan. 6, 1906, p. 58. *Power.* Heat Transmission through Corrugated Iron, A. H. Blackburn, Oct. 29, 1912. Coal Required to Heat Modern City Building, E. F. Tweedy, Jan. 16, 1912.

CHAPTER IV.

FURNACE HEATING AND VENTILATING.

PRINCIPLES OF DESIGN.

32. Furnace Systems Compared with Other Systems:—

The plan of heating residences and other small buildings by furnace heat, in which the air serves as a heat carrier, is a very common one in this country. Some of the points in favor of the furnace system are: low cost of installation, heating combined with ventilation, and the rapidity with which the system responds to light service or to sudden changes of outdoor temperatures. Compared with that of other heating systems, the furnace system can be installed for one-third to one-half the cost. In addition to this, the fact that ventilation is so easily obtained, and the fact that a small fire on a mild day may be sufficient to remove the chill from all the rooms, give this method of heating many advocates. The *objections* to the system are: cost of operation when outside air is circulated, difficulty of heating the windward side of the house, and the contamination of the air supply by the fuel gases leaking through the joints in the furnace. In a good system well installed, the only objection to be seriously considered is the difficulty of heating that part of the house subjected to the pressure of the heavy wind. The natural draft from a warm air furnace is not very strong at best and any differential pressure in the various rooms will tend to force the air toward the direction of least resistance. The cost of operating can be controlled to the satisfaction of the owner, consistent to his ideas of the quality of the ventilation needed. Arrangements may be made to carry the warm air from the room back again to the furnace to be reheated, in which case, if the fresh air be cut off entirely, the cost of heating is about the same as that of any system of direct radiation having no provision for ventilation. Any amount of fresh air, however, may be taken from the outside for the purpose of ventilation, thus requiring the same amount of air

to be exhausted at the room temperature and causing an increased cost of operation, as discussed in Art. 36.

33. Essentials of the Furnace System:—Fundamentally, this installation must contain: first, a furnace upon proper settings; second, a carefully designed and constructed system of fresh air supply and return ducts; and third, the warm air distributing leaders, stacks and registers. Fig. 13 shows, in elevation, a common arrangement of these essentials, and gives, also, the air circulation by arrow

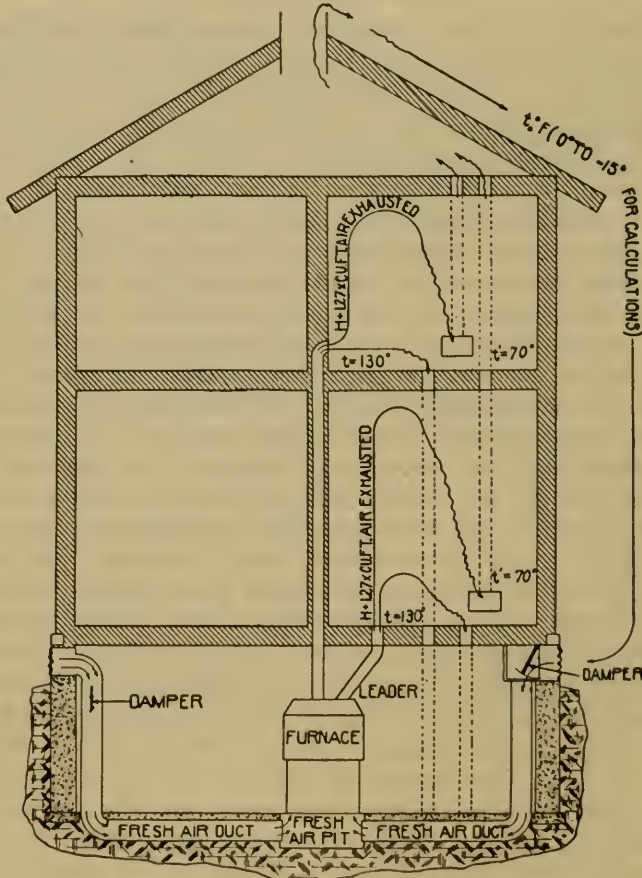

Fig. 13.

directions. The installation shown is rendered flexible in operation by the basement dampers, proper adjustment of which will allow fresh air to be taken from either side

of the house or furnished to the pit under the furnace by the duct from the first floor rooms. This return register is usually placed in the hall, under the stairway, or in some room which is generally in open connection with the other rooms on the first floor, as a large living room.

34. Points to be Calculated in a Furnace Design:—Besides the calculated heat loss, H , which of course would probably be the same for all methods of heating, other points in furnace design would be taken up in the following order: first, find the cubic feet of air needed as a heat carrier and determine if this amount of air is sufficient for ventilation; then calculate the areas of the following: net heat register, gross heat register, heat stack, net vent register, gross vent register, vent stack, leader pipes, fresh air duct and total grate area. From the total grate area the furnace may be selected.

35. Air Circulation in Furnace Heating:—The use of air in furnace heating may be considered from two standpoints, each very distinct in itself. First, *air as a heat carrier*; second, *air as a health preserver*. The first may or may not provide fresh air; it merely provides enough air to carry the required amount of heat from the furnace to the rooms, i. e., to take the place of the heat lost by radiation plus the small amount that is carried away by the natural interchange of air from within to without the building, as would be true in any residence that is not especially planned to provide ventilation. With certain allowable temperatures at the various parts of the system, this volume of air may be easily calculated. One point here should be remembered: when the cubic feet of air per hour as a heat carrier is found at the register, this volume remains the same, no matter if it enters the furnace through a duct from within or without the building. So this plan may be both a heat carrier and a ventilator if desired, subject only to the amount of air required. The second plan requires that enough air be sent to the rooms to provide ventilation. If this amount is less than that needed as a heat carrier, all well and good, the first amount will be used; but if it should be greater, then the first amount will need to be increased arbitrarily to agree. This increased volume will then be used instead of that calculated as a heat carrier

only. As previously stated, the cubic feet of air per hour as a ventilator may be taken as $1800 N$, where N is the number of persons to be provided for. See Art. 9.

36. Air Required per Hour as a Heat Carrier:—A safe temperature t , of the circulating air as it leaves the heat register, is 130 degrees. This may at times reach 140 degrees but it is not well to use the higher value in the calculations. If, as is nearly always the case, the room air temperature, t' , is 70 degrees, the incoming air will drop in temperature through 60 degrees and, since one cubic foot of air can be heated through 55 degrees by one B. t. u. (see Art. 27.), it will give off $60 \div 55 = 1.09$ (say 1.1) B. t. u.

Let Q = cubic feet of air per hour as a heat carrier; H = total heat loss in B. t. u. per hour by formula; t = temperature of the air at the register; and t' = temperature of the room air; then

$$Q = \frac{55 H}{t - t'} \quad (14)$$

Rule.—To find the cubic feet of air necessary to carry the heat to the rooms, multiply the heat loss calculated by formula by fifty-five and divide by the difference between the register and the room temperatures.

For ordinary furnace work this becomes

$$Q = \frac{H}{1.1}$$

Now if this air is not allowed to escape from the building, Fig. 13, but is taken back to the furnace and recirculated, the only loss of heat will be H , that calculated by the formula; but as a matter of fact, air thus used would soon become contaminated and wholly unfit for the occupants to breathe, hence, it is customary to exhaust through ventilating flues, either a part or all of the air sent from the furnace. This makes an additional loss of heat from the building corresponding to the drop in degrees from 70 to that of the outside air. Let the temperature of the outside air, t_o , be 0 degrees, then the resulting heat loss would be (see also Art. 110 on blower work.) $H' = H$ plus $(t' - t_o)$ divided by 55 and multiplied by the amount of air introduced for ventilation. Stated as a formula for the special conditions, this becomes

$$H' = H + 1.27 Q \quad (15)$$

Take for illustration the Sitting Room, Fig. 15, and consider it under three conditions on a zero day: first, when all the air is recirculated; second, when only enough air is exhausted to give good fresh air for ventilation; third, when all the air is exhausted. Under the first case the loss H , by formula is, say, 14000 B. t. u. per hour and no other loss is experienced. In the second case, let three people occupy the room and allow 1800 cubic feet of fresh air per hour for each person, or a total of 5400 cubic feet per hour, then the total heat loss from the room will be, Formula 13, $14000 + 5400 \times 70 \div 55 = 20873$, say 21000 B. t. u. The third case, where all the air is exhausted, gives $14000 \div 1.1 = 12727$ cubic feet of fresh air exhausted at 70 degrees, which requires the same amount of fresh air being raised from zero to 70 degrees to replace it. This necessitates the application of $12727 \times 70 \div 55 = 16198$ B. t. u. additional, or a total heat loss of 30198, say 30000 B. t. u. per hour.

The second condition is that which would be found most satisfactory. It is evident from inspection that the cubic feet of air necessary as a heat carrier will supply excessive air for ventilation in the average residence, and the designer need not necessarily consider the amount of air for ventilation except as he wishes to investigate the size of the furnace, the amount of coal burned or the cost of heating; the latter being in direct proportion to the respective total heat losses. (See also Art. 60.)

APPLICATION.—Referring to Table IX, page 63, the calculated amount of air per hour for the various rooms and for the entire building may be found.

37. Is this Amount of Air Sufficient for Ventilation if Taken from the Outside?—Take the $13 \times 15 \times 10$ foot sitting room, Fig. 15. Let the estimated heat loss be 14000 B. t. u. per hour, then $Q = 12727$ cubic feet. With a room volume of 1950 cubic feet, the air will change 6.5 times per hour, and, allowing 1800 cubic feet of air per person, will supply seven people with good ventilation if fresh air be used. Stated as a formula, this would be

$$N = \frac{H}{1.1 \times 1800} = \frac{H}{2000} \text{ approx.} \quad (16)$$

As a matter of fact, ventilation for half this number would be ample in an ordinary residence room excepting on extraor-

dinary occasions. So it would seem that the subject of ventilating air will be more than taken care of if the ducts and registers are planned to carry air for heating purposes only.

38. Given the Heat Loss H and the Volume of Air Q' for any Room, to find t , the Temperature of the Air Entering at the Register:—If for any reason Q is not sufficient for ventilation, then more air must be sent to the room and the temperature dropped correspondingly to avoid overheating the room. Let Q' = total volume of air per hour, including extra air for ventilation, measured at the register, then

$$t = 70 + \frac{55 H}{Q'} \quad (17)$$

Rule.—When it is necessary for ventilation purposes to circulate more air than that calculated from the heat loss formula, then the temperature at the register will be found by adding to seventy degrees the amount found by multiplying the heat loss by fifty-five and dividing by the cubic feet of ventilating air.

APPLICATION.—Suppose it were necessary to send 18000 cubic feet of fresh air to this sitting room per hour to accommodate ten people, the temperature of the air at the register should be

$$t = 70 + \frac{55 \times 14000}{18000} = 113^\circ.$$

39. Net Heat Registers:—The velocity of the air v , as it leaves the heat register, varies from 3 to 4 feet per second according to different designers. The first figure is objected to by some because it gives too large register areas; while the latter value is claimed to be great enough that the occupants of the room will notice the movement of the air. Practice no doubt tends to the higher velocity. Most heat registers in residences are placed at the floor line. If, however, they be placed above the heads of the occupants of the room (see Art. 102), higher velocities than the ones named can be used. The general formula for net registers is

$$N. H. R. = \frac{H \times 55 \times 144}{(t - t') \times v \times 3600} \quad (18)$$

Rule.—To find the square inches of net heat register, multiply the heat loss calculated by formula by two and two-tenths and divide by the product of the velocity in feet per second times the difference in temperature between the register and the room air.

Assuming a mean velocity of 3.5 feet per second, and 60 degrees drop in temperature from the register to the room, then the square inches of net register for any room are found by the formula:

$$N. H. R. = \frac{H \times 55 \times 144}{60 \times 3.5 \times 3600} = .01 H \quad (19)$$

40. Net Vent Registers:—Vent registers should be put in with any furnace plant, although this is not always done. In order that any room may be heated properly, it is absolutely necessary that the cold air in the room be allowed to escape to give room for the heated air to come in. This in some cases is done by venting through doors, windows or transoms. A tightly closed room cannot be properly heated by a furnace.

If all the air were to pass out the vent register at the same velocity as it entered through the heat register, the area of the vent register would be to the area of the heat register as the ratio of the absolute temperatures of the leaving and entering air; that is, the area of the vent register = .9 of the area of the heat register. As a matter of fact, since some of the air leaves the room through other openings, the vent register need not be so large. Practice has decided this area to be about

$$N. V. R. = .008 H = .8 N. H. R. \quad (20)$$

41. Gross Register Area:—The nominal size, or catalog size, of the register is usually stated as the two dimensions of the rectangular opening into which it fits, and varies from 1.5 to 2 times the net area. The larger value is probably the safer to follow unless the exact value be known for any special make of register. Floor registers have heavier bars and consequently for the same net area have somewhat larger gross area.

$$G. R. = (1.5 \text{ to } 2) \text{ times the net register} \quad (21)$$

Round registers may be had if desired. Register sizes may be found in Tables 17 and 19, Appendix.

42. Heat Stacks:—To get the proper sizes of the stacks in any heating system is a very important part of the design of that system. By some designers the cross sectional area is taken roughly as a certain ratio to that of the net

register. This has been quoted anywhere from 50 to 90 per cent. Such wide variations between extremes of air velocity should certainly require careful application. Prof. Carpenter in H. and V. B. Arts. 54 and 141, suggests 4, 5 and 6 feet per second respectively, as the air velocities for the first, second and third floors. Mr. J. P. Bird, in the "Metal Worker" of Dec. 16, 1905, uses 280, 400 and 500 feet per minute, which is approximately 4.5, 6.5 and 8 feet per second under like conditions. The formula for cross sectional area of the heat stack, from formula 19, then becomes, if the velocities are 4, 5.5 and 7 feet per second,

$$H. S. = \frac{H \times 55 \times 144}{60 \times (4, 5.5 \text{ or } 7) \times 3600} = \left\{ \begin{array}{l} .0091 H \text{ 1st floor} \\ .0066 H \text{ 2nd floor} \\ .0052 H \text{ 3rd floor} \end{array} \right\} \quad (22)$$

Rule.—See rule under net heat registers with changed value for velocity.

The air velocity in the stack is based upon the formula $v = \sqrt{2gh}$, where h = (effective height of stack) \times $(t - t') \div (460 + t')$; v is in feet per second; t is the temperature of the stack air and t' is the temperature of the room air. The calculated results from this formula are much higher than those obtained in practice because of the shape of cross sections of the stack, the friction of its sides and the abrupt turns in it.

From the basis of the net register (figured at 3.5 feet per second) the two quotations by Carpenter and Bird give heat stack areas as follows: first floor, 80 to 88 per cent.; second floor, 55 to 70 per cent.; and third floor, 44 to 60 per cent. Good sized stacks are always advisable (see Art. 55), but because of the limited space between the studing it becomes necessary at times to put in a stack that is too small or to increase the thickness of the wall, a thing which the architect is occasionally unwilling to do. From the above figures, checked by existing plants that are working satisfactorily, the following approximate figures, reduced to the basis of the net heat register area, will no doubt give good results.

$$H. S. = \left\{ \begin{array}{l} .8 \text{ times the net heat register. 1st floor} \\ .66 \text{ times the net heat register. 2nd floor} \\ .5 \text{ times the net heat register. 3rd floor.} \end{array} \right\} \quad (23)$$

$$43. \text{ Vent Stacks:—} V. S. = .8 H. S. \quad (24)$$

44. **Leader Pipes:**—Since all the air that passes through the stacks must pass through the leader pipes, it seems

reasonable to assume that the areas of the two would be equal. It must be remembered, however, that the stacks, because of their vertical position, offer less resistance in friction, while on the other hand the leader pipes, being nearly horizontal and having more crooks and turns in them, will have considerable friction and will consequently retard the air to a greater degree. There will also be some loss of temperature in the air as it passes through the leader pipes, consequently the volume of air entering the leader from the furnace will be greater than that going up the stack.

It would be well, from the above reasons, to make the area of the leader pipes

$$L. P. = (1.1 \text{ to } 1.2) \text{ times the stack area,} \quad (25)$$

the exact figures to depend upon the length and inclination of the leader and the selection of the diameter of the pipe.

45. Fresh Air Duct:—The area of the fresh air duct is determined largely by experience as in the case of the vent register. It is generally taken

$$F. A. D. = .8 \text{ times the total area of the leaders.} \quad (26)$$

Assume the average velocity of the air in the leaders to be 6 feet per second and the area of the fresh air duct to be as shown above, then, if the air in each were of the same temperature, the velocity in the fresh air duct would be $6 \div .8 = 7.5$ feet per second; but since the temperatures are different the velocities will be in proportion to the absolute temperatures. Hence it is, at 0 degrees, $.78 \times 7.5 = 5.8$; at 25 degrees, $.82 \times 7.5 = 6.2$; and at 50 degrees, $.88 \times 7.5 = 6.6$ feet per second. It is seen by this, that although the area of the fresh air duct is contracted to 80 per cent. of that of the leaders, the velocity is in all cases below that of the leaders. It is always well to have a fresh air duct that is large in cross sectional area and free from obstructions and sharp turns.

46. Grate Area:—The grate area of a furnace is estimated from the total heat lost from the building, figured on a basis of a certain degree of ventilation. In obtaining the grate area it is necessary to assume the quality of the coal, the efficiency of the furnace and the pounds of coal burned per hour per square foot of grate. The quality of

coal selected would be between 12000 and 14000 B. t. u. per pound as shown in Table 14, Appendix. The efficiency of the average furnace is about 60 per cent., and the coal burned per square foot of grate per hour ranges from 3 to 7 pounds. Concerning the last point there may be a wide difference of opinion. Higher temperatures in the combustion chamber are conducive to economy, because of the radiant heat of the fire; hence, to reduce the size of the fire pot, and fire small amounts of coal with greater frequency would seem to be the ideal way. On the other hand, with high temperatures in the combustion chamber, the loss up the chimney is increased. Probably the one factor which is most effective in settling this point is the inconvenience of frequent firing. Furnaces are charged from two to four times each twenty-four hours. This requires a good sized fire pot and a possibility of banking the fires. To allow 5 pounds per hour is probably as good an average as can be made for most coals in furnace work.

Let H' = total heat loss from the building including ventilation loss; E = efficiency of the furnace; f = value of coal in B. t. u. per pound; and p = pounds of coal burned per square foot of grate per hour; then the formula for the square inches of grate area is

$$G. A. = \frac{H' \times 144}{E \times f \times p} \quad (27)$$

Rule.—To find the square inches of grate area for any furnace, multiply the total heat loss from the building per hour by one hundred and forty-four and divide by the quantity found by multiplying the total pounds of coal burned per hour by the heat value of the coal and the efficiency of the furnace.

APPLICATION.—In the typical illustration, the total heat loss on a zero day by formula is, say, 100000 B. t. u. per hour. This will require 90909 cubic feet of air as a heat carrier. Assuming as a maximum that 10 people will be in the house and that they will need 18000 cubic feet of fresh air per hour for ventilation, this air will carry away approximately 22900 B. t. u. per hour, making a total heat loss from the building of 122900 B. t. u. per hour. Now, if the furnace is 60 per cent. efficient and burns 5 pounds of 14000 B. t. u. coal per hour per square foot of grate, we will have

$$G. A. = \frac{122900 \times 144}{.60 \times 14000 \times 5} = 421 \text{ square inches} = 23.2 \text{ inches}$$

diameter. With coal at 13000 B. t. u. per pound, the grate would be 454 square inches or 24 inches diameter. In either case a 24 inch grate would be selected. With the assumptions as made above, the formula becomes $G. A. = .0035 H'$ for the better grade of coal, and $G. A. = .0037 H'$ for the poorer grade, from which the following approximate formula may be taken:

$$G. A. \text{ square inches} = .0036 H' \quad (28)$$

47. Heating Surface:—The amount of heating surface to be required in any furnace is rather an indefinite quantity. Manufacturers differ upon this point. Some standard may soon be looked for but at present only rough approximations can be stated. One of the chief difficulties is in determining what is, or what is not, heating surface. Some quotations no doubt include some surface in the furnace that is very inefficient. In estimating, only prime heating surface should be considered, i. e., such plates or materials having direct contact with the heated flue gases on one side and the warm air current on the other. If these plates transmit K , B. t. u. per square foot per degree difference of temperature, t_z , per hour; if, also, one square foot of grate gives to the building $E \times f \times p$ B. t. u. per hour, there will be the following ratio between the heating surface and grate surface:

$$\frac{H. S.}{G. S.} = \frac{E f p}{K t_z} \quad (29)$$

APPLICATION.—Let the value $K t_z$ be 2500, as suggested by W. G. Snow, Trans. A. S. H. & V. E., 1906, page 133, and with the same notations as in Art. 46 obtain

$$\frac{H. S.}{G. S.} = \frac{.6 \times 14000 \times 5}{2500} = 17$$

In practice this ratio varies anywhere between 12 and 30.

In the investigations being made by the Federal Furnace League their furnaces show an average of $1\frac{1}{2}$ square feet of direct heating surface and 1 square foot of indirect heating surface per pound of coal burned in the furnaces per hour, making a total of $2\frac{1}{2}$ square feet of heating surface per pound of coal burned per hour. The average size of the furnaces submitted for tests, and probably the average size of furnaces used in actual practice, have a top fire-

pot diameter of 24 inches and a bottom fire-pot diameter of 21 inches, making an average fire-pot diameter of $22\frac{1}{2}$ inches and an average cross-sectional area of 2.83 square feet. The average depth of pot in this size of furnace is about $13\frac{1}{2}$ inches, and for the purpose of rating under the Federal System would burn 7.2 pounds of coal per hour per square foot of average fire-pot cross-section, making the ratio per square foot of grate surface about $8\frac{1}{4}$ pounds of coal per hour. This gives a ratio of heating surface to grate surface of approximately 20 to 1.

48. Application of the Above Formulas to a Ten Room Residence:—In every design the calculations should be made very complete and the results tabulated for easy reference and as a means of comparison. Such a tabulation is shown in Table IX, giving all the calculated quantities necessary in the installation of the furnace system illustrated in Figs. 14, 15 and 16. The value of so condensing the work will be readily apparent. The tabulation of the values used for the various terms of the formula facilitates checking and the detection of errors. Plans should be carefully drawn to scale and accompanied by a sectional elevation. The scale should be as large as can conveniently be made. The location of the building with reference to the points of the compass should always be given, as well as the heights of ceilings and the principal dimensions of each room. There will be a wide variety of practice in making allowance for exposure, floors, ceilings, closets and small rooms not considered of sufficient importance to have independent heat. The personal element enters into this part of the work very largely. Such points as these are left to the discretion of the designer who, after having had considerable experience is able to judge each case very closely.

TABLE IX.

Formula. $H = (G + .25 W + .02 n C) 70$

	Sitting Room	Dining Room	Study	Kitchen	Reception Hall	Chamber 1	Chamber 2	Chamber 3	Chamber 4	Bath	Totals
G.....	38	28	42	28	29	42	38	28	28	14	315
.25 W.....	85	28	52	65	73	45	60	26	30	17	481
.02 n C.....	78	84	78	55	104	35	36	31	22	26	-----
n.....	2	2	2	2	3	1	1	1	1	2	-----
H.....	14000	10800	13250	11900	14000	9400	9850	6600	5600	4400	99800
Q.....	12727	9818	12045	10818	12727	8544	8954	6000	5091	4000	-----
Area of Net Heat Register	140	108	132	119	140	94	98	66	56	44	-----
Heat Register Size.....	14x16	12x14	14x16	12x14	14x16	12x12	12x12	9x12	8x10	8x10	-----
Area of Heat Stack.....	-----	-----	-----	-----	-----	61	64	43	36	28	-----
Area of Leader.....	100	77	94	85	100	67	70	47	40	31	711
Area of Net Vent Register	112	86	106	95	112	75	78	53	45	35	-----
Vent Register Size.....	12x14	10x12	12x14	12x12	12x14	10x12	10x12	8x10	8x10	8x8	-----
Area of Vent Stack.....	67	52	64	60	67	45	48	32	27	22	-----
Remarks.....	Allow for cold floor	Allow 10 per cent. for closet and exposure	Allow 10 per ct. for exposure	Allow 15 per cent. for pantry, stair and exposure	Allow for floor and hall way on second floor	Allow 10 per ct. for exposure	Allow 5 per ct. for south closet	Allow 10 per cent. for closet and exposure	Add closet to room	Allow 10 per cent. for closet and exposure	-----

Diameter of grate allowing ventilation for ten people = 24 inches. Cold air duct = 569 square inches = 18 x 32 inches.

In selecting the various stacks and leaders it would be well to standardize as much as possible and avoid the extra expense of installing so many sizes. This can be done if the net area is not sacrificed.

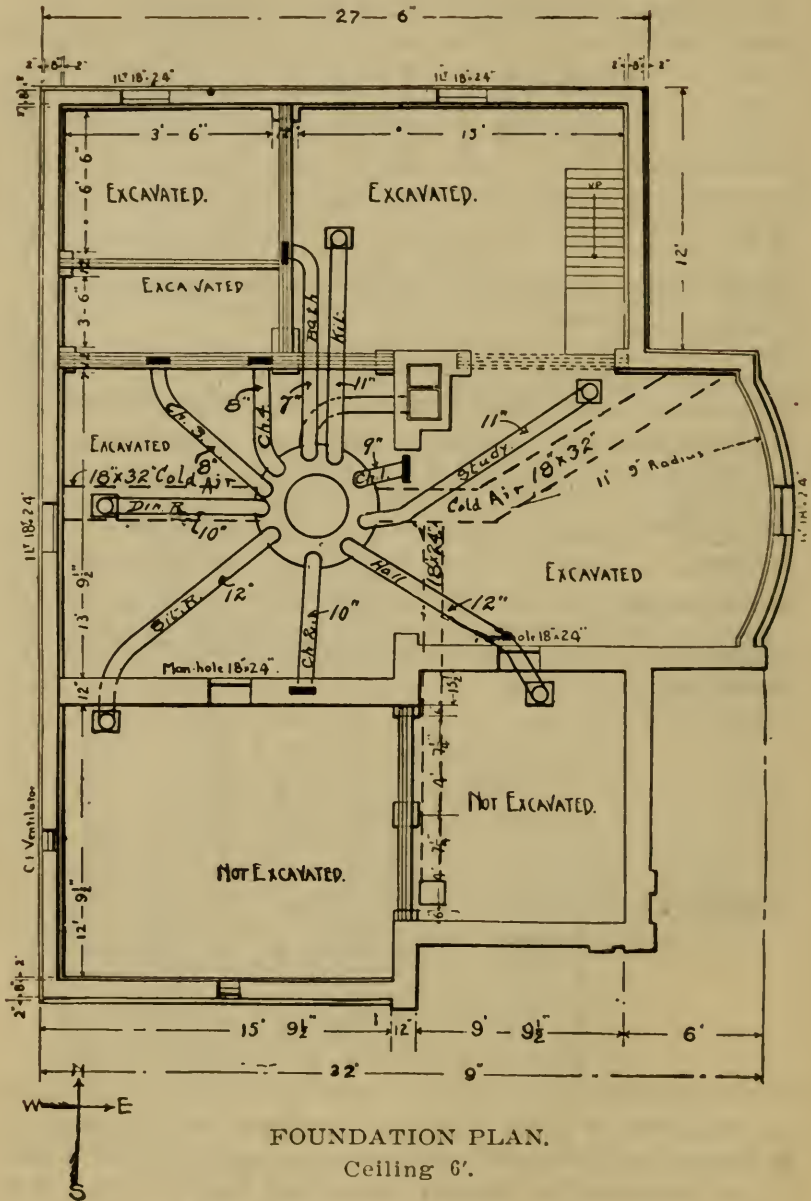

FOUNDATION PLAN.
Ceiling 6'.

Fig. 14.

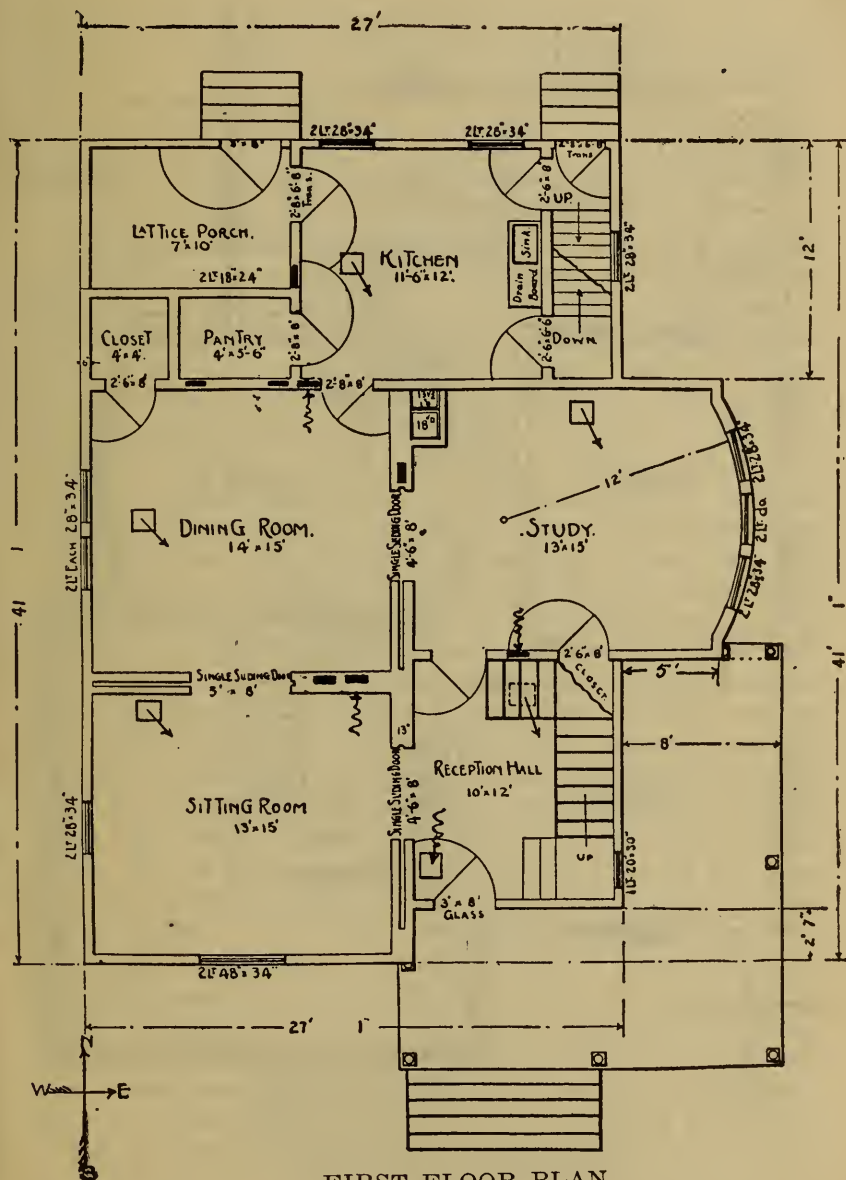

FIRST FLOOR PLAN,
Ceiling 10'.

Fig. 15

CHAPTER V.

FURNACE HEATING AND VENTILATING.

SUGGESTIONS ON THE SELECTION AND INSTALLATION OF FURNACE HEATING PARTS.

49. Selection of the Furnace:—In selecting a furnace for residence use or other heating service, special attention should be paid to the following points: easy movement of the air, arrangement and amount of heating surface, shape and size of the fire-pot, method of feeding fuel to the fire and type and size of the grate. The furnace gases and the air to be heated should not be allowed to pass through the furnace in too large a unit volume or at too high a velocity. The gases should be broken up in relatively small volumes, thus giving an opportunity for a large heating surface. Concerning the gas passages themselves, it may be said that a number of small, thin passages will be found more efficient than one large passage of equal total area. This is plainly shown in a similar case by comparing the efficiency of the water-tube or tubular boiler with that of the old fashioned flue boiler; i. e., a large heating surface is of prime importance. Again, it is desirable that the total flue area within the furnace should be great enough to allow the passage of large volumes of air at low velocities, rather than small volumes at high velocities. This permits of less forcing of the fire and consequently lowers the temperature of the heating surface. The latter point will be found valuable when it is remembered that metal at high temperatures transmits through its body a greater amount of impure gases from the coal than when at low temperatures. Concerning velocities, it may be said that on account of the low rate of transmission of heat to or from the gases, long flue passages are necessary, so that gases moving at a normal rate will have time to give off or to take up a maximum amount of heat before leaving the furnace.

Air is heated chiefly by actual contact with heated surfaces and not much by radiation. Consequently, the efficiency of a furnace is increased when it is designed so that the gases and air in their movement impinge perpen-

dicularly upon the heated surfaces at certain places. This point should not be so exaggerated that there would be serious interference with the draft. The efficiency is also increased if the general movement of the two currents be in opposite directions.

Furnaces for residences are usually of the portable type. Fig. 17, the same being enclosed in an outer shell composed of two metal casings having a dead air space or an asbestos insulation between them. Some of the larger sized

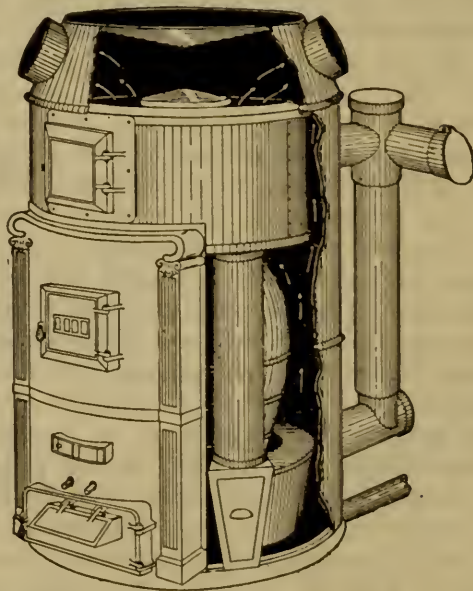

Fig. 17.

plants, however, have the furnace enclosed in a permanent casement of brick work, as in Fig. 18. Each of the two types of furnaces give good results. The points usually governing the selection between portable and permanent settings are price and available floor space.

The cylindrical fire-pot is probably better than a conical or spherical one, there being less danger of the fire clogging and becoming dirty. A lined fire-pot is better than an unlined one, because a hotter fire can be maintained in it with less detriment to the furnace. There is of course a loss of heating surface in the lined pot, and in some forms

of furnaces the fire-pot is unlined to obtain this increased heating surface. It seems reasonable to assume, however, that the lined pot is longer lived and contaminates the air supply less.

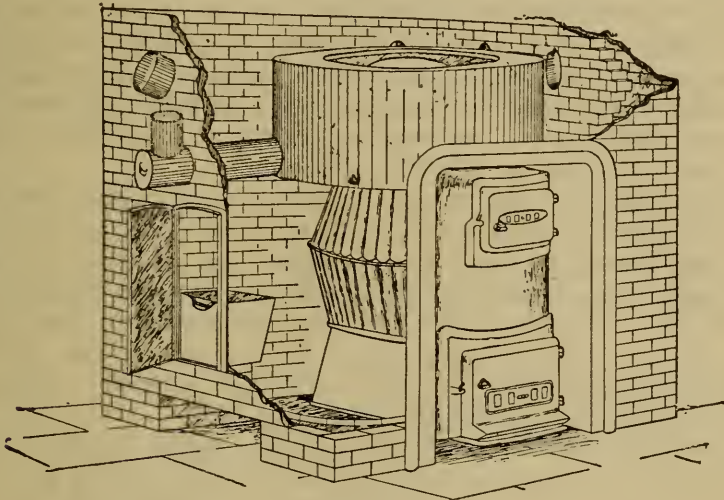

Fig. 18.

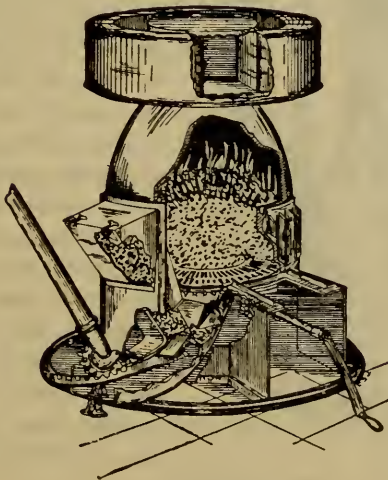

Fig. 19.

Some form of shaking or dumping grate should be selected, as a stationary grate is far from satisfactory. Care should be exercised also, in the selection of the movable grate, as some forms not only stir up the fire but permit much of it to fall through to waste when being operated.

The fuel is fed to the fire-pot from the door above the fire. This is called a *top-feed* furnace. In some forms, however, the fuel is fed up through the grate. This is called the *under-feed* furnace, Fig. 19, and is rapidly gaining in favor. The latter type requires a rotary ring grate with the fuel entering up through its center.

The *size of the furnace* may be obtained from the *estimated heating capacity* in cubic feet of room space as given in the sample Table 18, Appendix. Another and perhaps a better way, and one that serves as a good check on the above, is to select a furnace from the *calculated grate area*. See Art. 46. Having selected the furnace by the grate area, check this with the table for the estimated heating capacity and the heating surface to see if they agree.

What is known as a combination heater is shown in Fig. 20. It is used for heating part of the rooms of a resi-

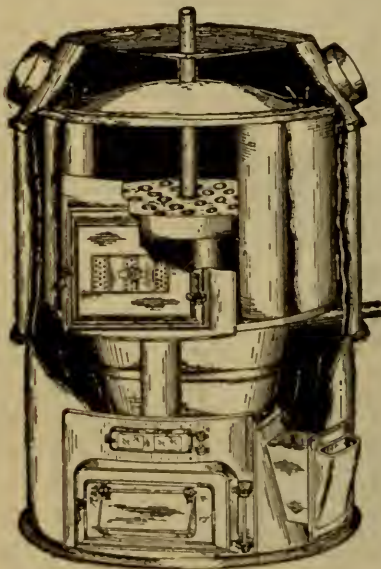

Fig. 20.

dence by warm air, as in regular furnace work, and the remainder of the rooms by hot water. In this manner, rooms to be ventilated as well as heated may be connected by the proper stacks and leaders to the warm air deliveries of such a combination heater, while rooms requiring less ventilation or heat only may have radiators installed and connected to the flow and return pipes shown in the figure. Also, because of the difficulty in heating certain exposed rooms with warm air, these rooms may be supplied by the positive heat of the

more reliable water circulation.

50. Location of Furnace:—Where other things do not interfere, a furnace should be set as near the center of the house plan as possible. Where this is not wise or possible, preference should be given to the colder sides, say the north or west. In any case, it is advisable to have the leader pipes as near the same length as can be made. The length of the smoke pipe should be as short as possible, but it will be better to have a moderately long smoke pipe and obtain a more uniform length of leader pipes than to have a short smoke pipe and leaders of widely different lengths.

The furnace should be set low enough to get a good upward slope to the leaders from the furnace to their respective stacks. This should be *not less than one inch per foot of length* and more if possible. These leader pipes should be dampered near the furnace.

The location of the furnace will call forth the best judgment of the designer, since the right or wrong decision here can make or mar the whole system more completely than in any other manner.

51. Foundation:—All furnaces should have directions from the manufacturer to govern the setting. Each type of furnace requires a special setting and the maker should best be able to supply this desired information concerning it. Such information may be safely followed. In any case the furnace should be mounted on a level brick or concrete foundation specially prepared and well finished with cement mortar on the inside, since this interior is in contact with the fresh air supply.

52. Fresh Air Duct:—This is best constructed of hard burned brick, vitrified tile or concrete, laid in four inch walls with cement mortar and plastered inside with cement plaster, all to be air tight. The top should be covered with flag stones with tight joints. The riser from this, leading to the outside of the building, may be of wood, tile or galvanized iron, and the fresh air entrance should be vertically screened. The whole should be with tight joints and so constructed as to be free from surface drainage, dirt, rats and other vermin. This duct may be made of metal or boards as substitutes for the brick, tile or concrete. Board construction is not so satisfactory, although it is the cheapest, and whenever used should be carefully constructed.

In addition to the opening for the admission of the fresh air duct, another opening may be made under the furnace for the purpose of admitting the duct which carries the recirculated air from the rooms to the furnace. Both of these ducts should have dampers that may be opened or

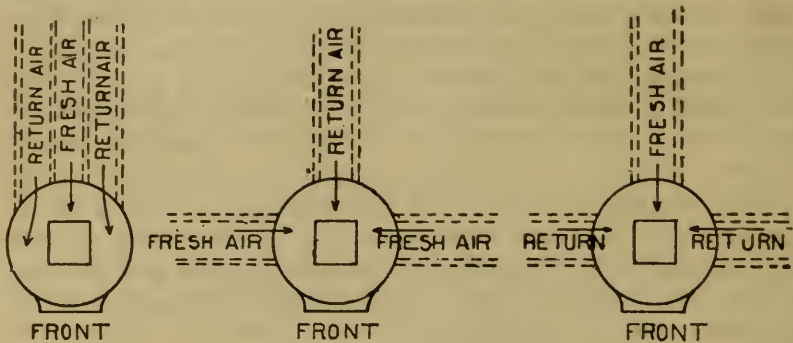

Fig. 21.

closed. See Figs. 13 and 21. Both ducts should also be provided with doors that can be opened temporarily to the cellar air. Sometimes it is desirable to have two or more fresh air ducts leading from the different sides of the house to the furnace so as to get the benefit of any change in air pressure on the outside of the building.

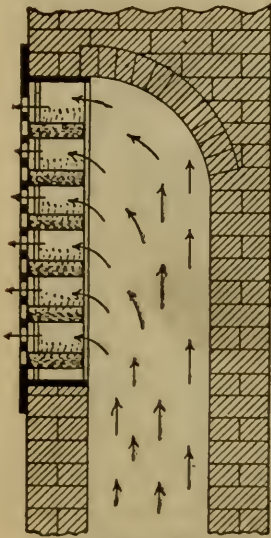

Fig. 22.

Proper arrangements may be made for pans of clear water in the air duct near the furnace to give moisture to the air current, although only a small amount of moisture will be taken up at this point. In most cases where moistening pans are used, they are installed in connection with the furnace itself. A good way to moisten the air is to have moistening pans built in just behind the register face, Fig. 22. These pans are shallow and should not be permitted to seriously interfere with the amount of air entering through the register.

53. Recirculating Duct:—A duct should be provided from some point within the building, through the cellar and entering into the bottom of the furnace. This is to car-

ry the warm air from the room back to the furnace to be reheated for use again within the building. In many cases tin or galvanized iron is used for the material for the recirculating pipe. Where this enters the furnace it should be planned with sufficient turn so that the air would be projected through the furnace, thus placing a hindrance to the fresh cold air from following back through this pipe to the rooms. The exact location of the same will depend, of course, on the location of the register installed for this purpose. The construction of the duct may agree with the similar construction of the fresh air duct.

54. Leader Pipes:—All leader pipes should be round and free from unnecessary turns. They should be made

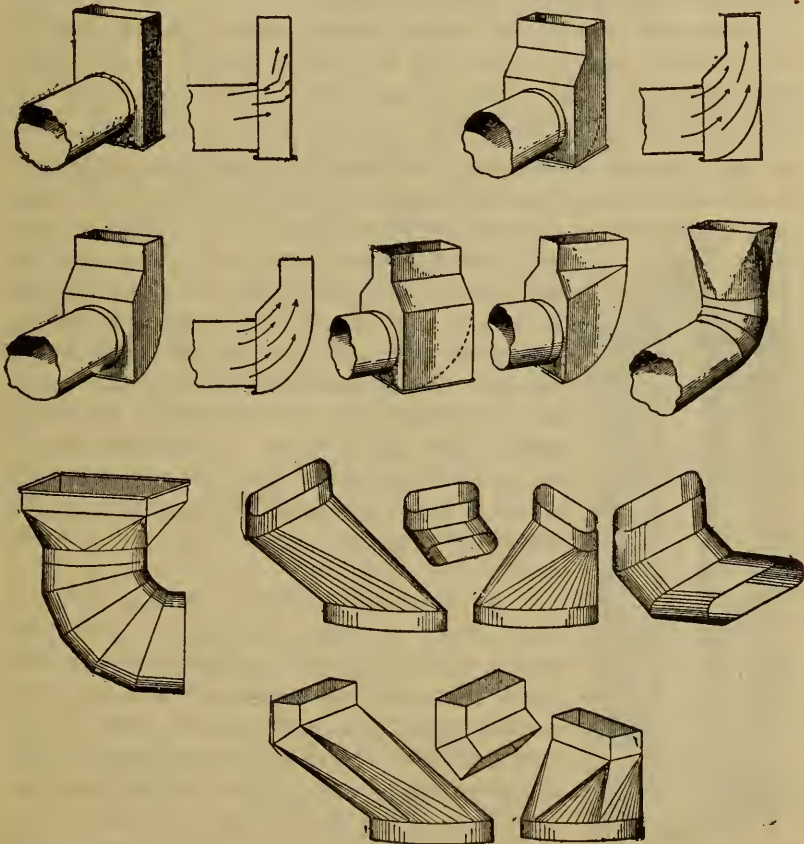

Fig. 23.

from heavy galvanized iron or tin and should be laid to an upward pitch of not less than one inch per foot of length, and more if it can possibly be given. The connections with the furnace should be straight, but if a turn is necessary, provide long radius elbows. All connections to risers or stacks should be made through long radius elbows. Rectangular shaped *boots* having attached collars are sometimes used, but these are not so satisfactory because of the impingement of the air against the flat side of the stack; also because of the danger of the leader entering too far into the stack and thus shutting off the draft. Leaders should connect to the first floor registers by long radius elbows. Leader pipes should have as few joints as possible and these should be made firm and air tight. Fig. 23 shows different methods of connecting between leaders and stacks, also between leaders and registers.

The outside of all leader pipes should be covered to avoid heat loss and to provide additional safety to the plant. The covering is usually one or more thicknesses of asbestos paper or mineral wool.

55. Stacks or Risers:—The vertical air pipes leading to the registers are called stacks or risers. They are rectangular or oblong in section and are usually fitted within the wall. See Fig. 24.

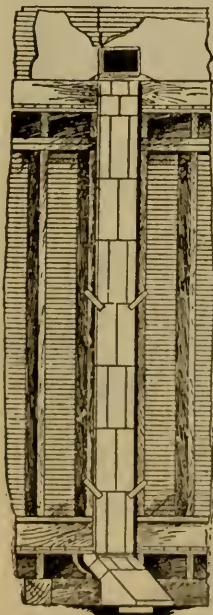

Fig. 24.

The size of the studding and the distances they are set, center to center, limit the effective area of the stack. All stacks should be insulated to protect the woodwork. This is done by making the stack small enough to clear the woodwork by at least one-quarter inch and then wrapping it with some non-conducting material such as asbestos paper held in place by wire.

Another way, and one which is probably more satisfactory, is to have patented double walled stacks having an air space between the walls all around. The outside wall is usually provided with vent holes which allow the circulation of air between the walls, thus protecting any one part from becoming overheated. All stacks should be made with tight joints.

and should have ears or flaps for fastening to the studding. Patented sacks are made in standard sizes and of various lengths. The sizes ordinarily found in practice are about as given in Table 19, Appendix.

A stack is sometimes run up in a corner or in some recess in the wall of a room where its appearance, after being finished in color to compare with that of the room, would not be unsightly. This is necessary in any case where the stack is installed after the building is finished. This method is desired by some because of its additional safety and because more stack area may be obtained than is possible when placed within a thin wall.

All stacks should be located in partition walls looking toward the outside or cold side of the room. This protects the air current from excessive loss of heat, as would be the case in the outside walls. It also provides a more uniform distribution of air.

The area of the stack best adapted to any given room is another point in furnace work which brings out a wide diversity of practice. Results from different installations show variations as great as 50 per cent. This is not so noticeable in the first floor rooms as it is in those of the second floor. In a great many cases the architect specifies light partition walls between large upper rooms, say, four inch studding set sixteen inch centers, between twelve foot by fifteen foot rooms, heavily exposed. From theoretical calculation of heat losses, these rooms require larger stacks than can be placed between studding as stated; however, it is very common to find such rooms provided for in this way. One possible excuse for it may be the fact that the room is designed for a chamber and not for a living room. Any sacrifice in heating capacity in any room, even though it be used as a sleeping room only, should be done at the suggestion of the purchaser and not at the suggestion of the architect or engineer. Every room should be provided with facilities for heat as though it were to be used as a living room in the coldest weather, then there would be fewer complaints of defective heating plants and less migrating from one side of the house to the other on cold days.

This lack of heating capacity for any room is sometimes overcome by providing two stacks and registers in-

stead of one. This plan is very satisfactory because one of the registers may be shut off in moderate weather; however, it requires an additional expense which is scarcely justified. A possible improvement would be for the architect to anticipate such conditions and provide suitable partition walls so that ample stack area could be put in. The ideal conditions will be reached when the architect actually provides air shafts of sufficient size to accommodate either a round or a nearly square stack. When this time comes a great many of the furnace heating difficulties will have been solved.

A double stack supplying air to two rooms is sometimes used, having a partition separating the air currents near the upper end. This practice is questionable because of the liability of the pressure of air in the room on the cold side of the house forcing the heated air to the other room. A better method is to have a stack for each room to be heated.

56. Vent Stacks:—Vent stacks should be placed on the inner or partition walls and should lead to the attic. They may there be gathered together in one duct leading to a vent through the roof if desired.

57. Air Circulation Within the Room:—The location of the heat register, relative to the vent register, will deter-

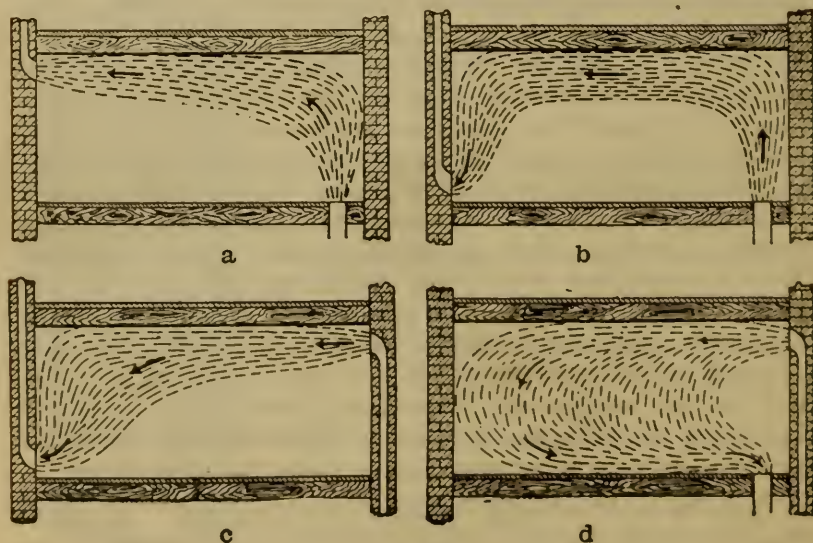

Fig. 25.

mine to a large degree the circulation of the air within the room. Fig. 25, a, b, c and d, shows clearly the effect of the different locations. The best plan, from the standpoint of heating, is to enter the air at a point above the heads of the occupants and withdraw it from the floor line, at or near the same side from which the air enters. This gives a more uniform distribution as shown by the last figure. It is doubtful, however, if this method will give the best ventilation in crowded rooms where the foul air naturally collects at the top of the room. Furnace heating is not so well cared for in this regard as are the other forms of indirect heating, the air being admitted at the floor line and required to find its own way out.

58. Fan-Furnace Heating System:—In large furnace installations where the air is carried in long ducts that are nearly, if not quite, horizontal, and where a continuous supply of air is a necessity in all parts of the building, a combination fan and furnace system may be installed. These are frequently found in hospitals, schools and churches. Such a system may be properly designated a mechanical warm air system. In comparison with other mechanical systems, however, it is simpler and cheaper. The arrangement may be illustrated by Fig. 96 with the tempering coils omitted and the furnace substituted for the heating coils. The fan should always be between the air inlet and the furnace so as to keep a slight pressure above atmosphere on the air side and thus reduce the leakage of the fuel gas through the joints of the furnace. By this arrangement there is less volume of air to be handled by the fan and a smaller sized fan may be used.

Fan-furnace systems may be set in multiple if desired, i. e., one fan operating in connection with two or more furnaces.

Fig. 26 represents a two-furnace plant showing the fan and the two furnaces. The air is drawn into the fresh air room through a grate in the outside wall and is forced through the fan to the furnaces where it divides and passes up through each furnace to the warm air ducts. Part of the fresh air from the fan is by-passed over the top of the furnaces and is admitted to the warm air ducts through mixing dampers. These dampers control the amount of hot and cold air for any desired temperature of the mix-

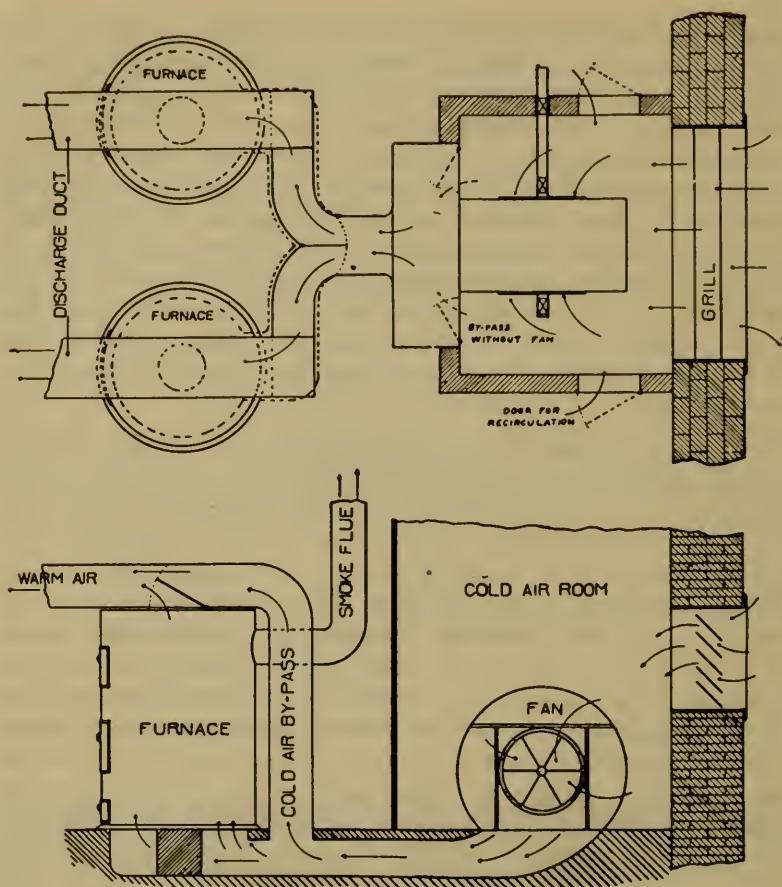

Fig. 26.

ture. Temperature control may be applied, also air washing and humidifying apparatus can be installed and operated with satisfaction. Paddle wheel fans are preferred, although the disk wheel may be used where the pipes are large and where the air must be carried but short distances. For fan types see Chapter X.

59. Suggestions for Operating Furnaces:—Furnaces are designated *hard coal* and *soft coal*, depending upon the type and the construction of the grate, hence the grade of coal best adapted to the furnace should be used. The size of the openings in the grate should determine the size of the coal used.

Keep the fire-pot well filled with coal and have it evenly distributed over the grate.

Keep the fire clean. Clinkers should be removed from the fire once or twice daily. It is not necessary to stir the fire so completely as to waste the coal through the grate.

When replenishing a poor fire do not shake the fire, but put some coal on and open the drafts. After the coal is well ignited clear the fire.

The ash pit should be frequently cleaned, because an accumulation of ashes below the grate soon warps the grate and burns it out.

Keep all the dampers set and properly working.

Have a damper in the smoke pipe and keep it open only so far as is necessary to create a draft.

Keep the water pans full of water.

Clean the furnace and smoke pipe thoroughly in all parts at least once each year.

Keep the fresh air duct free from rubbish and impurities.

Allow plenty of pure fresh air to enter the furnace. In cold weather part of this supply may be cut off.

Have the basement well ventilated by means of outside wall ventilators, or by special ducts leading to the attic. Never permit the basement air to be circulated to the living rooms.

To bank the fires for the night, clean the fire, push the coals near the rear of the grate, cover with fresh fuel to the necessary depth (this will be found by experience), set the drafts so they are nearly closed and open the fire doors slightly.

60. Determination of the Best Outside Temperature to Use in Design and the Costs Involved in Heating by Furnaces:—As a basis for the work of the heating and ventilating engineer it is necessary that he be well acquainted with the temperature conditions in the locality where his services are employed. He should compile a chart showing extreme and average temperatures covering a period of years and with this chart a fairly safe estimate may be made upon the costs involved in operating any heating and ventilating system during any part of the average season or throughout the entire heating season. Any costs of operation arrived at are only illustrative of method and probability, however. All one can say is that if the temperature in any one season averages what is shown by the average curve for the period of years investigated, then the cost in operating the system may be easily shown by

calculation. Costs in heating are relative figures only and cannot be predetermined exactly except under test conditions. The heating engineer should also know the minimum outside temperatures covering a period of years in that locality so as to determine upon an outside temperature for his design work. Any design is somewhat of a compromise between average conditions and the minimum or extreme conditions, approaching the extreme rather than the average. Patrons are willing that the heating systems be designed so as to give normal temperatures in the rooms on all but a few of the coldest days. These minimum conditions usually have a duration of from two to three days and it would not be considered good engineering from an economic standpoint to design the system large enough to heat to normal inside temperature on the coldest day experienced in a period of years. The plant would be too large and would require too much financial in-put. As an illustration of the method of obtaining the outside temperature to be used in design, also methods of determining approximate costs for heating, see Fig. 27. This has been worked up as an average for the temperatures of each of the days respectively between September fifteenth and May fifteenth, covering a period of thirty years, at Lincoln, Nebraska. The minimum temperature curve includes the outside temperatures for December 1911, and January 1912, which may be regarded as a period of unusual severity. Referring to the chart it will be seen that a cold period of one month was experienced from December nineteenth to January twenty-first, reaching its minimum temperature of -26° on January twelfth. If this curve were assumed to be the most severe weather that would be found in this locality, then by a study of conditions one may easily determine a good value for outside temperature in design. There were twenty days when the temperature was below zero, twelve days below -5° , six days below -10° , four days below -15° , two days below -20° , and a part of one day below -25° . Each of the extreme and sudden drops were such as to last from two to three days and were only experienced in two or three instances. It is very evident that a system designed for 0° outside would fall far short of the requirement even when put under heavy stress. On the other hand one designed for -25° outside would actually come up to its capacity for only a part of one day out

of the 240 heating days. One designed for -10° would fulfill conditions without forcing excepting at two or three periods of very short duration, at which times the system could be forced sufficiently without detriment. The per-

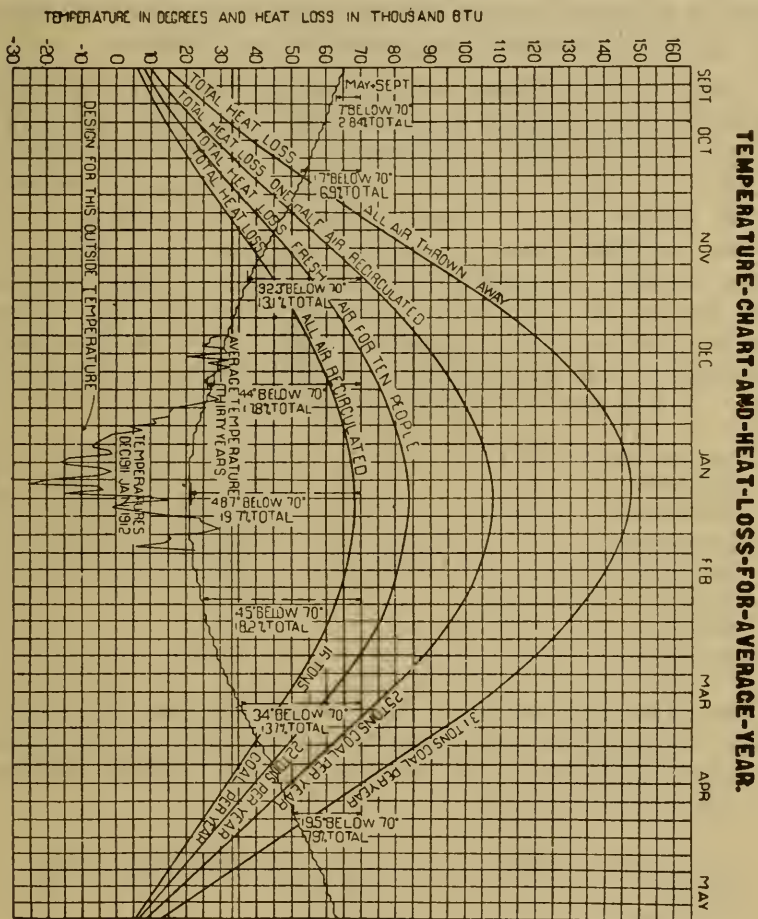

Fig. 27.

sonal equation enters into the calculation of the heat loss somewhat and there will be some difference of opinion concerning which to use, -10° or -15° . Probably the latter would be a safer value. All that is necessary is to plan

for ample service at all but one or two of the cold periods of short duration and the system will be considered very satisfactory from the standpoint of size and capacity. Any additional amount put in would be an investment of money, which is scarcely justified for the small percentage of time that this additional capacity would be called for.

After the minimum outside temperature has been decided and the plant is designed, one would like to know the probable expense in handling such a plant throughout the heating season. Assume an inside temperature *throughout the building* of 70°. Combine the two half months, September and May, into one month, and take the average of these average temperatures for the days of each month, thus giving the drop in temperature between the inside and the outside of the building. The heat loss from the building is then proportional to these drops in temperature. In this case the differences are as follows:

September + May	7°	below 70°
October	17°	" "
November	32.3°	" "
December	44°	" "
January	48.7°	" "
February	45°	" "
March	34°	" "
April	19.5°	" "

Taking the sum of all these differences as the total, 100%, and dividing each individual difference by the total, we have the percentages of loss for the various months as follows:

September + May.....	2.84%	of total yearly loss
October	6.9 %	" " " "
November	13.1 %	" " " "
December	17.8 %	" " " "
January	19.7 %	" " " "
February	18.2 %	" " " "
March	13.7 %	" " " "
April	7.9 %	" " " "

These percentages of loss indicate what may be expected in the expense for coal at various times of the heating year, based upon the average temperatures existing in the past thirty years. From this the heat loss has been

calculated for the sample design stated under Furnace Heating. The results are shown upon the chart in tons of coal per year, assuming that the entire house is heated to 70° upon the inside for each hour between September fifteenth and May fifteenth. The lowest curve is that for direct radiation only. The next superimposed curve assumes fresh air for ten people. The third curve assumes one-half of the required air to be recirculated and the upper curve assumes all the air to be fresh air.

REFERENCES.

References on Furnace Heating.

TECHNICAL BOOKS.

Snow, *Prin. of Heat.*, p. 27. Snow, *Furnace Heat.*, p. 7. I. C. S. *Prin. of Heat. & Vent.*, p. 1237. Carpenter, *Heat. & Vent. Bldgs.*, p. 310. Hubbard, *Power, Heat. & Vent.*, p. 423.

TECHNICAL PERIODICALS.

Engineering Review. Warm Air Furnace Heating, C. L. Hubbard, Nov. 1909, p. 42; Dec. 1909, p. 45; Jan. 1910, p. 66; Feb. 1910, p. 48; March 1910, p. 51; May 1910, p. 48; Aug. 1910, p. 29. Warm Air System of Heating and Ventilating, R. H. Bradley, May 1910, p. 32. Mechanical Furnace Heating and Ventilating, June 1910, p. 49. Heating and Vent. System Installed in Public School, Fairview, N. J., July 1910, p. 47. Combined System of Warm Air and Hot Water Heat. for a Residence, Jan. 1909, p. 26. Warm Air Heating Installation in a Brooklyn Residence, March 1909, p. 38. *The Heating and Ventilating Magazine.* Advanced Methods of Warm Air Heating, A. O. Jones, Aug. 1904, p. 88. Air Pipes, Sizes Required for Low Velocities, Oct. 1905, p. 7. Report of Committee (A. S. H. V. E.) to Collect Data on Furnace Heating, Jan. 1906, p. 35. An Improved Application of Hot Air Heating, A. O. Jones, July 1906, p. 31. The Official Federal Furnace League Method of Testing Furnaces, W. F. Colbert, July 1910. *Domestic Engineering.* Sanitation in Hot Air Heating, James C. Bayles, Vol. 25, No. 6, Sept. 25, 1903, p. 261. *Trans. A. S. H. & V. E.* Test of Hot Air Gravity System, R. C. Carpenter, Vol. IX, p. 111. Heat Radiators Using Air Instead of Water and Steam, Geo. Aylsworth, Vol. IX, p. 259. Velocities in Pipes and Registers in a Warm Air System, Vol. XII, p. 352. Relative Size Hot Air Pipes, Vol. XIII, p. 270. Velocity of Air in Ducts, Vol. VII, p. 162. *The Metal Worker.* Battery of Furnaces with Vent Ducts, Jan. 15, 1910, p. 85. Air Blast System, Jan. 15, 1910, p. 93. Origin and Comparative Cost of Trunk Main Furnace System, Aug. 6, 1910, p. 171. Example of Trunk Line Furnace Piping, April 2, 1910, p. 463. Furnace System with Piping 50 ft. Long, July 3, 1909, p. 45. Heat Unit in Furnace Heating, Aug. 8, 1908, p. 43. Data on a Notable School Heating Plant, Nov. 6, 1909, p. 37. Fan-Furnace Residence System, Oct. 3, 1908, p. 43. Theoretical Construction in Designing Furnace Heating, Dec. 26, 1908, p. 33. School Fan Furnace Heating Plant, Oct. 8, 1910. Combination Heating in Cold Territory, Sept. 29, 1911. Underwriters' Tests of Wall Stacks, July 1, 1911. Design of Fan Blast Heating, H. C. Russell, Jan. 21, 1911; Feb. 25, 1911.

CHAPTER VI.

HOT WATER AND STEAM HEATING.

DESCRIPTION AND CLASSIFICATION OF THE SYSTEMS.

61. Hot Water and Steam Systems Compared to Furnace Systems:—As compared to the warm air or furnace plant, the hot water and the steam installations are more complicated in the number of parts; they use a more cumbersome heat carrying medium, for which a return path to the boiler must be provided; and have parts, in the form of radiators, which occupy valuable room space. But the steam and hot water plants have the advantage in that their circulations, and hence their transference of heat, are quite positive, and not affected by wind pressures. A hot water or a steam system will carry heat just as readily to the windward side of a house as it will to the leeward side, a point which, with a furnace installation, is known to be quite impossible. Furnace heating, on the other hand, has the advantage of inherent ventilation, while the hot water and steam systems, as usually installed, provide no ventilation except that due to air leakage.

62. The Parts of Hot Water and Steam Systems:—A hot water or a steam system may be said to consist of three principal parts: first, the boiler or heat generator; second, the radiators or heat distributors; and third, the connecting pipe-lines, which provide the circuit paths for the hot water or the steam. In the hot water system it is essential that the heat generator be located at the lowest point in the circuit, for, as was explained in Art. 5, the only motive force is that due to the convection of the water. In the steam system this is not essential, as the pressure of the steam forces it outward to the farthest points of the system. The water of condensation may or may not be returned by gravity to the boiler. Hence, with a steam system a radiator may be placed below the boiler, if its condensation be trapped or otherwise taken care of.

63. Definitions:—In speaking of the piping of heating installations, several terms, commonly used by heating engineers, should be thoroughly understood. The large pipes in the basement connected directly to the source of heat, and serving as feeders or distributors of the heating medium to the pipes running vertically in the building, are known as *mains*. The flow mains are those carrying steam

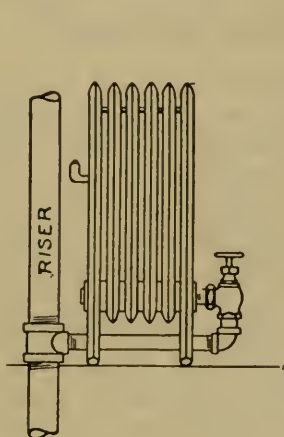

Fig. 28.

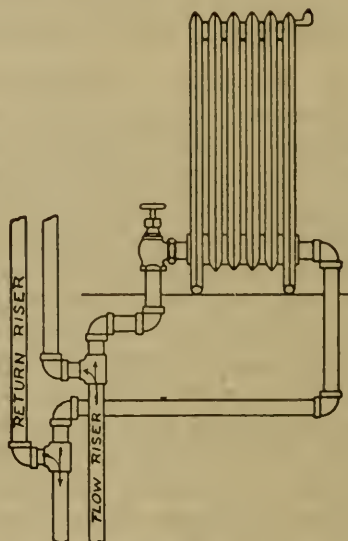

Fig. 29.

or hot water from the source of heat towards the radiators, and the return mains are those carrying water or condensation from the radiators to the source of heat. Those vertical pipes in a building to which the radiators are directly connected are called *risers*, while the short horizontal pipes from risers to radiators are usually termed *riser arms*. As there are flow mains and return mains, so also, there are flow risers and return risers. A radiator should have at least two tappings, one below for the entry of the heating medium, and one on the end section opposite, near the top for air discharge as shown by the connected steam radiator of Fig. 28. It may have three, a flow tapping and a return tapping at the bottom of the two end sections, and the third or air tapping near the top of the end section at the return end as shown by the connected hot water radiator of Fig. 29. A return

main traversing the basement above the water line of the boiler is designated as a *dry return* and carries both steam and water of condensation; one in such position below the water line as to be filled with water is designated a *wet return*, and the returns of all two-pipe radiators connecting with wet returns are said to be *sealed*.

64. Classification:—One classification of hot water and steam systems is based upon the position and manner in which the radiators are used. The system which is, perhaps, most familiar is the one wherein radiators are placed directly within the space to be heated. This heating is ac-

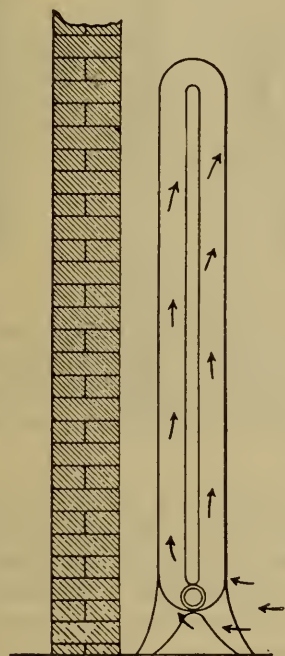

Fig. 30.

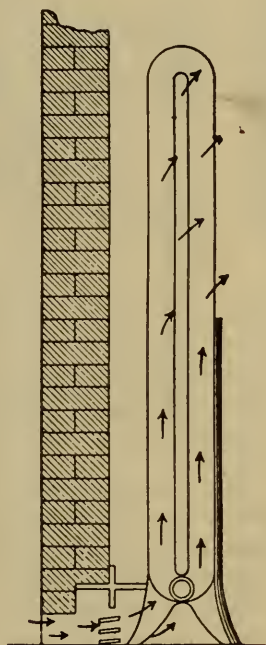

Fig. 31.

complished by *direct radiation* and by air convection currents through the radiators, no provision being made for a change of air in the room. This is known as the *direct system*, and, while it causes movements of the air in the room, it produces no real ventilation. See Fig. 30.

In the *direct-indirect* system, the radiator is also placed within the space or room to be heated, but its lower half is so encased and connected to the outside of the build-

ing that fresh air is continually drawn up through the radiator, is heated, and thrown out into the room as shown by Fig. 31. Thus is established a ventilating system more or less effective.

In the purely *indirect system*, Fig. 32, the radiating surface is erected somewhere remote from the rooms to be heated, and ducts carry the heated air from the radiator to the rooms either by natural convection, as in some installations, or by fan or blower pressure, as in others. When all the radiation for an entire building is installed

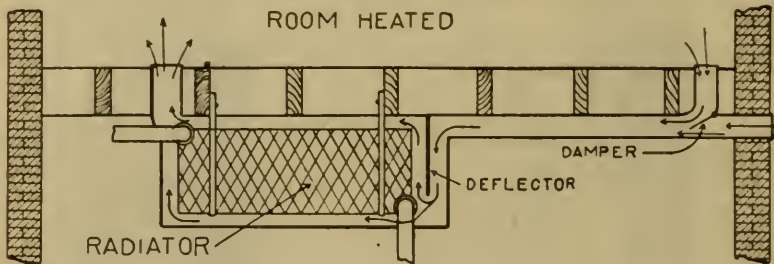

Fig. 32.

together in one basement room, and each room of the building has carried to it, its share of heat by forced air through ducts from one large centralized fan or blower, the system is called a *Plenum System*, and is given special consideration in Chapters X to XII.

65. A second classification of steam and hot water systems is made according to the method of pipe connection between the heat generator and the radiation. That known as the *one-pipe system*, Fig. 33, is the simplest in construction and is preferred by many for the steam installations. As the name indicates, its distinguishing feature is the single pipe leading from the source of heat to the radiator, the steam and the returning condensation both using this path. In the risers and connections, the steam and condensation flow in opposite directions, thus requiring larger pipes than where a flow and a return are both provided. In this system the condensation usually flows with the steam in the main, and not against it, until it reaches such a point that it may be dripped to a separate return and then led to the boiler. In the so-called *one-pipe hot water system*, radiators have two tappings and two

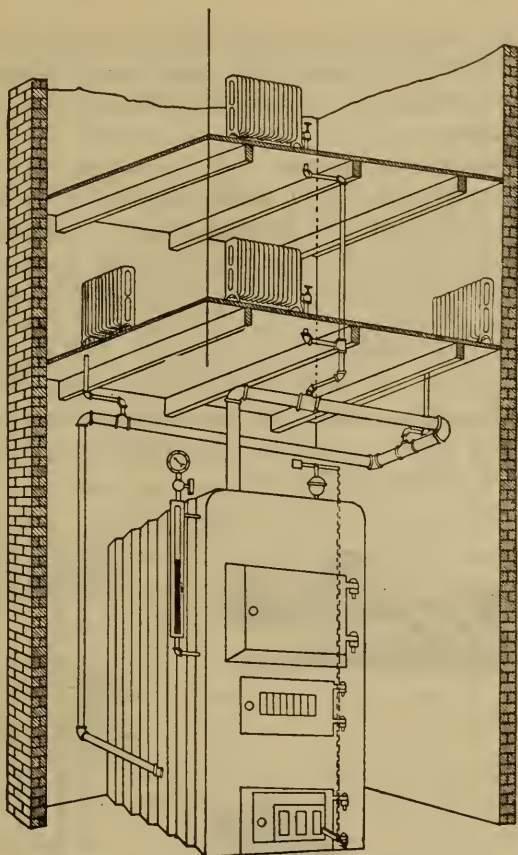

Fig. 33.

risers, but the flow riser is tapped out of the top of the single basement main, while the return riser is tapped into the bottom of that same main by either of the special fittings shown in section in Fig. 34. The theory is that the hot water from the boiler travels along the top of the horizontal basement main, while the cooler water from the radiators travels along the bottom of this same main. Hence the necessity for tapping flow risers out of the top and return risers into the bottom of this main, thus avoiding a mixing of the two streams. Where mains are short and straight as in the smaller residence installations, this system

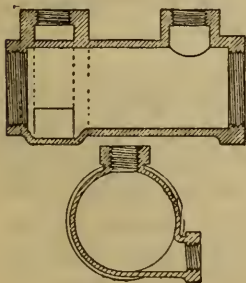

Fig. 34.

seems to give satisfaction; but it is very evident that, where basement mains are long and more complicated, a mixing of the two streams is unavoidable, thus rendering the system unreliable.

The *two-pipe system* is used on both steam and hot water installations. For steam work it is probably no better than the one-pipe system but for hot water work it is much preferred. In this system two separate and distinct paths may be traced from any radiator to the source of heat. In the basement are two mains, the flow and the return, and the risers from these are always run in pairs, the flow riser on one side of a tier of radiators, the return riser on the other side. A two-pipe steam system must have a *sealed return*. Typical two-pipe main and riser connections are shown in Fig. 35.

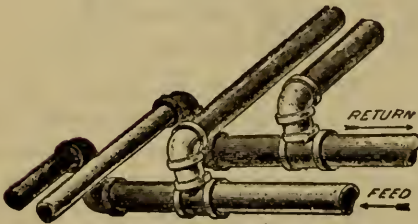
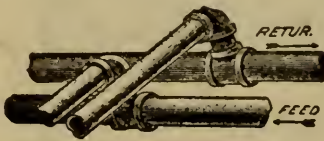

Fig. 35.

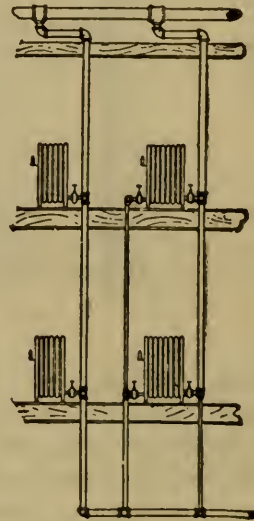

Fig. 36.

66. A third system, known as the attic main, or *Mills system*, has found much favor with heating engineers in the installation of the larger steam plants although it could be applied as well to the larger hot water plants. The distinguishing feature, when applied to a steam system, is the double main and single riser, so arranged that the condensation and live steam flow in the same direction.

This is accomplished by taking the live steam directly to the attic by one large main, which there branches, as need be, to supply the various risers, only one riser being used for each tier of radiators and the direction of flow of both steam and condensation in risers being downward. Hence, this system avoids the unsightliness of duplicate risers, as in the two-pipe system, and avoids the disadvantage of the one-pipe basement system, the last named having steam and condensation flowing in opposite directions in the same pipe. Fig. 36 shows two common methods of connecting risers and radiators with this system.

67. Diagrams for Steam and Hot Water Piping Systems:

—Figs. 37 to 43 inclusive show some of the methods for connecting up piping systems between the source of heat and the radiators. At the radiators A, B, C and D are shown different methods of connecting between the radiators and mains. In every case the various forms of branches below the floor and behind the radiators are for the purpose of taking up the expansion. It will be noticed that the two-pipe steam systems have sealed returns where they enter the main return above the water line of the boiler.

In some steam systems where atmospheric pressure is maintained, special valves with graduated control admit steam to the upper part of the radiator. The returns enter into a receiver near the boiler with a vapor and air relief to the atmosphere through some form of condenser, having an outlet pipe leading to an air shaft or to a chimney. The pressure upon this return is maintained in such a case approximately 14.7 pounds. The water type of radiator is used, having the sections connected both top and bottom and with this graduated control only that amount of radiation which is necessary to heat the room on a given day is employed. Such a system is economical, safe and can be operated in connection with any kind of radiation. Fig. 43 is typical of such systems.

ONE PIPE STEAM SYSTEM-BASEMENT MAIN

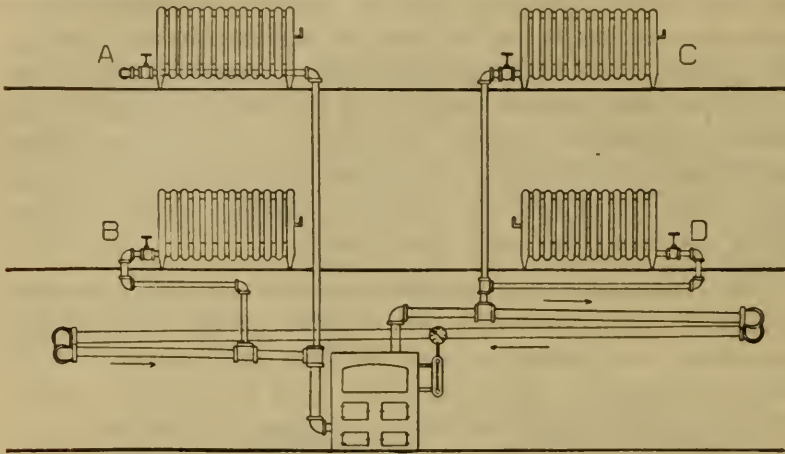

Fig. 37.

TWO PIPE STEAM SYSTEM-BASEMENT MAIN

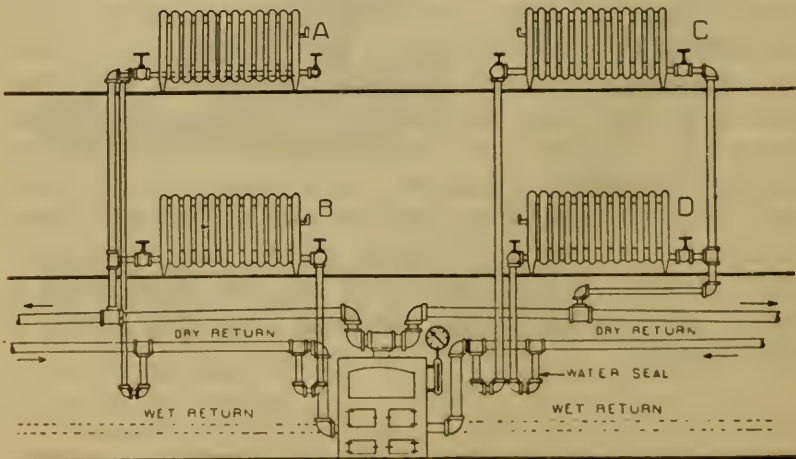

Fig. 38.

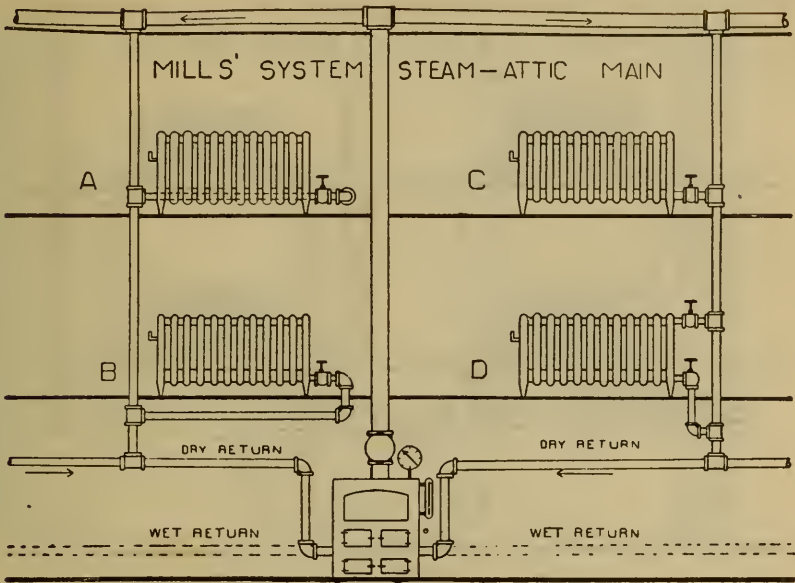

Fig. 39.

ONE PIPE SYSTEM-HOT WATER

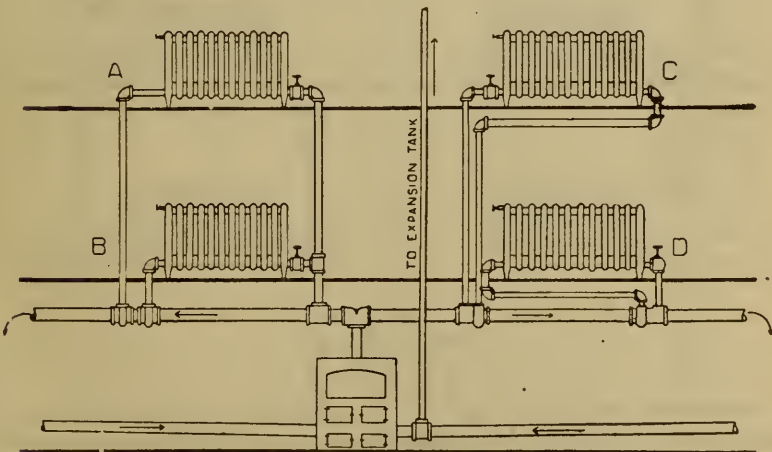

Fig. 40.

TWO PIPE SYSTEM HOT WATER—BASEMENT MAIN

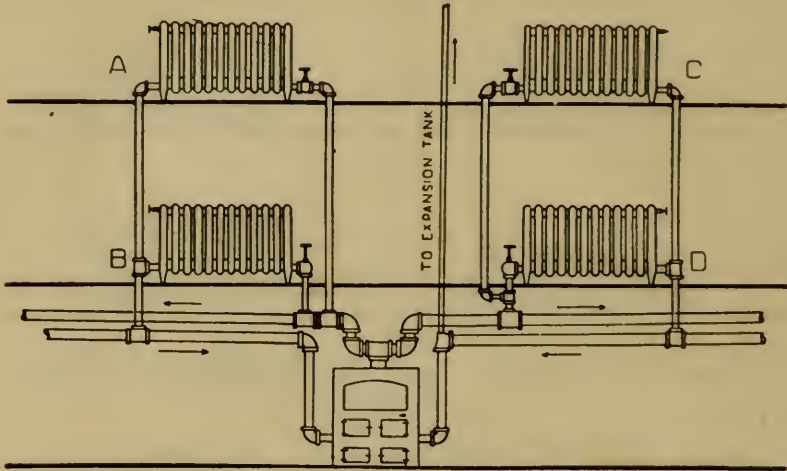

Fig. 41.

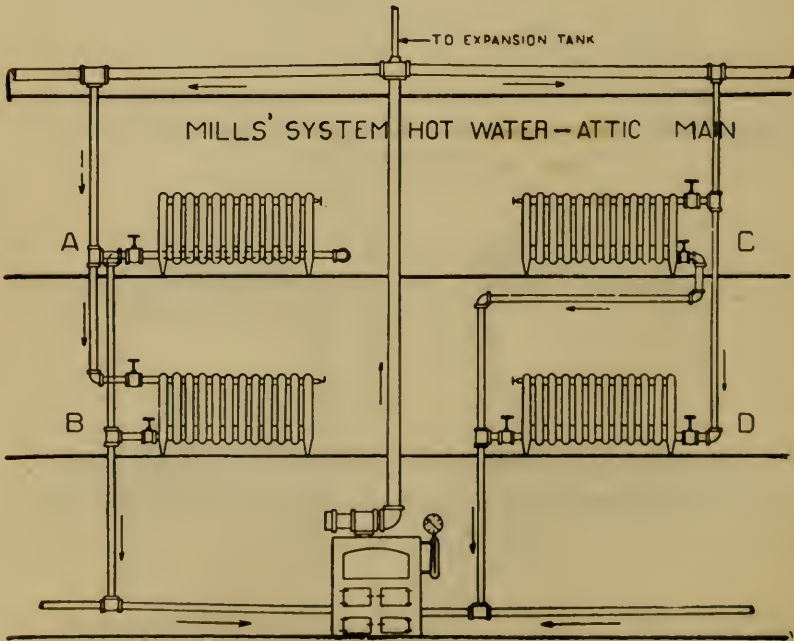

Fig. 42.

VAPOR SYSTEM OF STEAM HEATING

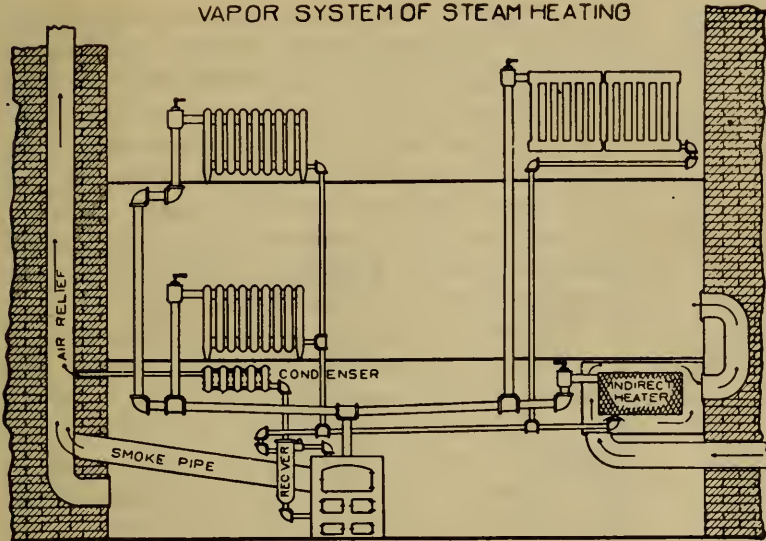

Fig. 43.

68. Accelerated Hot Water Heating Systems:—Improvements have been devised for hot water heating whereby the circulation of the water is increased above that obtained by the open tank system. By increasing the velocity of the water, pipe sizes may be reduced, resulting in an economy in the cost of pipe and fittings. In addition to this, where the temperature of the water is carried above that due to atmospheric pressure, the radiation may theoretically be reduced below that for the open tank system. How far these economies may be pursued in designing is a question which should be very carefully considered. In many cases the amount of radiation is kept the same and the chief difference merely that of pipe sizes. This article is descriptive of several of the types of accelerated systems in use and is not intended as a critical analysis of the merits of any one as compared to the others.

Of all the principles employed for accelerating the circulating water, four will be mentioned. First, by increasing the pressure of the open tank system thus raising the temperature above 212 degrees. Second, by superheating a part or all of the circulating water as it passes through the heater and condensing the steam thus formed by mixing it

with a portion of the cold circulating water of the return. Third, by introducing steam or air into the main riser pipe near the top of the system. Fourth, by mechanically operated pumps or motors.

Descriptive of the first principle, Fig. 44 shows a mercury-seal tube connected between the upper point of the

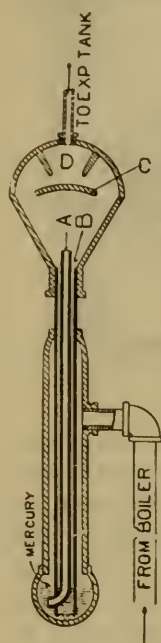

Fig. 44

main riser and the expansion tank. This is designed to hold a pressure of about 10 pounds gage, the water from the system filling the casing and pressing down upon the top of the mercury in the bowl. Increasing the pressure in the system lowers the level of the mercury in the bowl and forces the mercury up the central tube *A* until the differential pressure is neutralized by the static head of the mercury. If the pressure becomes great enough to drop the level of the mercury to the tube entrance, water and steam will force through the mercury to chamber *D* and from thence through the expansion tank to the overflow. Any mercury forced out of the tube *A* by the velocity of the water and steam, strikes the deflecting plate *C* and drops back through the annular opening *B* to the mercury bulb below. As the pressure is reduced in the system the mercury drops in tube *A* to the level of that in the bulb and water from the expansion tank passes down through the

mercury-seal into the heating system to replace any that has been forced out to the expansion tank. This action is automatic and is controlled entirely by the pressure within the system. The only loss, if any, is that amount which goes out the overflow. The above represents essentially what is known as the Honeywell System of acceleration. A modification of the above is used in the Cripps System. In this the mercury-seal is placed beyond the expansion tank and puts the expansion tank under pressure.

The second principle is illustrated by Figs. 45 and 46. Fig. 45, known as the Koerting System, has a series of motor pipes leading from the upper part of the heater to a mixer, where the steam is condensed before it reaches the

expansion tank by the water entering through the by-pass from the return. The velocity of the steam and water through the motor pipes and the partial vacuum caused by the condensation in the mixer produces the acceleration up the flow pipe.

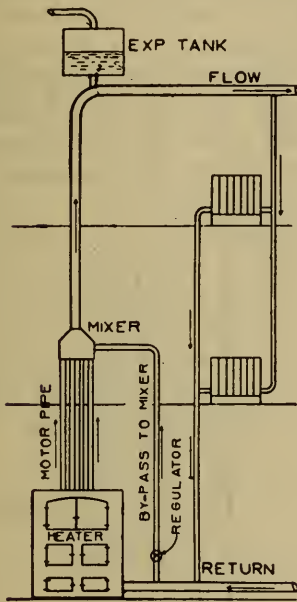

Fig. 45.

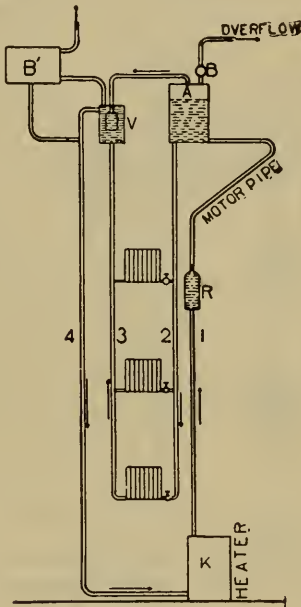

Fig. 46.

In the Jorgensen and Bruchner Systems the heater *K* delivers the hot water up the flow pipe to a regulator *R*, where a separation takes place between the steam particles and the water, thus causing an acceleration up the motor pipe to the expansion tank *A*. The water in the flow pipe 2 is probably near to the temperature of that in 1. After passing through the radiators the water in 3 is at a lower temperature than that in 2. The steam particles which have collected in the expansion tank *A* above the water line are condensed in *V*. The acceleration in the system is thus produced by a combination of the upward movement of the steam particles in motor pipe 1 and the induced upward current in 3 toward the condenser *V*. It will be noticed in the figures that the condensation in one system takes place before the expansion tank and in the other system after

it has passed the expansion tank. Each of the systems illustrated may be carried under pressure by a safety valve as at *B* or by an expansion tank located high enough to give sufficient static head.

The third principle is well shown by what is known as the Reck System. Fig. 47 is a diagrammatic view and Fig. 48 a detail of the accelerating part of the system. The

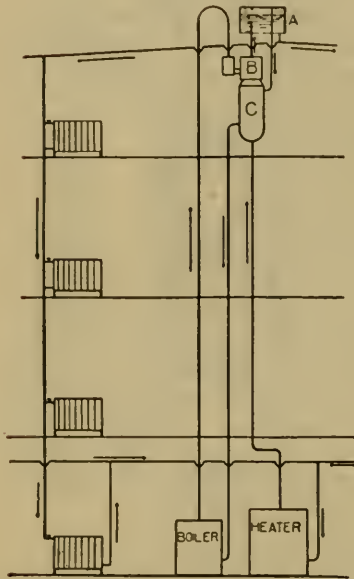

Fig. 47.

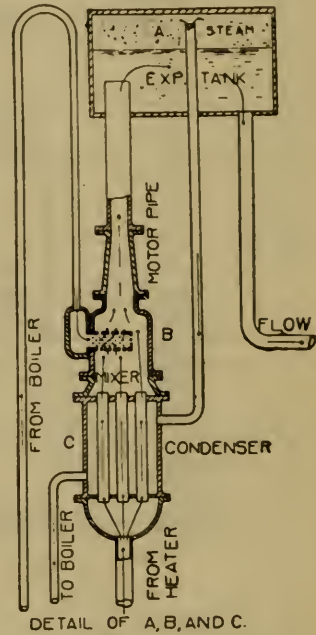

Fig. 48.

water passes directly from the heater up the main riser where it enters the condenser *C* and thence into the expansion tank *A* as a supply to the flow pipes of the system. Steam from a separate boiler is admitted to the mixer *B* above the condenser and enters the circulating water just below the expansion tank. The velocity of the steam and the partial vacuum caused by the condensation induces a current up the flow pipe to the expansion tank. When the water level in the expansion tank reaches the top of the overflow pipe the water returns to the steam boiler through the condenser *C* where it gives off heat to the upper current of the circulating water. It will be seen that the

water in the system and the steam from the boiler unite from the inlet at the mixer to the expansion tank. On all other parts of the systems they are independent.

Fig. 49 is a modification of this same principle, wherein air is injected in the riser pipe at *B* and causes the acceleration by a combination of the partial vacuum produced by the steam condensation as just mentioned and the upward current of the air particles as in an air lift. Steam enters through the pipe *J* and ejector *H* to the mixer at *B* where it is condensed. In passing through *H* air is drawn from the tank *E* and enters the main riser with the steam. The upward movement of this air through the motor pipe to the tank induces an upward flow of the water in the main riser. By this combination there are formed three complete circuits, water, steam and air, uniting as one circuit from the mixer *B* to the expansion tank *E*. The steam furnished in principle 3 may be supplied by a separate steam boiler or by steam coils in the fire box of a hot water boiler.

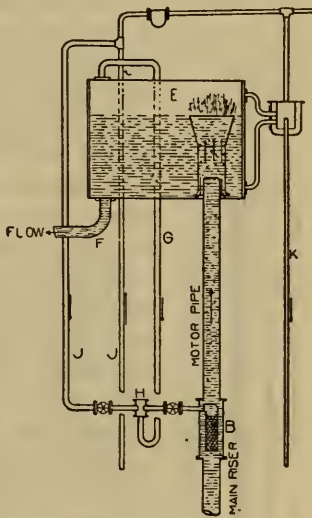

Fig. 49.

In the fourth principle the acceleration is produced by some piece of mechanism as a pump or motor placed directly in the circuit. This principle is discussed under District Heating and will be omitted here.

69. Vacuum Systems for Steam:—Most commonly, the systems mentioned, when steam, are installed as the so-called low pressure systems, which term indicates an absolute pressure of about 18 pounds per square inch or $3\frac{1}{2}$ pounds gage pressure. On extensive work, it has been found advantageous to install a vacuum system to increase economy, also to insure positive steam circulation by prompt removal of condensation through vacuum returns. Even for comparatively small residence installations vacuum applications of various kinds are becoming common.

Vacuum systems may be divided into two classes, according to the way in which the vacuum is maintained. For

comparatively small plants, not using exhaust steam, the vacuum is maintained by mercury seal connections, and these plants are usually referred to as mercury seal vacuum systems. These mercury seals may be attached to any standard one or two-pipe system by merely replacing the ordinary air valve by a special connection, which in reality is only a barometer. An iron tube, Fig. 50, dips just below the surface of the mercury in the well on the floor

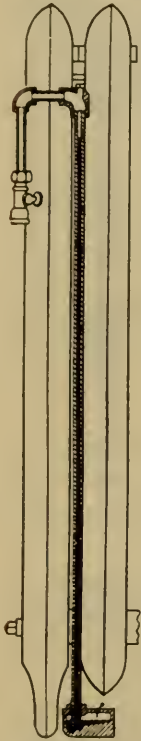

Fig. 50.

and extends vertically to the radiator air tapping to which the tube connects by a fitting which will allow air to pass into and through the barometer, but will not allow steam to pass. When the system is first fired up and steam is raised to several pounds gage, the air leaves all the radiators by bubbling through the mercury seal at the end of the vertical iron tube. If the fire is then allowed to go out, the steam will condense, and produce an almost perfect vacuum in the entire system, provided all pipe fitting has been carefully done. This system may be operated as a vacuum system at 4 or 5 pounds absolute pressure and have the water boiling as low as 150 to 160 degrees. The flexibility of this system recommends it highly. Applied to a residence or store, the plant may be operated during the day at several pounds gage pressure, if necessary, but when fires are banked for the night, steam remains in all pipes and radiators as long as the temperature of the water does not fall much below 150 degrees. This is in sharp contrast with the ordinary system, where steam disappears from all radiators as soon as the water temperature drops below 212 degrees. The

promptness with which heat may be obtained in the morning is noteworthy, for, if the vacuum has been maintained, steam will begin to circulate as soon as the water has been raised to about 150 degrees. According to demands of the weather, the radiators may be kept at any temperature along the range of 150 to 220 degrees, thus giving great flexibility.

Instead of having a barometric tube at each radiator, one mercury seal may be supplied in the basement, and the air tappings of all radiators connected to the top of the tube by $\frac{1}{4}$ inch piping. In practice it is found very difficult to obtain a system of piping sufficiently tight to maintain a high vacuum on the mercury seal system.

The second class of vacuum systems includes those designed especially for use in office buildings, and wherein the vacuum is maintained by an aspirator, exhauster or pump of some description. This exhauster may handle only

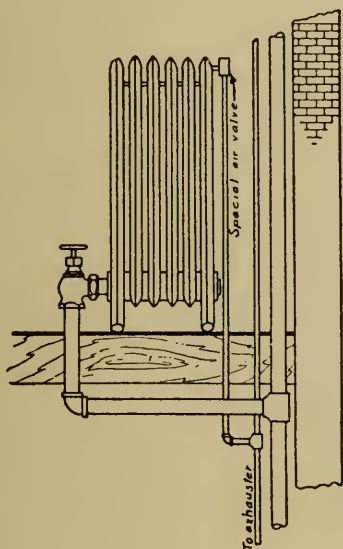

Fig. 51.

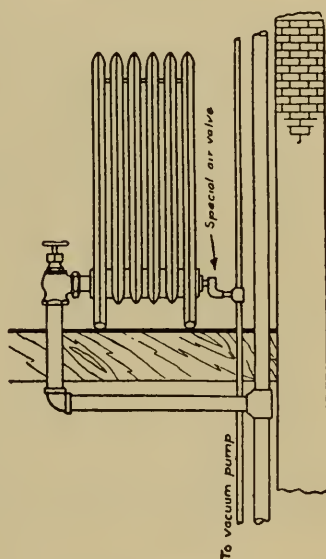

Fig. 52.

the air of the system, that is, it may be connected only to the air tappings of all radiators, as in the Paul system, Fig. 51, or the exhauster may handle both air and condensation and be connected to the return tappings of all radiators, as in the Webster system, Fig. 52. The Paul system is fundamentally a one-pipe system, using exhaust or live steam and maintaining its circulation without back pressure, by exhausting each radiator at its air tapping, and also exhausting the condensation from the basement tank in which it has been collected by gravity. For an

aspirator this system uses either air, steam, or hot water, as the conditions may determine. The Webster system is fundamentally a two-pipe system and exhausts, from the radiators both the air and water of condensation, all radiator returns being connected to the (usually) steam driven vacuum pump. These systems are designed to use both exhaust and live steam, and hence are finding wide application in the modern heating of manufacturing plants. See also Chapter IX.

CHAPTER VII.

HOT WATER AND STEAM HEATING.

RADIATORS, BOILERS, FITTINGS AND APPLIANCES.

The various systems just described are merely different ways of connecting the source of heat to the distributors of heat, i. e., methods of pipe connections between heater and radiators. Many forms of radiators exist, as well as many types of heaters and boilers, each adapted to its own peculiar condition. It is in this choice of the best adapted material that the heating engineer shows the degree of his practical training, and the closeness with which he follows the latest inventions, improvements and applications.

70. Classification as to Material:—Radiators may be classified, according to material, as cast iron radiators, pressed steel radiators and pipe coil radiators. Cast radiators have the hollow sections cast as one piece, of iron. The wall is usually about $\frac{1}{4}$ inch to $\frac{3}{8}$ inch thick, and is finally tested to a pressure of 100 pounds per square inch. Sections are joined by wrought iron or malleable nipples which, at the same time, serve to make passageways between any one section and its neighbors for the current of heating medium, whether of steam or hot water. Cast iron radiators have the disadvantage of heavy weight, danger of breaking by freezing, occupying much space, and having a comparatively large internal volume, averaging a pint and a half per square foot of surface.

Pressed radiators are made of sheet steel of No. 16 gage, and, after assembly, are galvanized both inside and out. Each section is composed of two pressed sheets that are joined together by a double seam as shown at a, Fig. 53, which illustrates a section through a two-column unit.



Fig. 53.

The joints between the sections or units are of the same kind. It is readily seen that such construction tends toward a very compact radiating surface. Pressed radia-

tors are comparatively new, but, in their development, promise much in the way of a light, compact radiation. In comparison with the cast iron radiators, they are free from the sand and dirt on the inside, thus causing less trouble with valves and traps. The internal volume will approximate one pint per square foot of surface. See Fig. 54.

Radiators composed of pipes, in various forms, are commonly referred to as coil radiators. They are daily becoming less common for direct and direct-indirect work, because of their extreme unsightliness. Piping is still much used as the heat radiator in indirect and plenum systems, although both cast and pressed radiators are now designed for both of these purposes where low pressure steam is used. In all coil radiator work, no matter for what purpose, 1 inch pipe is the standard size. However, in some cases pipes are used as large as 2 inches in diameter. Standard 1 inch pipe is rated at 1 square foot of heating surface per 3 lineal feet and has about 1 pint of containing capacity per square foot of surface.

71. Classification as to Form:—Radiators may again be classified in accordance with form, into the one, two, three, and four-column floor types, the wall type, and the flue type. See Fig. 54. These terms refer only to cast and pressed radiators. By the *column* of a radiator is meant one of the unit fluid-containing elements of which a section is composed. When the section has only one part or vertical division, it is called a single-column or one-column type; when there are two such divisions, a two-column; when three, a three-column; and when four, a four-column type. What is known as the wall type radiator is a cast section one-column type so designed as to be of the least practicable thickness. It presents the appearance, often, of a heavy grating, and is so made as to have from 5 to 9 square feet of surface, according to the size of the section. One-column floor radiators made without feet are often used as wall radiators. A flue radiator is a very broad type of the one-column radiator, the parts being so designed that the air entering between the sections at the base is compelled to travel to the top of the sections before leaving the radiator. This type is therefore well adapted to direct-indirect work. See Fig. 54.

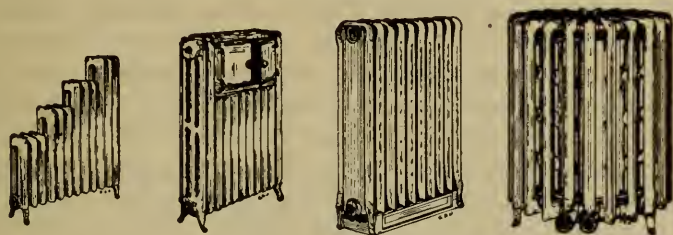

Stairway Type Dining Room Type Flue Type Circular Type

CAST RADIATORS

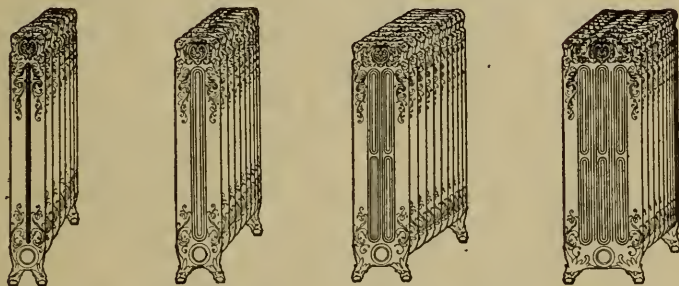

Wall Type Two-Column Type Three-Column Type Four-Column Type

PRESSED RADIATORS

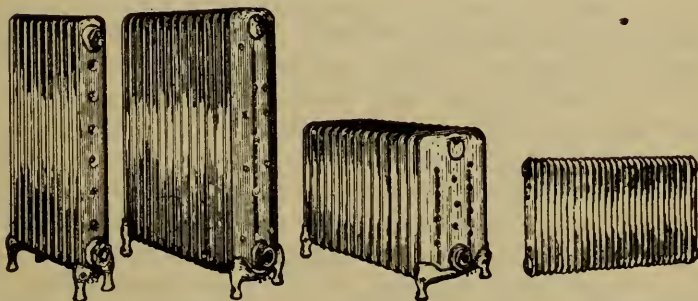

Single-Column Type Two-Column Type Three-Column Type Wall Type

Fig. 54.

Many special shapes of assembled radiators will be met with, but they will always be of some one of the fundamental types mentioned above. For instance, there are "stairway radiators," built up of successive heights of sections, so as to fit along the triangular shaped wall under stairways; there are "pantry" radiators built up of sections so as to form a tier of heated shelves; there are "dining room" radiators with an oven-like arrangement built into their center; and there are "window radiators" built with low sections in the middle and higher ones at either end, so as to fit neatly around a low window. Fig. 54 shows a number of these common forms as used in practice.

72. Classification as to Heating Medium:—A third classification of radiators, according to heating medium employed, gives rise to the terms *steam radiator* and *hot water radiator*. Casually, one would notice little difference between the two, but in construction there is a vital difference. Steam radiation has the sections joined by nipples along the bottom only, but hot water radiation has them joined along the top as well. This is quite essential to the proper circulation of the water. Steam radiation is always tapped for pipe connections at the bottom. Hot water radiation may have the flow connection enter at the top, and the return connection leave at the bottom, or may have both connections at the bottom. Hot water radiation can be heated very successfully with steam, but steam radiation cannot be used with hot water.

73. High versus Low Radiators:—In the adoption of a radiator height, the governing feature is usually the space allowed for the radiator. Thus, if a radiator of 26 inches in height requires so many sections as to become too long, then a 32 inch or a 38 inch section may be taken. In general, however, low radiators should be used as far as possible, for, with a high radiator, the air passing up along the sides of the sections becomes heated before reaching the top, and therefore receives less heat from the upper half of the radiator, since the temperature difference here is small. Hence, the statement that low radiators are more efficient, that is, will transmit more B. t. u. per square foot per hour than will the high radiators.

The amount of heat that will be transmitted through a radiator to a room is controlled also by the width of the

radiator, narrow radiators being more efficient than wide ones. Considering both height and number of columns the rate of transmission, used in formulas 30 and 31 as 1.7, would change to:

	1	column	radiator,	30"	high	1.8	B. t. u.
2 and 3		"	"	30"	"	1.7	"
4		"	"	30"	"	1.6	"

For high and low radiators this may be reduced or increased ten per cent. respectively for a 48 inch and a 16 inch radiator.

74. Effect of Condition of Radiator Surface on the Transmission of Heat:—The efficiency of a radiator depends very largely upon the condition of its outer surface, a rough surface giving off very much more heat than a smooth surface. Painting, bronzing, shellacing or covering the radiator in any manner affects the ability of the radiator to impart heat to the air circulating around it. Various tests bearing upon this question have been conducted, agreeing fairly well in general results. A series of tests conducted by Prof. Allen at the University of Michigan, indicated that the ordinary bronzes of copper, zinc or aluminum caused a reduction in the efficiency below that of the ordinary rough surface of the radiator of about 25 per cent., while white zinc paint and white enamel gave the greatest efficiency, being slightly above that of the original surface. Numerous coats of paint, even as high as twelve, seemed to affect the efficiency in no appreciable manner, it being the last or outer coat that always determined at what rate the radiator would transmit its heat.

75. Amount of Surface Presented by Various Radiators:—Table X, gives, according to the columns and heights, the number of square feet of heating surface per section in cast and pressed radiators. This table will be found to present, in very compact form, the similar and much more extended tables in the various manufacturers' catalogs. An approximate rule supplementing this table and giving, to a very fair degree of accuracy, the square feet of surface in any standard radiator section, is as follows: *multiply the height of the section in inches by the number of columns and divide by the constant 20. The result is the square feet of radiating surface per section.* The rule applies with least accuracy to the one-column radiators.

TABLE X.

Dimensions and Surfaces of Radiators, per Section.												
Type of Radiator	Ave. width of Section in Inches	Ave. thickness of Section in Inches	Radiator Heights.									
			45"	38"	32"	26"	23"	22"	20"	18"	16"	14"
1 Col. C. I.....	5	3	3	2½	2	1½	1½
2 Col. C. I.....	8	3	5	4	3½	2¾	2½	2
3 Col. C. I.....	9½	3	6	5	4½	3¾	3	---	2¼
4 Col. C. I.....	11	3½	10	8	6½	5	4	3
Flue Wide....	12½	3	6	5½	4¾	4
Flue Narrow	8	3	7	5¾	4½
1 Col. Press...	4	1½	1%	1½	1	¾
2 Col. Press ..	7¾	2	4	3½	2½	2	1½
3 Col. Press ..	12½	2¼	5¾	4%	3¾	2¾
1 Col. Wall Pressed	3½	1½	1	¾

76. Hot Water Heaters:—Heaters for supplying the hot water to a heating system may be divided into three classes:—the round vertical, for comparatively small installations; the sectional, for plants of medium size; and the water tube or fire tube heater with brick setting for the larger installations and for central station work. The round and sectional types usually have a ratio between grate and heating surface of 1 to 20, while the water tube or fire tube heater will have, as an average, 1 to 40. Many different arrangements of heating surface are in use to-day, every manufacturer having a product of particular merit. Trade catalogs supply the most up-to-date literature on this subject, but cuts of each of the types mentioned above may be found in Fig. 55.

77. Steam Boilers:—The products of many manufacturers show but little difference between the hot water heater and the steam boiler. The latter is usually supplied with a somewhat larger dome to give greater steam storage capacity. For heating purposes, steam boilers fall into the same three classes as mentioned under water heat-

ers, having about the same ratio of heating surface to grate surface. With the steam boiler generating steam at 5 pounds gage, the temperature on one side of the heating surface is about 227 degrees, while in a water heater the temperature on the same side is about 180 degrees. Hence, with the same temperature of the burning gases, the temperature difference is greater in a water heater than in a

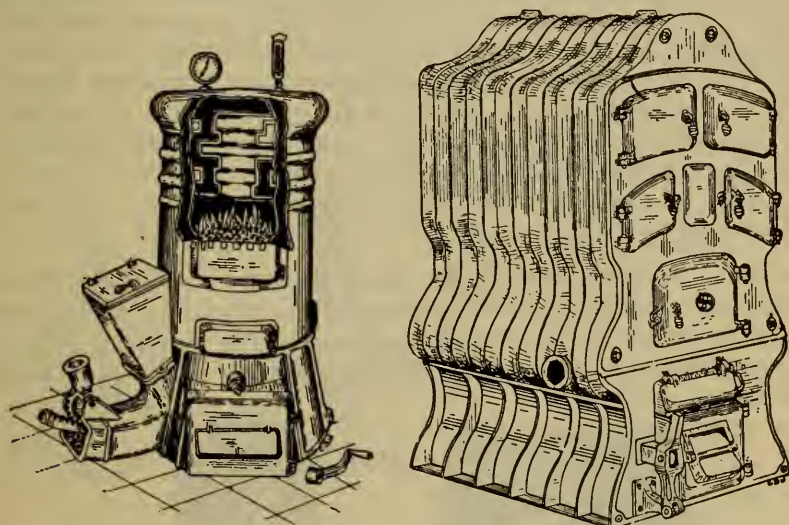

Round Under-Feed

Sectional Top Feed

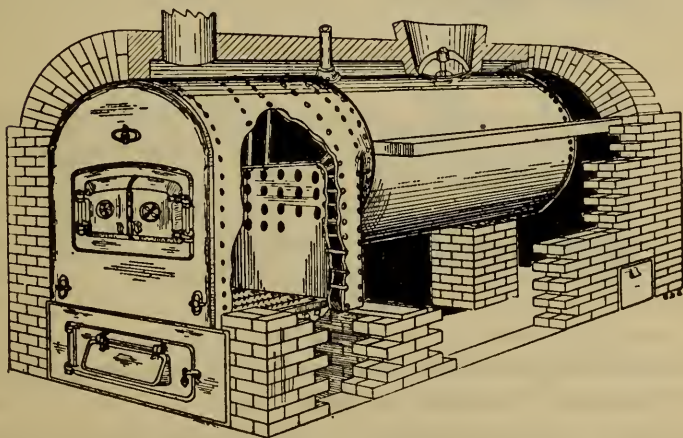

Fire Tube Type

Fig. 55.

boiler, resulting in a more rapid transfer of heat, and a correspondingly greater efficiency.

78. Combination Systems:—Combination systems are frequently used, principally the one which combines warm air heating with either steam or hot water. For such a system there is needed a combination heater, as shown in Fig. 20. It consists essentially of a furnace for supplying warm air to some rooms, the downstairs of a residence for instance, and contains also a coil for furnishing hot water to radiators located in other rooms, say, on the upper floors, or in places where it would be difficult for air to be delivered. Considerable difficulty has been encountered in properly proportioning the heating surface of the furnace to that of the hot water heater, and the systems have not come into general use.

79. Fittings:—Common and Special:—*Couplings, elbows* and *tees*, especially for hot water work, should be so formed as to give a free and easy sweep to the contents. It is highly desirable in hot water work to use pipe bends of a



Fig. 56.

radius of about five pipe diameters, instead of the common elbow. In either case all pipe ends should be carefully reamed of the cutting burr before assembling. This is most important, as the cutting burr is sometimes heavy enough to reduce the area of the pipe by one-half, thus creating serious eddy currents, especially at the elbows. If the single main hot water system be installed, great care should be used to plan the mains in the shortest and most direct routes, and the special fittings described and shown in Art. 65 should be used.

Eccentric reducing fittings are often of value in avoiding pockets in steam lines. Fig. 56 shows types of these, which should always be used when, by reduction or otherwise, a

horizontal steam pipe would present a pocket for the collection of condensation with its resultant water hammer.

Valves for either steam or hot water should be of the gate pattern rather than the globe pattern. The latter is objectionable in hot water systems because of the resistance offered the stream of water, due to the fact that the axis of the valve seat opening is perpendicular to the axis of the pipe. The globe valve is objectionable in some steam lines because of the fact that in a horizontal run of pipe it forms very readily a pocket for the collection of condensation, thus often producing a source of water hammer. In every way gate valves are preferable, for, as shown in Fig. 57, they present a free opening without turns.

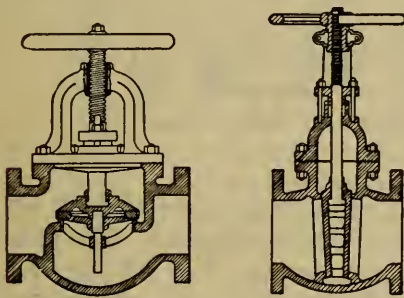

Fig. 57.

The same caution applies in the use of check valves. *Swing checks* should always be specified rather than *lift checks*, for the former offer much less resistance to the passage of the hot water, or the steam and condensation, as the case may be. Fig. 58 shows a lift check and a swing check.

To avoid the annoyance so often experienced by leaky packing around valve stems, there have been designed and

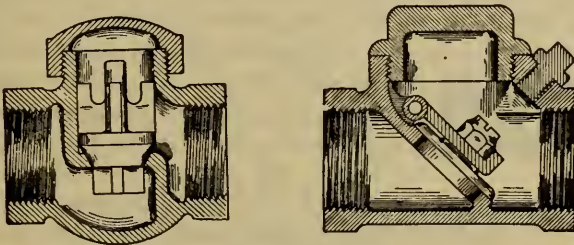

Fig. 58.

placed on the market various forms of *packless valves*. These are to be especially recommended for vacuum work, as the old style valve with its packed stem is, perhaps, the cause of more failures of vacuum systems than any other one item. Fig. 59 shows a section of this type of valve using

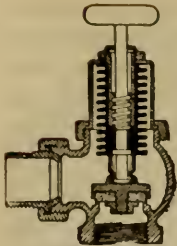

Fig. 59.

the diaphragm as the flexible wall. All packless valves will be found to use a diaphragm of one form or another.

Quick-opening Valves, or butterfly valves, are much used on hot water radiators; one-quarter turn of the wheel or handle serves to open these full and, when closed, they are so arranged that a small hole through the valve permits just enough leakage to keep the radiator from freezing. Special radiator valves for steam may also be obtained.

Air valves have a most important function to discharge. As the air accumulates above the water or steam in the



Fig. 60.

radiators, its removal becomes absolutely necessary, if all of the radiating surface is to remain effectual. For this purpose small hand valves or pet cocks, Fig. 60, are inserted near the top of the end section in all hot water work; and either these same valves or automatic ones are inserted for steam work. Valves are not as essential on two-pipe steam systems as on water or single-pipe steam systems, yet are generally used. For steam the air valve should be about one-third the radiator height from the top.



Fig. 61.

Fig. 61 shows a common type of automatic air valve using the principle of the expansion stem. As long as the air flows around the stem and exhausts, the stem remains contracted, and the needle valve open; but when the hot steam enters and flows past the expansion stem, it lengthens sufficiently to close the needle valve. In other forms of air valves the heat of the steam closes the needle valve by the expansion of a volatile liquid in a small closed retainer. In still other forms the lower part of the valve casing is filled with water of condensation upon which floats an inverted cup, having air entrapped within.

This cup carries the needle of the valve at its upper extremity, the heat of the steam expanding the air sufficiently to raise the cup and close the valve. Where the system is designed to act as a gravity installation, special air valves must be used which will not allow air to enter at any time. Fig. 62 shows a type of automatic valve designed to accommo-

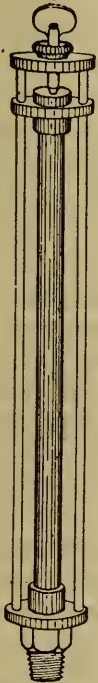

Fig. 62.

date larger volumes of air with promptness, as when a long steam main or large trap is to be vented. This type employs a long central tube; as shown, which carries at the top the valve seat of the needle valve. The needle itself is carried by the two side rods. As long as the air flows up through the central pipe, the needle valve will remain open; but when hot steam enters the tube, it expands, and carries the valve seat upward against the needle, thus closing the valve. The size and strength of parts makes this form a very reliable one.

The *expansion tank*, Fig. 63, for a hot water system is often located in the bath room or closet near the bath room and its overflow connected to proper drainage. It should be at least 2 feet above the highest radiator. The connection to the heating system mains is most often by a branch from the nearest radiator riser, or it may have an independent riser from the basement flow main. The capacity of the tank is usually taken at about one-twentieth of the volume of the entire system, or a more easily applied rule is to *divide the total radiation by 40 to obtain the capacity of the tank in gallons*. See Table 39, Appendix.

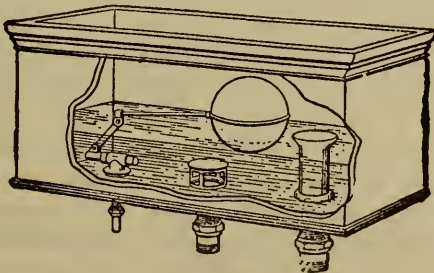

Fig. 63.

CHAPTER VIII.

HOT WATER AND STEAM HEATING.

PRINCIPLES OF THE DESIGN, WITH APPLICATION.

In a hot water or steam system, the first important item to be determined by calculation is the amount of radiation, in square feet, to be installed in each room. Nearly all other items, such as pipe sizes, boiler size, grate area, etc., are estimated with relation to this total radiation to be supplied. The correct determination, then, of the square feet of radiation in these systems is all-important.

80. Calculation of Radiator Surface:—Considering the standard room of Chapter III, where the heat loss was determined to be 14000 B. t. u. per hour on a zero day, the problem is to find what amount of surface and what size of radiator will deliver 14000 B. t. u. per hour to the room, under the conditions as given. Experiments by numerous careful investigators have shown that the ordinary cast iron radiator, located within the room and surrounded with comparatively still air, gives off heat at the rate of 1.7 B. t. u. (1.6 to 1.8, or 1.7 average) per square foot per degree difference between the temperature of the surrounding air and the average temperature of the heating medium, per hour. This is called the *rate of transmission*. With hot water the average conditions within the radiator have been found to be as follows: temperature of the water entering the radiator 180 degrees; leaving the radiator 160 degrees; hence, the average temperature at which the interior of the radiator is maintained is 170 degrees. Since, in this country, the standard room temperature is 70 degrees, and, for hot water, the "degree difference" is $170 - 70 = 100$, then a hot water radiator will give off under standard conditions $1.7 \times 100 = 170$ B. t. u. per sq. ft. per hour. The temperature within a steam radiator carrying steam at pressures varying between 2 and 5 pounds gage is usually taken at 220 degrees, and the total transmission is approximately $1.7 \times (220 - 70) = 255$ B. t. u. per square foot per

hour. The general formula for the square feet of radiation, then, is

$$R = \frac{\text{Total B. t. u. lost from the room per hour}}{1.7 (\text{Temp. diff. between inside and outside of rad.})}$$

For *hot water, direct radiation* heating, this becomes, to the nearest thousandth

$$R_w = \frac{H}{1.7 (170 - 70)} = .006 H \quad (30)$$

For *steam, direct radiation*

$$R_s = \frac{H}{1.7 (220 - 70)} = .004 H \quad (31)$$

Rule.—To find the square feet of radiation for any room divide the calculated heat loss in B. t. u. per hour by the quantity 1.7 times the difference in temperature between the inside and the outside of the radiator.

It will be noticed from (30) and (31) that $R_w = 1.5 R_s$ which accounts for the practice that some people have of finding all radiation as though it were steam, and then, when hot water radiation is desired, adding 50 per cent. to this amount.

APPLICATION.—From the standard room under consideration, formula 30 gives $R_w = .006 \times 14000 = 84$ square feet of radiator surface for hot water; and formula 31 gives $R_s = .004 \times 14000 = 56$ square feet of radiator surface for steam. From these values the number of sections of a given type of radiator can be determined by dividing by the area of one section, as explained in the preceding chapter. The length of the radiator may also be found from this same table, by noting the thickness of the sections, and multiplying by their number.

Formulas 30 and 31 give the standard ratios between the heat loss and direct radiation. If, however, the radiation is installed as *direct-indirect*, it is quite common practice to increase the amount of direct radiation by 25 per cent. to allow for the ventilation losses. On this basis formulas 30 and 31 become, respectively,

$$R_w = .0075 H \quad (32)$$

$$R_s = .005 H \quad (33)$$

Duct sizes for properly accommodating the air in direct-indirect heating may be taken from the following:

To obtain the duct area in square inches, multiply the square feet of radiation by .75 to 1 for steam, and by .5 to .75 for hot water. To obtain the amount of air which may be expected to enter and pass through the radiator into the room, multiply the square feet of radiation by 100 for steam, or by 75 for hot water. This gives the cubic feet of air entering per hour.

Again, if the radiation is installed as purely *indirect*, yet not as a plenum system, it is common to *increase the amount of direct radiation by 50 per cent.* Now formulas 30 and 31 become, respectively,

$$R_w = .009 H \quad (34)\text{-a}$$

$$R_s = .006 H \quad (34)\text{-b}$$

For proportioning the duct sizes in indirect heating use the following table. To obtain the duct area in square inches, multiply the square feet of radiation installed by

	Steam	Hot Water
First Floor	1.5 to 2.0	1.0 to 1.33
Second Floor	1.0 to 1.25	.66 to .83
Other Floors	.9 to 1.0	.6 to .66

Vent ducts, where provided, are usually taken .8 of the area of supply ducts. Also, for finding the amount of air in cubic feet, which may be reasonably expected to enter under these conditions, Carpenter gives the following: Multiply the square feet of indirect radiation by

	Steam	Hot Water
First Floor	200	150
Second Floor	170	130
Other Floors	150	115

If this amount of air is insufficient for the desired degree of ventilation, more air must be brought in by correspondingly larger ducts, and for each 300 cubic feet additional with steam, or each 200 cubic feet additional with hot water, add one square foot to the radiation surface.

A steam system may be installed to work at any pressure, from a vacuum of, say, 10 pounds absolute, to as high a pressure as 75 pounds absolute. To calculate the proper radiation for any of these conditions use formula 31 or its derivatives, and substitute the proper steam temperature in place of 220 degrees.

In like manner, to find the amount of hot water radiation for any other average temperatures of the water

than the one given, merely substitute the desired average temperature in the place of 170. One point should be remembered, the maximum drop in temperature as the water passes through the heater will seldom be more than 20 degrees, even under severe conditions. More often it will be less, but this value is used in calculations. Again, the temperature of the entering water may be at the boiling point, if necessary, thus causing each square foot of surface to be more efficient and consequently reducing the total radiation in the room. To illustrate, try formula 30 with a drop in temperature from 210 to 190 degrees and find 64 square feet of radiator surface for this room. Since a radiator always becomes less efficient from continued use, it is best to design a system with a lower temperature as given in the formula, and then, if necessary under stress of conditions, this system may be increased in capacity by increasing the water temperature up to the boiling point.

81. Empirical Formulas:—All of the above formulas may be considered as *rational* and checked by years of experience and application. Many empirical formulas have been devised in an attempt to simplify, but the results are always so untrustworthy that the rules are worthless unless used with that discretion which comes only after years of practical experience. Many of these rules are based on the cubic feet of volume heated, without any other allowance, these being given anywhere from one square foot of steam surface per 30 cubic feet of space, to one square foot to 100 cubic feet. The extreme variation itself shows the unreliableness of this method, and under no conditions should it be used for proportioning radiating surface. Various central heating companies, and others, proportion radiators for their plants according to their own formulas, among which the following may be noted.

$$(a) \quad R_w = \frac{G}{2} + \frac{W}{10} + \frac{C}{60} \qquad R_s = \frac{G}{2} + \frac{W}{10} + \frac{C}{200}$$

$$(b) \quad R_w = G + .05 W + .01 C \qquad R_s = \frac{2}{3} (G + .05 W + .01 C)$$

$$(c) \quad R_w = .75 G + .10 W + .01 C \qquad R_s = .5 G + .05 W + .005 C$$

It is evident that these are really simplified forms of Carpenter's original formula. When applied to the sitting room, where Carpenter's formula gave, for hot water and steam, 84 square feet and 56 square feet, respectively, (a)

gives 85.5 and 63, (b) gives 75 and 50, and (c) gives 82.5 and 46 respectively.

Another approximate rule devised by John H. Mills and still used to some extent is "Allow 1 square foot of steam radiation for every 200 cubic feet of volume, 1 square foot for every 20 square feet of exposed wall and 1 square foot for every 2 square feet of exposed glass." Applying this to the standard room, it gives $9.75 + 13.25 + 18 = 41$ square feet of steam radiation as against 56 square feet by rational formula. This shows a considerable difference from the rules preceding.

82. Greenhouse Radiation:—The problem of properly proportioning greenhouse radiation is considered, by some, of such special nature as to justify the use of empirical formulas. The fact that the glass area is so large compared to the wall area and the volume, combined with the fact that the head of water in the system is small and that the radiation surface is usually built up as coils from $1\frac{1}{4}$, $1\frac{1}{2}$ or 2 inch wrought iron pipe, gives rise to a problem that differs essentially from that of a room of ordinary construction. It is not surprising, therefore, to find a great variety of empirical formulas designed exclusively for this work. Whatever merit these may have, they do not give the assurance that comes from the application of rational formulas. It is always best to use rational formulas first and then check by the various empirical methods.

Formulas 30 and 31, stated in Art. 80, when properly modified, are applicable to greenhouses and give very reliable results. As stated above, the radiating surface is usually that of wrought iron pipes hung below the flower benches or along the side walls below the glass. The transmission constant, K , for wrought iron or mild steel is 2.0 to 2.2 B. t. u. per square foot per degree difference per hour, making the total transmission per square foot of coil surface per hour about $2(170 - 70) = 200$ for hot water, and $2(220 - 70) = 300$ for steam. These values may be safely used. The only necessary modification of the two formulas mentioned, consists in replacing the constant 1.7 by 2, giving for *hot water*

$$R_w = \frac{H}{2(170 - 70)} = .005 H \quad (35)\text{-a}$$

And for *steam*

$$R_s = \frac{H}{2(220 - 70)} = .0033 H \quad (35)\text{-b}$$

If, however, the highest temperature at which it is desirable to maintain the house in zero weather is other than 70 degrees, this temperature should be used instead of 70.

In a greenhouse there is very little circulation of air, hence the heat loss, H , would be found from the equivalent glass area i. e., $(G + .25 W)$. Formulas 35-*a* and *b* would then reduce to $R_w = .35 (G + .25 W)$ and $R_s = .23 (G + .25 W)$. It is noticed that these values give about *one square foot of H. W. radiation to 2.8 square feet of equivalent glass area, and one square foot of steam radiation to 4.4 square feet of equivalent glass area as approximate rules. These figures should be considered a minimum.*

Empirical rules for greenhouse radiation, quoted by many firms dealing in the apparatus, are usually given in the terms of the number of square feet of glass surface heated by one lineal foot of $1\frac{1}{4}$ inch pipe. A very commonly quoted and accepted rule is, one foot of $1\frac{1}{4}$ inch pipe to every $2\frac{1}{4}$ square feet of glass, for steam; or, one foot of $1\frac{1}{4}$ inch pipe to every $1\frac{1}{2}$ square feet of glass, for hot water, when the interior of the house is 70 degrees in zero weather. Table XI, taken from the Model Boiler Manual, shows the amount of surface for different interior temperatures and different temperatures of the heating medium.

In general, it may be said that in greenhouse heating, great care should be used in the rating and the selection

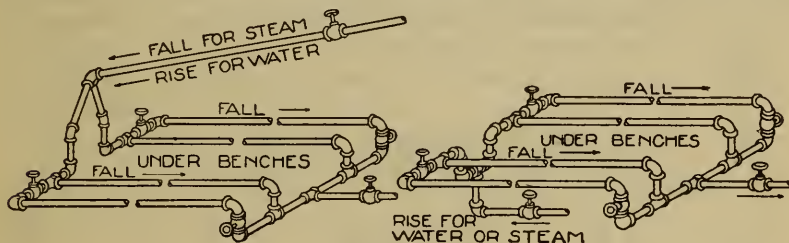

Fig. 64.

of the boilers or heaters. It is well to remember that the severe service demanded by a sudden change in the weather is much more difficult to meet in greenhouses than in ordinary structures, and that a liberal reserve in boiler capacity is highly desirable.

If any greenhouse under consideration can be heated from some central plant where the heat will be continuous throughout the night with a man in charge at all times,

then steam is very desirable because of the reduced amount of heating surface necessary. If, however, in cold weather the steam pressure to be allowed to drop during the night-time, then hot water should be used. This permits a better circulation of heat throughout the greenhouse during the night. The same rules apply in running the mains and risers as would apply in the ordinary hot water and steam systems. In greenhouse work the head of water is very low and this makes the circulation rather sluggish but with sufficient pipe area and a minimum friction a hot water system may be used with satisfaction. In some houses the coils are run along the wall below the glass and supported on wall brackets, in others they are run underneath the benches and supported from the benches with hangers, while in greenhouses with very large exposure there are sometimes required both wall and bench coils. In all of these piping layouts it is necessary that a good rise and fall be given to the pipes. Fig. 64 shows two systems of pipe connections, one where the steam or flow enters the coils from above the benches and the other where it enters from below, the return in each case being at the lowest point. These bench coils could be run along the wall with equal satisfaction.

TABLE XI.

Temperature of Air in House	Temperature of Water in Heating Pipes				Steam	
	140°	160°	180°	200°	Three lbs. Pressure	
Square feet of glass and its equivalent proportioned to one square foot of surface in heating pipes or radiator						
40°	4.38	5.25	6.66	7.69	8.	7.5
45°	3.63	4.65	5.55	6.66	7.5	6.75
50°	3.07	3.92	4.76	5.71	7.	6.0
55°	2.63	3.39	4.16	5.	6.5	5.5
60°	2.19	2.89	3.63	4.33	6.	5.0
65°	1.86	2.53	3.22	3.84	5.5	4.5
70°	1.58	2.19	2.81	3.44	5.	4.25
75°	1.37	1.92	2.5	3.07	4.5	4.0
80°	1.16	1.63	2.17	2.73	4.	3.75
85°	.99	1.42	1.92	2.46	3.5	3.5

This table is computed for zero weather; for lower temperatures add $1\frac{1}{2}$ per cent. for each degree below zero.

The last column in Table XI has been calculated from formula 35-b and added for purpose of comparison.

APPLICATION.—Given an even span greenhouse 25 ft. wide, 100 ft. long and 5 ft. from ground to eaves of roof, having slope of roof with horizontal 35°. Ends to be glass above the eaves line. What amount of hot water radiation with water at 170° and what amount of low pressure steam radiation would be installed?

$$\text{Length of slope of roof} = 12.5 \div \cos. 35^\circ = 15.25.$$

$$\text{Area of glass} = 15.25 \times 100 \times 2 + 2 \times 12.5 \times 8.8 = 3270 \text{ sq. ft.}$$

$$\text{Area of wall} = 5 \times 100 \times 2 + 5 \times 25 \times 2 = 1250 \text{ sq. ft.}$$

$$\text{Glass equivalent} = 3270 + .25 \times 1250 = 3582.5 \text{ sq. ft.}$$

$$R_w = .35 \times 3582.5 = 1253.8 \text{ sq. ft.}$$

$$R_s = .23 \times 3582.5 = 824. * \text{ sq. ft.}$$

From Table XI.

$$R_w = 3582.5 \div 2.5 = 1433 \text{ sq. ft.}$$

$$R_s = 3582.5 \div 5 = 716. \text{sq. ft.}$$

*Check with last column of Table XI.

83. The Determination of Pipe Sizes:—The theoretical determination of pipe sizes in hot water and steam systems has always been more or less unsatisfactory, first, because of the complicated nature of the problem when all points having a bearing upon the subject are considered, and second, because it is almost an impossibility to even approximate the friction offered by different combinations and conditions of piping. The following rather brief analysis gives a theoretical method for determining pipe sizes where friction is not considered.

In a *hot water system* let the temperatures of the water, entering and leaving the radiator be, respectively, 180 and 160 degrees; then it is evident that one pound of the water in passing through the radiator, gives off 20 B. t. u. Under these conditions the standard room would have $14000 \div 20 = 700$ pounds of water passing through the radiator per hour. Converting this to gallons, it is found to be 84.03. But the radiation for this room was found to be 84 square feet. Therefore, it may be said that a hot water radiator under normal conditions of installation and under heavy service requires one gallon of water per square foot of surface per hour. Knowing the theoretical amount of water per hour, it remains only to obtain the theoretical speed

at which it travels, due to unbalanced columns, to obtain finally, by division, the theoretical area of the pipe.

Consider a radiator to be about 10 feet above the source of heat, and the temperature in the flow riser to be 180 degrees and in the return riser 160 degrees, good values in practice. Now the heated water in the flow riser weighs 60.5567 pounds per cubic foot, while that in the return riser weighs 60.9697 pounds per cubic foot. The mo-

tive force is $f = g \left(\frac{W - W'}{W + W'} \right)$ where g is the acceleration due to gravity, W is the specific gravity (weight) of the cooler column and W' is the specific gravity (weight) of the warmer column. Substitute f for g in the velocity formula and obtain $v = \sqrt{2fh}$ and

$$v = \sqrt{2gh \left(\frac{W - W'}{W + W'} \right)} \quad (36)$$

Inserting values W , W' and assuming $h = 10$ feet, we have $v = \sqrt{2 \times 32.2 \times 10 \times .0034} = \sqrt{2.1896} = 1.47$ feet per second. From this it has become a custom to speak of 1.5 feet per second or 5400 feet per hour, as the theoretical velocity of water in, say, a first floor riser, disregarding the effect of all friction and horizontal connections. Theoretical velocities for any other height of column and for other temperatures may be obtained in like manner. Continuing this special investigation and changing the 84 gallons per hour to cubic inches per hour by multiplying by 231, the internal pipe area may be obtained by dividing by the unit speed per hour which gives $(84 \times 231) \div (5400 \times 12) = .3$ square inch. This corresponds to approximately a $\frac{5}{8}$ inch pipe and without doubt, would supply the radiator if the supposition of no frictional resistances could be realized. This ideal condition, of course, cannot be had, nor can the friction in the average house heating plant be theoretically treated with any degree of satisfaction. Hence it is still the custom to use tables for the selection of pipe sizes, based upon what experience has shown to be good practice. Such tables, from various authorities, may be found in the Appendix. It is safe to say that one should never use anything smaller than a 1 inch pipe in low pressure hot water work.

With *steam systems*, where the heating medium is a vapor,

and subject in a lesser degree to friction, the discrepancy between the theoretical and the practical sizes of a pipe is not so great as in hot water. Each pound of steam, in condensing, gives off approximately $1154 - 181 = 973$ B. t. u. To supply the heat loss of the standard room, 14000 B. t. u. per hour, it would require 14.5 pounds of steam per hour. When it is remembered that the calculated surface of the direct steam radiator for this room was 56 square feet, it appears that a radiator, under stated conditions and under a heavy service, requires *one-fourth of a pound of steam per square foot of surface per hour*. This may be shown in another way: each square foot of steam radiation gives off 255 B. t. u. per hour; then, each square foot will condense $255 \div 973 = .26 +$ pounds of steam per hour.

Now the volume of the steam per pound at the usual steam heating pressure, 18 pounds absolute, is 21.17 cubic feet. Since the standard room radiator required 14.5 pounds per hour, it would, in that time, condense steam corresponding to a void of $21.17 \times 14.5 = 307$ cubic feet per hour. This is the volume of the steam required by the radiator, and, if the speed of the steam in the pipe lines be taken at 15 feet per second, or 54000 feet per hour, the area of the pipe would be $307 \times 144 \div 54000$, or .82 square inch, corresponding very closely to a 1 inch pipe. For a two-pipe system this would be considered good practice under average conditions; but in a one-pipe system, where the condensation is returned against the steam in the same pipe that feeds, a pipe one size larger would be taken.

Table 35, Appendix, calculated from Unwin's formula, may be used in finding sizes and capacities of pipes carrying steam. In addition to this, Tables 31, 32, 33 and 34 give sizes that are recommended by experienced users.

For a theoretical discussion of loss of head by friction in hot water and steam pipes, see Arts. 147 and 175.

84. Grate Area:—To obtain the grate area for a direct radiation hot water or steam system by the B. t. u. method, the same analysis as found in Chapter IV may be applied. The total B. t. u. heat loss, H , is that calculated by the formula and does not include H_v , the heat loss due to ventilation, since with the direct hot water or steam system as usually installed no ventilation is provided. In any special case where ventilation is provided in excess, use H' instead of H . The commercial rating of heaters and boilers is a

subject each day receiving greater attention at the hands of manufacturers; yet it is a subject where much uncertainty is felt to exist. Hence the recommendation, "Always check grate area by an actual calculation," rather than rely entirely upon the catalog ratings.

85. Pitch of Mains:—The pitch of the mains is quite as important in hot water as in steam work. This should be not less than 1 inch in 10 feet for hot water systems, and not less than 1 inch in 30 feet for steam systems. Greater pitches than these are desirable, but not always practicable. In hot water plants the pitch of the basement mains, whether flow or return, is upward as these mains extend from the source of heat, that is, the highest point is the farthest from the heater. In steam plants the mains, under any condition of arrangement, always pitch downward in the direction of the flow of the condensation.

86. Location and Connection of Radiators:—In locating radiators, it is best to place them along the outside or the exposed walls. When allowable, under the windows seems to be a favorite position. Especially in buildings of several stories, the radiators should be arranged, where possible, in tiers, one vertically above another, thus reducing the number of and avoiding the offsets in the risers. In the one-pipe system any number of radiators may be connected to the same riser. In the two-pipe system several radiators may have either a common flow riser, or a common return riser, but should never have both, either with hot water or with steam.

The connections from the risers to the radiators should be slightly pitched for drainage and are usually run along the ceiling below the radiator connected. These connections should be at least two feet long to give that flexibility of connection to the radiator made necessary by the expansion and contraction of the long riser. Similarly, all risers should be connected to the mains in the basement by horizontals of about two feet to allow for the expansion and contraction of the mains. A system thus flexibly connected stands in much less danger of developing leaky joints than does one not so connected. For sizes of radiator connections see Table 29, Appendix.

87. General Application:—Figs. 65, 66 and 67 show the typical layout of a hot water plant. Due to the similarity between hot water and steam installations, the former only will be designed complete. In attempting the layout of such a system, the very first thing to be done is to decide at what points in the rooms the radiators should be placed. This should be done in conjunction with the owner as he may have particular uses for certain spaces from which radiators are hence excluded. The first actual calculation should be the heat loss from each room, with the proper exposure losses, and the results should be tabulated as the first column of a table similar to Table XII. In the example here given, this loss is the same as, and taken from, the table of computations for the furnace work, Art. 48, the house plans being identical. The second column of Table XII, as indicated, is the square feet of radiation; and since this is a hot water, direct radiation system, it is obtained by taking .006 of the items in the first column according to formula 30. Knowing this, a type and height of radiator can be selected, and the number of sections determined by Table X. Next obtain the lengths of radiators by multiplying the number of sections by the total thickness of the sections, as given in Table X, and determine whether or not the radiator of such a length will fit into the chosen space. If not, then a radiator of greater height and larger surface per section must be selected. Riser sizes and connections may be taken according to Tables 31 and 29 respectively. The column of Table XII headed "Radiators Installed" gives first the number of sections; second, the height in inches; and third, the number of columns or type of the section.

Locate radiators on the second floor and transfer the location of their riser positions to first floor plan, then to the basement plan. Locate radiators on the first floor and transfer their riser locations to the basement plan, which will then show, by small circles, the points at which all risers start upward. This arrangement will aid greatly in the planning of the basement mains.

The keynotes in the layout of the basement mains should be simplicity and directness. If the riser positions show approximately an even distribution all around the basement, it may be advisable to run the mains in

complete circuits around the basement. If, again, the riser positions show aggregation at two or three localities, then two or three mains running directly to these localities would be most desirable. As an example, take the application shown here. The basement plan shows three clusters of riser ends, one under the kitchen, another under the study, and a third on the west side of the house. This condition immediately suggests three principal mains, as shown. The main toward the kitchen supplies the bath, chamber 4 and the kitchen, making a total of 131 square feet. Being only about 13 feet long, it would readily carry this radiation if of 2 inch diameter. See Table 34, Appendix. The main to the study and the hall supplies chamber 1, the hall and the study, making a total of 221 square feet, which can be carried by a $2\frac{1}{2}$ inch pipe. The main to the west side of the house supplies chamber 2, chamber 3, the sitting room and the dining room, a total of 249 square feet, which would almost require a 3 inch main, according to the table, were it not for its comparatively short length. A $2\frac{1}{2}$ inch pipe would amply supply this condition.

In hot water work, as well as in steam, it is customary to take the connections to flow risers from the top of the mains, thus aiding the natural circulation, Fig. 35. If not taken directly from the top of the main, it is often taken at about 45 degrees from the top. This arrangement, with a short nipple, a 45 degree elbow, and the horizontal connection about $1\frac{1}{2}$ to 2 feet long, makes a joint of sufficient flexibility between the main and riser to avoid expansion troubles.

In the selection of a heater or boiler much that has been said concerning furnaces applies. The heater or boiler should, above all, have ample grate area, checked on a B. t. u. basis, and should have a sufficient heating surface so designed that the heated gases from the fire impinge perpendicularly upon it as often as may be without seriously reducing the draft. As shown by the total of the radiation column, a hot water boiler should be selected of such rated capacity as to include the loss from the mains and risers. Since this loss is usually taken from 20 to 30 per cent., depending upon the thoroughness with which the basement mains are insulated, the heater for this house should have a rated capacity of not less than 720 square feet of radiation.

TABLE XII.

	Heat loss, H , from Table IX	Rad'or surface $R = .006H$	Radiators installed		Lengths of rad'or installed		Riser sizes		Rad'or con- nection sizes
			Pressed	Cast	Pressed	Cast	Flow	Return	
Sitting R.....	14000	84	15-32-3	14-44-3	34	42	1½	1½	1½
Dining R.....	10800	65	14-26-3	18-26-3	32	54	1¼	1¼	1¼
Study	13250	80	32-14-3	20-14-F	72	60	1½	1½	1½
Kitchen.....	11900	70	12-32-3	8 -45-4	26	24	1½	1½	1½
Rec'p'n Hall ...	14000	84	15-32-3	14-44-3	34	42	1½	1½	1½
Chamber 1.....	9400	57	13-26-3	16-26-3	30	48	1¼	1¼	1¼
Chamber 2.....	9850	60	13-26-3	16-26-3	30	48	1¼	1¼	1¼
Chamber 3.....	6600	40	10-26-3	12-26-3	23	36	1	1	1
Chamber 4.....	5600	35	10-26-3	12-26-3	23	36	1	1	1
Bath.....	4400	26	6-26-3	7-26-3	14	21	1	1	1
		601							

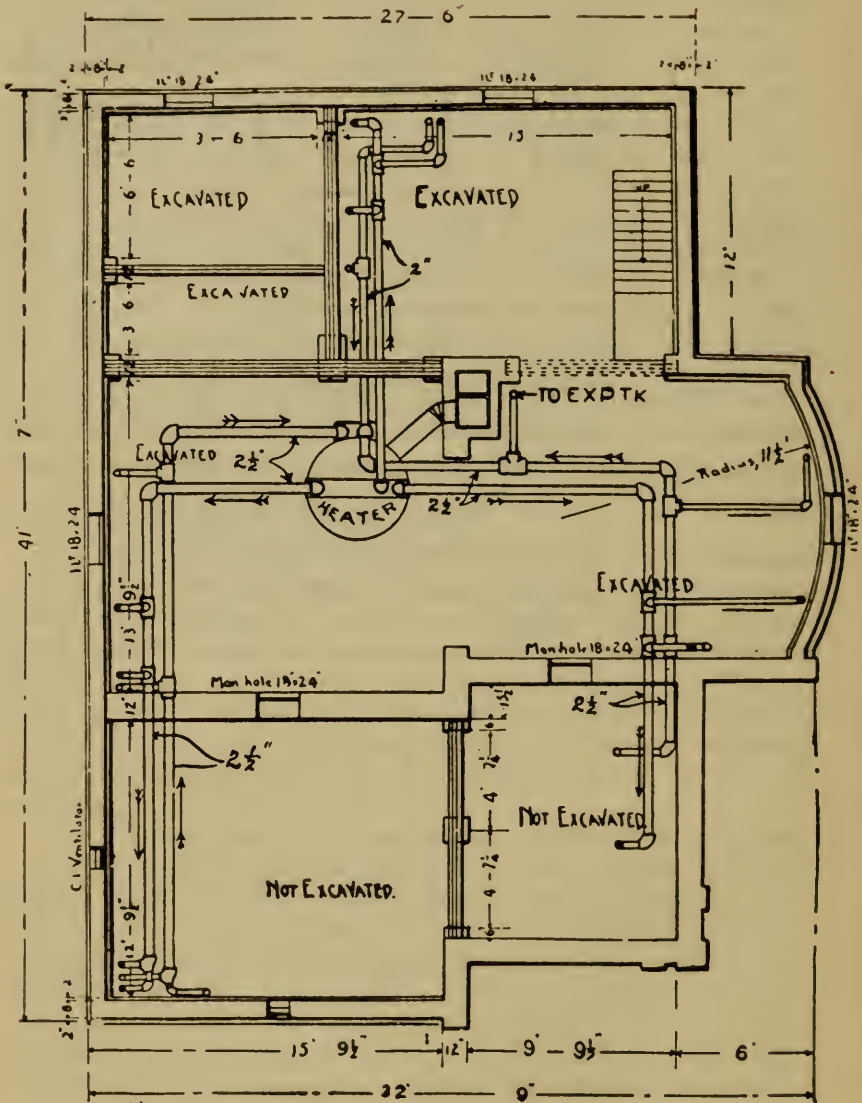

FOUNDATION PLAN.
Ceiling 6'.

Fig. 65.

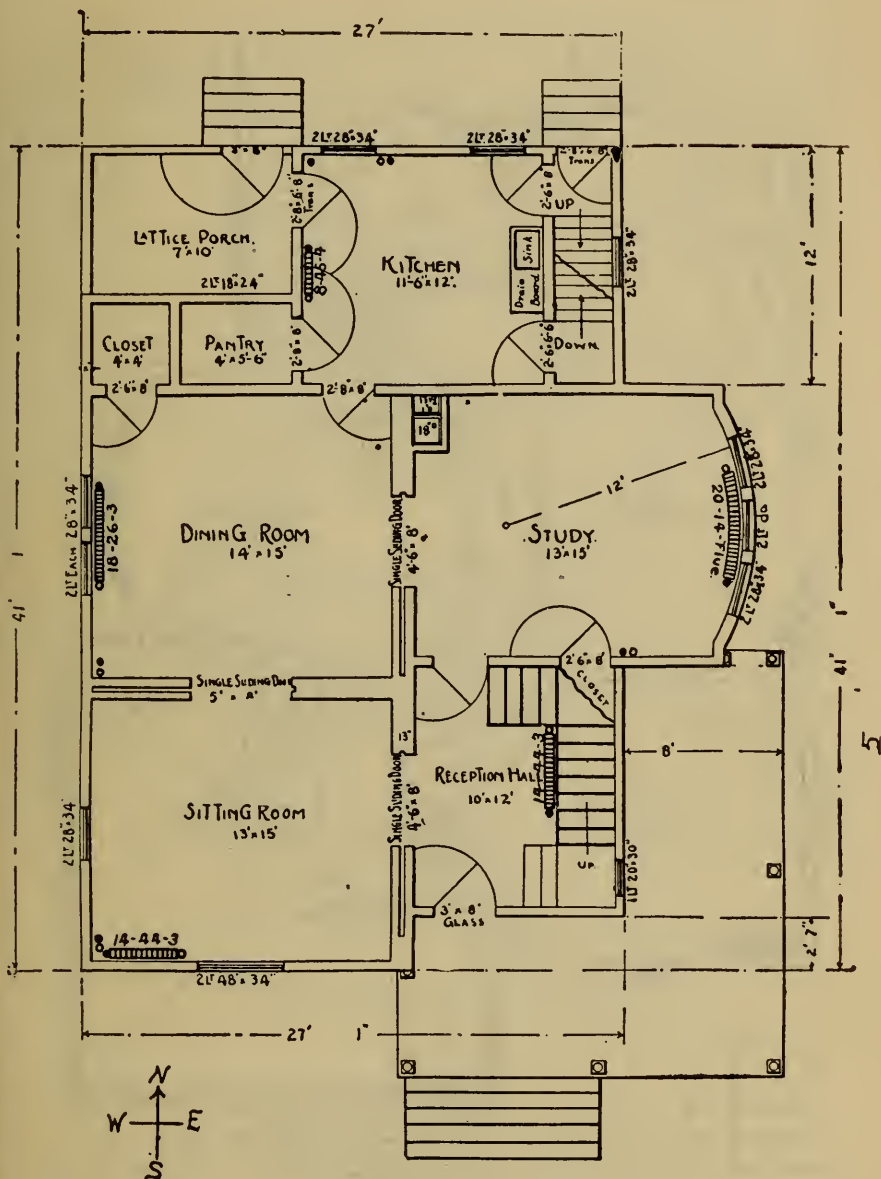

FIRST FLOOR PLAN.

Ceiling 10'.

Fig. 66.

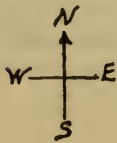
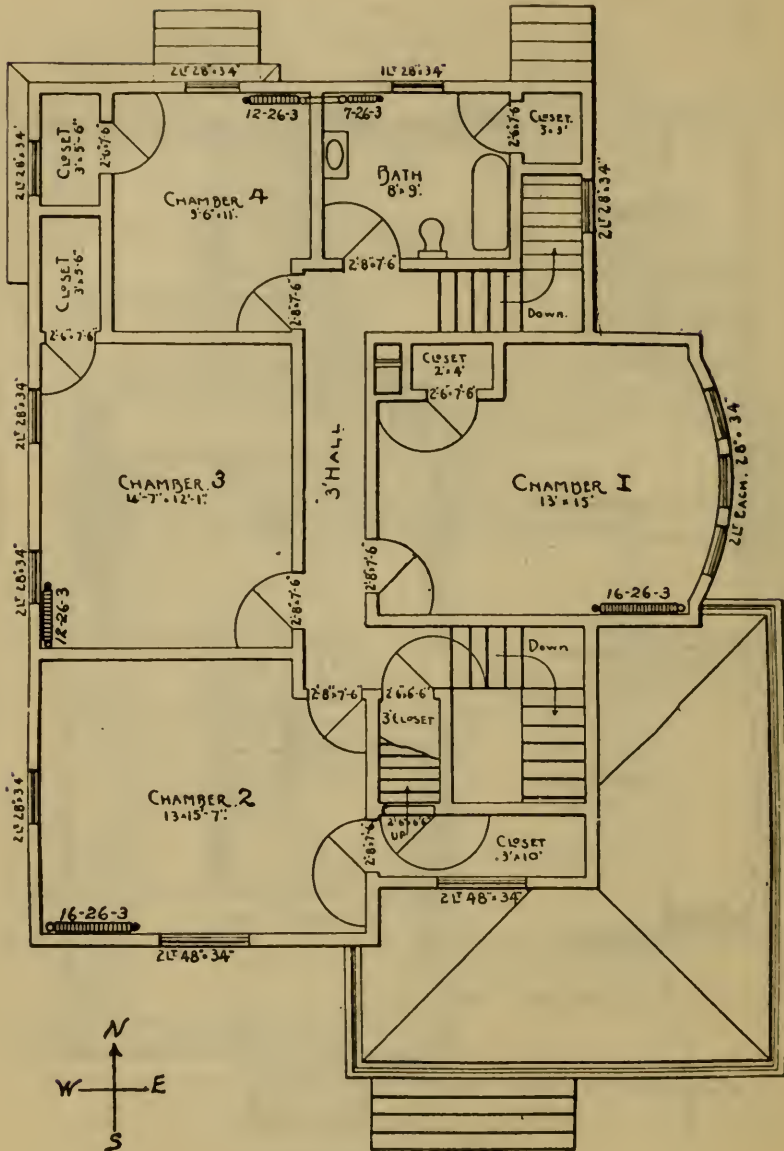

SECOND FLOOR PLAN.

Ceiling 9'.

Fig. 67.

one square foot of the average wrought iron pipe is from 2 to 2.2 B. t. u. per hour, per degree difference of temperature between the inside and the outside of the pipe. Assuming the minimum value, and also that the pipe is fairly well protected from air currents, the heat loss is, with steam at 100 pounds gage and 80 degrees temperature of the air, $(338 - 80) \times 2 = 516$ B. t. u. per hour. With steam at 50, 25 and 10 pounds gage respectively this will be 436, 374 and 320 B. t. u. If the pipe were located in moving air, this loss would be much increased. It is safe to say that the average low pressure steam pipe, when unprotected, will lose between 350 and 400 B. t. u. per square foot per hour. Taking the average of these two values and applying it to a six inch pipe 100 feet in length, for a period of 240 days at 20 hours a day, we have a heat loss of $171 \times 375 \times 240 \times 20 = 307800000$ B. t. u. With coal at 13000 B. t. u. per pound and a furnace efficiency of 60 per cent. this will be equivalent to 39461 pounds of coal, which at \$2.00 per ton will amount to \$39.46. From tests that have been run on the best grades of pipe insulation, it is shown that 80 to 85 per cent. of this heat loss could be saved. Taking the lower value we would have a financial saving of \$31.56 where the covering is used. Now if a good grade of pipe covering, installed on the pipe, is worth \$35.00, the saving in one year's time would nearly pay for the covering.

To be effective, insulation should be porous but should be protected from air circulation. Small voids filled with still air make the best insulating material. Hence, hair felt, mineral wool, eiderdown and other loosely woven materials are very efficient. Some of these materials, however, disintegrate after a time and fall to the bottom of the pipe, leaving the upper part of the pipe comparatively free. Many patented coverings have good insulating qualities as well as permanency. Most patented coverings are one inch in thickness and may or may not fit closely to the pipe. A good arrangement is to select a covering one size larger than the pipe and set this off from the pipe by spacer rings. This air space between the pipe and the patented covering is a good insulator itself. Table 45, Appendix, gives the results of a series of experiments on pipe covering, obtained at Cornell University under the direction of Professor Carpenter. These values are probably as nearly standard as may be had. (See Art. 138 for conduits.)

89. Water Hammer:—When steam is admitted to a cold pipe, or to a pipe that is full of water, it is suddenly condensed and causes a sharp cracking noise. The concussion produced by this condensation may become so severe as to crack the fittings and open up the joints. The noise is due to a sudden rush of water in an endeavor to fill the vacuum produced by the condensed steam. Steam at atmospheric pressure occupies 1644 times the volume of the water that formed it, hence, by suddenly condensing it, a very high vacuum may be produced. This action causes a relatively high velocity in any body of water adjacent to it. The worst condition is found when a quantity of steam enters a pipe filled with water. Condensation suddenly takes place and the two bodies of water come together with high velocity causing severe concussion. Steam should always be admitted to a cold pipe, or to one filled with water, very slowly.

90. Returning the Water of Condensation, in a Low Pressure Steam Heating System, to the Boiler:—In re-

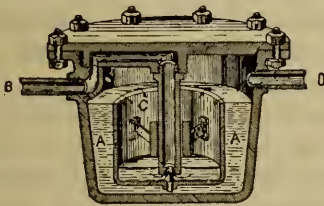

Fig. 68.

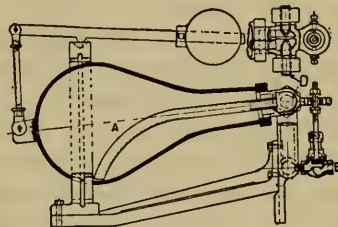

Fig. 69.

turning the water of condensation to the boiler four methods are in use; gravity, steam traps, steam loops and steam or electric pumps. The *gravity system* is the simplest and is used in all cases where the radiation is above the level of the boiler and where the boiler pressure is used in the mains. In a gravity return, no special valves or fittings are necessary, but a free path with the least amount of friction in it is provided between the radiators and a point on the boiler below the water line. No traps of any kind should be placed in this return circuit.

All radiation should be placed *at least* 18 inches above the water line of the boiler to insure that the water will not back up in the return line and flood the lower radiators.

This flooding is usually the result of a restricted steam main. When the radiation is below the water line, or where the pressure in the mains is less than that in the boiler, some form of *steam-trap* or motor pump must be put in with special provision for returning this water to the boiler. Two kinds of traps may be had, low pressure and high pressure. The first is well represented by the bucket trap, Fig. 68, and the second, by the Bundy trap, Fig. 69. The action of these traps is as follows. Bucket trap.—Water enters at *D* and collects around the bucket, which is buoyed up against the valve. The water collects and overflows the bucket until the combined weight of the water and bucket overbalances the buoyancy of the water. The bucket then drops and the steam pressure upon the inside, acting upon the surface of the water, forces it out through the valve and central stem to the outlet *B*. When a certain amount of this water has been ejected, the bucket again rises and closes the valve. This action is continuous. Bundy trap.—Water enters at *D* through the central stem and collects in the bowl *A*, which is held in its upper position by a balanced weight. When the water collects in the bowl sufficiently to lift the weight, the bowl drops, the valve *E* opens, and steam is admitted to the bowl, thus forcing the water out through the curved pipe and the valve *E*. This action is continuous.

Each trap is capable of lifting the water approximately 2.4 feet for each pound of differential pressure. Thus, for a pressure of 5 pounds gage within the boiler and 2 pounds gage on the return, the water may be lifted 7 feet above the trap, or say, to the top of an ordinary boiler. This is not sufficient, however, to admit the water into the boiler against the pressure of the steam. A receiver should be placed here to catch the water from the separating trap and deliver it to a second trap above the boiler which, in turn, feeds the boiler. Live steam is piped from the boiler to each trap, but the steam supply to the lower trap is throttled, to give only enough pressure to lift the water into the receiver. A system connected up in this way is shown in Fig. 70. Traps which receive the water of condensation for the purpose of feeding the boiler are called return traps and sometimes work under a higher pressure of steam than the separating traps. Many different kinds of traps are in general use but these will illustrate the principle of returning the condensation to the boiler.

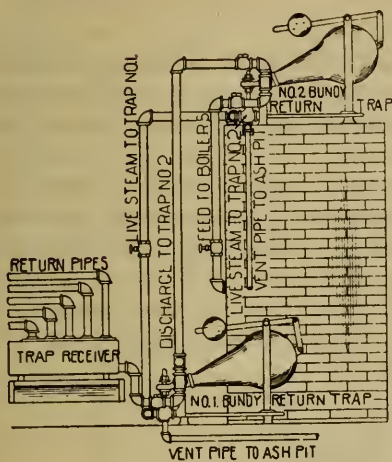

Fig. 70.

A very simple arrangement, and yet a very difficult one to operate satisfactorily, is by the use of the *steam loop*, Fig. 71. The water of condensation from the radiators drains to the receiver *A*, which is in direct communication with the riser *B*. The drop leg *D*, being in communication with the boiler through a check valve which opens toward the boiler at the lowest point, is filled with water to the point *X*, sufficiently high above the water line of the boiler that

the static head balances the differential pressure between the steam in the boiler and that in the condenser. The horizontal run of pipe *C* serves as a condenser and, in producing a partial vacuum, lifts the water from the receiver. This water is not lifted as a solid body, but as slugs of water interspersed with quantities of steam and vapor. The water in *A* is at or near the boiling point and the reduced pressure in *B* reevaporates a portion of it which, in rising as a vapor, assists in carrying the rest of the water over the goose-neck. When the condensation in *D* rises above the point *X*, the static pressure overbalances the differential steam pressure, and water is fed to the boiler through the check.

To find the location of the point *X*, above the water line in the boiler, the following will illustrate. Let the pressures in the boiler, condenser and receiver be respectively 5, 2 and 4 pounds gage, then the differential pressure between the boiler and condenser is 3 pounds per square inch. If the weight of one cubic foot of water at 212 degrees is 59.76 pounds, then the pressure is .42 pounds per square inch for each foot in height. Stated in other words, one pound differential pressure will sustain 2.4 feet of water. With a pressure difference of 3 pounds, this gives $3 \div .42 = 7.2$ feet from the water level in the boiler to the point *X*, not taking into account the friction of the piping and check which would vary from 10 to 30 per cent. Assuming this

friction to be 20 per cent. we have $7.2 \div .80 = 9$ feet of head to produce motion of the water.

The length of the riser pipe *B* and its diameter, depend upon the differential pressure between the condenser and the receiver, and upon the rapidity of condensation in the horizontal.

With a differential pressure of 2 pounds this would suspend $2 \times 2.4 = 4.8$ feet of solid water. The specific gravity, however, of the mixture in this pipe is much less than that of solid water. For the sake of argument let this specific gravity be 20 per cent. of that of solid water, then we would

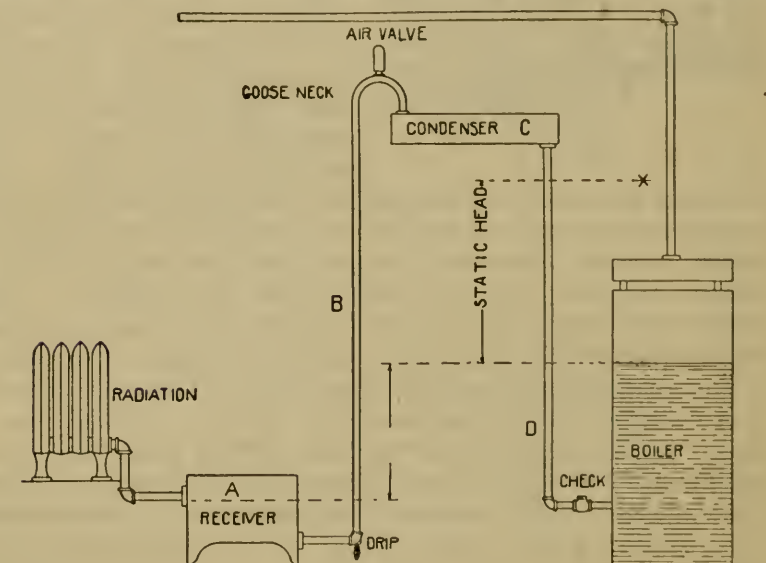

Fig. 71.

have a possible lift, not including friction, of $5 \times 4.8 = 24$ feet. This is $24 - 9 = 15$ feet below the water level in the boiler. The diameter of the riser may vary for different plants, but for any given plant the range of diameters is very limited. These, as has been stated, are usually found by experiment.

A drain cock should be placed in the receiver at the lowest point. When cold water has collected in the receiver it is necessary to drain this water to the sewer before the loop will work. An air valve should be placed at the top of the goose-neck to draw off the air. If the horizontal pipe is filled with air, there will be no condensation and the loop will refuse to work. Never connect a steam loop to a boiler

in connection with a pump or any other boiler feeder. To determine whether a loop is working or not, place the hand on the horizontal pipe. If this is cold it is not working.

The last method mentioned for feeding condensation to the boiler was by the use of a *steam* or *electric pump*. The operation of the steam pump is fully discussed in Art. 92. An electric motor-pump with its receiver and pipe connections is shown in Fig. 72. Its operation is very similar to that of the steam pump. When the returning condensation

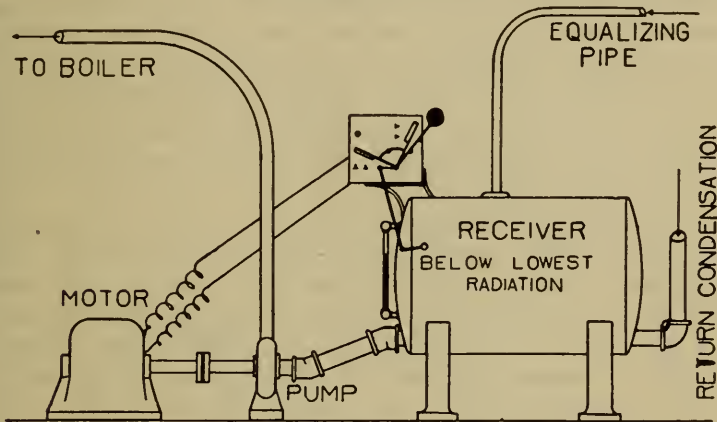

Fig. 72.

fills the receiver to a certain point a float regulator starts the motor and pumps the water from the receiver to the boiler. When the water level drops the operation is reversed and the pump is automatically stopped. The motor pump is used especially on low pressure heating systems where the water of condensation from the coils and radiators drains below the boiler. If the boiler pressure were high then the ordinary steam pump would be used. Where the pressure within the boiler, however, is near that in the return main the operation of such a piece of apparatus is less expensive than that of the steam pump.

91. Suggestions for Operating Hot Water Heaters and Steam Boilers:—Before firing up in the morning, examine the pressure gage to see if the system is full of water. If there be any doubt, inspect the water level in the expansion tank. If it is a steam system, examine the gage glass and try the cocks to see if there is sufficient water in the boiler.

See that all valves on the water lines are open. On the steam system try the safety valve to make sure that it is free. Also see if the pressure gage stands at zero.

Clean the fire and sprinkle over it a small amount of fresh coal.

Open up the drafts and when the fire is burning well fill up with coal.

In starting a fire under a cold boiler it should not be forced, but should warm up gradually.

Hard coal may be thrown evenly over the fire. Soft coal should be banked in front on the grate, until the gases are driven off. It is then distributed back over the fire.

The thickness of the fire will vary from four inches to one foot depending upon the draft and the kind of coal.

Clean the fire when it has burned low, partially closing the drafts while cleaning.

In a boiler or heater, using the water over continuously, there will be little need of cleaning out the inside. In a system using fresh water continuously, however, the boiler should be blown off and cleaned about once or twice a month. Never blow off a boiler while hot or under heavy pressure.

In every system the heater or boiler should be thoroughly overhauled and cleaned before firing up in the fall.

Keep the ash pit clean and protect the grates from burning out.

Keep the tubes and gas passages clean and free from soot.

Inspect the pressure gage, glass gage, water cocks and thermometers frequently.

In case of low water in a steam system, cover the fire with wet ashes or coal and close all the drafts. Do not open the safety valve. Do not feed water to the boiler. Do not draw the fire. Keep the conditions such as to avoid any sudden shock. After the steam pressure has dropped, draw the fire.

Excessive pressure may be caused by the sticking of the safety valve in the steam system, or by the stoppage of the water line to the expansion tank in the hot water system. The safety valve should never be allowed to lime up, and the expansion tank should always be open to the heater and to the overflow.

When leaving the fires for the night, push them to the rear of the grate and bank them as stated in Art. 59.

References on Hot Water and Steam.

TECHNICAL BOOKS.

Snow, *Principles of Heat.*, Chap. IX, X. I. C. S., *Prin. of Heat. and Vent.*, p. 1185, 1091. Monroe, *Steam Heat. & Vent.*, p. 13. Lawler, *Hot Water Heating*, p. 19. Carpenter, *Heat. & Vent. Bldgs.*, pp. 150, 231. Thompson, *House Heat. by Steam & Water*, p. 15. Hubbard, *Power, Heat. & Vent.*, pages 433, 464, 484, 505, 510.

TECHNICAL PERIODICALS.

Engineering News. Suggestions for Exh't Steam Heat, Apr. 7, 1904, p. 332. An Improved Steam Heat. System, Thermograde System, July 23, 1903, p. 80. Factory System of the United Shoe Machinery Co., W. C. Snow, May 25, 1905, p. 537. Heating a Trolley Car Barn, J. I. Brewer, April 29, 1909, p. 462. *Engineering Review.* Heat. & Vent. of the New Parental Home and School at Flushing, L. I., Jan. 1910, p. 48. A Hot Water System with Radiators and Boiler on the Same Level, J. P. Lisk, Aug. 1908, p. 34. A Hot Water Heat. System for a City Residence, J. P. Lisk, June 1909, p. 44. Hot Water Heat. Apparatus in Plymouth Church, Brooklyn, N. Y., Dec. 1908, p. 19. Heat., Vent. and Temperature Regulation in the Measles Pavilion of the Kingston Ave. Hospital, Brooklyn, N. Y., Jan. 1910, p. 35. Heat. and Vent. Plant of the Boston Safe Deposit and Trust Company's Building, C. L. Hubbard, April 1910, p. 37. Heat. and Vent. Installation in the Burnet St. School, Newark, N. J., Jan. 1909, p. 20. A Unique Low Pressure Steam Heat. Apparatus, Feb. 1909, p. 38. Practical Points on Steam Heating (Direct Heating), C. L. Hubbard, Aug. 1908, p. 29. (Indirect Heat.), Sept. 1908, p. 19. (Exhaust Steam Heat.), Nov. 1908, p. 21. Steam Heating Systems, Wm. J. Baldwin, March 1905, p. 7. *Machinery.* Shop Heating by Direct Radiation, C. L. Hubbard, July 1910, p. 884. Sizes of Pipe Mains for Hot Water Heating, C. L. Hubbard, Sept. 1909, p. 38. *The Railway Review.* Heating System of the Scranton St. Railway Shops, June 13, 1908, p. 480. Heating of Passenger Trains, May 23, 1908, p. 408. The Pennsylvania R. R. System of Heat. and Vent. Passenger Cars, Feb. 22, 1908, p. 157. Vent. and Heating of Coaches and Sleeping Cars, July 18, 1908, p. 586. Hot Water Heating Arrangements for Passenger Stations, Oct. 10, 1908, p. 829. Typical Heating Plants, Horace L. Winslow Co., June 18, 1910, p. 596. *The Heating & Ventilating Magazine.* Residence Heating by Direct and Indirect Hot Water, July 1905, p. 25. Carrying Capacities of Pipes in Low Pressure Steam Heating, Wm. Kent, Feb. 1907, p. 7. Standard Sizes of Steam Pipes, Jas. A. Donnelly, Jan. 1907, p. 21. Formula for Pipe Sizes in Hot Water Heating, Oliver H. Schlemmer, Sept. 1907, p. 9. Coefficient of Transmission in Cast Iron Radiation, John R. Allen, Aug. 1908, p. 20. Relative Capacities of Pipes, John Jaeger, May 1907, p. 1. Methods of Figuring Radiation, Gerard W. Stanton, Dec. 1907, p. 1. Computation of Radiating Surface, J. Byers Holbrook, Nov. 1904, p. 77. Coefficients of Heat Transmission, John R. Allen, July 1911. *Domestic Engineering.* A Practical Manual of Steam and Hot Water Heating, E. R. Pierce, (Series of Articles), Vol. 51, No. 2, April 9, 1910; Vol. 53, No. 9, Nov. 26, 1910. Proportions and Power of Low Pressure Heating Boilers, Vol. 47, No. 11, June 12, 1909, p. 319. How to Install and Cover a Steam or Hot Water Main, "Phoenix," Vol. 46, No. 10, March 6, 1909, p. 278. How to

Secure Correct Pipe Sizes for Low Pressure Steam Heating, E. K. Monroe, Vol. 45, No. 9, Nov. 28, 1908, p. 243. Rules for Proportioning Indirect Heating Plants, R. T. Crane, Vol. 49, No. 6, Nov. 6, 1909, p. 143. *Trans. A. S. H. & V. E.* Circulation of Hot Water, J. S. Brennan, Vol. XI, p. 93. Residence Heating by Direct and Indirect Hot Water, E. F. Capron, Vol. XI, p. 174. Standard Sizes of Steam Mains, J. A. Donnelly, Vol. XIII, p. 43. The Carrying Capacity of Pipes in Low Pressure Steam Heating, Wm. Kent, Vol. XIII, p. 54. Heating and Ventilating a Group of Public Schools, S. R. Lewis, Vol. XIII, p. 187. The Combined Pressure and Vacuum Systems of Steam Heating, G. Hoffman, Vol. XIII, p. 223. Sizes of Return Pipes in Steam Heating Apparatus, J. A. Donnelly, Vol. XII, p. 109. Proportioning Hot Water Radiation in Combination Systems of Hot Water and Hot Air Heating, R. C. Carpenter, Vol. VII, p. 132. Tests of Radiators with Superheated Steam, R. C. Carpenter, Vol. VII, p. 206. Relative Economy of Steam, Vapor, Vacuum and Hot Water Heating for Residences, Vol. XII, p. 341. The Relation between the Completeness of Air Removal and the Efficiency of Steam Radiators, Vol. XII, p. 315. Measurements of Wall Radiators, Vol. XII, p. 361. Advantages of Standard Dimensions of Radiator Valves and Connections, Vol. XIII, p. 145. The Relative Healthfulness of Direct and Indirect Heating Systems, Vol. XIII, p. 136. Improving the Heating Capacity of a Radiator by an Electric Fan, Vol. VIII, p. 222. *Engineering Record.* Mechanical Plant of the Harvard Medical School, No. 2, Aug. 7, 1909. Mechanical Equipment of the Hotel LaSalle, Chicago, Sept. 11, 1909. Mechanical Plant of the Washington Municipal Bldg., Oct. 30, 1909. Heating and Ventilation of the Museum of Fine Arts, Boston, Nov. 13, 1909. Heating Plant for a Railway Storehouse, Dec. 18, 1909. Heating and Ventilation of the Hotel Plaza, N. Y., Mar. 13 and Mar. 20, 1909. Central Heating and Lighting Plant for the United States Military Academy, May 1, May 8 and May 15, 1900. *Electric Railway Journal.* Heating System in Car House of Toronto & York Radial Railway, March 26, 1910, p. 543. The Elevated Shops and Terminals of the Brooklyn Rapid Transit Co.—Organization and General Layout at East New York, Feb. 2, 1907, p. 170. The Elevated Shops and Terminals of the Brooklyn Rapid Transit Co.—The Thirty-sixth St. Inspection Plant, March 9, 1907, p. 406. *The Metal Worker.* Unstable Water Lines in Steam Boilers, March 26, 1910, p. 429. Air Venting Hot Water Systems, June 4, 1910, p. 755. Heating Swimming Pool, June 25, 1910, p. 854. Air Venting Steam Systems, July 9, 1910, p. 30. Heating and Ventilating Six Room School Building, Oct. 23 1909, p. 45. Steam Heating in a Cottage, July 11, 1908, p. 45. Indirect Hot Water Heating in Residence, Oct. 24, 1908, p. 43. Hot Water Heating in a Factory in Hoboken, N. J., April 4, 1908, p. 39. *Power.* Economics of Hot Water Heating, Ira N. Evans, Sept. 12, 1911. Hot Water Heating for Institutions, Ira N. Evans, May 14, 1912. Forced Circulation in Hot Water Heating, Charles L. Hubbard, Dec. 20, 1912; Nov. 15, 1912.

CHAPTER IX.

MECHANICAL VACUUM, STEAM HEATING SYSTEMS.

92. In Addition to the Brief Discussion of vacuum steam heating as found in Art. 69, it will be well to discuss more in detail the various systems by which this heating is accomplished. The advantages to be derived by the positive withdrawal of the air and the condensation from the radiators and pipes, compared to the natural circulation of the gravity system, are now too well established to need much discussion. Mains and returns that are too small, horizontal runs of piping that are unevenly laid so as to form air and water pockets, radiators that are only partially heated because of the entrapped air, leaking air and radiator valves, radiators partially filled with condensation and all the accompanying cracking and pounding throughout many of the gravity systems, are sufficient causes to demand a cure, if such cure can be found. One should not understand by this statement that every mechanical vacuum system is a cure for all the ills in the heating work, for even these systems may be improperly designed. The steam pipes may be too small to supply the radiators, although smaller pipes may be used in this than in the gravity work, the valves may be defective, or the vacuum specialties may be inefficient. Most of the defects in the average plant, however, are because of imperfections in that part of the system from the radiator to the boiler, and all of the first class vacuum systems are planned to meet just these conditions.

Vacuum systems have other advantages over the gravity work, the principal one being that of lifting the return condensation to a higher level. This is noticeable in the placing of radiators or coils in basement rooms. Another very important advantage is in the laying out of the heating coils for shop buildings and manufacturing plants. Low pressure gravity coils are limited to a length of about 75 feet. Usually the condensation in a long coil of this kind is very great and requires extra heavy pressure on the steam end to circulate it. The steam follows the line of least resistance

and forces the air out of certain pipes and permits it to remain in others, the differential pressure not being great enough to eliminate all the air and heat the pipes uniformly. As a result of these conditions some of the pipes remain cold and ineffective as prime radiating surface. A vacuum system, with its positive circulation, increases the differential pressure, removes the air and gives uniform heating effect in coils that are several times as long as can be safely supplied by the gravity system. The accumulation of air in the radiators and coils is especially noticeable in systems using exhaust steam.

When exhaust steam from engines or turbines is used in a gravity heating system, the back pressure is carried from atmospheric pressure to 10 pounds gage. With the application of the vacuum system it is possible to maintain this constantly at about atmospheric pressure. It is claimed by some, that it is possible to reduce the pressure in the radiators to such a degree that the pressure in the supply mains will fall considerably below atmosphere. No doubt the specialty valves may be set so as to do this, but it would scarcely be considered an economical arrangement.

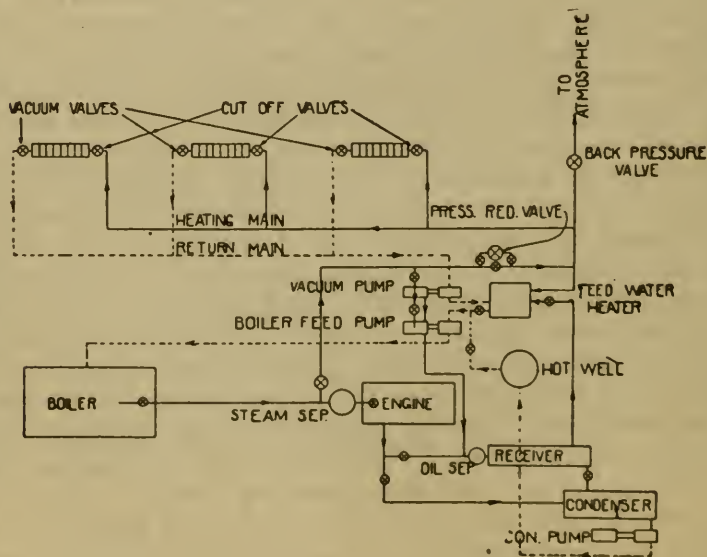

Fig. 73.

The principal features of a mechanical vacuum system are shown in Fig. 73. Live steam is conducted to the engine and to the heating main, the latter through a pressure reducing valve to be used only when exhaust steam is insufficient. The exhaust steam from the engines and pumps is conducted to the heating main and to the feed water heater. The exhaust steam line opens to the atmosphere through a back pressure valve which is set at the desired pressure for the supply steam. An oil separator shown on the exhaust steam line removes the oil and delivers it to an oil trap. At the entrance to the feed water heater, the exhaust steam passes through a series of baffle plates which remove the oil and entrained water from that part of the steam which enters the heater. A boiler feed pump and a vacuum pump, with the attending valves and governing appliances, complete the power room equipment. The steam supply to the heating system is piped to radiators and coils in the ordinary way, with or without temperature control. A thermostatic valve, or patented motor valve, is placed at the return end of each radiator and coil and these returns are then brought together in a common return which leads to a vacuum pump or ejector. The return pipe and specialty valve for any one unit is usually $\frac{1}{2}$ inch. The combined return increases in size as more radiation is taken on. Horizontal steam mains usually terminate in a drop leg which is tapped to the return 8 to 15 inches above the bottom of the leg. Each rise in the system has a drop leg at the lower end of the rise. These points and all other points where condensation may collect are drained through specialty valves to the return. Water supply systems may be tapped for steam and return condensation the same as any ordinary radiator. Steam is carried in the main at about atmospheric pressure, and just enough vacuum is maintained on the return to insure positive and noiseless circulation. In many cases where special lifts are required, these return systems are run under a negative pressure of 6 to 10 inches of mercury. Under such conditions water may be lifted from 6 to 10 feet. Either closed or opened feed water heaters may be used with the layout as given. (For comparative sizes of gravity and vacuum returns see Table 38, Appendix.)

Fig. 74 shows a section through the Marsh *vacuum pump* which represents a type very generally used in this work.

It will be noticed that this pump has a steam operated valve. The automatic governing feature of this valve tends to

equalize the cylinder pressure to meet the varying resistance in the main return of the heating system. Such a pump is handling alternately solid water and vapors, hence there is great tendency of the ordinary pump to race and pound at such times.

In its operation the steam enters at *A* and passes into the space *B* through the annular opening *C* between the reduced neck of the valve and

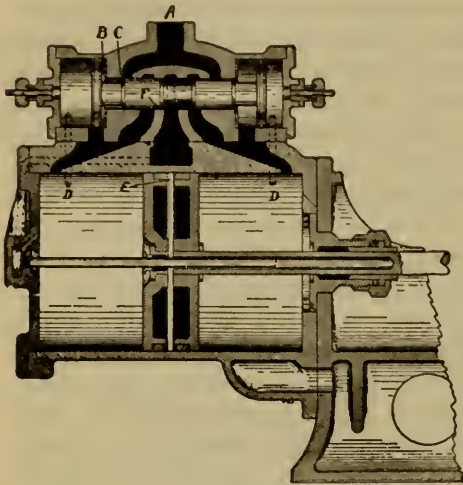

Fig. 74.

the bore of the first chest wall. It is thus projected against the inside surface of the valve head before entering into the port and passing to the cylinder. On reaching the cylinder and driving the piston to the right, the reaction of the steam through port *D* to the opposite side of the valve head, tends to further open the steam port *C*. The valve then holds a position depending upon the relative strength of the forces which tend to move it in opposite directions, i. e., admission steam which tends to close the valve, and the cylinder steam which tends to open the valve. This is the governing feature. It will be noticed that the pump piston is in two parts and carries steam at admission pressure upon the inside. This steam is admitted along the dotted line to the center of the cylinder head, thence through a small tube and packing box to the hollow piston rod, which has a direct connection with the center of the piston. When the piston has moved sufficiently to bring the central space *E* in line with the duct *D*, steam is admitted to the right of the piston valve thus forcing it back, cutting off the steam at *C*, opening up the exhaust to the atmosphere through *F* and admitting steam to the other end of the cylinder. The action is thus reversed and continuous. Eject-

tors operated by steam, water and electricity are also used to produce a vacuum. No comparison is made here of the various systems of producing vacuum since each gives satisfaction when properly installed. In each case there is a loss of energy but this loss is amply repaid in the added benefits.

Several patented systems of mechanical vacuum heating are now upon the market. These are in large measure an outgrowth of the original Williames System, patented in 1882. Each system is well represented by the above diagram in all particulars concerning the steam and water circulation. The chief difference between them is in the thermostatic or motor connection at the entrance to each individual return.

93. Webster System:—In this system a pump is used to produce the vacuum. A special fitting, called a *water-seal motor*, or *thermostatic valve*, is used on all radiators, coils and drainage points. Fig. 75 shows a section of one of the motor valves. Other models are constructed so as to have the outlet in a horizontal direction, either parallel with or 90 degrees to the inlet. Fig. 76 shows an application of this to a radiator or coil. The *dirt strainer* is usually placed between the radiator or coil and the motor valve. This strainer

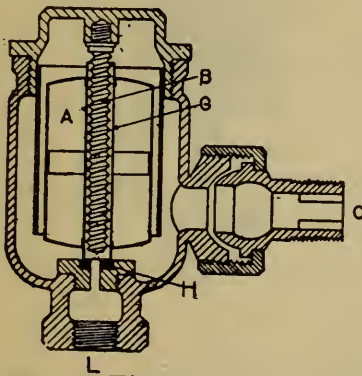

Fig. 75.

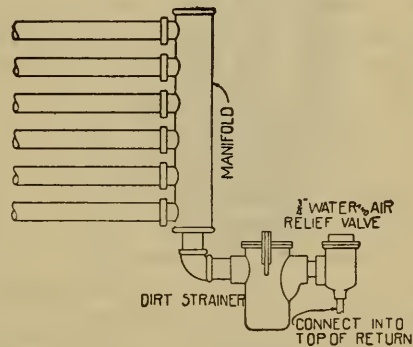

Fig. 76.

collects the dirt and protects from clogging the motor valve. *C* attaches to the return end of the radiator or coil and *L* leads to the vacuum pump. *G* is the central tube, the lower end of which is a valve. *A* is a hollow cylindrical copper float, the central tube of which fits loosely over spindle *B*.

The function of the cylinder *A* is to raise the tube *G* from the seat *H* and open the discharge to the pump. Ordinarily, the float is down and the central tube valve is resting upon the seat and cuts off communication with the radiator, excepting as air may be drawn from the radiator down the central tube around the spiral plug. The water of condensation accumulating in the radiator or coil passes into the chamber *E*, sealing the valve, and when sufficient water has accumulated to lift the float, it opens a passageway for a certain amount of the water to be withdrawn to the return. When this water becomes lowered sufficiently, the valve again seats itself and the cycle is completed. This action continues as long as water is present in the radiator. These motor valves are made of three sizes, $\frac{1}{2}$ inch, $\frac{3}{4}$ inch and 1 inch. The first is the standard size and has a capacity of approximately 200 feet of radiation.

Fig. 77 shows *thermostatic valves*. It will be seen that the automatic feature in *a* is the compound rubber stalk, which expands and contracts under heat and cold. The

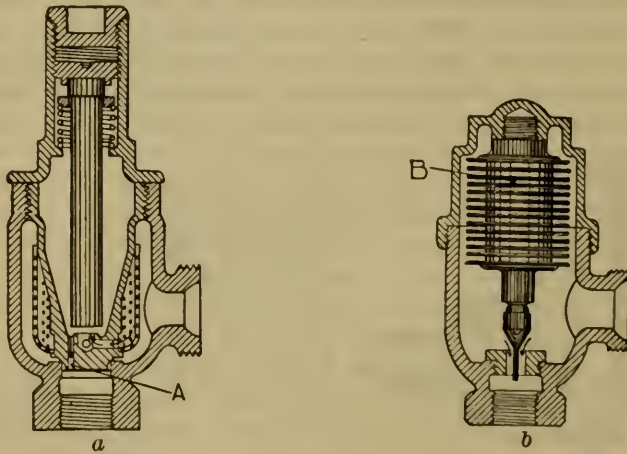

Fig. 77.

adjusting screw at the top permits the valve to be set for any conditions of temperature and pressure within the radiator. The water of condensation passes through a screen and comes in contact with the rubber stalk. The temperature of the water being less than that of steam the stalk contracts and the water is drawn through the opening *A* by the action of the pump. As soon as the water has been re-

moved, steam flows around the stalk and expands until it closes the seat. This process is a continuous one and automatically removes the water from the radiator. The screen serves the purpose of the dirt strainer as mentioned above. Fig. 77, *b*, shows a siphon arrangement where the movement of the valve is obtained by the expansion and contraction of the fluid inside the bellows.

A *suction strainer*, which is very similar to the dirt strainer only larger in capacity, is placed upon the return line next the pump. This fitting usually has a cold water connection to be used at times to assist in producing a more perfect vacuum. The piping system for the automatic control of the vacuum pump is shown in Fig. 78. It will be

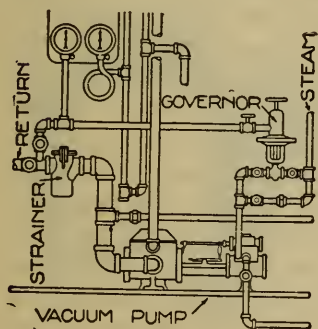

Fig. 78.

seen that the vacuum in the return operates through the governor to regulate the steam supply to the pump cylinder, thus controlling the speed of the pump.

Occasionally it is desirable to have certain parts of the heating system under a different vacuum. An illustration of this would be where the radiators within the building were run under a negative pressure of about one pound, and a set of heating coils

in the basement were to be carried under a negative pressure

of four pounds. The Webster System, type *D*, Fig. 79, meets this condition. The exact difference between the suction pressure and the pressure in the radiators can be varied to suit any condition by the controller valve. A trap and a controller valve should be applied to each line having a different

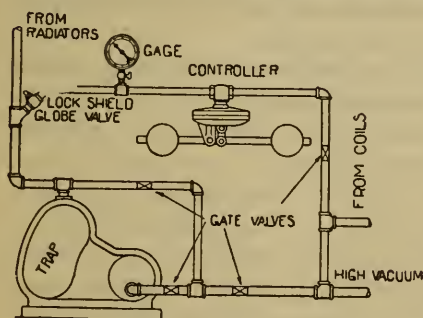

Fig. 79.

pressure from that in the suction line.

A *modulation valve*, for graduating the steam supply to the radiator, has been designed by this Company and may be applied to any Webster Heating System to assist in its

regulation. This modulation valve serves to graduate the steam supply to the radiators so that the pressure may be maintained at any point to suit the required heat loss from the building.

94. Van Auken System:—In this system, as in the previous one, the vacuum in the return main is produced by a vacuum pump which is controlled by a specially designed governor. The automatic valves which are placed on the radiators, coils and other drainage points along the system, are called *Belvac Thermofiers*, and are shown in section by Fig. 80. This valve is automatic and removes the water of

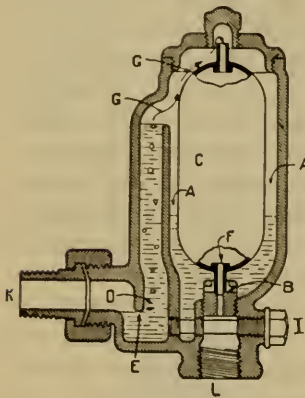

Fig. 80.

condensation by the controlling action of a float. It is connected to the radiator or coil at *K* and to the vacuum return pipe at *L*. The water of condensation is drawn through the return pipe into chamber *D* until it reaches the inverted weir *E* which gives it a water seal. It is thence drawn upward into space *D* until it overflows into the float chamber *A*, where it accumulates until the line of flotation is reached. When the float *C* lifts, the valve seat at *B* opens and allows the water to escape into the vacuum return pipe.

After the removal of the water the float again settles on seat *B* until sufficient water accumulates in the float chamber to again lift it, when the cycle is repeated.

The air contained in the radiators or coils is drawn through the return and up through chamber *D* into the top of the float chamber. Here its direction follows arrows *G G*, being drawn through the small opening in the guide-pin at *F*, down through the hollow body of the copper float and valve seat *B*, into the vacuum return. This removal of air is continuous regardless of the amount of water present. The by-pass *I*, when open, allows all dirt, coarse sand or scale to pass directly into the vacuum return, thus cleaning the valve. By opening the by-pass *I* only part way, the contents of chamber *A* may be emptied into the vacuum return without interfering with the conditions in space *D*. The ends of the float are symmetrical, hence it will work either way. The thermofiers are made in four standard sizes of

outlets, two having $\frac{1}{2}$ inch and two having $\frac{3}{4}$ inch outlets. These valves have capacities of 125, 300, 550 and 1200 square feet of radiation respectively.

Drop legs, strainers, governors and other specialties usually provided by such companies are supplied in addition to the thermofiers. When a differential vacuum is to be obtained a special arrangement of the piping system is planned to cover this point. The piping connections around the automatic pump governor are the same as are shown in Fig. 78.

95. Automatic Vacuum System:—In this system the *automatic vacuum valve*, which takes the place of the motor valve and thermofier in the two preceding systems, is shown in Fig. 81. *K* is the entrance to the radiator and *L* to the vacuum return. Screen *F*

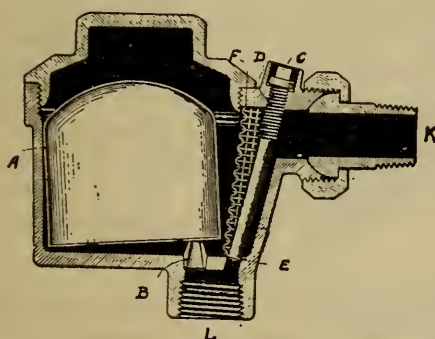

Fig. 81.

prevents scale and dirt from entering the valve. By-pass *E* is for emergency use in draining off accumulated water and dirt, should the valve clog. With such an adjustment the bonnet of the valve may be removed for inspection without overflowing. Before the steam is turned

on in the radiator the float is tipped, as shown in the figure, making a small wedge shaped opening through which the vacuum can pull on the radiator. When steam is admitted to the radiator, condensation flows into the valve, lifting the float and sealing the outlet against the passage of steam. As the valve continues to fill with water the float is lifted, and water passes to the vacuum return. As the water is drawn off the float falls and reseats on the nipple when about $\frac{1}{2}$ inch of water remains in the valve, thus maintaining the water seal. Fig. 82 shows the piping connections around the automatic pump governor. It will be seen that this connection

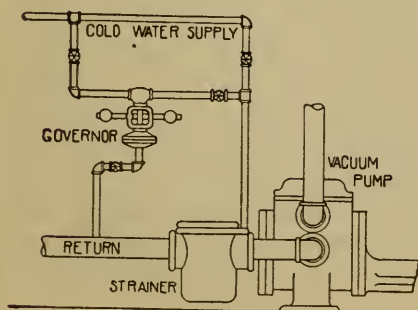

Fig. 82.

differs from those of the Webster and VanAuken Systems, in that the pressure in the return main controls the flow of injection water into the suction strainer.

96. Dunham System:—The special valve used upon the returns from radiators, coils and drainage points in the Dunham System is shown in Fig. 83. The chamber between the two corrugated disks *AA* is filled with a liquid which vaporizes at low temperatures. The adjustment is so made that the temperature of the steam creates pressure enough between the disks to close the valve and cut off drainage to the vacuum pump. When water collects under the disks the temperature of the water is sufficiently cooled below that of the steam to condense some of the liquid, reduce the pressure and open up the valve.

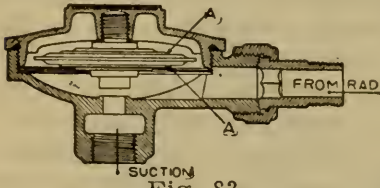

Fig. 83.

The action is therefore automatic and controlled entirely by the temperature of the water or steam in contact with the disks. In other respects this system is very similar to those previously described.

97. Paul System:—Referring to Art. 69 it will be seen that the Paul System is essentially a one-pipe system, with the vacuum principle attached to the air valve. Its use is not restricted to the one-pipe radiator, since it may be applied to the two-pipe radiator as well. The advantage to be gained, however, when applied to the former, is much greater than in the latter because of the greater possibility of air clogging the one-pipe radiator. This one fact has largely determined its field of operation. This system differs from the ones just mentioned in two essential points; first, the vacuum effect is applied at the air valve and the water of condensation is not moved by this means; second, the vacuum effect is produced by the aspirator principle using water, steam or compressed air, as against the pumps used by the other companies. The same principle may also be applied to the tank receiving the condensation. By this means it is possible to remove all the air in the system and to produce a partial vacuum if necessary. Ordinarily the vacuum is supposed to extend only as far as the air valve at the radiator. If desired, however, this valve may be ad-

justed so that the vacuum effect may be felt within the radiator, and in some cases may extend into the supply main. Many modifications of the Paul System are being used. In its latest development, the layout of the system for large plants,

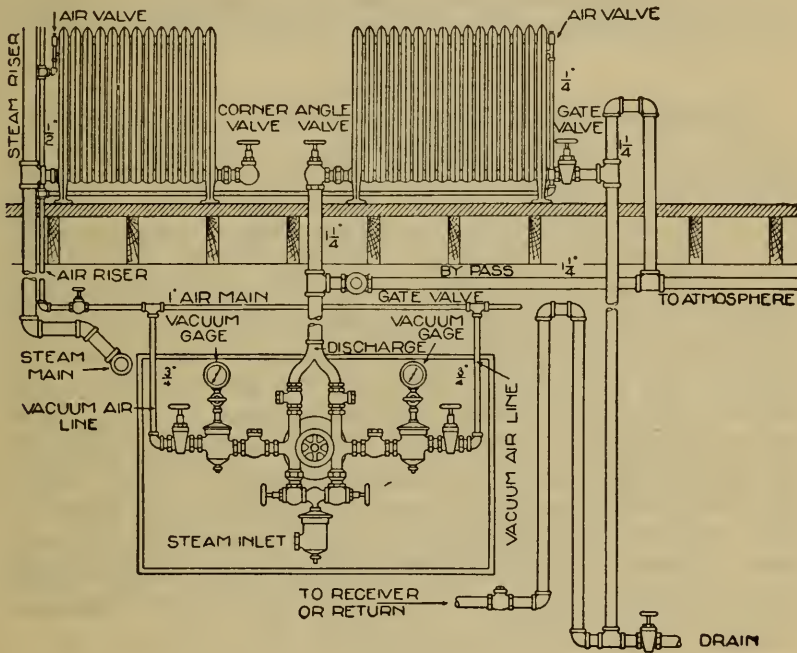

Fig. 84.

is about the same as that shown in Fig. 73, where all of the principal pieces of apparatus that go to make up the power room equipment are present. Fig. 84 shows a typical vacuum connection between one-pipe and two-pipe radiators and the exhauster. This diagram shows the discharge leading to a tank, sewer or catch basin. If exhaust steam were used, the discharge would probably lead into the steam supply to one or more of the radiators and then into the atmosphere. Where electric current can be had this exhausting may be done by the use of an electric motor. A specially designed thermostatic air valve is supplied by the Company to be used on this system.

Other vacuum systems, each having a full line of specialty appliances, might be mentioned here but the above are considered sufficient.

REFERENCES.

References on Mechanical Vacuum Heating.

TECHNICAL BOOKS.

Snow, *Principles of Heating*, Chap. XL. Carpenter, *Heating & Ventilating Buildings*, p. 285. Hubbard, *Power, Heating & Ventilation*, p. 568.

TECHNICAL PERIODICALS.

Engineering Review. Steam Heating Installation in the Biology and Geology Building and the Vivarium Building, Princeton University (Webster System), Jan. 1910, p. 27. Steam Heating and Ventilating Plant Required for Addition to Hotel Astor (Paul System), March 1910, p. 27. Heating Four Store Buildings at Salina, Kans., (Moline System. Vacuum Vapor), April 1910, p. 45. Steam Heating System for Henry Doherty's Mill, Paterson, N. J., May 1910, p. 37. Heating Residences at Fairfield, Conn., (Bromell's System of Vapor Heating), June 1910, p. 52. Heating Residence at Flemington, N. J., (Vapor-Vacuum System), July 1910, p. 43. Heating System Installed in the Haynes Office Building, Boston, (Webster Modulation System), Aug. 1910, p. 44. Heating the Silversmith's Building, New York, (Thermograde System), Jan. 1908, p. 8. Heating System in the New Factory of Jenkins' Bros., Ltd., Montreal, Canada, (Positive Differential System), Dec. 1907, p. 14. *The Railway Review*. Vacuum Ventilation for Street Cars, Oct. 23, 1909, p. 948. *The Metal Worker*. A Vapor Vacuum Heating System, April 4, 1910, p. 494. Heating Church by Vacuum System, Sept. 11, 1909, p. 46. Rehabilitation by Vacuum Heating, Jan. 21, 1911. *Power*. Combined Vacuum and Gravity Return Heating System, Charles A. Fuller, Aug. 11, 1911. *Vacuo Hot Water Heating*, Ira N. Evans, Mar. 12, 1912. *Heat. & Vent. Magazine*. Vacuum Heating Practice, J. M. Robb, Jan. 1912.

CHAPTER X.

MECHANICAL WARM AIR HEATING AND VENTILATION. FAN COIL SYSTEMS.

DESCRIPTION OF SYSTEMS AND APPARATUS EMPLOYED.

98. Fire-places, Stoves, Furnaces and Direct Radiation Systems of both steam and hot water have, individually, advantages and disadvantages, but, in common, all lack what is increasingly being considered as of more importance than heating, namely, *positive ventilation*. Merely to heat a poorly ventilated apartment only serves to increase the discomfort of the occupants, and modern legislative bodies are reflecting the opinion of the times by the passage of compulsory ventilation laws affecting buildings with numerous occupants, such as factories, barracks, school houses, hotels and auditoriums. To meet this demand for the positive ventilation of such classes of buildings, there has been developed what is variously known as the *hot blast heating system*, *plenum system*, *fan blast system* or *mechanical warm air system*.

99. Elements of the Mechanical Warm Air System:— Known by whatever name, this system contemplates the use of three distinctly vital elements; first, some form of hot metallic surface over which the forced air may pass and be heated; second, a blower or fan of some description to propel the air; and third, a proper arrangement of ducts or passageways to distribute this heated air to desired locations. Figs. 96 and 97 show these essentials, fan, heating coils and ducts in their relative positions with connections as found in a typical plant of this system. Many attachments and improved mechanisms may be had to-day in connection with this system, such as air washers and humidifiers, automatic damper control systems, and brine cooling systems whereby the heating coils may be used as cooling coils, and, during hot weather, be made to maintain the temperature within the building from 10 degrees to 15 degrees lower than the atmosphere. None of these auxiliaries, however, change in any way the necessity

for the three fundamentals named and their general arrangement as shown.

100. Variations in the Design of Mechanical Warm Air Systems:—With regard to the position of the fan, two methods of installing the system are common. The first and most used is that shown in Fig. 85, a, where the fan is in the basement and forces the air by pressure upward through the ducts and into the rooms. This causes the air within the entire building to be at a pressure

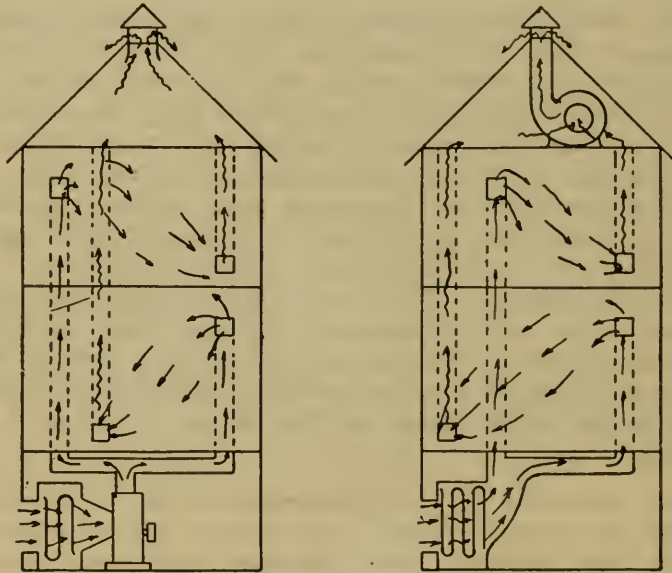

a. Plenum System.

b. Exhaust System.

Fig. 85.

slightly higher than the atmosphere, and hence all leakages will be outward through doors and window crevices. A system so installed is usually called a *plenum system*. The fan may, however, be of the exhausting type, Fig. 85, b, and placed in the attic with which ducts from the rooms connect, so that the fan tends to keep the air of the building at a slight vacuum as compared with the atmosphere, thus inducing ventilation. Air is then supposed to enter the basement inlet, pass over the coil surface, and, when heated, pass to the various rooms through the ducts provided. But air from the atmosphere will just as readily leak in at windows or other crevices, as come in over the

heaters, and then the system will fail in its heating work. For this reason the *exhaust heating system*, as it is usually known, is seldom installed, except where aid in the prompt removal of malodors is desired. Combined plenum and exhaust systems are to be recommended wherever the expense can be justified.

101. Blowers and Fans:—Many methods of moving air for ventilating and heating purposes have been devised; some positive at all times, others so dependent upon the existence of certain conditions as to be a constant source of trouble. It is coming to be a very generally accepted fact, that if air is to be delivered at definite times, in definite quantities and in definite places, it must be forced there, and not merely allowed to go under conditions readily changing or disappearing. The recognition of this fact has led to a very common use of the mechanical fan or blower for impelling air, and this use has, in turn, caused the development of fans and blowers to a fairly high degree of efficiency.

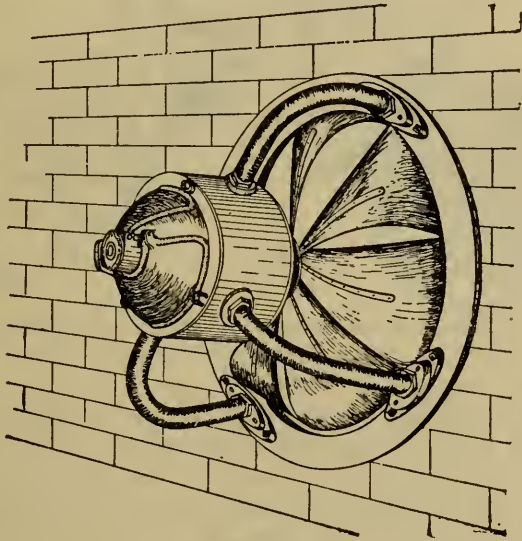

Fig. 86.

By the aid of mechanical apparatus, air may be moved positively in either of two ways, by the *exhaust method* or by the *plenum method*, each having fans developed best suited to its needs. In the exhaust method the fan is commonly of the *disk* or *propeller blade* type, shown in Figs. 86 and

87, and moves the air by suction. It is usually installed in the attic or near the top of the building, although with a system of return ducts it may be installed in the basement. The plenum system uses a fan of the paddle wheel or multiple blade type, shown in Figs. 88 and 89; the first is the standard form of fan wheel in common use, and the second is a more recent development of the same, called the "turbine" fan wheel, shown direct connected to a De Laval steam turbine. The wheels of the fans are also shown.

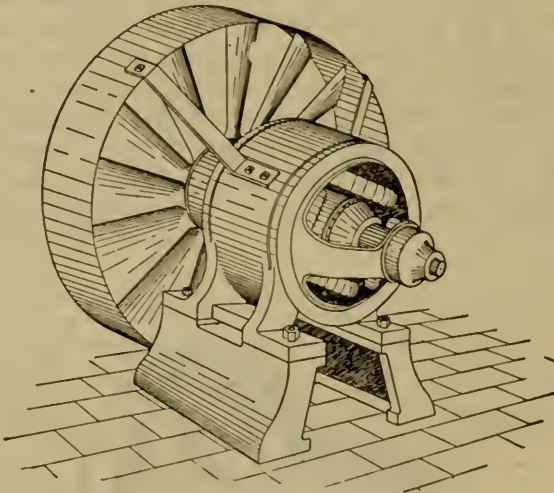

Fig. 87.

Tests of the latter wheel seem to show a somewhat higher efficiency than has heretofore been possible with the older forms. Both of these forms of fans are used in plenum work, and are placed on the forcing side of the circulating system just between the air intake and the heater coils, or just following the heater coils, and hence produce a pressure within the building or suite heated, so that leakages are outward and not so detrimental to the good working of the plant as in the exhaust system.

The motive power for fans may be of four kinds, electric direct drive, steam engine or steam turbine direct drive, and belt and pulley drive, as shown in Figs. 87, 88, 89 and 90. Which of these drives will be the most appropriate will depend entirely upon local conditions and the nature

of the available power supply. The steam engine or steam turbine drive is perhaps the most common, since some steam must be present for the supply of the heating coils, and since, too, the exhaust of the engine or turbine may be used to supplement the live steam used for heating. See Art. 122.

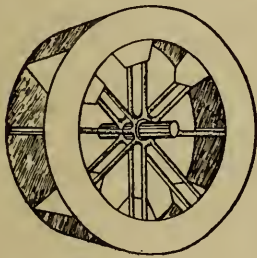
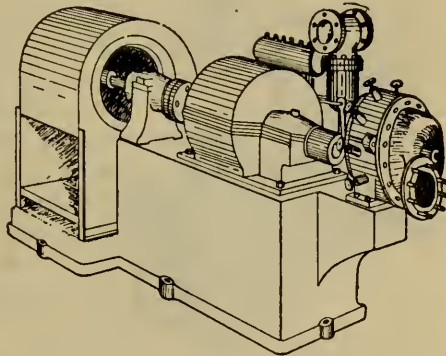
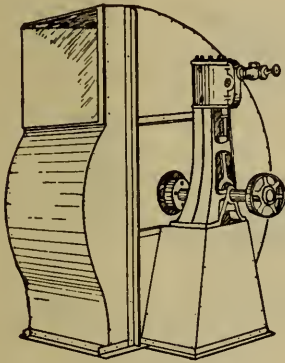

Fig. 88.

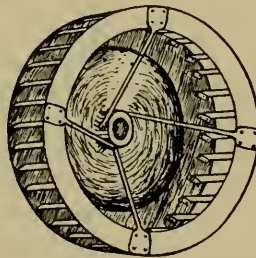

Fig. 89.

Fan housings are made in many different styles, and of various materials, the more readily to fit any given set of conditions. Materials employed may be of brick, wood, sheet steel or combinations of these. Steel housings are the most common and are made in such a variety of patterns as will fit any requirement of plenum duct direction. What are known as *full* housings are those in which the entire fan wheel is encased with steel and the entire unit is self-contained and above the floor line. *Three-quarter* housings are those in which only the upper three-fourths of the fan wheel is encased, the completion of the air-sweep around the

paddles being obtained by properly forming the brick foundation upon which the fan is installed. The larger fans are commonly three-quarter housed, especially if they are to deliver air directly into underground ducts. Fig. 88 shows a full housing and Fig. 90 a three-quarter housing.

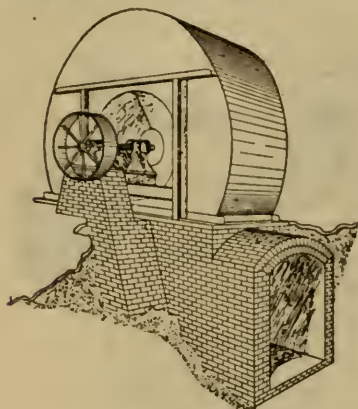

Fig. 90.

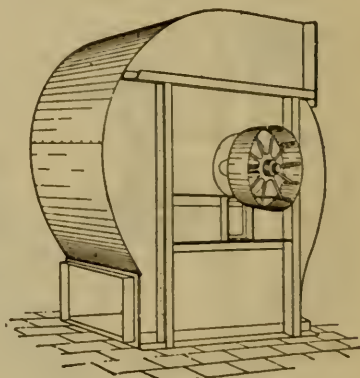

Fig. 91.

The circular opening in the housing around the shaft of the wheel is the inlet of the fan, the air being thrown by centrifugal force to the periphery and at the same time given a circular motion, thus leaving the fan tangentially through the discharge opening. Fans may be obtained which will deliver at any angle around the circumference, and fans may be obtained with two or more discharge openings, usually referred to as "multiple discharge fans," as shown in Fig. 91. Some fans have double side inlets, i. e., air enters the fan from each side at the center. These openings are smaller than the single side inlet. All fan casements should be well riveted and braced with angles and tee irons. The shaft should be fitted with heavy pattern, adjustable, self-oiling bearings, rigidly fastened to the casement and properly braced. The thickness of the steel used in the casement varies according to the size of the fan, from No. 14 to No. 11 for sizes in general use. The fan wheel should be well constructed upon a heavy spider to protect against distortion from sudden starting and stopping. The side clearance between the wheel and casement should be small. Fans should be bolted to substantial foundations of brick or concrete. When connecting them to metal ducts where any sound from the motion of the fan may be transmitted to the rooms, the connection should be made through flexible rubber cloth

102. Fresh Air Entrance to Building and to Rooms:—

The air may enter through the building wall at the ground level or it may be taken from a stack built for the purpose, providing a down draft with entrance for the air at the top. This may be done in case no washing or cleaning systems are applied and in case the air is heavily charged with dust or dirt from the street. Usually in isolated plants or in small cities, the air is taken in near the ground level from some area-way that is fairly free from dust. In the larger cities, however, either a washing system is installed to cleanse the air before it is sent around to the rooms, or the air is taken from an elevation somewhat above the ground as spoken of before. The velocity of the air should be from 700 to 1000 feet per minute at this point and where grill work or shutters of any sort are put in the opening, they are usually so planned as not to seriously obstruct the flow of the air. Usually a plain flat wire screen is placed in the opening to keep out leaves, and doors are swung from the inside in such a way as to be thrown open, leaving practically the full value of the opening as a net area.

Air entrance to rooms is accomplished through registers or gratings which cover the ends of rectangular ducts or conduits called stacks, built into the brick walls and opening into the respective rooms much as shown in section by Fig. 22. Register sizes considered standard are given in Table 17, Appendix. The velocity of the air at a plenum register may be somewhat higher than in a simple furnace installation. In the plenum system the heat registers are usually placed well above the heads of the occupants, near the ceiling, and the vent registers near the floor. Velocities allowable at registers and up stacks are shown in Table XIII, page 172.

103. Plenum Heating Surfaces:—Heating surfaces as used to-day in connection with plenum systems may be divided into two classes: *coil surface*, made of loops of 1 or $1\frac{1}{4}$ inch wrought iron pipe and *cast surface*, made of hollow rectangular castings provided with numerous staggered projections to increase the outside surface and provide greater air contact. To make a *heater* of either kind of surface, successive units are placed side by side, until the requisite total area and depth have been obtained. The total number of square feet of cast or pipe coil surface exposed to the

air determines the total number of heat units given to the air per hour, while the depth of the heater controls the final temperature of the air leaving the heater. Each of these points must be considered in designing the heater system. (See Arts. 118 and 119).

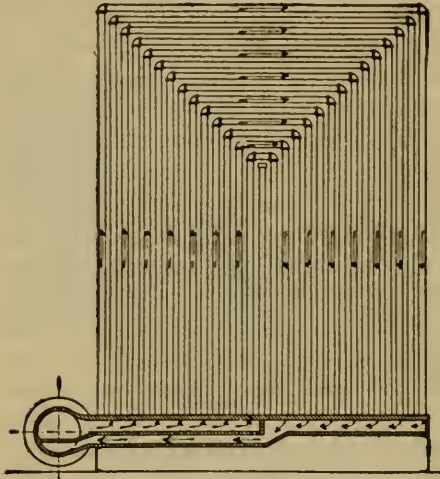

Fig. 92.

which forms the base of the section, Fig. 92, that having the pipes horizontally between two vertical side headers, Fig. 93, and that having one header vertical and one header horizontal called the *mitre coil*, Fig. 94. The first and last forms shown are made with two, three or four

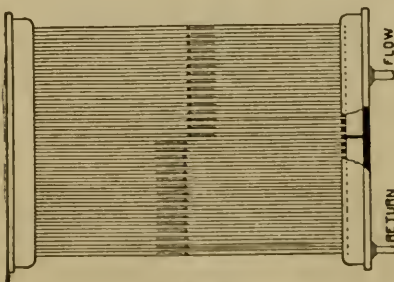

Fig. 93.

Pipe coils may be used under high pressures but cast coils should never be used under pressures exceeding 25 pounds per square inch gage. All plenum heating surfaces should be well vented and drained. Ample allowance also should be made for expansion and contraction.

Coil surface is of three kinds, that having the pipes inserted vertically into a horizontal cast iron header. Coil surface is of three kinds, that having the pipes inserted vertically into a horizontal cast iron header. The standard number of pipes in any one section is four. Sometimes these pipes are spaced in straight lines parallel with the wind and sometimes are staggered. Staggered spacing no doubt makes each pipe slightly more efficient but it adds friction to the air cur-

rent and power to the fan. Efficiency tests of both spacings, however, show little difference in these methods. The horizontal sections and the mitre sections present this advantage over the vertical pipe sections, that the steam and condensation are always flowing in the same direction and

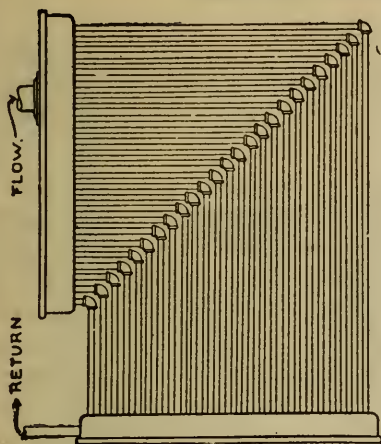

Fig. 94.

drainage is very simple. With the vertical pipe section, steam in one-half of the pipes must pass upward against the direction of the flow of condensation or it must carry the condensation with it. That half of the header supplying pipes which carry steam upward is usually drained for condensation by a small hole directly into the return with the result that steam often blows through the header without traversing the pipe circuits. The third, or mitre section, in addition to perfect drainage, has perfect expansion. The vertical header serves as a steam supply and the horizontal header as a drain, permitting every pipe to assume any position necessary to account for a reasonable change of length.

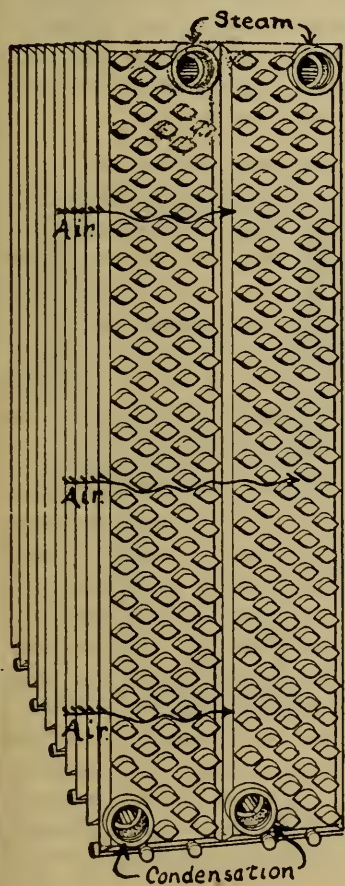

Fig. 95.

Cast iron radiating surface for plenum systems is shown in Fig. 95. It is composed, primarily, of sections not unlike the sections of an ordinary direct radiator in the way in which they are joined together at the top and bottom by nipples, thus forming what is termed a *stack*. Stacks are again assembled, one in front of another, with respect to the direction in which the air passes through them, the completed heater being then more or less cubical in proportion. The figure shows a heater two sections in depth

and ten sections in width. Provided the conditions demand it, the heater may be built two or even three stacks in height, thus doubling or tripling the gross wind area. See Art. 119.

Cast iron heaters are usually of the *Vento* type and are made in two thicknesses, 6.75 and 9.125 inches in the direction of the air velocity. They are also made in three heights, 40, 50 and 60 inches. These heaters present the following amounts of heating surface: 6.75 inch sections—7.5, 9.5 and 11 square feet; 9.125 inch sections—10.75, 13.5 and 16 square feet of surface for the 40, 50 and 60 inch sections respectively. These sections give such a variety of sizes as to permit combinations to fit almost any possible requirement in net area, gross area and heating surface. It is unusual to assemble less than five or more than twenty-five sections to the stack. By the proper adjustment of number of sections to the stack, and of stacks to the heater, any requirement of hot blast work may be met.

No matter what kind or type of heaters may be selected, certain methods of installing them have become common. They may be placed on either the suction or the force side of the fan, usually the former in drying or evaporating plants, but more often the latter in heating plants. Because of their weight, ample and firm foundations must be provided. In most installations for heating purposes, where both tempered and heated air is supplied, the heater should be raised on its foundation 18 to 24 inches to allow a damper and passage way for tempered air.

104. Division of Coil Surface:—It is considered best practice to install a hot blast heater in two parts, known as the *tempering coil* and the *heating coil*. In the calculations, Arts. 115-119, the total heating surface is first obtained and then this is split up into whatever arrangement is desired. The tempering coils should be placed in the air passage just within the intake for the building and should contain from one-fourth to one-third of the total heating surface. In this way the air is tempered before it reaches any other apparatus, thus protecting from accumulation of frost on fan and bearings and aiding in the process of lubrication. The main heat coil is placed just beyond the fan on its force side. Referring to Figs. 96 and 97 it will be seen that the

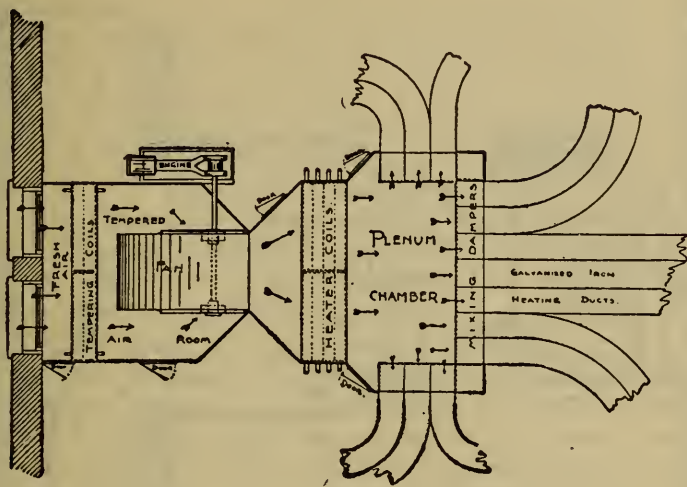

PLAN.

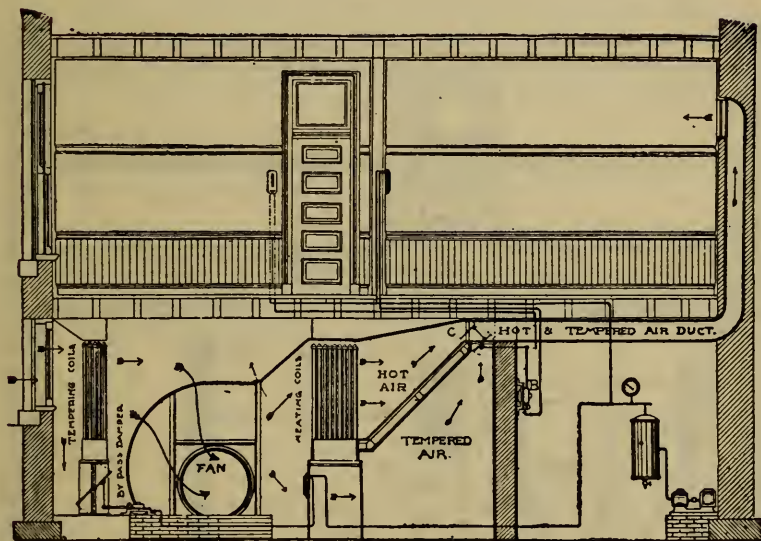

ELEVATION.

Fig. 96. Fan Room Layout with Single Ducts along Basement Ceiling and all Mixing Dampers at Plenum Chamber.

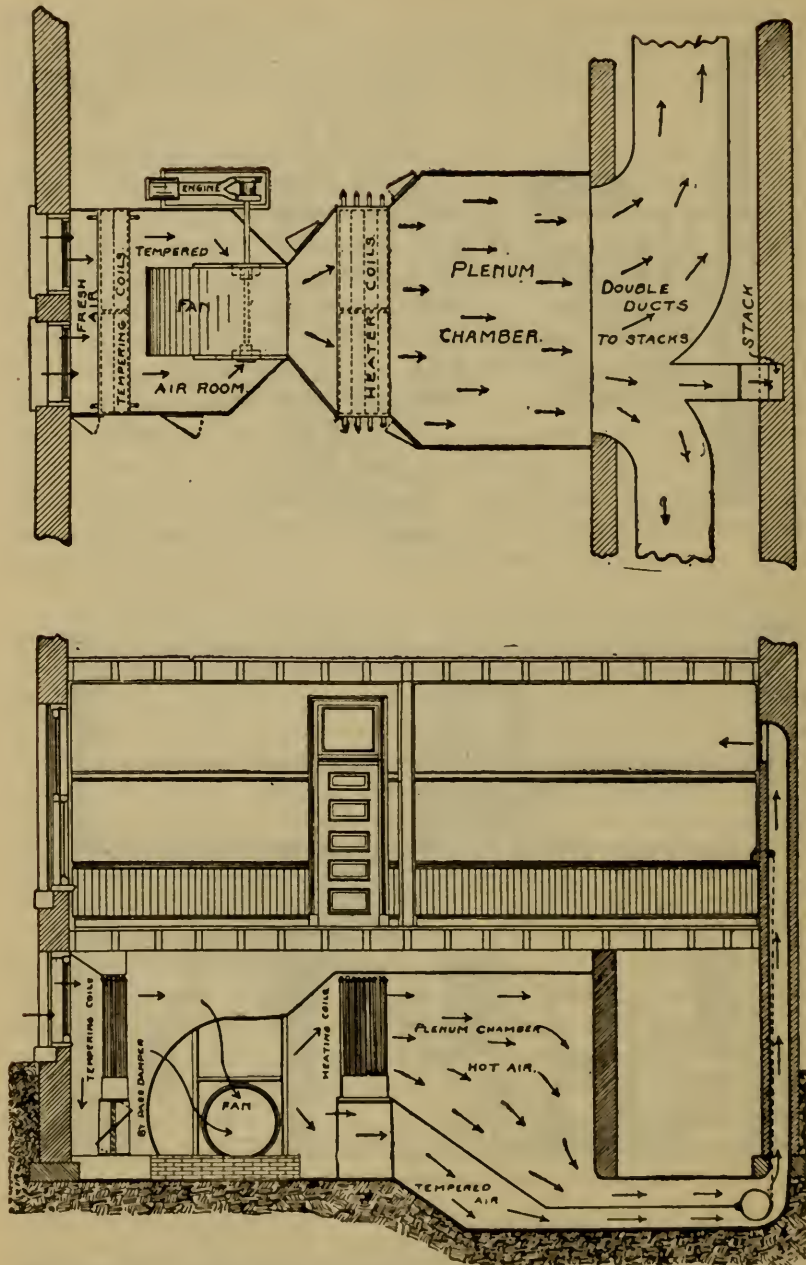

Fig. 97. Fan Room Layout with Double Underground Ducts and Mixing Dampers at Base of Room Stacks.

heating coils can be of service only at such times as the fan is in operation. If now these coils were split up into small heaters and placed at the foot of the stacks leading to the various rooms then air could be by-passed through the plenum chamber and ducts, over the various radiating surfaces to the rooms. In this way the heaters could be used as indirect gravity heaters. The radiation in such a case would be insufficient to keep the rooms at the same temperatures as if the same amount of surface were placed in the plenum coil next the fan. When the fan is in operation the air is moving at a high velocity over the heating surface and the rate of transmission is very high. On the other hand, when they are placed at the foot of the stacks and used as indirect heaters, without the operation of the fan, the air velocity and the amount of heat delivered to the rooms are correspondingly reduced. In some cases the heating coils are arranged in this way and used when the building is not occupied. The convenience of such an installation can readily be seen; however, the expense of installing is greater than where they are assembled as coils at the fan. Exhaust steam from the engine is commonly used in the tempering coil and live steam of low pressure in the main heating coil. This may be varied by conditions, however, and all surface supplied by exhaust steam if it is thought advisable.

105. Single Duct Plenum System:—Duct systems in hot blast work may be either of the single duct type or the double duct type. In the *single duct* plant, every horizontal duct is carried independently from the base of the room to be heated to the small room called the *plenum chamber*, which receives the hot blast from the heater. This chamber is divided into an upper and a lower part, the upper receiving the heated air that has been forced through the heater, while the lower part receives only air that has been through the tempering coils, or vice versa. The leader duct from the base of each vertical room duct is led directly opposite the partition between these two chambers, and a damper, regulated by some system of automatic control from the rooms to be heated, governs whether cool air from the lower chamber, or hot air from the upper chamber, or a mixture of both, shall be sent to the rooms. This system produces rather a complicated net work of dampers and ducts at the plenum chamber and this disadvantage has limited its use very much.

106. Double Duct Plenum System:—As its name indicates, this system runs a double leader duct from the plenum chamber to the base of each vertical room duct, the upper one of these ducts being in direct communication with the upper part of the plenum chamber and carries



Fig. 98.

hot air, while the lower one is in communication with the lower part of the plenum chamber and carries cool air. No mixing or throttling is done except at the base of the vertical room duct, where the mixing damper is located, it being controlled by hand or automatically directly from the room above. With this scheme it is evident that the leader ducts for each room need not be run singly, but all the ducts having the same general direction combined in one large double trunk, from which branches are taken to the various room ducts as required.

The difference between

the two systems is shown by the two sketches, Figs. 96 and 97.

A hot blast plant may be installed as a *basement* or as a *sub-basement* system. If the former, the leaders will be suspended from the basement ceiling and usually constructed of sheet metal, thus forming what is often called a "false ceiling." If the latter, they will be just below the floor of the basement and will be constructed of brick and mortar, or of concrete, about four inches thick. For designs of conduits, ducts and dampers, see Figs. 90, 96, 97 and 98, the last showing a simple and direct installation often applied to factories of several stories. Fig. 99 shows a complete steel housed plenum unit of fan, coils, dampers and duct connections.

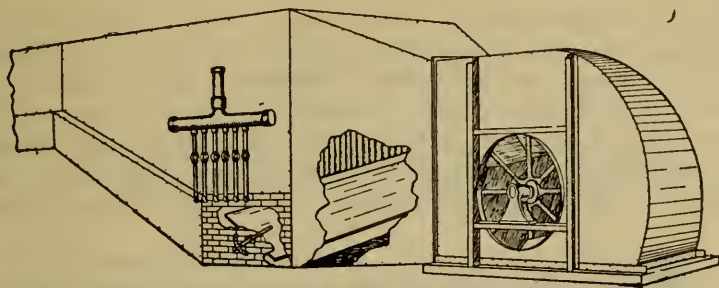

Fig. 99.

107. Air Washing and Humidifying Systems:—In connection with mechanical warm air heating and ventilating systems, there is often installed apparatus for washing and humidifying the air. In crowded city districts where the air is laden with dust, soot, the products of combustion and other harmful gases, its purification and moistening becomes a most important problem. The plenum system of heating and ventilating lends itself most readily to the solution of this problem, with the result that modern practice is tending more each day toward the combined installation of ventilating and humidifying apparatus. Fig. 100 shows a plenum system augmented by an air washing, purifying and humidifying apparatus.

A purifier contemplates the installation of two parts, a *washer* and an *eliminator*. The washer is built in the main air duct, located immediately behind the tempering coils, and provided with streams or sprays of water through which the air must pass. Numerous schemes for breaking up the water in the finest sprays are on the market, and their relative merits may be judged from trade literature. Having caught the dust particles and dissolved the soluble gases from the air, the water falls to a collecting pan at the bottom of the spray chamber, and from there is again pumped through the spraying nozzles. As the water becomes too dirty or too warm, a fresh supply is delivered to the collecting pan. A small independent centrifugal pump is commonly used for the circulation of the spray water.

After passing through the washer, the air next encounters the eliminator, the purpose of which is to remove the surplus moisture and water particles remaining suspended in the air. This is accomplished by an arrangement of

more or less complicated baffle plates, which cause the air to change its direction suddenly many times in succession, with the effect that the water particles impinge upon and adhere to, the baffle plates. These are suitably drained to the collecting pan beneath the washer. As the air leaves the eliminator and enters the fan it may, with good apparatus, be relieved of 98 per cent. of all dust and dirt, may

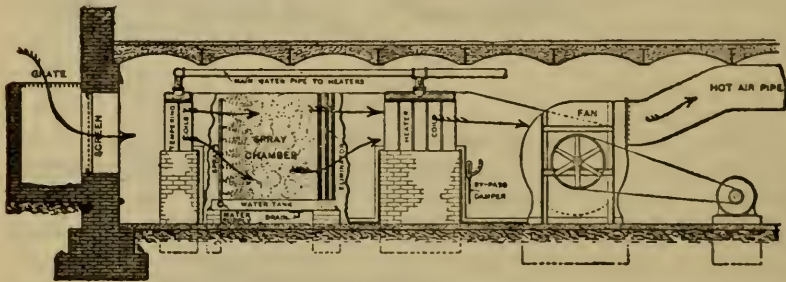

Fig. 100.

be supplied with moisture to very near the saturation point, and, in summer time under favorable conditions, may be cooled from 5 to 10 degrees lower than the atmosphere. This is due to the cooling effect of vaporizing part of the water.

Special air cooling plants have been installed in connection with the plenum system of ventilation, whereby refrigerated brine could be circulated in the regular heating coils. The description of such a plant with data, may be found in the transactions of the A. S. H. & V. E. for the year 1908.

CHAPTER XI.

MECHANICAL WARM AIR HEATING AND VENTILATION. FAN COIL SYSTEMS.

AIR, HEATING SURFACE AND STEAM REQUIREMENT. PRINCIPLES OF THE DESIGN.

108. Definitions of Terms:—In the work under this general heading, some of the technical abbreviations that are frequently used are the following: H = B. t. u. heat loss per hour by the formula, H_v = B. t. u. heat loss per hour by ventilation, H' = total B. t. u. loss including ventilation loss, Q = cubic feet of air used per hour as a heat carrier, Q' = cubic feet of air used including extra air for ventilation, R = total square feet of heating surface in indirect heaters, t_s = temperature of the steam or water in the heaters, t = highest temperature of the air at the register (let this be the same as the temperature of the air upon leaving the heater), t' = temperature of the air in the room, t_v = temperature of the air at the register when extra air is used for ventilation, t_o = temperature of the outside air, K = rate of transmission of heat per square foot of surface per degree difference per hour, N = the number of persons to be provided with ventilation, V = velocity in feet per minute and v = velocity in feet per second. Other abbreviations are explained in the text.

109. Theoretical Considerations:—For illustrative purposes, references will frequently be made throughout this discussion to a sample plenum design, Figs. 104, 105 and 106. These show the essential points of most plenum work and will serve as a basis for the applications. In working up any complete design the following points should be theoretically considered for each room: the heat loss, the cubic feet of air per hour needed as a heat carrier (this should be checked for ventilation), the net area of the register in square inches, the catalog size of the register, and the area and size of the ducts. In addition to these the following should be investigated for the entire plant: the size of the main leader at the plenum chamber, the size of the

principal leader branches, the square feet of heating surface in the coils, the lineal feet of coils, the arrangements of the coils in groups and sections, the horse-power and the revolutions per minute of the fan including the sizes of the inlet and the outlet of the fan, the horse-power of the engine including the diameter and the length of stroke, and the pounds of steam condensed per hour in the coils.

Fresh air is taken into the building at the assumed lowest temperature, t_0 degrees, is carried over heated coils and raised to t degrees, is propelled by fans through ducts to the rooms and then exhausted through vent ducts to the outside air, thus completing the cycle. It will be the object to so discuss this cycle that it will be general and so it will apply to any case which may be brought up.

110. Heat Loss and Cubic Feet of Air Exhausted per Hour:—It is assumed here, that in all mechanical draft heating and ventilating systems, *the circulating air is all taken from the outside and thrown away after being used.* Some installations have arrangements for returning the room air to the coils for reheating, but such schemes should be considered as features added to the regular design rather than as being a necessary part of it. It is best to design the plant with the understanding that all the air is to be thrown away, it will then be large enough for any service that it is expected to handle. Having found H by some acceptable formula, the total heat loss is (compare with Arts. 29 and 36.)

$$H' = H + \frac{(Q \text{ or } Q') (t' - t_0)}{55} \quad (37)$$

When $t' = 70$ and $t_0 = \text{zero}$, this formula reduces to

$$H' = H + 1.27 (Q \text{ or } Q')$$

To determine whether Q or Q' will be used find how many people would be provided with ventilating air with the volume Q . If $Q = 55 H \div (t - t')$, $t = 140$ and $t' = 70$, then

$$N = \frac{55 H}{1800 (t - t')} = \frac{H}{2290} = \text{approximately } \frac{H}{2300} \quad (38)$$

If more people than N will be using the room at any one time, then Q' will be used instead and this value would be 1800 times the number of persons in the room. In any ordinary case, Q will be sufficient. When this is so, formula 37 reduces to

$$H' = 2 H \quad (39)$$

The reasoning of this formula is easily seen when it is remembered that the heat given off from the air in dropping from the register temperature, 140° , to the room temperature, 70° , goes to the radiation and leakage losses, H , while that given off from the inside temperature, 70° , to that of the outside temperature, 0° , is charged up to ventilation losses, H_v . Since these values are equal, $H' = H + H_v = 2H$.

APPLICATION.—Referring to Fig. 105, room 15, and Table XVI, page 176, it is seen that the calculated heat loss H , for this room, with $t' = 70$ and $t_o = 0$, is 70224 B. t. u. per hour; also, that the cubic feet of air, Q , if $t = 140$, is 54775 per hour. Applying formula 39, the total heat loss, H' , becomes 140448 B. t. u. per hour, or twice the amount found by the heat loss formula. With 54775 cubic feet of air sent to the room per hour, this will provide good ventilation for thirty persons. Suppose, however, that fifty persons were to be provided for; this would require $50 \times 1800 = 90000$ cubic feet of air per hour. With this increased number of people in the room, the total heat loss would not be as stated above, but would be according to formula 37.

$$H' = 70224 + \frac{90000 (70 - 0)}{55} = 184864.$$

111. Temperature of the Entering Air at the Register:

—In plenum work, the registers are placed higher in the wall and the velocity of the air is carried a little higher than in furnace work. It may be said that 140° is probably the accepted temperature for design, excepting where an extra amount of air is demanded for ventilation purposes. In the latter case, the temperature of the air would necessarily drop below 140° in order that the room would not be overheated. The general formula is

$$t_v = t' + \frac{55 H}{Q'} \quad (40)$$

APPLICATION.—Referring to room 15 and (compare with Art. 38) assuming the heat loss to have been figured as before with ventilating air supplied sufficient for 50 persons, 90000 cubic feet per hour, then the temperature of the air at the register is

$$t = 70 + \frac{55 H}{90000} = 113^{\circ}$$

The temperature of the air at the register is the same or slightly less than the temperature of the air upon leaving the coils. If this room were to be the only one heated, then the coils would be figured for a final temperature of the air at 113° , but other rooms may have air entering at higher temperatures, hence the temperature t upon leaving the coils should be that of the highest t at the registers.

112. Cubic Feet of Air Needed per Hour:—The following amount of air will be needed per hour as a heat carrier (compare with Art. 36).

$$Q = \frac{55 H}{t - t'}; \text{ where } t = 140 \text{ and } t' = 70, Q = \frac{H}{1.27}$$

If extra air be needed for ventilation, $Q' = 1800 N$.

113. Air Velocities, V , in the Plenum System:—Table XIII gives the velocities in feet per minute that have been found to give good satisfaction in connection with blower systems.

TABLE XIII.

Air Velocities in the Plenum System.

	Fresh air intake	Over coils	Main duct near fan	Smaller branch ducts	Stacks	Reg'rs or other open'gs
Offices, schools, etc.	F. P. M. Average 850 F. P. M.	F. P. M. Average 1000 F. P. M.	1200 to 1800 say 1500	800 to 1200 say 900	500 to 700 say 600	300 to 400 say 300
Auditoriums, churches, etc.	700 to 1000 F. P. M. Average 850 F. P. M.	800 to 1200 F. P. M. Average 1000 F. P. M.	1500 to 2000 say 1800	1000 to 1500 say 1200	600 to 800 say 700	400 to 600 say 400
Shops and factories.	700 to 1000 F. P. M. Average 850 F. P. M.	800 to 1200 F. P. M. Average 1000 F. P. M.	1500 to 3000 say 2000	1000 to 2000 say 1500	600 to 1000 say 800	400 to 800 say 500

114. Cross Sectional Area of Registers, Ducts, etc.:—With the above velocities in feet per minute, the square inches of net opening at any part of the circulating system can be obtained by direct substitution in the general formula

$$A = (Q \text{ or } Q') \times \frac{144}{60 V} = 2.4 \frac{(Q \text{ or } Q')}{V} \quad (41)$$

The calculated duct sizes, of course, refer to the warm air duct. The cold air duct in double duct systems need not be so large because on warm days, when only tempered air is needed, the steam may be turned off from one or more of the heaters and the warm air duct can then be used to furnish what otherwise would be required from the cold air duct. On account of this flexibility, it seems only necessary to make the cold air duct about one-half the cross sectional area of the warm air duct. For convenience of installation, therefore, it would be well to make the former of equal width to the latter and one-half as deep, unless by so doing the cold air duct becomes too shallow.

APPLICATION.—Assuming 2000000 cubic feet of air to pass through the main heat duct, Fig. 104, per hour at the velocity of 1800 feet per minute, the duct will be approximately 20 square feet in cross section, or $2\frac{1}{2}$ by 8 feet. The two main branches at *B* will carry about 800000 cubic feet per hour each at the same velocity and will be 7.4 square feet in area or, say 2 by 4 feet. The same branches at *C* will carry about 400000 cubic feet per hour each at a velocity of 1500 feet per minute and will be 4.4 square feet in area or, say 2 by $2\frac{1}{2}$ feet and the branch *D* will carry about 300000 cubic feet at a velocity of 1200 feet per minute and will be, say $1\frac{1}{2}$ by $2\frac{3}{4}$ feet.

The stack sizes were first figured for the velocity of 600 feet per minute. These sizes were then made to fit the laying of the brick work such that the velocities would be anywhere between 300 to 600 feet per minute. The net register was figured for an air velocity of 300 feet per minute and the gross registers were assumed to be 1.6 times the net area. See Art. 134.

115. Square Feet of Heating Surface, *R*, in the Coils:—

To determine theoretically the number of square feet of heating surface in the coils of an indirect heater, the following formula may be used:

$$R = \frac{H'}{K \left(t_s - \frac{t + t_o}{2} \right)} \quad (42)$$

Rule.—To find the square feet of coil surface in an indirect heater, divide the total heat loss from the building in B. t. u. per hour by the rate of the transmission, multiplied by the difference in temperature between the inside and outside of the coils.

Since the coils are figured from the entire building loss, H' will include the sum of all the heat losses of the various rooms. The chief concern in the use of this formula, as stated, is to determine the best value for K , the rate of transmission. Prof. Carpenter in H. and V. B., Art. 52, quotes extensively from experiments with coils in blower systems of heating and summarizes all in the formula, $K = 2 + 1.3 \sqrt{v}$, where $v =$ average velocity of air over the coils in feet per second. With the four velocities most applicable to this part of the work, i. e., 800, 1000, 1200 and 1500 feet per minute, this becomes

$$800 \text{ feet per minute } K = 6.9$$

$$1000 \text{ feet per minute } K = 7.3$$

$$1200 \text{ feet per minute } K = 7.8$$

$$1500 \text{ feet per minute } K = 8.5$$

In the table of probable efficiencies of indirect radiators in Art. 54 by the same author, the values are somewhat higher, being

$$750 \text{ feet per minute } K = 7.1$$

$$1050 \text{ feet per minute } K = 8.35$$

$$1200 \text{ feet per minute } K = 9.$$

$$1500 \text{ feet per minute } K = 10.$$

The values of K , as given here, are certainly very safe when compared to quotations from other experimenters, some of them exceeding these values by 50 per cent. It is always well to remember that a coil that has been in service for some time is less efficient than a new coil, because of the dirt and oil deposits upon the surface, hence it is best in designing, not to take extreme values for efficiency. Assuming $K = 8.5$ and 1000 feet per minute air velocity, which are probably the best values to use in the calculations, also $t_s = 227$ (5 pounds gage pressure), $t = 140$ and $t_o = 0$, formula 42 becomes

$$R = \frac{H'}{8.5 \left(227 - \frac{140 + 0}{2} \right)} = \frac{H'}{1335} \text{ say } \frac{H'}{1400} \quad (43)$$

Table XIV quoted by Mr. C. L. Hubbard in Power Heating & Ventilation, Part III, page 557, gives the efficiencies of forced-blast pipe heaters and the temperatures of air delivered.

TABLE XIV.

Efficiencies of Forced-Blast Pipe Heaters, and Temperatures of Air Delivered.

Velocity of air over coils at 800 feet per minute.

Rows of pipe deep	Temp. to which the air will be raised from zero			Efficiency of the heating surface in B.t.u. per sq.ft.per hr.		
	Steam pressure in heater			Steam pressure in heater		
	5 lb.	20 lb.	60 lb.	5 lb.	20 lb.	60 lb.
4	30	35	45	1600	1800	2000
6	50	55	65	1600	1800	2000
8	65	70	85	1500	1650	1850
10	80	90	105	1500	1650	1850
12	95	105	125	1500	1650	1850
14	105	120	140	1400	1500	1700
16	120	130	150	1400	1500	1700
18	130	140	160	1300	1400	1600
20	140	150	170	1300	1400	1600

For a velocity of 1000 feet per minute multiply the temperatures given in the table by 0.9 and the efficiencies by 1.1.

Mr. F. R. Still of the American Blower Co., Detroit, gives the following formula for the total B. t. u. transmitted per square foot of surface per hour between the temperature of the steam and that of the entering air.

$$\text{Total B. t. u. transmitted} = c \sqrt{v}(t_s - t_o) \quad (44)$$

in which case v is the velocity in feet per second and c is a constant as follows:

TABLE XV.

Values of c .

	Safe factor	Max. factor
1 section 4 rows of pipe	3.45	4.40
2 sections 8 rows of pipe	3.00	3.40
3 sections 12 rows of pipe	2.63	2.85
4 sections 16 rows of pipe	2.33	2.45
5 sections 20 rows of pipe	2.12	2.20
6 sections 24 rows of pipe	1.95	2.05
7 sections 28 rows of pipe	1.80	1.95
8 sections 32 rows of pipe	1.65	1.85
9 sections 36 rows of pipe	1.52	1.80
10 sections 40 rows of pipe	1.40	1.75

From the above values of c , Table XVI has been compiled, assuming $t_s = 227$, $t_o = 0$ and $c =$ a safe value.

TABLE XVI.

Velocity of air in feet per min.	Total transmission in B. t. u. per sq. ft. per hour. $t_s = 227$; $t_o = 0$.							
	Rows of pipe deep.							
	4	8	12	16	20	24	28	32
800	2840	2470	2164	1920	1750	1606	1450	1360
1000	3200	2790	2440	2170	1900	1810	1670	1535
1200	3500	3040	2670	2360	2150	1980	1825	1678
1500	3950	3400	2981	2645	2400	2220	2020	1870

Cast iron heaters are being used for indirect heating in many cases, replacing the old-fashioned pipe coil heaters. The efficiency of these heaters is, according to tests, about the same as that of the pipe coil heaters and hence formulas 42 and 43 will apply to both pipe and cast heaters. Table

XVII gives values of heat transmission for various sections, taken from tests upon Vento cast iron heaters set up in banks, and is added as a means of comparison with the values quoted on the pipe coil heaters.

TABLE XVII.

Rate of Transmission of Heat, K , through Vento Colls.
Steam 227°, Air Entering at 0°.

Velocities of air over coils.				
Sections	800	1000	1200	1500
1	7.6	8.8	10.0	11.3
2	7.1	8.2	9.2	10.5
3	6.6	7.7	8.6	9.7
4	6.1	7.1	7.9	9.0
5	5.6	6.5	7.3	8.8
6	5.2	6.0	6.7	7.7
7	4.8	5.5	6.2	7.1

In applying these values of K to formula 42 it should be remembered that t_0 would be used instead of $\frac{t + t_0}{2}$

APPLICATION 1. *Where Heating Only is Considered.*—Referring to Table XXV let H for the entire building be 1483251. Then from Art. 112, $Q = 1156935$, by formula 39, $H' = 2966502$ and by formula 43, the coil surface is

$$R = \frac{2966502}{8.5 \left(227 - \frac{140 + 0}{2} \right)} = 2222 \text{ square feet.}$$

With three lineal feet of 1 inch pipe per square foot of surface, we have 6666 lineal feet of coils in the heater.

APPLICATION 2. *Where Ventilation is Considered.*—Assume 1100 people in the building on a zero day and $Q' = 2000000$, then,

$$H' = 1483251 + 1.27 \times 2000000 = 4023251 \text{ and}$$

$$R = \frac{4023251}{8.5 \left(227 - \frac{140 + 0}{2} \right)} = 3014 \text{ sq. feet} = 9042 \text{ lineal feet.}$$

This value is probably the greatest amount that would be needed. In such a case, when the rooms are supplied with extra air, the register temperatures over the entire building may be less than 140 degrees. Suppose in this case the temperature is, by formula 40, $t = 70 + 55 \times 1483251 \div 2000000 = 111^\circ$, then

$$R = \frac{4023251}{8.5 \left(227 - \frac{111 + 0}{2} \right)} = 2760 \text{ sq. ft.} = 8280 \text{ lineal ft.}$$

In using this formula, the value $t = 140$ is to be recommended wherever part of the rooms are not provided with extra amounts of ventilating air. By so doing the ducts and registers may be held down to a more moderate size and at the same time give a safer figure for the heating surface.

Suppose that in a certain building most of the rooms are to be ventilated and that these rooms will have large amounts of air delivered at low temperatures. In such a case it will be economy to heat the air for all rooms to this temperature and supply more air to the rooms that would otherwise be heated with air at 140 degrees, than to put in a heater large enough to heat all the air to 140 degrees and then dilute with large amounts of cold air to lower the temperature to what it should be. Again, suppose that a school building contains, in addition to the regular class rooms, laboratories, etc., an auditorium and gymnasium, the two together requiring an amount of air sufficient to justify a separate fan system (a condition which frequently exists), it would be economy to separate the heating system for these rooms from the rest of the building because of the comparatively short time the rooms are in use. When not in use the fan unit may be shut down without interfering with the rest of the system. On the other hand, if united with the rest of the building, the capacity of the unit would be reached only when these rooms were in use, while at other times it would run at a very low efficiency.

116. Approximate Rules for Plenum Heating Surfaces:

—The following approximate rules are sometimes used in checking up heating surface in the coils. These are not recommended and should be used with caution.

Rule 1.—“Allow one lineal foot of 1 inch pipe for each 65 to 125 cubic feet of room space”; 65 for office buildings, schools, etc., and 125 for shops and laboratories. Since this building has approximately 500000 cubic feet of room space, it gives 7700 lineal feet of 1 inch pipe in the heater.

Rule 2.—"Allow 200 lineal feet of 1 inch pipe for each 1000 cubic feet of air per minute at a velocity of 1500 feet per minute." Applying to the above building when the air moves over the coils at 1000 feet per minute, the heated surface is only about four-fifths as valuable and would require 250 lineal feet per each 1000 cubic feet of air per minute. This gives 8333 lineal feet of coils.

117. Final Air Temperatures:—Since the amount of heat transmitted is directly proportional to the difference of temperature between the two sides of the metal, the first coils in the bank are the most efficient, and this efficiency drops off rapidly as the air becomes heated in passing over the coils. Final temperatures for different numbers of coil sections in banks have been found by experiment and may be taken from Table XVIII. See also Table XIV, page 175.

TABLE XVIII.

Temperatures of Air upon Leaving Coils, Steam 227°, Air Entering at 0°.

Sections	No. of Rows	Velocities of air through coils in F. P. M.			
		800	1000	1200	1500
1	4	42	33	28	23
2	8	71	62	56	52
3	12	96	87	80	75
4	16	119	108	101	93
5	20	136	125	116	108
6	24	153	140	131	120
7	28	169	155	143	131
8	32	183	166	154	141

These temperatures may be increased about 10 per cent. for 20 pounds gage pressure.

Table XIX shows similar results quoted for the Vento cast iron heaters.

TABLE XIX.

Temperatures of Air upon Leaving Vento Coils, Steam 227°,
Air Entering at 0°. Regular and Narrow Sections
5 Inch Centers.

Number of stacks deep		Velocities of air through coils in F. P. M.											
		800			1000			1200			1500		
		0°	-10°	-20°	0°	-10°	-20°	0°	-10°	-20°	0°	-10°	-20°
1	Reg.	88			85			82			30		
	Nar.												
2	Reg.	68	61	55	63	55	48	59	51	44	53	45	39
	Nar.	51	43	36	46	38	31	43	35		39	31	
3	Reg.	93	87	82	87	80	75	82	75	69	74	68	61
	Nar.	70	64	57	65	58	52	61	54	47	55	48	41
4	Reg.	113	108	103	108	100	96	100	95	90	92	86	81
	Nar.	88	82	77	82	76	70	77	70	64	70	63	56
5	Reg.	130	126	122	122	118	114	116	111	107	108	102	97
	Nar.	103	97	93	96	90	86	90	84	80	83	77	71
6	Reg.	143	140	136	136	132	128	129	125	121	120	116	112
	Nar.	115	111	107	108	104	100	102	98	93	94	89	84
7	Reg.	154	151	148	147	144	141	141	137	133	132	128	124
	Nar.	127	123	120	120	115	111	114	109	105	105	100	96

118. Arrangement of Coils in Pipe Heaters:—Coil sections are arranged with 2, 3 and 4 rows of pipes per section. Unless special reference is made to this point, the latter value is understood. Having found the total square feet of heating surface in the heater, obtain from the temperature tables the number of sections deep the heater will need to be to produce the desired temperature, and find the number of square feet of heating surface per section and per row of coils. Let this latter value be *A*. Also find the net wind area across the coils, assuming, say 1000 feet per minute velocity. From the net wind area, find the gross cross sectional area of the heater by the value

$$\text{Gross wind area} = 2.5 \text{ times net wind area.} \quad (45)$$

From the gross area the size of the heater may be selected. In selecting the heater, the following check should be applied. Find the number of square feet of heating surface, *B*, in each row of the coils as figured from the gross area and compare with *A*. These must be made to agree.

Let the net area between the tubes, *N. A.*, the space

occupied by the tubes, $T. A.$, and the gross cross sectional wind area through the tube, $G. W. A.$, be respectively

$$N. A. = \frac{Q \text{ or } Q'}{60 V}; T. A. = \frac{Q \text{ or } Q'}{40 V}; \text{ and } G. W. A. = \frac{Q \text{ or } Q'}{24 V} \quad (46)$$

Since the cross sectional space $T. A.$ occupied by the tubes is to the coil surface per row as 1 : 3.1416, the total coil surface in one row of tubes is

$$R_1 = \frac{3.1416 (Q \text{ or } Q')}{40 V} = .08 \frac{(Q \text{ or } Q')}{V}$$

Reduced to the basis of the net area, $N. A.$, we have

$$R_1 = 4.8 \text{ times } N. A. \quad (47)$$

If B is greater than A , then the total heating surface must be increased in that proportion, since the number of sections cannot be less or the final temperature will drop below the required degree, and the net cross section cannot be less or the velocity of the air will be greater than that desired. On the other hand, suppose B should be less than A . In that case the total heating surface will not change from that calculated. Either B may remain the same as calculated and the number of sections increased (if desirable) until all the heating surface is accounted for, or A may remain constant and B may be increased. The latter method is probably a better one since it gives larger wind areas and consequently reduced velocities of the air, which in many cases is desirable, and avoids placing heating surface at the rear of the bank where it is less efficient.

Assembled sections of pipe coil heaters are supplied by manufacturers from the smallest size of 3 feet x 3 feet, to the largest size of 10 feet x 10 feet; these dimensions being those of the gross cross-sectional area, and not dimensions overall. Between the two limits, both height and breadth usually vary by 6 inch increments. For exact sizes, consult dimension tables in manufacturers' catalogs.

APPLICATION 1.—In Article 115, let $R = 2222$, $Q = 1156935$, $V = 1000$ and $t = 140$; then from Table XVIII the heater will require 24 rows of coils in depth to give the required temperature. Next find $R_1 = 93$ square feet of heating surface per row, also

$$N. A. = 19.7; T. A. = 29.6; \text{ and } G. W. A. = 48.3.$$

Checking $N. A.$ with an air velocity of 1000 feet per minute gives $1156935 \div (60 \times 1000) = 19.3$ square feet, which

shows that the above arrangement is satisfactory. Now from the value $G. W. A. = 48.3$ select a heater, say 6 feet \times 8 feet.

APPLICATION 2.—In article 115, let $R = 3014$, $Q' = 2000000$, $V = 1000$ and $t = 140$; then as before, the heater will need 24 rows of coils. Find in this case $R_1 = 126$ and

$N. A. = 26.3$; $T. A. = 39.4$; and $G. W. A. = 65.7$.

Checking from the volume of air delivered, obtain

$N. A. = 33.3$; $T. A. = 50$; and $G. W. A. = 83.3$.

From $N. A. = 33.3$ find $R_1 = 160$, which shows that it will

be necessary to increase the total heating surface to $\frac{160}{126}$

$\times 3014 = 3826$ square feet. If it were considered advisable to have 1200 feet air velocity the heating surface per row would be reduced to 135 and the temperature, t , would be reduced to 131. Both conditions are reasonable and in many cases would be considered satisfactory.

Selecting the heater for the gross area of 83.3 square feet, from the catalog size, would probably give a single section 9 feet \times 9 feet or a double section, each part 6 feet \times 7 feet.

119. Arrangement of Sections and Stacks in Vento Cast Iron Heaters:—Applying only to Case 2, Art. 115, let $R = 3014$, $Q' = 2000000$, $V = 1000$, $N. A.$ (least value) = 33.3, and $t = 140$.

From Table 48, Appendix, either of the following arrangements will give the necessary $N. A.$ *First.*—Six stacks deep, two sections high, 50 inches on top of 60 inches and twenty sections wide. This makes a total of 590 square feet to the stack or 3540 square feet total. The gross wind area looking in the direction of the wind is 103 inches by 110 inches. *Second.*—Six stacks deep, two sections high, 60 inches on top of 60 inches and eighteen sections wide. This makes a total of 576 square feet to the stack or 3456 square feet total. The gross wind area looking in the direction of the wind is 93 inches by 120 inches. These arrangements will guarantee a temperature of 136 degrees upon leaving the coils. If this temperature is not sufficient then the coils must be made seven sections deep and the total heating surface arbitrarily increased. Other arrangements could be worked out with $4\frac{1}{2}$ inch and $5\frac{1}{2}$ inch spacings. Also, narrow sections could be used in place of the regular. It will be found, however, that the two stated are probably

the best arrangements that could be made. (See Table XIX for temperatures.)

120. Use of Hot Water in Indirect Coils:—In most cases low pressure steam is used as a heating medium in the indirect coils. It is possible, however, to use hot water instead, where a good supply is to be had. In such an arrangement the coils will be figured from formula 42, using all values the same as for steam excepting t_s , which will be replaced by the average temperature of the water. The piping connections and the arrangement of the coils will follow the same general suggestions as already stated.

121. Pounds of Steam Condensed per Square Foot of Heating Surface per Hour:—From Art. 115 the number of pounds of condensation per hour per square foot of surface in the coils is

$$m = \frac{H'}{R \times \text{Heat given off per pound of condensation.}} \quad (48)$$

APPLICATION.—Let $R = 3014$ and $H' = 4023251$; also let one pound of dry steam at five pounds gage in condensing to water at 212 degrees give off $1155.6 - 180.9 = 974.7$. (See Tables 4 and 8, Appendix), then

$$m = \frac{4023251}{3014 \times 974.7} = 1.37 \text{ pounds.}$$

This amount should, of course, be considered an average.

The first and last section in any bank would vary above and below this amount by as much as 50 per cent. in the average plant. The first coils may condense as much as 2 pounds of steam per square foot of surface per hour.

122. Pounds of Dry Steam Needed in Excess of the Exhaust Steam Given off From the Engine:—Let the heating value of the exhaust steam from the engine be 85 per cent. of that of good dry steam, also let the engine use 40 pounds of dry steam per horse power hour in driving the fan. From Art. 132, the engine will use $40 \times 13.6 = 544$ pounds of steam per hour and the heating value will be $974.7 \times .85 = 828$ B. t. u. per pound or $828 \times 544 = 450432$ B. t. u. total per hour. Then $4023251 - 450432 = 3572819$ B. t. u., and $3572819 \div 974.7 = 3664$ pounds of steam. The boiler will then supply to the engine and coils, $3664 + 544 = 4208$ pounds of steam total and will represent, approximately, $4208 \div 30 = 140$ boiler horse power.

CHAPTER XII.

MECHANICAL WARM AIR HEATING AND VENTILATION. FAN COIL SYSTEMS.

PRINCIPLES OF THE DESIGN, CONTINUED. FANS AND FAN DRIVES.

123. Theoretical Air Velocity:—The theoretical velocity of air v , flowing from any pressure, p_a , to any pressure, p_b , is obtained from the general equation $v = \sqrt{2gh}$, where v is given in feet per second, $g = 32.16$ and $h =$ head in feet producing flow. This latter value may be easily changed from feet of head to pounds pressure and vice versa.

When exhausting air from any enclosed space into another space containing air at a different density, the force which causes movement of the air is $p_a - p_b = p_x$. These recorded pressures may be taken by any standard type of pressure gage and show pressures above the atmosphere. When exhausting into the atmosphere, the value p_b is zero and $p_a = p_x$. The fact that a difference of pressure exists between two points indicates that there are either two actual columns (or equivalent as in Fig. 8) of air at different densities connected and producing motion, or that, by mechanical means, a pressure difference is created which may easily be reduced to an equivalent head h , in feet, by dividing the pressure head by the density of the air, as

$$h = \frac{\text{pressure difference}}{\text{density}} = \frac{p_a - p_b}{d}$$

Let $p_a - p_b = p_x =$ ounces of pressure per square inch of area producing velocity of the air; also, let $g =$ acceleration due to gravity $= 32.16$ and $d =$ density, or weight, of one cubic foot of dry air at 60 degrees and at atmospheric pressure (Table 12, Appendix), then, substituting in the general equation, we have

$$v = \sqrt{\frac{64.32 \times 144 p_x}{.0764 \times 16}} = 87 \sqrt{p_x} \quad (49)$$

Since the pressure producing flow is usually measured in inches of water, h_w , the above can be changed to equivalent height of air column by

$$h = \frac{\text{weight of water, per cu. ft. at given temp.} \times h_w}{\text{weight of air at given temperature} \times 12} \quad (50)$$

Applying this to dry air at 60 degrees and water at the same temperature (Tables 12 and 8, Appendix, also Art. 15),

$$h = \frac{62.37 h_w}{12 \times .0764} = 68 h_w$$

then substituting in the general equation, find

$$v = \sqrt{64.32 \times 68 h_w} = 66.2 \sqrt{h_w} \tag{51}$$

Formula 50 at the temperatures 50, 55, 60, 65 and 70 degrees respectively, gives results varying between $v = 65.5 \sqrt{h_w}$ for 50 degrees and $v = 66.5 \sqrt{h_w}$ for 70 degrees, which leads to the approximate general rule that *the theoretical velocity of air, when measured by a water column gage that measures in inches of water, equals sixty-six times the square root of the height of the column in inches.* Stated as a formula

$$v = 66 \sqrt{h_w} \tag{52}$$

for calculations requiring accuracy, several factors affect the final result; atmospheric pressure, humidity, and the density and change of temperature in the air current. Let the atmospheric pressure and the humidity be constant, since these would affect the result but little, and first take into account the density of the air. Let the pressure of the atmosphere be 29.92 inches of mercury (14.7 pounds = 235 ounces per square inch area) then, since the density is proportional to the absolute pressure, the temperature remaining constant, we have from formula 49 with air exhausting into the atmosphere,

$$v = \sqrt{\frac{64.32 \times 144 p_x}{.0764 \times 16 \times \frac{235 + p_x}{235}}} = 1336 \sqrt{\frac{p_x}{235 + p_x}} \tag{53}$$

Also from the relation existing between formulas 49 and 51, formula 53 reduces to

$$v = 1336 \sqrt{\frac{h_w}{407 + h_w}} \tag{54}$$

From formulas 53 and 54 the second columns in Tables XX and XXI have been calculated.

APPLICATION.—Air is exhausted from an orifice in an air duct into the atmosphere. The pressure of the air within the duct is one ounce by pressure gage or 1.74 inches by a Pitot tube. Assuming the air to be dry and the barometer standing at 29.92 inches when the water in the tube is 60 degrees, what is the velocity of the air? By the approximate formulas 49 and 52

$$v = 87 \sqrt{1} = 87 \text{ F. P. S.}$$

$$\text{and } v = 66 \sqrt{1.74} = 87.2 \text{ F. P. S.}$$

By formulas 53 and 54

$$v = 1336 \sqrt{\frac{1}{235 + 1}} = 86.3 \text{ F. P. S.}$$

$$\text{and } v = 1336 \sqrt{\frac{1.74}{407 + 1.74}} = 87.1 \text{ F. P. S.}$$

TABLE XX.

Column 2 figured from formula 53.

Pressure in ounces per sq. inch.	Velocity of dry air at 60° escaping into the atmosphere through any shaped orifice in any pipe or reservoir in which a given pressure is maintained.		Vol. of air in cu. ft. which may be discharged in 1 min. through an orifice having an effective area of discharge of 1 sq. inch.	H. P. required to move the given vol. of air under the given conditions of discharge. (Col. 3 × Col. 1) 16 × 33000
	Ft. per sec.	Ft. per min.	Col. 3 ÷ 144	
⅛	30.80	1848.00	12.83	0.00044
¼	43.56	2613.60	18.15	0.00124
⅜	53.27	3196.20	22.19	0.00227
½	61.56	3693.60	25.65	0.00349
⅝	68.79	4127.40	28.66	0.00489
¾	75.35	4521.00	31.47	0.00642
⅞	81.37	4882.20	33.90	0.00809
1	86.97	5218.20	36.24	0.00988
1⅛	92.18	5530.80	38.41	0.01178
1¼	97.18	5830.80	40.49	0.01380
1⅝	101.90	6114.00	42.46	0.01592
1½	106.40	6384.00	44.33	0.01814
1⅞	110.82	6649.20	46.11	0.02046
1¾	114.86	6891.60	47.86	0.02284
1⅞	118.85	7131.00	49.52	0.02533
2	122.47	7348.20	51.03	0.02787

TABLE XXI.

Column 2 figured from formula 54.

Pressure head in inches of water	Velocity of dry air at 60° escaping into the atmosphere through any shaped orifice in any pipe or reservoir in which a given pressure is maintained.	
	Feet per second	Feet per minute
.1	29.04	1256.40
.2	29.67	1780.20
.3	36.25	2175.60
.4	41.86	2511.60
.5	46.80	2708.00
.6	51.26	3075.60
.7	55.36	3321.60
.8	59.10	3546.00
.9	62.60	3756.00
1.	66.14	3968.40
1 1	69.36	4161.60
1 2	72.44	4346.40
1 3	75.39	4523.40
1.4	78.21	4692.60
1.5	80.96	4857.60
1 6	83.59	5015.40
1.7	86.16	5169.60
1.8	88.65	5319.00
1.9	91.27	5476.20
2.	93.42	5605.20
2.1	95.72	5743.20
2 2	97.96	5877.60
2 3	100.15	6009.00
2.4	102.29	6137.40
2 5	104.39	6263.40
2 6	106.43	6385.80
2 7	108.46	6507.60
2.8	110.43	6625.80
2.9	112.37	6742.20
3.	114.28	6856.80
3 1	116.15	6969.00
3 2	118.00	7080.00
3 3	119.81	7188.60
3.4	121.60	7296.00
3.5	123.36	7401.60

Finally, after considering the change of velocity that takes place when the density changes with a constant temperature, let the temperature change. With a constant pressure, the volume changes with the absolute temperature ($460 + t$). From this basis the values given in the second

columns of Tables XX and XXI, which were figured for 60 degrees, would be multiplied by the relative factors for the given temperature as expressed in column two, Table XXII, to obtain the velocity of the exhausting air at any pressure and any temperature. Having found the data from Column 2, find other points of information concerning velocities, pressures, weights and horse powers in moving air by multiplying by the factors as given in the respective columns.

TABLE XXII.

Temp. in degrees.	Factor for relative vel. at same pressure also relative powers to move same vol. of air at same vel. = $\sqrt{\frac{\text{Wt. at any T}}{\text{Wt. at } 460^{\circ} + 60^{\circ}}}$	Factor for relative pressure, also wt. of air moved at same velocity = $\frac{460 + 60}{T}$	Factor for relative vel. to move same wt. of air also relative pressure to produce the vel. to move same wt. of air = $1 \div \text{Col. 3.}$	Factor for relative power to move same wt. of air at vel. in column 4 and pressure in column 4 = factor in column 4 squared
30	.97	1.07	.93	.87
40	.98	1.04	.96	.92
50	.99	1.02	.98	.96
60	1.00	1.00	1.00	1.00
70	1.01	.98	1.02	1.04
80	1.02	.96	1.04	1.08
90	1.03	.94	1.06	1.13
100	1.04	.92	1.09	1.19
125	1.06	.89	1.12	1.25
150	1.08	.85	1.18	1.39
175	1.10	.82	1.22	1.49
200	1.13	.79	1.27	1.61
250	1.17	.73	1.37	1.88
300	1.21	.68	1.47	2.16
350	1.25	.64	1.56	2.43
400	1.28	.60	1.67	2.79
500	1.36	.54	1.85	3.42
600	1.43	.49	2.04	4.16
700	1.49	.45	2.22	4.93
800	1.56	.41	2.44	5.95

124. Actual Amount of Air Exhausted:—When air of any pressure is exhausted from one receptacle to another through an orifice, the actual velocity remains about the same as the theoretical velocity, being slightly reduced by friction, but the volume of air discharged is greatly reduced because

of the contraction of the stream just as it leaves the orifice. The greatest contraction or least size of the jet is located from the orifice a distance of about one-half the diameter of the opening. A round opening is the most efficient. Since the velocity is slightly reduced and the effective area of the opening reduced a still greater amount, the actual amount of air exhausted in any given time will be found by multiplying the theoretical amount by a constant which is the product of the coefficient of reduced velocity and the coefficient of reduced area. From tests by Weisbach the following approximate values are quoted by the Sturtevant Company in Mechanical Draft, page 152.

Orifice in a thin plate,	.56
Short cylindrical pipe,	.75
Rounded off conical mouth piece,	.98
Conical pipe, angle of convergence about 6°,	.92

125. Results of Tests to Determine the Relation between Pressure and Velocity in Air Transmission:—In fan construction the number of blades, the shape of the blades, the sizes of the inlet and outlet openings, the shape and size of the casement around the blades and the speed, all have an effect upon the relation between the pressure and the velocity of the air discharge. From recent tests conducted in the Mechanical Engineering Department, University of Nebraska, the curves shown in Fig. 101, *a*, were ob-

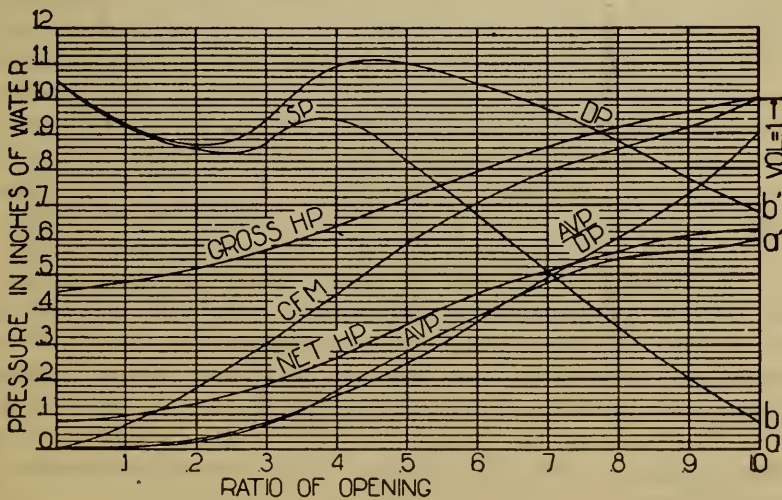

Fig. 101a.

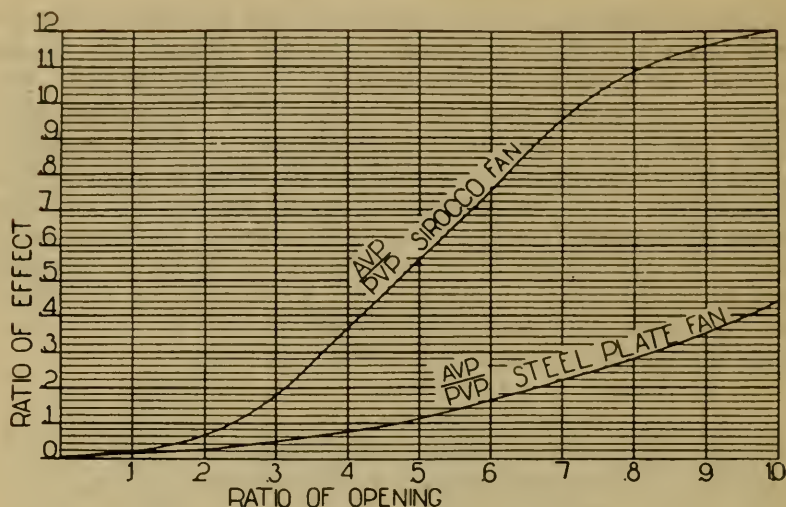

Fig. 101b.

tained. A Number 2 Sirocco blower was belted to an electric motor and delivered air to a horizontal, circular pipe whose length was nine times the diameter. This pipe was provided with reducing nozzles which varied the area of discharge by tenths from full opening to full closed. The air tube was provided also with manometer tubes for static, dynamic and velocity pressures, arranged with an adjustable scale to read to either .01 or .002 inch of water. The gross power was taken by wattmeter and the delivered power from motor to fan was taken by dynamometer. In addition to this, the frictional horse-power of the fan and motor unit was obtained by removing the fan wheel from the shaft and taking readings with all other conditions remaining as nearly constant as possible. The friction power, when deducted from the gross power recorded by the wattmeter, gave the readings for the net horse-power curve. A galvanized iron intake, enlarged from the size of the fan intake to a rectangle four square feet in area and divided up by fine wires into rectangles the size of the standard anemometer, was used to find the volume of air moved per minute. This volume is shown in the curve C. F. M. To check the curve, the volume was calculated for each opening by the Pitot tubes on the side of the experimental pipe.

To fully understand this article, refer to Art. 15 and note that *A*, Fig. 10, registers *static pressure plus velocity pressure*. This sum may be called the *dynamic pressure*. Also, note that *B* registers *only static pressure*, i. e., that pressure which acts equally in all directions and serves no usefulness in moving the air. Also, note that $A - B = C$, i. e., dynamic pressure minus static pressure equals velocity pressure. When applied in the form shown by *C*, the pressure recorded is that due to the velocity only. This is the form commonly used. Now referring again to Fig. 101, *A. V. P.* is that pressure recorded by *C* when applied to the air current at the fan outlet, = air velocity pressure. *P. V. P.* is that pressure (obtained by formulas 49 to 54) that would be shown on *C* if the air were moving as fast as the tip of the blades on the fan wheel, = peripheral velocity pressure. $P. V. P. = 1$ in Fig. 101, *b*. *D. P.* is the dynamic pressure and would be found by applying *A* only. *S. P.* is the static pressure as stated above.

In the tests, the fan was run at constant speed and the dynamic, static and velocity pressures were measured about midway of the pipe at full opening. Then the openings were changed by ten per cent. reductions until the pipe was fully closed and similar readings taken for each reduction. These readings were plotted in the upper set of curves. Because of the fact that the manometer tubes were located some distance from the end of the experimental pipe, there was a static pressure, *ab*, recorded at full opening. This caused the dynamic pressure to be raised a corresponding amount, *a' b'*. If the tubes had been located at the delivery end of the pipe the static and dynamic pressures would have fallen from *b* and *b'* to *a* and *a'*. The peripheral velocity of the wheel was 2828 feet per minute and the corresponding pressure, with corrections for temperature, was found by formula 52 to be .5 in. of water. The relation between this peripheral velocity pressure and the air velocity pressure is shown in the lower set of curves. In applying the lower curves to fan practice they are very valuable in showing the relation between the velocity of the wheel circumference and that of the air leaving the wheel. Notice that the relation between the observed air velocity pressure and the calculated peripheral velocity pressure at full opening and discharging into free air, is 1.20 : 1. Since the velocities vary as the square roots of the pressures ($v = \sqrt{2gh}$), we find the velocities to

be $\sqrt{1.20} : \sqrt{1} = 1.1 : 1$. That is to say, for this fan the air velocity at the free opening of the fan is 1.1 times the peripheral velocity of the wheel. The corresponding velocity of the air from the average steel plate fan as reported by the American Blower Company and as shown on the lower chart, is $\sqrt{.45} : \sqrt{1} = .67 : 1$, or .61 of the speed of the Sirocco fan for the same wheel speed. The resistance offered by the ducts in the average plenum heating system is equivalent, we will say, to that offered by a 75 per cent. gate opening in the experimental pipe. According to the diagrams for this opening, the ratio $A. V. P.$ to $P. V. P$ is 1.04 for the Sirocco fan and .25 for the steel plate fan. The ratio of the air velocities to the peripheral velocities then are, respectively, $\sqrt{1.04} : \sqrt{1} = 1.02 : 1$ and $\sqrt{.25} : \sqrt{1} = .5 : 1$: These show that with a 75 per cent. opening and with the fan wheels running with a peripheral velocity of 3000 feet per minute, the air would be entering the ducts at $1.02 \times 3000 = 3060$, and $.5 \times 3000 = 1500$ feet per minute respectively for the two types. Conversely, if it were desired to have the air enter the ducts at 1500 feet per minute, with a resistance equivalent to a 75 per cent. opening, the fan wheels would have peripheral speeds of $1500 \div 1.02 = 1470$, and $1500 \div .5 = 3000$ feet per minute respectively. From these we obtain the wheel diameter for any given $R. P. M.$ Other models of the Sirocco and multiple blade type of fans show less variation from the steel plate fan than the one under consideration. It will be seen from the above that the late change in construction from the steel plate type to the multiple blade type permits a smaller wheel and fan to be installed for any given work. This can be shown to be a desirable change. From formula 61, it is seen that the power required to drive a fan varies as the fifth power of the diameter and as the cube of the speed. With any given amount of air, Q , required per minute, the power will be reduced very greatly by reducing the diameter or by reducing the speed of the fan. Manufacturers' catalogs should be consulted for capacities, sizes, etc. Such tables are supplied by the trade in form for easy reference and use.

126. Work Performed and Horse-Power Consumed in Moving Air:—The foot pounds of work performed in moving air equals the product of the moving force into the distance

moved through in any given time. Let $p_a - p_b = p_x =$ moving force of the air in ounces per square inch and $A =$ cross-sectional area of current in square inches. Then the pounds per square inch will be $p_x \div 16$, and the foot pounds of work, W , and the horse-power, $H. P.$, absorbed per minute by the current of air in being moved, will be

$$W = \frac{60 p_x A v}{16} = 3.75 p_x A v \quad (55)$$

$$H. P. = \frac{3.75 p_x A v}{33000} = .000114 p_x A v \quad (56)$$

This formula may be stated in terms of the cubic feet of air discharged per minute. Take the relation between p_x and h_w at 60 degrees as $12 p_x = 16 \times .433 h_w$; also, $A \times v = 144 Q'$ when $Q' =$ cubic feet of air discharged per second and, from formula 54, $h_w = v^2 \div 4356$. Then by substituting in formula 56

$$H. P. = \frac{3.75 \times .577 \times v^2 \times 144 Q'}{4356 \times 33000} = .0000022 v^2 Q' \quad (57)$$

APPLICATION 1.—Let the effective area of a stream of dry air at 60 degrees, exhausting between the pressures of $p_a = 1\frac{1}{2}$ ounces and $p_b = \frac{1}{2}$ ounce, be 400 square inches. What is the work performed per minute and the horse-power consumed? (For velocity see second column Table XX).

$W = 3.75 \times (1\frac{1}{2} - \frac{1}{2}) \times 400 \times 87 = 130500$ foot pounds, and $H. P. = .000114 \times (1\frac{1}{2} - \frac{1}{2}) \times 400 \times 87 = 3.96$.

APPLICATION 2.—A fan is delivering 1000000 cubic feet of air per hour to a heating system with a pressure of $\frac{3}{4}$ ounce. What is the theoretical horse-power of the fan?

$$H. P. = .0000022 \times (74.5)^2 \times 277 = 3.38$$

127. Actual Horse-Power Consumed in Moving Air by Blower Fans:—The theoretical horse-power of a fan is that horse-power necessary to move the air. This amount is always exceeded, however, because of the inefficiency of the blower. Let $E =$ efficiency of the blower, then formulas 56 and 57 become

$$H. P. = \frac{.000114 p_x A v}{E} \quad (58)$$

$$H. P. = \frac{.0000022 v^2 Q'}{E} \quad (59)$$

The value of E varies with the peripheral velocity and the percentage of free outlet. When subjected to ordinary service, the efficiency of the fan or blower may vary anywhere from 10 to 40 per cent. Probably a safe figure, for an efficiency not definitely known, is 30 per cent. for centrifugal fans in heating systems. Later improved types, such as the Sirocco and Multivane fans, will be found from 40 per cent. to 60 per cent. efficient. See also Art. 131.

128. Carpenter's Practical Rules:—Many experiments have been run upon blower fans to determine their capacity in cubic feet of air delivered per minute and to determine the horse-power necessary to move this air. Probably as satisfactory as any are the rules quoted by Prof. Carpenter in H. & V. B., Art. 162, as follows:

Rule.—"The capacity of fans, expressed in cubic feet of air delivered per minute, is equal to the cube of the diameter of the fan wheel in feet multiplied by the number of revolutions, multiplied by a coefficient having the following approximate value: for fan with single inlet delivering air without pressure, 0.6; delivering air with pressure of one inch, 0.5; delivering air with pressure of one ounce, 0.4; for fans with double inlets, the coefficient should be increased about 50 per cent. For practical purposes of ventilation, the capacity of a fan in cubic feet per revolution will equal .4 the cube of the diameter in feet."

Rule.—"The delivered horse-power required for a given fan or blower is equal to the 5th power of the diameter in feet, multiplied by the cube of the number of revolutions per second, divided by one million and multiplied by one of the following coefficients: for free delivery, 30; for delivery against one ounce pressure, 20; for delivery against two ounces of pressure, 10."

The two above rules stated as formulas are as follows:

$$D = \sqrt[3]{\frac{\text{Cu. ft. of air per min.}}{C \times R. P. M.}} \quad (60)$$

where D = the diameter in feet and C = the coefficient, .4 for pressure of one ounce, .5 for pressure of one inch, and .6 for no pressure.

$$H. P. = \frac{D^5 (R. P. S.)^3 \times C}{1000000} \quad (61)$$

where C = 30 for open flow, 20 for one ounce and 10 for two ounces pressure respectively. These two rules may be

checked up by sizes obtained from catalogs. They give, however, in ordinary calculations, very close approximations.

Note.—In using formula 60 for Sirocco or Multivane fans, the coefficient, *C*, becomes 1.1, 1.2 and 1.3 respectively. Likewise, for formula 61 it becomes 100, 95 and 90 respectively.

129. If it is Desired to Obtain the Approximate Sizes of the Different Parts of the Fan Wheel and Opening, the same can be found by the following table which gives good average values for steel plate fans. For more complete data see tables in catalogs.

TABLE XXIII.*

Diameter wheel	<i>D</i>		
Diameter inlet, single	.66 <i>D</i>		
Diameter inlet, double	.50 <i>D</i>		
Dimensions of exhaust	.60 <i>D</i> ×	.50 <i>D</i>	
Width of wheel at outer circumference	.50 <i>D</i>	to	.60 <i>D</i>
Least radial distance from wheel to casing	.08 <i>D</i>	to	.16 <i>D</i>
Maximum radial distance from wheel to casing			
	.50 <i>D</i>	to	1.00 <i>D</i>
Least side distance from wheel to casing	.05 <i>D</i>	to	.08 <i>D</i>

Occupied space of full-housed fan		Discharge vert.	Discharge horiz.
		Length	1.7 <i>D</i>
	Width	.7 <i>D</i>	.7 <i>D</i>
	Height	1.5 <i>D</i>	1.7 <i>D</i>

*This table does not apply to Sirocco or Multivane fans.

130. Fan Drives:—Fans for heating and ventilating purposes, may be driven by simple horizontal or vertical, throttling or automatic steam engines, or by electric motors; the principal advantage of the latter being the cleanliness. In either case the power may be direct-connected or belt-connected to the fan. Direct-connected fans make a very neat arrangement, but they require slow speed engines or motors, occasionally making them so large as to be prohibitive. Where engines are used, any unusual noise or pounding in the parts is frequently carried through the fan to the air current and up to the rooms. Belted drives may run at higher speeds but they must of necessity be set off from the fan ten feet or more to get good belt contact.

Chain drives that are fairly quiet in operation will permit the same reductions of speed and will allow the engine to be set very close to the fan. Where a reduction is made in the space between the engine and the fan, it had best be made in the last named way.

In deciding between an engine drive and a motor drive for use with steam coils, the amount of steam used in the engine should not be considered a loss, since this is all exhausted into the heater coils and is used instead of live steam from the boilers. An engine of high efficiency is not so essential either, unless the exhaust steam cannot be used. Enclosed engines running in oil are preferred when used on high speeds. The belt when used should, if possible, have the tight side below to increase the arc of contact.

Electric motors have more quiet action and in special cases should be specified. They would generally be specified for installations where the exhaust steam could not be used, as in systems for ventilating only. This method of driving the fan is more satisfactory in many ways but its operation is usually more expensive. Direct current motors are desirable, whenever they can be applied, because of the convenience in obtaining changes of speed and because the motors may easily be direct-connected to the fan. Alternating current motors are used but they usually run at higher speeds, requiring reduction drives and are not so satisfactory in regulation. Speed reductions of 40 per cent. may be had with alternating current machines where required.

131. Speed of the Fan:—A blower fan, exhausting into the open air, will deliver air with a linear velocity slightly below the peripheral velocity of the fan blades, but if this same fan be connected to a system of ducts and heater coils, the linear velocity of the air becomes much less because of the increased resistance and the *lag* or *slip* that takes place between the fan blades and the moving air. In the average heating system this slip may be as great as 40 to 50 per cent. See Art. 127. It is customary, therefore, in applying blowers to heating systems, to consider the linear velocity of the air as it leaves the fan to be one-half that of the periphery of the fan blades. Since the velocity of the air upon delivery from the fan should not exceed 1800 to 2500 feet per minute, the outer point on the

fan blades should not be expected to move faster than 3600 to 5000 feet per minute. Knowing this peripheral velocity, the revolutions per minute may be selected and the diameter obtained.

In all direct-connected fans the revolutions per minute must agree with that of the engine or motor. In belted fans, however, this restriction need not apply. It is found that ordinary blower fans running at high speeds are very noisy and so practice has determined largely the number of revolutions to use. Speeds used by the American Blower Company in the latest type of Sirocco fan are given in the following table.

TABLE XXIV.

Speeds of Blower Fans in *R. P. M.*

Diameter of wheel in inches.	Differential pressures.				
	1-2 oz.	3-4 oz.	1 oz.	1 1-2 oz.	2 oz.
18	538	660	762	933	1076
24	404	495	572	700	807
36	269	330	381	466	538
48	202	248	286	350	403
60	161	198	228	280	322
72	134	165	190	233	269
84	115	142	163	200	231
90	107	132	152	186	214

In the recent developments for blower fans the number of blades is increased and the depth of the blades is diminished, making the operation of the fan somewhat similar to that of the steam turbine. These fans seem to develop a much higher efficiency under tests than the ordinary paddle wheel fan. As a result, the diameter of the wheel may be smaller with the same revolutions for a given work or the wheel may have the same diameter with a reduced speed for a given work. Tables 50, 51 and 52, Appendix, give a summary of the latest catalog data.

132. Size of the Engine:—In obtaining the size of the

engine, it will be necessary first to assume the horse-power. This had better be taken as a certain ratio to that of the fan. Probably a safe value would be

$$H. P. \text{ of the engine} = \frac{4}{3} H. P. \text{ of the fan} \quad (62)$$

Having obtained the horse-power of the engine, it will next be necessary to find the size of the cylinder. Let p_a = the absolute initial pressure of the steam in the cylinder, i. e., atmospheric pressure + gage pressure, and r = number of the steam expansions in the cylinder, i. e., reciprocal of the per cent. of cut-off. The cut-off allowed for high speed engines in economical power service, approximates 25 per cent. of the stroke, but in engines for blower work this may be taken at 50 per cent. or half stroke. Find the mean effective pressure, p_1 , by the formula

$$p_1 = p_a \frac{1 + \text{hyperbolic logarithm of } r}{r} - \text{back pressure} \quad (63)$$

Next, let l = length of the stroke in inches and N = number of revolutions per minute and apply the formula

$$H. P. = \frac{2 p_1 l A N}{12 \times 33000} \quad (64)$$

and find A , the area of the cylinder, from which obtain d , the diameter of the cylinder. In applying formula 64 it will be necessary to assume l . This, for engines operating blowers, may be taken

$$2 l N = 200 \text{ to } 400$$

Formula 63 assumes that the steam in the cylinder expands according to the hyperbolic curve, $pv = p'v'$. For values of hyperbolic or Napierian logarithms see Table 5, Appendix.

It also assumes no loss in the recompression of the steam in the cylinder. Both assumptions are only approximately correct, but the errors are slight and to a certain degree, tend to neutralize each other, hence the final results from this formula are near enough to be used for approximate calculations. For such work as this, r may be taken from 2 to 3, the former being probably preferred. The back pressure should not be taken higher than 5 pounds gage (19.7 pounds absolute), since this is determined by the pressure in the coils carrying exhaust steam. This pressure, in ordinary service, drops nearly to atmospheric pressure.

In finding the diameter and length of the stroke of the cylinder, it may be necessary to make two or more trial applications before a good size can be obtained. Owing to the fact that the initial steam pressure is frequently low, say not to exceed 40 or 50 pounds, the mean effective pressure is small, thus calling for a cylinder of large diameter. In such cases, the diameter of the cylinder may be greater than the length of the stroke. In cases where high pressure steam is used, say 100 pounds gage, the diameter of the cylinder would be less than the length of the stroke.

APPLICATION 1.—Assume the following to fit the design shown in Figs. 104, 105 and 106: good dry steam from the boiler to the engine at 100 pounds gage pressure; direct-connected engine to fan, running at 180 revolutions per minute and delivering 2000000 cubic feet of air per hour to the building; steam cut-off in the cylinder at one-third stroke and used in the coils at 5 pounds gage pressure; find the sizes and horse-powers of the fan and engine unit. Applying formulas 60, 61, 62, 63 and 64

$$D. \text{ of fan} = \sqrt[3]{\frac{2000000}{60 \times 1.1 \times 180}} = 5.5 \text{ feet.}$$

$$H. P. \text{ of fan} = \frac{(5.5)^5 \times (3)^3 \times 87}{1000000} = 11.8$$

Check the fan size and horse-power by Table 52, Appendix.

$$H. P. \text{ of Engine} = \frac{4}{3} \times 11.8 = 15.7$$

$$p_1 = 115 \left(\frac{1 + 1.0986}{3} \right) - 19.9 = 60.5 \text{ pounds per}$$

square inch. Now if $2 l N = 250$, then $l = \frac{250}{360} = .69 \text{ feet} =$

$$8.25 \text{ inches and } A = \frac{15.7 \times 12 \times 33000}{2 \times 60.5 \times 8.25 \times 180} = 34.5 \text{ square}$$

inches = 6.625 inches diameter. The engine would be 6.625 inches \times 8.25 inches, at 180 *R. P. M.*

APPLICATION 2.—Assuming the values as in application 1, excepting that the steam is taken from a conduit main under a pressure of, say 30 pounds per square inch gage, that $2 l N = 300$, and that the steam cut-off in the cylinder is at one-half stroke. Then, as before, *D* of fan = 5.5 feet;

H. P. of fan = 11.7; and *H. P.* of engine = 15.7; the mean effective pressure is, however,

$$p_1 = 45 \left(\frac{1 + .6931}{2} \right) - 19.9 = 18.2 \text{ pounds per sq. in.}$$

$$\text{and } A = \frac{15.7 \times 12 \times 33000}{2 \times 18.2 \times 10 \times 180} = 95 \text{ square inches.}$$

Size of engine would be 11 inches \times 10 inches, at 180 *R. P. M.*

133. Piping Connections around Heater and Engine:—

Where the fans are run by steam power it is considered best to reduce the pressure of the steam by a pressure reducing valve before allowing the live steam to enter the coils. Where this reduction is made to 5 pounds or below, it may be entered into the same main with the exhaust steam from the engine, if desired; the back pressure valve on the exhaust steam line providing an outlet to the atmosphere in case the pressure should run above the 5 pounds allowable back pressure. If the value of the back pressure is increased much above 5 pounds, the efficiency of the engine is seriously affected. In many installations where the condensation from the live steam is desired free from oil, a certain number of coils are tapped for exhaust steam and this condensation trapped to a waste or sewer, the other coils delivering to a receiver of some sort for boiler feed or other purposes as may be required.

Every system should be fully equipped with pressure reducing valves, back pressure valves, traps and a sufficient number of globe or gate valves on the steam supply, and of gate valves on the returns to make the system flexible and responsive to varying demands. Figs. 102 and 103 show a typical plan and elevation for such connections. Some engineers advocate lifting the returns about 20 or 30 inches as shown at *A* and *B* to form a water seal for each section, thus making them independent in their action. This, in some cases where the coils are very deep, would be a benefit.

134. Application to School Building:—The three following figures and summary show the results of an application of the above to a school building. The summary,

Table XXV, gives in compact form such calculated results as admit of tabulation. Most of the applications throughout Chapters X, XI and XII, also refer to this same building.

The plans show the double-duct system, with plenum chamber and ducts laid just below the basement floor. The small arrows show the heat registers and vent registers for each room. The same stack which served as a heat car-

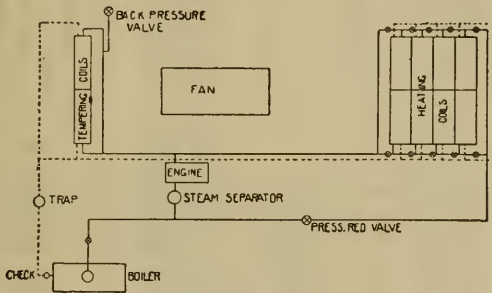

Fig. 102.

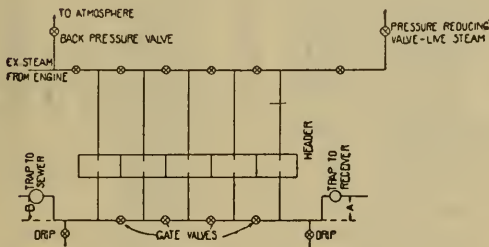

Fig. 103.

rier to the room on one floor serves as the vent stack for the corresponding room on the floor above, there being a horizontal cut-off between them. The cut-off at the heat register should be so curved as to throw the current of heated air into the room with the least possible friction or eddy currents, as shown in Fig. 22.

TABLE XXV.
Data Sheet for Figs. 104, 105, 106.

Room	n	Heat loss in B. t. u. per hour from room not counting ventilation	Heat loss counting exposure	Per cent. added	Cubic feet of air needed per hour as a heat carrier	No. of registers installed	Total net area of registers in sq. inches	Size of registers in inches	Size of stack in inches
1	1	51,520	-----	-----	40,185	2	322	13x20	13x13
2	$\frac{3}{4}$	74,200	-----	-----	57,876	---	---	-----	-----
3	$1\frac{1}{4}$	29,400	-----	-----	22,932	1	184	17x18	17x13
4	$1\frac{1}{4}$	36,260	-----	-----	28,283	1	226	17x21	17x13
5	$1\frac{1}{2}$	42,210	-----	-----	32,923	1	263	17x25	17x13
6	$1\frac{1}{2}$	35,350	-----	-----	27,573	1	220	17x21	17x13
7	-----	-----	-----	-----	-----	-----	-----	-----	-----
8	$1\frac{1}{2}$	16,520	-----	-----	12,885	1	103	13x13	13x 8
9	$1\frac{1}{2}$	16,520	-----	-----	12,885	1	103	13x13	13x 8
10	$1\frac{1}{2}$	42,210	-----	-----	32,923	1	263	17x25	17x13
Totals.	-----	344,190	-----	-----	268,466	-----	-----	-----	-----
11	1	81,130	-----	-----	63,281	2	506	17x24	17x13
12	$\frac{3}{4}$	115,430	126,973	10	99,039	4	792	17x18	17x13
13	$1\frac{1}{2}$	40,500	44,583	10	31,775	1	278	17x26	17x13
14	$1\frac{1}{2}$	55,370	60,907	10	47,507	2	380	17x18	17x13
15	$1\frac{1}{2}$	63,840	70,224	10	54,775	2	438	17x21	17x13
16	$1\frac{1}{2}$	48,440	50,862	5	39,072	1	317	17x30	17x13
17	1	51,940	-----	-----	40,513	2	324	13x20	13x13
18	$1\frac{1}{4}$	23,660	24,843	5	19,377	1	155	13x20	13x13
19	$1\frac{1}{4}$	23,660	-----	-----	18,455	1	148	13x20	13x13
20	$1\frac{1}{2}$	63,840	-----	-----	49,795	2	398	17x18	17x13
Totals.	-----	540,100	-----	-----	467,189	-----	-----	-----	-----
21	1	81,130	-----	-----	63,281	2	506	17x24	17x13
22	1	17,150	-----	-----	13,377	1	107	13x13	13x 8
23	1	103,460	113,800	10	88,764	2	710	21x28	17x 13
24	1	17,150	-----	-----	13,377	1	107	13x13	13x 8
25	1	31,900	35,189	10	27,447	1	220	17x21	17x13
26	1	48,580	53,438	10	41,682	2	333	13x20	13x13
27	1	93,030	102,333	10	79,819	2	638	17x30	17x13
28	$\frac{1}{2}$	23,420	-----	-----	22,163	2	177	13x15	13x 8
29	1	37,380	-----	-----	29,156	1	233	17x21	17x13
30	1	54,110	-----	-----	42,206	2	338	13x20	13x13
Totals.	-----	598,961	-----	-----	421,272	-----	-----	-----	-----

Vent registers taken same size as heat registers. For sizes of engine, fan, heater coils, etc., see applications under these heads

HEATING AND VENTILATING PLANS
BASEMENT PLENUM SYSTEM
CEILINGS 13'
WALLS 8 EXPOSED
WINDOWS 3 x 6'

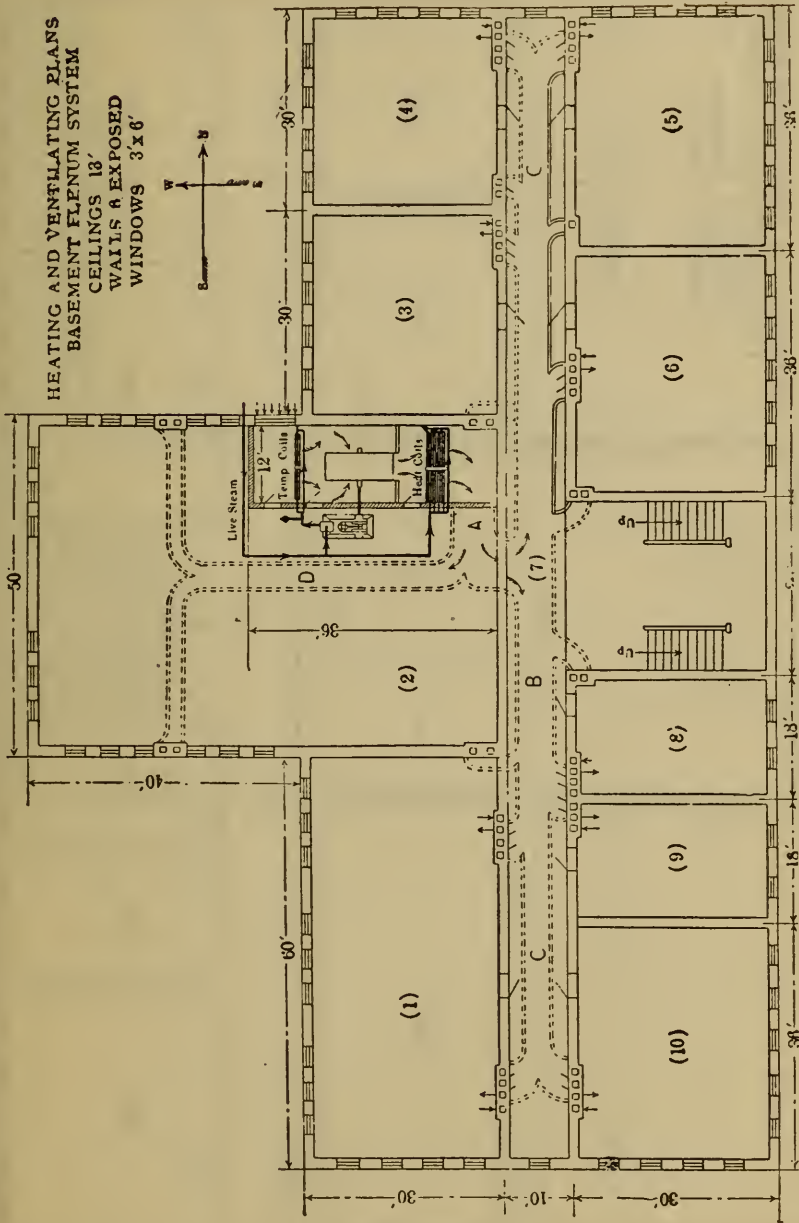

Fig. 104.

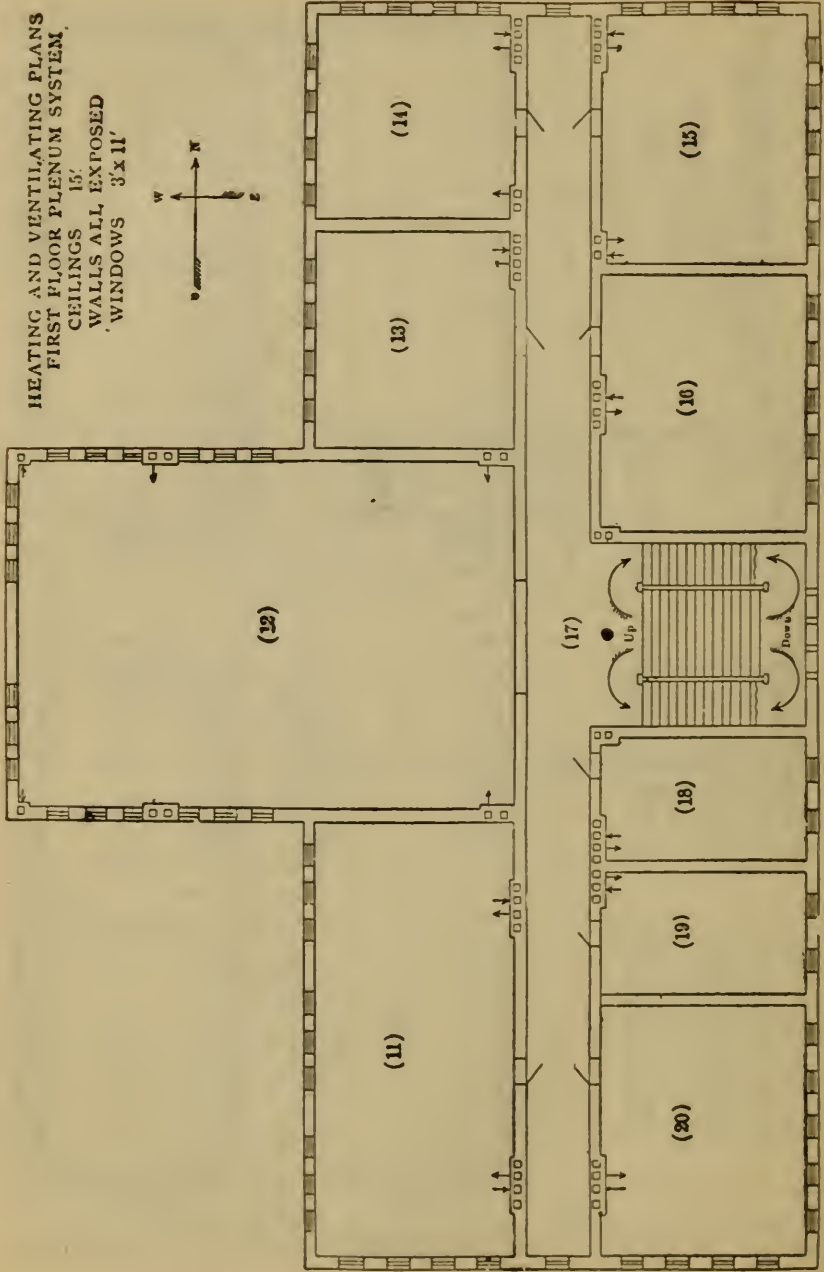

Fig. 105.

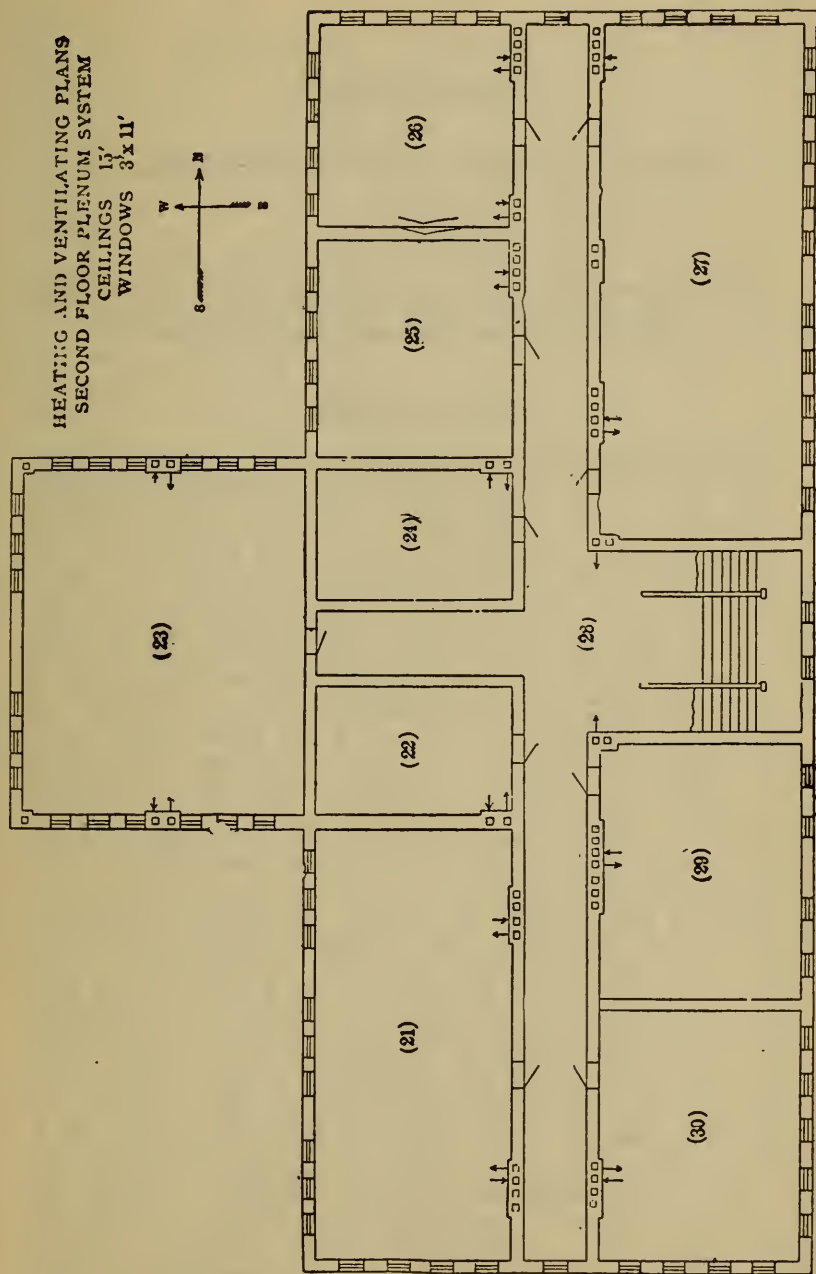

Fig. 106.

REFERENCES.

References on Mechanical Warm Air Heating.

TECHNICAL BOOKS.

Snow, *Furnace Heating*, p. 99. Monroe, *Steam Heat. & Vent.*, p. 124. Carpenter, *Heating and Ventilating Buildings*, p. 333. Hubbard, *Power, Heating and Ventilation*, pages 525 and 551.

TECHNICAL PERIODICALS.

Engineering Review. Ventilating and Air Washing Apparatus Installed in the Sterling-Welch Building, Cleveland, O., Jan. 1910, p. 38. Steam Heat. and Vent. Plant Required for Addition to the Hotel Astor, New York, March 1910, p. 27. Heating and Ventilating Plant of the Boston Safe Deposit and Trust Company's Building, C. L. Hubbard, April 1910, p. 37. Heating and Ventilating Installation on the Burnet St. School, Newark, N. J., Jan. 1909, p. 20. Heating and Ventilating the New Jersey State Reformatory, Sept. 1909, p. 27. Comparison of Heat. and Vent. Plants Installed in Chicago Schools and Buildings at Various Periods, T. J. Waters, June 1906, p. 14. Heating and Ventilating of Schools, F. G. McCann, June 1906, p. 11. The Heating and Ventilation of Schools, Dec. 1904, p. 1; March 1905, p. 4; Sept. 1905, p. 1; Oct. 1905, p. 5. Note:—The last two articles taken together comprise a complete series of the heating and ventilating of the schools of New York City. *Machinery.* Fans, C. L. Hubbard, Oct. 1905, p. 49; Nov. 1905, p. 109; Dec. 1905, p. 165. Heaters for Hot Blast and Ventilation, C. L. Hubbard, March 1907, p. 353. The Heating and Ventilation of Machine Shops, C. L. Hubbard, Sept. 1907, p. 1. Heating and Ventilating Offices in Shops and Factories, C. L. Hubbard, Feb. 1910, p. 437. Fans, *Machinery's Reference Series*, No. 39. *The Heating and Ventilating Magazine.* Figuring Flow of Air in Metal Pipes by Chart, B. S. Harrison, Dec. 1905, p. 1. Flow of Air in Metal Pipes, J. H. Kinealy, July 1905, p. 3. Friction of Bends in Air Pipes, J. H. Kinealy, Sept. 1905, p. 1. A Test of Hot Blast Heating Coils, March 1905, p. 1. Simplifying the Installation and Operation of School Heating and Ventilating Apparatus, S. R. Lewis, July 1908, p. 10. A Rational Formula Covering the Performance of Indirect Heating Surface, Perry West, March 1909, p. 1. Charts Showing the Performance of Hot Blast Coils, B. S. Harrison, Oct. 1907, p. 23. Loss of Pressure in Blowing Air through Heater Coils, with New Formula, E. M. Shealy, Nov. 1911. *The Engineering Magazine.* Modern Systems for the Ventilation and Tempering of Buildings, Percival R. Moses, Feb. 1908. *Domestic Engineering.* Practical Suggestions about Blower Systems for Shop Heating, F. R. Still, Vol. 46, No. 4, Jan. 23, 1909, p. 100; Vol. 46, No. 5, Jan. 30, 1909, p. 125. *Trans. A. S. H. & V. E.* Supplementing Direct Radiation by Fans, Vol. X, p. 236. Methods of Test-

ing Blowing Fans, R. C. Carpenter, Vol. VI, p. 69. Some Experiments with the Centrifugal Fan, W. S. Monroe, Vol. V, p. 117. *The Metal Worker*. Heating and Ventilating Willard Parker Hospital, New York, July 6, 1907, p. 43. New York Stock Exchange, Aug. 5, 1905, p. 55. Fans, serial article beginning May 2, 1908, p. 44. Heating and Ventilating a Factory, Sept. 12, 1908, p. 45. Obviating Noise in Fan Systems, serial beginning Oct. 31, 1908, p. 52. Heating Messiah Home, Fordham, N. Y., Nov. 21, 1908, p. 37. Filters for Air Supply, serial beginning Nov. 28, 1908, p. 44. Heating Christian Science Church, Boston, May 9, 1908, p. 35. Ventilation by Individual Air Ducts, Frederick Bass, June 7, 1912. *Railway Age Gazette*. Heating Plant for Mill, Nov. 13, 1908, p. 1369. *The Engineering Record*. A Formula for Indirect Heating, Dec. 13, 1909. Temperatures for Testing Indirect Heating Systems, W. W. Macon, Feb. 2, 1907, p. 135. Performance of Hot Blast Heating Coils, Jan. 28, 1905. Some Features of Indirect Heating, May 27, 1905. Heating and Ventilating in the Carnegie Residence, N. Y., Oct. 3, 1903, Vol. 48, p. 403. Ventilating and Heating the Rochester Athenaeum & Mechanics Institute, July 19, 1902, Vol. 46, p. 60. *Power*. Horse-Power of a Fan Blower, Albert E. Guy, June 13, 1911. Heating and Ventilating System of the Ritz-Carlton Hotel, Charles A. Fuller, Mar. 19, 1912. Ventilating System for Small Schools, Charles A. Fuller, Dec. 10, 1912.

CHAPTER XIII.

DISTRICT HEATING OR CENTRALIZED HOT WATER AND STEAM HEATING.

GENERAL.

135. Heating Residences and Business Blocks from a central station is a method that is being employed in many cities and towns throughout the country. The centralization of the heat supply for any district in one large unit has an advantage over a number of smaller units in being able to burn the fuel more economically, and in being able to reduce labor costs. It has also the advantage, when in connection with any power plant, of saving the heat which would otherwise go to waste in the exhaust steam and stack gases, by turning it into the heating system. The many electric lighting and pumping stations around the country give large opportunity in this regard. Since the average steam power plant is very wasteful in these two particulars, any saving that might be brought about should certainly be sought for. On the other hand, however, a plant of this kind has the disadvantage in that it necessitates transmitting the heating medium through a system of conduits, which generally is a wasteful process. The failure of many of the pioneer plants has cast suspicion upon all such enterprises as paying investments, but the successful operation of many others shows the possibilities, where care is exercised in their design and operation.

136. Important Considerations in Central Station Heating:—In any central heating system, the following considerations will go far towards the success or the failure of the enterprise:

First.—There should be a demand for the heat.

Second.—The plant should be near to the territory heated.

Third.—There should be good coal and water facilities at the plant.

Fourth.—The quality of all the materials and the installation of the same, especially in the conduit concerning in-

sulation, expansion and contraction, and durability, are points of unusual importance.

Fifth.—The plant must be operated upon an economical basis, the same as is true of other plants.

Sixth.—The *load-factor* of the plant should be high. This is one of the most important points to be considered in combined heating and power work. The greater the proportion of hours each piece of apparatus is in operation, to the total number of hours that the plant is run, the greater the plant efficiency. The *ideal* load-factor requires that all of the apparatus be run at full load all the time.

The average conduit radiates a great deal of heat, hence, the nearer the plant to the heated district the greater the economy of the system. Likewise a location near a railroad minimizes fuel costs, and good water, with the possibility of saving the water of condensation from the steam, assists in increasing the economy of the plant. It is to be expected that even a well designed plant, unless safeguarded against ills as above suggested, would soon succumb to inevitable failure.

Two types of centralized heating plants are in use, *hot water* and *steam*. Each will be discussed separately. In the discussion of either system, certain definite conditions will have to be met. First of all, there should be a demand in that certain locality for such a heating system, before the plant can be considered a safe investment. To create a demand requires good representatives and a first-class residence or business district. When this demand is obtained the plan of the probable district to be heated will first be platted and then the heating plant will be located. In many cases the heating plant will be an added feature to an already established lighting or power plant and its location will be more or less a predetermined thing.

In addition to these material and financial features just mentioned, one must consider the legal phases that always come up at such a time. These relate chiefly to the franchise requirements that must be met before occupying the streets with conduit lines, etc. All of these considerations are a part of the one general scheme.

137. The Scope of the Work in central station heating may be had from the following outline:

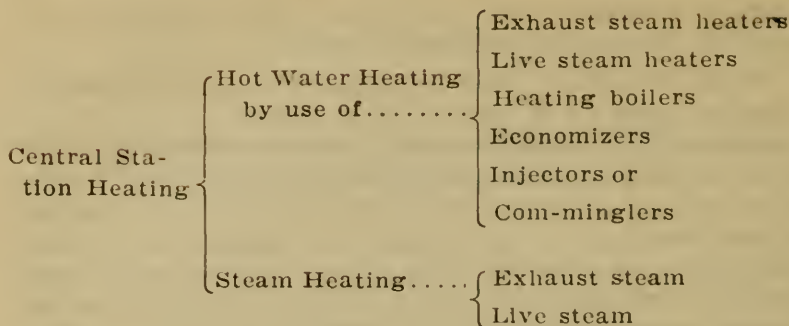

In the *hot water system* the return water at a lowered temperature enters the power plant, is passed through one or more pieces of apparatus carrying live or exhaust steam, or flue gases, and is raised in temperature again to that in the outgoing main. From the above, a number of combinations of reheating can be had. Any or all of the units may be put in one plant and the piping system so installed that the water will pass through any single unit and out into the main; or, the water may be split and passed through the units in parallel; or, it may be made to pass through the units in series. All of these combinations are possible, but not practicable. In most plants, two or three combinations only are provided. In the existing plants the order of preference seems to be, exhaust steam reheaters, economizers, heating boilers, injectors or com-minglers, and live steam heaters.

All of the above pieces of reheating apparatus operate by the transmission of heat through metal surfaces, such as brass, steel or cast iron tubes, excepting the com-mingler, this being simply a barometric condenser in which the exhaust steam is condensed by the injection water from the return main, the mixture being drawn directly into the pumps.

The objection to the tube transmission is the lime, mud and oil deposit on the tube surfaces, thus reducing the rate of transmission and requiring frequent cleaning. The objections to the com-minglers are, first, that the pump must draw hot water from the condenser and second, that a certain amount of the oil passes into the heating line. With perfected apparatus for removing the oil, the com-mingler will no doubt supersede, to a large degree, the tube reheaters in hot water heating.

In the *steam system* the proposition is very much simplified. The exhaust steam passes through one or more oil separating devices and is then piped directly to the header leading to the outgoing main. Occasionally a connection is made from this line to a condenser, such that the steam, when not used in the heating system, may be run directly to the condenser. These pipe lines, of course, are all properly valved so that the current of steam may easily be deflected one way or the other. In addition to this exhaust steam supply, live steam is provided from the boiler and enters the header through a pressure reducing valve. In any case when the exhaust steam is insufficient the supply may be kept constant by automatic regulation on the reducing valve.

In selecting between hot water and steam systems the preference of the engineer is very largely the controlling factor. The preference of the engineer, however, should be formed from facts and conditions surrounding the plant, and should not come from mere prejudice. The following points are some of the important ones to be considered:

First cost of plant installed.—This is very much in favor of the steam system in all features of the power plant equipment, the relative costs of the conduit and the outside work being very much the same in the two systems.

Cost of operation.—This is in favor of the hot water system because of the fact that the steam from the engines may be condensed at or below atmospheric pressure, while the exhausts from the engines in the steam systems must be carried from five to fifteen pounds gage, which naturally throws a heavy back pressure upon the engine piston.

Pressure in circulating mains.—This is in favor of the steam system. The pressure in any steam radiator will be only a few pounds above atmosphere, while in a hot water system, connected to high buildings, the pressure on the first floor radiators near the level of the mains becomes very excessive. The elevation of the highest radiator in the circuit, therefore, is one of the determining factors.

Regulation.—It is easier to regulate the hot water system without the use of the automatic thermostatic control, since the temperature of the water is maintained according to a schedule, which fits all degrees of outside temperature.

When automatic control is applied, this advantage is not so marked.

Returning the water to the power plant.—In most steam plants the water of condensation is passed through indirect heaters, to remove as much of the remaining heat as possible and is then run to the sewer. This procedure incurs a considerable loss, especially in cold weather when the feed water at the power plant is heated from low temperatures. This point is in favor of the hot water system.

Estimating charges for heat.—This is in favor of the steam system since, by meter measurement, a company is able to apportion the charges intelligently. The flat rate charged for water heating and for some steam heating is in many cases a decided loss to the company.

138. Conduits:—In installing conduits for either hot water or steam systems the selection should be made after determining, first, its efficiency as a heat insulator; second, its initial cost; third, its durability. Other points that must be accounted for as being very essential are: the supporting, anchoring, grading and draining of the mains; provision for expansion and contraction of the mains; arrangements for taking off service lines at points where there is little movement of the mains; and the draining of the conduit.

Some conduits may be installed at very little cost and yet may be very expensive propositions, because of their inability to protect from heat losses; while, on the other hand, some of the most expensive installations save their first cost in a couple of years' service. Many different kinds of insulating materials are used in conduit work such as magnesia, asbestos, hair felt, wool felt, mineral wool and air cell. Each of these materials has certain advantages and under certain conditions would be preferred. It is not the real purpose here to discuss the merits of the various insulators, because the quality of the workmanship in the conduit enters into the final result so largely. The different ways that pipes may be supported and insulated in outside service will be given, with general suggestions only. Fig. 107 shows a few of the many methods in common use. A very simple conduit is shown at A. This is built up of wood sections fitted end to end, then covered with tarred paper to prevent surface water leaking in and bound with straps. The pipe either is a loose fit to the bore and rests upon the inner sur-

face, or is supported on metal stools, driven into the wood or merely resting upon it. These stools hold the pipe concentric with the inner bore of the log. With much movement of the pipe endwise, from expansion and contraction, these stools should not be used unless they are loose and have a wide surface contact with the wood. A metal lining with the pipe resting directly upon it is considered good. The conduit is laid to a good straight run in a gravel bed and usually over a small tile drain to carry off the surface water, excepting as this drain is not necessary in sections where there is good gravel drainage. The insulation in *A* is only fair. The air space around the pipe, however, is to be commended. *B* is an improvement over *A* and is built up of boards notched at the edges to fit together. The materials used, from the outside to the center, are noted on the sketch beginning with the top and reading down. This covering is in general use and gives good satisfaction from every standpoint. *C* shows a good insulation and supports the pipe upon rollers at the center of a line of halved, vitrified tile. The lower half of the tile should be graded and the pipe then run upon the rollers, after which it may be covered with some prepared covering and the remaining space next the tile filled with asbestos, mineral wool or other like material. *D* shows the same adapted to cellar work. Occasionally two pipes are run side by side, main and return, in which case large halved tiles may be used as in *E*, having large metal supports curved on the lower face to fit the tile. If these supports are not desired the same kind of straight tiles may be used with a tee tile inserted every 8 to 12 feet having the bell looking down as in *F*. In this bell is built a concrete setting with iron supports for the pipes which run on rollers, over a rod. These rollers are sometimes pieces of pipes cut and reamed, but are better if they are cast with a curvature to fit the pipes to be supported. This form of conduit, when drained to good gravel, gives first-class service. *G*, *H* and *I* show box conduits with two or more thicknesses of $\frac{3}{8}$ inch boards nailed together for the sides, top and bottom. The bottom of the conduit is first laid and the pipe is run. The sides are then set in place and the insulating material put in, after which the top is set and the whole filled in. *I* shows the best form of box, since with the air spaces this is a very good insulator. All wood boxes are very temporary, hence, brick and concrete are usually preferred. *K* is a

HEATING AND VENTILATION

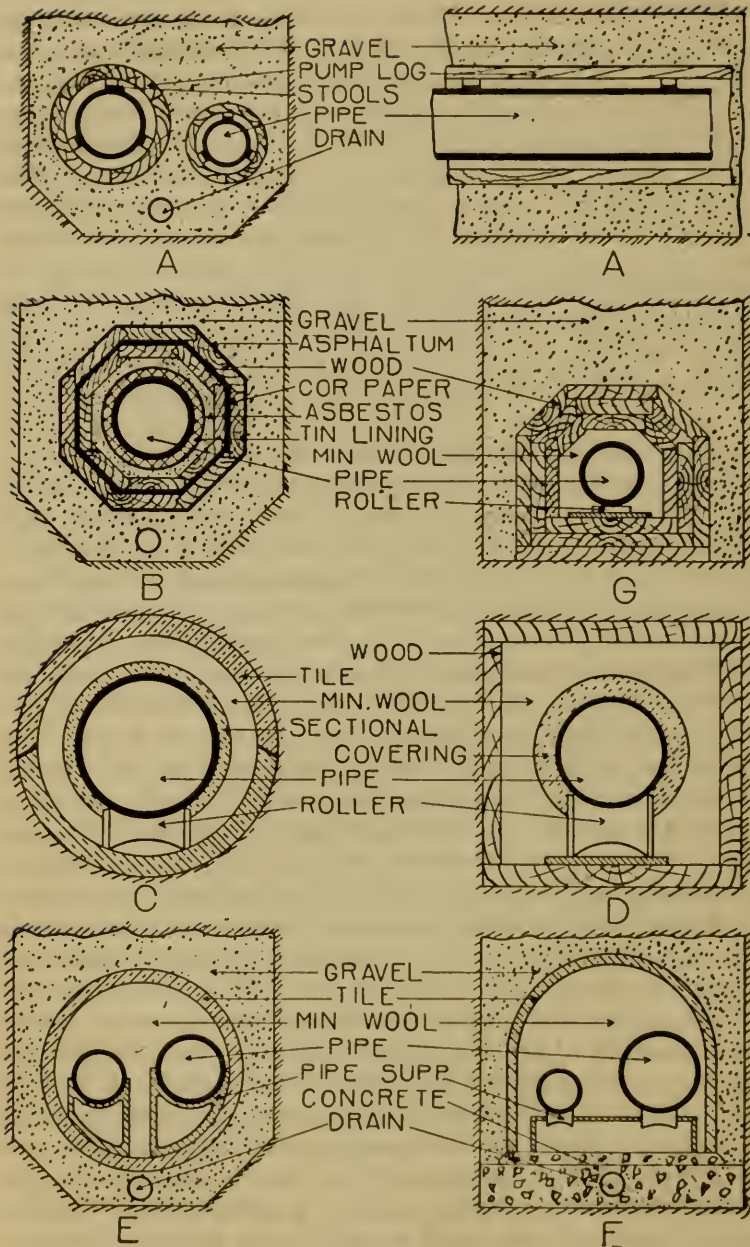

Fig. 107a.

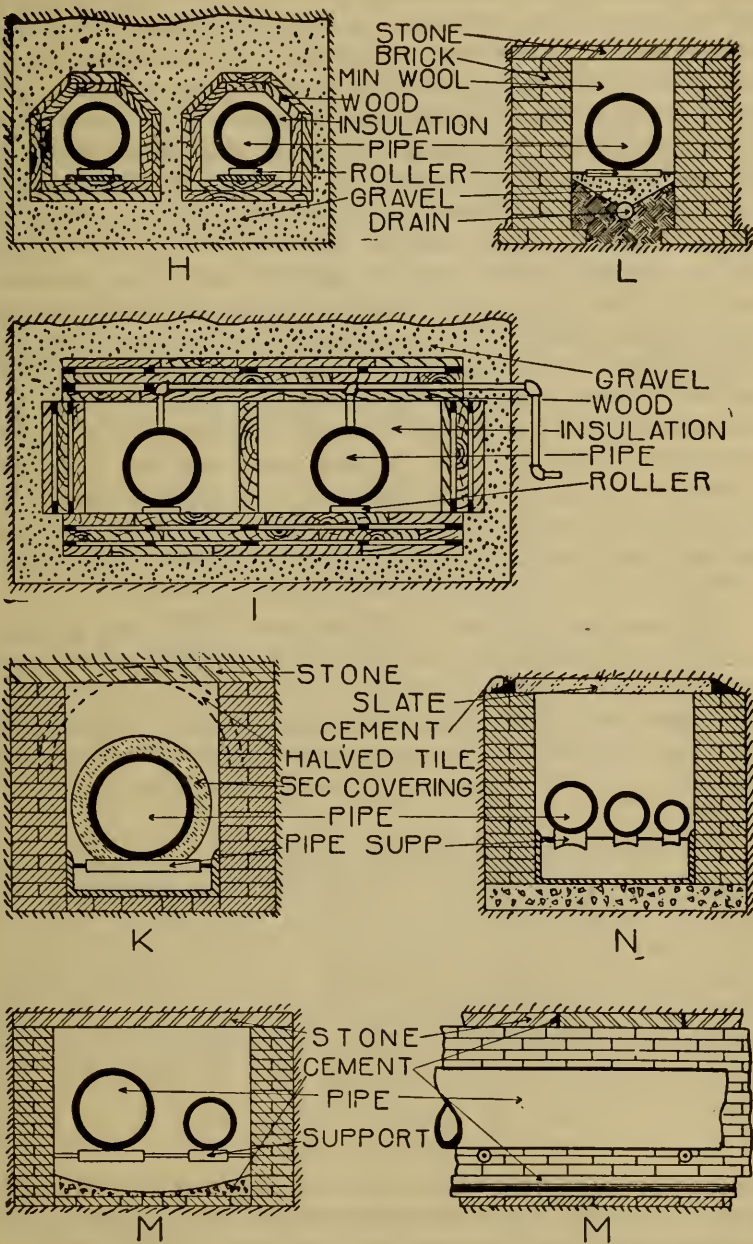

Fig. 107b.

conduit with 8 inch brick walls covered with flat stones or halved glazed tiles cemented to place to protect from surface leakage. The bottom of the conduit has supports built in every 8 to 12 feet, and between these points the conduit drains to the gravel. The usual rod and roller here serve as pipe supports. The pipe is covered with sectional covering and the rest of the space may or may not be filled with wool or chips, as desired. *L* shows the sectional covering omitted and the entire conduit filled with mineral wool, hair felt or asbestos, and ashes. *M* has the supporting rod built into the sides of the conduit and has the bottom of the conduit bricked across and cemented to carry the leaks and drainage to some distant point. *N* shows a concrete bottom with brick sides, having the pipe supported upon cast iron standards. The latest conduit has concrete slabs for bottom and sides and has a reinforced concrete slab top. This comes as near being permanent as any, is reasonable in price, and when the interior is filled with good non-conducting material, or when the pipe is covered with a good sectional covering, it gives fairly high efficiency.

All conduits should be run as nearly level as possible to avoid the formation of air and water pockets in the main. Any unusual elevation in any part of the main may require an air vent being placed at the uppermost point of the curve, otherwise air may collect in such quantities as to retard circulation. All low points in the steam lines must be drained to traps.

The *heat lost from conduits* is an item of considerable importance. A good quality of materials and insulation will probably reduce this loss as low as 20 to 25 per cent. of the amount lost from the bare pipe. To show the method of analysis and to obtain an estimate of the average conduit losses, the following application will be made to a supposed two-pipe hot water system. The loss of heat in B. t. u. per lineal foot from any pipe per hour may be taken from the formula

$$H_o = KCA (t - t')$$
(65)

where *K* = rate of transmission for uncovered pipes, *C* = 100 per cent. — efficiency of the insulation, *A* = area of pipe surface per lineal foot of pipe, *t* = average temperature in the

inside of the pipe and t' = average temperature on the outside of the conduit.

APPLICATION.—Having given a system of conduit pipes (two pipes in one conduit) with sizes and lengths as stated in the first and second columns of Table XXVI, what is the probable heat loss in B. t. u. per hour on a winter day and what is the radiation equivalent in a hot water system carrying water at an average temperature of 170 degrees?

TABLE XXVI.

Pipe size inches	Total lineal feet of main and return	Surface per foot of length <i>A</i>	B. t. u. per hr. per lineal foot <i>H_c</i>	Equivalent no. of sq. ft. of H.W. Rad.
2	5000	.62	48.8	1435
3	2000	.91	71.6	842
4	3000	1.06	83.4	1472
6	3000	1.73	137.1	2420
8	2000	2.26	177.9	2093
10	2000	2.83	221.9	2611
12	2000	3.33	262.0	3082
14	1000	4.00	314.8	1852
Totals. B. t. u. lost per hour 2687100				15807

If $K = 2.25$, $C = 100 - 75 = 25$ per cent., $t = 175$ and $t' = 35$, we have for a 2 inch pipe, $H_c = 2.25 \times .25 \times .62 \times 140 = 48.8$, which for 5000 lineal feet = 244000 B. t. u., and for the entire system 2687100 B. t. u. If each square foot of hot water radiation gives off 170 B. t. u. per hour then the radiation equivalent for the 2 inch pipe is $244000 \div 170 = 1435$ square feet. Similarly work out for each pipe size and obtain the values given in the last column of the table. This conduit loss is sufficient to heat 15807 square feet of radiation in the district. In terms of the coal pile it approximates 350 pounds per hour. Now assuming the 14 inch main to supply the entire district at a velocity of 6 feet per second we have approximately 162000 square feet of H. W. surface on the line. From this the line loss is $15807 \div 162000 = 9.1$ per cent. It should be remembered that the above assumes the plant working under a heavy load when the per cent. of line loss is a minimum. This loss remains fairly

constant while the heat utilized in the district fluctuates greatly. In mild weather, therefore, the per cent. of line loss to the total heat transmitted is much greater.

139. Layout of Street Mains and Conduits:—No definite information can be given concerning the layout of street mains, because the requirements of each district would call for independent consideration. The following general suggestions, however, can be noted as applying to any hot water or steam system:

Streets to be used.—Avoid the principal streets in the city, especially those that are paved; alleys are preferred because of the minimum cost of installation and repairs.

Cutting of the mains.—Do not cut the main trunk line for branches more often than is necessary. Provide occasional by-pass lines between the main branches at the most important points in the system, so that, if repairs are being made on any one line, the circulation beyond that point may be handled through the by-pass. Such by-pass lines should be valved and used only in case of emergency.

Offsets and expansion joints.—Offsets in the lines hinder the free movement of the water and add friction head to the pumps; hence, in water systems, the number should be reduced to a minimum. Long radius bends at the corners reduce this friction. Offsets are especially valuable to take up the expansion and contraction of the piping without the aid of expansion joints. This is illustrated in Fig. 108, where anchors are placed at A, and the gradual bending of the pipes at each corner makes the necessary allowance. The expansion in wrought iron is about .00008 inch per foot per degree rise in temperature; hence in a hot water main the linear expansion between 0° and 212° is .017 inch per foot of length or 1.7 inches for each 100 feet of straight pipe. In hot water heating systems, however, the temperature of this pipe would never be less than 50°, which would cause an expansion from hot to cold of only .013 inch per foot, or 1.3 inches for each 100 feet of straight pipe. In a steam main the temperature may vary anywhere from 50° to 300°, making a linear expansion of .02 inch per foot of length or 2 inches for each 100 feet of straight pipe. As here shown the

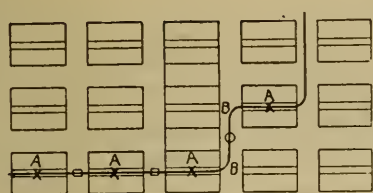

Fig. 108.

movement from the anchor at *A* toward *B* may be absorbed by the swinging of the pipe about *O*. *B.B.* should therefore be as long as possible, say one full block, to avoid unduly straining the pipe at the joints. Allowing a maximum movement of 6 inches for each expansion joint, the anchors would be spaced 500 and 300 feet center to center respectively, for hot water and steam mains. These figures would seldom be exceeded, and in some cases would be reduced, the spacing depending upon the type of expansion joint used. Ordinarily, 400 feet spacing would be recommended for hot water and 300 feet for steam. If the city layout meets this value fairly well, then the expansion joints and anchors may be made to alternate with each other, one each to every city block.

A few of the expansion joints in common use are shown in Fig. 109. *A* is the old slip and packed joint. This joint causes very little trouble except that it needs repacking frequently. It is very effective when properly cared for. The slip joint should have bronze bearings on both the outside of the plug and the lining of the sleeve. The ends of the plug and sleeve may be screwed for small pipes, or flanged for large ones. *B* shows an improved type of slip joint, having a roller bearing upon a plate in the bottom of the conduit, and plugs bearing against metal plates along the sides of the conduit to keep it in line. *C* and *D* show other slip joints very similar to *A* and *B*. *C* has one ball and socket end to adjust the joint to slight changes in the run of the pipe, and *D* has two packings enclosing the plug to give it rigidity. The drainage in each case is taken off at the bottom of the casting. *E* has two large flexible disks fastened to the ends of the pipe and separated from each other by an annular ring casting. These disks are frequently corrugated, are usually of copper and are very large in diameter so that the pipe has considerable movement without endangering the metal in the disks. *F* has a corrugated copper tube fastened at the ends to the pipe flanges. This is protected from excessive internal pressure by a straight tube having a sliding fit to the inside of the flanges, thus allowing for end movement. *G* is

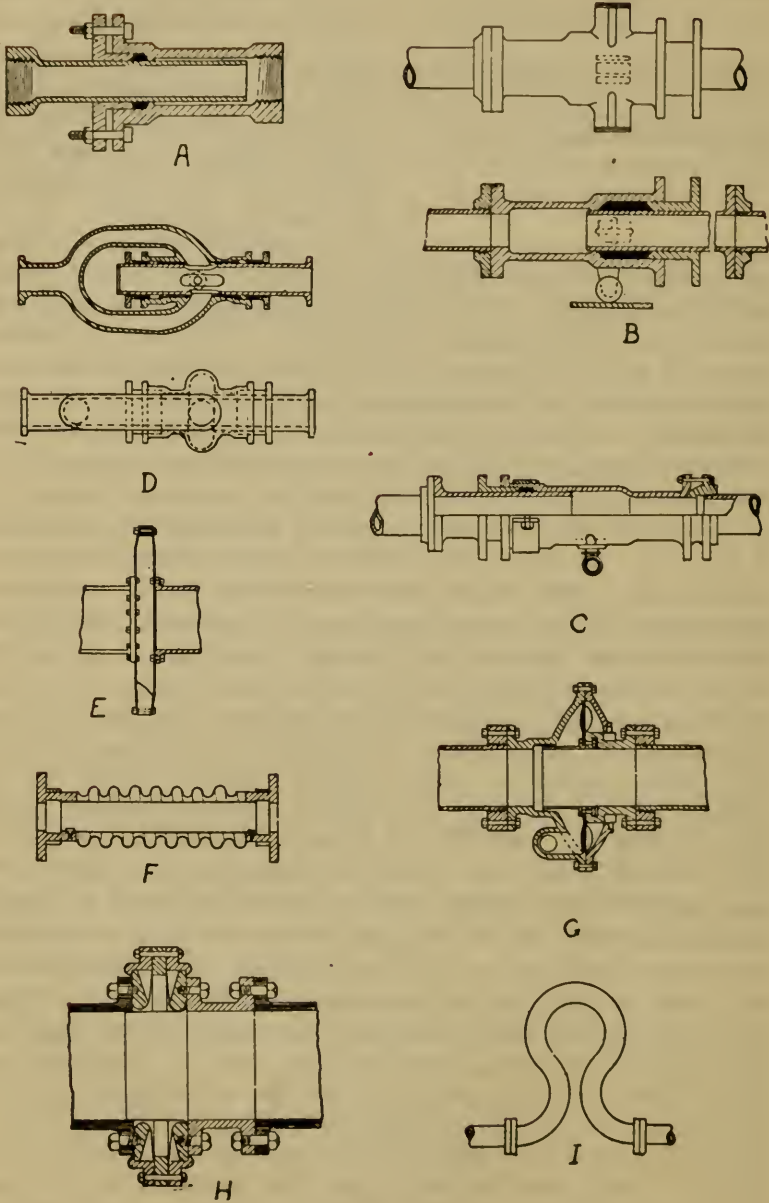

Fig. 109.

very similar to *E*. It has, however, only one copper disk. This disk is enclosed in a cast iron casement, one side of which is open to the atmosphere, the other side having the same pressure as within the pipe. *H* is very similar to *E*, having two copper diaphragms to take up the movement. These diaphragms flex over rings with curved edges and are thus protected somewhat against failure. *I* shows a copper U tube which is sometimes used. This is set in a horizontal position and the expansion and contraction is absorbed by bending the loop. In all these joints those which depend upon the bending of the metal require little attention except where complete rupture occurs. In old plants, however, the rupturing of these diaphragms is of frequent occurrence. The packed joint requires attention for packing several times in the year, but very seldom causes trouble other than this.

Anchors.—In any long run of pipe, where the expansion and contraction of the pipe causes it to shift its position very much, it is necessary to anchor the pipe at intervals so as to compel the movement toward certain desired points. The anchor is sometimes combined with the expansion joint, in which case the conduit work is simplified. See Fig. 110.

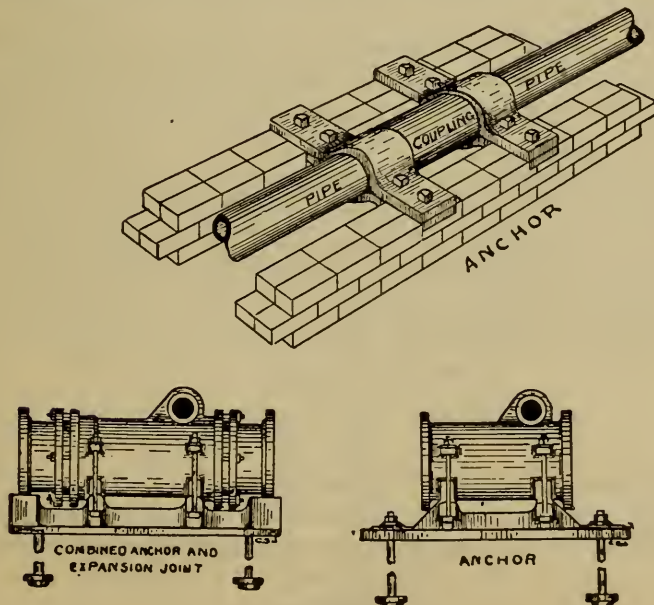

Fig. 110.

Service pipes to residences are taken off at or near the anchors. All condensation drains in steam mains are likewise taken off at such points.

Valves.—All valves on water systems should be straight-way gate valves. Valves on steam systems should be gate valves on lines carrying condensation, and renewable seat globe valves on the steam lines. Valves should be placed on the main trunk at the power plant, on all the principal branch mains as they leave the main trunk, on all by-pass lines, on all the service mains to the houses, and at such important points along the mains as will enable certain portions of the heating district to be shut off for repairs without cutting out the entire district.

Manholes.—Manholes are placed at important points along the line to enclose expansion joints and valves. These manholes are built of brick or concrete and covered with iron plates, flag stones, slate or reinforced concrete slabs. Care must be exercised to drain these points well and to have the covering strong enough to sustain the superimposed loads.

140. Typical Design for Consideration:—In discussing district heating, each important part of the design work will be made as general as possible and will be closed by an

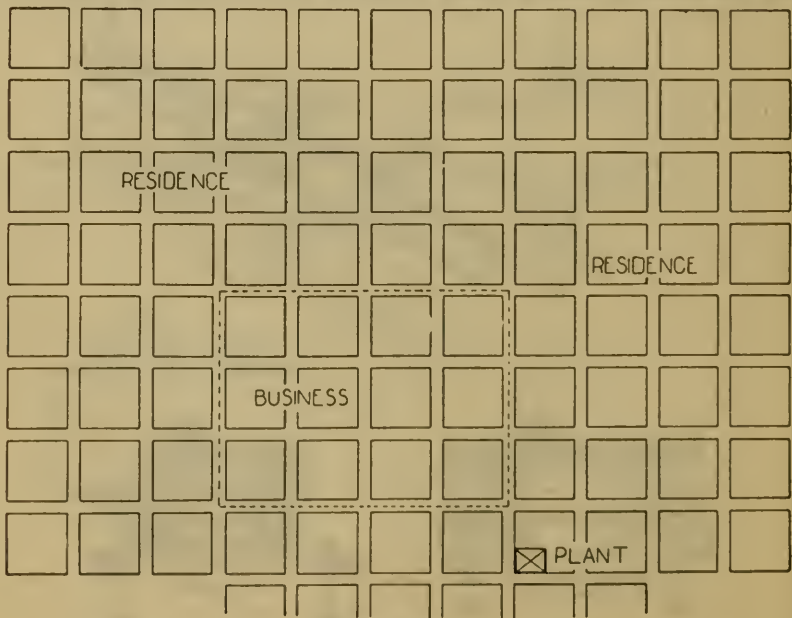

Fig. 111.

application to the following concrete example which refers to a certain portion of an imaginary city, Fig. 111, as available territory. A city water supply and lighting plant is located as shown, with lighting and power units aggregating 475 K. W., city water supply pumps aggregating 3000000 gallons maximum capacity, and smaller units requiring approximately 15 per cent. of the amount of steam used by the larger lighting units, all as suggested in general instructions in the problem pamphlet. It is desired to re-design this plant and to add a district heating system to it; the same to have all the latest methods of operation and to be of such a size as to be economically handled. Fig. 118 shows the essential details of the finished plant.

141. Electrical Output and Exhaust Steam Available for Heating Purposes from the Power Units:—In the operation of such a plant, one of the principal assets is the amount of exhaust steam available for heating purposes. The amount may be found for any time of the day or night by constructing a power chart as in Fig. 112, and a steam consumption chart as in Fig. 113. Referring to Fig. 112, the values here

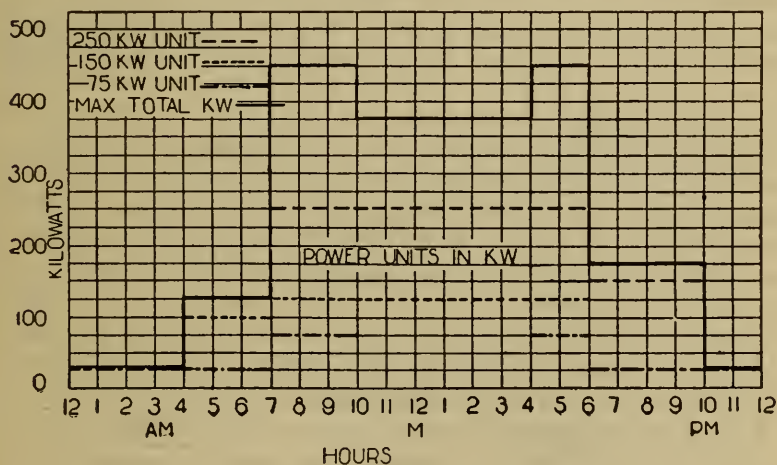

Fig. 112.

given are assumed, for illustration, to be those recorded at the switchboard of the typical plant on a day when heavy service is required. The curves show that the 75 K. W. unit runs from 12 P. M. to 7 A. M. and from 6 P. M. to 12 P. M. with an output of 25 K. W. It also runs from 7 A. M. to 10 A.

M. and from 4 P. M. to 6 P. M. under full load. The 150 K. W. unit runs from 4 A. M. to 7 A. M. with an output of 100 K. W. and then increases to 125 K. W. for the entire time until 6 P. M. when it is shut down. The 250 K. W. unit is started up at 7 A. M. and runs until 6 P. M. under full load, when the load drops off to 150 K. W. and continues until 10 P. M. when the unit is shut down, leaving only the 75 K. W. unit running. The heavy solid line shows all the power curves superimposed one upon the other. Having given the K. W. output, the general formula for determining the horse-power of the engines is

$$I. H. P. = \frac{K. W. \times 1000}{746 \times E \times E'} \quad (66)$$

where E and E' are the efficiencies of the generator and engine respectively. If we assume the efficiency of the generator to be 90 per cent., and that of the engine to be 92 per cent., then formula 66 becomes

$$I. H. P. = \frac{K. W. \times 1000}{746 \times .90 \times .92} = \text{approx. } 1.62 \text{ K. W.} \quad (67)$$

Assuming that the 250 K. W. unit consumes 24 pounds, the 150 K. W. unit 32 pounds, and the 75 K. W. unit 32 pounds of steam per I. H. P. hour respectively, when running under

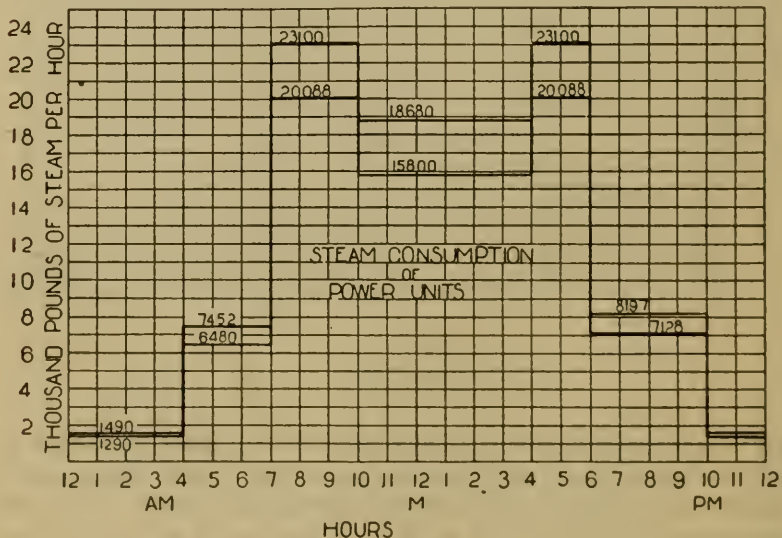

Fig. 113.

normal loads, we have the total steam consumed in the three units at any time shown by the lower curve in Fig. 113. The upper curve shows the 15 per cent. added allowance for smaller units not included in the above list. The values assumed for efficiencies and the values for steam consumption are reasonable, and may be used if a more exact figure is not to be had.

It will be seen that the maximum steam consumption in the generating units in the power plant is 23100 pounds per hour and the minimum is 1490 pounds per hour. These two amounts, then, together with the exhaust steam from the circulating pumps on the heating system, if a hot water system is installed, and that from the pumps in the city water supply, will determine the capacity of the exhaust steam heaters on the hot water supply and the capacity of the boilers or economizers to be used as heaters when the exhaust steam is deficient.

142. Amount of Heat Available for Heating Purposes in Exhaust Steam, Compared with That in Saturated Steam at the Pressure of the Exhaust:—To study the effect of exhaust steam upon heating problems and to determine, if possible, the theoretical amount of heat given off with the exhaust steam under various conditions of use, let us make several applications: first, to a simple high speed non-condensing engine using saturated steam; second, to a compound Corliss non-condensing engine using saturated steam; third, to the first application when superheated steam is used instead of saturated steam; and fourth, to a horizontal reciprocating steam pump. Assume the following safe conditions. Case one—boiler pressure 100 pounds gage; pressure of steam entering cylinder 97 pounds gage; quality of steam at cylinder 98 per cent.; steam consumption 34 pounds per indicated horse-power hour; one per cent. loss in radiation from cylinder; and exhaust pressure 2 pounds gage. Case two—boiler pressure 125 pounds gage; pressure at high pressure cylinder 122 pounds gage; quality of steam entering high pressure cylinder 98 per cent.; steam consumption 22 pounds per indicated horse-power hour; 2 per cent. loss in radiation from cylinders and receiver pipe, and exhaust pressure 2 pounds gage. Case three—same as case one with superheated steam at 150 degrees of superheat. Case four—as stated later.

The number of B. t. u. exhausted with the steam, in any case, is the total heat in the steam at admission, minus the heat radiated from the cylinder, minus the heat absorbed in actual work in the cylinder.

High speed engine. Case one.—Let r = heat of vaporization per pound of steam at the stated pressure, x = quality of the steam at cut-off, q = heat of the liquid in the steam per pound of steam, and W_s = pounds of steam per indicated horse-power hour. From this the total number of B. t. u. entering the cylinder per horse-power hour is

$$\text{Total B. t. u.} = W_s (xr + q) \quad (68)$$

From Peabody's steam tables $r = 881$, $x = .98$ and $q = 307$; then if $W_s = 34$, initial B. t. u. = $34 (.98 \times 881 + 307) = 39792.92$. Deducting the heat radiated from the cylinder we have $39792.92 \times .99 = 39395$ B. t. u. per horse-power left to do work. The B. t. u. absorbed in mechanical work (useful work + friction) in the cylinder per horse-power hour is $(33000 \times 60) \div 778 = 2545$ B. t. u. Subtracting this work loss we have $39395 - 2545 = 36850$ B. t. u. given up to the exhaust per horse-power hour. Comparing this value with the total heat in the same weight of saturated steam at 2 pounds gage, we have $100 \times 36850 \div (34 \times 1152.8) = 94$ per cent.

Compound Corliss engine. Case two.—With the same terms as above let $r = 867.4$, $x = .98$, $q = 324.4$, and $W_s = 22$, then the initial B. t. u. = $22 (.98 \times 867.4 + 324.4) = 25837.9$. Less 2 per cent. radiation loss = $25837.9 \times .98 = 25321.14$ B. t. u. The loss absorbed in doing mechanical work in the cylinder per horse-power is, as before, 2545 B. t. u. Subtracting this we have $25321.14 - 2545 = 22776.14$ B. t. u. given up to the exhaust per horse-power hour. Comparing as before with saturated steam at 2 pounds gage, we have $100 \times 22776.14 \div (22 \times 1152.8) = 90$ per cent.

Case three.—Now suppose superheated steam be used in the first application, all other conditions being the same, the steam having 150 degrees of superheat, what difference will this make in the result? The total heat entering the cylinder now is the total heat of the saturated steam at the initial pressure plus the heat given to it in the superheater. Let c_p = specific heat of superheated steam and

t_s = the degrees of superheat, then the total heat of the superheated steam is

$$\text{Total B. t. u. (sup.)} = W_s (xr + q + c_p t_s) \quad (69)$$

This for one horse-power of steam (34 pounds), if the specific heat of superheated steam is .54, will be $34 \times .99 \times (1188 + .54 \times 150) = 42714.5$ B. t. u. and the heat turned into the exhaust will be $42714.5 - 2545 = 40169.5$ B. t. u. Comparing this with the heat in saturated steam at 2 pounds gage, we have $100 \times 40169.5 \div (34 \times 1152.8) = 102$ per cent.

Case four.—Pump exhausts are sometimes led into the supply and used for heating purposes along with the engine exhausts. If such conditions be found, what is the heating value of such steam? Assume the live steam to enter the steam cylinder of the pump under the same pressure and quality as recorded for the high speed engine. The steam is cut off at about $\frac{7}{8}$ of the stroke and expands to the end of the stroke. With this small expansion the absolute pressure at the end of the stroke will be approximately $\frac{7}{8} \times 112 = 98$ pounds, and if enough heat is absorbed from the cylinder wall to bring the steam up to saturation at the release pressure, we will have a total heat above 32 degrees, in the exhaust steam per pound of steam at 98 pounds absolute, of 1185.6 B. t. u. Comparing this with a pound of saturated steam at 2 pounds gage, we have $100 \times 1185.6 \div 1152.8 = 103$ per cent. Under the conditions such as here stated with a high release pressure, a small expansion of steam in the cylinder and dry steam at the end of the stroke, it is possible to suddenly drop the pressure from pump release to a low pressure, say 2 pounds gage, and have all the steam brought to a state approaching superheat. It is not likely, however, that the steam is dry at the end of the stroke in any pump exhaust, because the heat lost in radiation and in doing work in the slow moving pump would be such as to have a considerable amount of entrained water with the steam, thus lowering the quality of the steam. These above conditions are extreme and are not obtained in practice.

From cases one and two it would appear that the *greatest* amount of heat that can be expected from *engine* exhausts, for use in heating systems at or near the pressure of the atmosphere, is 90 to 94 per cent. of that of

saturated steam at the same pressure. The percentage will, in most cases, drop much below this value. All things considered, *exhaust steam having 80 to 85 per cent. of the value of saturated steam at the same pressure is probably the safest rating when calculating the amount of radiation which can be supplied by the engines.* In many cases no doubt this could be exceeded, but it is always best to take a safe value. On the other hand, *when figuring the amount of condenser tube surface or reheater tube surface to condense the steam, it would be best to take exhaust steam at 100 per cent. quality, since this would be working toward the side of safety.*

In plants where the exhaust steam is used for heating purposes and where the amount supplied by direct acting steam pumps is large compared with that supplied by the power units, it is possible to have the quality of the exhausts anywhere between 800 and 1000 B. t. u. per pound of exhaust. It should be understood that saturated steam at *any* stated pressure always has the same number of B. t. u. in it, no matter whether it is taken directly from the boiler, or from the engine exhaust. A pound of the mixture of steam and entrained water, taken from engine exhausts, should not be considered as a pound of steam. If we are speaking of a pound of exhaust steam without the entrained water as compared with a pound of saturated steam at the same pressure, they are the same, but a pound of engine exhaust or mixture is a different thing.



Fig. 114.

HOT WATER SYSTEMS.

143. Four General Classifications of hot water heating may be found in current work, two applying to the conduit piping system and two to the power plant piping system. The first, known as the *one-pipe complete circuit system*, is shown in Fig. 114. It will be noticed that the water leaves the power plant and makes a complete circuit of the district, as *A, B, C, D, E, F, G*, through a single pipe of uniform diameter. From this main are taken branch mains and leads to the various houses, as *a, b, c* and *d, e*, each one returning to the principal main after having made its own minor circuit. The second is known as the *two-pipe high pressure system*, in which two main pipes of like diameter laid side by side in the same conduit, radiate from the power plant to the farthest point on the line reducing in size at certain points to suit the capacity of that part of the district served. This system is represented by Fig. 115. In the one-pipe system the circulation in the various residences is maintained, in part, by what is known as the *shunt system*, and in part, by the natural gravity circulation. The circulation in the two-pipe system is maintained by a high differential pressure between the main and the return at the same point of the conduit. The force producing movement of the water in the shunt system is, therefore, very much less than in the two-pipe system. As a consequence, the one-pipe system has a lower velocity of the

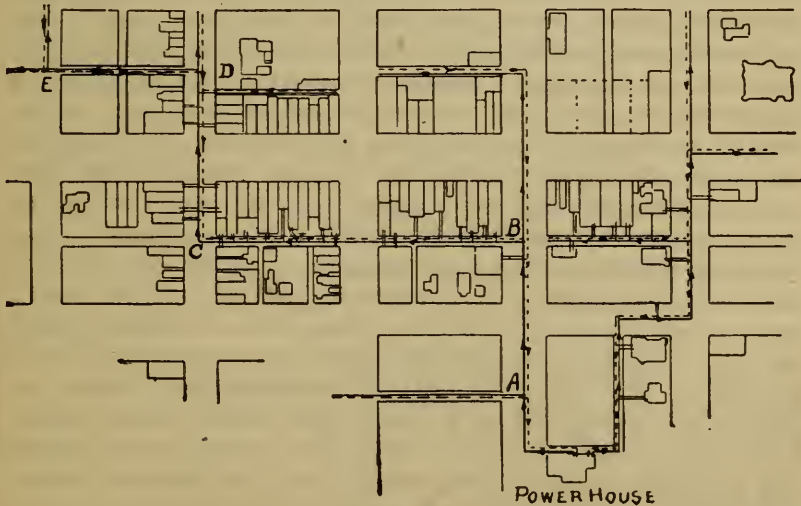

Fig. 115.

water in the houses and larger service pipes than the two-pipe system.

In many cases it is desired to connect central heating mains to the low pressure hot water systems in private plants. Such connections may easily be made with either one of the two systems by installing some minor pieces of apparatus for controlling the supply.

The third and fourth classifications, the *open* and *closed* systems, have about the same meaning as when applied to gravity work in isolated plants. The first is open to the atmosphere at some point along the circulating system, usually at the expansion tank which is placed on the return line just before the circulating pumps. The closed system presupposes some form of regulation for controlling excessive or deficient pressures without the aid of an expansion tank. In such cases pumps with automatic control may be used for taking care of the reserve supply of water. In the open system the exhaust steam may be injected directly into the return circulating water by the use of an open heater or a com-mingler. The open heater and com-mingler cannot be used on the pressure side of the pumps. Surface condensers or reheaters, heating boilers and economizers may be used on either open or closed systems.

144. Amount of Water Needed per Hour as a Heating Medium:—All calculations must necessarily begin with the heat lost at the residence. Referring to the standard room mentioned in Art. 80, we find the heat loss to be 14000 B. t. u. per hour, requiring 84 square feet of hot water heating surface to heat the room. Let the circulating water have the following temperatures: leaving the power plant 180°, entering the radiator 177°, leaving the radiator 157°, and entering the power plant 155°. According to these figures, which may be considered fair average values, the water gives off to the radiator 20 B. t. u. per pound or 166.6 B. t. u. per gallon, thus requiring $14000 \div 166.6 = 84$ gallons of water per hour to maintain the room at a temperature of 70°. From this a safe estimate may be given for design, i. e., *each square foot of hot water radiation in the city will require approximately one gallon of water per hour*, which in a plant operating under high efficiency may be reduced to 6 pounds per square foot per hour. It is very certain that some plants are designed to supply less than one gallon, but in such cases it requires a higher temperature of the circulating water and allows little chance

for future expansion of the plant. A drop of 20 degrees, i. e., 20 B. t. u. heat loss per pound of water passing through the radiator, is probably the most satisfactory basis. All things considered, the above italicised statement will satisfy every condition. (See Art. 173). Having the total number of square feet of radiation in the district, the total amount of water circulated through the mains per hour can be obtained, after which the size of the pumps in the power plant may be estimated.

145. Radiation in the District:—The amount of radiation that may be installed in the district is problematical. In an average residence or business district the following figures may easily be realized: *business square, 9000 square feet; residence square, 4500 square feet.* In certain locations these figures may be exceeded and in others they may be reduced. Where the needs of the district are thoroughly understood a more careful estimate can easily be made. It is always well to make the first estimate a safe one and any possible increase above this figure could be taken care of as in Art. 144. Referring to Fig. 111, an estimate of the amount of radiation that may be expected in this typical case, if we assume ten business squares and twenty-one residence squares, is 184500 square feet. This will call for the circulation of 184500 gallons of water per hour.

146. Future Increase in Radiation:—From the temperatures given in Art. 144, it will be seen that each pound of water takes on 25 B. t. u. at the power plant and that there is a possible increase of $212 - 180 = 32$ B. t. u. per pound that may be given to it, thus increasing the capacity of the system approximately 125 per cent. It would not be safe to count on such an increase in the average plant because of a defective layout in the piping system or because of a low efficiency in some of the pumps or other apparatus in the plant. If, however, a plant is installed according to the above figures, the capacity may be quite materially increased by increasing the temperature of the outgoing water at the plant to 212°.

147. The Pressure of the Water in the Mains:—The elevation above the plant at which a central station can supply radiation is limited. Water at 180° will weigh 60.55 pounds per cubic foot, and the pressure caused by an elevation of 1 foot is .42 pound per square inch. From this the static pres-

sure at the power plant, due to a hydraulic head of 100 feet, is 42 pounds per square inch. This value should not be exceeded, and generally, because of the influence it has on the machines and pipes toward producing leaks or complete ruptures, a less head than this is desirable. A static pressure of 42 pounds may be expected to produce, in a well designed plant, an outflow pressure of 65 to 75 pounds per square inch and a return pressure of 15 to 20 pounds per square inch, when working under fairly heavy service. In any case where the mains are too small to supply the radiation in the system properly, we may expect the value given for the outflow to increase and that for the return to decrease. A safe set of conditions to follow is: head, in feet, 60; static pressure, in pounds per square inch, 25; outgoing pressure at the pumps, in pounds per square inch, 50; return pressure at the pumps, in pounds per square inch, 5. This differential pressure of 45 pounds is caused by the friction losses in the piping system, pumps and heaters. *Long pipe systems*, as these are called, have much greater friction losses in the long runs of piping than in the ells, tees, valves, etc., hence, the friction head of the pipes is all that is usually considered. Where the minor losses are thought to be large, they may be accounted for by adding to the pipe loss a certain percentage of itself, say 10 to 20 per cent. *Pump power is figured from the differential pressure.*

The maximum and minimum pressures in the system are due to two causes; first, the static head, and second, the frictional resistances. These extremes of pressure are approximately—*static head plus (or minus) one-half the frictional resistances.* To obtain the frictional resistances, Chezy's formula, 70, is recommended. See Merriman's "A Treatise on Hydraulics," Arts. 86 and 100, and Church's "Mechanics of Engineering," Art. 519.

$$h_f = \frac{4\phi l}{d} \times \frac{v^2}{2g} \quad (70)$$

where h_f = feet of head lost in friction, ϕ = friction factor (synonymous with coefficient of friction. For clean cast iron pipes with a velocity of 5 to 6 feet per second this has been found to vary from .0065 to .0048 for diameters between 3 and 15 inches respectively. .005 is suggested as a safe average value to use), l = length of pipe in feet, v = velocity of water in feet per second, d = diameter of pipe in feet and $2g = 64.4$.

APPLICATION.—In Fig. 115, let it be desired to find the differential pressure at the pumps due to the friction losses in the line *A, B, C, D, E*. The lengths of the various parts are: power plant to *A*, 200 feet; *A* to *B*, 500 feet; *B* to *C*, 1500 feet; *C* to *D*, 1500 feet; and *D* to *E*, 500 feet. Assume, for illustration, that the total radiation in square feet beyond each of these points is: power plant, 125000; *A*, 85000; *B*, 50000; *C*, 28000; and *D*, 12000. This requires 125000, 85000, 50000, 28000 and 12000 gallons of water per hour, or 4.74, 3.27, 1.75, 1 and .44 cubic feet of water per second, respectively, passing these points. Now, if the velocities be roughly taken at 6 and 5 feet per second, (pipes near the power plant may be given somewhat higher velocities than those at some distance from the plant), the pipes will be 12, 10, 8, 6 and 4 inches diameter. In applying the formula to one part of the line we show the method employed for each. Take that part from the power plant to *A*. With $v = 6$

$$h_f = \frac{4 \times .005 \times 200 \times 36}{64.4 \times 1} = 2.2 \text{ feet.}$$

It should be noted here that formula 70 refers to pipes where *all the water that enters at one end passes out the other*. This is not true in heating mains where a part of the water is drawn off at intermediate points. On the other hand, Merriman, Art. 99, explains that a water service main, where the water is *all taken off from intermediate tapings* and where the *velocity at the far end is zero*, causes only one-third of the friction given by the above formula. The case under consideration falls somewhere between these two extremes, the part next the power plant approaching the former and the last part of the line exactly meeting the conditions of the latter. Assuming the mean of these two conditions, which is probably very close to the actual, gives two-thirds of that found by the formula. Now since this is a double main system, i. e., main and return of the same size, the friction head for the two lines becomes 2.94 feet, from the power plant to *A*. In a similar way the other parts may be tried and the results from the entire line assembled in convenient form as in Table XXVII.

TABLE XXVII.

	P. P. to A.	A to B	B to C	C to D	D to E
Distance between points.....	200	500	1500	1500	500
Radiation supplied.....	125000	85000	50000	28000	12000
Volume of water passing point in cu. ft. per sec.....	4.74	3.27	1.75	1.	.44
Velocity f. p. s.....	6	6	5	5	5
Area of pipe sq. ft.....	.79	.545	.35	.20	.087
Diam. of pipe in ft.....	1	.83	.66	.5	.33
h_f by (73) for flow main.....	2.2	6.7	17.4	23.3	11.7
h_f (taking $\frac{2}{3}$ value).....	1.47	4.47	11.6	15.5	7.8
h_f ($\frac{2}{3}$ val. flow and return)....	2.94	8.94	23.2	31.0	15.6

From the last line of the table we obtain the total friction head for both mains, not including ells, tees, valves, etc., to be 81.6 feet. This is equivalent to 34.3 pounds per square inch. Now if we allow about 20 per cent. of all the line losses to cover the minor losses we have approximately 40 pounds differential pressure, which is a reasonable value.

148. Velocity of the Water in the Mains and the Diameter of the Mains:—The district is first chosen and the layout of the conduit system is made. This is done independently of the sizes of the pipes. When this layout is finally completed, the pipe sizes are roughly calculated for all the important points in the system and are tabulated in connection with the friction losses for these parts, as in Art. 147. When this is done, formula 71, which is recommended to be used in connection with formula 70, may be applied and the theoretical diameters found. (The approximate diameters and the friction heads need not be calculated in formula 70 for use in formula 71, providing some estimate may be made for the value of h_f , for the various lengths of pipe. If desired, h_f may be assumed without any reference to the diameter, but this is a rather tedious process. For good discussion of this point see Church's Hydraulic Motors, Arts. 121-124 b.)

$$d = .629 \left[\frac{2}{3} \times \frac{\phi l Q^2}{h_f} \right]^{1/2} \quad (71)$$

where d , h_f , ϕ and l are the same as in formula 70, and Q = cubic feet of water passing through the pipe per second. This formula differs from those given in the references stated, in that the term $\frac{2}{3}$ is inserted as a mean value be-

tween the two extreme conditions, as stated in Art. 147.

APPLICATION.—Let it be desired to find the diameter for the single main between the power plant and *A*, Art. 147, with $h_f = 1.47$

$$d = .629 \left[\frac{2 \times .005 \times 200 \times (4.74)^2}{3 \times 1.47} \right]^{1/4} = 1 \text{ ft.} = 12 \text{ in.}$$

Applying to the entire line with h_f as given in next to last line of Table XXVII, gives power plant to *A*, $d = 12$ inches; *A* to *B*, $d = 10$ inches; *B* to *C*, $d = 8$ inches; *C* to *D*, $d = 6$ inches; and *D* to *E*, $d = 4$ inches.

In some cases, when close estimating is not required, it is satisfactory to assume a velocity of the water and find the diameter without considering the friction loss. In many cases, however, this would soon prove a positive loss to the company. With a low velocity, the first cost would be large and the operating cost would be low. On the other hand, if the velocity were high, the first cost would be small and the operating cost and depreciation would be large. As an illustration of how the friction head increases in a pipe of this kind with increased velocity, refer to the run of mains between *B* and *C*. Assuming a velocity of 10 feet per second, which in this case would be very high, the friction head, h_f , for the single main, becomes 62 and the theoretical diameter is 5.5, say 6 inches. The friction head, as will be seen, is 5.4 times the corresponding value when the velocity was 5 feet per second. Since the pump must work continually against this head, it would incur a financial loss that would soon exceed the extra cost of installing larger pipes. It is found in plants that are in first class operation that the velocities range from 5 to 7 feet per second.

The calculations in Arts. 147 and 148 are very much simplified by the use of the chart shown in the Appendix. In planning a system of this kind, find the friction head on the pumps and the diameters of the pipes for various velocities, say 4, 6, 8 and 10 feet per second. Estimate the probable first cost and the depreciation of the conduit system for each velocity, and balance these figures with the operating cost for a period of, say five years, to see which is the most economical velocity to use in figuring the system.

149. Service Connections are usually installed from 30 to 36 inches below the surface of the ground, and are insulated in some form of box conduit which compares favor-

ably with that of the main conduit. Service branches are $1\frac{1}{4}$, $1\frac{1}{2}$ and 2 inch wrought iron pipe. These are usually carried to the building from the conduit at the expense of the consumer. Such branch conduits are not drained by tile drains. See Art. 176.

150. Total Steam Available and B. t. u. Liberated per Hour for Heating the Circulating Water:—The amount of steam available for heating the circulating water is that given off by the generating units, plus that from the circulating pumps, plus that from the city water supply pumps if there be any, plus that from the auxiliary steam units in the plant, i. e., small pumps, engines, etc. In the typical application this amounts to $23100 + 12720 + 8680 = 44500$ pounds per hour.

This steam, of course, is not equal to good dry steam in heating value because of the work it has done in the engine and pump cylinders, but a good estimate of its value may be approximated. In addition to the terms used in formula 68, let q' = heat in the returning condensation per pound; then the heat available for heating purposes per pound of exhaust steam is

$$\text{B. t. u.} = xr + q - q' \quad (72)$$

It is probably safe to consider the quality of the steam as 85 per cent. of that of good dry steam at the same pressure. Since the pressure of the exhaust from a non-condensing engine, as it enters the heater, is near that of the atmosphere, and since the returning condensation is at a temperature of about 180° , the total amount of heat given off from a pound of exhaust steam to the circulating water is

$\text{B. t. u.} = .85 \times 969.7 + 180.3 - (180.3 - 32) = 856$, say 850. If W_s be the pounds of exhaust steam available, the total number of B. t. u. given off from the exhaust steam per hour is

$$\text{Total B. t. u.} = 850 W_s \quad (73)$$

Applying this to the typical power plant gives $850 \times 44500 = 37825000$ B. t. u. per hour. This amount is probably a maximum under the conditions of lighting units as stated, and would be true for only 5 hours out of 24. At other times the exhaust steam drops off from the lighting units and this deficiency must be made good by heating the circulating water directly from the coal, by passing the water through heating boilers or by passing it through economiz-

ers where it is heated by the waste heat from the stack gases.

151. Amount of Hot Water Radiation in the District that can be Supplied by One Pound of Exhaust Steam on a Zero Day:—In Art. 144, each pound of water takes on 25 B. t. u. in passing through the reheaters at the power plant, and gives off at least 20 B. t. u. in passing through the radiator. The number of pounds of water heated per pound of steam per hour is, $W_w = (\text{Total B. t. u. available per pound of exhaust steam per hour}) \div 25$, and the total radiation that can be supplied is

$$R_w = \frac{\text{Total B. t. u. available per lb. of exhaust steam per hr.}}{8.33 \times 25} \quad (74)$$

which for average practice reduces to

$$R_w = \frac{850}{208} = 4 \text{ square feet approx.} \quad (75)$$

Applying formula 74 for the five hour period when the exhaust steam is maximum gives $R_w = 37825000 \div 208 = 181851$ square feet. It is not safe to figure on the peak load conditions. It is better to assume that for half the time, 35000 pounds of steam are available and will heat $35000 \times 4 = 140000$ square feet of radiation.

152. The Amount of Circulating Water Passed through the Heater Necessary to Condense One Pound of Exhaust Steam is

$$W_w = \frac{\text{Total B. t. u. available per lb. of exhaust steam per hr.}}{25} \quad (76)$$

With the value given above for the exhaust steam this becomes, for 100 and 85 per cent. respectively,

$$W_w = \frac{1000}{25} = 40 \text{ pounds} \quad (77)$$

$$W_w = \frac{850}{25} = 34 \text{ pounds} \quad (78)$$

153. Amount of Hot Water Radiation in the District that can be Heated by One Horse-Power of Exhaust Steam from a Non-Condensing Engine on a Zero Day:—

$$R_w = 4 \times (\text{pounds of steam per H. P. hour}) \quad (79)$$

This reduces for the various types of engines, as follows:

Simple high speed	4 × 34 = 136	square feet.
“ medium “	4 × 30 = 120	“ “
“ Corliss	4 × 26 = 104	“ “
Compound high “	4 × 26 = 104	“ “
“ medium “	4 × 25 = 100	“ “
“ Corliss	4 × 22 = 88	“ “

154. Amount of Radiation that can be Supplied by Exhaust Steam in Formulas 74 and 75 at any other Temperature of the Water, t_w , than that Stated, with the Room Temperature, t' , Remaining the Same:—The amount of heat passing through one square foot of the radiator to the room is in proportion to $t_w - t'$. In formulas 74 and 75, $t_w - t' = 100$. Now if t_w be increased x degrees, so that $t_w - t' = (100 + x)$ then each square foot of radiation in the building

will give off $\frac{100 + x}{100}$ times more heat than before and each pound of exhaust steam will supply only

$$R_w = \frac{4 \times 100}{100 + x} \text{ square feet} \quad (80)$$

This for an increase of 30 degrees, which is probably a maximum, is

$$R_w = \frac{4}{1.3} = 3 \text{ square feet} \quad (81)$$

Compared with formula 75, formula 80 shows, with a high temperature of the water entering the radiator, that less radiation is necessary to heat any one room and that each square foot of surface becomes more nearly the value of an equal amount of steam heating surface. Calculations for radiation, however, are seldom made from high temperatures of the water, and this article should be considered an exceptional case.

155. Exhaust Steam Condenser (Reheater), for Reheating the Circulating Water:—In the layout of any plant the reheaters should be located close to the circulating pumps on the high pressure side. They are usually of the surface condenser type, Fig. 116, and may or may not be installed in duplicate. Of the two types shown in the figure, the water tube type is probably the more common. The same principles hold for each in design. In ordinary heaters for feed water service, wrought iron tubes of $1\frac{1}{2}$ to 2 inches

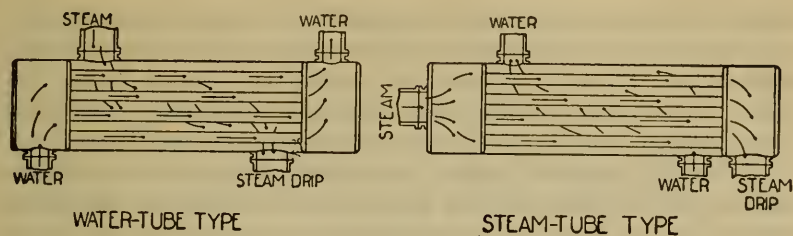

Fig. 116.

diameter are generally used, but for condenser work and where a rapid heat transmission is desired, brass or copper tubes are used, having diameters of $\frac{5}{8}$ to 1 inch. In heating the circulating water for district service, the reheater is doing very much the same work as if used on the condensing system for engines or turbines. The chief difference is in the pressures carried on the steam side, the reheater condensing the steam near atmospheric pressure and the condenser carrying about .9 of a perfect vacuum. In either case it should be piped on the water side for water inlet and outlet, while the steam side should be connected to the exhaust line from the engines and pumps, and should have proper drip connection to draw the water of condensation off to a condenser pump. This condenser pump usually delivers the water of condensation to a storage tank for use as boiler feed, or for use in making up the supply in the heating system.

In determining the details of the condenser the following important points should be investigated: the amount of heating surface in the tubes, the size of the water inlet and outlet, the size of the pipe for the steam connection, the size of the pipe for the water of condensation and the length and cross section of the heater.

156. Amount of Heating Surface in the Reheater Tubes:

—The general formula for calculating the heating surface in the tubes of a reheater (assuming all heating surface on tubes only), is

$$R: = \frac{\text{Total B. t. u. given up by the exhaust steam per hr.}}{K (\text{Temp. diff. between inside and outside of tubes})} \quad (82)$$

The maximum heat given off from one pound of exhaust steam in condensing at atmospheric pressure is 1000 B. t. u., the average temperature difference is approximately 47 degrees, and K may be taken 427 B. t. u. per degree dif-

ference per hour. In determining K , it is not an easy matter to obtain a value that will be true for average practice. Carpenter's H. & V. B. Art. 47 quotes the above figure for tests upon clean tubes, and volumes of water less than 1000 pounds per square foot of heating surface per hour. It is found, however, that the *average* heater or condenser tube with its lime and mud deposit will reduce the efficiency as low as 40 to 50 per cent. of the maximum transmission. Assume this value to be 45 per cent.; then if W_s is the number of pounds available exhaust steam, formula 82 becomes

$$R_t = \frac{1000 W_s}{K (t_s - t_w)} = \frac{1000 W_s}{427 \times .45 \times 47} = \frac{1000 W_s}{9031} = \frac{W_s}{9.1} \quad (83)$$

In "Steam Engine Design," by Whitham, page 283, the following formula is given for surface condensers used on shipboard:

$$S = \frac{W L}{cK (T_1 - t)}$$

where S = tube surface, W = total pounds of exhaust steam to be condensed per hour, L = latent heat of saturated steam at a temperature T_1 , K = theoretical transmission of B. t. u. per hour through one square foot of surface per degree difference of temperature = 556.8 for brass, c = efficiency of the condensing surface = .323 (quoted from Isherwood), T_1 = temperature of saturated steam in the condensers, and t = average temperature of the circulating water.

With $L = 969.7$, $c = .323$, $K = 556.8$ and $T_1 - t = 47$, we may state the formula in terms of our text as

$$R_t = \frac{969.7 W_s}{.323 \times 556.8 \times 47} = \frac{969.7 W_s}{8446} = \frac{W_s}{8.7} \quad (84)$$

In Sutcliffe "Steam Power and Mill Work," page 512, the author states that condenser tubes in good condition and set in the ordinary way have a condensing power equivalent to 13000 B. t. u. per square foot per hour, when the condensing water is supplied at 60 degrees and rises to 95 degrees at discharge, although the author gives his opinion that a transmission of 10000 B. t. u. per square foot per hour is all that should be expected. This checks closely with formula 83, which gives the rate of transmission 9031 B. t. u. per square foot per hour.

The following empirical formula for the amount of heating surface in a heater is sometimes used:

$$R_t = .0944 W_s \quad (85)$$

where the terms are the same as before.

APPLICATION.—Let the total amount of exhaust steam available for heating the circulating water be 35000 pounds per hour, the pressure of the steam in the condenser be atmospheric and the water of condensation be returned at 180°; also, let the circulating water enter at 155° and be heated to 180°. These values are good average conditions. The assumption that the pressure within the condenser is atmospheric might not be fulfilled in every case, but can be approached very closely. From these assumptions find the square feet of surface in the tubes.

$$\text{Formula 83, } R_t = \frac{35000}{9.1} = 3846 \text{ sq. ft.}$$

$$\text{Formula 84, } R_t = \frac{35000}{8.7} = 4023 \text{ sq. ft.}$$

$$\text{Formula 85, } R_t = 35000 \times .0944 = 3304 \text{ sq. ft.}$$

$$\text{Sutcliffe } R_t = \frac{1000 \times 35000}{10000} = 3500 \text{ sq. ft.}$$

If 3846 square feet be the accepted value it will call for three heaters having 1282 square feet of tube surface each.

157. Amount of Reheater Tube Surface per Engine Horse-Power:—Let w_s be the pounds of steam used per *I. H. P.* of the engine; then from formula 83

$$R_t \text{ (per } I. H. P.) = \frac{w_s}{9.1} \quad (86)$$

This reduces for the various types of engines as follows:

Simple high speed	34 ÷ 9.1 = 3.74	square feet
“ medium	30 ÷ 9.1 = 3.30	“ “
“ Corliss	26 ÷ 9.1 = 2.86	“ “
Compound high	26 ÷ 9.1 = 2.86	“ “
“ medium	25 ÷ 9.1 = 2.75	“ “
“ Corliss	22 ÷ 9.1 = 2.42	“ “

158. Amount of Hot Water Radiation in the District that can be Supplied by One Square Foot of Reheater Tube Surface:—If the transmission through one square foot of tube surface be $K (t_s - t_w) = 9031$ B. t. u. per hour and the

amount of heat needed per square foot of radiation per hour = $8.33 \times 25 = 208$, as given in formula 74, then

$$R_w \text{ (per sq. ft. of tube surface)} = \frac{9031}{208} = 43.4 \text{ sq. ft.} \quad (87)$$

159. Some Important Reheater Details:—Inlet and outlet pipes.—Having three heaters in the plant, it seems reasonable that each heater should be prepared for at least one-third of the water credited to the exhaust steam. From Art. 151 this is $140000 \div 3 = 46667$ gallons = 10800000 cubic inches per hour. The velocity of the water entering and leaving the heater may vary a great deal, but good values for calculations may be taken between 5 and 7 feet per second. Assuming the first value given, we have the area of the pipe = $10800000 \div (5 \times 12 \times 3600) = 50$ square inches, and the diameter 8 inches.

The size of the reheater shell.—Concerning the velocity of the water in the reheater itself, there may be differences of opinion; 100 feet per minute will be a good value to use unless this value makes the length of the tube too great for its diameter. If this is the case the tube will bend from expansion and from its own weight. At this velocity the free cross sectional area of the tubes, assuming the water to pass through the tubes as in Fig. 116, will be 150 square inches. If the tubes be taken $\frac{3}{4}$ inch outside diameter, with a thickness of 17 B. W. G., and arranged as usual in such work, it will require about 475 tubes and a shell diameter of approximately 30 inches. If the inner surface of the tube be taken as a measurement of the heating surface and the total surface be 1282 square feet, the length of the reheater tubes will be approximately 16 feet.

The ratio of the length of the tube to the diameter is, in this case, 256, about twice as much as the maximum ratio used by some manufacturers. It will be better, therefore, to increase the number of tubes and decrease the length. With a velocity of the water at 50 feet per minute, the values will be approximately as follows: free cross sectional area of the tubes, 300 square inches; number of tubes, 950; diameter of shell, 40 inches; length of tubes, 8 feet. These values check fairly well and could be used.

The size of exhaust steam connection.—To calculate this, use the formula

$$A = \frac{144 Q_s}{V} \quad (88)$$

where Q_s = volume of steam in cubic feet per minute, V = velocity in feet per minute, and A = area of pipe in square inches. When applied to the reheater using 35000 pounds of steam per hour, at 26 cubic feet per pound and at a velocity through the exhaust pipe of 6000 feet per minute, it gives

$$A = \frac{144 \times 35000 \times 26}{60 \times 6000} = 360 \text{ sq. in.} = 22 \text{ in. dia.}$$

Try also, from Carpenter's H. & V. B., page 284

$$d = \sqrt{\frac{{}^5/H P^2}{1.23}} \quad (89)$$

Allowing 30 pounds of steam per $H. P.$ hour for non-condensing engines we have $35000 \div 30 = 1166$ horse-power; then applying the above we obtain $d = 16$ inches. Comparing the two formulas, 88 and 89, the first will probably admit of a more general application. The velocity 6000 for exhaust steam may be increased to 8000 for very large pipes and should be reduced to 4000 for small pipes. In the above applications a 20 inch pipe will suffice.

The return pipe for condensation.—The diameter of the pipe leading to the condenser pump will naturally be taken from the catalog size of the pump installed. This pump would be selected from capacities as guaranteed by the respective manufacturers and should easily be capable of handling the amount of water that is condensed per hour.

The value of a high pressure steam connection.—If desired, the reheater may also be provided with a high pressure steam connection, to be used when the exhaust steam is not sufficient. This steam is then used through a pressure-reducing valve which admits the steam at pressures varying from atmospheric to 5 pounds gage. There is some question concerning the advisability of doing this. Some prefer to install a high pressure steam heater, as in Art. 160, to be used independently of the exhaust steam heaters. This removes all possibility of having excessive back pressure on the engine piston, as is sometimes the case where high pressure steam is admitted with the exhaust steam.

It has been the experience of some who have operated such plants that where more heat is needed than can be supplied by the exhaust steam, it is better to resort to heating boilers and economizers, than to use high pressure steam for heating.

160. High Pressure Steam Heater:—When this heater is used it is located above the boiler so that all the condensation freely drains back to the boilers by gravity as in Fig. 117. In calculating the tube surface, use formula 82 with the full value of the steam and the steam temperatures changed to suit the increased pressure. Such a heater as this gives good results.

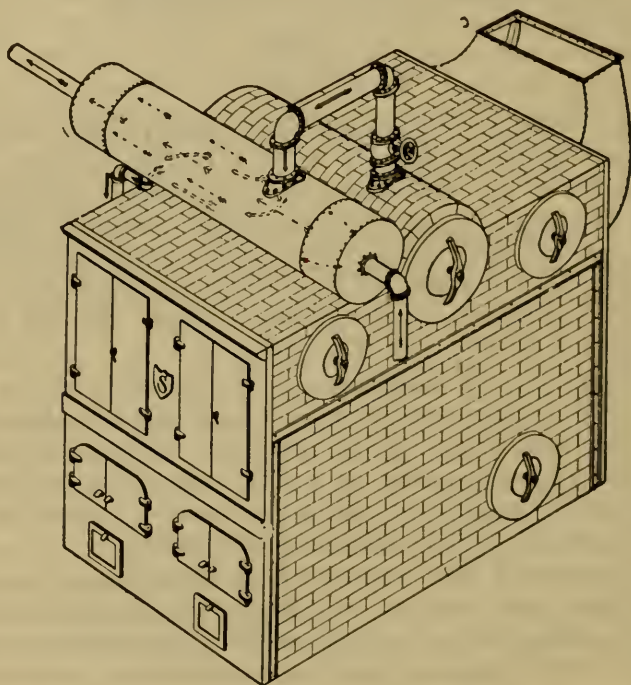

Fig. 117.

161. Circulating Pumps:—Two types of pumps are in general use: centrifugal and reciprocating. Each type is somewhat limited in its operation. The centrifugal pump has difficulty in operating against high heads and the reciprocating pump is very noisy when running at a high piston speed. Since each type is in successful operation in many plants, no comparisons will be made between them further than to say that the former, being operated by a steam engine, may be run more economically than the latter because of the possibilities of using the steam expansively. It will

be noted, however, that this same steam is to be used in the exhaust steam heaters for warming the circulating water and hence there would be little, if any, direct loss from this source in the use of the reciprocating pump.

Having given the maximum amount of water to be circulated per hour, consult trade catalogs and select the number of pumps and the size of each pump to be installed. The sizes of the pumps can easily be determined when the number of them has been decided upon. This latter point is one upon which a difference of opinion will probably be found. No exact rule can be applied. In a plant of, say not more than 150000 square feet of radiation (150000 gallons of water per hour, or 3 million gallons for twenty-four hours), some designers would put in three pumps, each having 1.5 million gallons capacity; in which case one pump could be cut out for repairs and the other two would be able to care for the service temporarily. Other designers would use four pumps at about one million gallons each. The fewer the pumps installed, in any case, the greater should be the capacity of each. The following values will be found fairly satisfactory:

1 Pump.	Cap. =	(1 to 1.25)	times	max.	requirem't	of	system
2 Pumps.	"	(each)	=	.75	"	"	"
3 Pumps.	"	"	=	.5	"	"	"
4 Pumps.	"	"	=	.3	"	"	"

Having given the capacity of each pump in gallons of water per minute, the size, the horse-power and the steam consumption of each pump can be calculated. In obtaining the size of the pump it will be necessary to know the *speed*, V , of the piston in feet per minute, the *strokes*, N , per minute and the per cent. of *slip*, s (100 per cent. — S , where S = hydraulic efficiency). The speed varies between 100, for small pumps, and 75, for large pumps. The strokes vary between 200, for small pumps, and 40, for large pumps, and the slip varies between 5 and 40 per cent., depending upon the fit of the piston and the valves. In pumps that have been in service for some time the slip will probably average 20 per cent.

The cross sectional area of the water cylinder in square inches is

$$W. C. A. = \frac{\text{cubic inches pumped per minute}}{S \times V \times 12} \quad (90)$$

from which we may obtain the diameter of the water cylinder.

The steam cylinder area is usually figured as a certain ratio to that of the water cylinder area, as

$$S. C. A. = (1.5 \text{ to } 2.5) \times W. C. A. \quad (91)$$

from which we may obtain the diameter of the steam cylinder.

The length of the stroke, L , in inches, may be obtained from the speed and the number of strokes such that

$$L = \frac{12 V}{N} \quad (92)$$

All direct acting steam pumps are designated by diameter of steam cylinder \times diameter of water cylinder \times length of stroke, as

$$14'' \times 12'' \times 18''$$

Duplex pumps have twice the capacity of single pumps having the same sized cylinders.

To find the indicated horse-power, *I. H. P.*, of the pumps, reduce the pressure head, p , in pounds per square inch, to pressure head in feet, h ; multiply this by the pounds of water, W , pumped per minute and divide the product by 33000 times the mechanical efficiency, E .

$$I. H. P. = \frac{W h}{33000 E} \quad (93)$$

To reduce from pressure head in pounds to pressure head in feet, divide the pressure head in pounds by weight of a column of water one square inch in area and one foot high. The general equation for this is

$$h = \frac{144 p}{w}$$

where w = the weight of a cubic foot of water at the given temperature and p = differential pressure in pounds per square inch.

In pump service of this kind the pressure head, p , against which the pump is acting, is not the result of the static head of water in the system but is due to the inertia of the water and to the resistance to the flow of water

through the piping system and the heaters. This frictional resistance may be calculated as shown in Art. 147. Read this part of the work over carefully.

For an illustration of combined pressure head, p , and friction head, h_f , see Art. 164 on boiler feed pumps. Having found the *I. H. P.* of any pump, multiply it by the steam consumption per *I. H. P.* hour and the result will be the steam consumption of the pump. This exhaust steam will be considered a part of the general supply when figuring the size of the exhaust steam heaters in the system.

The mechanical efficiency, E , of piston pumps depends upon the condition of the valves and upon the speed, and varies from 90 per cent. in new pumps, to 50 per cent. in pumps that are badly worn. A fair average would be 70 per cent.

The steam consumption for reciprocating, simple and duplex non-condensing pumps would approximate 100 to 200 pounds of steam per *I. H. P.* hour—the greater values referring to the slower speeds.

162. Centrifugal Pumps:—Centrifugal pumps are of two classifications, the Volute and the Turbine. The principles upon which each operate are very similar. The rotating impeller, or rotor, with curved blades draws the water in at the center of the pump and delivers it from the circumference. The rotor is enclosed by a cast iron casing which is shaped more or less to fit the curvature of the edges of the blades on the rotor. Centrifugal pumps are used where large volumes of water are required at low heads. They are used in city water supply systems, in central station heating systems, in condenser service, in irrigation work and in many other places where the pressure head operated against is not excessive. The efficiency of the average centrifugal pump is from 65 to 80 per cent., 75 per cent. being not uncommon. In places where such pumps are used the head is usually below 75 feet, although some types, when direct connected to high speed motors, are capable of operating against heads of several hundred feet.

Some of the advantages of centrifugal pumps over horizontal reciprocating pumps are: low first cost, simplicity, few moving parts, compactness, uniform flow and pressure of water, freedom from shock, possibilities of direct connec-

tion to high speed motors and the ability to handle dirty water without injuring the pump.

One of the advantages of piston pumps over centrifugal pumps is the fact that they are more positive in their operation and work against higher heads.

Centrifugal pumps, when connected to engine and turbine drives, benefit by the expansion of the steam and are much more economical than the direct acting piston pump, which takes steam at full pressure for nearly the entire stroke. The amount of steam used in the pumps in central station work, however, is not a serious factor, since all of the heat in the steam that is not used in propelling the water through the mains is used in the heaters to increase the temperature of the water.

The sphere of usefulness of the centrifugal pump in central station heating is increasing. The direct acting piston pump, when operating at fairly high speeds, causes hammering and pounding in the transmission lines, and these noises are sometimes conveyed to the residences and become annoying to the occupants. This feature is not so noticeable in the operation of the centrifugal pump.

APPLICATION.—In Art. 145 assume the capacity of the plant, 10 business squares and 21 residence squares, to require 184500 gallons of water per hour; the same to be pumped against a pressure head, Art. 147, of 50—5 pounds, by horizontal, direct acting piston pumps. Assume also the steam consumption of the pumps to be 100 pounds per *I. H. P.* hour and the average temperature of the water at the pumps to be $(180 + 155) \div 2 = 167.5$ degrees. Apply formula 93, where h = calculated total friction head for the longest line in the system (this is designated by h_f in Art. 147), or where p = total difference between the incoming and the outgoing pressures. With the weight of a cubic foot of water at 167.5 degrees = 60.87 pounds and with $p = 45$, we have $h = 106.5$ feet, and the indicated horse-power of the pumps, assuming 65 per cent. mechanical efficiency, is

$$I. H. P. = \frac{184500 \times 8.33 \times 106.5}{33000 \times .65 \times 60} = 127.2$$

From this the steam consumption will probably be 12720 pounds per hour.

If centrifugal pumps were selected, the horse-power would be calculated from the same formula, but the steam

consumption would probably be 30 to 40 pounds of steam per horse-power hour because of the expansive working of the steam.

163. City Water Supply Pumps:—Horizontal, direct acting duplex pumps for use on city water supply service are the same as those used to circulate the water in heating systems; hence, the foregoing descriptions apply here. The *I. H. P.* of the city water supply pumps would be calculated by use of formula 93. If the pumps lifted the water from the wells, as would probably be the case, the suction pressure would be negative and would be added to the force pressure.

APPLICATION.—Assume the pressure in the fresh water mains 60 pounds and the suction pressure 10 pounds; therefore, $p = 60 - (-10) = 70$ pounds, and with the water at 65 degrees, $h = 144 \times 70 \div 62.5 = 161$ feet. These pumps are each rated at 1.5 million gallons in 24 hours, and deliver $62500 \times 8.33 = 520833$ pounds of water per hour, when running at full capacity. Assuming each pump to deliver 75 per cent. of the full requirement of the system, the total amount of water pumped per hour for the city water supply would approximate $520833 \div .75 = 694444$ pounds, and the total average horse-power used in pumping the water would be

$$I. H. P. = \frac{694444 \times 161}{60 \times 33000 \times .65} = 86.8$$

With 100 pounds of steam per horse-power hour, this would amount to 8680 pounds of steam available per hour for use in heating the circulating water.

164. Boiler Feed Pumps:—Horizontal pumps for high pressure boiler feeding are selected in a similar way to the circulating pumps for the city water supply. Such units are called auxiliary steam units and, because the steam required is small, they are sometimes piped to a feed water heater for heating the boiler feed. The velocity of the water through the suction pipe is about 200 feet per minute and in the delivery pipe about 300 feet per minute. The piston speed, the strokes per minute and the slip would be very much the same as stated under circulating pumps. Such pumps should have a pumping capacity about twice as great as the actual boiler requirements, and in small plants where only one pump is needed, the installation should be in

duplicate. The sizes of the cylinders and the efficiencies are about as stated for the larger circulating pumps.

In determining the horse-power of a boiler feed pump, four resistances must be overcome; i. e., pressure head, p , or boiler pressure; suction head, h_s ; delivery head, h_d ; and the friction head, h_f . The first three values are usually given. The friction head includes the resistances in all piping, ells and valves from the supply to the boiler. The friction in the piping may be taken from Table 37, Appendix, or it may be worked out by formula 70. The friction in the ells and valves is more difficult to determine and is usually stated in equivalent length of straight pipe of the same diameter. A rough rule used by some in such cases is as follows: "to the length of the given pipe, add 60 times the nominal diameter of the pipe for each ell, and 90 times the diameter for each globe valve," then find the friction head as stated above. A straight flow gate or water valve could safely be taken as an ell. For simplicity of calculation, all of the above resistances may be reduced to an equivalent head, such that

$$h_e = \frac{144 p}{w} + h_d + h_s + h_f \quad (94)$$

where w = weight of one cubic foot of water at the suction temperature, w may be obtained from Table 8, Appendix, and h_f may be taken from Table 37. The horse-power by formula 93 then becomes, if W = pounds of water pumped per minute,

$$I. H. P. = \frac{W \times h_e}{33000 E} \quad (95)$$

APPLICATION.—Let p = 125 pounds gage, w = 62.5, h_d = 8 feet, h_s = 20 feet, horizontal run of pipe from supply to pump = 20 feet, horizontal run of pipe from pump to boiler = 30 feet; also, let the pump supply 89000 pounds of water per hour to the boiler. This is twice the capacity of the boiler plant. With this amount of water at the usual velocity it will give a suction pipe of 4.5 inches diameter, and a flow pipe of 4 inches diameter. Let there be two ells and one gate valve on the suction pipe, and three ells, one globe valve and one check valve on the delivery pipe. We then have an equivalent of 107 feet of suction pipe, and 158 feet of delivery pipe. Referring to Table 37, h_f is approximately 7 feet, and the total head is

$$h_e = \frac{144 \times 125}{62.5} + 8 + 20 + 7 = 323 \text{ feet.}$$

In most boiler feed pumps it is considered unnecessary to determine h_f so carefully. A very satisfactory way is to obtain the total head pumped against, exclusive of the friction head, and add to it 5 to 15 per cent., depending upon the complications in the circuit. Substituting the above in formula 95, we obtain

$$I. H. P. = \frac{89000 \times 323}{60 \times 33000 \times .65} = 22.3$$

Work out the value of h_f by formula 70 and see how nearly it checks with the above.

165. Boilers:—A number of boilers will necessarily be installed in a plant of this kind, and a good arrangement is to have them so piped with water and steam headers that any number of the boilers may be used for steaming purposes and the rest as water heaters. They should also be so arranged that any of the boilers may be thrown out of service for cleaning or repairs and still carry on the work of the plant. By doing this the boiler plant becomes very flexible and each boiler is an independent unit. Any good water tube boiler would serve the purpose, both as a steaming and as a heating boiler. Where the boilers are used as heaters, the water should enter at the bottom and come out at the top. Where the water enters at the top and comes out at the bottom, the excessive heating of the front row of tubes retards the circulation of the water by this heat, and produces a rapid circulation through the rear tubes where the heat is the least. This rapid circulation in the rear tubes is not a detriment, but it is less needed there than in the front ones. It would be decidedly better if the rapid circulation were in the front row, causing the heat from the fire to be carried off more readily, and by this means giving less danger of burning the tubes. In the latter case the forced circulation from the pumps will be aided by the natural circulation from the heat of the fire, and the life of all the tubes then becomes more uniform. Fig. 118 shows a typical header arrangement.

Boilers are usually classified as fire tube and water tube. *Fire tube boilers* are usually of the multitubular type, having the flue gases passing through the tubes and water sur-

rounding them. *Water tube boilers* have the water passing through the tubes and the flue gases surrounding them. The *heating surface* of a boiler is composed of those boiler plates having the heated flue gases on one side and the water on the other. A *boiler horse-power* may be taken as follows:

Centennial Rating.

One *B. H. P.* = 30 pounds of water evaporated from feed water at 100° F. to steam at 70 pounds gage pressure.

A. S. M. E. Rating.

One *B. H. P.* = 34.5 pounds of water evaporated from and at 212° F.

In laying out a boiler plant some good approximations for the essential details are:

One *B. H. P.* = 11.5 square feet of heating surface (multitubular type).

One *B. H. P.* = 10 square feet of heating surface (water tube type).

One *B. H. P.* = .33 square foot of grate surface (small plant, say one boiler).

One *B. H. P.* = .25 square foot of grate surface (medium sized plant, say 500 H. P.).

One *B. H. P.* = .20 square foot of grate surface (large plants).

Pounds of water evaporated per square foot of heating surface per hour = 3 (approx. value).

166. Square Feet of Hot Water Radiation that can be Supplied on a Zero Day by One Boiler Horse-Power when the Boiler is Used as a Heater:—Assuming that the coal used in the plant has a heating value of 13000 B. t. u. per pound, and that the efficiency of the boiler is 60 per cent., each pound of coal will transmit to the water 7800 B. t. u. Since each pound of water takes up 25 B. t. u. on its passage through the heating boiler, one pound of coal will heat 312 pounds, or 37.5 gallons of water. This is equivalent to supplying heat, under extreme conditions of heat loss, to 37.5 square feet of radiation for one hour. One boiler horse-power, according to Art. 165, is equivalent to the expenditure of $969.7 \times 34.5 = 33455$ B. t. u. Now since each pound of coal transfers to the water 7800 B. t. u., one boiler horse-power will require $33455 \div 7800 = 4.28$ pounds of coal. If, then, the burning of one pound of coal will supply 37.5 square feet of hot water radiation for one hour, one boiler

horse-power will supply $4.28 \times 37.5 = 160$ square feet for one hour, and a 100 H. P. boiler will supply 16000 square feet of water radiation in the district for the same time. These figures have reference to boilers under good working conditions and probably give average results.

167. Square Feet of Hot Water Radiation in the District that can be Supplied on a Zero Day by an Economizer Located in the Stack Gases between the Boilers and the Chimney:—In order to make this estimate it is necessary first to know the horse-power of the boilers, the amount of coal burned per hour, the pounds of gases passing through the furnace per hour and the heat given off from these gases to the circulating water through the tubes.

APPLICATION.—Let C = pounds of coal burned per hour = boiler horse-power \times pounds of coal per boiler horse-power hour, W_a = pounds of air passed through the furnace per pound of fuel burned, s = specific heat of the gases, t_b = temperature of gases leaving boiler, t_s = temperature of gases leaving economizer, t_w = temperature of water entering economizer and t_f = temperature of water leaving the economizer. Then, if 8.33 pounds of water will supply one square foot of radiation for one hour we have

$$R_w = \frac{s \times (C \times W_a + C) \times (t_b - t_s)}{8.33 \times (t_f - t_w)} \quad (96)$$

From a previous statement, 44500 pounds of steam per hour are generated in the steam boiler plant at a pressure of 125 pounds gage. To find the boiler horse-power let the total heat of the steam, above 32° at 125 pounds gage, be 1191.8 B. t. u., and let the temperature of the incoming feed water to the boilers be 60 degrees. (In most cases the feed water will be at a higher temperature, but since it will occasionally be as low as 60 degrees, this value will be a fair one.) The heat put into a pound of steam under these conditions is $1191.8 - (60 - 32) = 1163.8$ B. t. u., and in 44500 pounds it will be 51789100 B. t. u. Since one horse-power of boiler service is equivalent to 33455 B. t. u., we will need $51789100 \div 33455 = 1548$ boiler horse-power. This horse-power will take care of all the engines and pumps in the plant. If the coal used contains 13000 B. t. u. per pound and the boilers have 60 per cent. efficiency, then 7800 B. t. u. will be given to the water per pound of fuel burned, and

the amount of coal burned per hour will be $51789100 \div 7800 = 6640$ pounds. This gives $6640 \div 1548 = 4.3$ pounds of fuel per boiler horse-power hour, and 6.7 pounds of water evaporated per pound of fuel. If the flue gases have 12 per cent. CO_2 , there are used according to experimental data, about 21 pounds of air or 22 pounds of the gases of combustion, per pound of fuel burned. This is equivalent to $6640 \times 22 = 146080$ pounds of flue gases total. Suppose now that these gases leave the furnace for the chimney at a temperature of 550 degrees F., that the economizer drops the temperature of the gases down to 350 degrees (a condition which is very reasonable) and that the specific heat of the gases is about .22, we have $146080 \times .22 \times (550 - 350) = 6427520$ B. t. u. given off from the gases per hour in passing through the economizer (see numerator in formula 96). This heat is taken up by the circulating water in passing through the economizer toward the outgoing main. Now if the water, as it returns from the circulating system, enters the economizer at 155 degrees, and leaves at 180 degrees, we will have $6427520 \div (180 - 155) = 257100$ pounds of water heated per hour. This is equivalent to supplying $257100 \div 8.33 = 30864$ square feet of radiation per hour when the plant is running at its peak load. Taking the "pounds of steam per hour" in the above as the only variable quantity, we are fairly safe in saying that the heat in the chimney gases from one horse-power of steaming boiler service will supply, through an economizer, $30864 \div 1548 = 20$ square feet of radiation in the district. In plants where only 7 pounds of water are allowed to each square foot of radiation per hour, this becomes 23.8 square feet of radiation instead.

168. Square Feet of Economizer Surface Required to Heat the Circulating Water in Art. 167:—Let K = the coefficient of heat transmission through clean cast iron tubes and E = the efficiency of the tube surface when in average service, also let the terms for the temperatures of the gases and the circulating water be as given in Art. 167, then

$$R_e = \frac{\text{Heat trans. per hour from gases to water}}{K \times E \times \left(\frac{t_b + t_s}{2} - \frac{t_f + t_w}{2} \right)} \quad (97)$$

This formula assumes that the rate of heat flow through the tubes is the same at all points. As a matter of fact this rate changes slightly as the water becomes heated, but

the error is not worth mentioning in such a formula, where the efficiency of the surface may be anything from 100 per cent. in new tubes, to as low as 30 or 40 per cent. for old ones.

APPLICATION.—Let $K = 7$ and $E = .4$, then

$$R_e = \frac{6427520}{7 \times .4 \times \left(\frac{550 + 350}{2} - \frac{180 + 155}{2} \right)} = 8125 \text{ sq. ft.}$$

With 12 square feet of surface per tube this gives 677 tubes.

169. Square Feet of Economizer Surface to Install when the Economizer is to be Used to Heat the Feed Water for the Steaming Boilers:—If 30 pounds of feed water are fed to the boiler per horse-power hour, and if $K = 7$, $E = .4$, $t_b = 550$, $t_s = 350$, $t_f = 250$, and $t_w = 90$ (about the lowest temperature at which water should enter the economizer), then the square feet of surface per horse-power is

$$R_e = \frac{30 \times (250 - 90)}{7 \times .4 \times \left(\frac{550 + 350}{2} - \frac{250 + 90}{2} \right)} = 6.1 \text{ sq. ft.}$$

170. Total Capacity of the Boiler Plant and the Number of Boilers Installed:—The following discussion on the size of the boiler plant is purely for illustrative purposes and is intended to show how such problems may be analyzed. In most cases the exhaust steam, and the economizer, if used, will fall far short of supplying the total radiation in the district, especially when the electrical output is light and the weather is cold. Suppose it be desired to install extra boilers to be used as heaters for the radiation not supplied from these two sources. To determine the amount of extra boilers, find the amount of radiation to be supplied by the exhaust steam and the economizer and subtract this from the total radiation. The difference must be supplied by boilers used as heaters. It is probably not safe to estimate too closely on the amount of exhaust steam given to the heating system. The maximum amount of 44500 pounds per hour was obtained, in this case, by pumping one gallon of water per hour for each square foot of radiation and by pumping city water, in addition to that obtained from the engines. In heating, a less amount of water than this may be circulated even on the coldest day. This is possible, first, because water may be carried at a higher tem-

perature than that stated, and second, because there may be less loss of heat in the conduit, thus giving more heat per gallon of water to the radiation. Again, in estimating for a city water supply, the demands are not very constant and are difficult to estimate. In this one design it was thought that 44500 pounds per hour was a very liberal allowance and could be dropped to 35000 pounds (140000 square feet of radiation), when estimating the amount of radiation supplied by the exhaust steam.

By Fig. 113 it will be seen that the minimum load on the steaming boilers carries through six hours out of the entire twenty-four and that the exhaust steam at this time drops to 22890 pounds per hour, supplying 91560 square feet of radiation. This minimum load is 51 per cent. of the maximum, and 66 per cent. of the amount taken as an average, i. e., 35000. The work done by the economizer is fairly constant, since the amount of economizer surface lost by the steaming boilers under minimum load would be made up by the additional heating boilers thrown into service. *On the basis of 35000 pounds per hour*, the exhaust steam and the stack gases together would heat 170960 square feet and there would be left 13540 square feet ($184500 - 20 \times 1548 - 4 \times 35000$), to be heated by additional boilers. Under minimum load this would be approximately 122500, leaving 62000 square feet to be heated by additional boilers. If one boiler horse-power supplies 160 square feet of radiation, then it would require 84 and 387 boiler horse-power respectively to supply the deficiency and the total horse-power needed in each case would be 1632 and 1935. A more satisfactory analysis, however, is the following which is worked *on the basis of 44500 pounds per hour*.

Let W_s = total number of pounds of steam used in the plant per hour = approximate number of pounds of exhaust steam available for heating the circulating water per hour; W_e = equivalent number of pounds of steam evaporated from and at 212° ; λ = total heat, above 32° , in one pound of dry steam at the boiler pressure; q' = total heat, above 32° , in one pound of feed water entering the boiler; then, if the latent heat of steam at atmospheric pressure = 969.7 B. t. u., we have

$$W_e = \frac{W_s (\lambda - q')}{969.7} \quad (98)$$

and the corresponding boiler horse-power needed as steaming boilers will be

$$B_s. H. P. = \frac{W_e}{34.5} \quad (99)$$

Next, the radiation in the district that can be supplied by the exhaust steam is $R_w = 4 W_s$, and the amount supplied by the economizer is $R_e = 20 \times B. H. P.$ From which we may obtain the capacity of the heating boilers, as

$$B_w. H. P. = \frac{\text{Total Radiation} - 4 W_s - 20 B. H. P.}{160} \quad (100)$$

The total boiler horse-power of the plant is, therefore, the sum of $B_s. H. P.$ and $B_w. H. P.$ To obtain formula 100 for any specific case one must consider the maximum and minimum conditions of the steaming boiler plant. Let W_s (max) = maximum exhaust steam, and W_s (min) = minimum exhaust steam. Then for the two following conditions we have, Case 1, *where the steaming and heating boilers are independent of each other*, the total boiler horse-power installed = $B_s. H. P.$ + [total radiation — $4 W_s$ (min) — $20 \times B. H. P.$ in use] \div 160. Also, Case 2, *where a part or all of the steaming boilers are piped for both steaming and water service*, the total boiler horse-power installed = $B_s. H. P.$ + [total radiation — $4 W_s$ (max) — $20 \times B. H. P.$ in use] \div 160. It will be noticed that the last term representing the economizer service is simply stated as boiler horse-power and no distinction is made between steaming or heating service. This term is difficult to estimate to an exact figure because it should be the total horse-power in use at any one time, both steaming and heating, and this can only be obtained by approximation. It makes no difference what service the boiler may be used for, the work of the economizer is practically the same. Probably the most satisfactory way is to substitute the value of $B_s. H. P.$ for $B. H. P.$ in the economizer and get the approximate total horse-power, then if this approximate total horse-power differs very much from that actually needed, other trials may be made and new values for the total horse-power obtained until the equation is satisfied.

APPLICATION.—Let W_s = pounds of exhaust steam, λ = 1191.8 (125 pounds gage pressure), and q' = 28 (feed water at 60°); then when $W_s = 44500$

$$W_e = 53400$$

$$B_s. H. P. = 1548$$

$$B_w. H. P. \text{ Case 1} = \frac{184500 - 4 \times 22890 - 20 \times 1548}{160} = 387$$

$$B_w. H. P. \text{ Case 2} = \frac{184500 - 4 \times 44500 - 20 \times 1548}{160} = -153$$

This shows that there is an excess of waste heat in Case 2, making a total boiler horse-power, Case 1, = 1935 and Case 2, = 1548. Investigating Case 1 to see what error was introduced by using 1548 in the economizer, we find approximately 800 horse-power of steam boilers in use, and the total horse-power to be 1187, which is about 360 horse-power on the unsafe side. Substitute again and check results. Case 2 is reasonably close. In any case the most economical size of boiler plant to install in a plant requiring both steaming and heating boilers is one where at least a part, if not all, of the boilers are piped so as to be easily changed from one system to the other. By such an arrangement the capacity may be made the smallest possible. After obtaining the theoretical size of the plant, it would be well to allow a small margin in excess so that one or two boilers may be thrown out of commission for repairs and cleaning without interfering with the working of the plant. Case 2 seems to be the better arrangement. Assuming 1800 total boiler horse-power we might very well put in six 300 *H. P.* boilers arranged in three batteries.

171. Cost of Heating from a Central Station (Direct Firing):—It will be of interest in this connection to estimate approximately the cost in supplying heat by direct firing to one square foot of hot water radiation per year from the average central station. In doing this make the boiler assumptions to be the same as Art. 166. Take coal at 13000 B. t. u. per pound, 2000 pounds per ton, and a boiler efficiency of 60 per cent. Water enters the boiler at 155 degrees from the returns, and is delivered to the mains at 180 degrees. From the value of the coal as stated, we have 15600000 B. t. u. per ton given off to the water. This is

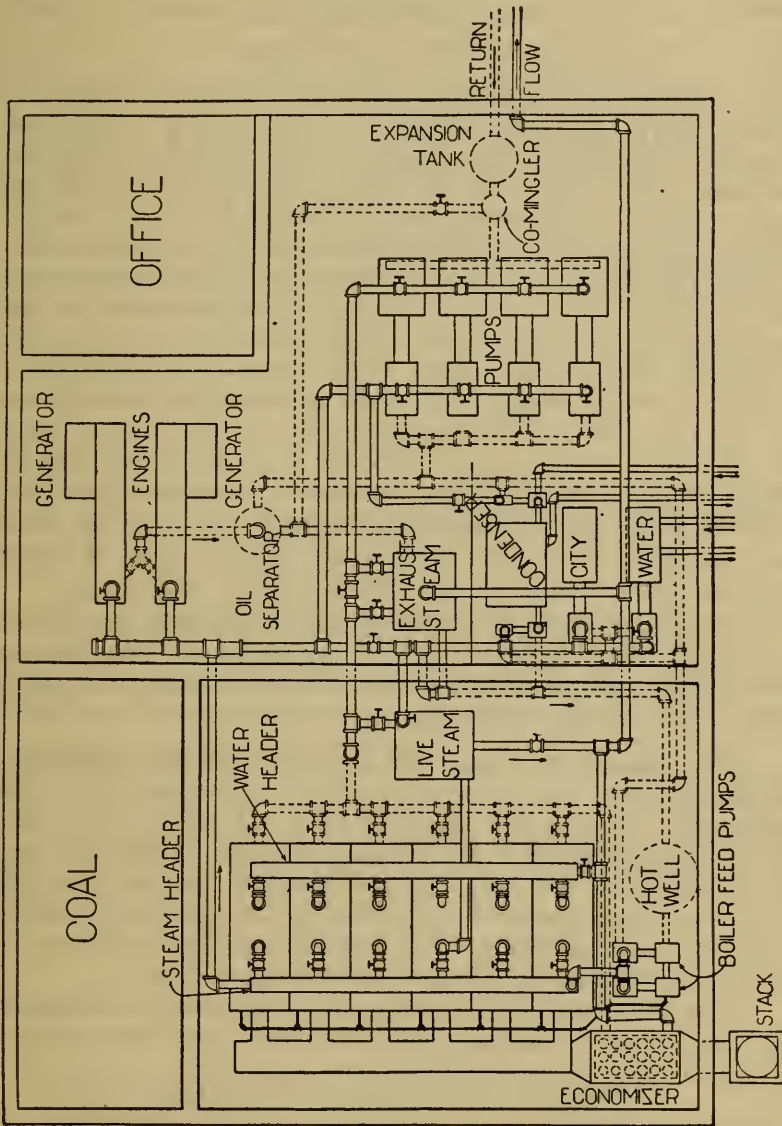

POWER PLANT LAYOUT.

Fig. 118.

equivalent to heating 624000 pounds, or 74910 gallons, of water. If one ton of coal costs \$2.00 at the plant, we have

$$200 \div 74910 = .0027 \text{ cents}$$

This represents the amount paid to reheat one gallon of water, or to supply one square foot of heating surface one hour at an outside temperature of zero degrees. Take the average temperature for the seven cold months at 32 degrees. This is the average for the coldest year in the twenty years preceding 1910, as recorded at the U. S. Exp. Station, LaFayette, Indiana. We then have an average difference between the inside and the outside temperatures in any residence of $70 - 32 = 38$. This makes the formula for the heat loss, Art. 28, reduce to $38 \div 70 = .54$ of its former value. Now, if it takes one gallon of water per square foot of radiation per hour under maximum conditions, we have for the seven months $.54 \times 7 \times 30 \times 24 = 2722$ gallons of water needed for each square foot of radiation per each heating year. This is equivalent to $2722 \times .0027 = 7.35$ cents per square foot of radiation for the heating year of seven months.

When the plant is working under the best conditions this figure can be reduced. It can be done with boilers of a higher efficiency than that stated, or by using a cheaper coal, both of which are possible in many cases.

172. Cost of Heating from a Central Station. Summary of Tests:—The following tests were conducted upon the Merchants Heating and Lighting Plant, LaFayette, Ind.; one in 1906 and the other in 1908. The plant was changed slightly between the two tests and the radiation carried upon the lines was much increased, although in all essential features the plant was the same. The circulating water was heated by exhaust steam heaters and by heating boilers.

The plant had the following important pieces of apparatus employed in generating or absorbing the heat supply:

BOILERS (Steaming and Heating).

Two 125 *H. P.* Stirling boilers. Total heating surface 2524 sq. ft.

Three 250 *H. P.* Stirling boilers. Total heating surface 7572 sq. ft.

Pressure on steam boilers (gage), 150 lbs.

Pressure on heating boilers (approx.), 60 lbs.

ENGINES.

One 450 *H. P.* Hamilton Corliss comp. engine, direct connected to a 300 *K. W.* Western Electric 72-pole alternating current generator 120 *R. P. M.* This engine carried the load of the plant when it was above 50 *K. W.*, which was generally from 5:30 *A. M.* to 11:30 *P. M.* When this unit was run, direct current was obtained by passing the alternating current through a motor generator set.

One 125 *H. P.* Westinghouse comp. engine, belted to one 75 *K. W.* 3-phase alternating and two direct current generators, and run at 312 *R. P. M.* This unit was generally run between 11:30 *P. M.* and 5:30 *A. M.*

One 250 *H. P.* Westinghouse comp. engine, belt connected to a 200 *K. W.* generator and two smaller machines.

PUMPS.

One centrifugal, two-stage pump, Dayton Hydraulic Co., direct connected to a Bates vertical high speed engine at 300 *R. P. M.*

Two Smith-Vaile horizontal recip. duplex pumps 14 in. \times 12 in. \times 18 in. Each of the three pumps connected to the return main in such a way as to be able to use any combination at any one time to circulate the water. The centrifugal pump had been in service only one season. It had a capacity about equal to the two reciprocating pumps and under the heaviest service this pump and one of the duplex pumps were run in parallel.

One Smith-Vaile horizontal reciprocating tank pump 6 in. \times 4 in. \times 6 in. to lift the water of condensation from the exhaust heater to the tank.

One Smith-Vaile horizontal reciprocating make-up pump 6 in. \times 4 in. \times 6 in. to replace the water that was lost from the system.

Two National horizontal reciprocating boiler feed pumps.

One 9½ in. Westinghouse air pump, to keep up the supply of air through the conduits to the regulator system in the heated buildings.

One Deane vertical deep well pump, to deliver fresh water to the supply tank.

One Baragwanath exhaust steam heater or condenser, having 1000 sq. ft. of heating surface.

PARTIAL SUMMARY OF RESULTS.

	1906	1908
1. Square feet of radiation	118000	150000
2. Temperature of circulating water in degrees F., flow main	158.36	164.4
3. Temperature of circulating water in degrees F., return main	139.9	139.6
4. Temperature of circulating water in degrees F., after leaving heater.....	145.6	147.
5. Temperature of outside air in degrees F.	32.6	37.5
6. Temperature of stack gases in degrees F., steaming boiler		566.8
7. Temperature of stack gases in degrees F., heating boiler	562.	656.
8. Draft in stacks (all boilers averaged) in inches of water689	.595
9. Heating value of coal in B. t. u. per pound	12800	11565
10. B. t. u. delivered to steaming boiler per hour by coal	18187000	25833000
11. B. t. u. delivered to heating boilers per hour by coal	19226000	27917000
12. B. t. u. delivered to circulating water by heating boilers per hour	11800000	15405000
13. B. t. u. to be charged to heating boilers (Item 12—Item 15).....	7650000	6934000
14. B. t. u. delivered to circulating water by exhaust steam from the generating engines per hour	3600000	6602000
15. B. t. u. thrown away during test from pump exhausts and available for heating circulating water.....	4150000	8471000
16. B. t. u. available for heating circulating water from all exhaust steam as in normal running (Item 14 + Item 15)	7750000	15073000
17. Total B. t. u. given to circulating water per hour (Item 13 + Item 16)..	15400000	22007000
18. Gallons of water pumped per hour [Item 17 ÷ (8.33 × Items 2—3)]......	100000	108000

19. Gallons of water pumped per square foot of radiation per hour (Item 18 ÷ Item 1)85	.70
20. Efficiency of heating boilers (Item 12 ÷ Item 11) approx.60	.55
21. Value of the coal in cents per ton of 2000 pounds at the plant	200.	175.
22. Average electrical horse-power	68	141

Note.—The above values are averages and were taken for each entire test. The B. t. u. values were considered satisfactory when approximated to the nearest thousand.

173. Regulation:—The regulation of the heat within the residences is best controlled from the power plant. In most heating plants a schedule is posted at the power house which tells the engineer the necessary temperature of the circulating water to keep the interior of the residences at 70 degrees with any given outside temperature. The Merchants Heating and Lighting Company mentioned above use the following schedule:

Atmosphere	Water	Atmosphere	Water
60 deg.	120 deg.	10 deg.	190 deg.
50 “	140 “	0 “	200 “
40 “	150 “	—10 “	210 “
30 “	160 “	—20 “	220 “
20 “	180 “		

In addition, read the article by Mr. G. E. Chapman, published in the Heating and Ventilating Magazine, August 1912, page 23, in which he describes the methods used in regulating the Oak Park, Ill. plant.

In some heating plants the regulation is by means of air carried from the compressor at the power house through a main running parallel with the water mains in the conduits and branching to each building where it is used under a pressure of 15 pounds to operate thermostats, which in turn control the water inlets to the radiators. A closer regulation is obtained in the latter system than in the former, but it is needless to say that the thermostats require careful adjustments and frequent inspections.

Diaphragms or *chokes* having different sized orifices may be placed on the return main from each building to regulate the supply. Those buildings nearest to the power plant have the advantage of a greater differential pressure than

those farther away, hence should have smaller diaphragms. By increasing the resistance in the return line from any building the water circulates more slowly and has time to give off more heat to the rooms. With a high temperature of the water and a careful adjustment of the diaphragms it is possible to have the amount of water circulated per square foot of radiation reduced much below one gallon per square foot per hour.

STEAM SYSTEMS.

174. Heating by steam from a central station, compared with hot water heating, is a very simple process. The power plant equipment is composed of a few inexpensive parts, the operation of which is very simple and easily explained. These parts have but few points that require rational design. Because of the simplicity and the similarity to the preceding discussion on hot water systems, the work on steam systems will be very brief. All questions referring to the construction of the conduit, the supporting of the pipes, the provision for contraction and expansion, the draining of the pipes and conduits, are common to both hot water and steam systems and are discussed in Arts. 138 and 139. A large part of the work referring directly to district hot water heating applies with almost equal force to steam heating. This part of the work, therefore, will deal with such parts of the power plant equipment as differ from those of the hot water system.

Steam heating may be classified under two general heads, high pressure and low pressure. A very small part of the heating in this country is now done by what may be strictly called high pressure service, i. e., where radiators or coils are under pressures from 30 to 60 pounds gage, and this small amount is gradually decreasing. Ordinarily, steam is generated at high pressure at the boiler, 60 pounds to 150 pounds gage, and reduced for line service to pressures varying from 0 to 30 pounds gage, with a still further reduction at the building to pressures varying from 0 to 10 pounds gage, for use in radiators and coils. Where exhaust steam is used in the main, the pressure is not permitted to go higher than 10 pounds gage, because of the back pressure on the engine piston. Where exhaust steam is not used, the pressures may go as high as 30 pounds gage, thus allowing for a greater pressure drop in the line and a corre-

sponding reduction in pipe sizes. *Vacuum returns* may be applied to central station work the same as to isolated plants.

The principles involved in the power plant end of a steam heating system may be represented by Fig. 119. It will be seen that the exhaust steam from the engines or turbines has four possible outlets. Passing through the oil separator, which removes a large part of the entrained oil, part of the exhaust steam is turned into the heater for use in heating the boiler feed water. The rest of the steam passes on into the heating system. If there be more exhaust steam than is necessary to supply the heating system, the balance may go to the atmosphere through the back pressure valve. When the heating system is not in use, as would be the case in the four warm months of the year, the exhaust steam may be passed into the condenser.

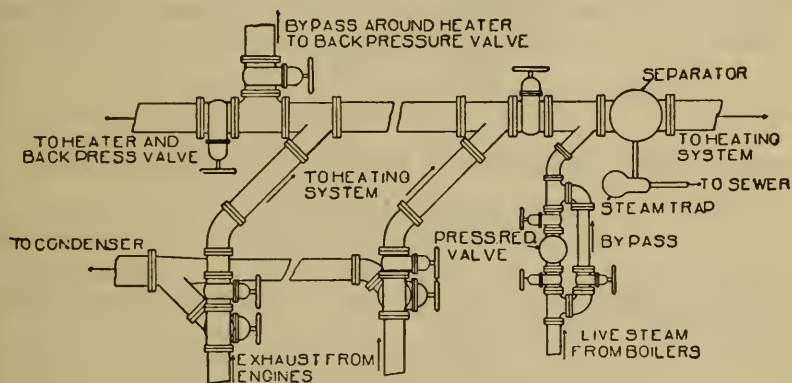

Fig. 119.

It is very evident, from what has been said before, that it would not be economical to condense the steam in a condenser as long as there is a possibility of using it in the heating system. The increased gain in efficiency, when condensing the exhaust steam under vacuum, is very small compared to the gain when this same steam is used for heating purposes. It would be also very poor economy to use any live steam for heating when there were any exhaust steam wasted. When the amount of exhaust steam is insufficient, live steam is admitted through a pressure reducing valve.

175. Drop in Pressure and the Diameter of the Mains:—

The flow of steam in a pipe follows the same general law as

the flow of water. The loss of head may be represented by the well known formula

$$h_f = \frac{2 \phi l v^2}{g d} \quad (101)$$

where h_f = loss of head in feet, ϕ = coefficient of friction, v = velocity in feet per second, l = length of pipe in feet, d = diameter of the pipe in feet and $g = 32.2$. Substitute, $h_f = 144 p \div D$, where p = drop in pressure in pounds and D = density of the steam, and find

$$p = \frac{2 \phi l v^2 D}{144 g d} \quad (102)$$

The coefficient of friction is found to vary with the velocity of the steam and with the diameter of the pipe. Prof. Unwin found that for velocities of 100 feet per second (good practice for transmission lines), it could be expressed as follows, where c is a constant to be found by experiment,

$$\phi = c \left(1 + \frac{3}{10 d} \right)$$

which, when substituted in formula 102, gives

$$p = \frac{l v^2 D c}{72 g d} \left(1 + \frac{3}{10 d} \right) \quad (103)$$

Let W = pounds of steam passing per minute and d_1 = diameter of pipe in inches, then

$$p = \frac{1}{20.663} \left(1 + \frac{3.6}{d_1} \right) \frac{W^2 l c}{d_1^5 D} \quad (104)$$

From this formula we may obtain any one of the three terms, W , d_1 or p , if the other two are known. Table 36, Appendix, was compiled from formula 104 with $c = .0027$. For discussion, see Trans. A. S. M. E., Vol. XX, page 342, by Prof. R. C. Carpenter. Also Encyclopedia Britannica, Vol. XII, page 491. See also, Kent, page 670, and Carpenter's H. & V. B., page 51.

It will be seen that Table 36 is compiled upon the basis of one pound pressure drop, at an average pressure of 100 pounds absolute in the pipe. Since in any case the drop in pressure is proportional to the square of the pounds of steam delivered per minute (other terms remaining constant), the amount delivered at any other pressure drop than that given (one pound) would be found by multiplying

the amount given in the table by the square root of the desired pressure drop in pounds. Also, since the weight of steam moved at the same velocity, under any other absolute pressure, is approximately proportional to the absolute pressures (other terms remaining constant), we have the amount of steam moved under the given pressure, found by multiplying the amount given in the table by the square root of the ratio of the absolute pressures. To illustrate the use of the table—suppose the pressure drop in a 1000 foot run of 6 inch pipe is 8 ounces, when the average pressure within the pipe is 10 pounds gage. The amount of steam carried per minute is $93.7 \times \sqrt{5} \div \sqrt{100} \div 25 = 33$ pounds. Or, if the drop is 4 pounds, at an average inside pressure of 50 pounds gage, the amount carried would be 150 pounds per minute. Conversely—find the diameter of a pipe, 1000 feet long, to carry 150 pounds of steam per minute, at an average pressure of 50 pounds gage and a pressure drop of 8 ounces.

$$W \text{ (table)} = \frac{150}{\sqrt{5}} \times \sqrt{\frac{100}{65}} = 264 \text{ pounds}$$

which, according to the table, gives a 9 inch pipe.

176. Dripping the Condensation from the Mains:—The condensation of the steam, which takes place in the conduit mains, should be dripped to the sewer or the return at certain specified points, through some form of steam trap. These traps should be kept in first class condition. They should be inspected every seven or ten days. No pipe should be drilled and tapped for this water drip. The only satisfactory way is to cut the pipe and insert a tee with the branch looking downward and leading to the trap. The sizes of the traps and the distances between them can only be determined when the pounds of condensation per running foot of pipe can be estimated.

177. Adaptation to Private Plants:—District steam heating systems may be adapted to private hot water plants by the use of a "transformer." This in principle is a hot water tube heater which takes the place of the hot water heater of the system. It may also be adapted to warm air systems by putting the steam through indirect coils and taking the air supply from over the coils.

178. General Application of the Typical Design:—The following brief applications are meant to be suggestive of the method only, and the discussions of the various points are omitted.

Square feet of radiation in the district.—

$$R_s = 184500 \times 170 \div 255 = 123000 \text{ square feet.}$$

Amount of heat needed in the district to supply the radiation for one hour in zero weather.—

$$\text{Total heat per hour} = 123000 \times 255 = 31365000 \text{ B. t. u.}$$

Amount of heat necessary at the power plant to supply the radiation for one hour in zero weather.—Assuming 15 per cent. heat loss in the conduit (this is slightly less than that allowed for the hot water two-pipe system, 20 per cent.), we have $31365000 \div .85 = 36900000$ B. t. u. per hour.

Total exhaust steam available for heating purposes.—

$$W_s \text{ (max.)} = (23100 + 8680) \times 1.15 = 36547 \text{ pounds per hour.}$$

$$W_s \text{ (min.)} = (1490 + 8680) \times 1.15 = 11696 \text{ pounds per hour.}$$

Total B. t. u. available from exhaust steam per hour for heating.—

Let the average pressure in the line be 5 pounds gage and let the water of condensation leave the indirect coils in the residences at 140 degrees. We then have from one pound of exhaust steam, by formula 72,

$$\text{B. t. u.} = .85 \times 960 + 195.6 - (140 - 32) = 903.7$$

Assuming this to be 900 B. t. u. per pound, the total available heat from the exhaust steam for use in the heating system is, maximum total = 32892300 B. t. u. and the minimum total, = 10526400 B. t. u.

Square feet of steam radiation that can be supplied by one pound of exhaust steam at 5 pounds gage.—

$$R_s = 900 \div (255 \div .85) = 3.$$

Total B. t. u. to be supplied by live steam.—

$$\text{B. t. u. (max. load)} = 36900000 - 32892300 = 4007700 \text{ B. t. u.}$$

$$\text{B. t. u. (min. load)} = 36900000 - 10526400 = 26373600 \text{ B. t. u.}$$

Total pounds of live steam necessary to supplement the exhaust steam.—Let the steam be generated in the boiler at 125 pounds gage. With feed water at 60 degrees

$$\text{Max. load} = 4007700 \div 1163.8 = 3444 \text{ pounds.}$$

$$\text{Min. load} = 26373600 \div 1163.8 = 22661 \text{ pounds.}$$

Boiler horse-power needed for the steam power units.—As in Arts. 167 and 170,

$$B. H. P. (max.) = 36547 \times 1.2 \div 34.5 = 1271.$$

$$B. H. P. (min.) = 11696 \times 1.2 \div 34.5 = 407.$$

Total boiler horse-power needed in the plant.—Maximum load.
B. H. P. (total) = 1271 + (3444 × 1.2 ÷ 34.5) = 1391.

It will be noticed that this total horse-power is 157 horse-power less than the corresponding Case 2 in Art. 170. This is accounted for by the fact that no steam is used up in work in the circulating pumps, also that the conditions of steam generation and circulation are slightly different. 1500 boiler horse-power would probably be installed in this case.

Size of conduit mains.—Let it be required to find the diameters of the main system in Fig. 115 at the important points shown. Art. 147 gives the length of the mains in each part. Allow .3 pound of steam for each square foot of steam radiation per hour (this will no doubt be sufficient to supply the radiation and conduit losses). Try first, that part of the line between the power plant and A, with an average steam pressure in the lines of about 5 pounds gage and a drop in pressure of 1½ ounces per each 100 feet of run (approximately 5 pounds per mile). 25200 pounds per hour gives *W* = 420. The length of this part of the line is 200 feet and the drop is 3 ounces, or .19 pound.

$$W \text{ (table)} = \frac{420}{\sqrt{.19}} \times \sqrt{\frac{100}{20}} = 2158 \text{ pounds}$$

which gives a 15 inch pipe.

Following out the same reasoning for all parts of the line, we have

TABLE XXVIII.

	PP to A	A to B	B to C	C to D	D to E
Distance between points.....	200	500	1500	1500	500
Radiation supplied, sq. ft.....	84000	57000	34000	19000	8000
Pressure-drop in pounds = <i>p</i>19	.47	1.4	1.4	.47
Diameter of pipe in inches, by table...	15	13	11	9	5

In general practice, these values would probably be taken 16, 14, 12, 10 and 6 inches respectively. Look up Table 36, Appendix, and check the above figures.

REFERENCES.

References on District Heating.

TECHNICAL BOOKS.

Allen, *Notes on Heating and Ventilation*, p. 131.
Gifford, *Central Station Heating*.

TECHNICAL PERIODICALS.

Engineering News. Comparison of Costs of Forced-Circulation Hot Water and Vacuum-Steam Central Heating Plants, J. T. Maguire, Dec. 23, 1909, p. 692. Design of Central Hot-Water System with Forced-Circulation, J. T. Maguire, Sept. 2, 1909, p. 247. *Engineering Review*. Determining Depreciation of Underground Heating Pipes, W. A. Knight, Jan. 1910, p. 85. Some Remarks on District Steam Heating, W. J. Kline, April 1910, p. 61. Toledo Yaryan System, A. C. Rogers, May 1910, p. 58. Some of the Factors that Affect the Cost of Generating and Distributing Steam for Heating, C. R. Bishop, Aug. 1910, p. 56. Central Station Heating Plant at Crawfordsville, Ind., B. T. Gifford, Dec. 1909, p. 42. Wilkesbarre Heat, Light and Motor Co., A Live Steam Heating Plant, J. A. White, July 1908, p. 32. *The Heating and Ventilating Magazine*. Schott Systems of Central Station Heating, J. C. Hornung, Nov. 1908, p. 19. Data on Central Heating Stations, Nov. 1909, p. 7. Cost of Heat from Central Plants, March 1909, p. 31. Steam Heating in Connection with Central Stations, Paul Mueller, Oct. 1909, p. 24; Nov. 1909, p. 1. A Modern Central Hot Water Heating Station, W. A. Wolls, July 1910, p. 15. Central Station Heating, F. H. Stevens, June 1910, p. 5. The Profitable Operation of a Central Heating Station without the Assistance of Electrical or Other Industries, Byron T. Gifford, Aug. 1910. Central Station Heating, Byron T. Gifford, Apr. 1911. Central Power and Heating Plant for a Group of School Buildings, May 1910. *Domestic Engineering*. Report of Second Annual Convention of the National District Heating Association at Toledo, O., June 1, 1910. Vol. 51, No. 11, June 11, 1910, p. 255. *The Metal Worker*. Central District Steam Heating from Hill Top, Jan. 15, 1910, p. 78. Central Heating at Crawfordsville, Ind., July 30, 1910, p. 135. Data of 77 Central Station Heating Plants, Sept. 4, 1909, p. 48. Hot Water Heating, Teupitz, Germany, Sept. 25, 1909, p. 45. High Pressure Steam Distribution, Munich, Germany, Oct. 2, 1909, p. 48. Central Plant Solely for Residence Oct. 16, 1909, p. 50. Two Types of Central Heating Plant Compared, Apr. 9, 1910. Central Heating at Crawfordsville, Indiana, July 30, 1910. *The Engineering Record*. District Heating, July 15, 1905. Economies Obtainable by Various Uses of Steam in a Combined Power and Heating Plant, Feb. 18, 1905. A Study for a Central Power and Heating Plant at Washington, Feb. 11, 1905. Utilization of Vapor of Steam Heating Returns, Oct. 22, 1904. A Central Heating, Lighting and Ice-Making Station, Gulfport, Miss., Feb. 27, 1904. Purdue University Central Heating and Power Station, Jan. 30, 1904. A Central Hot-Water Heating Plant in the Boston Navy Yard, July 16, 1904. *Power*. Combined Central Heating and Electric Plants, Edwin D. Dreyfus, Aug. 20, 1912.

CHAPTER XIV.

TEMPERATURE CONTROL IN HEATING SYSTEMS.

179. From tests that have been conducted on heating systems, it has been shown that there is less loss of heat from buildings supplied by automatic temperature control, than from buildings where there is no such control. A uniform temperature within the building is desirable from all points of view. Where heating systems are operated, even under the best conditions, without such control, the efficiency of the system would be increased by its application. No definite statement can be made for the amount of heat saved, but it is safe to say that it is between 5 and 20 per cent. A building uniformly heated during the entire time, requires less heat than if a certain part or all of the building were occasionally allowed to cool off. When a building falls below normal temperature it requires an extra amount of heat to bring it up to normal, and when the inside temperature rises above the normal, it is usually lowered by opening windows and doors to enable the heat to leave rapidly. High inside temperatures also cause a correspondingly increased radiation loss. Fluctuations of temperature, therefore, are not only undesirable for the occupants, but they are very expensive as well.

180. Principles of the System:—Temperature control may be divided into two general classifications,—small plants and large plants. The *control for small plants*, i. e., such plants as contain very few heating units, is accomplished by regulating the drafts by special dampers at the combustion chamber. This method controls merely the process of combustion and has no especial connection with individual registers or radiators, it being assumed that a rise or fall of temperature in one room is followed by a corresponding effect in all the other rooms. This method assumes that all the heating units are very accurately proportioned to the respective rooms. The dampers are operated through a system of levers, which system in turn is controlled by a thermostat. Fig. 120 shows a typical application of such regu-

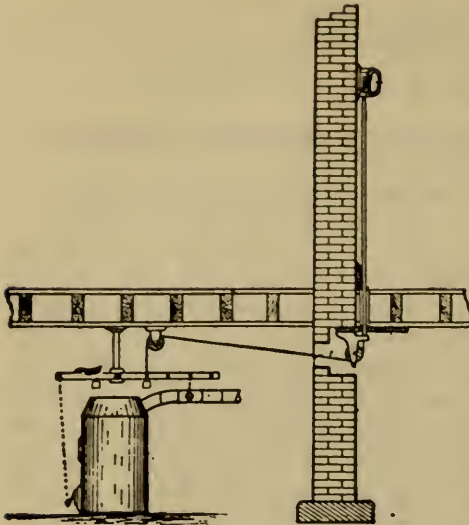

Fig. 120.

lation. This may be applied to any system of heat. In addition to the thermostatic control from the room to the damper, as has just been mentioned, closed hot water, steam and vapor systems should have regulation from the pressure within the boiler to the draft. Occasionally in the morning the pressure in either system may become excessive before the house is heated enough for the thermostat to act. With such

additional regulation no hot water heater or steam boiler would be forced to a dangerous pressure. Fig. 121 shows a thermostat manufactured by the Andrews Heating Co., Minneapolis. The complete regulator has in addition to this, two cells of open circuit battery and a motor box, all of which illustrate very well the thermostatic damper control.



Fig. 121.

The thermostat operates by a differential expansion of the two different metals composing the spring at the top. Any change in temperature causes one of the metals to expand or contract more rapidly than the other and gives a vibrating movement to the projecting arm. This is connected with the batteries and with the motor in such a way that when the pointer closes the contact with either one of the contact posts, a pair of magnets in the motor causes a crank arm to rotate through 180 degrees. A flexible connection between this crank and the damper causes the damper to open or close. A change in temperature in the opposite direction makes contact with the other post and reverses the movement of the crank and damper. The movement of the arm between the contacts is very small thus

making the thermostat very sensitive. No work is required of the battery except that necessary to release the motor.

Occasionally it is desirable to connect small heating plants having only one thermostat in control, to a central station system. Fig. 122 shows how the supply of heat may be controlled by the above method.

Fig. 123 shows the Slyphon Damper Regulator made by The American Radiator Co., and applies to steam pressure control. The longitudinal expansion of a corrugated brass or copper cylinder operates the damper through a system of levers. The longitudinal movement of the cylinder is small and hence the bending of the metal in the walls of the cylinder is very slight. This small movement is multiplied

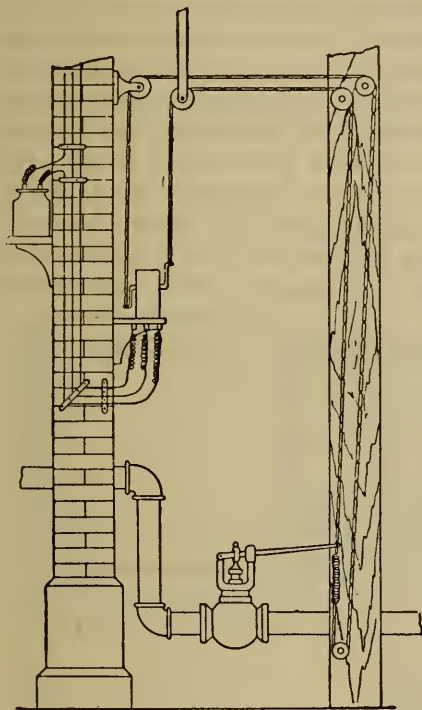

Fig. 122.

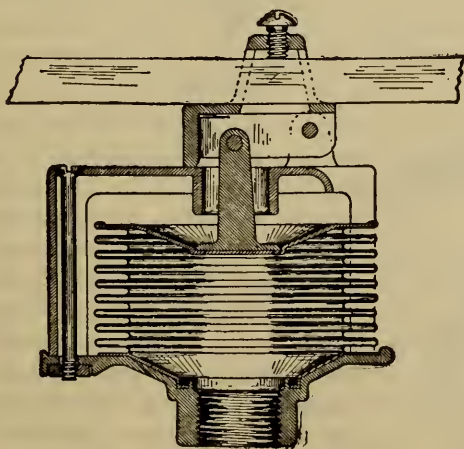

Fig. 123.

through the system of levers to the full amount necessary to operate the damper. A similar device is made by the same company for application to hot water heaters.

Temperature control in large plants, i. e., those plants having a large number of heating units, is much more complicated. In furnace systems this is very much the same as described under small plants, with additional dampers placed in the air lines. The following discussions, therefore, will apply to hot water and steam systems, and will be additional to the control at the heater and boiler as discussed under small plants. Fig. 124 shows a typical layout of such a system. Compressed air at 15 pounds per square inch gage is maintained in cylinder, S_1 , which is located in some convenient

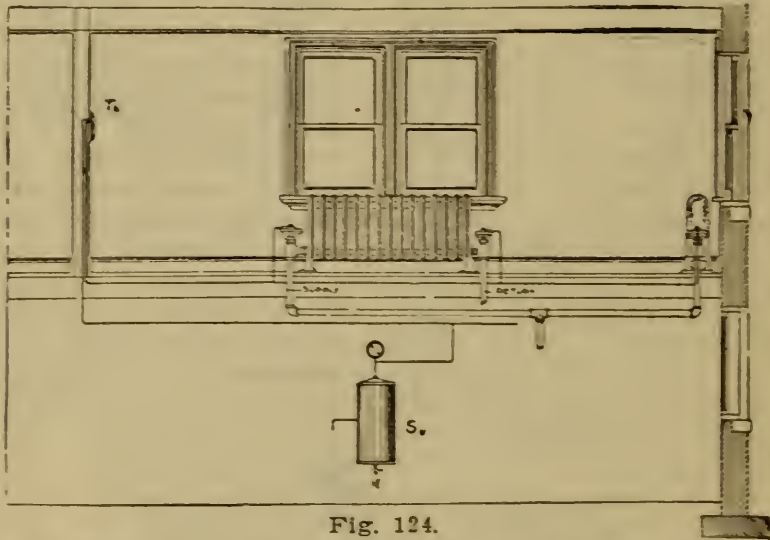

Fig. 124.

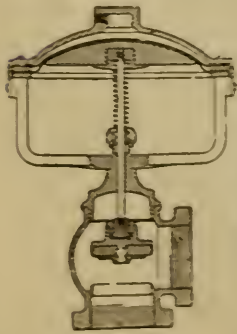

Fig. 125.

place for the attendant. This air is carried to the thermostat, T_1 , on one of the protected walls in the room. Here it passes through a controlling valve and is then led to the regulating valve on the radiator. This air acts on the top of a rubber diaphragm as shown in Fig. 125 to close the valve and to cut off the supply. When the room cools off, the controlling valve at T_1 cuts off the supply and opens the air line to the radiator. This removes the air pressure above the

diaphragm and permits the stem of the valve to lift. On the opening of the valve the steam or water again enters the radiator and the cycle is completed.

Fig. 96 shows the application of the thermostatic control to the blower work. This shows the thermostat *B* and the mixing dampers, located at the plenum chamber, in the single duct system. The same general arrangement could be applied to the double duct system, with the dampers in the wall at the base of the vertical duct leading to the room.

181. Some of the Important Points in the Installation:—

Each radiator has its own regulating valve. All rooms having three radiators or less are provided with one thermostat. Large rooms having four or more radiators have two or more thermostats with not more than three radiators to the thermostat. Where other motive power is not available for the air supply, a hydraulic compressor is used. This compressor automatically maintains the air pressure at 15 pounds gage in the steel supply tank. The main air trunk lines are galvanized iron, $\frac{3}{8}$ and $\frac{1}{2}$ inch in diameter, and are tested under a pressure of 25 pounds gage. All branch pipes are $\frac{1}{4}$ and $\frac{1}{8}$ inch galvanized iron. All fittings on the $\frac{1}{8}$ inch pipes are usually brass. Where flexible connections are made, this is sometimes done by armoured lead piping. Thermostats are usually provided with metallic covers, and are finished to correspond with the hardware of the respective rooms. Each thermostat is provided with a thermometer and a scale for making adjustments. Each radiator is provided with a union diaphragm valve having a specially prepared rubber diaphragm with felt protection. This valve replaces the ordinary radiator valve. One of these valves is used on the end of each hot water radiator, one on each one-pipe steam radiator and two on each two-pipe low pressure steam radiator. This last condition does not hold for two-pipe steam radiators with mechanical vacuum returns, in which case patented specialties are applied by the vacuum company. In such cases the supply to the radiator only is controlled. In any first class system of control, the temperature of the room may easily be kept within a maximum fluctuation of three degrees.

182. Some Special Designs of Apparatus:—All temperature control work is solicited by specialty companies, each having a patented system. In the essential features these

systems all agree with the foregoing general statements. The chief difference is in the principle upon which the thermostat, T_h , operates.

INTERMEDIATE

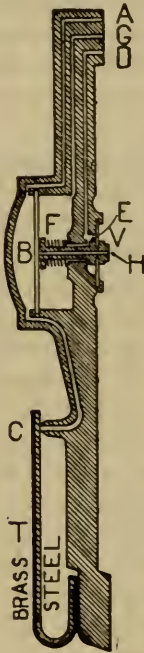

POSITIVE

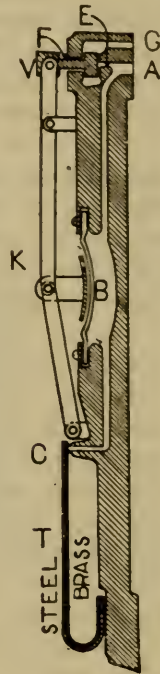

Fig. 126.

Fig. 126 shows sections through the intermediate and positive thermostats manufactured by the Johnson Service Company, Milwaukee. The interior workings of the thermostats are as follows: *Intermediate*.—Air enters at *A* from the supply tank, passes into chamber *B* and escapes at port *C*. If thermostatic strip *T* expands inward to close *C*, the air pressure collects in *B* and presses down port valve *V*, thus opening port *E*, letting air through into *F* and out at *G* to close the damper. When *T* expands outward, pressure at *B* is relieved and *V* is forced back by a spring, closing *E*. Air in *F* reacts against the diaphragm and escapes through hollow valve *V* at *H*, permitting the damper to open. *Positive*.—Air enters at *A*, passes into chamber *B* and escapes at *C*. If thermostatic strip *T* expands inward to close *C*, air pressure collects in *B*, forces out the knuckle joint *K* and

operates the three-way valve *V*, thus shutting port *E* and opening port *F*, letting air escape and radiator valve open. When *T* expands outward, pressure at *B* is relieved, knuckle joint *K* returns, pulling *V* outward, thus shutting port *F*, opening *E*, letting air escape through *G* and shutting off radiator valve.

The real thermostat is the spring *T*. This is composed of steel and brass strips brazed together. Because of a higher coefficient of expansion in the brass than in the steel, a change in the room temperature causes the spring to move toward or away from the seat *C*. *T* is adjustable for any desired room temperature. The intermediate thermostat is used on indirect heating where mixing dampers are employed and where an intermediate position of the valve is necessary. The positive thermostat is used on direct radiators and coils where a full open or full closed movement of the valve is desired.

Fig. 127 shows a section through the pattern *K* thermostat, manufactured by the Powers Regulator Co., Chicago. This thermostat consists of a frame carrying two corrugated disks, brazed together at the circumference and containing a volatile liquid having a boiling point at about 50 degrees F. At a temperature of about 70 degrees, the vapor within the disks has a pressure of about 6 pounds to the square inch. This pressure varies with every change of temperature and produces variations in the total thickness at the center of the disks.

The compressed air enters at *H* and passes into chamber *N* through the controlling valve *J*, which is normally held to its seat by a coil spring under cap *P*. Within the flange *M* is located an escape valve *L* upon which the point of the supply valve *J* rests. Valve *L* tends to remain open when permitted by reason of the spring underneath the cap. When the temperature rises sufficiently to cause the disks to increase in thickness and move the flange *M*, the first action is to seat the escape valve *L*, its spring being weaker than that above *J*. If the expansive motion is continued after valve *L* is seated, the valve *J* is then lifted from its seat and compressed air flows into the chamber *N*. As the air accumulates in chamber *N*, it exerts a pressure upon the elastic diaphragm *K* in opposition to the expansive force of the disk. So, whenever there is sufficient pressure in *N* to balance the power exerted by the disks, the valve *J* returns

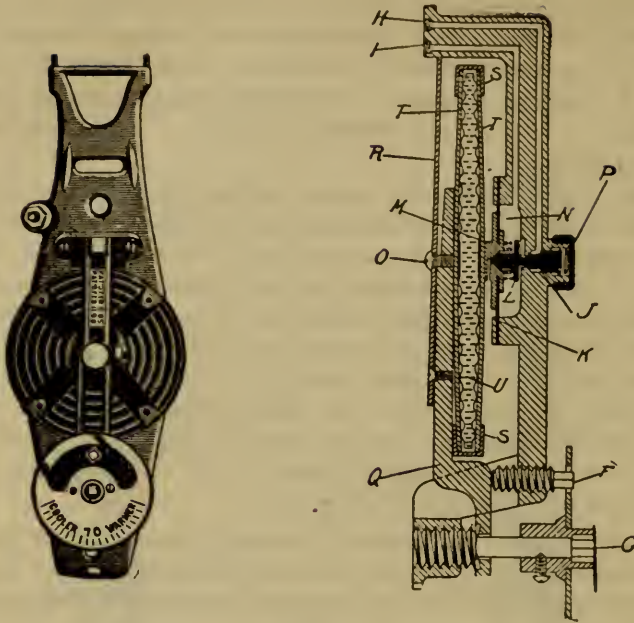

Fig. 127.

to its seat and no more air is permitted to pass through. If the temperature falls, the pressure within the disks becomes less, the disks draw together and the over-balancing air pressure in *N* reverses the movement of the flange *M* and permits the escape valve *L* under the influence of its spring to rise from its seat, whereupon a portion of the air in *N* is discharged until the pressure in *N* becomes equal to the diminished pressure from the disks. Thus the pressure of the air in *N* is maintained always in direct proportion to the expansive power (temperature) of the disks. Port *I* connects with chamber *N* and leads to the diaphragm valve.

This thermostatic valve controls the regulator valve by a graduated movement and is used on the dampers for blower work. Another form with maximum movement only is designed for steam systems.

Fig. 128 shows the positive and graduated thermostats as manufactured by the National Regulator Company, Chicago. The thermostatic element in these thermostats is the vulcanized rubber tube *A*, which changes its length with the varying room temperatures and causes the valve *O* to open or close the port *G*, thus controlling the supply of air to

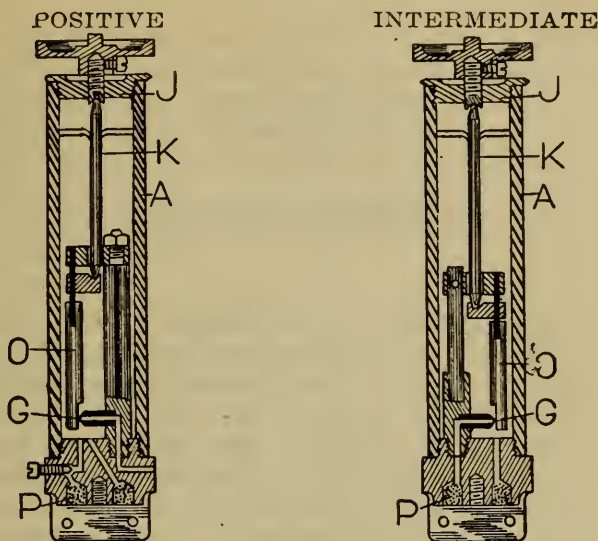

Fig. 128.

and from the radiator valve or the regulating damper. In the positive thermostat air enters the tube from the supply through the filter and restricted passage *P*. From the interior of the tube the air leaves through the middle orifice and enters the pipe leading to the radiator valve. If the room temperature is above the normal, port *G* closes and the air pressure collects in the tube, thus creating a pressure in the line leading to the radiator valve and closing it. If the room temperature falls below the normal, port *G* opens, air is exhausted from the tube to the atmosphere, the pressure on the radiator valve is released and the valve opens. The intermediate thermostat differs from the positive thermostat in having but one air line. Room temperatures below the normal contract tube *A*, open port *G*, and exhaust the air to the atmosphere. With this release in pressure in the pipe at *P* the regulating damper is turned to admit more warm air into the room. With the room temperature above the normal, tube *A* expands, port *G* closes, pressure in pipe *P* increases and the regulating damper is turned so as to admit a lower temperature of air in the room. By means of this a graduated movement of the damper is obtained.

REFERENCES.

References on Temperature Control.

Metal Worker. Temperature Control in House Heating, Jan. 7, 1911.

CHAPTER XV.

ELECTRICAL HEATING.

In the present state of the heating business it seems almost unnecessary to discuss electrical heating, in any serious way, in connection with steam power plants. The reasons will be seen in the following brief discussion. Electrical heating can appeal to the public only from the standpoint of convenience, since a comparison of economies between steam, hot water or warm air heating on one hand, and electrical heating on the other, is wholly against the latter. Its application to the processes of heating will find its greatest economy in connection with water power plants where the combustion of fuel is eliminated from the proposition. This discussion will not bear in any way upon the water power generator.

183. Equations Employed in Electrical Heating Design:—

1 H. P. = 746 watts.

1 H. P. = 33000 ft. lbs. per min. = 1980000 ft. lbs. per hr.

1 B. t. u. = 778 ft. lbs.

1 H. P. hr. = $1980000 \div 778 = 2545$ B. t. u. per hr.

1 H. P. hr. = 746 watt hrs. = 2545 B. t. u. per hr.

1 watt hr. = 3.412 B. t. u. per hr.

1 watt hr. = $3.412 \div 170 = .02$ sq. ft. of hot water rad.

1 watt hr. = $3.412 \div 255 = .0134$ sq. ft. of steam rad.

1 kilo-watt hr. = 20.1 sq. ft. of hot water rad. (105)

1 kilo-watt hr. = 13.4 sq. ft. of steam rad. (106)

184. Comparison between Electrical Heating and Hot Water and Steam Heating:—The loss in transmitting electricity from the generators through the switchboard to the radiators may be small or large, depending upon the conditions of wiring, the current transmitted and the pressure on the line. In all probability it would equal or exceed the transmission losses in hot water or steam lines. Assuming these losses to be the same, a fair comparison may be made in the cost of heating by the various methods. The operating efficiency of an electric heater is 100 per cent., since all

the current that is passed into the heater is dissipated in the form of heat and no other losses are experienced. This is not true of steam systems where the water of condensation is thrown away at fairly high temperatures. Where electricity or steam is generated and distributed all in the same building, there is no line loss to be accounted for, since all of this heat goes to heating the building and counts as additional radiation.

Equations 105 and 106 show the theoretical relation existing between electrical heating and hot water and steam heating compared at the power plant. The following discussion is based, therefore, upon the assumption that 1 kilo-watt hour, in an electric radiator, will give off the same amount of heat as 20.1 and 13.4 square feet of hot water and steam radiation respectively. With coal having 13000 B. t. u. per pound and a furnace efficiency of 60 per cent., it will require $3412 \div 7800 = .44$ pound of coal per hour. If coal costs \$2.00 per ton of 2000 pounds, there will be an actual fuel expense of .044 cent. On the other hand, assuming the combined mechanical efficiency of an engine or turbo-generator set to be 90 per cent., the heat from the steam that is turned into electrical energy per hour is $1000 \div .90 = 1111$ watts, for each kilo-watt delivered. Now if this unit has 15 per cent. thermal efficiency, we have the initial heat in the steam equivalent to $1111 \div .15 = 7400$ watt hours. From this obtain $7400 \times 3.412 = 25249$ B. t. u. per hour; or, $25249 \div 7800 = 3.2$ pounds of coal per hour. This, at the same rate as shown above, would be worth .32 cent. Comparing, the electrical generation actually costs 7.2 times as much as the other. This comparison has dealt with the fuel costs at the plant and has not taken into account the depreciation, labor costs, etc., the object being to show relative efficiencies only.

Another way of looking at this subject is as follows. A fairly large turbo-generator set (say 500 K. W.) will deliver 1 kilo-watt hour to the switchboard on 20 pounds of steam. With 10 per cent. additional steam for auxiliary units, this amounts to 22 pounds of steam per kilo-watt hour at the switchboard. One pound of steam generated in a plant of this kind with the above efficiencies and value of coal, also with a steam pressure of 150 pounds and a good feed water heater, will give to each pound of steam approximately 1000 B. t. u. This makes 22000 B. t. u. or 2.8 pounds

of coal required to each kilo-watt output. This is about 10 per cent. less than the above figures.

The ratio of 7 to 1, as shown in the above efficiencies, does not seem to hold good in the selling price to the consumer. In round numbers, district steam and hot water heating systems supply 25000 B. t. u. to the consumer for one cent. The cost for electrical energy to the consumer is between 6 and 7 cents per kilo-watt. This gives $3412 \div 6.5 = 525$ B. t. u. for one cent. Comparing with the above, gives a ratio of 48 to 1.

185. The Probable Future of Electrical Heating:—Because of the low efficiency of electrical heating as compared to other methods of heating, it is very probable that it will not replace the other methods except in so far as the conveniences of the user is the principal thing sought for, and the expense of operating a minor consideration. In some forms of domestic service, however, electrical heating is sure to find considerable usefulness. The temperatures of low pressure steam and hot water, together with the inconvenience of use, are such as to eliminate them from many of the household economies. They will probably continue to be used for house heating, water heating and laundry work. For occupations that require temperatures above 250 degrees, such as broiling, frying, ironing, etc., the electrical supply will be in demand.

Heating by electricity on a large scale is being planned in Stavanger, Norway. 25000 horse-power can be developed by water power. This will be turned into electrical energy and sold at \$7.00 per horse-power year.

REFERENCES.

References on Electrical Heating.

TECHNICAL PERIODICALS.

The Heating and Ventilating Magazine. Electrical Heating and Steam Heating, Feb. 1907, p. 28. Electric Heating, W. S. Hadaway, Jr., Nov. 1908, p. 28; Dec. 1908, p. 26. *The Electrical World*, Vol. 52, pages 450, 903, 1112 and 1358, and Vol. 53, pages 5, 274 and 921. *The Metal Worker.* Electrical Heating at Biltmore, N. C., March 7, 1908, p. 37. Electric Heating with Fan Blast in Paris, Aug. 29, 1908, p. 55. Cooling and Electric Heating on Ship Board, Sept. 15, 1906; Sept. 22, 1906; Oct. 6, 1906; Nov. 21, 1908. Unit Cost Limit of Electric Heating, Dec. 26, 1908, p. 43. Cost of Electric and Gas Cooking, Aug. 29, 1909, p. 50. Electric Heating and Steam Train in France, Nov. 27, 1909, p. 37. *Railway Age Gazette.* New Electric Boiler, June 20, 1910, p. 1680. *Cassier's Magazine.* Electric Heaters, H. M. Phillips, Dec. 1909.

CHAPTER XVI.

REFRIGERATION.

DESCRIPTION OF SYSTEMS AND APPARATUS.

186. General Divisions of the Subject:—The rapidly increasing demand for the cold storage of food products, the production of artificial ice and the cooling of buildings have developed for the heating engineer a broad and inviting field, namely, refrigeration. A municipal electric or pumping station with a district heating plant to utilize the exhaust steam in winter and a refrigeration plant to utilize the same in summer furnishes a unique opportunity for economic engineering. One application of the above principle where a 10-ton ice plant of the absorption type was so operated in a town of 3500 population and earned a dividend of 13 per cent. on the investment, is proof, if any is needed, that the field is an intensely practical one.

As in heating systems there must be sources of heat, circulating mediums, distributing systems and delivering systems whereby the carriers give up their heat at the proper places in the circuits, so in refrigerating systems there must be sources of minus heat or of heat abstraction, circulating mediums, distributing systems and receiving systems whereby the carriers take up heat at the proper places in the circuits from articles or rooms that are being cooled. The carriers (circulating mediums), and the receiving and transmitting of the heat to and from them present no special difficulties or great diversity of practice, but in the methods of producing and maintaining the sources of minus heat there are considerable differences and numerous methods.

187. Refrigerating Systems may be divided into two groups, those producing cold by more or less chemical action between ingredients upon mixing, called *chemical systems*, and those producing cold by the evaporation of a liquified gas or the expansion of a compressed gas, called *mechanical systems*. Chemical systems are used only occasionally in commercial work, but are frequently found in small sized plants for domestic purposes. Low first cost and convenience of handling are the principal advantages. This division includes the simple melting of ice and the mixing of ice and

salt for temperatures as low as 0 to -5 degrees. The latter is much used in domestic processes for the production of table ices, etc. Other ingredients used in the mixtures with the corresponding temperature drops which may be expected are given in Table 53, Appendix. The chemical method of producing cold is occasionally used to maintain low temperatures in storage rooms while repairs are being made upon the regular machinery. The chemical methods of cooling are so simple in principle that they will not be discussed further in this work. Mechanical systems include all the practical methods of commercial refrigeration. These are, the *vacuum system*, the *cold air system*, the *compression system* and the *absorption system*.

188. Vacuum System:—This system was formerly of some importance but of late years has given place to other and more efficient methods. Fig. 129 shows a vacuum system in diagram.

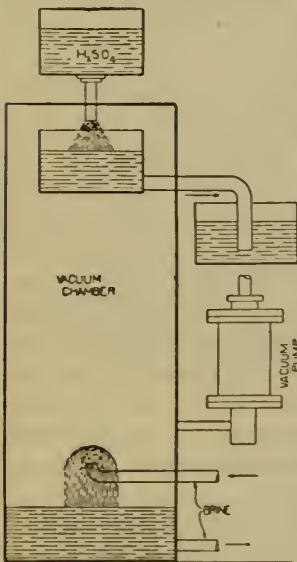

Fig. 129.

If a spray of water or brine is injected into a chamber that contains pans of sulphuric acid and is kept at a partial vacuum of one or two ounces, the acid absorbs the water vapor from the spray, thus assisting in maintaining the vacuum and lowering the temperature of the remainder of the spray. The vaporization of the part that is absorbed by the acid requires heat. This heat is taken from the liquid of the spray that is not absorbed, consequently the temperature of the remaining liquid is lowered. In a system of this kind a temperature of 32 degrees may easily be obtained. The water or brine after cooling is then circulated through the coils of the cold storage room

where it takes up the heat of the rooms and contents and returns to the vacuum chamber to be again partially evaporated and cooled.

189. Cold Air System:—The cold air system is used principally on ship board. Fig. 130 shows diagrammatically the parts and the operation of the system. The cycle has four

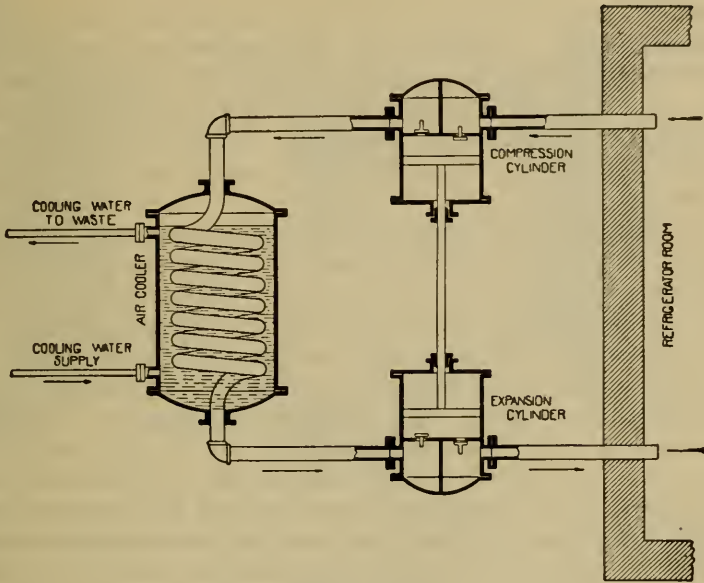

Fig. 130.

parts, *compression* in one of the cylinders of the compressor, *cooling* in the air cooler by giving off heat to the cold water thus removing the heat of compression, *expansion* in the second cylinder of the compressor thus cooling the air, and *refrigeration* in the cold storage room where the heat lost during expansion is regained from the articles in cold-storage. Cold air machines work at low efficiencies because of the necessarily large cylinders and their attendant losses due to clearance, heating of the compression cylinder, snow in the expansion cylinder and friction. The system has much to recommend it, however, since it is extremely simple, occupies a very small space compared with other systems and uses no costly gases, chemicals or supplies.

190. The Compression and the Absorption Systems have in common this fact—both use a *refrigerant*, i. e., a liquid having a comparatively low boiling point. Perhaps the most common refrigerant is anhydrous ammonia, which boils, at atmospheric pressure, at 28.5 degrees below zero and in doing so absorbs as latent heat 573 B. t. u. Table 54, Appendix, gives further properties. Other refrigerants used to a lesser extent are sulphur dioxide, SO_2 , which boils at -14 degrees under atmospheric pressure with a latent heat

of 162 B. t. u. and carbon dioxide, CO_2 , which boils at -30 degrees under a pressure of 182 pounds per square inch absolute with a latent heat of 140 B. t. u. A comparison of the temperatures and pressures of four common refrigerants is given in Table 59, Appendix. Pictet's fluid is a mixture of 97 per cent. sulphur dioxide and 3 per cent. carbon dioxide.

A choice of a universal refrigerant can scarcely be made because of the varying conditions of individual plants. The principal difficulty with the use of sulphur dioxide is the fact that any water uniting with it by leakage immediately produces sulphurous acid with its corroding action upon all the iron surfaces of the system. This same objection holds also for Pictet's fluid. The objections to the use of carbon dioxide are, first, its comparatively low latent heat, and second, the high pressure to which all parts of the apparatus and piping are subjected. Pressures of from 300 to 900 pounds per square inch are very common. Perhaps the worst charge that can be made against ammonia as a refrigerant is that it is highly poisonous and corrodes metals, particularly copper and copper alloys. However, the high latent heat of ammonia, together with the fact that its pressure range is neither so high as with carbon dioxide, nor so low as with sulphur dioxide, are perhaps the chief reasons for the very general preference for ammonia as the commercial refrigerant in compression systems; while its great affinity for and solubility in water, are what make the absorption system a possibility.

191. Compression System:—Compression machines may work well with the use of any one of the four refrigerants of Table 59, if the proper pressures and temperatures are observed and maintained. The common refrigerant for this type is, however, anhydrous ammonia, for reasons given above. Fig. 131 shows a diagrammatic sketch of the compression system. To follow the closed cycle of the ammonia, start with a charge being compressed in the cylinder of the compressor. From this it is conveyed by pipe to the condenser which, being cooled by water, abstracts the latent heat of the refrigerant and condenses it to a liquid. From the condenser the liquid refrigerant is conveyed to the expansion valve through which it expands into the evaporator or brine cooler. In changing from a liquid to a gas in the evaporator it absorbs from the brine an amount of heat

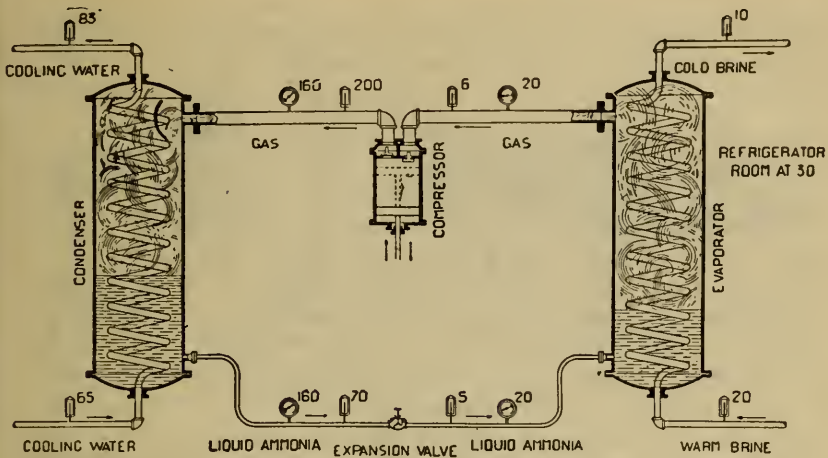

Fig. 131.

equivalent to the heat of vaporization of the ammonia. Upon leaving the evaporator the refrigerant is again ready for the cylinder of the compressor, thus completing the cycle.

If the refrigerant is ammonia, the compressor is commonly of the vertical type, direct connected to a horizontal Corliss engine as shown in Fig. 132. This type of com-

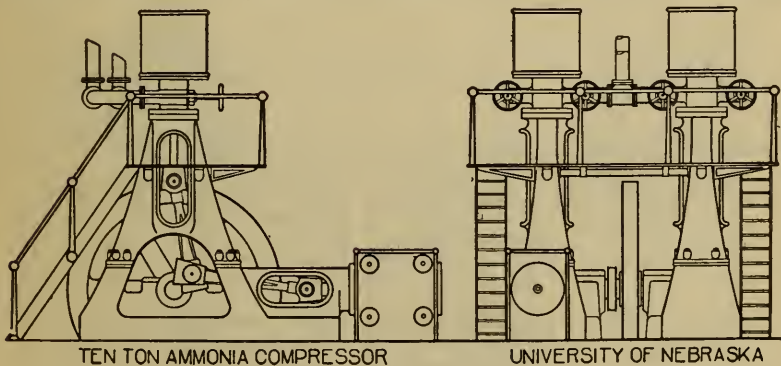

Fig. 132.

pressor combines the high efficiency of the Corliss engine with the vertical type of compressor which is probably the best type for reliable service of valves and pistons. The vertical compressor is usually single acting with water jacketed cylinders. Horizontal compressors are usually double acting, as shown in Fig. 133, where the prime mover

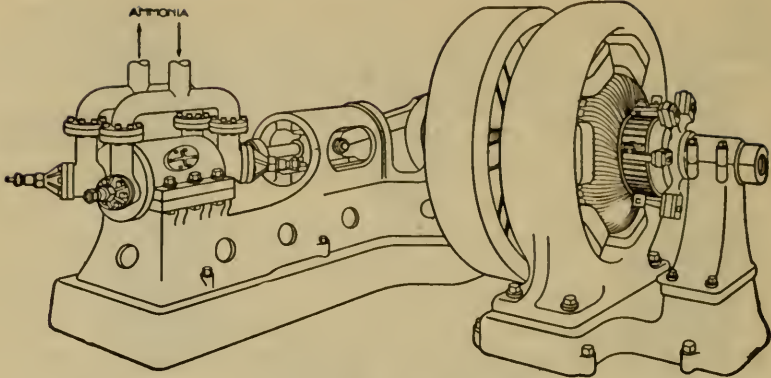

Fig. 133.

is a direct connected electric motor. Poppet valves in this type are placed at an angle of 30 degrees to 45 degrees with the center line of the cylinder, a construction made necessary by space restrictions on the cylinder heads. Compressors for other refrigerants are commonly of these same types, the main difference being that compressors for carbon dioxide systems are nearly always two-stage to produce high compressions. The intermediate cooler pressures range from 300 to 600 pounds per square inch. Horizontal steam

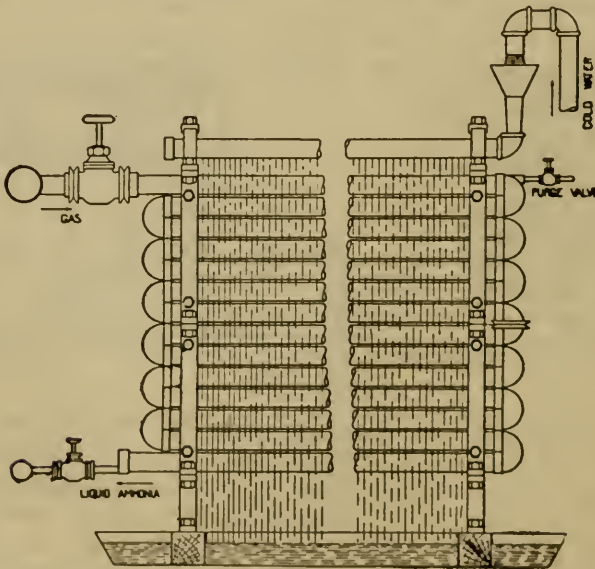

Fig. 134.

cylinders in tandem with the compressor cylinders are common for the carbon dioxide systems and the compressor cylinders are usually single acting.

192. Condensers for Compression Systems are classified under four heads, atmospheric condensers, concentric tube condensers, enclosed condensers and submerged condensers. An elevation of an *atmospheric condenser* is shown in Fig. 134. As illustrated it consists of vertical rows of pipes so connected by return bends as to make the hot refrigerant pass through each pipe beginning at the top, while the cold water main at the top of the row furnishes a spray of water which trickles over the outside of the pipes. The gas on the inside of the pipes is thus cooled by the extraction of the quantity of heat that is used in raising the temperature of the water and evaporating a part of it. The complete condenser may consist of any required number of these vertical rows, placed side by side, each row properly connected to the hot gas header and to the liquid header.

An elevation of one section of a *concentric tube condenser* is shown in Fig. 135. The arrows show the paths of the gas and water. As in the atmospheric type the gas enters at the top and the liquid is drawn off below. In its descent it

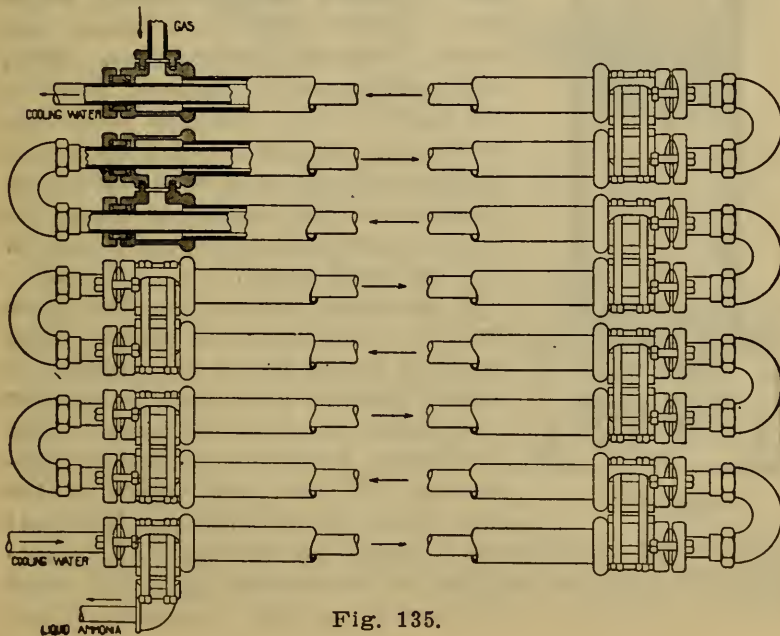

Fig. 135.

passes through the annular space between the two concentric pipes and is cooled by the atmosphere on the outside of the larger pipes and by the water circulating through the inner pipes. This condenser has the advantage over the simple atmospheric condenser in that the water may be made to have an upward course through the apparatus, thus bringing the coldest water in contact with the pipes carrying the liquid rather than with the pipes carrying the hot gas. Since the efficiency of the plant as a whole is very largely dependent upon the temperature of the liquid at the expansion valve this matter of the "counter flow" of the cooling water is an important one. For the medium sized and large compression systems this form of condenser is used almost without exception.

The enclosed condenser, Fig. 136, is very similar to the surface

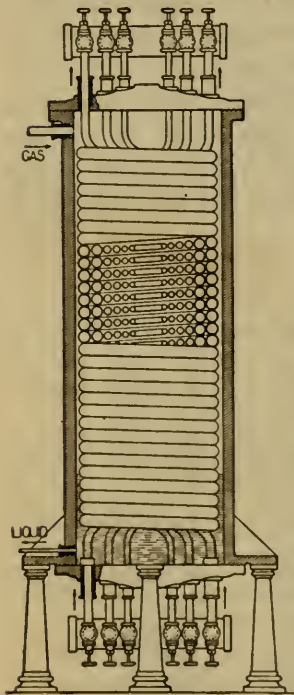

Fig. 136.

coil condenser in steam engine plants. It consists of a cylindrical chamber with a number of concentric pipe spirals connecting a hot water header at the top with a cold water header at the bottom of the cylinder. The pipes of the spirals are provided with stuffing boxes where they pierce the upper and lower heads of the cylinder. With this condenser a counter flow of the water is used, the cold water entering the bottom of the coils and flowing upward, so that the liquid refrigerant at the bottom of the cylinder is very near the temperature of the incoming water.

A *submerged condenser*, as the name implies, contemplates a rather large body of water below the surface of which there is submerged a coil for circulating the hot refrigerant. Fig. 137 shows a section of such a condenser. The hot gas enters at the top fitting of the coil and leaves at lower fitting. Cold water is constantly flowing in at the bottom of the tank and leaving by the overflow at the top, being heated as it rises. The form of the coil is usually spiral.

although this condenser may be built with coils of the return bend type when larger surface is required. Only the smaller compression plants use the enclosed or the submerged type of condenser.

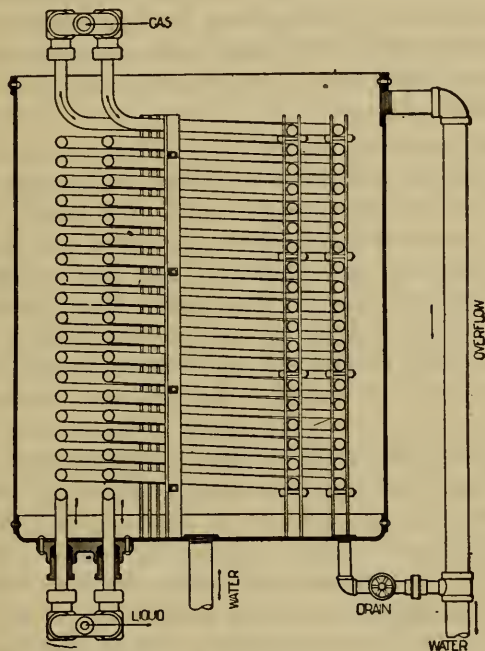

Fig. 137.

In general, condensers may be considered vital factors in the economy of compression plants. They must be reliable in service and economical in operation, and must be so designed and proportioned that they will deliver liquid refrigerant within five degrees of the temperature of the incoming cooling water. A condenser should present all joints, particularly those holding the refrigerant, to plain view for easy inspection and repair. Since it is the function of the condenser to dissipate the heat of the refrigerant gas, it is not uncommon to install it upon the roof or outside the building in some cool place. This is especially true where the atmospheric or the concentric tube* types are used. In such positions the heat radiated by the condenser is not given back to the rooms and piping systems. In addition, the cooling action of the atmosphere assists in making the system more efficient.

103. Evaporators for compression systems may be considered as condensers, reversed in action but very similar in form. If the refrigerating effect is accomplished by the brine cooling system an evaporator of some type will be necessary, but if the refrigeration is accomplished by circulating the expanding refrigerant itself, no evaporator is required. Evaporators, or brine coolers, may be classified according to the method of construction, as shell coolers and concentric tube coolers.

The *shell cooler* takes various forms. One is shown by Fig. 136, being in effect an enclosed condenser with brine instead of cold water circulating in the coils. The heat of the brine is transferred to the cool liquid refrigerant, causing the refrigerant to evaporate and take from the brine an amount of heat equal to the latent heat of the refrigerant. The proper height to which the liquid refrigerant should be allowed to rise in the evaporator is a very much disputed point, some old and experienced operators claiming greatest efficiency when about one-third of the cooling surface is covered with liquid refrigerant leaving two-thirds to be covered with gaseous refrigerant. Others claim that the entire surface should be covered or "flooded" with liquid refrigerant. These points of view give rise to the two terms *dry systems* and *flooded systems*. Of late years the flooded systems are gaining somewhat in favor, a separator being installed between the evaporator and the compressor to prevent any liquid being drawn into the compressor cylinder. This separator drains any liquid which

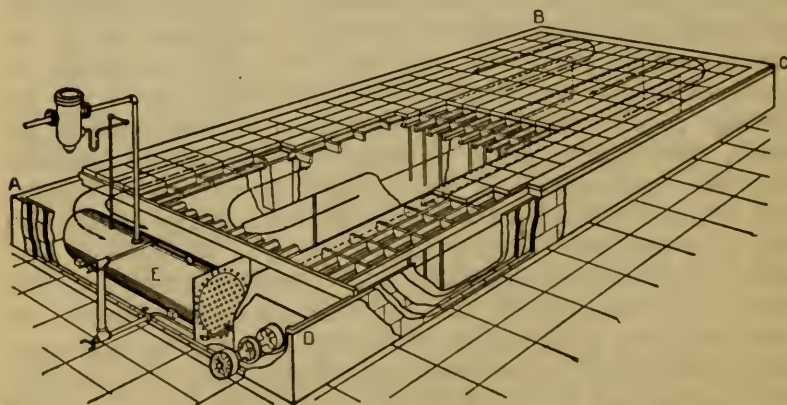

Fig. 138.

may collect therein, back into the evaporator. In the flooded system the brine cooler more commonly takes the form shown in Fig. 138, where at the end *A D* of the brine tank *ABCD* is shown the flooded cooler *E*. This cooler consists of a boiler shell filled with tubes, the brine circulating through the inside of the tubes while the interior of the large shell is nearly or quite filled with liquid refrigerant.

Concentric tube brine coolers are made of piping very similar in principle to that shown in Fig. 135, with the exception that instead of two concentric pipes, three are more commonly employed. The brine circulates through the innermost of the three and through the outermost, while the annular space between the smallest pipe and the middle pipe is traversed by the liquid refrigerant. In this way the annular space filled with refrigerant has brine on both sides and the cooling of the brine is very rapid. The numerous joints in this cooler present a constant source of trouble. Salt brine will usually freeze in the inner pipe, so that calcium chloride brine must be used.

A choice of evaporators or coolers depends mainly upon whether the plant is to run continuously or intermittently. When run continuously only a small amount of brine is required and this, when cooled quickly and circulated quickly, would call for a concentric tube cooler. When run intermittently a much larger body of brine is desirable so as to remain cool longer during the night hours when the plant is not operating. For this condition a shell type cooler would probably be preferred.

In addition to the condensers and evaporators that were described in detail, there are to be found on the well equipped compression system the following pieces of apparatus which will be mentioned and described only briefly. An *oil separator* is commonly found in the line connecting the condenser with the compressor. This is simply a large cast iron cylinder with baffle plates to separate the oil from the ammonia. Since the oil is heavier than the ammonia it settles to the bottom and may be drawn off. An *ammonia scale strainer* is often found just before the compressor intake. Small *purge valves* are located at all high points in the system for the purpose of exhausting the foul gases or the air which may collect in the system. Such a purge connection is shown on the right end of the upper coil in Fig. 134.

194. Pipes, Valves and Fittings for compressor refrigerant piping are considerably different from the standard types, If the refrigerant is ammonia, no brass enters into the design of any part of the piping or auxiliaries traversed by the ammonia. The operating principles of all valves are the same as standard ones but they are made heavier and entirely of iron, or iron and aluminum. The common threaded joint used on all standard fittings is replaced in ammonia systems by the bolted and packed joint. It is not within the scope of this work to go into these details further than to

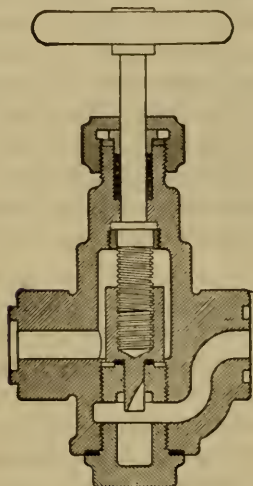

Fig. 139.

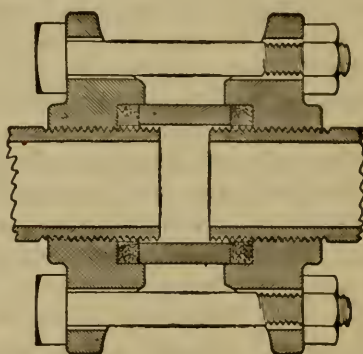

Fig. 140.

give a section of an ammonia expansion valve, Fig. 139, and a section of a typical ammonia joint, Fig. 140.

195. Absorption System:—As stated in Art. 190, the great affinity of ammonia gas for water and its solubility therein, are what make the absorption system a possibility and give it the name as well. At atmospheric pressure and 50 degrees temperature one volume of water will absorb about 900 volumes of ammonia gas. At atmospheric pressure and 100 degrees temperature one volume of water will absorb only about one-half as much gas, or 450 volumes. If then, one volume of water is saturated at 50 degrees with ammonia gas and heated to 100 degrees there will be liberated about 450 volumes of ammonia gas. Hence it is evident that a stream of water may be used as a conveyor of ammonia gas from one place or condition to another, say from a condition of low temperature and pressure where the absorbing stream of water would be cool, to

a condition of high temperature and pressure, where the gas would be liberated by simply heating the water. It will be noticed that the gas has been transferred as a liquid without a compressor or any compressive action, by pumping a stream of water of approximately one-four hundred and fiftieth of the volume of the gas transferred. This, in the abstract, is the method employed in the absorption system to convey the ammonia gas from the relatively low temperature and pressure of the evaporator to the high temperature and pressure at the entrance of the condenser.

The absorption system, when closely compared in principles of operation to the compression system, differs only in one respect, namely, the absorption system replaces the gas compressor by the strong and weak liquor cycle. As

shown in Fig. 141, both systems have arrangements of condenser, expansion valve and evaporator that are identical, hence the part of the cycle through these need not be considered. The problem of completing the cycle from evaporator to condenser, however, is solved quite differently in the two systems. In the compression system (upper diagram) the evaporator delivers the expanded

gas to the compressor, from which, under high pressure and temperature, it is delivered to the condenser and the cycle is completed. In the absorption system (lower diagram) the evaporator delivers the expanded gas to an absorber, in which the gas comes in contact with a spray of so-called *weak liquor*,

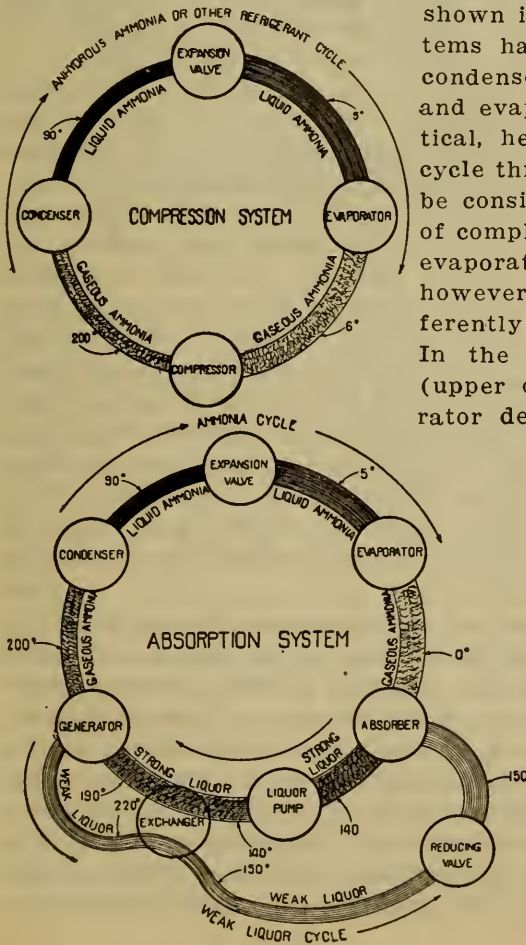

Fig. 141.

consisting of water containing about 15 to 20 per cent. of anhydrous ammonia. The weak liquor absorbs the ammonia gas through which the liquor is sprayed and collects in the upper part of the absorber as *strong liquor*, containing about twice as much anhydrous ammonia as the weak liquor, or 30 to 35 per cent. From here it is pumped through the exchanger (which will be ignored for the present) into the generator at a pressure of about 170 pounds per square inch gage. In the generator heat is supplied by steam coils immersed in the strong liquor. As this liquor is heated it gives up about half of the contained ammonia gas which rises and passes from the generator to the condenser, thus completing the ammonia or primary cycle, while the weak liquor flows from the bottom of the generator through the exchanger and pressure reducing valve back to the absorber, thus completing the secondary or liquor cycle.

In general then, the absorption system uses two cycles, that of the ammonia and that of the liquor, the paths of the two cycles being coincident from the absorber to the generator. The liquor pump serves to keep both cycles in motion. The pump creates the pressure for both cycles and the expansion valve and the reducing valve reduce the pressure respectively for the ammonia cycle and the liquor cycle. The *exchanger* does not mix or alter the condition of the two streams of liquor passing through it, for its only function is to bring these two streams close enough that the heat of the *weak liquor from the generator* may be transferred to the *strong liquor going to the generator*. Stated in other words, the exchanger heats the strong liquor by cooling the weak liquor, thus effecting a saving of heat which would otherwise be lost, since the weak liquor must be cooled before it is ready to properly absorb the gas in the absorber.

196. An Elevation of an Absorption System with the elements piped according to what is considered best practice is shown in Fig. 142. Starting at the expansion valve, the ammonia (liquid, gas or gas in solution) passes in order through these pieces of apparatus: the evaporator, the absorber, the liquor pump, the chamber of the exchanger or the coil of the rectifier, the generator, the chamber of the rectifier and the condenser back to the expansion valve. At the same time the liquor used to absorb the gas travels in order through these pieces: the absorber, the liquor pump, the

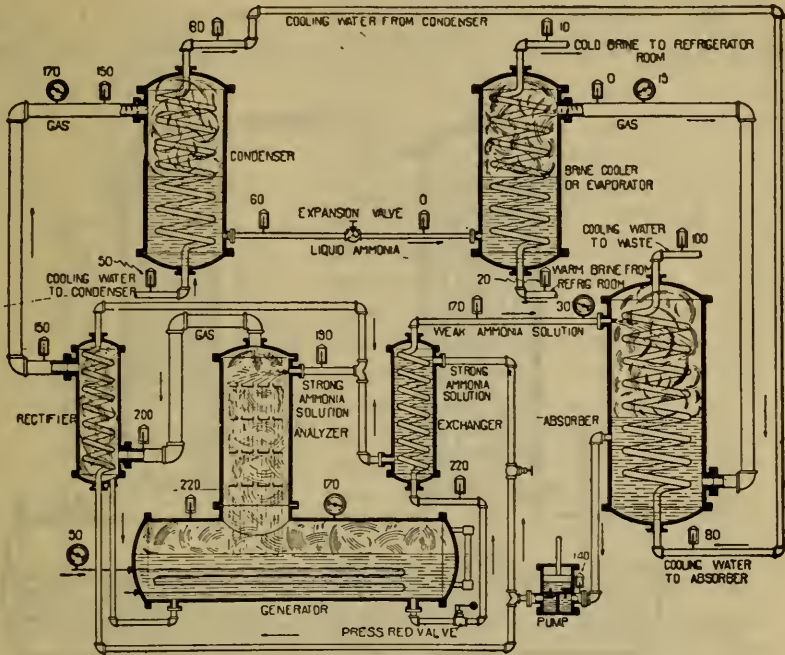

Fig. 142.

chamber of the exchanger or the coil of the rectifier, the generator, the pressure reducing valve and the coil of the exchanger back to the absorber. The method of pipe connections shown is a very common one although some variation may be found, especially in the continued use of cooling water in consecutive pieces of apparatus. As shown, the cooling water is first used in the condenser. This will be found so in all plants. From the condenser the cooling water may next be taken to the absorber, as shown in the sketch, or it may be used in the rectifier coil instead of the strong liquor. In recent years the practice of by-passing a certain amount of the cool, strong liquor from the pump through the rectifier is gaining in favor. Fig. 142 shows a plant having bent coil construction. Plants are also built having straight pipe construction, where all coil surfaces shown are replaced by straight pipes, the condenser being usually of the concentric tube atmospheric type and the evaporator being also of the concentric tube brine cooler type, as mentioned under compression systems. Both types of absorption plants are found in use.

197. **Generators** are classified as horizontal and vertical. Fig. 143 shows a horizontal type generator, with the

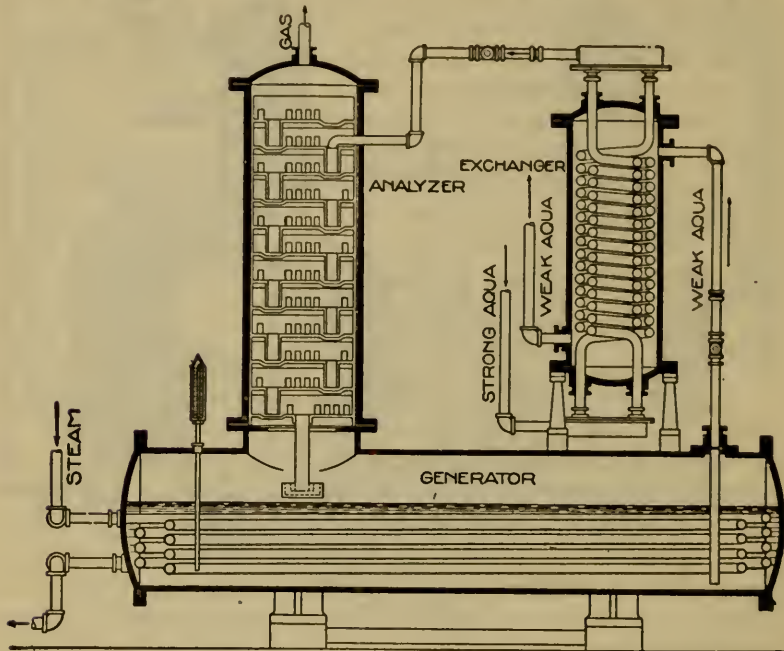

Fig. 143.

analyzer and exchanger, and Fig. 144 shows the vertical type, also with the analyzer. The horizontal type may have one or more horizontal cylinders equipped with steam coils. The analyzer, which may be considered as an enlarged dome of the generator, is used to condense the water vapor which rises from the surface of the liquid in the generator. To do this the analyzer has a series of horizontal baffle plates through which the incoming cool, strong liquor trickles downward while the heated mixture of ammonia gas and water vapor passes upward through interstices. In this way the strong liquor gradually cools the ascending water vapor and condenses much of it on the surfaces of the baffle plates.

198. **Rectifiers** are arrangements of cooling surface designed to thoroughly dry the gas just before it passes into the condenser. This is accomplished by presenting to the hot product of the generator just enough cooling surface to condense the water vapor without condensing any of

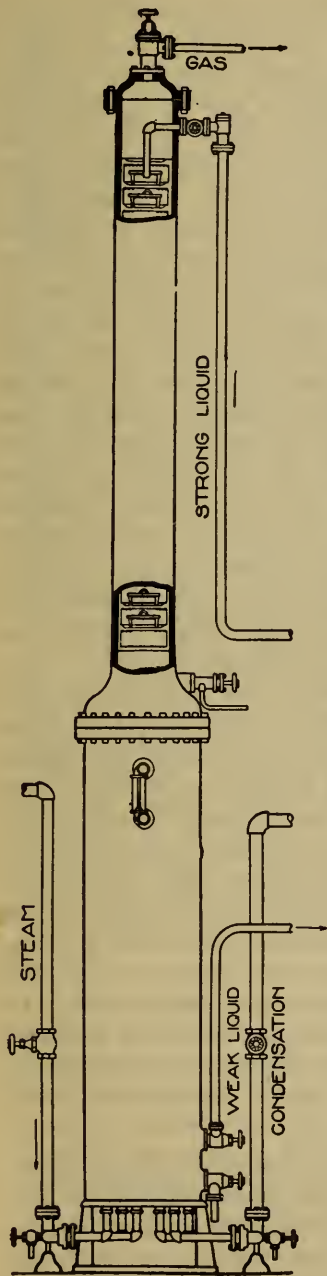

Fig. 144.

the ammonia gas. Rectifiers are very similar in general design to the various types of condensers, there being atmospheric, concentric tube, enclosed and submerged rectifiers just as there are these same type of condensers, each described under the head of condensers for compression systems. Rectifiers may save heat by the arrangement shown in Fig. 142, where the heat abstracted from the water vapor is given to the cool, strong liquor before entering the generator. As shown, the strong liquor may be divided, part passing through the rectifier and part through the exchanger, or the strong liquor may all go through the exchanger first and then through the rectifier. Where strong liquor is so used, the rectifier is always of the enclosed type. Rectifiers using water as the cooling medium are often called dehydrators, the term rectifier being more properly used when the cooling medium is the strong liquor.

199. Condensers for absorption systems do not differ in design from those used for compression systems. The same types are used, and in the same manner, the surface being somewhat less due to the precooling effect of the rectifiers or dehydrators. As a general statement, it is claimed that from 20 to 25 per cent less surface is required in the condenser for an absorption machine than is required in one for a compression machine.

200. Absorbers may be classified as dry absorbers, wet absorbers, atmospheric absorbers, concentric tube absorbers and horizontal tubular absorbers. In the *dry absorber*, the top section of which is shown in Fig. 145,

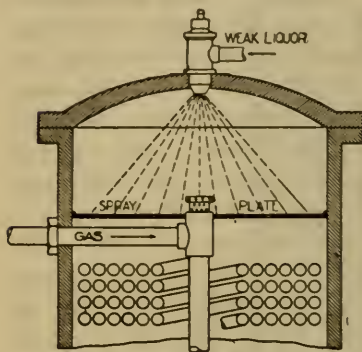

Fig. 145.

the weak liquor enters at the middle of the top header and is sprayed upon a spray pan, from which it drips downward over the coils. The gas enters as shown, part being delivered above the spray plate, so as to come into contact with the spray and the larger part being taken downward through the central pipe to a point near the bottom of the absorber, from which point it flows upward against the descending weak liquor by which it is absorbed. As the gas is dissolved by the weak liquor the heat of absorption is given off, and taken up by the cooling water in the coils. The result is a strong liquor which collects in the absorber ready to be delivered to the pump.

The *wet absorber*, on the contrary, has practically the whole body filled with weak liquor and the ammonia gas enters near the bottom, bubbling up through the weak liquor thus saturating it. Various baffle plates with fine perforations break up the gas into small bubbles thus aiding in presenting a large surface of gas to the liquor which, as it becomes saturated and lighter, rises to the top of the body of the absorber and is ready to be drawn off by the pump. Instead of spiral cooling coils, this type is often made with straight cooling tubes inserted between two tube sheets, boiler fashion. This straight tube construction is much simpler and cheaper, and much more easily cleaned than the spiral type. It is favored by some on this account, especially where the cooling water has a tendency to form scale.

Atmospheric absorbers resemble atmospheric condensers of the single tube type. The ammonia gas and weak liquor enter the bottom through a fitting commonly called a *mixer*, and the two flow upward through the inside of the pipe while the cooling water is in contact with the outside thus taking up the heat of absorption generated within the pipes.

Concentric tube absorbers are very similar in design to concentric tube condensers, the cooling water passing through the central tube and the weak liquor and expanded gas entering at the bottom of the annular space and circulating to the top, absorption taking place on the way. Because of the small capacity of the last two mentioned absorbers, it is necessary to use with them an aqua ammonia receiver between the absorber and the ammonia pump, to act as a reservoir for storing a reserve supply of the strong liquor.

Horizontal and vertical tubular absorbers are those in which the cooling surface is composed of straight, horizontal or vertical tubes inserted between tube sheets, the cooling water flowing inside the tubes and the absorption taking place within the drum or body of the absorber.

201. Exchangers may be of two types, the shell type or the concentric tube type. The *shell* type, as the name implies, is composed of a main body or shell through which circulates the strong liquor to be heated and within this shell is a coil or other arrangement of heating pipes through which the hot, weak liquor flows. Fig. 142 shows the elementary arrangement of such an exchanger. Concentric tube exchangers are used on large plants. They are similar in every way to the concentric tube condensers shown in Fig. 135, with the exception that larger pipes are needed for the exchangers. The cold, strong liquor is usually carried through the pipes and the hot, weak liquor through the annular space. The great advantage of this type of exchanger is the same as that of the concentric tube condenser, namely, the counter flow of the two streams. With this arrangement the total transfer of heat is a maximum, for which reason this type of exchanger is generally preferred.

202. Coolers for the weak liquor are often found in plants. This piece of apparatus is not indicated in Fig. 142. It is usually installed as the lower three coils of the atmospheric condenser, and hence is simply a small condenser used to further cool the weak liquor just before its entrance into the absorber. With a counter flow, concentric tube exchanger a weak liquor cooler is seldom found necessary.

203. The Pump used in absorption systems to raise the pressure of the strong aqua ammonia may be steam driven, electric driven or belt driven, as best suits the particular plant conditions. The power required by this piece of appa

ratus is about one horse power per 20 to 25 tons of refrigeration capacity.

204. Compression Systems and Absorption Systems Compared:—A comparison drawn between the compression system and the absorption system brings out the following facts. The compression system depends fundamentally upon the transferring of heat energy into mechanical energy and vice versa, with the attendant heavy losses. The absorption system merely transfers heat from one liquid to another. This is a process which is attended by only moderate losses. The compression system is comparatively simple, its processes readily understood and its machinery easily kept in good running order. The absorption system is complicated with a greater number of parts, its processes are often not thoroughly understood by those in charge and its machinery is likely to become inefficient because heat transferring surfaces are allowed to become dirty. For these reasons the attendance necessary upon an absorption plant must be of a higher order than that necessary for a compression plant.

205. Circulating Systems:—The refrigerating effect produced by either one of the two systems may be delivered to the place of application in two ways. The first is the *brine circulation method* wherein a brine cooler is used through which the brine flows causing the evaporation of the liquid refrigerant and the cooling of the brine. This cold brine is then circulated through pipes to the place where refrigeration is desired. Fig. 138 shows an evaporator placed in one end of a large brine tank. The refrigerating effect is carried to the cans of water by the circulation of this body of brine through the evaporator and out past the cans, the circulation through the channels shown being maintained by the pump. Brine, commonly used for such work, is made by dissolving calcium chloride in water. A 20 per cent. solution is generally used. Salt brine is used to some extent but it has many disadvantages compared with calcium brine. The second method is the *direct circulation method* wherein the liquid refrigerant is conveyed to the place to be cooled, is passed through an expansion valve and then circulated through coils in the space to be refrigerated, changing into gaseous form as fast as it can absorb enough heat. If ammonia is the refrigerant the direct circulation is not often favored because of its highly penetrative nature and odor, even a leak so small as to escape detection being sufficient

to fill the refrigerated space with the odor, which many food stuffs will absorb.

206. There are Three Methods Employed for Maintaining Low Temperatures in storage and other rooms. The first is by *direct radiation* where the pipes are placed within the room and the refrigerant is circulated through them. This is the oldest, simplest and cheapest system to install. In this the proper location and arrangement of the pipes are essential to the most efficient operation. Since the temperature to be maintained in a storage room depends upon the products to be kept in the room, it may be necessary to have a considerable range of temperature. It is desirable to have the pipes arranged as coils in two or three sets, each being valved so that the amount of refrigerant being circulated may be increased or decreased as the temperature of the stored product may require.

The pipes should be set out from the wall several inches to give free air circulation and keep the frost that collects on them from coming into contact with the wall. The coils should be so placed that the temperature of all parts of the room may be kept as nearly uniform as possible. Some products keep as well in still air as when it is in motion, but others, such as fruits, eggs, cheese, etc. are better preserved when the air is circulated. Circulation may be effected in a room piped for direct radiation by putting aprons over the coils as shown in Fig. 146. These aprons consist of

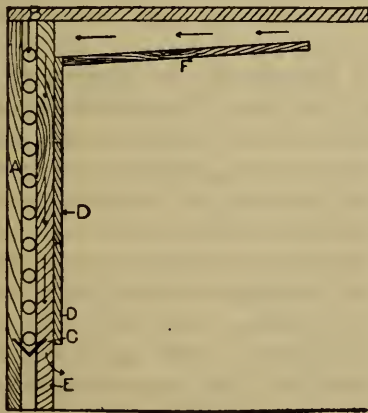

Fig. 146.

12 inch boards *D* nailed to studding *E* and the whole fastened to the coils, the studding serving to keep the boards from coming into contact with the pipe coils. A false ceiling *F* is placed a few inches below the ceiling of the room so that the warm air flows towards the pipes and over them, dropping to the floor and passing out under the lower edge of the apron into the room. Wherever direct radiation is used drip pans should be

placed directly underneath the coils in order to catch and drain off the water when the coils are cut out and the frost

melts. This water should be drained into a receptacle that can be easily emptied when filled.

The second method of room cooling is by *indirect radiation*. Let Fig. 147 represent a section of a storage building.

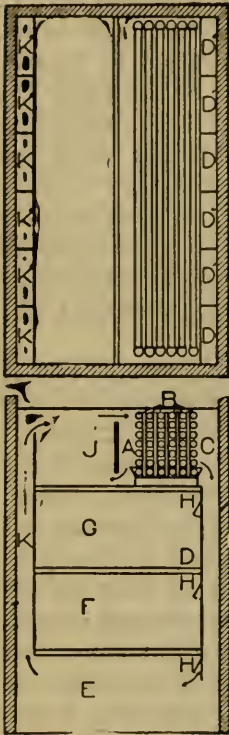

Fig. 147.

The essential parts of the cooling system are, a bunker room AC, in the top part of the building, containing the cooling coils B, a series of ducts on either side of the building, so arranged that the air after passing over the cooling coils, drops downward. These ducts are provided with dampers for admitting as much of the cold air to the rooms as is desired. On becoming warmed this air is crowded out on the opposite side of the room into the ducts K and rises to the bunker-room where it is again cooled by passing over the coils. By the use of the dampers the cold air may be cut off from any room or admitted in large quantities thus making it an easy matter to maintain the temperature at any point desired. The ducts leading the air from the rooms should be 25 per cent. larger than the ones leading to the rooms and the latter should have about three square inches cross-section per square foot of floor area in rooms having a ten foot ceiling.

The third method is by means of a *plenum system* of air circulation, Fig. 148. The arrangements are quite similar to those of the plenum system for heating,

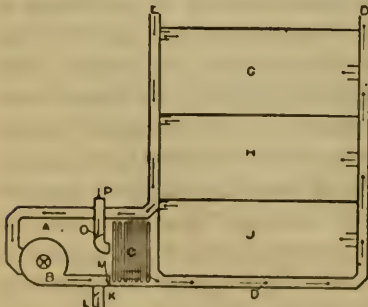

Fig. 148.

except that the heating coils are replaced by the refrigerating coils. The air required for ventilation is blown over the coil surface, erected in a coil or bunker room, over which, oftentimes, cold water is sprayed. This not only washes the air but tends to lower its temperature. If ammonia is used as a refrigerant, brine is circulated in the coils, but if

carbon dioxide is used direct expansion is employed, thus dispensing with the use of brine. The principal advantage of the plenum system of cooling is that a positive circulation of air may be maintained in any room even though the bunker room be placed on the first floor or in the basement of the building. This is the system used in large buildings that are cooled during the summer as well as heated during winter, in factories where changes of temperature seriously affect the product, as in chocolate factories, in fur storage rooms, in drying the air before it is blown into blast furnaces and in the solution of many other important economic problems.

207. Influence of the Dew Point:—In cooling a building by means of a plenum refrigerating system, great trouble is experienced with the formation of ice on the coils. For example, suppose such a cooling system on a hot summer day is taking in air at 90 degrees temperature and 85 per cent. humidity. If this air is cooled only ten degrees (see chart, page 29), it will have reached its dew point and as the cooling continues will deposit frost and ice on the coils from the liberated moisture, the air meantime remaining at the saturation point and being so delivered to the rooms. The undesirable feature of delivering saturated air to the rooms may be avoided by cooling only part, say half of the air stream, considerably lower than the final temperature desired, and then mixing it with the other half, which is drier, before delivering it to the rooms. The troublesome coating of ice and frost on the pipes may be avoided by combining the cooling system with the air washing system and using a brine spray instead of water for washing the air during cooling. The brine, which freezes at a very low temperature compared with water, plays over the cooling coils, and cleans both coils and air. The brine should preferably be a chloride brine. A modification of this method of avoiding ice and frost is to provide pans above the coils and fill them with lumps of calcium chloride. The pans have perforations so arranged that as the strong chloride solution forms (due to the deliquescence of the salt) it trickles down over the pipes and holds the freezing point of any collecting moisture far below the temperature of the coils. A sketch of this arrangement is shown in Fig. 149, which has the disadvantage of the clumsy handling of the calcium chloride. Plants operating only during the day, as for

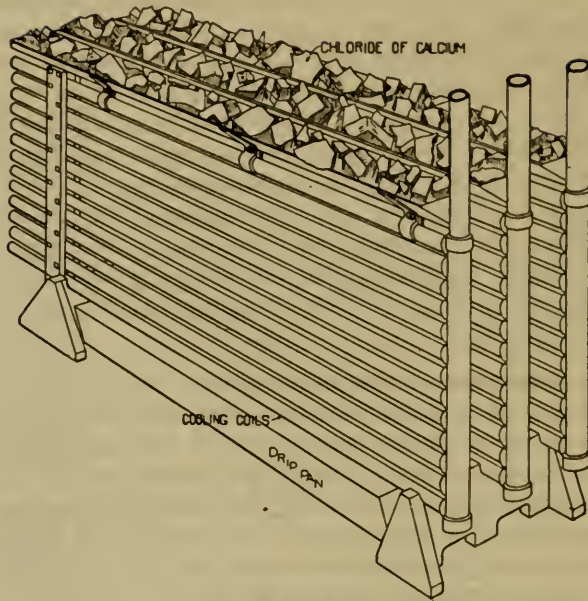

Fig. 149.

Instance, auditoriums, commerce chambers, etc., often have no equipment for preventing the accumulation of frost and ice, it being allowed to form during the short period of use and to melt during the period of rest.

208. Pipe Line Refrigeration:—In a number of the larger cities refrigeration is furnished to such places as cold storage rooms, restaurants, hotels, auditoriums, etc., by a conduit system or central station system. The length of the mains in the various cities where used, ranges from a few hundred feet to twenty miles and the circulating medium employed is either liquid ammonia or brine. In the ammonia system two pipes are used, one carrying the liquid ammonia to the place desired and the other returning it after expansion to the central station. When brine is used it is good practice to circulate it at from 12 to 15 degrees *F*. Occasionally the conduits carry three parallel pipes, two of which are for circulating the brine and the third is for emergency cases. The line should be divided into sections, with valves and by-passes so arranged that a defective section could be repaired without interfering with the other parts. All valves should be readily accessible and all high points in the system should be equipped with purge valves.

The service pipes should be two inches in diameter and well insulated.

Either the ammonia absorption or compression system may be used for cooling the brine but according to Mr. Jos. H. Hart, the latter, making use of direct expansion, is the most efficient and the one most commonly installed. The loss by radiation to the pipes in the conduits is not great but numerous mechanical difficulties are yet to be overcome. It would seem desirable to make the pipe-line system of cooling general for residence use but as yet it has not been

found economical to cool buildings using less than the equivalent of 500 pounds of refrigeration in 24 hours. Although not an efficient method, it seems probable that cold air refrigeration by using balanced expansion may supersede the other systems.

209. As a Final Application of refrigeration we may mention the cooling of the drinking water supply in large office buildings, hotels, etc. Usually this is simply a small part of the work of a large refrigerating plant. Fig. 150 gives a diagrammatic elevation of such an arrangement.

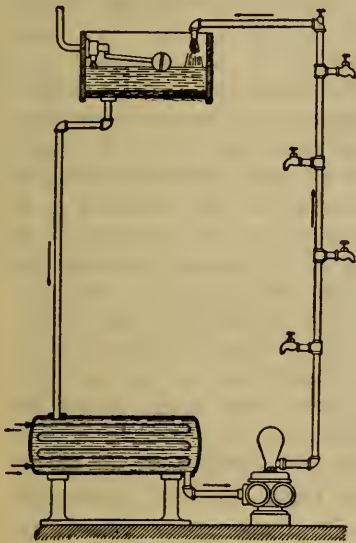

Fig. 150.

CHAPTER XVII.

REFRIGERATION CALCULATIONS.

210. Unit Measurement of Refrigeration:—Since the first efforts toward refrigeration employed the simple process of melting ice by the abstraction of heat from nearby articles, it is not surprising to find the accepted standard unit for expressing refrigeration capacities referred to the refrigerating effect of a known quantity of ice. In fact, since the latent heat of fusion of ice is a constant, this furnishes an excellent basis for estimating refrigeration. The generally accepted unit of measure is the *ton of refrigeration*, which may be defined as *the amount of heat (B. t. u.) which one ton of 2000 pounds of ice at 32 degrees, will absorb in melting to water at 32 degrees.* Since the latent heat of ice is 144 B. t. u. per pound, one ton of refrigeration is equal to 288000 B. t. u. Just as a pumping plant is rated at a certain number of millions of gallons, meaning millions of gallons in twenty-four hours, so a refrigeration plant is rated in so many tons of refrigeration, meaning so many tons in twenty-four hours. Hence one ton of refrigeration capacity for one day is equivalent to 12000 B. t. u. per hour, this value being *the unit of refrigerating capacity*, sometimes referred to as *tonnage capacity*, or *refrigerating effect*, and usually designated by *T*.

211. Calculation of Required Capacity:—To estimate closely the tonnage capacity of a refrigerating plant for any certain store space requires specific attention to supplying the following losses:

(a) The radiated and conducted heat entering the room. This may be divided into that due to the walls and that due to the windows and sky-lights.

(b) The heat entering by the renewal of the air, or ventilation of the enclosed space. This may be divided into heat given off by the air and heat given off due to the latent heat of the moisture.

(c) The heat entering by the opening of doors.

(d) The heat from the men at work, lights, chemical fermentation processes, etc.

(e) The heat abstracted from material in cold storage.

Refrigeration losses due to entrance of *radiated and conducted heat* may be calculated by formulas 10, 11 and 12,

Chapter III, if the proper transmission constants are inserted. To obtain these constants for various types of insulation use Tables IV and XXIX.

TABLE XXIX.

Heat Transmission of Standard Types of Dry Insulation.

Material	K	Material	K
Mill shavings, Type (a)		Hair Felt, Type (a)	
1" thickness.....	.1330	1" thickness138
2" "1090	¼", ½", ¾", Type (c)	.105
3" "0920	Sheet Cork, Type (d)	
4" "0800	4" with 1" air space	.050
5" "0710	5" with 1" air space	.037
6" "0630	3", Type (b)087
7" "0570	1", Type (a)137
8" "0520	Granulated Cork	
10" "0440	4", Type (a)071
12" "0390	Mineral Wool	
14" "0340	2½", Type (b)151
16" "0308	1", Type (b)192
18" "0279	Air Spaces	
20" "0255	8", Type (a)112
22" "0235		
24" "0218		

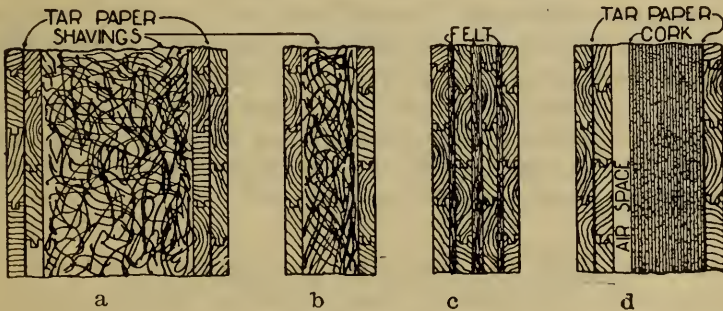

Fig. 151.

In general any space to be kept at or below zero degrees should have insulation allowing no greater transmission than .04, and for spaces to be kept at from 0 degrees to 30

degrees no greater transmission should be allowed than .06, while for temperatures above 30 degrees a transmission as great as .1 is allowable. In any case, however, it should be remembered that the heat loss, and therefore the expense of operation, is directly proportional to this factor and the best possible insulation, consistent with available building funds, is the one to use, the ceiling and floor being as carefully insulated as the walls. Window construction should be tight, non-opening, and at least double.

The refrigeration *loss due to ventilation* may be considered under two heads, i. e., the cooling of the air from the higher to the lower temperature, and the cooling, condensing and freezing of the moisture in the air. In this particular, air cooling cannot be considered exactly the reverse of air warming. In air warming the vapor present absorbs heat but this vapor has so little heat capacity compared with that of the air that no noteworthy error is introduced by ignoring the vapor. However, in air cooling the dew point is almost invariably reached and passed, so that considerable moisture is changed from the vapor to the liquid with a liberation of its heat of vaporization. This is considerable and cannot be ignored without serious error. If, further, conditions are such that this moisture is frozen, its latent heat of freezing must also be accounted for. These two items are relatively so large that to cool air through a given range of temperature may involve several times the heat transfer required to warm the same air through the same range of temperature.

APPLICATION.—Assume outside air 95 degrees, relative humidity 85 per cent., temperature of air upon leaving cooling coils 30 degrees and temperature of coil surface 10 degrees. If 180000 cubic feet of air per hour are drawn in from the atmosphere, the refrigerating capacity of the coils may be obtained as follows. To cool the air from 95 degrees to 30 degrees will require (formula 9),

$$\frac{180000 \times (95 - 30)}{55} = 212700 \text{ B. t. u.}$$

At 95 degrees and 85 per cent. humidity one cubic foot of air contains, (Table 10, Appendix,) $.85 \times 17.124 = 14.555$ grains of moisture. At 30 degrees and saturation one cubic

foot of air contains, (Table 10), 1.935 grains. Hence there

would be deposited upon the coils $\frac{180000 (14.555 - 1.935)}{7000} =$

324.5 pounds of moisture per hour. Now there would be absorbed from each pound of this moisture

32 B. t. u. to cool from 95 to 32 degrees.

1073 B. t. u. to change to liquid form.

144 B. t. u. to freeze (if allowed to freeze on coils).

11 B. t. u. to cool from 32 to 10 degrees.

1260 B. t. u. total.

Hence the coils would have to absorb from the moisture alone, $1260 \times 324.5 = 408870$ B. t. u. per hour, or for both moisture and air, $212700 + 408870 = 621600$ B. t. u. per hour. This indicates, for the ventilation proposed, a tonnage capacity of $621600 \div 12000 = 51.8$ tons of refrigeration needed at the bunker room coils. The above provides that the air is rejected at the interior temperature, 30 degrees. Modern plants, however, would pre-cool the incoming air before it reached the bunker room by having part of its heat absorbed by the outgoing 30 degree air, which would reduce the estimate somewhat below 51.8 tons.

In considering the refrigeration *loss due to the opening of doors* no rational method of calculation is applicable, but if the nature of the cold storage service is such that doors are frequently opened, as high as 25 per cent. may be allowed. Generally this is taken from 10 to 15 per cent.

The refrigeration *loss due to persons, lights, etc.*, may be estimated as suggested in Art. 31. If the cooling air is recirculated, the cooling and freezing of the moisture given off by each person should be taken into account, especially if the number is large. For this purpose it is safe to assume a maximum of 500 grains of moisture given off per person per hour when such persons are not engaged in active physical exercise.

212. Calculations for Square Feet of Cooling Coil:—This problem presents greater uncertainty in its solution than does the design of a heating coil surface because of the lack of experimental data and because of the variable insulating effect of ice and frost accumulations, if allowed to form. Professor Hanz Lorenz in "Modern Refrigrating Machinery," page 349, quotes 4 B. t. u. per square foot per hour per

degree difference between the average temperatures on the inside and outside of the coils, as a safe designing value when the air speed is 1000 feet per minute over the coils. This is for plants in continuous operation, as abattoirs, cold stores and in places where no provision is made against ice formation. For clean pipe surface in the plenum air cooling plant of the New York Stock Exchange Building the heat transmission is approximately 430 B. t. u. per square foot per hour with air over coils at 1000 feet per minute. Under the average temperatures there used, this corresponds to a transmission per degree difference per square foot per hour of approximately 7 B. t. u. These two values, 4 and 7, may be taken as about the minimum and maximum transmission constants for plenum cooling coil installations.

For direct cooling coils, where the pipe surface is simply exposed to the air of the room to be cooled, Lorenz recommends a transmission allowance of not over 30 B. t. u. per square foot per hour, for in such installations the removal of ice and frost is seldom contemplated. For an average room temperature of 30 degrees and average brine temperature of 10 degrees, this would correspond to $30 \div 20 = 1.5$ B. t. u. transmitted per square foot per hour per degree difference.

APPLICATION 1.—How many lineal feet of $1\frac{1}{4}$ inch direct refrigerating coils would be required to keep a cold storage room at 30 degrees if the refrigeration loss is 80000 B. t. u. per hour total and the temperatures of the brine entering and leaving the coils are 10 degrees and 20 degrees respectively? Average brine temperature = 15 degrees. Allowing a transmission constant of 1.5, formula 30 becomes,

$$R_r = \frac{H}{1.5 (15 - 30)} = .0445 H$$

For this problem we have $.0445 \times 80000 = 3500$ square feet, or $3500 \times 2.3 = 8050$ lineal feet of $1\frac{1}{4}$ inch pipe.

APPLICATION 2.—The cooling of 180000 cubic feet of air per hour in Art. 211 required the extraction of 621600 B. t. u. per hour. Determine the plenum cooling surface required, if brine enters at 0 degrees and leaves at 20 degrees.

Average brine temperature = 10 degrees. Assuming that there is provision for keeping coils clear of ice, and

hence a transmission constant of 7 B. t. u. is allowable, formula 42 gives

$$R_r = \frac{621600}{7 \left(10 - \frac{95 + 30}{2} \right)} = - 1691 \text{ square feet of surface.}$$

The negative sign indicates a flow of heat in the direction opposite to the flow in heating installations, for which the formula was primarily designed.

213. General Application:—Considering the school building and the table of calculated results on pages 202 to 205 what amount of cooling coil surface would be required to keep the temperature of all rooms of this building at 73 degrees on a day when the outside air temperature is 95 degrees and the relative humidity 85 per cent.?

Data Table XXV gives the total heat loss of the three floors of this building as 1483250 B. t. u. per hour on a zero day when the rooms are kept at 70 degrees. Now this same building under the summer conditions would have delivered to it heat due to a temperature difference of 95 degrees — 73 degrees = 22 degrees. Hence the total refrigeration loss dur-

ing the summer day would be approximately $\frac{22}{70} \times 1483250 =$

466000 B. t. u. per hour, which amount of heat would be used to warm the incoming air from some temperature up to 73 degrees. Suppose the ventilation requirement of the building is 2000000 cubic feet per hour. Since it requires $\frac{1}{55}$ of a B. t. u. to warm one cubic foot of air one degree, $[2000000 (73 - t)] \div 55 = 466000$, or $t = 60.2$, say 60 degrees. (See Arts. 36 and 38 and observe that the second term of the right hand member of formula 17 becomes a negative term).

While the air is traversing the ducts between the coils and the rooms, allow a rise in temperature of 5 degrees. The coils would then be required to deliver 2000000 cubic feet of air per hour at 55 degrees when supplied with air at 90 degrees and 85 per cent. humidity. To cool this amount of air through the given range would require the absorption of (formula 9), $[2000000 \times (95 - 55)] \div 55 = 1454500$ B. t. u. At 95 degrees and 85 per cent. humidity, 1 cubic foot of air contains (Table 10), $.85 \times 17.124 = 14.555$ grains of moisture. At 55 degrees and saturation point, 1 cubic foot of air contains (Table 10), 4.849 grains of moisture. Hence, neglecting

change in air volume, there would be deposited on the coils approximately $[2000000 (14.555 - 4.849)] \div 7000 = 2775$ pounds of moisture per hour.

Now, if an average brine temperature of 10 degrees is used and provision is made for keeping the coils clear of ice, the condensation will leave at some temperature above 10 degrees, say 20 degrees, and there will be absorbed from each pound of this moisture approximately

20 B. t. u. to cool from 95 to 55 degrees.

1061 B. t. u. to change to liquid form at 55 degrees.

35 B. t. u. to cool the water from 55 to 20 degrees.

1116 B. t. u. total.

Hence the coils would have to absorb from moisture alone, $2775 \times 1116 = 3096900$ B. t. u., or from both moisture and air a total of $1454500 + 3096900 = 4551400$ B. t. u. per hour. At an allowed rate of transmission of 7 B. t. u. there would be required to cool this building a total of approximately 9100 square feet of coil surface, under the conditions of ventilation as assumed.

It should be noted that whereas only 3000 square feet of plenum surface were sufficient to heat the building according to Application 2, Art. 115, it requires fully three times this amount of surface in cooling coils to cool the building under the assumed conditions. Upon inspection it is seen that the greatest work of the cooling coils is the condensation and cooling of the moisture.

The relative humidity within the cooled rooms would be approximately 55 per cent., for the content per cubic foot of incoming air is 4.849 grains, and the capacity of the air when heated to 73 degrees is 8.782 grains showing a relative

humidity, after heating, of $\frac{4.849}{8.782} = 55$ per cent. This would

be raised somewhat by the persons present.

214. Ice Making Capacity. Calculation:—Neglecting losses, the ice making capacity of a refrigerating plant for a certain refrigeration tonnage may be expressed

$$I = \frac{144 T}{(t - 32) + 144 + .5 (32 - t_1)} \quad (107)$$

In which I = tons of ice produced per 24 hours, T = refrig-

eration tonnage or rating of plant, t = initial temperature of water and t_1 = final temperature of ice, usually 12 to 18 degrees.

· APPLICATION.—What should be the ice making capacity of a plant having a tonnage rating of 100, if $t = 70$ degrees and $t_1 = 16$ degrees? Take losses at 35 per cent.

$$I = \frac{.65 \times 144 \times 100}{(70 - 32) + 144 + .5 (32 - 16)} = 49.3 \text{ tons in 24 hours.}$$

215. Gallon Degree Calculation:—For use in plants producing ice by brine circulation a unit called the *gallon degree* is sometimes used. It represents a change of one degree temperature in 1 gallon of brine in one minute of time. It is not a fixed unit representing a constant number of B. t. u., since the brine strength, and therefore its specific heat, may vary. The value in B. t. u. per minute, of a gallon degree for any plant may be obtained by multiplying the specific gravity of the brine by its specific heat and by 8.35, the weight of one gallon of water, or as a formula may be stated

$$D = 8.35 gh \quad (108)$$

where D = B. t. u. per minute equal to one gallon degree, g = specific gravity of brine and h = specific heat of brine.

The number of gallon degrees per ton of refrigerating capacity may be found by dividing 200 by D , since one ton of refrigerating capacity is equal to 200 B. t. u. per minute, then

$$D_t = \frac{200}{8.35 gh} = \frac{24}{gh} \text{ for all practical purposes.} \quad (109)$$

The refrigerating capacity of a given brine circulation may be obtained by dividing the product of the gallons circulated and the rise in brine temperature by the value D_t . Stated as a formula this is

$$T = \frac{G (t_2 - t_3)}{D_t} = \frac{gh G (t_2 - t_3)}{24} \quad (110)$$

where T = tonnage capacity, G = gallons of brine circulated per minute and $(t_2 - t_3)$ = rise of brine temperature.

216. Refrigerating Capacity of Brine Cooled System:—To calculate the capacity but two things are required, the amount of brine circulated, and the rise in temperature of the brine. From these the capacity may be obtained by the formula

$$T = \frac{W h (t_2 - t_3)}{12000} \quad (111)$$

where T = tonnage capacity, W = weight of brine circulated, in pounds, h = specific heat of brine and $(t_2 - t_3)$ = rise in temperature of brine.

217. Cost of Ice Making and Refrigeration:—The cost of ice manufacture is affected principally by the following items: price and kind of fuel, kind of water, cost of labor, regularity of operation, method of estimating costs, etc. It is found in practice to range anywhere from \$0.50 to \$2.50 per ton. The items making up the cost of ice manufacture are: fuel for power, labor at the plant, water, ammonia and minor supplies, maintenance of the plant, interest and taxes, and administration. Mr. J. E. Siebel in his "Compend of Mechanical Refrigeration and Engineering" gives an itemized account of the daily operating expense of a 100-ton plant with which he was connected, the plant operating 24 hours per day.

Chief engineer	\$ 5.00
Assistant engineers	6.00
Firemen	4.00
Helpers	5.00
Ice pullers	9.00
Expenses	12.00
Coal at \$1.10 per ton	18.00
Delivery (wholesale) 50c per ton.....	50.00
Repairs, etc.	3.00
Insurance, taxes, etc	6.00
Interest on capital	20.55
	<hr/>
Total for 100 tons of ice	\$138.55

The length of time that the ice is permitted to freeze is a factor affecting the cost of production. The following figures are given for a 10-ton plant:

	Ten tons in 12 hours	Ten tons in 24 hours
Engineer	\$2.50	\$ 5.00
Fireman	1.50	3.00
Tankmen, helpers ..	1.50	3.00
Coal	3.00	3.00
Repairs, supplies, etc.	1.50	1.50
	<hr/>	<hr/>
Total for 10 tons	\$10.00	\$15.50

Mr. A. P. Criswell, in "Ice and Refrigeration," gives the following approximate costs for the production of can ice per ton with coal at \$2.50 per ton and with a simple distilling system. The figures are for the plant operating at full capacity and do not include cost of administration.

Capacity of plant	Cost per ton
10 tons	\$1.58
20 "	1.48
30 "	1.42
40 "	1.38
50 "	1.36
70 "	1.34
100 "	1.34
120 "	1.30

Mr. Karl Wegemann states that a certain moderate sized plant of the absorption system produced ice for a number of years at an average cost of \$0.85 per ton after allowing for melting and breakage. This included all charges except for interest, insurance and administration.

The following figures taken from the books of another plant show clearly the effect of demand upon the cost of manufacture.

Month	Cost per ton
January	\$3.50
February	3.70
March	2.80
April	2.17
May	1.75
June	1.19
July	1.02
August	1.02
September	1.03
October	1.26
November	2.10
December	2.94

REFERENCES.

References on Refrigeration.

TECHNICAL BOOKS.

A. J. Wallis-Taylor, *Pocket-Book of Refrigeration*. John Wemyss Anderson, *Refrigeration*. James Alfred Ewing, *Mechanical Refrigeration*. J. E. Siebel, *Compend of Mechanical Refrigeration*. *International Library of Technology*, pp. 643-966. I. C. S. Pamphlets, 1238 A, 1238 B, 1238 C, 1240, 1241, 1242, 1243, 1246 A, 1246 B, 1247 and 1250. American School of Correspondence; *Refrigeration*, Dickerman & Boyer; *Refrigeration*, Milton W. Arrowwood.

TECHNICAL PERIODICALS.

Ice and Refrigeration. The Ice Factory of the Future, Victor H. Becker, Jan. 1910. Cell Box System for Making Raw Water Ice, A. C. Bishop, Dec. 1909. The Flooded System, H. Rassbach, Jan. 1910. Baker Chocolate Cooling Plant, Aug. 1910. The Working Fluid in Refrigeration, H. J. MacIntyre, Nov. 1910. Sulphur Dioxide as Refrigerating Agent, W. S. Douglas, Oct. 1911. Dry Blast Refrigeration, Nov. 1912. *Power*, Artificial Systems of Refrigeration, C. P. Wood, May 3, 1910. Mechanical Refrigeration, F. E. Matthews, Aug. 9, 1910. Elements of Compression System, F. E. Matthews, Sept. 6, 1910. Can and Plate Systems of Making Ice, F. E. Matthews, Mar. 14, 1911. Cold Storage of Furs and Fabrics, E. F. Tweedy, Feb. 20, 1912. Ammonia Absorption Refrigeration System, Fred Ophuls, Apr. 23, 1912. Central Refrigerating Plant at Atlanta, Georgia, May 7, 1912. Pre-Cooling Plant of Southern Pacific Railway, LeRoy W. Allison, June 4, 1912. Cooling Air of Buildings by Mechanical Refrigeration, E. F. Tweedy, Nov. 28, 1911. *Electrical World*. Ice Making from Exhaust Steam, Apr. 7, 1910.

CHAPTER XVIII.

PLANS AND SPECIFICATIONS FOR HEATING SYSTEMS.

218. In Planning for and Executing Engineering Contracts, the responsibilities assumed by the various interested parties should be thoroughly studied. The following outline shows the relationship between these parties and the order of the responsibility.

Owner	}	Engineer.
or		Superintendent and Inspector.
Purchaser		General contractor, Subcontractors, Foremen and Workmen.

The engineer, the superintendent and the general contractor occupy positions of like responsibility with relation to the purchaser. The first two work for the interest of the purchaser to obtain the best possible results for the least money, and the last endeavors to fulfill the contract to the satisfaction of the superintendent, at the least possible expense to himself. These points of view are quite different and sometimes are antagonistic, but both are right and just. Of the three parties, the engineer has the greatest responsibility. It is his duty to draw up the plans and to write the specifications in such a way that every point is made clear and that no question of dispute may arise between the superintendent and the contractor. His plans should detail every part of the design with full notes. His specifications should explain all points that are difficult to delineate on the plans. They should give the purchaser's views covering all preferences, and should definitely state where and what materials may be substituted. Where any point is not definitely settled and left to the judgment of the contractor, he may be expected to interpret this point in his favor and use the cheapest material that in his judgment will give good results. This opinion may differ from that held by the purchaser. All parts should be made so plain that no two opinions could be had on any important point. The engineer should also be careful that the plans and specifications agree in every part. The inspector is the superintendent's representative on the grounds and is supposed to inspect and pass upon all materials delivered on the grounds, and the

quality of workmanship in installing. For such information see Byrne's "Inspector's Pocket-Book." The general contractor usually sublets parts of the contract to subcontractors who work through the foreman and workmen to finish the work upon the same basis as the general contractor.

The following brief set of specifications are not considered complete but are merely inserted to suggest how such work is done.

Typical Specifications.

TITLE PAGE:—

SPECIFICATIONS

for the

MATERIALS AND WORKMANSHIP

Required to Install

(Type of system)

HEATING AND VENTILATING SYSTEM

in the

(Building)

(Location)

by

(Name of designer)

INDEX PAGE:—

(To be compiled after the specifications are written.)

General Remarks to Contractor.—In the following specifications, all references to the Owner or Purchaser will meanor any person or persons delegated byto serve as the representative. The *Superintendent of Buildings* will be the purchaser's representative at all times, unless otherwise definitely stated. The contractor will, therefore, refer all doubtful questions or misunder-

standings, if any, to the superintendent, whose decision will be final. In case of any doubt concerning the meaning of any part of the plans or specifications, the contractor shall obtain definite interpretation from the superintendent before proceeding with the work.

These specifications with the accompanying plans and details (sheets to inclusive) cover the purchase of all the materials as specified later (the same materials to be new in every case), and the installation of the same in a first class manner within the above named building, located at (street) (city) (state).

It will be understood that the successful bidder, hereinafter called the contractor, shall work in conformity with these plans and specifications and shall, to the best of his ability, carry out their true intent and meaning. He shall purchase and erect all materials and apparatus required to make the above system complete in all its parts, supplying only such quality of materials and workmanship as will harmonize with a first class system and develop satisfactory results when working under the heaviest service to which such plants are subjected.

The contractor shall lay out his own work and be responsible for its fitting to place. He shall keep a competent foreman on the grounds and shall properly protect his work at all times, making good any damage that may come to it, or to the building, or to the work of other contractors from any source whatsoever, which may be chargeable to himself or to his employees in the course of their operations.

Any defects in materials or workmanship, other than as stated under—(state exceptions if any)—that may develop within one year, shall be made good by the contractor upon written notification from the purchaser without additional cost to the purchaser.

The contractor shall, wherever it is found necessary, make all excavations and back-fill to the satisfaction of the superintendent.

The contractor shall be responsible for all cuttings of wood work, brick work or cement work, found necessary in fitting his materials to place, either within or without the building; the cutting to be done to the satisfaction of the superintendent. The contractor shall be required to connect and supply water and gas for building purposes, and shall

assume all responsibility for the same.

The contractor shall be required to protect the purchaser from damage suits, originating from personal injuries received during the progress of the work; also, from actions at law because of the use of patented articles furnished by the contractor; also, from any lien or liens arising because of any materials or labor furnished.

The purchaser reserves the right to reject any or all bids.

No changes in these plans and specifications will be allowed except upon written agreement signed by both the contractor and the purchaser's representative.

System.—Specify the system of heating in a general way; high pressure, low pressure or vacuum; direct, direct-indirect or indirect radiation; basement or attic mains; one or two-pipe connections to radiators. If ventilation is provided, state the movement of the air and the general arrangement of fans, coils or other heating surfaces. Single or double duct air lines, etc.

Boilers.—Specify type, number, size and capacity, steam, pressure, approximate horse-power, heating surface, grate surface and kind of coal to be used. Locate on plan and elevation. Explain method of setting, portable or brick. Specify also, flue connection, heating and water pipe connections, kind of grate, thermometers, gages, automatic damper connection, firing tools and conditions of final tests.

Conduits and Conduit Mains.—(In this it is assumed that the boilers are not within the building). In addition to the layout, give sections of the conduit on plans showing method of construction, supporting and insulating pipes, and drainage of pipes and conduits. Specify quality and size of materials, pitch and drainage of pipes and all other points not specially provided for in the plans.

Anchors.—Locate and draw on plans and specify for the installation regarding quality of materials.

Expansion Joints or Take-ups.—Locate and draw on plans. Select type of joint and specify for amount of safe take-up and for quality of material.

Mains and Returns.—Trace the steam from the point where it enters the main, through all the special fittings of the system. Show where the condensation is dripped to the returns through traps or separating devices. Specify

Amount and direction of pitch, kind of fittings (flanged or screwed, cast iron or malleable iron), kind of corners (long or short), method of taking up expansion and contraction. Trace returns and specify dry or wet.

Branches to Risers.—Take branches from top of mains by tees, short nipples and ells, and enter the bottom of the risers by sufficient inclination to give good drainage.

Risers.—Locate risers according to plan. They shall be straight and plumb and shall conform to the sizes given on the plans. No riser shall overlap the casing around windows. State how branches are to be taken off leading to radiators, relative to the ceiling or floor.

Radiator Connections.—Specify, one-pipe or two-pipe, number and kind of valves, sizes of connections and hand or automatic control. All connections shall allow for good drainage and expansion. Distinguish between wall radiator and floor radiator connections. If automatic control is used, hand valves at the radiators are usually omitted.

Radiators.—Specify floor or wall radiators, with type, height, number of columns and number of sections. If other radiators are substituted for the ones that are referred to as acceptable, they must be of equal amount of surface and acceptable to the superintendent. Specify brackets for wall radiators, also, air valves for all radiators, stating type and location on the radiator. Require all radiators to be cleaned with water or steam at the factory and plugged at inlet and outlet for shipment.

Piping.—Define quality, weight and material in all mains, branches and risers. All sizes above one and one-half inch are usually lap welded. Piping should be stood on end and pounded to remove all scale before going into the system. All pipes 1 inch and smaller should be reamed out full size after cutting.

Fittings.—Specify quality of fittings, whether light, standard or heavy, malleable or cast iron. Fittings with imperfect threads should be rejected.

Valves.—Specify type (globe, gate or check), whether flanged or screwed, rough or smooth body, cast iron or brass, and give pressure to be carried. All valves should be located on the plans.

Expansion Tank.—Specify capacity of tank in gallons, kind

of tank (square or round, wood or steel), method of connecting up with fittings and valves, and locate definitely on plan and elevation. Connect also to fresh water supply and to overflow.

Hangers and Ceiling Plates.—Wall radiators and horizontal runs of pipe shall be supported on suitable expansion hangers or wall supports that will permit of absolute freedom of expansion. Supports shall be placed . . . feet centers. Pipe holes in concrete floors shall be thimbled. Holes through wooden walls and floors shall have suitable air space around the pipe, and all openings shall be covered with ornamental floor, ceiling or wall plates.

Traps.—Specify type, size, capacity and location. State whether flanged or screwed fittings are used and whether by-pass connection will be put in. Refer to plans.

Pressure Regulating Valve.—Specify type, size and location, also maximum and minimum steam pressure, with guarantee to operate under slight change of pressure. State if by-pass should be used and explain with plans.

Separators.—Specify type (horizontal or vertical), also size and location.

Automatic Control.—The contractor will be held responsible for the installation of all thermostats, regulator valves, air compressor, piping and fittings required to equip all rooms and halls with an automatic . . . temperature control system. Specify approximate location and number of thermostats with the desired finish. Specify in a general way, regulator valves on radiators, quality of pipe, maximum test pressure for pipe, power for air supply (hydraulic, pneumatic, etc.), and supply tank. All materials in the temperature control system shall be guaranteed first class by the manufacturer through the contractor, and the system shall be guaranteed to give perfect control for a period of (two) years.

Fans.—Specify for direct connected or belt driven, right or left hand, capacity, size, housing, direction of discharge, horse-power, *R. P. M.* and pressure. State in a general way the requirements of the fan wheel, steel plate housing, shaft, bearings and the method of lubrication.

Engine.—Specify type, horse-power, steam pressure, approximate cut-off, speed and kind of control.

Electric Motors.—Specify type, horse-power, voltage, cycles, phases and R. P. M.

Indirect Heating Surface.—Specify the kind of surface to be put in and then state the total number of square feet of surface, with the width, height and depth of the heater. State definitely how the heaters will be assembled, giving free height of heater above the floor. Describe damper control, steam piping to and from heater, housing around heater, connection from cold air inlet to heater and connection from heater to fan. See plans. The contractor will usually follow installation instructions given by the manufacturers for the erection of the heater and engine, consequently the specifications should bear heavily only upon those points which may be varied to suit any condition. All valves, piping and fittings in this work should be controlled by the general specifications referring to these parts.

Foundations.—Specify materials and sizes.

Air Ducts, Stacks and Galvanized Iron Work.—The drawings should give the layout of all the air lines, giving connections between the air lines and the fan, and the air lines and the registers. Where these air lines are below the floor, the conduit construction should be carefully noted. All galvanized iron work should be shown on the plans and the quality and weight should be specified. Air lines should have long radius turns at the corners.

Registers.—Specify height above floor, nominal size of register, method of fitting in wall, the finish of the register and whether fitted with shutters or not.

Protection and Covering.—Specify kind and quality of pipe covering and the finish of the surface of the covering. State the amount of space between heating pipes and unprotected woodwork. Distinguish between pipes that are to be covered and those that are to be painted. All radiators and piping not covered should be painted with two coats of . . . bronze or other finish acceptable to the superintendent.

Completion.—Require all rubbish removed from the building and immediate grounds and deposited at a definite place.

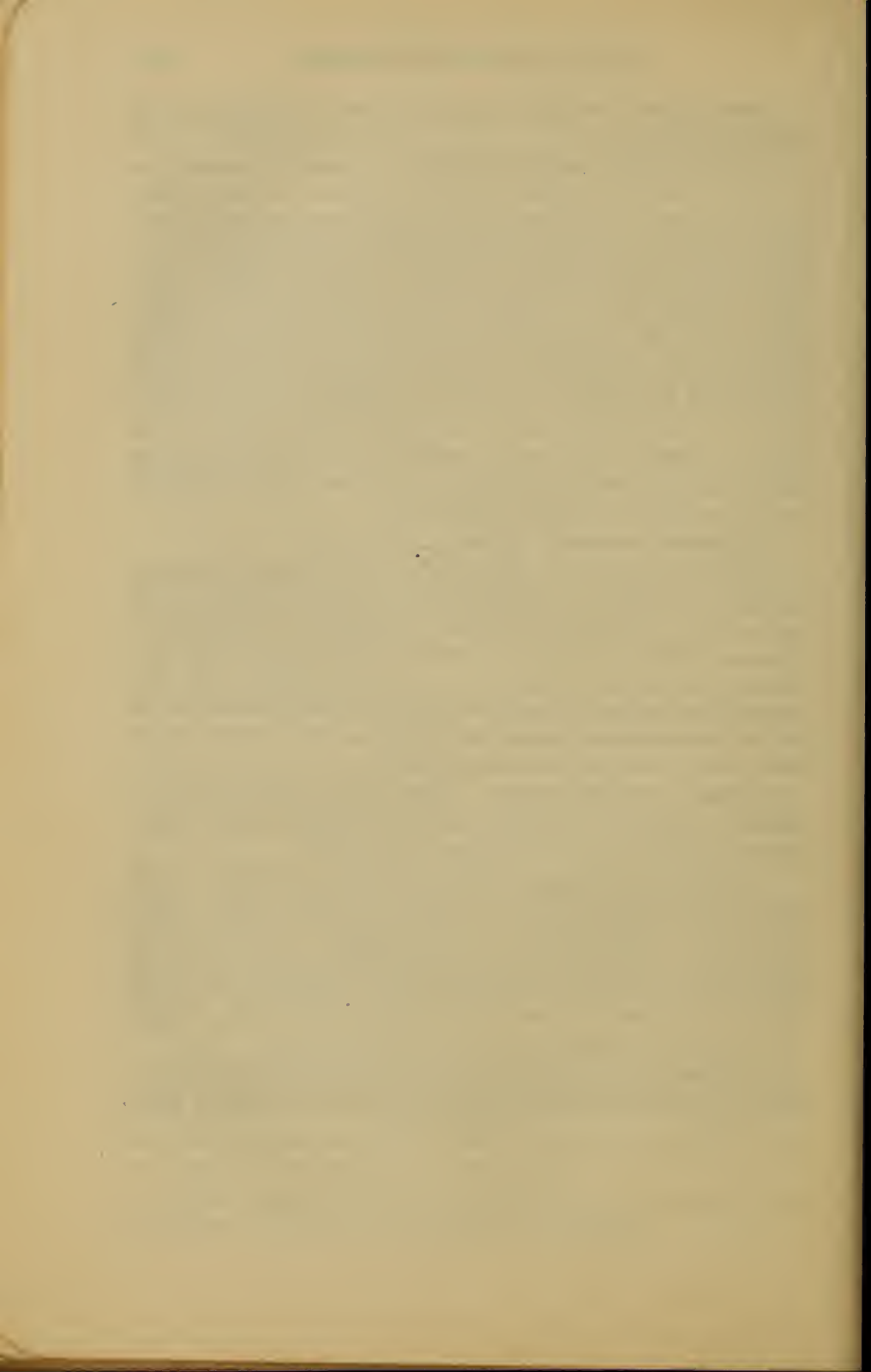

APPENDIX

I.

GENERAL TABLES. HEATING AND VENTILATION.

Tables in body of text are numbered in Roman numerals, those in the Appendixes are numbered in Arabic numerals.

All tables that are not considered general are credited and added by permission of the authors.

TABLE 1.

Squares, Cubes, Square Roots, Cube Roots, Circles.

No. Diam.	Square	Cube	Sq. root	Cube root	Circle	
					Circumf	Area
.1	.010	.001	.316	.464	.314	.00785
.2	.040	.008	.447	.585	.628	.03146
.3	.090	.027	.548	.669	.942	.07069
.4	.160	.064	.633	.737	1.257	.12566
.5	.250	.125	.707	.794	1.570	.19635
.6	.360	.216	.775	.843	1.885	.28274
.7	.490	.343	.837	.888	2.200	.38485
.8	.640	.512	.894	.928	2.513	.50266
.9	.810	.729	.949	.965	2.830	.63620
1.0	1.000	1.000	1.000	1.000	3.1416	.7854
1.1	1.210	1.331	1.0488	1.0323	3.456	.9503
1.2	1.440	1.730	1.0955	1.0627	3.770	1.1310
1.3	1.690	2.197	1.1402	1.0914	4.084	1.3273
1.4	1.960	2.744	1.1832	1.1187	4.398	1.5394
1.5	2.250	3.375	1.2247	1.1447	4.712	1.7672
1.6	2.560	4.096	1.2649	1.1696	5.027	2.0106
1.7	2.890	4.913	1.3038	1.1935	5.341	2.2698
1.8	3.240	5.832	1.3416	1.2164	5.655	2.5447
1.9	3.610	6.859	1.3784	1.2386	5.969	2.8353
2.0	4.000	8.000	1.4142	1.2599	6.283	3.1416
2.1	4.410	9.261	1.4491	1.2806	6.597	3.4636
2.2	4.840	10.648	1.4832	1.3006	6.912	3.8013
2.3	5.290	12.167	1.5166	1.3200	7.226	4.1548
2.4	5.760	13.824	1.5492	1.3389	7.540	4.5239
2.5	6.250	15.625	1.5811	1.3572	7.854	4.9087
2.6	6.760	17.576	1.6125	1.3751	8.168	5.3093
2.7	7.290	19.683	1.6432	1.3925	8.482	5.7256
2.8	7.840	21.952	1.6733	1.4095	8.797	6.1575
2.9	8.410	24.389	1.7029	1.4260	9.111	6.6052
3.0	9.000	27.000	1.7321	1.4422	9.425	7.0688
3.1	9.610	29.791	1.7607	1.4581	9.739	7.5477
3.2	10.240	32.768	1.7889	1.4736	10.053	8.0425
3.3	10.890	35.937	1.8166	1.4888	10.367	8.5530
3.4	11.560	39.304	1.8439	1.5037	10.681	9.0792
3.5	12.250	42.875	1.8708	1.5183	10.996	9.6211
3.6	12.960	46.656	1.8974	1.5326	11.310	10.179
3.7	13.690	50.653	1.9235	1.5467	11.624	10.752
3.8	14.440	54.872	1.9494	1.5605	11.938	11.341
3.9	15.210	59.319	1.9748	1.5741	12.252	11.946
4.0	16.000	64.000	2.0000	1.5870	12.566	12.566
4.1	16.810	68.921	2.0249	1.6005	12.881	13.203
4.2	17.640	74.088	2.0494	1.6134	13.195	13.854
4.3	18.490	79.507	2.0736	1.6261	13.509	14.522
4.4	19.360	85.184	2.0976	1.6386	13.823	15.205

No. Diam.	Square	Cube	Sq. root	Cube root	Circle	
					Circumf	Area
4.5	20.250	91.125	2.1213	1.6510	14.137	15.904
4.6	21.160	97.336	2.1448	1.6631	14.451	16.619
4.7	22.090	103.823	2.1680	1.6751	14.765	17.349
4.8	23.040	110.592	2.1909	1.6869	15.080	18.096
4.9	24.010	117.649	2.2136	1.6985	15.394	18.859
5.0	25.000	125.000	2.2361	1.7100	15.708	19.635
5.1	26.010	132.651	2.2583	1.7213	16.022	20.428
5.2	27.040	140.608	2.2804	1.7325	16.336	21.237
5.3	28.090	148.877	2.3022	1.7435	16.650	22.062
5.4	29.160	157.464	2.3238	1.7544	16.965	22.902
5.5	30.250	166.375	2.3452	1.7652	17.279	23.758
5.6	31.360	175.616	2.3664	1.7760	17.593	24.630
5.7	32.490	185.193	2.3875	1.7863	17.907	25.518
5.8	33.640	195.112	2.4083	1.7967	18.221	26.421
5.9	34.810	205.379	2.4290	1.8070	18.536	27.340
6.0	36.000	216.000	2.4495	1.8171	18.850	28.274
6.1	37.210	226.981	2.4698	1.8272	19.164	29.225
6.2	38.440	238.328	2.4900	1.8371	19.478	30.191
6.3	39.690	250.047	2.5100	1.8469	19.792	31.173
6.4	40.960	262.144	2.5298	1.8566	20.106	32.170
6.5	42.250	274.625	2.5495	1.8663	20.420	33.183
6.6	43.560	287.496	2.5691	1.8758	20.735	34.212
6.7	44.890	300.763	2.5884	1.8852	21.049	35.257
6.8	46.240	314.432	2.6077	1.8945	21.363	36.317
6.9	47.610	328.509	2.6268	1.9038	21.677	37.393
7.0	49.000	343.000	2.6458	1.9129	21.991	38.485
7.1	50.410	357.911	2.6646	1.9220	22.305	39.592
7.2	51.840	373.248	2.6833	1.9310	22.619	40.715
7.3	53.290	389.017	2.7019	1.9399	22.934	41.854
7.4	54.760	405.224	2.7203	1.9487	23.248	43.008
7.5	56.250	421.875	2.7386	1.9574	23.562	44.179
7.6	57.760	438.976	2.7568	1.9661	23.876	45.365
7.7	59.290	456.533	2.7749	1.9747	24.190	46.566
7.8	60.840	474.552	2.7929	1.9832	24.504	47.784
7.9	62.410	493.039	2.8107	1.9916	24.819	49.017
8.0	64.000	512.000	2.8284	2.0000	25.133	50.266
8.1	65.610	531.441	2.8461	2.0083	25.447	51.530
8.2	67.240	551.468	2.8636	2.0165	25.761	52.810
8.3	68.890	571.787	2.8810	2.0247	26.075	54.106
8.4	70.560	592.704	2.8983	2.0328	26.389	55.418
8.5	72.250	614.125	2.9155	2.0408	26.704	56.745
8.6	73.960	636.056	2.9326	2.0488	27.018	58.088
8.7	75.690	658.503	2.9496	2.0567	27.332	59.447
8.8	77.440	681.473	2.9665	2.0646	27.646	60.821
8.9	79.210	704.969	2.9833	2.0724	27.960	62.211

No. Diam.	Square	Cube	Sq. root	Cube root	Circle	
					Circumf	Area
9.0	81.000	729.000	3.0000	2.0801	28.274	63.617
9.1	82.810	753.571	3.0166	2.0878	28.588	65.039
9.2	84.640	778.688	3.0332	2.0954	28.903	66.476
9.3	86.490	804.357	3.0496	2.1029	29.217	67.929
9.4	88.360	830.584	3.0659	2.1105	29.531	69.398
9.5	90.250	857.375	3.0822	2.1179	29.845	70.882
9.6	92.160	884.736	3.0984	2.1253	30.159	72.382
9.7	94.090	912.673	3.1145	2.1327	30.473	73.898
9.8	96.040	941.192	3.1305	2.1400	30.788	75.430
9.9	98.010	970.299	3.1464	2.1472	31.102	76.977
10	100.000	1000.000	3.1623	2.1544	31.416	78.540
11	121.000	1331.000	3.3166	2.2239	34.558	95.033
12	144.000	1728.000	3.4641	2.2894	37.699	113.097
13	169.000	2197.000	3.6056	2.3513	40.841	132.732
14	196.000	2744.000	3.7417	2.4101	43.982	153.938
15	225.000	3375.000	3.8730	2.4662	47.124	176.715
16	256.000	4096.000	4.0000	2.5198	50.265	201.062
17	289.000	4913.000	4.1231	2.5713	53.407	226.980
18	324.000	5832.000	4.2426	2.6207	56.549	254.469
19	361.000	6859.000	4.3589	2.6684	59.690	283.529
20	400.000	8000.000	4.4721	2.7144	62.832	314.159
21	441.000	9261.000	4.5826	2.7589	65.973	346.361
22	484.000	10648.000	4.6904	2.8021	69.115	380.133
23	529.000	12167.000	4.7958	2.8439	72.257	415.476
24	576.000	13824.000	4.8990	2.8845	75.398	452.389
25	625.000	15625.000	5.0000	2.9241	78.540	490.874
26	676.000	17576.000	5.0990	2.9625	81.681	530.929
27	729.000	19683.000	5.1962	3.0000	84.823	572.555
28	784.000	21952.000	5.2915	3.0366	87.965	615.752
29	841.000	24389.000	5.3852	3.0723	91.106	660.520
30	900.000	27000.000	5.4772	3.1072	94.248	706.858
31	961.000	29791.000	5.5678	3.1414	97.389	754.768
32	1024.000	32768.000	5.6569	3.1748	100.531	804.248
33	1089.000	35937.000	5.7446	3.2075	103.673	855.299
34	1156.000	39304.000	5.8310	3.2396	106.841	907.920
35	1225.000	42875.000	5.9161	3.2710	109.956	962.113
36	1296.000	46656.000	6.0000	3.3019	113.097	1017.88
37	1369.000	50653.000	6.0827	3.3322	116.239	1075.21
38	1444.000	54872.000	6.1644	3.3620	119.381	1134.11
39	1521.000	59319.000	6.2450	3.3912	122.522	1194.59
40	1600.000	64000.000	6.3246	3.4200	125.66	1256.64
41	1681.000	68921.000	6.4031	3.4482	128.81	1320.25
42	1764.000	74088.000	6.4807	3.4760	131.95	1385.44
43	1849.000	79507.000	6.5574	3.5034	135.09	1452.20
44	1936.000	85184.000	6.6333	3.5303	138.23	1520.53

No. Diam.	Square	Cube	Sq. root	Cube root	Circle	
					Circumf	Area
45	2025.000	91125.000	6.7082	3.5569	141.37	1590.43
46	2116.000	97336.000	6.7823	3.5830	144.51	1661.90
47	2209.000	103823.000	6.8557	3.6088	147.65	1734.94
48	2304.000	110592.000	6.9282	3.6342	150.80	1809.56
49	2401.000	117649.000	7.0000	3.6593	153.94	1885.74
50	2500.000	125000.000	7.0711	3.6840	157.08	1963.50
51	2601.000	132651.000	7.1414	3.7084	160.22	2042.82
52	2704.000	140608.000	7.2111	3.7325	163.36	2123.72
53	2809.000	148877.000	7.2801	3.7563	166.50	2206.18
54	2916.000	157464.000	7.3485	3.7798	169.65	2290.22
55	3025.000	166375.000	7.4162	3.8030	172.79	2375.83
56	3136.000	175616.000	7.4833	3.8259	175.93	2463.01
57	3249.000	185193.000	7.5498	3.8485	179.07	2551.76
58	3364.000	195112.000	7.6158	3.8709	182.21	2642.08
59	3481.000	205379.000	7.6811	3.8930	185.35	2733.97
60	3600.000	216000.000	7.7460	3.9149	188.50	2827.43
61	3721.000	226981.000	7.8102	3.9365	191.64	2922.47
62	3844.000	238328.000	7.8740	3.9579	194.78	3019.07
63	3969.000	250047.000	7.9373	3.9791	197.92	3117.25
64	4096.000	262144.000	8.0000	4.0000	201.06	3216.99
65	4225.000	274625.000	8.0623	4.0207	204.20	3318.31
66	4356.000	287496.000	8.1240	4.0412	207.34	3421.19
67	4489.000	300763.000	8.1854	4.0615	210.49	3525.65
68	4624.000	314432.000	8.2462	4.0817	213.63	3631.68
69	4761.000	328509.000	8.3066	4.1016	216.77	3739.28
70	4900.000	343000.000	8.3666	4.1213	219.91	3848.45
71	5041.000	357911.000	8.4261	4.1408	223.05	3959.19
72	5184.000	373248.000	8.4853	4.1602	226.19	4071.50
73	5329.000	389017.000	8.5440	4.1793	229.34	4185.39
74	5476.000	405224.000	8.6023	4.1983	232.48	4300.84
75	5625.000	421875.000	8.6603	4.2172	235.62	4417.86
76	5776.000	438976.000	8.7178	4.2358	238.76	4536.46
77	5929.000	456533.000	8.7750	4.2543	241.90	4656.63
78	6084.000	474552.000	8.8318	4.2727	245.04	4778.36
79	6241.000	493039.000	8.8882	4.2908	248.19	4901.67
80	6400.000	512000.000	8.9443	4.3089	251.33	5026.55
81	6561.000	531441.000	9.0000	4.3267	254.47	5153.00
82	6724.000	551368.000	9.0554	4.3445	257.61	5281.02
83	6889.000	571787.000	9.1104	4.3621	260.75	5410.61
84	7056.000	592704.000	9.1652	4.3795	263.89	5541.77
85	7225.000	614125.000	9.2195	4.3967	267.04	5674.50
86	7396.000	636056.000	9.2736	4.4140	270.18	5808.80
87	7569.000	658503.000	9.3274	4.4310	273.32	5944.68
88	7744.000	681472.000	9.3808	4.4480	276.46	6082.12
89	7921.000	704969.000	9.4340	4.4647	279.60	6221.14

No. Diam.	Square	Cube	Sq. root	Cube root	Circle	
					Circumf	Area
90	8100.000	729000.000	9.4868	4.4814	282.74	6361.73
91	8281.000	753571.000	9.5394	4.4979	285.88	6503.88
92	8464.000	778688.000	9.5917	4.5144	289.03	6647.61
93	8649.000	804357.000	9.6437	4.5307	292.17	6792.91
94	8836.000	830584.000	9.6954	4.5468	295.31	6939.78
95	9025.000	857375.000	9.7468	4.5629	298.45	7088.22
96	9216.000	884736.000	9.7980	4.5789	301.59	7238.23
97	9409.000	912673.000	9.8489	4.5947	304.73	7389.81
98	9604.000	941192.000	9.8995	4.6104	307.88	7542.96
99	9801.000	970299.000	9.9499	4.6261	311.02	7697.69
100	10000.000	1000000.000	10.0000	4.6416	314.16	7853.98
105	11025.000	1157625.000	10.2470	4.7177	329.87	8659.01
110	12100.000	1331000.000	10.4881	4.7914	345.58	9503.32
115	13225.000	1520875.000	10.7238	4.8629	361.28	10386.89
120	14400.000	1728000.000	10.9545	4.9324	376.99	11309.73
125	15625.000	1953125.000	11.1803	5.0000	392.70	12271.85
130	16900.000	2197000.000	11.4018	5.0658	408.41	13273.23
135	18225.000	2460375.000	11.6190	5.1299	424.12	14313.88
140	19600.000	2744000.000	11.8322	5.1925	439.82	15393.80
145	21025.000	3048625.000	12.0416	5.2536	455.53	16513.00
150	22500.000	3375000.000	12.2474	5.3133	471.24	17671.46
155	24025.000	3723875.000	12.4499	5.3717	486.95	18869.19
160	25600.000	4096000.000	12.6491	5.4288	502.65	20106.19
165	27225.000	4492125.000	12.8452	5.4848	518.36	21382.46
170	28900.000	4913000.000	13.0384	5.5397	534.07	22698.01
175	30625.000	5359375.000	13.2288	5.5934	549.78	24052.82
180	32400.000	5832000.000	13.4164	5.6462	565.49	25446.90
185	34225.000	6331625.000	13.6015	5.6980	581.19	26880.25
190	36100.000	6859000.000	13.7840	5.7489	596.90	28352.87
195	38025.000	7414875.000	13.9642	5.7989	612.61	29864.77
200	40000.000	8000000.000	14.1421	5.8480	628.32	31415.93
205	42025.000	8615125.000	14.3178	5.8964	644.03	33006.36
210	44100.000	9261000.000	14.4914	5.9439	659.73	34636.06
215	46225.000	9938375.000	14.6629	5.9907	675.44	36305.03
220	48400.000	10648000.000	14.8324	6.0368	691.15	38013.27
225	50625.000	11390625.000	15.0000	6.0822	706.86	39760.78
230	52900.000	12167000.000	15.1658	6.1269	722.57	41547.56
235	55225.000	12977875.000	15.3297	6.1710	738.27	43373.61
240	57600.000	13824000.000	15.4919	6.2145	753.98	45238.93
245	60025.000	14706125.000	15.6525	6.2573	769.69	47143.52
250	62500.000	15625000.000	15.8114	6.2996	785.40	49087.30
255	65025.000	16581375.000	15.9687	6.3413	801.11	51070.52
260	67600.000	17576000.000	16.1245	6.3825	816.81	53092.92
265	70225.000	18609625.000	16.2788	6.4232	832.52	55154.59
270	72900.000	19683000.000	16.4317	6.4633	848.23	57255.53

No. Diam.	Square	Cube	Sq. root	Cube root	Circle	
					Circumf	Area
275	75625.000	20796875.000	16.5831	6.5030	863.94	59395.74
280	78400.000	21952000.000	16.7332	6.5421	879.65	61575.22
285	81225.000	23149125.000	16.8819	6.5808	895.35	63793.97
290	84100.000	24389000.000	17.0294	6.6191	911.06	66051.99
295	87025.000	25672375.000	17.1756	6.6569	926.77	68349.28
300	90000.000	27000000.000	17.3205	6.6943	942.48	70685.83
305	93025.000	28372625.000	17.4642	6.7313	958.19	73061.66
310	96100.000	29791000.000	17.6068	6.7679	973.89	75476.76
315	99225.000	31255875.000	17.7482	6.8041	989.60	77931.13
320	102400.000	32768000.000	17.8885	6.8399	1005.31	80424.77
325	105625.000	34328125.000	18.0278	6.8753	1021.02	82957.68
330	108900.000	35937000.000	18.1659	6.9104	1036.73	85529.86
335	112225.000	37595375.000	18.3030	6.9451	1052.43	88141.31
340	115600.000	39304000.000	18.4391	6.9795	1068.14	90792.03
345	119025.000	41063625.000	18.5742	7.0136	1083.85	93482.02
350	122500.000	42875000.000	18.7083	7.0473	1099.56	96211.28
355	126025.000	44738875.000	18.8414	7.0807	1115.27	98979.80
360	129600.000	46656000.000	18.9737	7.1138	1130.97	101787.60
365	133225.000	48627125.000	19.1050	7.1466	1146.68	104634.67
370	136900.000	50653000.000	19.2354	7.1791	1162.39	107521.01
375	140625.000	52734375.000	19.3649	7.2112	1178.10	110446.62
380	144400.000	54872000.000	19.4936	7.2432	1193.81	113411.49
385	148225.000	57066625.000	19.6214	7.2748	1209.51	116415.64
390	152100.000	59319000.000	19.7484	7.3061	1225.22	119459.06
395	156025.000	61629875.000	19.8746	7.3372	1240.93	122541.75
400	160000.000	64000000.000	20.0000	7.3681	1256.64	125663.71
405	164025.000	66430125.000	20.1246	7.3986	1272.35	128824.93
410	168100.000	68921000.000	20.2485	7.4290	1288.05	132025.43
415	172225.000	71473375.000	20.3715	7.4590	1303.76	135265.20
420	176400.000	74088000.000	20.4939	7.4889	1319.47	138544.24
425	180625.000	76765625.000	20.6155	7.5185	1335.18	141862.54
430	184900.000	79507000.000	20.7364	7.5478	1350.88	145220.12
435	189225.000	82312875.000	20.8567	7.5770	1366.59	148616.97
440	193600.000	85184000.000	20.9762	7.6059	1382.30	152053.08
445	198025.000	88121125.000	21.0950	7.6346	1398.01	155528.47
450	202500.000	91125000.000	21.2132	7.6631	1413.72	159043.13
455	207025.000	94196375.000	21.3307	7.6914	1429.42	162597.05
460	211600.000	97336000.000	21.4476	7.7194	1445.13	166190.25
465	216225.000	100544625.000	21.5639	7.7473	1460.84	169822.72
470	220900.000	103823000.000	21.6795	7.7750	1476.55	173494.45
475	225625.000	107171875.000	21.7945	7.8025	1492.26	177205.46
480	230400.000	110592000.000	21.9089	7.8297	1507.96	180955.74
485	235225.000	114084125.000	22.0227	7.8568	1523.67	184745.28
490	240100.000	117649000.000	22.1359	7.8837	1539.38	188574.10
495	245025.000	121287375.000	22.2486	7.9105	1555.09	192442.18
500	250000.000	125000000.000	22.3607	7.9370	1570.80	196349.54

TABLE 2.
Trigonometric Functions.

Angle, degrees	Sine	Tangent	Angle, degrees	Sine	Tangent	Angle, degrees	
0.0	0.00000	0.00000	90.0	47.5	0.73728	1.0913	42.5
2.5	0.04362	0.04362	87.5	50.0	0.76604	1.1917	40.0
5.0	0.08716	0.08749	85.0	52.5	0.79335	1.3032	37.5
7.5	0.13053	0.13165	82.5	55.0	0.81915	1.4281	35.0
10.0	0.17365	0.17633	80.0	57.5	0.84339	1.5697	32.5
12.5	0.21644	0.22169	77.5	60.0	0.86603	1.7321	30.0
15.0	0.25882	0.26795	75.0	62.5	0.88701	1.9210	27.5
17.5	0.30071	0.31530	72.5	65.0	0.90631	2.1445	25.0
20.0	0.34202	0.36397	70.0	67.5	0.92388	2.4142	22.5
22.5	0.38263	0.41421	67.5	70.0	0.93969	2.7474	20.0
25.0	0.42262	0.46631	65.0	72.5	0.95372	3.1716	17.5
27.5	0.46175	0.52057	62.5	75.0	0.96593	3.7321	15.0
30.0	0.50000	0.57735	60.0	77.5	0.97630	4.5107	12.5
32.5	0.53730	0.63707	57.5	80.0	0.98481	5.6713	10.0
35.0	0.57358	0.70021	55.0	82.5	0.99144	7.5958	7.5
37.5	0.60876	0.76733	52.5	85.0	0.99619	11.430	5.0
40.0	0.64279	0.83910	50.0	87.0	0.99863	19.081	3.0
42.5	0.67559	0.91633	47.5	88.5	0.99966	38.188	1.5
45.0	0.70711	1.0000	45.0	90.0	1.0000	Infinite	0.0
	Cosine	Cotan- gent	Angle, degrees		Cosine	Cotan- gent	Angle, degrees

TABLE 3.
Equivalents of Compound Units.

1 lb. per sq. in.	=	$\left\{ \begin{array}{l} 27.71 \text{ in. of water at } 62^\circ \text{ F.} \\ 2.0355 \text{ in. of mercury at } 32^\circ \text{ F.} \\ 2.0416 \text{ in. of mercury at } 62^\circ \text{ F.} \\ 2.3090 \text{ ft. of water at } 62^\circ \text{ F.} \\ 1784. \text{ ft. of air at } 32^\circ \text{ F.} \end{array} \right.$
1 oz. per sq. in.	=	$\left\{ \begin{array}{l} 0.1276 \text{ in. of mercury at } 62^\circ \text{ F.} \\ 1.732 \text{ in. of water at } 62^\circ \text{ F.} \end{array} \right.$
1 in. of water at 62° F.	=	$\left\{ \begin{array}{l} 0.03609 \text{ lb. or } .5574 \text{ oz. per sq. in.} \\ 5.196 \text{ lbs. per sq. ft.} \\ 0.0736 \text{ in. of mercury at } 62^\circ \text{ F.} \end{array} \right.$
1 in. of water at 32° F.	=	$\left\{ \begin{array}{l} 5.2021 \text{ lbs. per sq. ft.} \\ 0.036125 \text{ lb. per sq. in.} \end{array} \right.$
1 in. of mercury at 62° F.	=	$\left\{ \begin{array}{l} 0.491 \text{ lb. or } 7.86 \text{ oz. per sq. in.} \\ 1.132 \text{ ft. of water at } 62^\circ \text{ F.} \\ 13.58 \text{ in. of water at } 62^\circ \text{ F.} \end{array} \right.$
1 ft. of air at 32° F.	=	$\left\{ \begin{array}{l} 0.0005606 \text{ lb. per sq. in.} \\ 0.015534 \text{ in. of water at } 62^\circ \text{ F.} \end{array} \right.$

TABLE 4.

Properties of Saturated Steam.*

Absolute press're lbs. per sq. in.	Tempera- ture deg. F.	Heat of the liquid	Heat of the vaporiza- tion	Total heat above 32°
1	101.84	69.8	1034.7	1104.5
2	126.15	94.2	1021.9	1116.1
3	141.52	109.6	1012.2	1121.8
4	153.00	121.0	1005.5	1126.5
5	162.26	130.3	1000.0	1130.3
6	170.07	138.1	995.5	1133.6
7	176.84	144.9	991.4	1136.3
8	182.86	150.9	987.8	1138.7
9	188.27	156.4	984.5	1140.9
10	193.21	161.3	981.4	1142.7
11	197.74	165.9	978.6	1144.5
12	201.95	170.1	976.0	1146.1
13	205.87	174.1	973.6	1147.7
14	209.55	177.8	971.2	1149.0
14.7	212.00	180.3	969.7	1150.0
15	213.03	181.3	969.1	1150.4
16	216.31	184.6	967.0	1151.6
17	219.43	187.8	965.0	1152.8
18	222.40	190.8	963.1	1153.9
19	225.24	193.7	961.2	1154.9
20	227.95	196.4	959.4	1155.8
21	230.56	199.1	957.7	1156.8
22	233.07	201.6	956.0	1157.6
23	235.50	204.1	954.4	1158.5
24	237.82	206.4	952.9	1159.3
25	240.07	208.7	951.4	1160.1
26	242.26	210.9	949.9	1160.8
27	244.36	213.0	948.5	1161.5
28	246.41	215.1	947.1	1162.2
29	248.41	217.2	945.8	1163.0
30	250.34	219.1	944.4	1163.5
31	252.22	221.0	943.1	1164.1
32	254.05	222.9	941.8	1164.7
33	255.84	224.7	940.6	1165.3
34	257.59	226.5	939.4	1165.9
35	259.29	228.2	938.2	1166.4
36	260.96	229.9	937.1	1167.0
37	262.58	231.6	935.9	1167.5
38	264.17	233.2	934.8	1168.0
39	265.73	234.8	933.7	1168.5
40	267.26	236.4	932.6	1169.0
41	268.76	237.9	931.6	1169.5
42	270.23	239.4	930.6	1170.0
43	271.66	240.8	929.5	1170.3
44	273.07	242.3	928.5	1170.8

*Condensed from Peabody's Steam Tables. 1911 Edition.

Absolute press're lbs. per sq. in.	Tempera- ture deg. F.	Heat of the liquid	Heat of the vaporiza- tion	Total heat above 32°
45	274.46	243.7		
46	275.82	245.1	927.5	1171.2
47	277.16	246.4	926.6	1171.7
48	278.47	247.8	925.6	1172.0
49	279.76	249.1	924.7	1172.5
			923.8	1172.9
50	281.03	250.4		
51	282.28	251.7	922.8	1173.2
52	283.52	253.0	921.9	1173.6
53	284.74	254.2	921.0	1174.0
54	285.93	255.4	920.1	1174.3
			919.3	1174.7
55	287.09	256.6		
56	288.25	257.8	918.4	1175.0
57	289.40	259.0	917.6	1175.4
58	290.53	260.1	916.7	1175.7
59	291.64	261.3	915.9	1176.0
			915.1	1176.4
60	292.74	262.4		
61	293.82	263.5	914.3	1176.7
62	294.88	264.6	913.5	1177.0
63	295.93	265.7	912.7	1177.3
64	296.97	266.7	911.9	1177.6
			911.1	1177.8
65	298.00	267.8		
66	299.02	268.8	910.4	1178.2
67	300.02	269.8	909.6	1178.4
68	301.01	270.9	908.9	1178.7
69	301.99	271.9	908.1	1179.0
			907.4	1179.3
70	302.96	272.9		
71	303.91	273.8	906.6	1179.5
72	304.86	274.8	905.9	1179.7
73	305.79	275.8	905.2	1180.0
74	306.72	276.7	904.5	1180.3
			903.8	1180.5
75	307.64	277.7		
76	308.54	278.6	903.1	1180.8
77	309.44	279.5	902.4	1181.0
78	310.33	280.4	901.8	1181.3
79	311.21	281.3	901.1	1181.5
			900.4	1181.7
80	312.08	282.2		
81	312.94	283.1	899.8	1182.0
82	313.79	283.9	899.1	1182.2
83	314.63	284.8	898.5	1182.4
84	315.47	285.7	897.8	1182.6
			897.2	1182.9
85	316.30	286.5		
86	317.12	287.4	896.6	1183.1
87	317.93	288.2	895.9	1183.3
88	318.73	289.0	895.3	1183.5
89	319.53	289.9	894.7	1183.7
			894.1	1184.0
90	320.32	290.7		
91	321.10	291.5	893.5	1184.2
92	321.88	292.3	892.9	1184.4
93	322.65	293.1	892.3	1184.6
94	323.41	293.9	891.7	1184.8
			891.1	1185.0

Absolute press're lbs. per sq. in.	Tempera- ture deg. F.	Heat of the liquid	Heat of the vaporiza- tion	Total heat Above 32°
95	324.16	294.6	890.5	1185.1
96	324.91	295.4	889.9	1185.3
97	325.66	296.2	889.3	1185.5
98	326.40	296.9	888.7	1185.6
99	327.13	297.7	888.2	1185.9
100	327.86	298.5	887.6	1186.1
101	328.58	299.2	887.0	1186.2
102	329.30	299.9	886.5	1186.4
103	330.01	300.6	885.9	1186.5
104	330.72	301.4	885.3	1186.7
105	331.42	302.1	884.8	1186.9
106	332.11	302.8	884.3	1187.1
107	332.79	303.5	883.7	1187.2
108	333.48	304.2	883.2	1187.4
109	334.16	304.9	882.6	1187.5
110	334.83	305.6	882.1	1187.7
111	335.50	306.3	881.6	1187.9
112	336.17	307.0	881.0	1188.0
113	336.83	307.7	880.5	1188.2
114	337.48	308.3	880.0	1188.3
115	338.14	309.0	879.5	1188.5
116	338.78	309.7	879.0	1188.7
117	339.42	310.3	878.5	1188.8
118	340.06	311.0	878.0	1189.0
119	340.69	311.7	877.4	1189.1
120	341.31	312.3	876.9	1189.2
121	341.94	312.9	876.4	1189.3
122	342.56	313.6	875.9	1189.5
123	343.18	314.2	875.4	1189.6
124	343.79	314.8	875.0	1189.8
125	344.39	315.5	874.5	1190.0
126	345.00	316.1	874.0	1190.1
127	345.60	316.7	873.5	1190.2
128	346.20	317.3	873.0	1190.3
129	346.79	317.9	872.6	1190.5
130	347.38	318.6	872.1	1190.7
131	347.96	319.2	871.6	1190.8
132	348.55	319.8	871.1	1190.9
133	349.13	320.4	870.7	1191.1
134	349.70	320.9	870.2	1191.1
135	350.27	321.5	869.8	1191.3
136	350.84	322.1	869.3	1191.4
137	351.41	322.7	868.8	1191.5
138	351.98	323.3	868.3	1191.6
139	352.54	323.9	867.9	1191.8
140	353.09	324.4	867.4	1191.8
141	353.65	325.0	867.0	1192.0
142	354.20	325.6	866.5	1192.1
143	354.75	326.2	866.1	1192.3
144	355.29	326.7	865.6	1192.3

TABLE 5.

Napierian Logarithms.

$e = 2.7182818$

$\text{Log } e = 0.4342945 = M.$

1.0	0.0000	4.1	1.4110	7.2	1.9741
1.1	0.0953	4.2	1.4351	7.3	1.9879
1.2	0.1823	4.3	1.4586	7.4	2.0015
1.3	0.2624	4.4	1.4816	7.5	2.0149
1.4	0.3365	4.5	1.5041	7.6	2.0281
1.5	0.4055	4.6	1.5261	7.7	2.0412
1.6	0.4700	4.7	1.5476	7.8	2.0541
1.7	0.5306	4.8	1.5686	7.9	2.0669
1.8	0.5878	4.9	1.5892	8.0	2.0794
1.9	0.6419	5.0	1.6094	8.1	2.0919
2.0	0.6931	5.1	1.6292	8.2	2.1041
2.1	0.7419	5.2	1.6487	8.3	2.1163
2.2	0.7885	5.3	1.6677	8.4	2.1282
2.3	0.8329	5.4	1.6864	8.5	2.1401
2.4	0.8755	5.5	1.7047	8.6	2.1518
2.5	0.9163	5.6	1.7228	8.7	2.1633
2.6	0.9555	5.7	1.7405	8.8	2.1748
2.7	0.9933	5.8	1.7579	8.9	2.1861
2.8	1.0296	5.9	1.7750	9.0	2.1972
2.9	1.0647	6.0	1.7918	9.1	2.2083
3.0	1.0986	6.1	1.8083	9.2	2.2192
3.1	1.1312	6.2	1.8245	9.3	2.2300
3.2	1.1632	6.3	1.8405	9.4	2.2407
3.3	1.1939	6.4	1.8563	9.5	2.2513
3.4	1.2238	6.5	1.8718	9.6	2.2618
3.5	1.2528	6.6	1.8871	9.7	2.2721
3.6	1.2809	6.7	1.9021	9.8	2.2824
3.7	1.3083	6.8	1.9169	9.9	2.2925
3.8	1.3350	6.9	1.9315	10.0	2.3026
3.9	1.3610	7.0	1.9459		
4.0	1.3863	7.1	1.9601		

TABLE 6.

Water Conversion Factors.*

U. S. gallons	×	8.33	= pounds.
U. S. gallons	×	0.13368	= cubic feet.
U. S. gallons	×	231.00000	= cubic inches.
U. S. gallons	×	3.78	= liters.
Cubic inches of water (39.1°)	×	0.036024	= pounds.
Cubic inches of water (39.1°)	×	0.004329	= U. S. gallons.
Cubic inches of water (39.1°)	×	0.576384	= ounces.
Cubic feet of water (39.1°)	×	62.425	= pounds.
Cubic feet of water (39.1°)	×	7.48	= U. S. gallons.
Cubic feet of water (39.1°)	×	0.028	= tons.
Pounds of water	×	27.72	= cubic inches.
Pounds of water	×	0.01602	= cubic feet.
Pounds of water	×	0.12	= U. S. gallons.

*American Machinist Hand Book.

TABLE 7.

Volume and Weight of Dry Air at Different Temperatures.*

Under a constant atmospheric pressure of 29.92 inches of mercury, the volume at 32° F. being 1.

Temp. deg. F.	Volume	Weight per cu. ft.	Temp. deg. F.	Volume	Weight per cu. ft.
0	.935	.0864	500	1.954	.0413
12	.960	.0842	552	2.056	.0385
22	.980	.0824	600	2.150	.0376
32	1.000	.0807	650	2.250	.0357
42	1.020	.0791	700	2.362	.0338
52	1.041	.0776	750	2.465	.0328
62	1.061	.0761	800	2.566	.0315
72	1.082	.0747	850	2.668	.0303
82	1.102	.0733	900	2.770	.0292
92	1.122	.0720	950	2.871	.0281
102	1.143	.0707	1000	2.974	.0268
112	1.163	.0694	1100	3.177	.0254
122	1.184	.0682	1200	3.381	.0239
132	1.204	.0671	1300	3.584	.0225
142	1.224	.0659	1400	3.788	.0213
152	1.245	.0649	1500	3.993	.0202
162	1.265	.0638	1600	4.196	.0192
172	1.285	.0628	1700	4.402	.0183
182	1.306	.0618	1800	4.605	.0175
192	1.326	.0609	1900	4.808	.0168
202	1.347	.0600	2000	5.012	.0161
212	1.367	.0591	2100	5.217	.0155
230	1.404	.0575	2200	5.420	.0149
250	1.444	.0559	2300	5.625	.0142
275	1.495	.0540	2400	5.827	.0138
300	1.546	.0522	2500	6.032	.0133
325	1.597	.0506	2600	6.236	.0130
350	1.648	.0490	2700	6.440	.0125
375	1.689	.0477	2800	6.644	.0121
400	1.750	.0461	2900	6.847	.0118
450	1.852	.0436	3000	7.051	.0114

*Supplee's M. E. Reference Book.

TABLE 8.

**Weight of Pure Water per Cubic Foot at Various
Temperatures.***

Temp. deg. F.	Weight lbs. per cu. ft.	B. t. u. per pound above 32	Temp. deg. F.	Weight lbs. per cu. ft.	B. t. u. per pound above 32
32	62.42	0.00	77	62.26	45.04
33	62.42	1.01	78	62.25	46.04
34	62.42	2.02	79	62.24	47.04
35	62.42	3.02	80	62.23	48.03
36	62.42	4.03	81	62.22	49.03
37	62.42	5.04	82	62.21	50.03
38	62.42	6.04	83	62.20	51.02
39	62.42	7.05	84	62.19	52.02
40	62.42	8.05	85	62.18	53.02
41	62.42	9.05	86	62.17	54.01
42	62.42	10.06	87	62.16	55.01
43	62.42	11.06	88	62.15	56.01
44	62.42	12.06	89	62.14	57.00
45	62.42	13.07	90	62.13	58.00
46	62.42	14.07	91	62.12	59.00
47	62.42	15.07	92	62.11	60.00
48	62.41	16.07	93	62.10	60.99
49	62.41	17.08	94	62.09	61.99
50	62.41	18.08	95	62.08	62.99
51	62.41	19.08	96	62.07	63.98
52	62.40	20.08	97	62.06	64.98
53	62.40	21.08	98	62.05	65.98
54	62.40	22.08	99	62.03	66.97
55	62.39	23.08	100	62.02	67.97
56	62.39	24.08	101	62.01	68.97
57	62.39	25.08	102	62.00	69.96
58	62.38	26.08	103	61.99	70.96
59	62.38	27.08	104	61.97	71.96
60	62.37	28.08	105	61.96	72.95
61	62.37	29.08	106	61.95	73.95
62	62.36	30.08	107	61.93	74.95
63	62.36	31.07	108	61.92	75.95
64	62.35	32.07	109	61.91	76.94
65	62.34	33.07	110	61.89	77.94
66	62.34	34.07	111	61.88	78.94
67	62.33	35.07	112	61.86	79.93
68	62.33	36.07	113	61.85	80.93
69	62.32	37.06	114	61.83	81.93
70	62.31	38.06	115	61.82	82.92
71	62.31	39.06	116	61.80	83.92
72	62.30	40.05	117	61.78	84.92
73	62.29	41.05	118	61.77	85.92
74	62.28	42.05	119	61.75	86.91
75	62.28	43.05	120	61.74	87.91
76	62.27	44.04	121	61.72	88.91

*Kent's M. E. Pocket-Book. 8th Edition.

Temp. deg. F.	Weight lbs. per cu. ft.	B. t. u. per pound above 32	Temp. deg. F.	Weight lbs. per cu. ft.	B. t. u. per pound above 32
122	61.70	89.91	167	60.83	134.86
123	61.68	90.90	168	60.81	135.86
124	61.67	91.90	169	60.79	136.86
125	61.65	92.90	170	60.77	137.87
126	61.63	93.90	171	60.75	138.87
127	61.61	94.89	172	60.73	139.87
128	61.60	95.89	173	60.70	140.87
129	61.58	96.89	174	60.68	141.87
130	61.56	97.89	175	60.66	142.87
131	61.54	98.89	176	60.64	143.87
132	61.52	99.88	177	60.62	144.88
133	61.51	100.88	178	60.59	145.88
134	61.49	101.88	179	60.57	146.88
135	61.47	102.88	180	60.55	147.88
136	61.45	103.88	181	60.53	148.88
137	61.43	104.87	182	60.50	149.89
138	61.41	105.87	183	60.48	150.89
139	61.39	106.87	184	60.46	151.89
140	61.37	107.87	185	60.44	152.89
141	61.36	108.87	186	60.41	153.89
142	61.34	109.87	187	60.39	154.90
143	61.32	110.87	188	60.37	155.90
144	61.30	111.87	189	60.34	156.90
145	61.28	112.86	190	60.32	157.91
146	61.26	113.86	191	60.29	158.91
147	61.24	114.86	192	60.27	159.91
148	61.22	115.86	193	60.25	160.91
149	61.20	116.86	194	60.22	161.92
150	61.18	117.86	195	60.20	162.92
151	61.16	118.86	196	60.17	163.92
152	61.14	119.86	197	60.15	164.93
153	61.12	120.86	198	60.12	165.93
154	61.10	121.86	199	60.10	166.94
155	61.08	122.86	200	60.07	167.94
156	61.06	123.86	201	60.05	168.94
157	61.04	124.86	202	60.02	169.95
158	61.02	125.86	203	60.00	170.95
159	61.00	126.86	204	59.97	171.96
160	60.98	127.86	205	59.95	172.96
161	60.96	128.86	206	59.92	173.97
162	60.94	129.86	207	59.89	174.97
163	60.92	130.86	208	59.87	175.98
164	60.90	131.86	209	59.84	176.98
165	60.87	132.86	210	59.82	177.99
166	60.85	133.86	211	59.79	178.99
			212	59.76	180.

TABLE 9.

Boiling Point of Water at Different Heights of Vacuum.

Temp. F.	Height of mercury in vacuum tube in inches	Temp. F.	Height of mercury in vacuum tube in inches
212.0	0.00	175.8	16.00
210.3	1.00	172.6	17.00
208.5	2.00	169.0	18.00
206.8	3.00	165.3	19.00
204.8	4.00	161.2	20.00
202.9	5.00	156.7	21.00
200.9	6.00	151.9	22.00
199.0	7.00	146.5	23.00
196.7	8.00	140.3	24.00
194.5	9.00	133.3	25.00
192.2	10.00	124.9	26.00
189.7	11.00	114.4	27.00
187.3	12.00	108.4	28.00
184.6	13.00	102.0	29.00
181.3	14.00	98.0	29.92
178.9	15.00		

TABLE 10.

Weight of Water with Air per Cubic Foot at Different Temperatures and at Saturation.

Temp. F.	Weight, grains	Temp. F.	Weight, grains	Temp. F.	Weight, grains	Temp. F.	Weight, grains	Temp. F.	Weight, grains
-20	0.166	2	0.529	24	1.483	46	3.539	68	7.480
-19	0.174	3	0.554	25	1.551	47	3.667	69	7.726
-18	0.184	4	0.582	26	1.623	48	3.800	70	7.980
-17	0.196	5	0.610	27	1.697	49	3.936	71	8.240
-16	0.207	6	0.639	28	1.773	50	4.076	72	8.508
-15	0.218	7	0.671	29	1.853	51	4.222	73	8.782
-14	0.231	8	0.704	30	1.935	52	4.372	74	9.066
-13	0.243	9	0.739	31	2.022	53	4.526	75	9.356
-12	0.257	10	0.776	32	2.113	54	4.685	76	9.655
-11	0.270	11	0.816	33	2.194	55	4.849	77	9.962
-10	0.285	12	0.856	34	2.279	56	5.016	78	10.277
-9	0.300	13	0.898	35	2.366	57	5.191	79	10.601
-8	0.316	14	0.941	36	2.457	58	5.370	80	10.934
-7	0.332	15	0.986	37	2.550	59	5.555	81	11.275
-6	0.350	16	1.032	38	2.646	60	5.745	82	11.626
-5	0.370	17	1.080	39	2.746	61	5.941	83	11.987
-4	0.389	18	1.128	40	2.849	62	6.142	84	12.356
-3	0.411	19	1.181	41	2.955	63	6.349	85	12.736
-2	0.434	20	1.235	42	3.064	64	6.563	86	13.127
-1	0.457	21	1.294	43	3.177	65	6.782	87	13.526
0	0.481	22	1.355	44	3.294	66	7.009	88	13.937
1	0.505	23	1.418	45	3.414	67	7.241	89	14.359

TABLE 11.

Relative Humidities.

Difference between the dry and wet thermometers.

Air temperatures										Air temperatures																													
0	1	2	3	4	5	6	7	8	9	10	11	12	13	14	15	16	17	18	19	20	21	22	23	24	25	26	27	28	29	30	31	32	33	34	35	36			
30	100	99	78	67	57	47	36	26	17	7	—	—	—	—	—	—	—	—	—	—	—	—	—	—	—	—	—	—	—	—	—	—	—	—	—	—	—	—	—
35	100	91	82	73	65	54	45	37	28	19	12	3	—	—	—	—	—	—	—	—	—	—	—	—	—	—	—	—	—	—	—	—	—	—	—	—	—	—	—
40	100	92	84	76	68	60	53	45	38	30	22	16	8	1	—	—	—	—	—	—	—	—	—	—	—	—	—	—	—	—	—	—	—	—	—	—	—	—	—
45	100	92	85	78	71	64	58	51	44	38	32	25	19	13	7	1	—	—	—	—	—	—	—	—	—	—	—	—	—	—	—	—	—	—	—	—	—	—	—
50	100	93	87	80	74	67	61	55	50	44	38	33	27	22	16	11	6	1	—	—	—	—	—	—	—	—	—	—	—	—	—	—	—	—	—	—	—	—	—
55	100	94	88	82	76	70	65	59	54	49	43	39	34	29	24	19	16	10	6	1	—	—	—	—	—	—	—	—	—	—	—	—	—	—	—	—	—	—	—
60	100	94	89	84	78	73	68	63	58	53	48	44	39	34	30	26	22	18	14	10	6	—	—	—	—	—	—	—	—	—	—	—	—	—	—	—	—	—	—
65	100	95	90	85	80	75	70	65	61	56	52	48	44	39	35	31	28	24	20	17	13	10	6	3	—	—	—	—	—	—	—	—	—	—	—	—	—	—	—
70	100	95	90	86	81	77	72	68	64	60	55	52	48	44	40	36	33	29	26	23	19	16	13	10	7	4	1	—	—	—	—	—	—	—	—	—	—	—	—
75	100	95	91	87	82	78	74	70	66	62	58	55	51	47	44	40	37	34	31	27	24	21	19	16	13	10	7	5	2	—	—	—	—	—	—	—	—	—	
80	100	96	92	87	83	79	75	72	68	64	61	57	54	51	47	44	41	38	35	32	29	26	23	20	18	15	13	10	8	6	3	1	—	—	—	—	—	—	
85	100	96	92	88	84	80	77	73	70	66	63	60	56	53	50	47	44	41	38	36	33	30	28	25	22	20	17	15	13	11	9	6	4	2	—	—	—	—	—
90	100	96	92	88	85	81	78	75	71	68	65	62	59	56	53	50	47	44	41	39	36	34	32	29	26	24	22	20	17	15	13	11	9	7	5	3	2	—	—
95	100	96	93	89	86	82	79	76	72	69	66	63	60	58	55	52	49	47	44	42	39	37	35	32	30	28	25	23	21	19	17	15	13	11	10	8	6	5	—
100	100	97	93	90	86	83	80	77	74	71	68	65	62	59	57	54	51	49	47	44	42	39	37	35	33	31	29	27	25	23	21	19	17	15	14	12	10	100	
105	100	97	93	90	87	84	81	78	75	72	69	66	64	61	58	56	53	51	49	46	44	42	40	38	35	33	31	30	28	26	24	22	20	19	17	15	14	105	
110	100	97	94	90	87	84	81	78	76	73	70	67	65	62	60	57	55	50	48	46	44	42	40	38	36	34	32	30	28	27	25	23	22	20	19	17	110		
115	100	97	94	91	88	85	82	79	76	74	71	69	66	64	61	59	57	54	52	50	48	46	44	42	40	38	36	34	33	31	29	28	26	24	23	21	20	115	
120	100	97	94	91	88	85	83	80	77	75	72	70	67	65	62	60	58	56	54	51	49	47	45	44	42	40	38	36	35	33	31	30	28	27	25	24	22	120	
125	100	97	94	91	88	86	83	80	78	75	73	70	68	66	64	62	59	57	55	53	51	49	47	45	43	42	40	38	37	35	33	32	30	29	27	26	24	125	
130	100	97	94	91	89	86	83	81	78	76	74	71	69	67	65	62	60	58	56	54	52	50	49	47	45	43	42	40	38	37	35	33	32	31	29	28	27	130	
135	100	97	94	92	89	86	84	81	79	77	74	72	70	68	65	63	61	59	57	55	53	51	50	48	46	45	43	41	40	38	37	35	34	32	31	30	28	135	
140	100	97	95	92	89	87	84	82	79	77	75	73	71	68	66	64	62	60	58	56	55	53	51	49	48	46	44	43	41	40	38	37	35	34	33	31	30	140	
—	0	1	2	3	4	5	6	7	8	9	10	11	12	13	14	15	16	17	18	19	20	21	22	23	24	25	26	27	28	29	30	31	32	33	34	35	36	—	

TABLE 12.

Properties of Air with Moisture under Pressure of One Atmosphere.*

1	2	3	4	5	Mixtures of air saturated with vapor.					11	12							
					Temperature Fahrenheit	Vol. of dry air at different temp. the vol. at 32° being 1.000	Weight of a cu. ft. of dry air at different temps. in lbs.	Elastic force of vapor in inches of mercury (Regnault.)	Elastic force of the air in the mixture of air & vapor in inches of mer.			Weight of cubic foot of the mixture.			Ratio of water to dry air.	Ratio of dry air to water vapor.	Cubic feet of vapor from one pound of water at pressure as in column 4.	Cubic feet dry air warmed one degree per B. t. u.
												Weight of the air in pounds.	Weight of the vapor in pounds.	Total weight of mixture in lbs.				
0	.935	.0864	0.044	29.877	.0863	.000079	.086379	.000092	1092.40	-----	48.5							
12	.960	.0842	0.074	29.849	.0840	.000130	.084130	.00115	646.10	-----	50.1							
22	.980	.0824	0.118	29.803	.0821	.000202	.082302	.00245	406.40	-----	51.1							
32	1.000	.0807	0.181	29.740	.0802	.000304	.080504	.00379	263.81	3289.0	52.0							
42	1.020	.0791	.0267	29.654	.0784	.000440	.078840	.00561	178.18	2252.0	53.2							
52	1.041	.0766	0.388	29.533	.0766	.000627	.077227	.00819	122.17	1595.0	54.0							
60	1.057	.0764	0.522	29.399	.0751	.000830	.075252	.01251	92.27	1227.0	55.0							
62	1.061	.0761	0.556	29.365	.0747	.000881	.075581	.01179	84.79	1135.0	55.2							
70	1.078	.0750	0.754	29.182	.0731	.001153	.073509	.01780	64.59	882.0	56.2							
72	1.082	.0747	0.785	29.136	.0727	.001221	.073921	.01680	59.54	819.0	56.3							
82	1.102	.0733	1.092	28.829	.0706	.001667	.072267	.02361	42.35	600.0	57.2							
92	1.122	.0720	1.501	28.420	.0684	.002250	.070717	.03289	30.40	444.0	58.4							
100	1.139	.0710	1.929	27.992	.0664	.002848	.069261	.04495	23.66	356.0	59.1							
102	1.143	.0707	2.036	27.885	.0659	.002997	.068897	.04547	21.98	334.0	59.5							
112	1.163	.0694	2.731	27.190	.0631	.003946	.067042	.06253	15.99	253.0	60.6							
122	1.184	.0682	3.621	26.300	.0599	.005142	.065046	.08584	11.65	194.0	61.7							
132	1.204	.0671	4.752	25.169	.0564	.006639	.063039	.11771	8.49	151.0	62.5							
142	1.224	.0660	6.165	23.756	.0524	.008473	.060873	.16170	6.18	118.0	63.7							
152	1.245	.0649	7.930	21.991	.0477	.010716	.058416	.22465	4.45	93.3	64.7							
162	1.265	.0638	10.099	19.822	.0423	.013415	.055715	.31713	3.15	74.5	65.8							
172	1.285	.0628	12.758	17.163	.0360	.016682	.052682	.46338	2.16	59.2	66.9							
182	1.306	.0618	15.960	13.961	.0288	.020536	.049336	.71300	1.402	48.6	68.0							
192	1.326	.0609	19.828	10.093	.0205	.025142	.045642	1.22643	.815	39.8	69.0							
202	1.347	.0600	24.450	5.471	.0109	.030545	.041445	2.80230	.357	32.7	70.0							
212	1.367	.0591	29.921	0.000	.0000	.036820	.036820	In- finite	.000	27.1	71.1							

*Carpenter's H. & V. B. and Sturtevant's Mech. Draft.

TABLE 13

Dew-Points of Air According to Its Hygrometric State.*

Temp.		Relative moisture									
		90%		80%		70%		60%		50%	
C.	F.	C.	F.	C.	F.	C.	F.	C.	F.	C.	F.
0	32.0	-1.5	29.3	-3.0	26.6	-4.9	23.2	-6.5	20.3	-9.2	15.4
2	35.6	0.9	33.6	-0.9	30.4	-2.5	27.5	-4.8	23.4	-7.1	19.2
4	39.2	2.4	36.3	0.9	33.6	-0.9	30.4	-2.9	26.8	-5.3	22.5
6	42.8	4.5	40.1	2.9	37.2	0.9	33.6	-1.3	29.7	-3.7	25.3
8	46.4	6.4	43.5	4.5	40.1	2.7	36.9	0.6	33.1	-1.9	28.6
10	50.0	8.5	47.3	6.8	44.2	4.5	40.1	2.5	36.5	0.0	32.0
12	53.6	10.5	50.9	8.5	47.3	6.8	44.2	4.3	39.7	2.0	35.6
14	57.2	12.3	54.1	10.5	50.9	8.5	47.3	6.2	43.2	3.7	38.7
16	60.8	14.4	57.9	12.6	54.7	10.5	50.9	8.3	46.9	5.6	42.1
18	64.4	16.5	61.7	14.6	58.3	12.4	54.3	10.0	50.0	7.4	45.3
20	68.0	18.3	64.9	16.5	61.7	14.4	57.9	11.9	53.4	9.2	48.6
22	71.6	20.3	68.5	18.4	65.1	16.3	61.3	13.7	56.7	11.6	52.8
24	75.2	22.2	72.1	20.5	68.9	18.4	65.1	15.6	60.0	13.0	55.4
26	78.8	24.4	75.9	22.2	72.1	20.1	68.2	17.6	63.6	14.7	58.5
28	82.4	26.3	79.3	24.2	75.6	22.0	71.6	19.5	67.1	17.5	63.5
30	86.0	28.3	82.9	26.3	79.3	23.9	75.0	21.5	70.7	18.3	64.9

*Bulletin 21, Int. Ass'n of Refrig.

Psychrometric Charts Recent Tests.

In recent years a highly technical study of humidity and its control has been made by Mr. Willis H. Carrier. Fig. A shows, merely for the sake of comparison, how closely his results checked the earlier values obtained by the Government Weather Bureau. The following charts, Figs. B and C, summarize the results of Mr. Carrier's experiments. Fig. C is a part of Fig. B drawn to a larger scale.

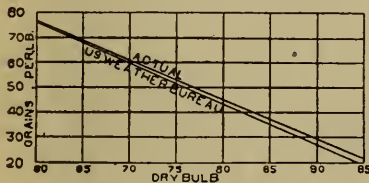

Fig. A.

As one illustration of the use of the chart, refer to Fig. C with air at 40 degrees and 40 per cent. humidity. If this air be heated to 100 degrees without addition of moisture it will be seen by interpolation that the humidity drops to about 8 per cent. If the same be heated to 100 degrees and enough moisture be added to keep the relative humidity at 40 per cent., then the absolute humidity changes from 15 grains to 120 grains per pound of air. These figures may be reduced to grains per cubic foot by dividing by the volume per pound as given in the second column and will be found to check closely with those given by Fig. 7 and Table 9. Almost any other points relating to changes in volume, humidity and contained heat may be easily worked out by these curves.

TABLE 14.

Fuel Value of American Coals.*

Coal Name or locality	Fuel value per pound of coal.		
	B. t. u. calculated.	B. t. u. by calorimeter.	Theoretical evap- oration in lbs. from and at 212 deg. F.
ARKANSAS.			
Spadra, Johnson Co.-----	14,420		14.90
Coal Hill, Johnson Co.-----		11,812	12.22
Huntington Co.-----		11,756	12.17
Lignite-----	9,215		9.54
COLORADO.			
Lignite-----	13,560		14.04
Lignite, slack-----	8,500		8.80
ILLINOIS.			
Big Muddy, Jackson Co.-----		11,781	12.19
Colchester, Slack-----		9,035	9.35
Gilispie, Macoupin Co.-----		9,739	10.09
Mercer Co.-----		13,123	13.58
INDIANA.			
Block-----	14,020		14.50
Cannel-----	13,097		13.56
IOWA.			
Good cheer-----		8,702	9.01
KENTUCKY.			
Caking-----	14,391		14.89
Cannel-----	15,198		16.76
Lignite-----	9,326		9.65
MISSOURI.			
Bevier Mines-----		9,890	10.24
NEW MEXICO.			
Coal-----		11,756	12.17
OHIO.			
Briar Hill, Mahoning Co.-----	13,714		14.20
Hocking Valley-----	13,414		13.90
PENNSYLVANIA.			
Anthracite-----	14,199		14.70
Anthracite, pea-----	12,300		12.73
Pittsburgh (average)-----		13,104	13.46
Youghiogeney-----		12,936	13.39
TEXAS.			
Fort Worth-----		9,450	9.78
Lignite-----	12,962		13.41
WEST VIRGINIA.			
Pocahontas-----		14,273	14.71
New River-----	14,200		14.70

*Sturtevant's "Mechanical Draft."

TABLE 15.

Capacities of Chimneys.*

Inside diameter of lined flue (inches)		Maximum sq. ft. of cast iron radiating surface and B. t. u. for a flue of the given diameter and height					
		25 ft. high	36 ft. high	49 ft. high	64 ft. high	81 ft. high	100 ft. high
6	Steam -----	146	175	204	233	262	291
	Hot water -----	243	291	340	388	437	485
	B. t. u. -----	36500	43750	51000	58250	65500	72750
7	Steam -----	228	273	319	364	410	455
	Hot water -----	379	455	531	607	683	758
	B. t. u. -----	57000	68250	79750	91000	102500	113750
8	Steam -----	327	392	457	523	588	653
	Hot water -----	544	653	762	871	980	1083
	B. t. u. -----	81750	98000	114250	130750	147000	163250
9	Steam -----	445	534	623	712	801	890
	Hot water -----	742	890	1038	1187	1335	1483
	B. t. u. -----	111250	133500	155750	178000	200250	222500
10	Steam -----	582	698	814	930	1047	1163
	Hot water -----	969	1163	1357	1551	1745	1938
	B. t. u. -----	145500	174500	203500	232500	261750	290750
12	Steam -----	909	1090	1272	1454	1636	1817
	Hot water -----	1514	1817	2120	2423	2726	3028
	B. t. u. -----	227250	272500	318000	363500	409000	454250
15	Steam -----	1537	1844	2151	2458	2766	3073
	Hot water -----	2561	3073	3586	4098	4610	5122
	B. t. u. -----	384250	461000	537750	614500	691500	768250
18	Steam -----	2327	2792	3257	3722	4188	4653
	Hot water -----	3878	4653	5429	6204	6980	7755
	B. t. u. -----	581750	698000	814250	930500	1047000	1163250

Radiation is calculated at 250 B. t. u. steam, 150 B. t. u. water.

*The Model Boiler Manual.

TABLE 16.

Equalization of Smoke Flues—Commercial Sizes.*

Inside diameter lined flue	Brick flue not lined well built	Rectangular lined flue outside of tile	Outside iron stack
6	8½x8½		8
7	8½x8½	7x7	9
8	8½x8½	8½x8½	10
9	8½x13	8½x13	11
10	8½x13	8½x13	12
12	13x13	13x13	14
15	13x17	13x18	17
18	17x21½	18x18	20

Round flue tile lining is listed by its inside measurement. Rectangular lining by outside measurement.

TABLE 17.

Dimensions of Registers.*

Size of opening, inches	Nominal area of opening, square inches	Effective area of opening, square inches	Tin box size, inches	Extreme dimensions of register face, inches
6 x 10	60	40	6 ¹ / ₈ x 10 ¹ / ₈	7 ¹ / ₈ x 11 ¹ / ₈
6 x 10	80	53	8 ⁵ / ₈ x 10 ⁵ / ₈	9 ³ / ₄ x 11 ³ / ₄
8 x 12	96	64	8 ⁵ / ₈ x 12 ⁵ / ₈	9 ³ / ₄ x 13 ³ / ₄
8 x 15	120	80	8 ⁷ / ₈ x 15 ⁷ / ₈	9 ³ / ₄ x 16 ¹ / ₈
9 x 12	108	72	9 ¹ / ₄ x 12 ¹ / ₄	10 ⁷ / ₈ x 13 ⁷ / ₈
9 x 14	126	84	9 ¹ / ₄ x 14 ¹ / ₄	10 ⁷ / ₈ x 15 ⁷ / ₈
10 x 12	120	80	10 ¹ / ₈ x 12 ¹ / ₈	11 ¹ / ₈ x 13 ¹ / ₈
10 x 14	140	98	10 ¹ / ₈ x 14 ¹ / ₈	11 ¹ / ₈ x 15 ¹ / ₈
10 x 16	160	107	10 ¹ / ₈ x 16 ¹ / ₈	11 ¹ / ₈ x 17 ⁷ / ₈
12 x 15	180	120	12 ³ / ₄ x 15 ³ / ₄	14 ¹ / ₈ x 17
12 x 19	228	152	12 ³ / ₄ x 19 ³ / ₄	14 ¹ / ₈ x 21
14 x 22	308	205	14 ⁷ / ₈ x 22 ⁷ / ₈	16 ¹ / ₄ x 24 ¹ / ₄
15 x 25	375	250	15 ⁷ / ₈ x 25 ⁷ / ₈	17 ¹ / ₄ x 27 ¹ / ₄
16 x 20	320	218	16 ⁷ / ₈ x 20 ⁷ / ₈	18 ¹ / ₈ x 22 ¹ / ₈
16 x 24	384	256	16 ⁷ / ₈ x 24 ⁷ / ₈	18 ¹ / ₈ x 26 ¹ / ₈
20 x 20	400	267	20 ¹ / ₈ x 20 ¹ / ₈	22 ³ / ₈ x 22 ³ / ₈
20 x 24	480	320	20 ¹ / ₈ x 24 ¹ / ₈	22 ³ / ₈ x 26 ³ / ₈
20 x 26	520	347	20 ¹ / ₈ x 26 ¹ / ₈	22 ³ / ₈ x 28 ³ / ₈
21 x 29	609	403	21 ¹ / ₈ x 29 ¹ / ₈	23 ³ / ₈ x 31 ³ / ₈
27 x 27	729	486	27 ¹ / ₈ x 27 ¹ / ₈	29 ³ / ₈ x 29 ³ / ₈
27 x 38	1026	684	27 ¹ / ₈ x 38 ¹ / ₈	29 ³ / ₈ x 40 ³ / ₈
30 x 30	900	600	30 ¹ / ₈ x 30 ¹ / ₈	32 ³ / ₈ x 32 ³ / ₈

Dimensions of different makes of registers vary slightly. The above are for Tuttle & Bailey manufacture.

*The Model Boiler Manual.

TABLE 18.

**Capacities of Warm Air Furnaces of Ordinary Construction in
Cubic Feet of Space Heated.***

Divided space			Fire-pot		Undivided space		
+10°	0°	-10°	Diam.	Area	+10°	0°	-10°
12000	10000	8000	18 in.	1.8 sq. ft.	17000	14000	12000
14000	12000	10000	20 "	2.2 "	22000	17000	14000
17000	14000	12000	22 "	2.6 "	26000	22000	17000
22000	18000	14000	24 "	3.1 "	30000	26000	22000
26000	22000	18000	26 "	3.7 "	35000	30000	26000
30000	26000	22000	28 "	4.3 "	40000	35000	30000
35000	30000	26000	30 "	4.9 "	50000	40000	35000

TABLE 19.

Capacities of Hot-Air Pipes and Registers.†

Size of register	Equivalent area in round or leader pipe.	Equivalent in square or riser pipe.	Cubic feet of space on first floor same will heat.	Cubic feet on second floor.	Cubic feet on third floor.
6x8	6 in.	4x8	400	450	500
8x8	7 "	4x10	450	500	560
8x10	8 "	4x10	500	850	880
8x12	8 "	4x11	800	1000	1050
9x12	9 "	4x12	1050	1250	1320
9x14	9 "	4x14	1050	1350	1450
10x12	10 "	4x14	1500	1650	1800
10x14	10 "	6x10	1800	2000	2200
10x16	10 "	6x10	1800	2000	2200
12x14	12 "	6x12	2200	2300	2500
12x15	12 "	6x12	2250	2300	2500
12x17	12 "	6x14	2300	2600	2800
12x19	12 "	6x14	2300	2600	2800
14x18	14 "	6x16	2800	3000	3200
14x20	14 "	6x16	2900	3000	3200
14x22	14 "	8x16	3000	3200	3400
16x20	16 "	8x18	3600	4000	4250
16x24	16 "	8x18	3700	4000	4250
20x24	18 "	10x20	4800	5400	5750
20x26	20 "	10x24	6000	7000	7450

*Federal Furnace League Handbook.

†Kidder's Arch. and B'ld'rs. Pocket-Book.

TABLE 20.

Air Heating Capacity of Warm Air Furnaces.*

Fire-pot		Casing	Total cross sec. area of heat pipes	No. and size of heat pipes that may be supplied
Diam.	Area	Diam.		
18 in.	1.8 sq. ft.	30"-32"	180 sq. in.	3-9" or 4-8"
20 "	2.2 "	34"-36"	280 "	2-10" and 2-9" or 3-9" and 2-8"
22 "	2.6 "	36"-40"	360 "	3-10" and 2-9" or 4-9" and 2-8"
24 "	3.1 "	40"-44"	470 "	3-10", 1-9" and 2-8" or 2-10" and 5-8"
26 "	3.7 "	44"-50"	565 "	5-10" and 3-9" or 3-10", 4-9" and 2-8"
28 "	4.3 "	48"-56"	650 "	2-12", 3-10" and 3-9" or 5-10", 3-9" and 2-8"
30 "	4.9 "	52"-60"	730 "	3-12", 3-10" and 3-9" or 5-10", 5-9" and 1-8"

TABLE 21.

Sectional Area (Square Inches) of Vertical Hot Air Flues, Natural Draft, Indirect System.†

Outside temperature 50° F. Flue temperature 90° F.

Sq. ft. cast iron radiation	STEAM				WATER			
	First story	Second story	Third story	Fourth story	First story	Second story	Third story	Fourth story
0 to 50	100	75	63	60	75	63	60	60
50 " 75	150	113	94	80	113	94	80	80
75 " 100	200	150	125	100	150	125	100	100
100 " 125	250	188	156	125	188	156	125	125
125 " 150	300	225	188	150	225	188	150	150
150 " 175	350	263	219	175	263	219	175	175
175 " 200	400	300	250	200	300	250	200	200
200 " 225	450	338	281	225	338	281	225	225
225 " 250	500	375	313	250	375	313	250	250
250 " 275	550	413	344	275	413	344	275	275
275 " 300	600	450	375	300	450	375	300	300
300 " 325	650	488	406	325	488	406	325	325
325 " 350	700	525	438	350	525	438	350	350
350 " 375	750	563	469	375	563	469	375	375
375 " 400	800	600	500	400	600	500	400	400
Velocity feet per sec.	2½	4½	5½	6½	1½	2½	4	4
Effective area of register. Factor for	1.00	1.50	1.83	2.17	1.00	1.00	1.33	1.33

*Federal Furnace League Handbook.

†The Model Boiler Manual.

TABLE 22.

Sheet Metal Dimensions and Weights.

Decimal gage	Approximate millimeters	Wt. per sq. ft. in lbs.		U. S. gage numbers
		Iron 480 lbs. per cu. ft.	Steel 489.6 lbs. per cu. ft.	
0.002	0.05	0.08	0.082	
0.004	0.10	0.16	0.163	
0.006	0.15	0.24	0.245	33-39
0.008	0.20	0.32	0.326	34-35
0.010	0.25	0.40	0.408	32
0.012	0.30	0.48	0.490	30-31
0.014	0.36	0.56	0.571	29
0.016	0.41	0.64	0.653	27-28
0.018	0.46	0.72	0.734	26-27
0.020	0.51	0.80	0.816	25-26
0.022	0.56	0.88	0.898	25
0.025	0.64	1.00	1.020	24
0.028	0.71	1.12	1.142	23
0.032	0.81	1.28	1.306	21-22
0.036	0.91	1.44	1.469	20-21
0.040	1.02	1.60	1.632	19-20
0.045	1.14	1.80	1.836	18-19
0.050	1.27	2.00	2.040	18
0.055	1.40	2.20	2.244	17
0.060	1.52	2.40	2.448	16-17
0.065	1.65	2.60	2.652	15-16
0.070	1.78	2.80	2.856	15
0.075	1.90	3.00	3.060	14-15
0.080	2.03	3.20	3.264	13-14
0.085	2.16	3.40	3.468	13-14
0.090	2.28	3.60	3.672	13-14
0.095	2.41	3.80	3.876	12-13
0.100	2.54	4.00	4.080	12-13
0.110	2.79	4.40	4.488	12
0.125	3.18	5.00	5.100	11
0.135	3.43	5.40	5.508	10-11
0.150	3.81	6.00	6.120	9-10
0.165	4.19	6.60	6.732	8-9
0.180	4.57	7.20	7.344	7-8
0.200	5.08	8.00	8.160	6-7
0.220	5.59	8.80	8.976	4-5
0.240	6.10	9.60	9.792	3-4
0.250	6.35	10.00	10.200	3

For weights of galvanized iron, multiply weight, black, by:—

No. 28	No. 26	No. 24	No. 22	No. 20	No. 18	No. 16
1.25	1.21	1.16	1.13	1.11	1.08	1.07

TABLE 23.

**Weight of Round Galvanized Iron Pipe and Elbows of the
Proper Gages for Heating and Ventilating Work.**

Gage and weight per sq. ft.	Diam of pipe	Circumf. of pipe in inches	Area in sq. in.	Weight per running foot	Weight of full elbow	Gage and weight per sq. ft.	Diam. of pipe	Circumf. of pipe in inches	Area in sq. in.	Weight per running foot	Weight of full elbow
No. 28 0.78	3	9.43	7.1	0.7	0.4	No. 20 1.66	36	113.10	1017.9	17.2	124.4
	4	12.57	12.6	1.1	0.9		37	116.24	1075.2	17.8	131.4
	5	15.71	19.6	1.2	1.2		38	119.38	1134.1	18.2	139.4
	6	18.85	28.3	1.4	1.7		39	122.52	1194.6	18.7	146.0
	7	21.99	38.5	1.7	2.3		40	125.66	1256.6	19.1	152.9
	8	25.13	50.3	1.9	2.9		41	128.81	1320.6	19.6	160.7
No. 26 0.91	9	28.27	63.6	2.4	4.3		42	131.95	1385.4	20.1	168.6
	10	31.42	78.5	2.7	5.3		43	135.09	1452.2	20.6	176.7
	11	34.56	95.0	2.9	6.4		44	138.23	1520.5	21.0	185.0
	12	37.70	113.1	3.2	7.6		45	141.37	1590.4	21.5	193.4
	13	40.84	132.7	3.4	8.9		46	144.51	1661.9	22.0	202.2
	14	43.98	153.9	3.7	10.4						
No. 25 1.03	15	47.12	176.7	4.5	13.5		47	147.65	1734.9	22.2	211.8
	16	50.27	201.1	4.7	15.1		48	150.80	1809.6	22.8	221.4
	17	53.41	227.0	5.0	17.0	49	153.94	1885.7	23.4	231.8	
	18	56.55	254.5	5.3	19.1	50	157.08	1963.5	24.0	243.0	
	19	59.69	283.5	5.6	21.4	51	160.22	2042.8	24.6	254.8	
	20	62.83	314.2	6.0	23.9	52	163.36	2123.7	25.2	267.2	
No. 24 1.16	21	65.97	346.4	7.0	29.6	53	166.50	2206.2	25.8	280.2	
	22	69.12	380.1	7.3	32.3	54	169.65	2290.2	26.4	293.8	
	23	72.26	415.5	7.7	35.6	55	172.79	2375.8	27.0	308.0	
	24	75.40	452.4	8.0	38.6	56	175.93	2463.0	27.6	322.8	
	25	78.54	490.9	8.3	41.7	57	179.07	2551.8	28.2	338.2	
	26	81.68	530.9	8.7	45.1	58	182.21	2642.1	28.8	354.2	
No. 22 1.41	27	84.82	572.6	10.9	59.1	59	185.35	2734.0	29.4	370.8	
	28	87.97	615.7	11.4	64.2	60	188.50	2827.4	30.0	388.0	
	29	91.11	660.5	11.8	68.6						
	30	94.25	706.9	12.2	73.4	61	191.64	2922.5	30.6	405.8	
	31	97.39	754.8	12.6	78.3	62	194.78	3019.1	31.2	424.2	
	32	100.53	804.3	13.0	83.4	63	197.92	3117.3	31.8	443.2	
	33	103.67	855.3	13.5	88.9	64	201.06	3217.0	32.4	462.8	
	34	106.84	907.9	13.9	94.3	65	204.20	3318.2	33.0	483.0	
	35	109.96	962.1	14.3	99.9	66	207.34	3421.2	33.6	503.8	
						67	210.48	3526.0	34.2	525.2	
						68	213.63	3631.7	34.8	547.2	
						69	216.77	3739.0	35.4	569.8	
						70	219.91	3848.5	36.0	593.0	
						71	223.05	3959.0	36.6	616.8	
						72	226.19	4071.5	37.2	641.2	

TABLE 24.

Specific Heats, Coefficients of Expansion, Coefficients of Transmission, and Fusing-Points of Solids, Liquids or Gases.*

SUBSTANCE	Specific heats	Coefficient of expansion	Coefficient of transmission	Fusion points, degrees
Antimony -----	0.0508	.0000602	.00022	815
Copper -----	0.0951	.00000955	.00404	1949
Gold -----	0.0324	.00001060	-----	1947
Wrought iron -----	0.1138	.00000895	.00089	2975
Glass -----	0.1937	.00000478	.0000008	1832
Cast iron -----	0.1298	.00000618	.000659	2192
Lead -----	0.0314	.00001580	.00045	621
Platinum -----	0.0324	.00000530	-----	3452
Silver -----	0.0570	.00001060	.00610	1751
Tin -----	0.0562	.00001500	.00084	446
Steel (soft) -----	0.1165	.00000600	.00062	2507
Steel (hard) -----	0.1175	.00000689	.00034	2507
Nickel steel 36%-----	-----	.00000003	-----	-----
Zinc -----	0.0956	.00001633	.00170	787
Brass -----	0.0939	.00001043	.00142	1859
Ice -----	0.5040	.00000375	.000024	32
Sulphur -----	0.2026	.00006413	-----	-----
Charcoal -----	0.2410	.00007860	.000002	-----
Aluminum -----	0.1970	.00002313	.00203	1213
Phosphorus -----	0.1887	.00012530	-----	-----
Water -----	1.0000	.00008806	.000008	-----
Mercury -----	0.0333	.00003333	.00011	-----
Alcohol (absolute) ..	0.7000	.00015151	.000002	-----

	Con- stant pres- sure	Con- stant volume	Coefficient of cubical ex- pansion at 1 atmos.		
Air -----	0.23751	0.16847	.003671	.0000015	----
Oxygen -----	0.21751	0.15507	.003674	.0000012	----
Hydrogen -----	3.40900	2.41226	.003669	.0000012	----
Nitrogen -----	0.24380	0.17273	.003668	.0000012	----
Superheated steam ..	0.4805	0.346	.003726	-----	----
Carbonic acid -----	0.2170	0.1535	-----	.00000122	----

*Kent and Suplee.

TABLE 25.

Pressure, in Ounces, per Square Inch, Corresponding to Various Heads of Water, in Inches.*

Head in inches	Decimal parts of an inch									
	.0	.1	.2	.3	.4	.5	.6	.7	.8	.9
0	-----	.06	.12	.17	.23	.29	.35	.40	.46	.52
1	.58	.63	.69	.75	.81	.87	.93	.98	1.04	1.09
2	1.16	1.21	1.27	1.33	1.39	1.44	1.50	1.56	1.62	1.67
3	1.73	1.79	1.85	1.91	1.96	2.02	2.08	2.14	2.19	2.25
4	2.31	2.37	2.42	2.48	2.54	2.60	2.66	2.72	2.77	2.83
5	2.89	2.94	3.00	3.06	3.12	3.18	3.24	3.29	3.35	3.41
6	3.47	3.52	3.58	3.64	3.70	3.75	3.81	3.87	3.92	3.98
7	4.04	4.10	4.16	4.22	4.28	4.33	4.39	4.45	4.50	4.56
8	4.62	4.67	4.73	4.79	4.85	4.91	4.97	5.03	5.08	5.14
9	5.20	5.26	5.31	5.37	5.42	5.48	5.54	5.60	5.66	5.72

TABLE 26.

Height of Water Column, in Inches, Corresponding to Pressures, in Ounces, per Square Inch.*

Pressure in ounces per square inch	Decimal parts of an ounce									
	.0	.1	.2	.3	.4	.5	.6	.7	.8	.9
0	-----	.17	.35	.52	.69	.87	1.04	1.21	1.38	1.56
1	1.73	1.90	2.08	2.25	2.42	2.60	2.77	2.94	3.11	3.29
2	3.46	3.63	3.81	3.98	4.15	4.33	4.50	4.67	4.84	5.01
3	5.19	5.36	5.54	5.71	5.88	6.06	6.23	6.40	6.57	6.75
4	6.92	7.09	7.27	7.44	7.61	7.79	7.96	8.13	8.30	8.48
5	8.65	8.82	9.00	9.17	9.34	9.52	9.69	9.86	10.03	10.21
6	10.38	10.55	10.73	10.90	11.07	11.26	11.43	11.60	11.77	11.95
7	12.11	12.28	12.46	12.63	12.80	12.97	13.15	13.32	13.49	13.67
8	13.84	14.01	14.19	14.36	14.53	14.71	14.88	15.05	15.22	15.40
9	15.57	15.74	15.92	16.09	16.26	16.45	16.62	16.76	16.96	17.14

*Supplee's M. E. Reference Book.

TABLE 27. Wrought Iron and Steel, Steam, Gas and Water Pipe.

Normal Internal	Diameter		Nominal Thick- ness—Inches	Circumference		Transverse Areas			Length of pipe per sq. ft. of		Feet of pipe containing one cubic foot	Normal weight per foot	No. of threads	Weight of water per lineal foot
	Actual external Inches	Approx. Internal Inches		External Inches	Internal Inches	External sq. Inches	Internal sq. Inches	Metal. sq. Inches	External Surface, ft.	Internal Surface, ft.				
1/8	.405	.270	.068	1.272	.845	.129	.0568	.0720	9.440	14.150	2513.0	.241	27	.024
1/4	.540	.364	.088	1.696	1.144	.229	.1041	.1249	7.075	10.490	1383.3	.420	18	.044
3/8	.675	.494	.091	2.121	1.549	.358	.1909	.1669	5.657	7.760	751.2	.559	18	.082
1/2	.840	.623	.109	2.629	1.954	.554	.3039	.2503	4.547	6.150	472.4	.837	14	.132
3/4	1.050	.824	.113	3.299	2.589	.866	.5333	.3327	3.637	4.635	270.0	1.115	14	.230
1	1.315	1.048	.134	4.131	3.289	1.358	.8609	.4972	2.904	3.645	166.9	1.668	11 1/2	.373
1 1/4	1.660	1.380	.140	5.215	4.385	2.164	1.496	.6685	2.301	2.768	96.25	2.244	11 1/2	.648
1 1/2	1.900	1.611	.145	5.969	5.038	2.835	2.038	.7995	2.010	2.371	70.66	2.678	11 1/2	.883
2	2.375	2.067	.154	7.461	6.494	4.430	3.356	1.074	1.608	1.848	42.91	3.609	11 1/2	1.454
2 1/2	2.875	2.468	.204	9.032	7.750	6.492	4.780	1.712	1.328	1.547	30.10	5.739	8	2.072
3	3.500	3.067	.217	10.996	9.632	9.621	7.388	2.238	1.091	1.245	19.50	7.536	8	3.202
3 1/2	4.000	3.548	.226	12.566	11.146	12.566	9.887	2.680	.955	1.077	14.57	9.001	8	4.285
4	4.500	4.026	.237	14.137	12.648	15.904	12.730	3.175	.849	.949	11.31	10.665	8	5.517
4 1/2	5.000	4.508	.246	15.708	14.162	19.635	15.961	3.675	.764	.848	9.02	12.340	8	6.908
5	5.563	5.045	.259	17.477	15.849	24.306	19.985	4.321	.687	.757	7.20	14.502	8	8.668
6	6.625	6.065	.280	20.813	19.054	34.472	28.886	5.586	.587	.630	4.98	18.762	8	12.521
7	7.625	7.023	.301	23.955	22.063	45.664	38.743	6.921	.501	.544	3.72	23.271	8	16.790
8	8.625	7.982	.322	27.096	25.073	58.426	50.021	8.405	.443	.478	2.88	28.177	8	21.688
9	9.625	8.937	.344	30.238	28.076	72.760	62.722	10.400	.397	.427	2.29	33.701	8	27.580
10	10.750	10.019	.366	33.772	31.472	90.763	78.882	11.940	.355	.381	1.82	40.065	8	34.171
11	11.750	11.000	.375	36.914	34.558	108.434	95.034	13.401	.325	.348	1.51	45.950	8	41.189
12	12.750	12.000	.375	40.055	37.700	127.677	113.068	14.590	.299	.319	1.27	48.985	8	49.017
13	14.000	13.250	.375	43.98	41.620	153.940	137.880	16.060	.270	.290	1.04	54.000	8	59.762
14	15.000	14.250	.375	47.120	44.760	176.710	169.480	17.230	.250	.270	.90	58.000	8	69.125
15	16.000	15.400	.280	50.260	48.480	201.060	187.040	14.020	.240	.250	.77	62.000	8	81.070
16	17.000	16.400	.300	53.410	51.520	226.980	211.240	15.740	.230	.230	.68	49.188	8	91.559
17	18.000	17.300	.340	56.550	54.410	254.470	235.610	18.860	.210	.220	.61	58.920	8	102.122

TABLE 28.

Expansion of Wrought-Iron Pipe on the Application of Heat.*

Temp. air when pipe is fitted	Increase in length in inches per 100 feet when heated to								
	Deg. F.	160	180	200	212	220	228	240	274
0	1.28	1.44	1.60	1.70	1.76	1.82	1.92	2.19	
32	1.02	1.18	1.34	1.44	1.50	1.57	1.66	1.94	
50	.88	1.04	1.20	1.30	1.36	1.42	1.52	1.79	
70	.72	.88	1.04	1.14	1.20	1.26	1.36	1.63	

TABLE 29.

Tapping List of Direct Radiators.†**STEAM.**

ONE-PIPE WORK.		TWO-PIPE WORK.	
Radiator area square feet	Tapping diam- eter—inches	Radiator area square feet	Tapping diam- eter—inches
0 — 24	1	0 — 48	1 x ¾
24 — 60	1¼	48 — 96	1¼ x 1
60 — 100	1½	96 and above	1½ x 1¼
100 and above	2		

WATER.

Tapped for supply and return.

Radiator area square feet	Tapping diameter inches
0 — 40	1
40 — 72	1¼
72 and above.	1½

*Holland Heating Manual.

†American Radiator Co.

TABLE 31.

Capacities of Hot Water Risers in Square Feet of Direct Radiation.*

Drop in temperature 20°.

D. of riser inches	First floor	Second floor	Third floor	Fourth floor	Fifth floor	Sixth floor
$\frac{3}{4}$	12	17	21	24	-----	-----
1	22	32	40	48	-----	-----
$1\frac{1}{4}$	38	56	70	80	88	-----
$1\frac{1}{2}$	66	92	112	132	145	-----
2	140	196	238	280	310	-----
$2\frac{1}{2}$	240	328	400	470	515	-----
3	350	490	595	700	770	850
$3\frac{1}{2}$	510	705	860	1010	1110	1215
4	700	980	1190	1280	1540	1660

A small pipe should never be run to a great height where it only supplies one radiator. It is better to have limits for pipes as follows:

D. in inches:-----	$\frac{3}{4}$	1	$1\frac{1}{4}$	$1\frac{1}{2}$	2	(Reduce size by floors.)
Height in feet:----	20	30	45	60	80	

TABLE 32.

Capacities of Pipes in Square Feet of Direct Steam Radiation.†

Diam. of supply inches	Diam. of return inches	2 lbs. gage.		5 lbs. gage.		2 lbs. gage.		5 lbs. gage.	
1	1	36	60	5	$3\frac{1}{2}$	3720	6200		
$1\frac{1}{4}$	1	72	120	6	$3\frac{1}{2}$	6000	10000		
$1\frac{1}{2}$	$1\frac{1}{4}$	120	200	7	4	9000	15000		
2	$1\frac{1}{2}$	280	480	8	4	12800	21600		
$2\frac{1}{2}$	2	528	880	9	$4\frac{1}{2}$	17800	30000		
3	$2\frac{1}{2}$	900	1500	10	5	23200	39000		
$3\frac{1}{2}$	$2\frac{1}{2}$	1320	2200	12	6	37000	62000		
4	3	1920	3200	14	7	54000	92000		
$4\frac{1}{2}$	3	2760	4600	16	8	76000	130000		

*International Correspondence School.

†Kent's M. E. Pocket-Book.

TABLE 33.

Capacities of Hot Water Pipes in Square Feet of Direct Radiation.*

Diameter of pipes, inches	Indirect radiation	Direct radiation.						
		Height of coil above bottom of boiler, in ft.						
	0	10	20	30	40	50	70	100
	sq. ft.	sq. ft.	sq. ft.	sq. ft.	sq. ft.	sq. ft.	sq. ft.	sq. ft.
¾	49	50	52	53	55	57	61	68
1	87	89	92	95	98	101	108	121
1¼	136	140	144	149	153	158	169	189
1½	196	202	209	214	222	228	243	271
2	349	359	370	380	393	405	433	483
2½	546	561	577	595	613	633	678	755
3	785	807	835	856	888	912	974	1086
3½	1069	1099	1132	1166	1202	1241	1327	1480
4	1395	1436	1478	1520	1571	1621	1733	1933
4½	1767	1817	1871	1927	1988	2052	2193	2445
5	2185	2244	2309	2376	2454	2531	2713	3019
6	3140	3228	3341	3424	3552	3648	3897	4344
7	4276	4396	4528	4664	4808	4964	5308	5920
8	5580	5744	5912	6080	6284	6484	6932	7735
9	7068	7268	7484	7708	7952	8208	8774	9780
10	8740	8976	9236	9516	9816	10124	10852	12076
11	10559	10860	11180	11519	11879	12262	13108	14620
12	12560	12912	13364	13696	14208	14592	15588	17376
13	14748	15169	15615	16090	16591	17126	18307	20420
14	17104	17584	18109	18656	19232	19856	21232	23680
15	19634	20195	20789	21419	22089	22801	24373	27168
16	22320	22978	23643	24320	25136	25936	27728	30928

TABLE 34.

Capacities of Hot Water Mains in Square Feet of Direct Radiation.†

D. of mains	Total estimated length of circuit									
	100	200	300	400	500	600	700	800	900	1000
1	20									
1¼	35	20								
1½	56	40	25							
2	116	85	70	50						
2½	220	150	120	100	90					
3	345	240	200	170	150	140	125	110	100	90
3½	500	340	280	245	225	205	190	175	162	150
4	700	485	390	340	310	280	260	240	230	220
4½	925	640	535	460	410	375	345	325	300	295
5	1200	830	700	600	540	490	450	420	400	380
6	1900	1325	1100	950	850	775	700	650	620	600
7		2000	1600	1400	1250	1140	1050	975	925	875
8				1970	1720	1550	1440	1350	1300	1250
9							1900	1800	1700	1620

*Kent's M. E. Pocket-Book.

†International Correspondence School.

TABLE 35.

Sizes of Steam Mains for Direct Radiation.*

Showing drop of pressure, in ounces, for 100-foot run. (Unwin formula).
condensation three-tenths pound per square foot per hour.

Velocity feet per sec.	10 ft. vel.		20 ft. vel.		30 ft. vel.		40 ft. vel.		50 ft. vel.		70 ft. vel.		100 ft. vel.		100 ft. Run 1 Oz. drop.	
	oz. drop.	sq. ft. Rad'n.	oz. drop.	sq. ft. Rad'n.	oz. drop.	sq. ft. Rad'n.	oz. drop.	sq. ft. Rad'n.	oz. drop.	sq. ft. Rad'n.	oz. drop.	sq. ft. Rad'n.	oz. drop.	sq. ft. Rad'n.	Vel.	Rad'n. sq. ft.
1 inch	.4	25	1.6	49	3.6	74	6.	100	10.	124	19.6	174	40.	248	15.8	40
1 1/4 ins.	.29	39	1.16	77	2.61	116	6.64	165	7.25	194	14.21	271	29.	388	18.5	75
1 1/2 "	.2	56	.8	112	1.80	168	3.2	224	5.	280	9.8	392	20.	560	22.5	126
2 "48	200	1.08	300	1.92	400	3.	500	5.88	700	12.	1000	29.	286
2 1/2 "75	405	1.34	620	2.1	775	4.1	1085	8.4	1550	34.5	635
3 "56	669	1.	892	1.56	1115	3.06	1561	6.25	2230	40.	890
3 1/2 "85	1216	1.33	1520	2.6	2128	5.81	3040	43.4	1360
4 "66	1600	1.04	2000	2.04	2800	4.16	4000	49.	1950
4 1/2 "53	2005	.75	2506	1.63	3508	3.33	5012	54.8	2747
5 "48	2480	.57	3100	1.37	4340	3.	6200	58.	3600
6 "45	4470	1.12	6258	2.3	8940	66.	5900
7 "	6083	.887	8516	1.81	12167	74.3	9040
8 "76	11130	1.56	15900	80.	12700
9 "637	14095	1.3	20187	87.4	17600
10 "57	17360	1.18	24800	92.	22900
12 "94	35800	108.	37000
14 "78	48700	113.	55300
16 "65	63600	123.	78300

*Condensed from "Steam Circulation" Positive Differential System Co.

TABLE 36. Sizes of Steam Mains.*
Pounds of steam delivered per minute. See formula 104.

Diam. In	LENGTH IN FEET															
	50	100	175	250	325	400	475	550	700	850	1000	1150	1300	1450	1600	1750
8	65.17	46.0	35.0	29.2	25.6	23.0	21.2	19.6	17.4	15.8	14.5	13.6	12.7	12.10	11.5	11.0
8 3/4	98.3	69.5	52.7	44.6	38.6	34.7	31.9	29.6	26.3	23.8	22.0	20.5	19.2	18.2	17.4	16.6
9	188.1	97.6	73.8	61.8	54.2	48.8	44.8	41.5	36.7	33.5	30.8	28.7	27.1	25.6	24.4	23.8
9 1/4	187.9	132.9	102.0	84.1	73.8	66.45	61.2	56.6	50.1	45.6	42.0	39.2	36.75	34.75	33.2	31.8
10	255.6	180.7	136.2	114.3	102.2	90.3	83.3	76.9	68.2	62.1	57.1	53.2	50.0	47.2	45.2	43.2
11	419.4	296.5	224.1	187.4	164.2	148.2	136.1	125.8	111.8	101.8	93.7	87.2	82.2	77.6	74.1	71.0
12	618	437	330	276	242	218	200	186	165	150	138	129	121	115	109	104
13	890	624	472	394	346	312	286	266	236	214	197	184	173	164	156	149
14	1206	853	644	539	478	426	391	363	322	292	269	251	236	224	213	204
15	1592	1126	851	712	624	568	516	480	425	386	356	332	312	295	281	269
16	2046	1447	1093	915	803	728	664	617	546	496	457	426	401	380	361	346
17	2575	1887	1428	1192	1044	948	862	803	714	648	598	557	523	494	472	451
18	3165	2238	1692	1415	1242	1119	1027	954	846	767	707	660	620	588	559	535

Diam. In	LENGTH IN FEET															
	100	200	300	400	500	600	700	800	900	1000	1200	1400	1600	1800	2000	2200
14	2714	1920	1567	1357	1213	1108	1025	959	904	858	783	725	675	639	606	578
15	3260	2300	1873	1625	1453	1327	1228	1149	1083	1028	938	868	812	766	726	693
16	4000	2880	2315	2000	1785	1638	1513	1413	1333	1268	1153	1072	1000	945	895	854
17	4500	3210	2635	2250	2021	1841	1702	1591	1500	1424	1302	1200	1124	1061	1006	962
18	5211	3685	3008	2605	2330	2128	1970	1843	1737	1648	1504	1393	1302	1228	1165	1111
19	5992	4237	3459	2996	2680	2447	2265	2119	1997	1895	1730	1602	1498	1412	1340	1278
20	6839	4835	3948	3419	3059	2793	2585	2418	2279	2163	1974	1828	1706	1612	1529	1458
22	8743	6183	5048	4371	3910	3570	3278	3063	2914	2765	2524	2337	2185	2061	1955	1864
24	11308	7990	6535	5650	5065	4522	4185	3905	3769	3580	3271	3023	2820	2665	2535	2415

*Trans. A. S. M. E. Vol. XX, page 358.

TABLE 37

Loss of Head by Friction of Pipes.*

Loss of head by friction in each 100 feet in length of different diameters of pipe when discharging the following quantities of water per minute.

VELOCITY IN FEET PER SECOND	INSIDE DIAMETER OF PIPE IN INCHES															
	1	2	3	4	5	6	7	8	9	10	11	12	14	16	18	20
2.0	2.87	.65	1.185	2.62	.791	5.89	.593	10.4	.474	10.3	.895	23.5	.838	32.0	.296	41.9
3.0	4.89	.99	2.44	8.92	1.62	8.83	1.22	15.7	9.78	24.5	.815	35.3	.698	48.1	.611	62.8
4.0	8.20	1.32	4.10	5.23	2.73	11.80	2.05	20.9	1.64	32.7	1.37	47.1	1.175	63.1	1.027	83.7
5.0	12.33	1.65	6.17	6.54	4.11	14.70	3.08	26.2	2.46	40.9	2.05	58.9	1.76	80.2	1.54	105.0
6.0	17.23	1.98	8.61	7.85	5.74	17.70	4.31	31.4	3.45	49.1	2.87	70.7	2.46	96.2	2.15	125.
7.0	22.89	2.31	11.45	9.16	7.02	20.6	5.72	33.6	4.57	57.2	3.81	82.4	3.26	112.0	2.85	146.
2.0	.284	.53	.237	65.4	.216	79.2	.198	94.2	.169	128	.147	107	.132	212	.119	262
3.0	.544	.79.5	.488	98.2	.444	119	.407	141.	.349	192	.306	261	.271	318	.245	393
4.0	.913	106.	.822	131	.747	158	.685	188.	.587	266	.518	335	.456	424	.410	523
5.0	1.37	132.	1.23	163	1.122	198	1.028	235.	.881	321	.770	419	.685	530	.617	654
6.0	1.82	169.	1.71	196	1.56	237	1.43	283	1.229	385	1.076	602	.957	636	.861	785
7.0	2.62	185.	2.28	229	2.07	277	1.91	330	1.63	449	1.43	586	1.27.	742	1.143	916

*Dayton Hydraulic Co. Catalog.

TABLE 38.

**Comparative Sizes of Steam Mains and Returns for Gravity
and Vacuum Systems.**

Size of supply pipe	Size of return		Size of supply pipe	Size of return	
	Gravity	Vacuum		Gravity	Vacuum
$\frac{3}{4}$	$\frac{3}{4}$	$\frac{1}{2}$	4	$2\frac{1}{2}$	$1\frac{1}{2}$
1	$\frac{3}{4}$	$\frac{1}{2}$	$4\frac{1}{2}$	$2\frac{1}{2}$	$1\frac{1}{2}$
$1\frac{1}{4}$	1	$\frac{1}{2}$	5	3	2
$1\frac{1}{2}$	$1\frac{1}{4}$	$\frac{3}{4}$	6	$3\frac{1}{2}$	$2\frac{1}{2}$
2	$1\frac{1}{2}$	$\frac{3}{4}$	8	$4\frac{1}{2}$	$3\frac{1}{2}$
$2\frac{1}{2}$	2	1	10	6	4
3	2	$1\frac{1}{4}$	12	6	$4\frac{1}{2}$
$3\frac{1}{2}$	$2\frac{1}{2}$	$1\frac{1}{4}$	14	7	5

Note.—For short runs of piping where the friction is not a serious matter the above table will work out satisfactorily. These sizes are only approximate and should be used with caution.

TABLE 39.

Expansion Tanks—Dimensions and Capacities.*

Size in inches	Capacity gallons	Sq. ft. of radiation
9x20	$5\frac{1}{2}$	150
10x20	8	250
12x20	10	350
12x24	12	450
12x30	15	550
12x36	18	650
14x30	20	700
14x36	24	850
16x30	26	900
16x36	32	1250
16x48	42	1750
18x60	66	2750
20x60	82	4500
22x60	100	6000
24x60	122	7500

*The Model Boiler Manual.

TABLE 40.

Sizes of Flanged Fittings.

Pipe size in inches	All fittings and flanges											
	Diameter of flange	Thickness of flange	No. of bolts	Diameter of bolt circle	Size of bolts	90° elbow	45° elbow	Long turn elbow	Tee	Cross	Lateral	Lateral
						Center to face "C"	Center to face "C"	Center to face "C"	Center to face "C"	Face to face "F"	Center to face "C"	Center to face "C"
												Center to face short end "O"
4	9	1 1/8	8	7 1/2	3/4	6 1/2	4	10	6 1/2	13	12	3
6	11	1 1/8	8	9 1/2	3/4	8	5	13	8	16	14 1/2	3 1/2
8	13 1/2	1 3/8	8	11 3/4	3/4	9	6	16	9	18	17 1/2	4 1/2
10	16	1 3/8	12	14 1/4	7/8	11	7	20	11	22	20 1/2	5
12	19	1 3/4	12	17	7/8	12	7 1/2	22	12	24	24 1/2	5 1/2
14	21	1 3/8	14	18 3/4	1	14	7 1/2	24	14	28	27	6
16	23 1/2	1 7/8	16	21 1/4	1	15	8	28	15	30	30	6 1/2
20	27 1/2	1 1 1/4	20	25	1 1/8	18	9 1/2	32	18	36	35	8
24	32	1 7/8	20	29 1/2	1 1/8	22	11	36	22	44	40 1/2	9

TABLE 41.

Dimensions of Ells and Tees for Wrought Iron Pipe.

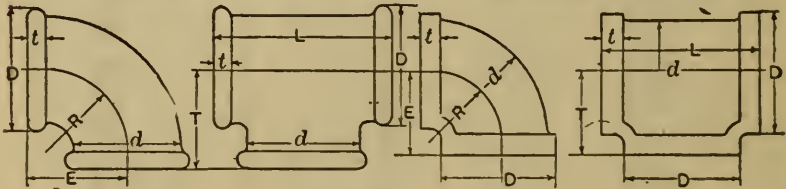

SIZE	E	R	D	d	t	L	T
1/8	5/8	5/8	1 1/8	1 1/8	3/8	1-1/4	5/8
1/4	3/4	3/4	1-1/8	1-1/8	3/8	1-1/4	3/4
3/8	3/4	3/4	1-1/8	1-1/8	3/8	1-3/4	3/8
1/2	1-1/8	1-1/8	1-1/4	1-1/4	1/2	2-1/4	1-1/8
3/4	1-3/8	1-3/8	1-1/2	1-1/2	5/8	2-3/4	1-3/8
1-	1-1/2	1-1/2	1-3/4	1-3/4	3/4	3-1/8	1-1/2
1-1/4	1-3/4	1-3/4	2-1/4	2-1/4	7/8	3-3/8	1-3/4
1-1/2	2-	2-	2-1/2	2-1/2	7/8	3-3/4	1-1/2
2-	2-3/8	2-1/2	3-3/8	3-3/8	7/8	4-	2-
2-1/2	2-3/4	2-1/2	4-	4-	7/8	4-3/4	2-3/8
3-	3-3/8	2-3/4	4-5/8	4-5/8	7/8	5-3/8	2-3/8
3-1/2	3-3/8	3-3/8	5-1/4	5-1/4	7/8	6-3/8	3-3/8
4-	4-	3-3/8	5-7/8	5-7/8	7/8	7-1/4	3-3/8
4-1/2	4-3/8	4-	6-1/8	6-1/8	1-	8-	4-
5-	4-5/8	4-1/8	6-1/2	6-3/8	1-1/8	8-3/4	4-3/8
6-	5-1/4	4-7/8	8-1/2	7-3/8	1-1/8	11-	4-3/4
							5-1/2

TABLE 42.

Loss of Pressure in Pipes 100 Feet Long in Ounces per Square Inch when Delivering Air at the Velocities Given.

Velocity in ft. per min.	Diameter of pipe in inches										
	1	2	3	4	6	8	10	12	14	16	18
	300	0.100	0.050	0.033	0.025	0.017	0.012	0.010	0.008	0.007	0.006
400	0.178	0.088	0.059	0.044	0.030	0.022	0.018	0.015	0.013	0.011	0.010
600	0.400	0.200	0.133	0.100	0.067	0.050	0.040	0.033	0.029	0.025	0.022
800	0.711	0.356	0.237	0.178	0.119	0.089	0.071	0.059	0.051	0.044	0.040
1000	1.111	0.556	0.370	0.278	0.185	0.139	0.111	0.092	0.079	0.069	0.062
1200	1.600	0.800	0.533	0.400	0.267	0.200	0.160	0.133	0.114	0.100	0.089
1500	2.500	1.250	0.833	0.625	0.417	0.312	0.250	0.208	0.179	0.156	0.139
1800	3.600	1.800	1.200	0.900	0.600	0.450	0.360	0.300	0.257	0.225	0.200
2400	6.400	3.200	2.133	1.600	1.067	0.800	0.640	0.533	0.457	0.400	0.356
	20	24	28	32	36	40	44	48	52	56	60
300	0.005	0.004	0.004	0.003	0.003	0.002	0.002	0.002	0.002	0.002	0.002
400	0.009	0.007	0.006	0.006	0.005	0.004	0.004	0.004	0.003	0.003	0.003
600	0.020	0.017	0.014	0.012	0.011	0.010	0.009	0.008	0.008	0.007	0.007
800	0.036	0.029	0.025	0.022	0.020	0.018	0.016	0.015	0.014	0.013	0.012
1000	0.056	0.046	0.040	0.035	0.031	0.028	0.025	0.023	0.021	0.020	0.019
1200	0.080	0.067	0.057	0.050	0.044	0.040	0.036	0.033	0.031	0.029	0.027
1500	0.125	0.104	0.089	0.078	0.069	0.062	0.057	0.052	0.048	0.045	0.042
1800	0.180	0.167	0.129	0.112	0.100	0.090	0.082	0.075	0.069	0.064	0.060
2400	0.320	0.313	0.239	0.200	0.178	0.160	0.145	0.133	0.123	0.119	0.107

Diagrams for Pipe Sizes and Friction Heads.

To illustrate the use of the two following diagrams, apply to the pipe line, *B, C*, Art. 147. First, let $l = 1500$ feet, $d = 8$ inches and $v = 5$ feet per second. Trace along the velocity line until it intersects the diameter line, then follow the ordinate to the top of the page and find the friction head, 13 feet for 1000 foot run or 19.5 feet for the 1500 foot run. Second, let $Q = 1.75$ cubic feet per second and $d = 8$ inches. Trace to the left along the horizontal line representing the volume of 1.75 cubic feet until it intersects the diameter line, then read up and find the same friction head as before. Third, let the allowable friction head for 1500 feet of main be 19 feet, when $Q = 1.75$ cubic feet per second or when $v = 5$ feet per second. Reverse the process given above and find an 8 inch pipe.

Pipe Diameters and Friction Heads.*

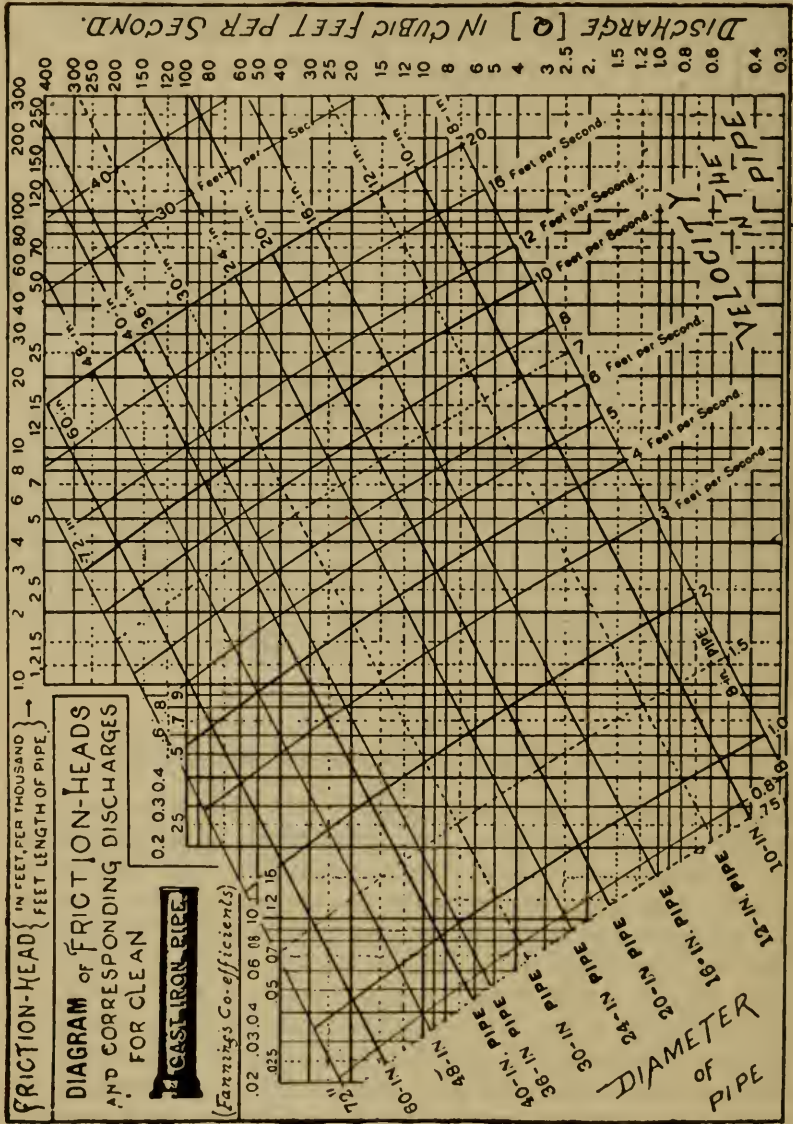

*Church's "Hydraulic Motors."

Pipe Diameters and Friction Heads.*

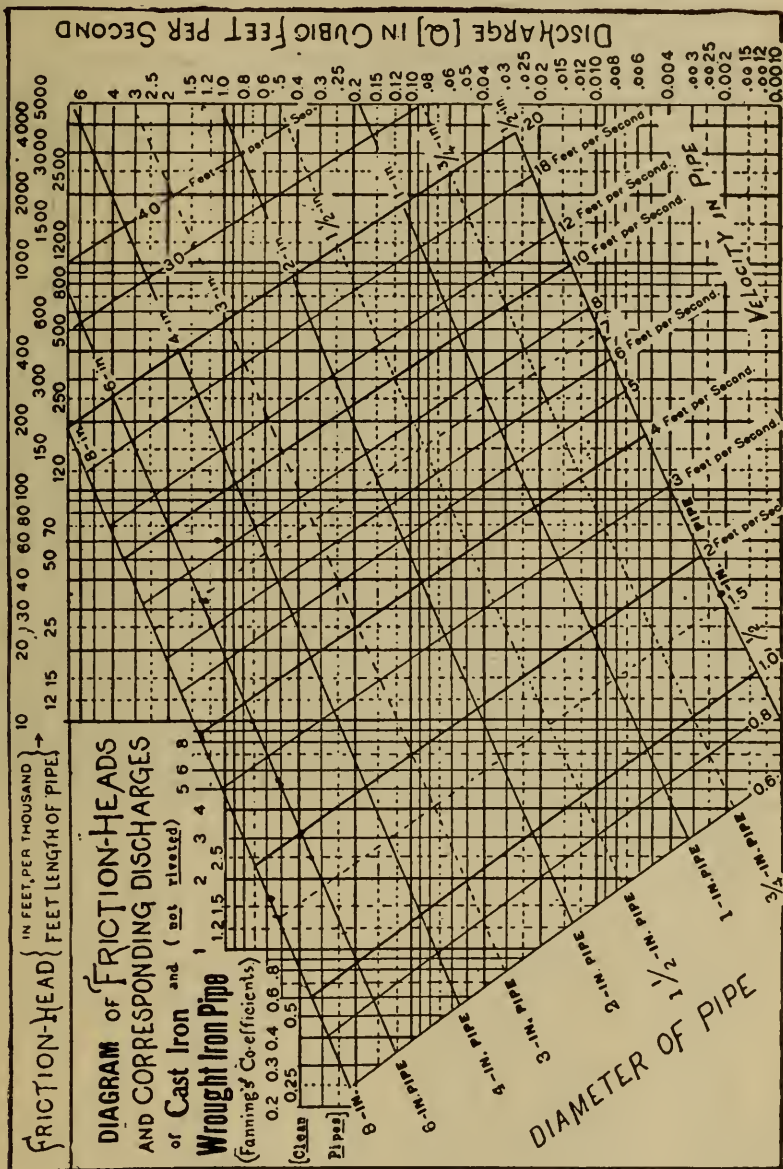

*Church's "Hydraulic Motors."

TABLE 43.

Temperatures for Testing Direct Steam Radiation Plants.*

Gage pressure, lbs. per sq. in. Inches of vacuum.	Test condition	Steam Temperature	Steam pressure intended for zero weather																	
			0 lb.	1 lb.	2 lb.	3 lb.	4 lb.	5 lb.	6 lb.	7 lb.	8 lb.	9 lb.	10 lb.							
10 in.	192.0	63.3	62.3																	
9 "	194.5	64.2	63.2	62.3																
8 "	197.0	65.0	64.0	63.0	62.2															
7 "	199.0	65.6	64.7	63.7	62.8	62.0														
6 "	201.0	66.3	65.3	64.3	63.4	62.6	62.0													
5 "	203.0	67.0	66.0	65.0	64.0	63.3	62.6	61.9												
4 "	205.0	67.6	66.6	65.6	64.7	63.9	63.2	62.5	61.7											
3 "	207.0	68.3	67.2	66.2	65.3	64.5	63.8	63.1	62.3	61.7										
2 "	208.5	68.8	67.7	66.7	65.7	65.0	64.2	63.6	62.8	62.0	61.5									
1 "	210.5	69.4	68.3	67.5	66.4	65.6	64.8	64.2	63.3	62.6	62.1	61.5								
0 lb.	212.0	70.0	68.8	67.8	66.9	66.1	65.3	64.6	63.8	63.1	62.6	62.0	61.5							
1 "	215.5	71.2	70.0	69.0	68.0	67.2	66.3	65.8	65.0	64.2	63.7	63.0	62.0							
2 "	218.7	72.1	71.0	70.0	69.2	68.2	67.3	66.7	65.9	65.1	64.5	64.0	63.0							
3 "	221.7		72.0	71.0	70.0	69.2	68.3	67.6	66.7	66.0	65.4	64.8	63.8							
4 "	224.5			71.8	70.8	70.0	69.2	68.4	67.5	66.7	66.2	65.7	64.8							
5 "	227.2				71.7	70.8	70.0	69.2	68.3	67.6	67.0	66.3	65.3							
6 "	229.8					71.7	70.8	70.0	69.2	68.4	67.7	67.2	66.2							
7 "	232.4						71.7	70.8	70.0	69.2	68.6	68.0	67.0							
8 "	234.9							71.7	70.8	70.0	69.3	68.7	67.7							
9 "	237.3								71.5	70.5	70.0	69.3	68.7							
10 "	239.4									71.3	70.7	70.0	69.3							
Factors		.670	.675	.678	.684	.688	.692	.694	.698	.702	.705	.707								

The temperatures in this table are for a plant designed for 0° and 70°.

Example.—It is desired to test a plant designed for 5 pounds gage pressure on a day when the outside temperature is 22 degrees. What should be the temperature in the rooms with steam at 3 pounds gage pressure? It will be noted in the vertical column marked 5 pounds, that opposite the 3 pound pressure 68.3 degrees may be expected on a zero day. As the temperature was 22 degrees above we must add 22 times .692, or 15.2 degrees, thus making a total of 83.5 degrees, the temperature which should exist indoors.

*W. W. Macon.

TABLE 44. Specifications of Kewanee Firebox Boilers.* (Steam and water heating.)

Number	0	1	2	3	4	5	6	7	8	9	10	12	14	16	18	20
Capacity steam.....sq. ft.	700	900	1000	1200	1400	1700	2100	2200	2500	2900	3200	4400	5800	8500	10500	12800
Capacity water.....sq. ft.	1100	1400	1600	1900	2200	2700	3400	3500	4000	4600	5100	7000	9300	13600	16800	20500
Diameter	24	30	30	30	36	36	36	42	42	42	48	48	54	60	66	72
Length over all.....feet	7½	7½	7½	8½	7½	9	10½	8½	10	11½	10½	13½	16½	18	18	18
Width of firebox.....inches	19	24	24	24	30	30	30	36	36	36	42	42	48	54	60	66
Length of firebox.....inches	26	26	32	38	32	38	44	38	44	50	44	56	62	68	68	74
Height of firebox.....inches	30	36	36	36	41	41	41	43	43	43	47	47	49	54	59	64
Size of tubes.....inches	3	3	3	3	3	3	3	3	3	3	3	3	4	4	4	4
Length of tubes.....inches	60	48	55	61	55	67	79	61	73	85	79	103	132	144	144	138
Square feet fire surface.....	93	120	138	154	186	222	258	259	304	348	393	502	647	954	1177	1442
Ratio rad. to fire surface.....	7.4	7.5	7.3	7.8	7.5	7.7	8.2	8.5	8.2	8.3	8.2	8.8	8.9	8.9	8.9	8.9
Square feet of grate.....	3.30	4.3	5.0	6.33	6.33	8.0	8.8	9.5	11.0	12.5	12.5	16.0	20.6	25.3	28.3	33.8
Ratio fire surface to grate	28.0	27.0	27.0	24.0	29.0	27.0	29.0	27.0	28.0	28.0	31.0	31.0	31.0	38.0	42.0	43.0
Diam. of smoke-pipe, inches	12	16	16	16	18	18	18	20	20	20	22	22	24	30	34	38
Size of steam supply, inches	2½	3	3	3	4	4	4	6	6	6	6	7	7	7	8	8
Size of return.....inches	2	2½	2½	3	3	3	3	4	4	4	4	5	5	5	6	6
Flow & ret., hot water...in.	2-3	2-4	2-4	2-4	2-5	2-5	2-5	2-5	2-6	2-6	2-6	2-7	2-7	2-8	2-10	2-10
Depth of water leg.....inches	15	15	15	15	15	15	15	15	15	15	15	15	15	16	16	16
Shipping weight.....lbs.	2300	2450	2750	3150	3450	3850	4350	4500	5000	5650	6650	8000	10250	15250	18400	22000
Height of brickwork.....	63"	69"	69"	69"	75"	75"	75"	81"	81"	81"	87"	87"	93"	103"	109"	115"
Height of water line.....	48"	54"	54"	54"	59"	59"	59"	61"	61"	61"	65"	65"	67"	75"	80"	87"
Floor space { length	9' 5"	8' 8"	9' 8"	10' 8"	9' 6"	11' 2"	12' 8"	11' 1"	12' 7"	14' 1"	13' 1"	16' 1"	19' 7"	21' 1"	21' 1"	21' 5"
{ width	4' 6"	5' 0"	5' 0"	5' 0"	5' 6"	5' 6"	5' 6"	6' 0"	6' 0"	6' 0"	6' 6"	6' 6"	7' 8"	8' 2"	8' 8"	9' 2"
Approximate number brick	1500	1600	1700	1800	2000	2300	2400	2500	2800	3000	3200	3700	5700	6500	7100	8000

Note.—A late modification of these boilers called the Kewanee "Smokeless" Firebox Boiler, with numbers increased by 100 and with capacities increased approximately 15 per cent. may be had in place of the above. The dimensions of the Smokeless boiler differ somewhat from those in this table. If exact dimensions are needed data must be obtained from the manufacturers.

*Kewanee Catalog.

TABLE 45.

**Percentage of Heat Transmitted by Various Pipe-Coverings,
From Tests Made at Sibley College, Cornell University,
and at Michigan University.***

Kind of covering	Relative amount of heat transmitted
Naked pipe	100.
Two layers asbestos paper, 1 in. hair felt, and canvas cover	15.2
Two layers asbestos paper, 1 in. hair felt, canvas cover wrapped with manilla paper.....	15.
Two layers asbestos paper, 1 in. hair felt.....	17.
Hair felt sectional covering, asbestos lined.....	18.6
One thickness asbestos board	59.4
Four thicknesses asbestos paper	50.3
Two layers asbestos paper	77.7
Wool felt, asbestos lined	23.1
Wool felt with air spaces, asbestos lined.....	19.7
Wool felt, plaster paris lined	25.9
Asbestos molded, mixed with plaster paris.....	31.8
Asbestos felted, pure long fibre	20.1
Asbestos and sponge	18.8
Asbestos and wool felt	20.8
Magnesia, molded, applied in plastic conditnon.....	22.4
Magnesia, sectional	18.8
Mineral wool, sectional	19.3
Rock wool, fibrous	20.3
Rock wool, felted	20.9
Fossil meal, molded, $\frac{3}{4}$ inch thick	29.7
Pipe painted with black asphaltum.....	105.5
Pipe painted with light drab lead paint.....	108.7
Glossy white paint	95.0

*Carpenter's H. and V. B.

Note.—These tests agree remarkably well with a series made by Prof. M. E. Cooley of Michigan University, and also with some made by G. M. Brill, Syracuse, N. Y., and reported in Transactions of the American Society of Mechanical Engineers, vol. XVI.

TABLE 46.

Factors of Evaporation.

Gage pressure	.3	10	20	30	50	100	125	135	150	175
Feed water	Factors of evaporation									
212	1.0003	1.0103	1.0169	1.0218	1.0290	1.0396	1.0431	1.0443	1.0460	1.0483
200	1.0127	1.0227	1.0293	1.0343	1.0414	1.0520	1.0555	1.0567	1.0584	1.0608
185	1.0282	1.0382	1.0448	1.0498	1.0569	1.0675	1.0710	1.0722	1.0739	1.0763
170	1.0437	1.0537	1.0603	1.0653	1.0724	1.0830	1.0865	1.0877	1.0894	1.0917
155	1.0592	1.0692	1.0758	1.0807	1.0878	1.0985	1.1020	1.1032	1.1048	1.1072
140	1.0715	1.0846	1.0912	1.0962	1.1033	1.1139	1.1174	1.1186	1.1203	1.1227
125	1.0901	1.1001	1.1067	1.1116	1.1187	1.1293	1.1328	1.1341	1.1357	1.1381
110	1.1055	1.1155	1.1221	1.1270	1.1341	1.1447	1.1482	1.1495	1.1511	1.1535
95	1.1209	1.1309	1.1375	1.1424	1.1495	1.1602	1.1637	1.1649	1.1665	1.1689
80	1.1363	1.1463	1.1529	1.1578	1.1650	1.1756	1.1791	1.1803	1.1820	1.1843
65	1.1517	1.1617	1.1683	1.1733	1.1804	1.1910	1.1945	1.1957	1.1974	1.1997
50	1.1672	1.1772	1.1838	1.1887	1.1958	1.2064	1.2099	1.2112	1.2128	1.2152
35	1.1827	1.1927	1.1993	1.2042	1.2113	1.2219	1.2255	1.2267	1.2283	1.2307

TABLE 47.

Per Cent. of Total Heat of Steam Saved per Degree Increase of Feed Water.

Initial temp. of feed	Gage pressure in boiler, lbs. per sq. in.									
	0	20	40	60	80	100	120	140	160	180
32	.0872	.0861	.0855	.0851	.0847	.0844	.0841	.0839	.0837	.0835
40	.0878	.0867	.0861	.0856	.0853	.0850	.0847	.0845	.0843	.0839
50	.0886	.0875	.0868	.0864	.0860	.0857	.0854	.0852	.0850	.0846
60	.0894	.0883	.0876	.0872	.0867	.0864	.0862	.0859	.0856	.0853
70	.0902	.0890	.0884	.0879	.0875	.0872	.0869	.0867	.0864	.0860
80	.0910	.0898	.0891	.0887	.0883	.0879	.0877	.0874	.0872	.0863
100	.0927	.0915	.0908	.0903	.0899	.0895	.0892	.0890	.0887	.0883
120	.0945	.0932	.0925	.0919	.0915	.0911	.0908	.0906	.0903	.0899
140	.0963	.0950	.0943	.0937	.0932	.0929	.0925	.0923	.0920	.0916
160	.0982	.0968	.0961	.0955	.0950	.0946	.0943	.0940	.0937	.0933
180	.1002	.0988	.0981	.0973	.0969	.0965	.0961	.0958	.0955	.0951
200	.1022	.1008	.0999	.0993	.0988	.0984	.0980	.0977	.0974	.0969
220	-----	.1029	.1019	.1013	.1008	.1004	.1000	.0997	.0994	.0989
.240	-----	.1050	.1041	.1034	.1029	.1024	.1020	.1017	.1014	.1009

Example.—Boiler pressure 120 lbs. gage, initial temperature of feed water 60 deg., heated to 210 deg. Then increase in temperature 150, times tabular figure, .0862, equals 12.93 per cent. saving.

TABLE 48. Vents Cast Iron Hot-Blast Heaters.

No. of loops	In stack	† Width of standard stack in inches	40" Section						50" Section						60" Section					
			Width 9 1/2"			Width 6 3/4"			Width 9 1/2"			Width 6 3/4"			Width 9 1/2"			Width 6 3/4"		
			Square feet of heating surface	Net air space in square feet	Equivalent in one-inch pipe lineal feet	Square feet of heating surface	Net air space in square feet	Equivalent in one-inch pipe lineal feet	Square feet of heating surface	Net air space in square feet	Equivalent in one-inch pipe lineal feet	Square feet of heating surface	Net air space in square feet	Equivalent in one-inch pipe lineal feet	Square feet of heating surface	Net air space in square feet	Equivalent in one-inch pipe lineal feet			
7	35		75.2	4.34	226	52.5	4.34	138	94.5	5.37	284	66.5	5.37	200	112.0	6.45	336	77.0	6.45	231
8	40		86.0	4.96	258	60.0	4.96	180	108.0	6.14	324	76.0	6.14	228	128.0	7.37	384	88.0	7.37	264
9	45		96.7	5.58	290	67.5	5.58	203	121.5	6.91	365	85.5	6.91	257	144.0	8.29	432	99.0	8.29	297
10	50		107.5	6.20	323	75.0	6.20	225	135.0	7.68	405	95.0	7.68	285	160.0	9.21	480	110.0	9.21	330
11	55		118.2	6.82	355	82.5	6.82	248	148.5	8.45	446	104.5	8.45	314	176.0	10.13	528	121.0	10.13	363
12	60		129.0	7.44	387	90.0	7.44	270	162.0	9.22	486	114.0	9.22	342	192.0	11.05	576	132.0	11.05	396
13	65		139.7	8.06	419	97.5	8.06	293	175.5	9.99	527	123.5	9.99	371	208.0	11.97	624	143.0	11.97	429
14	70		150.5	8.68	452	105.0	8.68	315	189.0	10.76	567	133.0	10.76	399	224.0	12.89	672	154.0	12.89	462
15	75		161.2	9.30	484	112.5	9.30	338	202.5	11.53	608	142.5	11.53	428	240.0	13.81	720	165.0	13.81	495
16	80		172.0	9.92	516	120.0	9.92	360	216.0	12.30	648	152.0	12.30	456	256.0	14.73	768	176.0	14.73	528
17	85		182.7	10.54	548	127.5	10.54	383	229.5	13.07	689	161.5	13.07	485	272.0	15.65	816	187.0	15.65	561
18	90		193.5	11.16	581	135.0	11.16	405	243.0	13.84	729	171.0	13.84	513	288.0	16.57	864	198.0	16.57	594
19	95		204.2	11.78	613	142.5	11.78	428	256.5	14.59	770	180.5	14.59	542	304.0	17.50	912	209.0	17.50	627
20	100		215.0	12.40	645	150.0	12.40	450	270.0	15.36	810	190.0	15.36	570	320.0	18.42	960	220.0	18.42	660
21	105		225.7	13.02	677	157.5	13.02	473	283.5	16.13	851	199.5	16.13	599	336.0	19.34	1008	231.0	19.34	693
22	110		236.5	13.64	710	165.0	13.64	495	297.0	16.90	891	209.0	16.90	627	352.0	20.26	1056	242.0	20.26	726
23	115		247.2	14.26	742	172.5	14.26	518	310.5	17.67	932	218.5	17.67	656	368.0	21.18	1104	253.0	21.18	759
24	120		258.0	14.88	774	180.0	14.88	540	324.0	18.44	972	228.0	18.44	684	384.0	22.10	1152	264.0	22.10	792

† Note.—Add to the width of stack 2 1/2 inches for staggering of stacks. In addition to standard spacing (5" centers), Vents are also made having wide spacing (5 1/2" centers), and narrow spacing (4 1/2" centers). To change from standard to narrow spacing, multiply by .85, and from standard to wide, multiply by 1.15, for net air space.

Tapping 2 1/2" right hand on supply, 2 1/2" left hand on return, and bushed to required size. Steam and return on opposite ends, air vent on both ends. Steam and return on same end, air vent on same end.

TABLE 49.

Steam Consumption of Various Types of Non-Condensing Engines.* (Approximate).

Pounds per indicated horse-power hour.

Horse-power	Simple throttling 100 lbs. at throttle	Simple automatic 100 lbs. initial	Simple Corliss 100 lbs. initial	Simple four valve 100 lbs. initial	Compound four valve and Corliss 100 lbs. initial	Compound four valve and Corliss 125 lbs. initial	Compound four valve and Corliss 150 lbs. initial
10	52						
20	50	40.0					
30	49	39.0					
40	48	38.0					
50	48	38.0	34.5	35.0			
60	47	36.0	32.5	33.0			
70	47	35.0	31.5	32.0			
80	46	34.0	30.5	31.0			
90	45	33.0	29.5	30.0			
100	45	32.0	28.5	29.0			
150	44	31.5	28.0	28.5	22.5-23	21.5-22	21-21.5
200	43	30.5	27.0	27.5	22-22.5	21-21.5	20.5-21
250	43	30.0	26.5	27.0	22-22.5	21-21.5	20-20.5
300	42	29.0	25.5	26.0	22-22.5	20.5-21	20-20.5
400	41	28.5	25.0	25.5	21.5-22	20-20.5	19.5-20
500	41	28.5	25.0	25.5	20-21.5	19.5-20	19-19.5

The foregoing table was compiled principally from the records of a large number of actual tests of engines of various makes, under reasonably favorable conditions. It is based upon the actual weight of condensed exhaust steam.

*Atlas Engine Works Catalog.

TABLE 50.

**Speeds, Capacities and Horse-Powers of "Green" Steel Plate
Fans at Varying Pressures.***

Diam. wheel	Pressures	.26 in.	.87 in.	1.3 in.	1.7 in.	2.2 in.	2.6 in.	3.02 in.	3.46 in.	4.33 in.
		¼ oz.	½ oz.	¾ oz.	1 oz.	1¼ oz.	1½ oz.	1¾ oz.	2 oz.	2½ oz.
30	CU. FT.	2249	3176	3891	4498	5029	5513	5956	6372	7135
	R. P. M.	330	466	571	660	738	809	874	935	1047
	H. P.	.286	.811	1.491	2.298	3.213	4.227	5.311	6.515	9.120
36	CU. FT.	3239	4581	5605	6477	7242	7937	8584	9173	10268
	R. P. M.	275	389	476	550	615	674	729	779	872
	H. P.	.413	1.170	2.148	3.311	4.625	6.086	7.681	9.375	13.125
42	CU. FT.	4398	6214	7617	8815	9864	10799	11679	12483	13981
	R. P. M.	235	332	407	471	527	577	624	667	747
	H. P.	.537	1.576	2.898	5.473	6.300	8.287	10.450	12.750	17.825
48	CU. FT.	5750	8123	9937	11500	12867	14123	15240	16301	18282
	R. P. M.	206	291	356	412	461	506	546	584	655
	H. P.	.733	2.076	3.810	5.880	8.223	10.832	13.636	16.670	23.370
54	CU. FT.	7602	10758	13167	15203	17030	18650	20145	21558	24174
	R. P. M.	183	259	317	366	410	449	485	519	582
	H. P.	.970	2.750	5.047	7.767	10.880	14.300	18.017	21.992	30.896
60	CU. FT.	9715	13718	16780	19429	21725	23786	25728	27495	30792
	R. P. M.	165	233	285	330	369	404	437	467	523
	H. P.	1.241	3.506	6.433	9.932	13.882	18.230	22.996	28.077	39.355
66	CU. FT.	12078	17071	20855	24156	26975	29551	32047	34221	38247
	R. P. M.	150	212	259	300	335	367	398	425	475
	H. P.	1.542	4.361	7.996	12.352	17.238	22.666	28.675	35.123	48.895
72	CU. FT.	15608	21942	26918	31103	34835	38115	41169	44109	49312
	R. P. M.	138	194	235	275	308	337	364	390	436
	H. P.	1.983	5.601	10.322	15.881	22.252	29.223	36.808	45.043	62.783
84	CU. FT.	20192	28405	34907	40383	45174	49452	53387	57152	63996
	R. P. M.	118	166	204	236	264	289	312	334	374
	H. P.	2.581	7.262	13.387	20.650	28.875	37.931	47.775	58.450	81.812
96	CU. FT.	23008	32614	39762	46016	51601	56515	60983	65227	73045
	R. P. M.	103	146	178	206	231	253	273	292	327
	H. P.	2.941	8.337	15.261	23.531	32.982	43.348	54.511	66.707	93.380
108	CU. FT.	29260	41027	50568	58519	65198	71559	77284	82690	92549
	R. P. M.	92	129	159	184	205	225	243	260	291
	H. P.	3.737	10.488	19.397	30.060	41.666	54.871	69.163	84.556	118.291
120	CU. FT.	36209	51042	62384	71982	80270	88559	95539	102083	114298
	R. P. M.	83	117	143	165	184	203	219	234	262
	H. P.	4.628	13.050	23.925	36.807	51.307	67.928	85.495	104.401	146.116
132	CU. FT.	43560	61565	75504	87120	97575	106868	115580	123711	138231
	R. P. M.	75	106	130	150	168	184	199	213	233
	H. P.	5.568	15.730	28.957	44.550	62.370	82.096	103.430	126.521	176.715
144	CU. FT.	52026	73138	89726	103298	116116	127426	137228	147030	164372
	R. P. M.	69	97	119	137	154	169	182	195	218
	H. P.	6.65	18.700	34.411	52.822	74.221	97.741	127.802	150.371	210.133

Manufacturer's Note.—The horse-power required to drive a fan will vary according to the manner of application. The horse-powers given above are 25 per cent. greater than would be required under ideal conditions.

TABLE 51.

**Speeds, Capacities and Horse-Powers of "A. B. C." Steel
Plate Fans at Varying Pressures.***

Fan Number	Diam. of wheel	Static press.	½"	1"	1½"	2"	2½"	3"	3½"	4"
			.29 oz.	.58 oz.	.87 oz.	1.16 oz.	1.44 oz.	1.73 oz.	2.02 oz.	2.31 oz.
50	30	C. F. M.	3840	5425	6640	7650	8595	9400	10110	10810
		R. P. M.	471	665	816	945	1060	1150	1250	1330
		B. H. P.	.88	2.48	4.55	7.00	9.81	12.85	16.20	19.75
60	36	C. F. M.	5475	7740	9460	10900	12250	13400	14410	15420
		R. P. M.	393	555	681	786	880	961	1040	1110
		B. H. P.	1.25	3.53	6.49	9.94	14.00	18.35	23.10	28.10
70	42	C. F. M.	7100	10020	12280	14150	15900	17400	18700	20010
		R. P. M.	336	475	583	675	755	825	890	950
		B. H. P.	1.62	4.58	8.35	12.93	18.19	23.80	29.90	36.60
80	48	C. F. M.	8640	12200	14950	17200	19350	21150	22800	24350
		R. P. M.	294	416	511	590	660	722	780	832
		B. H. P.	1.97	5.57	10.20	15.71	22.10	28.90	36.50	44.50
90	54	C. F. M.	11000	15540	19000	21900	24600	26950	29000	31000
		R. P. M.	262	370	454	525	587	641	693	740
		B. H. P.	2.52	7.08	13.00	20.00	28.10	36.85	46.40	56.50
100	60	C. F. M.	14050	19850	24300	28000	31450	34400	37000	39600
		R. P. M.	236	333	409	473	529	578	625	665
		B. H. P.	3.21	9.05	16.65	25.60	35.95	47.10	59.10	72.30
110	66	C. F. M.	16600	23500	28800	33100	37200	40700	43800	46900
		R. P. M.	214	303	371	430	480	525	568	605
		B. H. P.	3.80	10.75	19.70	30.25	42.50	55.60	70.00	85.60
120	72	C. F. M.	20300	28700	35100	40500	45500	49700	53500	57300
		R. P. M.	196	278	340	394	440	481	520	555
		B. H. P.	4.64	13.10	24.00	37.00	52.00	68.00	85.50	104.50
140	84	C. F. M.	27400	38700	47400	54500	61300	67000	72200	77250
		R. P. M.	168	238	292	337	378	413	445	475
		B. H. P.	6.25	17.75	32.40	49.80	70.00	91.70	115.20	140.9
160	96	C. F. M.	34500	48900	59800	68900	77300	84500	91000	97500
		R. P. M.	147	208	256	296	331	362	390	416
		B. H. P.	7.88	22.30	41.00	62.90	88.40	115.5	145.4	178.0
180	108	C. F. M.	42600	60300	73800	85000	95500	104300	112500	12000
		R. P. M.	131	185	227	262	293	320	346	369
		B. H. P.	9.75	27.55	50.50	77.60	109.0	143.0	180.0	219.0
200	120	C. F. M.	51600	73000	89400	103000	115700	126500	136100	145800
		R. P. M.	118	166	204	236	264	289	312	332
		B. H. P.	11.8	33.30	61.20	93.50	132.1	173.0	217.50	266.0
220	132	C. F. M.	61400	86800	106000	122200	137400	150200	162000	173000
		R. P. M.	107	151	185	214	240	262	283	302
		B. H. P.	14.0	39.60	72.50	111.50	157.0	206.0	259.0	316.0
240	144	C. F. M.	72000	101800	124500	143500	161000	176000	189500	203000
		R. P. M.	98	139	170	197	220	241	260	277
		B. H. P.	16.5	46.50	85.00	131.00	184.0	241.0	303.0	370.5

Manufacturer's Note.—Any of the above fans, when running at the speed and pressure indicated, will deliver the volume of air and require no more power than given in the table.

Allowances must be made for the inefficiency of the motive power and for transmission losses between motive power and the fan.

*Condensed from the A. B. C. Co. Catalog.

TABLE 52.

Speeds, Capacities and Horse-Powers of "Sirocco" Fans at Varying Pressures.*

Fan Number	Diam. of wheel	Pressures	$\frac{3}{4}$ in.	1 in.	$1\frac{1}{4}$ in.	$1\frac{1}{2}$ in.	2 in.	$2\frac{1}{2}$ in.	3 in.	$3\frac{1}{2}$ in.	4 in.
			.43 oz.	.58 oz.	.72 oz.	.87 oz.	1.16 oz.	1.44 oz.	1.73 oz.	2.02 oz.	2.31 oz.
4	24	C. F. M.	4260	4920	5500	6020	6945	7770	8520	9200	9840
		R. P. M.	301	453	505	554	640	714	783	846	905
		B. H. P.	.879	1.348	1.89	2.475	3.8	5.32	7.00	8.825	10.77
5	30	C. F. M.	6650	7690	8600	9416	10870	12150	13320	14380	15380
		R. P. M.	313	362	403	443	512	571	625	676	724
		B. H. P.	1.37	2.105	2.96	3.868	5.95	8.315	10.94	13.80	16.85
6	36	C. F. M.	9580	11060	12350	13540	15630	17470	19150	20680	22150
		R. P. M.	260	302	336	369	427	477	523	565	604
		B. H. P.	1.975	3.03	4.25	5.563	8.56	11.96	15.72	19.85	24.23
7	42	C. F. M.	13050	15070	16800	18425	21260	23800	26100	28200	30140
		R. P. M.	223	259	288	316	366	408	447	483	517
		B. H. P.	2.69	4.126	5.78	7.565	11.66	16.28	21.43	27.06	33
8	48	C. F. M.	17000	19700	22000	24100	27820	31100	34080	36800	39370
		R. P. M.	196	226	252	277	320	358	392	424	453
		B. H. P.	3.51	5.39	7.58	9.9	15.22	21.30	28.0	35.3	43.15
9	54	C. F. M.	21500	24860	27800	30440	35140	39300	43100	46600	49800
		R. P. M.	174	201	224	246	285	317	348	376	402
		B. H. P.	4.43	6.81	9.57	12.52	19.23	26.94	35.38	44.70	54.5
10	60	C. F. M.	26500	30750	34300	37650	43400	48570	53220	57500	61500
		R. P. M.	156	181	202	222	256	286	313	338	362
		B. H. P.	5.46	8.42	11.8	15.47	23.77	33.23	43.72	55.2	67.4
11	66	C. F. M.	32200	37200	41500	45530	52550	58830	64450	69630	74400
		R. P. M.	142	165	184	202	233	260	285	308	329
		B. H. P.	6.65	10.18	14.3	18.72	28.77	40.24	52.9	66.85	81.5
12	72	C. F. M.	38300	44240	49400	54130	62500	69000	76600	82800	88500
		R. P. M.	130	151	168	185	214	238	261	282	302
		B. H. P.	7.9	12.11	17	22.25	34.2	47.85	63	79.5	97
13	78	C. F. M.	45000	52000	58100	63600	73500	82100	90000	97300	104000
		R. P. M.	120	140	155	171	197	220	241	261	279
		B. H. P.	9.28	14.22	20	26.16	40.22	56.2	74	93.35	113.9
14	84	C. F. M.	52100	60200	67300	73700	85000	95000	104200	112700	120400
		R. P. M.	112	130	144	158	183	204	224	242	259
		B. H. P.	10.75	16.49	23.2	30.3	46.6	65	85.6	108	132
15	90	C. F. M.	59900	69230	77500	84700	97800	109200	119800	129600	138500
		R. P. M.	104	121	135	148	171	191	209	226	242
		B. H. P.	12.34	18.93	26.6	34.8	53.55	74.9	98.5	124.2	151.7
16	96	C. F. M.	67950	78430	81800	96140	114300	124500	136000	147000	157300
		R. P. M.	98	114	126	139	160	178	196	211	226
		B. H. P.	13.98	21.5	30.2	39.6	63	85.7	112	142	173

*Condensed from A. B. C. Co. Catalog.

APPENDIX II

References used Chiefly in Refrigeration
and Ice Production

TABLE 53.
Freezing Mixtures.*

Names and proportions of ingredients in parts	Reduction of temp. deg. F.		Total Reduction of temp. deg. F.
	From	To	
Snow or pounded ice 2; sodium chloride 1.....		- 5	
Snow 5; sodium chloride 2; ammonium chloride 1.....		-12	
Snow 12; sodium chloride 5; ammonium nitrate 5.....		-25	
Snow 8; calcium chloride 5.....	+32	-40	72
Snow 2; sodium chloride 1.....		- 5	
Snow 3; dilute sulphuric acid 2.....	+32	-23	55
Snow 3; hydrochloric acid 5.....	+32	-27	59
Snow 7; dilute nitric acid 4.....	+32	-30	62
Snow 3; potassium 4.....	+32	-51	83
Ammonium chloride 5; potassium nitrate 5; water 16.....	+50	+ 4	46
Ammonium nitrate 1; water 1.....	+50	+ 4	46
Ammonium chloride 5; potassium nitrate 5; sodium sulphate 8; water 16.....	+50	+ 4	46
Sodium sulphate 5; dil. sulphuric acid 4.....	+50	+ 3	47
Sodium nitrate 3; dil. nitric acid 2.....	+50	- 3	53
Ammonium nitrate 1; sodium carbonate 1; water 1.....	+50	- 7	57
Sodium sulphate 6; ammonium chloride 4; potassium nitrate 2; dil. nitric acid 4.....	+50	-10	60
Sodium phosphate 9; dil. nitric acid 4.....	+50	-12	62
Sodium sulphate 6; ammonium nitrate 5; dil. nitric acid 4.....	+50	-14	64

TABLE 54.
Properties of Saturated Ammonia.†

Temp. deg. F.	Pressure absolute lbs. per sq. in.	Heat of vaporization	Vol. of vapor per lb. cu. ft.	Vol. of liquid per lb. cu. ft.	Wt. of vapor lbs. per cu. ft.
-40	10.69	579.67	24.38	.0234	.0411
-35	12.31	576.69	21.21	.0236	.0471
-30	14.13	573.69	18.67	.0237	.0535
-25	16.17	570.68	16.42	.0238	.0609
-20	18.45	567.67	14.48	.0240	.0690
-15	20.99	564.64	12.81	.0242	.0775
-10	23.77	561.61	11.36	.0243	.0880
- 5	27.57	558.56	9.89	.0244	.1011
± 0	30.37	555.50	9.14	.0246	.1094
+ 5	34.17	552.43	8.04	.0247	.1243
+10	38.55	549.35	7.20	.0249	.1381
+20	47.95	543.15	5.82	.0252	.1721
+30	59.41	536.92	4.73	.0254	.2111
+40	73.00	530.63	3.83	.0257	.2577
+50	88.96	524.30	3.21	.02601	.3115
+60	107.60	517.93	2.67	.0265	.3745
+70	129.21	511.52	2.24	.0268	.4664
+80	154.11	504.66	1.89	.0272	.5291
+90	182.80	498.11	1.61	.0274	.6211
+100	215.14	491.50	1.36	.0279	.7353

*Tayler. Pocket Book of Refrigeration.

†Wood—Thermodynamies, Heat Motors and Refrigerating Machines.

TABLE 55.

Solubility of Ammonia in Water at Different Temperatures and Pressures. (Sims).*

1 lb. of water (also unit volume) absorbs the following quantities of ammonia.

Absolute pressure in lbs. per sq. in.	32° F.		68° F.		104° F.		212° F.	
	Lbs.	Vols.	Lbs.	Vols.	Lbs.	Vols.	Grms.	Vols.
14.67	0.899	1180	0.518	683	0.338	443	0.074	97
15.44	0.937	1231	0.535	703	0.349	458	0.078	102
16.41	0.980	1287	0.556	730	0.363	476	0.083	109
17.37	1.029	1351	0.574	754	0.378	496	0.088	115
18.34	1.077	1414	0.594	781	0.391	513	0.092	120
19.30	1.126	1478	0.613	805	0.404	531	0.096	126
20.27	1.177	1546	0.632	830	0.414	543	0.101	132
21.23	1.236	1615	0.651	855	0.425	558	0.106	139
22.19	1.283	1685	0.669	878	0.434	570	0.110	140
23.16	1.336	1754	0.685	894	0.445	584	0.115	151
24.13	1.388	1823	0.704	924	0.454	596	0.120	157
25.09	1.442	1894	0.722	948	0.463	609	0.125	164
26.06	1.496	1965	0.741	973	0.472	619	0.130	170
27.02	1.549	2034	0.761	999	0.479	629	0.135	177
27.99	1.603	2105	0.780	1023	0.486	638		
28.95	1.656	2175	0.801	1052	0.493	647		
30.88	1.758	2309	0.842	1106	0.511	671		
32.81	1.861	2444	0.881	1157	0.530	696		
34.74	1.966	2582	0.919	1207	0.547	718		
36.67	2.070	2718	0.955	1254	0.565	742		

TABLE 56.

Strength of Ammonia Liquor.*

Degrees Baume	Specific gravity	Percent-age	Degrees Baume	Specific gravity	Percent-age
10	1.0000	0.0	20	0.9333	17.4
11	0.9929	1.8	21	0.9271	19.4
12	0.9859	3.3	22	0.9210	21.4
13	0.9790	5.0	23	0.9150	23.4
14	0.9722	6.7	24	0.9090	25.3
15	0.9655	8.4	25	0.9032	27.7
16	0.9589	10.0	26 (a)	0.8974	30.1
17	0.9523	11.9	27	0.8917	32.5
18	0.9459	13.7	28	0.8860	35.2
19	0.9396	15.5	29	0.8805	

Note.—Sp. gr. of pure anhydrous ammonia = .623

(a) Known to the trade as "20½ per cent."

*Tayler. Pocket-Book of Refrigeration.

TABLE 57.

Properties of Saturated Sulphur Dioxide. (Ledoux).*

Temp. of ebullition deg. F.	Absolute pressure lbs. per sq. in. $P \div 144$	Total heat from 32 deg. F.	Latent heat of vaporization	Heat of liquid from 32 deg. F.	Density of vapor wt. per cu. ft.
-22	5.56	157.43	176.99	-19.56	.076
-13	7.23	158.64	174.95	-16.30	.097
-4	9.27	159.84	172.89	-13.05	.123
5	11.76	161.03	170.82	-9.79	.153
14	14.74	162.20	168.73	-6.53	.190
23	18.31	163.36	166.63	-3.27	.232
32	22.53	164.51	164.51	0.00	.282
41	27.48	165.65	162.38	3.27	.340
50	33.25	166.78	160.23	6.55	.407
59	39.93	167.90	158.07	9.83	.483
68	47.61	168.99	155.89	13.11	.570
77	56.39	170.09	153.70	16.39	.669
86	66.36	171.17	151.49	19.69	.780
95	77.64	172.24	149.26	22.98	.906
104	90.31	173.30	147.02	26.28	1.046

TABLE 58.

Properties of Saturated Carbon Dioxide.†

Temp. of ebullition deg. F.	Absolute pressure in lbs. per sq. in.	Total heat from 32 deg. F.	Latent heat of vaporization	Heat of liquid from 32 deg. F.	Density of vapor or wt. per cu. ft.
-22	210	98.35	136.15	-37.80	2.321
-13	249	99.14	131.65	-32.51	2.759
-4	292	99.88	126.79	-26.91	3.265
5	342	100.53	121.50	-20.92	3.853
14	396	101.21	115.70	-14.49	4.535
23	457	101.81	109.37	-7.56	5.331
32	525	102.35	102.35	0.00	6.265
41	599	102.84	94.52	8.32	7.374
50	680	103.24	85.64	17.60	8.708
59	768	103.59	75.37	28.22	10.356
68	864	103.84	62.98	40.86	12.480
77	968	103.95	46.89	57.06	15.475
86	1080	103.72	19.28	84.44	21.519

*Kent's M. E. Pocket-Book.

†I. C. S. Pamphlet 1238 B.

TABLE 59.

**Pressures and Boiling Points of Liquids Available for Use
in Refrigerating Machines.***

Temperature of ebullition deg. F.	Pressure of vapor Pounds per square inch absolute			
	Sulphur dioxide	Ammonia	Carbon dioxide	Pictet fluid
-40		10.22		
-31		13.23		
-22	5.56	16.95		
-13	7.23	21.51	251.6	
-4	9.27	27.04	292.9	13.5
5	11.76	33.67	340.1	16.2
14	14.75	41.58	393.4	19.3
23	18.31	50.91	453.4	22.9
32	22.53	61.85	520.4	26.9
41	27.48	74.55	594.8	31.2
50	33.26	89.21	676.9	36.2
59	39.93	105.99	766.9	41.7
68	47.62	125.08	864.9	48.1
77	56.39	146.64	971.1	55.6
86	66.37	170.83	1085.6	64.1
95	77.64	197.83	1207.9	73.2
104	90.32	227.76	1338.2	82.9

TABLE 60.

Table of Calcium Brine Solution.†

Deg. Baume 60 deg. F.	Per cent. calcium by weight	Lbs. per cu. ft. solution	Specific gravity	Specific heat	Freezing point deg. F.	Amm. gage pressure
0	0.000	0.0	1.000	1.000	32.00	47.31
2	1.886	2.5	1.014	.988	30.33	45.14
4	3.772	5.0	1.028	.972	28.58	43.00
6	5.658	7.5	1.043	.955	27.05	41.17
8	7.544	10.0	1.058	.936	25.52	39.35
10	9.430	12.5	1.074	.911	22.80	36.30
12	11.316	15.0	1.090	.890	19.70	32.93
14	13.202	17.5	1.107	.878	16.61	29.63
16	15.088	20.0	1.124	.866	13.67	27.04
18	16.974	22.5	1.142	.854	10.00	23.85
20	18.860	25.0	1.160	.844	4.60	19.43
22	20.746	27.5	1.179	.834	-1.40	14.70
24	22.632	30.0	1.198	.817	-8.60	9.96
26	24.518	32.5	1.218	.799	-17.10	5.22
28	26.404	35.0	1.239	.778	-27.00	.65
30	28.290	37.5	1.261	.757	-39.20	8.5" vac.
32	30.176	40.0	1.283		-54.40	15" vac.
34	32.062	42.5	1.306		-39.20	4" vac.

*Kent's M. E. Pocket-Book.

†Am. Sch. of Cor. Dickerman-Boyer.

TABLE 61.
Table of Salt Brine Solution.*
 (Sodium chloride).

Degrees Salometer at 60 deg. F.	Percent. by wt. of salt	Pounds of salt per cu. ft.	Specific gravity	Specific heat	Freezing point deg. F.	Amm. gage pressure
0	0.00	0.000	1.0000	1.000	32.0	47.32
5	1.25	0.785	1.0090	.990	30.3	45.10
10	2.50	1.586	1.0181	.980	28.6	43.03
15	3.75	2.401	1.0271	.970	26.9	41.00
20	5.00	3.239	1.0362	.960	25.2	38.96
25	6.25	4.099	1.0455	.943	23.6	37.19
30	7.50	4.967	1.0547	.926	22.0	35.44
35	8.75	5.834	1.0640	.909	20.4	33.69
40	10.00	6.709	1.0733	.892	18.7	31.93
45	11.25	7.622	1.0828	.883	17.1	30.33
50	12.50	8.542	1.0923	.874	15.5	28.73
55	13.75	9.462	1.1018	.864	13.9	27.24
60	15.00	10.389	1.1114	.855	12.2	25.76
65	16.25	11.384	1.1213	.848	10.7	24.46
70	17.50	12.387	1.1312	.842	9.2	23.16
75	18.75	13.396	1.1411	.835	7.7	21.82
80	20.00	14.421	1.1511	.829	6.1	20.43
85	21.25	15.461	1.1614	.818	4.6	19.16
90	22.50	16.508	1.1717	.806	3.1	18.20
95	23.75	17.555	1.1820	.795	1.6	16.88
100	25.00	18.610	1.1923	.783	0.0	15.67

TABLE 62.

Horse-Power Required to Produce One Ton of Refrigeration.†
 Condenser pressure and temperature.

Refrigerator press. and temp. P	P	103	115	127	139	153	168	184	200	218
	T	65	70	75	80	85	90	95	100	105
4	-20°	1.0584	1.1304	1.2051	1.2832	1.3611	1.4427	1.5251	1.6090	1.6910
6	-15	.9972	1.0694	1.1450	1.2221	1.3001	1.4101	1.4609	1.5458	1.6300
9	-10	.9026	.9777	1.0453	1.1183	1.1926	1.2602	1.3471	1.4352	1.5003
13	-5	.8184	.8833	.9537	1.0230	1.0935	1.1679	1.2437	1.3209	1.3961
16	0	.7352	.8008	.8648	.9323	1.0019	1.0718	1.1467	1.2194	1.2547
20	5	.6665	.7312	.7946	.8593	.9278	.9978	1.0656	1.1381	1.2121
24	10	.5915	.6629	.7257	.7894	.8545	.9205	.9911	1.0595	1.1294
28	15	.5410	.5998	.6641	.7276	.7924	.8553	.9224	.9943	1.0603
33	20	.4745	.5340	.5923	.6716	.7148	.7796	.8420	.9031	.9736
39	25	.4103	.4659	.5227	.5804	.5992	.7022	.7667	.8289	.8922
45	30	.3509	.4056	.4612	.5178	.5755	.6353	.6944	.7590	.8172
51	35	.3005	.3546	.4101	.4666	.5214	.5804	.6398	.7000	.7629

Note.—The above figures are purely theoretical. In practice about 50 per cent. must be added.

*Am. Sch. of Cor. Dickerman-Boyer.
 †De La Vergne Catalog.

TABLE 63.

**Cubic Feet of Ammonia Gas per Minute to Produce One Ton
of Refrigeration per Day.***

Condenser pressure and temperature.

Refrigerator pressure and temperature	Press.	Press.	103	115	127	139	153	168	185	200	218
		Temp.	65°	70°	75°	80°	85°	90°	95°	100°	105°
	4	-20°	5.84	5.90	5.96	6.03	6.06	6.16	6.23	6.30	6.36
6	-15°	5.35	5.40	5.46	5.52	5.58	5.64	5.70	5.77	5.83	5.90
9	-10°	4.66	4.73	4.76	4.81	4.86	4.91	4.97	5.05	5.13	5.20
13	-5°	4.09	4.12	4.17	4.21	4.25	4.30	4.35	4.40	4.44	4.49
16	0°	3.59	3.63	3.66	3.70	3.74	3.78	3.83	3.87	3.91	3.95
20	5°	3.20	3.24	3.27	3.30	3.34	3.38	3.41	3.45	3.49	3.53
24	10°	2.87	2.90	2.93	2.96	2.99	3.02	3.06	3.09	3.12	3.15
28	15°	2.59	2.61	2.65	2.68	2.71	2.73	2.76	2.80	2.82	2.85
33	20°	2.31	2.34	2.36	2.38	2.41	2.44	2.46	2.49	2.51	2.54
39	25°	2.06	2.08	2.10	2.12	2.15	2.17	2.20	2.22	2.24	2.26
45	30°	1.85	1.87	1.89	1.91	1.93	1.95	1.97	2.00	2.01	2.03
51	35°	1.70	1.72	1.74	1.76	1.77	1.79	1.81	1.83	1.85	1.87

TABLE 64.

Table of Refrigerating Capacities.†

Size of building				Number of cu. ft. per ton of refrigeration at temperatures given						
Dimen- sions of building	Con- tents cu. ft.	Sur- face in sq. ft.	Ratio cu. ft. to sq. ft.	Temperatures						
				0°	8°	16°	24°	32°	40°	48°
5x4x5	100	130	1.3	900	1100	1300	1500	1700	1900	2100
8x10x10	800	520	.65	1800	2200	2600	3000	3400	3800	4200
25x40x10	10000	3300	.33	3600	4400	5200	6000	6700	7600	8400
20x50x20	20000	4800	.24	4860	5940	7020	8100	9180	10260	11340
40x50x20	40000	7600	.19	6300	7700	9100	10500	11900	13300	14700
60x50x20	60000	10400	.17	6840	8360	9880	11400	12920	14440	15960
80x50x20	80000	13200	.165	7200	8800	10700	12000	13600	15200	16800
100x50x20	100000	16000	.16	7200	8800	10400	12000	13600	15200	16800
100x100x20	200000	28000	.14	8100	9900	11700	13000	15300	17100	18900
100x100x40	400000	36000	.09	13050	15950	18850	21750	24650	27550	30450
100x100x60	600000	44000	.073	16200	19800	23400	27000	30600	34200	37800
100x100x80	800000	52000	.065	18000	22000	26000	30000	34000	38000	42000
100x100x100	1000000	60000	.06	19350	23650	27950	32250	36550	40850	45150

*Featherstone Foundry and Machine Co. Catalog.

†Tayler. P. B. of R.

TABLE 65.
Approximate Cost of Ice Making.*

Tons ice per day	Engineers \$2.50 to \$5.00 per day	Oilers \$2.00 per day	Firemen \$1.50 to \$1.75 per day	Tankmen and laborers \$1.25 to \$1.50 per day	Coal \$2.00 per ton	Oil, waste, light and sundries	Daily operating expenses	Cost of ice per ton
10	2 at \$4.50		2 at \$3.00	2 at \$3.00	3600 at \$3.60	\$1.50	\$12.60	\$1.26
20	2 " 5.00		2 " 3.00	2 " 3.00	6600 " 6.60	2.00	19.60	.98
25	2 " 5.25		2 " 3.00	2 " 3.00	8000 " 8.00	2.50	21.75	.87
30	2 " 5.50		2 " 3.00	2 " 3.00	9300 " 9.30	3.00	23.80	.79
40	2 " 6.00		2 " 3.00	3 " 4.50	12300 " 12.30	3.50	29.30	.76
60	3 " 9.00	1 at \$2.00	3 " 4.50	3 " 4.50	18000 " 18.00	4.00	42.00	.70
75	3 " 10.00	1 " 2.00	3 " 4.50	4 " 6.00	22000 " 22.00	4.50	49.00	.65½
100	3 " 11.00	1 " 2.00	4 " 6.00	6 " 9.00	28500 " 28.50	5.00	61.50	.61½
120	3 " 11.50	1 " 2.00	4 " 6.00	6 " 9.00	34000 " 34.00	5.00	67.50	.56¾

This table does not include such charges as delivery, interest, taxes, etc.
* Featherstone Foundry and Machine Co.

Table 66.

**Temperatures to Which Ammonia Gas is Raised by
Compression.***

Tempera- ture of suction	Absolute condensing pressure	Absolute suction pressure					
		20	25	30	35	40	45
0 deg. F.	90	199	165	138	116	98	83
	110	232	196	166	145	126	109
	130	261	222	193	169	150	132
	150	285	246	216	191	171	153
	160	296	257	226	202	181	163
5 deg. F.	90	266	172	145	123	104	89
	110	239	203	174	151	132	115
	130	268	230	200	176	156	139
	150	293	254	223	198	178	160
	160	305	265	234	209	188	170
10 deg. F.	90	213	178	151	129	110	96
	110	247	210	181	158	139	122
	130	275	237	207	183	163	145
	150	301	262	231	205	185	167
	160	313	273	241	216	195	176
15 deg. F.	90	221	185	158	135	117	101
	110	254	217	188	164	145	128
	130	283	245	214	191	170	152
	150	309	269	238	213	192	173
	160	321	281	249	223	202	183
20 deg. F.	90	228	192	164	141	123	106
	110	262	224	195	171	150	134
	130	291	252	222	197	176	158
	150	317	277	245	220	198	180
	160	329	288	256	230	209	190
25 deg. F.	90	235	199	171	148	129	111
	110	269	230	200	178	155	140
	130	299	259	229	204	183	165
	150	325	284	253	227	205	187
	160	338	296	264	237	216	197
30 deg. F.	90	242	206	177	154	134	118
	110	277	239	208	184	164	147
	130	307	267	236	211	190	171
	150	334	292	260	234	212	193
	160	346	304	271	245	223	203
35 deg. F.	90	249	213	182	160	141	124
	110	286	246	215	191	170	153
	130	315	274	243	217	196	178
	150	341	300	268	241	219	200
	160	354	312	279	252	230	210

*Tayler. P. B. of R.

TABLE 67. Comparison of Various Hydrometer Scales. (Varyan).*

Degrees Baume	0	5	10	15	20	25	30	35	40	45	50	55	60	65	70
Degrees Densimetric 15.5° C. (60° F.)	0	3.6	7.4	11.5	16.0	20.8	26.1	31.8	38.1	45.0	52.6	61.1	70.6	81.2	93.3
Degrees Twaddell 60° F. T° = 200 (sp. gr. - 1)	0	7.2	14.8	23.0	32.0	41.6	52.2	63.6	76.2	90.0	105.2	122.2	141.2	162.4	186.6
Degrees Brix. 15.5° C. Official Prussian. 400 sp. gr. = $\frac{400 - B X}{400 - B X}$	0	13.9	27.5	41.3	55.2	68.9	82.8	96.5	110.3	124.1	137.9	151.7	165.5	179.3	193.0
Degrees Beck 12.5° C. 170 sp. gr. = $\frac{170 - B K}{170 - B K}$	0	5.9	11.7	17.6	23.5	29.3	35.2	41.0	46.9	52.8	58.6	64.5	70.4	76.2	82.1
Degrees Brix. Saccharimetric. (per cent. sugar)	0	9.0	18.0	27.0	36.2	45.5	55.1	64.7	74.7	85.1					
Gay-Lussac (C) 100 sp. gr. = $\frac{100}{100 - C}$	0	3.5	6.9	10.3	13.8	17.2	20.7	24.1	27.6	31.0	34.5	37.9	41.4	44.8	48.3
Liquids heavier than water	1	1.036	1.074	1.115	1.160	1.208	1.261	1.318	1.381	1.450	1.526	1.611	1.706	1.812	1.933
sp. gr. = $\frac{145}{145 - B}$															
Liquids lighter than water															
sp. gr. = $\frac{140}{130 + B}$			1.000	0.966	0.933	0.903	0.875	0.849	0.824	0.800	0.778	0.757	0.737	0.718	0.700
U. S. Chem. Assn. Modulus 144.38. Custom in France	1	1.0380	1.0745	1.1160	1.1607	1.2095	1.2625	1.3200	1.3830	1.4525	1.5300	1.6150	1.7110	1.8155	1.9410

*Taylor. P. B. of R.

TABLE 68.

Time Required to Freeze Ice in Cells or Cans. (a) (Siebert).*

Temp. deg. F.	Thickness in inches											
	1	2	3	4	5	6	7	8	9	10	11	12
10	0.32	1.28	2.86	5.10	8.00	11.5	15.6	20.4	25.8	31.8	38.5	45.8
12	0.35	1.40	3.15	5.60	8.75	12.6	17.3	22.4	28.4	35.0	42.3	50.4
14	0.39	1.56	3.50	6.22	9.70	14.0	19.0	25.0	31.5	39.0	47.0	56.0
16	0.44	1.75	3.94	7.00	11.00	15.8	21.5	28.0	35.5	43.7	53.0	63.0
18	0.50	2.00	4.50	8.00	12.50	18.0	24.5	32.0	40.5	50.0	60.5	72.0
20	0.58	2.32	5.25	9.30	14.60	21.0	28.5	37.3	47.2	58.3	70.5	84.0
22	0.70	2.80	6.30	11.20	17.50	25.2	34.3	44.8	56.7	70.0	84.7	100.0
24	0.88	3.50	7.86	14.00	21.00	31.5	42.8	56.0	71.0	87.5	106.0	126.0

(a) Time required from one wall, for plate ice, two times the above values.

TABLE 69.

Standard Sizes of Ice Cans.†

Size of cake, in pounds	Size of top, inches	Size of bottom, inches	Inside depth, inches	Outside depth, inches	Size of band, inches
50	8x8	7½x7½	31	32	¼x1½
100	8x16	7¼x15¼	31	32	¼x1½
200	11½x22½	10½x21½	31	32	¼x2
300	11½x22½	10½x21½	44	45	¼x2
400	11½x22½	10½x21½	57	58	¼x2

TABLE 70.

Cold Storage Temperatures for Various Articles.*

Article	Temp. deg. F.	Article	Temp. deg. F.	Article	Temp. deg. F.
Apples -----	32-36	Fruits -----	26-55	Oranges -----	45-50
Asparagus -----	34	Fruits (dried)---	35-40	Oysters -----	33-35
Bananas -----	40-45	Fruits (canned)---	35	Oysters (in	
Beans (dried)---	32-40	Furs (un-		tubs) -----	25
Berries (fresh)---	36-40	dressed) -----	35	Oysters (in	
Buckwheat		Furs (dressed) -	25-32	shells) -----	33
flour -----	40	Game (frozen)---	25-28	Peaches -----	45-55
Butter -----	32-33	Game (to		Pears -----	34-36
Cabbage -----	34	freeze) -----	15-28	Peas (dried) ---	40
Cantaloupes -----	40	Grapes -----	36-38	Pork -----	34
Celery -----	32-34	Hams -----	30-35	Potatoes -----	36-40
Cheese -----	32-33	Hops -----	33-40	Poultry	
Chocolate -----	40	Honey -----	45	(frozen) -----	28-30
Cider -----	30-40	Lard -----	34-45	Poultry (to	
Claret -----	45-50	Lemons -----	36-40	freeze) -----	18-22
Corn (dried)---	35	Meat (canned)---	35	Sugar, etc. ---	40-45
Cranberries -----	34-36	Meat (fresh)---	34	Syrup -----	35
Cream -----	35	Meat (frozen)---	25-28	Tobacco -----	35
Cucumbers -----	39	Milk -----	32	Tomatoes -----	36
Dates -----	55	Nuts -----	35	Vegetables -----	34-40
Eggs -----	33-35	Oat meal -----	40	Watermelons ---	34
Figs -----	55	Oil -----	35	Wheat flour ---	40
Fish (fresh)---	25-30	Oleomargarine -	35	Wines -----	40-45
Fish (dried)---	35	Onions -----	34-40	Woc lens, etc.---	25-32

*Taylor. P. B. of R.

†As adopted by the Ice Machine Builders' Association of the U. S.

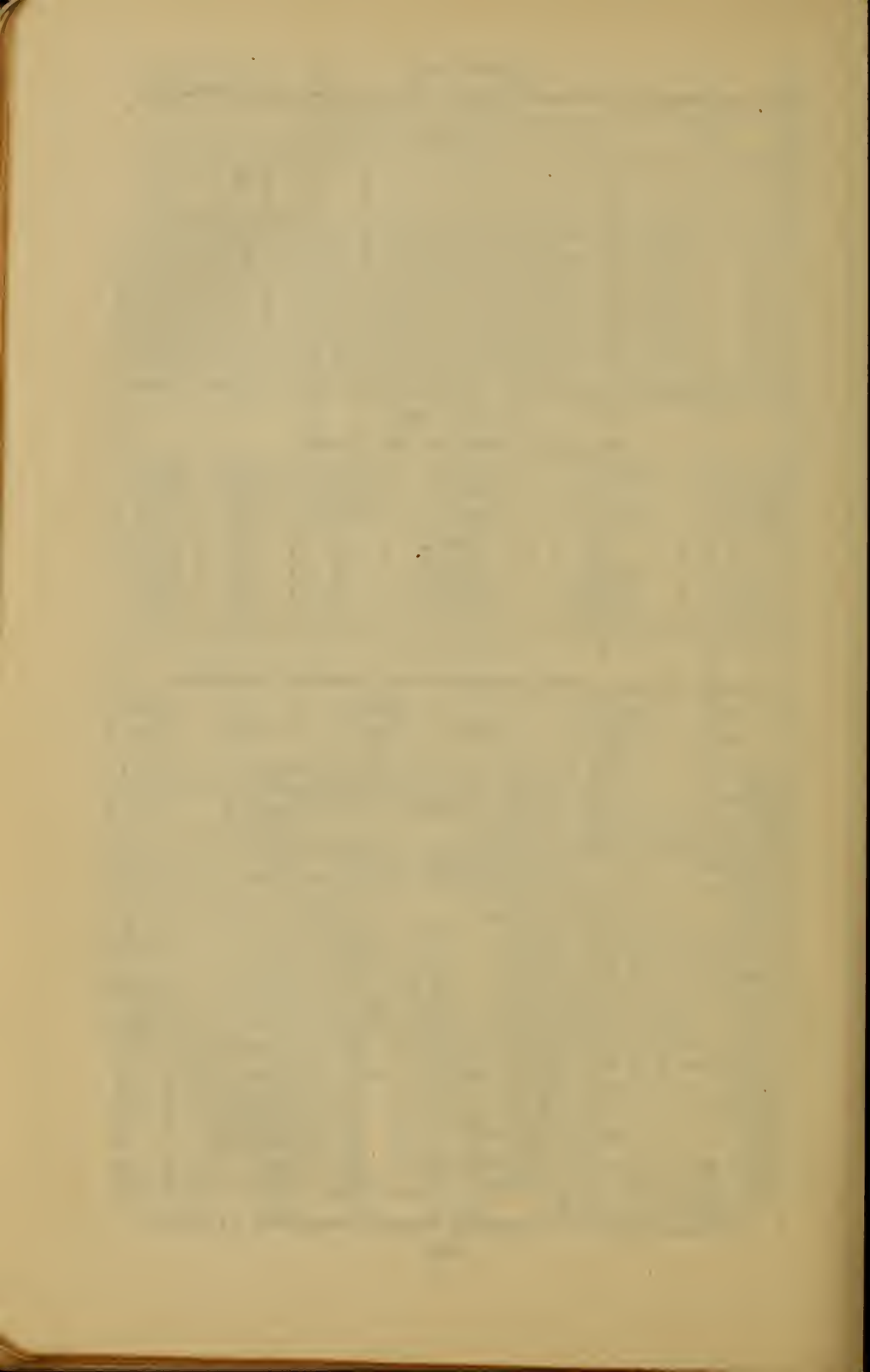

APPENDIX III

Tests of House Heating Boilers.

The following extract from a series of tests on a Number S-48-7 Ideal Sectional Boiler from the reports of the American Radiator Company's Institute of Thermal Research, Buffalo, New York, will be of interest.

Size of grate.....	48x64½ in.	Grate area.....	21.6 sq. ft.
Heating surface—total			300.0 sq. ft.
		Hard	Hard
0—Fuel used in tests		Coal	Coal
1—No. of boiler	S-48-7	S-48-7	S-48-7
2—Duration of test hours.....	8:00	7:00	8:00
4—Fuel burned during test, lbs.....	1360.00	1344.00	1434.00
5—Fuel per hour, lbs.	170.00	192.00	178.20
6—Fuel per sq. ft. grate per hour, lbs.....	7.90	8.95	8.35
7—Stack temperature, degrees Fahrenheit	750.00	725.00	600.00
8—Evaporation per sq. ft. of heating surface			
per hour, lbs.	4.97	5.60	5.24
9—Evaporative power available—lbs. of water			
per lb. of coal	8.80	8.75	8.77
10—Boiler-power (evaporation per hour)—lbs.			
(item 5 × item 9).....	1496.00	1680.00	1562.00
11—Capacity—sq. ft. (item 10 ÷ 0.22).....	6800.00	7640.00	7100.00
12—Capacity—sq. ft. (item 10 ÷ 0.25).....	5980.00	6720.00	6250.00
Catalog rating			5700 sq. ft.

The accompanying figure shows the combustion chart as developed for this same boiler. The tests were run to find the *evaporative power* and *capacity* with varying amounts of coal burned per hour. Coal was fired at regular intervals and the steam pressure was maintained at two pounds gage on the radiation. Line 11 gives the capacity in square feet of radiation including mains and risers, at the rate of .22 pound of steam per square foot per hour. Line 12 gives the capacity at .25 pound of steam per square foot per hour. In average service about one-third of these quantities of coal would be burned. The catalog rating is based upon burning 167.5 pounds of coal per hour and an evaporation of 8.5 pounds of water per pound of coal (rates of combustion and evaporation that seem justifiable). As

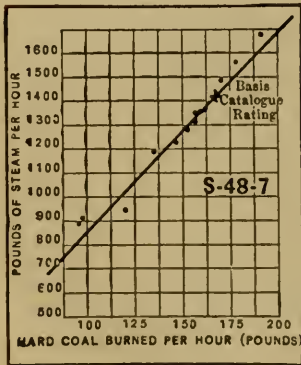

will be seen from lines 5 and 9 the actual amount of coal burned and the actual evaporation in each test exceed this figure. Multiplying 167.5 by the assumed evaporative rate of 8.5 and dividing by .25 = 5700 square feet. Comparing with column 2, line 5 times line 9 divided by .25 gives 6720 square feet, which is above the catalog rating. Test number two compared with test number one shows that by increasing the amount of coal from 170 pounds to 192 pounds per hour increases the boiler capacity 740 square feet.

INDEX

- Absolute pressure, 12
 temperature, 12
- Absorbers, 300
- Absorption system of refrigeration, 294
 and compression system compared, 302
 system condensers for, 299
 system, elevation of, 296
 system pumps for, 301
- Accelerated systems hot water, 95
- Adaptation of district steam to private plants, 267
- Advantages of vacuum systems, 142
- Air, amount to burn carbon, 35
 circulation furnace system, 53
 circulation within room, 76
 composition, 16
 duct, fresh, 59
 exhausted, actual from nozzle, 188
 exhausted per hour plenum system, 170
 h. p. in moving, 192
 h. p. in moving, table, 186
 humidity of, 25
 leakage, heat loss by, 43
 moisture required by, 30
 needed plenum system, 172
 per person, table, 24
 required as heat carrier, 54
 temperature at register, 56
 valves, 112
 velocities of in convection, 31
 velocities, measurement of, 32
 velocities, plenum system, table, 172, 184
 required, ventilating purposes, 21
 washing and humidifying, 167
- Ammonia for one-ton refrig., 385
 solubility in water, 381
 strength of liquor, 381
- Anchors, types of, 221
- Anemometer, 32
- Appendix
 table 1 squares, cubes, etc., 328
 table 2 trigonometric functions, 334
 table 3 equivalents of units, 334
 table 4 properties of steam, 335
 table 5 Napierian logarithms, 338
 table 6 water conversion factors, 338
 table 7 volume and wt. of dry air, 339
 table 8 weight of pure water, 340
 table 9 boiling points of water, 342
 table 10 weight of water in air, 342
 table 11 relative humidities, 343
 table 12 properties of air, 344
 table 13 dew points of air, 345
 table 14 fuel values Am. coals, 34^a
 table 15 cap. of chimneys, 349
 table 16 equalization of smoke flues, 350
 table 17 dimensions of reg., 350
 tables 18, 20 cap. of fur., 351, 352
 table 19 cap. pipes and reg., 351
 table 21 area vertical flues, 352
 table 22 sheet metal dim., 353
 table 23 weight of G. I. pipe, 354
 table 24 sp. ht., etc., of substances, 355
 tables 25, 26 water pressures, 356
 table 27 wrought iron pipes, 357
 table 28 expansion of pipes, 358
 table 29 tapping list of rad., 358
 table 30 pipe equalization, 359
 table 31 cap. hot water risers, 360
 table 32 cap. steam pipes, 360
 table 33 cap. hot water pipes, 361
 table 34 cap. hot water mains, 361
 tables 35, 36 sizes of steam mains, 362, 363
 table 37 friction in pipes, 364
 table 38 grav. and vac. returns, 365
 table 39 expansion tanks, 365
 table 40 sizes of flanged fittings, 366
 table 41 pipe fittings, 366
 table 42 friction in air pipes, 367
 table 43 temp. for testing steam plants, 370
 table 44 spec. for boilers, 371
 table 45 heat trans. through pipe covering, 372
 table 46 factors of evap., 373
 table 47 heat in feed water, 373
 table 48 sizes of Vento heater, 374
 table 49 steam used by engines, 375
 tables 50, 51, 52 speeds, cap. and h. p. of various fans, 376, 378
 table 53 freezing mixtures, 380
 table 54 properties of ammonia, 380
 table 55 sol. of ammonia in water, 381
 table 56 strength of ammonia liquor, 381
 table 57 prop. of sulphur dioxide, 382
 table 58 prop. of carbon dioxide, 382
 table 59 boiling pts. of liquids, 383
 table 60 calcium brine sol., 383
 table 61 salt brine sol., 384
 table 62 horse-power for refrig., 384

- table 63 ammonia for one-ton
refrig., 385
- table 64 refrigeration caps., 385
- table 65 cost of ice making, 386
- table 66 temperature of ammonia,
387
- table 67 hydrometer scales, 388
- table 68 time to freeze ice, 389
- table 69 sizes of ice cans, 389
- table 70 temp. for cold storage, 389
- Application of formula in furnace
heating, 62
- of plenum system, 200
- Area of ducts, plenum system, 172
- of chimney determination of, 35
- of grate, 59
- Arrangement of Vento heaters, 161
- of coils, plenum system, 160
- Automatic vacuum system, 149
- valves, 149
- Basement plans plenum system, 203
- Belvac thermofiers, 148
- Blowers and fans, speeds of, table,
197
- work, Carpenter's rules, 194
- Boilers, 251
- feed pumps, 249
- capacity and number of, 255
- radiation supplied by, 252
- plant capacity of, 255
- steam, 108
- tests of, 392
- Boiling point of water, table, 342
- Bolling points of liquids, 383
- Brine cooling system, cap. of, 315
- British thermal unit, 10
- B. t. u. lost in plenum system, 176
- Building materials, conductivities of,
40
- Calcium brine solution, 383
- Calculating chimney areas, 35
- heat loss, 45-46
- Calorie, 10
- Carbon amount of air to burn, 35
- dioxide, 18
- dioxide per cent., table, 19
- dioxide tests for, 19
- Carpenter's practical rules, 194
- Cast radiators, 103
- surfaces, plenum system, 161
- Centrifugal pumps, 247
- Check valve, 111
- Chimney area, determination of, 35
- Chimneys, 36
- capacity of, table, 349
- Circulating system for refrigerating,
302
- duct in furnace design, 72
- water to condense steam, 237
- Classification of radiators, 104
- Coal, fuel values of, table, 348
- Coils, arrangement of in pipe heater,
180
- arrangement of Vento in stacks,
182
- heat transmission through, 174
- heat transmission through Vento,
table, 177
- sq. ft. for cooling, 311
- surface, plenum system, 173
- temp. leaving Vento, table, 180
- Cold air system of refrigeration, 284
- Combination systems, 110
- heaters, 70
- Comparison of furnace and other
systems, 51
- Composition of air, 16
- Compression and absorption system
compared, 302
- systems, condensers for, 289
- system of refrigeration, 286
- Condensation, dripping from mains,
267
- return to boilers, 133
- Condenser, concentric tube, 289
- enclosed, 290
- for compression systems, 289
- submerged, 290
- for exhaust steam, 238
- heating surface in, 239
- Conduction, 14
- of building material, table of, 40
- Conduits, district heating, 212
- Convection, 15
- Conversion factors for water, 338
- Coolers for weak liquor, 301
- Cost of heating from central sta-
tion, 253
- of ice making, 316, 386
- Data for estimate, 394
- Data, table for plenum system, 202
- Design, hot water and steam, 114
- Determination of pipe sizes, 121
- Dew point, influence of on refrigera-
tion, 305
- Dew points of air, 345
- Direct radiation, tapping list, table,
358
- Dirt strainer, Webster, 147
- District heating
- adaptation to private plants, 267
- amount of radiation supplied by
one horse-power exhaust steam,
237
- amount of radiation supplied, 237
- amount of radiation supplied by
reheater, 241
- application to typical design, 268
- boiler feed pumps, 249
- boilers, 251
- by steam, 264
- capacity of boiler plant, 255
- centrifugal pumps, 247
- circulating pumps, 244
- city water supply, 249
- classification, 229
- condensation from mains, 267

- conduits, 212
 cost of heating, 258
 cost, summary of tests, 260
 design for consideration, 222
 dripping condensation from mains,
 267
 diameter of mains, 265
 economizer, 253
 exhaust steam available, 223
 future increase, 231
 general application of design, 268
 heat available in exhaust steam,
 225
 heating by steam, 264
 heating surface in reheater, 239
 high pressure steam heater, 244
 hot water systems, 229
 important reheater details, 242
 layout for conduit mains, 218
 power plant layout, 259
 pressure drop in mains, 231, 265
 radiation in district, 231
 radiation supplied by 1 h. p. of ex.
 st., 237
 radiation supplied by economizer,
 253
 radiation supplied per boiler h. p.,
 252
 references on district heating, 270
 regulation, 263
 reheater details, 242
 reheater for circulating water, 238
 reheater tube surface, 241
 scope of work, 209
 service connections, 235
 steam available for heating, 236
 systems classified, 229
 typical design, 222
 velocity of water in mains, 234
 water per hour, as heating medium,
 230
 water to condense one pound of
 steam, 237
 Division of coils, plenum sys., 162
 Ducts, furnace, cold air, 59
 plenum system, 165-166
 recirculating, 72
 Economizers, 253
 radiation supplied by, 253
 surface, 255
 Efficiency of plenum coils, table, 175
 Electrical heating, 279
 formulas used in, 279
 future of, 282
 references, 282
 Electric pumps, 137
 Engine, size of, 197
 Equivalents of units, 334
 Evaporators for refrig., 292
 Exchangers, 301
 Exhaust steam available in district
 plants, 223
 Exhaust steam condenser, 238
 Expansion joints, 218
 tanks, 113, 365
 Exposure heat losses, table, 43
 Factors of evaporation, 373
 Factor table, velocity and vol., 188
 Fans and blowers, 155
 drives, 195
 housings, 157
 power of engine for, 197
 size of parts, 195
 speed of, 196
 Fire places, stoves, etc., 153
 Fittings, steam and hot water, 110,
 366
 Floor plans for furnace heating,
 64-66
 Floor plans for plenum sys., 203-205
 Formulas, empirical for radiation,
 117
 Freezing mixtures, 380
 Fresh air duct, 59-71
 Fresh air entrance to bldgs., 159
 Friction diagrams, 368, 369
 in pipes, 364
 of air in pipes, 367
 Fuel values of Am. coals, table, 348
 Furnace,
 air circulation within room, 76
 foundations, 71
 heating, 51
 location, 71
 selection, 67
 Furnace system, air circulation, 53
 air required as heat carrier, 54
 circulating duct in, 72
 design of, 62
 essentials of, 52
 fan in, 77
 fresh air duct in, 71
 grate area in, 59
 gross register area in, 57
 heat stacks, sizes of, 57
 heating surface in, 61
 leader pipes in, 59, 73
 net vent register in, 56
 plans for, 64
 points to be calculated in, 53
 registers, temperatures in, 56
 stacks or risers in, 74
 three methods of installation, 55
 vent stacks, 76
 Gage pressure, 12
 Gallon degree calculation, 315
 Gate valve, 111
 Generators, 298
 Globe valve, 111
 Grate area, boilers and heaters, 123
 Grate area for furnaces, 59
 Greenhouse heating, 118
 Gross register area, 51
 Hammer, water, 133

- Heat given off by persons, lights, etc., 49
 latent, 13
 measurement of, 10
 mechanical equivalent of, 13
 stacks, sizes of, 57, 74
 Heaters, hot water, 108
 Heating, district, cost of, 258
 Heating surface in coils, plenum system, 159
 Heating sur., in economizer, 254
 in furnace system, 61
 in reheater, 239
 per h. p. in reheater, 241
 Heat loss, 43, 44, 45, 46
 calculation of, 45
 calculation for refrig., 308
 chart, 81
 combined, 47
 for a 10 room house, table, 63
 High pressure heater, 244
 High pressure steam trap, 134
 Horse-power, in moving air, 192
 of engine for fan, 197
 required to move air in plenum system, 193
 Hot air pipes, cap. of, table, 351
 water heaters, 108
 water pipes, capacity of, table, 361
 water radiators, 106
 water risers, cap. of, table, 360
 water system, 85
 water used in indirect coils in plenum system, 183
 Hot water and steam heating, accelerated systems, 95
 calculation of rad. sur. for, 114
 classifications, 87
 connection to radiators, 124
 determination of pipe sizes, 121
 diagrams for, 91
 empirical formula for, 117
 expansion tank for, 113
 for district heating, 229
 fittings, 110
 grate area for heaters, 123
 greenhouse radiation, 118
 layout, 128
 location of radiators for, 124
 parts of, 85
 pitch of mains for, 124
 principles of design of, 114
 second classification of, 88
 suggestions for operating, 137
 temperature, table, 120
 Humidity of the air, 25
 Humidities, relative, table, 343
 Hydrometric scales, 388
 Hygrodeik, 27
 Hygrometer, 26
 Hygrometric chart, 29
 Ice making, capacity, calculation, 314
 costs of, 316
 Indirect radiators, 88
 Insulation of steam pipes, 131, 309
 'K' values for pipe coils, table, 174
 'K' values for Vento coils, 177
 Latent heat, 13
 Layout for furnace system, 64
 for hot water heating plant, 128
 for plenum system, 163
 of power plant, 259
 main and riser, 131
 steam mains and conduits, 218
 Leader pipes, 58
 Location of furnaces, 71
 of radiators, 124
 Low pressure steam traps, 133
 Main and riser layout, 131
 Mains, cap. of hot water, table, 361
 condensation, dripping from, 267
 diameter of, 234
 pitch of, 124
 pressure drop and diam. of, 265
 velocity of water in, 234
 Manholes, 222
 Measurement of air velocities, 32
 of heat, 10
 of high temperatures, 11
 Mechanical equivalent of heat, 13
 Mechanical vacuum steam litg. sys., advantages of, 142
 automatic pump for, 144
 automatic system, 149
 Dunham system, 150
 Paul system, 150
 principal features of, 143
 Van Auken, 148
 Webster system, 145
 Mechanical warm air heating and ventilating sys., 153, 169, 184
 blowers and fans for, 155
 definitions of terms, 169
 elements of, 153
 exhaust, 154
 heat loss and cu. ft. air exhausted, 170
 theoretical considerations for, 169
 variations in design of, 154
 Mills system (attic main), 90, 93
 Modulation valve for Webster system, 147
 Moisture, addition of, to air, 30
 with air, 25
 Napierian logarithms, table, 333
 Nitrogen, 17
 'n,' values of, 47
 Operation of furnaces, 78
 of hot water heaters and steam boilers, 137
 suggestions for, 137
 Outside temp. for design, 79
 Oxygen, 17

- Packless valves, 112
 Paul sys. of mech. vac. heating, 150
 typical piping connections for, 150
 Pipe coil radiators, 104
 capacity of, in sq. ft. of steam radiation, 360
 equalization, table of, 359
 for refrigeration, 294
 line refrigeration, 306
 sizes, determination of, 121
 Pipe, leader, 58
 Piping connection around heater and engine, 200
 connections for auto. vac. sys., 149
 connections for Paul sys., 151
 for heating sys. definitions, 86
 system for automatic control of Webster system, 147
 Pitot tubes, 33
 Plans and speci. for htg. sys., 318
 typical specifications, 319
 Plenum system, actual amount of air exhausted in, 188
 air needed cu. ft. per hour in, 172
 air velocity, table, 186
 air velocity theoretical in, 184
 air washing and humidifying, 167
 amount of steam condensed, 183
 application of to school bldgs., 200
 approximate rules for, 178
 approximate sizes of fan wheels, table, 195
 arrangement of coils in pipe heaters, 180
 arrangement of secs. and stacks in Vento heaters, 182
 basement plans for, 203
 blower fans, actual h. p. to move air, 193
 Carpenter's rules for, 194
 cast surface for, 161
 coil surface in, 173
 cross sectional area ducts, registers, etc., 172
 data, table, 202
 division of coil surface in, 162
 double ducts in, 166
 dry steam needed in excess of exh. from engine, 183
 efficiency and air temp., table, 175
 factors for change of velocity and volume, table, 188
 fan drives for, 195
 final air temperature in, 179
 floor plans for, 203-205
 heating surface in coils of, 173
 heating surfaces, 159
 h. p. of engine for fan for, 192
 h. p. to move air, table, 186
 'K,' values of, 174
 layout, 163, 164
 piping connections around heater and engine, 200
 pressure and velocity, results of tests of, 189
 single duct in, 165
 speed of blower fans, table, 197
 speed of fans for, 196
 temp. of air at register in, 171
 temp. of air leaving coils, 180
 total B. t. u. transmitted per hr., table, 176
 use of hot water in indirect coils, 183
 values of 'c,' 176
 values of 'K,' 174
 velocity of air escaping to atmosphere, table, 187
 work done in moving air, 192
 Power plant layout, 259
 Pressed steel radiators, 103
 Pressure, absolute, 12
 and velocity, results of tests, 189
 gage, 12
 in ounces per sq. in., table, 356
 water in mains, 231
 Principal features of mechanical vacuum heating system, 143
 Properties of air, table, 344
 of ammonia, table, 380
 of carbon dioxide, table, 382
 of steam, table, 335
 of sulphur dioxide, table, 382
 Psychometric chart, 345
 Pumps, boiler feed, 249
 centrifugal, 247
 circulating, 244
 city water supply, 249
 electric, 137
 for absorption system, 301
 for mech. vac. steam heating, 144
 Radiation, 14
 amount of, one sq. ft. reheater tube surface will supply, 241
 amt. supplied by economizer, 253
 amt. supplied by one h. p., 252
 hot water, 106
 one lb. exh. steam will supply, 237
 supplied by 1 h. p. exh. steam, 237
 sur. to heat circulating water, 254
 surface to heat feed water, 255
 Radiators, amt. of surface on, 108
 cast, 103
 classification of, 104
 columns of, 104
 direct, 87
 direct-indirect, 87
 height of, 106
 indirect, 88
 location and connection of, 124
 pipe coil, 104
 pressed steel, 103
 sizes, etc., for ten room house, table, 127
 sizes, table of, 108
 steam, 106
 surface calculation for, 114
 sur. effect on trans. of heat, 107
 tapping list, 358

- Recirculating duct, 72
 Rectifiers, 298
 References,
 district heating, 270
 electrical heating, 282
 furnace heating, 84
 heat loss, 50
 hot water and steam heating, 139
 plenum heating, 206
 vacuum heating, 152
 ventilation and air supply, 38
 refrigeration, 318
 Refrigeration,
 absorbers, 300
 absorption and compression systems compared, 302
 absorption system, 294
 absorption system, elevation of, 296
 capacity of brine cooled system, 315
 capacities, table, 385
 circulating system, 302
 classification of systems, 283
 coils, sq. ft. cooling, 311
 cold air system, 284
 compression system, 286
 condenser, 289
 coolers for weak liquor, 301
 costs of ice making, 316
 evaporators, 292
 exchangers, 301
 gallon degree calculation, 315
 general application, 313
 generators, 298
 horse-power for, 384
 heat loss, 308
 ice making cap. calculation, 314
 influence of dew point, 305
 methods of maintaining low temp., 303
 pipe line, 306
 pipes, valves and fittings, 294
 pump for absorption system, 301
 rectifiers, 298
 vacuum system, 284
 Register, area of, 56
 dimensions of, table, 350
 ducts, area of, 172
 sizes, net heat, 56
 temperature, 56
 Regulation, district heating, 263
 Sylphon damper, 273
 Room temperature, standard, 47

 Salt brine solution, 384
 Service connections, 235
 Sheet metal dimensions, 353
 Single duct, plenum system, 165
 Sizes of fan wheels, approximate, table, 195
 Sizes of ice cans, 389
 Smoke flues, equalization of, 350
 Specifications for plans, 319
 for boilers, 371

 Specific heat, 13
 heats, etc., of substances, 355
 Speeds of blower fans, 196
 Squares, cubes, etc., table, 328
 Stacks and risers, 74
 Standard room temperature, 47
 Steam and hot water fittings, 110
 available for heating circulating water, 237
 boilers, 108
 condensed per sq. ft. of heating sur. per hour, plenum sys., 183
 dry, needed in excess of engine exhaust, 183
 heater, high pressure, 244
 heating, district, 264
 loop, 135
 mains, diameter of, 265, 362
 pipe fittings, 366
 pipe insulation, 131
 radiators, 106
 traps, high pressure, 134
 used by engines, 375
 Steam system, 85
 amt. condensed in plenum sys., 183
 classification, 87
 diagrams for, 91
 parts of, 85
 second classification of, 83
 Street mains and conduits, layout, 218
 Suggestions for operating furnaces, 78
 hot water heaters and boilers, 137
 Sylphon damper regulator, 273

 Table I determination of CO₂, 21
 Tables II, III volume of air per person, 23, 24
 Table IV conductivities of materials, 40
 Table V exposure losses, 44
 Table VI values of t' , 48
 Table VII values of t_0 , 49
 Table VIII heat given off by persons, lights, etc., 49
 Table IX application to 10 room res., 63
 Table X size and sur. of rads., 108
 Table XI temp. of water in mains, 120
 Table XII summary, h. w. htg., 127
 Table XIII vel. in plenum sys., 172
 Tables XIV-XVII efficiencies of coils, 175, 177
 Tables XVIII-XIX temp. of air on leaving coils, 179, 180
 Tables XX-XXII air pressure and velocity, 186, 188
 Table XXIII sizes of fans, 195
 Table XXIV speeds of fans, 197
 Table XXV data for plenum sys., 202
 Table XXVI heat loss from pipes, 217
 Table XXVII pressure of water in mains, 234

- Table XXVIII cal. of conduit mains, 269
- Table XXIX transmission through insulation, 309
- Table 1 squares, cubes, etc., 328
- Table 2 trigonometric functions, 334
- Table 3 equivalents of units, 334
- Table 4 properties of steam, 335
- Table 5 Napierian logarithms, 338
- Table 6 water conversion factors, 338
- Table 7 vol. and wt. of dry air, 339
- Table 8 weight of pure water, 340
- Table 9 boiling points of water, 342
- Table 10 wt. of water and air, 342
- Table 11 relative humidities, 343
- Table 12 properties of air, 344
- Table 13 dew points of air, 345
- Table 14 fuel value of Am. coals, 348
- Table 15 capacities of chimneys, 349
- Table 16 equalization of smoke flues, 350
- Table 17 dimensions of registers, 350
- Tables 18, 20 cap. of fur., 351, 352
- Table 19 cap. of pipes and reg., 351
- Table 21 area of vertical flues, 352
- Table 22 sheet metal dimensions, 353
- Table 23 weight of G. I. pipe, 354
- Table 24 sp. ht., etc., of substances, 355
- Tables 25, 26 water pressures, 356
- Table 27 wrought iron pipes, 357
- Table 28 expansion of pipes, 358
- Table 29 tapping list of rad., 358
- Table 30 pipe equalization, 359
- Table 31 cap. of hot water risers, 360
- Table 32 cap. of steam pipes, 360
- Table 33 cap. of hot water pipes, 361
- Table 34 cap. of hot water mains, 361
- Tables 35, 36 sizes of steam mains, 362
- Table 37 friction in pipes, 364
- Table 38 grav. and vac. returns, 365
- Table 39 expansion tanks, 365
- Table 40 sizes of flanged fittings, 366
- Table 41 dimensions of pipe fittings, 366
- Table 42 friction in air pipes, 367
- Table 43 temp. for testing plants, 370
- Table 44 spec. for boilers, 371
- Table 45 heat trans. through pipe covering, 372
- Table 46 factors of evaporation, 373
- Table 47 heat in feed water, 373
- Table 48 sizes of Vento heaters, 374
- Table 49 steam used by engines, 375
- Tables 50, 51, 52 speeds, cap., h. p. of various fans, 376-378
- Table 53 freezing mixtures, 380
- Table 54 properties of ammonia, 380
- Table 55 sol. of ammonia in water, 381
- Table 56 strength of ammonia liquor, 381
- Table 57 properties of sulphur dioxide, 382
- Table 58 properties of carbon dioxide, 382
- Table 59 boiling points of liquids, 383
- Table 60 calcium brine solution, 383
- Table 61 salt brine solution, 384
- Table 62 horse-power for refrig., 384
- Table 63 ammonia for one-ton refrig., 385
- Table 64 refrigeration caps., 385
- Table 65 cost of ice making, 386
- Table 66 temperature of ammonia, 387
- Table 67 hydrometer scales, 388
- Table 68 time to freeze ice, 389
- Table 69 sizes of ice cans, 389
- Table 70 temp. for cold storage, 389
- Tanks, expansion, 113, 365
- Temperature absolute, 12
- best for design, 79
- chart, 81
- Temp. control in heating sys., 271
- Andrews system, 272
- important points in, 275
- in large plants, 274
- Johnson system, 276
- National system, 278
- Powers system, 277
- principle of system, 271
- special designs of, 275
- Sylphon damper control, 273
- thermostat, 272
- of air entering plenum system, 171
- of air in greenhouses, table, 120
- of air leaving coils in plenum system, 179
- of ammonia, 387
- for cold storage, 389
- for testing plants, 370
- measurement of high, 11
- methods of obtaining low, 303
- room standard, 47
- Thermofers, Belvac, 148
- Thermostat, 272
- thermostatic valve, 146
- Time to freeze ice, 389
- Traps, high pressure steam, 134
- low pressure steam, 133
- Trigonometric functions, 334
- Under-feed furnaces, 69
- Use of hot water in indirect coils, 183
- Vacuum systems, 99
- and gravity returns, 365
- of refrigeration, 284
- Values of 'c,' 176
- of 'k,' 177
- of 'n,' 47
- of 't,' 48, 49
- Valves, air, 112
- automatic vacuum, 149
- modulation valve, 147

- thermostatic, 146
- types of, 111
- Velocity of air by application heat,
 - 31
 - of air escaping to atmosphere, 187
- Vent registers (net), 57
- stacks, 58
- Ventilation heat loss, 44
 - air required per person, 21
- Vento coils, values of 'k' for, 177
- Vento heater sizes, 374
- Vertical hot air flues, table, 352
- Volume and wt. of dry air, table, 339
- Warm air fur., cap. of, table, 351
 - air heating cap., 352
- Washing and humidifying of air, 167
- Water, conversion factors, table, 338
 - hammer, 133
 - needed per hour in dist. htg., 230
 - pressure in mains, 231
 - pressure, table of, 234
 - seal motor, Webster, 145
 - weight of column corresponding to
 - air pressure in ozs., 356
 - weight of pure, table, 340
 - weight of water and air, table, 342
 - Webster system of vac. heating, 145
 - Weight of pure water, 340
 - Weight of G. I. pipe, 354
 - of water and air, table, 342
 - Work done in moving air, 192
 - Wrought iron and steel pipes, table,
 - 357
 - expansion of, table, 358



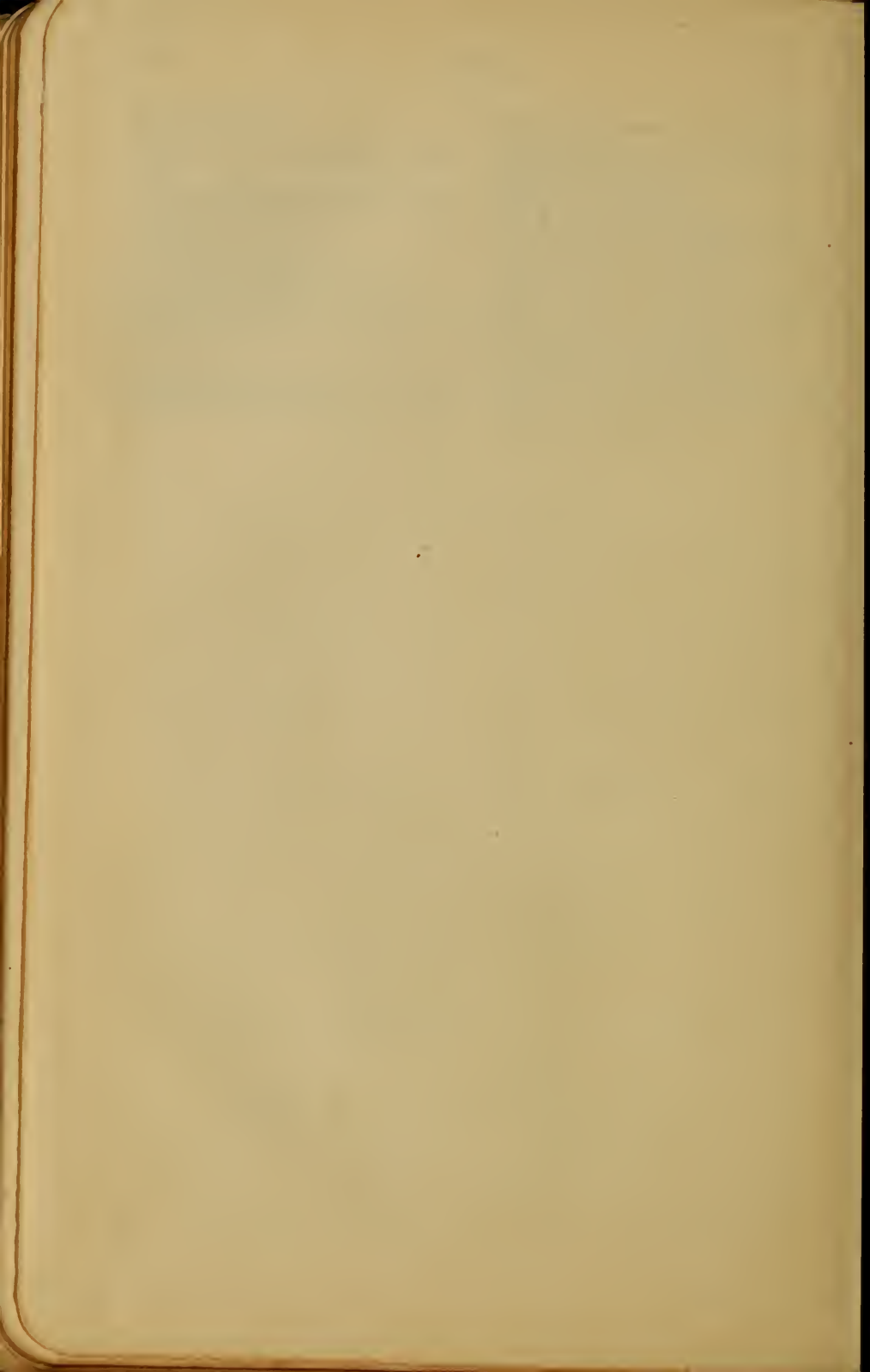

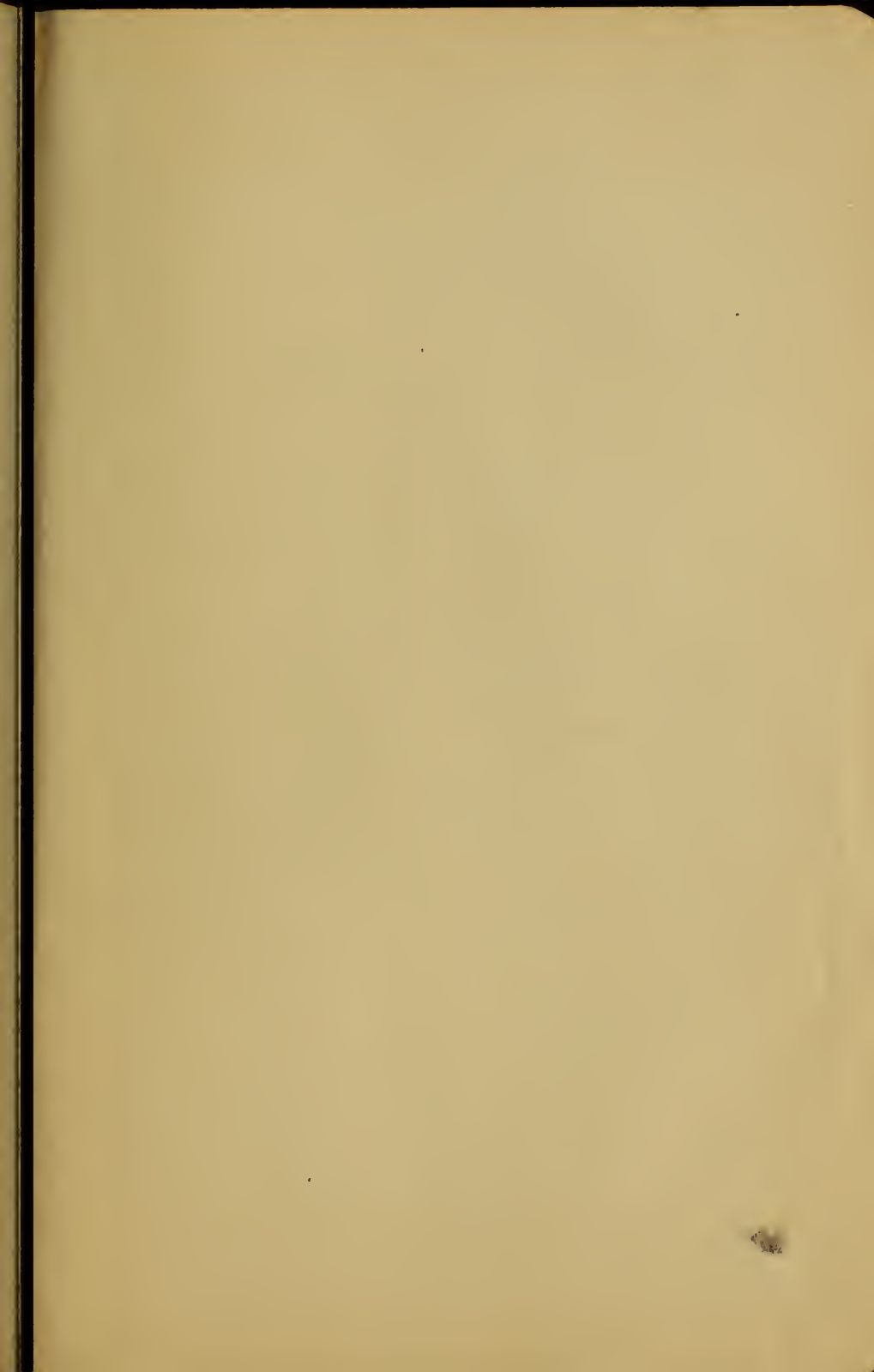





LIBRARY OF CONGRESS

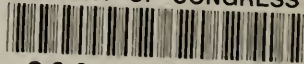

0 020 237 571 6