

ALLEN

Explosive Properties  
of Gas and Gasoline  
Vapor Mixtures

Mechanical Engineering

B. S.

1901

Learning and Labor.

LIBRARY

OF THE

University of Illinois.

CLASS.

BOOK.

VOLUME.

1901

AR5

Accession No.





261  
Investigation of the Explosive Properties of Gas and  
Gasoline Vapor Mixtures

.. BY ..

FRANK GILBERT ALLEN

---

THESIS

FOR THE DEGREE OF BACHELOR OF SCIENCE IN

MECHANICAL ENGINEERING

IN THE

COLLEGE OF ENGINEERING

OF THE

UNIVERSITY OF ILLINOIS

---

PRESENTED JUNE, 1901



UNIVERSITY OF ILLINOIS

May 31, 1901 190

THIS IS TO CERTIFY THAT THE THESIS PREPARED UNDER MY SUPERVISION BY

Frank Gilbert Allen

ENTITLED Investigation of the Explosive Properties of Gas and  
Gasoline Vapor Mixtures

IS APPROVED BY ME AS FULFILLING THIS PART OF THE REQUIREMENTS FOR THE DEGREE  
OF Bachelor of Science in Mechanical Engineering

L. P. Breckemidge

HEAD OF DEPARTMENT OF Mechanical Engineering

1901  
ALS

Binding 22 N'01 1.00





1.

The investigation herein described was undertaken with a view to determining the explosive properties of mixtures of gas and gasoline vapors with air with special reference to the following points.

- a. Maximum pressure obtained and how effected by various initial pressures.
- b. Effect of burned gases in the mixture.
- c. Time required for cooling.
- d. Effect of various initial temperatures.
- e. Best Proportions for the mixture.

Little investigation seems to have been carried on bearing directly upon the above points, at least, little with reference to the gas engine. Extended research has been made by Bunsen relating to the explosive properties of gas and air mixtures, and his results have been confirmed by Davy and others, but the conditions



Digitized by the Internet Archive  
in 2013

<http://archive.org/details/investigationofe00alle>

met with in the gas or gasoline engine have not been dealt with. Gas and air mixtures at atmospheric pressure have also been studied with special reference to their use in the gas engines, but the results of these investigations have been limited in their value on account of the fact that modern gas engines are almost universally run with an initial pressure of several atmospheres. However, some investigations carried on at the Massachusetts Institute of Technology during the year ending June, 1900, considered the effect of different initial pressures on the explosive properties of various mixtures of gas with air, but the results of these experiments have as yet not been obtainable for comparison with those in the present discussion.

It has been the aim in this investigation to pay special attention to mixtures of gasoline with air, although mixtures of illuminating gas with air will also be considered.



Design of special apparatus necessary.

In order to investigate the explosive properties of gas and gasoline mixtures with air, some special apparatus was constructed. This consisted in general of five parts, thus:—

1. A cylinder sufficiently strong to withstand the pressure due to the explosion of a gas and air mixture within it.
2. A device for introducing a gas mixture of known proportions into the above cylinder.
3. A device for igniting the mixture.
4. A pressure recording apparatus to indicate the pressure obtained by exploding the mixture.
5. Apparatus for measuring and recording the time required for the various phenomena of explosion and cooling.

A cylinder of cast iron with walls about one inch thick was constructed to be used as the explosion cylinder, but upon testing it by hydraulic pressure up to 600 pounds per square inch, it was



found to have a number of blow-holes through the walls and was discarded. The cylinder shown in plate 1. was then constructed and tested and proved satisfactory.

In introducing a charge into the cylinder of a gasoline engine one of several methods of obtaining the proper mixture of gasoline vapor with air may be employed. (a) The air may be charged with the desired quantity of the vapor by being caused to pass over the surface of liquid gasoline, or (b.) it may be forced through a wire gauze wet with gasoline, -absorbing the vapor as it passes through the gauze. Other methods are also employed but will not be mentioned here. The second method mentioned was adopted in these experiments for the reason that it was desired to measure or weigh the gasoline used for each charge entering the cylinder, which could be readily done by this method.





Plate 3 shows the carburettor employed to vaporize the gasoline Plug 3 having been removed, oil introduced at 1 passed down into the shallow pan 2 after which plug 3 was replaced and screwed down so as to close the opening 1. Compressed air, from a large receiver, was then admitted by opening valves 4 and 5. The cup 6 being filled with fine copper wire, the oil was entrapped in the spaces between the wires and held until it all was evaporated by the air and carried into the cylinder below. The quantity of gasoline to be introduced at a charge was measured by means of the graduated glass tube 7, the gasoline being drawn into and forced out of the tube by means of the rubber bulb B. In measuring with this tube, it was found best to draw in more liquid than it was desired to measure with it at once and force out the excess until the bottom of the meniscus at the surface of the liquid was level



with the desired graduation. In this way no bubbles of air were entrapped in the liquid to cause error in measurement.

In introducing the charge of gasoline and air into the cylinder by the above method, all of the gasoline was found to pass out of the cup *b* into the cylinder, but it is believed that in cases in which the quantity of gasoline was large, some of it entered the cylinder in the liquid state. In order to vaporize this liquid and also to better mix the gases in the cylinder, a small fan was placed inside the cylinder to be operated by means of a pulley on the fan shaft outside the cylinder. The fan shaft was carefully packed with asbestos where it passed through the cylinder head.

In experiments with mixtures of illuminating gas with air, the mixture was introduced in a somewhat different way. The gas was introduced through a rubber tube connected at *C*. (Plate 2) until



a sample of the gas flowing out of the lower part of the cylinder at 1 (Plate 2.) was found to be free from air by burning a quantity of it collected in a test tube; when the gas burned quietly it was assumed to be free from air. The outlet valve H was then closed and compressed air admitted at E until the desired proportions of gas and air were obtained as calculated from the pressure indicated by gauge C. If the pressure in cylinder was then greater than required for the initial pressure of the mixture to be exploded, - after careful stirring by means of the fan, the excess of the mixture was allowed to pass out through the valve H until the pressure was lowered to the desired point.

After the desired mixture was introduced into the cylinder, the valves G, X, Y and H, (Plate 2) being closed and the indicator cock Z opened, the mixture was fired by means of the apparatus now to



be described.

**Igniting apparatus.** This consisted of an induction coil *H* (Plate 2), capable of giving a  $\frac{3}{4}$ " spark, operated by a 5 cell Edison Lalande battery *L*. The spark from the secondary of the coil passed through an insulating plug into the explosion cylinder, where it jumped across a short air gap thus igniting the charge of gas.

In order to cause the spark to pass at the right moment, the primary circuit which is shown in blue in plate 2, was closed by a contact point *J* on the drum of the indicator *B*, after this drum started to rotate. The use of the drum and the reason for placing the contact point upon it will appear later.

**Recording apparatus.** In order to obtain a record of the phenomena taking place during the combustion of the gas and air mixture, an ordinary gas engine indicator with an enlarged drum was connected to the explosion





cylinder. This indicator had a piston with an area of  $\frac{1}{4}$  sq. inch, so that an ordinary indicator spring calibrated for an indicator with a piston area of  $\frac{1}{2}$  sq. inch was regarded as of double its rated capacity when used in this gas engine indicator.

The drum of the indicator was caused to rotate by means of a string passing over a pulley, *R*, and thence down to a weight, *W*.

The rate at which the weight, *W*, was allowed to fall was regulated by means of the oil cylinder, *P*. This cylinder was filled with oil and contained a piston connected to the rod on which weight, *W*, was hung.

In order for the piston to move downward, it must force the oil below it up through the by pass, shown in the figure, and and into the cylinder again above the piston. A valve was placed in the by pass so that the rate of flow of the oil could be regulated, and thus the rate of fall of weight *W* was regulated.



When the indicator drum started to rotate, the contact point, *T*, completed the primary circuit of the induction coil, thus causing a spark to pass through the gas in the explosion cylinder. In this way the explosion could be made to take place at the proper time during the rotation of the indicator drum. The pressure caused by the explosion, acting on the indicator piston and thus compressing the indicator spring caused the indicator pencil to rise an amount proportional to the pressure. The pencil thus traced on a strip of paper wrapped around the drum a continuous record of the pressure in the explosion cylinder during the rotation of the drum.

#### Time recording device.

The motion of the indicator drum was not perfectly uniform and its speed was not known, so that in order to find the time elapsing between any two points of the curve traced by the indicator pencil, a time recording device was



needed. This requirement was met by fastening a large tuning fork, M (Plate 2), in such a position above the indicator drum that a pencil carried on a spring fastened to one prong of the fork could be brought to bear on the drum in the same vertical line with the indicator pencil. This fork was so constructed, as shown in plate four, - as to be kept vibrating by means of an electro magnet; thus as the indicator drum revolved the pencil on the tuning fork traced a wavy line on the upper portion of the paper strip on the drum. The pitch of the fork having been accurately determined, the time increment between any two points of the pressure curve could be easily determined by projecting vertically upward to intersect the tuning fork record and counting the number of waves between the two intersections. The tuning fork used in these experiments was ground so that its pitch was 50 vibrations per second.



Experiments were made as follows:

1. Tests on gasoline mixtures to determine;
  - a. The maximum pressure obtained.
  - b. The time required for cooling of the gases.
  - c. Effect of initial pressure on maximum pressure.

2. A second series of tests was made on gasoline mixtures to determine the effect of burned gases in the mixture.

From the results of the above two series of tests the best proportions of mixture were decided upon.

In making the first series of tests a mixture of given proportions was exploded at different initial pressures varying from atmospheric pressure up to 50 or 60 pounds gauge. This was repeated for mixtures of other proportions. Since the indicator cards obtained from these tests contained the time record made by the tuning fork as explained above, the time required for explosion, or in other





words, the time during which the pressure was increasing, and the time required for the pressure to fall a given per cent due to the cooling of the gases, could be determined. The same cards also gave records of the maximum pressure obtained in each case. From the data thus obtained the effect of the initial pressure became apparent.

The second series of tests was conducted as follows. The same mixture of gasoline and air as used in the first series of tests were exploded in the cylinder, and indicator cards taken as before. After each explosion of a fresh charge of gasoline and air, the burned gases in the cylinder after the explosion were allowed to escape until the pressure fell to atmospheric pressure. A fresh charge of gasoline and air in the same proportions as the original charge was forced into the cylinder until the pressure was the same as the initial pressure before the explosion.



This mixture, consisting partly of burned gases from the previous explosion and partly of fresh gases, was then exploded and an indicator card taken as before. In this way a series of cards were obtained showing very plainly the effect of the burned gases in the mixture.

It was hoped when these tests were begun to find the effects of initial temperatures and also to find the highest temperature reached by some method of direct measurement, but this was not satisfactorily accomplished. The initial temperature could be approximately found by means of a thermometer in an ordinary thermometer cup screwed into the cylinder, but such a determination was not sufficiently close to base upon it any detailed conclusions as to the effects of initial temperature. No measurement was made of the temperature of the gas during explosion. It is believed,



however, that the temperature of the burning gas can be obtained by means of a platinum-iron thermocouple connected to a d'Arsonval galvanometer, the readings of the galvanometer having been previously calibrated for various differences of temperature between the ends of the thermocouple.

As stated before, the greater part of the time spent on the experiments described in this discussion was devoted to the investigation of gasoline mixtures. However, a few tests were made upon mixtures of illuminating gas with air. These tests were confined to a number of trials relating to the effect of initial pressure on maximum pressure, and did not differ materially in methods of procedure from the similar tests upon gasoline mixtures.



## Conclusions.

After tabulating and plotting the more important results of the experiments which have been described, the following conclusions were drawn:

1. The maximum pressure obtained by the explosion of a gasoline and pure air mixture of given proportions varies directly as the initial pressure of that mixture. This is seen at once upon examining the curves on pages 22 to 30 inclusive. It will be seen that all of the results lie very nearly in a straight line passing through the point of zero pressure (absolute). This holds also for mixtures of illuminating gas with air, as shown by the curve on page 32.

2. Burned gases from previous explosions, when mixed with a fresh charge of gasoline and air, have several very marked effects which may be stated thus:





a. The mixture does not explode as readily or at as low a pressure as a pure mixture. In the curves on pages 26 to 31, the curves indicating the results obtained with mixtures containing burned gases do not extend to as low an initial pressure on account of the fact that these mixtures do not explode at these low pressures. This might have been expected, since at the lower pressures a larger proportion of the mixture is made up of the burned gases.

b. The maximum pressure is greatly reduced by the presence of the burned gases. The plotted results on pages 26 to 31 show this, all of the curves representative of mixtures containing burned gases being much below the corresponding curves for the pure mixtures. This is even more strikingly shown, however, by the series of indicator cards pages 33 to 42.



It will be seen that these cards are placed two on a page, the upper one being a card from the explosion of a mixture of gasoline and pure air, while the lower card is from a mixture of the same proportions and initial pressure, introduced into a cylinder full of burned gases at atmospheric pressure.

c. It will also be seen by reference to the indicator cards that the rate of combustion of the mixture is much retarded by the presence of the burned gases, in some cases the pressure continuing to rise slowly for a second of time or more.

3. The time required for the pressure to fall a certain per cent, due to the cooling of the gases, is shown on the indicator cards and by the tabulated results on page 43. It will also be noticed that, in general, the pressure resulting from the explosion of mixtures containing burned gases



-drops more slowly than does the pressure -after the explosion of a charge of pure gases. This is probably due to the fact that in the case of the burned gas mixtures the combustion continues after the pressure has reached a maximum.

4. The effect of various initial temperatures was not considered in detail, but it seems that the higher the initial temperature the more easily the charge is ignited and the more rapid the rate of combustion after ignition.

5. From a consideration of the above statements together with an examination of the curves on page 31, it seems that best proportions for a gasoline and air mixture are about 1 of gasoline to 10 or 11 of air by weight. It is noticeable that the variation in the pressures obtained from various mixtures is



not nearly in proportion to the amount of gasoline in the mixtures; some mixtures containing 5 parts of air to one of gasoline gave the lowest pressure, while 11 parts of air to one of gasoline gave a much higher pressure. A second consideration relating to the determination of the best mixture is the fact that the mixture of 1 of gasoline to 10 or 11 of air, not only gives a high pressure when the pure mixture is used but also gives a high pressure when mixed with burned gases. The effect of burned gases has been dwelt upon as an important point for the reason that nearly all gasoline engines are operated with burned gases in the mixture. It will be seen by a glance at the curves plotted to show the effects of burned gases that the pressures obtained from the





explosion of such mixtures approach more and more nearly the pressures obtained from the corresponding mixtures of pure gases as the initial pressure increases. This fact together with the one that the explosion becomes more rapid at higher pressures, may in some measure account for the increased efficiency of the gas engine at high initial pressures.



CURVE  
 SHOWING EFFECT OF  
 INITIAL PRESSURE ON  
 MAXIMUM PRESSURE.  
 RATIO OF MIXTURE:  
 GASOLINE --- 1. ] BY WEIGHT.  
 AIR --- 5.]

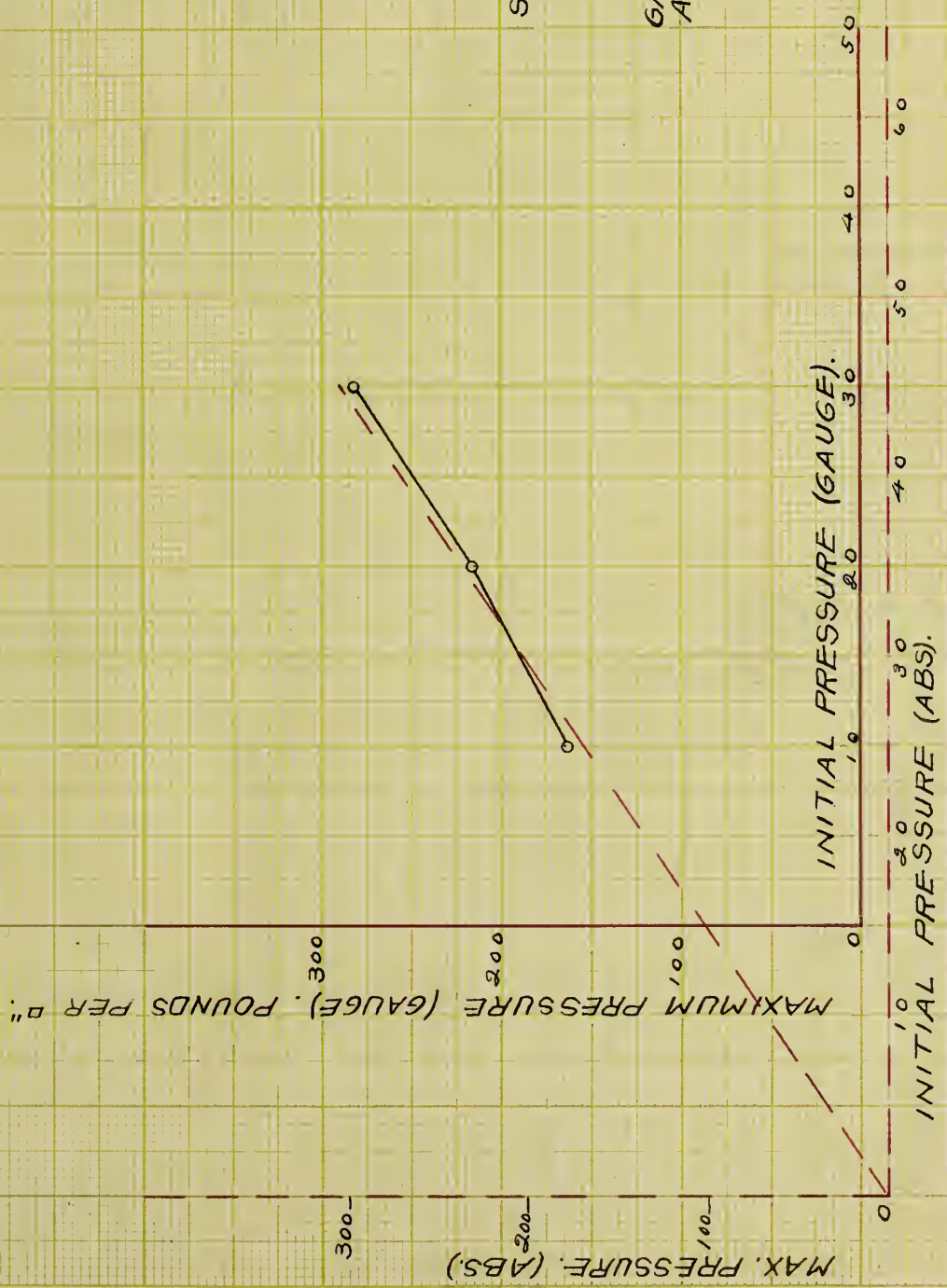



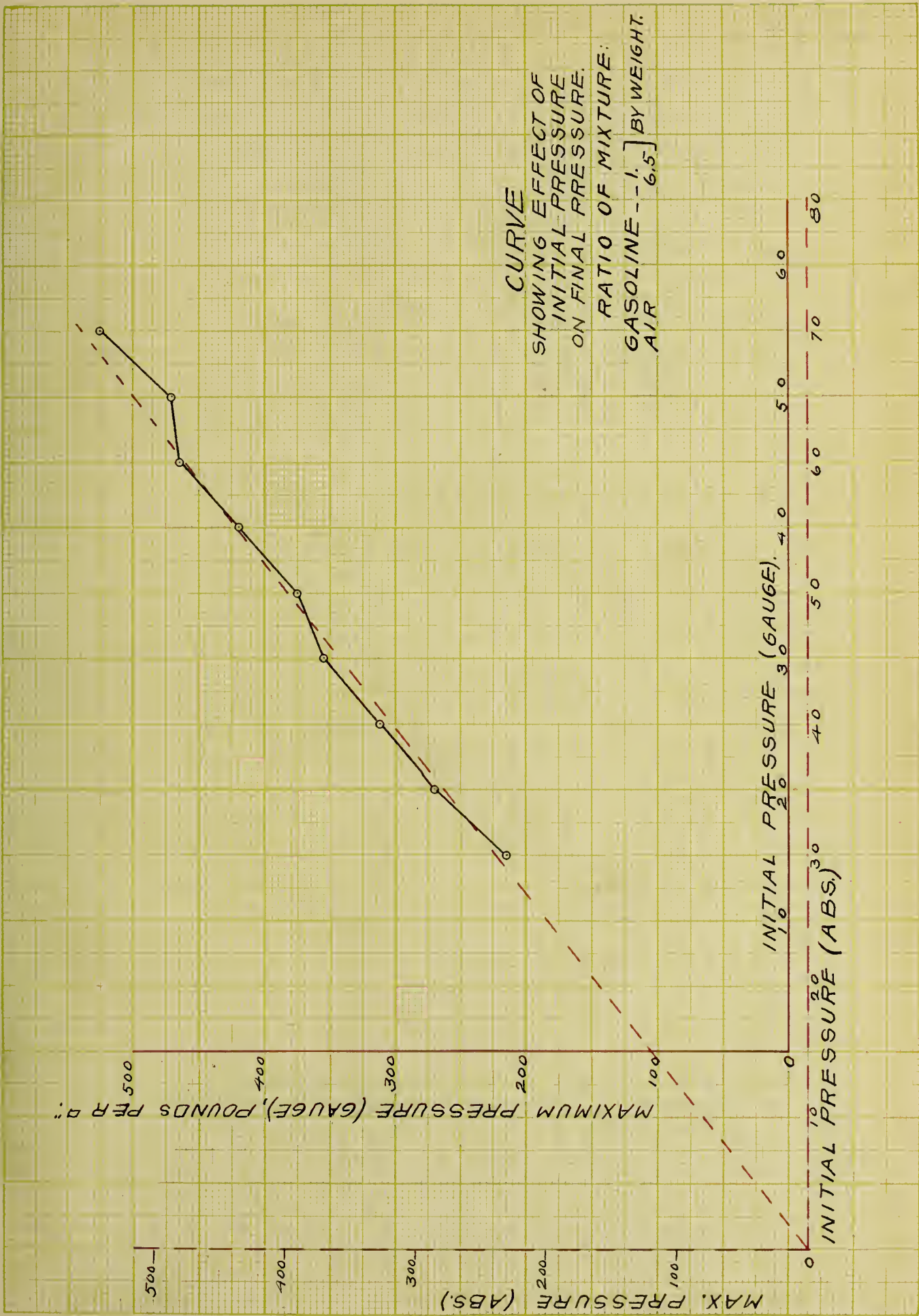



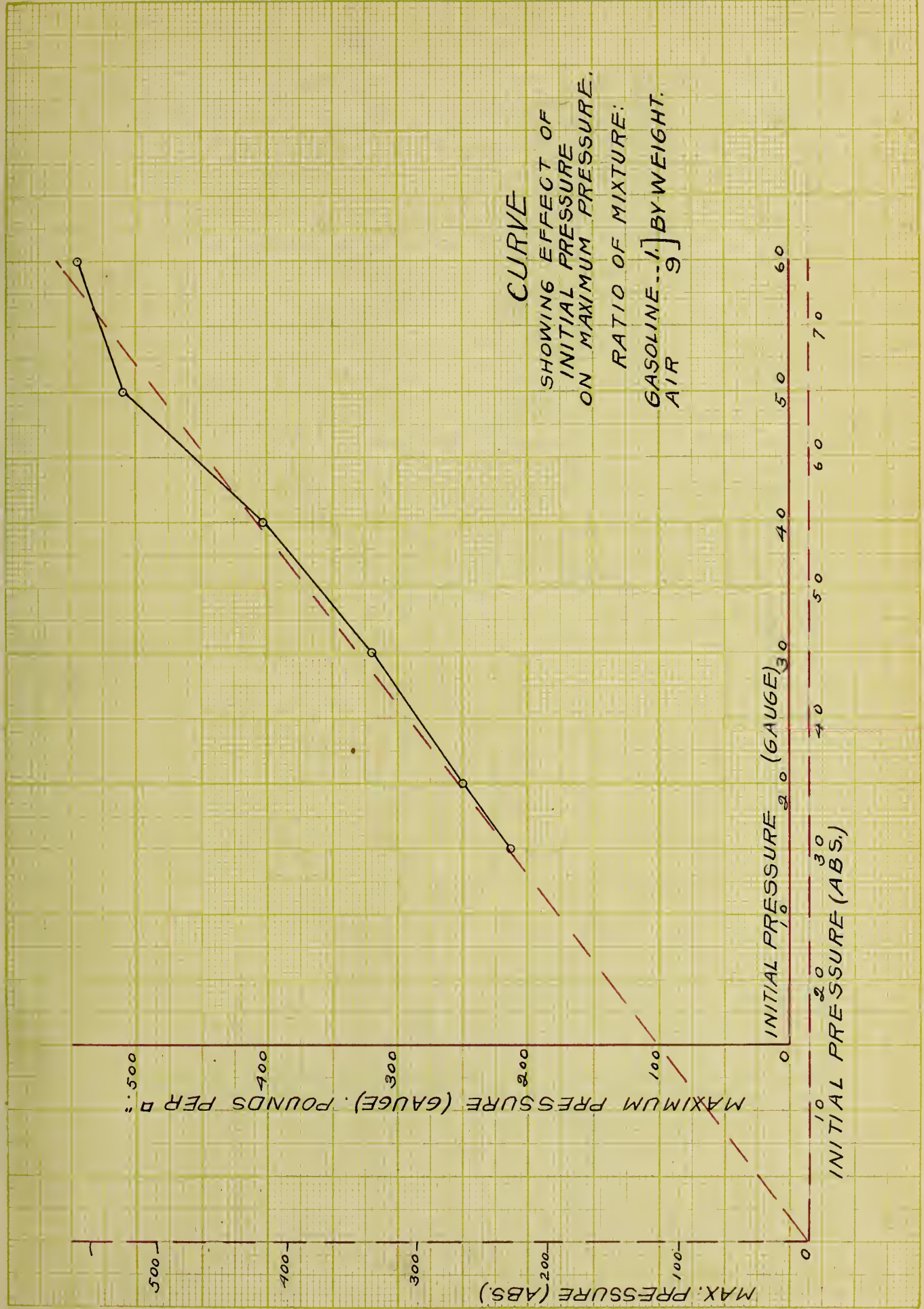





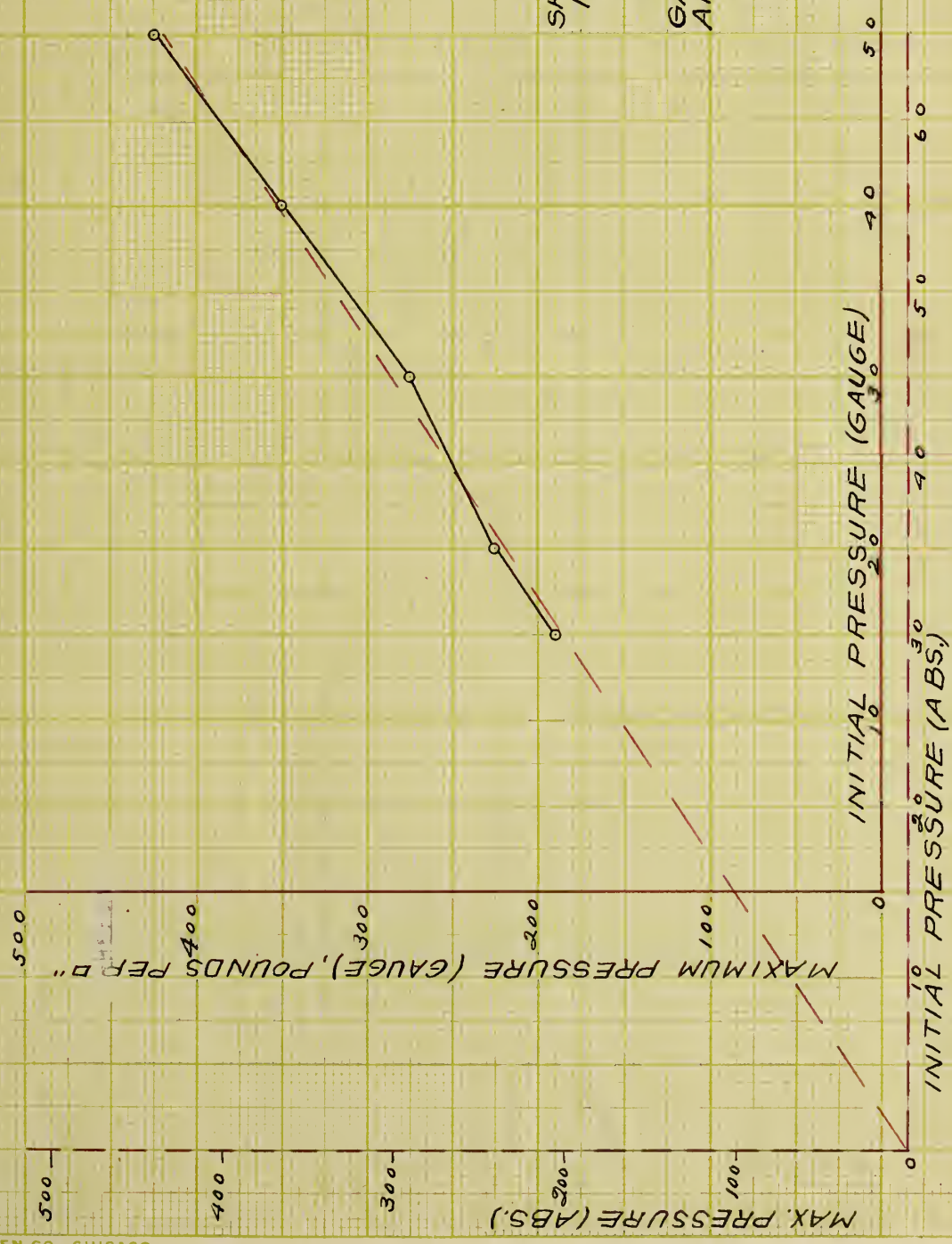

CURVE  
 SHOWING EFFECT OF  
 INITIAL PRESSURE ON  
 MAXIMUM PRESSURE.  
 RATIO OF MIXTURE:  
 GASOLINE --- 1 ---  
 AIR --- 12 ---



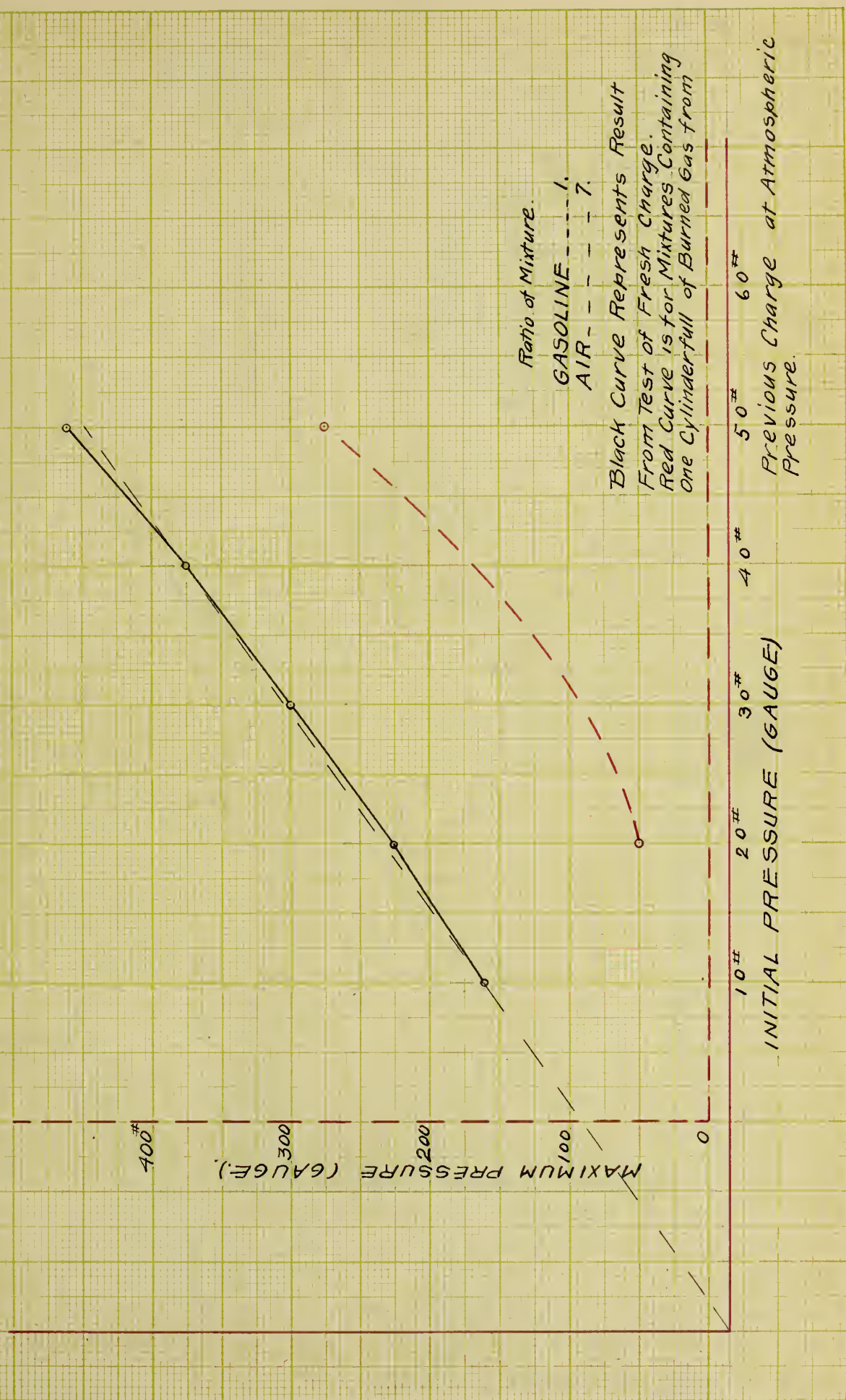



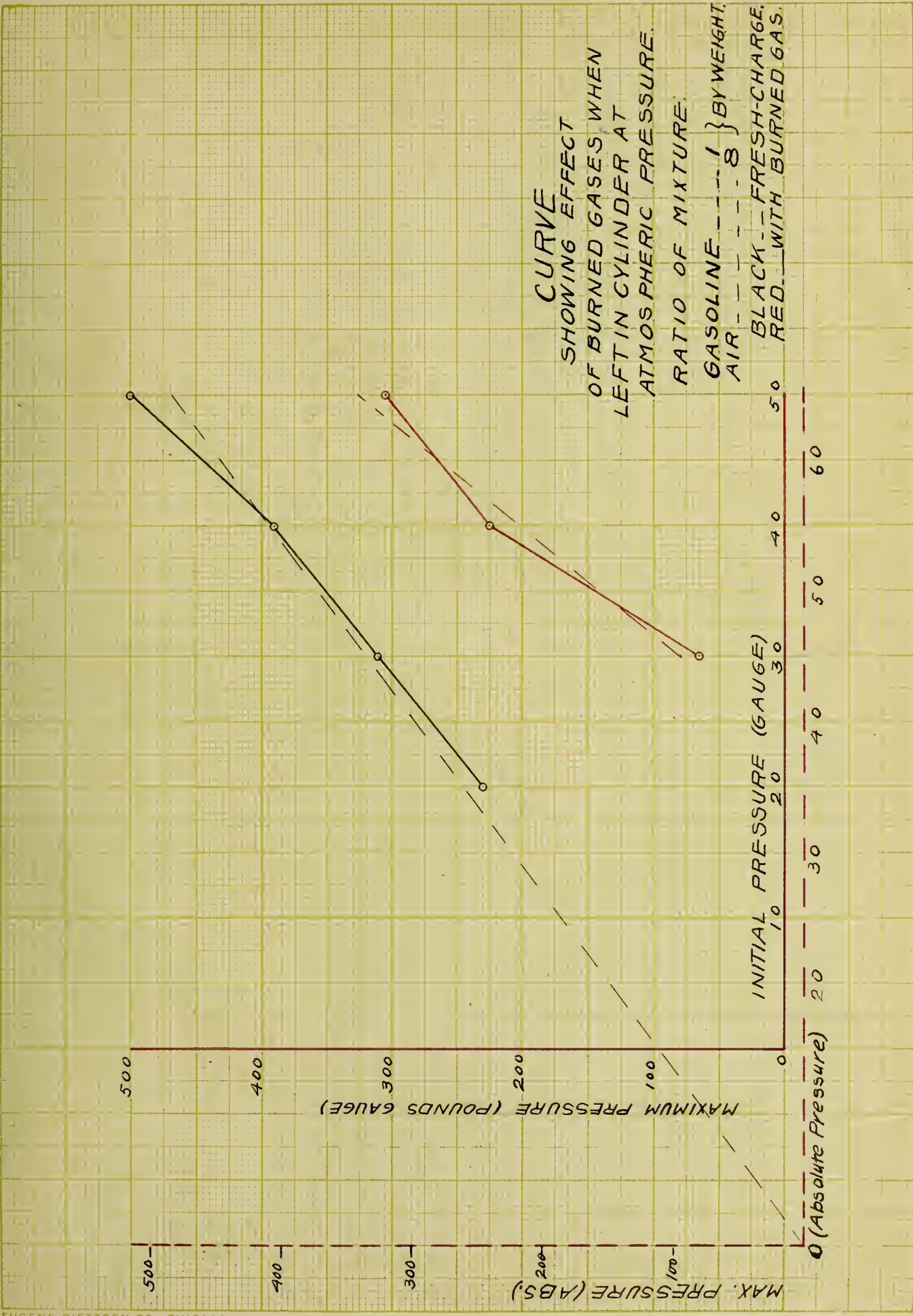



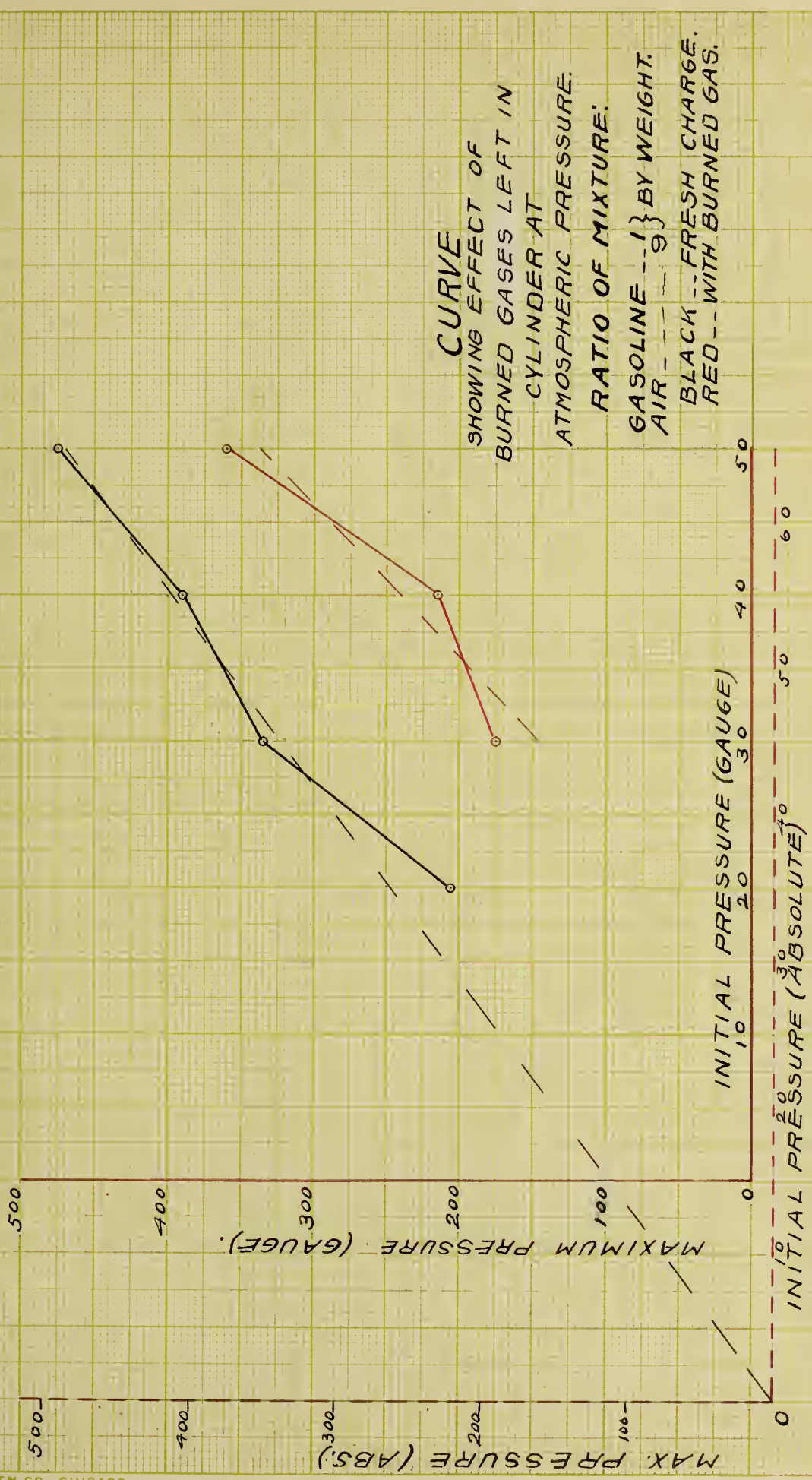

**CURVE**

SHOWING EFFECT OF  
BURNED GASES LEFT IN  
CYLINDER AT  
ATMOSPHERIC PRESSURE.

RATIO OF MIXTURE:

GASOLINE -- 1 } BY WEIGHT.  
AIR -- 9 }

BLACK -- FRESH CHARGE.  
RED -- WITH BURNED GAS.





CURVE  
 SHOWING EFFECT OF  
 BURNED GASES LEFT IN  
 CYLINDER AT  
 ATMOSPHERIC PRESSURE.  
 RATIO OF MIXTURE.  
 GASOLINE --- 1 | BY WEIGHT.  
 AIR --- 10  
 BLACK --- FRESH CHARGE.  
 RED --- WITH BURNED GAS.

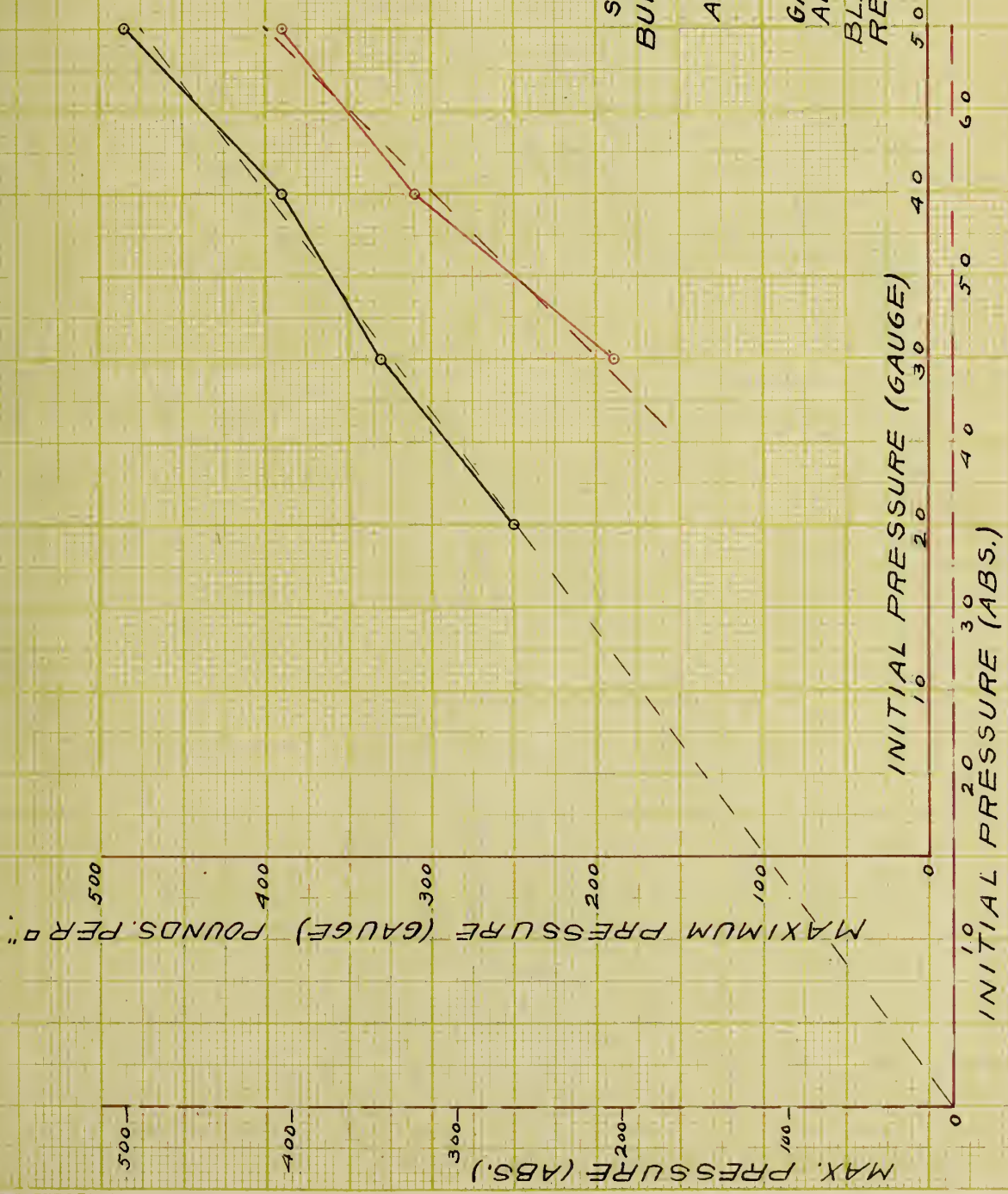



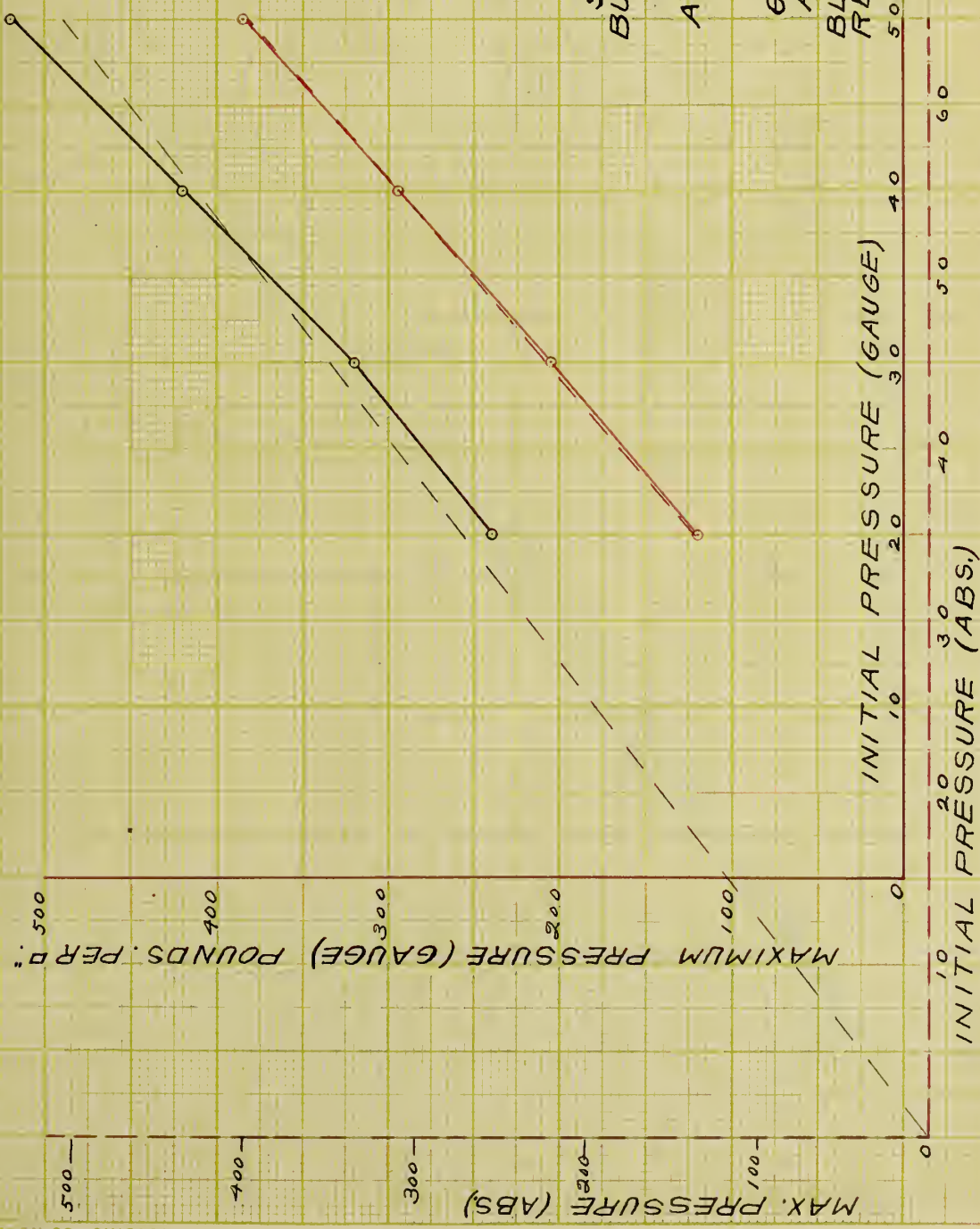

### CURVE

SHOWING EFFECT OF  
 BURNED GASES LEFT IN  
 CYLINDER AT  
 ATMOSPHERIC PRESSURE.

RATIO OF MIXTURE:  
 GASOLINE --- I ---  
 AIR --- II --- BY WEIGHT.

BLACK --- FRESH CHARGE.  
 RED --- WITH BURNED GAS.

MAXIMUM PRESSURE (GAUGE) POUNDS PER IN.<sup>2</sup>

INITIAL PRESSURE (GAUGE)

INITIAL PRESSURE (ABS.)

MAX. PRESSURE (ABS.)



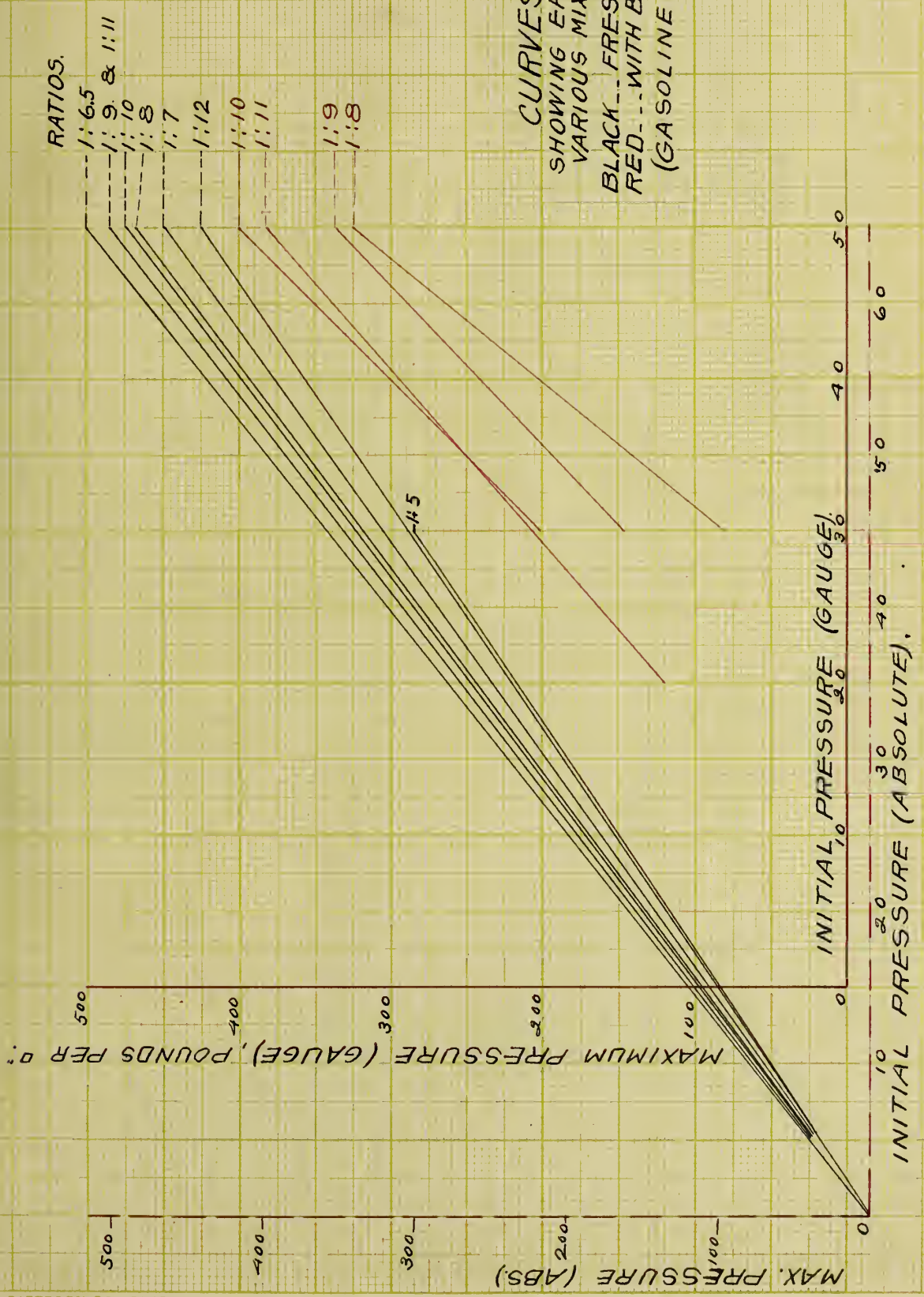

**CURVES**

SHOWING EFFECT OF VARIOUS MIXTURES.

BLACK... FRESH CHARGES,  
RED... WITH BURNED GASES.  
(GASOLINE AND AIR)



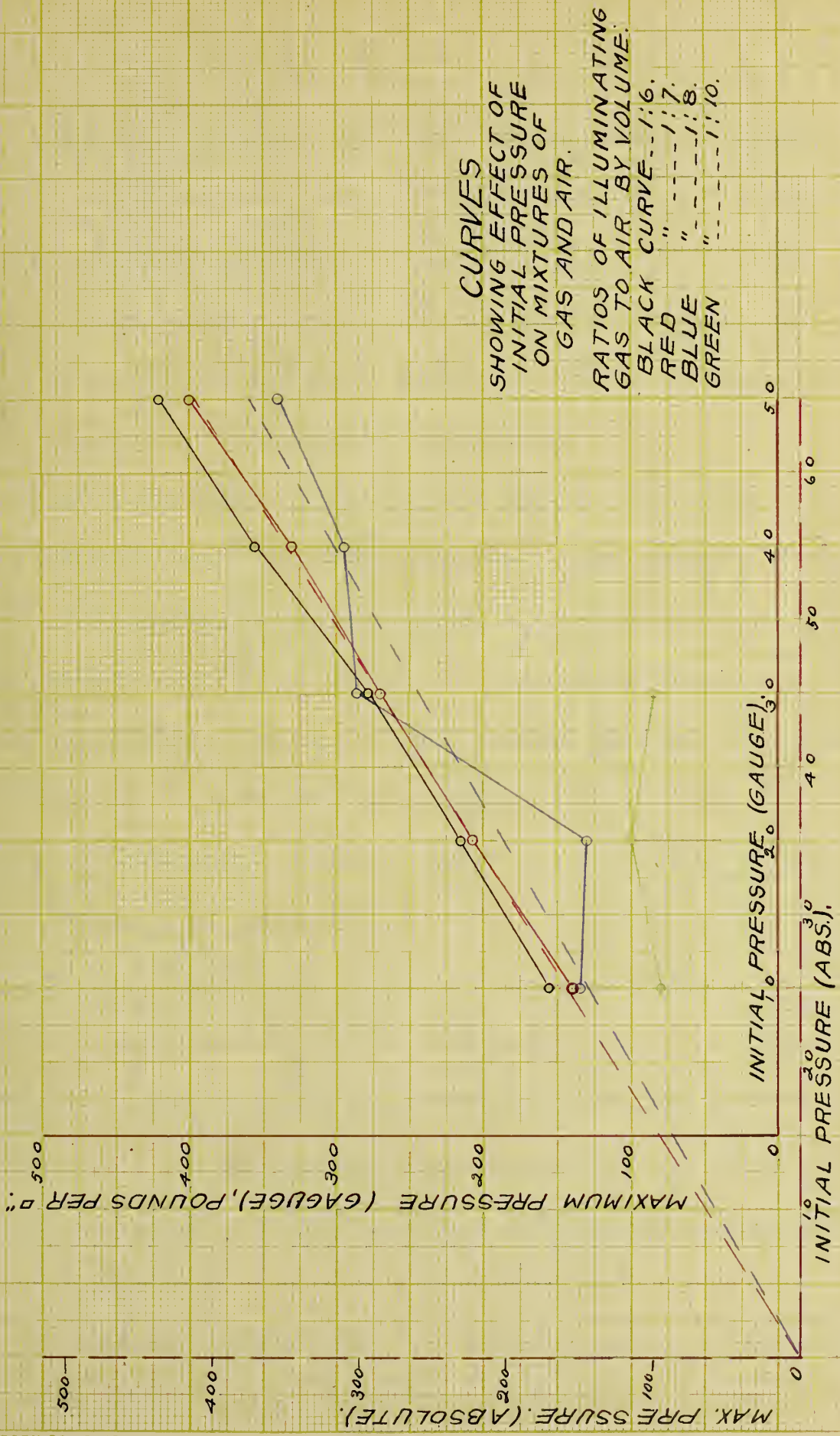





## Explanation of the Indicator Cards.

The following cards, which are thought to be representative ones, will serve to illustrate some of the points discussed.

In these cards the bottom line is a line of atmospheric pressure.

The initial pressures mentioned in connection with the cards are gauge pressures.

The scale of the spring used in the indicator is to be taken as 320<sup>#</sup> per inch.

The two cards on each page are from the same ratio of mixture and the same initial pressure, the upper card being from a mixture of gasoline and pure air, while the lower card is from a mixture as obtained by leaving the burned gases from the previous explosion in the cylinder at atmospheric pressure and adding enough fresh mixture to raise the pressure to the desired point.

A characteristic crook will be noticed to be present in the explosion line of



all of the cards. The explanation offered for this is that the explosion cylinder being long in proportion to its diameter, when the explosion took place a sort of wave passed from one end to the other of the gas in the cylinder causing a variation in the pressure.

This crook does not seem to be present in the case of explosions in the clearance space of a gas engine which is short in comparison with its diameter. This would go to uphold the above explanation. It is noticeable, too, that this crook tends to disappear when the explosion takes place very slowly as in Cards numbered 2, 4, 8 and 16.

The line of dots at the top of each card gives the time between any two points on the pressure curve the distance between two adjacent dots corresponding to  $\frac{1}{50}$  second.



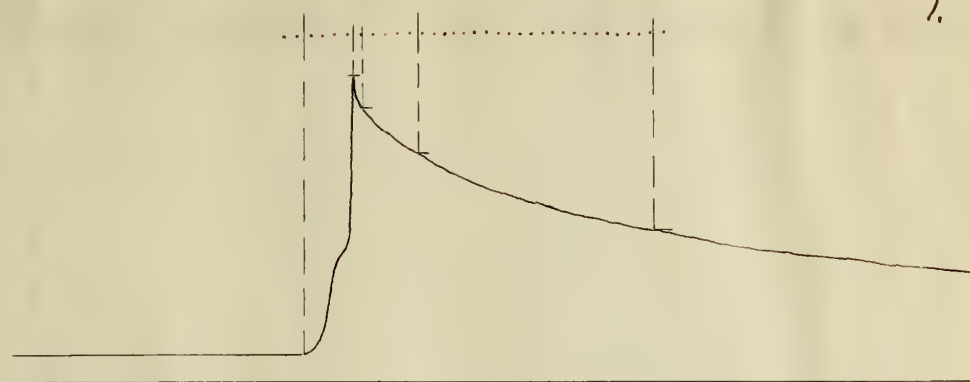

Card no. 1.

Initial Pressure 50#      Ratio of Mixture:  
 Maximum " 500#      Gasoline 1, Air 8.  
 Fresh Charge.

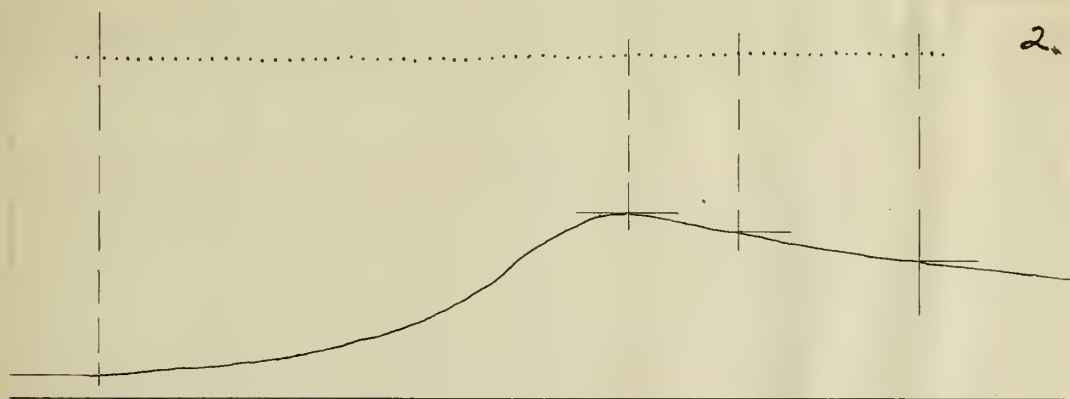

Card No. 2.

Initial Pressure 50#      Ratio of Mixture:  
 Maximum " 305#      Gasoline 1, air 8.  
 Charge containing burned gases at  
 atmospheric pressure.



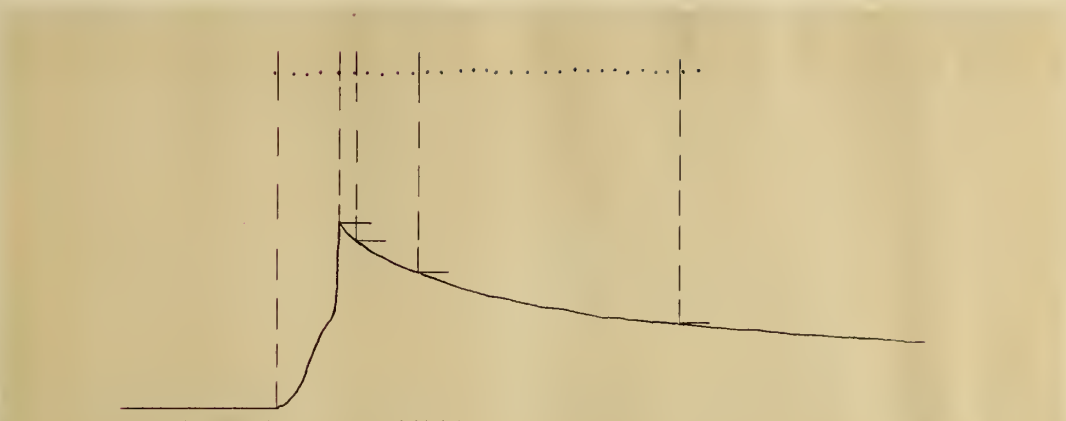

Card number 3.

Initial Pressure, 30<sup>#</sup>

Maximum " 335<sup>#</sup>

Fresh Charge.

Ratio of Mixture:

Gasoline 1, Air 9.

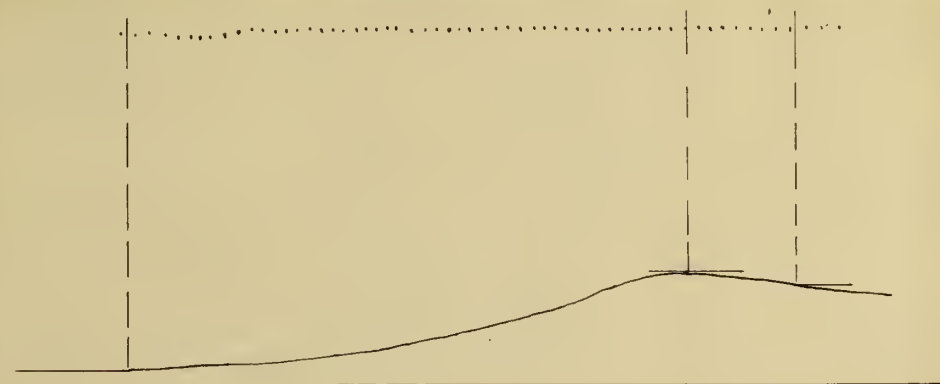

Card number 4.

Initial Pressure 30<sup>#</sup>

Maximum " 175<sup>#</sup>

Ratio of Mixture

Gasoline 1, Air 9.

Cylinder charged when full of burned gas from previous charge at atmospheric pressure.





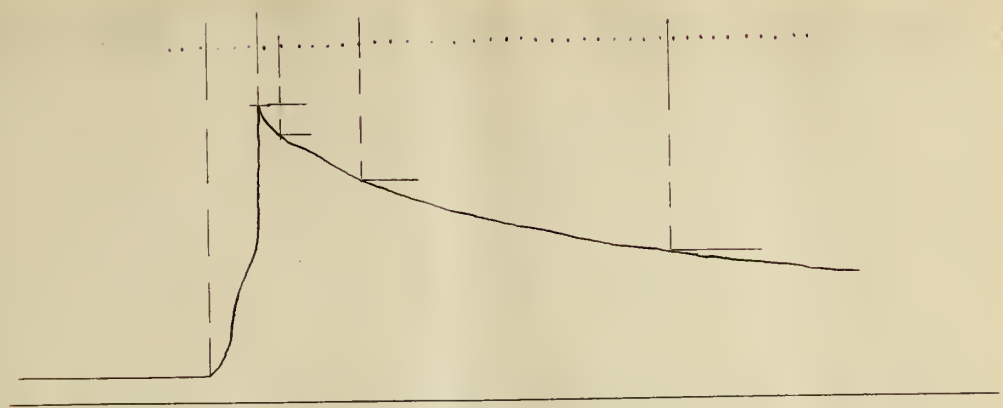

Card No. 5.

Initial Pressure 50#      Ratio of Mixture  
 Maximum "      495#      Gasoline 1, Air 9.  
 Fresh Charge.

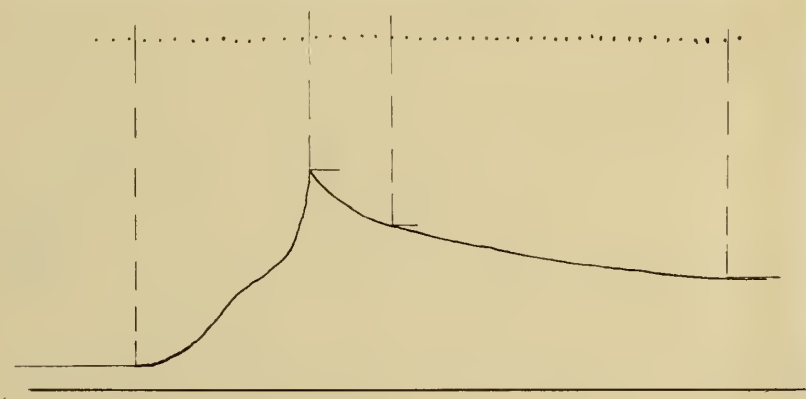

Card No. 6.

Initial Pressure 50#      Ratio of Mixture  
 Maximum "      360#      Gasoline 1, Air 9.  
 Cylinder Charged when full of burned  
 gas from previous charge at Atmospheric  
 pressure.



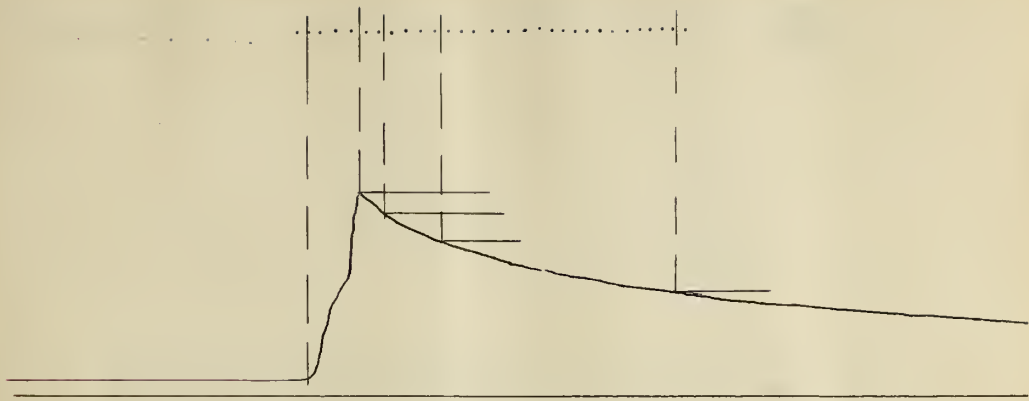

Card No. 7.

Initial pressure 30#      Ratio of Mixture  
 Maximum "      330#      Gasoline 1, Air 10.  
 Fresh Charge.

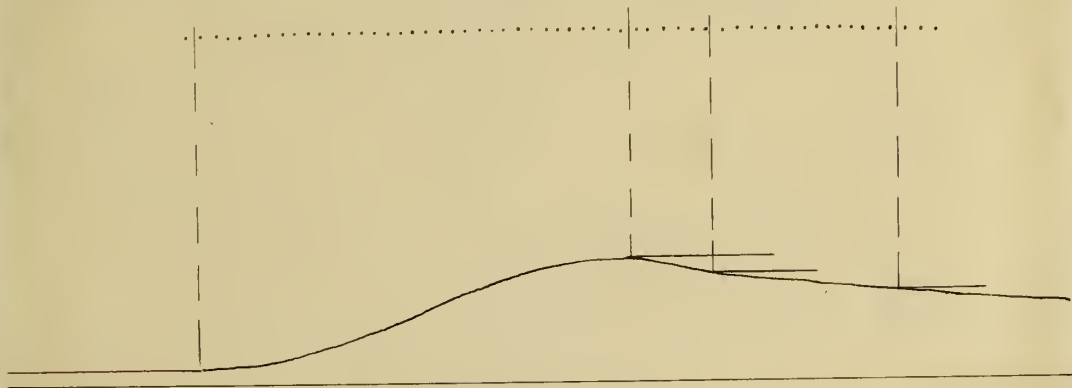

Card No. 8.

Initial pressure 30#      Ratio of Mixture  
 Maximum "      190#      Gasoline 1, Air 10.  
 Cylinder charged when full of burned  
 gas from previous charge at atmospheric  
 pressure.



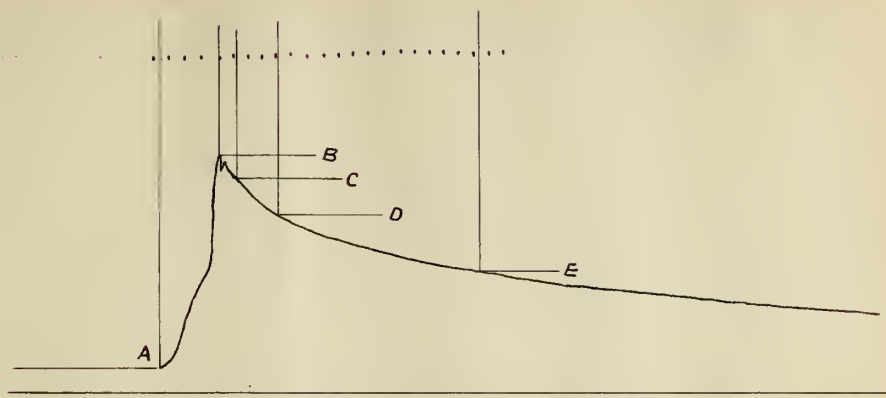

Card No. 9.

Initial Pressure. 40# Ratio of Mixture,  
 Maximum " 390# Gasoline 1, Air 10.  
 Fresh Charge.

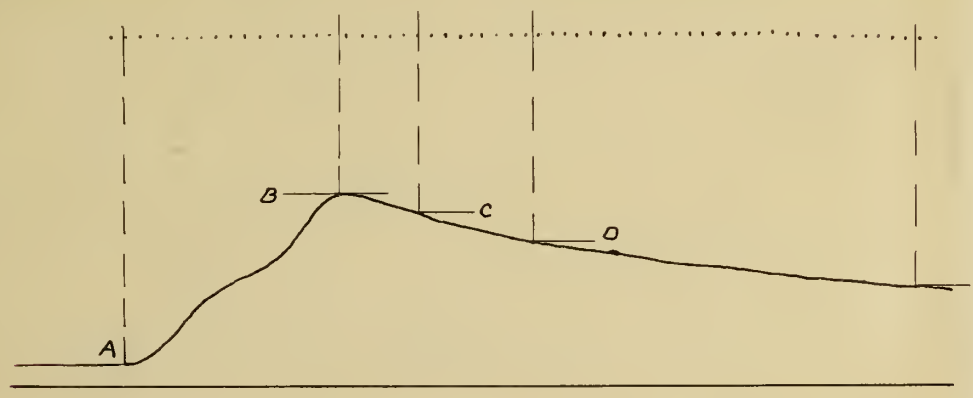

Card No. 10.

Initial Pressure 40# Ratio of Mixture  
 Maximum " 310# Gasoline 1, Air 10.  
 Cylinder charged when full of burned  
 gas from previous Charge at Atmospheric  
 pressure.



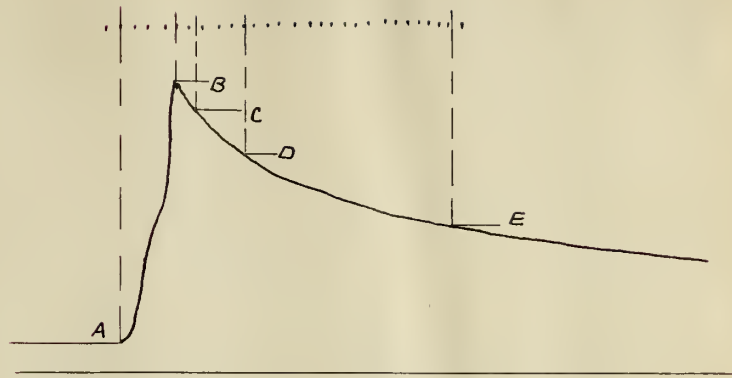

Card No. 11.

Initial Pressure 50#. Ratio of Mixture,  
 Maximum " 485# Gasoline 1, Air 10.  
 Fresh Charge.

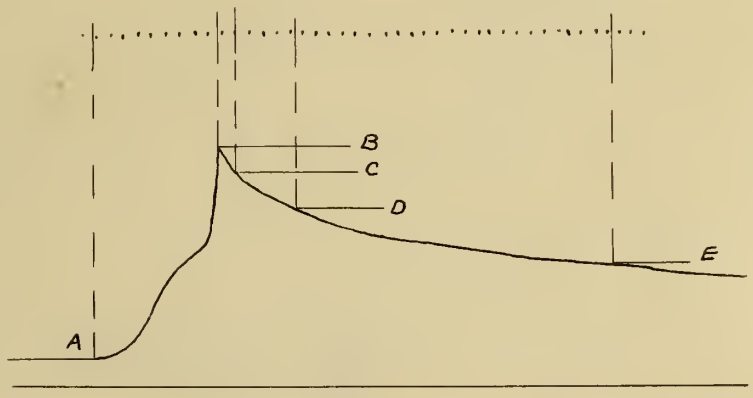

Card No. 12.

Initial Pressure. 50# Ratio of Mixture  
 Maximum " 390# Gasoline 1, Air 10.  
 Cylinder charged when full of burned  
 gas from previous Charge at atmospheric  
 pressure.





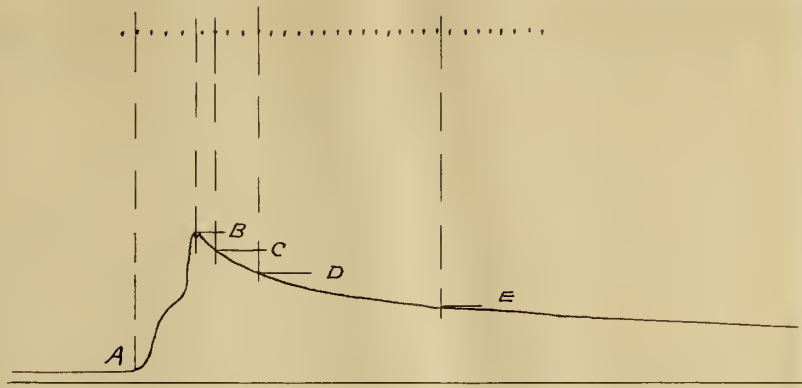

Card No. 13.

Initial Pressure - 20#      Ratio of Mixture  
 Maximum "      240#      Gasoline 1, Air 11.  
 Fresh Charge.

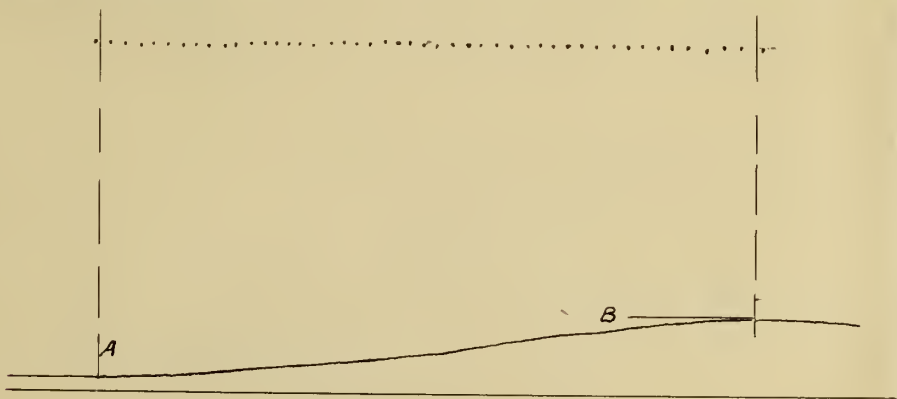

Card No. 14.

Initial Pressure 20#.      Ratio of Mixture  
 Maximum "      120#      Gasoline 1, Air 11.  
 Cylinder Charged when full of burned  
 gas at atmospheric pressure.



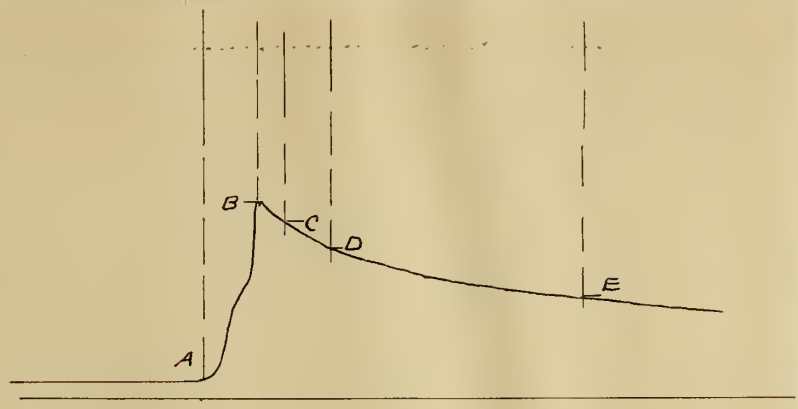

Card No. 15.

Initial Pressure 30<sup>#</sup>      Ratio of Mixture  
 Maximum      "      320<sup>#</sup>      Gasoline 1, Air 11.  
 Fresh Charge.

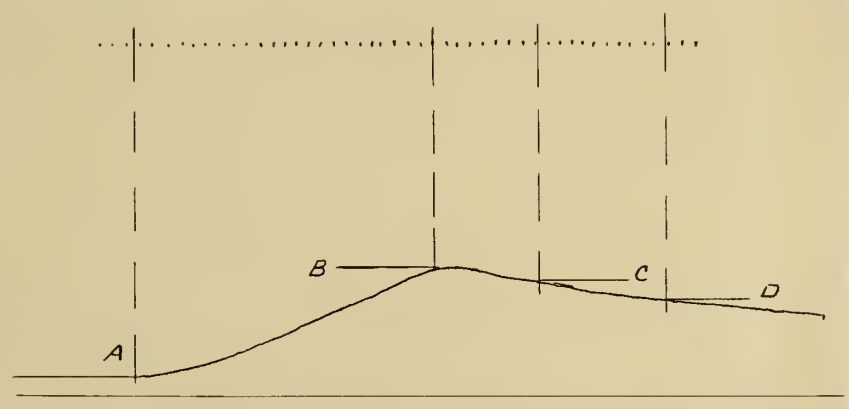

Card No. 16.

Initial Pressure 30<sup>#</sup>      Ratio of Mixture  
 Maximum Pressure 205<sup>#</sup>      Gasoline 1, Air 11.  
 Cylinder Charged when full of burned  
 gas from previous charge at atmospheric  
 pressure.



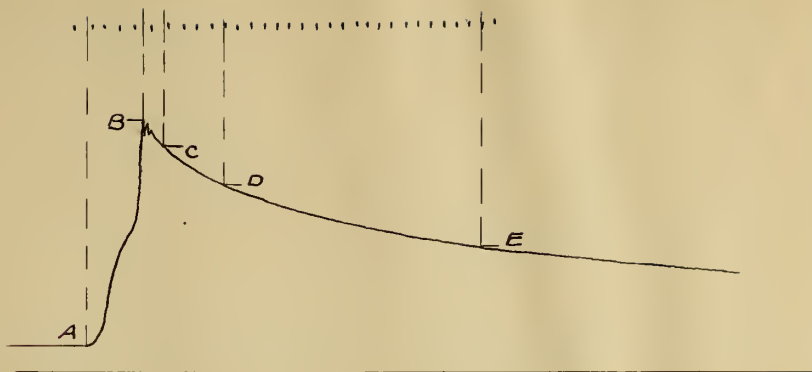

Card No. 17.

Initial Pressure 40 #. Ratio of Mixture  
 Maximum " 420 # Gasoline 1, Air 11.  
 Fresh Charge.

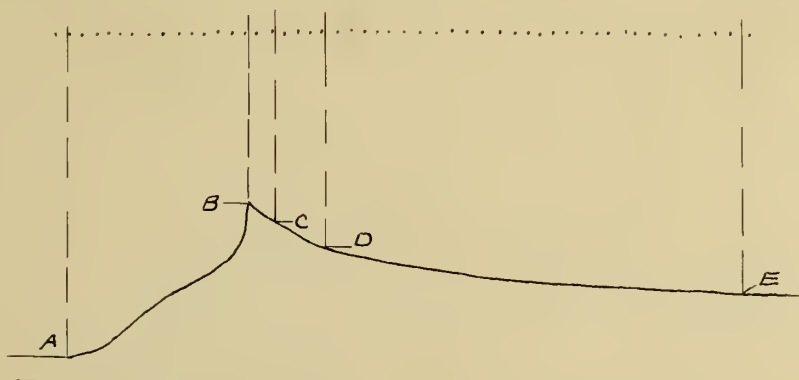

Card No. 18.

Initial Pressure 40 # Ratio of Mixture  
 Maximum " 295 # Gasoline 1, Air 11.  
 Cylinder Charged when full of burned  
 gas from previous Charge at Atmospheric  
 pressure.



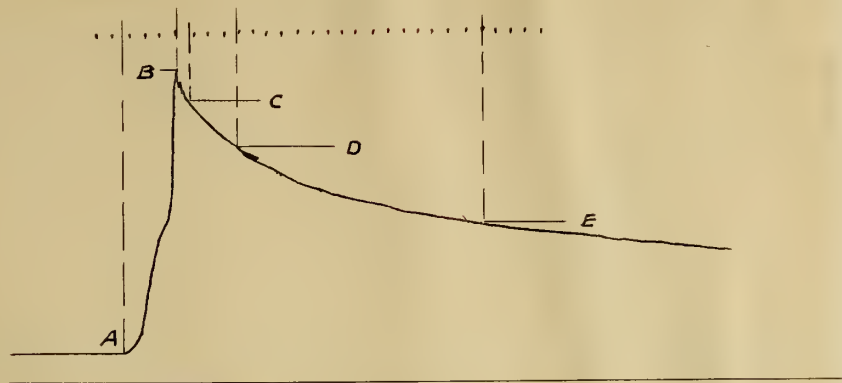

Card No. 19.

Initial Pressure 50# Ratio of Mixture,  
 Maximum " 520# Gasoline 1, Air 11.  
 Fresh Charge.

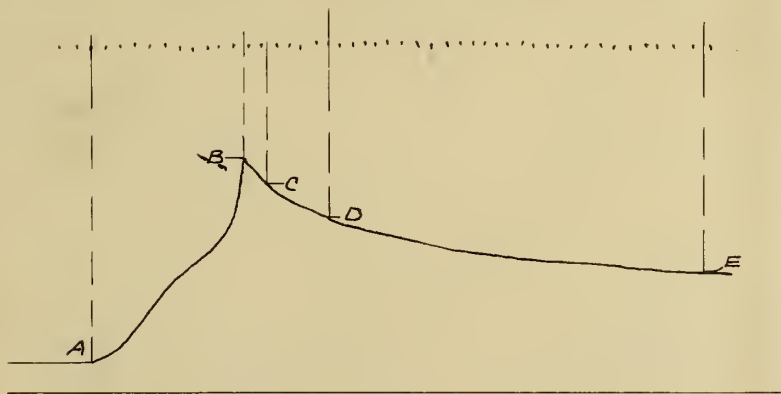

Card No. 20.

Initial Pressure 50# Ratio of Mixture  
 Maximum " 385# Gasoline 1, Air 11.  
 Cylinder Charged when full of burned  
 gas from previous charge at atmosphere  
 pressure.





INITIAL PRESSURE POUNDS (GAUGE) PER 0"	RATIO		TIME REQUIRED FOR COMBUSTION SECONDS		MAXIMUM PRESSURE POUNDS (GAUGE) PER 0"		TIME REQUIRED FOR A DROP IN PRESSURE OF —					
	Gasoline	Air.	FRESH	OLD	FRESH	OLD	10%		25%		50%	
							SECONDS		SECONDS		SECONDS	
							FRESH	OLD	FRESH	OLD	FRESH	OLD.
20	1	7	.17	X	225	50	.02		.08		.48	
30	1	7	.16	X	300		.02		.08		.54	
50	1	7	.09	X	465	275	.02		.08		.50	
20	1	8	.09	X	230		.04		.14		.50	
30	1	8	.09	X	310	65	.02		.08		.50	
40	1	8		X	390							
50	1	8	.08	.85	500	305	.01	.18	.10	.48	.53	
30	1	9	.08	.95	335	175	.02	.16	.11		.48	
50	1	9	.06	.22	495	360	.03	.03	.12	.11	.50	.63
30	1	10	.07	.66	330	190	.04	.11	.12	.40	.48	
40	1	10	.07	.29	390	310	.02	.11	.08	.28	.34	.82
50	1	10	.08	.18	485	390	.03	.02	.10	.11	.44	.60
20	1	11	.08	.92	240	120	.03		.09		.37	
30	1	11	.08	.47	320	205	.04	.16	.10	.38	.46	.47
40	1	11	.08	.27	420	295	.03	.04	.11	.12	.51	.69
50	1	11	.07	.21	520	385	.02	.04	.08	.13	.40	.68

Note: X means that the combustion took place too slowly to be called an explosion.



Heating value and Specific Gravity  
of gasoline used in all tests  
mentioned in this discussion.

Heating value.  
19400 to 19500 B.T.U. per pound.

Specific-gravity.

As determined by hydrometer	.7095
" " " weighing	.710

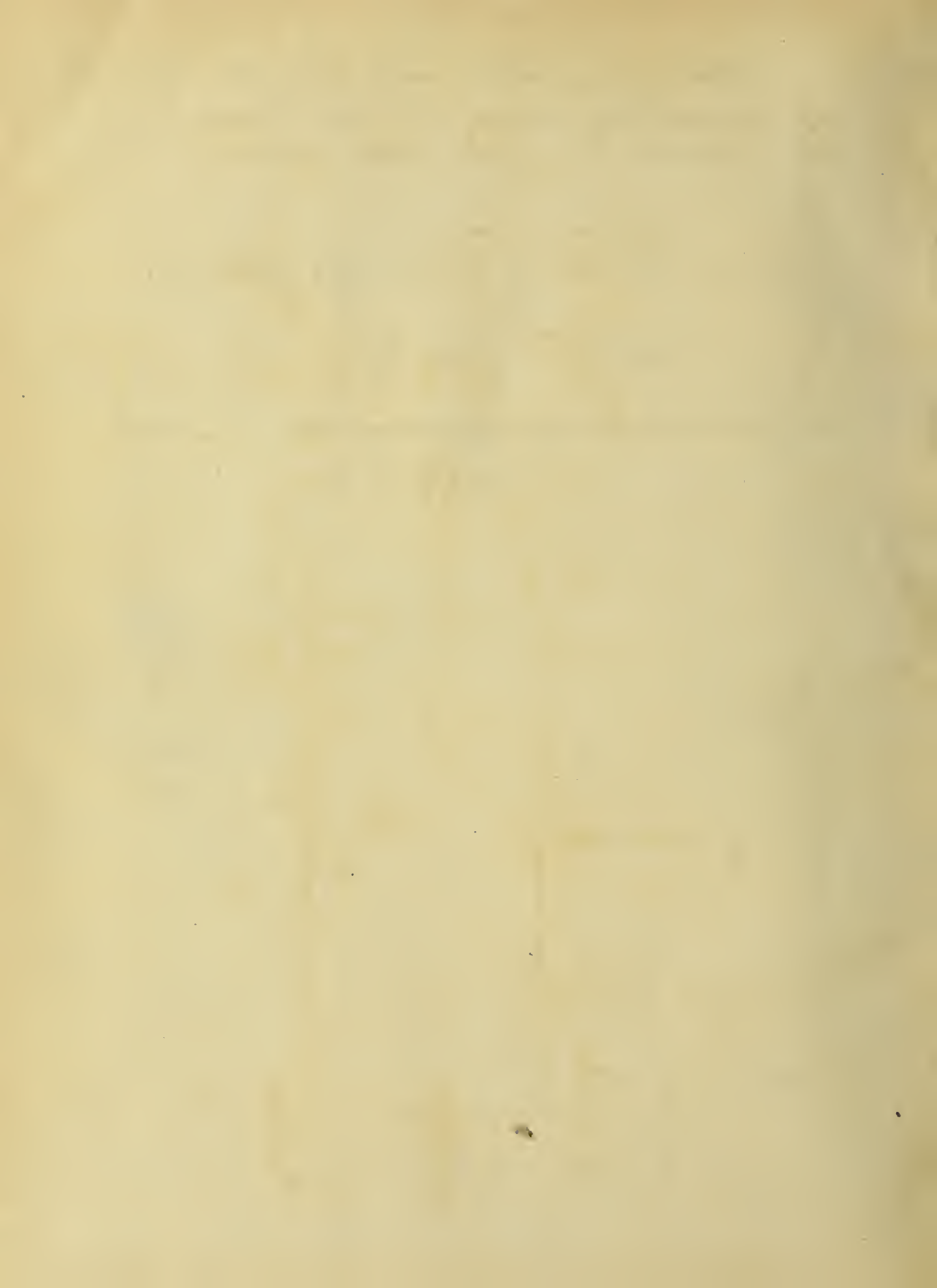

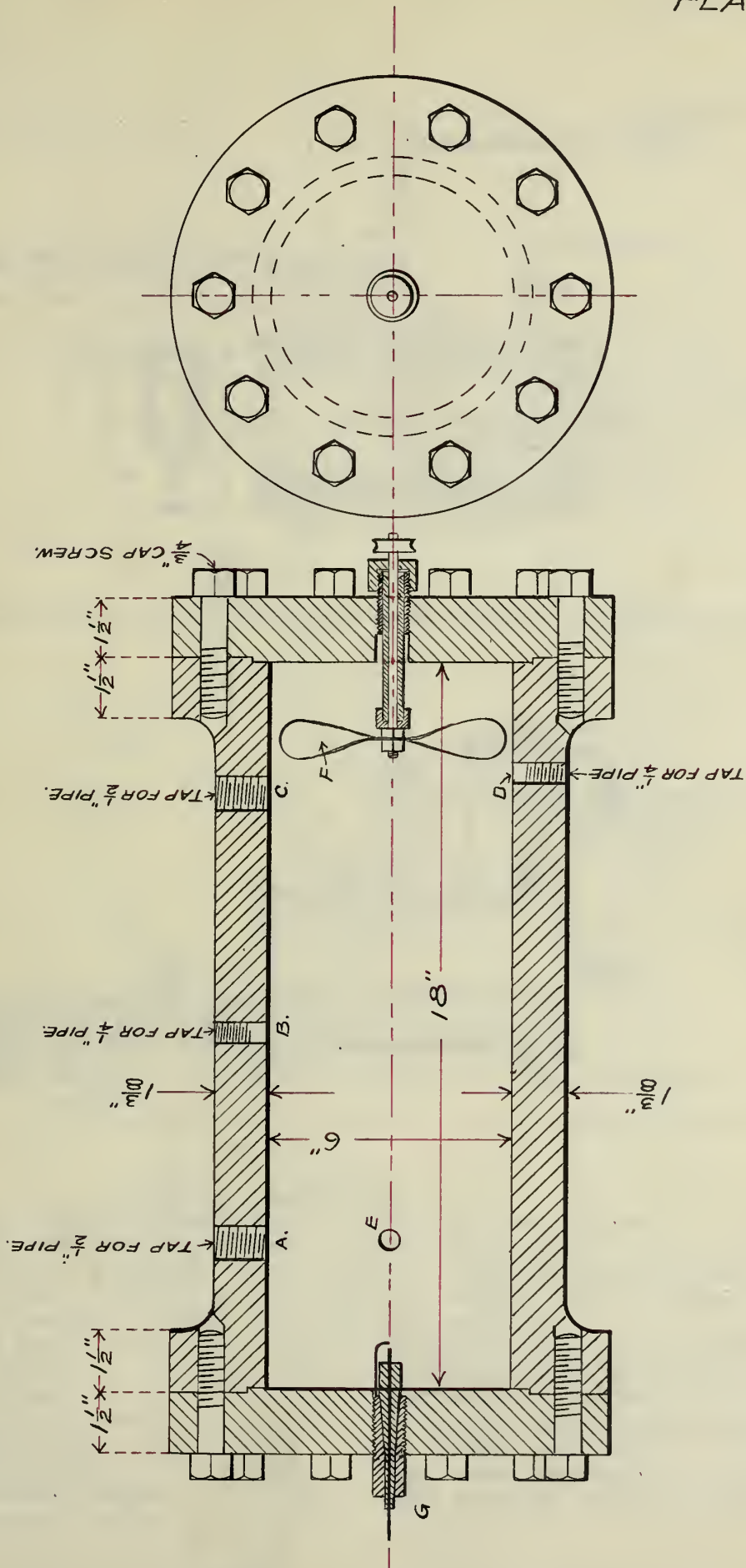

CAST IRON EXPLOSION CYLINDER.  
SCALE 1" = 4"



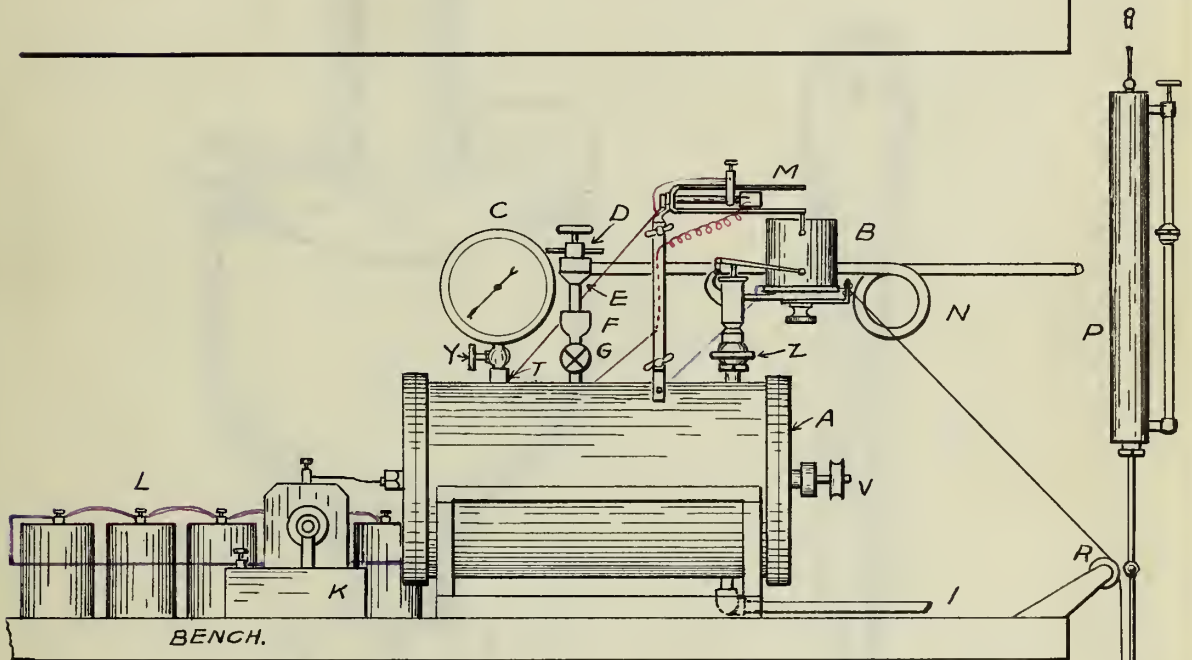
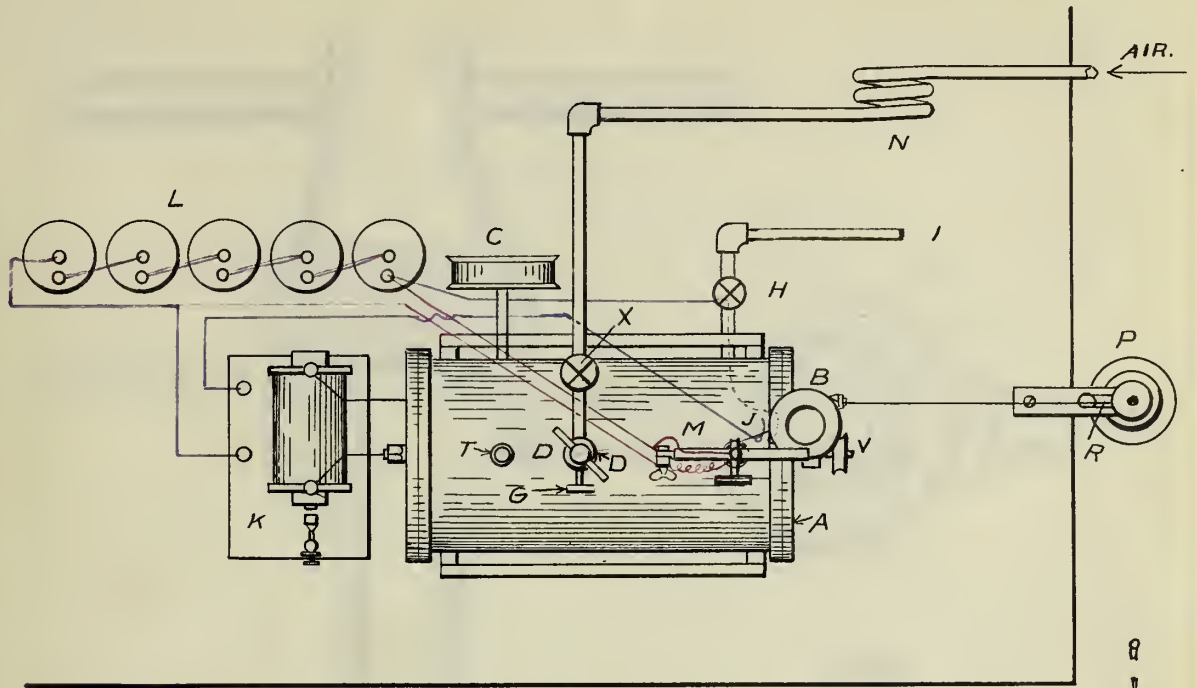

— EXPLANATION. —

- A - EXPLOSION CYLINDER.
- B - GAS ENGINE INDICATOR.
- C - STEAM GAUGE.
- D - PLUG.
- E - OIL INLET.
- F - CARBURETOR.
- G - VALVE.
- H - VALVE
- I - OUTLET PIPE.
- K - INDUCTION COIL.
- L - BATTERY.
- M - TIMING FORK.
- N - COILED PIPE.

- P - OIL CYLINDER.
- R - PULLEY.
- T - THERMOMETER CUP.
- V - PULLEY OF STIRRIN' FAN.
- W - WEIGHT.

ELECTRIC CIRCUIT FOR INDUCTION COIL IS SHOWN IN BLUE.  
 CIRCUIT FOR TIMING FORK IS SHOWN IN RED.  
 THE TWO COMPLETE CIRCUITS ARE SHOWN ONLY IN PLAN.





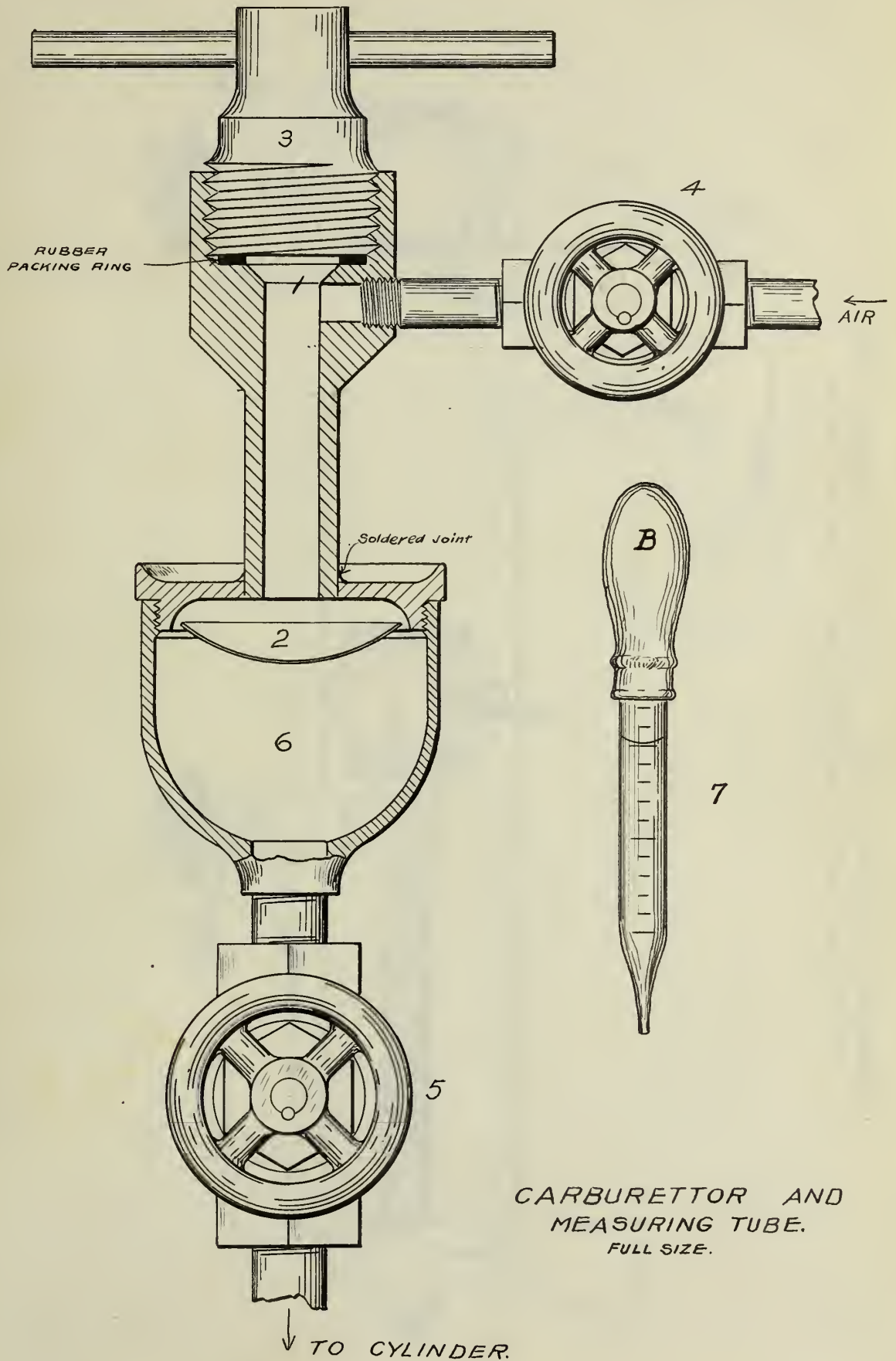

CARBURETTOR AND  
MEASURING TUBE.  
FULL SIZE.



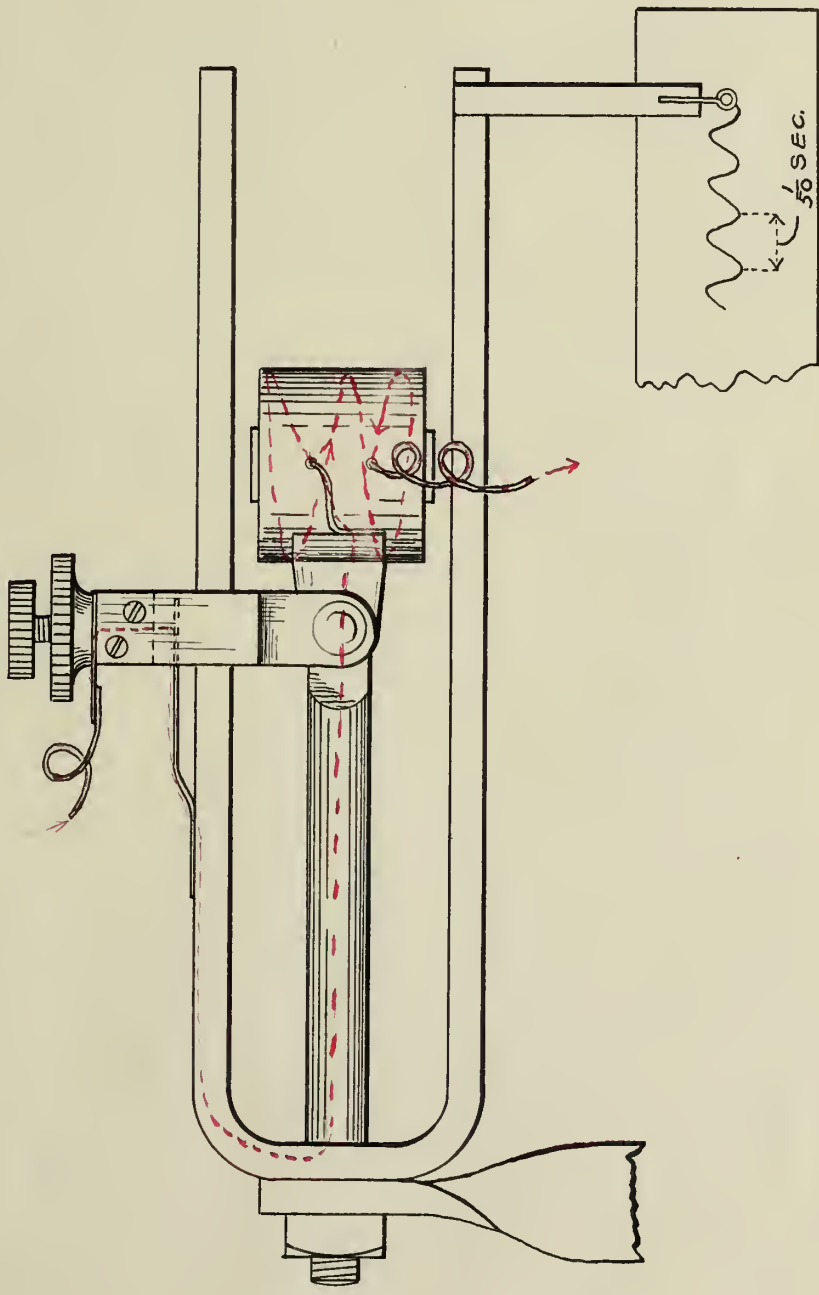
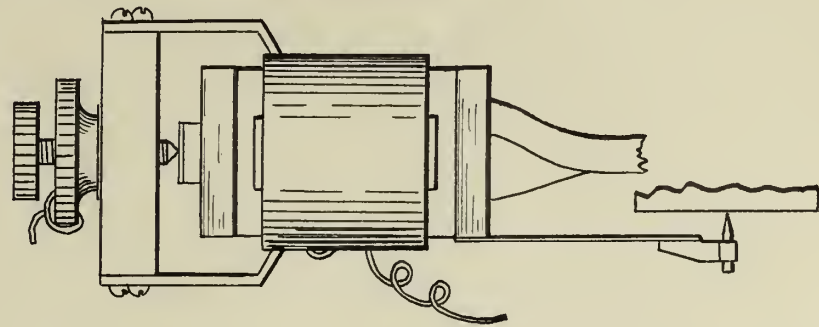

ELECTRICALLY OPERATED TIMING FORK.  
CURRENT FOLLOWS PATH SHOWN IN DOTTED RED.





