

EX LIBRIS



TELEPHONE APPARATUS

TELEPHONE APPARATUS

AN INTRODUCTION TO THE DEVELOPMENT AND THEORY

BY

GEORGE DEFREES SHEPARDSON, Sc.D.

PROFESSOR OF ELECTRICAL ENGINEERING, UNIVERSITY OF MINNESOTA



WITH ONE HUNDRED AND FIFTEEN FIGURES IN THE TEXT

UNIVERSITY OF
CALIFORNIA

D. APPLETON AND COMPANY
NEW YORK LONDON

1917

TK6471
S5

COPYRIGHT, 1917, BY
D. APPLETON AND COMPANY

TO WHOM
APPROPRIATE

Printed in the United States of America

DEDICATED TO THE
MEMORY OF MY FATHER
DANIEL SHEPARDSON
AN INSPIRING TEACHER
AND COUNSELLOR

359442

PREFACE

Progress is possible for those who know not only how, but also why a thing is done.

Appreciation of present practice and ability to promote progress are open to those who have knowledge of how and why certain things are commonly done, and are familiar with other ways by which equal or better results have been attempted or might be achieved.

Study of the art and of the science of any line of human endeavor (telephony, for example) should therefore include historical and other possible methods, as well as current practice.

The development and application of the laws which express the ways in which nature works in any line of activity, may be considered as the theory of that subject. In the early stages, a theory may be considered as only a tentative supposition, or hypothesis, or guess at the way in which nature works. But with more extended experience and philosophical analysis comes better understanding, and the tentative explanation develops into a theory. When properly developed and properly understood, theory should not only explain phenomena which have been observed already, but should even enable one to predict with reasonable assurance what result may be expected when new conditions arise. Theory should also point out more or less distinctly not only possible means of securing desired results, but may even indicate the best of several means. Theory and practice are usually developed together, sometimes one being further advanced and then the other.

Telephony may be considered in a broad or in a narrow sense, accordingly as one considers only what is peculiar to the transmission of speech, or whether there is included the

whole plant and organization that is directly or indirectly involved. Taken in a broad way, a complete discussion of the theoretical and operative details of a modern telephone system would cover nearly the entire field of knowledge, including especially physical science and engineering, business management and finance, law and psychology.

Considering telephony in the narrower sense, the construction and operation of telephone stations, and their connections through lines and exchanges, involve a large part of the fundamental principles of physics, chemistry, mathematics and electrical engineering, and also special applications and developments peculiar to telephony.

The wise student of telephony will precede and accompany his special study by a training in both the directly and the indirectly underlying and affiliated subjects.

Numerous books on telephony have been published, and there is an abundance of periodical and of trade literature; descriptive matter is plentiful, but there is a paucity of systematic, historical, and theoretical treatment, especially as regards talking and signaling apparatus. The following pages have been prepared to help meet this deficiency.

Investigators will appreciate the numerous references to original and secondary sources. It is hoped that this contribution may stimulate others to help further the science of telephony toward a higher stage, and that the occasional suggestions of room for improvement may indicate paths of future progress.

A telephone system may be considered as an electrical transmission system, including three essential parts:

- (a) Apparatus for originating and for receiving calls.
- (b) Apparatus for transmitting and for reproducing speech.
- (c) Circuits for connecting the apparatus.

There is more or less overlapping of functions, some devices being used in connection with both signaling and talking,

while some might be considered either as parts of the circuit or as pieces of apparatus.

Since electromagnets, inductive coils and condensers are used principally in connection with signaling circuits, such will be considered as signaling devices, even though some of them are used exclusively in connection with talking apparatus or as desirable parts of the talking circuit.

This volume deals principally with apparatus, giving only minor attention to circuits, which may be studied more fully elsewhere. Consideration is given to the laws of sound, and to the characteristics of speech sounds, since their transmission is the *raison d'être* of the telephone. Little space is devoted either to batteries, generators, or motors, which have been standardized in older branches of electrical engineering, or to switchboards, prepayment or selective devices, which are amply presented in the descriptive treatises. Little space is given to wireless telephone apparatus, as belonging more properly to radio engineering.

This book presumes that the reader has a working knowledge of algebra, trigonometry, calculus, and physics, including the laws governing direct and alternating currents. It is hoped, however, that the treatment is such that the practical telephone man, who may not be familiar with these tools, may be helped to appreciate more of the reasons for telephone practice.

For the convenience of readers who may be out of practice in mathematical work, the more extended mathematical developments have been segregated in the Appendices, only the conclusions being incorporated in the body of the text.

The author acknowledges indebtedness to many sources. In several of the investigations here presented for the first time, valuable assistance has been rendered by the author's students. Writings of previous investigators have been drawn upon freely, as indicated by the footnotes. Specific credit can hardly be given for much that has become incorporated in the general body of telephone literature.

Grateful acknowledgment is made to Professor Kennelly

for permission to reproduce Figures 16 and 19 to 22 from reports of his investigations in Proceedings of American Academy of Arts and Sciences and in Bulletins of Massachusetts Institute of Technology; to American Institute of Electrical Engineers for Figures 4 to 10, 17, 18 and 31; to *American Telephone Journal* for Figure 52; to Carnegie Institution for permission to reproduce Figure 3 from Scripture's "Speech Curves"; to McGraw-Hill Book Company for permission to reproduce from their copyrighted publications the whole or parts of Figures 12, 23, 47, 66, 90, 91, 100 and 101 from Abbott's "Telephony," Shepardson's "Electrical Catechism," and Vandeventer's "Telephonology"; to the *National Telephone Journal* for Figures 82 and 83; to *Telephone Review* for Figure 11; to *Telephony* for Figure 30.

Grateful acknowledgment is also made to various manufacturing and operating companies who have coöperated by furnishing apparatus for investigations and material for illustrations, including Automatic Electric Company, F. B. Cook Company, Cracraft-Leich Company, Garford Manufacturing Company, Kellogg Switchboard and Supply Company, Monarch Telephone Manufacturing Company, Northwestern Telephone Exchange Company, Stromberg-Carlson Telephone Manufacturing Company, Sumter Telephone Manufacturing Company, Tri-State Telephone and Telegraph Company, Warner Electric Company and especially the Western Electric Company. Thanks are due to H. M. Twiner for reading proof.

It is recognized that this treatment is not complete, that some parts have been developed further than others, and that the fullness of treatment is not always commensurate with the relative importance of the topic. The author will appreciate frank criticisms. As it is too much to expect the first edition to be free from errors, or even from possible blunders, the author will thank any who will point out such faults.

GEORGE DEFREES SHEPARDSON.

University of Minnesota.

CONTENTS

PART I

SPEECH SOUNDS, RECEIVERS, TRANSMITTERS

CHAPTER	PAGE
I. INTRODUCTION	3
II. SOUND	6
III. SPEECH SOUNDS	19
IV. TELEPHONE RECEIVERS	43
V. TELEPHONE RECEIVER INVESTIGATIONS	57
VI. TELEPHONE TRANSMITTERS	83
VII. TELEPHONE TRANSMITTER INVESTIGATIONS	100

PART II

SIGNALING EQUIPMENT

VIII. SIGNALING DEVICES	125
IX. DESIGN OF NON-POLARIZED SIGNALING APPARATUS	141
X. PERMANENT MAGNETS AND POLARIZED APPARATUS	168
XI. DESIGN OF POLARIZED APPARATUS	177

PART III

SOURCES OF ELECTROMOTIVE FORCE AND PROTECTION

XII. ELECTROMOTIVE FORCES AND CURRENTS	193
XIII. PRINCIPLES OF INDUCTION COILS	215
XIV. USES OF INDUCTION COILS IN TELEPHONY	223
XV. CONDENSERS IN TELEPHONY	240
XVI. PROTECTIVE DEVICES	255

PART IV

APPENDICES

	PAGE
A. LAWS OF MAGNETIC CIRCUIT AND OF MAGNETIC PULL	271
B. MAGNETIC FLUX IN A CIRCUIT CONTAINING A PERMA- NENT MAGNET	286
C. MATHEMATICAL THEORY OF POLARIZED RELAY OR RINGER	290
D. THEORY OF FORCES ACTING ON RECEIVER DIAPHRAGM	295
E. SOLUTION OF DIFFERENTIAL EQUATION FOR RECEIVER	302
F. DOUBLE FREQUENCY OF ELECTRODYNAMIC PULL ON RE- CEIVER DIAPHRAGM	307
G. APPROXIMATE EQUATION FOR MICROPHONE	309
H. MICROPHONE EQUATION BY INVERSE METHOD	312
I. HISTORICAL NOTES ON SIGNALING DEVICES	314
J. BOOKS MENTIONED SEVERAL TIMES.	319
INDEX	321

LIST OF ILLUSTRATIONS

FIGURE	PAGE
1. Vibrations of bell	7
2. Musical scale	12
3. Phonographic speech curves	20
4. Apparatus for telephonic oscillograms	33
5. Oscillogram of current	34
6. Oscillogram of current	34
7. Oscillogram of current	34
8. Oscillogram of current	34
9. Oscillogram of current	35
10. Oscillograms of currents for alphabet	35
11. Oscillograms of telephonic currents	38
12. Single pole receiver	51
13. Bipolar receiver	52
14. Welded receiver	53
15. Electromagnetic receiver	54
16. Apparatus for measuring amplitude of vibration of diaphragm	58
17. Variation of receiver sensibility with pitch	61
18. Variation of receiver sensibility with pitch	62
19. Resonance curve for receiver	63
20. Optical system for vibration explorer	70
21. Vibration contours of receiver diaphragm	71
22. Effect of diaphragm vibration upon resistance and reactance of receiver	80
23. Blake transmitter	91
24. Western electric transmitter	92
25. Cracraft-Leich transmitter	93
26. "Turkey foot" transmitter	95
27. Detail of Kellogg transmitter	96
28. Change of microphone resistance with time	102
29. Circuits for microphone test	103
30. Change of microphone resistance with noise	104
31. Microphone current changes by sound	104
32. Resistance variation required for sinusoidal current in trans- mitter	114
33. Sensibility curve for microphone	116
34. Siren used in author's tests	117
35. Diagrams of apparatus used in author's tests of transmitters	117
36. Sensibility curve of a Bell transmitter	118
37. Sensibility curve of another Bell transmitter	118
38. Sensibility of transmitter as affected by position of damping spring	119

FIGURE	PAGE
39. Sensibility of transmitter as affected by tension of damping spring	120
40. Sensibility curve of a Sumter transmitter	121
41. Sensibility curve of a Dean transmitter	122
42. Intercommunicating sets	125
43. Automatic telephone station	126
44. Apparatus in automatic exchange	127
45. Front and rear views of small magneto switchboard	128
46. Types of circuit for small magneto switchboard	129
47. Shutter signals or drops	130
48. Combined drops and jacks	132
49. Section of combined drop and jack	133
50. Electrically operated self-restored drop	133
51. Drop operating night bell	134
52. Types of telephone relay	135
53. Central energy circuit for calling operator	136
54. Central energy supervisory circuit	136
55. Multiple switchboard	138
56. Circuits of a multiple switchboard showing busy test	139
57. Busy test circuits simplified	140
58. Diagram of circuits for oscillograph	149
59. Oscillograms of current and voltage in telegraph relay	150
60. Oscillograms of current and voltage in telephone relay	151
61. Growth of current in electromagnet	152
62. Alternating current magnet	156
63. Alternating current magnet windings	157
64. Pole-changer to obtain alternating current from direct current	161
65. Pole-changer to obtain alternating or pulsating current from direct current	162
66. Circuits of a pole-changer	163
67. Oscillograms from pole-changers	164
68. Field around bar permanent magnet	169
69. Field around horseshoe permanent magnet	170
70. Field around horseshoe magnet with armature in place	171
71. Polarized ringer	175
72. Polarized mechanism	178
73. Polarized mechanism	179
74. Polarized ringer diagrams	180
75. Polarized ringer	181
76. Vibrators tuned for selective ringing	184
77. Circuits of harmonic ringing system	186
78. Retardation coils	224
79. Retardation coils	226
80. Station circuit with local battery	231
81. Station circuits for central energy	233
82. Repeating coil between grounded and full-metallic circuits	235
83. Repeating coils in cord circuit of central energy system	236
84. Phantom circuit	238

LIST OF ILLUSTRATIONS

XV

FIGURE	PAGE
85. Condenser for selective ringing without grounding the line	243
86. Condenser in receiver circuit on multiparty line	245
87. Station circuits for central energy	247
88. Direction of currents when microphone resistance increases	248
89. Direction of currents when microphone resistance decreases	249
90. Condensers for transferring voice currents through cord circuit	250
91. Condensers carrying voice currents around retardation coils in cord circuit	251
92. Disconnect signal based on voltage rise	253
93. Condensers for bridging telephones across composite circuit	254
94. Telephone protector	256
95. Types of telephone fuse	257
96. Types of heat coil	258
97. Grasshopper fuses	259
98. Two types of lightning arrester	262
99. Heat coils and lightning arresters for exchanges	263
100. Exchange protectors with re-soldering coils	264
101. Exchange protectors with self-soldering coils	265
102. Telephone station protector against abnormal and sneak currents and lightning	266
103. Diagram and details of protector	266
104. Magnetic field about a permanent magnet	272
105. Magnetic field about single conductor	273
106. Magnetic field between two conductors	274
107. Magnetic field about solenoid	276
108. Magnetic field about solenoid with iron core	277
109. Hysteresis curve	278
110. Hysteresis loops	279
111. Experimental magnet	287
112. Electrical circuit for experimental magnet	287
113. Curve showing relation between coil position and change of flux	288
114. Diagrams of polarized ringers	291
115. Graphical construction for double frequency	307

LIST OF ABBREVIATIONS

Because of the large number of citations, abbreviations have been adopted for periodicals to which reference is made frequently.

- Amer. Jour. Sci.—American Journal of Science, and Silliman's Journal, New Haven.
- Amer. Elec.—American Electrician, merged in Electrical World, New York.
- Ann. d. Phys.—Annalen der Physik und Chemie, Annalen der Physik (including Poggendorff's and Wiedemann's Annalen), Leipzig.
- Beiblatter.—Beiblatter zu den Annalen der Physik und Chemie, Wiedemann, Leipzig.
- Compt. Rend.—Comptes Rendus Hebdomadaires des Séances de l'Académie des Sciences, Paris.
- Elec. Lon.—Electrician, London.
- El. Rev. Lon.—Electrical Review, including Telegraphic Journal, London.
- El. Rev. N. Y.—Electrical Review, New York, merged with Western Electrician into Electrical Review and Western Electrician, Chicago.
- El. Rev. W. El.—Electrical Review and Western Electrician, Chicago.
- El. Eng. Chi.—Electrical Engineering, changed to Telephone Magazine, Chicago.
- El. Eng. N. Y.—Electrical Engineer, merged in Electrical World, New York.
- El. Jour.—Electric Journal, Pittsburgh.
- Elek. Zeit.—Elektrotechnische Zeitschrift, Berlin.
- El. World.—Electrical World, including Electrical World and Engineer, New York.
- Jour. El. P. G.—Journal of Electricity, Power and Gas, San Francisco.
- Jour. Fkln. Inst.—Journal of Franklin Institute, Philadelphia.
- Jour. Inst. El. Eng.—Journal of Institution of Electrical Engineers, London, succeeding Journal of Society of Telegraph Engineers.
- Jour. Soc. Tel. Eng.—Journal of Society of Telegraph Engineers, London.
- Jour. Soc. Arts.—Journal of Society of Arts, London.
- La Lum. Elec.—La Lumière Electrique, Paris.

- L'Ecl. Elec.—L'Eclairage Electrique, succeeding and succeeded by La Lumière Electrique, Paris.
- Phil. Mag.—The London, Edinburgh and Dublin Philosophical Magazine and Journal of Science, London.
- Pogg. Ann.—Poggendorff's Annalen der Physik und Chemie, Leipzig.
- Phys. Rev.—Physical Review, New York.
- Phys. Zeit.—Physikalische Zeitschrift, Leipzig.
- Proc. Am. Acad. Art. Sci.—Proceedings of the American Academy of Arts and Sciences, Boston.
- Proc. Am. Inst. El. Eng.—Proceedings American Institute of Electrical Engineers, New York.
- Sci. Abstr.—Scientific Abstracts (Physics and Electrical Engineering sections), London.
- Sci. Amer.—Scientific American, New York.
- Sci. Amer. Supp.—Scientific American Supplement, New York.
- Sill. Jour.—Silliman's American Journal Science, New Haven.
- Tel.—Telephony, Chicago.
- Tel. Eng.—Telephone Engineer, Chicago.
- Tel. Mag.—Telephone Magazine, Chicago.
- Tel. Jour.—Telegraphic Journal, succeeded by Electrical Review, London.
- Trans. Am. Inst. El. Eng.—Transactions American Institute of Electrical Engineers, New York.
- West. Elec.—Western Electrician, combined with El. Rev., N. Y., Chicago.
- Wied. Ann.—Wiedemann's Annalen der Physik und Chemie, Leipzig.

In making citations, the series (if any), volume, page, and date are given in order, the series being parenthesized, the volume number being followed by a colon, then the page number, the date being last and in parentheses. Consecutive references to the same journal are separated by semicolons.

Titles of books are generally given but once in the footnotes in each chapter, being referred to later as "op. cit." (*opus citatum*, meaning "work cited").

PART I

SPEECH SOUNDS, RECEIVERS, TRANSMITTERS



CHAPTER I

INTRODUCTION

1. Importance of Communication and Transportation.

—Easy interchange of ideas and easy transportation of persons and of goods are among the most valuable contributions of the engineer to modern civilization. The greater freedom of intercourse broadens everybody's outlook on life, and the resulting better knowledge of other people makes the whole world more closely akin. The saving of time and expense effected by rapid communication and transportation virtually lengthens the life of the individual, increases the number of business and social affairs in which he may participate, enables everyone to handle larger affairs, and makes possible modern large business undertakings. Among these facilities the telephone is one of the more important.

2. Volume of Business of Communication Utilities.—

During the year 1909, the number of telephone conversations was estimated ¹ at 4,937,000,000 in Europe and at 12,617,000,000 in the United States of America. For conducting electrical communications, there were in use in the world approximately 27,000,000 miles of telephone wire and 7,500,000 miles of telegraph wire. The total investment was estimated in January, 1911, as being \$1,561,777,000 for the telephonic equipment of the world, \$707,720,000 for the overland telegraphic equipment, and \$350,000,000 for the submarine telegraphic cable equipment, a grand total of \$2,619,497,000 invested in telephonic and telegraphic equipment, not including the rapidly increasing investments in wireless signaling. Another ² computation for 1913 shows about 15,-

¹ "Telephone Statistics of the World," issued by the American Telephone and Telegraph Company in May, 1912.

² KINGSBURY. The Telephone and Telephone Exchanges, p. 517. Longmans (1915).

000,000 telephone stations in the world, with an investment of \$2,090,000,000. For the year 1915, the gross earnings by these utilities (excluding wireless) in the United States alone were estimated ¹ at \$350,000,000 by telephones and \$100,000,000 by telegraph.

3. Relation of Telephony to Other Means of Communication.—In order to appreciate the relation of telephony to other means of communication, it may be noted that each of the five commonly recognized special senses may serve as a medium for receiving information, both electrically and otherwise, the eye and the ear being so used most frequently. In addition to these orthodox means of communication, there are others which might be designated as supersensory, or as mind-reading, which though commonly clouded by fraud and superstition, have an incontrovertibly real existence and may confidently be expected to come within the realm of exact science. For convenience the various sensory methods are summarized in tabular form.

4. Summary of Methods of Communication.

- A. Taste
 - Identification of substances
 - Signals
- B. Smell
 - Identification of substances
 - Trails
- C. Touch
 - Identification of substances
 - Reminders
 - Signals by feeling or electric shock
 - Reading by blind
 - Sounds through bones of head
- D. Sight
 - Transient
 - Gestures, sign languages

¹ MARTIN. *El. World*, 67:14 (Jan. 1, 1916).

- Lanterns, rockets, "wigwag"
- Stereopticon, moving pictures
- Semitransient
 - Flags, markers, beacons
 - Block signals
 - Annunciators
 - Chemical telegraph registers
- Permanent
 - Owners' marks, reminders
 - Ideograms
 - Picture writing
 - Sign writing, ink or punch telegraph
 - Alphabetic writing
- E. Sound
 - Transient
 - Inarticulate
 - Whistle, bell, knocker, torpedo
 - Telegraph
 - Conductor
 - Radio
 - Fire alarm, police, messenger call
 - Articulate
 - Direct conversation,
 - Messenger
 - Trumpet, speaking tube
 - Telephone
 - Mechanical
 - Electrical
 - Electromagnetic
 - Electrostatic
 - Radio
 - Permanent
 - Inarticulate
 - Music roll
 - Music box
 - Articulate
 - Phonograph

CHAPTER II

SOUND

5. Transmission of Sound the Object of Telephony.—Since the purpose of the telephone is to receive and transmit sound, the general nature of sound and the methods by which it is generated, transmitted, and received are of prime importance.

6. Characteristics of Sound.—Sound consists of a vibratory motion which may be simple, but which is generally quite complex. The frequency, or the number of complete vibrations in a second, determines the pitch of the sound. The amplitude of the vibration, that is, the distance any particle travels from its position of rest, determines the intensity; this, in combination with the auditory apparatus of the hearer, determines the sensation of loudness. When the vibration is simple, such as may be represented by a sine wave,¹ the sound is said to be pure or simple; the combination of a number of vibrations whose frequencies bear comparatively simple ratios gives a sound known as a musical chord; most sounds are quite complex, consisting of a more or less dominant tone modified by the presence of less prominent components whose frequencies and intensities may or may not bear simple ratios to the dominant tone and which give to the whole sound what is known as its quality or timbre.

The sound vibrations may consist of motions of the particles of a gas, such as air, or of a liquid or of a solid. By means of a telephone transmitter, the sound vibrations may cause electrical vibrations which a telephone receiver at a distance will transform back into sound vibration, so that sound may be conducted indirectly by electricity.

¹ Discussed in books on trigonometry, on physics, on alternating currents, etc.

7. **Generation of Sound Illustrated by Bell.**—The generation of sound may be illustrated by the action of a bell, such as the gong of a telephone ringer.

In the figure, let $abcd$ represent the rim of a gong which is circular when not sounding. The effect of a blow from the hammer at any point, such as at a , is to drive the metal away at that point, say to the position a' , as shown greatly exaggerated in the figure. The rigidity of the metal then pushes

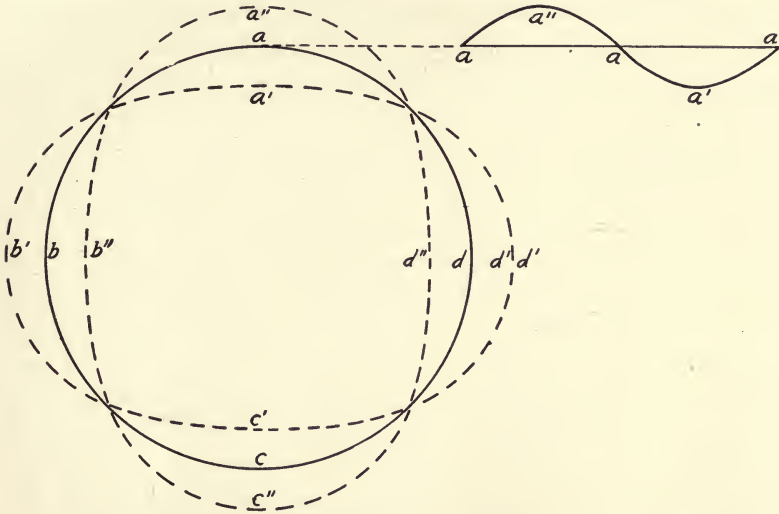

FIG. 1.—VIBRATIONS OF BELL

out the rim at neighboring portions and pushes it in at more distant portions. Thus, in the simplest case, the effect of a blow is to change¹ the shape of the gong for an instant from a circle to an ellipse, such as shown greatly exaggerated by $a'b'c'd'$; when the force of the hammer is expended, the elasticity of the metal takes the bell back to its initial circular shape, $abcd$; but inertia carries the particles on past their

¹ The vibration of the bell is not limited to four segments or sections; it may vibrate in six, eight, ten or more sections; in fact, a bell generally has a very complex vibration consisting of a number of sets of vibrations, so that it gives out several different tones at the same time, easily distinguished in the sound of a large bell.

initial positions toward positions indicated by the second ellipse, $a''b''c''d''$. Again elasticity drives the particles toward their initial positions in the circle $abcd$, and their velocity again carries them on past toward the first ellipse $a'b'c'd'$; thus the bell continues to vibrate a number of times after each blow of the hammer.

The vibrations gradually become less and less intense—that is, of smaller amplitude—as the energy imparted to the bell by the blow of the hammer becomes dissipated, partly by internal friction within the substance of the bell, and partly by transfer to the surrounding air which is set into motion.

8. Transmission of Sound Through Air.—As the bell vibrates from one shape to another, the adjacent air is set into a corresponding vibratory motion; as a portion of the bell moves outward, the air in front is pushed along and compressed somewhat; this compresses to a somewhat smaller degree the air beyond, and that in turn passes the compression along; as the portion of the bell moves inward, the air close to it expands in filling up the space vacated by the bell, and this brings about an impulse of expansion or rarefaction in the air beyond.

The inertia of the particles of air causes them to move on past the position to which they are pushed by their neighbors, and thus the impulses of compression and rarefaction are carried along, going further and further from the source of disturbance.

9. Generation of Sound by Telephone Receiver, by Voice.—The sound from a telephone receiver¹ is transferred to the air in a similar manner, the metallic diaphragm being caused to vibrate by the electrical impulses, and the diaphragm setting the air into vibration.

The formation of the intricate sounds of the human voice²

¹ See §§ 16, 63, 64.

² See bibliography under No. 9510, "Arrangement and Action of the Vocal Organs," in Roy. Soc. Lon. Catalogue of Scientific Papers, 1800-1900, vol. 3, Physics, Part 1.

is naturally more complicated¹ than that of the relatively simple sound from a bell. These are generated principally by interruptions of the flow of air from the lungs as it passes between the vocal cords, its motion being modified by the lips and by the oral and nasal cavities.

10. Diminution of Intensity with Distance.—As each impulse gets further away from the source, it acts upon larger and larger quantities of air. Consequently the amount of energy received from the original source of disturbance is divided among more and more particles, so that any given particle of air is disturbed less as the distance from the source increases.

If the sound came from a single source and spread equally in all directions, each wave would become a larger and larger spherical shell whose area and volume would be proportional to the square of the distance from the source; thus, the travel of each vibrating particle depends on its distance, the amount of travel and the intensity of the sound varying inversely as the square of the distance.

Practically, the intensity of the sound does not follow exactly the law of inversed squares. Reflections and refraction frequently intervene to cause the sound to travel unequally in various directions, and more or less interference occurs to complicate the situation. For example, near a gong there may be eight sets of waves, coming from the outside and from the inside of the four sections considered in the typical vibration, and these combine so as to strengthen the sound at some places and to weaken it at others. Within buildings, the reflections from the walls and ceilings and floors and from other objects have much influence upon the rate of decrease of sound intensity with distance. Even in the open air outside buildings, there seems to be more or less of stratification of the sound conduction, the dense earth below and the thin air above seeming to make the sound travel in more or less clearly defined layers, so that its intensity seems to

¹ See §§ 25-33.

vary inversely with the distance more nearly ¹ than with the square of the distance. Moreover, the apparent intensity of the sound as received by the ear is influenced by physiological conditions ² varying with the intensity of the sound observed and with the disturbing influence of other sounds.

11. Pitch of Sound.—The pitch of a sound is determined ³ by the number of complete vibrations per second, a sound of high pitch having many vibrations per second, a sound of low pitch having few. A simple or pure sound consists of vibrations of only a single frequency, the vibrating particles moving back and forth with a velocity varying regularly from zero to a maximum and the reverse according to the law of sines.⁴ A number of sounds of different frequencies may be combined into a single complex sound and, vice versa, a complex sound may be resolved ⁵ into ⁶ components. The pitch of a complex sound is generally determined by that of the most prominent component, usually the lowest.

12. Ranges of Pitch.—The range of pitch of sounds that can be heard by the human ear ⁷ varies somewhat with individuals, being narrowed by advancing years and by weakening the sound. Very loud sounds have been heard at frequencies as low as 10 vibrations per second, and as high as 45,000. Some people cannot bear the squeak of a bat nor the

¹ McQUILLAN AND BURROWS. A Study of the Effect of Mechanical Adjustments on Telephone Ringers, 1911 thesis in library of University of Minnesota.

Similar conclusions were reached by A. Sturmhoefel, reported in *Deutsche Bauzeitung* (Berlin), pp. 24-27 (Jan. 13, 1894).

See, however, different conclusions by W. W. Jacques, reported in *Proc. Amer. Acad. Arts and Sci.*, 11:265 (1876).

² See § 21.

³ Bosanquet. Article, "Music," in *Encyclopædia Britannica* (9) 17:111.

See also bibliography under No. 9320, "Frequency Measurement," and No. 9460, "Standards of Pitch," in *Roy. Soc. Lon. Catalogue of Scientific Papers, 1800-1900, vol. 3, Physics, Part 1.*

⁴ See textbooks on physics or on alternating currents.

⁵ See footnotes under §§ 38, 39.

⁶ See §§ 38, 39.

⁷ See bibliography under No. 9520, "Arrangement and Action of the Ear," in *Roy. Soc. Lon. Catalogue, vol. 3, Physics, Part 1.*

chirp of a cricket. When the upper limit of audition is too low, the perception of certain consonants¹ is defective. The range of tones ordinarily used in music is from 40 to 4,000, embracing nearly seven octaves, the highest note used being about d^{vi} of 4,752 vibrations made by the piccolo flute. The fundamental sounds by singers usually range between about 64 vibrations per second at the "low C" of a deep bass, and about 1,024 vibrations at the "high C" of a soprano, though these limits are occasionally exceeded. The range of vibration in speech sounds² seems to lie between 100 and 5,000 periods per second, the most important seeming to lie between 600 and 1,200 periods.

13. Sensitiveness of Ear Affected by Pitch.—High notes seem to be heard with greater difficulty in the presence of low notes, the low seeming to absorb or drown out the high, especially when they are in tune, the high notes acting as overtones which modify the quality of the low notes rather than stand out by themselves. The musical feeling for pitch and for correctness and beauty of intervals is much surer for high than for low notes, probably because slight errors of intonation of high notes produce more rapid beats.

The range of maximum sensitiveness or audibility lies between about 700 and 3,000 vibrations per second. Experiments by Wien³ showed that the energy required by a telephone receiver to make a distinguishable sound of 64 vibrations per second was 100,000,000 times as great as that required for 1,024 vibrations, an unrecognized though doubtless large part of the difference being due to the greater sensitive-

¹ TYNDAL. *Sound*, p. 100. Appleton, New York (1893).

SCRIPTURE, *Elements of Experimental Phonetics*, pp. 97-99.

² See § 38.

³ WIEN. *Ann. d. Phys.* (4) 4:450 (1901); *Elec. Lon.*, 47:99 (May 10, 1901); *El. World*, 37:987 (June 8, 1901); Pflüger's *Archiv. f. d. Gesell. Physiol.*, 97:1 (1903).

Also *Phys. Zeit.*, 4:69-74 (Oct. 10, 1902); *Sci. Abstr. (Phys.)*, 6: No. 814, p. 301 (July, 1903).

TAYLOR. *Trans. Am. Inst. El. Eng.*, 28:1186 (1909).

AUSTIN. See page 60.

ness of the telephone¹ at the higher frequency. Rayleigh² concluded that the maximum sensitiveness of the human ear was reached at not less than 1,024 vibrations and perhaps not lower than 2,048 vibrations per second.

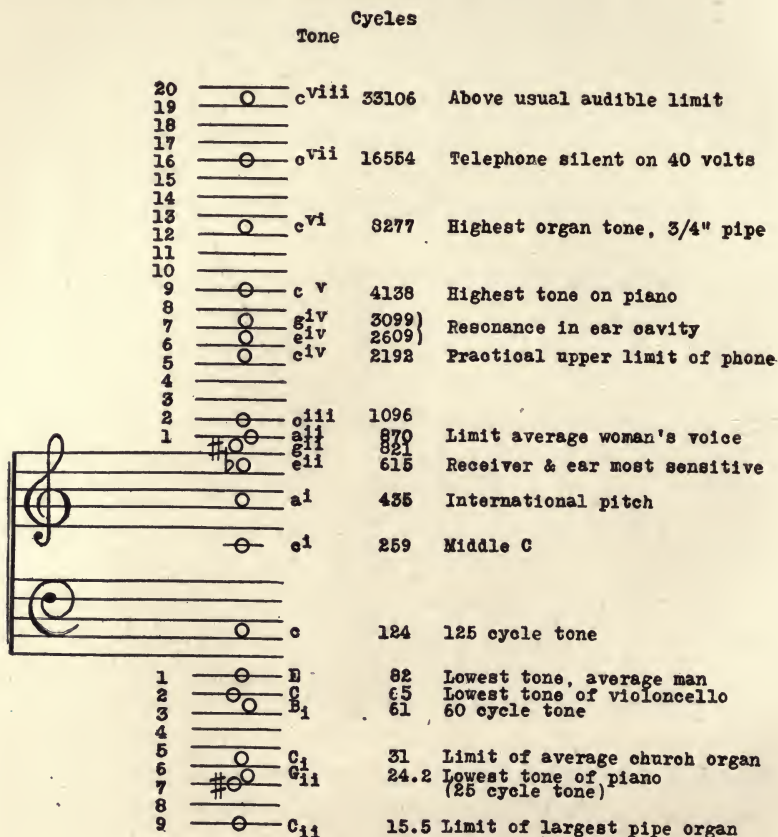

FIG. 2.—MUSICAL SCALE
Showing pitch of characteristic sounds

14. Harmonics and Chords; Musical Scales; Clefs.—Sounds whose frequencies are exact multiples of the lowest are said to be its harmonics. A sound having twice the fre-

¹ See § 66.

² RAYLEIGH. *Phil. Mag.* (6), 14:596 (1907).

quency of another is said to be ¹ an octave higher. There is generally a simple ratio between the frequencies of sounds which combine pleasingly.

For the convenient designation of tones, musicians have adopted staves or clefs, and these are frequently used for indicating pitch in scientific study. There are two staves, each consisting of five lines with the included four spaces, the upper staff being designated as the treble or soprano clef, and the lower as the base clef. These are usually separated by a distance sufficient for one line and two spaces.

A note on the line between the two clefs is called "middle C," and would indicate 256 vibrations per second if the older theoretical or scientific pitch ² were used, 270 for "concert pitch," or 259 for "international pitch." The sign, or signature, of the upper clef is coiled about its origin on the second, or G, line, and the upper clef is therefore sometimes called the G clef; the sign of the lower or bass clef centers about the F line, giving it the name, F clef. Added short lines above or below provide for notes outside the limits of the clefs, notes at a considerable distance outside being indicated by notes in the clefs accompanied by the word "octave" or "8va."

15. Timbre or Quality.—The timbre or quality of a sound is determined by the pitch and relative strength of the several components. For example, a cornet, a violin, a piano, a man, a woman, and a child may each make a sound of the same general pitch and intensity, and yet each has its own ³ individuality. In a rich musical sound, the various components have frequencies with simple ratios, being usually a fundamental with more or fewer harmonics. In a harsh

¹ In musical parlance the tone one octave above the fundamental and having twice its frequency is said to be the first harmonic or overtone; similarly, the tone having three times the frequency of the fundamental is called the second harmonic or overtone.

In electrical terminology, the fundamental is generally called the first harmonic; the component having twice that frequency is called the second harmonic, and so forth.

² ELSON. *Musical Dictionary*. Boston (1905).

MILLER. *Science of Musical Sounds*, p. 49. Macmillan (1916).

³ MILLER. *Op. cit.*, chap. 6.

sound, the higher frequency components predominate. In a "sweet" sound, the higher harmonics are weak, and all are concordant.

Proper training of human voices, in addition to distinct articulation, involves making the tones sweet, so that the various components harmonize and so that the higher harmonics do not predominate. Voices which sound well in solo, but which do not harmonize well in quartet or chorus, usually have prominent overtones dissonant with the overtones of other voices, even though the main tones are in concord. The timbre or quality of the sound (in connection with peculiarities of inflection, and sometimes of diction) enables one to recognize the voice of an acquaintance over the telephone or otherwise. Purity of tone and clearness of articulation have much to do with the successful transmission of speech, especially over long or noisy lines.

16. Transmission of Sounds Between Solids and Fluids.

—Sound is communicated from one solid body to another solid body without much difficulty and without much loss. But when sound vibrations are transmitted from a solid to a liquid or gas, there is apt to be considerable loss; for, unless the velocity of the solid is very great, or unless the surface of contact between the two is large, or unless the liquid or gas is confined, there will be considerable slippage, the vibrating solid moving through the fluid without making much more than local eddies. If, however, the surface is large, or if the fluid is more or less confined (as by the cap¹ of a telephone receiver), the vibrations of the solid are more effective in setting the body of liquid or gas into vibration. For example, a tuning fork by itself can be heard only a short distance through the air; but when it is put in contact with a large surface, such as a table or other "sounding board," the vibrations communicated to the table or board are more effective in setting the adjacent air into vibration. Thus, within certain limits, the sound from a telephone increases

¹ Credited to Professor Pierce of Brown University, in Enc. Brit. (9) 23:931. *Jour. Soc. Tel. Eng.*, 6:411, 412, 548, 550 (1877).

with size of diaphragm of transmitter or of receiver, and is strengthened by the use of a mouthpiece or cap which prevents the air from slipping past and around the diaphragm.

17. Mechanical Aids to Hearing.—People deaf from certain causes, such as diseases of the tympanum or middle ear, are likely to hear with comparative ease through a telephone receiver, the vibrations being carried both through the usual channel and also through the temporal bones, the greater concentration of the mind being also an important though not generally admitted factor. An extension of the same principle was the basis of the audiphone, or dentiphone,¹ in which the sound vibrations were taken up by a sheet of vulcanite or of stiff paper and thence transmitted through the bones of the head to the inner ear. A similar process enables deaf persons to hear² a piano by holding between the teeth one end of a stick whose further end rests upon the piano or its sounding board. Similar transmission was contemplated³ in the Lowth⁴ telephone.

18. Resonance; Uses in Speaking; Effects in Hearing.—Resonance is important among the phenomena of sound, having a close analogy in electrical circuits⁵ subject to variable currents and in other cases of wave motion where energy may surge back and forth from one form to another. The phenomena of resonance modify⁶ sounds and may also help

¹ U. S. Patents, No. 219,828, Sept. 23, 1879, and No. 236,177, Jan. 4, 1881, to R. S. Rhodes.

U. S. Patent, No. 221,892, Nov. 18, 1879, to W. W. Bostwick.

U. S. Patents, No. 224,177, Feb. 3, 1880, and No. 225,364, Mar. 9, 1880, to T. W. Graydon; *Sci. Amer.*, 41:342, Nov. 29, 1879.

U. S. Patent, No. 238,576, Mar. 8, 1881, to C. Dwega.

GANOT. *Physics*. Wood, New York (1907).

See also instances dating back perhaps to Egyptian musicians in the time of Rameses the Great, quoted in KNIGHT. *Practical Dictionary of Mechanics*, 3:2515; 4:55. Cassel, London (1884).

² *Sci. Amer. Supp.*, vol. 6: No. 131, p. 2081 (July 6, 1878); vol. 10: No. 244, p. 3887 (Sept. 4, 1880).

³ See § 98.

⁴ U. S. Patents, Nos. 312,365 and 312,366 (Feb. 17, 1885).

⁵ See §§ 191, 208.

⁶ BARTON. *Textbook of Sound*, pp. 146-148. London (1908).

to analyze them or to detect¹ the presence of a component sound of given pitch. An acoustic resonator, such as is commonly used for studies in sound, is a hollow globe or tube having at one end a small opening to which the ear may be applied, and at the opposite end a larger opening through which vibrations in the outside air may be communicated to the body of air within the resonator; when exposed to any sound which contains as an element a note of the particular pitch for which the resonator is adjusted, the body of inclosed air (acting much like a pendulum or swing which can be set into vigorous oscillation by a series of impulses which are properly timed) will respond and accumulate vibrations of one definite frequency. By listening to one after another of a series of resonators, an observer may determine which ones respond and may thus recognize the tones which form part of a given sound.

Air chambers of complicated form seem to be able to respond to a variety of pitches, as illustrated by the cavities in the mouth and in the nasal passages, which strengthen² the sounds from the vocal cords, or by the horns³ or chambers which amplify the sound from a phonograph or victrola.

The meatus, or tube leading into the human ear, acts as a resonating chamber. It is likely to give painful resonances to sounds of about 3,000 vibrations per second, and may be a cause of "ringing in the ears" under certain conditions of closure by wax or otherwise. The human voice, both male and female, is rich⁴ in harmonics near this pitch, sometimes

SABINE. Series of articles on "Architectural Acoustics," in *American Architect and Building News*, 68:3, 19, 35, 43, 59, 75, 83, Boston (April 7 to June 16, 1900); also in *Engineering Record*, 41:349, 376, 400, 426, 450, 477, 503 (April 14 to May 25, 1900); also in Contributions from Jefferson Physical Laboratory, vol. 4 (1906); *Proc. Amer. Acad. Arts and Sci.*, 42:51-48 (June, 1906); *Brickbuilder* (Boston), 23:1 (Jan., 1914).

WATSON. Bulletin 73, Eng. Exper. Station, Union of Illinois (1914); *Phys. Rev.* (2), 6:56 (July, 1915).

¹ KOENIG. See footnote ² on page 29.

² See §§ 28, 29.

³ MILLER. *Science of Musical Sounds*, pp. 155-162. Macmillan (1916).

⁴ HELMHOLTZ. *Sensations of Tone*, pp. 167-169.

painfully so. The howling of dogs at the ringing of bells or the singing of high notes, is probably due to painful resonance of certain overtones in the meatus.

19. **Duration of Acoustic Sensations.**—The impression upon the ear lasts for a short time after the cessation of the stimulus. The continuance of the sensation varies with the pitch, varying¹ from about 1/16 second for a tone of 64 vibrations, to 1/135 second for a tone of 1,024 vibrations. When sound impulses increase in rapidity to about 30 per second, they merge into a deep tone; but with sounds of high pitch the ear can distinguish² interruptions as high as about 130 intermissions³ a second.

20. **Velocity of Sound; Wave-length.**—The velocity at which sound vibrations travel depends on the elasticity and density of the conducting medium, and to some extent upon the pitch and intensity of the sound. Sound travels about 1,090 feet per second in air, or about 4,680 feet per second in water, or about 17,000 feet per second in iron. (When the disturbance travels as waves of light or of electricity the velocity is about 188,000 miles per second, being somewhat less through cables.) As temperature affects the density and elasticity of air, the velocity of sound is affected correspondingly, increasing⁴ about 1.1 foot per second for each degree rise above 32° Fahrenheit. The knowledge that sound travels about one mile in five seconds enables one to estimate

¹ MAYER. *Amer. Jour. Sci.* (3), 8:241 (Oct., 1874).

² For further discussion of the ear and of hearing, consult: *Encyclopædia Britannica* on "Acoustics," "Ear," and "Hearing."

HELMHOLTZ. *Sensations of Tone*, pp. 190-226.

DANIELL. *The Principles of Physics*, pp. 419-424. Macmillan (1884).

HOWELL. *American Textbook of Physiology*. Philadelphia (1900).

MYERS. *Textbook of Experimental Psychology*. London (1909).

See also footnote⁷ on p. 10, and footnote¹ on page 24.

³ HELMHOLTZ. *Op. cit.*, p. 262.

⁴ PARRY. *Journal of a Second Voyage to Arctic Regions*. London (1824).

REGNAULT. *Phil. Mag.* (4), 35:161 (1868).

POYNTING and THOMSON. *Sound*, p. 29. Griffin, London (1904).

"Acoustics," § 25, in ninth edition of *Encyclopædia Britannica*.

"Sound," in eleventh edition of *Encyclopædia Britannica*.

approximately the distance of a lightning stroke by noting the time elapsing between the flash and the sound of the thunder.

Dividing the distance a sound travels in a second by the number of vibrations per second gives the wave-length of the vibrations, that is, the distance between two particles which are moving simultaneously in the same direction and at the same rate. Thus, the wave-length of a sound of 256 vibrations traveling 1,090 feet per second in air is $1,090/256$, or 4.26 feet.

21. Loudness of Sound.—The sensific effect or loudness of a sound depends both upon the amplitude of the sonorous vibration and also upon the characteristics of the receiving ear. The sensitiveness of the ear varies with the pitch or frequency of the sound, and also with its intensity. No satisfactory method has been found¹ for measuring or indicating the intensity or loudness of sound, except that musicians have adopted the terms pianissimo, piano, mezzo-piano, mezzo-forte, forte, and fortissimo (abbreviated to *pp*, *p*, *mp*, *mf*, *f*, and *ff*, with the additional marks, *ppp*, *pppp*, *fff*, and *ffff*) for indicating relative degrees of loudness.

22. Variation of Sensitiveness with Intensity.—The ear seems to be less sensitive as the sound vibration gets more intense, as indicated by the difficulty of conversing in a noisy place. The logarithmic law as announced by Weber and Fechner may apply; if, for example, the stimulus increases from 10 to 100 and then to 1,000 units of intensity, the sensation increases from 1 to 2 and then to 3 times the original amount. This law, recognized as applying to vision, has doubtful applicability² to audition. It does not seem to apply to persons having disease of the tympanum or middle ear, for they usually hear better in a noisy place, as though the general disturbance makes the bony links transmit the sound better

¹ See bibliography in Roy. Soc. Catalogue of Scientific Papers, No. 9320, "Intensity Measurement."

See also MILLER. Science of Musical Sounds, pp. 53-56, 78-87.

² GREENWOOD. Physiology of the Special Senses. London (1910).

BOSANQUET. Under "Music," in Encyc. Brit. (9) 17:111.

CHAPTER III

SPEECH SOUNDS

23. Comparison of Written and Spoken Language.—

In comparing written and spoken language, it may be fairly questioned which, if either, represents the other. In the development of civilization, as in the growth of the individual man, ideas were communicated by sounds¹ and articulate speech long before written symbols or letters came into use for representing such ideas. The reduction of a language to writing has a powerful conservative and standardizing influence, partly because practical considerations limit the number of letters and indicated sounds, and partly because people are inclined to talk and to think in terms which have become standardized by general use. Written language tends to become limited to words and to spellings which are readily understood by any people of that tongue, even though separated by many miles and by many years. Spoken language is much more mobile than is written; local idioms become current in the vernacular long before, if ever, finding a place in the literature; local differences of pronunciation may develop into distinct dialects, so that persons who use the same written language may find difficulty in oral communication. Again, inflections and emphasis, facial expression and bodily gestures greatly facilitate personal interviews but are represented only with difficulty, if at all, by printed characters. Articulate speech, therefore, is represented only imperfectly by printed words.

¹ Some animal sounds convey information more tersely than articulate speech. Music often expresses and arouses feelings difficult to translate into words.

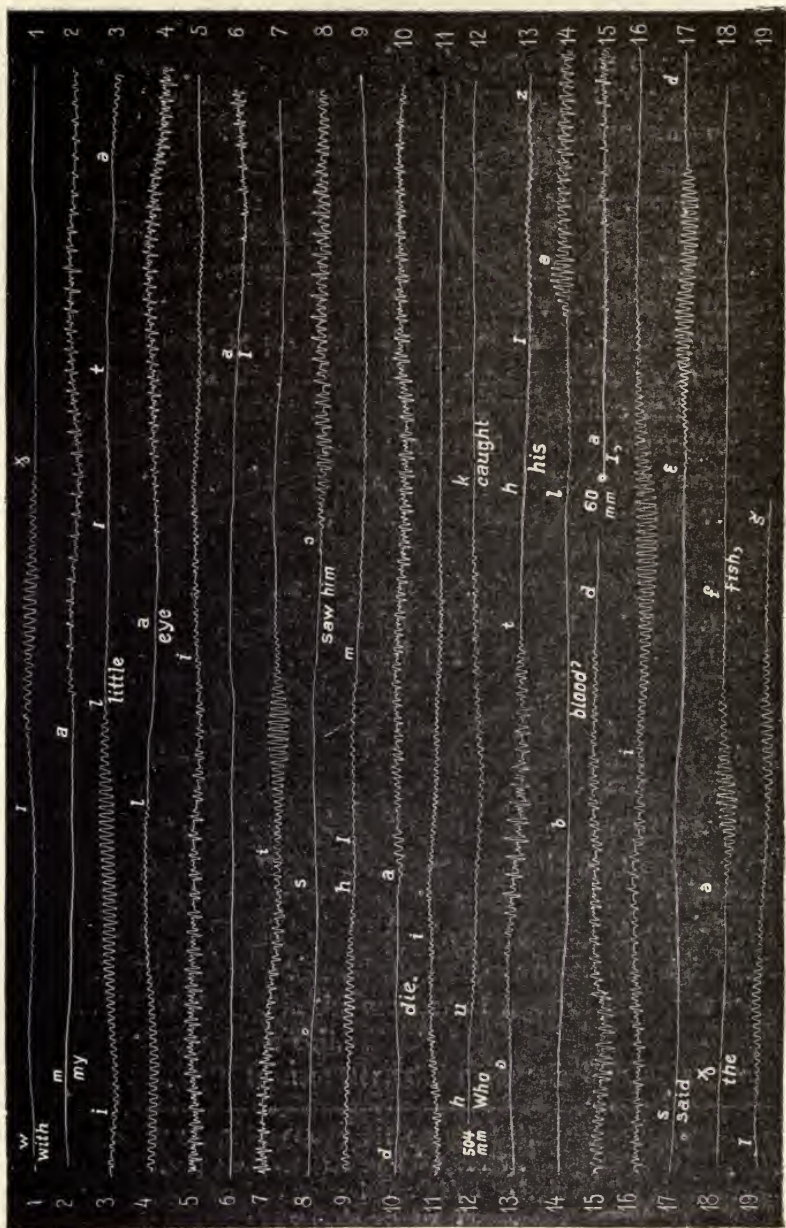

FIG. 3.—PHONOGRAPHIC SPEECH CURVES
 Part of "Cock Robin," from Scripture, Speech Curves. Each line represents about 0.42 second

24. Spoken Language More Continuous Than Written.

—Written language consists of a number of syllables grouped into words, each word representing part or all of an idea. In spoken language, the words are separated by more or less distinct pauses, while the syllables of a word are separated by less distinct pauses, each syllable being principally a vowel sound modified more or less at one or both ends by consonant sounds.

Experimental investigations¹ show that, strictly speaking, "A spoken word is not a placing side by side of independent sounds, each of which can be expressed by a letter of the alphabet, but is nearly always a continued series of a great number of sounds, the letters indicating in an incomplete fashion nothing more than certain characteristic points in the series."

Nevertheless, for analytical purposes, spoken words may be dissected into separate elements or sounds corresponding more or less closely to the letters composing the written words.

25. Elementary Sounds Limited in Number.—In the spoken languages of various nations which have been studied² carefully by phonologists, there have been found about two hundred elementary sounds which are combined in almost endless variety.

Fortunately there are only about fifty elementary sounds in any one language. There are generally recognized in the English language forty-two or forty-three elementary sounds, which are represented by twenty-six letters. English letters are divided into six vowels and twenty

¹ SCRIPTURE. *Experimental Phonetics*, pp. 446, 453; *Speech Curves*. Carnegie Institution. Washington (1906).

PAUL. *Principien d. Sprachgeschichte*, p. 48. Halle (1898).

GAVEY. *Jour. Inst. Elec. Eng.*, 36:29 (1905).

COHEN and SHEPHERD. *Jour. Inst. Elec. Eng.*, 39:507 (1907).

GATI. *Proc. Int. Cong. Tel Eng.*, Paris (1910); *Elec. Lon.*, 66:456 (Dec. 30, 1910).

² Bibliography given in encyclopedias, under Phonetics, or Speech Sounds.

See also SCRIPTURE. *Elements of Experimental Phonetics*.

consonants, the former representing vocal or tonic sound in which the breath is not interrupted by the vocal organs. When the current of air from the lungs is wholly or partly stopped by contact with one or more of the organs of speech, the sounds are called consonant, since they cannot be uttered perfectly without a vowel.

26. Vocal Sounds.—Each of the vowels represents several different sounds, according to its usage. Phonologists find ¹ as many as eleven different shades of sound for the vowel *a* in various languages, twelve for *e*, six for *i*, six for *o*, seven for *u*, two for the diphthong *æ*, and eight for the diphthong *æ*. In the English language are recognized six pronunciations for the vowel *a*, three for *e*, two for *i*, and for its equivalent *y*, four for *o*, two for *u*, and one each for the diphthongs *oi* or *oy* and *ou* or *ow*; to these should be added various transpositions and modifications as provincialisms characteristic of some large cities and of some rural districts.

27. Origination of Sounds by Vocal Cords.—The vowel sounds and some of the consonant sounds are made primarily by the vibration of the vocal cords, which are part of the larynx situated in the upper and fore part of the neck where it forms the prominence often called the “Adam’s apple.” The larynx consists of a framework of cartilages connected by elastic membranes or ligaments, two of which constitute the true vocal cords (or chords). The larynx opens below into the trachea (or windpipe), which carries the air from the lungs and which for purposes of speech may be considered as a source of air under controllable ² pressure.

The process of setting the vocal cords into vibration is more or less like that of making a sound by “blowing grass” between the lips, being probably about as follows: the cords are stretched so as to leave only a narrow chink or aperture

¹ ELLIS. “Speech Sounds,” in ninth edition of Encyclopædia Britannica.

² The pressure on the air at the trachea is estimated as corresponding to that required to sustain a column of mercury about 160 millimeters high for a tone of medium pitch, about 920 millimeters of mercury for tones of high pitch, and about 30 millimeters of water for whispering.

between them; the pressure of the air from the lungs causes the membranes to stretch somewhat and thus to open the aperture between the vocal cords so as to allow some air to escape; this lowers the pressure on the air, and the membranes spring back toward their former positions, thus shutting off the air; this partial or complete stoppage allows the air pressure to rise again and stretch the membranes again. Thus there is set up a vibration of the cords and of the air, whose rapidity depends on the tightness with which the membranes are stretched and also upon the pressure of the air.

The vocal cords seem to be able to vibrate not only as a whole, but also simultaneously in fractional parts, so as to superpose harmonics of higher pitch upon the fundamental or main vibration.

28. Modification of Sounds by Oral and Nasal Cavities.

—The voice sounds initiated at the vocal cords are greatly modified by the shape and size of the cavities or passages in the mouth and nose, which by resonance reinforce certain vibrations, a partial or complete closure of the nasal passages giving the quality contradictorily described as “talking through the nose.”

29. Click and Smack Sounds Without Expulsion of Air.—A few sounds, such as smacks and clicks, are made without the movement of any air into or from the lungs, the air in the mouth being set into rapid vibration by a quick motion of the tongue or of the lips, the position and configuration of the tongue and cheeks determining the tones which are reinforced and made prominent by resonance.

30. Sounds by Inspiration of Air.—A larger variety of sounds is made by drawing in air, either through the mouth, as in chirps, sobs, gasps, or certain whistles, or through the nose, as in snuffles or snores.

31. Sounds by Expulsion of Air.—The great majority of speech sounds are made by air expelled from the lungs and passing principally through the mouth. Such sounds may be flated, the vocal cords being wide apart so as not to vibrate, as for open sounds, like *s*, *sh*, *th*, *f*, *wh*, etc., or for sounds

made with the air passage shut part of the time, such as *k*, *t*, *p*, etc.

Sounds made by the expulsion of air from the lungs may be voiced, as when the vocal cords are close together and vibrate fully, as in making the vowel sounds, *a*, *e*, *i*, *o*, *u*, *y*, and their combinations in diphthongs; or they may be voiced consonants, such as *b*, *d*, *g*, *j*, *l*, *m*, *n*, *v*, *w*, *z*; or these sounds may be whispered, the vocal cords being near together but not touching one another, only their edges vibrating; whispered sounds may be considered simply as weak voiced sounds.

Flated and voiced sounds are known as fixed, when the vocal organs continue unchanged during the sound; or changing, when they continually change¹ from one position to another, as in forming the sounds known as "glides."

32. Consonant Sounds Classified by Effects.—Consonant sounds are classified in various ways. One method distinguishes them as mutes, half-mutes, liquids, aspirates, and compound mutes. Mutes, explosives, or checks are those which at the end of a syllable completely stop the vowel sound, including: *b*, *d*, *c* (hard, as in *came*), *g* (hard, as in *go*), *k*, *p*, *t*. Half-mutes are those through which the vowel sound may be prolonged more or less imperfectly, including *f*, *c* (soft, as in *center*), *g* (soft, as in *general*), *j*, *s*, *v*, *z*. Liquids are those which combine easily with the mutes, being sometimes called semi-vowels, including: *l*, *m*, *n*, *r*. The aspirate or breathing sound is *h*. Compound mutes include: *x* (equal to *ks*), *q* (always attended by *u*, and with it equal to *kw*).

33. Consonant Sounds Classified by Methods of Production.—Other classifications of consonant sounds are based

¹ Other extended discussions of the mechanism of the voice may be found in encyclopedia articles on Voice, Speech, Anatomy, and Physiology. Also A. G. BELL. *Mechanism of Speech*, New York (1906).

See also article on "Voice," in SCHAFFER. *Textbook on Physiology*, vol. 2. Edinburgh and London (1900).

CUNNINGHAM. *Textbook of Anatomy*. Wood, New York (1905).

SCRIPTURE. *Elements of Experimental Phonetics; Mechanics of the Human Voice*, *Carnegie Institute Yearbook*, 2:243. Washington (1904).

on the organs involved in their production. The labials, *b*, *f*, *m*, *p*, *v*, *w* and *wh*, are made by the lips; the linguals or trills, *l* and *r*, are made by the tongue; the linguo-dentals, *d*, *ch*, *j*, *sh*, *t*, *th*, and *z*, are made by the tongue and teeth; the linguo-nasal, *n*, is articulated by the tongue, while the sound passes through the nose; the palato-nasal, *ng*, is made by the palate, while the sound passes through the nose; the palatals, *g* (as in *nag*), *h* (as in *how*), *k* and *y* (as in *yes*), are made by the palate.

These sounds are also classified into sub-vocals or sub-tonics, which are obstructed by the vocal organs during articulation; and aspirates or atonics, which are mere emissions of the breath articulated by the lips, tongue, teeth, and palate.

The sub-vocals include: the labials, *b*, *m*, *v*, and *w*; the linguals, *l* and *r*; the linguo-dentals, *d*, *j*, *th* (as in *thou*), *z* (as in *size* and as in *azure*); the linguo-nasal, *n*; the palato-nasal, *ng*; the palatals, *g* (as in *nag*), and *y* (as in *yes*).

The aspirates include: the labials, *f*, *p*, and *wh*; the linguo-dentals, *ch* (as in *rich*), *s*, *sh*, *t*, and *th* (as in *thin*); the palatals, *h* and *k*. The aspirates, sometimes called "surds" (from a Latin word meaning "deaf"), are almost without vocal tone and are very difficult to reproduce on the telephone or on the phonograph.

Some writers designate *k* and *g* as gutturals or throat-sounds; *b*, *d*, *g*, and *z* as sonants, having a slight vocal tone; *f*, *k*, *p*, *q*, *s*, and *t* as surds, being without vocal tone; *ch* and *th* as aspirates, breath following explosion; *f*, *ph*, *h*, *s*, *th* (as in *thin*), and *z* (some including *l* and *r*) as fricatives, the sound being made by friction; *s* and *z* as sibilants, being hissing sounds; *m*, *n*, and *ng* as nasals, the sound passing through the nose; *d*, *t*, and *th* as dentals or tooth sounds.

34. Modifications of Speech Sounds.—The number of speech sounds is increased indefinitely by varying usage in different localities. Individual modifications of the fundamental sounds constitute an important factor in the recognition of a voice over a telephone or phonograph. The irregularities in the spelling and pronunciation of the English lan-

guage (which are the despair of foreigners and the inspiration of spelling reformers) are mostly entailed upon the rich legacy from other languages, and seem to be unavoidable results of the facility with which the English language adopts whatever is desired from any source as occasion arises.

35. Transmission of Some Sounds More Accurate Than of Others.—Marked differences exist in the accuracy with which the various speech sounds are made and identified. The sounds most easily recognized¹ are the vowels, while the surds are almost without vocal tone² and are difficult to transmit and distinguish. Tests³ show surprising vagaries in the interpretation of spoken words by people not specially trained.

Skilled observers⁴ can receive correctly from 87 to 100 per cent of test syllables transmitted directly through air when the hearer cannot see the speaker, and receive correctly from 41 to 98 per cent of similar syllables sent through regular commercial telephone circuits over one hundred miles of line; the average of records of many syllables gave an accuracy of 96 per cent through fifteen feet of air in a quiet room, and an average of 59 per cent through commercial telephone apparatus over one hundred miles of line; certain syllables, *we* and *lee*, were received correctly 98 per cent of the time.

The damping out of high frequency harmonics by the electrostatic susceptance and electromagnetic reactance of telephone lines introduces changes in the character of transmitted speech, making it more or less "drummy" after traversing a long line. Thus the word *three* is likely to be misunderstood as *two*, unless the *r* is strongly trilled.

Differences in individual observers result in marked differ-

¹ *Telephony*, 66:347 (Mar. 18, 1911).

² In Fig. 3, compare the phonographic records of *f* in *fish*, *s* in *saw* and in *said*, *t* in *little* with the various vowel sounds. Similar contrasts may be found in the oscillogram of telephonic currents reproduced in Fig. 11.

³ *Amer. Jour. Psychology*, 1:702. Baltimore, Md., and Worcester, Mass. (1888).

SCRIPTURE. *Experimental Phonetics*, p. 116.

⁴ *Phil. Mag.* (6), 19:155. (Jan., 1910).

ences in ability to distinguish sounds. Thus, in experiments conducted by one scientist,¹ the letters *f* and *s* were found to be indistinguishable, the hearer being unable to distinguish between *fix* and *six* unless assisted by the context in making a judicious guess. On the other hand, trained telephone employees using the same consonants found *fee* and *see* interchanged 27 per cent of the time, and received correctly 58 per cent of the times sent.

French people are said to experience considerable difficulty² in conversing satisfactorily over the telephone, partly because of the characteristics of the language, partly on account of the large part played by gestures, invisible over the telephone. Some of the French numerals are difficult to identify, *vingt* being easily confused with *cing*, and *six* with *dix*. These correspond with the difficulty of distinguishing between *five* and *nine* or between *second* and *seventh* over the telephone.

36. Syllabification; Accent; Emphasis.—Intelligible speech involves not only the various elementary sounds and their assembly into syllables, words, and sentences (with due regard to rules of grammar, rhetoric, and logic), but also variations in accent, emphasis, and intonation. In polysyllabic words, one or more syllables are rendered conspicuous, either by the length of the syllable (as with Arabs, Persians, and Indians), or by lowered or heightened or gliding pitch (as in Sanscrit, Latin and Greek, and somewhat in Norwegian and Swedish), or by a greater stress (as in English, German, and Italian), or by a peculiar pronunciation (as in Danish). In certain dialects in China and in Africa minute changes in inflection, whose detection and imitation baffle a foreigner, are said to make complete changes in the meanings of common words.

As accent makes a syllable conspicuous in a word, so emphasis makes a word conspicuous in a sentence. Emphasis includes not only greater stress on a word, but also changed

¹ *Phil. Mag.* (6), 16:242 (Aug., 1908).

² Note, however, contrary view presented in *El. World*, 20:255 (Oct. 22, 1892).

qualities of tone, length, and pitch. Musical accent is not prominent in English speech, as contrasted with many foreign tongues which have a distinctively musical cadence, although a sort of singsong is frequently noted in public reading or speaking. The pitch is generally raised at the end of a question or lowered at the end of a declaration.

37. Use of Imagination in Hearing.—Imperfections in articulation on the part of the speaker, disturbances in the transmitting medium, imperfect hearing apparatus and inattention on the part of the listener, all combine to reduce the reliability with which information is transmitted, whether directly from mouth to ear through the air or through the medium of the telephone. As the partially deaf person distinguishes parts of words or sentences and fills in the gaps with varying success by reading the lips of the speaker and by general knowledge of the subject, so the person of normal hearing learns to recognize woeful caricatures of spoken words, whether through the telephone or in direct conversation.

38. Composition of Vowel Sounds; Relative Amplitude of Components.—The composition of speech sounds has been investigated¹ by a number of physicists, the vowel tones being more readily analyzed because they are continuous. The theory of vowel tones was first enunciated by Wheatstone² in discussing experiments by Willis.³ Melville Bell⁴ showed

¹ See bibliography under No. 9420, "The Voice, Speaking Machines," in Roy. Soc. Lon. Catalogue of Scientific Papers, 1800-1900, vol. 3, Part I. Cambridge University Press (1912).

² WHEATSTONE. *London and Westminster Review* (Oct., 1837).

³ WILLIS. *Trans. Cambridge Philosophical Society*, 3:231. *Pogg. Ann.*, 24:397 (1832).

⁴ BELL. *Visible Speech*. London (1867).

Histories of early theories of voice production are given by:

LONGET. *Traité de Physiologie*, 2:777. Paris (1869).

BELL, A. G. *Mechanism of Speech*. New York (1906).

KINGSBURY. *Telephone and Telephone Exchanges*, chap. 3.

Bibliographies are given by:

BEAUNISS. *Physiologie Humaine*, 2:946. Paris (1881).

QUAIN. *Anatomy*, 2:538. Longmans (1882).

WINKELMANN. *Handbuch der Physik*, "Akustik," pp. 681-705. Auerbach.

that variations in the oral cavities produce great variations in the vowel sounds. H. L. F. Helmholtz¹ showed that each vowel has a fixed pitch almost independent of the general pitch of the voice, and that several of the vowels are not simple sounds, but have two or more components. Koenig² obtained results rather similar, as indicated by the following table, showing the vibrations per second found by them in vowel sounds.

Vowels	OU	O	A	AI	E	I	EU	U
Helmholtz	170	470	940	1536 576	1920 341	2304 170	1024 341	1536 170
Koenig	235	470	940		1880	3760		

With the development of more highly refined methods, the number of components has been extended. Thus Bevier³ verifies the conclusion that the characteristic tones of the various vowels are almost independent of the pitch of the fundamental tone.

Bevier finds that the vowel *a* (as in *hat*) has: (1) a chord-tone more or less strong according to the reinforcement of the mouth, generally strong below 200 and weak between 200 and 600 vibrations per second; (2) characteristic resonance in the region of 1,550 always present, though not absolutely stationary, since this vowel may tend toward *a* or *e* with endless nuances; (3) a strong resonance at one or two lower regions about 650 and 1,050, respectively. The characteristic resonance at 1,550 vibrations per second largely determines the vowel character, but it must receive "body" by one or more reinforced lower tones.

¹ HELMHOLTZ. *Die Lehre von der Tonempfindungen*. Braunschweig (1862), translated by Ellis as *Sensations of Tone*. London (1896).

² KOENIG. *Compt. Rend.*, 70:931 (Apr. 25, 1870); *Ann. d. Phys. u. Chem.*, 146:161 (1872); *Phil. Mag.* (4), 45:1 (Jan., 1873); *Quelques Experiences d'Acoustique*, p. 56. Paris (1882).

NICHOLS and MERRITT. *Phys. Rev.*, 1:166 (Nov.-Dec., 1893); 7:93 (Aug., 1898).

³ BEVIER. *Phys. Rev.*, 10:193 (Apr., 1900); 14:171 (Mar., 1902); 14:214 (Apr., 1902); 15:44, 271 (Jul., Aug., 1902); 21:80 (Aug., 1905).

Bevier finds similarly that the vowel *a* (as in *father*, *palm*, *part*) has maximum characteristic reinforcements at about 1,150 vibrations per second, with lower overtones at about 650 and 800 vibrations.

Miller's investigations¹ confirm those of Bevier. The vowel sounds in *ma*, *maw*, *mow*, and *moo* have maximum intensities at pitches of 910, 732, 461 and 362 vibrations per second, as much as 90 per cent of the total energy of the sound lying within the region of characteristic resonance. By making a phonographic record of the vowel of higher pitch, and then changing the speed of the reproducing phonograph, the single record was made to produce each of the several sounds in succession at pitches 924, 730, 444, and 311, respectively, which correspond closely with those of the spoken vowels. He notes further that a vowel sound cannot be enunciated at a pitch higher than that of its characteristic, as easily shown by trying to sing the word *gloom* at high pitch. The difficulty of understanding words that are sung, by high sopranos especially, is due in part to the necessity of intoning the vowel sounds upon the pitch assigned by the composer, which is often higher than the characteristic pitch of the vowel.

Devaux-Charbonnel,² analyzing oscillographic records of telephonic currents representing vowels, obtains quantitative measurements of the various components or harmonics whose absolute pitch is not constant. Distinguishing a fundamental vibration corresponding to the note on which he speaks, he finds one or more harmonics in each vowel sound stronger than the fundamental. Thus:

Vowel	Harmonics	Amplitudes
A	1	1.0
	2	1.7
	4	3.0
	6	4.8

¹ MILLER. *Science of Musical Sounds*, chap. 7. Macmillan (1916).

² DEVAUX-CHARBONNEL. *Compt. Rend.*, 146:1258 (June 15, 1908); *La Lum. Elec.* (2), 3:215, 323 (Aug. 15, Sept. 12, 1908); *Proc. Int. Cont. Tel. Eng.* Paris (1910).

Vowel	Harmonics	Amplitudes
O	1	1.0
	3	2.4
	5	4.2
U	1	1.0
	2	2.0
	9	1.5
I	1	1.0
	2	4.2
	13	2.8

39. Speech Sounds Represented by Fourier Equation.

Cohen and Shepherd¹ examined oscillographic records of telephonic currents to which, as did Devaux-Charbonnel, they applied analytic methods based on the Fourier² theorem. They conclude:

¹ COHEN and SHEPHERD. *Jour. Inst. Elec. Eng.*, 39:503-565 (May, 1907); *Elec. Lon.*, 59:124 and 182 (May 10 and 17, 1907); *Proc. Phys. Soc. London*, 21:283 (May 22, 1908); *Phil. Mag.* (6), 16:480 (Sept., 1908).

BELL, A. G. *Mechanism of Speech*. New York (1906).

² In his treatise on heat, "Théorie Analytique de la Chaleur," published in 1822, Jean Baptiste Fourier (1768-1830) assumed that any curve which repeats itself at regular intervals may be resolved into a number of component sine waves of definite periods. His ability to determine the components thus assumed, indicated the truth of the theorem. Dirichlet, in a paper "Sur le Convergence des Séries Trigonometriques," published in *Crelle's Journal* in 1829, proved that the development assumed by Fourier was mathematically correct. Since then, many greater or lesser lights have discussed the proposition with more or less lucidity. The following presentations will be found useful to the student:

THOMSON and TAIT. "Natural Philosophy," Part I, p. 55. Cambridge (1883).

PRICE. *Infinitesimal Calculus*, vol. 2. Oxford (1889).

ZIWET. *Theoretical Mechanics*, p. 105. New York (1893).

BYERLY. *Fourier Series and Spherical Harmonics*, chaps. 1, 2, 3. Boston (1902).

JACKSON. *Alternating Currents*, pp. 27-43. Macmillan (1913).

RYAN, NORRIS and HOXIE. *Textbook of Electrical Machinery*, vol. 1, chap. 3. Wiley, New York (1903).

LANGSDORF. *Phys. Rev.*, 12:184 (May, 1901).

KINTNER. *El. World*, 43:1023 (May 28, 1904).

WEDMORE. *Elec. Lon.*, 35:512 (Aug. 16, 1895).

STEINMETZ. *Engineering Mathematics*, pp. 94-146. McGraw-Hill (1911).

MILLER. *Science of Musical Sounds*, chap. 4. Macmillan (1916).

"It has been found that the words representing the numbers '1, 2, 3, 4, 5' embody all the frequencies of telephonic importance, and these numbers are invariably used for testing purposes. Inspection of oscillograms of these five words as spoken by a number of persons shows that they may be approximately represented by the equation :

$$\begin{aligned}
 y = & 0.29 \sin pt + 0.32 \sin 2 pt + 0.39 \sin 3 pt \\
 & + 0.55 \sin 4 pt + 1.06 \sin 5 pt + 6.5 \sin (6 pt - \pi / 2) \\
 & - 1.06 \sin 7 pt - 0.56 \sin 8 pt - 0.39 \sin 9 pt \\
 & - 0.32 \sin 10 pt - 0.29 \sin 11 pt,
 \end{aligned}$$

in which $\pi = 3.1415$, $p = 290 \pi = 911$, and t represents seconds of time."

40. Speech Sound Patterns.—Recent investigations by Flowers¹ indicate that the characteristic features of voice sounds depend not so much upon the absolute frequencies of the various component vibrations as upon the progressive variation of amplitude of the current during the continuance of the sound. Studies of telephonic currents, produced by whispering into a sensitive transmitter and recorded on a rapidly moving photographic film by means of an intense light and an exceedingly sensitive string galvanometer² (Fig. 4), show that the sounds corresponding to the various letters of the alphabet have characteristic forms which may be recognized. Flowers notes incidentally that whispered speech always has the same sound, whether the speaker is a man or a woman. For example, the current corresponding to the sound *b* uttered in 0.02 second at a pitch of 250 cycles per second or at a pitch of 1,000 cycles, varies according to the same pattern as indicated in Figs. 5 and 6.

As illustrative of the original oscillograms Fig. 7 shows the record of the sound *d* as in *day*, indicating a definite pattern completed in about 0.02 second, the straight cross lines 0.002 second apart giving the scale of time. Similarly, Fig.

¹ FLOWERS. *Proc. Amer. Inst. Elec. Eng.*, 35:183, 1083 (Feb., Aug., 1916).

² EINTHOVEN. *Sci. Abstr. (Physics)*, 1364 (1902); 172, 2261 (1905).

8 illustrates the record of the sound *e* as in *me*, showing 2,500 cycles superposed on 200 cycles per second. Fig. 9 illustrates the sound *f* as in *fee*, showing alternations of 1,000 and 2,000 cycles per second, the special patterns repeating after about $10/500$ second. By such studies, Flowers determined pattern pictures of the various letter sounds, shown in Fig. 10.

Corroborative evidence that form rather than frequency is

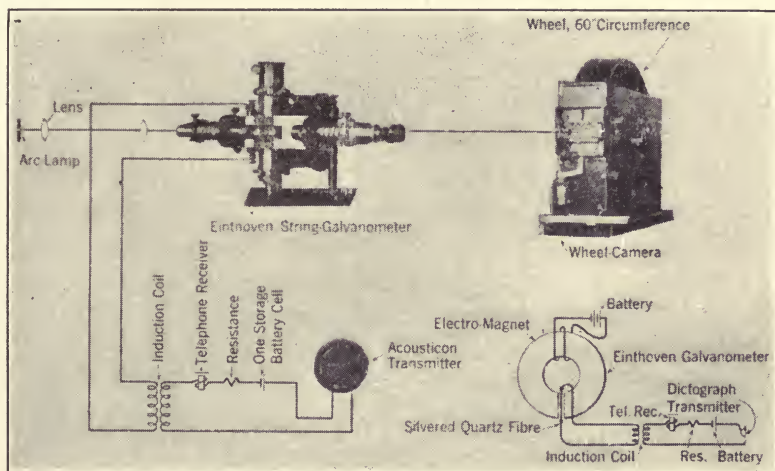

FIG. 4.—APPARATUS FOR TELEPHONIC OSCILLOGRAMS
(Flowers. *Trans. Amer. Inst. El. Eng.*)

the determining characteristic of a speech sound is given by the phonograph, whose reproduced words (though distorted¹) are recognizable over wide ranges of speed and therefore of pitch.

41. Speech Sounds a Series of Changing Waves.—Examination² of the various published³ curves showing the wave-forms of speech justifies the conclusion that in a general way speech may be considered as represented with approximate accuracy by a series of waves whose amplitude and frequency change continuously, but with sufficient

¹ Compare work of Miller noted in § 38. See also § 37.

² See Fig. 3 and Fig. 11.

³ See footnote on page 21.

slowness to be considered as periodic during short epochs.

At first thought, one would expect speech sounds to be a

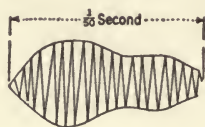

FIG. 5.—OSCILLOGRAM OF CURRENT
Letter "B" 1,000-cycle tone. (Flowers. *Trans. Amer. Inst. El. Eng.*)

rapid succession of changes so sudden that the science of telephony must deal principally with transient or starting elec-

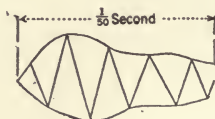

FIG. 6.—OSCILLOGRAM OF CURRENT
Letter "B" 250-cycle tone. (Flowers. *Trans. Amer. Inst. El. Eng.*)

trical phenomena rather than with steady or regularly alternating phenomena. Graphical records, such as Figs. 3 and 11,

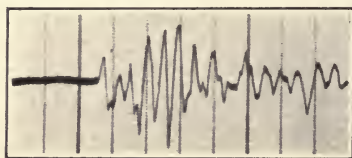

FIG. 7.—OSCILLOGRAM OF CURRENT
Letter "D" as in "Day." (Flowers. *Trans. Amer. Inst. El. Eng.*)

show, however, that articulate speech does not consist of a series of detached individual sounds, as represented by the

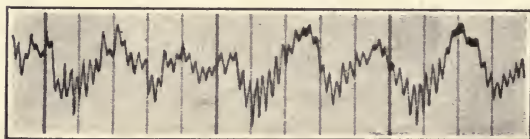

FIG. 8.—OSCILLOGRAM OF CURRENT
Letter "E" as in "Me." (Flowers. *Trans. Amer. Inst. El. Eng.*)

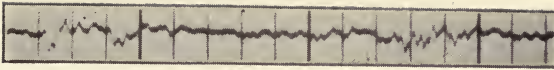

FIG. 9.—OSCILLOGRAMS OF CURRENT
Letter "F" as in "Fee." (Flowers. *Trans. Amer. Inst. El. Eng.*)

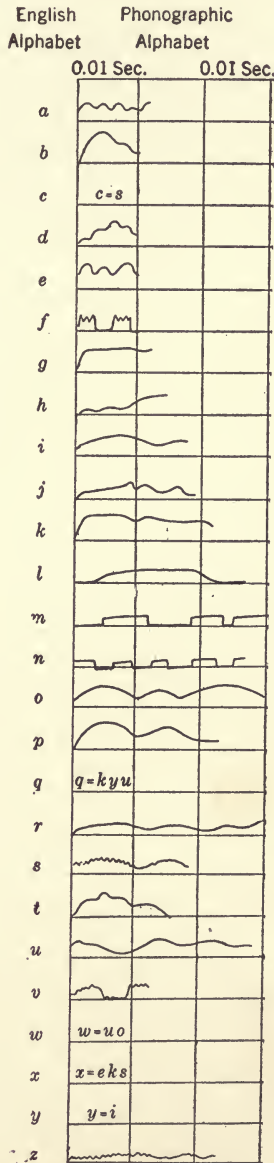

FIG. 10.—OSCILLOGRAMS OF CURRENTS FOR ALPHABET
(Flowers. *Trans. Amer. Inst. El. Eng.*)

printed letters and words, but rather that the sound vibrations are continuous, gradually shifting from one dominant frequency to another so that it is difficult if not impossible to specify exactly where one sound stops and another begins. Conversation consists principally of vowel sounds which gradually change from one to the next, with more or less irregularity introduced by the interspersed consonants.

42. Pitch of Voice Independent of Speed of Talking.

—Since speech sounds consist generally of a gradual transition from one frequency to another, it is apparent how there is no inherent connection between the pitch of a person's voice and the rapidity with which he speaks (though on a phonograph or other talking apparatus with fixed record the pitch rises with the speed). Slow speech allows time for many repetitions of the characteristic vibrations, while rapid speech allows fewer repetitions and therefore requires greater accuracy in articulation and closer attention in listening. (This involves difficulty in determining the frequency of the sound vibrations in a photographic or similar record, unless on the same plate is a record made simultaneously by a timed spark or other device of known period.)

43. Number of Sounds per Second in Ordinary Speech.

—That the changes from one sound to another are comparatively slow in ordinary speech, and allow time for a number of repetitions of the characteristic waves, may be shown¹ by a simple experiment. Let a person read a num-

¹ In an experiment conducted by the author, each of four persons read several times the preamble to the Declaration of Independence, and the paragraph following. The preamble contains 71 words, which may be considered as requiring 283 distinguishable sounds; the paragraph following, with 158 words, required 649 sounds. The results were:

READER	TIME	
	For the preamble	SOUNDS PER SECOND
MKS	21	13.5
MKS	19	14.9
HKS	15	18.8
HKS	14	20.2
GT	26	10.9
GDS	18	15.7
GDS	18	15.7

ber of sentences at an ordinary conversational rate, and note the time required; then count the number of words in the passage and estimate the number of distinguishable sounds composing the spoken words; dividing the number of sounds by the time in seconds gives the number of sounds per second; repeating the test with a number of persons will give a reasonable average. Such tests indicate that ordinary reading involves from about ten to twenty different sounds per second.

44. Laws of Alternating Currents Applicable to Telephony.—Tests by Cohen and Shepherd¹ and by Devaux-Charbonnel² show that the most important frequencies included in the human voice are comprised between the limits of 700 and 1,200 vibrations per second, those above 1,500 being unimportant. Tests by Kempf-Hartmann³ indicate that 0.001 second is sufficient time to establish a steady vibration of a telephone diaphragm, and it is understood that a considerably longer period is required to establish in the brain a sensation of recognizable sound.

It therefore appears that telephone currents and the motions of the diaphragms may properly be considered as being in a fairly steady state most of the time. As the large majority of speech sounds are glides from one form to another, the changes are not so abrupt as to vitiate the conclusion that

Reader	Time For paragraph following	Sounds per second
MKS	55	11.8
MKS	45	14.4
HKS	41	15.8
HKS	38	17.1
GT	59	11.0
GDS	47	13.8
GDS	49	13.3

One of the party then read aloud from a juvenile story, at the rate of 200 words per minute; estimating 684 distinct sounds for the passage gave an average of 14 sounds per second.

¹ See §§ 39, 40, 41.

² DEVAUX-CHARBONNEL. *La Lum. Elec.* (2), 3:323 (Sept. 12, 1908).

³ R. KEMPF-HARTMANN. *Ann. d. Phys.*, 8:3, pp. 481-538 (June, 1902); *Sci. Abstr. (Phys.)*, 6:27 (1903).

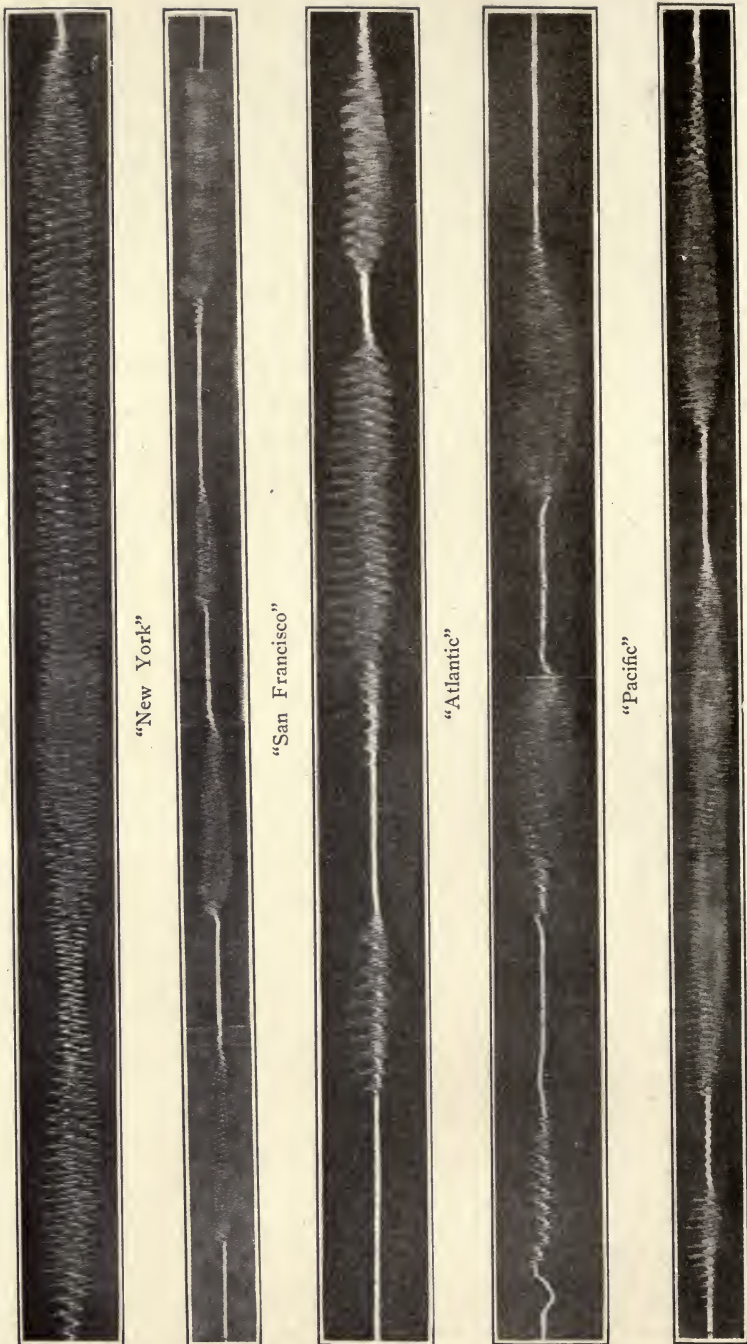

FIG. 11.—OSCILLOGRAMS OF TELEPHONIC CURRENTS
(From *Telephone Review*)

the individual waves are either sinusoidal or are resolvable into sine waves.

We may therefore have confidence that telephonic currents and apparatus are for the most part closely amenable to the ordinary laws governing alternating currents rather than to those governing transient phenomena, and that the application of such laws will account for most of the phenomena of the telephone.

45. Dominant Pitch of Speech Sounds not that of Singing.—Directed by musical experience, one would expect that the average frequency of vibration for a man's voice would be somewhere in the octave whose upper limit is middle C, that is, between 129 and 258 vibrations per second, while a woman's voice would be somewhere in the octave above. Investigation, however, shows that the dominant pitch of the voice for singing has little to do with the frequency of the components of the speech sounds, the latter being of higher frequency and superposed on the slower musical vibrations. Analyses of records¹ of speech sounds indicate that while the vowel sounds include vibrations ranging² from about 170 to perhaps 3,760 per second, the most prominent vibrations lie within a narrow³ range.

46. Equivalent Single Frequency of Telephone Current; Various Methods of Determining Equivalent Frequency.—Investigations of the performance of the telephone current in various circuits indicate that under given conditions it acts much as though it were a simple alternating current of single frequency. The simpler investigations by Breisig,⁴ by Devaux-Charbonnel,⁵ and by Wagner,⁶ were based on the determination of the amount of induction or of capac-

¹ See §§ 38, 39, 40.

² See § 38.

³ See equation in § 40.

⁴ BREISIG. *Verh. d. Deutsch Gesell.*, 12:184 (1910); reprinted in *Mitteilungen aus dem Telegraphen-Versuchsamt des Reichs-Postamts*, vol. 5. Julius Springer, Berlin.

⁵ DEVAUX-CHARBONNEL. See footnote on page 30.

⁶ WAGNER. *Proc. International Conf. Tel. Eng.*, Paris (1910).

ity which would have the same effect¹ as a known resistance in reducing the telephone sound by an equal amount or to inaudibility; from the reactance found to have an effect equal to the known resistance (when connected in series or in multiple with the receiver), the equivalent frequency of the telephone current may be computed roughly from the simple relation:

$$r = 2\pi fL \quad \text{or,} \quad r = \frac{I}{2\pi fC}$$

Or it may be computed more accurately by including the resistance and reactances of the entire circuit in the general equations² for impedance.

The actual or equivalent frequency of an alternating current may be determined by noting the rate at which it attenuates as it passes through a circuit containing distributed leakage and capacity. The equations for such a circuit, which have been developed by various writers³ with some modifications in detail, show that in a long circuit the current at any point is related to that at the beginning by the equation,

$$\frac{I'}{I_0} = \epsilon^{-Pl} \quad \text{or} \quad \frac{I_0}{I'} = \epsilon^{lP}$$

in which ϵ is the base of Napierian logarithms, or 2.7183, l is the distance from beginning of line to the point, and P is a complex exponent equal to

$$P = a' + ja'' = \sqrt{(R + j\omega L)(G + j\omega C)}$$

of which need be considered only the real part,

¹ See § 237.

² See page 188.

³ STEINMETZ. *Alternating Current Phenomena*, third edition, chap. 10. New York (1900); *Transient Electric Phenomena*, pp. 284-285.

FLEMING. *Propagation of Electric Currents in Telephone and Telegraph Circuits*, pp. 66-72. Van Nostrand (1911).

KENNELLY. *Hyperbolic Functions Applied to Electrical Engineering*.

JACKSON. *Alternating Currents and Alternating Current Machinery*, pp. 932-954. Macmillan, New York (1913).

DRYSDALE. *Elec. Lon.*, 60:392 (Dec. 27, 1908).

$$a' = \sqrt{\frac{1}{2}[\sqrt{(R^2 + \omega^2 L^2)(G^2 + \omega^2 C^2)} + GR - \omega^2 LC]}$$

By suitable apparatus and methods, each of the various quantities may be measured, except $\omega = 2\pi f$, which can then be determined. By such reasoning, Kennelly¹ computed from a curve by Hayes² that the equivalent frequency of that telephone current was 871 cycles per second, or $\omega = 2\pi f = 5,469$, the relative strengths of current being estimated from the loudness of sound in a telephone receiver at various points along the line. Using a similar artificial line, and measuring the currents by means of a thermo-galvanometer, the author³ found that the equivalent frequency varied from 739 to 1,044 cycles (4,641 to 6,560 radians) with Bell transmitters, and from 770 to 1,344 cycles (4,840 to 8,450 radians) with others, it being noted that generally the transmitters which indicated the higher equivalent frequency were those whose maximum sensitiveness was for sound of higher pitch.

Using a property of line coils first noted by Campbell,⁴ that all frequencies above the natural period of a loaded line are throttled out, Cohen⁵ and Shepherd concluded that the average frequency is about 800 periods or cycles per second. Preece⁶ at first considered 800 as the equivalent frequency, but later favored 1,500 as more probable.

47. Agreement as to Equivalent Frequency.—At the Conférence Internationale des Techniciens des Administrations des Télégraphes et des Téléphones de l'Europe, held in Paris, the chairman of the Committee on Choice of Frequency, Devaux-Charbonnel, Engineer of Telegraphs, City of Paris, reported⁷ that his own investigations indicated that 6,000

¹ KENNELLY. *Op. cit.*, p. 135.

² HAYES. *Trans. Int. Elec. Congress*, 3:638, St. Louis (1904); *Elec. Lon.*, 54:362 (Dec. 16, 1904).

³ SHEPARDSON. *Equivalent Frequency of Telephone Currents*, a thesis in library of Harvard University. Cambridge (1912).

⁴ CAMPBELL. *Phil. Mag.* (6), 5:313 (1903).

BREISIG. *Elek. Zeit.*, 30:462 (May 20, 1909).

⁵ COHEN. *Phil. Mag.* (6), 16:480 (Sept., 1908).

⁶ PREECE. *Jour. Soc. Tel. Eng.*, 16:87 (Feb. 10, 1887).

⁷ DEVAUX-CHARBONNEL. *Proc. Int. Conf. Tel. Eng.* Paris (1910).

radians corresponded best with his experiments; that Bela Gati, Engineer of Telegraphs, Budapest, advised 10,000 radians (1,600 periods) as the result of his studies; that Martin recommended 750 periods; that Wagner recommended 5,000 radians as the most important frequency. At the session on September 10, 1910, the Conférence adopted the resolution: "In the practical calculations, the telephonic current may be replaced by a sinusoidal current. So as regards intensity, the pulsation of 5,000 may be adopted as a mean value. It is convenient to consider in addition the pulsations of 3,000 and 7,000 as those which concern questions of timbre."

Pending further investigations, the value of 5,000 radians, or 800 cycles, is generally adopted by telephone engineers as representing sufficiently well the frequency of the simple alternating current which the average telephone current most nearly resembles.

CHAPTER IV

TELEPHONE RECEIVERS

48. The Ordinary Receiver.—The telephone¹ receiver in almost universal use is that developed by Alexander Graham Bell² and his associates, in which the sound waves emanate from an iron diaphragm which is set in motion by variations in the strength of a magnetic field, due principally to a permanent magnet of steel to whose poles are attached soft iron extensions surrounded by coils through which circulates the current from a suitable transmitter. Many varia-

¹ The first use of the word "telephone," meaning "sound at a distance," is often attributed to Philip Reis in a lecture [REIS. "Ueber Telephonie durch den galvanischen Strom," "Jahresbericht der physikalischen Vereins zu Frankfurt am Main, 1860-1861," p. 57] before the Physical Society of Frankfurt in 1861. The word was used earlier [LOCKWOOD. "The Story of the word 'Telephone,'" *El. Eng. N. Y.*, 6:131 (April, 1887); *Elec. Lon.*, 18:492 (Apr. 15, 1887)] in TIMBS' Yearbook of Facts in Science and Art, p. 55. London (1845), and even earlier by Wheatstone. [1840 and 1860 claimed in *Elec. Lon.*, 18:521 (Apr. 22, 1887); *El. World*, 9:211 (Mar. 7, 1887). KINGSBURY. Telephone and Telephone Exchanges, pp. 8-13. LOCKWOOD. *El. Eng. N. Y.*, 6:131 (April, 1887). THOMSON. *El. World*, 10:116 (July 9, 1887).]

The preferable word "teleloge," meaning "words at a distance," was proposed [McDONOUGH. *El. Eng. N. Y.*, 4:137 (April, 1885)] by J. W. McDonough in an application for a patent on April 10, 1876, which was for some time in interference with Bell's application.

² A. G. BELL. *Proc. Am. Acad. Arts and Sci.*, 12:1 (1877); "Researches in Electric Telephony," *Jour. Soc. Tel. Eng.*, 6:385 (1877). The Bell Telephone. American Bell Telephone Co., Boston (1908).

HOPKINS. *The Telephone*, pp. 11-14.

PREECE and STUBBS. *Manual of Telephony*, pp. 15-21.

MILLER. *American Telephone Practice*, pp. 13, 34-37. U. S. Patent No. 174,465, March 7, 1876. *El. World*, 7:250 (May 29, 1886); 11:163 (Mar. 31, 1888).

KINGSBURY. *The Telephone and Telephone Exchanges*, pp. 31-65.

See also Reports U. S. Circuit Court at Boston, New York, and Philadelphia; also Record U. S. Supreme Court for 1886.

tions¹ have been proposed, and some of them have been used.

49. Various Phenomena Available as Basis for Receivers.—While the modification of a magnetic field by a variable current is the basis of the commercial telephone of today, one should recognize that other phenomena have been and may yet become the basis of telephone receivers. Mechanical vibration, electrochemical decomposition, surface tension, electrostatic attraction, physiological reaction, thermal expansion, and electrodynamic attraction, as well as electromagnetic attraction with and without permanent magnets, have been tried with more or less success as basic principles for telephone receivers.

50. Mechanical Telephone.—Mechanical vibration, without any recognized electrical coöperation, was the basis of the oldest method of telephony or of reproducing sound at a distance, and it continues in such use in limited fields today. The string or "lover's" telephone, consisting of a tube over whose end is stretched a paper or other membrane from the center of which a cord or wire extends to a similar device, has been attributed to the enterprise of Robert Hooke² in 1664. As developed by Wheatstone and others³ in the nineteenth century, it became operative over distances as great as 2,000 feet. The stretched membranes at each end of the line acted both as transmitters and as receivers, while the loud noise made by striking one membrane or its support acted as a calling signal at the other membrane. Modifications are the warning of an approaching train by the ringing of the

¹For accounts of various early receivers, see:

PRESCOTT. *The Electric Telephone*. New York (1890).

PREECE and STUBBS. *Manual of Telephony*. *Jour. Fkln. Inst.*, vols. 119, 120, 121. *La Lum. Elec.*, vols. 1 and 2. Encyclopedia articles on Telephone.

For the modern receivers see books by ABBOTT, McMEEN, MILLER, POOLE, VANDEVENTER and WILDER, listed in Appendix J.

²PREECE and STUBBS. *Manual of Telephony*, p. 1.

KINGSBURY. *Op. cit.*, p. 8.

³WHEATSTONE. *Jour. Roy. Inst.* (1831); *Scientific Papers*, p. 47. London (1879); *El. World*, 11:304 (June 16, 1888); 14:82 (Aug. 10, 1889); 6:259 (Dec. 26, 1885); 7:27, 46, 69 (1886).

See also not regarding use in China: *Nature*, 31:321, London (Feb. 5, 1885); *El. Eng. N. Y.*, 4:144 (April, 1885).

rails, the announcement of an approaching trolley car by means of the vibrations carried along the wire and emerging as sound through the roof of a waiting car, the detection of a leaking pipe or open valve by means of the sound from the pipes.

51. Electrochemical Receivers.—An electrochemical¹ telephone receiver was operated by A. E. Dolbear, who found that sound was emitted from two plates between which extended a few drops of solution of ammonium chloride that was decomposed with the generation of bubbles of gas as a variable uni-directional current passed. This might be considered as developing a discovery by Gore² in 1859, that sounds were produced by passage of current through cyanide of mercury and potassium.

52. Receivers Based on Surface Tension.—The variation of surface tension with electromotive force, which is closely associated with electrochemical action, was used by Breguet³ in a sort of Lippmann electrometer modified into a telephone receiver. Gray⁴ had found, about 1873, that vibratory high tension currents increased the adhesion⁵ between the finger tips and a metallic plate. Edison's "motograph" receiver⁶ was based on the reduction of the friction between platinum and a chalk cylinder when current passed.

¹ DOLBEAR. *Jour. Fkln. Inst.*, 121:21 (Jan., 1886).

² GORE. *Elec. Lon.*, 62:467 (Jan. 1, 1909); *Proc. Roy. Soc.*, 12:217.

³ BREGUET. *Jour. Fkln. Inst.*, 121:23 (Jan., 1886).

PREECE and STUBBS. *Op. cit.*, p. 99.

⁴ GRAY. "Experimental Researches," *Jour. Am. El. Soc.*, 1:10. Chicago (1875).

PRESCOTT. *Electricity and the Electric Telegraph*, pp. 870, 875. New York (1877).

⁵ Daft, Ries and others [DAFT, RIES, etc. *Elec. Eng. N. Y.*, 2:301 (Oct., 1883); 9:310, 432, 504 (1890); 10: 18, 55, 103 (1890)] used a similar property of large currents for increasing adhesion.

⁶ EDISON. U. S. Patents No. 158,787 (Jan. 19, 1875); No. 221,957 (Nov. 25, 1879); No. 231,704 (Aug. 31, 1880).

PREECE and STUBBS. *Op. cit.*, p. 96.

JONES. *Thomas Alva Edison*, pp. 76-86. Crowell, New York (1908).

POOLE. *Practical Telephone Handbook*, pp. 57-59.

Jour. Fkln. Inst., 119:140 (Feb., 1885).

Sci. Amer., 40:260 (Apr. 26, 1879).

53. **Electrostatic Receivers.**—An electrostatic telephone receiver was discovered when Professor Dolbear¹ unintentionally allowed his electrochemical receiver to run dry, and found that a condenser of 0.0002 microfarads would emit considerable sound. Sir W. Thomson² had noted in 1863 that sound emanated from an air condenser charged with several hundred volts. Varley³ had found sounds issuing from condensers with large loose sheets. Du Moncel⁴ developed an idea attributed to Pollard, and reproduced singing clearly by sheets of tinfoil between sheets of ordinary paper. Gray⁵ found similar sounds, using dry fingers. Electrostatic attraction seems to have been the basis of a “musical telegraph receiver” of Elisha Gray⁶ brought out about 1875. At about the same time, Edison⁷ and Giltay⁸ developed electrostatic receivers. More recently, Ort and Rieger⁹ have developed a loud-speaking electrostatic receiver.

Electrostatic repulsion seems to be the basis claimed for the telephone receiver patented by Emile Berliner,¹⁰ in connection with the transmitter which was a focus for much litigation. In this receiver, which consisted of a diaphragm

¹ DOLBEAR. *Sci. Amer.*, 44:383, 388 (June 18, 1881); *Jour. Soc. Tel. Eng.*, 11:130 (Mar. 23, 1882); *Sci. Amer. Supp.*, 13:5298 (May 13, 1882); *Jour. Fkln. Inst.*, 119:46 (Jan., 1885); 121:21 (Jan., 1886).

² THOMSON. *Papers on Electrostatics and Magnetism*, p. 239. Macmillan (1872).

³ VARLEY. *Jour. Soc. Tel. Eng.*, 6:476 (1877); *Tel. Jour.*, 5:178. London (Aug. 1, 1877); *Sci. Amer. Supp.*, 7:2595 (Feb. 15, 1879); *Sci. Amer.*, 40:6 (Jan. 4, 1879).

See also experiments by Peukert, in *Elek. Zeit.*, 30:51 (Jan. 21, 1909).

⁴ DU MONCEL. *Le Téléphone, le Microphone et le Phonographe*, p. 26. Paris (1878); *Sci. Amer. Supp.*, 6:2435 (Dec. 7, 1878).

⁵ GRAY. *Jour. Amer. El. Soc.*, 1:10. Chicago (1875).

PRESCOTT. *Speaking Telephone*, pp. 151-166. Appleton (1879).

⁶ GRAY. See footnote on page 232.

⁷ EDISON. *Sci. Amer. Supp.*, 7:2591 (Feb. 15, 1879).

ABBOTT. *Telephony*, Part 5, p. 147. McGraw (1905); *El. World*, 42:917 (Dec. 5, 1903).

⁸ GILTAY. *La Lum. Elec.* (1), 7:119 (July 29, 1882); *El. World*, 6:188 (Nov. 7, 1885).

⁹ ORT and RIEGER. *Elek. Zeit.*, 30:655 (July 15, 1909); *El. Rev. Lon.*, 65:832 (Nov. 19, 1909); *Elec. Lon.*, 64:593 (Jan. 21, 1910).

¹⁰ BERLINER. U. S. Patent No. 233,969 (Nov. 2, 1880).

against which was pressed a ball rigidly held from the rear, "if a current of electricity passes through the plate and the point of contact, or vice versa, a repulsive movement will take place between the plate and the ball, because both are charged with the same kind of electricity; this force of repulsion may be weakened or strengthened by varying the strength of the current." It seems more likely that any articulation by such an instrument would be caused by the expansion at the contact point due to the variable heating.

54. Receivers Based on Physiological Action.—Physiological action¹ was utilized by Dolbear, who arranged a diaphragm so that it was set into vibration by the twitching of a frog's leg in response to current impulses. By placing near his ear a charged Leyden jar, or an incandescent lamp, or a Crookes tube, Dolbear² was able to hear sounds. Of similar nature is the device said to be resorted to in an emergency when a telegraph operator at a railway wreck received messages by taste as he held his tongue to the wire; such action was even proposed³ as a regular system.

55. Receivers Based on Heating Effects.—Thermal expansion of a wire or other conductor by the passage of current has been used as a source of sound by several, such as Wiesendanger,⁴ Hopkins,⁵ Ader,⁶ Preece,⁷ Bergman,⁸ Camp-

¹ DOLBEAR. *Jour. Fkln. Inst.*, 121:23 (Jan., 1886).

² DOLBEAR. *Jour. Fkln. Inst.*, 121:26-27 (Jan., 1886).

³ *Sci. Amer.*, 38:346 (June 7, 1878).

⁴ WIESENDANGER. *English Mechanic and World of Science* (Sept. 13, 1878). DU MONCEL, "Sur le Téléphone, le Microphone et le Phonographe," p. 155, Paris (1878); *The Telephone, the Microphone and the Phonograph*, Harper, New York (1879); *Elec. Lon.*, 1:215 (Dec. 21, 1878); *Tel. Jour.* (London), 6:400 (Oct. 1, 1878); *Sci. Amer.*, 43:37 (July 17, 1880); *La Lum. Elec.* (1), 2:266 (July 1, 1880).

⁵ HOPKINS. *Sci. Amer.*, 43:37 (July 17, 1880); *La Lum. Elec.* (1) 2:335 (Aug. 15, 1880).

⁶ ADER. *Compt. Rend.*, 88:575 (Mar. 17, 1879); *Elec. Lon.*, 2:253 (Apr. 19, 1879); *La Lum. Elec.* (1), 6:339 (Apr. 15, 1882).

⁷ PREECE. *Proc. Roy. Soc. Lon.*, 30:408 (May 27, 1880); *Sci. Amer.*, 43:37 (July 17, 1880); *El. World*, 6:229 (Dec. 5, 1885).

PREECE and STUBBS. *Manual of Telephony*, p. 100.

⁸ BERGMAN. *Elek. Zeit.*, 11:674 (Dec. 19, 1890).

bell,¹ Cross,² and others, most of them using longitudinal expansion of a wire attached between a diaphragm and a fixed support. Ader,³ Cram and Hayes,⁴ Bell,⁵ Simon,⁶ Snyder,⁷ Duddell,⁸ Ruhmer,⁹ and others developed the talking arc, the pulsations in the strength of the current causing corresponding variations in the sectional area of the arc stream of vapor between the carbons and thereby causing vibrations in the surrounding air. This was based on the well-known singing of a long electric arc¹⁰ in unison with the pulsations of current due to commutation at the dynamo or to the reversal of polarity in alternating current arcs.

¹ CAMPBELL. *Jour. Inst. Elec. Eng.*, 39:643 (May, 1907).

² CROSS. *Proc. Amer. Acad. Arts and Sci.* (Oct., 1885); *El. Eng. N. Y.*, 4:419 (Nov., 1885).

BERLINER. *Jour. Fkln. Inst.*, 121:18 (Jan., 1886).

VANDEVENTER. *Telephony*, p. 58. McGraw-Hill (1910).

³ ADER. See note on page 47.

⁴ CRAM and HAYES. U. S. Patent No. 654,630, filed June 7, 1897, granted July 31, 1900.

RUHMER. *Wireless Telephony*, p. 30. Translation by Erskine-Murray. Van Nostrand (1908).

⁵ HAYES and BELL. *El. Rev. N. Y.*, 34:325 (May 24, 1899); *Elek. Zeit.*, 20:459 (June 29, 1899).

RUHMER. *Op. cit.*, pp. 30-32.

See bibliography of Photophone in Roy. Soc. Lon. Catalogue, No. 4200, p. 426.

⁶ SIMON. *Ann. d. Phys.*, 64:233 (1898); *Elek. Zeit.*, 19:321 (May 26, 1898); 22:510 (June 20, 1901); *Elec. Rev. Lon.*, 42:342 (Mar. 25, 1898); 42:393; *Elec. Lon.*, 40:683 (Mar. 18, 1898); *El. World*, 39:876 (May 17, 1902); *Phys. Zeit.*, 3:278 (Apr. 1, 1902).

⁷ SNYDER. *Trans. Amer. Inst. Elec. Eng.*, 21:93 (Feb., 1903); *El. World*, 41:319 (Feb. 21, 1903).

⁸ DUDDELL. *Jour. Inst. El. Eng.*, 30:232 (1900); *Elec. Lon.*, 46:269, 310 (Dec. 14, 21, 1900); 48:722 (Feb. 28, 1902); *El. World*, 39:521 (Mar. 22, 1902).

⁹ RUHMER. *Wireless Telephony*. Translated by Murray. Van Nostrand (1908); *West. Elec.*, 33:287 (Oct. 17, 1903); *Elek. Zeit.*, 22:196 (Feb. 28, 1901).

COLLINS. *Sci. Amer. Supp.*, 63:26177, No. 1634 (Apr. 27, 1907).

GUTHE. *West. Elec.*, 30:248 (Apr. 12, 1902); *El. World*, 39:826 (May 10, 1902).

¹⁰ BAIN. *West. Elec.*, 20:130 (Mar. 6, 1897).

See also § 91.

Hughes and Wiesendanger¹ found that the carbon microphone was reversible,² acting as a receiver, and they proposed the name "thermophone." A recent development³ is the thermophone receiver by Gwozdz in 1907, improved by Lange in 1914, using the lateral expansion of a very fine platinum (Wollaston) wire placed in a minute cell which may be inserted in the external ear. This receiver, while sensitive and subject to damage by excessive current, is reported as giving excellent reproduction of speech without the distorting effects of the diaphragm of the usual electromagnetic receiver.

56. Sounds from Electromagnets; Early Electromagnetic Receivers.—Sounds from an electromagnet⁴ were noted by Page⁵ in 1837. Joule⁶ showed that the sounds were caused by magnetic-mechanical strain; Marrian,⁷ Matteucci, Beatson, Wertheim,⁸ and De la Rive⁹ continued the investigations. Articulate sounds were reported as having been heard coming from a telegraph sounder by Cushman¹⁰

¹ HUGHES and WIESENDANGER. *Tel. Jour.* (London), 6:400 (Oct. 1, 1878); *Sci. Amer.*, 43:37 (July 17, 1880).

See also Blyth in *Nature* (London), 18:172 (June 13, 1878). A similar development was the "krotophone" of E. S. Spaulding; U. S. Patents Nos. 345,084 and 345,085 (July 6, 1886); *El. World*, 8:48 (July 31, 1886).

² Note also Berliner receiver, § 53.

³ GWODZ and LANGE. *Proc. Roy. Soc. Lon.* (Dec. 3, 1914); *Elec. Lon.*, 74:358, 362 (Dec. 18, 1914); *El. World*, 65:73, 96 (Jan. 9, 1915); *Tel. Eng.* (Chicago), 13:76 (Feb., 1915).

⁴ See bibliography in WIEDEMANN. *Elektricitæt*, 3; 730-739. Braunschweig (1883); *Jour. Soc. Tel. Eng.*, 6:390; *Roy. Soc. Cat.* (1800-1900), § 5462.

⁵ PAGE. *Am. Jour. Sci.*, 32:396 (July, 1837); 33:118 (Jan., 1838); *Pogg. Ann.*, 43:411 (1838).

⁶ JOULE. Sturgeon's *Annals of Electricity*, 8:222. London (1842); *Pogg. Ann.*, 77:46; *Phil. Mag.* (3), 30:76 (Feb., 1846).

⁷ MARRIAN. *Phil. Mag.* (3), 25:382 (1844).

⁸ WERTHEIM. *Ann. de Chim. et de Phys.* (2), 23:302 (1848); *Pogg. Ann.*, 77:43 (1849).

WIEDEMANN. *Elektricitæt*, vol. 3, art. 841. Braunschweig (1883).

⁹ DE LA RIVE. *Compt. Rend.*, 20:1287 (1845); *Fortschritte der Physik*, 1:144; *Pogg. Ann.*, 65:637 (1845); 76:270 (1849).

DU MONCEL. *Exposé des Applications de l'Electricité*, 1:167. Paris (1853).

¹⁰ CUSHMAN. *West. Elec.*, 2:281 (June 9, 1888); 2:295 (June 16, 1888); 3:38 (July 28, 1888); *Elec. Rev. Lon.*, 23:186, 368, 581 (Aug. 17, Sept.

in 1851. In 1873-74 Elisha Gray¹ developed an electromagnetic telegraph that reproduced both simple and composite tones, either simple melodies or discords. Ader, in 1879, developed² several receivers based on the longitudinal expansion and contraction of a stretched iron wire magnetized by a coil. Peukert³ was able to make the field magnet of a dynamo talk loudly enough to be heard through a large room. Telegraph sounders have long been known⁴ to emit considerable sound, even though the armature was screwed down hard, such sounds, however, being hardly articulate. Such sounds seem to be molecular, and to be distinguished from sounds from a thin diaphragm.

Some of the early telephone workers used electromagnets with more or less imperfect diaphragms and without permanent magnets. Such were Reis,⁵ Farrar,⁶ Drawbaugh,⁷ Meucci⁸ and Bell.⁹ These early telephones were displaced by more effective and convenient forms having permanent magnets. With the cycle of progress, improved forms of

28, Nov. 23, 1888); *Elec. Rev. N. Y.*, Nov. 10, 1888, p. 6; June 16, 1888, p. 4; *El. World*, 12:38, 252 (July 28, Nov. 10, 1888); *El. Rev. N. Y.*, 41:849 (Dec. 20, 1902); *Engineer's Yearbook*, 2:72. University of Minnesota (1894).

See also *Zcit. für Elek.* (Aug. 1, 1894); *El. World*, 24:213 (Sept. 1, 1894).

¹ GRAY. *Jour. Amer. Elec. Soc.*, 1:12. Chicago (1875).

PRESCOTT. *Speaking Telephone, &c.*, pp. 159-160. Appleton, New York (1879); *Electricity and the Electric Telegraph*, p. 872. Appleton, New York (1877).

U. S. Patent Nos. 166,094, 166,095, 166,096 (July 27, 1875).

² ADER. *Compt. Rend.*, 88:575 (March 17, 1879); *La Lum. Elec.* (1), 1:27 (May 15, 1879).

³ PEUKERT. *Elek. Zeit.*, 30:51 (Jan. 21, 1909); *Sci. Amer.*, 101:40 (July 17, 1909).

⁴ CUSHMAN. See footnote on page 49.

⁵ REIS. Thompson's Philip Reis, the Inventor of the Telephone. Spon (1883). Bibliography given on p. 180.

⁶ FARRAR. *Sci. Amer.*, 40:261 (Apr. 26, 1879); *Elec. Lon.*, 2:278 (May 3, 1879).

⁷ DRAWBAUGH. *El. World*, 3:119 (Apr. 13, 1884); 4:229 (Dec. 6, 1884).

⁸ MEUCCI. *El. World*, 6:219 (Nov. 28, 1885).

⁹ BELL. See footnote on page 43.

electromagnetic telephone¹ receivers without permanent magnet are coming into somewhat extensive use.

57. Magnetic Circuits of Telephone Receivers.—The ordinary telephone receiver consists essentially of a magnetic system having rigid and movable portions, whose relative motion causes the adjacent air to vibrate to and fro in approximate unison with the variations in the strength of the

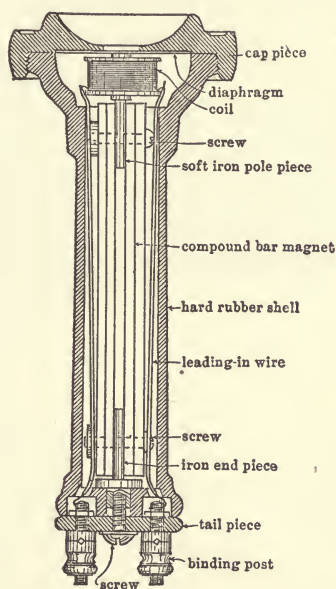

FIG. 12.—SINGLE POLE RECEIVER (Obsolete)
(By permission McGraw-Hill Co.)

current through coils which affect the magnetomotive force² of the system, and consequently affect the magnetic attraction³ between the fixed and movable portions.

58. Single-pole Receivers with Permanent Magnet.—In the older⁴ unipolar type, sometimes called monopolar, the rigid portion of the magnetic circuit was principally a per-

¹ See § 61.

² See Appendix A.

³ See page 142.

For details of receivers, see pages 44 and 56.

⁴ See footnote on page 44.

manent magnet ¹ consisting of one or two straight steel bars with like poles together, fastened at one end to an adjusting block; the other end carried a soft iron pole-piece for supporting the single coil and for carrying part of the magnetic flux toward the center of the sheet-iron diaphragm. The useful part of the flux passed from the near end of the permanent magnet through the pole-piece into the near part of the diaphragm, whence it radiated and spread out through space in its path toward the other pole. In some "watchcase" receivers, the magnetic flux is from the edge to a single pole opposite the center of diaphragm.

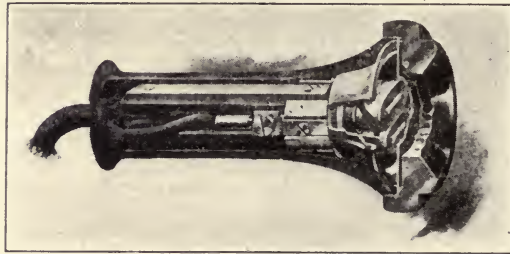

FIG. 13.—BIPOLAR RECEIVER

59. Bipolar Receiver with Permanent Magnet; Welded Receiver.—In the common bipolar ² type, the rigid portion includes a permanent magnet ³ consisting of two bars of hardened and magnetized steel fastened to a spacer at one end, with the north pole of one near the south pole of the other. To the free end of each steel bar is attached a flat soft-iron extension or pole-piece which carries a coil of insulated fine copper wire and which extends toward the diaphragm, being separated from it by a small air-gap. In a recent type of receiver, the entire magnetic circuit, except diaphragm and clearance, is welded ⁴ into a continuous structure which includes the cup that supports the diaphragm.

¹ See §§ 169-174.

² See footnote ³ on page 43.

³ See §§ 170-175, pages 168-172.

⁴ Welded receiver. U. S. Patents: No. 1,062,082, May 20, 1913, to E. B. Craft and J. N. Reynolds; No. 1,063,237, June 3, 1913, to V. Anderson; No. 1,063,270, June 3, 1913, to J. J. Lyng. *West. Elec. News*, vol. 3, No. 9, p. 4 (Nov., 1914).

60. Useful and Leakage Magnetic Flux in Bipolar Receiver.—In the bipolar receiver, the useful part of the magnetic flux passes from one pole of the permanent magnet through its pole-piece and the air-gap into the region of the diaphragm which is in the near vicinity; thence it passes along in the diaphragm to the vicinity of the other pole-piece, whence it goes through the air to the other pole-piece and completes the circuit through the permanent magnet.

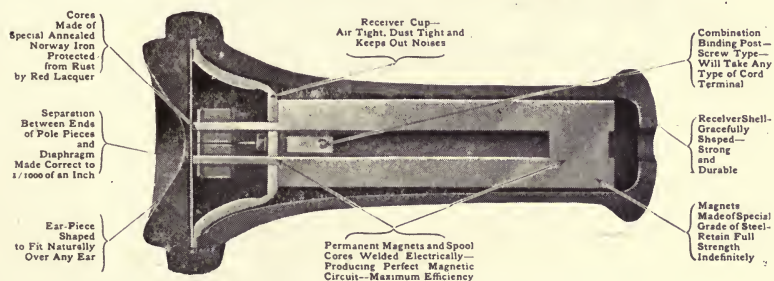

FIG. 14.—WELDED RECEIVER
(Western Electric Co.)

A large part of the flux passes directly between the pole-pieces without going through the diaphragm. The choice of position for fastening the soft-iron pole-pieces to the ends of the permanent magnet bars is a compromise. When they are fastened to the inner or nearer surfaces of the steel bars, the magnetic leakage is increased, but the pull on the diaphragm comes closer to its center and is therefore more effective than if they were further apart as when fastened to the outer surfaces of the permanent magnet.

61. Permanent Magnet not Always Necessary for Modern Electromagnetic Receivers.—The permanent magnet has generally been considered as necessary, because an electromagnet gives out a sound of twice¹ the frequency of the

¹ See also § 77 and Appendix F.

The double frequency of the electromagnetic receiver is indicated by the equation (developed in Appendix A, especially in § 301) for magnetic pull, $P = B^2 A / 8\pi$, which has the same value and direction for $(-B)^2$ as for $(+B)^2$ and therefore has a maximum in the same direction for each half-cycle of current, that is, two complete vibrations for each

alternating current, since the direction of pull is independent of the direction of the current, being proportional to the square of the current. But in recent years, with the development of the central energy system, it has been appreciated that the polari-

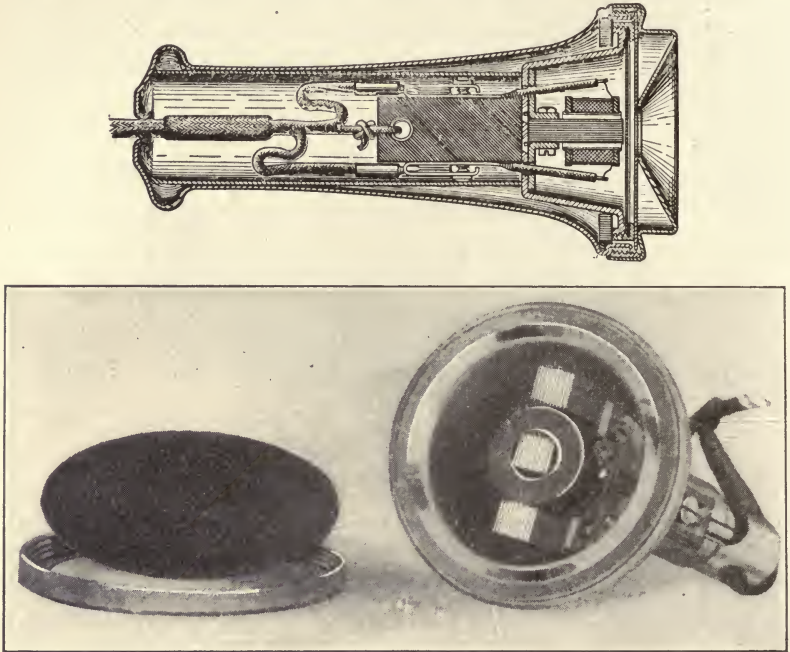

FIG. 15.—ELECTROMAGNETIC RECEIVER (Dean)

zation of an electromagnetic receiver¹ by the steady component of the current from the central exchange battery is very similar to that from a permanent magnet, and that under

cycle of current. (A more full mathematical treatment for the similar case of the electrodynamic receiver is given in Appendix F.)

On the other hand, if merely strengthens the current through the coils and weakens the magnetization, as is the case with the receiver with permanent magnet, then there will be a maximum pull in the half-cycle when the current and the permanent magnet act cumulatively and a minimum pull in the half-cycle when the current and permanent magnet act differentially, there being one complete cycle of variation of pull for each complete cycle of current.

¹ One type is described in *Telephony*, 59:466. Chicago (Oct. 15, 1910).

such conditions the electromagnetic receiver¹ will reproduce sounds faithfully and may be made lighter than a receiver with permanent magnet.

In the modern receivers without permanent magnets, the magnetic circuit consists of a soft-iron structure (preferably laminated) somewhat like a letter *E*, with three legs of equal length, thus providing three faces extending toward the diaphragm, the middle leg carrying the coil. The magnetic flux in this case extends through the central leg, then divides between the two outer legs, thence passes through the air into the diaphragm, then toward its center and thence through the air to the central leg. A large part of the flux through such a receiver is effective.

62. Electrodynamical Receiver.—For use on circuits with currents of high frequency, such as used in radio signaling, telephone receivers are sometimes made² without iron, the actuating force being the attraction between currents in the coil and the induced currents in a silver or copper diaphragm close to the coil which carries the line current. Even the diaphragm may be omitted, the minute movements of a loosely wound coil³ of wire being sufficient to reproduce speech faintly.

63. Construction and Adjustment of Receivers.—The diaphragms of telephone receivers, except those of the electro-dynamometer type, are made of sheet iron coated with japan (the so-called tin-type or ferro-type metal) or with tin, to prevent rusting. They are usually about 5.4 to 5.5 centimeters (2.12 to 2.17 inches) in diameter, and about 0.02 to

¹ Our terminology seems to lack concise expressions to distinguish between a magnetic system whose magnetomotive forces are due entirely to currents through windings and those which include also one or more permanent magnets. The distinction between magnetic and electromagnetic is hardly parallel. For lack of precise terms, a telephone receiver based upon magnetic pull and not having a permanent magnet is commonly called an electromagnetic receiver, though the same term is really applicable to the more common type with permanent magnet.

² PIERCE, G. W. Principles of Wireless Telegraphy, p. 222. McGraw-Hill (1910).

³ *Elec. Lon.*, 2:253 (Apr. 14, 1879).

0.05 centimeter (0.0079 to 0.018 inch) thick,¹ including the japan or other coating, which is about 0.007 centimeter (0.0027 inch) thick. The clamping ring reduces the free diameter to about 4.8 to 4.9 centimeters (1.89 to 1.93 inches). The distance between the diaphragm and the ends of the magnet is about 0.025 to 0.05 centimeter (0.01 to 0.02 inch), from which is to be deducted an undetermined amount due to the steady deflection by the pull of the magnet.

Receivers² generally have two coils wound with fine copper wire, the size varying between Nos. 32 and 38 Brown and Sharp gage (that is, having diameter from about 0.008 to about 0.004 inch, or about 0.02 to about 0.01 centimeter), the insulation being enamel or single silk wrapping. Each coil contains from about 300 to 700 turns. The resistance of ordinary receivers is generally close to 70 ohms, varying from 25 to 100 ohms; some operator's head receivers have about 600 ohms, while those used in radio signaling sometimes have 1,000 ohms or even higher resistance..

¹ Receiver diaphragms.

POOLE. *Practical Telephone Handbook*, p. 72.

WIETLISBACH. *El. Eng. Chi.*, 9:20-21 (Jan., 1897); *Handbuch der Telephonie*, pp. 56-61.

ABBOTT. *Telephony*, vol. 5, p. 143.

MILLER. *American Telephone Practice*, p. 47.

VANDEVENTER. *Telephonology*, p. 54.

MEYER and WHITEHEAD. *Trans. Am. Inst. El. Eng.*, 31:1399, 1407 (June, 1912).

²For notes on electrical design of receivers, see §§ 143, 146. For notes on magnetic design, see §§ 57-61, 139-145. For notes on the general mechanical design, see § 71.

CHAPTER V

TELEPHONE RECEIVER INVESTIGATIONS

64. **Experimental Difficulties Encountered; Amplitude of Vibration of Receiver Diaphragms.**—Quantitative study of the performance of the telephone receiver has been found to be very difficult and often baffling, because the forces and movements are so exceedingly small. Nevertheless some progress has been made toward getting reliable quantitative results.

The amplitude of the vibration has been variously measured. Froehlich¹ reported a loud-speaking Siemens telephone as giving a maximum amplitude of 0.0035 centimeter; experiments by the German Telegraph Engineering Bureau² indicated an amplitude of 0.000052 centimeter when the sound could be heard several centimeters away; Salet³ estimated the amplitude to be 0.00002 to 0.00003 centimeter; Bosscha⁴ reported the amplitude for the most faintly audible tone to be 0.000002 centimeter; Franke⁵ gave 0.00000012 centimeter; Barus⁶ found it less than 0.000001 centimeter; Cross and Mansfield⁷ found about 0.00022 centimeter for a

¹ FRÖHLICH. *La Lum. Elec.* (1), 25:180 (July 23, 1887); *Elek. Zeit.*, 8:210 (May, 1887); *El. Eng. Chi.*, 5:296 (June, 1895).

² FRANKE. *Jour. Soc. Tel. Eng.*, 7:247 (1878); *Elek. Zeit.*, 11:288 (May 16, 1890); *Mittheilungen aus dem Telegraph Ingenieur Bureau des Reichs-Postamts*, 1:23. Springer, Berlin (1892).

³ SALET. *Compt. Rend.*, 95:178 (July 24, 1882); *La Lum. Elec.* (1), 7:211 (Aug. 26, 1882); *Beiblatter*, 7:54 (1883).

⁴ BOSSCHA. *Arch. neerlandaises* 13:1, 247 (1878); *Amsterdamer Akad.* (Dec., 1877); *Beiblatter*, 2:513 (1878); *El. Eng. Chi.*, 5:302 (June, 1895).

⁵ FRANKE. *Loc. cit.*

⁶ BARUS. *Am. Jour. Sci.*, 153:219 (Mar., 1897); 153:107 (Feb., 1897); *Elec. Lon.*, 38:678 (Mar. 19, 1897); *Electricity* (New York), 12:215; *Phil. Mag.* (5), 38:558 (Dec., 1894).

⁷ CROSS and MANSFIELD. *Proc. Amer. Acad. Sci.*, 28:93, 234 (1892); 25:69, 233 (1890); *Technology Quarterly* (Boston) 6:69-79 (April, 1893).

strong current; Kennelly and Affel¹ found 0.00066 to 0.0010 centimeter with 0.000012 to 0.00002 ampere. Wietlisbach² concluded that the "amplitude for speaking must certainly be considerably greater than that for a mere hum, and it is fair to estimate it at from 0.001 to 0.0001 centimeter." On the latter estimates, the variation in the length of the air-gap is from $1/25$ to $1/350$ of the whole length of air-gap; moreover, the reluctance within³ the permanent magnet multiplies

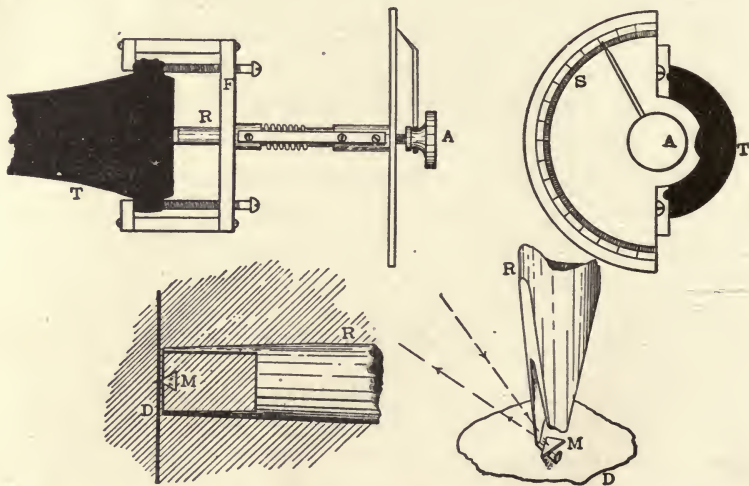

FIG. 16.—APPARATUS FOR MEASURING AMPLITUDE OF VIBRATION OF DIAPHRAGM (Kennelly and Affel)

that of the air-gap by perhaps hundreds of times. On the other hand, with central energy systems the receiver diaphragm seems to come into actual contact with the pole-pieces when the receiver "rattles" from too vigorous talking; in even this extreme case it seems not unlikely that the remaining reluctance is vastly greater than the variable portion.

One of the most simple and direct methods of measuring

¹ KENNELLY and AFFEL. *Proc. Amer. Acad. Arts and Sci.*, 51:449 (Nov., 1915).

Bulletin No. 8, Research Division, Elec. Eng. Dept., Mass. Inst. Tech.

² WIETLISBACH. *El. Eng. Chi.*, 5:303 (June, 1895); 9:32 (Jan., 1897).

³ See also § 174, pages 171-172.

the amplitude of the vibration of the receiver diaphragm was that employed by Kennelly and Affel,¹ who used a minute triangular mirror each of whose sides was about a millimeter in length, this being mounted on a thin strip of phosphor-bronze about 4 millimeters long and stretched between pointed extensions of a tube which was movable lengthwise against a spring by a micrometer screw. The deflection of a narrow beam of light reflected by the minute mirror gave a measure of any deflection of the diaphragm. Since the effective radius of the lever arm in the mirror was about $1/3$ millimeter, the amplitude of vibration was easily magnified about 8,000 times on a scale one meter distant. The magnification factor was determined by noting the amount of deflection of the beam of light when the micrometer screw head was turned several successive angles in the same direction.

65. Sensitiveness of Telephone Receiver.—The telephone receiver is almost incredibly sensitive. Early investigations by Preece² indicated that sound could be heard from a receiver when actuated by current as small as 0.000,000,000,000,6 ampere. Kennelly³ reported 0.000,000,044 ampere. Tests by Pellatt⁴ indicated that the amount of energy required to heat one cubic centimeter of water one centigrade degree would maintain an audible sound in a sensitive receiver for about 10,000 years.

While the receiver is sensitive to exceedingly minute currents when applied continuously so as to have cumulative effect, the current required⁵ for intelligible reproduction of speech is much greater, being of the order of 0.00001 to 0.0001 ampere.

¹ KENNELLY and AFFEL. See footnote on page 58.

² PREECE. "Report British Association, Manchester (1887)," p. 611.

PREECE and STUBBS. Manual of Telephony, p. 26.

WIETLISBACH. Handbuch der Telephonie, p. 55; *Elec. Eng. Chi.*, 9:31 (Jan., 1897).

³ ABBOTT. Telephony, 5:21.

⁴ PELLATT. *Journal de Physique*, 10:358 (Aug., 1881).

PREECE and STUBBS. Manual of Telephony, p. 26.

⁵ WIETLISBACH. Handbuch der Telephonie, p. 55; *El. Eng. Chi.*, 9:31 (Jan., 1897).

66. Variation of Sensitiveness with Frequency; Effect of Cap.—Investigations show that the sensitiveness of a telephone receiver depends upon the frequency¹ of the current, that is, upon the pitch of the sound, the results being more or less confused by the fact that the sensitiveness of the human ear² varies greatly with the pitch³ of the sound. Ferraris,⁴ in 1877, using a make-and-break apparatus as source of current and measuring current in terms of amperes multiplied by 10^{-9} , found the minimum currents at various frequencies to be:

Frequency	264	352	440	528	594
Current	23	17	10	7	5

Wien,⁵ in 1901, using a 187-ohm Siemens receiver and measuring current in terms of amperes multiplied by 10^{-8} , found:

Frequency	64	128	256	512	720	1024	1500	2400	4000
Current	1800	220	20	1.7	1.5	3.0	6.0	2.0	50

Rayleigh,⁶ in 1904, using a 70-ohm ordinary receiver and measuring current in terms of amperes multiplied by 10^{-8} , found:

Frequency	128	192	256	307	320	384	512	640	768
Current	2800	250	83	49	32	15	7	4.4	10

Austin,⁷ in 1908, using a Schmidt-Wilkes sensitive receiver (having a resistance of 813 ohms to direct current, 862 ohms

¹ See § 81.

² See § 13.

³ WIEN. *Pflüger's Arch.*, 97:1 (1903).

RAYLEIGH. *Phil. Mag.* (6) 14:596 (Nov., 1907).

⁴ FERRARIS. *Atti della Roy. Accad. d. Sci. di Torino*, 13:1024 (1877); *El. Eng. Chi.*, 9:31 (Jan., 1897).

⁵ See footnote on page 11.

⁶ RAYLEIGH. *British Association Report* (1894); *Phil. Mag.*, 38:365 (Sept., 1894); 38:294; *El. Rev. Lon.*, 35:334 (Sept. 14, 1894); *El. World*, 24:343 (Oct. 6, 1894); *Theory of Sound*, 1:473. Macmillan (1894).

⁷ AUSTIN. *Bulletin of the Bureau of Standards*, 5:153. Washington (1908).

to alternating current of 100 cycles per second, and 1,548 ohms to alternating current of 900 cycles per second, the inductance varying from 404 millihenries at 100 cycles to 241 millihenries at 900 cycles) using sinusoidal currents and determining the required electromotive force to produce audible sound, and expressing results in terms of volts multiplied by 10^{-7} , found:

Frequency	60	120	180	300	420	540	660	780	900
E. M. F.	6200	2900	1700	600	170	80	30	11	6

Taylor,¹ in 1909, published curves indicating the loudness of sound emitted by currents of varying frequency but of the

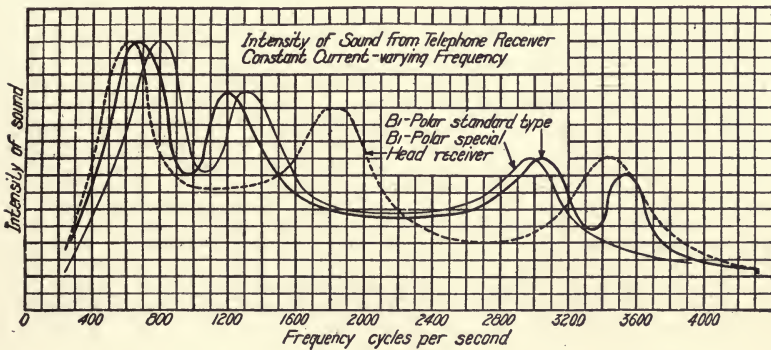

FIG. 17.—VARIATION OF RECEIVER SENSIBILITY WITH PITCH
(Taylor. *Trans. Amer. Inst. El. Eng.*)

same strength. Meyer and Whitehead,² in 1912, obtain somewhat similar curves by oscillographic measurements of the amplitude of vibration of a receiver diaphragm, eliminating the varying sensitiveness of the ear, but using currents greatly in excess of those in usual practice.

Robertson and Schroeder,³ in 1915, testing a number of receivers by current from a high frequency alternator, found

¹ TAYLOR. *Trans. Amer. Inst. El. Eng.*, 28:1186 (Oct., 1909).

² MEYER and WHITEHEAD. *Trans. Amer. Inst. El. Eng.*, 31:1397 (June, 1912).

³ ROBERTSON and SCHROEDER. "Study of Telephone Receivers," 1915 thesis in library of University of Minnesota.

that each receiver has a number of resonant frequencies, the summum maximum for various receivers being 540, 600, 660, 720, 740, 780, 800, 800, 830, 850, 860, 860, 860, 900, 920, 920, 940, 900, 800, 821. Two samples of "153-W" welded receivers showed maxima at 420, 820 and 1,240, and at 400, 800, and 1,200 cycles, respectively, those at 820 and 800 being summa maxima. With the diaphragms removed, the receivers gave feeble tones at certain ranges, with somewhat sharply defined maxima at 660, 720, 1,040, and 1,440 cycles, the louder sounds being at the 600- and 720-cycle maxima.

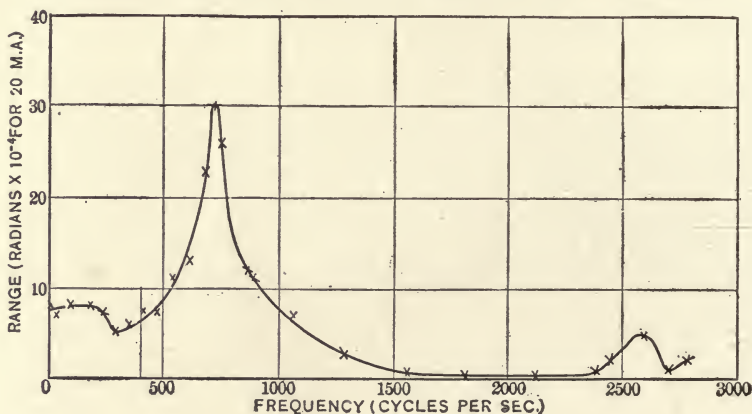

FIG. 18.—VARIATION OF RECEIVER SENSIBILITY WITH PITCH
(Meyer and Whitehead. *Trans. Amer. Inst. El. Eng.*)

Kennelly and Affel¹ made measurements of the velocity of the diaphragm (which is proportional to the amplitude) at different frequencies. Their results, Fig. 19, show marked resonance or maximum sensitiveness at 1,020 cycles per second for a Western Electric 75-ohm bipolar receiver.

In a study of the resistance and reactance of a telephone receiver as affected by the frequency of the current and by damping the diaphragm, Kennelly and Pierce² found marked changes in these values, which seem to indicate corresponding

¹ KENNELLY and AFFEL. See footnote on page 58.

² KENNELLY and PIERCE. *Proc. Amer. Acad. Arts and Sci.*, 48:113-151, Boston (Sept., 1912); *Trans. Amer. Inst. Elec. Eng.*, 31:1422 (June, 1912); *El. World*, 60:560 (Sept. 14, 1912).

variations in sensitiveness of the diaphragm. For example, the resistance of a Bell bipolar receiver, beginning with 71 ohms at 20° C. for direct current, became 138 ohms at 428 cycles, increasing to a maximum of 242.5 ohms at 754 cycles,

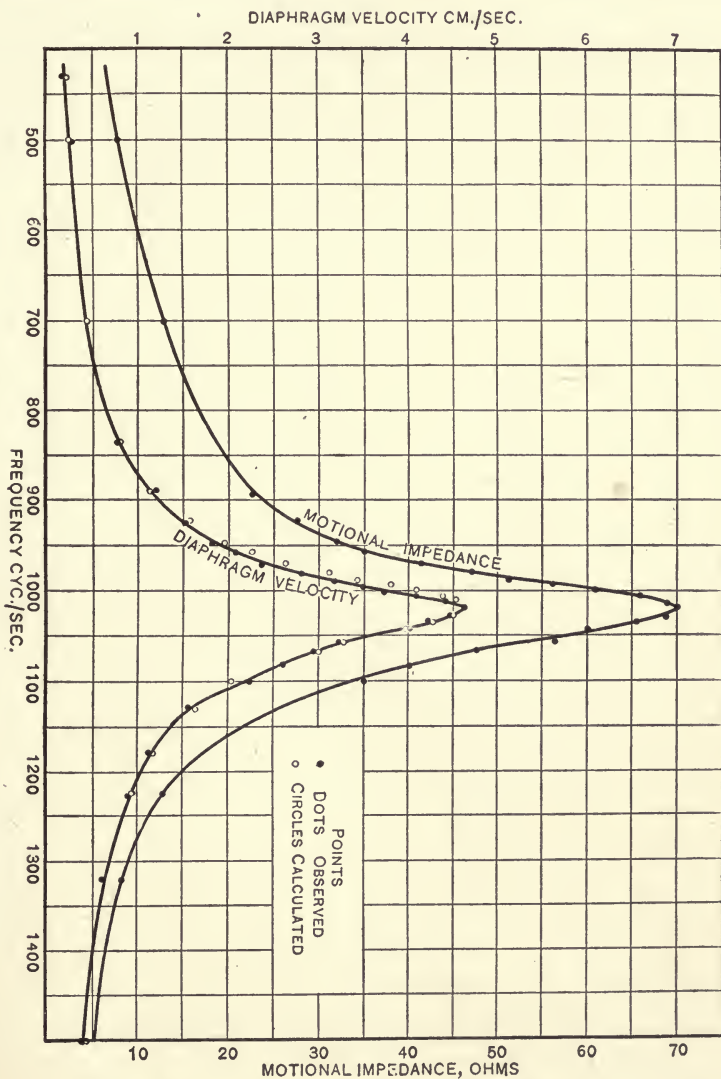

FIG. 19.—RESONANCE CURVE FOR RECEIVER
(Kennelly and Affel)

decreasing to a minimum of 142 ohms at 822 cycles and increasing to 306.5 ohms at 2,464 cycles (measurements not being taken for frequencies between 890 and 2,464 cycles). For the same receiver, the reactance was 129.5 ohms at 428 cycles, increasing to a maximum of 164 ohms at 704 cycles and then dropping to a minimum of 76 ohms at 792 cycles, then rising gradually to 171.5 ohms at 890 cycles and 291.9 ohms at 2,464 cycles. These values obtained when the diaphragm was free to vibrate under the influence of alternating current at 0.42 volt between receiver terminals.

In order to test the expected influence¹ of the air chamber between the receiver cap and diaphragm upon the sensitiveness and natural period of the diaphragm, Robertson and Schroeder² conducted a series of experiments. Spacers placed so as to increase the distance between the diaphragm and the magnets did not affect the frequencies at which maximum intensities were obtained, but did affect loudness. Spacers placed between the diaphragm and the cap so as to change the thickness of the air chamber were found to have considerable effect upon the frequency for summum-maximum sensitiveness, this frequency being lower as the distance was increased. This is well shown by the attached table, showing results with three receivers of standard type.

RECEIVER No.	DISTANCE DIAPHRAGM TO CAP.		FREQUENCY FOR MAXIMA			
	Inches	Cm.			SUMMUM MAXIMUM	
17	.029	.074	340	880	940	1000-1300
17	.095	.356			720	
18	.029	.074	460	820	900-940	1240
18	.095	.356			360	660
6	.029	.074	400		900	
6	.095	.356			320	

The magnitude of the influence of the air chamber was corroborated by later experiments by Kennelly and Affel.³

¹ See §§ 16, 66, 68, 319.

² See footnote on page 61.

³ See footnote on page 58.

who by quite different methods found a reverse effect, a standard bipolar receiver showing a resonant frequency of 872 cycles when the air chamber was 0.5 mm. thick, increasing to 892 cycles when the air chamber was 5 mm. thick, and 927 cycles when the center of the cap was entirely removed.

Miller¹ also found that the shape and size of the air cavities affected the performance of the diaphragm.

Evidently the efficiency of a receiver, of fixed design in other respects, is greatly influenced by the shape and size of the air chamber between diaphragm and cap, by the relative size and smoothness of the opening through the cap and by the configuration of the outer surface. Presumably the largest output of sound is obtained when the energy transferred, say by compression from the outward swing of the diaphragm, to the air between the diaphragm and the inner wall of the cap is most completely transmitted to the outside air before the diaphragm begins its travel in the opposite direction.

Closely connected with the influence of the dimensions of the air chamber is that of the atmospheric pressure. Experiments by Kennelly and Affel² showed that the resonant frequency of an ordinary bipolar receiver varied from 1,020 cycles in air at ordinary pressure of 76 centimeters of mercury to 956 cycles in a vacuum with a pressure of one centimeter, the temperatures being the same, and that the mechanical resistance offered by the air was about 30 per cent of the total mechanical resistance opposing the vibration of the diaphragm.

67. Sensitiveness to Disturbing Currents.—The lack of sensitiveness to sounds of low pitch renders the telephone almost immune to outside disturbances, since ordinary alternating currents for electric light and power have frequencies of 25 or of 60 cycles per second; for these the sensitiveness of the receiver is very low, though the ninth, eleventh, and higher harmonics often present³ have frequencies near those

¹ MILLER. *Science of Musical Sounds*, pp. 155-162. Macmillan (1916).

² KENNELLY and AFFEL. See page 58.

³ See § 14 and footnote.

for which the receiver is quite sensitive. Direct current circuits, such as arc light lines, or electric railway lines with but few cars, are likely to carry pulsations of relatively high frequency, which may induce noise-producing currents¹ in neighboring telephone lines.

68. Functions of the Receiver Diaphragm.—The telephone receiver diaphragm performs the important function of transforming the vibrations in the magnetic field into the vibrations of the air which constitute sound, the effects of the various elements yielding readily to mathematical analysis.² It operates first as a part of the magnetic system, incidentally as part of the electric system, and finally as a mechanical vibrating system. In each of these relations, faithful reproduction of the original sound requires that the motion of the diaphragm shall correspond in respect to direction and relative amount with that of the electromotive force applied to the terminals of the electric circuit, this in turn being assumed to correspond faithfully to the vibrations of the original sound.

69. Magnetic Pull on Diaphragm; Components of Pull.—As part of the magnetic circuit,³ the diaphragm is pulled where the magnetic flux enters or leaves the diaphragm. In the unipolar receiver, the flux enters or leaves the diaphragm in the region about the center, diverges radially, and leaves principally in radial directions where its net effect is nil, the main effective pull being near the center opposite the pole-piece. In the bipolar receiver, the flux enters the diaphragm along a small area at one side of the center and leaves through a corresponding area on the same face and at an equal distance on the other side of the center; consequently the pull is all on the one face, but it is distributed over a somewhat wide area about the center.

¹ SHEPARDSON. "Telephone Disturbances from Electrical Generators," *Trans. Amer. Inst. El. Eng.*, 15:443-460 (1898).

TOMLINSON. "Disturbances Caused by Electromagnetic Waves in Telephony," 1909 thesis in library of University of Minnesota.

² See Appendix D, §§ 317-326.

³ See §§ 57-60.

The useful pull is that at right angles to the diaphragm. The magnetic flux enters and leaves at various angles as it spreads through the air; the pull due to each small portion may be resolved into a useful component perpendicular to the diaphragm and into useless components in planes parallel to the diaphragm; as the flux spreads out almost symmetrically from the pole-pieces, the various elements of pull in the planes parallel to the diaphragm neutralize one another and may be neglected; the more nearly a line of magnetic force is perpendicular to the diaphragm the more effective it is in producing useful pull. The effect of the current through the coil surrounding the pole-piece may be to send a greater or less flux to the diaphragm, or it may be simply to gather ¹ or to scatter the flux already there, thus making it more or less nearly perpendicular and so more or less effective.

70. Variation of Pull the Essential Consideration; Effects of Hysteresis; Magnetic Saturation Desirable.—The variation ² in the pull, rather than the total pull, is the cause of the vibration of the diaphragm. It is therefore desirable that the effective component of the magnetic flux shall change in close harmony with the changes of current through the coil. This requires that throughout the entire range of current variation a given amount of increase in current shall produce a magnetic effect exactly equal and opposite to that produced by the same amount of decrease in current; this involves, among other things, the elimination or minimization of magnetic hysteresis ³ in the parts of the magnetic circuit affected by the current. The pole-pieces and the diaphragm should therefore be made of material which has a small hysteresis coefficient, that is, of soft iron; since the rising and falling limbs of the hysteresis curves nearly coincide when the iron is saturated, faithful reproduction of sound indicates that the pole-pieces and diaphragm should be worked well above the knee of the saturation ⁴ curve. Since, however,

¹ See §§ 173, 174.

² See § 318.

³ See Appendix A, § 297.

⁴ HOPKINS. *The Telephone*, pp. 58-73, abstracts work of Cross *et al.* reported in *Proc. Amer. Acad. Sci.*, 24:113 (Nov. 14, 1888); 25:233 (Nov. 12,

the reluctance of the air-gap constitutes a large part of the variable reluctance, and since air has no hysteresis, a long air-gap tends toward more faithful reproduction of the sound, though it also tends to make it weaker¹ by increasing the total reluctance upon which the current must act.

71. Mechanical Design of Receiver for Permanence of Adjustment and for Safety.—The mechanical design and construction of the receiver should be such as to maintain the factory adjustment of the distance between the diaphragm and the pole faces. This distance may be subject to change by loosening of the parts, or by unequal expansion of the exterior casing and the interior parts by changes of either temperature or humidity. Changes due to varying humidity of the atmosphere are minimized by avoiding the use of hygroscopic materials, such as wood or fiber.

In order to minimize the possibility of receiving shocks from stray currents, it is customary to have the outside of the receiver constructed of or covered with insulating material, such as rubber composition or bakelite. Since these materials expand and contract with temperature at a different rate from the metallic parts, it is important that the distance between diaphragm and pole faces be not dependent upon the insulating casing.

The earlier practice of fastening the permanent magnet at the cord end of the casing and of supporting the diaphragm by the cap end of the casing has therefore been superseded by improved methods of supporting the diaphragm on a metallic cup attached to the near end of the magnet. Typical methods of construction are shown² in Figures 12 to 15.

72. Loud-Speaking Receivers; Compromise Between

1890); 28:234 (Jan. 11, 1893); *Elec. Rev. Lon.*, 24:409 (Apr. 12, 1889).

GANZ. *Archiv für Elektrotechnik*, No. 3 (1913); *Lä Lum. Elec.* (2), 24:26 (Jan. 3, 1914).

¹ See § 66. Compare also §§ 72, 110 and 114.

² VANDEVENTER. *Telephonology*, pp. 51-54.

POOLE. *Practical Telephone Handbook*, pp. 63-73.

ABBOTT. *Telephony*, 5:4-143.

MILLER. *American Telephone Practice*, pp. 34-52.

MCMEEN and MILLER. *Telephony*, pp. 70-81.

Intensity and Clearness.—While the usual type of the telephone receiver responds to small currents with marvelous sensitiveness and faithfulness, yet there is a field for a loud-speaking¹ receiver which can be heard by many people and at considerable distances. Attempts to produce such receivers have met with some success, although clearness must generally be sacrificed to some extent in obtaining greater power. The intensity of sound from an ordinary receiver increases with the intensity of the current, up to the limit where the diaphragm strikes the pole-pieces or when the magnetic effect of the current overpowers² that of the permanent magnet. Therefore, within certain limits, an ordinary receiver becomes a loud-speaking instrument if sufficiently strong current is supplied.

In order to increase the power, it has been proposed to increase the travel of the diaphragm, which may be accomplished by increasing its diameter and by increasing the variation of magnetic flux. For accomplishing the latter end, there is a tendency to enlarge the area of the magnetic circuit, either by using a thicker diaphragm (which is part of the magnetic circuit), or by using a separate armature attached to the diaphragm through a magnifying lever or equivalent movement. Increasing the mass of the moving parts, diaphragm or lever or both, reduces the relative sensitiveness to the higher frequency³ sounds, and also exaggerates the differences in time-lag⁴ with the various frequencies. Unless also the path of the variable magnetic flux is well saturated, there are differences in the relative flux variations⁵ for rising and for falling current. These several influences militate against clear-

¹ *Telephony*, 59:8 (July 2, 1910).

Elec. Rev. Lon., 34:606 (May 25, 1894).

El. World, 62:251 (Aug. 2, 1913); *Elec. Lon.*, 72:179 (Nov. 7, 1913).

POOLE. *Practical Telephone Handbook*, pp. 71-72.

FESSENDEN. *Trans. Am. Inst. El. Eng.*, 27:594 (June, 1908).

² SHEPARDSON. *Trans. Amer. Inst. Elec. Eng.*, 31:1419, 1427 (1912).

³ See Appendix D, § 323.

⁴ See Appendix D, § 322.

⁵ See Appendix A, § 297.

ness in loud-speaking receivers of the electromagnetic type.

The effects of mass also involve incompatibility between clearness and loudness¹ in the case of any other type of receiver using a diaphragm.

73. The Diaphragm as a Mechanical Vibrating System.—From a mechanical standpoint, the telephone diaphragm may be considered as lying in the borderland between a stretched membrane and a circular plate, and somewhere between a plate with free edges and one with clamped edges. In the receiver, it is common to have the diaphragm clamped² almost

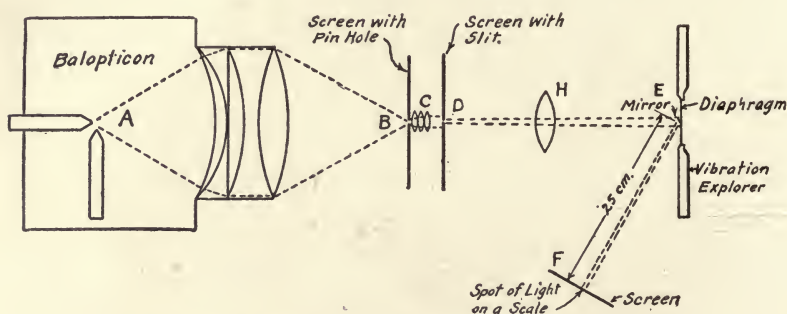

FIG. 20.—OPTICAL SYSTEM FOR VIBRATION EXPLORER
(Kennelly and Taylor)

rigidly between practically hard seats or ridges in shell and cap; in the transmitter,³ it is more common to have the diaphragm cushioned between soft rubber seats and held loosely at several points. Experiments by Kennelly and Affel⁴ showed that the natural period of vibration of the diaphragm of a standard bipolar receiver varied from 859 cycles per second when the cap was loose, to 891 cycles when the cap was tightly screwed into place.

The load varies, from a fairly close approximation to a concentrated central loading in the case of unipolar receivers

¹ See Appendix D, § 323.

² See Figs. 12-15.

³ See Figs. 23-27, also §§ 75, 99.

⁴ KENNELLY and AFFEL. See page 58.

and in most transmitters, to a distributed and fairly uniform load in the case of bipolar receivers extending over a central zone having a diameter about forty per cent of that of the diaphragm. Experiments by Kennelly and Taylor¹ making explorations over the diaphragm of a No. 144 Western Electric telephone receiver kept in vibration by 2 milliamperes of alternating current at 974 cycles per second (the resonant

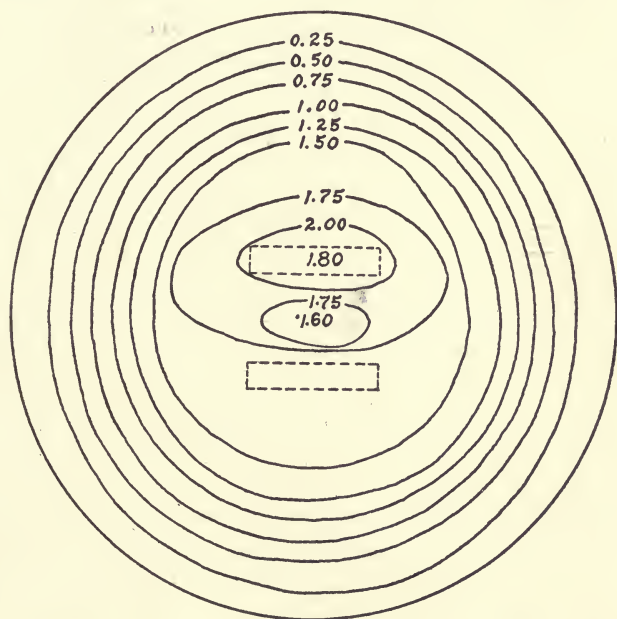

FIG. 21.—VIBRATION CONTOURS OF RECEIVER DIAPHRAGM
(Kennelly and Taylor)

frequency being 992 cycles) showed, Fig. 21, that the amplitude of vibration increased almost uniformly from zero at the clamped edge to a maximum of 2.00 microns (or thousandths of a millimeter) near one of the pole-pieces.

Experimental investigation of the effects of changing the

¹ KENNELLY and TAYLOR. *Proc. Amer. Philosophical Soc.*, 54:96 (1915); Bulletin 7, Research Division, Elec. Eng. Dept., Massachusetts Institute of Technology.

diameter of the diaphragm is complicated by the unavoidably attendant changes in the cap and in the air-chambers on both sides of the diaphragm and by the difficulty of maintaining the same average distance between the diaphragm and the magnet tips.

Investigation of the effect of thickness of diaphragm is complicated by the difficulty of getting sheets of iron of different thickness and with exactly the same chemical composition and physical characteristics. Mercadier's study¹ of a d'Arsonval receiver, with diaphragms varying from 0.148 to 2.0 millimeters thick, showed the sensitiveness to be a maximum for a thickness of 0.2 millimeter and to fall off rapidly for thickness greater or less. Further experiments by Cross² showed that, as might be expected, the maximum sensitiveness varied both with the thickness of the diaphragm and with the strength of the magnetic field.

74. Investigations Toward the Theory of the Diaphragm.—The mathematical theory of the receiver diaphragm is not yet entirely satisfactory, though by making somewhat broad assumptions it is possible to reach conclusions which at least show the general tendency of various elements.

The first detailed discussion of the mathematical theory of the circular elastic vibrating plate seems to have been presented by Poisson,³ who solved the problem of the symmetrical vibration of a free circular plate. Kirchhoff⁴ made the theory more complete, and it has become more or less standardized in the textbooks⁵ on Mechanics. The drum-

¹ WIETLISBACH. *Handbuch der Telephonie*, p. 16.

² CROSS. See footnote on page 73.

WIETLISBACH. *Op. cit.*, p. 16.

³ POISSON. *Mémoires de l'Académie des Sciences*, vol. 8 (1829).

⁴ KIRCHHOFF. *Crelle's Journal fuer Mathematik*, 40:51-88, Berlin (1850).

⁵ MERRIMAN. *Mechanics*, art. 160, p. 411. Wiley & Sons (1906).

IBBETSON. *Mathematical Theory of Elasticity*, chap. 8. New York (1887).

LOVE. *Theory of Elasticity*, chap. xxiv, second edition. Cambridge University Press (1906).

head, as a sort of limiting case of circular plate, was discussed by Byerly.¹

The diaphragm as a receiver or producer² of sound has been given considerable attention by Rayleigh,³ Cree,⁴ Abraham,⁵ Poincare,⁶ Kennelly and Upson,⁷ Hermann,⁸ Thompson,⁹ Cross and Page,¹⁰ Wietlisbach,¹¹ Eddy,¹² Wiersch,¹³ Wien,¹⁴ Kempf-Hartmann,¹⁵ Fairbanks,¹⁶ Gati,¹⁷ Holstrom,¹⁸ Meyer and Whitehead,¹⁹ Kennelly and Pierce,²⁰ Taylor,²¹ Abbott,²² Kennelly and Affel.²³

¹ BYERLY. Fourier Series, arts. 11, 123, 126. Ginn & Co. (1893).

² See § 66.

³ RAYLEIGH. Theory of Sound, arts. 100, 221a, 235y. Macmillan (1894); *Phil. Mag.* (5), 38:295 (Sept., 1894); (6), 21:53 (Jan., 1911); *Elec. Rev. Lon.*, 35:334 (Sept. 19, 1894).

⁴ CREE. *Trans. Cambridge Philosophical Soc.*, vol. 15 (1891).

⁵ ABRAHAM. *Compt. Rend.*, 144:906 (Apr. 29, 1907).

⁶ POINCARÉ. *L'Ecl. Elec.*, 50:221, 257, 329, 365, 401 (1907).

⁷ KENNELLY and UPSON. *Proc. Amer. Philosophical Soc.*, 47:352. Philadelphia (July, 1908); *Telephony*, 18:460, 492, 699 (1909).

⁸ HERMANN. "Phonophotographische Untersuchungen" in *Arch. f. d. Ges. Physiol.* (Pflueger) 45:582 (1889).

SCRIPTURE. "Experimental Phonetics," p. 30. New York (1902); *Theorie der Phonographischen Schallreproduction in Phon. Zeit.*, 9:684-686, 771-773, &c. Berlin (1908).

⁹ THOMPSON. *Jour. Inst. El. Eng.*, 16:46 (1887).

¹⁰ CROSS and PAGE. *El. Rev. Lon.*, 17:412 (Nov. 14, 1885); *Elec. Eng. N. Y.*, 4:420 (Nov., 1885).

¹¹ WIETLISBACH. *Handbuch der Telephonie*, p. 29; *Elec. Eng. Chi.*, 9:33 (Jan., 1897).

¹² EDDY. *Engineers' Yearbook*, University of Minnesota, Minneapolis, 7:31 (1897).

¹³ WIERSCH. *Ann. d. Phys.*, 17:999 (1905); 18:1049 (1905); *Jour. de Phys.* (4), 5:275; (4), 5:678.

¹⁴ WIEN. *Ann. d. Phys.* (14) 4:450 (1901); *Phys. Zeit.* (4) 16:69-74 (Oct. 10, 1902); *Phil. Mag.* (6), 14:596-604 (Nov., 1907).

¹⁵ KEMPF-HARTMANN. *Ann. d. Phys.* (4), 8:481 (1902).

¹⁶ FAIRBANKS. *Telephony*, 59:293 (Sept. 10, 1910).

¹⁷ GATI. *Elec. Lon.*, 66:456 (Dec. 30, 1910).

¹⁸ HOLSTROM. *Elec. Lon.*, 66:181 (Nov. 11, 1910).

¹⁹ MEYER and WHITEHEAD. *Proc. Amer. Inst. El. Eng.*, 31:1023-1044 (1912); *Trans. Amer. Inst. El. Eng.*, 31:1396 (1912).

²⁰ KENNELLY and PIERCE. See footnote on page 62.

²¹ TAYLOR. *Proc. Amer. Inst. El. Eng.*, 28:1184 (1909); *Trans. Amer. Inst. El. Eng.*, 28:1169 (1909).

²² ABBOTT. *Telephony*, 5:84.

²³ See footnote on page 58.

75. **Natural or Free Period of the Diaphragm.**—The natural or free period of the diaphragm may have appreciable importance, when it approximates that of the applied current, both in its effect in exaggerating sounds of resonant frequency, and in its influence^{1, 2} upon the equivalent impedance³ of the electric circuit.

The free period of a diaphragm without load has been computed by a formula derived by Rayleigh,⁴ but which needs some modification before being accurately applicable to the loaded diaphragm. Moreover, it does not specifically take account of the temperature. When the diaphragm is rigidly clamped at its edges, it is quite sensitive to changes⁵ in temperature, for they affect the radial tension; when the diaphragm is clamped somewhat loosely, it is found in practice to be less sensitive to temperature. Experiments by Kennelly and Affel⁶ showed that the natural period of vibration for a certain standard receiver (with cap screwed down tightly) varied from 887 cycles per second at 19.3° to 835 cycles at 47°; another varied from 867.5 cycles at 22° to 817 cycles at 51°. In this respect the receiver diaphragm acts differently from the transmitter diaphragm,⁷ for the latter is held in a soft rubber cushion lightly clamped at two diametral points, while the former is generally clamped tightly all around and is thus more largely affected by temperature.

The natural period and the natural frequency of a diaphragm may be determined by several experimental methods, described in the investigations already mentioned, especially those of Rayleigh,⁴ Wien,⁸ Kempf-Hartmann,⁹ Kennelly and

¹ MEYER and WHITEHEAD. See footnote on page 73.

² KENNELLY and PIERCE. See footnote on page 62.

³ See § 81.

⁴ RAYLEIGH. *Theory of Sound*, 1:331, 366, 473. Macmillan (1894); *Phil. Mag.* (5), 38:295 (Sept., 1894).

See also appendices to paper by KENNELLY and AFFEL.

⁵ SHEPARDSON. *Trans. Amer. Inst. El. Eng.*, 31:1419 (1912).

⁶ KENNELLY and AFFEL. See footnote on page 58.

⁷ See §§ 73, 99.

⁸ WIEN. See footnote on page 73.

⁹ KEMPF-HARTMANN. See footnote on page 73.

Upson,¹ Meyer and Whitehead,² Kennelly and Pierce,³ Kennelly and Affel,⁴ and of Kennelly and Taylor.⁵ It is difficult to eliminate or to make proper allowance for damping by the air chambers.

76. Dissymmetry of Vibration; Compensation.—The general solution⁶ for the displacement of the diaphragm assumes that the vibration is symmetrical about the neutral or level plane. In fact, however, the attraction of the flux due to the permanent magnet or equivalent magnetomotive force puts an initial deflection into the diaphragm. If the initial displacement is excessive, a given increment of current in a direction to strengthen the pull will give less increment of displacement than the decrement of displacement by an equal increment of current in the opposite direction; this introduces some dissymmetry into the vibration. In early days of telephony it was not appreciated that the power of a telephone receiver depends not so much upon the strength of the magnetic pull as upon its variation, and early types⁷ included many attempts to get very strong fields, with generally disappointing results.

Another method proposed⁸ for lessening the dissymmetry of vibration is to give the diaphragm an initial set or buckling in the opposite direction, so that the pull by the permanent magnet will about neutralize the buckling and bring the diaphragm back to flatness.

A compensating factor⁹ in the operation of the receiver, which does not appear in the general equation and which seems to have been seldom³ recognized (though it is the basis of its use as a transmitter), is the change of reluctance as the diaphragm vibrates and introduces periodic fluctuations in the

¹ KENNELLY and UPSON. See footnote on page 73.

² MEYER and WHITEHEAD. See footnote on page 73.

³ KENNELLY and PIERCE. See footnote on page 62.

⁴ KENNELLY and AFFEL. See footnote on page 58.

⁵ KENNELLY and TAYLOR. See footnote on page 71.

⁶ See Appendix D, §§ 319-323.

⁷ See footnote ¹ on page 44.

⁸ ABBOTT. Telephony, Part v, p. 84.

⁹ See Appendix D, § 317.

lengths of the air-gaps in the magnetic circuit. If this effect were appreciable, the magnetomotive force of a given current would act on smaller reluctance when in a direction to strengthen the permanent magnet than when opposed; consequently a symmetrical alternating current would exert an unsymmetrical variation of the pull on the diaphragm. The change in reluctance tends to neutralize the change in rigidity of the diaphragm at varying distance from its initial plane. The whole effect is generally small, since the travel of the diaphragm is small, and the change of reluctance is a small portion¹ of the whole.

77. Electromotive Forces Induced in the Diaphragm; Secondary Currents Approximate Quadrature with Primary Current; Electrodynamic Pull of Double Frequency.—The induced currents in the diaphragm, whose effect on the displacement was combined with that of rigidity in the general equation,² may play an important part in the ordinary type of receiver. They constitute the entire moving force in ironless receivers³ (such as are sometimes used in wireless telegraphy), the diaphragm being made of silver or of copper and being near the coil of insulated wire.

The electromotive force induced in the diaphragm is similar to that in the secondary of an induction coil or transformer. By Lenz's law it is proportional to the rate at which the current changes in the primary circuit, or the rate at which the magnetic flux changes; it is therefore at maximum value when the primary current changes most rapidly, that is, when it passes through zero. The secondary current induced in the diaphragm, if in phase with the induced electromotive force, would thus be in quadrature with (ninety electrical degrees from) the primary current in the coil. While this may easily be admitted in the case of the ironless receiver, at first thought the secondary current in the iron diaphragm might be expected to lag considerably behind the induced electromotive

¹ See § 64.

² See Appendix D, § 320.

³ See § 62.

force, because of the path of the current being in iron; but though the current is in iron, the path of the magnetic flux resulting from and surrounding the current is mostly through non-magnetic material, merely crossing the iron twice and perpendicularly at that; the counter-electromotive force of self-induction reacting on the secondary current is therefore that of a loop of one turn with magnetic circuit through air, and thus is so small as to be negligible. Since also the resistance in iron is high, the secondary current in the diaphragm is thus practically in quadrature with the primary current.

The electrodynamic pull due to the current in the diaphragm acting upon the flux in phase with the current in the coils is equal to their product multiplied by a proportionality factor. Equating these, and reducing, gives expressions¹ which show that the electrodynamic pull on the diaphragm varies with a frequency double that of the current in the coils, and is not suitable for reproducing voice sounds at proper pitch. The maximum electrodynamic pull is displaced 45 time-degrees from the maximum current in the coils, and is therefore 45 time-degrees from the maximum electromagnetic pull. The two attractions, when both are present, therefore give a confusing result, and one of them should be suppressed. Diaphragms in telephone receivers based on electromagnetic pull should therefore have high electrical resistance to minimize the induced currents.

For this purpose, silicon steel seems² to be promising material, since steel containing 4.8 per cent of silicon has high permeability, while its resistance is six times that of ordinary iron.

78. Effects from Metallic Heads on Coil Spools.—The metallic heads commonly used on the spools on which the magnet coils are wound have a compensating effect on the currents induced in the diaphragm and also upon the current

¹ See Appendix F; also § 61.

² BURGESS and ASTON. *Met. and Chem. Eng.* (Mar., 1910); *Elec. Lon.*, 65:769 (Aug. 19, 1910).

GUGGENHEIM. *Elec. Lon.*, 66:539 (Jan. 13, 1911).

in the coil and upon the resulting pull on the diaphragm. Since they are close to the coils and constitute closed paths surrounding the same iron core, electromotive forces are induced¹ in them, both by the direct electrodynamic action of the coils and also by the changing of the main magnetic flux, such induced electromotive force being proportional to the rate of change and therefore being in quadrature with (90 degrees behind) the primary current; since the current path around the spool heads surrounds an iron circuit of fairly low reluctance, it has considerable self-inductance; this makes the resulting current lag toward 90 degrees behind the induced electromotive force.

The ampere-turns in the spool heads are thus approximately opposite to the ampere-turns in the coil, and thus neutralize more or less completely the tendency of the primary current to induce currents in the diaphragm, this being especially true of the spool heads close to the diaphragm, the remote heads having less effect in this respect. At the same time, the ampere-turns in the spool heads also neutralize part of the ampere-turns in the coils in their effect upon the magnetic circuit and consequently upon the variation of pull on the diaphragm. The two effects seem to be about equally helpful and harmful, for the performance of a receiver seems to be but little affected by the removal of the spool heads. Their net effect is probably harmful. As they involve more or less waste of the precious energy which reaches the receiver, it is likely that they will be abandoned when their effect is better appreciated.

79. Reactions of Induced Currents upon Primary Current.—The secondary currents in the diaphragm, in the spool heads, and in the pole-pieces and end regions of the permanent magnet, have a further effect in modifying the primary current. They may be considered as resolvable into two components, respectively, in quadrature with and in opposition to the primary current; or, their effects may be combined and considered as involving energy losses in phase with

¹ See § 77.

the currents and as producing oscillating magnetic energy in quadrature. Without stopping for a complete analysis¹ of how these may be resolved into components in parallel and in quadrature with the primary current, it may be noted that the energy loss due to the secondary currents is derived from the primary circuit (to which it adds an increment of effective resistance), and that the oscillating magnetic energy in quadrature may be considered as neutralizing part of that from the primary current and therefore as reducing the effective reactance.

80. Reaction of Hysteresis upon Primary Current.—Hysteresis² in the diaphragm not only adds an increment to the equivalent rigidity³ of the diaphragm, but, also, since it involves the absorption of energy, it adds an increment to the equivalent resistance of the primary circuit. A similar increment of resistance is added by the hysteresis in the pole-pieces and end regions of the permanent magnet where the distribution of magnetism is probably affected to some extent by the magnetomotive force of the current in the coils and spool heads.

81. Effects of Secondary Currents upon Equivalent Resistance and Reactance of Primary Circuit; Extent of Such Effects.—The variations in the magnetic reluctance due to the vibrations of the diaphragm, combined with the effects of secondary currents and hysteresis, have an appreciable effect on the equivalent resistance and reactance of the primary circuit, and therefore upon the strength and phase of the current which a given impressed electromotive force will send through the circuit. Moreover, since they depend on the frequency, it follows that a current which includes components of varying frequencies will have its char-

¹ STEINMETZ. *Alternating Current Phenomena*, chap. 14.

JACKSON. *Alternating Currents and Alternating Current Machinery*, chap. 9.

² See § 70; also Appendix D, § 320.

³ WIETLISBACH. *El. Eng. Chi.*, 9:17 (Jan., 1897); *Handbuch der Telephonie*, p. 54.

WAGNER. *Elek. Zeit.*, 32:80 (Jan. 26, 1911); 32:110 (Feb. 2, 1911).

acter modified considerably, the components of higher frequency being both reduced in amplitude and shifted in phase more than those of low frequency.

The extent of these influences in practice may be inferred from tests made by Kennelly and Pierce¹ upon a standard bipolar receiver which had a resistance of 71 ohms to direct

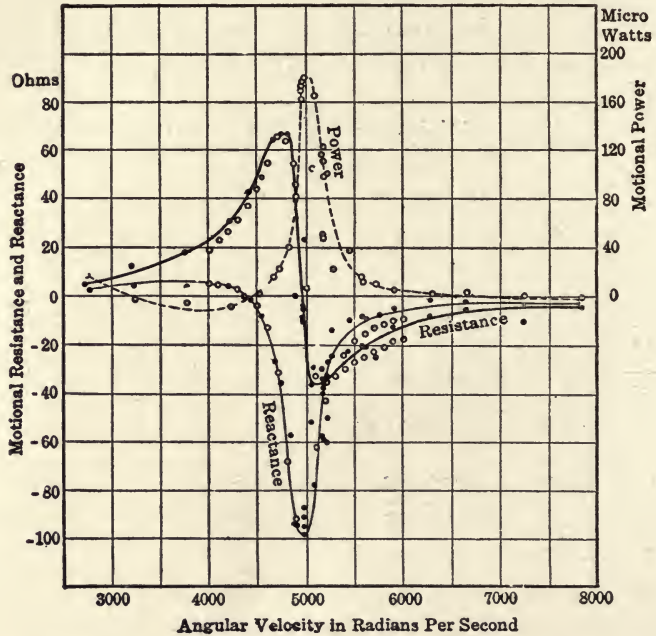

FIG. 22.—EFFECT OF DIAPHRAGM VIBRATION UPON RESISTANCE AND REACTANCE OF RECEIVER
(Kennelly and Pierce)

current. When the diaphragm was prevented from vibrating, and when approximately sinusoidal currents from a Vreeland² oscillator were sent through the receiver at different frequencies and with 0.3 volt at the receiver terminals, the equivalent resistance varied from 146 ohms at 440 cycles (2,760 radians) per second to 325 ohms at 2,464 cycles (15,-

¹ KENNELLY and PIERCE. See footnote on page 62.

² VREELAND. U. S. Patents No. 829,447 and No. 829,934 (Aug. 28, 1906); *Phys. Rev.*, 27:286 (Oct., 1908); *El. World*, 52:1134 (Nov. 21, 1908).

500 radians) per second; the coefficient of inductance varied from 0.0486 henry at the lower frequency to 0.019 henry at the higher frequency; the corresponding reactances (or products of self-inductance by radians or by 2π times the frequency) being 135 ohms at the lower frequency and 294 ohms at the higher frequency. When the diaphragm was allowed to vibrate as usual, the resistance was sometimes higher and sometimes lower than the corresponding resistance with damped diaphragm, and somewhat similar changes occurred in the equivalent inductance and reactance. The differences between corresponding values for the same frequency may be called the "motional" resistance and reactance, the former varying from 68 ohms greater to 38 ohms less resistance when free to vibrate, the latter varying from 4.2 ohms greater to 98 ohms less.

82. Efficiency of the Telephone Receiver; Prospects for Improvement.—The efficiency of the receiver probably varies considerably with the pitch of the sound, high frequencies involving greater electrical and magnetic losses, while favoring the acoustic efficiency of transmission from diaphragm to air. These effects are complicated¹ by the natural frequency of vibration of the diaphragm.

Widely differing estimates have been made for the energy efficiency of the telephone receiver. H. Abraham² concludes that less than one one-thousandth of the energy in the received current is transmitted to the air. Experiments by Siemens reported by Wietlisbach³ indicate that the force of the air vibrations operating on a transmitter is ten thousand times greater than that of the vibrations reproduced by the receiver. Tests by Pickard⁴ indicate an efficiency of about five per cent in the receiver.

These efficiencies in respect to energy present a woeful contrast with the high efficiencies attained by apparatus for trans-

¹ See § 66.

² ABRAHAM. *Compt. Rend.*, 144:906 (Apr. 29, 1907); *Sci. Abstr. (Phys.)*, 10:1039 (1907).

³ WIETLISBACH. See footnote on page 79.

⁴ PICKARD. *West. Elec.*, 58:899 (May 6, 1911).

forming large quantities of power. The low energy efficiency is also in marked contrast with the high "accuracy efficiency" of 40 to 98 per cent ¹ attained in the recognition of words sent over regular commercial telephone circuits. It seems to be the combined result of several actions where accuracy of reproduction of sound is inconsistent with energy efficiency. It seems to issue a challenge to the telephone engineer and should stimulate him to deeper investigation of the fundamental principles underlying his art, to the obtainment of accurate quantitative data, to the promotion of telephony from the "cut-and-try" or "imitate" stage to the more respectable, efficient, and effective "quantitative" stage which has been attained in some other branches of electrical engineering.

¹ See § 35.

CHAPTER VI

TELEPHONE TRANSMITTERS

83. Apparatus for Sending Speech.—The apparatus for transmitting speech, that is, for changing sound vibrations into electrical impulses, is known as the transmitter. Most of these are of the microphone type, based on the fact that variable pressure changes the resistance of carbon; these are usually, though not necessarily or invariably, accompanied by induction coils for changing unidirectional impulses into alternating current or for magnifying the unidirectional impulses.

Occasional use is made of magneto transmitters based on electromagnetic induction, these being usually ordinary permanent magnet receivers employed as transmitters. Other phenomena are in occasional or of possible use, but have not been reduced to commercial service as telephone transmitters.

84. Operation of the Ordinary Transmitter or "Sender."—In the operation of the transmitter,¹ the usual procedure is that sound waves coming through the air strike a diaphragm and cause it to vibrate and thus either to change a magnetic field so as to induce electromotive forces in a suitably arranged circuit, or to change the resistance of an electrical circuit and so to cause variations of current, thus producing electric currents which follow the wave form of the original sound with sufficient accuracy to reproduce recognizable sounds from a suitable receiver.

85. Transmitters of Two Types, Generators and Modifiers.—Telephone transmitters are of two general classes: those which generate, and those which modify electromotive

¹ The apparatus generally known as a "transmitter" might more properly be called a "sender," for the whole telephone system and especially the line connecting the stations is really the transmitting agency.

forces or currents. As an engineer's hand on the throttle can control forces far greater than his own, so the modifying transmitter is more powerful than the generating transmitter.

86. The Magneto Transmitter; Construction and Operation.—With the exception of the feeble thermopile¹ transmitter, the sole representative of the generating class is the magneto transmitter, and this is principally of historical interest. Being less powerful than the microphone transmitter, it is used at present only where batteries are troublesome on account of space, weight, or exposure, as in some kinds of linemen's test sets² and in some police call boxes.

The construction of the magneto telephone transmitter is essentially that of the receiver,³ the operation being reversed, the sound being the cause instead of the result of the vibration of the diaphragm.

The vibrations caused by the sound waves at the transmitter are modified⁴ by the various disturbing factors⁵ which are involved in the vibration of the receiver diaphragm, except that, in some, cause becomes the effect.

87. Electromotive Forces Induced; Cycle of Operations; Modifying Factors.—The fundamental principle of the magneto transmitter is that underlying all electrical induction generators such as dynamos, alternators, induction coils, and transformers. When a coil or magnetic field changes so as to vary the total amount of magnetic flux threading through the coil, there is induced in the coil an electromotive force equal to the product of the number of turns in the coil by the rate of change in the number of lines of magnetic flux threading through the coil.

In the magneto transmitter, the magnetic flux at any in-

¹ SULLIVAN. *Phil. Mag.* (3) 27:261 (Oct., 1845).

DOLBEAR. *Jour. Fkln. Inst.*, 121:24 (Jan., 1886).

² Example shown by THIESS and JOY. *Toll Telephone Practice*, p. 373. Early magneto transmitters shown by POOLE. *Practical Telephone Handbook*, pp. 50-53.

³ See §§ 57-63.

⁴ See §§ 75-81.

⁵ See investigations by CROSS and WILLIAMS. *Proc. Amer. Acad. Arts and Sci.*, 24:113 (Nov. 14, 1888); *Elec. Eng. N. Y.*, 8:213 (May, 1889).

stant spreads out from the pole-pieces in various directions, so that hardly any two turns in the coil inclose the same number of lines of flux, the outside turns near the permanent magnet inclosing the most, the inside turns near the diaphragm inclosing the least amount of flux. As the diaphragm bends to and fro, the distance between the diaphragm and the pole-pieces of the magnet varies, thus changing the magnetic reluctance and modifying¹ the distribution and, to a somewhat smaller extent, the quantity of magnetic flux between the magnet pole-pieces and the diaphragm. As the diaphragm vibrates, the greater rate of change of inclosed flux will be in the inside turns closest to the diaphragm. It may be assumed with reasonable confidence that, within the narrow limits of the travel² of the diaphragm, the summation or integral of the flux inclosed by the various turns (or the flux inclosed by the average turn at any instant) varies inversely as the distance between the diaphragm and the pole-pieces. The rate at which the inclosed flux changes and the resulting electromotive force are each proportional to the rate at which the diaphragm moves.

The cycle of operations in the magneto transmitter includes, then, the following: sound waves, or impulses³ of compression and rarefaction in the air, strike the diaphragm and set it into corresponding vibration; this changes the reluctance of the magnetic circuit, and modifies the distribution of the magnetic flux; the flux turns through the coil or coils are changed at the same rate, inducing electromotive forces which are proportional to the velocity of the diaphragm and have a wave form closely similar to that of the sound wave.

88. Various Phenomena Available as Basis of Modifier Transmitter.—Various physical phenomena are available for use as the basis of transmitters of the “modifying” class. One might expect that any of the elements which affect the

¹ See § 174.

² See § 64.

³ See § 8.

electromotive force or the current in a circuit might be modified by sound vibrations so as to serve as the basis for a transmitter. The smallness of the movement available, however, seems to bar out some methods which might be available for larger movements, such as the operation of switches¹ to change the number of cells in the circuit, or the introduction of variable self-induction in the circuit, or the operation of a throttle or valve which might magnify the power.

89. Transmitters Based on Changes of Electromotive Force; Electrostatic Transmitters.—Apparently the only practical way of changing the total electromotive force directly is by inductive methods, such as form the basis of the magneto transmitter.

The distribution of the electromotive force in a circuit without steady current has been shifted² by sound vibrations in a diaphragm which was one electrode of an electrostatic condenser whose capacity was thereby modified; this caused corresponding currents to flow while the charge in the condenser was being modified to suit the changing capacity. The condenser was used experimentally³ as a transmitter by Varley, by Du Moncel, by Dolbear, and by Giltay, though it seems to have worked better as a receiver.

90. Methods of Varying Resistance.—Various methods of changing the resistance of a conductor have been the basis of practically all the transmitters, except those of the magneto type. The resistance of a homogeneous material increases with the length and decreases with the area of the conductor, and also depends on the specific resistance of the material, which latter changes somewhat with the temperature; when the conductor is not homogeneous, as when consisting of small particles, pressure makes the resistance less. Variation of each of the elements which determine resistance has been proposed for use as the basis of a transmitter, but variation of pressure is the only one that has become commercially successful.

¹ Note, however, proposals of Field, Edison, Cuttriss, and Ahearn, mentioned in §§ 91, 93.

² See §§ 201-203.

³ See § 53.

91. Transmitters Based on Heating Effects; Use of Temperature Coefficient of Resistance; Linear Expansion; Arc Stream.—The change of resistance with temperature was utilized by Forbes,¹ who arranged a fine platinum wire in a narrow slit through which the sound waves passed after being concentrated by a funnel, thus cooling the wire which was heated by current from a battery. Change of temperature of air confined in a shallow chamber behind a diaphragm was found by the author to give feeble changes of resistance and to act feebly as a transmitter.

Field² proposed to have the motion of the diaphragm connect a shunt intermittently about a heated conductor.

Sound waves of air arranged to affect the length and area of minute electric arcs were early used by Blyth,³ who inserted a pointed carbon pencil into a carbon tube, thus closing a circuit through which current was passed; he then withdrew it slightly until minute electric arcs appeared; voice sounds directed through the tube caused vibrations in the length and area of the minute arcs, which operated as a fair transmitter. The Reis⁴ transmitter of 1861, which seems⁵ to have been operative, may have utilized⁶ minute arcs. Dolbear⁷ used an arc as transmitter in experimental work. Simon⁸ is usually credited with first using the arc as both transmitter and receiver, though the early Brush and Thomson-Houston arc lights had long been known to give out sounds of commutator pitch, especially when the arcs were long. Hayes and Bell⁹ used the arc in their photophone.

¹ FORBES. *Proc. Roy. Soc. Lon.*, 42:141 (Feb. 24, 1887); *El. World*, 9:189 (Apr. 16, 1887); *El. Eng. N. Y.*, 6:205 (May, 1887).

² FIELD. U. S. Patent No. 433,120 (July 29, 1890); *El. Eng. N. Y.*, 10:138 (Aug. 6, 1890).

³ BLYTH. *Proc. Roy. Soc. Edinburgh*, 11:622 (Apr. 17, 1882); *Tel. Jour. Lon.*, 10:317 (May 6, 1882); *Elec. Lon.*, 10:42 (Nov. 25, 1882).

⁴ THOMPSON. Philip Reis, The Inventor of the Telephone. Spon, London (1883).

KINGSBURY. The Telephone and Telephone Exchanges, chap. xii.

⁵ REIS. *Jour. Fkln. Inst.*, 121:49 (Jan., 1886).

⁶ REIS. *Elec. Eng. N. Y.*, 6:281 (July, 1887).

⁷ DOLBEAR. *Jour. Fkln. Inst.*, 121:25 (Jan., 1886).

⁸ SIMON. ⁹ HAYES and BELL. See footnotes on page 48.

92. **Transmitters Using Liquid Conductors.**—Variation of resistance of a liquid conductor has been tried by a number of investigators. Perhaps the first was Yeates¹ of Dublin, who is said to have put a drop of water between the points of a Reis transmitter and to have transmitted speech in 1860. Elisha Gray and Alexander Graham Bell² used a wire dipping into a liquid, the pulsations of the diaphragm causing the wire to dip more or less deeply and thus to vary the area of contact with the liquid. Edison³ proposed to use a larger surface between parallel plates. C. A. Bell⁴ and Majorana⁵ caused the vibration to vary the resistance of a water jet. A later proposal by Chambers⁶ is to vary the diameter and length of a liquid path emerging from a nozzle against a diaphragm. Breguet⁷ proposed a modification of the Lippmann electrometer. Dolbear⁸ in 1878 found that a moistened finger tip pressed against the diaphragm would work as a microphone, the variations in pressure perhaps changing the length of the path of the current through the high resistance skin. Elisha Gray⁹ had almost similar experience. Dolbear¹⁰

¹ YEATES. *Phil. Soc. Dublin* (1865); *Jour. Soc. Tel. Eng.*, 16:45 (Jan. 27, 1887); *Jour. Fkln. Inst.*, 121:13 (Jan., 1886); *Elec. Eng. N. Y.*, 2:130 (May, 1883).

² GRAY and BELL. *El. World*, 7:263 (June 5, 1886); *Jour. Fkln. Inst.*, 121:14-15 (Jan., 1886); *Encyc. Brit.* (9) 23:142.

KINGSBURY. *The Telephone and Telephone Exchange*, pp. 99-106. Longmans (1915).

³ EDISON. U. S. Patent No. 203,018 (Apr. 30, 1878).

PRESCOTT. *Speaking Telephone*, pp. 223-225.

⁴ BELL. *Proc. Roy. Soc. Lon.*, 40:368 (May 13, 1886); *El. World*, 12:68 (Aug. 11, 1888); *Sci. Amer. Supp.*, 26:10574, No. 662 (Sept. 8, 1888).

⁵ MAJORANA. *Elec. Lon.*, 62:609 (Jan. 29, 1909); *Elek. Zeit.*, 30:685 (July 22, 1909).

⁶ CHAMBERS. *Elec. Lon.*, 65:560 (July 15, 1910).

⁷ PRESCOTT. *Speaking Telephone*, p. 287; *Jour. Fkln. Inst.*, 121:24 (Jan., 1886); *La Lum. Elec.*, 14:259 (Nov. 15, 1884).

PREECE and STUBBS. *Manual of Telephony*, p. 100.

⁸ DOLBEAR. *Jour. Fkln. Inst.*, 119:42 (Jan., 1885).

⁹ GRAY. "Experimental Researches," *Jour. Amer. Elec. Soc.* (Chicago), 1:10 (Mar. 17, 1875).

PRESCOTT. *Speaking Telephone*, pp. 151-166.

¹⁰ DOLBEAR. *Jour. Fkln. Inst.*, 121:20 (Jan., 1886).

also had the sound vibrations modify the internal resistance of a battery.

93. Transmitters Based on Changing Dimensions of Solid Conductor.—Variations in the effective length of a solid conductor were tried by Edison,¹ Cuttriss,² and Ahearn.³ Variation of resistance, resulting from the diaphragm stretching a fine wire, thus changing both length and area, was proposed by C. R. Cross.⁴

94. Transmitter Based on Varying Magnetic Permeability.—Garrett and Lucas⁵ succeeded in making an operative transmitter based on the variation of magnetic permeability resulting from change of pressure upon nickel.

95. Transmitters Based on Variable Pressure.—Variation of resistance with pressure has been used as a basis for transmitters by many, since Beetz⁶ discovered that the resistance of platinum sponge varied with pressure. The variable resistance between a rounded metallic knob and a vibrating metallic plate was the basis of the much litigated Berliner⁷ patent, for which application was made in 1877. Edison⁸ claimed the variation of resistance within a mass of

¹ EDISON. U. S. Patent No. 203,013 (Apr. 30, 1878); *Jour. Fkln. Inst.*, 119:126 (Feb., 1885); *El. World*, 5:76 (Feb. 21, 1885).

² CUTTRISS. *El. World*, 21:150 (May 4, 1893).

³ MILLER. *American Telephone Practice*, fourth edition, p. 71.

⁴ CROSS. *Proc. Amer. Acad. Arts and Sci.* (Oct., 1885); *El. Rev. Lon.*, 17:412 (Nov. 14, 1885); *Elec. Eng. N. Y.*, 4:420 (Nov., 1885).

⁵ GARRETT and LUCAS. *Phil. Mag.* (5), 44:26 (July, 1897); *Elec. Lon.*, 38:837 (Apr. 6, 1897).

⁶ BEETZ. *Pogg. Ann.*, 31:620 (Oct., 1860); *El. World*, 9:164 (Apr. 2, 1887).

⁷ BERLINER. U. S. Patent No. 463,569, applied for June 4, 1877, issued Nov. 17, 1891.

See also U. S. Patent No. 233,969 (Nov. 2, 1880); caveat filed Apr. 14, 1877, see *Operator*, New York (Nov. 1, 1880); *La Lum. Elec.* (1), 7:283 (Sept. 16, 1882); *El. World*, 29:610 (May 15, 1897); 29:651 (May 22, 1897); 18:397 (Nov. 28, 1891); *Electricity*, New York, 10:133, 150, 170 (Mar. 11, 18, 25, 1896); 11:276 (Nov. 11, 1896); 12:276 (May 12, 1897).

⁸ EDISON. British Patent No. 2909 (July 30, 1877); U. S. Patent No. 474,231 (May 3, 1892); *Jour. of Telegraph*, New York (April, 1877, April 16, 1878); *Jour. Fkln. Inst.*, 119:131 (Feb., 1885); *El. World*, 5:76 (Feb. 28, 1885); 19:338 (May 14, 1892); *Encyc. Brit.* (9), 23:931; (11), 26:549.

carbon. Drawbaugh¹ may have used carbon powder in transmitters between 1866 and 1868. Hughes² in 1878 discovered the sensitiveness of the resistance in light contacts between conductors, and he revived the word "microphone" (from Greek words meaning "small sound") which had been used by Wheatstone³ in 1827, for an acoustic apparatus for magnifying feeble sounds. Ludtge⁴ seems to have made a similar discovery at about the same time as Hughes.

The first commercially successful carbon microphone transmitter was that of Francis Blake,⁵ in which a pellet of platinum attached to a light spring was pressed by the diaphragm against a flat button of carbon held in a somewhat heavy brass socket supported on a heavier spring, both springs being mounted on a flexibly supported arm by which the normal pressure could be adjusted. While the Blake transmitter came into extensive use for short telephone lines, it required occasional adjustment, and was not suitable for long distance work because it could carry but little current without disastrous burning of the carbon contact.

The Hughes carbon pencil microphone was developed in

KINGSBURY. *Telephone and Telephone Exchanges*, pp. 106-119. Longmans (1915).

For Edison's claims to priority over Hughes, see *Elec. Lon.*, 1:117 (July 27, 1878).

¹ DRAWBAUGH. *El. World*, 3:119 (April 12, 1884); compare also *Elec. Eng. N. Y.*, 3:234 (Nov., 1884); *El. World*, 4:229 (Dec. 6, 1884).

² HUGHES. *Proc. Roy. Soc. Lon.*, 27:362 (May 9, 1878); *Jour. Soc. Tel. Eng.*, 7:270 (May, 1878); *Proc. Phys. Soc. Lon.*, 2:255; *Phil. Mag.* (5), 6:44 (July, 1878); *Dingler Journal*, 229:147 (1878); *Sci. Amer. Supp.*, 5:2024, No. 127 (June 8, 1878).

PREECE and STUBBS. *Manual of Telephony*, p. 34.

See also references to anticipatory work collected by Tanner, in *Elec. Rev. Lon.*, 27:612 (Nov. 21, 1890); *El. World*, 16:419 (Dec. 13, 1890).

³ WHEATSTONE. *Quarterly Journal of Science* (1827). *Scientific Papers*, p. 34. London (1879); *Encyclopædia Britannica* (9), 23:931; (11) 26:549.

⁴ LUDTGE. German Patent No. 4000, issued Jan. 12, 1878; *Dingler's Polytechnisches Journal*, 229:148 (1878); 232:231 (1879); *Berlin Phys. Soc.* (April, 1878); *Elec. Lon.*, 1:109 (July 27, 1878); *Encyc. Brit.* (9), 23:140.

⁵ BLAKE. British Patent No. 229 (Jan. 20, 1879); U. S. Patents 250,126 to 250,129 (Nov. 29, 1881); *Sci. Amer.*, 41:274 (Nov. 1, 1879).

various ways, the most successful being those of Crossley¹ and Gower² in England and of Ader³ in France, pencils being coupled in multiple and in series to magnify the changes in the current.

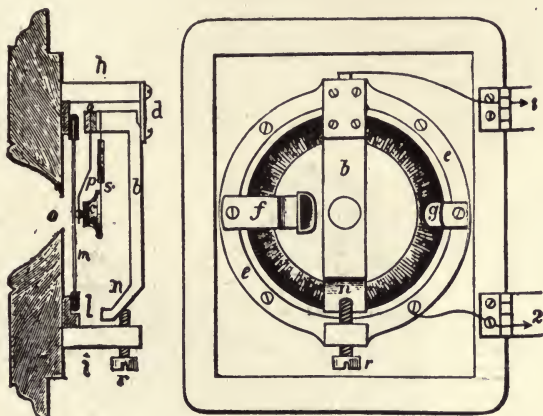

FIG. 23.—BLAKE TRANSMITTER (Obsolete)
(By permission McGraw-Hill Co.)

96. Granular Transmitters; Packing.—The granular type of transmitter seems largely due to Hunnings,⁴ who used finely divided carbon between the diaphragm and a back plate. The granular carbon transmitter was found to be subject to “packing” of the carbon, necessitating frequent shaking⁵ to

¹ CROSSLEY. British Patent No. 412 (Feb. 1, 1879); *Tel. Jour.*, 7:144, London (May 1, 1879).

PREECE and STUBBS. *Manual of Telephony*, p. 61.

POOLE. *Practical Telephone Handbook*, p. 76.

MILLER. *American Telephone Practice*, p. 57.

² GOWER. *Elec. Lon.*, 30:306 (Jan. 13, 1893).

PREECE and STUBBS. *Manual of Telephony*, pp. 62 and 106.

POOLE. *Practical Telephone Handbook*, p. 77.

³ PREECE and STUBBS. *Manual of Telephony*, p. 64.

POOLE. *Practical Telephone Handbook*, p. 77.

⁴ HUNNINGS. British Patent (Sept. 16, 1878); U. S. Patent No. 246,512 (Aug. 30, 1881); U. S. Patent No. 250,250 (Nov. 29, 1881).

POOLE. *Practical Telephone Handbook*, p. 78.

ABBOTT. *Telephony*, 5:163.

HOPKINS. *The Telephone*, pp. 45-48.

⁵ See § 106.

keep it in sensitive condition; the size of the carbon cell, which extended across the entire diaphragm, exaggerated the tendency to pack; it also tended to inefficiency, because of the small variation in the resistance of the outer zones of carbon where the motion of the diaphragm was a minimum.

These difficulties were largely overcome in the "solid back" transmitter invented by A. C. White¹ of the American Bell Telephone Company; in this transmitter,² which with minor

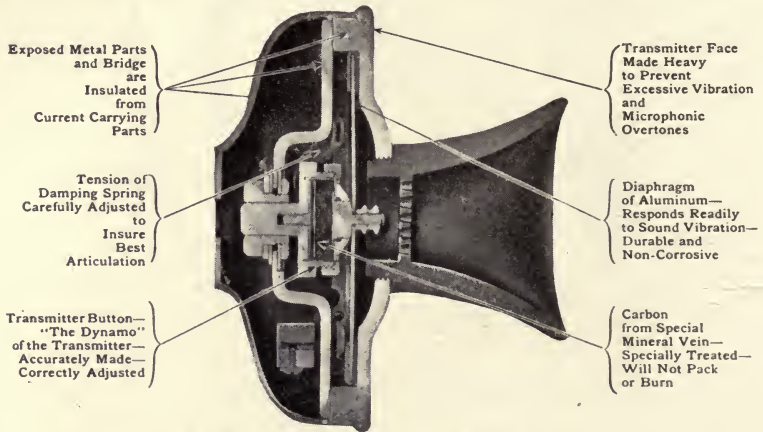

FIG. 24.—WESTERN ELECTRIC TRANSMITTER

modifications³ is in almost universal use today, the carbon cell has about one-third the diameter of the diaphragm, and is placed at the center where it is subjected to the maximum vibration.

The current taken by ordinary carbon transmitters averages from about 0.140 to 0.320 ampere, though some transmitters work well with as low as 0.050 ampere. When the current rises much above 0.250 ampere, the carbon cell is apt

¹ WHITE. U. S. Patent No. 485,311 (Nov. 1, 1892).

HOPKINS. *The Telephone*, pp. 51-54.

ABBOTT. *Telephony*, 5:164.

POOLE. *Practical Telephone Handbook*, p. 79.

² Note early approximations by Edison: *Elec. Lon.*, 2:3 (Nov. 23, 1878); 2:15 (Nov. 30, 1878); *Jour. Fkln. Inst.*, 119:129-131 (Feb., 1885).

³ Descriptions of various other transmitters will be found in the works of Abbott, Poole, Miller, and Vandeventer.

to become overheated, and the surfaces of both the electrodes and the granules become pitted and rough. By using grains of osmium-iridium alloy and gold-plated electrodes instead of carbon granules and electrodes, Brown¹ constructed a transmitter which easily carried 1.0 ampere indefinitely. Such a transmitter spoke as loudly and clearly at a distance of 12 inches from the speaker as did a good carbon transmitter when one spoke directly into the mouthpiece. By the use of

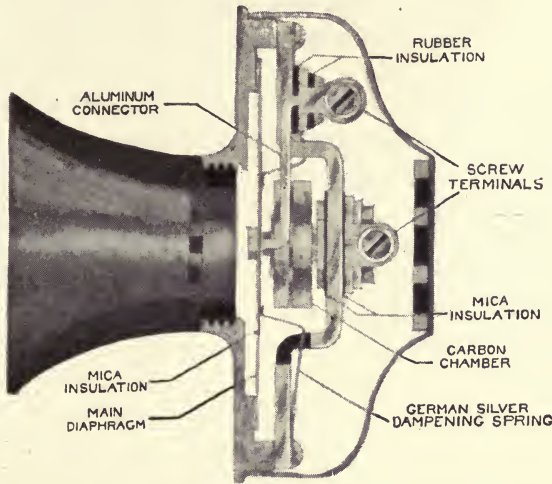

FIG. 25.—CRACRAFT-LEICH TRANSMITTER

water-jacketed platinum-iridium electrodes and carbon granules, Fessenden² constructed transmitters capable of carrying 15 amperes continuously and giving remarkably clear and perfect articulation, such construction being better adapted for special purposes than for general use.

97. Care Necessary for Uniformity in Transmitters; Great Sensitiveness not Generally Desired.—In the construction of the higher grade of transmitters, great care³ is taken to secure uniformity in the quality and dimensions of

¹ BROWN. *Jour. Inst. El. Eng.*, 45:590 (May, 1910); *Elec. Lon.*, 66:990.

² FESSENDEN. *Trans. Amer. Inst. Elec. Eng.*, 27:592 (June, 1908).

³ *El. Rev. & West. Elec.*, 58:764 (Apr. 15, 1911); *El. Rev. N. Y.*, 41:334 (Sept. 13, 1902); *Elec. Lon.*, 66:990 (Mar. 31, 1911).

the various parts; the carbon granules being screened to the right size and tested for correct hardness; the proper amount being insured by careful weighing or by volume measurement; the front and back carbon electrodes being carefully surfaced and polished like mirrors; the mica diaphragm for closing the carbon cells being selected for quality and thickness, the latter being required uniform to within 0.0003 inch.

Uniformity and durability are generally of more importance than is great sensitiveness, the latter being sometimes undesirable lest the transmitter be too responsive to the general noise¹ or "side tones" which should not be reproduced. It is difficult to carry on conversation from noisy places unless the transmitter is rather insensitive to room noises and requires that the speaker have his lips close to the mouthpiece and use a firm tone of voice. For country use and where there is little noise, a more sensitive microphone gives satisfaction.

98. Neither Air, Diaphragm, nor Carbon Essential to Microphone.—While practically every microphone in actual service depends on the action of sound waves through the air striking a diaphragm and changing the resistance of carbon contacts, it is an interesting fact that none of these elements is essential to the operation of the transmitter.

The air as a medium for the sound was found to be unnecessary in the Lowth² transmitter, in which the vibration was transmitted to the diaphragm by means of a light rod whose further end was held against the throat of the speaker. A modification constructed by the author would act as either transmitter or receiver when the rod was placed against the bones of the head.

The diaphragm is unnecessary in the transmitters based on the changing resistance of electric arcs³ or on the temperature⁴ coefficient. The diaphragm was claimed to be unneces-

¹ See § 99.

² LOWTH. U. S. Patents 312,365 and 312,366 (Feb. 17, 1885); *West. Elec. Chi.*, 3:104 (Sept. 1, 1888); *El. World*, 13:202 (Apr. 6, 1889).

See also *Elec. Lon.*, 76:40, Oct. 15, 1915.

³ See § 91.

⁴ See § 91, page 87.

sary¹ in the Edison carbon transmitter, and it seems likely that the Lowth² idea³ might be applied directly to the carbon cell of a modern transmitter.

The carbon contacts are unnecessary in a number of the miscellaneous experimental transmitters⁴ mentioned.

99. Diaphragm Action in Microphone Different from That of Receiver.—The performance of the diaphragm in the microphone is in some respects similar to that⁵ of the receiver. Having no magnetic action, there is no hysteresis loss to consider; as it is not limited to magnetic materials,

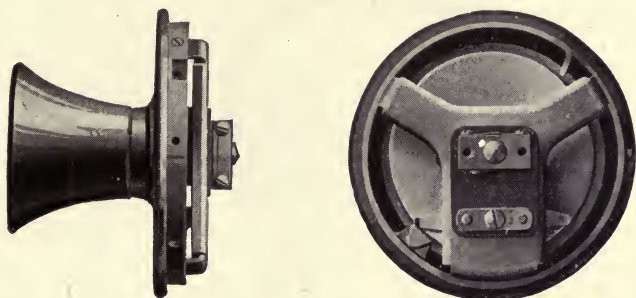

FIG. 26.—“TURKEY FOOT” TRANSMITTER
(Garford and Stromberg-Carlson)

light and elastic materials like hard rolled aluminum are available for use; not being subject to induced currents, its electrical conductivity is not considered. Differing from the receiver⁶ diaphragm, which is rigidly clamped all around the edges, the transmitter diaphragm is generally mounted loosely, being anchored at only a few points, and usually having a soft rubber seat. Instead of the loading by magnetic pull in the central region, the transmitter diaphragm carries more or less mass and pressure from the carbon cell electrode and its attachments. Instead of vibrating as a whole, the transmitter

¹ Encyc. Brit. (9), 23:931.

² See footnote on page 94.

³ See § 17.

⁴ See §§ 86-96. Metallic granules used by Brown. *Jour. Inst. Elec. Eng.*, 45:590 (May 5, 1910); *Elec. Lon.*, 66:990 (Mar. 31, 1911).

⁵ See §§ 79-81 and Appendix D.

⁶ See §§ 73, 75.

diaphragm generally vibrates in segments, these being determined by one or more damping springs whose function apparently is to lessen the sensitiveness¹ to general noise or "side tone." The complete theory of the microphone diaphragm is yet to appear.

100. **Methods of Damping Microphone Diaphragms.**—As indicating the lack of definiteness in knowledge of the

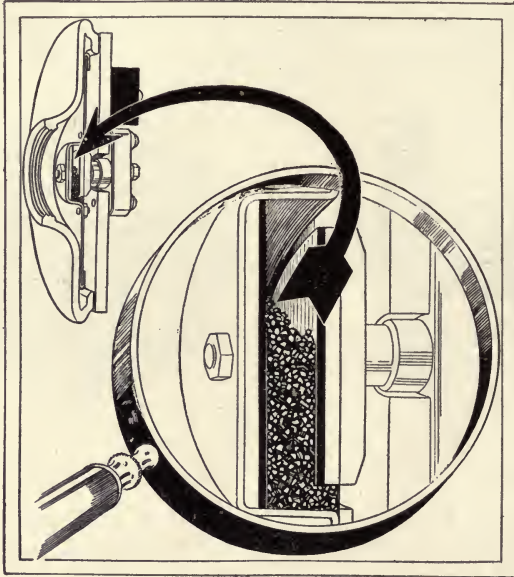

FIG. 27.—DETAIL OF KELLOGG TRANSMITTER

theoretical and actual performance of the diaphragm as applied to the microphone, some of the variations in practice may be noted.

In the Blake and solid back Bell² transmitters, the diaphragm rests on a soft rubber³ cushion; it is held at one point against the supporting ring by a rubber-cushioned spring; diametrically from this and about midway between the edge and center, it is pressed by a second rubber-cushioned spring

¹ See § 97.

² See §§ 95, 96, 120, 121.

³ WILSON. U. S. Patent 250,616 (Dec. 6, 1881).

whose force is adjustable by bending at the factory. In the Kellogg type of Dean¹ transmitter, the dampers are placed as in the Bell transmitter, except that each spring has a rubber or felt pad between it and the diaphragm. A cup for the carbon cell is pressed out from the center of the diaphragm, this changing the vibrating qualities. In a later Dean² transmitter, the damping is by a double spring with sharp feet which press at points on the same diameter about midway between the center and the edge; the diaphragm itself has the edge turned up, and the center is stamped into a flat cone which the damping springs tend to flatten.

The Monarch³ transmitter has four damping pads under the feet of springs, the diaphragm being struck up so that it has a stiff edge that "keeps the vibrating surface clear of the front and avoids the damping noted where the outer surface of the diaphragm comes in contact with solid; the edge has a wide base, to eliminate harsh tones."

The Randall⁴ transmitter has the diaphragm free at the edges, except two spring clips, "and may vibrate throughout its mass and not centrally only, which admits of truer and more natural vibration under the influence of the air waves impinging on it, and consequently obtains sharper and more natural voice transmission."

In the Mason⁵ transmitter,⁶ the carbon cell is mounted on springs independently of the main diaphragm, the pressure being transmitted to the diaphragm by means of two pins which "are purposely located at points outside the center of the diaphragm, preferably one-third the distance between the center and the edge thereof; the sound waves strike the diaphragm, the latter is set in vibration, which is of greater

¹ VANDEVENTER. *Telephonology*, p. 64.

ABBOTT. *Telephony*, 5:172.

² See § 123.

VANDEVENTER. *Op. cit.*, p. 65.

³ MONARCH. *Telephony*, 18:454. Chicago (Oct. 30, 1909).

⁴ RANDALL. U. S. Patent No. 970,288 (Sept. 13, 1910); *Telephony*, 60:142 (Feb. 4, 1911).

⁵ VANDEVENTER. *Telephonology*, p. 68.

⁶ See § 122.

force or amplitude at points beyond the center; these amplified vibrations are transmitted to the pins, so that the pins have an oscillatory motion, which is transferred to the cell."

The above practice and quotations from practical men in the telephone manufacturing business indicate varying ideas of the actual operation of the transmitter diaphragm. In some transmitters, the apparent intent is to damp out the free vibrations of the diaphragm; at the other extreme, a diaphragm stretched¹ somewhat like a drumhead is reported as giving improved performance and as increasing the limiting distance over which the transmitter will operate. For a while the tendency seemed to be² toward the use of a diaphragm of lower fundamental note, as giving greater rate of current variation for a given sound intensity, and as lessening the tendency to emphasize tones near the natural period of the diaphragm. The theory of the microphone diaphragm is an inviting field for experimental and mathematical research.

101. Secondary Transmitters or Amplifiers.—For use as secondary transmitters or amplifiers, the phenomena previously mentioned may be supplemented by others. Various combinations of receiver and transmitter have been proposed³ as telephone repeaters, somewhat analogous to the repeaters

¹ EGNER and HOLSTROM. British Patent No. 12,918 of 1909; *El. World*, 54:1057 (Oct. 28, 1909); *Elec. Lon.*, 64:229 (Nov. 19, 1909); 66:181 (Nov. 11, 1910); *Elec. Engineering*, London (Oct. 7, 1909).

² M. A. Edson, before Chicago Electrical Association; *El. World*, 42:970 (Dec. 12, 1903).

³ BROWNE. *Jour. Inst. Elec. Eng.*, 45:590 (May 5, 1910); *Elec. Lon.*, 75:99 (April 23, 1915).

KINGSBURY. Telephone and Telephone Exchanges, pp. 459, 460-461.

ADAMS-RANDALL. *Telephony*, 60:141 (Feb. 4, 1911).

GILLILAND. U. S. Patent No. 247,631 (Sept. 27, 1881).

GRISSINGER. *Telephony*, 64:7:35 (Feb. 15, 1913).

POLLAK. French Patent No. 939,625 (Nov. 9, 1909); *Telephony*, 18:541 (Nov. 20, 1909).

ROBINSON and CHAMNEY. *Elec. Lon.*, 73:761 (Aug. 14, 1914).

SHREEVE. British Patent No. 9605, of 1905; British Patent No. 9606, of 1905; U. S. Patent No. 835,037 (Nov. 6, 1906). *El. World*, 48:1205 (Dec. 22, 1906); *West. Elec.*, 43:26,33 (July 11, 1908); *Jour. Inst. El. Eng.*, 45:608 (May 5, 1910).

used in long telegraph circuits, most of them encountering insuperable difficulty in the attempt to operate in either direction indiscriminately.

Cooper Hewitt¹ obtained an amplifier by having the magnetic field from one circuit deflect a stream of mercury vapor and thereby change its resistance and the strength of the current.

The vacuum oscillation valve of Elster and Geitel² has been developed for use as an amplifier by Fleming,³ De Forest,⁴ Reisz and Lieben,⁵ Langmuir⁶ and others. De Forest's audion⁷ has been developed for transcontinental telephony, the details of which are not yet public.

¹ COOPER HEWITT. *El. World*, 64:1051 (Nov. 28, 1914).

² POOLE. *Practical Telephone Handbook*, p. 566. Macmillan (1910).

³ ELSTER and GEITEL. *Wied. Ann.* (1882-1889).

⁴ FLEMING. *Proc. Roy. Soc.*, 47:118 (1896); *Phil Mag.*, 42:52 (1896); *Proc. Phys. Soc. Lon.*, 20:177 (Mar. 23, 1906).

⁵ LEE DE FOREST. U. S. Patent No. 836,070 (Jan. 18, 1906); U. S. Patent No. 841,387 (Jan. 15, 1907); U. S. Patent No. 879,532 (Feb. 18, 1908); *Proc. Inst. Radio Eng.*, New York (Nov. 3, 1913); *Elec. Zeit.*, 35:222,699 (Feb. 19, June 18, 1914); *Elec. Lon.*, 72:285 (Nov. 21, 1913); *Elec. Lon.*, 72:726 (Feb. 6, 1914).

⁶ REISZ and LIEBEN. *Elek. Zeit.*, 34:1359 (Nov. 27, 1913); *Elek. Zeit.*, 35:222, 947 (Feb. 19, Aug. 13, 1914); *Elec. Lon.*, 72:726 (Feb. 6, 1914); *Elec. Lon.*, 72:956 (Mar. 13, 1914).

⁷ LANGMUIR. *Proc. Inst. Radio Eng.* (Sept., 1915); *Telephony*, 70:7:17 (Feb. 12, 1916); 70:8:26 (Feb. 19, 1916).

⁸ AUDION. *El. World*, 65:900 (April 10, 1915); *Elec. Lon.* (April 16, 1915).

CHAPTER VII

TELEPHONE TRANSMITTER INVESTIGATIONS

102. **Physical Theories for the Microphone.**—The physical theory of the carbon microphone has been the subject of some controversy. Blyth¹ held that the action was that of minute arcs² between the carbon surfaces. Munro³ concluded that there was a sort of “silent discharge” through the film of air at the contacts. Edison⁴ claimed that the internal resistance of the carbon varied. Thomson⁵ thought that the area of contact varied with pressure, a view previously expressed by Rayleigh.⁶ Berliner⁷ and Heaviside⁸ held that air was condensed at the surface of each carbon particle, which air was squeezed out more or less by the varying pressure. Bidwell⁹ suggested that internal heat due to the current had much to do with it, perhaps somewhat like the Trevelyan¹⁰ rocker. Stroh,¹¹ following Probert and Soward,¹² held that the repellant action of the current at the points of contact helped vary the thickness of the thin layer of air; along a somewhat similar line, Lodge¹³ notes that electrostatic attraction be-

¹ BLYTH. See footnote on page 87.

² See § 91.

³ MUNRO. *Jour. Soc. Tel. Eng.*, 12:123 (Mar. 8, 1883).

⁴ EDISON. See footnote on pages 89, 90.

⁵ THOMSON. *Jour. Soc. Tel. Eng.*, 12:123 (Mar. 8, 1883).

⁶ RAYLEIGH. *Proc. Roy. Soc. Lon.*, 27:362 (1878).

⁷ BERLINER. *Elec. Lon.*, 10:135 (Dec. 23, 1882); *Amer. Elec.*, 9:91 (Mar. 7, 1897).

⁸ HEAVISIDE. *Elec. Lon.*, 10:293 (Feb. 10, 1883); *Electrical Papers*, 1:181. Macmillan (1892).

⁹ BIDWELL. *Jour. Soc. Tel. Eng.*, 12:173 (1883); *Proc. Roy. Soc. Lon.*, 35:1 (1883).

¹⁰ Trevelyan rocker. See treatises on physics or on heat.

¹¹ STROH. *Jour. Soc. Tel. Eng.*, 16:101 (Feb., 1887).

¹² PROBERT and SOWARD. *Jour. Soc. Tel. Eng.*, 12:205 (1883).

¹³ FLEMING. *Principles of Wave Telegraphy*, p. 377. London (1910).

tween conducting particles of carbon may introduce forces of considerable magnitude: Fessenden¹ combats the film idea.

The well-known power of freshly heated charcoal to absorb many times its own bulk of air invites the belief that its attraction for air may easily be sufficient to condense a superficial layer to the density required for fair conductivity, the resistance of such a film of possibly liquefied air varying with the thickness.

103. Relations Between Pressure and Resistance in Microphone.—Considerable experimental work has been done to determine the relations between pressure and resistance in a microphone. Shelford Bidwell² showed that the curve of pressure and resistance was nearly quadratic. Quantitative tests of resistance in microphones of the Blake type were conducted by Cross.³ Published data from similar tests of modern transmitters of the carbon cell type seem to be wanting. Here seems to be a fruitful field for investigation.

104. Vagaries in Resistance of Carbon Microphone.—The microphone cell with carbon electrodes and granules seems to have some vagaries which are not thoroughly understood. When not subjected to noise or other vibration, the quiet resistance and the fall of potential vary considerably, apparently being gravely influenced by the condition in which the cell was left at the previous use. The steady current is likely to change⁴ considerably during the first few minutes of use, as though the heat from the current changes the internal resistance, possibly by varying the pressure between the granules. Generally the steady portion of the current has a different value during use from that at rest. The resistance is liable to change with use, generally getting less, but some-

¹ FESSENDEN. *Amer. Elec.*, 9:46 (Feb., 1897); 9:163 (May, 1897).

² BIDWELL. See footnote on page 100.

³ CROSS. *Proc. Amer. Acad. Arts and Sci.*, 24:90 (Nov., 1889).

HOPKINS. *The Telephone*, pp. 35-44.

⁴ CLARK. *Phys. Rev.*, (2), 1:50 (Jan., 1913); (2), 5:21 (Jan., 1915); *El. World*, 65:479 (Feb. 20, 1915).

See also § 105.

times getting several fold greater than when new. Access of moisture to the carbon cell has deleterious effects on its performance, and therefore modern transmitters have cells made as nearly moisture-proof as practicable.

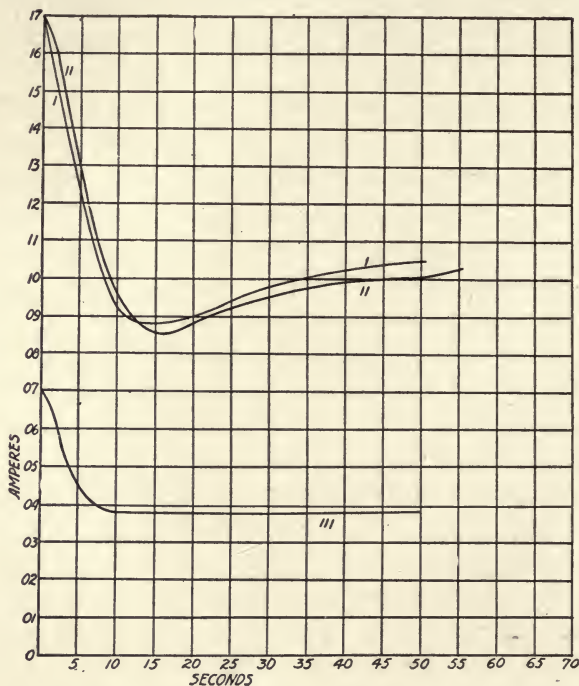

FIG. 28.—CHANGE OF MICROPHONE RESISTANCE WITH TIME
I and II—Current through transmitter in normal condition. III—Current after vigorous shaking. (Edelmann and Gannett)

105. **Experimental Studies of Microphone Resistance.**
—The rapid changes in the resistance of a carbon microphone may be shown by student experiments. Fig. 28 shows the variation of current due to changes in the resistance in a quiet transmitter of the type known as 229-W. After taking the reading for Curve I the current was cut off and the carbon cell allowed to cool off.

A second run, Curve II, was then made, giving a close duplicate of Curve I. After cooling again, the transmitter

was vigorously shaken and a third set of readings taken, Curve III, with quiet transmitter. Current was measured by a Weston mil-ammeter, readings being taken at intervals of two seconds, by Edelmann and Gannett, junior students at the University of Minnesota.

These curves agree in general with the results obtained by Clark.¹ They show a rapid change in resistance during the first fifteen or twenty seconds, after which the resistance becomes fairly constant.

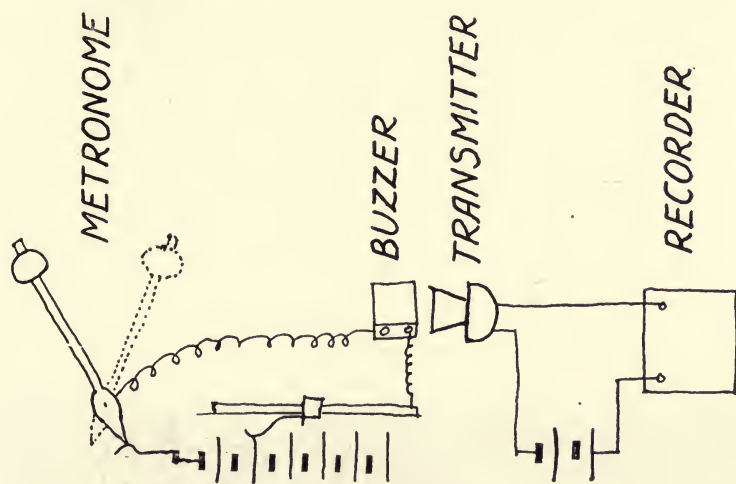

(Johnson and Jones)

FIG. 29.—CIRCUITS FOR MICROPHONE TEST

In order to show the effect of noise, a buzzer was fastened to the mouthpiece of a 229-W transmitter and was switched on and off once a second by means of a contact device attached to a metronome. A continuous record of the current was obtained by means of a Springer² spark recorder. The curve, Fig. 30, shows the transmitter current steady at first, then falling off,³ due to increased resistance when the

¹ CLARK. See footnote on page 101.

² SPRINGER. *El. World*, 46:16 (July 1, 1905); 48:34 (July 21, 1906); *Standard Handbook*, 3:230, third edition.

³ JOHNSON and JONES. "Studies with Spark Recorder," 1915 thesis in library at University of Minnesota.

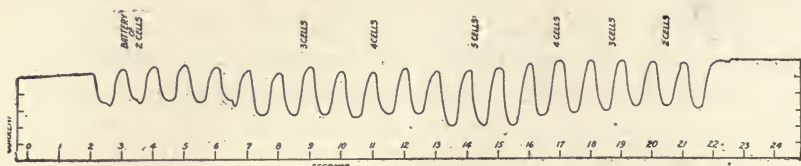

FIG. 30.—CHANGE OF MICROPHONE RESISTANCE WITH NOISE
(Exaggerated.) (Johnson and Jones)

buzzer is operated. By applying 2, 3, 4, and 5 dry cells to the buzzer, the disturbance is magnified, as shown by the successively increasing steps. These disturbances, which illustrate the changes of current during intermittent conversation, are greatly magnified in the figure, the sound vibrations reaching the diaphragm through the air being strongly reinforced by other vibrations reaching the microphone cell through the solid parts of the transmitter.

Fig. 31 is a record by the more sensitive oscillograph, taken by G. A. Hult, student at the University of Minnesota, showing rapid cyclic variations in the current through a trans-

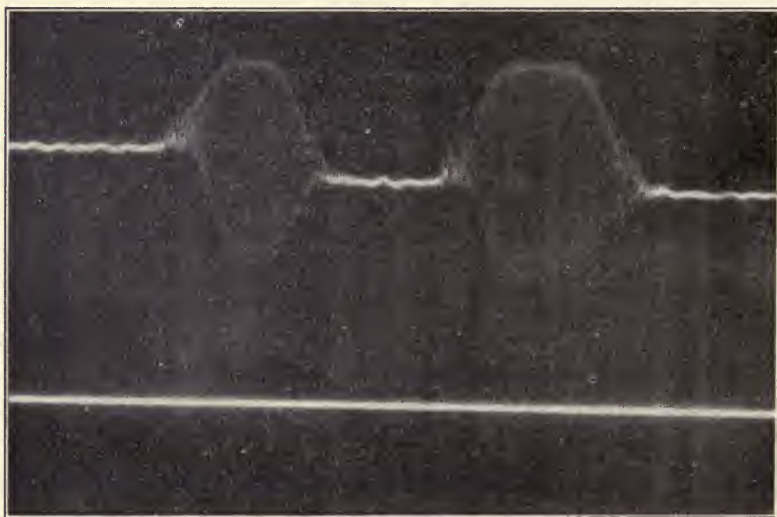

FIG. 31.—MICROPHONE CURRENT CHANGES BY SOUND
(Hult)

mitter due to two short blasts from an organ pipe near the mouthpiece. The steady current is seen to have different values before and after the noise, illustrating the general instability of the resistance of a quiet transmitter. (During the time of the blasts, the mirror on the oscillograph sent the spot of light across the field so fast that the photographic film was able to record only the turning points.)

106. Packing and Aging of Microphones.—The phenomenon¹ known² as “packing” in the microphone cell has given considerable trouble and has received corresponding attention. A packed transmitter has its resistance lowered, and it becomes less sensitive to variations in pressure from the vibrations of the diaphragm. When a transmitter thus ceases to work properly, it may usually be restored by vigorous shaking or jarring, indicating that the carbon granules have become wedged. Packing sometimes seems to be due to the use of granules of differing size, the smaller ones gradually settling into the interstices between the larger ones and wedging into a nearly solid mass. In other cases the granules, which may have been of equal size originally, seem to have become broken. The remedy evidently lies in the choice of more uniform and durable granules. In other cases the entrance of moisture into the carbon chamber seems responsible, for which source of trouble a more nearly weatherproof construction is a remedy. In some cases the resistance of a transmitter rises to many times its original value after several years of service, sometimes reaching as high as 1,000 ohms; such excessive resistances suggest loosened or corroded contacts or loss of carbon granules.

Excessive outward travel of the diaphragm, such as is sometimes caused maliciously by placing the mouth over the transmitter mouthpiece and sucking in the breath, will sometimes

¹ See HOPKINS. *The Telephone*, pp. 32-33, 48-53.

MILLER. *American Telephone Practice*, p. 71.

ABBOTT. *Telephony*, 5:163, 215.

FESSENDEN. *Trans. Am. Inst. El. Eng.*, 27:592 (June, 1908).

² See also § 96.

cause the carbon granules to settle and wedge in the lower part of the carbon chamber. Such tampering may be nullified by vent holes. The packing is automatically corrected by some transmitters in which the carbon cell is a part of the diaphragm, and it is unusually remediable by rotating and shaking the transmitter.

107. Microphone Amenable to Mathematical Treatment; Four Methods Available.—The comparatively large element of uncertainty in the resistance of the carbon cell microphone would seem at first thought to be an insuperable obstacle to the development of any reliable mathematical theory of its performance. Fortunately, the changes in the “steady” resistance are rather slow and have comparatively little effect upon the pulsations of resistance due to the vibration of the diaphragm and upon the resulting pulsations of current through the microphone.

When the microphone constitutes a large part of the resistance of the circuit, as when local batteries are used with each transmitter, an induction coil usually transforms the pulsations of the direct current into alternating currents which are proportional to the changes rather than to the total amount of the current.

When the microphone is used on a central energy system, the resistance of the transmitter is a rather small part of the whole, so that comparatively large slow changes in its resistance do not have a formidable effect. It seems safe to conclude that although the value of the steady or quiet microphone resistance may not be a fixed definite quantity from hour to hour or from year to year, it may nevertheless be justifiably considered as fixed for a short time.

Conclusions drawn from mathematical theories based on the assumption that the resistance of the microphone consists of a definite steady part and a periodic part may therefore be looked upon with assurance as showing the general trend, even though the quantitative results involve a “constant” resistance difficult to evaluate.

The performance of the microphone may be considered

mathematically in four ways or steps: (a) assuming a circuit having resistance only, without inductance or capacity; (b) taking account of induction and using an approximate method; (c) taking account of induction and using a more rigid method; (d) assuming the desired form of current and determining the required form of resistance variation.

108. Microphone in Series with Simple Resistance; Clearness Improved by Resistance.—(a) Assuming that a

sinusoidal sound sets up sinusoidal motion of the diaphragm, which in turn causes sinusoidal variation of pressure in the carbon cell and consequently sinusoidal variation in the resistance therein, the elementary form of Ohm's law indicates the current in a circuit without inductance or capacity to be

$$I = \frac{E}{R + r \sin \omega t} = \frac{E}{R \left(1 + \frac{r}{R} \sin \omega t\right)}$$

in which R is the steady resistance and r is the maximum variation from R . In this, as in the later developments, the resistance represented by R is that of the entire talking circuit of which the transmitter is a part. (In the general case, where the circuit includes induction and repeating coils, R includes also more or less of vicarious or equivalent resistance representing the energy transferred through the coils.) Generally speaking, the larger the ratio of the transmitter resistance to that of the total circuit, the larger will be the ratio r/R .

The denominator may be developed as a series by the relation¹

$$\frac{1}{1+x} = 1 - x + x^2 - x^3 + x^4 - \text{etc.}$$

$$I = \frac{E}{R} \left(1 - \frac{r}{R} \sin \omega t + \frac{r^2}{R^2} \sin^2 \omega t - \text{etc.}\right)$$

The squared terms indicate components of higher than fundamental frequency,² for

¹ Series developed in textbooks on algebra.

² See textbooks on trigonometry.

$$\sin^2 \omega t = \frac{1}{2} (1 - \cos 2\omega t).$$

The smaller the ratio r/R the smaller will be the disturbing influence of the terms of higher orders, but the less will be the energy efficiency. The effect of a comparatively large series resistance in reducing the intensity of the higher harmonics was clearly brought out in oscillograms published by Blondel¹ and Polak in 1913. They also found that the relative strength of the higher harmonics was influenced by the microphone carbon, granules favoring harmonics more than did carbon filings.

109. Approximate Solution for Microphone Circuit with Induction.—(b) Applying the above general equation to the usual circuit having inductance involves differential terms, since E is no longer a simple constant, as developed in Appendix G. The term E includes the counter-electromotive forces about the inductive portions of the circuit, which are proportional to the rate of change of current; E also includes the voltage drop through non-inductive portions, which is proportional to the current itself. These complications seem to have staggered early investigators.

Wietlisbach² gives curves plotted from a number of calculations, showing that if the steady part of the resistance is five times the maximum value of the variable part, the resulting current variation is closely sinusoidal.

An approximate solution³ gives⁴

$$\begin{aligned} I &= I_0 + \frac{I_0 r \sin(\omega t - a)}{\sqrt{R^2 + L^2 \omega^2} - r \sin(\omega t - a)} \\ &= I_0 + \frac{I_0 r \sin(\omega t - a)}{Z - r \sin(\omega t - a)} \end{aligned}$$

in which R is the steady resistance with quiet diaphragm, r

¹ BLONDEL and POLAK. *Annales des Postes, Télégraphes et Téléphones* (Dec., 1913); *Elec. Lon.*, 73:99 (Apr. 24, 1914).

² WIETLISBACH. *El. Eng. Chi.*, 11:3 (Jan., 1898); *Handbuch der Telephonie*, p. 21.

³ Solution suggested by NOEBELS, JENTSCH and SCHLUCKEBIER. *Telegraphie und Telephonie*, p. 495.

⁴ See development in Appendix G.

is the maximum variation therefrom, L is the equivalent inductance in the circuit, and $\omega = 2\pi f$ in which f is the number of complete cycles per second.

110. **Conclusions from Approximate Solution; Impedance Desirable; Clearness and Strength Incompatible.**—This equation shows that as the impedance Z of the circuit increases, the sine term in the denominator becomes relatively unimportant, and the expression for current approximates more and more closely the desired form:

$$I = I_0 + \frac{I_0 r \sin(\omega t - a)}{\sqrt{R^2 + L^2 \omega^2}}$$

consisting of the steady current I_0 with the addition of a sinusoidal component, which latter component should develop a sinusoidal electromotive force in the secondary or line circuit.

The full equation of § 109 indicates that, for faithful transmission of the sound, the impedance of the circuit should be large, or the variable part of the resistance should be small. Either condition results in the variable part of the current being small as compared with the steady part, and forces the conclusion that clearness and strength are incompatible in the telephone transmitter. Similar conclusions are reached in § 72 and in § 114.

This conclusion is corroborated by tests made¹ for the American Bell Telephone Company, to determine the faithfulness with which various speech elements are transmitted over telephone circuits.

“While it is obvious that the telephone seriously distorts speech waves, nevertheless even those consonants which most nearly resemble each other are not distorted sufficiently to be undistinguishable. Tests indicate that the greater part of the distortion occurs in the subscribers’ sets, and that a short length of line may actually improve intelligibility as compared with zero line.”

¹CAMPBELL. *Phil. Mag.* (6), 19:155 (Jan., 1910).

111. Further Conclusions; High Electromotive Force Desirable; Large Current Desirable for Long Distance.

—The equation of § 109 shows further that with a given circuit and with a given resistance variation in the transmitter, the resemblance of the current variation to the diaphragm variation is enhanced by larger circuit impedance and by corresponding increase in the battery voltage. Thus, central energy systems with 48-volt battery should have more distinct transmission than those with 24-volt battery, impedances being in proportion and other conditions being equal. This is known to be true in the case of at least one city where competing telephone companies use 24 and 48 volts respectively.

The equation shows further, that with given variation of resistance, the variation of current is proportional to the steady current. Consequently, for powerful transmission, it is desirable to increase the current up to the limits of heating in the transmitter and elsewhere, keeping within the limit where the receiver diaphragm begins to strike and produce the effect usually ascribed to "speaking too loudly into the transmitter."

This conclusion is corroborated again by the practice of the American Telegraph and Telephone Company in using 48 volts on local apparatus when talking over long toll lines, though 24 volts is used on local service in most of the exchanges.

112. Further Conclusions; High Pitch Tones Favored.

—The equation of § 109 shows further that the larger $L^2\omega^2$, the less the relative value of the sinusoidal term in the denominator; that is, sounds of high frequency are transmitted more faithfully than those of low frequency, other things being equal; for high frequency increases the relative value of the line impedance, and this conduces to closer approximation of current wave to received sound wave. This appears to be the explanation of the general belief that a woman's voice "carries better"¹ over the telephone circuit than does

¹ MARAGE. *Jour. de Phys.*, 7:298 (April, 1908).

a man's voice, in spite of the greater attenuation¹ of the higher frequencies in the line itself (the clearer articulation of the trained operator being no small factor).

113. **Rigid Solution for Microphone with Induction and Resistance.**—(c) Taking account of induction in the circuit, and using more rigorous mathematical processes, including the expansion of exponential factors by means of the exponential series, similar solutions have been derived by B. V. Hill² and independently by the writer.³ With these solutions, however, difficulty is experienced when actual values are substituted for the symbols. The exponential series involved in the solution,

$$e^x = 1 + x + \frac{x^2}{1 \cdot 2} + \frac{x^3}{1 \cdot 2 \cdot 3} + \text{etc.},$$

is convergent from the first if x equals unity or less; but if x is greater than unity, the series is divergent until the term expressed approximately by

$$\frac{x^x}{1 \cdot 2 \cdot 3 \cdots x}$$

is reached, after which it becomes convergent. With data

¹The literature regarding attenuation is somewhat extensive, and the treatments somewhat complex. Some of the more easily followed discussions are:

FRANKLIN. *Jour. Fkln. Inst.*, 160:51 (July, 1905).

EDDY. *Science* (NS), 16:457 (Sept. 19, 1902).

DRYSDALE. *Elec. Lon.*, 60:277, 316, 359, 392, 468 (1907-1908).

ROEBER. *El. World*, 37:440, 477, 510 (Mar. 16, 23, 30, 1901).

JACKSON. *Alternating Currents and Alternating Current Machinery*, p. 938.

POOLE. *Practical Telephone Handbook*, chap. 26.

KENNELLY. *Application of Hyperbolic Functions to Electrical Engineering Problems*, chap. 8. University of London (1912).

FLEMING. *Propagation of Electric Currents in Telephone and Telegraph Conductors*. Van Nostrand (1911).

PUPIN. *Trans. Amer. Inst. El. Eng.*, 16:93 (Mar., 1899); 17:445 (May, 1900).

²HILL. *Phys. Rev.*, 28:70 (Jan., 1909); *Telephony*, 16:506 (Nov. 21, 1908); 17:42, 73 (Jan. 9, 16, 1909).

³SHEPARDSON. "Equivalent Frequency of Telephone Currents," 1912 thesis in library of Harvard University, pp. 29, 219.

applicable¹ to ordinary cases, the series is divergent for so many terms as to be unwieldy.

A similar development² by the writer, using the Fourier series, also gives a long series which is divergent for a number of terms.

114. Microphone Equation by Inverse Method; Double Frequency Term; Power and Clearness Incompatible.—

(d) The most satisfactory solution of the microphone equation seems to be that derived by the inverse method,³ by assuming a sinusoidal current and then determining the conditions required for obtaining it. An extension of this method⁴ shows that the divergence from sinusoidal variation of resistance required by the inverse theory is precisely what results from factors heretofore ignored. The required variation of resistance is found to be:

$$r = R - K \sqrt{R^2 + L^2 \omega^2} \left\{ \sin(\omega t + \phi) + \frac{K}{2} [\cos(2\omega t + \phi) - \cos \phi] \right\}$$

in which R is the steady resistance, in which $\tan \phi = \omega L/R$ and in which K is the ratio between the steady current and the variation therefrom.

Thus the resistance variation required for producing a sinusoidal variation of current consists mainly of a sine wave of fundamental frequency, to which are added a double frequency component having a maximum value $K/2$ times that of the fundamental, and another component which is of steady value for any given frequency and whose maximum value is $K/2$ times that of the fundamental.

Thus, the smaller the relative value of the alternating current compared with the steady direct current through the

¹ ANDEREGG. *Telephony*, 17:106 (Jan. 23, 1906).

POOLE. *Practical Telephone Handbook*, p. 593.

² SHEPARDSON. *Op. cit.*, p. 226.

³ Inverse method, suggested by ANDEREGG in *Telephony*, 17:105 (Jan. 23, 1909); developed further herein in Appendix H.

See also discussion by SHEPARDSON. *Trans. Amer. Inst. El. Eng.*, 31:1425 (June, 1912).

⁴ See Appendix H.

transmitter, that is, the smaller the value of K , the more nearly will a sinusoidal variation of resistance produce a sinusoidal variation of current. This is precisely in agreement with the results indicated by the approximate equation of §108. It emphasizes the well-known fact that with the usual form of microphone, power and clearness¹ are divergent characteristics.

115. Required Resistance Variation Dependent on Impedance and on Frequency; Partial Compensation by Characteristics of the Ear; Unsymmetrical Vibration of Diaphragm not Undesirable.—The presence of ω , or $2\pi f$, in the coefficient of the trigonometric term, combined with L , shows that for a given amplitude of alternating component of the current, the variable resistance r should decrease as the impedance of the circuit increases. Moreover, for a given amplitude of current, the resistance variation depends on the frequency; this is compensated by the greater sensitiveness of the human ear² for sounds of higher frequency, within ordinary limits of frequency.

Anderegg³ has computed curves for a circuit in which $R = 100$, $L = 0.02$, $K = 0.1$, $\omega = 5,000$, showing that, for a sinusoidal induced current, the combination of the components of required resistance variation gives a resultant curve which is higher than the fundamental sine curve on one maximum and which is lower at the antipode. Although Anderegg seems not to have appreciated the point, this is precisely what should be expected in the microphone. For it has been assumed, usually tacitly, that the diaphragm executes a sinusoidal vibration under the impulse of a received sinusoidal sound; whereas the opposition due to the varying pressure upon the carbon granules is a maximum at one extreme of diaphragm travel and a minimum at the other. The varying opposition to diaphragm travel, therefore, is precisely the qualification needed to modify the resistance variation in the car-

¹ See § 110. Compare § 72.

² See § 13.

³ ANDEREGG. See footnote on page 112.

bon cell, so that the impingement of a sinusoidal sound upon the microphone diaphragm may give rise to a sinusoidal current variation.

116. Variation of Transmitter Sensitiveness with Pitch of Sound; Experimental Difficulties.—Some work has been done to determine the effect of pitch or frequency upon the relative sensitiveness of the microphone transmitter. Such investigations involve difficulty of separating the influences

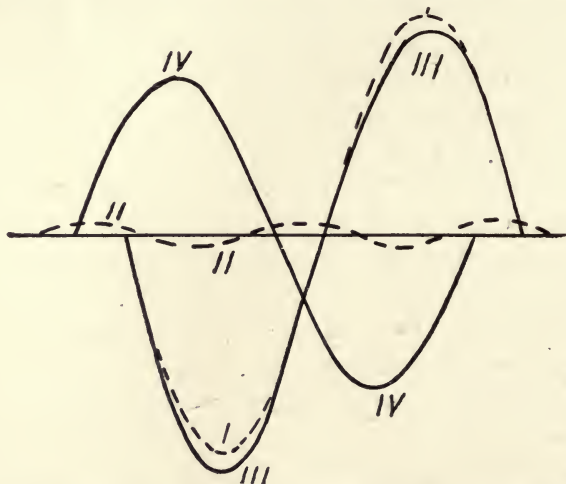

FIG. 32.—RESISTANCE VARIATION REQUIRED FOR SINUSOIDAL CURRENT IN TRANSMITTER

I—Sinusoidal resistance variation. II—Double-frequency resistance variation. III—Combined resistance variation. IV—Resulting sinusoidal current. (Anderegg.)

of the mechanical properties¹ of the diaphragm (including mounting, damping, and load) and of the microphone cell, the acoustic effects of the air chambers in the transmitter (including mouthpiece), acoustic resonance in the laboratory spaces, variations in character of the exciting sound with changes of pitch, and electrical resonance.²

117. Early American Studies.—Apparently the first systematic study of variation of transmitter sensitiveness with

¹ See § 100.

² See § 211.

pitch was that begun under the author's direction in 1906-1907 by Eddy¹ and Thornton, using a siren as source of sound. While this preliminary study was somewhat crude, they found maximum sensitiveness at 470, 900, and 1,860 periods per seconds, and minima at 400, 800, and 1,600 periods. Changing the mouthpiece affected the frequencies for maxima and minima.

The Minnesota studies were continued in 1907-1908 by Bachrach and Schildt,² using organ pipes as sound sources. They found marked maxima and minima when the apparatus was in a room with wooden walls; but when the pipes and transmitter were placed out of doors on a still night, no minimum was found within the available range from 256 to 576 vibrations.

118. European Studies.—In 1907 A. Campbell³ reported marked maxima and minima, using an adjustable stopped organ pipe as sound source and measuring with static voltmeter across an induction coil. The quality of sound from a stopped organ pipe varies with the position of the plug. He may have had electrical resonance.

In 1910 Bela Gati⁴ used a variable condenser adjusted for each frequency so as to get maximum current by resonance. Seven transmitters showed only one maximum each within the range of his tests, four of them being at 700, two at 650, and one at 600 periods per second. Three transmitters showed two maximum values each, one being at 300 and at 700, one at 700 and 800, and one at 700 and 1,000 periods per second.

119. Later American Studies.—In 1912 Meyer and Whitehead⁵ mechanically drove a microphone diaphragm by

¹ EDDY and THORNTON. "Study of Telephone Ringers and Pole-Changers," 1907 thesis in library of University of Minnesota.

² BACHRACH and SCHILDT. "Effect of Sound on Telephone Transmitters," 1908 thesis in library of University of Minnesota.

³ CAMPBELL. *Jour. Inst. El. Eng.*, 39:534 (May, 1907).

⁴ GATI. *Proc. Int. Cong. Tel. Eng.* Paris (1910); *Elec. Lon.*, 66:456 (Dec. 30, 1910).

⁵ MEYER and WHITEHEAD. *Trans. Am. Inst. El. Eng.*, 31:1411 (June, 1912).

means of a telephone receiver operated by alternating current of adjustable frequency, and obtained oscillographic simultaneous records of the driving current and of that which a battery sent through the microphone. These show flattening of the microphone current at one end of the vibration, due¹ partly to increasing mechanical resistance² within the carbon cell and partly to irregularities³ from the use of excessive

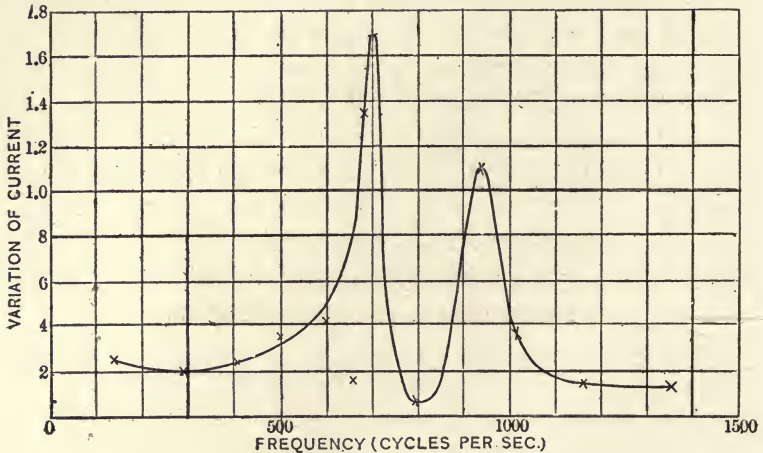

FIG. 33.—SENSIBILITY CURVE FOR MICROPHONE
(Meyer and Whitehead. *Trans. Am. Inst. El. Eng.*)

current through the telephone receiver used as driving power. Their derived curve for variation of microphone current change with frequency was influenced more or less by the greater sensitiveness of the driving receiver⁴ at certain frequencies.

In 1911-1912, the author⁵ renewed the study, using a siren driven by shunt-wound motor and storage battery with regulating resistances, speed being measured by a flexibly con-

¹ See also SHEPARDSON. *Trans. Am. Inst. El. Eng.*, 31:1425 (June, 1912).

² See § 115.

³ See SHEPARDSON. *Trans. Am. Inst. El. Eng.*, 31:1419 (June, 1912).

⁴ See § 66.

⁵ SHEPARDSON. "Equivalent Frequency of Telephone Currents," 1912 thesis in library of Harvard University.

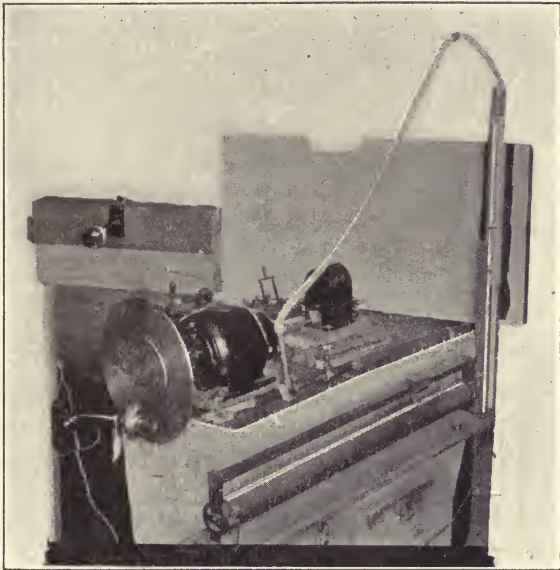

FIG. 34.—SIREN USED IN AUTHOR'S TESTS

nected magneto generator and voltmeter, the air pressure being regulated by valve and U-tube manometer. The transmitter current, from storage battery with rheostat, passed

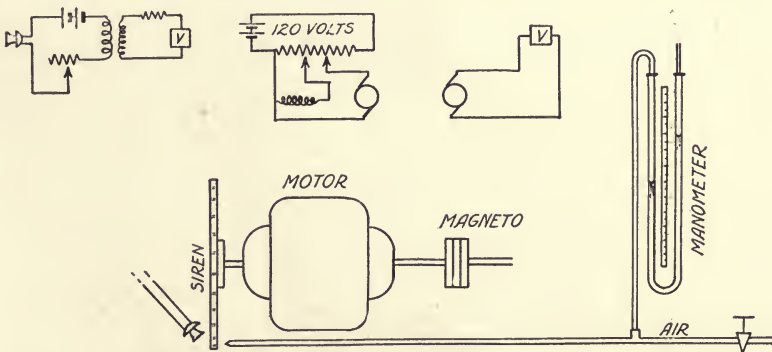

FIG. 35.—DIAGRAMS OF APPARATUS USED IN AUTHOR'S TESTS OF TRANSMITTERS

through the coarse winding of an induction coil, to whose fine wire winding was connected either a high resistance heater of a thermogalvanometer or an electrostatic voltmeter with

megohm resistance to avoid resonant rise. Results were fairly satisfactory, after overcoming certain experimental difficulties, and curves were plotted in terms of puffs of air per sec-



FIG. 36.—SENSIBILITY CURVE OF A BELL TRANSMITTER

ond and of voltage in the fine wire winding of the induction coil. Although not entirely free from suspicion of distortion

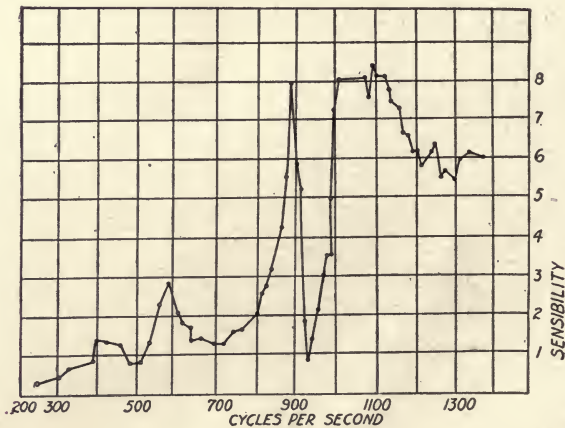

FIG. 37.—SENSIBILITY CURVE OF ANOTHER BELL TRANSMITTER

by acoustic resonance, some of the results are presented in §§ 120 to 123 following.

120. **Effect of Frequency on Sensitiveness of Bell Transmitters.**—One of the Bell¹ transmitters, Fig. 36, showed clearly defined maxima at 300, 460, 910 and 1,120 periods, and minima at 360, 540, 1,170 periods, with a wide valley between 600 and 740, and a series of minor maxima and minima at frequencies above 1,100. Another Bell transmitter,

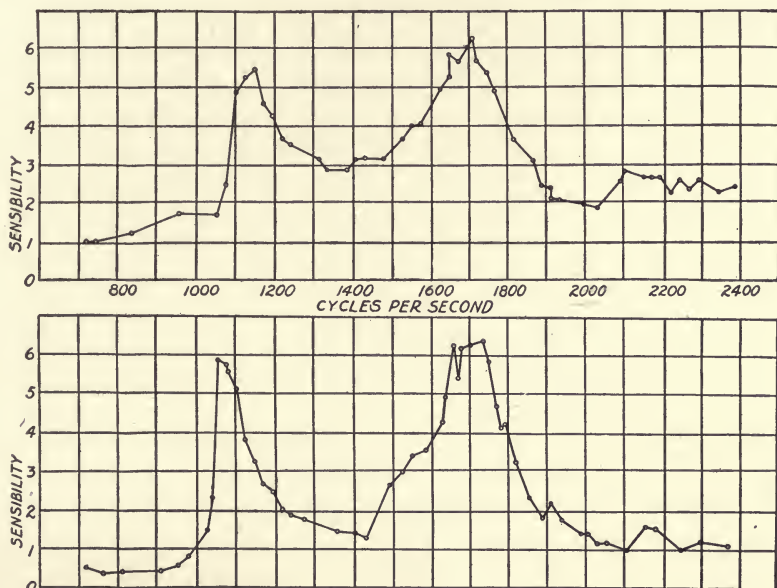

FIG. 38.—SENSIBILITY OF TRANSMITTER AS AFFECTED BY POSITION OF DAMPING SPRING

Fig. 37, showed maxima at 300, 410, 510, 575, 870, 970, 1,035, 1,085, 1,130, 1,140, 1,275, with minima at 380, 480, 540, 700, 910, 1,015, 1,060, 1,105, 1,260, 1,325, the wide valley about 700 and the narrow chasm at 1,010 with principal peaks at 970 and 1,080 being prominent.

121. **Effect of Damping on Sensitiveness of Bell Transmitter.**—For testing the effect of the damping spring which presses against the Bell diaphragm about midway between the center and circumference, runs were made with the spring in its usual position (lower curve in Fig. 38), and with the

¹ See § 100.

spring removed to the edge of the diaphragm (upper curve). The first pronounced peak of maximum sensitiveness is shifted from 1,060 with the damper in its usual position, to 1,150 with the damper at the side, confirming in a general way other tests. The region of maximum sensitiveness about 1,700 periods per second does not seem to be affected by the shifting of the damper.

To try the effect of the adjustment of the force of the

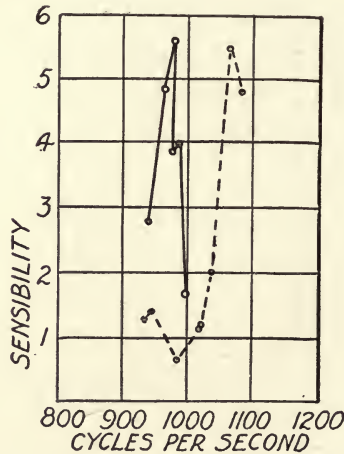

FIG. 39.—SENSIBILITY OF TRANSMITTER AS AFFECTED BY TENSION OF DAMPING SPRING

damping spring, short runs were made with the screw set up tightly, and then with it loosened one-fourth of a turn. The apparent effect, Fig. 39, was to shift the maximum peak from 975 to 1,070 periods.

122. **Effect of Frequency on Sumter Transmitter.**—For studying the effect of a different loading of the diaphragm, a test was made with the Mason¹ (or Sumter) transmitter. In this instrument the vibrations are transmitted to the carbon cell through two pins which press upon the diaphragm at points diametrically opposite and at one-third the distance from the center to the edge. This transmitter is seen to have regions of maximum sensitiveness, about 900 and 1,060, as

¹MASON. See page 97.

shown in Fig. 40, with a summum maximum at 1,640 periods per second. The valley of small sensitiveness reaches minima at 720 and 770 periods per second. At 1,060 is a sharp valley, probably due to interference of sound by external reflection. The transmitter maintains its sensitiveness for frequencies as high as 2,100 periods per second, the upper limit of the readings.

123. **Effect of Frequency on Dean Transmitter.**—Similar tests were made on a Dean¹ transmitter whose diaphragm

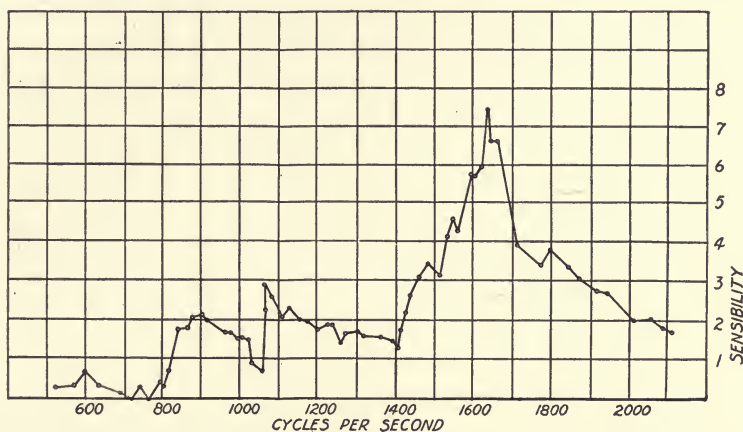

FIG. 40.—SENSIBILITY CURVE OF A SUMTER TRANSMITTER

is markedly different from the others tested, having the edge stiffened by a rim 0.075 inch high stamped up from the same piece as the diaphragm, and having the central vibrating portion dished in about 0.04 inch so as to form a flat cone which is pushed partly back to the initial plane by two springs whose sharp edges (0.1 inch long) press against the diaphragm at points diametrically opposite and one inch apart. This transmitter, as shown by Fig. 41, is almost uniformly sensitive for vibrations from about 500 to about 1,050 periods per second, the sensitiveness increasing to a minor maximum at 1,190 periods, falling to the earlier sensitiveness at 1,220 periods, then rising to a maximum at 1,520 periods, followed by a

¹ DEAN. See page 97.

minor minimum at 1,610, a minor maximum at 1,650, and a minor minimum at 1,800 periods; then comes the summum maximum at 1,950 periods with a gradual falling off to 2,550 periods, the upper limit of the test. As might be expected from the general conditions of this diaphragm, it seems to vibrate in small sections which favor the tones of high pitch to the detriment of the lower tones.

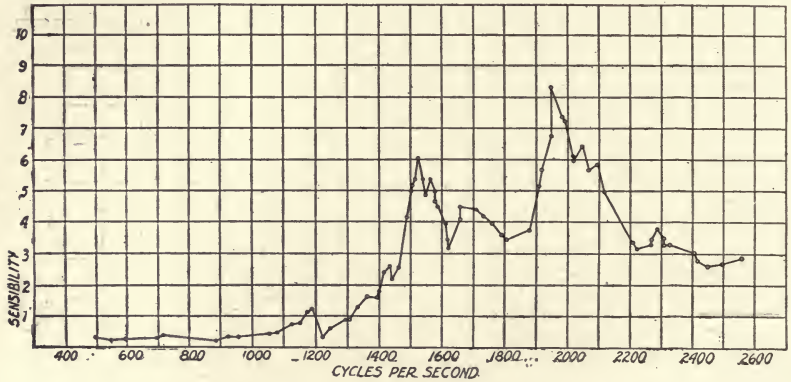

FIG. 41.—SENSIBILITY CURVE OF A DEAN TRANSMITTER

124. Summary.—While there is much to be desired in the further development of the theoretical and experimental knowledge of the microphone and of the diaphragm, the results obtained thus far seem to justify the conclusion that the microphone transforms the sound vibrations with approximate faithfulness, and that sinusoidal sounds will be transmitted by current closely sinusoidal.

PART II
SIGNALING EQUIPMENT

CHAPTER VIII
SIGNALING DEVICES

125. **Signaling Requirements Outlined.**—The practical operation of a telephone involves not only the talking apparatus and the connecting circuit, but also more or less of signaling equipment. It is necessary to have signals, both for calling the desired subscriber and for informing the operator at the exchange that a connection is wanted or that the communication is ended. The operator must have some ready means of ascertaining whether a desired line is already in

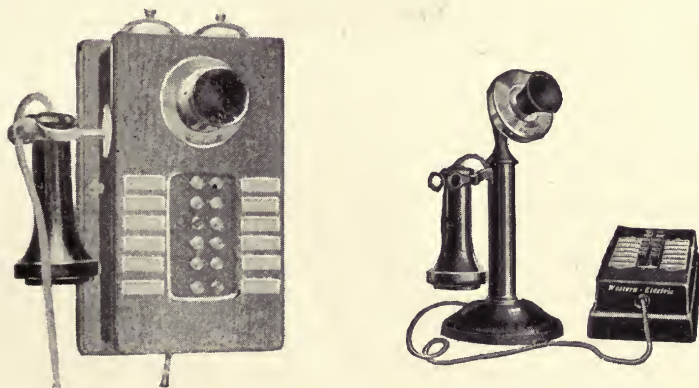

FIG. 42.—INTERCOMMUNICATING SETS
(Western Electric Inter-phones)

use, and must also be able to get the attention of a forgetful subscriber who occasionally leaves his receiver off the hook-switch. In a busy office it is desirable to have automatic devices that will continue to ring at intervals until the called party responds, inducing an assuring “ring back” notice to the calling party, or will indicate that the line is busy. In

the case of a private interior or intercommunicating¹ system, the calling subscriber is likely to be his own operator, and some of the connecting operations are simplified. With the automatic² exchanges, the conscious operations are simplified



FIG. 43.—AUTOMATIC TELEPHONE STATION

by the use of more complicated electromagnetic and other devices.

¹ For descriptions of intercommunicating sets, or "inter-phones," see: Trade literature of telephone manufacturers. Standard Handbook for Electrical Engineers, § 21, arts. 76-80. MILLER. American Telephone Practice, p. 736. McMEEN and MILLER. Telephony, p. 648.

² For descriptions of automatic systems see: SMITH and CAMPBELL. Automatic Telephony. McGraw-Hill, New York (1914).

Standard Handbook for Electrical Engineers, § 21, arts. 64-75.

VANDEVENTER. Telephonology, chap. 14.

MILLER. American Telephone Practice, p. 691.

McMEEN and MILLER. Telephony, pp. 501-583.

BOYRER. Telephony, pp. 365, 403. Chicago (1905).

GREEN. "Western Electric System," *Elec. Lon.*, 74:394, 420, 453, 494 (Dec. 25, 1914, to Jan. 15, 1915).

THOMPSON and DECKER. *Electric Power*, 9:23-32 (Jan., 1896).

HAMMER. *Trans. Am. Inst. El. Eng.*, 21:31 (Jan., 1903).

CAMPBELL. *Trans. Am. Inst. El. Eng.*, 29:55 (Jan., 1910).

SMITH. *Trans. Am. Inst. El. Eng.*, 29:1357 (June, 1910).

FRIENDLY and BURNS. *Trans. Am. Inst. El. Eng.*, 32:1305 (June, 1913).

126. **Fundamental Apparatus Required.**—The performance of the various signaling functions involves directly or indirectly the use of electromagnets, permanent magnets, relays, induction coils, condensers, lamps, resistors, suitable sources of current, together with more or less complicated and extensive electrical circuits and mechanical auxiliaries.

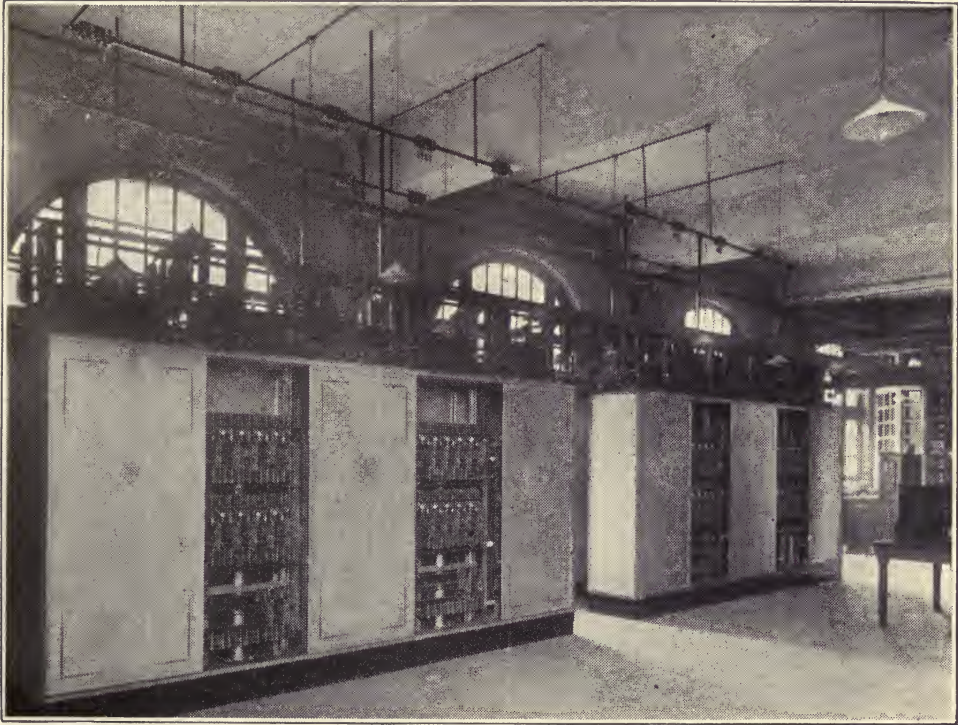

FIG. 44.—APPARATUS IN AUTOMATIC EXCHANGE

127. **Fundamental Laws Involved.**—The construction and operation of the electrical signaling devices involve the laws governing magnetism and electric currents, both direct and alternating. It is presumed that the reader is familiar with such laws and their usual applications. In the following chapters and appendices are discussed phases of these laws which are specially applicable to telephony, some of which are not so well known.

128. Choice Between Audible and Visible Signals; Devices in Use.—The type of signaling device for calling the attention of the desired party at the distant end of a telephone

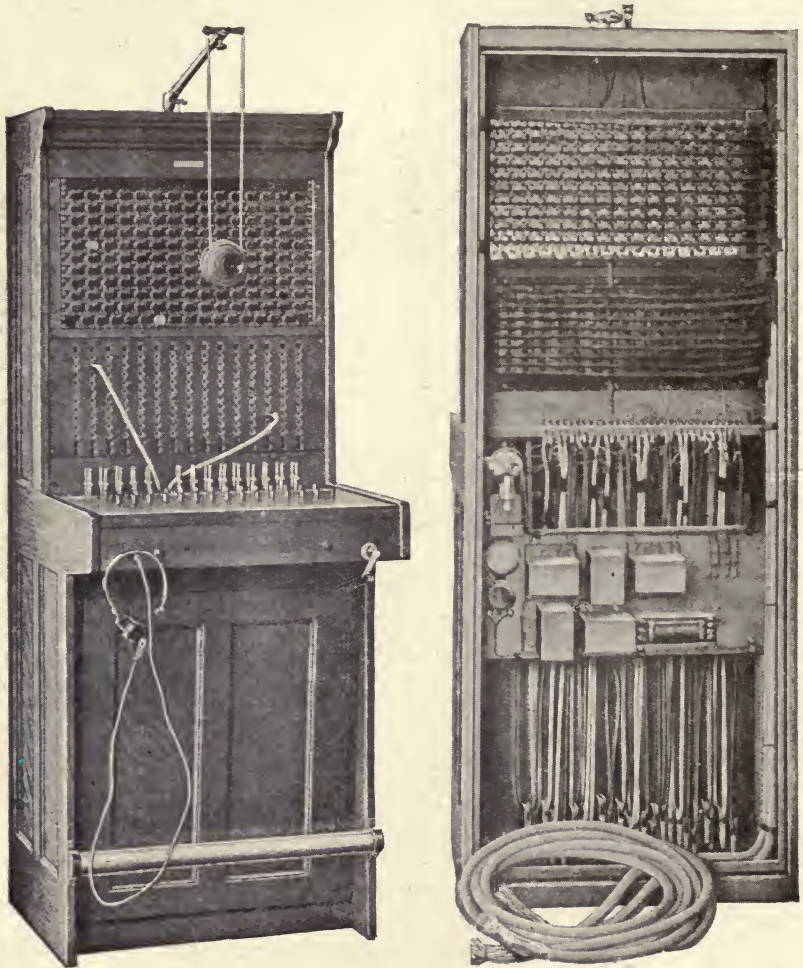

FIG. 45.—FRONT AND REAR VIEWS OF SMALL MAGNETO SWITCHBOARD
(Western Electric)

line depends upon the difficulty of securing such attention. Where the called party is constantly on the watch, as is normally the case with the exchange operator, the signal may be either visual or audible. Where the called party is usually

at a distance from the phone, as is the case with most subscribers, the signal must be audible.

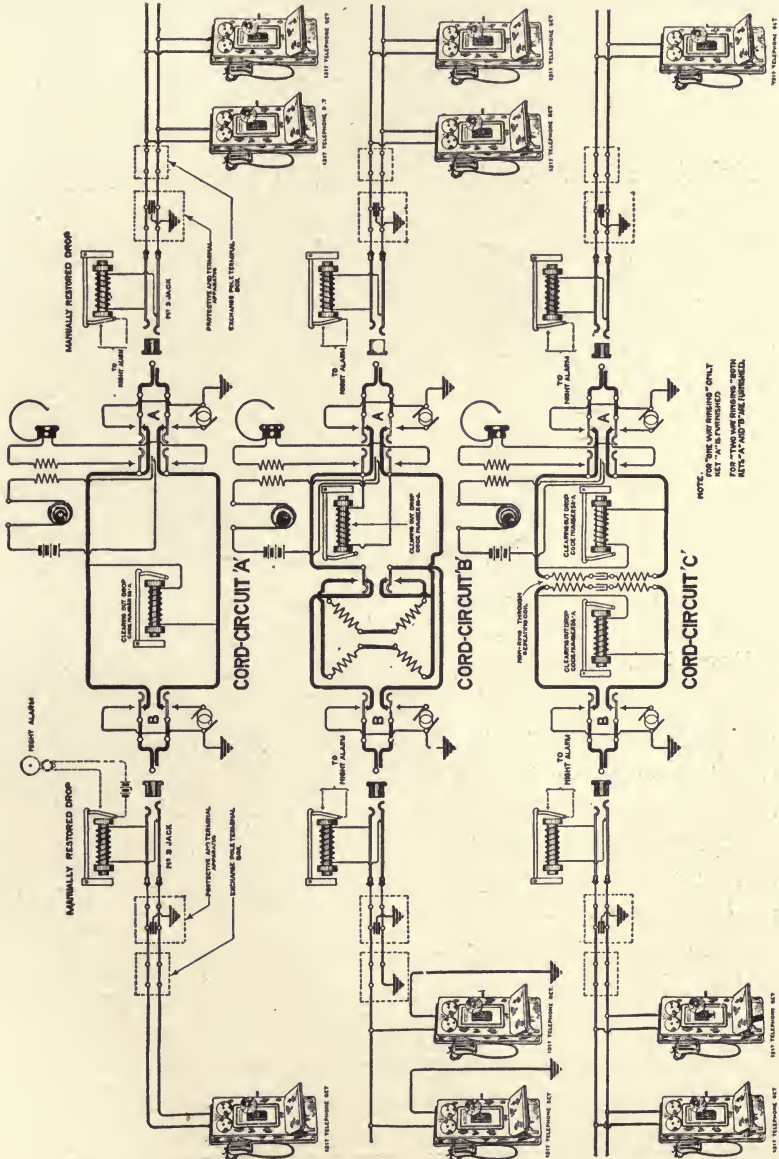

FIG. 46.—TYPES OF CIRCUIT FOR SMALL MAGNETO SWITCHBOARD
(Western Electric)

Audible signals are usually given by polarized ringers¹ operated by alternating or by pulsating unidirectional currents. On short lines it is practicable and common to use vibrating contact bells or buzzers operated by direct current.

Visible signals in the newer and larger exchanges are usually given by small incandescent lamps connected to a battery by relays operated by current coming over the calling subscriber's line. In the older and in most of the smaller

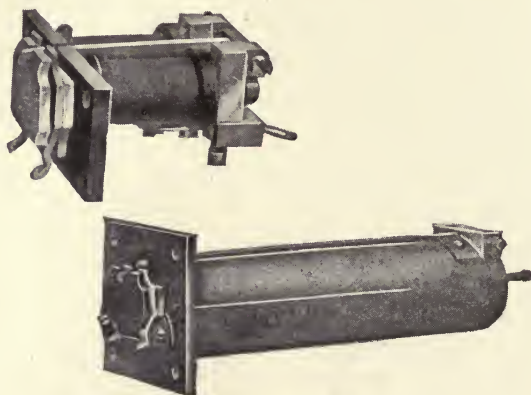

FIG. 47.—SHUTTER SIGNALS OR DROPS

Above: Early type with two coils. Below: Later single-coil ironclad type (Western Electric)

exchanges, the visible signals are given by annunciators, often called "answering drops," whose shutters or drops are operated by current from the subscriber's line.

129. Signals for Calling Subscribers.—For calling a subscriber to the telephone it is generally necessary to use an audible signal.

With short lines, such as used in "intercommunicating" systems, it is practicable to use electric bells (sometimes called "tremblers" or buzzers) of the vibrating contact type.

The polarized ringer, discussed more fully on later pages,² is operative over wider ranges of length of line and of current strength than is the direct current vibrating contact bell.

¹ See §§ 178, 179, 181.

² See pages 174 to 188.

It is therefore generally used for signaling subscribers or exchange circuits.

130. Polarized Ringers Preferable for Exchange Lines.

—Aside from the difficulties with ringing over long lines, the direct current bell is not so well adapted for use with central energy systems as is the polarized ringer. The combination¹ of a polarized ringer in series with a condenser bridged² across the line at the subscriber's station allows alternating or pulsating current to pass, while barring steady direct current. This renders it possible for the exchange operator to call³ a subscriber by alternating or by pulsating currents, while the circuit is "open" so far as direct currents are concerned; the subscriber's circuit, being normally open, allows him to call⁴ the operator by the simple act of lifting his receiver from the hook and thereby closing a circuit through the central battery and through the answering signaling relay at the exchange.

The polarized ringer also makes possible selective⁵ ringing, whereby one of a number of parties⁶ connected with the same line may be called without disturbing others.

131. Answering Drops in Small Exchanges; Tubular Magnets and Removable Coils.

—The answering drops, used for signaling operators in small exchanges, are developments of the annunciator formerly prominent in hotel offices for indicating calls from guest-rooms. They are operated⁷ by electromagnets energized by current controlled by the calling party. When current passes through the electromagnet, a movable part of the magnetic circuit is attracted and it moves

¹ See § 267.

² U. S. Patent No. 449,106 (March 31, 1891), to J. J. Carty.

³ See Figs. 53 and 77, pages 136 and 186.

⁴ See Fig. 53.

⁵ See §§ 190-192, 265.

⁶ See chapters on Selective and Lockout Systems and on Composite Systems in recent books on telephony, such as:

VANDEVENTER. Telephonology.

MILLER. American Telephone Practice.

McMEEN and MILLER. Telephony.

⁷ See Figs. 47-52.

so as to lessen the reluctance of the magnetic circuit. This motion is magnified by levers or tripping devices so as to bring some sort of target into prominence.

The electromagnets of the drops are usually of the tubular or iron-clad¹ type, in order to secure greater compactness and at the same time to minimize stray magnetic flux from the magnet which might cause false signals from neighboring lines or which might cause inductive "cross-talk" between them.

As considerable trouble may arise from lightning,² the coils

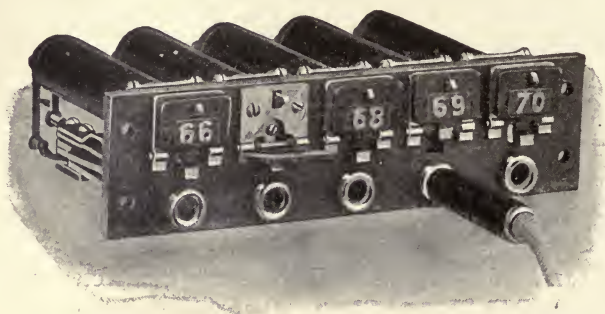

FIG. 48.—COMBINED DROPS AND JACKS (Monarch)

The insertion of an answering plug restores the drop and makes connection with the calling party

of the answering drops are frequently wound on removable spools, so that they may be renewed easily.

132. Manually and Automatically Reset Drops.—In the earlier³ and smaller exchanges, the answering drop or shutter was reset for the next call by a separate act of the operator, these being known as "manually restored" drops. As this act became burdensome and liable to be overlooked at busy times, there were developed several types of automatically restored drops. Some were combined with the an-

¹ See §§ 144, 287.

² See §§ 286, 288.

³ See account of the first telephone exchange in:

CASSON. *History of the Telephone*, p. 53. McClurg, Chicago (1910).

KINGSBURY. *Jour. Inst. El. Eng.*, 24:36-88 (1895); *Elec. Lon.*, 34:395 (Feb. 1, 1895). *The Telephone and Telephone Exchanges*, chap. 9.

swering jacks in such a way that the act of inserting a plug of a connecting cord into the answering jack restored the shutter mechanically.¹

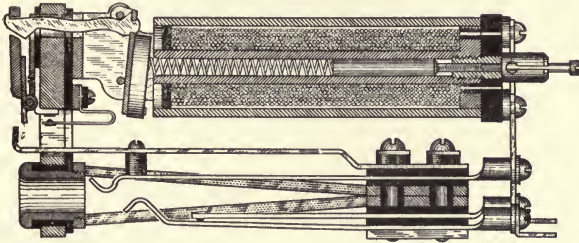

FIG. 49.—SECTION OF COMBINED DROP AND JACK (Monarch)

In other cases, the drops were at some distance from the corresponding jacks, and were reset electromagnetically² by means of an auxiliary winding which became energized by

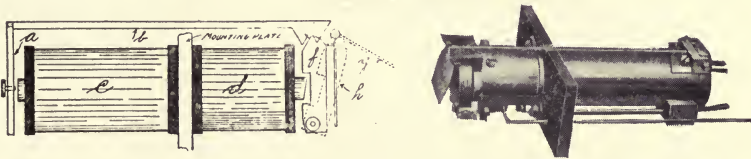

FIG. 50.—ELECTRICALLY-OPERATED SELF-RESTORED DROP

The operating coil *c* attracts armature *a*, which lifts arm *b*, this releasing armature *f* and lifting shutter *g*. The restoring coil *d* resets armature *f*.
(Courtesy of McGraw-Hill Co. and Western Electric Co.)

the closing of a circuit as the answering plug was pushed into the jack. The electrically operated, self-restored drop has not come into very extensive use.

¹ See examples by:

VANDEVENTER. *Telephonology*, pp. 103-113.

ABBOTT. "Evolution of the Line Signal," *Trans. Am. Inst. El. Eng.*, 15:425 (1898).

POOLE. *Practical Telephone Handbook*, pp. 150-152.

² See examples by:

VANDEVENTER. *Op. cit.*, pp. 109, 173.

McMEEN and MILLER. *Telephony*, p. 338.

MILLER. *American Telephone Practice*, p. 195.

POOLE. *Op. cit.*, pp. 147-150.

133. **Night Bells.**—For night service ¹ in a small exchange where the operator is allowed to sleep on the watch or has other duties at a distance from the switchboard, the falling of any shutter closes an auxiliary circuit including a battery and a vibrating contact bell ² or buzzer of the type used for doorbells and similar calls and often used for calling subscribers on short telephone lines. During busy hours with such exchanges, an incandescent lamp may be substituted for the bell, using a suitable source of current.

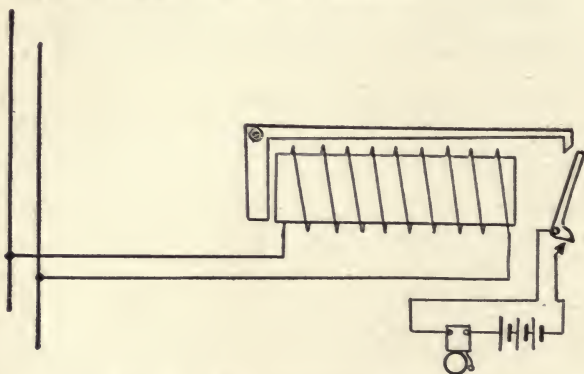

FIG. 51.—DROP OPERATING NIGHT BELL

134. **Lamp Signals.**—In larger exchanges the attention of the operator is called by incandescing ³ lamps which are energized from a central battery switched usually by means of electromagnetic relays connected with the subscribers' lines, the subscriber being required merely to lift his receiver from the hook, thereby completing a circuit through the central battery and the lamp or relay.

135. **Order Wires.**—In some of the early central exchange systems, such as the Law ⁴ system, the operator's telephone

¹ U. S. Patent No. 245,931 (Aug. 23, 1881), to F. G. Beach.

² See § 163.

³ Because of poverty or inexactitude of our language, an electric lamp is usually called incandescent, both when current is heating its filament to incandescence and also when the current is absent and the filament is cold. In this respect "glow lamp" or the older term "incandescence lamp" is more precise. When used for signaling purposes, it might better be called an incandescing lamp.

⁴ *Electrician*, 1:63. N. Y. (April, 1882); *El. W.*, 5:227 (June 6, 1885).

receiver was constantly connected to a special calling circuit which was connected with every station, so that any subscriber could connect with central by throwing over a switch that transferred his talking apparatus temporarily to the calling wire. While the calling wire was abandoned as impracticable for a general system covering a wide territory and many subscribers, it has been found satisfactory and is in extensive service for certain uses in the exchange where two

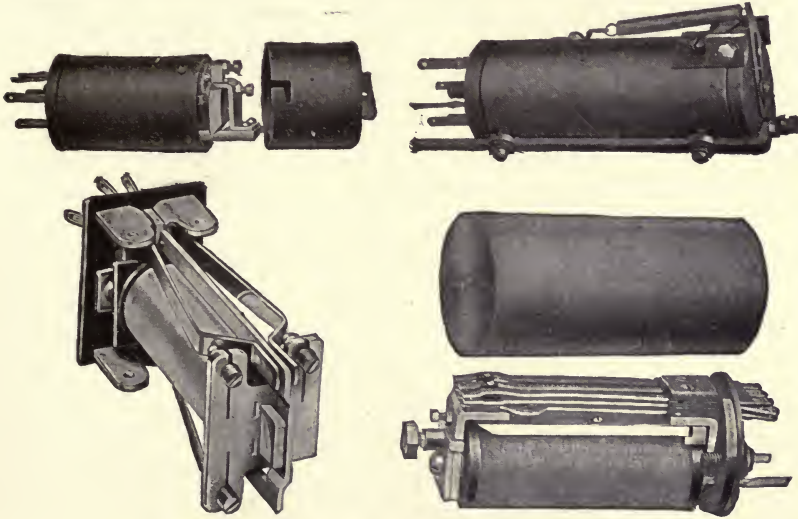

FIG. 52.—TYPES OF TELEPHONE RELAY
(Courtesy of Western Electric Co.)

operators are required for making connections, the B operator getting her directions from the A operator over an order wire¹ to which her talking set is constantly connected.

136. Supervisory Signals.—Besides calling the attention of the exchange operator when a subscriber wishes a connection, it is desirable that the operator be able to learn quickly and easily whether the called party has responded. In small exchanges, the operator may have time to “listen in,” by connecting her talking set across the connecting cord by pushing

Cassier's Magazine, 8:11 (May, 1895).

PREECE and STUBBS. *Manual of Telephony*, p. 233.

¹VANDEVENTER. *Op. cit.*, pp. 163, 378, 393.

the table key connected with that cord, as when answering the calling subscriber. In the large and busy exchanges, it is necessary to have some sort of supervisory signal by which the operator may ascertain at a glance whether the called subscriber has responded. The supervisory signal in general use is a small incandescent lamp connected to the cord circuit in such a way that when the cord connects two subscribers'

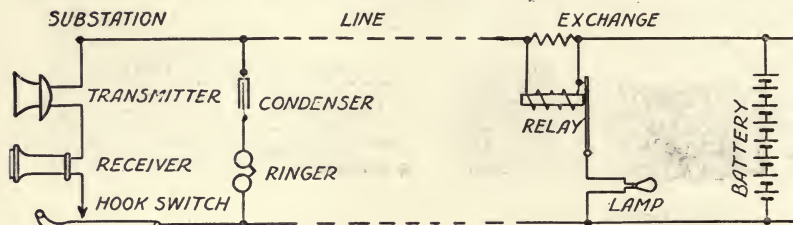

FIG. 53.—CENTRAL ENERGY CIRCUIT FOR CALLING OPERATOR

lines the lamp is lighted while the subscriber's receiver is on the hook, but is extinguished when the receiver is taken off. The lamp is usually operated by a relay which either opens the circuit or shunts the lamp by a low resistance, the relay being operated by the cessation of current when the subscriber hangs up the receiver on the hook switch. In some cases the

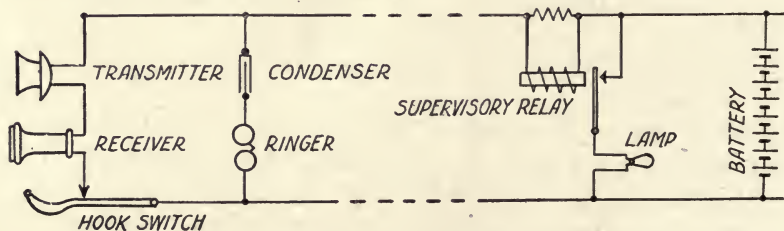

FIG. 54.—CENTRAL ENERGY SUPERVISORY CIRCUIT

relays are omitted, the supervisory lamp being extinguished when shunted by the subscriber's line as the receiver is taken off the hook.

137. **Disconnect Signals; Use of "Howler."**—It is essential to prompt service that the operator be notified immediately when either or both parties are ready to be disconnected.

With a magneto exchange, a subscriber may "ring off" by turning the handle of his magneto generator, thereby sending current through a "clearing-out drop" on the exchange switchboard. The clearing-out drop is usually connected across the cord, as shown in Fig. 46, so as to be in multiple with the two subscribers' lines, though there are several modifications of the circuit. Where a separate conscious effort on the part of the subscriber is necessary for giving the disconnecting signal, unnecessary congestion of the switchboard and excessive reports of lines being "busy" result from careless or lazy subscribers neglecting to ring off. With "central energy" or "common battery" exchanges, the simple act of hanging up the receiver at the close of a conversation gives the disconnecting or clearing-out signal, usually by lighting the supervisory¹ lamp, somewhat as shown in Fig. 54.

For reminding careless subscribers who neglect even to hang up the receiver after completing a conversation, the operator can send the ordinary ringing current over the line so as to actuate the subscriber's bell or make a noise in his receiver, or may send out a strong current of comparatively high frequency from the "howler,"² which will make a loud noise in the receiver, after gentler methods fail.

138. Busy Tests; Guard Rings.—For satisfactory and prompt telephone service, it is not only necessary to prevent the annoyance consequent upon connecting a third party to a line which is already in use, but it is essential, also, to provide the operator with a quick and reliable means of telling whether a line is already in use.

With a small board and a single operator, it is possible to see at a glance whether a line is busy, and it is usually impossible to connect more than one line with any other line except by the use of multiple cords which are frequently provided for coupling a number of lines together during the absence of the operator.

On a large board the lines are so arranged that only a

¹ See §§ 133, 147.

² See § 223.



FIG. 55.—MULTIPLE SWITCHBOARD (Stromberg-Carlson)

limited number of the answering drops and jacks are in front of a given operator; but each line has a number of calling jacks, one for every third operator's "position" on the switchboard, a jack for each subscriber being thus within the reach of every operator, making it possible for any operator to call any subscriber and to connect a party to his line.

In order to prevent more than one operator from connecting with a given line at the same time, a guard ring or thimble

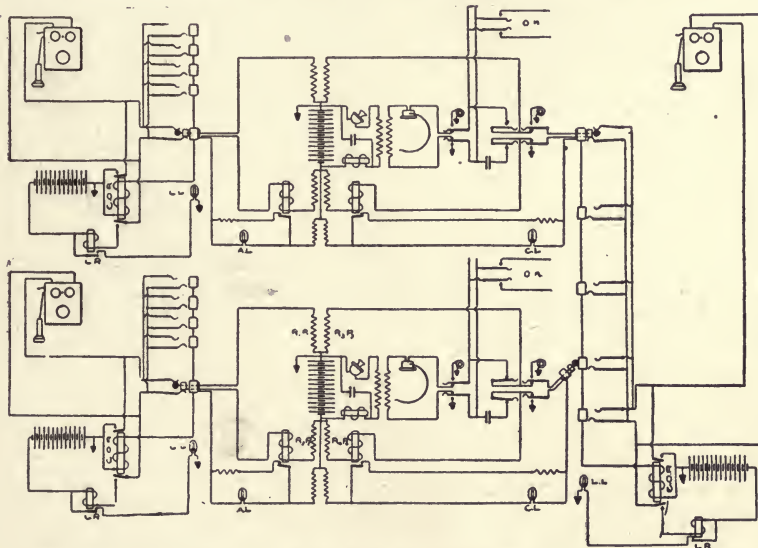

FIG. 56.—CIRCUITS OF A MULTIPLE SWITCHBOARD SHOWING BUSY TEST

is arranged at the opening of each jack so that when a plug is inserted into either the answering or the calling jack the guard or test ring is connected through a sleeve on the plug to one side of a battery. Since the guard rings of every jack connected with the same line are electrically connected, the charging of one jack charges the guard ring of every other jack connected with that line. If the line is already busy when an operator undertakes to insert a calling plug into a calling jack, the tip of the plug touches the guard ring as it enters, and this completes a circuit from the test battery through the operator's receiver and instantly gives her a click

before she has time to push the plug home and make the proposed¹ connection.

In the upper part of Fig. 57 the dotted lines show the connections made when a plug is inserted into a jack, the sleeve connecting the guard ring of the jack to an earthed battery;

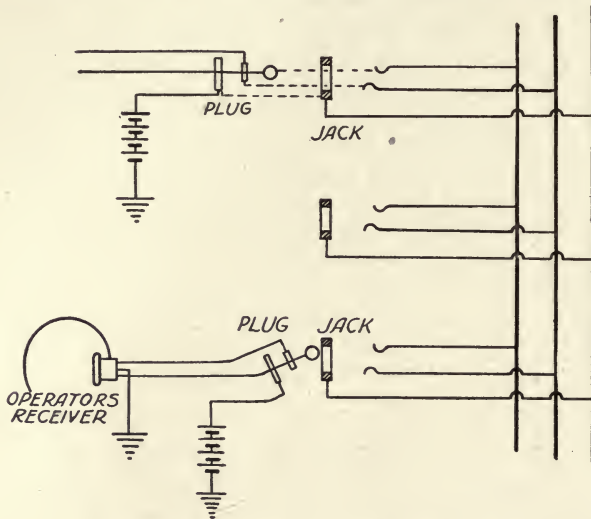

FIG. 57.—BUSY TEST CIRCUITS SIMPLIFIED

the lower part of the figure indicates an operator touching the tip of a plug to a guard ring preparatory to making a connection, in this case getting a click in her phone to indicate that the circuit is already in use.

¹Diagrams of several cord circuits with busy tests are shown:

Standard Handbook, § 21.

VANDEVENTER. *Op. cit.*, pp. 172, 371.

MILLER. *Op. cit.*, pp. 225, 227, 231, 314, 320, 326.

POOLE. *Op. cit.*, pp. 194, 224.

CHAPTER IX

DESIGN OF NON-POLARIZED SIGNALING APPARATUS

139. Importance of Electromagnetic Attraction and Repulsion.—Electromagnetic attraction and repulsion form the fundamental basis of most signaling devices and of many auxiliaries, such as bells, annunciators, relays, pole-changers, telephone receivers, line connection registers, telegraph sounders and relays, electric clocks and synchronizers, watchman's registers, measuring instruments, and a multitude of apparatus used in other applications of electricity.

140. Magnetic Flux; Magnetomotive Force; Reluctance; Pull.—The fundamental equations ¹ for magnetic flux and magnetic pull show that the quantity of magnetic flux through a circuit equals the net sum of the various magnetomotive forces divided by the reluctance of the circuit as a whole. Similarly, the quantity of flux through any portion of a branched or multiple circuit equals the total magnetomotive force acting on that part of the circuit divided by its reluctance.

The magnetomotive force may include that of a permanent magnet ² and that of current through one or more coils, the latter equaling 0.4π , or 1.257, times the number of amperes of current times the number of convolutions or turns of the wire in the coil.

The reluctance in the magnetic circuit is usually the sum of several parts, all or part of the magnetic flux passing through one or more paths of iron and one or more of air or other non-ferric material. The reluctance of each part is directly proportional to its length and inversely proportional

¹ See Appendix A, §§ 299, 301.

² See §§ 171, 306-308.

to the area or cross-section of the path, and is inversely proportional to the permeability of the material. The permeability of air, and of most substances other than iron or nickel, is of constant value taken as unity. The permeability of iron varies according to the density of the magnetic flux, and according to previous magnetization, being less for decreasing than for increasing flux. The permeability apparently ¹ varies to some extent, also, with the rate of change of magnetization, being much less for frequencies of several hundred thousand per second than for frequencies of a few hundred or less per second, the difference being due really to "skin effect" and to the counter-magnetizing effects of induced currents.

The magnetic flux exerts a pull along the directions of its path and a repulsion at right angles thereto. When expressed in C. G. S. units, it is approximately ² equal to

$$P = 0.00004 B^2 A \quad \text{grams,}$$

in which P is the force measured in grams weight, A is the area of cross-section measured in square centimeters, and B is the number of unit lines of force per square centimeter. Expressed in English measures, the pull in pounds equals ³ the area in square inches multiplied by the square of the number of magnetic lines per square inch and divided by 72,134,000.

141. Unstable Magnetization; Demagnetizing Influences.—Since the establishment of the magnetic field involves the changing of kinetic into potential energy,⁴ the cessation of the magnetomotive force leaves the system in more or less unstable equilibrium. When the entire magnetic circuit consists of iron of high permeability, a small coercitive force will hold the energy of magnetization in the potential state, though a mechanical shock may destroy the equilibrium. An air-gap, however small, increases the reluctance of the circuit and requires greater coercitive force to hold up the magnetic

¹ STEINMETZ. Transient Electric Phenomena and Oscillations, pp. 361-365, 376-378, 405.

² See § 301, equation 20.

³ See § 301, equation 22.

⁴ See Appendix A, § 299.

field, that is, to hold the energy in the potential state. Thus, a short air-gap or space of non-magnetic material brings about the speedy demagnetization of the circuit. This result is commonly attributed to "the demagnetizing effect of the ends" of the iron parts of the magnetic circuits.

142. Magnetic Repulsion.—The spreading¹ of the flux to secure minimum reluctance may be considered as equivalent to a *repulsion* between parallel lines of magnetic force. Equilibrium of the ether, which may be considered as the medium for the magnetic flux, requires that, if the magnetic flux is uniform (the magnetic lines of force being parallel), equal forces act on each face of each unit cube of the medium; therefore parallel magnetic lines of force repel each other with a force equal to their contractile force.

In certain cases, the apparent repulsion between lines of magnetic force of similar direction or polarity may be seen as a direct consequence of the tension along each line. For example, in the case of a bar magnet or a solenoid with air return, each line at its turn is radial to the axis of the solenoid; hence each end or half of each line of force is pulled away from the axis with a force closely proportional to $B^2A/8\pi$ dynes, or $0.04 B^2A$ grams, in which A is the area of the magnetic path as measured in square centimeters, and B is the number of unit magnetic lines of force per square centimeter.

143. Design of Electromagnets for Telephonic Purposes.—The design of electromagnets for pulling purposes has been so well treated by previous writers² that little detail need be given here.

¹ See Appendix A, § 300.

See also Figs. 68, 69, 107, 108, pages 169, 170, 276, 277.

² CARICHOFF. "Design of Electromagnets for Specific Duty," *El. World*, 23:113, 212, 214 (Jan. 27, Feb. 17, 1894).

THOMPSON. The Electromagnet.

WOLCOTT, KENNELLY, VARLEY. The Electromagnet. Varley (1900).

UNDERHILL. "Operation of Plunger Electromagnets," *El. World*, 59:388 (June 22, 1912); Solenoids. Van Nostrand (1914).

DUBOIS. The Magnetic Circuit. Longmans (1896).

KARAPETOFF. The Magnetic Circuit. McGraw-Hill (1911).

Since most of the electromagnets used in telephony are of the short-range type, in which the moving part travels only a short distance, it is generally practicable to have the poles close together, and for many purposes it is feasible to use tubular or iron-clad magnetic circuits.

In the case of polarized ringers and of vibrating contact devices, such as pole-changers and direct current bells, in which the vibrator travels relatively larger distances, the poles of the electromagnet must be relatively far apart, in order to minimize magnetic leakage and to give more uniform pull throughout the stroke.

In the design of electromagnets for telephonic use, special care should be taken that the magnets have a minimum of stray field, that they operate with sufficient speed and with certainty, and that in some cases they be adapted to operation by alternating currents.

144. Avoidance of Stray Magnetic Fields.—In order to avoid magnetic induction between different circuits, with possible cross-talk and even false signals, it is desirable that the electromagnets used in a telephone exchange be so designed that so far as possible the entire magnetic flux shall remain in the intended magnetic circuit and not stray¹ outside. Since no known substance acts as a magnetic insulator, the only

KENYON. Standard Handbook for Electrical Engineers, § 5.

FOSTER. Electrical Engineer's Pocket Book, pp. 108 to 130.

THOMPSON. *Proc. Int. El. Cong.*, 1:542; St. Louis (1904); *El. World*, 44:997 (Dec. 10, 1904).

VANDEVENTER. Telephonology, pp. 20-30.

FOWLE. *Proc. Am. Inst. El. Eng.*, 30:1236 (June, 1911); *Trans. Am. Inst. El. Eng.*, 30:1729 (1911).

McMAHON. "Electromagnetic Mechanisms," *Elec. Lon.*, 35:291, 348, 494, 584, 604 (1895).

GEORGE and PENDER. "Calculations of Electromagnet Windings," *El. World*, 65:529 (Feb. 27, 1915).

WIKANDER. "Economical Design of Direct-current Electromagnets," *Trans. Am. Inst. El. Eng.*, 30:2019 (June, 1911).

THOMPSON and WALKER. *Phil. Mag.* (5), 37:564 (June, 1894).

MITCHELL. "Telephone Relay Design;" Series of papers in *Telephony*, Chicago (Dec., 1915; Jan., Feb., 1916).

¹ See § 236.

way to keep practically all the magnetic flux within a desired path is to make the reluctance of that path far less than that of any alternative path. Consequently, magnetic circuits are so designed as to consist (to the largest proportion possible) of soft iron of ample sectional area. Where air-gaps are necessary, they are made short so that the reluctance across the shortest path from iron to iron is much less than that of any other path. By having the winding surrounded by iron, as in the common iron-clad tubular magnets, the fall of magnetic potential along exposed portions is reduced to a minimum, and there is little tendency for the magnetic field to spread.

145. Avoidance of Secondary Currents and of Sticking.

—Secondary currents,¹ with their reduction of the speed of demagnetizing² and their waste of energy, are avoidable by thorough lamination, that is, by breaking up their electric circuits. In some apparatus, with relatively slow changes of current and of moving parts, solid parts in the magnetic circuit give commercially satisfactory results. Secondary, or eddy, currents are reduced to a large extent by one or more radial slits lengthwise of the magnetic path. Economy of space and of manufacturing cost (when on a large scale) together with effective lamination may sometimes be effected by the use of punched sheet iron³ parts for the magnetic circuit, as in the newer types of telephone relay.

While a short air-gap in the magnetic circuit is desirable, both for avoiding stray magnetism and for reducing the amount of power required to operate the magnet, the gap must be long enough⁴ to prevent sticking even after some wear of spacing stop or of pivots.

146. Design of Magnet Winding.—The design of the winding of the telephonic electromagnet is governed largely by the circuit of which it is to be a part. The ampere-turns

¹ See §§ 200, 231, 233.

² See §§ 150-153.

³ See lower part of Fig. 52, page 135.

⁴ See §§ 141, 150.

required are determined by the work to be done. When the magnet is to form part of a series circuit, the amperes are determined in advance within a moderate range, and the coil is given a comparatively small number of turns as required to make the necessary ampere-turns. When the coil is to be bridged across a circuit, finer wire is used and the coil is designed for many turns and a small fraction of an ampere. In the early days of telephony, the signaling magnets were commonly connected in series in the talking circuit, but it was soon discovered that they were detrimental to both strength and clearness of the talking current. The signaling apparatus was then designed for connection across the circuit¹ in multiple (or bridged) with the talking apparatus. The coils of the ringers and of the generators are wound with many turns of fine wire so as to have high reactance and impedance for the talking currents, which are of the order of 1,000 cycles per second, while the ringing currents of 16 to 66 cycles per second meet comparatively little impedance. Such ringers, having a resistance of 1,000 ohms to continuous current, present an impedance of approximately 11,000 ohms to currents of 1,000 cycles per second,² and do not greatly drain the talking current even though permanently bridged across the circuit.

The efficiency of a signaling circuit may be considered as the ratio between power delivered to signal receiving device and that in the entire circuit. With longer lines, the bell or other signaling device should have greater resistance or, rather, impedance. Since ampere-turns rather than ohms determine the power of an electromagnet, the mere resistance of a bell gives little insight as to its performance, except in comparison with others of corresponding design.

The longer lines are liable to require more battery power, that is, more cells in series, and this involves greater liability to sparking³ at contact points.

¹ See Fig. 81, page 233.

² Data by Cohen and Shepherd, quoted in POOLE. *Practical Telephone Handbook*, p. 593.

³ See §§ 166-168.

147. Shunting of Coils to Reduce Impedance.—When, as in some central energy systems,¹ it is desirable to have an electromagnet in series with the circuit in order to keep the supervisory or other relay closed for indicating when the subscribers are on the line, the magnet is wound with comparatively few turns and is then shunted by a non-inductive resistance as a by-pass through which the major portion of the talking current will pass rather than through the coil, because the coil offers very high impedance to the high frequency talking current.

148. Speed of Armature ; Growth of Current.—For magnets intended for use on telephone and telegraph circuits, the speed with which the armature is attracted and released is much more important than with simple lifting magnets. For many uses, such as in most relays or drops, only moderate speed of attracting or releasing the armature is required. For certain selective switching devices, timing devices, and high speed automatic telegraphic relays and recorders, high speed is essential. On the other hand, for certain operations in automatic telephone-selecting switches it is desirable that a relay remain closed for an appreciable time after the cessation of the actuating current.

The speed with which the armature of a magnet is attracted to its final or nearest position depends upon the rate of growth of the electric current. With magnets operated by direct currents, the current does not have its final value immediately after closing the circuit; it grows in approximate accordance with the logarithmic law developed by Helmholtz.² The rate of growth or rise of current depends upon the effective resistance (which, in turn, varies somewhat with the rate of change of current) and upon the inductance of the electric circuit. The latter depends primarily on the general design of the magnetic circuit and the number of turns in the coils; it is modified by the saturation or permeability

¹ See §§ 136, 137.

² HELMHOLTZ. *Pogg. Ann.*, 83:505 (1851).

See also textbooks on alternating currents; also §§ 197, 205.

of the iron and by the relative position of the armature; it is also affected by transient currents in the iron or other neighboring conductors. The time required depends also upon the length of travel of the armature, its inertia,¹ and its friction.

149. Variation of Resistance and Inductance with Reluctance.—The effective resistance to alternating currents is somewhat greater than the resistance to steady currents, being increased temporarily by the energy component of currents induced² in neighboring circuits such as in the iron core or in the spool heads or even within the conductor itself when the changes are very rapid. The self-induction also varies somewhat, being affected by the magnetism remaining³ from previous use, becoming less as the magnetization increases but increasing as the moving element is drawn toward the stationary parts so as to diminish the reluctance in the magnetic circuit. When the magnetic circuit contains one or more air-gaps, the self-induction of the entire circuit is more nearly independent of the intensity of magnetization, for the reluctance of the air-gap (a portion of the magnetic circuit better named by the French word *entrefer* or “between iron,” than by any accepted English word) is generally by far the greatest part of the total reluctance, and the permeability of air is constant. Until the armature of the magnet has begun to move, we are therefore justified in assuming that the reluctance and the self-induction of the electromagnet are reasonably constant.

150. Oscillographic Illustrations.—The growth of current through the windings about a magnetic circuit is exemplified in the oscillograms in Fig. 59, which show a cycle of changes in voltage and currents through a 20-ohm telegraph relay as a battery circuit is closed and opened by a key, horizontal distances representing time and vertical distances representing current or electromotive force. The diagram shows

¹ See § 187.

² See §§ 200, 231, 233.

³ See Appendix A, §§ 296, 297; also § 154.

the general arrangement of the circuits, two of the vibrators of the oscillograph being shunted around resistances in series in the main and in the secondary circuits respectively, while a third one is shunted around the magnet coils to show terminal voltage.

When the circuit is closed, the current, curve I , rises rapidly from zero, more or less closely along a logarithmic curve

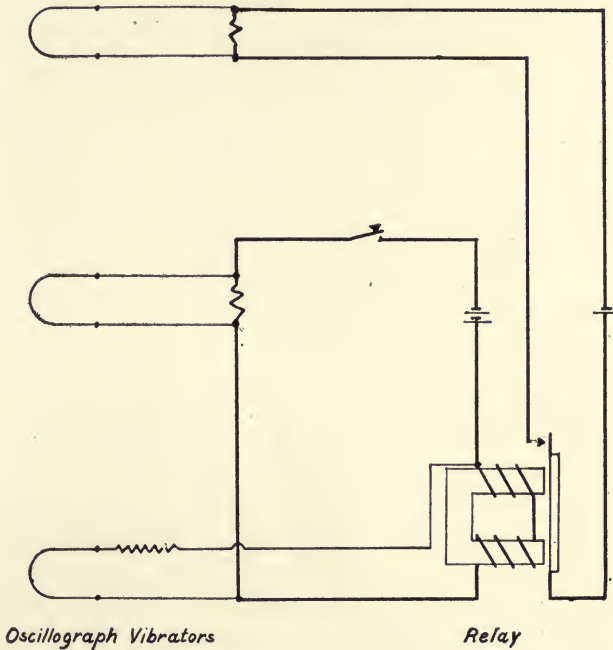

FIG. 58.—DIAGRAM OF CIRCUITS FOR OSCILLOGRAPH

(being somewhat irregular at first if there be imperfect contact at the key). After a short time the armature is attracted, and closes the secondary circuit, as shown at b in curve I'' . The approach of the armature lessens the reluctance of the magnetic circuit and thus increases the magnetic flux for a given value of current, thereby increasing the self-inductance of the electric circuit. The increase in magnetic flux, consequent upon the approach of the armature, involves a corresponding increase in the 'counter-electromotive force

of self-induction (indicated at *c*), which causes a temporary actual decrease in current strength, as shown by the jog *d* in the current curve. The current then continues to rise along a new logarithmic curve *e* corresponding to the increased self-induction. When the circuit is opened, the resistance increases very rapidly and the current falls off almost instantly, as shown at *f*, being continued, *g*, through the spark at the key for a very short time.

Curve *E*, showing difference of potential between the ter-

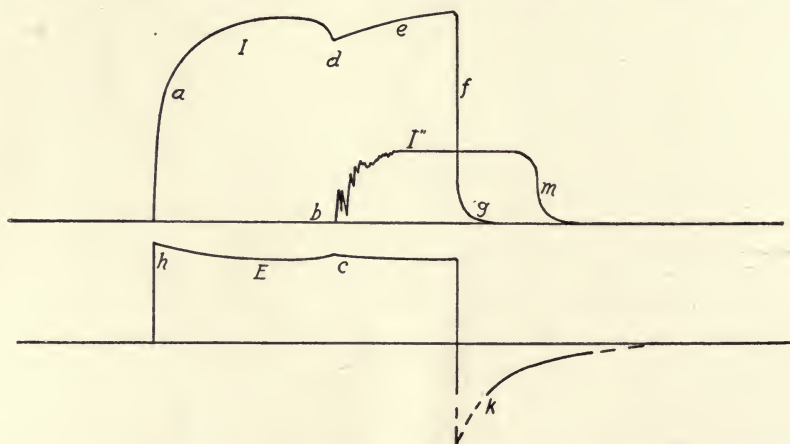

FIG. 59.—OSCILLOGRAMS OF CURRENT AND VOLTAGE IN TELEGRAPH RELAY (Hult)

minals of the sounder, rises almost instantly from zero to a maximum value *h* and then falls off somewhat in proportion to the rise of current strength, this falling off being due to drop through resistance in other parts of the circuit. At the instant *f*, when the main circuit is opened and the main current dies down, the oscillogram of terminal electromotive force shows, *k*, a sudden reversal. This is due to the rapid dying down of the magnetization, which induces in the coil winding an electromotive force in a direction tending to maintain the magnetizing current in its previous direction, and thereby sending a reversed transient current through the vibrator circuit of the oscillograph which is shunted across the terminals of the coil winding. When the magnetization has

fallen sufficiently low, the armature falls away and so opens the secondary circuit, as indicated at *m*.

Fig. 60 shows somewhat similar oscillograms from a telephone relay (*W. E. No. BIAIAI*) with pressed sheet-iron core and armature.

151. Effect of Secondary Currents upon Rise of Magnetization.—The secondary currents which may be induced in other circuits, as in the solid cores of electromagnets or in the heads or sleeves of the winding spools, or in special retarding slugs¹ or sleeves, modify the growth and decay

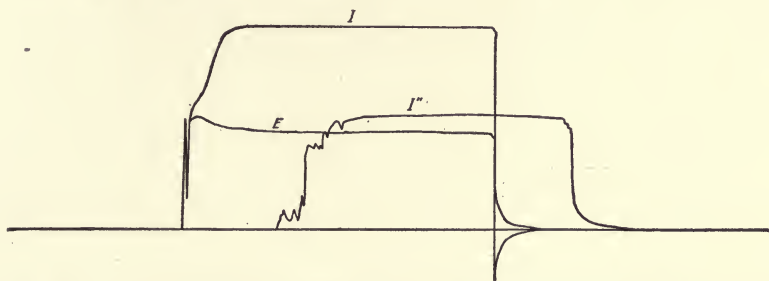

FIG. 60.—OSCILLOGRAMS OF CURRENT AND VOLTAGE IN TELEPHONE RELAY (Hult)

of the magnetic flux. These currents, being the result of what constitutes counter-electromotive force in the primary winding, are in the opposite direction to the main magnetizing current and partially neutralize it while they last. While the primary current is rising after closing the circuit, the secondary currents partially neutralize the magnetic effect of the primary current for a time, having their greatest value when the primary current is changing most rapidly at the first, and decreasing as the primary current changes less rapidly as it approaches its final value.

The secondary currents have two effects which are opposite and partially self-corrective: By partially neutralizing the magnetic effect of the primary current, they temporarily reduce the net value of the self-induction of the primary circuit, and thus allow the primary current to rise faster than it would in the absence of secondary currents; since the secondary cur-

¹ MITCHELL. *Telephony*, 70: 1:37. Chicago (Jan. 1, 1916).

rents represent energy which is partially dissipated as heat, they add an energy component to the primary circuit and thereby temporarily increase the primary resistance and thus reduce its time constant and allow the current to rise faster,

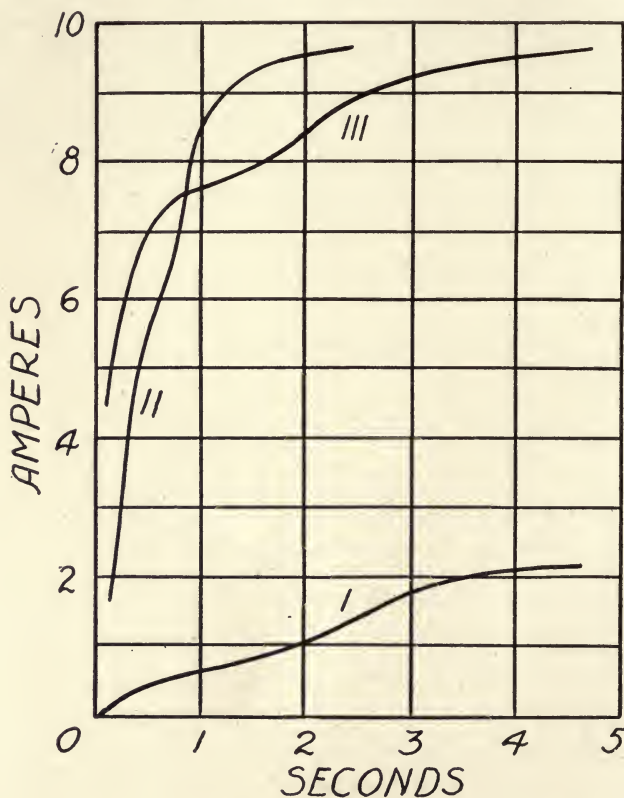

FIG. 61.—GROWTH OF CURRENT IN ELECTROMAGNET

I—8,400 turns in circuit. II—2,165 turns in circuit. III—2,165 turns in circuit, 6,235 turns short-circuited. Applied voltage and final pull the same in each case. (Lindquist)

thus augmenting the demagnetizing effect. But the temporary increase in the primary resistance reduces what might be called the temporary final value of the primary current and thus partially neutralizes the accelerating effect of the counter-magnetization by the secondary currents. Whether the net effect of secondary currents will be to accelerate or

to retard¹ the building up of the magnetization will depend upon proportions.

152. Effect of Self-induction upon Decay of Magnetization.—Self-induction and secondary currents also exert a retarding effect upon the dying down of the magnetization when the current is cut off. If the primary electromotive force could be suddenly removed without opening the circuit, and if the magnetic field strength followed closely the current strength (as with a magnetic circuit without iron), then the falling magnetism would induce in the primary circuit an electromotive force of such strength as to uphold the magnetization so that it would fall in accordance with a logarithmic law or curve closely the reverse of the curve of rising magnetization. In the actual case without iron, the magnetism would generally drop faster than indicated by the simple equation, because the opening of the circuit adds resistance to the magnetizing circuit, and the energy of the induced electromotive force is largely expended in the spark at the switch.

153. Effects of Mutual Induction and of Lamination upon the Rate of Decay of Magnetization.—The rate at which the magnetization decays,² after the cessation of the primary electromotive force, depends not only on the rate of decay of the primary current but also on the strength and persistence of secondary currents and on the relations between total coercitive force and total reluctance of the magnetic circuit. When the iron core is surrounded by one or more secondary circuits, such as metallic heads or sleeves for holding the coils in place, or the retarding copper sleeves or slugs sometimes added for the purpose, mutual induction reinforces self-induction. The falling magnetism induces electromotive forces in these circuits as in the main or primary winding and the resulting currents help retard

¹ See experimental observations by LINDQUIST. *El. World*, 47:1295 (June 23, 1906); abstracted in Standard Handbook for Electrical Engineers, § 5, art. 38.

² The subject of growth and decay of magnetization is treated somewhat differently by STEINMETZ. *Transient Electric Phenomena and Oscillations*.

the decay of magnetization. The lower the resistances of the secondary paths, the stronger will be the secondary currents and the longer will they persist and retard the demagnetization. In a similar way, secondary currents will persist in the iron core unless it be slotted or laminated so as to break up the paths for secondary currents. When rapid demagnetization is desired, all paths for secondary currents should be opened or removed.

154. Effect of Hysteresis.—In the case of magnetic circuits composed mostly of iron, the logarithmic curves of increase and decrease of current and magnetism are modified by the hysteresis or molecular friction of the iron. The magnetization corresponding to a given current is greater¹ for falling than for rising current, and if the circuit is wholly of iron, there will be considerable remanent magnetism after the current has fallen to zero. Air has no magnetic hysteresis, and the magnetic field in air represents energy in unstable equilibrium, which tends to some other form as soon as the magnetizing force is removed; therefore, a magnetic circuit containing an air-gap or *entrefer* will demagnetize quickly after the magnetomotive force stops. Since the permeability of iron is generally several hundred times that of air, most of the entire reluctance is in the air-gap, though it may constitute only a few per cent of the total length of the circuit. Thus the introduction of an air-gap or other non-magnetic “anti-sticker” assists an electromagnet to “let go” quickly upon the cessation of the magnetizing current. Likewise, the use of soft iron with low hysteresis, rather than of hard iron, accelerates the demagnetization.

155. Coercitive Force.—The tendency of iron to retain a portion of its previous magnetization may be considered as a sort of magnetomotive force or coercitive force, which may be measured in terms of the ampere-turns required to reduce the magnetization to zero. The coercitive force is a dominant factor in so-called “permanent” magnets. The smaller the total coercitive force in the magnetic circuit, or the larger the

¹ See Appendix A, §§ 296, 297.

proportion of the magnetic circuit which has negligible coercitive force, the more quickly will the energy unstably stored in the magnetic field degrade into some other form, such as heat resulting from induced currents. Thus softness of iron cores and the introduction of air-gaps accelerate the decay of magnetization.

156. Operation of Electromagnets by Alternating or Pulsating Currents.—Since the attractive power of an electromagnet is proportional to the square of the current, it is independent of the direction of the current unless it is used in connection with some unidirectional magnetomotive force such as that of a permanent magnet. Alternating current may therefore be used either to give unidirectional attraction when used by itself, or to give alternating attraction and repulsion when used in connection with a permanent magnet.

The performance, and therefore the design, of magnets for alternating currents or for pulsating currents differs from that of direct current magnets in respect to pull, noise, induction, hysteresis and eddies, flux density, and insulation.

157. Variation of Pull by Alternating Current Magnets.—As a pulsating or alternating current passes through zero, the pull diminishes more or less closely in proportion; consequently the magnetic pull varies from a maximum to a minimum once for every pulsation or twice for every cycle of alternating current, the average pull corresponding to the square root of the mean squared current. If, as is usual, there is a force tending to separate one portion of the magnetic circuit from the rest, the movable portion will tend to fall away during the part of the cycle in which the attractive force is less than the separating force. The length of time of falling away and the distance of separation will depend on the frequency, wave form, and mean value of the alternating current, and upon the value (usually steady) of the separating force. For example, assume that the separating force exceeds the attracting force during $1/120$ second; if the separating force be gravity, and if the holding force be assumed,

for simplicity, as being negligible during such time, the usual gravitational formula¹ gives:

$$s = \frac{1}{2} g t^2 = \frac{1}{2} (980.6) (1/120)^2 = 0.0341 \text{ centimeter}$$

as the distance the movable portion could drop before the attractive force would again predominate. The actual distance would be less, since the magnetizing force has appreciable value most of the time during the 1/120 second assumed, and therefore reduces the net excess retractile force. So small a separation would not ordinarily allow the movable

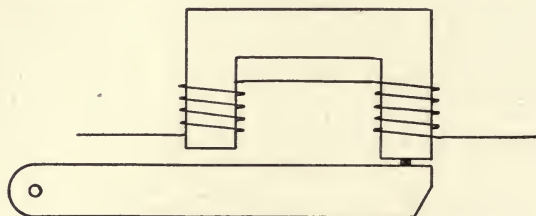

FIG. 62.—ALTERNATING CURRENT MAGNET

portion to drop away permanently, but it would account for much of the chattering frequently characteristic of alternating current electromagnets.

158. Noise from Alternating Current Magnets; Methods of Reducing Chattering.—The noise from alternating current magnets is due to: (1) molecular strains in the cores; (2) molar strains in the cores and their attachments; (3) mechanical vibrations at pivots and other bearing surfaces.

Noise from the first cause is seldom noticeable. Noise from the second cause is minimized by fastening laminated portions firmly together so as to prevent movement due to mutual repulsion. Noise from the third cause is minimized by mounting the movable portion of the magnetic circuit on springs instead of on pivots or other bearings. When the vibrating element is mounted so that one pole is further away from the support than the other, chattering is somewhat

¹Formulae for gravitation are derived in textbooks on physics and those on mechanics.

less if the armature strikes the further pole or a non-magnetic spacer thereon; if the armature strikes the nearer pole first, the free end tends to vibrate and thus to cause rattling at the contact pole and also at the pivots.

By causing a difference in phase between the currents around the two legs of a magnet, as by shunting one of the two coils by a condenser or by a non-inductive resistance, the time of unbalanced pull is shortened; this is a result of changing the wave form of magnetomotive force acting on the

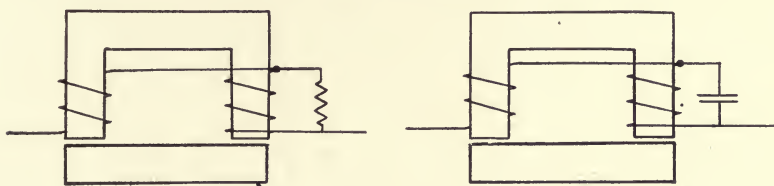

FIG. 63.—ALTERNATING CURRENT MAGNET WINDINGS

magnetic circuit as a whole, or of the excitation of independent fields through the two coils and through leakage return paths, or, more commonly, of both effects combined. By designing the electromagnet so that the period of unbalance is short, alternating current may be made to give sufficiently steady pull to operate even a single-stroke bell or similar device. For similar service in telegraphing¹ by alternating currents, one or more intermediate relays, known as "bug-traps," control local circuits which include the sounders and sources of direct current.

159. Inductive Effects in Alternating Current Magnets.

—Induction acts somewhat differently in alternating and in direct current magnets. The current taken by an electromagnet to which is applied a unidirectional electromotive force of constant value, is determined by the voltage and resistance, being reduced at first by the counter-electromotive force of self- or of mutual induction, and by any later change such as increase of induction due to decreased reluctance as the movable armature approaches the poles.

¹ McNICOL. American Telegraph Practice, pp. 309-311, 395-398.

With alternating currents, the counter-electromotive force of self-induction persists, being proportional to the number of cycles per second, to the flux, and to the number of wraps or turns in the coil. As the armature moves from its furthest position to its nearest, the reluctance decreases, the counter-electromotive force increases and the current decreases.

One effect of the increasing counter-electromotive force is a tendency to reduce the current as the reluctance decreases, thus keeping the flux, and consequently the pull, constant through the whole range of travel of the armature, assuming constant applied electromotive force. Another effect of such increase of counter-electromotive force decreasing the current is to reduce the heating of the coil and the energy taken by it.

160. Hysteresis Effects in Alternating Current Magnets.

—The losses by magnetic hysteresis in the iron cores, and by induced eddy currents in the iron or other conducting materials traversed by the magnetic field, are usually negligible with direct currents, especially when of steady value. But with alternating currents the hysteresis loss¹ varies directly with the frequency and with something less than the square of the magnetic density (being proportional to about the 1.6th power); and the eddy current loss² varies with the square of the frequency and the square of the magnetic density, and inversely as the fineness of the lamination.

161. Flux Density.—Since the mean magnetic pull rather than the maximum pull is usually the vital requirement in the design of a magnet for use with alternating currents, and since the permeability, ampere-turns, and hysteresis and eddy losses are determined by the maximum value of the flux, the average flux density in the core will usually be chosen at a lower value for alternating current magnets than for direct current magnets.

¹ See derivation of formulae by:

STEINMETZ. *Alternating Current Phenomena*, pp. 169-216.

JACKSON. *Alternating Currents and Alternating Current Machinery*, pp. 400-442.

² See textbooks on Alternating Currents.

162. Insulation of Windings.—The insulation and workmanship should be better in a coil intended for carrying alternating currents. The short-circuiting of one or more turns would simply cut out the turns and weaken the magnet if on constant direct current, or lessen the resistance and increase the current proportionally if connected across a constant direct electromotive force; but with alternating currents, the short-circuited turns would constitute a secondary circuit in which large induced currents¹ would flow in a counter-magnetizing² direction, and these would tend to neutralize the magnetic pull if in a constant current circuit, or would allow large currents to flow through the normal winding if on constant potential circuit. In one case, the short-circuited turns would be a source of dangerous heat; in the other case, all of the coil would be heated abnormally, destruction of the coil being imminent in either circumstance.

For further discussion of alternating current magnets, see other works³ cited.

163. Vibrating Contact Devices.—Vibrating contact devices are used in telephony for various signaling purposes. Examples are the direct current buzzers and bells,⁴ or tremblers, used on short lines or for night alarms⁵ in small exchanges. Another example is the vibrating pole-changer⁶ used in small exchanges to obtain alternating or pulsating current from batteries.

The operation of these well-known devices depends on the magnetic pull on a portion of an electromagnetic circuit, this pull changing the position of the movable portion so that the reluctance of the magnetic circuit as a whole is diminished. In the vibrating contact bell, the movable portion, or armature, carries a rodlike extension ending in a hammer or clap-

¹ See §§ 200, 231, 233.

² See Fig. 61, page 152.

³ See footnote on pages 143, 144.

Also a series of articles by LINDQUIST. *El. World*, 47:1295; 48:128, 564 (June 23, July 21, Sept. 22, 1906).

⁴ See Appendix I, §§ 342-344; also § 163.

⁵ See §§ 128, 129.

⁶ See §§ 165, 166.

per which strikes a gong at one or both ends of its travel; in the buzzer, the gong and clapper are omitted, the noise being made by the armature striking against the magnet or other portion of the frame. In the make-and-break contact bell or buzzer, the armature carries a contact spring which ceases to make contact with a post or adjusting screw shortly before the armature reaches its position of minimum reluctance; this opens the circuit and stops the current; whereupon the retractile force of an opposing spring draws the armature away until the contact has been restored; this cycle is repeated so long as the circuit is closed at the push button or other switch.

164. Adjustment of Vibrators.—For each bell or buzzer there are certain adjustments of the retractile spring and of the contact point which give maximum noise for a given applied electromotive force and circuit resistance. As with the polarized ringer,¹ the amount of noise is proportional to the strength of the blow of the tapper against the gong, and this is determined by the momentum of the moving system accumulated from the pull on the vibrating armature throughout its forward travel. Other things being equal, the longer the travel the harder² the blow. If, however, the armature falls back too far, the available current may not be able to set up a magnetic field strong enough to attract the armature from its extreme position, and so the alarm may fail to operate.

On the other hand, if the adjusting screw is too close, the circuit may fail to open when the armature is in the closest position, and again the alarm will fail to vibrate. Sometimes the adjustment is so close that the contact is only partially opened and there is only a feeble trembling of the parts.

The length of travel of the vibrator should be great enough to allow time³ for the current to build up to full value at an early epoch in the swing, such time being determined by the relative resistance and inductance in the electric circuit.

¹ See §§ 184-189.

² See preceding note.

³ See §§ 200, 231, 233, and Fig. 61.

165. Pole-changers; Oscillograms.—Exchanges of small or medium size frequently use some sort of “pole-changer”¹ for obtaining alternating or pulsating current of a definite² frequency from a primary or secondary battery. The driving portion of a pole-changer³ is essentially that of a vibrating make-and-break bell; the vibrating element carries two or more contact members which close a battery circuit upon the line or upon one circuit of an induction coil in such a way that

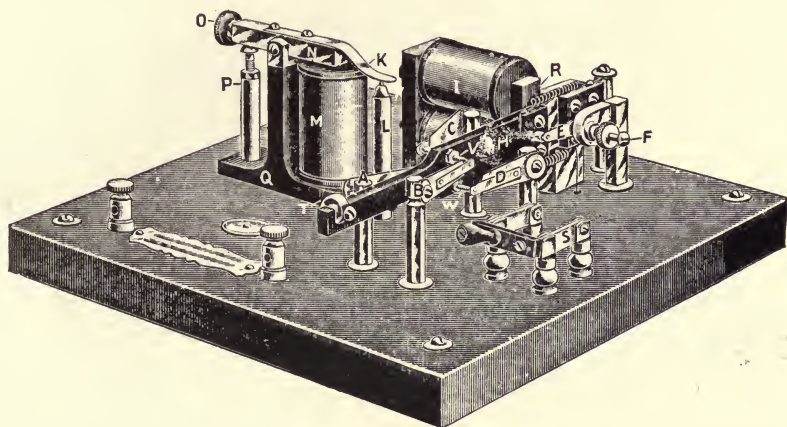

FIG. 64.—POLE-CHANGER TO OBTAIN ALTERNATING CURRENT FROM DIRECT CURRENT (Warner)

the polarity of the line is reversed at each end of the movement of the vibrating member.

A typical example is the Warner pole-changer, in which a

¹ While in one sense the pole-changer comes under the head of polarized apparatus and might be considered in the following chapter, yet it does not depend upon a permanent magnet or its equivalent. It seems to fall logically among vibrating contact apparatus.

² See §§ 187, 188, 189.

³ Descriptions of pole-changers will be found.

U. S. Patent No. 299,926 (June 3, 1884), to C. D. Haskins.

PREECE and STUBBS. *Manual of Telephony*, p. 197.

ABBOTT. *Op. cit.*, Part VI, pp. 218, 225.

VANDEVENTER. *Op. cit.*, pp. 128-134.

West. Elec., 37:381 (Nov. 11, 1905).

El. World, 41:364 (Feb. 28, 1903); 45:1130 (June 17, 1905).

Jour. Fkln. Inst., 119:47 (Jan., 1885).

vibrating electromagnetic mechanism (I, R, E, F) carrying an insulated arm H with speed-adjusting weight T causes two or four contact pins (V and W , for alternating currents, with the addition of X and Y for pulsating currents also) to make contact with stationary spring brushes. In order to improve the wave form of the ringing current, and also to reduce sparking at the brushes, an electromagnet M connects a condenser across the line when ringing current is used, this

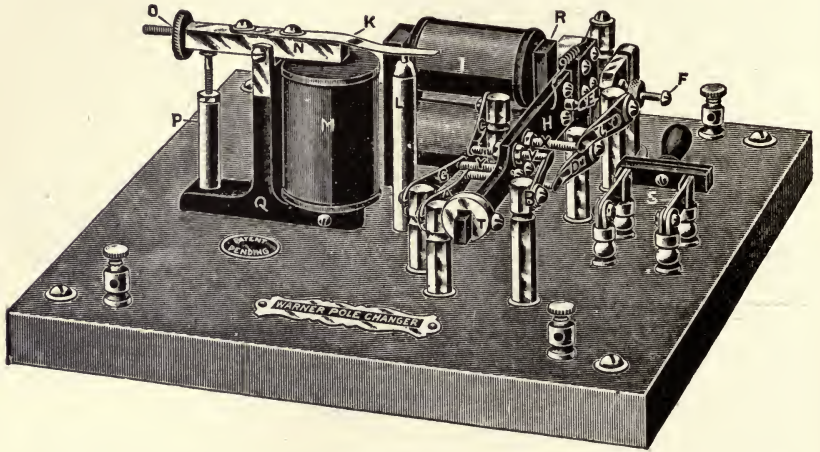

FIG. 65.—POLE-CHANGER TO OBTAIN ALTERNATING OR PULSATING CURRENT FROM DIRECT CURRENT

circuit being open at other times in order to avoid draining the ringing battery.

In the construction and use of pole-changers, care should be taken to avoid unnecessary elasticity in the contact members, in order that each reversal may be clean and not a series of imperfect ones.

Oscillographic records¹ taken from two types of pole-changer are shown in Fig. 67. The lower one of each pair of curves shows the wave form of electromotive force at the outgoing terminals. The upper curve shows the resulting current delivered through a ringing circuit.

¹ SHEPARDSON. "Telephone Disturbances from Electrical Generators," *Trans. Am. Inst. El. Eng.*, 15:443-460 (1898).

At first thought, one might expect the electromotive force to be a series of rectangular curves, but various influences modify it. For example, in the upper set the tendency of the electromotive force to rise along a logarithmic curve is due to the influence of a circuit-closing relay in the main or ringing circuit, while the jog in this curve seems due to the charging of an internal condenser. Because of the inductive character of the ringers which constitute the load, the current

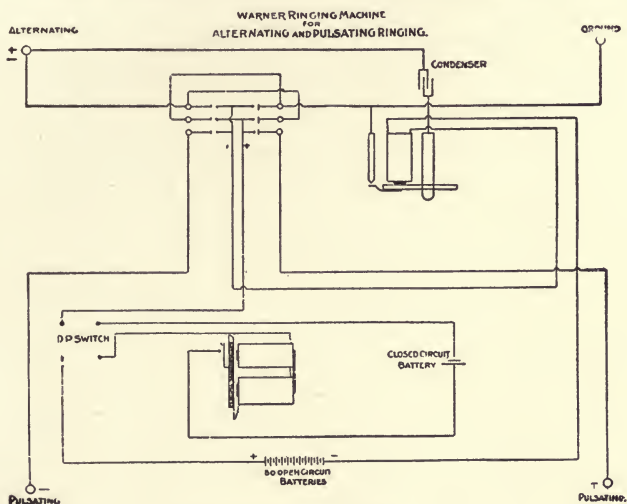

FIG. 66.—CIRCUITS OF A POLE-CHANGER

builds up more slowly than the electromotive force, and also lags behind it about 45 electrical degrees.

In the lower pair of curves, taken from a pole-changer which does not have an internal coil in the main ringing circuit, the terminal electromotive force tends toward the expected rectangular wave form, but has a number of jogs which are due to imperfect action at the contact points. The influence of the ragged action of the contacts is plainly seen in the form of the current wave.

TOMLINSON. "Disturbances Caused by Electromagnetic Waves in Telephony," 1909 thesis in library of University of Minnesota.

ALTON, EDDY, SMITHSON, and THORNTON. "A Study of Telephone Ringers and Pole-changers," 1907 thesis in library of University of Minnesota.

166. Causes of Sparking at Contact Points.—In the operation of vibrating contact bells, pole-changers, busy-backs, howlers, and similar apparatus in which an inductive circuit is opened frequently, trouble may be expected from

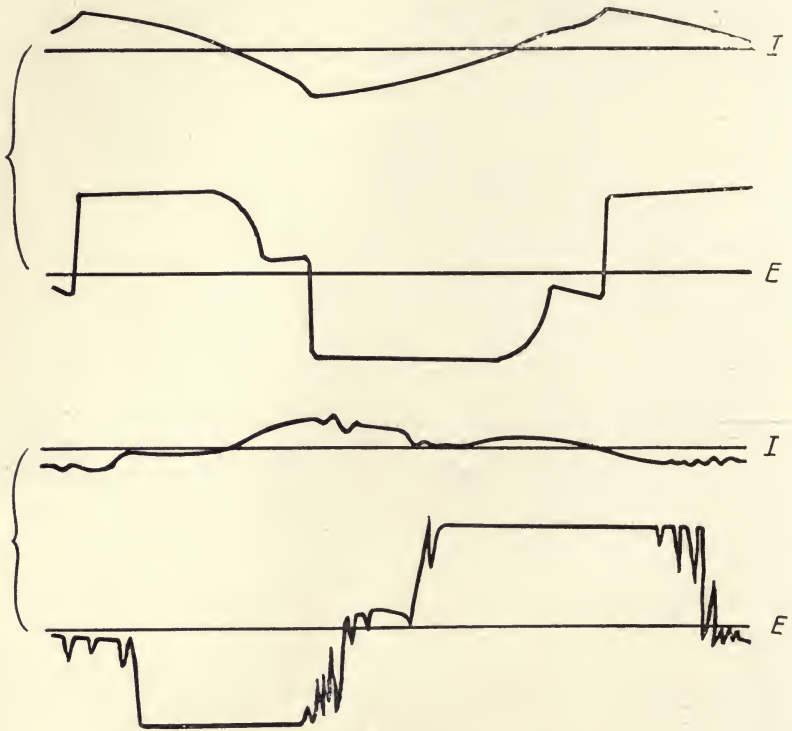

FIG. 67.—OSCILLOGRAMS FROM POLE-CHANGERS
(Alton, Eddy, Smithson, and Thornton)

arcking at the contact points. The current does not stop¹ at the instant the circuit begins to open, but continues for an appreciable time, because to the electromotive force of the battery or other original source of current there is added an electromotive force of self-induction from the coils which are crossed by the magnetic flux as it rapidly decays or collapses while the current becomes less. The combined electromotive

¹ See also § 141.

forces maintain the current through the spark or arc which exists for a short time after the contact points have become separated, the material of the terminal contacts being vaporized by the heat generated by the I^2R loss as the current passes through the high resistance at the break.

Pioneer students of the spark at opening a circuit were Vassali-Eandi,¹ Forbes,² Faraday,³ Henry,⁴ Fizeau,⁵ and Thomson.⁶

Though sparking has been studied for more than a century, the subject is far from being exhausted.

167. Reduction of Sparking.—For the reduction of the arcking at the break, several plans⁷ have been proposed:

- a. Shunting the break⁸ by a resistance;
- b. Shunting the break⁵ by a condenser;
- c. Shunting the break⁹ by a polarized liquid resistance;

¹ VASSALI-EANDI. *Phil. Mag.*, 15:1803; also (4), 3:455; 1852.

² J. D. FORBES. *Phil. Mag.* (2), 11:359 (May, 1832).

³ FARADAY. *Electrical Researches*, 1:322, § 1048. Quaritch, London (1839); *Phil. Mag.* (2), 11:300 (April, 1832).

⁴ HENRY. *Phil. Mag.* (3), 16:200, 254, 551 (1840); *Silliman's Jour.*, 22:403 (July, 1832); Memorial of Joseph Henry, pp. 233-238, 493. Washington (1880).

⁵ FIZEAU. *Compt. Rend.*, 36:418 (Mar. 7, 1853); *Pogg. Ann.* (3), 89:173 (1853).

RAYLEIGH (J. W. STRUTT). *Phil. Mag.* (4), 39:428 (June, 1870).

THOMSON. *Phil. Mag.* (4), 5:393 (June, 1853).

FLEMING. *Alternating Current Transformer*, 1:383. London (1890).

BURSTYN. *Elek. Zeit.*, 34:1225 (Oct. 23, 1913).

WAGHORN. *Elec. Lon.*, 66:172 (Nov. 11, 1910).

⁶ THOMSON. *Phil. Mag.* (4), 5:393 (June, 1853).

⁷ VASCHY. *Compt. Rend.*, 107:780 (Nov. 12, 1888).

THOMPSON. *The Electromagnet*, pp. 368-383.

PREECE. *Jour. Soc. Tel. Eng.*, 6:53 (Feb. 14, 1877).

LOCKWOOD. *Trans. Am. Inst. El. Eng.*, 7:226 (1890); *El. Eng. N. Y.*, 9:390 (May 28, 1890).

⁸ Used by Dering in 1854, by Dujardin in 1864, by Higgins in 1866, by Culley and others. See footnote ¹ above. Anticipated by Staite and Petrie in British Patent, No. 12,772 (Sept. 20, 1849).

⁹ J. E. SMITH. U. S. Patent No. 33,269 (Sept. 10, 1861).

D'ARSONVAL. *Compt. Rend.*, 100:239 (Jan. 26, 1885).

RIEFTER and PAULES. *Elek. Zeit.*, 31:861 (Aug. 25, 1910); *La Lum. Elec.* (2), 12:244 (Oct. 29, 1910).

- d. Shunting a condenser¹ around the inductive part of the circuit;
- e. Placing inductive sheaths² around the coils;
- f. Adding a differential winding which neutralizes the main winding when in circuit;
- g. Winding in multiple several coils having different time constants;
- h. Short-circuiting the coil instead of opening the main circuit.

The choice of method and the design of the component parts will depend on whether the main desire is to have the current decay as rapidly as possible, or whether it is simply to reduce the spark. The arrangement of the parts in the main circuit is also a dominant feature. The first two methods are most generally applicable.

Arcking at the point of opening a circuit can usually be mitigated by connecting a condenser³ across the break; the electromotive force from the decaying magnetic field will store much of its energy in the condenser, whence it will be discharged through the local circuit when the break is closed again, part going back through the main circuit if the condenser is so small that it becomes charged to a potential higher than that of the battery.

When pole-changers are used for ringing purposes, a condenser is frequently connected⁴ across the outside ringing line; then the energy of self-induction charges the condenser as the battery circuit is opened; the condenser then discharges through the ringing circuit, and may be adjusted so as to help the next impulse of ringing current in the opposite direction.

¹ VARLEY. British Patent No. 3,453 (Dec. 6, 1862).

LOCKWOOD. See footnote on p. 165.

ELISHA GRAY. U. S. Patent No. 203,264 (May 7, 1878).

² Copper sheath used by Varley in 1867, by Brush in 1878.

THOMPSON. Electromagnet, p. 370.

³ See footnote 5, page 165.

⁴ Warner pole-changer described:

VANDEVENTER. *Op. cit.*, p. 131.

MCMEEN and MILLER. *Op. cit.*, p. 596.

See also § 165.

168. Disturbances from Sparking.—Sparkling at the brushes or at other contact points in the signaling equipment of an exchange should be kept down to a minimum, both to avoid unnecessary wearing of the contact points (with the consequent increase in required amount of care or liability to derangement), and also to avoid unnecessary noise in the exchange. There is good evidence¹ that arcking contacts on motors, generators, and vibrators are a prolific source of high frequency waves which travel in trains whose frequency corresponds with the number of breaks in the arcking circuit; these trains of waves are conducted by the wire circuits, and constitute a frequently unsuspected source of the disturbances which are often attributed to “noisy lines.” Such sparking can frequently be mitigated by attention to the adjustment of the contact surfaces, especially at the points where the current is finally broken.

¹ See footnote on pages 163 and 164.

CHAPTER X

PERMANENT MAGNETS AND POLARIZED APPARATUS

169. Importance of Permanent Magnets and Polarized Apparatus in Telephony.—The permanent magnet is the basis of most polarized apparatus as well as of the magneto generator, which latter is used in larger numbers than all other electrical generators combined, excepting the dry cell.

Polarized apparatus¹ used in telephony includes such important devices as receivers, ringers, relays used in selective ringing and in telegraphy, several kinds of measuring instruments, vibrating commutating rectifiers, and some types of reverse current circuit-breaker for protecting batteries during charge.

170. Steel for Permanent Magnets.—The material for permanent magnets is almost invariably hardened steel, an alloy of iron with various other substances in varying proportions. The best composition and the best degree of hardness² for steel magnets have been the subjects of much investigation, the results of which, for commercial reasons, are only partially available.

¹ See §§ 175-179. See also Appendix C for development of theory.

² BARUS and STROUHAL. *Wied. Ann.*, 11:930 (1880); 20:525, 621, 662 (1883); Bulletin of U. S. Geological Survey, No. 14. Washington (May, 1885).

HOPKINSON. *Phil. Trans. Roy. Soc.*, 176:463. London (1885); Smithsonian Physical Tables, p. 319. Washington (1914).

S. P. THOMPSON. *The Electromagnet*, pp. 381-411; *Elec. Lon.*, 27:240, 274, 355 (July 3, 10 and 31, 1891); *El. World*, 18:80 (Aug. 1, 1891); 18:91 (Aug. 8, 1891).

EWING. *Magnetic Induction in Iron and Other Metals*, pp. 82-86. Electrician Pub. Co., London; Van Nostrand, New York (1892).

DUBOIS. *The Magnetic Circuit*, p. 230. Longmans, Green & Co., New York (1896).

ABBOTT. *Telephony*, 5:56-61.

BARRETT, BROWN and HATFIELD. *Jour. Just. Elec. Eng.*, 31:674 (1902).

SWINDEN. *Jour. Inst. Elec. Eng.*, 42:641 (1909).

171. **Permeability, Coercitive Force; Magnetomotive Force.**—Hardened steel is magnetized less strongly and with greater difficulty than is soft iron. It retains its magnetization with greater tenacity, as though its constituent particles were polarized or oriented with difficulty but retained their

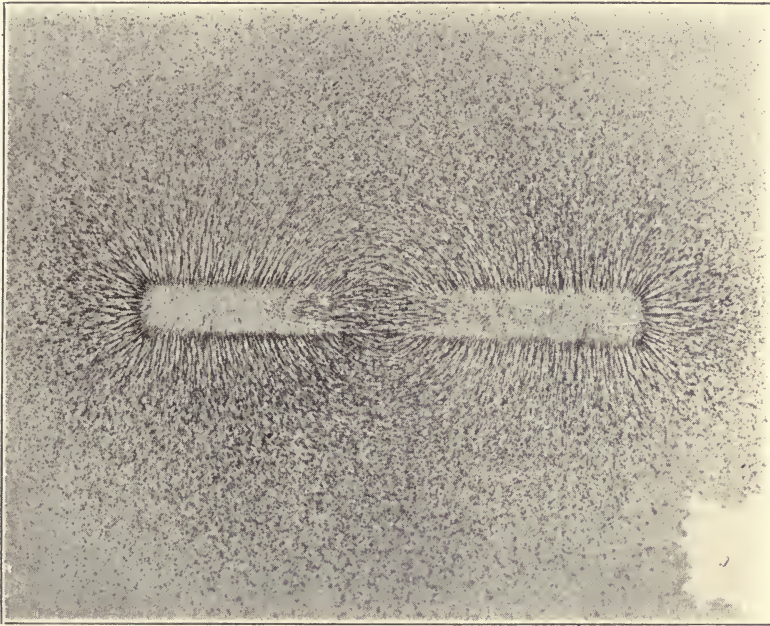

FIG. 68.—FIELD AROUND BAR PERMANENT MAGNET

positions with corresponding tenacity or coercitive force. A commonly accepted belief is that the residual magnetism is due to minute and persistent electric currents¹ which circu-

¹ AMPERE. *Journal des Mines*, 5:537 (1821).

WIEDEMANN. *Elektricität*, 3:96. Braunschweig (1885).

MAXWELL. *Electricity and Magnetism*, vol. 2, part 4, chap. 22. Oxford (1881).

J. J. THOMSON. "Report on Electrical Theories," British Association Report (1885), pp. 97-155.

EWING. *Magnetic Induction in Iron and Other Metals*, chap. 11.

WILLIAMS. "The Electron Theory of Magnetism," Bulletin No. 62, University of Illinois, Urbana (1912).

ONNES. *Sci. Amer. Supp.*, 78:131 (Aug. 27, 1914); *Sci. Amer.*, 111:145 (Aug. 29, 1914).

late through the individual particles of the steel and which, after being oriented so as to cooperate, constitute a permanent magnetomotive force.

172. Field Distribution and Poles of Permanent Magnet.—When the field about a permanent magnet is explored, as by bits of iron, it is found that magnetic flux ordinarily leaves the steel over its entire surface, feebly in some places

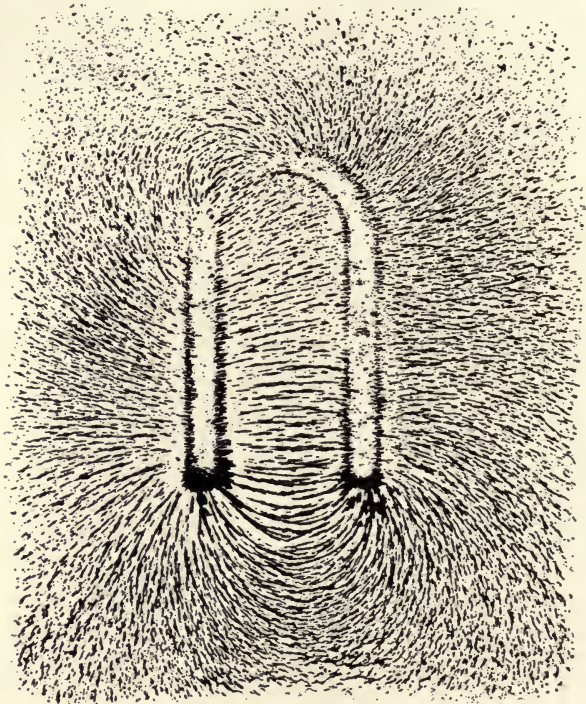

FIG. 69.—FIELD AROUND HORSESHOE PERMANENT MAGNET

and strongly at others, Figs. 68 and 69, there being more or less clearly defined places which may be called "poles," whence most of the flux may be considered as emanating.

173. High Internal Reluctance; Magnetomotive Force and Reluctance Resolvable into Two Parts.—Since experiment shows that the total flux through a permanent magnet is nearly constant¹ whether the magnetic circuit between its

¹ See Appendix B.

terminals or poles is closed through soft iron or through air, it may be considered that the reluctance within the permanent magnet is very high. The total magnetomotive force within the permanent magnet may therefore be considered as divisible into two parts, a constant and large portion which maintains the flux through the portion of the permanent magnet lying between the poles or main centers of efflux, and a con-

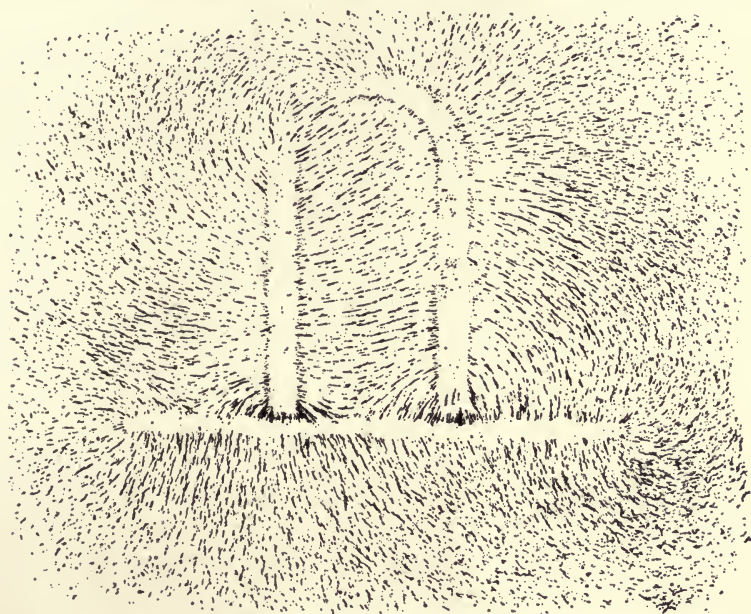

FIG. 70.—FIELD AROUND HORSESHOE MAGNET WITH ARMATURE IN PLACE

stant remainder which sends the flux through the remaining portion of the circuit.

174. Flux Distribution in External Field; Armature Changes Distribution Rather Than Amount; Similar Effect by External Magnetomotive Force.—The flux through the portion of the magnetic circuit¹ external to the permanent magnet usually distributes through a wide path whose reluctance is small because of its large area. When an armature or other good conducting path is placed across the ends or

¹ See Appendix A, §§ 294, 301; also Figs. 68-70.

poles of the permanent magnet, it presents a path of lower reluctance than the air; and much of the flux concentrates both outside and inside the hard steel in order to follow the path of least net reluctance. Because of the greater concentration of the flux near the poles in the hard steel, the consequent increase in the reluctance (because of the smaller area of the path within the steel) nearly offsets the decrease of reluctance through the external part of the circuit. The net result is that the total reluctance of this kind of circuit as a whole is affected to only a small extent¹ by the presence or absence of an armature between the poles; the armature, therefore, changes the distribution rather than the amount of the magnetism from a permanent magnet.

Similarly, the effect of a second magnetomotive force, such as current through a coil surrounding part of the magnetic circuit, is to change the direction or distribution² of the magnetism, while it rarely affects the total amount of flux through the permanent magnet.

175. Physical Basis of Polarized Apparatus.—In polarized apparatus,³ motion of part of a magnetic circuit, or of a conductor carrying current through a magnetic field which is energized principally by a constant source (such as a permanent magnet or a unidirectional current), is caused by variations in strength or direction of an auxiliary deflecting current which changes the position of part or all of the magnetic flux from the steady source. In each case there are main and auxiliary magnetomotive forces whose directions may or may not coincide.

176. Polarized Apparatus with Movable Member in the Electric Circuit.—If the movable portion is part of the electric circuit, such as the coil of a galvanometer of the d'Arsonval type, it tends to move against a restraining force so as to include as large as possible a portion of the resulting

¹ See Appendix B.

² See § 69.

³ In a sense, commutating apparatus, such as pole-changers (see § 165), might be called polarized apparatus, though not in the sense here used.

magnetic flux. The most sensitive and generally satisfactory instruments for electrical measurements with direct currents (such as ammeters, voltmeters, and galvanometers) are of the polarized type in which the principal magnetic field is furnished by a permanent magnet. The oscillograph,¹ which is one of the best means of obtaining photographic records of telephonic talking currents, is generally of the polarized type, having in a strong unidirectional field either a vibrating loop conducting the current, or else a needle movable under the combined influence of a permanent magnetic field and of current through a neighboring coil. The thermogalvanometer,² which is one of the most sensitive instruments for measuring very small alternating currents such as telephone voice currents or those received in radio or wireless signaling, is based upon the deflection of the minute current from a thermocouple in a loop delicately suspended in a strong unidirectional magnetic field, one end of the couple being warmed by the current to be measured. The Einthoven³ "string galvanometer," consisting essentially of a single delicate conductor crossing an intense magnetic field, may be used with a moving photographic film as an oscillograph, or may be used as a sensitive galvanometer for direct or alternating currents by measuring the distance of travel of its image.

¹ For bibliography of the oscillograph, with description of the G.E. type, see ROBINSON. *Trans. Amer. Inst. El. Eng.*, 24:214 (Apr., 1905).

For examples of use of oscillograph in telephone research, see:

GAVEY. *Jour. Inst. Elec. Eng.*, 36:4 (Nov., 1905).

COHEN and SHEPHERD. *Jour. Inst. Elec. Eng.*, 39:507 (May, 1907); *Elec. Lon.*, 59:124 (May 10, 1907); 59:182 (May 17, 1907).

DEVAUX-CHARBONNEL. *Compt. Rend.*, 146:1258 (June 15, 1908); *La Lum. Elec.* (2), 3:215, 323 (Aug. 15, Sept. 12, 1908); *Proc. Int. Cong. Tel. Eng.*, Paris (1910).

GATL. *Proc. Int. Cong. Tel. Eng.*, Paris (1910); *Elec. Lon.*, 66:456 (Dec. 30, 1910).

FLOWERS. *Proc. Amer. Inst. Elec. Eng.*, 35:183-201 (Feb., 1916).

² DUDELL. *Phil. Mag.* (6), 8:91 (July, 1904); *Phil. Trans. Roy. Soc.*, London, 180:159 (1889); 203 (A):305 (1904).

For early forms by Watson and others see KINGSBURY. Telephone and Telephone Exchanges, pp. 141-148. Longmans (1915).

³ EINTHOVEN. See § 40.

177. Polarized Apparatus with Movable Member in the Magnetic Circuit.—If the movable portion is part of the magnetic circuit, it tends to move to a position where it will carry as large a portion as possible of the total magnetic flux and thereby reduce the reluctance of the magnetic circuit as a whole (or the reverse, according to conditions); the result is generally to cause at least part of the flux through the permanent magnet, or its equivalent electromagnet, to alternate between two paths and thereby to cause motion of the armature or diaphragm.

In the usual form of telephone receiver, the magnetic effect of the current through the coils is alternately to cooperate with and to oppose the magnetomotive force of the permanent magnet and to cause a varying proportion of the total flux from the permanent magnet to pass through the iron diaphragm or through the leakage path between the soft iron tips. In the electromagnetic type of telephone receiver, the alternating impulses from the voice currents affect the total flux from the steady unidirectional current from the central battery.

In the reverse current circuit-breakers (frequently used on power switchboards to prevent the storage battery from discharging back through the charging line in case of trouble), a permanent magnet or an equivalent electromagnet cooperates with a coil in the main battery circuit, so as to result in attraction holding the switch closed when the current is in the right direction for charging, and so as to result in repulsion letting the switch open when the current is in the wrong direction.

178. Polarized Ringer and Relay Mechanisms.—In most of the polarized ringer¹ or relay mechanisms, the middle portion² of an electromagnet is fastened near one pole of a permanent magnet, and a vibrating armature is arranged to move so as to make the path from one pole of the permanent

¹ For descriptions of modern polarized ringers see:

VANDEVENTER. *Telephonology*, pp. 19-38.

ABBOTT. *Telephony*, part V, pp. 332-344.

MILLER. *Op. cit.*, pp. 124-129.

² See Figs. 71, 74, 75.

magnet to the other pole now better through one leg of the electromagnet and now better through the other leg, according to the position of the vibrator. The motion of the vibrator is caused by the shifting of the magnetic flux as the magnetomotive forces due to the current in the coils combine with that of the permanent magnet to strengthen the flux through one leg and to weaken it through the other when the current is in one direction, and to reverse the action when the current changes direction.

179. Biased Mechanism.—In the usual form of polarized

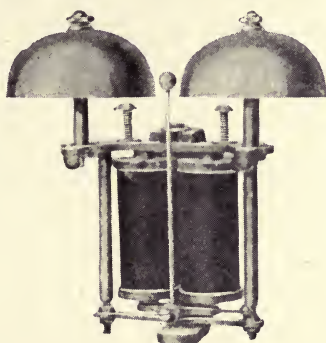

FIG. 71.—POLARIZED RINGER
Adjustable gong posts

ringer, the vibrator has a symmetrical motion, from a position nearly touching one leg of the electromagnet to a position equally close to the other leg, remaining in one or the other position according to the direction of the last impulse of current.

Some apparatus is "biased," so as to respond to currents in one direction but not in the other, a spring holding the vibrator normally in one extreme position so that it responds only to impulses of current in the direction tending to move the vibrator to the other leg. This is the usual arrangement for ringers and relays intended for selective¹ ringing, and lock-out²

¹ See §§ 187-192.

² See footnote on page 131.

mechanisms for calling one station on a party line without disturbing others.

In other biased apparatus, such as the polarized relays¹ used in duplex and quadruplex telegraphy, the stops are so adjusted that the vibrator is always closer to one leg of the electromagnet than to the other, never passing the neutral position beyond which the net attraction due to the permanent magnet would pull the vibrator toward the other leg.

When the axis of rotation of the vibrator is vertical, gravity exerts no influence beyond a slight increase in the pressure on the pivots; in other planes, the influence of gravity may be considered as that of a biasing spring. The amplitude of the vibration is generally so small that the influence of gravity is sensibly constant.

¹ McNICOL. American Telegraph Practice, pp. 255-279, 289-343.

MAVER. American Telegraphy, pp. 181-230. Bunnell, New York (1892).

CHAPTER XI

DESIGN OF POLARIZED APPARATUS

180. General Conditions.—To a large extent, the design of polarized apparatus is similar to that of non-polarized apparatus. The uses of permanent magnets and of alternating currents introduce a number of additional elements, to some of which attention is called in the following paragraphs. Reference is made in the Appendix to some of the underlying mathematical developments, including some original investigations in Appendix C.

181. Two Classes of Armature.—Practically all of the polarized ringer or relay mechanisms may be grouped under one of two classes. In one class the armature is supported at one end by pivots or by a spring, and all the useful magnetic flux passes through its entire length, this class being represented by the Siemens polarized relay¹ and by a few types of ringer. In the other class the armature is supported at its center, and the magnetic flux shifts between its halves, as in the usual type of ringer. With but little modification, the same theory applies to both classes.

182. Desirability of Constant Reluctance.—In order to minimize the weakening of the permanent magnet with use, since in a cycle of magnetization a weakening force is more effective² than a corresponding strengthening force, it is desirable to have the polarized apparatus so designed that the reluctance of the main path of the magnetic flux through the permanent magnet shall be sensibly constant; otherwise, as in Fig. 72, the oscillation of the vibrator tends alternately to weaken and to strengthen the permanent magnet, which results in a net weakening because of hysteresis. The advan-

¹ See Appendix I.

² See Appendix A, § 297; also Figs. 109, 110.

tages of using a single coil instead of two coils are sometimes thought¹ to outweigh this disadvantage.

183. **Conditions Determining Minimum Operating Current.**—The equation² for ampere-turns ni (and minimum

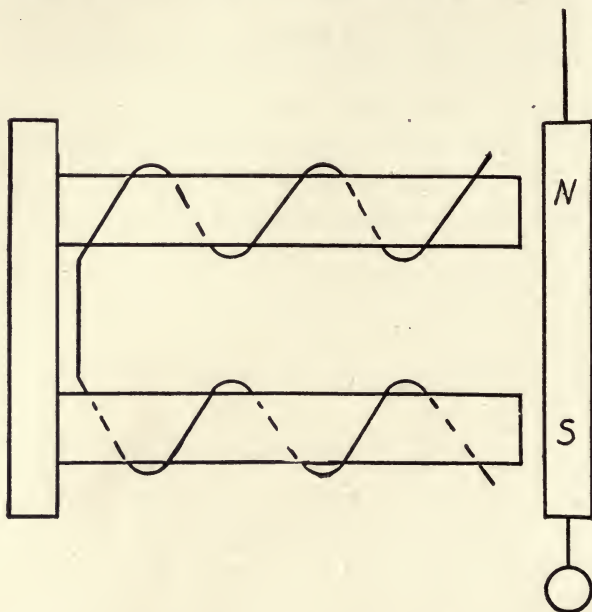

FIG. 72.—POLARIZED MECHANISM
Variable flux through permanent magnet

operating current i) in a polarized ringer, when the vibrator or armature is at one end of its throw,

$$ni = \frac{M}{4\pi} \frac{y - x}{y + x + 2g}$$

shows that the ampere-turns (or, for a given winding of the coils, the current) required to start the vibrator moving must increase with the strength M of the permanent magnet. The

¹ S. P. THOMPSON. *The Electromagnet*, p. 295.

VANDEVENTER. *Telephony*, pp. 29, 30, 190.

ABBOTT. *Telephony*, 5:342.

El. World, 41:364 (Feb. 28, 1903); 45:1130 (June 17, 1905).

U. S. Patent No. 692,579 (Feb. 4, 1902).

² See Appendix C, § 316, page 294.

required current strength decreases as the distance, $y + x$, between the ends of the electromagnet increases, and as the distance, g , between the vibrator and the pole of the permanent magnet increases.

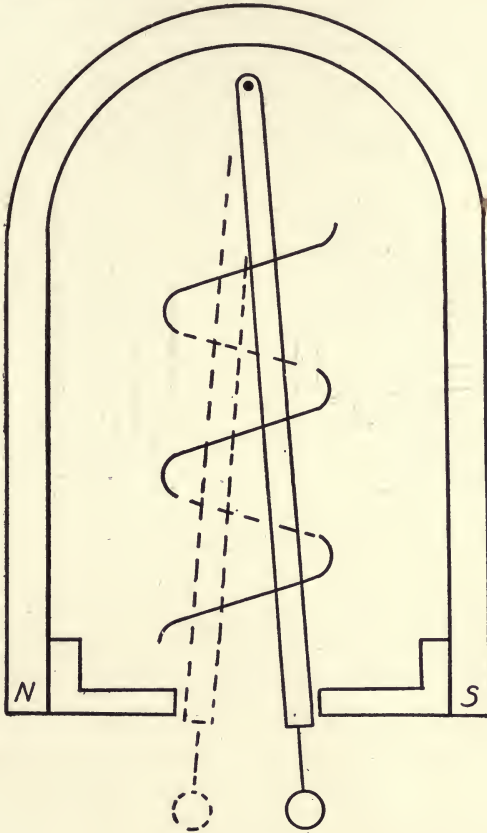

FIG. 73.—POLARIZED MECHANISM
Single coil and soft-iron vibrator

With a given construction, the required starting current varies directly with the distance of travel, $y - x$, of the vibrator.

It should be borne in mind that these conclusions apply only to the determination of the current which will balance the pull of the permanent magnet so as to make the vibrator

ready to move away. A somewhat larger current will be required to make the vibrator actually move against the restraint of friction or other cause such as a biasing spring. These conclusions, also, do not throw light upon the strength of the blow or the pressure upon the gong or other limiting stop, those being determined¹ by other equations.

184. Adjustments of Air-gaps.—Applying these conclusions to the actual ringer or relay, if the intent is to make it operate on as small current as possible (as when used at

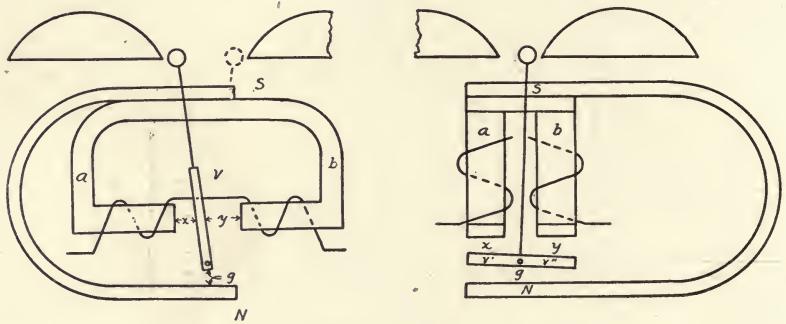

FIG. 74.—POLARIZED RINGER DIAGRAMS

the end of a long line), the air-gap between vibrator and permanent magnet should be made large, or the gongs or other limiting stops should be adjusted to make the angle of movement small. For obtaining equally strong blows on the two gongs of an unbiased ringer, the adjustment should be symmetrical so that the vibrator shall swing as close to one end of the electromagnet as to the other.

Symmetry of adjustment of the gongs or of the magnetic circuit is not so important for a biased ringer, since it is generally operated by unidirectional current.

185. Elements Determining Strength of Blow and Noise.—The amount of noise made by the polarized ringer depends on the design, size, and material of the gongs and their mounting, upon the electrical and magnetic design, upon the mechanics of the moving system, and upon the

¹ See § 185 and Appendix C, § 315.

strength, frequency, and wave form of the electric current. Other things being equal, the noise emitted is proportional to the amplitude of vibration of the gongs, and this is proportional to the strength of the blow by the hammer.

The strength of the blow is determined by the momentum of the moving system, accumulated as a result of the net pull on the vibrator or armature throughout its stroke or travel.

Other things being equal, the strength of the blow, and

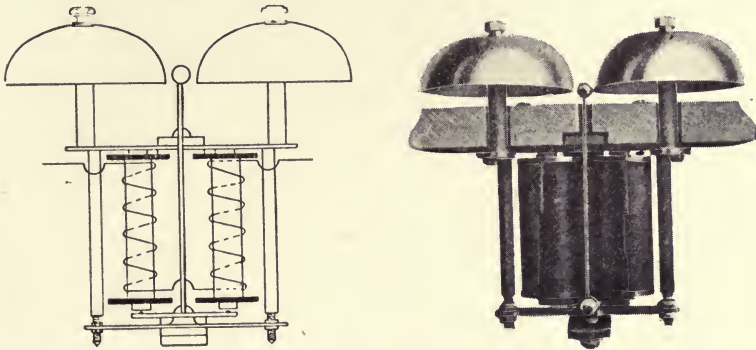

FIG. 75.—POLARIZED RINGER
Air gaps and gongs adjustable

therefore the amount of noise from the gongs, within certain limits indicated by the mathematical theory, increases with the strength of the permanent magnet and also with the strength of the current.

Profitable study might be given to the determination of the best form for the current wave.

186. Elastic Blow Desirable.—The rebound of the gong helps accelerate the return swing of the tapper, at the same time helping prevent the tapper from following up the motion of the gong and so muffling its vibrations. To sharpen the blow by insuring the prompt removal of the tapper after striking, the hammer head is frequently mounted on a flexible stem or helve (sometimes called the clapper wire), and the vibrating armature strikes a stop shortly before the hammer strikes the gong,¹ so that the hammer strikes only after

¹ See also VANDEVENTER. *Op. cit.*, p. 186.

slightly springing the stem. Unless such elastic blow is secured, the hammer is apt to muffle the sound by following up the gong until the changing direction of the current¹ attracts the armature in the opposite direction.

187. Natural Period of Pivoted Vibrators and of Reeds.—For highest efficiency, the natural period of the moving system of a ringer should be the same as that of the ringing current. The moving system, including the magnetic portion of the vibrator and the hammer or other load carried by it, may be considered as a sort of pendulum whose actuating force is a combination of electromagnetic pull with gravity or the resiliency of a spring, together with more or less of a positive or negative impulse due to the striking and rebound of the gong. (Experience shows that the natural period of vibration of a ringer is faster² when the hammer head or tapper strikes the gongs than when the gongs are removed.)

The laws of the pendulum are involved in the action of a number of telephonic signaling devices, such as the make-and-break vibrating bell or buzzer, the vibrating pole-changer, the step-by-step selector, the polarized pivoted ringer, the tuned harmonic ringer, and the non-selective reed type of ringer. In some cases, gravity is the principal force against which the electromagnetic forces operate; in other cases a spring furnishes the principal opposing force.

In the case of a simple pendulum acted upon by gravity only, the effective pull equals the product of the mass (assumed concentrated at the end of the pendulum) by the effective component of the force of gravity (which varies with the sine of the angle of displacement of the pendulum from its lowest position). Neglecting friction, the power or the rate of work done by gravity upon the pendulum equals at any instant the product of the mass by its acceleration or

¹ Similar action is secured in large church bells by special steel springs, which accelerate the rebound of the clapper.

² W. W. DEAN. *Amer. Tel. Jour.* (June 20, 1903; June 17, 1905); Bulletin No. 100, p. 6, by Dean Electric Co. (Garford Mfg. Co.), Elyria, Ohio.

McMEEN and MILLER. *Op. cit.*, pp. 240-246.

change of velocity. (The total work done in moving the pendulum from its position of rest to that of greatest velocity equals the product of its mass by half the square of the velocity.) Since both the effective force of gravitation and the resulting acceleration include the mass as a multiplier, the mass cancels out when they are equated, the result being that the time of a complete vibration is independent of the mass of the pendulum, and is determined only by the strength of gravity and by the length of the pendulum (which determines the effective component of gravity for a given amplitude of vibration). The natural period of vibration of a simple pendulum, consisting of a mass concentrated at the end of a weightless arm and acted upon by gravity alone, is determined by the relation ¹

$$T = 2 \pi \sqrt{\frac{L}{G}}$$

in which T is the time required for a complete or double vibration, L is the effective length of the pendulum, G is the strength of the force of gravity, and π is the constant 3.1415 representing the relation between the diameter and circumference of a circle.

When, as in the ordinary case, the pendulum is not simple, but consists of several extended masses distributed at various distances from the point of support, the factor L is replaced by the summation of the moments of inertia ml^2 of the various elements divided by the product of the total mass of the moving system times the distance of its center of gravity from the point of suspension, or

$$T = 2 \pi \sqrt{\frac{\sum m l^2}{M L G}}$$

188. Control of Natural Period.—In most of the vibrating systems found in telephonic apparatus gravity is only one and often the least of several forces acting. In many cases

¹Derived in most treatises on physics or on mechanics.

the motion is in the horizontal plane, for which gravity has no accelerating effect, or the angular displacement is so small that the effective component of gravity is negligible.

The action of a spring on a vibrating system, such as the retractile spring of a make-and-break direct current bell or buzzer, or the supporting spring of a vibrating reed as used



FIG. 76.—VIBRATORS TUNED FOR SELECTIVE RINGING

in tuned harmonic ringers, is somewhat similar to that of gravity, in that the restorative force is directly proportional to the angular displacement, which for gravity and within the small limits usual in practice is closely equal to the sine of the angle. The force required for bending the spring a given distance is directly proportional to the sectional area and inversely proportional to the length of the spring. Since the mass of the vibrating element is not a factor in the force of the spring (as it is in the force of gravity), while it is a factor in the force required to accelerate the vibrating element, the mass or weight of the spring-controlled vibrating system is a determining factor in its natural period of vibration and hence in the number of free vibrations per second. Therefore a spring-supported pendulum, such as in a pole-changer or a reed ringer, will vibrate more slowly as the weight is increased; as with a gravity-controlled pendulum, it will also vibrate more slowly as the weight is moved fur-

ther from the support so as to increase the effective length of the vibrating system.

While the natural period of vibration of a spring-supported pendulum is determined by the strength of the spring and by the length and weight of the pendulum, it is modified or forced when acted upon by other forces such as that of an electromagnet. In certain apparatus, such as vibrating reeds used in polarized ringers, especially those of the tuned variety, the electromagnetic pull augments the accelerating effect of the spring during the first part of the swing or half-vibration, and overbalances the spring during the second part. In other mechanisms, such as certain pole-changers, the electromagnetic effect is similar during one half-vibration, but is absent during the return stroke. In such mechanisms as vibrating contact bells the electromagnetic pull works against the spring continuously while the motion is in one direction and is absent during the return stroke.

Further, the electromagnetic effect varies throughout the stroke because of the varying strength of the current. When vibrating contact devices are used with direct current sources, such as batteries, the current tends to rise in approximate accordance with a logarithmic curve, this curve being modified by the increasing value of the self-inductance as the armature moves so as to reduce the reluctance of the magnetic circuit; when the current is alternating, the varying value of the inductance distorts the wave form of current.

The electromagnetic forces thus alter the acceleration of the vibrating element and tend to make it vibrate in other than its natural period.

189. Forced Vibration.—If the electromagnetic pull is sufficiently strong, it will force the vibrating element to move in harmony and synchronism with the actuating current, executing what may be considered as a forced vibration. If, however, the natural period of the vibrator corresponds closely to that of the current, much less current will be required than for a forced vibration. It is possible to secure "selective" operation of bells or similar signaling apparatus by adjust-

ing their natural periods of vibration so that certain ones respond readily to currents of a specified frequency while they are relatively insensitive to currents of other frequencies.

190. Harmonic Selective Ringing; Checking Standards.

—In the so-called “harmonic” systems¹ for selecting stations on a multi-party line, it is common to use currents whose frequencies have harmonic ratios, such as 1:2:3:4, as would be

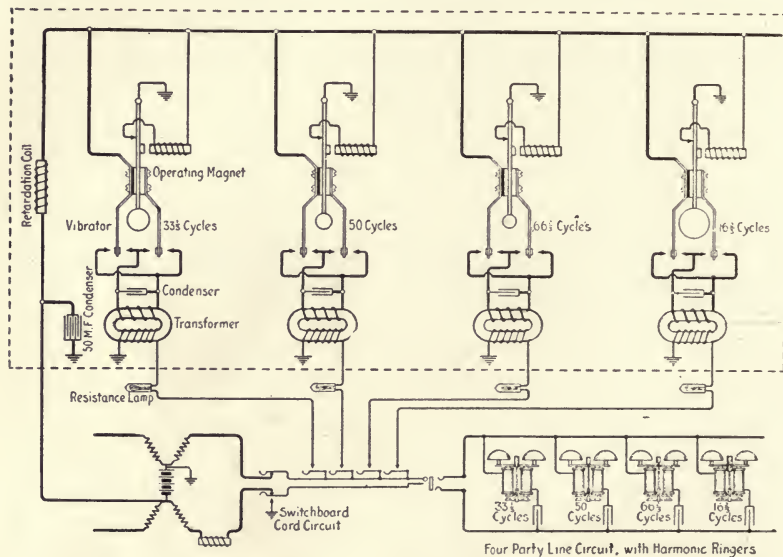

FIG. 77.—CIRCUITS OF HARMONIC RINGING SYSTEM
(Western Electric)

given by generators having 16.66, 33.33, 50 and 66.66 periods per second respectively. Such currents are obtainable from tuned “pole-changers” whose vibrating switches change direct currents from a battery into alternating current, or from a

¹ Descriptions of harmonic or otherwise selective systems are given by: LOCKWOOD. “Selective Signals,” *Trans. Am. Inst. El. Eng.*, 9:527 (1892).

WILDER. *Telephone Principles and Practice*, pp. 321-326.

VANDEVENTER. *Op. cit.*, pp. 175-206, 423-466.

DEAN. “Harmonic Party Line Systems,” *Telephony*, 12:37. Chicago (July, 1906).

McMEEN and MILLER. *Telephony*, pp. 228-252.

set of alternators having suitable numbers of poles and coupled together so as to rotate in unison.

To check the adjustment of the speed of the generating apparatus for selective ringing, in order to give best results by supplying currents of proper frequencies, it is common to have near the generator a set of standardized reeds. The adjustment of the speed which makes each test ringer operate most vigorously indicates the correct frequency for the generating apparatus.

191. Avoidance of Cross-ringing.—Difficulty may be expected on harmonic ringing systems because of “cross-ringing,” when bells or ringers for one frequency respond to currents of another frequency. If the electromotive force and resulting currents are sufficiently strong, any ringer may be expected to execute forced vibrations. With currents too small to cause forced vibrations, there is little tendency for a ringer to respond to a current of half or twice its natural frequency, for, in response to a current of half frequency, the reed would tend to swing in the wrong direction during half of each impulse of current, and there would be no cumulative action; likewise, currents of double frequency would exert positive and negative pulls in each single vibration, and would have no cumulative action. Currents of one-third or of three times the natural period of the reed or other vibrating system would have a net pull in the right direction for each impulse or vibration; consequently, reeds tuned for 16.66 periods are liable to respond to currents of 50 periods per second, and vice versa.

In order to reduce the liability to cross-ringing, some prefer¹ to use frequencies of 30, 42, 54 and 66 cycles, these having no simple frequency ratios and therefore being less likely to give false signals. Frequencies as low as 16 are liable to be reached by subscribers on party lines when calling the exchange by operating the ordinary bipolar magneto generator, and thus are liable to give undesired calls to other

¹An example is the “sychromonic” system of the North Electric Company.

parties on the same line whose ringers are sensitive to such currents.

192. Adjustment of Impedance for Selective Ringing.— Since the amount of alternating current which will pass through a given circuit when a given electromotive force is applied depends upon the impedance of the circuit (which in turn depends not only upon the resistance, but also upon the frequency, the electromagnetic induction, and the electrostatic capacity in the circuit), it is possible to design the electric circuits of polarized ringers so that each will take a maximum of current of any specified frequency and much less current of any other frequency. When sinusoidal current is supplied, the impedance of a circuit containing resistance and inductance is expressed¹ by

$$Z = \sqrt{R^2 + (2\pi fL)^2},$$

in which R is ohmic resistance, generally somewhat greater than that opposed to direct currents, f is the frequency in complete cycles per second, and L is the coefficient of self-induction expressed in henries. When a condenser is in series with the ringer, the impedance¹ is

$$Z = \sqrt{R^2 + \left(2\pi fL - \frac{1}{2\pi fC}\right)^2},$$

in which C is² the capacitance in farads.

By choosing suitable condensers, it is theoretically possible to balance capacity against induction so as to obtain resonance, and thus to reduce the value of the impedance to that of the resistance; in practice, however, the wave form of the ring-

¹ Derived in most treatises on alternating currents.

² Because the word *capacity* is used in different senses and sometimes leads to ambiguity, it is recommended (Standardization Rules of American Institute of Electrical Engineers, in *Proceedings* for August, 1915, and for September, 1916) that the descriptive terms *power capacity* or *current capacity* be used when referring to the power or current that a device can safely carry, and that the term *capacitance* be used when referring to the electrostatic capacity. This usage may cause temporary confusion, since *capacitance* has been used to some extent to denote condensive reactance, $\frac{1}{2\pi fC}$, sometimes called *condensance*.

ing current is likely to depart widely from the sinusoid. Some manufacturers or inventors have attempted to secure complete or partial resonance¹ by the use of condensers; some have put inductive coils in series or in shunt with the ringer coils; some have made the auxiliary coils adjustable by varying the iron cores; some have wound the ringer coils with resistance to suit the frequency; and some have made ringers and circuits uniform for all frequencies, depending on the natural period of the reed. For perfect resonance, each ringer would have to be adjusted for the particular line on which it was to be used.

¹ See also § 273; also § 237.

PART III

SOURCES OF ELECTROMOTIVE FORCE AND
PROTECTION

CHAPTER XII

ELECTROMOTIVE FORCES AND CURRENTS

193. Electromotive Forces and Currents, Intentional, Volunteer, Secondary, and Stray; Limitations of This Treatment.—The electromotive forces and resulting currents in telephone circuits are partly intended and partly volunteer. The latter may be secondary, that is, caused by the intended current, or they may come in as stray disturbances from foreign circuits.

To a large extent, the apparatus used as sources of electromotive force and of current for telephonic purposes has been developed and standardized in the more general branches of electrical engineering and is amply discussed in the general and special treatises. Varieties and uses peculiar to telephony are discussed in the descriptive books. Consideration here will be limited to a general analysis and to notes on design and theory.

194. Current Transformations of Energy.—Electric current in a circuit involves the transformation of energy in one or more of five forms: as electromagnetic field, as electrostatic field, as electrochemical action, as heat, as mechanical energy. Any of these may be either the origin or the result of the electric current.

195. Current Cause and Effect; Kirchhoff's Law.—The current may be considered as causing or as being caused by one or more electromotive forces associated with the several transformations. The total electromotive force which causes the current is equal to the net sum of the various counter-electromotive forces against which the current may be considered as forced.

196. Power in a Circuit; Difficulty of Measuring Power in Some Telephone Circuits.—In any part or in the whole

of the circuit, the power¹ (or the rate of transforming energy) at any instant equals the product of the current by the corresponding electromotive force, both being taken at the same instant and for the same part of the circuit. When the current and electromotive force are constant from instant to instant, as when a battery sends current steadily through an unchanging circuit, the power (measured in watts) equals the product of current strength (amperes) by electromotive force (volts). When electromotive force and current vary from instant to instant, as with pulsating or with alternating currents, the power at each instant equals the product of the current and electromotive force values at that same instant.

The mean or average power, as measured by a watt-meter, equals the product of the effective amperes (square root of the average of the squares of the successive instantaneous values), multiplied by the effective volts and by the power factor which is a proportionality factor equal to unity or less, depending upon the relative wave forms of the electromotive force and of the current, and upon the angular distance between their corresponding zero values.

The characteristic telephone currents, the voice currents,² are so small that they are measured with difficulty and only by refined methods. Since both the currents and the electromotive forces are small, their power is of a still lower order and is exceedingly difficult to measure. From the viewpoint of power or energy, as considered for ordinary commercial purposes, the kilowatts and the kilowatt-hours involved in telephonic transmission are entirely negligible. The power used, however, for the auxiliary operations (such as the cen-

¹ See books on alternating currents, such as:

JACKSON. Alternating Currents and Alternating Current Machinery.

FLEMING. Alternating Current Transformer.

MAGNUSSON. Alternating Currents. McGraw-Hill, New York (1916).

THOMAELEN. Elements of Electrical Engineering.

For special methods applicable to measuring power in telephonic apparatus, see paper by COHEN and SHEPHERD in *Jour. Inst. El. Eng.*, 39:521 (1907); abstracted by FLEMING. Propagation of Electric Currents in Telephone and Telegraph Conductors, pp. 228-231.

² See § 65.

tral energy supply for switchboard operation and the lighting and ventilation of the building as well as the talking current) runs into kilowatts and comes within the range of electric light and power engineering.

197. Energy in Magnetic Field; Logarithmic Law with Steady Electromotive Force.—The electromagnetic field,¹ that is, the field of force through and about an electromagnet (used in its broad sense including induction coils), involves transformation of energy both in its establishment and in its decay.

Suppose that a steady electromotive force, such as that of a battery, is applied to a circuit including an electromagnet. As the current begins to pass through the windings of the electromagnet, the magnetic field begins to build up in more or less close² proportion; at the same time there is induced in the windings an electromotive force which is directly proportional to the rate at which the magnetic field builds up; this electromotive force is in a direction to oppose the building up of the current. The result is that in such a circuit the current does not rise instantly to its full value, as indicated by the simpler form of Ohm's law, $I = E/R$, but it builds³ up more or less closely in accordance with a logarithmic⁴ law.

Similarly, if the applied electromotive force be removed, the current dies down more or less closely in accordance with the logarithmic law, the electromotive force induced by the decaying magnetic field tending to retard⁵ such decay. The early deficit and the later discharge involve storing and restoring energy. Thus the induced electromotive force, known as the counter-electromotive force of self-induction, tends to resist any change in the strength of the magnetic field.

¹ See §§ 200, 292.

² See Appendix A, §§ 296, 297.

³ BEDELL and CREHORE. Alternating Currents.

JACKSON. *Op. cit.*

PENDER. Principles of Electrical Engineering.

⁴ See § 151 and Fig. 61; also § 205.

⁵ See § 165.

198. Magnetic Field with Alternating Current; Counter-electromotive Force; Resistance; Lag.—When an alternating electromotive force is applied to a circuit containing an electromagnet, a more complicated cycle follows. The current rises and falls and reverses in somewhat close conformity to the wave form of the applied electromotive force, involving more or less similar changes in the strength and direction of the magnetic field. There are induced counter-electromotive forces, strictly proportional to the rate of change of the magnetic field.

These counter-electromotive forces involve more or less complicated variations¹ in the strength and wave form of the current during a number of cycles after the first application of the impressed electromotive force. After the starting phenomena have subsided, the general effect of the counter-electromotive force is to retard the current, so that it reaches its maximum and minimum values somewhat later than the corresponding values of the applied electromotive force. The counter-electromotive force also reduces the effective value² of the current to something considerably less than that indicated by Ohm's law for direct currents. This is the basis of the retardation coil.

199. Instantaneous and Effective Values.—In general, the current at any instant through a circuit containing an electromagnet is expressed by the equation

$$i = \frac{e - e'}{r}$$

in which r is the resistance of the conductor, e is the applied and e' is the counter-electromotive force or forces.

When effective instead of instantaneous values are considered, the current, after the starting irregularities have quieted, is expressed³ by

$$I = \frac{E}{\sqrt{R^2 + 4\pi^2 f^2 L^2}}$$

¹ STEINMETZ. *Transient Electric Phenomena and Oscillations.*

JACKSON. *Op. cit.*

² See §§ 199, 207, 208. ³ See footnotes on page 194.

in which: I (amperes) is the current; E (volts) is the electromotive force, applied to the whole circuit, or measured between the terminals of any portion of the circuit considered; R (ohms) is the resistance in the electrical circuit, including that of the regular conductor and a more or less variable portion representing the energy transferred to other circuits through the changing magnetic field; L (henries) is the coefficient of self-induction,¹ influenced more or less by the counter magnetomotive force of secondary currents, and by variations of magnetic permeability through the cycle of current and of magnetism; f (cycles per second) is the frequency of the current; and 2π is the proportionality constant.

200. Induced Electromotive Forces; Transformer Action.

—The electromotive force induced² by the changing magnetic flux is strictly proportional at every instant to the rate of change of the flux. Electromotive forces are induced not only in the original or primary magnetizing circuit, but also in every electric circuit through which the changing magnetic flux passes, the electromotive force being proportional to the number of turns (convolutions or complete wraps) surrounding the flux. These electromotive forces will cause secondary currents to flow, if the circuits are complete. Thus, secondary currents will flow in the iron core through which the magnetic flux passes, unless the core be split or otherwise laminated.³

If the magnetic flux be surrounded by a number of circuits or coils, each will have induced therein electromotive forces which may impel secondary currents, each of which tends to set up its magnetic field and thereby to react upon the primary circuit. The net magnetic flux is the resultant of the several fluxes; or, what results in practically the same, the net magnetomotive force acting on the magnetic circuit is the net sum of the several magnetomotive forces, due consideration being given to their relative time and space relationships. The en-

¹ See Appendix A, § 304.

² See § 291; also §§ 197, 198.

³ See §§ 153, 233.

ergy is transferred from the primary to the secondary circuits by forcing the changes in the magnetic flux against their opposing magnetomotive forces. This is the basis of the induction coil,¹ or repeating coil, or transformer.

201. Energy in Electrostatic Field; Strain in Dielectric.

—The electrostatic field involves transformation of energy; this includes storing and restoring energy as electrostatic charges, associated with more or less loss, principally heat.

Whenever two or more conductors are connected respectively with the terminals of a battery (or to other parts of a circuit between which there exists a voltage, or difference of potential) the air or other insulating material between them is subjected to a sort of strain, which is proportional to their difference of potential and which may be said to be caused by tubes of electrostatic force extending from one conductor to the other. The strain in the insulating medium, which medium is usually called the dielectric, tends to draw together conductors between which the difference of potential is greater than that to other near conductors, and to push apart those whose difference of potential is less than to their neighbors. (In the older terminology, bodies charged with unlike electricity attract each other, while those charged alike repel.)

202. Condenser; Dielectric Capacity.—When conductors are specially arranged to facilitate the existence of tubes of force, the assemblage of conductors and insulating medium is called a condenser. The capacity of a condenser to hold electrostatic flux is independent of the material of the conductors, being a property of the dielectric or insulating medium. It is directly proportional to the dielectric area between the conductors, and is inversely proportional to its thickness. Some dielectric materials give much greater capacity than others, this property being known as the specific inductive capacity² of the material; sometimes it is called the dielectric capacity or the dielectric coefficient, that of air being taken as unity.

¹ See §§ 239, 240.

² See §§ 263, 264.

203. Storage of Energy in Condenser; Capacity.—When the assumed two conductors are first connected to a battery or other source of difference of potential, the establishment of the strain in the dielectric involves a storage of energy which is supplied by a transient current flowing from the battery to one conductor, thence into the dielectric (as strain) to the other conductor and thence back to the battery. As current flows between the two conductors, the strain on the dielectric increases, each ampere-second adding its quota; this results in the establishment of a difference of potential, or counter-electromotive force, between the conductors or terminals of the condenser. The quantity of electricity, or the number of coulombs in the charge, equals the summation or integral of the ampere-seconds of current which have passed through the condenser. The capacitance of the condenser, as measured in farads, is determined by the number of coulombs or ampere-seconds passing in or out of the condenser when the difference of potential between its terminals changes by one volt. (Condensers practically are rated in terms of microfarads, that is, in millionths of a farad.)

204. Condenser Action Common.—Electrostatic capacity is not limited¹ to conductors and dielectrics especially arranged for the purpose. For example, electrostatic capacity exists between neighboring conductors (whether of the same or of different circuits), between aerial conductors and the clouds, between aerial conductors and the earth, between the earth and the conductors within an underground cable. In any of these cases, any change in the potential of either of the conductors involves a change in the strain on the dielectric between it and the other conductors in the vicinity, and consequently transient currents arise in the conductors leading to them.

205. Logarithmic Charging Current from Steady Electromotive Force.—The charging current varies from instant to instant, being usually greatest at first and then gradually getting less as the counter-electromotive force across the con-

¹ See § 202.

denser increases in consequence of the increasing charge and strain.

When the circuit contains only resistance and capacity, and the impressed electromotive force is constant, as from a battery, the charging current follows¹ a logarithmic² curve. But this ideal condition is generally complicated by the unavoidable presence³ of more or less self-induction in the circuit, which adds a varying quota of counter-electromotive force due to the growth and decay of the electromagnetic field resulting from the charging current.

206. Condenser Charge from Pulsating or Alternating Current.—When a condenser is subjected to an alternating or to a pulsating electromotive force, it is charged and discharged every half-cycle or pulsation, thus passing an alternating current.

When a sinusoidal alternating electromotive force is impressed upon a circuit containing capacity only, the resistance (exclusive of that in the condenser dielectric) and the electromagnetic inductance being negligible, the effective (root-mean-square) current is expressible,⁴ after transient starting phenomena have quieted, by:

$$I = 2 \pi f C E$$

being directly proportional to the capacitance, C , to the frequency, f , and to the voltage, E , using either maximum or square root of mean squared values for both I and E .

207. Alternating Current in Circuit with Resistance and Capacity.—When the circuit contains capacity in series with resistance (exclusive of that of the dielectric in the condenser), the electromagnetic inductance being negligible, the expression for current⁵ is complicated by the fact that the applied electromotive force overcomes two opposing components which are ninety electrical degrees apart. The resis-

¹ See §§ 151, 197.

² See footnotes on page 195.

³ See § 200.

⁴ Obtained by assuming $R = 0$ in the equations of § 207.

⁵ See footnote 1 on page 194.

tance component is in phase with the current, the ohmic drop being the greatest at the instant when the current is the greatest, and zero when the current is zero. The condenser component of electromotive force, on the other hand, is the result of the coulombs accumulated in the condenser, and is greatest at the instant when the condenser is fully charged, which is at the instant when the current ceases to flow into the condenser again. The condenser voltage passes through zero at the instant when the current into or from the condenser has its greatest value as the condenser discharges and begins to charge in the opposite sense, the terminal which previously was positive now becoming negative. The resistance and capacity components of electromotive force being thus ninety electrical degrees apart may be combined like the sides of a right-angled triangle, their resultant like the hypotenuse of the triangle being equal to the square root of the sum of the squares of the components or sides. Moreover, since the electromotive force required to send a given current into a condenser is less as the frequency and as the capacity are greater, the reciprocal value is taken for the capacity component, called condensive or capacity reactance. The total or resultant electromotive force required is then, using either maximum or square root of mean squared values for both E and I :

$$E = \sqrt{(IR)^2 + \left(\frac{I}{2\pi fC}\right)^2} = I \sqrt{R^2 + \left(\frac{1}{2\pi fC}\right)^2}$$

whence.

$$I = \frac{E}{\sqrt{R^2 + \left(\frac{1}{2\pi fC}\right)^2}} = \frac{E}{Z}$$

the denominator of which expression is called the "impedance" of the circuit.

208. Alternating Current in Circuit with Resistance, Capacity, and Inductance.—When the circuit contains resistance in series with both capacity and electromagnetic in-

ductance, the expression for current¹ is somewhat more complicated. The applied electromotive force must then overcome three counter-electromotive forces. Fortunately, the components due to the capacity and to the inductance are in opposite directions, each being ninety electrical degrees from the component due to the resistance.

The electromotive force of electromagnetic self-induction is in a direction to oppose changes in the strength of the current, tending to prevent the current from increasing and also to prevent it from decreasing. On the other hand, capacity acts more or less like a vacuum tending to hasten the influx of current and retarding its return. The total impressed electromotive force may then be expressed² by

$$E = I \sqrt{R^2 + \left(2\pi fL - \frac{1}{2\pi fC}\right)^2}$$

whence,

$$I = \frac{E}{\sqrt{R^2 + \left(2\pi fL - \frac{1}{2\pi fC}\right)^2}} = \frac{E}{Z}$$

209. Transient Phenomena.—These expressions indicate the effective values of the current and electromotive force when conditions have become steady. When the electromotive force is first applied, or when its effective value is suddenly changed, somewhat complicated transient elements³ may become important.⁴

¹ SIR WM. THOMSON. *Phil. Mag.* (4), 5:393 (June, 1853).

BEDELL and CREHORE. *Op. cit.*, chaps. 6-11.

STEINMETZ. *Transient Electric Phenomena and Oscillations*, chap. 5.

JACKSON. *Op. cit.*, pp. 187-195.

FLEMING. *Alternating Current Transformer*, vol. 1, chap. 5. Van Nostrand (1890).

² For derivation see footnote 7 on page 218.

BEDELL and CREHORE. *Op. cit.*, chap. 9.

JACKSON. *Op. cit.*, pp. 195-204.

Experimental illustrations by Pupin. *Trans. Am. Inst. El. Eng.*, 10:370 (May, 1893).

³ See footnote 1 on page 196.

⁴ For examples, see § 272, and Figs. 58 and 60.

210. Alternating Currents in Branched Circuits.—When the circuit contains two or more elements in multiple, that is, when the main circuit divides into two or more branches, it is necessary to consider ¹ for each branch conductance instead of resistance, susceptance instead of reactance, and admittance instead of impedance. Admittance equals the reciprocal of impedance; conductance equals resistance divided by the square of the impedance, and susceptance equals reactance divided by the square of the impedance. The conductance of the group of branches equals the sum of the several conductances, and the susceptance of the group equals the net sum of the several susceptances, noting that capacity and inductance have opposite signs. The admittance of the group equals the square root of the sum of the square of the group conductance plus the square of the group susceptance.

When it is necessary to consider a circuit in which an impedance is in series with a branched circuit, the latter is treated as if reduced to an equivalent simple series impedance whose equivalent resistance equals the combined conductances of the group divided by the square of the admittance of the group, and whose reactance equals the combined net susceptances of the group divided by the square of the admittance of the group.

211. Total Electromotive Force or Current Less Than Sum of Parts.—Because of the opposite signs of the electromotive forces about series capacity and inductance, it follows that the sum of the partial electromotive forces is generally greater ² than the total, and one or more of the partial electromotive forces may be greater than the total. Similarly, in a branched circuit, the sum of the individual currents ³ is likely to be greater ⁴ than the whole; and when there is capac-

¹ For derivation of formulae, and for graphical treatment, see:

JACKSON. *Op. cit.*, pp. 277-311.

BEDELL and CREHORE. *Op. cit.*, pp. 233-259.

STEINMETZ. *Alternating Current Phenomena*, pp. 54-60.

² See numerical examples given by JACKSON. *Op. cit.*, pp. 270-275.

³ For example, see § 253.

⁴ See example given by JACKSON. *Op. cit.*, pp. 281-296.

ity in one circuit and electromagnetic inductance in a parallel circuit, the current in one or more branches may be greater than the total. This is a reason for shunting coils by condensers, as is frequently done¹ in cord circuits² at the exchange and sometimes in subscribers' sets.

212. Chemical Energy and Current.—Electrochemical action is important in telephony, as both a source and a result of current. Chemical action develops electromotive force and current in one direction, although of course commutating devices may be used to make it pulsate or alternate in direction. Conversely, chemical action is electrically produced principally by direct current, since with alternating current the chemical effect produced by one half-cycle is for the most part neutralized by the succeeding half-cycle in the opposite direction. (In some of the electrochemical industries where heat and not electrolysis is the requisite, alternating currents are effective.)

213. Fundamental Electrochemical Relations.—Without going into details, which are discussed sufficiently in books³ on electrochemistry and on batteries, the electrochemical actions of most importance in telephony are simply expressed. When a metallic conductor is dissolved more or less by a liquid, a difference of potential (that is, an electromotive force) exists between them. When two different kinds of conducting material are partially immersed in a liquid which dissolves one faster than the other, a difference of potential exists between the two, and this action becomes a source of current if an electric circuit is completed between the two conductors. Whenever current passes from a solid conductor into a liquid conductor, material from the solid conductor is

¹ For example, see Fig. 91, §§ 270, 271.

² See examples in McMEEN and MILLER. *Telephony*, p. 175.

³ COOPER. *Primary Batteries*. London (1901).

CARHART. *Primary Batteries*. Boston (1891).

LYNDON. *Storage Battery Engineering*. New York (1911).

MORSE. *Storage Batteries*. New York (1912).

DOLEZALEK. *Theory of the Lead Accumulator*. New York (1904).

LE BLANC. *Electro Chemistry*. New York (1907).

FARADAY. *Experimental Researches in Electricity*. London (1839).

carried into solution and may be deposited at some other place where current passes from the liquid into some other solid conductor. The weight of solid conductor carried into solution depends upon the material and upon the ampere-hours, that is, upon the strength of the current and the length of time during which it acts.

214. Deleterious and Helpful Electrochemical Effects in Telephony.—Deleterious electrochemical effects in telephony include electrolytic eating away¹ of lead cable sheaths by stray currents, local action as an after-effect of using corrosive soldering salts, and local action on plates in primary and secondary batteries.

Helpful electrochemical effects are utilized in the “dry” and the “wet” primary cells used so extensively as small electrical generators, in the charging and discharging of secondary (or storage) batteries and in the electroplating processes for depositing copper and nickel coatings on various metallic or carbon parts used in telephone apparatus.

215. Primary and Secondary Batteries.—For direct current used intermittently, nothing is more convenient than the “dry” cell,² in which, for the sake of portability and general adaptability, the electrolyte is held in the interstices of absorbent material. This is suitable for supplying transmitters of local battery systems, for operating signal lamps, pole-changers, and ringing circuits on small exchanges, and for testing and miscellaneous purposes.

For larger uses of direct current, as in central energy exchanges, it is customary to employ secondary,³ often called “storage,” cells. The secondary battery is charged from a direct current dynamo electric generator, or from direct current service from a power station, or from alternating cur-

¹ See §§ 279-282.

² CARHART. *Op. cit.*

Trans. Amer. Elec. Chem. Soc., 16:97 (1909); 17:341 (1910); 19:31 (1911).

Standard Handbook, § 20, arts. 29-42.

Telephony, 59:791 (Dec. 31, 1910).

³ See footnote 3 on page 204.

rent service through an intermediary rectifying device, such as a motor-generator, or mercury-vapor rectifier, or equivalent.

216. Heat Transformable to Electricity.—Transformations of energy between heat and electricity have numerous direct and indirect connections with telephony. Passing by the indirect transformations by which the energy of fuel is used to drive electrical generators by power through the medium of steam boilers and engines, or by gas or oil motors, the direct transformations¹ are but feeble. Thermoelectric currents, based on maintaining differences of temperature between alternate junctions of unlike conductors in the same electrical circuit, are a source of annoyance in refined electrical measurements, and are also the basis of certain electrical measuring instruments, such as the thermogalvanometer² and the electric thermometer. From an energy standpoint, these transformations are pitifully inefficient.

217. Heat from Electricity.—On the other hand, practically the entire electrical energy in a circuit may be transformed into heat, a large part of which may be developed close to the exact locality desired. Any temperature desired in the manufacture or operation of telephone equipment may be secured, from the melting temperature of the arc or the incandescent welding processes, or the brilliant incandescent lamp, or the more moderate temperature of the electric soldering copper, to the lower temperatures desired in the resistors used for controlling current strength or in the safety fuses designed to protect the circuits from excessive currents.

The rate at which electrical energy is transformed into heat in any part of a circuit equals the product of the resistance in that part multiplied by the squared value of the current; or, more tersely, watts equal ohms times square of amperes; or,

$$W = I^2R.$$

¹ SHEPARDSON. "Electricity from Heat," 1889 thesis in library of Cornell University.

² See § 175.

This product, multiplied by the time during which the current continues, gives the watt-seconds or watt-hours of energy transformed.

218. Ohmic Drop Associated with Heating.—The electric power being transformed into heat in a circuit or part of a circuit may also be expressed as the product of current by an electromotive force.

$$w = I^2R = I IR = Ie$$

in which e may be considered as the "ohmic drop" or the electromotive force necessary to send the current through the resistance. It may be considered as a sort of counter-electromotive force developed by the flow of current, and which neutralizes part or all of the impressed electromotive force which sends current through the circuit.

219. Ohmic Drop as Secondary Source of Electromotive Force; Divided Circuits.—The ohmic drop may be utilized as, in a sense, a source of current for supplying other circuits which may be shunted off from the main circuit. In such case the main current divides among the several paths, and the difference of potential between the junction points becomes proportionately smaller. Thus, an electromagnet for operating a telephone signal, such as a supervisory¹ lamp, may be shunted around a non-inductive resistance in the main talking circuit and not interfere much with the transmission of the voice currents, which would be greatly retarded and confused if compelled to pass through the coil.

220. Mechanical and Electrical Power Interchangeable.—Transformations between mechanical and electrical power or energy are highly and about equally efficient in either direction. Electric motors and electric generators of sizes used in telephone exchanges have efficiencies between forty and ninety or more per cent, while the larger machines in power houses sometimes approach ninety-seven or ninety-eight per cent efficiency. The energy efficiency is less as the apparatus becomes smaller, and becomes of minor interest in much of

¹ See Figs. 53, 54, § 136.

the telephone equipment, in which reliability and accuracy are far more important.

221. Motors, Generators; Principles Well Known.—

Electric motors, in the broad sense, include not only the power machines with revolving armatures, but also the vibrating devices,¹ such as pole-changers, ringing mechanisms, relays, annunciator drop mechanisms, indicating measuring instruments, and (not the least important) telephone receivers.

Electric generators, likewise, include not only power-driven machines, and the smaller hand-operated magneto generators, but also the magneto telephone transmitter.

The general principles of the dynamo-electric generator (now abbreviated to "generator") and motor are generally well understood, these being satisfactorily treated in the general books on electrical engineering² and in special treatises. Attention need be given here to only a few details.

222. Special Construction of Direct Current Generators for Exchange Use; Sparkless Commutation; Care in Operation.—Direct current generators for central exchange work, such as charging storage batteries, should be specially designed and constructed to give a smooth current. This is approximated by providing more sections in the armature winding and in the commutator than are used in machines for ordinary commercial purposes. The fluctuations are further reduced by a reactance, or choke coil,³ with laminated iron core having a large diameter and an open magnetic circuit, the winding being connected in series in the main circuit between the generator and the exchange bus-bar or storage bat-

¹ See §§ 163-166.

² THOMAELEN. *Op. cit.*

THOMPSON. *Dynamo Electric Machinery*. Spon and Chamberlain, New York (1904).

HAWKINS and WALLIS. *The Dynamo*. Macmillan, New York (1913).

RYAN. *Electrical Design*. Wiley, New York (1912).

FRANKLIN and ESTY. *Elements of Electrical Engineering*. New York (1906).

LANGSDORF. *Principles of Direct Current Machines*. McGraw-Hill, New York (1915).

³ See § 248.

tery. Extra care should be taken to keep the commutator smooth and the brushes properly set, to insure sparkless¹, commutation and collection of the current.

223. Special Signaling Attachments; Care in Maintenance.—Large exchanges use motor generators having one or more switching or commutating attachments for obtaining special signaling current, with various combinations and speeds of on-and-off contacts for developing the pitches and sequences of sound desired for the “busy-back” or “they-do-not-answer” signals,² or for the “tone-test” for holding lines while securing toll connections, or for the occasional “howler”³ or other signals. Sparking at the breaking points should be reduced to the minimum.

224. Magneto Generator; Importance; Design.—The magneto generator⁴ deserves careful study. There are probably in service more magneto generators than all other types combined, though their aggregate output is less than that of a single large modern turbo-generator. Though it is the oldest type of electrical generator in use today, it seems to have profited comparatively little by the results of modern knowledge of electrical design. In recent years, more attention has been paid to proper lamination of the armature. There is room for improvement in the proper choice of wave form and its attainment. The space efficiency of the winding is worthy of careful study, as is also the material and disposition of the permanent magnets to obtain and maintain the highest strength. As the speed of a magneto should be kept reason-

¹ See footnote on page 163.

² Descriptions may be found in:

MILLER. *American Telephone Practice*, fourth edition, p. 563.

VANDEVENTER. *Telephonology*, pp. 389, 411.

ABBOTT. *Telephony*, part VI, pp. 213-221.

³ See § 137.

⁴ Descriptions may be found in:

ABBOTT. *Telephony*, part V, pp. 344-363; *Amer. Elec.*, 13:453 (Sept. 1901).

VANDEVENTER. *Op. cit.*, pp. 38-48.

MILLER. *Op. cit.*, pp. 104-131.

McMEEN and MILLER. *Op. cit.*, pp. 105-118.

ably close to that which gives the best¹ frequency for the ringers, there is no independent way of regulating its voltage except by the insertion of series resistance or by placing a magnetic shunt across its field magnets (as was done in the Clarke² magneto generator of 1835, which continued in use for medical purposes for thirty years or more, and was revived³ about 1878 for use as the first telephone ringing generator).

A feature of magneto generator construction, whose importance does not seem to be generally appreciated, is that magnetic leakage between the poles of the permanent magnet should be reduced to a minimum (unless desired for regulation in rare cases), since the magnetic flux which does not pass through the armature winding reduces proportionally the electromotive force and power of the generator. Since the amount of leakage flux is proportional to the conductivity of the leakage⁴ path, which is closely proportional to the amount of exposed iron or steel surface connected with the poles (other than that which faces the armature), it follows that necessary attachments or extensions, such as the screws which hold the magneto to the containing box, should be made of non-magnetic material, such as brass or aluminium, rather than of iron.

225. Foreign Currents or Disturbances.—Foreign currents are derived from outside sources by leakage, by electromagnetic induction, by electrostatic induction, and by radiation.⁵ Foreign currents are objectionable and should be

¹ See §§ 187-190.

² *Phil. Mag.* (3) 9:262, 1836; (3) 10:365, 455, 1837.

THOMPSON. *Dynamo Electric Machinery*, p. 9. Spon, London (1892).

GANOT. *Physics*, p. 815. Wood, New York (1881).

³ *Sci. Amer.*, 42:307 (May 15, 1880).

LOCKWOOD. *Nat. Tel. Exch. Assoc.* (Sept. 26, 1887); *El. World*, 10: 180 (Oct. 1, 1887).

KINGSBURY. *The Telephone and Telephone Exchanges*, pp. 142-145.

⁴ UNDERHILL. *Solenoids*, pp. 36, 78. Van Nostrand, New York (1914).

Standard Handbook of Electrical Engineers, third edition, § 5, arts.

53-59.

⁵ See §§ 168, 229.

avoided as far as possible. They are apt to make the lines noisy and thus to interfere with clear transmission. They are apt to give false signals, or to operate the protective devices and thus open the circuit, or they may damage the apparatus or lines or both.

226. Leakage Currents.—Poor insulation is probably the most prolific inlet for disturbances. This may arise from contact between the live wires and trees or other wires, or from broken or missing insulators. It may arise from moisture in the cables or in the cable heads or other distributing connection centers. It may arise from accumulations of dust or other stray conducting material that sometimes form bridges between neighboring circuits. A new telephone exchange system is generally much more free from disturbing foreign currents than is the same installation after several years of service, the difference being due partly to the increased extent of exposure with growth of business but largely also to deterioration of insulation.

During wet weather, and especially during storms which may whip the wires about into occasional contact with trees or with other lines, the telephone lines are liable to become highly charged by leakage currents.

Leakage currents obey the laws announced by Ohm and by Kirchhoff, their strength being proportional to the difference of potential between the places of exposure and being inversely proportional to the resistance between such points. The conditions are often complicated by the existence of several points of exposure, and by the presence of several paths in the telephone circuit.

Part of the trouble from electrolysis of underground cables¹ comes from leakage currents from electric railway or other systems which use the earth as a part of their conducting circuit. In a sense, some of the atmospheric disturbances may be considered as leakage currents. In the rare case where the line lies in the path of a direct stroke of lightning to earth, as indicated by shattered poles, the telephone line

¹ See §§ 279-282.

carries off part of the current to the earth at more distant places. Open aerial lines are frequently charged by contact with highly electrified particles of dry snow or of dust driven by the wind, these having been charged by friction and by induction.

227. Disturbances from Electromagnetic Induction; Mitigation.—Foreign currents are frequently the result of electromotive forces induced by changing magnetic fields from neighboring circuits. The mutual induction between neighboring circuits is closely comparable with that between the windings¹ of an induction coil. The electromotive force induced in one circuit is proportional to the rate of change of strength of current in the other circuit, being greater as the nearer wires of the two circuits are closer together and as the farther wires are further apart, and being greater as the length of exposure between the circuits increases. In other words, the electromotive force induced in one circuit is proportional to the rate of change in the magnetic flux inclosed by or threading through that circuit and caused by current in the other circuit.

These induced electromotive forces are minimized by increasing the distance between the two circuits. Their effects are nullified by twisting or transposing the conductors, so that the partial electromotive forces in one direction are neutralized by equal electromotive forces in the other direction.

When the exposure is between neighboring coils, as frequently occurs in an exchange, interference is mitigated by surrounding one or both coils by metallic sheaths.² Under some conditions, the sheath is of iron, which helps form a closed path of excellent permeability and conducts the flux from a given coil through its own path and so prevents it from straying out through other circuits. In other cases, the sheath is of highly conducting non-magnetic material, such as aluminium or copper, in which are induced currents in the re-

¹ See §§ 197-200, 231.

² See §§ 144, 236.

verse direction to that of the inducing current, so that their net effect upon other circuits is nil.

228. Disturbances by Electrostatic Induction; Mitigation.—Disturbing currents are sometimes the result of electrostatic induction from neighboring high-tension conductors, including thunder-clouds. The disturbing and the disturbed conductors act more or less like the two surfaces of a condenser. The charge on the disturbed conductor (and the transient current resulting from the redistribution) is proportional to the area of exposure and to the rate of change in the difference of potential.

Telephone lines stretching across the country are liable to become charged¹ to high potentials; that is, their potential is liable to become hundreds or thousands of volts higher or lower than that of the earth. This charge is caused on rare occasions by direct lightning stroke (which might be considered as a leakage disturbance). Lines are frequently charged by electrostatic induction, due to the rapid changes in potentials of neighboring clouds as lightning discharges in various directions. Such charges are commonly known as static charges, or simply as "static." Electromagnetic induction from the flashes adds to the disturbance.

When a conductor is charged, as by a passing electrified cloud or by drifting snow, the changes in potential and in dielectric strain are likely to be so slow as to be inappreciable, except that charges from the snow may cause sparks from an ungrounded circuit. But if the cloud discharges by a flash to more distant clouds or to the earth, the strain on the air dielectric between the cloud and the conductor changes very rapidly, and the resulting adjustment by the charging and discharging currents, as they seek the earth or distant parts of the circuit, are liable to cause damage to property or to person, unless provided with suitable paths to the earth. Hence the "lightning² arrester."

¹ SHEPARDSON. *Electrical Catechism*, pp. 42-45.

THOMAS. *Trans. Am. Inst. El. Eng.*, 27:773 (June, 1908).

² See §§ 283-285.

Telephone lines are also liable to become charged by electrostatic and by electromagnetic induction from nearby high potential power lines, both by the ordinary operation and also by sudden changes in load or by severe atmospheric disturbances.

If the disturbing circuit is thoroughly insulated from the earth, then transposing the conductors of either or both circuits at regular intervals will usually result in the mixing of the partial charges and currents so that the net disturbance will be nil. If, however, either or both circuits are grounded, there is likely to be a lack of balance in the various partial exposures, for the earth comes in as part of the circuit.

229. Disturbances by Radiation; Mitigation.—Radiation¹ is a means of bringing more or less disturbance to telephone circuits. Arcking contacts on electric motors, generators, and signaling apparatus, are a prolific source of high-frequency waves which travel in trains or groups whose frequency corresponds with the partial breaks in the arcking circuit. These trains of waves² travel along the wire circuits more or less closely, and constitute a frequently unsuspected source of disturbances which are often attributed to "noisy lines." Such disturbances can frequently be mitigated by attention to the contact surfaces and springs.

¹ See footnote on page 163.

² See § 168.

CHAPTER XIII

PRINCIPLES OF INDUCTION COILS

230. Two Classes of Induction Coil Used in Telephony; Use of the Word "Coil."—The induction coils used in telephony are of two general classes.

In one class, all the windings are part of the same electrical circuit. When these are used to check the flow of alternating or of pulsating current more than that of direct current, they are called retardation, reactance, inductance, impedance, or choke coils. When they are used to correct the effect of capacity on long lines, they are known as loading coils.

In the other class, the windings compose parts of two or more electrical circuits, and are used principally to transfer energy from one circuit to another. The special uses and features of these coils are considered in the next chapter.

While the term "coil" refers strictly to the winding, its use is frequently extended to include the entire structure, embracing both windings and core, together with mountings and any auxiliary devices, such as a vibrating armature.

231. Underlying Principles.—The induction coil consists essentially of one or more coils of wire arranged to surround a magnetic field. It is based on the fundamental law that an electromotive force is induced whenever an electrical conductor moves in a magnetic field or, what amounts to the same thing, whenever there is a change in the net amount of magnetic flux passing through a loop or coil of conductor. The electromotive force induced¹ in each loop (or convolution, or complete turn) of the conductor is proportional to the rate of change in the amount of magnetic flux (in the same general direction) inclosed by (or threading through) the loop.

¹ See §§ 77, 197, 200, 243.

When, as is usually the case, the conductor includes a coil having a number of turns or loops connected in series, the electromotive force induced in the entire conductor is the sum of the several electromotive forces in the individual turns. If the windings consist of several sections or coils, the electromotive forces in the various sections are proportional to the number of turns in each.

If the magnetic flux through the windings could increase, or decrease, continuously at the same rate, the induced electromotive force would have a constant value in the same direction. But since there are limitations to the density and amount of magnetic flux through a given space, the practical operation is that the magnetic flux can only increase and decrease alternately. The electromotive forces induced by the changes in magnetic flux are therefore first in one direction and then in the other. The magnetic flux may or may not change direction, depending upon whether the net magnetizing forces are unidirectional or alternating.

232. Magnetic Circuits; Closed; Open; Air.—In order that the magnetic flux may vary through wider values, the reluctance¹ of the magnetic circuit is generally reduced by means of an iron core extending through the coils. The core may or may not provide the magnetic flux with a complete path through iron.

The magnetic circuit is said to be “closed” when it is entirely through iron. It is said to be “open” when part of the path is through air.² It is said to be an “air-cored coil” when the magnetic circuit is entirely through air, as is usual with lightning arrester coils and with other high-frequency circuits such as used in radio signaling.

233. Lamination of Core.—In order to minimize the eddy or local currents, with their counter magnetizing and distorting influence³ and the loss of energy entailed, it is customary to laminate the iron core by the use of fine iron wire insulated

¹ See Appendix A, §§ 293, 294.

² See §§ 150-155.

³ See § 162.

by oxide, by varnish, or even by fibrous covering in case energy losses are extremely objectionable, as in coils for loading long distance lines; for the same purpose it is customary to use non-conducting material for the heads¹ of the spools which are used to hold the windings.

234. Choice Between Closed and Open Cores.—When the currents in all of the coils are alternating, it is common to have the entire magnetic path through iron, in order to secure the maximum effect. When one or more of the currents are unidirectional, it is customary to have an “open” magnetic circuit,² in order that the high reluctance of the part through air (with its lack of hysteresis) may render the flux less stable and more quickly responsive to changes in the net magnetizing force.

235. Reluctance with Straight Cores; Power Incompatible with Clearest Voice Transmission.—The older type of induction coil³ had a straight core of iron wire, the magnetic flux completing its path through the air beyond the coils; since the reluctance of the air-path is directly proportional to its length and inversely proportional to its area, lengthening the iron core was found to increase the area of the air-path faster than the length increased, and thus to decrease the reluctance⁴ of the air-path; the common practice was to make the iron cores from about seven to twenty diameters long.

With the open coils with straight cores, increasing the diameter of the cores decreases the reluctance of the magnetic path both within and without the iron, and so increases the power of the coil; but the smaller core, having higher reluctance through the air, has less stability and demagnetizes

¹ See § 78.

² See §§ 141, 149, 235.

³ ABBOTT. *Telephony*, 5:227-245.

MILLER. *American Telephone Practice*, pp. 74-81.

VANDEVENTER. *Telephonology*, p. 406.

WIETLISBACH. *Elec. Eng. Chi.*, 11:41 (Jan. 15, 1898).

MCMEEN and MILLER. *Telephony*, pp. 154, 157.

WILDER. *Telephone Principles and Practice*, pp. 130-133.

⁴ See Appendix A, § 294.

more quickly, and therefore gives more crisp or clear¹ voice transmission.

236. Stray Magnetic Fields Objectionable; Magnetic Shields.—As the flux through an open magnetic circuit spreads out widely in its path through the air, the flux from one induction coil is quite likely to return through other coils which may be in the vicinity, as was the case in early telephone exchange boards, and thus may be the cause of false signals² or of cross-talk to other lines. To prevent such stray fields, induction coils are now generally provided with all-iron magnetic circuits, or are covered with iron shells or jackets³ which serve both to improve the magnetic circuit and also to shield neighboring circuits; in modern practice, even the coils whose cores are complete rings of iron are covered with iron shells⁴ to make more sure of avoiding stray magnetic fields.

237. Current Through a Single-circuit Coil; Effect of Capacity; Resonance.—The counter-electromotive force induced in a coil surrounding a magnetic circuit, is the basis of the use of the single circuit induction coil⁵ for controlling the intensity of current. As noted in the previous chapter,⁶ the current through a circuit including a coil depends on the frequency and voltage of the impressed electromotive force, and also upon the resistance and self-induction of the coil or coils in the circuit, and upon the capacity in series. The generalized expression of Ohm's law is,⁷ then:

¹ MILLER. *Op. cit.*, pp. 75, 80, 84.

² See §§ 144, 227.

³ VANDEVENTER. *Op. cit.*, pp. 140, 402, 555, 663, 566.

McMEEN and MILLER. *Telephony*, pp. 155, 159, 160.

⁴ VANDEVENTER. *Op. cit.*, p. 403.

⁵ See §§ 230, 241-244. ⁶ See §§ 208.

⁷ JACKSON. *Alternating Currents and Alternating Current Machinery*, p. 197.

THOMAELEN. *Elements of Electrical Engineering*, p. 249.

BEDELL and CREHORE. *Alternating Currents*, p. 131.

MAGNUSSON. *Alternating Currents*. McGraw-Hill (1916).

SHELDON, MASON and HAUSMANN. *Alternating Current Machines*, pp. 76-80. Van Nostrand (1911).

See also § 208.

$$I = \frac{E}{\sqrt{R^2 + \left(2\pi fL - \frac{I}{2\pi fC}\right)^2}}$$

in which I (amperes) is the current, E (volts) is the electromotive force at the terminals of the circuit, R (ohms) is the resistance in the electrical circuit (including the regular conductor and a more or less variable portion representing the energy transferred to other circuits when alternating current passes), L (henries) is the coefficient of self-induction (influenced more or less by the counter magnetizing force of secondary currents, and in some cases by variations of magnetic permeability throughout the cycles of current and of magnetism), C (farads) is the electrostatic capacity in series, f (cycles per second) is the frequency of the current, and 2π is the proportionality constant. (The equation holds equally true for practical units as indicated, or when using absolute units throughout.)

To eliminate the capacitance term from the general equation, it may be assumed that some elementary portion of the conductor represents a hypothetical condenser whose dielectric became so thin that the conducting surfaces came into actual contact. The capacity then became infinitely great, for it would require an infinite quantity of electricity to maintain unit difference of potential between the condenser surfaces in actual contact. Under such conditions the condensive reactance becomes

$$\frac{I}{2\pi fC} = \frac{I}{\infty} = 0.$$

For given values of inductance, L , and capacitance, C , there is a certain frequency for which

$$2\pi fL = \frac{I}{2\pi fC}$$

$$f = \frac{I}{2\pi\sqrt{LC}}$$

$$I = \frac{E}{\sqrt{R^2 + 0}} = \frac{E}{R}$$

As this frequency is approached, the circuit is said to be in resonance, and the current rises to a maximum value, approaching that which an equal steady unidirectional electromotive force would send through a circuit which included no capacity. This property¹ has been used somewhat for selective ringing or similar operations.

When the frequency is zero, as with direct currents, no current will pass through the circuit having capacity in series, this property being utilized² with bells on central energy systems.

When the circuit does not contain capacity in series, the equation for current becomes:

$$I = \frac{E}{\sqrt{R^2 + 4\pi^2 f^2 L^2}} = \frac{E}{\sqrt{R^2 + \omega^2 L^2}}$$

When the term $2\pi fL$ has a large value, either from high frequency, f , or from large inductance, L , the current becomes very small. This property also is used for filtering purposes, to prevent the passage of appreciable amounts of high-frequency currents, such as voice currents, while affording easy passage³ to low-frequency ringing currents or to direct current.

238. Telephone Induction Coils with Two Circuits Similar to Transformers.—The type of induction coil in which two or more circuits are influenced by mutual induction, by reason of surrounding the same magnetic circuit, is used in several ways for transferring energy from one circuit to another without direct electrical connection. The action of such a device is closely similar to that of the transformers used on electric light and power circuits, and the theory of its design and operation is essentially that discussed in textbooks⁴ on Alternating Currents.

Such a device is commonly called an "induction coil" when

¹ See § 273; also §§ 191, 192, 208.

² See §§ 265, 267.

³ See § 246.

⁴ See footnote on page 194.

used as part of a talking set, but is designated as a "repeating coil" when used in a trunk or cord circuit.

239. Outline of Transformer Operation.—Briefly, the device has two or more coils of insulated wire surrounding the same magnetic circuit, one coil being connected to one of the lines or systems and the other coil to the other.

The magnetic flux is due to the combined action¹ of the currents in all the coils. If an alternating current is sent through one of the coils, it causes corresponding changes in the magnetic flux (or a tendency to such changes, which must be overcome by current in the secondary) and these induce in each coil electromotive forces which are proportional to its number of turns or convolutions and which cause to flow in the second circuit (if there is a complete path) current which is a close copy of the primary current.

If the two coils have the same number of turns of wire, the electromotive force induced in the secondary is closely the same as that required to send the current through the primary, this being called a "one-to-one" coil, transformer, or translator. When one coil has a larger number of turns than the other, the device is called a "step-up" or "step-down" transformer, according to whether the actuating current is in the coil having the smaller or the larger number of turns. Because both the ampere-turns and the energy in both coils must be closely the same, it follows that the two currents are inversely proportional to the number of turns in their respective coils.

240. Quantitative Study of Telephone Induction Coils.—On account of the smallness of the currents,² voltages, and energy involved, great difficulty has been experienced³ in obtaining reliable quantitative experimental data regarding

¹ See § 200.

² See § 65.

³ See for examples:

E. C. HELWIG. "Telephone Transformers," Bulletin No. 6, Engineering and Science Series, Rensselaer Polytechnic Institute, Troy, New York.

H. PLEIJEL. *La Lum. Elec.* (2) 11:259 (Aug. 27, 1910).

COHEN and SHEPHERD. See footnote on page 194.

the action of the telephone induction coil. Its operation has been discussed by Rayleigh,¹ by Poincare,² by Wietlisbach,³ and by Noebels, Schluckebier, and Jentsch,⁴ who have applied Maxwell's equations for the energy in the circuits; the time-phase relationships involve difficulties in application. Pending the availability of reliable quantitative information, the performance of the telephone induction coil may be assumed as closely that of the ordinary transformer. This has been discussed graphically, following the Maxwell equations, by Fleming,⁵ Bedell⁶ and others. Graphical and analytical treatments have been given by Steinmetz,⁷ Jackson,⁸ Franklin,⁹ Thomaelen¹⁰ and others.

¹ RAYLEIGH. *Theory of Sound*, art. 235k, p. 436 ff.

² POINCARÉ. *L'Ecl. Elec.*, 50:221, 257, 329, 365, 401 (1907).

³ WIETLISBACH. *El. Eng. Chi.*, 9:51, 60, 96 (Jan., 1897); 11:1 (Jan., 1898); *Handbuch der Telephonie*, pp. 91-110.

⁴ NOEBELS, SCHLUCKEBIER and JENTSCHE. *Telegraphie und Telephonie*, p. 495 ff.

⁵ FLEMING. "Alternating Current Transformer," *Elec. Lon.* (1901).

⁶ BEDELL. *Principles of the Transformer*. Macmillan (1896).

⁷ STEINMETZ. *Alternating Current Phenomena*.

⁸ JACKSON. *Alternating Currents and Alternating Current Machinery*.

⁹ FRANKLIN and WILLIAMSON. *Alternating Currents*. Macmillan (1901).

¹⁰ THOMAELEN. *Elements of Electrical Engineering*, pp. 258-269.

CHAPTER XIV

USES OF INDUCTION COILS IN TELEPHONY

241. Single-circuit Coils as Filters; Impedance.—The inductive effect gives coils the ability to act as filters which allow direct current or low-frequency alternating current to pass through, while barring high-frequency alternating or pulsating currents. This effect may be helpful or harmful in telephony.

For the high frequency¹ of the telephone voice current (for which the accepted average angular velocity is $2\pi f = 5,000$ radians per second), a small amount of self-induction, L , will give a high value to the reactance term, $2\pi fL$, in the general equation for current. Moreover, any energy losses (such as by hysteresis or by induced secondary currents which are proportional to the frequency) add to the effective resistance, which thus becomes larger² for alternating or pulsating currents than for direct current. Thus, for a double reason, the impedance of an inductive circuit increases rapidly with the frequency.

242. Obstruction to Voice Currents; Bridging and Shunting Coils.—The obstruction or impedance presented by electromagnets (the word used in the broad sense) to the high-frequency voice currents was not well understood in the early days of telephony, when it was not unusual to have ringers, annunciators, and other signaling devices connected in series³ in the talking circuit. The appreciation of this effect⁴ led to the "bridging" of the signaling equipment, that is, to connecting it across between the line wires⁵ so that it

¹ See §§ 46, 47.

² See example in § 81.

³ Examples given in PREECE and STUBBS. Manual of Telephony.

⁴ See § 231.

⁵ See Fig. 81, § 253; also § 146.

was in multiple with the talking equipment instead of being in series. This involved the redesign of the windings, so that they consisted of many turns of fine wire instead of few turns of coarse wire. The high resistance and high reactance increased the impedance so much that but little talking current "leaked" through the signaling equipment, which is sometimes said to be "in leak circuit."

A way of obviating the reactance to talking currents through coils at the central exchange which seem to be necessarily in series in the connecting cords is to shunt each coil¹ by a non-inductive resistance,² which allows the talking cur-

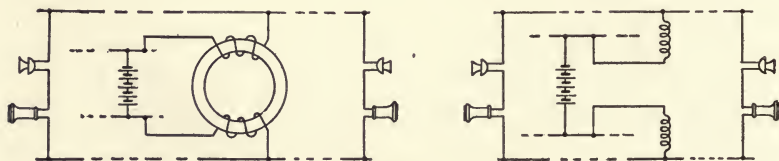

FIG. 78.—RETARDATION COILS
For common-battery cord circuit

rent to side-step or evade the coil, but which shunts enough battery or other signaling current through the coil to attract its armature.

243. Retardation Coils in Common Battery Cord Circuits.—Induction coils with single electric circuits are used in the cord circuits of some central energy telephone systems,³ for the purpose of allowing many talking circuits to be energized with direct current from the same common battery at the exchange, while inserting sufficient impedance to be an

¹ See Figs. 53, 54, §§ 134, 136.

² For other examples, see VANDEVENTER. *Telephony*. Figs. 464-468.

³ Descriptions of Stone, Dean and other systems with single-circuit retardation coils given by:

ABBOTT. *Telephony*, 5:266-269.

MILLER. *American Telephone Practice*, pp. 268-273.

POOLE. *Practical Telephone Handbook*, p. 212.

VANDEVENTER. *Telephony*, pp. 373, 390, 391, 398.

The early Buell system of 1881 used resistance instead of inductance, as noted by POOLE. *Op. cit.*, p. 208.

effectual barrier to the interchange of pulsating or alternating components of current which might cause cross-talk between parties on different cord circuits. Each cord circuit usually has two coils, one being between each battery terminal and the corresponding line. In some cases each coil has its own magnetic circuit, but more commonly the two coils of a pair are wound about the same iron core, the currents flowing in the same direction so as to coöperate in magnetizing the core.

244. Transmission of Voice Currents with Reactance Coils in Battery Circuit.—The transmission of voice currents through a central energy system with reactance coils between the lines and the battery may be described briefly as follows.

The voltage impressed upon the pair of circuits by the central exchange battery is partly used up in the resistance of the reactance coils, so that the electromotive force between the terminals of the lines is less than that between the terminals of the battery (when neither party is talking) by an amount equal to the product of the resistance of the reactance coils multiplied by the current. Any change in the current causes a corresponding change in the amount of drop through the reactance coils. Any sudden change in the current also develops in the coils a counter-electromotive force of self-induction which tends to reduce the amount of change.

As impulses of sound strike the diaphragm of one of the transmitters, a positive or compression impulse¹ causes a temporary lowering of that transmitter resistance and therefore an increased flow of current. This increased flow of current through the circuit of the talking transmitter causes in the reactance coils a greater drop due to resistance, and also a counter-electromotive force of self-induction tending to oppose the change of current. Both of these coöperate to cause a lowering of the electromotive force between the outside terminals of the reactance coils, and so of that between the terminals of the receiving line. This results in a diminution of

¹ See §. 8.

the current through the receiving end of the line corresponding to each increase of current through the transmitting end of the line.

Similarly, as the sound wave recedes, an increase in the transmitter resistance causes a decrease in the transmitter current and an increase in the received current.

245. Retardation Coils in Simultaneous Telephony and Telegraphy; Shunted Condensers; Graduator.—Retardation coils are used in several ways in connection with simul-

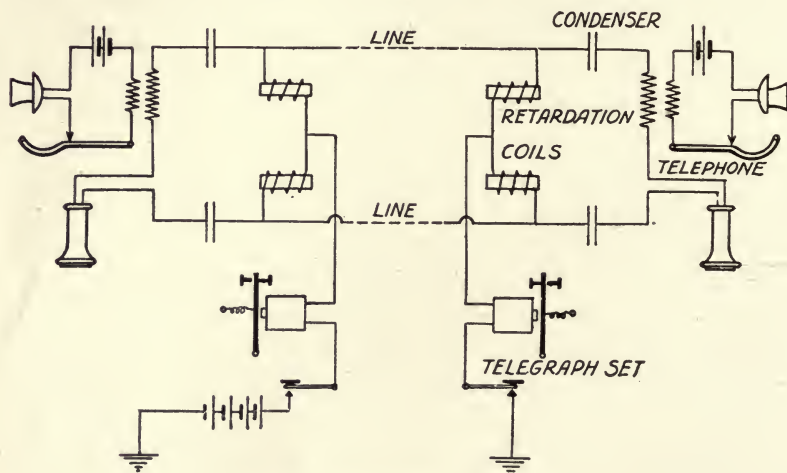

FIG. 79.—RETARDATION COILS
Bridged across composite circuit

taneous¹ telephony and telegraphy² over the same lines, two wires being generally used for the outgoing and return conductors for the telephones while either or both of the wires are used independently for telegraphy. At the terminals of

¹ See also Fig. 93, page 254.

² For details, see:

MAVER. *American Telegraphy*, pp. 345-350. New York (1892).

McNICOL. *American Telegraph Practice*, pp. 436-448.

THIESS and JOY. *Toll Telephone Practice*, pp. 187-210.

VANDEVENTER. *Op. cit.*, pp. 547-570.

POOLE. *Op. cit.*, p. 565.

WIETLISBACH. *Op. cit.*, pp. 421-435.

McMEEN and MILLER. *Op. cit.*, pp. 690-698.

the line, retardation coils in series with the telegraph instruments prevent the higher-frequency telephonic current from draining off through the telegraph set, and condensers interposed in the telephone sets allow the high-frequency telephonic current to pass while barring most of the lower frequency telegraphic impulses.

For the more effectual separation of the currents, the retardation coils and condensers are usually arranged in two stages.

In some cases, the retardation coils have their inductance adjustable by a variable air-gap in the magnetic circuit, such being called "graduator."

Condensers shunted around the telegraph relays seem to provide local partial resonance,¹ which magnifies the intensity of the received impulses, condensers of about 6 to 10 microfarads being used for such purpose as compared with 2 to 4 microfarads used in the telephone circuit.

In single-wire telegraph lines composited² for simultaneous telephony, condensers shunted around the telegraph sets of intermediate (or "way") stations, render the passage of telephone currents independent of whether or not the station key is opening and closing as in sending messages.

246. Operation of Coils in Simultaneous Transmission.

—The retardation coils serve the double purpose of barring out the telephonic currents and also of smoothing out the impulses of telegraphic current so that they rise and fall in strength gradually instead of suddenly, and thereby cause less disturbance in the telephone sets and in neighboring circuits.

An unusual procedure³ seems to be followed in connection with retardation coils used for simultaneous telegraphy and telephony, the two parts of the winding being coupled differentially instead of cumulatively. An explanation proposed⁴

¹ See §§ 211, 269.

² See § 247; also footnote 1 on page 228.

³ See footnote 2 on page 226.

⁴ HILBISH, THIESS and JOY. *Telephony*, 16:134 (Sept., 1908).

is that the comparatively slow telegraphic impulses meet no appreciable inductive reactance in passing through the differentially connected windings, but that the comparatively high-frequency telephonic currents meet high reactance. The efficiency of such design of retardation coil may be questioned.

247. Retardation Coils with Telephone on Single-wire Telegraph Lines.—Retardation coils are used for operating telephone sets on a single-wire telegraph line¹ with ground return, each telephone set being shunted by a coil which offers but small impedance to the telegraph current, but which offers high impedance to the voice current and sends most of it around through the telephone set.

248. Use of Impedance Coils in Battery Charging.—Coils² made with larger core and larger wire are placed in series with generators or rectifiers used for charging³ storage batteries of central energy exchanges. These allow a smooth direct current to pass from the generator to the storage battery, which acts as the general source of current supply for the exchange; but by reason of the high inductance they form an effectual barrier to the high-frequency pulsations, due to imperfect commutation in the generator, which would otherwise give rise to a disturbing noise like the humming of the brushes. The impedance coil thus effectually “irons out the wrinkles” from the current.

249. Loading to Reduce Attenuation on Long Lines.—Another application of self-inductive apparatus in telephony is “loading” long distance lines. A transmission line consisting of two conductors is characterized by four electrical elements: a given length of line, say one mile of line or two miles of conductor, has a certain resistance in the main conductor; the loop (the outgoing and the return conductors and the area between them) has a certain amount of self-inductance; likewise, the insulation between the conductors in this distance has a certain amount of leakage conductivity; and, finally,

¹ VANDEVENTER. *Op. cit.*, p. 548.

² MILLER. *American Telephone Practice*, p. 559; *Standard Handbook*, § 21, art. 63.

³ See § 222.

there is a certain amount of electrostatic capacity between them.

It is found theoretically and experimentally that the alternating current in a long line has different average values at different distances from the source, being gradually dissipated by leakage and by capacity. Mathematical investigation and practical tests¹ show that the rate of attenuation or falling off in current strength is reduced to a minimum when, in each unit length of line, the ratio between conductor resistance and insulation conductivity is the same as the ratio between the self-inductance and the electrostatic capacity between the two conductors.

250. Continuous and Lumpy Loading.—With most practicable types of construction suitable for long distance telephony, there is an excess of electrostatic capacity which should

¹ HEAVISIDE. *Electromagnetic Theory*, 1:321, 420-433; 2:v. Macmillan (1894); Reprint of *Electrical Papers*, 2:119 ff. Macmillan (1892).

PUPIN. "Propagation of Long Electrical Waves," *Trans. Am. Inst. El. Eng.*, 16:93 (March, 1899); "Wave Transmission Over Non-uniform Cables and Long Distance Air Lines," *Trans. Am. Inst. El. Eng.*, 17:445 (May, 1903); "Note on Loaded Conductors," *El. World*, 38:587 (Oct. 12, 1901); "Wave Propagation Over Non-uniform Conductors," *Trans. Amer. Math. Soc.*, 1:259 (July, 1900); U. S. Patents Nos. 652,230 and 652,231 (June 19, 1900).

CAMPBELL. "On Loaded Lines in Telephonic Transmission," *Phil. Mag.* (6), 5:313 (March, 1903).

ROEBER. "Long Distance Telephone Lines," *El. World*, 37:440, 477, 510 (March, 1901); U. S. Patent No. 779,443 (Jan. 10, 1905).

THOMPSON. "Ocean Telephony," *Proc. Int. Elec. Cong.*, p. 143. Chicago (1893)

REED. U. S. Patents Nos. 510,612, 510,613 (Dec. 12, 1893).

HAYES. "Loaded Telephone Lines in Practice," *Proc. Int. Elec. Cong.*, 3:638. St. Louis (1904).

DRYSDALE, "Theory of Alternate-current Transmission in Cables," *Elec. Lon.*, 60:277, 316, 359, 392, 468 (1907-1908).

POINCARÉ. "Propagation of Current Along a Line," *L'Ecl. Elec.*, 40: 121, 161, 201, 241.

GHERARDI. "The Commercial Loading of Telephone Circuits in the Bell System," including description of coils, *Trans. Amer. Inst. Elec. Eng.*, 30:1743 (June, 1911).

FLEMING. "Propagation of Electric Currents in Telephone and Telegraph Conductors." Van Nostrand (1911).

KENNELLY. "Hyperbolic Functions Applied to Electrical Engineering."

be compensated by the addition of self-induction. This may be done by "continuous loading," as in the Krarup or similar¹ cables in which the copper conductor is surrounded by a continuous wrapping of iron; or by discontinuous (or "lumpy") loading by the insertion of reactance coils² at definite intervals along the line, as proposed by Heaviside, Thompson, Pupin, developed and reduced to practice by the American Telephone and Telegraph Company.

251. Notes on Design of Loading Coils.—The design of telephone loading coils is a highly specialized branch of the art. There are, however, certain points which are well recognized. As with most engineering practice, the design of loading coils is a compromise.

The size, material, spacing, and insulation of the main conductors determine the resistance, capacity, inductance, and leakage conductance of the line, whence the additional amount of inductance per mile required for loading is obtainable from ratios mentioned above. A compromise is then to be made between the use of few large loading coils at long intervals or of many small coils at short intervals, considerations of first cost and of maintenance favoring the former.

Efficient telephone transmission, however, favors the use of many small coils; for both theory and practice show that large amounts of inductance concentrated at few points cause objectionable reflection of the electrical waves, with resulting confusion and loss of articulation.

The contribution of Pupin, which made discontinuous loading commercially practicable, consisted principally in developing methods for determining the size and spacing of loading coils which would give satisfactory transmission with the minimum number of coils. Since the loading coil adds both resistance and loss of energy both in the conductor and in the iron, it should be designed and constructed very carefully to

¹ KRARUP. "Moderne Telefonkabler," *Elektrotekniren* (Dec. 10, 1904).

FLEMING. *Op. cit.*, p. 276.

O'MEARA. *Jour. Inst. El. Eng.*, 46:309 (Nov., 1910).

HENLEY and SAVAGE. British Patent 7,105 (1905).

² See footnote on page 229.

reduce both to a minimum; this indicates large cores of fine iron wire carefully annealed and well insulated; both the outgoing and the incoming conductor are wound about the same iron core.

Since the resistance of the insulation between the two conductors is an uncertain quantity, being liable to vary with the weather conditions and with the growth of vegetation near aerial open lines, it is very desirable that the insulation both of lines and of loading coils should be maintained uniform; this is most easily done when the insulation is rather high,

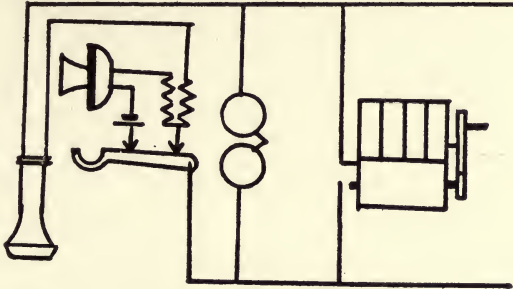

FIG. 80.—STATION CIRCUIT WITH LOCAL BATTERY

indicating the desirability of high poles which will keep aerial lines clear of trees.

252. Induction Coil with Microphone and Local Battery.—The earliest and, for a number of years, the only use of the induction coil in telephony was in connection with microphones having local batteries. Such use was introduced by Edison¹ and by Berliner² in 1877 and 1878. The induction coil was originally due to Faraday³ in 1831, developed by Page⁴ in 1838, and Ruhmkorff⁵ in 1851, these men being

¹ EDISON. U. S. Patents Nos. 203,013, 203,016, 203,017, applications filed Dec. 13, 1887, granted Apr. 30, 1878; *Jour. Fkln. Inst.*, 119:126 (Feb., 1885); *El. World*, 5:76 (Feb. 21, 1885).

ABBOTT. *Telephony*, 5:23.

² BERLINER U. S. Patent No. 199,141, application filed Oct. 16, 1877, granted Jan. 15, 1878; U. S. Patent Reissue No. 9,499 (Dec. 14, 1880).

³ FARADAY. *Trans. Phil. Soc.* (1832).

⁴ PAGE. *Silliman's Amer. Jour. Sci.*, 35:259 (1839).

STURGEON. *Annals of Electricity*, p. 290 (1839).

⁵ RUHMKORFF. *Les Mondes*, 27:60 (1872).

interested in the sparks obtained when the secondary had a great many turns. Elisha Gray¹ used it in connection with his harmonic telegraph in 1873 to 1875. Induction coils used with microphones have open magnetic² circuits, as they are used to change the energy of pulsations in a unidirectional current in the primary circuit into alternating currents in the secondary circuit.

In such use, the induction coil serves several purposes: it provides a local circuit for each transmitter, whereby the variations in the transmitter resistance become a relatively large part³ of the whole; it changes the current impulses from unidirectional to alternating, these affecting the receiver more strongly⁴ by passing through zero; it allows variations in coil ratios, so that the induced electromotive force may be adapted to the line, allowing the easy securing of relatively high electromotive force⁵ for sending the current through long lines. The greater economy in operation secured by supplying all the energy for a telephone system from large batteries at the exchange has practically eliminated the local batteries and their induction coils, except in connection with small exchanges or on long party lines. Details of such induction coils have been published⁶ freely.

253. Induction Coils with Microphones and Central Battery.—By a sort of evolutionary persistence, induction coils.⁷

¹ GRAY. U. S. Patents 166,095 and 166,096, application filed Jan. 19, 1875, granted July 27, 1875.

PRESCOTT. *Electricity and the Electric Telegraph*, p. 872. New York (1877).

PREECE and STUBBS. *Manual of Telephony*, p. 33.

ABBOTT. *Telephony*, 5:224.

Compare footnote 5 on page 46.

² See §§ 149-155, 232.

³ See §§ 108, 110.

⁴ See § 76. ⁵ See § 239.

⁶ ABBOTT. *Telephony*, 5:221-248.

MILLER. *Op. cit.*, pp. 72-78, 139-146.

VANDEVENTER. *Op. cit.*, chap. 6.

WIETLISBACH. *El. Eng. Chi.*, 9:47; 10:281, 11:41; *Handbuch der Telephonie*, pp. 98-101.

⁷ See pages 248-249.

are commonly used at subscribers' stations connected with central energy systems, thereby securing mutually inductive relations between the transmitter and receiver circuits of the subscriber's set. Excellent results are obtainable by connecting across the line a high resistance transmitter in series with a receiver. Sometimes the transmitter is connected in series with a reactance coil about which is shunted the receiver connected in series with a condenser. In other cases, the transmitter is in series with one winding of an induction coil, while the receiver in series with the other winding of the induction coil constitutes a second circuit by itself without elec-

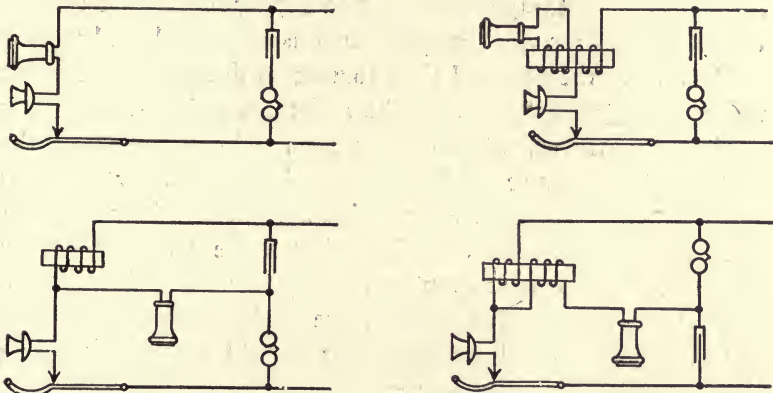

FIG. 81.—STATION CIRCUITS FOR CENTRAL ENERGY

trical connection with the line. In still other cases the transmitter is in series with one or both windings of an induction coil, one of the windings being in series with the receiver, a condenser completing the circuit from one or the other of the windings to the other side of the line, the polarized ringer being connected sometimes on one side and sometimes on the other side of the condenser. Almost every conceivable arrangement¹ of the several parts (transmitter, receiver, condenser, ringer and one- or two-winding induction coils) has been proposed, the reasons for some being inscrutable. Some

¹ ABBOTT. *Op. cit.*, 5:270-284.
 MILLER. *Op. cit.*, pp. 304-312.
 VANDEVENTER. *Op. cit.*, pp. 348-356.

hold that the variation of resistance in the transmitter is inadequate of itself to send sufficiently high variations of electromotive force into the line, and that a step-up transformer¹ is essential to good performance; others not only dispense with the coil entirely, connecting the transmitter and receiver in series directly across the line, but even go further and connect a retardation coil in series with the transmitter as though to weaken its effect on the line. Some arrangements seem to give more trouble than others from "side-tones," whereby the speaker hears his own words too strongly. Ingenious explanations are offered to show that the condenser acts as a local storage of energy to supply additional current to the transmitter when its resistance is decreased, and to take current from the line and thus further to decrease the current through the transmitter when its resistance is increased. It is doubtful, however, whether any such gain compensates the additional resistance and reactance introduced by the coil windings, which are placed in series with the receiver and thus reduce its sensitiveness to incoming voice currents, which are apt to be too weak even under the most favorable circumstances. A quantitative comparative study of the efficiency of the various proposed arrangements should throw interesting light upon their relative values.

254. Repeating Coils for Talking and Ringing.—Simple transformer action serves in the "repeating coils," sometimes called "translators," used for transferring the energy of ringing or talking current from one circuit to another, as from a grounded single-wire to a full metallic circuit, or from a central energy circuit to a local battery circuit or from one to another central energy system. Such transformers require only two windings, though it is not uncommon to have four windings or coils to improve the electrostatic balance and to facilitate their use for other purposes. "Talk-through" coils usually have but a small amount of iron in the core, in order to minimize the distortion of the voice-currents by hysteresis²

¹ See § 239.

² See Appendix A, § 297; also § 70.

and eddy currents in the iron. On the other hand, "ring-through" coils should have larger cores, in order to transfer more power from one circuit to the other, especially for ringing over heavily loaded "farmer" party lines. When the same coil is to be used for both talking and ringing purposes, a compromise should be made.

255. Effects of Direct Current Component in Induction Coils.—As used in connection with transmitters, one or both of the windings of a telephone induction coil may carry a component of steady unidirectional current upon which is superposed an alternating current. With certain reservations

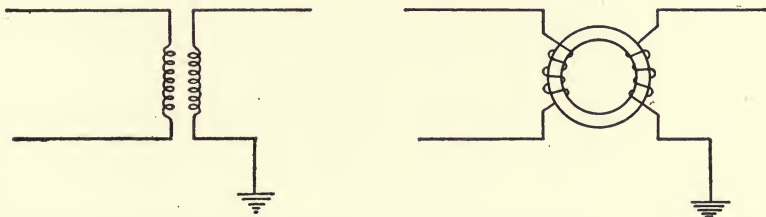

FIG. 82.—REPEATING COIL BETWEEN GROUNDED AND FULL-METALLIC CIRCUITS

as to the steady component of current, the usual graphical and analytical treatments of the alternating current transformer¹ may be applied to this type of induction coil as well as to those which carry only alternating currents. (The neglect to consider the direct current component is likely to introduce little if any more discrepancy between actual and represented performance than is involved in the usual treatment of the alternating current transformer, which ignores the varying values of permeability and of induction coefficients through the cycles of current.)

The presence of the steady unidirectional component of current has the effect of modifying the magnetic saturation of the iron core, so that the coefficient of induction² is somewhat less during the half-cycle when the direct and the alternating components of current are cumulative, than during

¹ See § 240.

² See Appendix A, §§ 299, 304.

the other half-cycle when they are differential. (The greater saturation and the lower coefficient of induction occur during the half-cycle when the transmitter diaphragm is compressing the carbon cell and when its mechanical resistance is greater.¹) By connecting the receiver for best polarity, the greater sensitiveness² of the receiver diaphragm during the half-cycle when the magnetomotive forces of the current and of the permanent magnet are opposed may be arranged to compensate the dissymmetry of the alternating current.

256. Performance of Repeating Coils in Central Energy Cord Circuits.—Repeating coils with two or four windings are used in the connecting “cord” circuits³ of most central

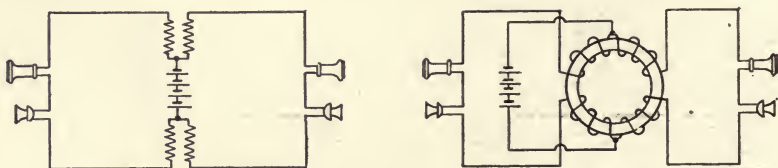

FIG. 83.—REPEATING COILS IN CORD CIRCUIT OF CENTRAL ENERGY SYSTEM

energy systems, each cord circuit usually including in each of the two connected talking circuits two coils, one at each end of the battery. Changes in the transmitter resistance in one of the two lines cause corresponding fluctuations in the current through that transmitter and through the two sections of the repeating coil in series with it. These fluctuations affect the magnetic flux through the iron core of the repeating coil, and by mutual induction cause corresponding impulses of electromotive force in the two sections of the coil in the receiving circuit. These impulses, superposed upon the battery electromotive force, cause pulsations of current through the receiving circuit, and thus reproduce the sound.

By properly connecting the windings of the two circuits, the

¹ See § 115.

² See § 76.

³ Descriptions given by:

VANDEVENTER. *Op. cit.*, pp. 390, 402, 407.

MILLER. *Op. cit.*, p. 270.

magnetizing effects of the steady unidirectional components of the current through the transmitting end and of that through the receiving end of the line may be opposed, so that their net effect upon the iron core is due only to any difference of currents brought about by unequal lengths of the coupled circuits, and is therefore almost negligible. This makes the performance of the repeating coil approximate yet more closely that of the ordinary alternating current without direct current.

While acting as the secondary circuits of a transformer, the coils in the receiving circuit also act as choke coils, or retardation coils, to prevent the entrance of stray impulses due to the minute changes in the terminal electromotive force of the battery caused by the pulsations in the currents delivered by the same central battery to other cord circuits. The use of repeating coils instead of reactance coils in the cord circuit lessens the trouble formerly experienced in coupling long and short lines together, for it allows each one of a coupled pair of lines to get its own direct current independently of the relative length and resistance of the line to which it is coupled.

257. Repeating Coils in Phantom Circuits.—Repeating coils with four windings, usually connected as two pairs of windings, are sometimes used in composite circuits for simultaneous telephony and telegraphy, and also ¹ in building up “phantom” ² circuits. For such uses, two windings are coupled in series, one pair being connected to the telephone apparatus at one end of the circuit, the other pair being across the line. Each pair of line wires, with its two four-winding repeating coils, constitutes a physical circuit (often called a “side circuit”) and conducts telephonic currents in the usual manner, the two line wires being virtually coupled as part

¹ See descriptions by:

VANDEVENTER. *Op. cit.*, p. 564 ff.

THIESS and JOY. *Op. cit.*, pp. 211-218.

MCMEEN and MILLER. *Op. cit.*, pp. 687-698.

² The “phantom” seems to have been named by Geo. Black [BLACK. *El. World*, 1:71 (Feb. 3, 1883)] in connection with his system of simultaneous telegraphy and telephony over the same lines in 1878.

of an independent series circuit. By connecting to the middle points of the line windings of the repeating coils, the two line wires of each physical circuit act toward an outside current as if coupled in multiple, each line wire carrying its portion of the current; by connecting thus to the middle points of two pairs of line windings, there is obtained a third or phantom

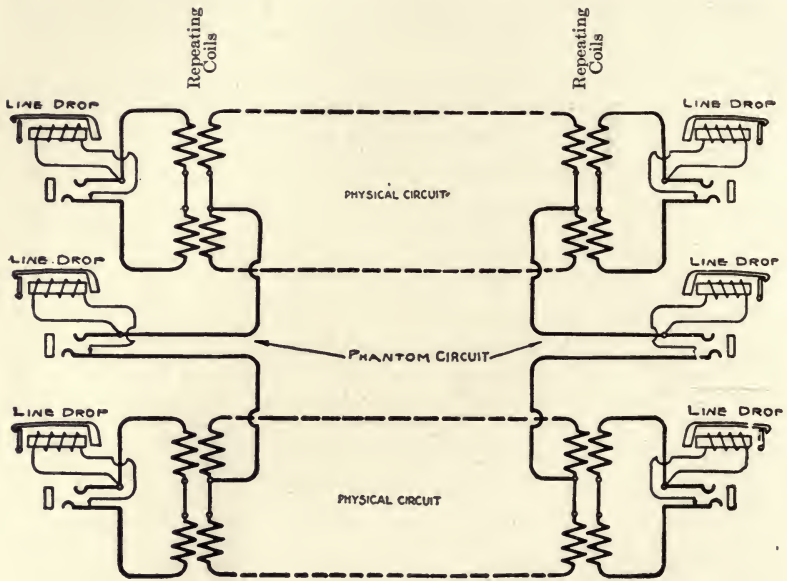

FIG. 84.—PHANTOM CIRCUIT

circuit which will conduct telephonic or telegraphic currents without disturbing or being disturbed by any currents that may be circulating in the side circuits, provided that the circuits are properly balanced. The impulses of current from the phantom circuit divide equally between the two windings of each repeating coil, so that their electromagnetic effects are equal and opposite; thus they do not induce disturbing electromotive forces in the other pair of windings, nor on the other hand are they disturbed by impulses of current therein.

It is practicable to phantom and composite two pairs of lines so that four line wires will act simultaneously as two

“physical” or “side” telephone circuits, one “phantom” telephone circuit, and four telegraph circuits; theoretically it would be possible to operate each of the telegraph circuits¹ as a duplex² or even as a quadruplex circuit for sending two or four telegraph messages over the same line circuit, but the difficulties of securing and of maintaining exact balance to prevent one of the multiplex uses from disturbing others on the same or on adjacent lines render such superutilization impracticable.

It is possible in rare cases to superpose a phantom upon two phantoms, so that eight line wires may carry four physical telephone circuits, two phantoms, and one hyperphantom, but such arrangement requires unusually good and uniform insulation and careful transpositions of line wires to secure immunity from disturbance. (It may be noted, in passing, that much of the very long distance work is over phantom circuits. It should also be noted that lightning protection is even more important for composite lines than for single lines.)

¹ An example is the Washington-Philadelphia cable. *El. World*, 57: 475 (Apr. 20, 1911).

² See footnote 1 on page 237.

CHAPTER XV

CONDENSERS IN TELEPHONY

258. Helpful Effects of Capacity in Telephony.—Electrostatic capacity¹ is of importance in telephony, both as a source of disturbance and trouble and also as a helpful ally.

A frequent use of capacity in telephony is in its function as a selective screen or filter, whereby it affords an easy path for alternating currents while presenting an impassable barrier to steady direct currents; in this respect the condenser is a counterpart to the reactance coil² which affords easy path for direct currents but obstructs the passage of alternating currents. The complementary properties³ of condensers and of coils are utilized in numerous combinations, the two being connected sometimes in series and sometimes in multiple according to the results desired. In numerous uses⁴ the condenser acts as a true electric storage battery or cell for storing and restoring electrical energy. Condensers may even act as receivers and transmitters for conversation.⁵

259. Harmful Effects.—In telephone practice, as in high tension power transmission, appreciable capacity is found not only in regularly and intentionally organized condensers,

¹ Elementary discussions in such books as:

THOMPSON. - Elementary Lessons in Electricity and Magnetism. Macmillan (1895).

NICHOLS and FRANKLIN. Elements of Physics, Vol. 2. Macmillan (1896).

PENDER. Principles of Electrical Engineering.

More advanced discussions by:

MAXWELL. Electricity and Magnetism. Oxford (1881).

WEBSTER. Theory of Electricity and Magnetism. Macmillan (1897).

PEIRCE. Newtonian Potential Function. Ginn, Boston (1902).

² See §§ 241, 243.

³ See § 208.

⁴ For example, see § 167.

⁵ See §§ 53, 89.

but also as an unavoidable result of having parallel conductors extending across the country for miles. With high tension power transmission lines the current required for electrostatically charging the wire¹ frequently taxes the generators rated at thousands of kilowatts. On long telephone lines the electrostatic capacity introduces difficulty from distortion of the voice currents in the line itself, and from cross-talk² between neighboring telephone circuits, and also introduces disturbances from power transmission lines and from atmospheric electrifications. The capacity between a pair of conductors is such that only a few hundred feet of a twisted pair, or of lamp cord, will pass enough current so that a good magneto generator will ring a bell through it as a condenser in series. A shorter length will pass voice currents.

Uncomfortably loud noises in the receiver are occasionally experienced as a direct or indirect result³ of the rush of current when the voltage across the circuit is suddenly changed, sometimes caused by the second party on the line cutting in or out of circuit, or by the operator signaling the called party, or by loose connections in the circuit, or by disturbances from other circuits or from atmospheric electrifications.

260. Distortion of Voice Currents by Capacity of Line.

—The electrostatic capacity between a pair of conductors⁴ on an open aerial line several hundred miles in length is enough to distort the voice currents to such an extent that the introduction of compensating self-induction at intervals is necessary to secure high-class transmission. A much shorter length of conductors in a cable has a similar effect.

Since the current taken by a condenser⁵ is proportional to

¹ See examples given in *Trans. Am. Inst. El. Eng.*, 19:217 (Feb., 1902); 18:363 (Aug., 1901); 30:81 (Jan., 1911); 30:340 (Feb., 1911); 30:1995, 1999, 2003 (June, 1911).

² CARTY. "Inductive Disturbances in Telephone Circuits," *Trans. Amer. Inst. El. Eng.*, 8:100 (Mar., 1891); *El. World*, 17:241, 276 (Mar. 28, Apr. 11, 1891).

KENNELLY. *El. World*, 17:276-278 (Apr. 11, 1891).

DUNBAR. *El. World*, 23:83, 115 (Jan. 20, Jan. 27, 1894).

³ See § 272.

⁴ See § 204.

⁵ See § 206.

the frequency, it follows that the higher frequency components of the voice currents are absorbed by the capacity along the line faster than are those of lower frequency. The result is that the character of the voice currents is gradually changed, so that the voice sounds drummy after passing through a cable several miles long, and becomes unintelligible if the cable exceeds certain lengths.

The absorption of the higher frequency components of the voice currents¹ is also accompanied by corresponding variations in the phase relationships between current and electromotive force for the different frequency components, and this seems to contribute to lowering intelligibility with increase in length of line.

261. Elements Determining Electrostatic Capacity.—The capacity² between conductors, whether fortuitous or in a formal condenser, depends upon the area, shape, and proximity of the conducting surfaces and upon the specific inductive capacity of the dielectric or insulating medium between them.

262. Importance of Dielectric Strength.—If there is likely to be exposure to large differences between the potentials of the conductors, such, for example, as might come from atmospheric disturbances, the insulating medium should have dielectric strength to resist breakdown under the electric strain. The dielectric strength of a given material varies according to circumstances, such as wave form, shape and separation of conductors, and time of exposure, that of air and other gases varying also with the atmospheric pressure; the dielectric strength is greater between smooth flat surfaces than between points and is greater for brief than for long exposures to the strain. The dielectric strength of insulating material is usually given in terms of volts per millimeter (0.0394 inch), or per thousandth of an inch, taking mean effective rather than maximum volts and assuming that sinusoidal electromotive forces are applied.

¹ See §§ 38, 40, 46.

² See § 202.

263. **Dielectric Constants of Materials.**—The dielectric constants¹ of the substances more commonly used in condensers are:

	Spec. Ind. Capacity	Dielectric Strength (Volts per millimeter)
Air	1.00
Glass	2.8 to 9.9	5,500 to 8,000
Mica	4.6 to 8.0	17,000 to 28,000
Paper, dry	1.7 to 1.9	1,460 to 2,200
Paraffin	1.68 to 2.47	11,500
Rubber	2.12 to 2.69
Shellac	2.74 to 3.73
Petroleum	2.02 to 2.19
Impregnated paper	2.8 to 3.8	4,200 to 30,000

Air breaks down at about 20,000 volts per inch (about 790 volts per millimeter) of separation between sharp points,

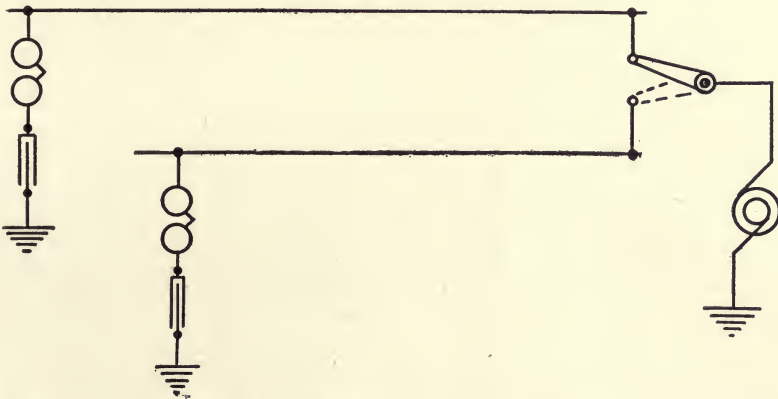

FIG. 85.—CONDENSER FOR SELECTIVE RINGING WITHOUT GROUNDING THE LINE

while it stands about twice as much between flat surfaces. The dielectric strength of oils varies from about 40,000 to 1,000,000 volts per inch (about 1,580 to 3,950 volts per millimeter), depending on shape of electrodes and their separa-

¹ *Trans. Am. Inst. El. Eng.*, 10:85 (Feb., 1893); 15:119-160 (Mar., 1898); 15:281 (June, 1898); 29:1125-1232 (June, 1910); 30:1-76 (Jan., 1911).

FOSTER. *Electrical Engineer's Pocket Book*, pp. 227-228; *Standard Handbook*, 5:159.

tion, dry oil standing about 45,000 to 50,000 volts across a distance of 0.2 inch.

264. Construction of Condensers.—The choice of material for the dielectric of a condenser depends upon its use. For standards, where great accuracy and constancy is required, mica is used for condensers having capacities from about .001 to 1.0 or more microfarads.¹ For smaller standards, especially of the adjustable type, air is commonly used. For ordinary telephonic purposes, paraffined paper is generally used, the condenser being wound up in a roll² from two strips of tin foil separated by four wide strips of dry paper, the whole being then boiled in paraffin, pressed, and then sealed in a tin case. In some condensers the conducting coating is made as part of the paper, this construction³ being said to avoid some of the troubles found with tin foil. Care is taken to exclude both moisture and air from the finished condenser, as small inclosures of either make the condenser slower in responding to changes of impressed voltage. Condensers made with care in this way have sufficient dielectric strength not only to stand up under the highest voltages used in telephony, but also to withstand most stray electro-motive forces, including most of the inductive disturbances from lightning.

265. Condenser or Filter in Ringing to Ground.—The ability of the condenser to act as a filter which prevents the passage of steady direct current while giving easy passage to alternating current is utilized in various arrangements for sending alternating currents through subscribers' calling de-

¹ For the units used, see:

THOMPSON. *Op. cit.*, arts. 283, 356, 359.

FOSTER. *Electrical Engineer's Pocket Book*, pp. 4-8; *Standard Handbook for Electrical Engineers*, § 1.

HERING. *Ready Reference Tables*, pp. 11, 96-144. Wiley, New York (1904).

² LEE, WESTCOTT and ROBES. U. S. Patent No. 575,653 (Jan. 19, 1897).

KINGSBURY. *Telephone and Telephone Exchanges*, p. 458.

McMEEN and MILLER. *Telephony*, pp. 172-174.

³ MANSBRIDGE. *Jour. Inst. El. Eng.*, 41:535-585 (May, 1908); *Elec. Lon.*, 61:139, 178, 211 (1908).

vices. A common practice¹ (credited to J. A. Lighthipe) is to connect a condenser in series² with the subscriber's ringer. The combination may be connected between the ground and either wire of a double metallic telephone line, thus allowing the operator to ring either of two bells according to the side of the line to which she temporarily connects her ringing generator, and thus making it possible to call either subscriber on a two-party line without disturbing the other subscriber; while the condensers allow either ringer to be operated as desired, yet there is no electrical connection through

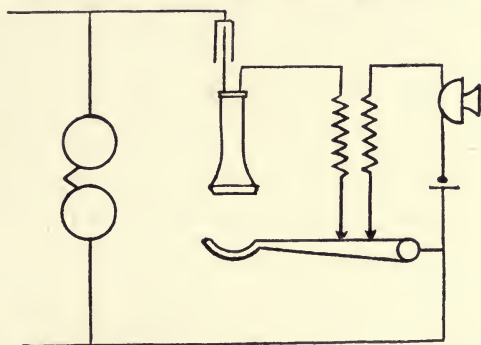

FIG. 86.—CONDENSER IN RECEIVER CIRCUIT ON MULTIPARTY LINE

which stray direct currents (such as return currents from electric railways) may get from the earth to the telephone circuit.

266. Filtering Action of Condenser on Farmer Lines.—

Another example of the selective action of a condenser is its use on multiparty farmer lines on which so much of the ringing current might otherwise be shunted off through eavesdropping³ receivers that the bells sometimes would not receive sufficient current for satisfactory ringing. Since the current through a condenser is governed largely by the frequency, small condensers in series with the receivers will pass but little current of the low frequency used for ringing pur-

¹ McMEEN and MILLER. *Op. cit.*, pp. 319-324.

VANDEVENTER. *Op. cit.*, pp. 122, 350, 397, 425.

² See §§ 192, 208; also Figs. 53, 81.

³ McMEEN and MILLER. *Op. cit.*, p. 223.

poses, while the higher frequency voice currents are admitted freely.

267. Condenser in Ringing from Central Energy Exchange.—In central energy systems the subscriber's circuit is normally kept open¹ (uncompleted) for direct currents, in order that the subscriber may call the operator by the simple act² of lifting the receiver from the hook and thereby completing a circuit between the two line conductors and thus allowing direct current from the central exchange battery to pass through the talking circuit and also through the calling signal at the exchange. While the subscriber's circuit is normally uncompleted (for direct current), it must be possible to operate the ringer for calling the subscriber, and this is accomplished by connecting a condenser in series with the ringer windings; the operator can then ring the subscriber's bell by connecting the line with an alternating current generator which then sends current through the condenser circuit that could not pass direct current.

268. Condenser to Protect Receivers with Permanent Magnets.—Another use of the filtering action of the condenser is in keeping the direct current from a central energy exchange battery from passing through the windings of telephone receivers with permanent magnets. Such receivers are generally adjusted at the factory for maximum sensitiveness. Should the direct current from the exchange battery pass through the receiver windings, it might be in a direction to strengthen the pull from the permanent magnet, and might thus draw the diaphragm into contact with the magnet poles, either occasionally, so as to make it rattle, or constantly, so

¹ Electrical phraseology is not always precise. When we complete a circuit, as by closing a switch, we "close" the electrical circuit by opening the way for current to pass, contrasting with civil terminology where "closing" a road obstructs rather than invites traffic. There is frequent lack of distinction between "Stromkreis," "circuit," the physical structure for conveying current, and "Stromweg," "trajet du courant," or "parcours du courant," referring to the current as it follows the successive parts of the route.

See also §§ 230, 149.

² See footnote 2 on page 245.

as to make it inoperative. Even though the receiver might be adjusted for the combined pull of the permanent magnet and the direct current, yet the polarity is likely to be changed during repairs on the lines and thereby the receiver thrown out of adjustment. In some cases, the receiver is placed in the secondary circuit of an induction coil, which isolates it from the direct circuit. In other cases, the receiver is connected to the condenser in series with the ringer, the two being shunted around an impedance coil in series with the transmitter, thus giving a path for the received voice cur-

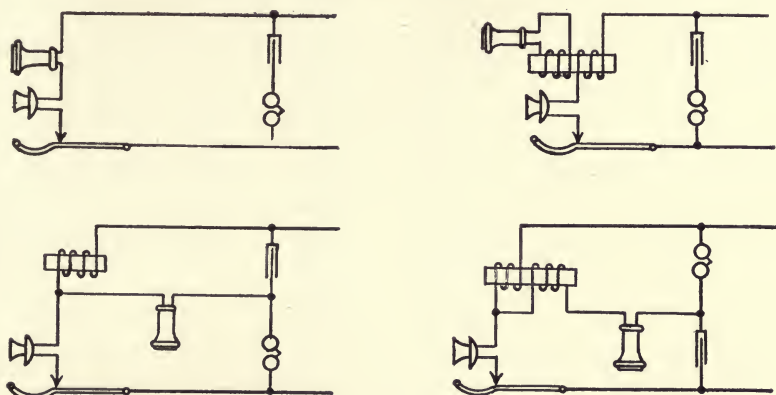

FIG. 87.—STATION CIRCUITS FOR CENTRAL ENERGY

rents to pass through the condenser and receiver and thence through the transmitter to the other side of the line; in this case, there are two paths through which the transmitter current may pass.

269. Condenser to Magnify Effect of Transmitter.—

In other cases, the receiver, the condenser, and the secondary winding of an induction coil are connected in multiple with the transmitter, whereby the storing effect of the condenser helps magnify¹ the changes in current directly caused by the changes in transmitter resistance.

With this arrangement, consider the conditions at an instant when the transmitter diaphragm is moving out-

¹ VANDEVENTER. *Op. cit.*, p. 351.

wardly, so that the resistance of the microphone cell is increasing say from 55 toward 60 ohms. The increasing resistance causes the line current to decrease, and therefore the voltage between the terminals of the telephone set increases; this tends to increase the voltage between the terminals of the condenser in series with the receiver; the decreasing current through the primary winding in series with the transmitter, Fig. 88, induces an electromotive force in

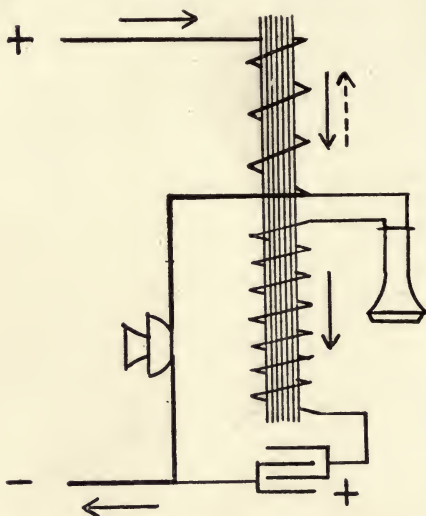

FIG. 88.—DIRECTION OF CURRENTS WHEN MICROPHONE RESISTANCE INCREASES
(From Blight *National Telephone Journal*)

the secondary winding in a direction to charge the condenser yet higher, and the resulting transient current reacts upon the transmitter coil so as to reduce its current yet more.

Conversely, when the transmitter diaphragm is moving inwardly so as to decrease the resistance say from 55 toward 50 ohms, the current through the line increases, lowering the voltage at the terminals of the telephone set, and consequently that at the terminals of the condenser which then begins to discharge;¹ the discharge of the condenser is assisted by the electromotive force induced in the secondary winding; more-

¹ See § 167.

over the discharge current from the condenser induces in the primary winding an electromotive force which tends to increase the transmitter current and thus to increase the current from the main line.

270. Condenser for Transferring Energy from One Circuit to Another.—The condenser has been used to some extent as a device for transferring energy from one circuit to another, thus doing work somewhat analogous to that of the

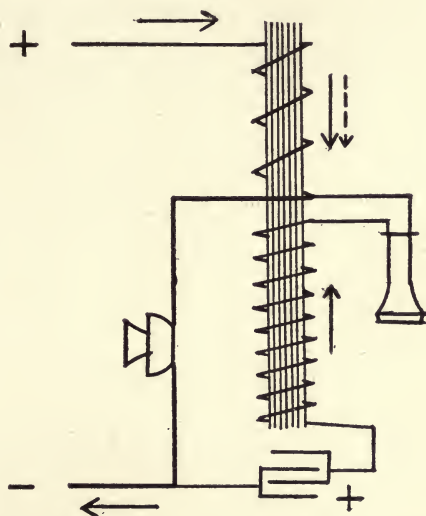

FIG. 89.—DIRECTION OF CURRENTS WHEN MICROPHONE RESISTANCE DECREASES
(From *Blight National Telephone Journal*)

transformer or induction coil. Thus, Fitch¹ in 1879, and Boudet² at Paris, about 1885, transferred the fluctuations of current from a local circuit with battery, transmitter, and condenser to the outside telephone line.

A somewhat similar function is performed by condensers used to transfer voice currents through the connecting cord at the exchange from one circuit to another in a local battery telephone system. In a sense, the apparatus of the talking and of the listening subscribers may be considered as part of

¹ FITCH. U. S. Patent No. 249,605 (Nov. 15, 1881); *El. World*, 6:222, 252 (Nov. 28, Dec. 19, 1885).

² BOUDET. *L'Electricien*; *El. World*, 6:188 (Nov. 7, 1885).

the same circuit of which the two condensers at the exchange are parts. From a slightly different viewpoint, the two condensers may be considered as transformers or translating devices which transfer energy from one circuit to another, the varying changes in the potentials of the condenser surfaces conductively connected with the sending circuit, inducing strains in the dielectrics, which involve corresponding currents in the receiving circuit.

A modification is the use of condensers to transfer voice currents from one half to the other half of a cord circuit of a central energy telephone exchange having a double battery,

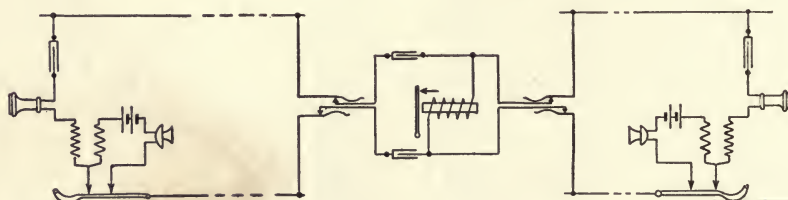

FIG. 90.—CONDENSERS FOR TRANSFERRING VOICE CURRENTS THROUGH CORD CIRCUIT

such as that of Kellogg.¹ Others have used the condenser for similar purpose in exchange cord circuits of central energy systems using only a single battery, such as the Scribner,² the North,³ the Dean,⁴ the Stromberg-Carlson,⁵ or the Vote-Berger.⁶ A similar use has also been made in some of the "composite" circuits⁷ for simultaneous telephony⁸ and telegraphy.

¹ McMEEN and MILLER. *Op. cit.*, p. 185.

ABBOTT. *Telephony*, 5:269.

VANDEVENTER. *Op. cit.*, p. 391.

² ABBOTT. *Op. cit.*, 5:268.

³ VANDEVENTER. *Op. cit.*, p. 390.

⁴ VANDEVENTER. *Op. cit.*, p. 390.

McMEEN and MILLER. *Op. cit.*, p. 461.

⁵ VANDEVENTER. *Op. cit.*, p. 373.

McMEEN and MILLER. *Op. cit.*, p. 464.

⁶ VANDEVENTER. *Op. cit.*, p. 397.

⁷ See footnote 2 on page 226.

⁸ See §§ 245, 246, 257.

271. Outline of Condenser Operation as Translator.—

The operation of the condenser as a translator in these systems may be illustrated by Figure 91. Let T' and R' represent the transmitter and receiver of the party talking (these being assumed for simplicity as connected in series), and T'' and R'' those of the party listening; current is supplied to each half of the circuit by the central energy battery, B , through the coils, A' , A'' , S' , S'' , of signaling relays in the exchange; the answering and the calling sides of the cord circuit are connected through the two condensers ab and cd which are shunted around the relay coils.

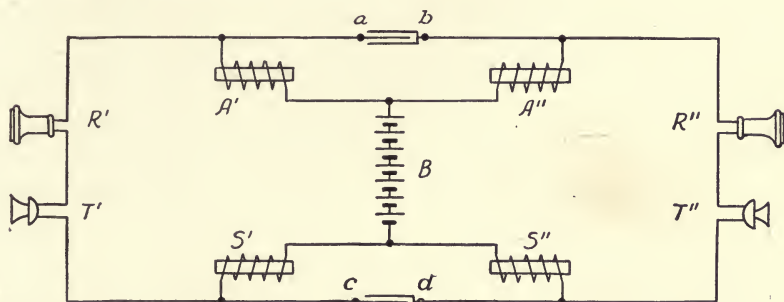

FIG. 91.—CONDENSERS CARRYING VOICE CURRENTS AROUND RETARDATION COILS IN CORD CIRCUIT

When neither party is talking, steady current flows through each transmitter circuit; then if the resistances of the two circuits are equal, the currents through them are equal; the fall of potential through coil A' will equal that through A'' , and that through S' will equal that through S'' ; thus there will be no difference of potential between the conducting surfaces of condenser ab nor between those of condenser cd .

Now, suppose at a certain instant that the resistance of transmitter T' is lessened by a voice sound; then more current will pass through the circuit $BA'R'T'S'B$ than through the circuit $BA''R''T''S''B$, and the fall of potential or "ohmic drop" through A' and through S' will be greater than through A'' and S'' ; this results in a difference of potential between the conducting surfaces a and b , and also between surfaces c

and d , and from this results a transient flow of current to b and d , which current flows partly through the circuit $R''T''$ and causes in the receiver R'' a sound similar to that which caused the change of resistance in transmitter T' ; part of the current which charges the condenser goes through the circuit $A''BS''$ and thus has no direct effect on receiver R'' .

A similar cycle in the opposite direction follows when the resistance in transmitter T' increases, and thus the wave form of the induced current through the receiving circuit follows closely the changes in the current in the sending circuit.

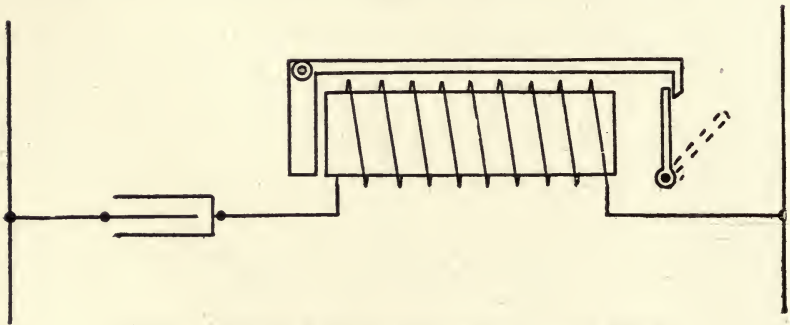

FIG. 92.—DISCONNECT SIGNAL BASED ON VOLTAGE RISE

When the sending and receiving circuits have unequal resistance, as occurs when the parties are at unequal distances from the exchange, the steady currents through the two circuits will be somewhat unequal, and there will result differences of potential and steady charges in the two condensers, upon which are superposed the changes as outlined above.

272. Condenser Current for Operating Drop.—The transient rush of current charging or discharging a condenser in consequence of a change in the electromotive force applied to the terminals may be a source of annoyance in some cases, or in others the basis of useful applications.

In certain types of private branch exchange,¹ such as the "cordless P.B.X." used in connection with central energy systems, the disconnect or "clearing out" signal (by which

¹ McMEEN and MILLER. *Telephony*, p. 642.

a party notifies the P.B.X. operator that the line is no longer required) consists of an annunciator or relay coil which is connected in series with a condenser and bridged across the circuit at the switchboard. When the line is in use, the current through the talking subscriber's circuit experiences a considerable fall of potential due to the resistance in the trunk line between the central exchange battery and the P.B.X. board; when, however, the subscriber hangs up his receiver and thereby opens the circuit, the current through the line ceases almost immediately, and the voltage between the wires of the line suddenly becomes practically constant at all parts, and equal to that of the battery at the central exchange; the sudden increase in the voltage at the P.B.X. causes a transient rush of current through the condenser in series with the annunciator drop winding, and thus causes it to give a transient electromagnetic pull and so to release the shutter or other indicating device.

273. Use of Resonance for Selective Ringing.—By proper design, so that the capacity of the condenser balances the induction of the ringer windings at the ordinary frequency of the ringing generator, the ringing current may be increased¹ considerably.

This property of electrical resonance has been used to some extent in connection with selective² signaling systems, it being possible to match capacity with self-induction in such a way that a circuit will take a comparatively large current at a certain frequency, but will take only inappreciable current from an electromotive force whose frequency differs much from that of resonance; the use of electrical resonance combined with mechanical tuning of the moving parts of the ringer or other selective device has been of considerable importance in the success of certain selective ringing systems.

A practical difficulty is that the inductance and capacity in different lengths and kinds of line combine with those of the apparatus and destroy the accuracy of the factory adjustment

¹ See § 208.

² See § 192; also Fig. 77, page 186.

for resonance. To secure perfect resonance in practice would require special adjustment of each ringer or similar device to suit the particular line upon which it is used.

For best operation of electrically resonant circuits, it is important not only that the principal or fundamental frequency of the current be kept at standard value, but also that

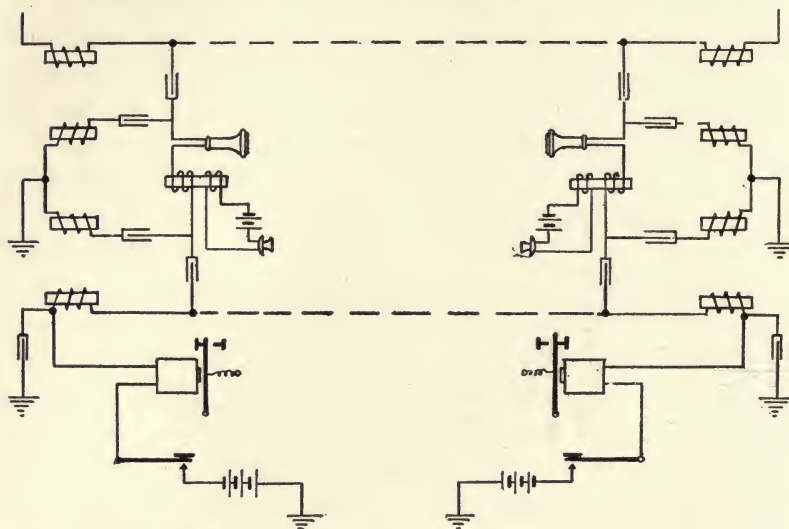

FIG. 93.—CONDENSERS FOR BRIDGING TELEPHONES ACROSS COMPOSITE CIRCUIT

the wave form be such that the harmonics will not be prominent; otherwise, for example, the third harmonic¹ impulses from a 16-cycle generator might operate the devices tuned for 48 cycles.

274. Miscellaneous Uses.—The condenser is largely used in simultaneous² telephony and telegraphy over the same line wires, operating as filter, as reservoir and as transferring agent. Similar uses are found in radiotelegraphy and in radiotelephony.

¹ See § 191.

² See §§ 245-247, 257.

CHAPTER XVI

PROTECTIVE DEVICES

275. Need of Protective Devices; Heating Troubles from Excessive Currents; Electrolytic Damage; Troubles from High Potentials.—In order to maintain continuity of service, it is necessary that the apparatus and lines be protected against excessive currents or potentials that might otherwise cause damage.

Currents of excessive strength, whether coming from the batteries or generators of the company or from some foreign source, are liable to cause damage by overheating the conductors, especially within windings of magnets or other coils, and thereby damaging or destroying the insulation, not only injuring the apparatus but also introducing danger from fire. In extreme cases the excess current may even melt the conductor and so open the circuit. Foreign currents are also liable to cause damage by electrolysis, especially to the sheaths of underground cables.

Excessive difference of potential between the two sides of a circuit or between either side and the earth is liable to cause damage: either by causing excessively large current to pass through the regular circuit; or by jumping through or across the insulation and damaging it, either directly or as a result of excessive current which may flow after the insulation has been broken down by the high potential. The charging of part of the circuit to a high difference of potential from the earth is also liable to cause shocks to persons using the telephone, current passing through them to the earth either directly from the circuit or by induction.

276. Excessive Currents Prevented by Fuses.—In any conductor carrying current, electrical energy is transformed into heat energy at a rate equal to the resistance of the con-

ductor multiplied by the squared value of the current, that is,

$$W = I^2R.$$

The heat thus developed raises the temperature of the conductor and of the surrounding materials at a rate depending on the mass and the thermal capacity (specific heat) of the material heated. This heat energy is carried off by conduction into and partly through neighboring substances, by convection currents through any surrounding fluids (such as oil or air) and by radiation through the air. The rates at which

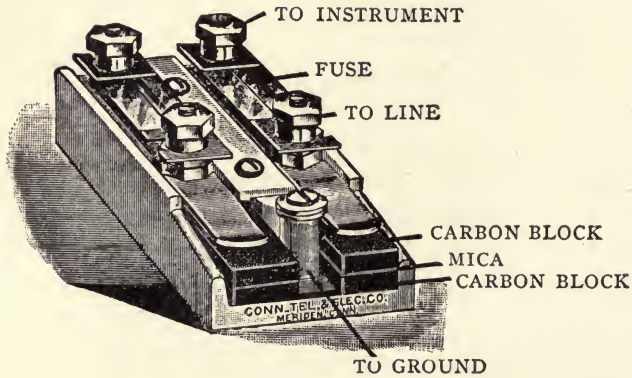

FIG. 94.—TELEPHONE PROTECTOR
Mica-supported open fuses and carbon-block lightning arrester
(By permission)

the heat is carried off by these methods are closely proportional to the differences of temperature. If the electrical source of heat continues indefinitely, the temperatures rise until the outward flow of heat equals that of the transformation of electrical energy.

A consequence is that, when the conductor is in the form of a winding, the heat from the inner portions has to travel further and over poorer paths than that from the outer portions, and thus the inner portions get hotter. If the development of heat continues indefinitely, the temperature may rise so high as to damage the insulation and even to set fire to

it or to surrounding objects. Hence the need of fuses or other excess current protectors.

277. Conditions for Melting a Fuse; Required Length of Fuse.—Protection from currents of excessive strength is usually obtained by the use of fuses,¹ which are short sections of conductor designed to melt and thus open the circuit when the current exceeds a certain value. (Telephone fuses are made to carry normal currents ranging from $1/3$ to 8 am-

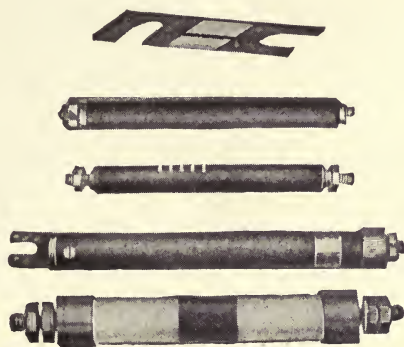

FIG. 95.—TYPES OF TELEPHONE FUSE

peres, being expected to melt when the current continues to exceed the rating by 50 per cent.)

The ordinary fuse consists of a short piece of a conductor of fairly high resistance and of material that will melt at fairly low temperature, so as not to endanger igniting nearby substances; the conditions of dissipating the heat are improved and the danger of fire is lessened by mounting the fusible portion within a tube or other suitable inclosure.

The required length of the fusible portion between the larger terminals depends both upon the strength of the current which is liable to pass, and also upon the voltage which sends such current through the circuit. Fuses intended to

¹ For further discussion see:

SHEPARDSON. Electrical Catechism, pp. 90-105.

National Electrical Code, Rules 68, 85. Underwriters' Laboratories, 207 East Ohio Street, Chicago, and 135 William Street, New York City.

protect the telephone circuit from stray currents from high potential circuits, such as the 2,300-volt lighting circuits, should be several inches long.

278. Protection from Sneak Currents; Heat Coils; Grasshopper Fuses.—Protection is required also from stray currents which are not large enough to “blow,” that is, to melt an ordinary fuse, but which may slowly raise to a dangerous degree the temperature of windings that have poor cooling facilities, or which may interfere with the normal working of the apparatus. Protection from such “sneak” currents is obtained by the use of special fuses,¹ commonly



FIG. 96.—TYPES OF HEAT COIL
(Western Electric and Kellogg)

known as “heat coils,” which contain considerable resistance within a small space, usually covered to minimize the cooling effects; a comparatively small current, say $1/3$ ampere, passing through 3 to 45 ohms of fine wire closely coiled, will raise the temperature to a point where solder will melt and allow a spring to separate two parts and thus either open the circuit or connect it with the earth so that the stray current will then pass directly to earth instead of going through the telephone apparatus; usually this lowering of the resistance will increase the strength of the foreign current so that it

¹ Tests on heat coil protectors are reported by ACHATZ. *Telephony*, 70:6:22-25 (Feb. 5, 1916).

H. V. HAYES. U. S. Patent No. 441,066 (Nov. 18, 1890).

In some cases the “heat coil” consists of a small block of high-resistance material. A well-known manufacturer of telephone protective devices states (MILLER. *American Telephone Practice*, p. 597) that all telephone apparatus should stand 0.3 ampere for an indefinite period, and that a heat coil should operate on 0.35 ampere within two minutes, this being feasible with a resistance of 5 ohms or less in the heat coil. Recent practice tends toward 3.5 ohms.

will then melt the ordinary fuse. For this reason, the ordinary or "abnormal current" fuse is connected on the line side of the heat coil. In an earlier type, the resistance wire was imbedded in wax which softens by heat and allows a spring to break the wire, this being called a "grasshopper" fuse, a name applied also to straight fuses with spring indicators.

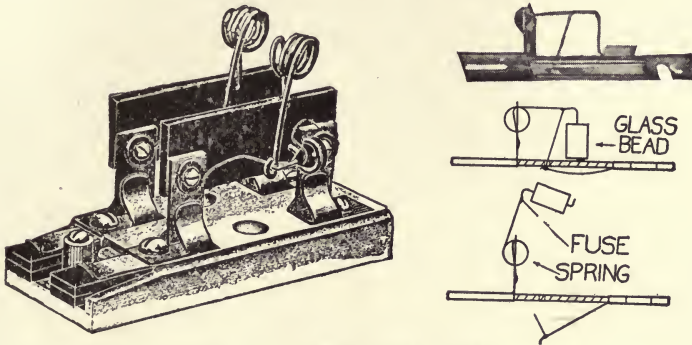

FIG. 97.—GRASSHOPPER FUSES

279. Sources of Electrolytic Trouble; Elementary Laws of Electrolysis; Amount of Metal Eaten Away.—Troubles from electrolysis¹ arise either from the effect of stray currents, such as part of the current from an electric railway following the underground cables part of the distance between the rails and the power house, or from the effect of local currents due to lack of homogeneity in the lead or iron protecting jacket of the cables, or to variations in the surrounding soil.

In accordance with laws discovered by Faraday,² whenever current passes from a solid conductor into a liquid conductor, the material from the solid conductor is carried into solution and is usually deposited at some other place where current passes from the liquid into some other solid conductor. The amount of metal eaten away by electrolysis is directly proportional to the amount of current flowing and to the

¹ See §§ 212-214.

² FARADAY. *Experimental Researches in Electricity*, 1:127-164. Quaritch, London (1839).

SHEPARDSON. *Op. cit.*, pp. 144, 161-167.

length of time during which it acts. It depends also upon the character of the metal and to a limited extent upon the difference of potential between the metal and the surrounding electrolyte, and upon the nature of the material to which the metal is carried. For example, one ampere flowing one thousand hours or one thousand amperes continuing one hour will transfer 2.6 or 5.2 pounds of copper, 1.54 or 2.3 pounds of iron, or 8.5 pounds of lead, the factors for iron and copper depending upon the electrolyte.

280. Electrolysis of Buried Conductors.—Damp earth acts as a liquid conductor or electrolyte; sometimes it acts as an inert electrolyte which has no appreciable effect except when current from an outside source is passed through it; where the earth contains substances (such as acids or alkalies) that tend to dissolve the metal, there is a tendency for local currents to flow from the metal into the earth to some other place where the earth does not act upon the metal so vigorously, the combination constituting a sort of primary cell or battery. Lack of homogeneity in the metal, such as the presence of particles of imbedded carbon, gives the required elements of a local cell, the damp earth being the electrolyte, the general body of the metal being the dissolvable metal or active electrode, and the impurity being the inactive electrode. It may be mentioned, incidentally, that much of the so-called "electrolytic trouble" is due to local action far more than to extraneous currents.

281. Prevention of Trouble from Electrolysis; Increase of Resistance to Leakage Currents; Grounding Conductor.—Electrolytic troubles from local action are minimized by securing purity of lead in the cable sheath. Both local and stray currents¹ are reduced by the use of insulating ducts,

¹ FARNHAM. *Trans. Am. Inst. El. Eng.*, 11:191-245 (April, 1894).

SHELDON. *Trans. Am. Inst. El. Eng.*, 17:335-344 (May, 1900).

CLARK. *Trans. Am. Inst. El. Eng.*, 25:205-206 (April, 1906).

HAYDEN. *Trans. Am. Inst. El. Eng.*, 26:201-229 (Mar., 1907).

MAGNUSSON and SMITH. *Trans. Am. Inst. El. Eng.*, 30:2055-2101 (June 1911).

McCOLLUM and LOGAN. *Trans. Am. Inst. El. Eng.*, 32:1345-1412 (June, 1913).

which add to the resistance of the path offered to such currents and thereby help keep them out of the cable sheath. The grease used for lessening the friction encountered while drawing in the cables also may help insulate the cable, and should give additional protection if free from corrosive ingredients.

Since the protecting metal sheath of a cable is eaten away where the current goes away from the metal to the soil and not where it enters, electrolytic action is reduced by leading the current from the cables through some conductor whose corrosion will do no harm. In some cases it seems desirable to connect the cable sheaths to a large copper conductor which carries the current either to an earthing plate or directly to the railway power house.

282. Objections to Grounding; Detection of Reverse Currents; Introduction of Counter-electromotive Force.

—Sometimes the cables at the exchange are connected to the rails at the nearest point; but this is likely to invite trouble, as current may come from instead of to the rails and may pass off at various places along the cable. A polarized ammeter in the grounding conductor will show the amount of the current and also its direction, a convenient switch providing for opening the circuit in case the current is found to be coming into the cables at the exchange.

Some object to grounding the cables at the exchange, believing that this offers a path of such low resistance as to invite railway currents that otherwise might not follow the telephone cables.

Some have proposed using a counter-electromotive force in the grounding conductor in order to lessen the tendency for currents to follow the cables, but this is also liable to make current leave at more undesirable places.

283. Static Dischargers; Brass "Saw Teeth" and Discs.

—Protection from excessive differences of potential¹ is obtained by what are frequently known as "lightning arresters,"²

¹ See §§ 226-228.

² VANDEVENTER. *Telephonology*, pp. 96-101, 479.

POOLE. *Practical Telephone Handbook*, pp. 103-108.

consisting generally of short air-gaps between conductors connected respectively with the line and with the earth. The protection is based on the ability of high electromotive forces to jump across a gap which presents an impassable barrier to currents from moderate electromotive forces.

On telegraph circuits and on country telephone lines the older practice was to remove discharges through serrated or "saw-tooth" strips of brass separated by short distances. A later practice was to use brass discs separated by mica washers perforated by a number of holes. Besides being an easy metal to work, brass has the characteristic of being a non-arcking¹ metal, its vapor being so poor a conductor as to help

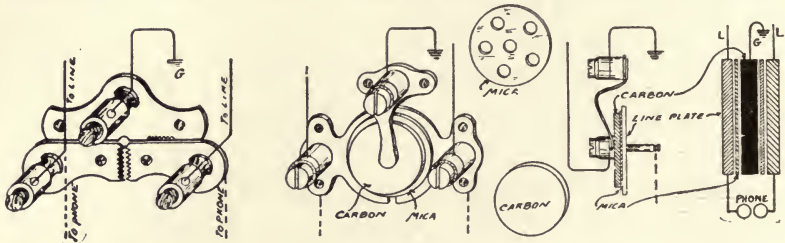

FIG. 98.—TWO TYPES OF LIGHTNING ARRESTER
(By permission)

extinguish the arc that might otherwise carry a low-voltage current after the lightning had broken down the resistance of the gap. To facilitate the breaking down of the air-gap by stray high potential differences, the opposing points should be sharp, but these are dulled by every discharge.

284. Carbon Plate Arresters; Renewing the Surfaces; Fusible Pellets.—It is, therefore, the more common practice to substitute carbon blocks whose granular structure presents many sharp points easily renewed; the carbon blocks are placed close together, being separated by thin mica strips which either have perforations, or preferably have one side cut away so as to allow any detached particles of carbon to fall away. The heat from the discharge is apt to disintegrate the carbon so that fine particles may form a bridge across the gap and

¹ WURTS. *Trans. Am. Inst. El. Eng.*, II:337-405 (May, 1894).

so cause steady grounding of the circuit until their removal; fortunately, a light wiping or scraping of the carbon blocks renews the parallelism of their surfaces. Some types of carbon arrester are provided with pellets of fusible metal, which is supposed to melt and form a permanent bridge between the line carbon and the ground carbon in case of pro-

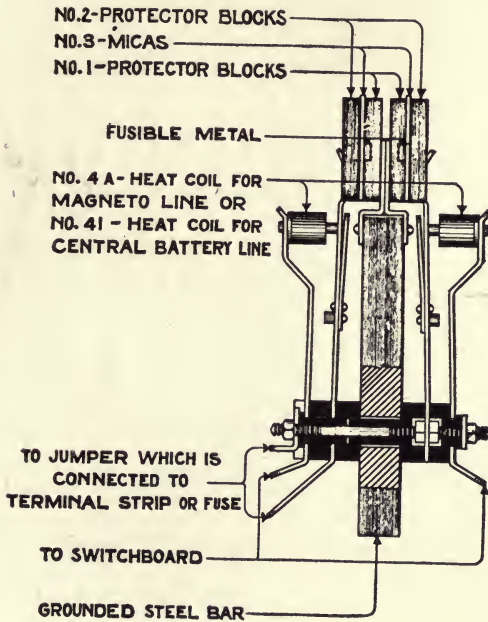

FIG. 99.—HEAT COILS AND LIGHTNING ARRESTERS FOR EXCHANGES
(Western Electric)

longed discharges from lightning or from contact with high potential lines. Copper blocks are sometimes used instead of carbon blocks, when the lines are long or the lightning is severe. An air-gap of 0.005 inch (0.0127 centimeter) between the blocks will break down at about 300 volts.

In some of the more recent lightning protectors for telephone lines, the carbon blocks are placed inside a glass bulb from which the air is exhausted; the partial vacuum allows the discharge to jump longer distances, and hence makes safe a wider spacing of the carbons, thus reducing the trouble from

permanent grounding through the particles of carbon torn loose by the discharges and causing continuous connection between the line and ground plates. Such arresters should reduce the cost of inspection and maintenance.

285. Multigap Arresters.—Some arresters are practically of the multigap¹ type, having one or more coils close to a grounded conductor so that discharges may pass to earth at a number of places along the coil. Others things being equal, some advantage lies with those having rectangular rather than

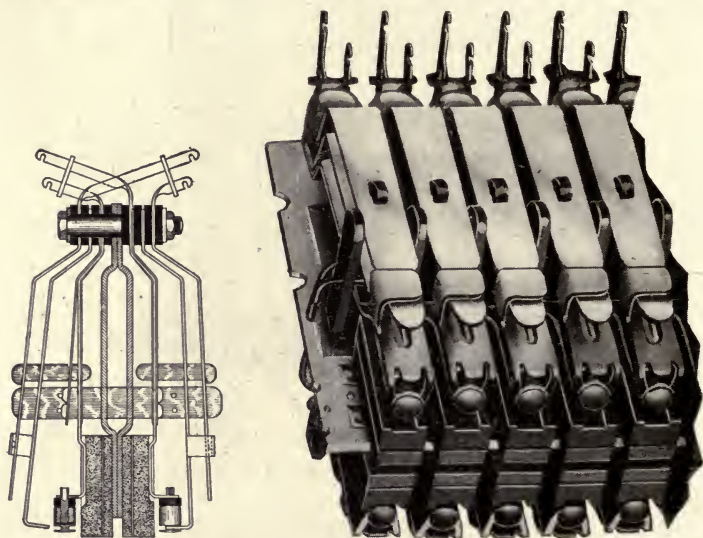

FIG. 100.—EXCHANGE PROTECTORS WITH RE-SOLDERING COILS (Cook)

circular coils, since the sharper radii of curvature at the corners bring about a concentration of magnetic flux (resulting in unequal distribution of self-inductance along the length of the conductor) and thereby assist in the reflection of the incoming impulses from the atmospheric discharges.

Since the lightning seems generally to consist of a number of oscillations of high frequency, and since even in unidirectional discharges the change of current strength is exceedingly rapid, any magnetic field caused by the discharge induces a large counter-electromotive force which is proportional to

¹ VANDEVENTER. *Op. cit.*, pp. 99-100.

the square of the number of convolutions in any coil and, inferentially, to the sharpness of curvature of any part of the path. Charges on the line induced by lightning tend, therefore, to jump across rather than to pass through a coil.

286. Locating Protecting Devices; Avoidance of Sharp Turns; Protection Desirable for Stations, for Cable Terminals, for Exchanges.—The protective devices for a telephone station are generally located close to the place where

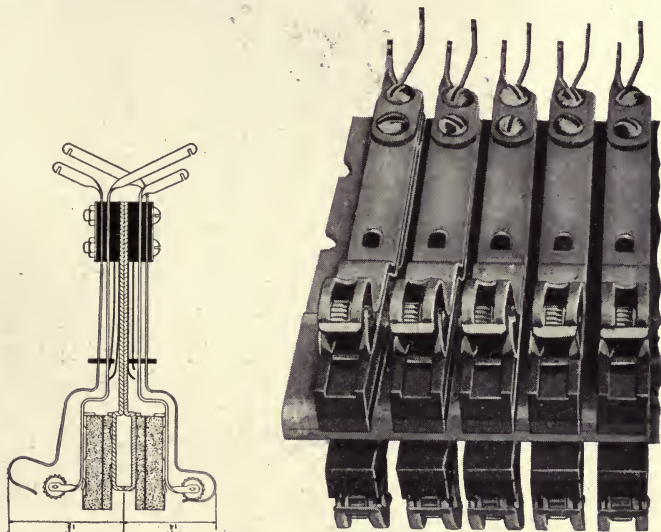

FIG. 101.—EXCHANGE PROTECTORS WITH SELF-SOLDERING COILS (Cook)

the outside wires enter the building. When the lines are entirely underground and not exposed to other circuits, open fuses are sometimes used as the only protection, and even these are sometimes omitted. Telephone stations connected with overhead open lines exposed to lightning or to other circuits are generally provided with lightning arresters and fuses, and also, in some practice, with sneak-current protectors. The drop from the outside lines should go as directly as practicable to the lightning arrester and fuse. Sharp turns should be avoided, both in the drop and especially in the wire to the ground connection. In the wires leading from the protective devices to the instrument, coils are not objectionable but

are rather desirable as furnishing some additional impedance to lightning following the wires toward the instruments, and thereby helping divert it through the gap in the arrester.

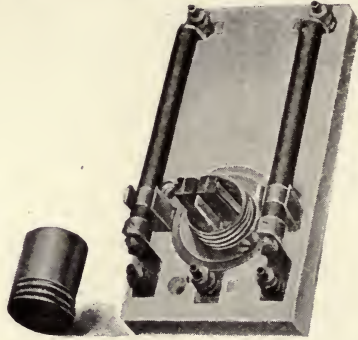

FIG. 102.—TELEPHONE STATION PROTECTOR AGAINST ABNORMAL AND SNEAK CURRENTS AND LIGHTNING (Western Electric)

When open aerial lines exposed to atmospheric disturbances and to power circuits connect with a cable, it is customary to install both fuses and static arresters in the cable terminal box in order to protect the cable.

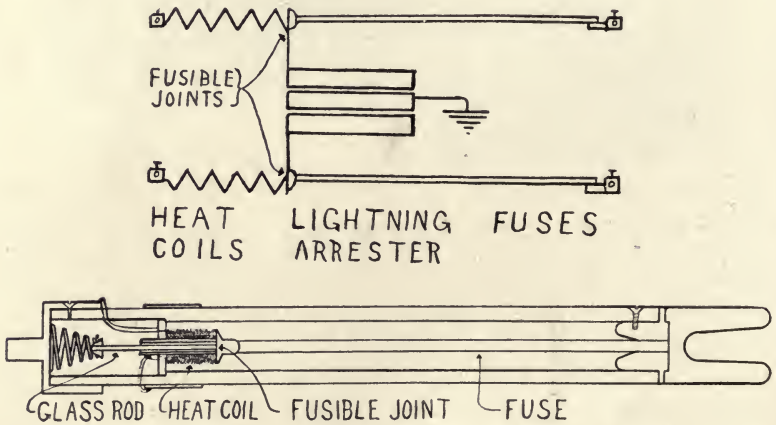

FIG. 103.—DIAGRAM AND DETAILS OF PROTECTOR

Lines entering the exchange should be protected against abnormal currents, sneak currents, and also against high potentials when the lines are exposed. As at stations, the pro-

tective devices should be located as close as practicable to the place where the lines enter the building, in order to minimize the dangers.

287. Protection by Shields; Ground Wires.—Protection against electrostatic or electromagnetic induction from neighboring circuits is frequently obtained by interposing shields which inclose one or both circuits where in close¹ proximity. A complete conducting sheath, especially when of iron, will protect against electromagnetic disturbances between adjacent coils.

A grounded conductor placed between two neighboring circuits is an effective protection against electrostatic induction; for if the barrier is well grounded through a path of low resistance, its potential persists as that of the earth and is therefore constant. Under such conditions, one circuit is free from static induction from the other, since all the electrostatic flux from the disturbing circuit ends in the grounded barrier.

Partial protection against electrostatic disturbances from lightning or other atmospheric electricity is secured by stretching grounded wires on the outside pins of the top cross-arm of a pole line, or on special supports somewhat higher. Such ground wires are frequently used on high tension power transmission lines.

288. The Earth Connection; Conditions for Quick Discharge; Objections to Inductance in Path of Discharge; Importance of Low Resistance.—Efficient electrical connection with the earth is essential to the successful operation of devices for protection against high potentials. The electrical charge on the line should be conducted to the earth as quickly as practicable, both to limit the time during which persons might receive shocks, and also to relieve the strain on the insulation² quickly. Most insulation will stand up for a frac-

¹ See § 131.

² See § 262.

For development of equations for discharging current and residual electromotive force see footnote 3 on page 195.

tion of a second under a dielectric strain which would break it down if continued for some seconds or minutes. Quick relief is therefore an important factor in reducing the liability to damage by high potential strains from lightning or other sources.

If the path of the discharge current between the line and the earth contains self-induction (such, for example, as would be introduced by coiling the wire either with or without an iron core, or passing it through an iron pipe) the discharge becomes more complicated. If the inductance is greater than one-fourth the product of capacity by square of resistance, the discharge becomes oscillatory,¹ as results of which the difference of potential between line and ground may become temporarily even higher than that from the original disturbance, and the oscillating current may induce disturbances in neighboring circuits. Induction in the path of the discharge circuit may cause so great counter-electromotive force as to make the discharge jump to other paths where damage may result.

Low resistance to the earth is of importance not only as an assistance to quick relief from high potential disturbances, but also to secure efficiency when the earth is used as part of the regular circuit, as in single-wire telephone lines or as the return for calling signals over metallic currents. Theoretical analysis shows² that most of the resistance to or through the earth is in the immediate vicinity of the rod or plate attached to the grounding wire. Low resistance to earth is secured by using a terminal of large area buried in permanently damp earth.

Hygroscopic salts, such as chloride of lime, tend to retain moisture in the soil near the ground plate or rod, and thus maintain relatively low resistance to earth.

¹ See § 208.

² SHEPARDSON. Proceedings Association of Railway Telegraph Superintendents (June, 1916).

PART IV
APPENDICES

APPENDIX A

LAWS OF THE MAGNETIC CIRCUIT AND OF MAGNETIC PULL

289. **Derivations by Maxwell and Others.**—The fundamental laws of the electromagnet have been derived by a number of writers,¹ who follow Maxwell more or less closely. The following treatment is believed to be more easily followed and quite as convincing.

290. **Unit Magnetic Line of Force; Unit Magnet Pole; Actual Magnet Pole.**—The strength of a magnetic field is expressed in terms of the hypothetical unit magnet pole which exerts upon an equal pole at a distance of one centimeter a force of one dyne (a force which, if acting for one second upon a mass of one gram free to move, would give it a velocity of one centimeter per second). The strength of the magnetic field at unit distance (one centimeter) from unit pole is taken as the unit of measurement, and is considered as being one line of force per square centimeter. Assuming the unit pole as concentrated at a point, or as occupying negligible space, the entire area at a distance of one centimeter may be considered as the surface of a sphere of one centimeter radius. Since such a spherical area contains 4π or 12.57 square centimeters,² there are as many lines of force emanating from unit magnet pole; from a physical magnet pole of strength m there emanate $4\pi m$ lines of force.

The paths of magnetic flux from an actual magnet pole may be shown by placing over a magnetized bar of hard steel a sheet of glass

¹ MAXWELL. *Electricity and Magnetism*, vol. 2, arts. 409-411, 482-485. Oxford (1873).

MERRITT. *El. World*, 21:223 (Mar. 25, 1893).

THOMPSON. *Elementary Lessons in Electricity and Magnetism*, arts. 338-342. London (1900).

PENDER. *Principles of Electrical Engineering*, art. 102.

GRAY. *Absolute Measurements in Electricity and Magnetism*, vol. 2. Macmillan (1893).

Standard Handbook for Electrical Engineers, 2:43-55.

² Expression derived in textbooks on integral calculus.

In electromagnetic equations it is customary to use several Greek letters: μ (mu, equal to Roman m) for permeability; π (pi, equal to Roman p) for ratio of circumference to diameter of a circle; ρ (rho, equal to Roman r) for specific reluctance; ϕ (phi, equal to Roman ph or f) for magnetic flux; ω (o-me-ga, equal to Roman long o) for angular velocity.

or cardboard, upon which are scattered iron filings or small chips; these quickly arrange themselves in more or less definite lines, as illustrated in the figure. The lines of force which may thus be shown in one plane actually exist in all directions, forming continuous and more or less clearly defined paths from points near one end of the bar to points near the other end. In the actual magnet, the "pole" is not a single point, such as assumed for the hypothetical unit magnet pole, but is an area of appreciable size.

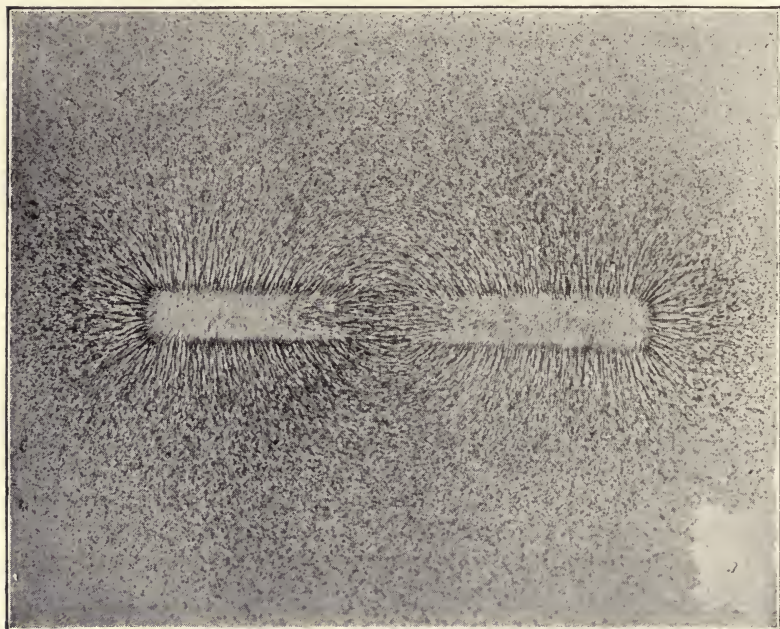

FIG. 104.—MAGNETIC FIELD ABOUT A PERMANENT MAGNET

291. Counter-electromotive Force and Work of Relative Motion Between Current and Magnet.—When there is relative motion between a conductor and a magnetic field, there is induced an electromotive force equal to the rate of change of lines of force inclosed by the electric circuit, the average electromotive force being equal to the number of magnetic lines of force crossed, divided by the length of time (seconds) involved; or, mathematically,

$$E = (\phi' - \phi'') / T = \phi / T \quad [1]$$

This may be considered as a counter-electromotive force opposing the current which may have been flowing in the electric circuit, and involving work. The work done upon the circuit equals the electro-

motive force multiplied by the current and by the time during which the opposition exists; or

$$W = E I T \quad [2]$$

Substituting the elements which determine the electromotive force gives:

$$W = E I T = (\phi / T) I T = \phi I \quad [3]$$

that is, the work done in moving a current across a magnetic field equals the product of the current by the number of lines crossed.

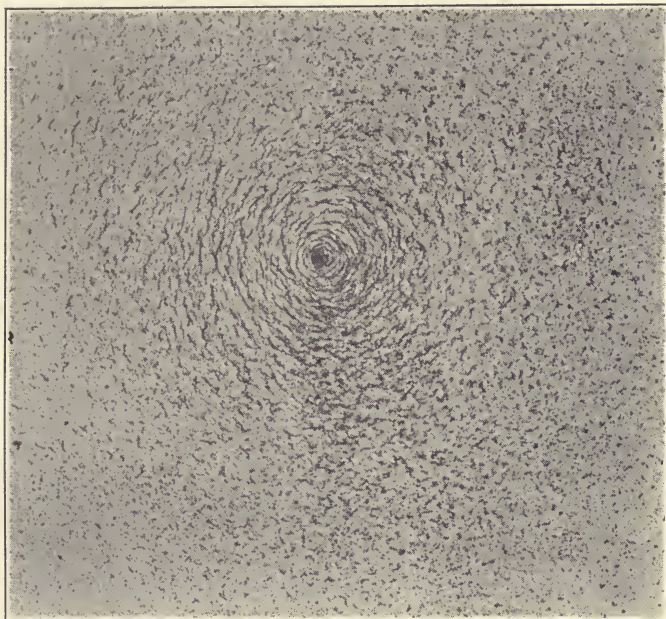

FIG. 105.—MAGNETIC FIELD ABOUT SINGLE CONDUCTOR

292. Magnetomotive Force of a Straight Wire and of a Coil; Magnetic Flux Shown by Iron Filings.—The work done in moving a unit magnetic pole around a current is a measure of the power of the current to magnetize, that is, a measure of its magnetomotive force. Suppose that a unit magnet pole is moved so as to make a complete circuit about a current; then each line of force crosses the electric circuit; an electromotive force is induced equal to the rate of change of the number of lines of force inclosed by the circuit; and as shown above, the work done equals (if rate of change is constant)

$$W = E I T = \phi I$$

when the conductor consists of a single loop or convolution.

If the conductor be wound into a coil of n turns or convolutions, each of which crosses the same average number of lines of force, then each will have induced equal electromotive force and the total will equal that in one multiplied by the number of turns; similarly, the work upon or by the current through the coil will equal that in

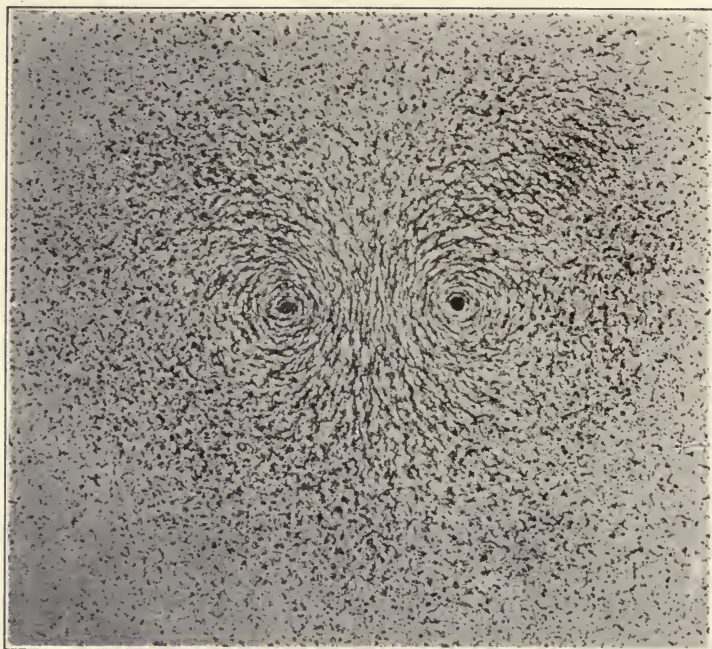

FIG. 106.—MAGNETIC FIELD BETWEEN TWO CONDUCTORS

one turn multiplied by the number of turns. Then we may write

$$W = n \phi I \quad [4]$$

for a coil of n loops or convolutions.

Since each unit pole carries 4π lines of force, the work of carrying unit pole about a circuit is $4\pi I$ for each convolution, or $4\pi n I$ for a coil of n convolutions. But this is a measure of the power of the coil to magnetize or send magnetic flux through the circuit; that is, the magnetomotive force of a coil carrying current is $4\pi n I$, in terms of absolute or CGS (centimeter gram second) units; using amperes, the magnetomotive force is $0.4\pi n I$ ampere turns. Magnetomotive force is frequently expressed in terms of gilberts, the product $4\pi n I$ equaling the number of gilberts in absolute measure.

The magnetic flux about a conductor may be shown by iron filings or small chips sprinkled on a cardboard through a hole in which

passes a wire carrying about 20 amperes. Upon gently tapping or jarring the cardboard, the iron filings will arrange themselves in more or less perfect circuits somewhat as shown in Fig. 105. Passing about 20 amperes through a coil of several turns of wire threaded through a series of holes in a cardboard so as to form a solenoid (or pipe), the iron filings will arrange themselves in straight lines through a core of the solenoid, completing their circuit along paths which may extend to a considerable distance. In this case, the magnetic circuits are entirely through air.

293. Rowland's Law of Magnetic Circuit.—By the general law of activity as first applied by Rowland¹ to the magnetic circuit, the flux equals the magnetomotive force divided by the reluctance.

294. Reluctance of a Uniform Circuit.—Reluctance in a magnetic circuit is closely analogous to resistance in an electric circuit. The reluctance varies directly with the length of the circuit, since each unit of length interposes a certain amount of reluctance; it varies inversely as the area of the cross-section, since each element of section adds to the carrying power, that is, to the number of paths over which the magnetic flux may spread; it also depends upon the specific reluctance of the material through which the flux passes, that of soft iron being several hundred times less than that of air. Sometimes it is more convenient to consider permeability, which is the reciprocal of specific reluctance.

The reluctance of any part of the magnetic circuit may then be expressed in the form of an equation:

$$R = \frac{l\rho}{A} = \frac{l}{A\mu} \quad [5]$$

in which R is the total reluctance of the portion considered, l is the length in centimeters, A is the area in square centimeters, ρ is the specific reluctance, and μ is the permeability, the specific reluctance being expressed in terms of that between two parallel faces of a centimeter cube of the material. The reluctance and permeability of air are constant and are taken as unity. The permeability of iron depends on its chemical composition, upon the temper or hardness, upon the intensity of magnetization and upon the previous magnetic history, being greater when the magnetization is decreasing, and vice versa.

295. Reluctance of Series and Multiple Magnetic Circuits.—In some cases, such as the magnetic cores of the toroidal repeating coils

¹ ROWLAND. *Phil. Mag.* (4) 46:140 (Aug., 1873); *Proc. Nat. Conf. Elec. Phil.*, p. 103. New York (1884); *Elec. Lon.*, 13:516, 535 (Oct. 18, 25, 1884); *Elec. Rev. Lon.*, 15:368 (Nov. 8, 1884).

and of the coils used for loading telephone lines, the magnetic circuit is of uniform reluctance throughout. In most cases, the magnetic circuit consists of a number of non-uniform parts, each of which may have a constant or a variable area and corresponding permeability; thus, the magnetic circuit of a telegraph sounder or of an

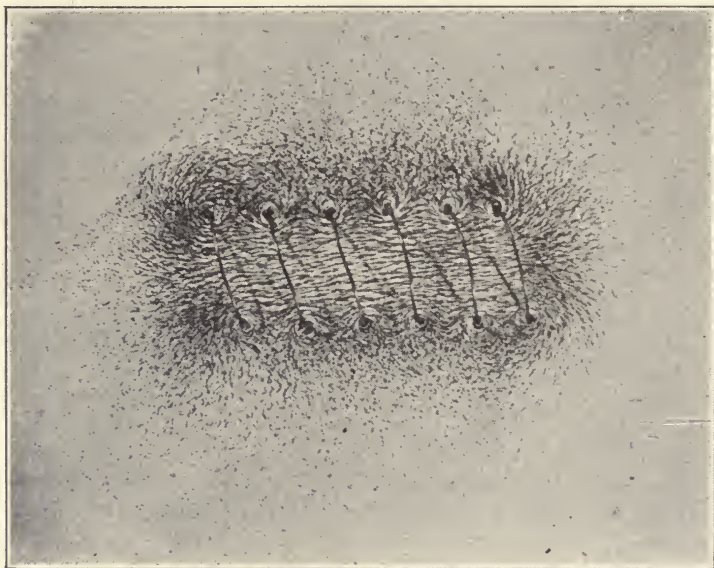

FIG. 107.—MAGNETIC FIELD ABOUT SOLENOID

electric bell may pass through a cast-iron base, cylindrical wrought-iron cores, flat wrought-iron armature, and two air-gaps of varying length and section; in such cases, the total reluctance of the circuit is the sum of the several reluctances of the parts, or,

$$R = R' + R'' + R''' + \text{etc.} \quad [6]$$

In some cases, as in most polarized apparatus and as in the magnetic circuits of many alternating current transformers for lighting and power, or in the field magnets of multipolar and consequent-pole dynamos and motors, the magnetic flux may divide among two or more paths. In such cases, the permeance or magnetic conductivity of the divided part of the circuit equals the sum of the individual permeances, and the combined reluctance of the several multiple paths equals the reciprocal of the sum of their several permeances; the combined reluctance of the several paths may also be expressed

as the reciprocal of the sum of the reciprocals of the reluctances of the several parts which are in multiple, or

$$R = \frac{1}{\frac{1}{R'} + \frac{1}{R''} + \frac{1}{R'''} + \text{etc.}} \quad [7]$$

296. Permeability; Saturation; Remanence.—The limits of magnetic permeance are much narrower than those of electrical resistance. No known substance has lower permeability than that of air, which is taken as unity; the permeability of soft wrought iron ranges from as high as 5,000 in some specimens at moderate magnetization, down

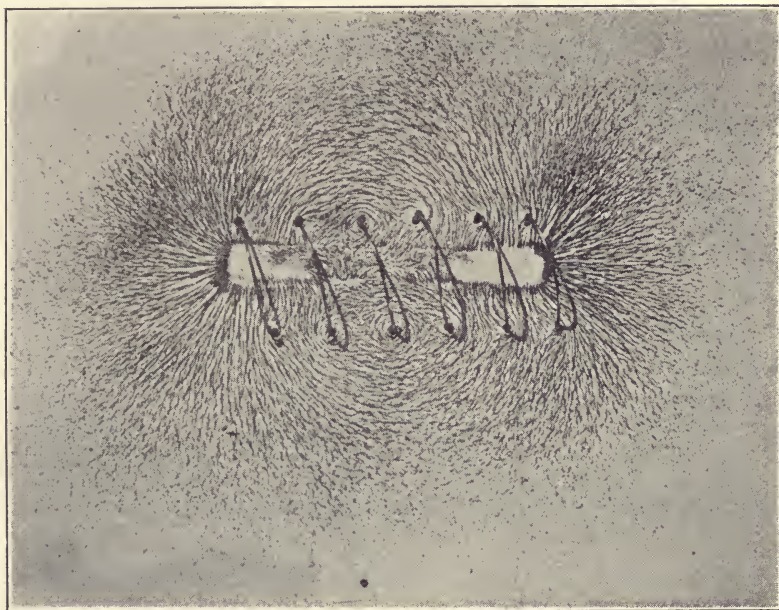

FIG. 108.—MAGNETIC FIELD ABOUT SOLENOID WITH IRON CORE

to but little above unity when the magnetization has increased to above 20,000 lines or units of magnetic flux per square centimeter; certain other substances rarely used for magnetic purposes (such as manganese alloys, magnetic iron ore, nickel, and cobalt) have permeabilities greater than air, and become saturated at much lower values of magnetic flux than does iron. No known substance acts as a magnetic insulator better than air; consequently the magnetic flux is caused to follow the desired path only by making that path of vastly better permeance, that is, of lower reluctance than any other path.

The permeability of air is taken as unity, this being closely the value for copper and other "non-magnetic" materials. The permeability of iron or steel varies¹ both with the chemical composition and heat treatment of the material and also with the intensity of the magnetic field.

The effect of varying permeability is illustrated by the accompanying figure showing the relations between magnetomotive force and resulting magnetization. If the iron core has not been previously magnetized, then as the magnetizing current (the curve may be

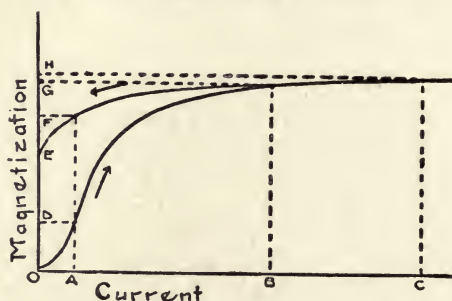

FIG. 109.—HYSTERESIS CURVE
(By permission)

drawn to scale to represent amperes in the magnetizing coil, or ampere-turns, or magnetomotive force of 0.4π times ampere-turns) increases from zero to any value, such as represented by the distance OA , the magnetization increases from zero to some value such as represented by the distance OD . The magnetization rises rapidly with the current until the iron begins to be "saturated" with magnetic flux and the permeability begins to get less, this more or less definite value being known as the "knee" of the magnetization curve. With current increasing yet further, the magnetization continues to rise, though less rapidly, as indicated by the current OB producing magnetization OG , and current OC producing magnetization OH .

Supposing next that the magnetizing current becomes less, within certain limits BC the magnetization will have the same value for falling as for rising current. As the "saturation" value is approached, the magnetization falls off less rapidly than does the current, the falling current of value OA maintaining, for example, the magnetization represented by OF . When the current has been reduced to zero, there still exists a more or less permanent magnetization such as indicated by OE , the power of holding this residual magnetization

¹ See data in handbooks. For permeabilities to 70,000 see YENSEN: Bulletins 72, 82, Eng. Exper. Sta., Univ. Illinois; Proc. Am. Inst. El. Eng. 34:207, 2455 (Feb., Oct., 1915); 35:638 (May, 1915).

being sometimes called the "remanence" of the iron, sometimes expressed as a percentage of the maximum magnetization. The magnetomotive force necessary to remove the residual magnetization is a measure of the coercive force of the iron.

297. Hysteresis Loop.—When iron is subjected to a magnetizing force that varies through a regular cycle, such as given by alternating current, increasing from zero to a maximum and then decreasing to zero, reversing and increasing to a maximum and decreasing again to zero, the magnetization follows more or less closely the changes in the current. The figure shows cyclic magnetization curves

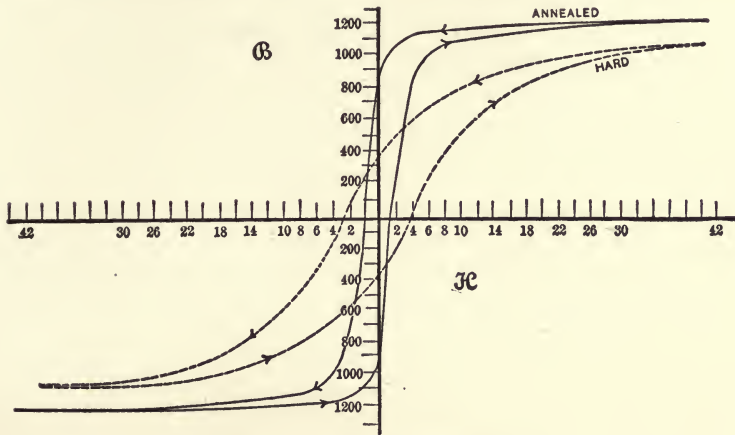

FIG. 110.—HYSTERESIS LOOPS

for iron wire, both when hard and after being annealed. Such curves are usually known as "hysteresis loops." When plotted in terms of magnetic lines of force per square centimeter of cross-section of iron, as ordinates or vertical distances, and in terms of CGS units of magnetomotive force (1.257 times ampere-turns), as abscissae or horizontal distances, the area of the loop represents¹ the energy (in ergs or CGS units of work, 981 such units being the work done in raising one cubic centimeter of water to a height of one centimeter against the force of gravity) changed into heat during each complete cycle of magnetization. The total energy of alternating currents lost by hysteresis equals the energy per cycle multiplied by the number of cycles per second. The energy lost by hysteresis is also found to be closely proportional to the 1.6th power of the maximum

¹ EWING. *Magnetic Induction in Iron and Others Metals*, chap. V. Van Nostrand (1892).

value of the magnetization, the energy loss per cubic centimeter of iron and per cycle being represented¹ by Steinmetz' equation:

$$W = K B^{1.6} \quad [8]$$

in which K is the coefficient of hysteresis for the particular brand of iron, this value varying from .00124 to .0055, an average value for good wrought iron being about .0025; for cast iron .013, and for cast steel from .0032 to about .028; B is the maximum number of magnetic lines per square centimeter of iron.

298. Eddy Currents.—As the magnetization changes through the cycle, electromotive forces are induced within the iron core and in the neighboring conductors. By suitable lamination of the iron or other conducting material, the electromotive forces are prevented from causing currents. At high frequencies, the resulting local or "eddy" currents may become so strong as to have appreciable effect, even in well laminated structures. Since the eddy currents tend to be in the opposite direction to the primary current, they exert a demagnetizing influence, which prevents the magnetization from penetrating evenly through the iron body; thus they have the effect of making the apparent permeability of the iron for high frequency currents less than for those of low frequency. For example, the permeability of iron which has a value of 1,000 at low frequency falls to an apparent value² of 198 at 10,000 cycles, and to 19.8 at 1,000,000 cycles, the reduction being due to a change not in the real permeability, but rather in the effective area of the iron path, due to the smaller penetration of the magnetization.

299. Energy in a Magnetic Circuit.—By Rowland's law, the magnetic flux through a circuit of uniform permeability and section is, in CGS units:

$$\phi = 4 \pi n i A \mu / l \quad [9]$$

in which n is the number of turns in the magnetizing coil, A is the area and l the length of magnetic circuit, μ is the permeability with the given flux ϕ corresponding to the current i . Substituting $B = \phi/A$, gives:

$$ni = \frac{\phi l}{4 \pi A \mu} = \frac{B l}{4 \pi \mu} \quad [10]$$

The rate at which the flux changes with the current is indicated by differentiating Equation [9]:

¹ STEINMETZ. *Elec. Eng. N. Y.*, 10:677 (Dec. 17, 1890); *Trans. Amer. Inst. El. Eng.*, 9:3, 621 (Jan and Sept., 1892); 11:570 (May, 1894).

² STEINMETZ. *Transient Electric Phenomena and Oscillations*, p. 367.

HEAVISIDE. *Electrical Papers*, 1:361. Macmillan (1892).

ST. JOHN. *Phil. Mag.* (5) 39:297 (Mar., 1895).

$$d\phi = d(4\pi ni A\mu/l) = \frac{4\pi n A\mu}{l} di. \quad [11]$$

As the current grows from zero value to its maximum steady value I , that is, from $i=0$ to $i=I$, the magnetic flux grows from $\phi'=0$ to $\phi''=\phi$. The increase in the magnetic flux inclosed by the coil induces therein a counter-electromotive force equal to the number of turns in the coil multiplied¹ by the rate of change of magnetic flux with time, or;

$$e = n \frac{d\phi}{dt} = \frac{4\pi n^2 A\mu}{l} \frac{di}{dt} = L \frac{di}{dt} \quad [12]$$

The rate of transfer of energy from the electric to the magnetic circuit equals the product of current by counter-electromotive force during any instant, or:

$$dW = ei dt = \frac{4\pi n^2 A\mu}{l} \frac{di}{dt} i dt = \frac{4\pi n^2 A\mu}{l} i di \quad [13]$$

The total energy transferred² from the electric to the magnetic circuit (assuming hysteresis and secondary currents as negligible, and assuming constant or average permeability) is found by integrating [13] between the limits $i=0$ and $i=I$:

$$W = \int e i dt = \frac{4\pi n^2 A\mu}{l} \int_0^I i di = \frac{4\pi n^2 A\mu}{l} \frac{I^2}{2} = \frac{LI^2}{2} \quad [14]$$

Substituting Equation [10]:

$$W = \frac{2\pi A\mu}{l} (ni)^2 = \frac{2\pi A\mu}{l} \frac{(BI)^2}{(4\pi\mu)} = \frac{B^2 A l}{8\pi\mu} \quad [15]$$

The total volume of the magnetic circuit equals the area times the length, or Al . Dividing Equation [15] by this value gives, as the energy stored in each cubic centimeter of the uniform magnetic circuit:

$$W = \frac{W}{Al} = \frac{B^2}{8\pi\mu} \quad [16]$$

300. Magnetic Stability; Adjustment of Flux for Minimum Energy.—To reach stable equilibrium, a magnetic field tends to take such a disposition as to reduce to a minimum the energy expressed by Equation [15]. Substituting $\phi=BA$, Equation [15] becomes:

$$W = B^2 A l / 8\pi\mu = \phi^2 l / 8\pi A\mu. \quad [17]$$

¹ See Appendix A, § 304.

² See Appendix A, § 305.

Therefore, in a field of uniform permeability, μ , a given flux will spread out¹ so as to make the summation of $1/A$ a minimum.

301. **Equations for Magnetic Pull.**—Another conclusion from Equation [17] is that the magnetic flux gathers toward substances of higher permeability, and that such objects tend to move² to positions which make the entire path of minimum reluctance, that is, so that the summation of $1/A\mu$ is a minimum.

Suppose that the original magnetic circuit is lengthened by the introduction of an air-gap, or *entrefer*, of length l' , while the flux is maintained constant by increasing the current in the coil. Since the flux in the original part of the circuit remains constant, no additional energy is there required; the additional energy is chargeable to the air-gap, and equals

$$W' = B'^2 A' l' / 8 \pi \mu' = B'^2 A' l' / 8 \pi \quad [18]$$

since $\mu' = 1$ for air or other non-magnetic substance.

Since the flux through the original part of the magnetic circuit is assumed not to have changed by the introduction of the air-gap, the energy in the air-gap may be considered as having been supplied by other means, as mechanically instead of electrically; such, for example, would be the case in pulling the armature a short distance from the poles of a permanent magnet. The mechanical energy would be the product of pull by distance moved, whence the pull equals the energy divided by the distance. The assumed mechanical, electrical, and magnetic energy being equal and the same, we may write:

$$P = W' / l' = B'^2 A' / 8 \pi \quad \text{dynes; [19]}$$

$$= B'^2 A' / (8 \pi \ 981,000) \cong 4 B'^2 A' \ 10^{-8} \quad \text{kilograms; [20]}$$

$$= B'^2 A' / (8 \pi \ 981 \ 453.6) = B'^2 A' / 11,183,000 \quad \text{pounds. [21]}$$

If B and A are in terms of square inches instead of centimeters,

$$P = B^2 A / 72,134,000 \quad \text{pounds. [22]}$$

These are the accepted formulæ for the pull between two parts of a magnetic circuit. If the air-gap is in two places, as when a ring is divided, the pull at each crevasse is expressed by Equations [19] to [22].

When the magnetic flux is not evenly distributed over the surface of the magnet or armature, the total pull is the summation of the pulls on the elements of the surface:

$$P = \Sigma B^2 dA / 8 \pi \cong \Sigma 0.04 B^2 dA, \quad \text{dynes. [23]}$$

¹ See Figs. 104-108; also Figs. 68, 69.

² Compare Figs. 69 and 70.

302. Pull Dependent on Magnetic Gradient.—When the magnetic flux enters and leaves on opposite sides of a piece of iron in a magnetic field, the iron is subjected to two opposing pulls, and the net pull equals $(B^2, A, - B^2, A, //) / 8\pi$.

When there is little or no magnetic gradient, that is, when the density of the flux on the side furthest from the magnet is practically the same as that nearest the magnet, the opposing pulls are practically equal and there is little or no net force pulling the iron piece toward the magnet. When the magnetic flux entering one side of a test piece leaves on all sides and in various directions, the forces on some laterals balance more or less completely those on others, and there is a net pull. Thus, a test piece of iron is strongly pulled toward the edges of a permanent magnet where the magnetic gradient is steep; but there is very little pull when the magnetic gradient is small, as when the test piece is brought near the middle of the outer flat surface of a horseshoe permanent magnet, since the magnetic flux leaves along lines that are practically parallel for a considerable distance. For similar reasons, when a horseshoe magnet made of flat bar steel is dipped into iron filings, they attach themselves principally to the edges and but little to the parallel flat surfaces.

Since by Equation [18] the absence, presence, or position of a substance of the same permeability as air does not affect the energy required for the interferric space (*entrefer*), no magnetic pull is exerted on a non-magnetic body unless secondary currents are induced therein by *changes* in the magnetic flux through the body.

303. Alternate Derivations of Equation for Magnetic Pull.—A favorite development¹ of Equation [19] for magnetic pull is along the following outline:

a. Definition of terms; unit force; unit magnetic pole; unit line of force; unit current.

b. The magnetic effect of a current is equivalent to that of a magnetic shell having equal boundaries.

c. The magnetic potential at any point due to magnetic shell or to current is $V = Niw$; Gauss' theorem.

d. The work done in carrying unit pole around a magnetic shell is $W = 4\pi Ni$ ergs.

e. The force exerted on a unit pole in a long solenoid is $H = W / l = 4\pi Ni / l$ dynes.

f. Each end face of a long solenoid is equivalent to NiA / l unit poles.

¹ JACKSON. Electromagnetism and the Construction of Dynamos, pp. 11-19. Macmillan (1896).

THOMAELEN. Elements of Electrical Engineering, pp. 70-72.

g. Each unit pole in a face of a long solenoid is acted on by a force equal to $2\pi Ni/1$ dynes.

h. The total force exerted upon a shell face is then

$$(NiA/1) (2\pi Ni/1 = 2\pi(Ni/1)^2 A \text{ dynes.}$$

i. Substituting $H = 4\pi Ni/1$ makes the force $H^2A/8\pi$ dynes.

Another favorite argument is from analogy¹ to electrostatic forces.

305. Coefficient of Self-induction; Reactance.—The quantity expressed² by the fraction $4\pi n^2 A\mu/1$ is usually known as the coefficient of self-induction of the electric circuit, and is generally represented by the letter L . Self-induction is measured in terms of the henry, a modern unit replacing the older “quadrant” or “sec-ohm,” named³ after Joseph Henry, an American physicist, who discovered many of the laws of induction. As expressed by the above fraction, it is seen that the self-induction of a circuit is independent of the current, except as the permeability μ of the iron is affected. Another mode of expressing the same relation (only using practical instead of absolute units) is: the coefficient of self-induction of a circuit equals one henry when a change in the current at the rate of one ampere per second induces within the circuit an electromotive force of one volt. The same unit is used to measure the inductive effect of one circuit upon another; thus, the mutual inductance between two circuits is one henry when a change in the current in one at the rate of one ampere per second induces in the other circuit an electromotive force of one volt. For greater convenience, the inductances usually met in telephonic lines and apparatus are commonly expressed in terms of millihenries, that is, in the thousandths of a henry.

When dealing with alternating currents, the coefficient of self-induction is frequently combined with the frequency f and the ratio 2π , to give the product $2\pi fL$ known as the inductive reactance, expressed in ohms and generally represented by the letter x . The quantity $2\pi f$ is known as the angular velocity of the current, and is often expressed by the Greek letter ω (pronounced o-mé-ga).

305. Energy of Self-induction.—The energy transferred to the magnetic field becomes stored or potential energy, that is, energy which

¹ MAXWELL. *Electricity and Magnetism*, arts. 630-645. Oxford Press (1881).

MASCART and JOUBERT. *Electricity and Magnetism*, vol. 1, arts. 99-107. De La Rue (1883).

DUBOIS. *The Magnetic Circuit*, arts. 101-109. Longmans (1896).

EWING. *Magnetic Induction in Iron and Other Metals*, arts. 143-148. Van Nostrand (1900).

JACKSON. *Electricity and Magnetism*, pp. 11-30. Macmillan (1902).

² See Equation [12] on page 281.

³ HENRY. *Trans. Am. Inst. El. Eng.*, 7:359 (Sept., 1890).

is not necessarily doing work, but which may do work. The total energy stored is expressed by Equations [14] and [15], using either absolute or practical units; thus, the energy measured in watt-seconds equals half the number of henries of self-induction multiplied by the square of the number of amperes. When the current is alternating, the stored energy is greatest at the instant of maximum current; if the current varies sinusoidally, its maximum value is the square root of two times the root of mean square value as measured by ordinary ammeters, and the maximum value of the stored energy is, as anticipated in Equation [14],

$$W = \frac{L(I\sqrt{2})^2}{2} = LI^2 \quad [16]$$

in which I is the current as measured by ammeter.

APPENDIX B

THE MAGNETIC FLUX¹ IN A CIRCUIT CONTAINING A PERMANENT MAGNET

306. Importance of Reluctance and Magnetomotive of Permanent Magnets.—The operation of the telephone ringer, magneto generator, receiver, and other polarized apparatus, depends on changes in the flux through a circuit containing a variable reluctance and two magnetomotive forces. The major reluctance and major magnetomotive force usually reside in the permanent magnet.

307. Early Experiments on Constancy of Flux.—Experiments by S. P. Thompson² indicate that the total flux through a permanent magnet is independent of the presence or absence of the soft-iron armature, and that therefore the flux through the permanent magnet in a telephone receiver is entirely unaffected by any motion of the diaphragm.

308. Late Experiments Show Variation with Reluctance.—Experiments under the author's direction³ indicate that the removal of the soft-iron armature from the ends of a U-shaped permanent magnet does reduce the flux through the magnet, and that its replacement restores the flux. The experiments show that the permanent magnet may be considered as having an inherent magnetomotive force and that the magnetic flux through the permanent magnet (neglecting any extraneous magnetomotive force) is a function of the reluctance of the total circuit. Since the reluctance of the hardened steel is high, a considerable variation of the reluctance between the pole extensions constitutes but a relatively small variation in the reluctance of the total magnetic circuit.

309. Experimental Apparatus.—An exploring coil was arranged to be placed in marked positions along a hardened steel magnet, to whose ends were attached soft-iron pole extensions in imitation of the magnetic circuit of a telephone receiver; the steel magnet consisted of a bar $\frac{1}{2}$ inch (1.27 cm.) thick and $1\frac{1}{2}$ inch (3.81 cm.)

¹ Supplementing Chapters V, X, and XI.

² THOMPSON. *The Electromagnet*, p. 213. Spon, London (1891).

³ SHEPARDSON. "Equivalent Frequency of Telephone Currents," 1912 thesis in Library of Harvard University, p. 210; *Trans. Am. Inst. El. Eng.*, 31:1419 (June, 1912).

wide, formed into the shape of the letter U, having a height of $5\frac{3}{4}$ inches (14.6 cm.) and an opening of 2 inches (5.08 cm.); bars of soft iron $\frac{3}{16}$ inch (0.48 cm.) thick and $1\frac{1}{2}$ inch (3.81 cm.) wide and $5\frac{1}{2}$ inches (14 cm.) long were fastened to the ends of the magnet by windings of hard cord and shellac, thus extending the U to a height of $9\frac{3}{4}$ inches (24.8 cm.); a soft iron bar of equal section

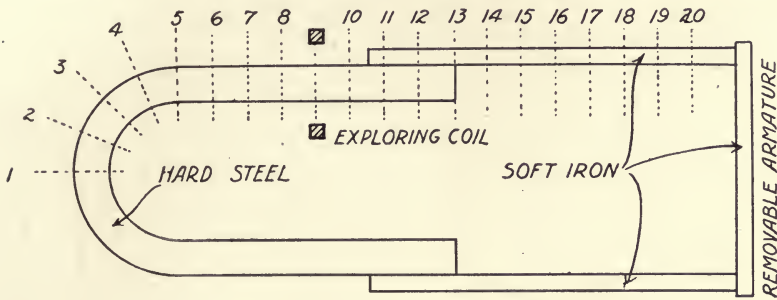

FIG. 111.—EXPERIMENTAL MAGNET

was provided, for placing across the squared ends of the pole extensions and for quick removal; the coil consisted of 50 turns of No. 34 copper wire wound into a sort of pancake coil so as to be very narrow; the coil was connected to a ballistic galvanometer through a line key for convenient manipulation, a short-circuiting key being provided for bringing the galvanometer to rest by the retarding force of the currents due to the electromotive force induced by the motion of the coil through the magnetic field.

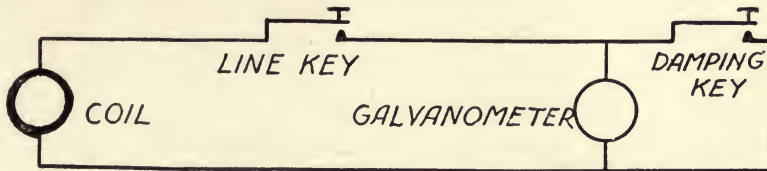

FIG. 112.—ELECTRICAL CIRCUIT FOR EXPERIMENTAL MAGNET

The exploring coil being in a marked position on the steel magnet or on the pole extensions, the armature was suddenly removed, so as to induce in the coil an electromotive force proportional to the amount of change of flux through the coil. The line key was then quickly opened, so as to avoid damping the galvanometer by self-induced currents.

310. Experimental Results; Data.—Numbering the positions on the magnet one-half inch apart from No. 1 at the heel or bend to No. 13

at the end of the steel portion and No. 20 near the end of the soft iron extension, observations were taken when the armature was removed as the coil occupied the successive positions.

The galvanometer readings, plotted on the accompanying curve sheet, show the maximum flux variation to be at the positions nearest the armature, as was to be expected. The flux variation gradually

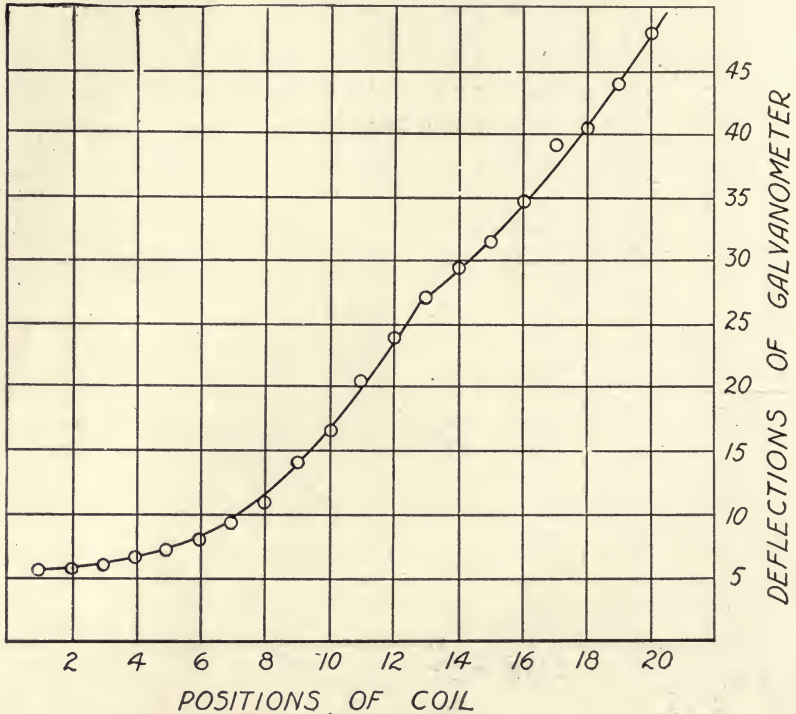

FIG. 113.—CURVE SHOWING RELATION BETWEEN COIL POSITION AND CHANGE OF FLUX

falls off from that point to a minimum at the heel, there being a sudden change of curvature at position No. 13 at the end of the steel portion. Similar tests of flux variation by replacing the armature gave smaller changes, but less regular on account of experimental difficulty in getting uniform speed of replacement.

Similar experiments by other students in the laboratory, carried along both legs of the steel magnet, failed to find any position where there was a total absence of flux variation when the soft-iron armature was removed from closing the gap between the pole exten-

sions, though with some magnets there were two positions of minimum change.

The apparent discrepancy between these results and those of S. P. Thompson is probably due to the fact that his permanent magnet was much longer, so that the internal reluctance of his magnet was much greater in comparison with his air-gap reluctance.

VARIATION OF FLUX THROUGH PERMANENT MAGNET AS ARMATURE IS
WITHDRAWN

(Measurements by A. E. Brockway)

<i>Coil Position</i>	<i>Galvanometer Deflections</i>		
1	5.75	6.00	5.75
2	6.00	5.75	6.00
3	6.10	6.10	6.00
4	6.75	6.50
5	7.20	7.50	7.50
6	8.00	8.00	
7	9.50	9.30	
8	11.00	11.00	
9	14.10	14.20	
10	16.50	16.80	
11	20.50	20.60	
12	24.00	24.00	
13	27.00	27.50	
14	29.00	29.50	
15	31.50	31.50	
16	35.00	34.50	
17	38.00	38.50	
18	40.50	40.50	
19	44.00	44.00	
20	47.50	48.50	

APPENDIX C

MATHEMATICAL THEORY OF POLARIZED RELAY OR RINGER¹

311. Magnetomotive Forces.—The mathematical theory of the polarized relay or ringer may be developed as follows:

Assume a permanent magnet with poles at N and S and with external magnetomotive force M . Between the poles of the permanent magnet, and attached to one of them, assume an electromagnet, one leg of which carries a coil of n' turns and has a reluctance a within the iron, the other leg of which carries a coil of n'' turns and has a reluctance b within the iron, that is, between the end facing the vibrator and the point of attachment to the permanent magnet. Then the magnetomotive forces of the coils are $4\pi n'i'$ and $4\pi n''i''$, respectively; ordinarily, the coils are alike and are connected in series, in which case the magnetomotive force of either coil is $4\pi ni$, in which i is the current at any instant.

312. Components of Reluctance.—Assume a vibrator V of soft iron and pivoted near the other pole of the permanent magnet, so as to carry the magnetic flux from that pole to either or both of the legs of the electromagnet, and also carrying a hammer rod if a ringer, or contact strip if a relay; the magnetic reluctance of the vibrator V may be considered as practically constant and small; for a complete discussion it may be assumed as offering a reluctance V' to the magnetic flux through the leg a , and a reluctance V'' to the flux through leg b of the electromagnet.

Let x represent the reluctance between the end of leg a and the vibrator at any given position, say at the limit of the swing toward a ; let y be the reluctance between the end of leg b and the vibrator at that position; then if the vibrator does not have too large an amplitude of vibration and does not come too close to the end of the electromagnet, the effective area of each air-gap may be considered as constant; the sum of the reluctances x and y may be considered as sensibly constant, and we may write

$$x + y = z \quad \text{or} \quad y = z - x$$

The same assumption also makes the reluctances x and y directly

¹Supplementing Chapters X and XI.

proportional to the respective distances between the vibrator and the ends of the electromagnet.

The reluctance g between the vibrator and the near pole of the permanent magnet may be considered as practically constant, though the angular position of the vibrator may affect the distribution of the flux emanating from the pole and thus may affect the terminal reluctance of the permanent magnet to a small extent.

The reluctances of the cores a and b vary, within usual limits, directly with the magnetic flux. Since the flux from the permanent

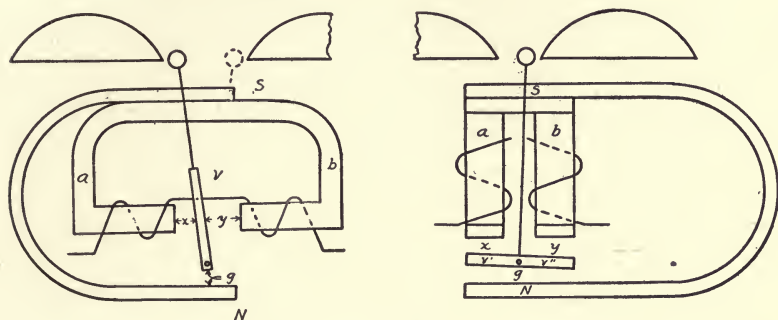

FIG. 114.—DIAGRAMS OF POLARIZED RINGERS

magnet divides between a and b in proportion to the conductivities of the two paths, the flux and therefore the reluctance through a and through b vary according to the reluctances x and y , respectively, and we may write

$$a = \frac{k}{x} \quad \text{and} \quad b = \frac{k}{y} = \frac{k}{z - x}$$

in which k is the proportionality factor dependent on the length and sectional area of the soft iron core and its permeability.

The reluctances of a and b are also affected by the local flux through the electromagnet, the magnetomotive forces of the two coils uniting to send flux through the cores, yoke, and air-gaps and across more or less of the vibrator. The local flux has little, if any, effect on the net pull on the vibrator, since the same flux enters and leaves on opposite sides and with about the same distribution; it is minimized by having large reluctance in the electromagnetic circuit, as by making the sum of x and y large.

313. Division of Flux Between Two Paths.—For any assumed position of the vibrating armature, the flux through each path is determined by the total magnetomotive force divided by the total reluctance. The fluxes through the two paths are

$$\phi' = \frac{M \pm C'}{a + x + v' + g} \quad \text{and} \quad \phi'' = \frac{M \mp C''}{b + y + v'' + g}$$

in which $C' = 4\pi n' i'$ and $C'' = 4\pi n'' i''$ are the magnetomotive forces due to the currents in the two coils, respectively, being usually equal. M represents the external magnetomotive force of the permanent magnet.

The upper signs between M and C apply when the current is in the direction to hold the vibrator against the a leg, and are of interest in determining the conditions for the strength of the blow on the gong of a ringer or the pressure on the stops of a relay or vibrating rectifying commutator; the lower signs are of interest in determining the strength of current required to move the vibrator away from the position of rest.

314. Magnetic Pulls on the Vibrator.—The net force, exclusive of springs and gravity, pulling the armature equals the difference between the pulls in the opposite directions. By Maxwell's law,¹ the pull (measured in dynes²) equals the area (in centimeters) times the square of the magnetic density (in terms of gaussses, that is, lines of force or maxwells per square centimeter) divided by the constant 8π or 25.14). Letting A' and A'' represent the areas of the paths of flux from the vibrator to a and b , respectively, and writing $B' = \frac{\phi'}{A'}$ and $B'' = \frac{\phi''}{A''}$ for the densities,

$$P = \frac{B'^2 A'}{8\pi} - \frac{B''^2 A''}{8\pi} = \frac{\phi'^2 A'}{8\pi A'^2} - \frac{\phi''^2 A''}{8\pi A''^2} = \frac{\phi'^2}{8\pi A'} - \frac{\phi''^2}{8\pi A''}$$

If the movement of the vibrator is not large, the magnetic paths between the vibrator and the ends of the electromagnet may be assumed as sensibly equal, and then $A' = A'' = A$; then,

$$P = \frac{\phi'^2 - \phi''^2}{8\pi A}$$

Substituting the values for ϕ' and ϕ'' gives

$$P = \frac{(M \pm C)^2}{8\pi A (a + x + v' + g)^2} - \frac{(M \mp C)^2}{8\pi A (b + y + v'' + g)^2}$$

as the general equation for the pull on the armature or vibrator of a polarized ringer or relay, the upper signs being taken when the current is in such direction as to increase the pull on the x or near side, the lower signs being taken when the current is in the opposite direction.

315. Force Holding Vibrator Against Stop; Effect of Air-gap Upon Strength of Blow.—The force with which the vibrator is held against

¹ See Appendix A, § 301.

² See Appendix A, § 290.

the limiting stop, which is one of the elements determining the blow of a ringer, is expressed by the general equation when the upper signs are used, these indicating that the magnetomotive forces of the permanent magnet and of the current are cumulative on the near side and are differential on the far side of the vibrator.

$$P = \frac{(M + C)^2}{8\pi A (a + x + v' + g)^2} - \frac{(M - C)^2}{8\pi A (b + y + v'' + g)^2}$$

Since x is smaller than y , the denominator of the first term of the right-hand or dexter member of the equation is smaller than that of the second term. Since the numerator of the first term is the sum of M and C , while the numerator of the second term is their difference, the first is the larger. Therefore the first term, having the larger numerator and the smaller denominator, is always larger than the second term, and the pull, P , will be increased by increasing either M or C or both indefinitely.

Since the reluctance of the air-gap, g , between the vibrator and the permanent magnet is a larger part of the first denominator than of the second, reducing this gap increases the strength of the pull or blow. It should be remembered, however, that while increasing the strength of the permanent magnet and decreasing the reluctance between vibrator and magnet increases the strength of the pull against the stop or gong, it also increases the minimum current below which the vibrator will remain in its previous position; that is, it increases the current which must be supplied before the device will operate.

316. Current Required to Move Vibrator from Extreme Position.—The magnetomotive force, and thence the current, required to release the vibrator is determined by the value which makes the net pull zero. To make P equal zero, the second member of the equation must equal zero when the lower signs are taken for the numerator. Canceling the common factor $8\pi A$, and taking the square root, clearing of fractions and collecting, gives

$$\frac{(M - C)^2}{8\pi A (a + x + v' + g)^2} = \frac{(M + C)^2}{8\pi A (b + y + v'' + g)^2}$$

$$\frac{M - C}{a + x + v' + g} = \frac{M + C}{b + y + v'' + g}$$

$$(M - C)(b + y + v'' + g) = (M + C)(a + x + v' + g)$$

$$M(b + y + v'' + g - a - x - v' - g) = C(a + x + v' + g + b + y + v'' + g)$$

$$C = M \frac{b - a + y - x + v'' - v'}{b + a + y + x + v'' + v' + 2g}$$

When, as is usual, $a = b$ and $v' = v''$, it simplifies to

$$C = M \frac{y - x}{y + x + 2a + 2g + 2v'} = 4\pi ni$$

Neglecting relatively small quantities gives

$$C = M \frac{y - x}{y + x + 2g} = 4\pi ni$$

The equations show: that the current required to make the vibrator ready to move away increases with increasing strength of the permanent magnet, other things being equal; that the required current becomes less as x and y approach equality, no current being required when x and y are equal—that is, the vibrator is in unstable equilibrium when at the neutral position; that the required current becomes less as y and x and g increase—that is, as the distance between the ends of the electromagnet increases or as the distance between the vibrator and the pole of the permanent magnet increases.

APPENDIX D

THEORY OF FORCES ACTING ON RECEIVER DIAPHRAGM¹

317. Elements of Magnetic Pull; Magnetomotive Forces; Flux; Pull.

—The force tending to draw together two portions of a magnetic circuit has been shown² to be $B^2A/8\pi$ dynes per square centimeter, in which A is the area and B is the number of magnetic lines of force per square centimeter. As applied to the telephone receiver in which the intensity and direction of the flux vary from point to point, B may be considered as the average intensity at right angles to the diaphragm over the area near the pole-pieces. (While the actual numerical determination of such intensity and such area would be troublesome if not impossible, yet the conclusions to be derived should give reliable insight into the character of the effects produced by each variable.) Assuming the area A opposite each pole as known, the intensity B is obtainable if the total flux, $\phi = BA$, is known; in the case of the unipolar receiver the flux pulls once, while in the bipolar receiver each line of force pulls both where it enters and where it leaves the diaphragm.

The magnetic flux through the active part of the magnetic circuit of the receiver is determined by the total magnetomotive force acting on that path divided by the total reluctance³ of the same path. The magnetomotive forces include that of the permanent magnet and that of the current through the coil, the latter being equal to 4π times the product of amount of current by the number of turns or convolutions of the wire in the coil. The reluctances include a constant part, and a variable part which depends on the changing distance between diaphragm and pole-piece and upon the amount of concentration due to the action of the current. (The magnetomotive force and the reluctance of the permanent magnet may include the whole of each, or those portions which may be considered as between the poles and the outside circuit, as noted⁴ elsewhere.)

Since the change of reluctance due to the vibration of the dia-

¹ Supplementing Chapter V, §§ 68-81.

² See Appendix A, § 301.

³ See Appendix A, §§ 294, 295; also § 174.

⁴ See §§ 173-175.

phragm is a small part of the total, its influence may be neglected in the first approximation to the theory of the receiver.

The flux may be expressed¹ by

$$\phi = \frac{M + 4\pi Ni}{R} = BA \quad [1]$$

in which M is the magnetomotive force of the permanent magnet, or of the steady portion of the current through an electromagnetic receiver without permanent magnet, while i is the value of the current at any instant, and R is the reluctance of the magnetic path.

Then the pull on the diaphragm of a unipolar receiver² is

$$P = \frac{B^2 A}{8\pi} = \frac{\phi^2}{8\pi A} \quad [2]$$

and the pull on the diaphragm of a bipolar receiver is

$$P = 2 \frac{B^2 A}{8\pi} = \frac{\phi^2}{4\pi A} \quad [3]$$

in which A is the effective area of each pole.

318. Variation of Pull with Position of Diaphragm.—As was first pointed out by Heaviside,³ the amplitude of the sound is determined not by the simple pull upon the diaphragm, but by the change in the pull. Extending his suggestion, the effective force causing the diaphragm to vibrate from one extreme position to the other is expressed by

$$2F = P' - P'' = \frac{\phi'^2}{4\pi A} - \frac{\phi''^2}{4\pi A} \quad [4]$$

$$= \frac{(M + 4\pi NI')^2}{4\pi AR'^2} - \frac{(M - 4\pi NI'')^2}{4\pi AR''^2}$$

$$= \frac{(M^2 + 8\pi NIM + 16\pi^2 N^2 I^2) - (M^2 - 8\pi NIM + 16\pi^2 N^2 I^2)}{4\pi AR^2}$$

$$= \frac{16\pi NIM}{4\pi AR^2} = \frac{4NMI}{AR^2} \quad [5]$$

in which P' and ϕ' refer to the pull and flux when the diaphragm is closest to the pole-piece, and P'' and ϕ'' refer to similar quantities when the diaphragm is furthest away, while I is the maximum value of the current strengthening or weakening the total magnetomotive force. In practice, I' equals I'' and R' nearly equals R'' .

¹ See Appendix A, §§ 292, 299.

² See Appendix A, § 301.

³ HEAVISIDE. *Electrical Papers*, 2:155. Macmillan (1892); *Elec. Lon.*, 18:302 (Feb. 11, 1887).

Assuming that the force varies symmetrically on the two sides of the neutral position, which may be allowed for a first approximation, the force or change of pull measured from the neutral position may be expressed by

$$F = 2 \frac{N M I}{A R^2} = KI \quad [6]$$

If the current varies sinusoidally, and I is the maximum value, the force moving the diaphragm at any instant is

$$K i = KI \sin (2 \pi f t) \quad [7]$$

in which f is the frequency or number of cycles per second, and t is the epoch of time measured from the zero value.

319. Forces Acting on Diaphragm; Effect of Elasticity Proportional to Displacement of Receiver Diaphragm.—In the receiver diaphragm, the varying force due to the combined action of the permanent magnet and of the current through the coils is balanced against the resisting mechanical forces, including elasticity, rigidity, momentum, retardation by the air,¹ and electrical and magnetic reactions which may be included with the mechanical forces. These may all be represented in terms of the displacement u of the diaphragm from its neutral position, the displacement being assumed as measured not at the center of the diaphragm but at some position of average displacement. The effect of the elasticity, which is proportional to the displacement, may be represented by Pu .

320. Forces Proportional to Rate of Displacement of Diaphragms.—The effect of rigidity of the diaphragm is proportional to the velocity or rate of displacement. The retarding effect of the air² which is set in motion is also, within the limits of such low linear speeds as are found in the telephone diaphragm, closely proportional to the velocity. The electrical currents³ induced in the diaphragm (because of its motion in the magnetic field) are also proportional to the velocity, and may be considered as involving a resisting force directly proportional to the velocity. Magnetic hysteresis⁴ in the diaphragm may also be considered as exerting a resisting force proportional to the velocity. All of these may be combined and represented by a coefficient Q multiplied by the velocity V , which is conveniently expressed by the first differential coefficient $\frac{du}{dt}$ giving the term $Q \frac{du}{dt}$ in the general equation.

321. Force Proportional to Acceleration of Diaphragm.—The effect

¹ See § 16; also tests noted in §§ 66 and 68.

² See footnote 1. The effect is small.

³ See §§ 77-79.

⁴ See §§ 70, 80.

of momentum of the diaphragm is represented by the product of mass by acceleration and may be expressed by the second differential coefficient $M \frac{d^2 u}{dt^2}$, it being observed that not all the mass¹ of the diaphragm is included.

322. Differential Equation for the Forces Acting on Diaphragm; Periodic and Transient Terms in Solution.—Equating the sum of the various resisting forces against the impelling force gives the expression, apparently due to Wietlisbach,²

$$M \frac{d^2 u}{dt^2} + Q \frac{du}{dt} + Pu = KI \sin(2\pi ft) \quad [8]$$

which is a linear differential equation of the second order, whose solution³ is

$$u = \frac{KI \cos \alpha}{MQ} \sin(2\pi ft - \alpha) + C e^{-\frac{Qt}{2M}} \sin\left(\frac{\sqrt{P^2 - \frac{Q^2}{4}}}{M} t - a\right) \quad [9]$$

in which C and a are constants depending on the original condition of the diaphragm before the application of current to the coil, and in which the phase or displacement angle α is determined by

$$\tan \alpha = \frac{MQ}{P - M\omega^2} \quad [10]$$

in which $\omega = 2\pi f$ is the angular velocity.

Each term in the value for u represents a periodic motion, the first being a forced vibration having the same frequency as the actuating current, the second being a transient term representing a starting phenomenon of "free" vibrations which soon die out.

323. Forced Vibrations of Diaphragm; Effects of Frequency, Elasticity, and Mass.—Deferring⁴ consideration of the transient term, the elements of the forced vibration may be clarified by developing the cosine factor by substituting the above value of the tangent in the equivalent⁵ expression:

¹ Bouthillon and Drouet [*Compt. Rend.*, 158:1568 (June 2, 1914); *La Lum. Elec.* (2) 26:16 (July 4, 1914); *El. World*, 64:629 (Sept. 26, 1914)] considered one-fifth the total mass of the diaphragm as applicable in the formula. Kennelly and Affel [*Proc. Amer. Acad. Arts and Sci.*, 51:476 (Nov., 1915)] derived a mathematical expression for approximating the equivalent mass.

² WIETLISBACH. *Elec. Eng. Chi.*, 9:33 (Jan., 1897); *Handbuch der Telephonie*, p. 69.

³ See Appendix E.

⁴ See Appendix D, § 325.

⁵ Derived in treatises on trigonometry.

$$\cos \alpha = \frac{I}{\sqrt{I + \tan^2 \alpha}} = \frac{I}{\sqrt{I + \left(\frac{MQ}{P - 4\pi^2 f^2 M}\right)^2}} \quad [11]$$

Then, after the transient free vibrations have died out, the forced vibrations are represented by

$$u = \frac{KI}{MQ \sqrt{I + \left(\frac{MQ}{P - 4\pi^2 f^2 M}\right)^2}} \sin(2\pi ft - \alpha) \quad [12]$$

This equation shows that, other things remaining constant, the amplitude of the forced vibration of the receiver diaphragm is less for a given actuating current as the frequency f increases. This, however, is partly compensated by the increased efficiency of the faster vibrations, since there is likely to be less slippage of the air at the higher velocities.

The effect of design in diminishing the relative effect of the frequency is indicated better by a further reduction, making

$$u = \frac{KI}{MQ \sqrt{I + \left(\frac{Q}{\frac{P}{M} - 4\pi^2 f^2}\right)^2}} \sin(2\pi ft - \alpha) \quad [13]$$

whence it is apparent that the effect of frequency upon relative amplitude of vibration is minimized by making P large and M small, that is, by increasing the elasticity and decreasing the mass of the diaphragm. Thus, a telephone receiver with highly elastic and very light diaphragm should respond more uniformly to tones of different frequency than would one with heavier and less elastic diaphragm.

324. Phase Shifting of Forced Vibration.—The equation shows further that the vibration is not exactly in phase with the impelling current; that is, the maximum value of u does not correspond with the maximum value of $KI \sin(2\pi ft)$, but rather with that of $KI \sin(2\pi ft - \alpha)$.

Inspection of Equation [10]¹ for $\tan \alpha$ shows that the tangent (and therefore the angle) becomes larger as the mass and the elements of the rigidity coefficient Q increase, and also as the frequency increases, so long as $4\pi^2 f^2 M$ is less than P , as seems² to be

¹ See Appendix D, § 322.

² Taking the coefficient of elasticity of iron as about 2×10^{13} in terms of dynes, or about 2×10^9 in terms of grams; taking the operative mass of the diaphragm as about 4 grams; and assuming the average telephone current to have a frequency of about 800 cycles per second, making the angular velocity $2\pi f = 5,000$ radians gives:

$$P - 4\pi^2 f^2 M = 2,000,000,000 - 100,000,000 = 1,900,000,000.$$

the case in practice. Therefore the differential angle $2\pi ft - a$ is somewhat less for currents of high frequency than for currents of low frequency. This leads to some confusion and distortion, since in the reproduction of a complex sound composed of many frequencies the diaphragm responds to the high frequency components slightly faster than to the low frequency components. Fortunately the effect seems to be small. It also tends to correct an opposite influence due to self-induction in the line and apparatus which tends to make the high frequency components in the current lag behind the low frequency components.

325. Transient Effects on Vibration of Diaphragm; Rate of Decay of Transient Term.—The second term in the general Equation [9] for the displacement of the diaphragm

$$C \epsilon^{-\frac{Qt}{2M}} \sin \left(\frac{\sqrt{P^2 - \frac{Q^2}{4}}}{M} t - a \right) \quad [14]$$

represents a transient periodic effect.

The maximum value is determined by the constant C , which seems to depend on the initial condition of the diaphragm at the time the current under consideration is applied, and by the factor $\epsilon^{-\frac{Qt}{2M}}$

Since ϵ (which is the constant 2.718, the base of the Naperian logarithms) has in this case a negative exponent, the factor continually becomes less with the lapse of time from the instant when the current begins in the coil or when it changes frequency. The rate at which the transient factor decays depends upon the time multiplier $\frac{Q}{2M}$; therefore the less the mass M of the diaphragm, and the larger the coefficient Q representing the combined influence of rigidity, air resistance, induced currents, and hysteresis, the more rapidly the transient term decays. These features quickly damp out the transient term, so that it probably has little effect on continued sounds, though it may affect short sounds such as those of the "mutes," $b, d, g, k, p, t,$ and j .

An analogous expression may be derived¹ to express velocity instead of displacement of the diaphragm.

326. Period of the Free Vibrations.—The sine factor in [14] shows that the transient term represents a vibratory motion having the frequency f' included in

$$2\pi f' = \frac{\sqrt{P^2 - \frac{Q^2}{4}}}{M} \quad [15]$$

¹KENNELLY and AFFEL. *Proc. Amer. Acad. Arts and Sci.*, 51:468 (Nov., 1915).

which is independent of the frequency of the actuating current, except as the coefficient Q is affected by the induced currents, which have the same frequency as the primary current; this may therefore be considered as closely representing the frequency of the natural or free vibrations of the diaphragm. Inspection shows that it is lowered by making M or Q large or by making P small.

APPENDIX E

SOLUTION OF DIFFERENTIAL EQUATION FOR RECEIVER

327. Equation Put Into Standard Form; Characteristics Indicate Process of Solution.—The Wietlisbach equation¹ is put into standard form by dividing through by M , giving

$$\frac{d^2 u}{d t^2} + \frac{Q}{M} \frac{d u}{d t} + \frac{P}{M} u = \frac{A I}{M} \sin (\omega t)$$

or, more briefly,

$$\frac{d^2 u}{d t^2} + B \frac{d u}{d t} + G u = H \sin (\omega t) \quad [1]$$

This is a single equation with ordinary derivatives; with two variables, u and t ; it is of the second order, containing a single derivative; it is linear, since the unknown quantity u and its derivative appear only in the first power; the coefficients are constant, and the second member is not zero. These characteristics indicate the method of attack to be the theorem² that the complete solution of a differential equation is any particular solution obtained by inspection, plus the solution of the complementary equation which assumes the second member equal to zero.

328. Solution Assumed; Justified by Evaluation of Constants.—Assume the solution

$$u = H x \sin (\omega t - \alpha) \quad [2]$$

which will be justified as the solution of Equation [1] if the constants x and α can be evaluated. Toward this, take the first and second differentials of u with respect to t , according to Equation [2]:

$$\frac{d u}{d t} = H x \omega \cos (\omega t - \alpha) \quad [3]$$

$$\frac{d^2 u}{d t^2} = -H x \omega^2 \sin (\omega t - \alpha) \quad [4]$$

Expand $\sin (\omega t)$ of Equation [1] by the usual trigonometric formula,

¹ Equation [8], Appendix D, § 322. See Note on p. 306.

² FORSYTH. *Differential Equations*, arts. 39, 44. London (1885).

MURRAY. *Differential Equations*, chap. 6. Longmans, Green & Co. (1912).

MERRIMAN and WOODWARD. *Higher Mathematics*, p. 337. Wiley (1902).

$$\begin{aligned}\sin(\omega t) &= \sin(\omega t - \alpha + \alpha) \\ &= \sin(\omega t - \alpha) \cos(\alpha) + \cos(\omega t - \alpha) \sin(\alpha)\end{aligned}\quad [5]$$

Substitute [2], [3], and [4] in first member of [1], and substitute [5] in the second member:

$$\begin{aligned}-Hx\omega^2 \sin(\omega t - \alpha) + BHx\omega \cos(\omega t - \alpha) + GHx \sin(\omega t - \alpha) = \\ H[\sin(\omega t - \alpha) \cos(\alpha) + \cos(\omega t - \alpha) \sin \alpha]\end{aligned}\quad [6]$$

Cancel out H and collect:

$$\begin{aligned}(Gx - \omega^2 x) \sin(\omega t - \alpha) + B\omega x \cos(\omega t - \alpha) \\ = \cos(\alpha) \sin(\omega t - \alpha) + \sin(\alpha) \cos(\omega t - \alpha)\end{aligned}\quad [7]$$

Equating the coefficients of $\sin(\omega t - \alpha)$ in [7] gives:

$$\cos(\alpha) = (G - \omega^2) x \quad [8]$$

Similarly,

$$\sin(\alpha) = B\omega x \quad [9]$$

From [8] and [9] follows:

$$x = \frac{\cos(\alpha)}{G - \omega^2} = \frac{\sin(\alpha)}{B\omega} \quad [10]$$

whence

$$\tan(\alpha) = \frac{\sin(\alpha)}{\cos(\alpha)} = \frac{B\omega x}{(G - \omega^2)x} = \frac{B\omega}{G - \omega^2} \quad [11]$$

Having thus evaluated x and α , Equation [2] is justified as a solution of Equation [1].

Equation [2] may be written:

$$\begin{aligned}u &= Hx \sin(\omega t - \alpha) \\ &= H \frac{\sin(\alpha)}{B\omega} \sin(\omega t - \alpha) \\ &= \frac{AI}{Q\omega} \sin(\alpha) \sin(\omega t - \alpha)\end{aligned}\quad [12]$$

329. Solution of Complementary Equation; Two Solutions.—Next solve the equation complementary to [1], assuming the second member as zero; that is, solve for the instant when $\sin(\omega t) = 0$:

$$\frac{d^2 y}{dt^2} + B \frac{dy}{dt} + Gy = 0 \quad [13]$$

A recognized form of solution to try is:

$$y = e^{lt} \quad [14]$$

Differentiating [14] twice with respect to t gives:

$$\frac{dy}{dt} = j1 e^{lt} \quad [15a]$$

$$\frac{d^2 y}{dt^2} = j^2 l^2 e^{lt} = -l^2 e^{lt} \quad [15b]$$

in which $j = \sqrt{-1}$ as commonly used in complex numbers. Substituting [14] and [15] in [13] gives:

$$j^2 l^2 e^{lt} + j B l e^{lt} + G e^{lt} = 0 \quad [16]$$

Divide out e^{lt}

$$j^2 l^2 + j B l + G = 0 \quad [17]$$

Move G to second member, complete square of first member, and multiply second member by $-j^2 = -(\sqrt{-1})^2 = +1$:

$$j^2 l^2 + j B l + \frac{B^2}{4} = \frac{B^2}{4} - G = j^2 \left(G - \frac{B^2}{4} \right) \quad [18]$$

Take the square root of [18]:

$$j l + \frac{B}{2} = \pm j \sqrt{G - \frac{B^2}{4}} \quad [19]$$

whence:

$$j l = -\frac{B}{2} \pm j \sqrt{G - \frac{B^2}{4}} \quad [20]$$

Substituting [20] in [14] gives:

$$\begin{aligned} y = e^{lt} &= e^{-\frac{Bt}{2} \pm jt \sqrt{G - \frac{B^2}{4}}} \\ &= e^{-\frac{Bt}{2}} e^{\pm jt \sqrt{G - \frac{B^2}{4}}} \end{aligned} \quad [21]$$

The double sign of the second exponent indicates two solutions, and since the second member of [13] is zero, the sum of the two solutions will satisfy [13]. Thus

$$y = e^{-\frac{Bt}{2}} \left[e^{+jt \sqrt{G - \frac{B^2}{4}}} + e^{-jt \sqrt{G - \frac{B^2}{4}}} \right] \quad [22]$$

By Euler's development¹ of Maclaurin's theorem² in calculus,

$$\cos \alpha = \frac{e^{+j\alpha} + e^{-j\alpha}}{2} \quad [23]$$

Substituting [23] in [22] gives:

$$y = 2 e^{-\frac{Bt}{2}} \cos \left(t \sqrt{G - \frac{B^2}{4}} \right) \quad [24]$$

330. Constants of Integration Introduced.—It is necessary to introduce constants of integration to represent any constant terms

¹ See Appendix E, § 332.

² See textbooks on calculus.

which would have been lost during the differentiation if they had been present originally. Introducing these in [21] and [24] gives:

$$y = e^{-\frac{Bt}{2} + b} e^{j \left(t \sqrt{G - \frac{B^2}{4}} - a \right)}$$

$$= C e^{-\frac{Bt}{2}} \cos \left(t \sqrt{G - \frac{B^2}{4}} - a \right) \quad [25]$$

in which $C = 2 e^b$.

331. **Complete Solution.**—The complete solution of [1] is the sum of the particular solution [12] and of the complementary solution [25]; or, replacing the quantities represented by B , G , and H :

$$u = \frac{A I \sin(\alpha)}{Q \omega} \sin(\omega t - \alpha) + C e^{\frac{Qt}{2M}} \cos \left(t \sqrt{\frac{P}{M} - \frac{Q^2}{4M^2}} - a \right) \quad [26]$$

in which by [11],

$$\tan(\alpha) = \frac{Q \omega}{P - M \omega^2}$$

and C and a are constants of integration.

332. **Euler's Development of Maclaurin's Theorem.**—Euler's value, used in Equation [23], may be derived as follows:

By Maclaurin's formula

$$e^a = 1 + a + \frac{a^2}{1 \cdot 2} + \frac{a^3}{1 \cdot 2 \cdot 3} + \text{etc.} \quad (i)$$

$$\sin(\alpha) = \alpha - \frac{\alpha^3}{3!} + \frac{\alpha^5}{5!} - \frac{\alpha^7}{7!} + \text{etc.} \quad (ii)$$

$$\cos(\alpha) = 1 - \frac{\alpha^2}{2!} + \frac{\alpha^4}{4!} - \frac{\alpha^6}{6!} + \text{etc.} \quad (iii)$$

in which the angle α is in radians or "pi" measure, $3! = 1 \cdot 2 \cdot 3$, etc.

Substituting $+ja$ and $-ja$ in [i] gives; noting $j^2 = -1$;

$$e^{ja} = 1 + ja + \frac{j^2 a^2}{2!} + \frac{j^3 a^3}{3!} + \frac{j^4 a^4}{4!} + \text{etc.}$$

$$= 1 + ja - \frac{a^2}{2!} - \frac{j a^3}{3!} + \frac{a^4}{4!} + \frac{j a^5}{5!} - \frac{a^6}{6!} + \text{etc.} \quad (iv)$$

$$e^{-ja} = 1 + (-ja) + \frac{(-ja)^2}{2!} + \frac{(-ja)^3}{3!} + \frac{(-ja)^4}{4!} + \text{etc.}$$

$$= 1 - ja - \frac{a^2}{2!} + \frac{j a^3}{3!} + \frac{a^4}{4!} - \frac{j a^5}{5!} - \frac{a^6}{6!} + \text{etc.} \quad (v)$$

Adding [iv] and [v],

$$e^{ja} - e^{-ja} = 0 + 2ja - 0 - \frac{2ja^3}{3!} + 0 + \frac{2ja^5}{5!} + \text{etc.}$$

$$= 2j \left(a - \frac{a^3}{3!} + \frac{a^5}{5!} + \text{etc.} \right) \quad (vi)$$

$$\frac{e^{ja} - e^{-ja}}{2j} = a - \frac{a^3}{3!} + \frac{a^5}{5!} - \frac{a^7}{7!} + \text{etc.} \quad (\text{vii})$$

$$= \sin(a) \quad (\text{viii})$$

$$\frac{e^{ja} + e^{-ja}}{2} = 1 - \frac{a^2}{2!} + \frac{a^4}{4!} - \frac{a^6}{6!} + \text{etc.} \quad (\text{ix})$$

$$= \cos(a) \quad (\text{x})$$

The values in [vii] and [ii] and in [ix] and [iii] were derived by Euler in 1748.

NOTE.—A solution of the general equation, with details differing in several respects from the development in this Appendix, and reaching the same final form, is given by R. Weber in an appendix to WIELTSLBACH. *Handbuch der Telephonie*, second edition. Hartleben, Wien and Leipzig (1910).

APPENDIX F

DOUBLE FREQUENCY¹ OF ELECTRODYNAMIC PULL ON RECEIVER DIAPHRAGM

333. Pull Proportional to Product of Sine and Cosine Factors.—The pull on the diaphragm at any instant as a result of the reactions between the primary current in the winding and the secondary current in the diaphragm equals the product of their simultaneous values multiplied by a constant that depends upon the general construction, and upon the units used for expressing the pull.

Assuming that the primary current is sinusoidal, and that the secondary current is also sinusoidal and in quadrature with the primary

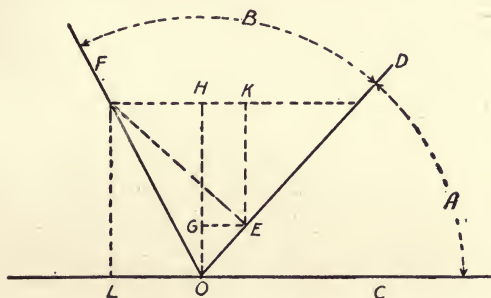

FIG. 115.—GRAPHICAL CONSTRUCTION FOR DOUBLE FREQUENCY

current (that is, the secondary is ninety electrical or time degrees behind the primary) the pull on the diaphragm at any instant may be represented by

$$\begin{aligned}
 P &= k (I' \sin A) [I'' \sin (A - 90^\circ)] \\
 &= k I' I'' \sin A \cos A,
 \end{aligned}$$

in which P is the pull, k is a constant, and A is the number of electrical degrees since the current passed through zero value.

334. Product Reduced to Sine of Double Angle.—The equation may be reduced further by showing that the product of the sine and cosine of the same angle equals half the sine of twice the angle. This may be shown as follows:

¹Supplementing §§ 61, 77.

Draw OD , making any angle, A , with the base line OC ; draw OF , making any angle, B , with the line OD ; from the vertex draw the line OH perpendicular to the base line OC ; from any point in the line OF draw a line FE perpendicular to OD ; draw the lines FHK and GE parallel to OC , and therefore perpendicular to OH ; draw EK and FL parallel to OH , and therefore perpendicular to OC ;

Then:

$$OH = FL = OF \sin (COF) = OF \sin (A + B);$$

$$OG = OE \cos (GOE) = OE \sin (A) = OF \cos (B) \sin (A);$$

$$GH = KE = FE \sin (KFE) = FE \cos (A) = OF \sin (B) \cos (A);$$

$$OH = OG + GH = FL;$$

$$FL = OF \sin (A+B) = OF \cos (B) \sin (A) + OF \sin (B) \cos (A);$$

Dividing out the common multiplier, OF , leaves

$$\sin (A + B) = \cos (B) \sin (A) + \sin (B) \cos (A).$$

When $A = B$, as is the case in § 333, this reduces to

$$\sin (2A) = 2 \cos (A) \sin (A), \text{ or}$$

$$\sin A \cos A = 1/2 \sin 2A.$$

Making this substitution, the above equation for P becomes:

$$P = 1/2 k I' I'' \sin 2A.$$

Since $\sin (A)$ is a maximum when A equals 90° , it follows that $\sin (2A)$ is a maximum when $2A$ is 90° , that is, when A is 45° .

APPENDIX G

APPROXIMATE EQUATION¹ FOR MICROPHONE

335. General Expressions for Resistance, Current, and Electromotive Force.— Assuming that a sinusoidal sound wave impinging upon a microphone diaphragm imparts to it a sinusoidal motion, and assuming that sinusoidal motion of the diaphragm causes a sinusoidal variation in the resistance of the carbon cell, the resistance of the circuit at any instant may be represented by

$$R_t = R - r \sin(\omega t) \quad [1]$$

in which R is the steady resistance (which may not be same when the microphone is quiet²), r is the maximum variation from the steady value of the resistance, and R_t is the total resistance. This properly neglects slow changes due to heating or to packing of the carbon granules.

The current at any instant may be represented by

$$I = I_0 + i \quad [2]$$

in which I_0 is the current which passes through the steady resistance, and i is the difference between the steady and the instantaneous values of current.

With a steady battery electromotive force E applied to a circuit containing various resistances and inductances, and neglecting transient effects, there applies:

$$E = R_t I - L \frac{dI}{dt} = R I_0 \quad [3]$$

in which L includes the self-induction of the various coils as affected by mutual induction from any secondary currents, all being reduced to an equivalent series coil; R_t includes not only the resistance in the primary circuit, but also an element representing all sources of energy dissipation connected directly or indirectly with the circuit (these being proportional to the frequency f , that is, to the angular velocity, $\omega = 2\pi f$).

¹ Supplementing § 109.

² See §§ 104, 105.

336. **Approximate Differential Equation.**—Substituting [1] and [2] in [3] gives:

$$E = [R - r \sin(\omega t)] (I_0 + i) + L \frac{d(I_0 + i)}{dt} \quad [4]$$

$$E = R I_0 + R i - [r \sin(\omega t)] (I_0 + i) + L \frac{di}{dt} \quad [5]$$

Canceling out $E = R I_0$ and re-arranging,

$$\begin{aligned} \frac{di}{dt} + \frac{R}{L} i &= \frac{(I_0 + i) r}{L} \sin(\omega t) \\ &= A \sin(\omega t) \end{aligned} \quad [6]$$

Since the variable portion i is usually small in comparison with the steady portion I , the fraction $(I + i)r/L$ represented by A may be temporarily assumed as sensibly constant.

337. **Trial Solution; Determination of Constants.**—Inspection of [6] suggests as a solution:

$$i = A k \sin(\omega t - \alpha) \quad [7]$$

in which k and α are unknown quantities to be determined if possible.

To attempt their determination, differentiate [7]:

$$\frac{di}{dt} = A k \omega \cos(\omega t - \alpha) \quad [8]$$

Expand the second member of [6]:

$$\begin{aligned} \sin(\omega t) &= \sin(\omega t - \alpha + \alpha) \\ &= \sin(\omega t - \alpha) \cos(\alpha) + \cos(\omega t - \alpha) \sin(\alpha) \end{aligned} \quad [9]$$

Substitute [7], and [8] in the first member of [6], and substitute [9] in the second:

$$\begin{aligned} A k \omega \cos(\omega t - \alpha) + \frac{R}{L} A k \sin(\omega t - \alpha) \\ = A \sin(\alpha) \cos(\omega t - \alpha) + A \cos(\alpha) \sin(\omega t - \alpha) \end{aligned} \quad [10]$$

Equating the coefficients of $\cos \omega t - \alpha$ and canceling A gives:

$$\sin(\alpha) = k \omega \quad [11]$$

Similarly, $\cos(\alpha) = \frac{R}{L} k \quad [12]$

Then $\tan(\alpha) = \frac{\sin(\alpha)}{\cos(\alpha)} = \frac{k \omega}{\frac{R}{L} k} = \frac{\omega L}{R} \quad [13]$

Substituting [13] in the trigonometric equation¹

$$\cos(\alpha) = \frac{1}{\sqrt{1 + \tan^2(\alpha)}} \quad [14]$$

¹Derived in treatises on trigonometry.

gives:

$$\cos(\alpha) = \frac{1}{\sqrt{1 + \frac{\omega^2 L^2}{R^2}}} = \frac{R}{\sqrt{R^2 + \omega^2 L^2}} \quad [15]$$

Then, transposing [12] and substituting [15] gives:

$$k = \frac{L \cos(\alpha)}{R} = \frac{L}{R} \frac{R}{\sqrt{R^2 + \omega^2 L^2}} = \frac{L}{\sqrt{R^2 + \omega^2 L^2}} \quad [16]$$

Having thus determined the values of k and α , Equation [7] is justified as a solution of [6].

338. Desired Form of Equation Obtained.—Substituting in [7] the values of A and k from [6] and [16],

$$i = \frac{(I_0 + i) r}{L} \frac{L}{\sqrt{R^2 + \omega^2 L^2}} \sin(\omega t - \alpha) \quad [17]$$

Canceling L and collecting terms in i ,

$$i \left(1 - \frac{r \sin(\omega t - \alpha)}{\sqrt{R^2 + \omega^2 L^2}} \right) = \frac{I_0 r}{\sqrt{R^2 + \omega^2 L^2}} \sin(\omega t - \alpha) \quad [18]$$

$$i = \frac{\frac{I_0 r \sin(\omega t - \alpha)}{\sqrt{R^2 + \omega^2 L^2}}}{1 - \frac{r \sin(\omega t - \alpha)}{\sqrt{R^2 + \omega^2 L^2}}} = \frac{I_0 r \sin(\omega t - \alpha)}{\sqrt{R^2 + \omega^2 L^2} - r \sin(\omega t - \alpha)} \quad [19]$$

Substituting [19] in [2] gives the desired¹ form:

$$I = I_0 + i = I_0 + \frac{I_0 r \sin(\omega t - \alpha)}{\sqrt{R^2 + \omega^2 L^2} - r \sin(\omega t - \alpha)} \quad [20]$$

¹ See page 108.

APPENDIX H

MICROPHONE EQUATION BY INVERSE¹ METHOD

339. General Assumption for Current and Electromotive Force; Derivation of General Equation for Required Resistance.—Assuming that the inductance of the circuit is independent of current strength, and that the desired current through the transmitter is a steady current combined with a sinusoidal element, the initial equations are:

$$i = I[1 + K \sin(\omega t)] \quad [1]$$

$$E = ri + L \frac{di}{dt} \quad [2]$$

Differentiating [1] gives:

$$\frac{di}{dt} = \omega K \cos(\omega t) \quad [3]$$

Substituting [1] and [3] in [2]:

$$E = rI[1 + K \sin(\omega t)] + L\omega KI \cos(\omega t) \quad [4]$$

Solving for r :

$$r = \frac{E - L\omega KI \cos(\omega t)}{I[1 + K \sin(\omega t)]} = \frac{E}{I} \frac{1 - \frac{L\omega KI}{E} \cos(\omega t)}{1 + K \sin(\omega t)} \quad [5]$$

Add and subtract $K \sin(\omega t)$ in the numerator, and write $R = \frac{E}{I}$:

$$\begin{aligned} r &= R \frac{1 + K \sin(\omega t) - K \sin(\omega t) - \frac{L\omega K}{R} \cos(\omega t)}{1 + K \sin(\omega t)} \\ &= R(1 - K) \frac{\sin(\omega t) + \frac{L\omega}{R} \cos(\omega t)}{1 + K \sin(\omega t)} \\ &= R - K \frac{R \sin(\omega t) + L\omega \cos(\omega t)}{1 + K \sin(\omega t)} \quad [6] \end{aligned}$$

340. Reduction of Numerator; Expansion by Use of Series.—The numerator may be reduced by the trigonometric formula²

¹ Supplementing § 114.

² Derived in treatises on trigonometry.

$$A \sin \alpha + B \cos \alpha = \sqrt{A^2 + B^2} \sin (\alpha + \phi) \quad [7]$$

where $\tan \phi = \frac{A}{B}$

Substituting [7] in [6]:

$$r = R - K \sqrt{R^2 + L^2 \omega^2} \frac{\sin (\omega t + \phi)}{1 + K \sin (\omega t)} \quad [8]$$

where $R = \frac{E}{I}$ and $\tan (\phi) = \frac{L \omega}{R}$ [9]

R being the resistance which would allow the steady current I to flow impelled by the electromotive force E .

The fraction may be expanded into a series¹ by the formula:

$$\frac{1}{1+x} = 1 - x + x^2 - x^3 + x^4 - \text{etc.} \quad [10]$$

$$\frac{\sin (\omega t + \phi)}{1 + K \sin (\omega t)} = \sin (\omega t + \phi) [1 - K \sin (\omega t) + K^2 \sin^2 (\omega t) - K^3 \sin^3 (\omega t) + \text{etc.}] \quad [11]$$

Since K , the ratio between the steady direct current and the variation therefrom, is small, the series is rapidly convergent, and the higher powers may be neglected. Equation [11] then becomes:

$$\frac{\sin (\omega t + \phi)}{1 + K \sin (\omega t)} \sin (\omega t + \phi) - K \sin (\omega t + \phi) \sin (\omega t) \quad [12]$$

341. Reduction of Product of Series; Reduction to Desired Equation.—The last term is reduced by the trigonometric formula:

$$\begin{aligned} \cos (a + b) - \cos (a - b) &= [\cos (a) \cos (b) - \sin (a) \sin (b)] - [\cos (a) \cos (b) + \sin (a) \sin (b)] \\ &= -2 \sin (a) \sin (b) \end{aligned} \quad [13]$$

Then

$$\begin{aligned} -K \sin (\omega t + \phi) \sin (\omega t) &= \frac{K}{2} [\cos (\omega t + \phi + \omega t) - \cos (\omega t + \phi - \omega t)] \\ &= \frac{K}{2} [\cos (2 \omega t + \phi) - \cos (\phi)] \end{aligned} \quad [14]$$

Substituting [11] and [14] in [8],

$$r = R - K \sqrt{R^2 + L^2 \omega^2} \left\{ \sin (\omega t + \phi) + \frac{K}{2} [\cos (2 \omega t + \phi) - \cos (\phi)] \right\} \quad [15]$$

which is the equation desired in § 114.

¹ Derived in treatises on algebra.

APPENDIX I

HISTORICAL NOTES ON SIGNALING DEVICES¹

342. Order of Development.—Since apparatus with vibrating armatures is used so largely in signaling operations connected with telephony, considerable interest is attached to the early steps in its development. The early records are meager accounts of groping in the dark. After the early stages, the development proceeded along two rather distinct lines leading respectively to vibrating contact apparatus and to polarized apparatus.

343. Early Stages.—William Gilbert² seems to have made no mention of electrical repulsion, though he made much of electrical attraction in his classic treatise of 1600. Cabeo,³ in 1629, noted repulsion. Descartes,⁴ in 1650, noted the orientation of small magnets placed near a lodestone. Probably the first electric bell of any sort was that of 1745 by Gordon⁵ or that of 1752 by Franklin,⁶ whose electric chime was operated by suspended insulated balls carrying electrostatic charges from gongs connected with a lightning conductor to gongs connected with the ground.

Mojon,⁷ in 1804, magnetized needles placed in the path of a current. The next step may have been made about 1809 by Sæmmerring⁸

¹ Supplementing Chapters VII to X.

² GILBERT. *De Magnete Magneticisque Corporibus et de Magno Magnete Tellure Physiologia Nova*. London (1600); "William Gilbert, On the Loadstone and Magnetic Bodies, and On the Great Magnet the Earth," translation by P. F. Mottelay. Wiley, New York (1893).

³ CABEO. *Philosophia Magnetica*, p. 194. Cologne (1629); *Catalogue of Wheeler Gift to American Institute of Electrical Engineers*, 1:37, 101. New York (1909).

⁴ DESCARTES. *Principal Philosophiæ*, art. 133, p. 255. Amsterdam (1650). *Catalogue of Wheeler Gift*, etc., 1:31, 119.

⁵ BENJAMIN. *Intellectual Rise in Electricity*, p. 507. Wiley (1898).

⁶ WIEDEMANN. *Elektricitæet*, Part I, p. 8. Braunsweig (1882).

THOMPSON. *Elementary Lessons in Electricity and Magnetism*, p. 53. Macmillan (1895).

⁷ MOJON. *Annals of Philosophy*, 18:81. London (Aug., 1829). *Catalogue of Wheeler Gift*, etc., 1:40, 259.

⁸ SÆMMERRING. *Munich Academy of Sciences* (Aug. 29, 1809).

FAHIE. *History of the Electric Telegraph*, p. 231. Spon (1884).

TURNBULL. *Electromagnetic Telegraph*, pp. 31-34. Philadelphia (1853); *Jour. Soc. Arts.*, 7:595-599, 605-610 (1859).

as part of his early telegraph system, in which the attention of the receiving operator was called by a stroke of a bell operated by a cup which was immersed in the liquid of an electrolytic cell so that the gases developed by the passage of current would collect under the cup and cause it to rise and thereby trip off a weight which fell against a gong.

Oersted,¹ in 1820, announced the electromagnetic effect of current upon a magnet. Arago² and Davy,³ in 1820, discovered independently the power of the electric current to magnetize iron and steel.

Sturgeon⁴ and Brewster and Henry⁵ soon constructed powerful electromagnets with iron cores.

344. Development of Vibrating Contact Devices.—Vibrators operated by electrodynamic action may be attributed to Marsh,⁶ who, in 1824, arranged a wire between the poles of a permanent magnet so that the connection at a mercury cup was broken by the reaction of the magnetic field against the current in the wire. Wheatstone⁷ used an electromagnet to release a clockwork mechanism to ring a bell. Henry⁸ brought out an oscillating lever arrangement about 1831, this being adapted by Wagner⁹ and Neeff¹⁰ to use with induction coils. Froment seems to have developed this into the buzzer, in 1847.

¹ OERSTED. *Experimenta circa effectum conflictus electrici in acum magneticam*. Copenhagen (1820).

THOMPSON. *Annals of Philosophy*, 16:273. London (October, 1820).

² ARAGO. *Annales de Chimie et de Physique*, 15:93 (1820).

³ DAVY. *Philosophical Transactions* (1821); *Annals of Philosophy*, 2:81 (1821).

⁴ STURGEON. *Annals of Philosophy*, 12:359; *Encyc. Brit.* (9) 15; (11) 9:227; *Trans. Soc. Arts.*, 43:38 (1825).

THOMPSON. *The Electromagnet*, pp. 2-9.

⁵ HENRY. *Silliman's Amer. Jour. Sci.*, 19:400 (Jan., 1831).

⁶ THOMPSON. *The Electromagnet*, p. 318.

⁷ PRESCOTT. *The Speaking Telephone, Electric Light and Other Electrical Inventions*, p. 375. Appleton (1879); see also pp. 375-399.

Later device operated by relay described by TURNBULL. *Op. cit.*, p. 81.

See also British Patent No. 7,390 (June 12, 1837), to W. F. Cooke and Chas. Wheatstone, and *Mechanics Magazine*, 34:433; 45:460; 46:208.

⁸ HENRY. *Silliman's Journal*, 20:340 (July, 1831); *Century Magazine*, 35:932 (April, 1888); *El. Eng. N. Y.*, 13:54 (Jan. 20, 1892).

⁹ WAGNER. *Pogg. Ann.*, 46:107 (1839).

¹⁰ NEEFF. *Pogg. Ann.*, 46:104 (1847).

Page claimed [PAGE. *History of Induction*. Washington (1867)]. See also *Induction Coils*, by ARMAGNAT, translation by KENYON, p. 11. McGraw, New York (1908)] that MacGauley of Dublin anticipated Neeff by making an interrupter in 1837.

¹¹ FROMENT. *Compt. Rend.* 24:428, 1847.

Mirand¹ seems to have been the first to add the hammer and gong about 1850.

345. Development of Polarized Devices.—The first clear case of polarized apparatus seems to have been due to Schweigger,² who, in 1820, brought out the "multiplier," one of the first electromagnetic indicating or measuring instruments. In 1833, Schuller³ obtained a pendulum motion between two horseshoe magnets. In 1835, Sturgeon⁴ devised a thermogalvanometer, in which the minute current in a thermocouple suspended in the field of a permanent magnet gave a deflection; this seems to have been the forerunner of the Duddell⁵ thermogalvanometer. In 1836, Sturgeon⁶ devised an electrical measuring instrument in which a polarized needle was deflected by an electromagnet. In 1837, Magrini,⁷ by reversing current through a solenoid, caused the armature to drop off by repulsion of residual magnetism. A construction similar to Sturgeon's was applied to telegraphy⁸ by Laplace, Ampere, Triboaillet, Schilling, Cooke, and Wheatstone between 1836 and 1840. In 1841, Bain⁹ used a movable coil in the field of a permanent magnet as a telegraph instrument, an arrangement suggestive of the Weston measuring instruments. Glesner,¹⁰ in 1842, brought out a polarized ringer in which a permanent magnet acted as an armature for an electromagnet, being attracted or repelled according to the direction of the current; Du Moncel¹¹ showed that the force of repulsion was less than the attraction with this construction. E. W. Siemens¹² used a polarized move-

¹ MIRAND. British Patent No. 750 of 1852, issued Nov. 15, 1852;

THOMPSON. *The Electromagnet*, p. 319.

² SCHWEIGGER. *Journal fuer Chemie und Physik*, 31:1.

FAHIE. *History of the Electric Telegraph*, p. 279. Spon (1884).

Encyclopedia Britannica (9) 8:13.

³ SCHULLER. *Ann. of Elec.*, 3:433. TRUMBULL. *Electric Telegraph*, p. 223. Philadelphia (1853).

⁴ THOMPSON. *The Electromagnet*, p. 298.

⁵ DUDDELL. *Jour. Inst. El. Eng.*, 35:321 (May, 1905); 39:517, 522 (May, 1907); *Phil. Mag.* (6) 8:91 (July, 1904); *Phil. Trans. Roy. Soc. Lon.*, 180:159 (1889).

⁶ THOMPSON. *Op. cit.*, p. 293; *Ann. of Elec.* (1840).

⁷ FAHIE. *Op. cit.*, p. 486.

⁸ FAHIE. *Op. cit.*, pp. 302, 307, 512; *Encyc. Brit.* (9) 23:120.

TURNBULL. *Electro Magnetic Telegraph*, pp. 55-87.

⁹ THOMPSON. *Op. cit.*, p. 298.

¹⁰ THOMPSON. *Op. cit.*, p. 293.

¹¹ DU MONCEL. *La Lum. Elec.* (1) 2:109 (Mar. 15, 1880).

¹² SIEMENS. British Patent, (April 23, 1850). TURNBULL. *Electric Telegraph*, p. 140.

ment in a duplex telegraph, in 1850. Werner Siemens,¹ in 1851, patented a polarized relay in which the armature is pivoted to one pole of a permanent magnet and vibrates between the poles of an electromagnet whose yoke or central portion is attached to the other end of the permanent magnet; when the armature is adjusted so as to be a little closer to one pole than to the other, it stays normally on that side, but is moved away by current in the right direction through the electromagnet, being capable of high sensibility. D. E. Hughes,² in 1856, brought out a printing telegraph system of which the fundamental part was a permanent magnet upon whose poles were attached soft-iron tips wound with coils, a spring being arranged and adjusted so as almost to pull the armature away when no current passed through the coils; a small current in the direction to weaken the magnetic field was sufficient to trip off the armature. The polarized ringer, such as developed later for telephone signaling, may have made its first appearance³ in 1860. In 1867, Sir William Thomson⁴ (later Lord Kelvin) brought out his siphon recorder, which was used for a number of years for recording messages received over the transatlantic cable, the indicator consisting of a light rectangular coil of fine wire suspended between the poles of two powerful electromagnets and carrying a siphon tube from which ink was spurted against a paper tape. In 1882, the stationary magnet and rotatable coil were developed by Deprez⁵ and d'Arsonval into the well-known galvanometer bearing their name, the prototype of the modern Weston direct current ammeters and voltmeters, of the best modern galvanometers and oscillographs.

346. Development of Telephone Calls.—Cushman,⁶ in 1852, and Reis,⁷ in 1861, brought out electromagnetic telephones that seem to have been almost successful. Bell,⁸ in 1875, brought out his first

¹ SIEMENS. British Patent of 1851; *Jour. Soc. Arts.*, 6:353, Apr. 23, 1858. His relay exhibited by Siemens and Halske at the Great Exhibition, in 1851.

² THOMPSON. *Op. cit.* p. 296; *Encyc. Brit.* (9) 23:129; (11) 26:521.

³ British Patent No. 2,462 of 1860.

⁴ THOMPSON (KELVIN). *Mathematical and Physical Papers*, 2:168. Cambridge University Press (1884); British Patent of 1867; *Encyc. Brit.* (9) 23:134; (11) 26:523.

⁵ DEPREZ and d'ARSONVAL. *Compt. Rend.*, 94:1347 (May 15, 1882); *Beiblatter*, 6:596 (1883).

⁶ CUSHMAN. *West. Elec.*, 2:281 (June 9, 1888, etc.).

See footnote 10 on pages 49, 50.

⁷ THOMPSON. Philip Reis, *The Inventor of the Telephone*. Spoken (1883).

⁸ BELL. "Telephone Researches," *Jour. Soc. Tel. Eng.*, 6:385 (Oct. 31, 1877).

electromagnetic telephone, and, in 1877, with the help¹ of Professor Pierce of Brown University, and William F. Channing, of Providence, R. I., brought out the prototype of the modern receiver with permanent magnet carrying soft-iron tips surrounded by coils of wire and facing a soft-iron diaphragm. With the development of the telephone, came that of the polarized ringer, in which a number of inventors have had a part.

Some of the earliest telephone calling devices were based on sending strong alternating currents through the ordinary telephone² receiver, or something equivalent. Polarized visual indicators were also developed. Make-and-break vibrating bells (English "tremblers"), operated by current from primary batteries, were used³ on many of the early short lines. As the length of the lines⁴ increased, the polarized bell came into extended use in the larger cities as early as 1878. Magnetos of the Clark form⁵ were used at first, but the modern type with shuttle armature was developed,⁶ about 1881, by Gilliland⁷ and others.

¹ PIERCE and CHANNING. *Encyc. Brit.* (9) 23:138, 931.

² STABLER. French Patent No. 151,421 (Oct. 5, 1882); *La Lum. Elec.* (1) 8:157 (Feb. 3, 1883).

ROENTGEN. *Sci. Amer.*, 38:89 (Feb. 9, 1878).

LORENZ. *Tel. Jour.*, 6:438 (Nov., 1878).

WEINHOLD. Du Moncel's "Le Téléphone, Le Microphone, etc." Paris (1878); pp. 239-240; translation, Harpers, New York (1879).

URBANITSKY. *Electricity in the Service of Man*, p. 731. London (1890).

SIEMENS. *El. Eng. Chi.*, 9:21 (Jan., 1897).

KINGSBURY. "The Telephone and Telephone Exchanges," chap. 13.

³ ADER. *La Lum. Elec.* (1) 2:34 (Jan. 15, 1880).

⁴ *Sci. Amer.*, 42:307 (May 15, 1880).

LOCKWOOD. *Nat. Tel. Ex. Assoc.* (Sept. 26, 1887); *El World*, 10:180 (Oct. 1, 1887).

WATSON. U. S. Patent No. 210,886, Dec. 17, 1878.

⁵ *Elec. Rev. Lon.*, 41:659 (Nov. 12, 1897).

KINGSBURY. *The Telephone and Telephone Exchanges*, pp. 142-145.

⁶ *El. Rev. N. Y.*, 38:84 (Jan. 12, 1901).

⁷ *El. Rev. N. Y.*, 32:14 (Jan. 5, 1898).

KINGSBURY. *Loc. cit.*

APPENDIX J

BOOKS MENTIONED SEVERAL TIMES

- ABBOTT.—Telephony. 6 vols. McGraw Publishing Co., New York (1905).
- BEDELL and CREHORE.—Alternating Currents. W. J. Johnston Co., New York (1893).
- FOSTER.—Electrical Engineer's Pocket Book. Van Nostrand Co., New York (1908).
- HELMHOLTZ.—Sensations of Tone. Trans. by Ellis. London (1896).
- HOPKINS.—The Telephone. Longmans, Green & Co., New York (1898).
- JACKSON.—Alternating Currents and Alternating Current Machinery. Macmillan, New York (1913).
- KENNELLY.—Hyperbolic Functions Applied to Electrical Engineering. University of London Press, London (1912).
- KINGSBURY.—The Telephone and Telephone Exchanges. Longmans, Green & Co., New York (1915).
- MCMEEN and MILLER.—Telephony. American School of Correspondence, Chicago (1912).
- McNICOL.—American Telegraph Practice. McGraw-Hill Book Co., New York (1913).
- MILLER.—Science of Musical Sounds. Macmillan, New York and London (1916).
- MILLER.—American Telephone Practice. McGraw-Hill Book Co., New York (1905).
- NOEBELS, SCHLUCKEBIER und JENTSCH.—Telegraphie und Telephonie. Hirzel, Leipzig (1907).
- PENDER.—Principles of Electrical Engineering. McGraw-Hill, New York (1910).
- POOLE.—Practical Telephone Handbook. Macmillan, New York and London (1910).
- PREECE and STUBBS.—Manual of Telephony. Whittaker & Co., London (1893).
- PRESCOTT.—Speaking Telephone. Appleton, New York (1879).

- ROYAL SOCIETY OF LONDON.—Catalogue of Scientific Papers, 1800-1900. Cambridge University Press (1912).
- SCRIPTURE.—Elements of Experimental Phonetics. Scribner, New York (1902).
- SHEPARDSON.—Electrical Catechism. McGraw-Hill Book Co., New York (1901, 1908).
- STEINMETZ.—Alternating Current Phenomena. McGraw-Hill Book Co., New York (1916).
- STEINMETZ.—Transient Electric Phenomena and Oscillations. McGraw-Hill Book Co., New York (1909).
- THIESS and JOY.—Toll Telephone Practice. Van Nostrand, New York (1912).
- THOMAELEN.—Elements of Electrical Engineering. Longmans, Green & Co., New York (1908).
- THOMPSON.—The Electromagnet. Spon, London (1891).
- VANDEVENTER.—Telephonology. McGraw-Hill Book Co., New York (1910).
- WIETLISBACH.—Handbuch der Telephonie. Hartleben, Vienna and Leipzig (1910).
- WILDER.—Telephone Principles and Practice. Cantwell Press, Madison (1904).
- Standard Handbook for Electrical Engineers. McGraw-Hill Book Co., New York (1910, 1915).

NAME INDEX

Figures refer to pages

- Abbott, 73, 105, 209, 319
Abraham, 73, 81
Achatz, 258
Adams-Randall, 98
Ader, 47, 48, 50, 91, 318
Affel. *See* Kennelly and Affel
Ahearn, 86, 89
Alton, 164
Ampere, 169
Anderegg, 112-114
Anderson, 52
Arago, 315
Aston, 77
Austin, 11, 60
- Bachrach, 115
Bain, 316
Barrett, 168
Barus, 57, 168.
Beatson, 49
Bedell and Crehore, 195, 202, 319
Beetz, 89
Bell, A. G., 24, 28, 43, 48, 50, 87
Bell, C. A., 48, 88
Bell, Melville, 28
Bergman, 47
Berliner, 46, 89, 100, 231
Bevier, 29-30
Bidwell, 100, 102
Black, 237
Blake, 90
Blondel, 108
Blyth, 87, 100
Bosenquet, 10, 18
Bosscha, 57
Bostwick, 15
Bouthillon, 298
Breguet, 45, 88
Breisig, 39
Brewster, 315
- Brockway, 289
Brown, 93, 168
Browne, 231
Brush, 166
Burgess, 77
Burrows, 10
Byerly, 31, 73
- Cabeo, 314
Campbell, A., 48, 115
Campbell, G. A., 41, 109, 229
Campbell, W. L., 126
Carhart, 204
Carichoff, 143
Carty, 131, 241
Chambers, 88
Clark, 102, 318
Channing, 318
Cohen and Shepherd, 21, 31, 38, 41,
146, 173, 194
Collins, 48
Cooper-Hewitt, 99
Craft, E. B., 52
Cram, 48
Cree, 73, 74
Cross, 48, 89, 102
Cross and Mansfield, 57
Cross and Page, 73
Cross and Williams, 84
Crossley, 91
Culley, 165
Cushman, 49, 317
Cuttriss, 86, 89
- Daft, 45
D'Arsonval, 165, 317
Davy, 315
Dean, 97, 182, 186
De Forest, 99
De la Rive, 49

- Deprez, 317
 Dering, 165
 Descartes, 314
 Devaux-Charbonnel, 30, 38, 39, 41,
 173
 Dirichlet, 31
 Dolbear, 45, 46, 84, 86, 88
 Drawbaugh, 50, 90
 Drouet, 298
 Drysdale, 40, 229
 DuBois, 143, 168
 Duddell, 48, 173, 316
 Dujardin, 165
 Du Moncel, 46, 86, 316
 Dunbar, 241
 Dwega, 15

 Eddy, H. T., 73
 Eddy, L., 115, 164
 Edison, 45, 46, 89, 90, 95, 100, 231
 Edelmann, 101, 103
 Egner and Holstrom; 73, 98
 Einthoven, 32
 Ellis, 22, 319
 Elster and Geitel, 99
 Ewing, 168, 169, 280

 Fairbanks, 73
 Faraday, 165, 204, 231, 259
 Farrar, 50
 Ferraris, 60
 Fessenden, 93, 101, 105
 Field, 86, 87
 Fitch, 249
 Fizeau, 165
 Fleming, 40, 99, 229
 Flowers, 32-35
 Forbes, 87, 165
 Forsyth, 302
 Foster, 319
 Fowle, 144
 Franke, 57
 Franklin, 208, 222
 Froehlich, 57
 Froment, 315

 Gannett, 101, 103
 Garford, 182

 Garrett and Lucas, 89
 Gati, 21, 42, 73, 115, 173
 Gavey, 21, 173
 Geitel, Elster and, 99
 George, Pender and, 144
 Gilbert, 274, 314
 Gilliland, 98, 318
 Giltay, 46, 86
 Gloesner, 316
 Gordon, 314
 Gherardi, 229
 Gore, 41
 Gower, 91
 Gray, 45, 46, 50, 88, 166, 232
 Graydon, 15
 Greenwood, 18
 Grissinger, 98
 Guggenheim, 77
 Guthe, 48
 Gwozdz, 49

 Haskins, 162
 Hatfield, 168
 Hawkins and Wallace, 208
 Hayes, 41, 48, 87, 229
 Heaviside, 100, 229, 230, 280, 296
 Helmholtz, 17, 29, 147, 319
 Helwig, 221
 Henley and Savage, 230
 Henry, 165, 284, 315
 Hermann, 73
 Higgins, 165
 Hill, 111
 Holstrom, Egner and, 73, 98
 Hooke, 44
 Hopkins, 47, 319
 Hopkinson, 168
 Hughes, 49, 90, 317
 Hunnings, 91
 Hult, 104, 105

 Jackson, 40, 159, 222, 283, 319
 Jacques, 10
 Johnson and Jones, 104
 Joule, 49

 Kellogg, 97
 Karapetoff, 143

- Kelvin, 317
See also W. Thomson
 Kempf-Hartmann, 38, 73, 74
 Kennelly, 40, 41, 59, 229, 241, 319
 Kennelly and Affel, 58, 62, 64, 65,
 70, 73, 74, 75, 298, 300
 Kennelly and Pierce, 62, 73, 74, 75,
 80
 Kennelly and Taylor, 71, 75
 Kennelly and Upson, 73, 75
 Kingsbury, 319
 Kirchhoff, 72
 Koenig, 16, 29
 Krarup, 230

 Lange, 49
 Langmuir, 99
 Le Blanc, 204
 Lee, 244
 Lieben and Reisz, 99
 Lighthipe, 245
 Lindquist, 152, 153, 159
 Lippmann, 45, 88
 Lockwood, 165, 186
 Lodge, 100
 Lorenz, 318
 Lowth, 15, 94
 Lucas, Garrett and, 89
 Ludtge, 90
 Lyndon, 204
 Lyng, 52

 McDonough, 43
 MacGauley, 315
 McMahan, 144
 McMeen, Müller and, 319
 McNicol, 157, 319
 McQuillan, Burrows and, 10
 Magnusson, 194
 Magrini, 316
 Majorana, 88
 Mansbridge, 244
 Mansfield, Cross and, 57
 Marrian, 49
 Marsh, 315
 Martin, 42
 Matteucei, 49
 Mayer, 17, 19

 Maxwell, 169, 271, 284
 Mercadier, 72
 Merriman, Woodward and, 302
 Merritt, 29, 271
 Meucci, 50
 Meyer, Whitehead and, 61, 73, 74,
 75, 116
 Miller, D. C., 30, 65, 319
 Miller, K. B., 105, 319
 Mirand, 316
 Mitchell, 144, 151
 Mojon, 314
 Munro, 100
 Murray, 302

 Neeff, 315
 Nichols, Merritt and, 29
 Noebels, Schluckebier and Jentsch,
 108, 222, 319

 Oersted, 315
 O'Meara, 230
 Onnes, 169, 171
 Ort and Rieger, 46

 Page, 49, 231
 Page, Cross and, 73
 Parry, 17
 Paul, 21
 Paules, 165
 Pellatt, 59
 Pender, 144, 319
 Petrie, 165
 Peukert, 50
 Pickard, 81
 Pierce, G. W. *See* Kennelly and
 Pierce
 Pierce, John, 14, 318
 Pleijel, 221
 Poisson, 72
 Polak, 108
 Pollak, 98
 Poincare, 73, 222, 229
 Pollard, 46
 Poole, 319
 Preece, 47, 59, 319
 Prescott, J., 319

- Probert, Soward and, 100
 Pupin, 202, 229, 230
 Randall, 97
 Rayleigh, 60, 73, 74, 100, 222
 Reed, 229
 Regnault, 17
 Reis, 43, 50, 87, 317
 Reisz, 99
 Reynolds, 52
 Rhodes, 15
 Riefert, 165
 Rieger, 46
 Ries, 45
 Robertson, Schroeder and, 61, 62,
 64
 Robes, 244
 Robinson, 173
 Roeber, 229
 Roentgen, 318
 Rowland, 275
 Ruhmer, 48
 Ruhmkorff, 231
 Ryan, 208

 Sabine, 16
 St. John, 280
 Salet, 57
 Savage, Henley and, 230
 Schildt, Bachrach and, 115
 Schroeder, Robertson and, 61, 62,
 64
 Schulter, 316
 Schweigger, 316
 Scribner, 250
 Scripture, 20, 21, 24, 320
 Shepardson, 41, 66, 111, 112, 116-
 122, 163, 167, 286, 320
 Shepherd. *See* Cohen and Shep-
 herd
 Shreeve, 98
 Siemens, 57, 316, 318
 Simon, 48
 Smith, 165
 Smithson, 164
 Snyder, 48
 Soemmerring, 314
 Soward, Probert and, 100

 Springer, 104
 Stabler, 318
 Staite, 165
 Steinmetz, 40, 142, 153, 159, 196,
 222, 280, 320
 Stroh, 100
 Strouhal, 168
 Stubbs, Preece and, 319
 Sturmhoefel, 10
 Sturgeon, 315, 316
 Swinden, 168

 Taylor, 24, 61, 71, 73, 74, 75
 Thiess, Joy and, 320
 Thomas, 213
 Thomaelen, 194, 283, 320
 Thompson, 73, 143, 165, 168, 229,
 230, 286, 320
 Thomson, E., 100
 Thomson, J. J., 169
 Thomson, W. (Kelvin), 46, 165,
 202, 317
 Thornton, Eddy and, 115, 164
 Tomlinson, 66, 164, 167

 Underhill, 143, 210
 Upson, Kennelly and, 73, 75

 Vandeventer, 320
 Varley, 46, 86, 166
 Vaschy, 165
 Vassali-Eandi, 165
 Vreeland, 80

 Watson, 16, 173
 Wagner, 39, 42, 79, 315
 Weber, R., 307
 Weinhold, 318
 Wertheim, 49
 Westcott, 244
 Weston, 316
 Wheatstone, 28, 44, 90, 315, 316
 White, A. C., 92
 Whitehead, Meyer and, 61, 73, 74,
 75, 116
 Wien, 11, 60, 73, 74
 Wiersch, 73
 Wiesendanger, 47, 49

Wietleisbach, 59, 73, 79, 81, 108, 222, 298, 302, 320	Willis, 28
Wikander, 144	Wilson, 96
Wilder, 320	Wurtz, 262
Williams, 169	Yeates, 88, 92
Williams, Cross and, 84	Yensen, 278

SUBJECT INDEX

Figures refer to pages

- Acoustics of transmitter, 114
Air chambers in transmitter, 114
Air-gap, 148, 154, 155
 effect of, on magnetism, 143, 145, 154
 lightning arresters with, 262-265
Alternating currents, hysteresis effects on, 158
 in branched circuits, 203
 laws of, applicable to telephony, 38
 less than sum of parts, 203-204
 magnets, 155-159
 with resistance and capacity, 201
 with resistance, capacity and inductance, 202
 with resistance and inductance, 220
American Bell Telephone Co., 92, 109
American Telephone & Telegraph Co., 110, 230
Ampere-turns, 274
Amplifiers, 98, 99
Animal sounds, 19
Annunciators, 131, 133
Anti-sticker for magnets, 143, 145, 154
"A" operator, 135
Arc, as receiver, 48
 as transmitter, 87
Articulation, important, 14
Atmospheric electricity, 213
Attenuation, 111, 229
Audion, 99
Audiphone, 15
Automatic telephones, 126, 147

Batteries, 204, 205
Bell, vibration of, 7

Biased mechanisms, 175, 176
"B" operator, 135
Branched circuits, sum of currents, 203-204
Bridged circuits, 146
Bridged *v.* series connections, 223-224
Bug-trap relays, 157
Busy-back, 209
Buzzer, 163, 164

Cable grounding, 261
Calling devices, development of, 317-318
Capacitance, 188, 189, 199
Capacity, 188
 balancer induction, 202
 charging current, 199
 elements of, 242
 harmful effects of, 240-241
 helpful effects of, 240
 in circuits, 199
 logarithmic charge, 199, 200
 reactance, 201
 specific inductive, 198
 to ground, 199
 with reactance coil, 219
Carbon granules, 94
Carrying power, 110
Central energy. *See* Common battery
Central energy exchange voltage, 110
Challenge to telephone engineer, 82
Chattering of electromagnets, 156-157
Chemical energy and current, 204
Choke coil for smoothing current, 208
Clarke magneto, 210

- Clearing-out signal, 252-253
 Clearness incompatible with power, 217
 Coefficient of self-induction, 219, 284
 Coercitive force, 154
 of permanent magnet, 169
 Coil, as filter, 223
 uses of word, 215
 Common battery systems, 224-225
 retardation coils in cord, 224-225
 shunting of coils, 147
 uses of condenser, 246
 Communication by inarticulate sounds, 19
 importance of, 3
 Complementary equation, 303
 Composite circuit, 237
 retardation coils in, 228
 Condensance, 188
 Condenser, 198, 199
 as filter, 244, 245
 common, 199
 construction of, 244
 for operating drop, 252
 for ringing to ground, 245
 for storing energy, 240
 for transferring energy, 249, 250
 in central energy systems, 246
 in simultaneous transmission, 226-227
 Mansbridge, 244
 miscellaneous uses of, 254
 on alternating currents, 200, 201
 on farmer lines, 245
 operation of, as translator, 251
 rolled type, 244
 rush of current in, 253
 to help transmitter, 247
 to protect permanent magnet, 246
 to reduce sparking, 165, 166
 uses in telephony, 240-254
 Condensive reactance, 201
 Conductors, heating, 255-259
 Consonants, 22
 Constants of integration, 304, 305
 Copper sleeves, 151, 153
 Cord circuits, 236, 250, 270
 use of retardation coils in, 224, 225
 Counter-electromotive force, 196, 281
 Cross-ringing, 187
 Cross-talk, 132, 218
 Currents, abnormal, 255-259
 dangerous, 255
 foreign, 255
 induced. *See* Induced currents
 in magnetic field, 273
 local, 260
 protection, 255, 259
 rush, 253
 Cycle of operations in magneto instruments, 84-85
 D'Arsonval galvanometer, 172, 176
 Deaf, aids to, 15, 18
 Dean circuit, 224
 Dentiphone, 15
 Design, of dynamos and motors, 208
 of magnets, 140-147
 of non-polarized signals, 141-167
 of polarized apparatus, 177-189
 of receivers, 53, 143-146
 of transmitters, 92-98, 105
 Diaphragm, buckled, 77
 damping methods used on, 96-98
 difference of, in receiver and transmitter, 95
 effect on, of damping, 119-120
 operation of, in magneto transmitter, 84, 85
 phase of current affected by, 80
 silicon steel, 77
 theory of, 72-81
 vibration of, 95, 113-114
 See also Receiver diaphragm
 Dielectric, coefficient, 198
 constants, 243
 strain, 198
 strength, importance of, 242
 Differential equation, constants, 310
 for forces on diaphragm, 298
 for receiver, 302-306

- Differential equation, solution of, 310
 standard forms of, 302
- Differential winding of retardation coils, 227-228
- Difficulties in telephone study, 222
- Distinction between induction and repeating coils, 220
- Distortion of voice current by line capacity, 241, 242
- Disturbances, by radiation, 214
 from sparking, 167
 sources of, 65, 66
- Double-frequency pull, 307-308
- Drummy sound from capacity, 242
- Duplex circuit, 239
- Dyne, 271, 282, 283
- Ear, duration of sensation of sound in, 17
 range of pitch recognized by, 10, 11
 resonance of, 16-17
 sensitiveness variation of, 11, 18
- Earnings of telephones, 4
- Earth connection, 267-268
 low resistance, 267-268
 use of salts for, 268
- Earth currents, 211
- Eddy currents, avoidance of, 216-217
 loss by, 280
- Efficiency, of receiver, 81-82
 of signaling systems, 146
- Electrical machinery, principles of, 208
- Electricity, heat and, 206, 207
- Electrochemical effects in telephony, 205
 relations of, 204-206
- Electrodynamic pull, 77, 307-308
- Electrodynamic receiver, 55, 307-308
- Electrolysis, 211, 259-260
 laws of, 259-260
 objectionable, 255
 of buried conductors, 260
 prevention of, 260, 261
 source of, 259-261
- Electromagnetic attraction and repulsion, 141
- Electromagnets, 132, 133
 alternating current, 155-159
 design of, 143-147
 flux density of, 158
 insulation of, 159
 iron-clad, 144, 145
 noises from, 156, 157
 pulsating current, 155
 speed of, 145
 speed of armature in, 147
 tubular, 132, 133, 144, 145
 winding of, 145, 146
- Electromotive forces, 193-214
 of conductor in field, 272-273
 total less than sum of, 203
- Electrostatic capacity, common, 199
 disturbances of, 267
 energy of, 198
 receivers, 46
 transmitters, 86
 voltmeter, 117, 118
- Energy, in electrostatic field, 198
 in magnetic field, 142, 195, 280-282
 of self-induction, 284
 stored in condenser, 199
 transformation of, by current, 193
- Entrefer*, 149, 154, 282, 283
- Epsilon (ϵ), 300
- Equivalent frequency of telephone current, 39, 41-42
- Equivalent resistance affected by diaphragm, 80-81
- Euler's development, 304, 305
- Excess current dangerous, 255
- Expansion by series, 313
- Exponential series, 111
- Farmer lines, 235, 245
- Fechner's law, 18
- Filtering action, of coil, 208, 228
 of condenser, 240
- Forced vibrations, 185, 186
- Foreign currents, 210, 211, 255
- Fourier equation, 31, 32
- Fundamental, harmonies and, 13

- Fuse, conditions for melting, 257
 grasshopper, 259
 required, 256
 types of, 257
- Fusible pellets in arresters, 264
- Gauss's theorem, 283
- Gilbert, unit, 274
- Graduators, 227
- Grasshopper fuse, 259
- Greek letters, 271
- Grounding cable sheaths, 261
- Grounded wires as shields, 267
- Ground wires, sharp turns avoided
 in, 265
- Guard ring, 139, 140
- Harmonics, 65
- Harmonic selective ringing, 184,
 186-189
- Hearing, aids to, 15
- Heat, electricity and, 206
 amount of, from current, 255-258
 in conductors, 255-259
- Heat coils, 258
- Henry, unit, 197, 284
- Howler, 136, 137, 209
- Hyper-phantom, 239
- Hysteresis, effect of, on magnetiza-
 tion, 154, 278, 279
 on primary current, 79
 energy of, 279, 280
 in alternating current magnets,
 158
 in receiver, 67
 loop, 279
- Impedance, 201
 as a filter, 223
 desirable in telephone circuit,
 109
 in battery charging, 228
 in selective ringing, 188
 of inductive circuit, 219
 reduced by shunting coils, 147
- Importance of communication, 3
- Incandescent lamp signals, 134, 136,
 137
- Induced currents, 145, 147, 148
 affecting speed of demagnetiza-
 tion, 153
 affecting speed of magnetization,
 151
 effects of, in magnets, 157, 158
 on resistance and reactance, 79-
 81
 in receiver diaphragm, 76-77
 in spool heads, 78
 reaction upon primary, 78-79
- Induced electromotive force, 197,
 212-214
- Inductance affected by pressure,
 148, 151
- Induction balancing capacity, 202
- Induction coil, basis of, 197,
 198
 distinguished from repeating
 coils, 220
 effect of direct current on, 235
 electromotive forces in, 215-216
 general principles of, 215
 magnetic circuits in, 216
 operation of, 221
 other names of, 215
 quantitative study of, 221-222
 uses of, in telephony, 223-239
 with C. B. transmitter, 232-233
 with local battery, 231-232
- Inductive disturbances, 212-214
- Instantaneous and effective values,
 196, 197
- Insulation, effect of, on leak-
 age, 211
 of magnet windings, 159
- Intercommunicating telephone, 125,
 126
- International pitch, 13
- Interphones, 125, 126
- Inverse method for microphone
 theory, 112-114, 312-313
- Investment in telephones, 3
- Iron of high permeability, 278
- Iron shields, 218
- Kirchhoff's law, 49, 193
- Krotophone, 49

- Lamination, 145, 216-217
 effect of, on magnetization, 153
- Language, inadequacy of, 55, 246
 written, compared with spoken,
 19, 21
- Laws of pendulum in vibrators,
 182-185
- Law system, 134, 135
- Leak circuits, 224
- Lenz's law, 76
- Limitations of this book, 193
- Lightning, 132, 211-213
 location of protectors against,
 265, 266
 oscillatory, 265
 protection against, 239
 sharp turns in, avoided, 265,
 266
- Lightning arrester, 213, 262-264
- Loading coils, design of, 230, 231
 continuous and lumpy, 229, 230
 on long lines, 228-230
- Lock-out systems, 131
- Logarithmic charge, 199, 200
 law of, 147, 148, 151, 152, 153,
 195
- Logarithms, Napierian, 40
- Loss, by eddy currents, 280
 by hysteresis, 280
- Maclaurin's theorem, 304, 305
- Magnetic circuit, energy in, 142,
 280-281
 law of, 275
 of induction coils, 216
 open *v.* closed, 217
 varieties of, 216
- Magnetic disturbances, 212
- Magnetic field. *See* Magnetic flux
- Magnetic flux, 197
 equations for, 142, 280, 281
 for alternating current, 158, 196
 shown by iron filings, 273
 work in moving, 272, 273
- Magnetic gradient, 283
- Magnetic insulator, 144, 145
- Magnetic laws, 271-285
- Magnetic leakage, 210
- Magnetic line of force, 271
- Magnetic permeability, 277
- Magnetic pole, 272
- Magnetic pull, 141, 282
 equations for, 282, 283
 on non-magnetic bodies, 283
 with alternating currents, 155
- Magnetic reluctance, 217
 variation in receiver, 75-76
- Magnetic repulsion, 141, 143
- Magnetic saturation, 277
 desirable in receiver, 67-68
 effect of, in induction coils, 235-
 236
- Magnetic shields, 218
- Magnetic stability, 281-282
- Magnetism, avoidance of stray, 144
 effect of air-gap, 143, 145, 154
 effect of induced currents, 147-
 154
 effect of mutual induction, 153
 energy in, 142, 195, 280, 281
 instability of, 142
 relations of, to current, 273
- Magneto generator, design of, 209
- Magnetomotive force, 141, 169, 170,
 273, 286
 flux and, 275-278
 in ringers, 178
 of induced currents, 78
 of straight conductor, 273
- Magneto transmitter, 84-85
- Mathematical series, 107
- Mason, transmitter, 97, 120
- Maxwell equation, 222
 law of, 292
 unit of, 292
- Mechanical and electrical power,
 interchangeable, 207
- Mechanical telephone, 44
- Methods of communication, sum-
 mary, 4, 5
- Microphone, approximate equation
 for, 309-311
 clearness and strength incom-
 patible, 109, 113
 clearness of, improved by re-
 sistance, 107, 109

- Microphone, high electromotive force desirable in, 110
 high tones favored, 110
 inverse equation for, 112, 312-313
 mathematical theories of, 107-113
 mica diaphragm in, 94
 packing in, 105
 physical theories of, 100
 resistance studies of, 101-105
 resistance vagaries of, 102
 rigid, theory of, 111
See also Transmitter
- Monarch drop and jack, 133
 Monarch transmitter, 97
 Multiparty line, 235, 245
 Multiple cords, 137, 138
 Musical scales and staffs, 13
- Naperian logarithms, 40, 300
 National Electrical Code, 257
 Natural period of vibrators, 182-185
 Need of protective devices, 255
 Night alarm, 134
 Noise-producing currents, 65, 167
 North selective ringing system, 187
- Ohmic drop as source of current, 207
 Ohm's law, 195, 196
 Order wires, 134, 135
 Oscillating currents, 265
 Oscillograms, 148-152, 163
 Oscillograph, 32, 173
- Party lines, 235
 "PBX" signal, 252-253
 Permanent magnets, polarized apparatus and, 168-176
 apparatus for studying, 286-287
 coercitive force of, 154
 condenser as protection to, 246
 constancy of flux in, 286
 effect of armature on flux in, 171-172
 experimental studies of flux in, 286-289
 field distribution of, 170
- Permanent magnets, flux in external field of, 171-172
 importance of, 168
 importance of magnetomotive force and reluctance in, 286
 internal magnetomotive force and reluctance in, 171
 magnetomotive force in, 169
 pole of, 170
 suitable steel for, 168
- Permeability, 142, 169, 277
 basis of transmitter, 89
- Phantom circuits, 237-239
- Phonograph, 25, 30, 33
- Physical circuit, 237, 238
- Pi (π), 271
- Pitch, 10-13
- Polarized apparatus, 168-176
 air-gap adjustment, 180
 armatures, two classes, 177
 components of reluctance, 290-291
 constant reluctance desirable, 177
 current required to start, 293
 design of, 177-189
 development of, 316
 division of flux between paths of, 291-292
 effect of air-gap on blow, 292-293
 force holding vibrator, 292-293
 magnetomotive forces in, 290
 mathematical theory of, 290-294
 mechanisms, 174
 minimum operating current for, 178
 motion in magnetic circuit, 174-186
 movable electric circuit, 172-173
 physical basis of, 172
 pull on vibrator, 292
 strength of blow, 180, 181
 uses in telephony, 168
 wave form of, 181
See also Polarized ringer
- Polarized ringer, 130, 131, 160, 174-188
 cross-ringing, 187
 elastic blow desirable, 181

- Polarized ringer, elements determining noise of, 180
 single coil, Wotton, 178
 why bridged, 223-224
- Pole-changers, 159-167
 oscillograms of, 163
 tuned, 187
 Warner, 161, 162, 166
- Position on switchboard, 139
- Power in a circuit, 193, 194
 telephonic, difficult to measure, 194
- Protection, against abnormal currents, 255-259
 against sneak currents, 258, 259
 by sheath, 212
 by shield, 267
See also Lightning
- Protective devices, 255-268
 location for, 265-266
- Quadrant, unit, 284
- Reactance coils, 218-220
 for smoothing current, 208, 228
See also Retardation coil
- Receiver, construction and adjustment of, 55-56
 details of construction of, 56
 double-frequency pull in, 77
 efficiency of, 81-82
 electromagnets in, 50-53
 insulation of, 68
 magnetic circuit in, 51, 65, 67
 magnetic saturation desirable in, 67
 mechanical structure of, 68
 metallic heads on spools of, 77-78
 permanent magnet not essential to, 53-55
 polarity of, 236
 sensitiveness of, to disturbing currents, 65, 66
 shocks from stray currents, 68
 useful and leakage magnetic flux in, 53
- Receiver diaphragm, affected by hysteresis, 79
 affects equivalent resistance, 80
 double-frequency pull of, 77
 effects of elasticity, frequency, and mass, 297, 299
 forced vibrations of, 298, 299
 forces acting on, 295, 301
 free vibrations of, 298, 300
 functions of, 66
 induced currents in, 76-77
 magnetic pull in, 66, 67
 mechanics of, 70-76
 phase shifting in, 299
 silicon steel, 77
 transient effects on, 300
 vibration unsymmetrical in, 75
See also Diaphragm
- Receiver investigations, 57-82
 amplitude of vibrations, 57
 disturbing currents, 65
 effect of cap, 64, 65
 efficiency, 65
 experimental difficulties, 57
 loudness *v.* clearness, 69
 motional resistance, 80-81
 sensitiveness, 59
 sensitiveness and frequency, 60-64
- Receivers, based on heating effects, 47-49
 bipolar, 52-53, 55-56
 chalk cylinder, 45
 electrochemical, 45
 electrodynamic, 55
 electromagnetic, 51, 53-55
 electrostatic, 46
 loud-speaking, 69
 mechanical, 44, 45
 motograph, 45
 permanent magnet, 51-56
 phenomena available as basis of, 44
 physiological action of, 47
 Schmidt-Wilkes, 60
 Siemens, 57
 single-pole, 51
 surface tension, 45
 welded, 52, 53, 62
 Western Electric, 62-65, 66, 71

- Receivers, Wollaston wire, 49
 Rectifier, 228
 Reed, vibration of, 182-186
 Relay, bug-trap, 157
 design, 140-155, 177-180
 uses, 130, 134-139, 168, 175, 176
 Reluctance, 141, 275
 complex circuit, 275
 effect of, on resistance and inductance, 148, 149
 in permanent magnet, 170, 171
 multiple path of, 275, 276
 Remanence, 277, 278
 Repeaters, telephonic, 98, 99
 Repeating coil, basis of, 198
 in cord circuits, 236
 in phantom circuits, 237
 other uses of, 98, 99
 ring-through and talk-through, 234, 235
 See also Induction coil
 Resistance, effect of reluctance on, 148
 elements of, 86
 methods of varying, 86
 of microphone, 101-105
 variation of, with pressure, 101, 102
 Resolution of currents into components, 78-79
 See also Sounds; Speech sounds
 Resonance, acoustical, 16
 effect of condensers, 227
 electrical, 115, 118, 219, 227
 for selective ringing, 253
 in ringer circuits, 189
 mechanical, 184, 189
 uses of, in hearing and speaking, 16-17
 Retardation coil, 196
 differential winding of, 227-228
 in cord circuits, 224-225
 in simultaneous transmission, 226
 Retarding sleeves, 151, 153
 Ringer. *See* Polarized ringer
 Rowland's law of magnetism, 275
 Royal Society, 320
 Rush of current, 241
 Secondary currents. *See* Induced currents
 Self-induction, 148, 149, 195, 196
 coefficient of, 284
 effect of, on decay of current, 153
 energy, 284-285
 units of, 284
 variation of, 235-236
 Selective ringing, 131, 186-188, 243-245, 253
 effect of impedance on, 188
 synchronomic system of, 187
 Series, mathematical, 107
 Sheath for protection, 212
 Shields, against induction, 267
 Short circuits, effect of, in magnet windings, 159
 Shunting of coils, 147, 224, 228
 Side circuits, 237, 238
 Side tones, 94, 234
 Signaling devices, 125-140
 annunciator, 131
 attachments on generators, 209
 buzzer, 130, 134
 drops, 131-133, 252
 fundamental apparatus of, 127
 fundamental laws of, 127
 historical notes on, 314-318
 lamp, 134, 136
 night bells, 133, 134
 non-polarized, design of, 141-167
 order of development of, 314
 polarized, design of, 141-167
 polarized ringer, 131-133
 requirements for, 125
 shutters, 132-134
 trembler, 130, 134
 visual and audible, compared, 128, 130
 Signals, busy test, 139, 140
 clearing-out, 137
 disconnect, 136, 137
 subscriber's calls, 130, 131
 supervisory, 135-137, 207
 Silicon steel for diaphragm, 77
 Simultaneous telephony and telegraphy, 226, 227, 228
 Sine wave, 6, 7

- Singing arc, 48
- Single circuit coils, use of, for controlling current, 218-219
- Siren as source of sound, 115, 117
- Sneak current, protection of, 258, 259
- Sound, 6-18
 amplitude of vibrations of, 18
 analysis of, 16, 28-35
 characteristics of, 6
 diminution of, with distance, 9
 duration of sensation of, 17
 few elementary kinds of, 21
 from electromagnet, 49-50
 fundamental and harmonics, 29-32
 generation of, by bell, 7, 10
 harmonics and chords, 12-13
 high frequencies damped, 26
 loudness of, 18
 octaves, 13
 pitch of, 10
 quality of, 6, 13
 ranges of pitch of, 10, 11
 resolution of, into components, 11
 resonator, 16
 siren as source, 115, 117
 timbre, 6, 13
 transmission of, 8, 14
 velocity and wave length of, 18
See also Speech sounds
- Sparking, 146
 causes of, 164-165
 disturbances from, 167
 reduction of, 165, 166
- Sparkless commutation important, 208, 209
- Spark recorder, 104, 105
- Specific inductive capacity, 198
- Speech sounds, 19-42
 ability to recognize, 26-28
 accent, 27
 analysis of, 29-32
 Asiatic, 27
 by expulsion of air, 23-24
 by inspiration of air, 23
 clicks and smacks, 23
 consonants, classification, 24-25
- Speech sounds, dominant pitch of, not that of singing, 39
 drummy, 26
 emphasis, 27, 28
 formation of, 22-23
 French, 27
 imagination in hearing, 28
 modifications of, 25-26
 modified by resonance, 23
 number per second in conversation, 38
 oscillographic records of, 30
 patterns of, 34-35
 pitch of, 28
 pitch independent of speed of, 36
 pronunciation variations of, 25
 relative accuracy of transmission of, 26-27
 represented by Fourier equation, 31-32
 Scandinavian, 27
 series of changing waves, 33-36
 syllabification of, 27
 vowel, composition, 28-32
 whispers, 24, 32
 woman's and man's voice compared, 39
- Spool heads, effect of, on current, 148
- Suggestions for development, 82, 98
- Standardization in telephone apparatus, 193
- Standard Handbook, 320
- Static removal, 261-265
- Station circuits, for central battery, 233, 247
 for local battery, 231
- Steel for magnets. *See* Permanent magnets
- Stone circuit, 224
- Storage batteries, 205
- Stray fields, troubles with, 144-145, 218
- String galvanometer, 32
- Summum maximum* sensitiveness, 64

- Switchboard, position of, 139
Stromberg-Carlson, 138
- Telegraphy, duplex and quadruplex, 176
simultaneous with telephony, 226
use of polarized relays in, 175, 176
- Teleloge, 43
- Telephone conversations, number of, 3
- Telephone receivers, 43-56
cap, 14
differential equation of, 298, 302
elements of magnetic pull in, 295
magnetomotive forces in, 295
variation of pull in, with position, 296
See also Receivers
- Telephonic currents, alternating
current laws apply to, 38
difficulty of measuring, 194
equivalent frequency of, 39, 41-42
time required to establish, 38
- Telephony, relation to other methods of communication, 4
- Temperature of conductor, 256
- Terminology, incomplete, 246
- Thermogalvanometer, 41, 117, 173, 316
- Thermophone, 49
- Transformer action in telephone coils, 220-221
- Transformers, action of, 197
ratio of transformation in, 221
step-up, 221
- Transient phenomena, 199, 202
- Transmitter, acoustics of, 114
aging of, 105
care in making, 93-94
clearness of, improved by resistance, 107, 109
common battery, 233-234
condenser with, 247-248
currents in, 92-93
damping of, 96-98, 119, 120
generators and modifiers, 83
- Transmitter, high electromotive force desirable in, 110
high tones favored in, 110
investigations of, 100-122
local battery, 231, 232
mathematical theories of, approximate equation, 309-311
inverse method, 112, 312-313
rigid solution, 111
with resistance, 107
with resistance and inductance, 108-114
mica diaphragm in, 94
non-essentials of, 94
operation of, 83
packing in, 91, 92, 105
physical theory of, 100
power and clearness incompatible in, 109, 113
pressure and resistance of, 101
resistance variation in, 101-105
resonance, mouthpiece, 114, 115
sensitiveness, not required, 94
to pitch, 114-122
See also Diaphragm
- Transmitters, 83-99
arc, 87, 94
based on changing permeability, 89
based on changing resistance, 86
based on heating, 87
electromagnetic, 84-85
electrostatic, 86
granular, 91-92
magneto, 84-85
metallic granular, 93
phenomena available in, 85, 86
secondary, amplifiers, 98, 99
solid back, 92
thermopile, 84
variable pressure, 80-94
Bell, 92, 96, 101, 102, 118, 119, 120
Berliner, 89
Blake, 90, 91, 96
Cracraft-Leich, 93
Dean, 97, 121, 122
Edison, 89, 90, 95
Garford, 95

- Transmitters, Hunnings, 91
Kellogg, 96, 97
Lowth, 94
Mason, 97, 120
Monarch, 97
Randall, 97
Reis, 88
Sumter, 120
Turkey-foot, 95
Western. *See* Bell
White, 92
- Trembler, 159, 160, 318
- Tube of force, 198
- Unit, line of force, 271
magnet pole, 271
magnetomotive force, 274
self-induction, 197, 284
- Units, dyne, 271, 282
gilbert, 274
henry, 197, 284
- Units, maxwell, 292
quadrant, secohm, 284
- Vibrating contact devices, 159-167,
315
- Vibrations, of bell, 7
forced period, 185-187
natural period, 182-185, 187
- Vibrator adjustment, 160
- Voice currents, in C. B. circuits, 225
stopped by impedance, 223-224
- Voice harmonics, 16, 17
- Voice qualities, 14
- Voltage, excess dangerous, 255
- Vowels, 21, 22
- Warner pole-changer, 161, 162, 166
- Wave length of sound, 18
- Waves, 167, 214
- Whispers, 24, 32
- Wollaston wire receiver, 49



14 DAY USE
RETURN TO DESK FROM WHICH BORROWED
LOAN DEPT.

This book is due on the last date stamped below, or
on the date to which renewed.
Renewed books are subject to immediate recall.

ICLF (N)

JAN 22 1984

OCT 04 1995
RECEIVED

DEC 06 1984

REC'D LD FEB 22 '68 - 4PM

SNAG

~~JUL 27 1990~~

INTERLIBRARY LOAN

JUL 27 1990

UNIV. OF CALIF., BERK.

LD 21A-60m-2,'67
(H241810)476B

General Library
University of California
Berkeley

44
—
Piso m

U. C. BERKELEY LIBRARIES



051334486



