



Class [REDACTED] Book [REDACTED]



PRESENTED BY

Mr Andrew Carnegie.

The Locomotive.

PUBLISHED BY THE

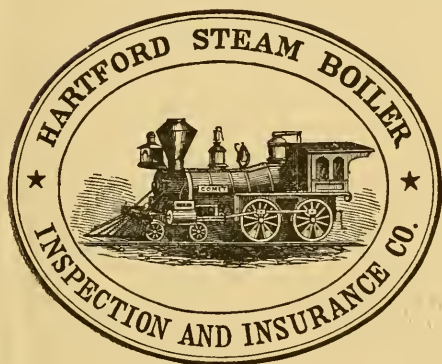

NEW SERIES.

Vol. I.

SECOND EDITION

HARTFORD, CONN.

1880.

The Locomotive.

PUBLISHED BY THE HARTFORD STEAM BOILER INSPECTION AND INSURANCE COMPANY.

NEW SERIES—VOL. I. HARTFORD, CONN., JANUARY, 1880.

No. 1.

Explosion of the "Lehigh."

From the records of the coroner's court held in Hoboken, N. J., November, 1879, it appears that the Lehigh, which exploded in that city on the 28th of October, 1879, killing the engineer and fireman, was a passenger locomotive that had been remodeled in 1874, at which time the boiler was new. It had been in constant service, except while undergoing slight repairs, since May, 1874, on the Morris & Essex division of the D., L. & W. R. R. It was rebuilt under the direction of the master mechanic of the division, and was

stayed in an extraordinary manner, having over fifty sling stays from the arch of the wagon top to the crown bars of the furnace, arranged in four rows, set as near radial to the arch as practicable, Figs. 1 and 2. There were also horizontal cross stays from side to side of the shell between the crown bars, one to about every $5\frac{1}{2}$ inches, and the crown bars were spaced the same distance apart, and consisted each of two broad parallel bars seated edgewise on the edge of the side plates of the furnaces and secured to the crown sheet by bolts, washers, and gibbs in the usual manner. See Fig. 1. The shell of the boiler was made of $\frac{5}{8}$ iron plate, marked C. H. No. 1, and the pressure was limited to 130 lbs. per square inch. There were two "pop" safety-valves and a steam gauge; the latter was tested by the master mechanic after the explosion, and he swore that it was

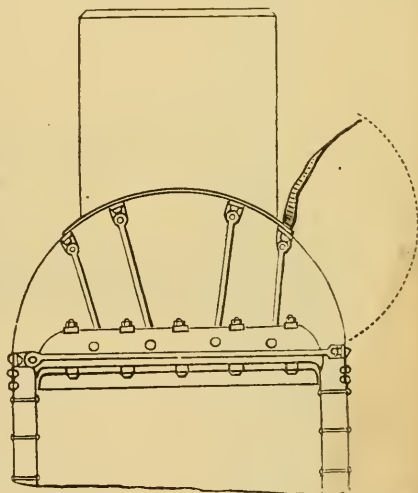

FIG. 1.

correct and its connection to the boiler free from obstructions. The iron was tested at the Stevens Institute and found to have a good degree of tensile strength, viz.: 46,000 lbs. The accompanying cuts are intended to illustrate the construction and the character of the defect from which the explosion arose. Only such parts of the boiler as were supposed to be concerned in the explosion are shown in the cuts. The only plate involved was the crown plate of the wagon top, which was about 6x7 feet in area, out of which a piece $5\frac{1}{2} \times 1\frac{1}{2}$ was torn from the right side and blown away a considerable distance, the reaction overturning the engine upon its left side. The opening is bounded by the fastenings of the cross stays on the lower side, by the fastenings of the right-hand row of sling stays on the upper side, at the forward end by the waist seam of rivets, six of which were sheared off, and at the back end by the foot of a short head brace, shown in Fig. 2. Fig. 1 is a section back of the dome, and Fig. 2 is a side elevation of the wagon top and dome, all other parts omitted in drawing (not torn off by the explosion).

Fig. 3 is a full-size section of the plate and seam at *c, d*, Fig. 2, where indications of a recent leak were observed, shown by dots, Fig. 2. At *c*, Fig. 3, is seen the char-

acter of the defects. Fig. 4 is cut from a sketch, full-size, of the edge of the plate *c, d*, shown in plan. The lines *v, v*, indicate the worn edges of the laminae of the plate covered with old iron oxides and clayey sediment from the interior of the boiler. The line *N, O*, represents the inner boundary of the new fracture indicated by its sparkling and bright appearance, and the dotted area below the line *N, O*, represents its area as compared with that of the old fracture above the line. This appearance was observed to extend a considerable distance each way from the points *c, d*, the proportion of old fracture varied, in general rather diminishing each way. It is probable that the fracture began at this point and extended forward and backward, reaching the waist girth seam forward, when a sufficiently long line was forced from its proper connections with the adjacent part below, it was bulged outward by the force of the expanding water, and the strain thus produced sheared the rivets of the seam. The progress of the explosion is now plain and natural. The gushing of the entire contents of the boiler,

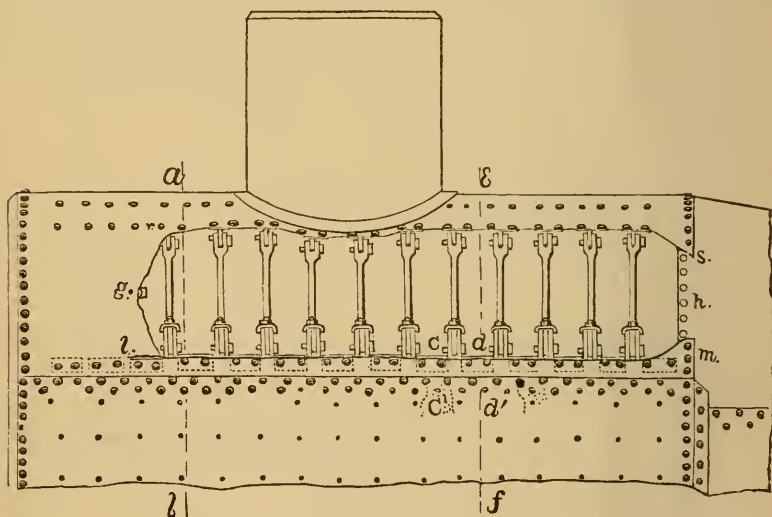

FIG. 2.

now relieved of superincumbent pressure, out of this opening, strips the plate along its supported boundaries and it is blown away, while the machine is capsized by the reaction of the issuing stream. The pressure on this area of $7\frac{1}{4}$ square feet was but little less than 70 tons at the maximum pressure of 130 lbs. per square inch, and something like this force would react on the machine to overturn it if the opening had been made instantaneously, which would have been quite sufficient not only to overturn the machine when applied to its side, but to lift it bodily in the air if it had been applied at its centre of gravity and issued downward. The time that elapsed between the initial break and the entire separation of the piece of the plate that was blown away allowed the internal pressure to fall somewhat, but the time was something like that which expires between the lighting of the cartridge and the rending of the rock; and notwithstanding the force was to some extent employed in breaking the plate, still enough remained, reacting on the atmosphere, to upset the engine. The balance of the force that was employed in overturning the engine must therefore have been tremendous in velocity to have done this work.

The problem as to the cause of the defect from which this explosion arose is a little more difficult to solve. It is proper, however, to ask what is the legitimate office of the extra stays that we find in this boiler, and since there are, according to the evidence

adduced in this case, thousands of locomotives in which they are not found, we may well ask whether they are needed at all when crown bars in sufficient number and size are applied to support the top of the furnace. It may be difficult to understand just how

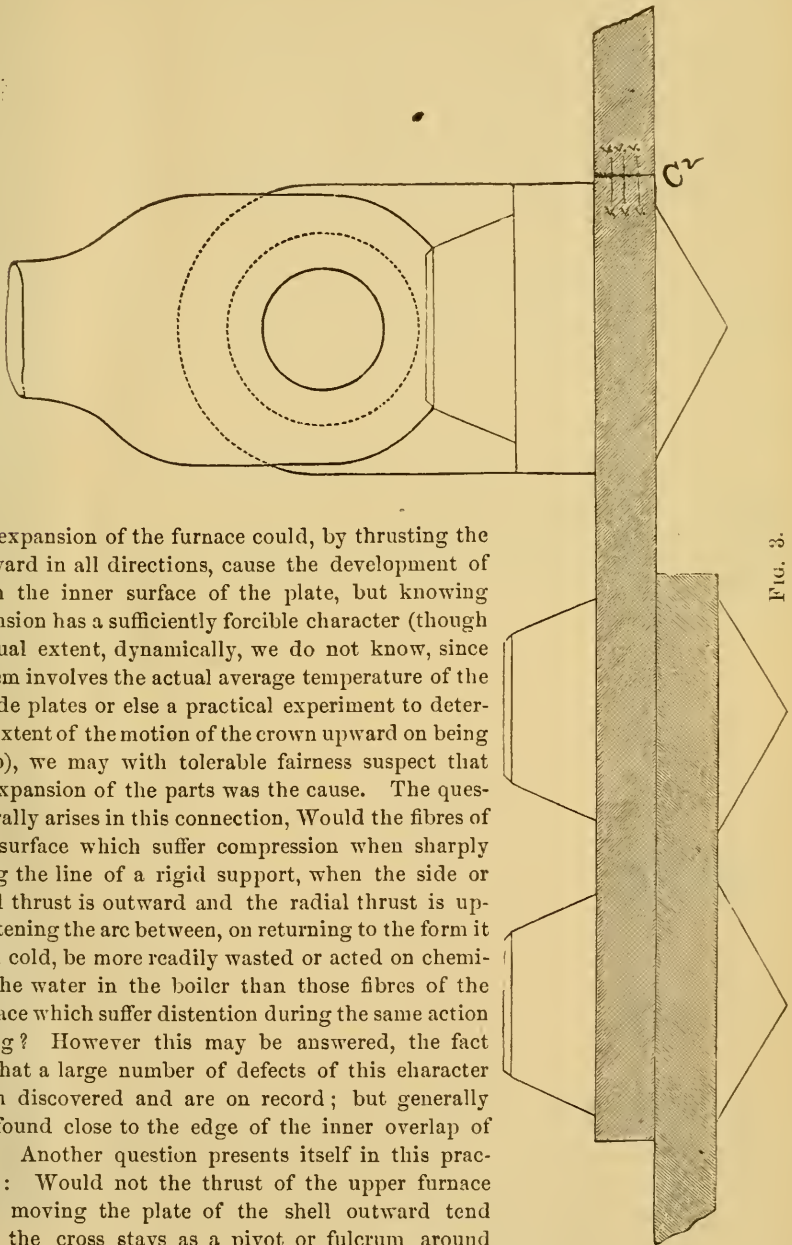

FIG. 3.

the extra expansion of the furnace could, by thrusting the shell outward in all directions, cause the development of a crack on the inner surface of the plate, but knowing that expansion has a sufficiently forcible character (though of its actual extent, dynamically, we do not know, since the problem involves the actual average temperature of the furnace side plates or else a practical experiment to determine the extent of the motion of the crown upward on being heated up), we may with tolerable fairness suspect that unequal expansion of the parts was the cause. The question naturally arises in this connection, Would the fibres of the inner surface which suffer compression when sharply bent along the line of a rigid support, when the side or horizontal thrust is outward and the radial thrust is upward, flattening the arc between, on returning to the form it had when cold, be more readily wasted or acted on chemically by the water in the boiler than those fibres of the outer surface which suffer distention during the same action of bending? However this may be answered, the fact remains that a large number of defects of this character have been discovered and are on record; but generally they are found close to the edge of the inner overlap of the seam. Another question presents itself in this practical case: Would not the thrust of the upper furnace stay-bolts moving the plate of the shell outward tend to utilize the cross stays as a pivot or fulcrum around which the point *c*, Fig. 3, would move inward, thus causing distention of the inner fibres at the defective point. Sometimes defects located as this one is and those in the two following reports do not assume the form shown in these three cases, but the wasting

extends some distance above and below, thinning the plate by the formation of a furrow or groove, but always on the wet side of the plate so far as observed or recorded.

If we find that a boiler has its shell and furnace rigidly stayed together with the ends of stays set with round pins fitting nicely in round holes, and the stays sufficiently strong and numerous to act as struts, then every motion of the furnace will be communicated to the shell. In this particular case the number of the extreme thermal changes corresponds with the number of times that steam has been raised during a period of about 2,000 days, from May 1, 1874, to Oct. 28, 1879. Deducting the idle days, we have a fair statement of the number of the motions due to unequal expansion. We should hardly expect to find so many stays each bearing its exact proportion of the stress, and under unfavorable circumstances of construction they might be set so that a little additional distention or compression of the arch of the wagon top might be accomplished with each stay or even row of stays. The shell, which yields readily to a comparatively slight local force when not supported in form by internal pressure, would certainly suffer such distortion of form as would place it in a very unfavorable condition to sustain the pressure of steam in addition to the thrust of the expanding furnace.

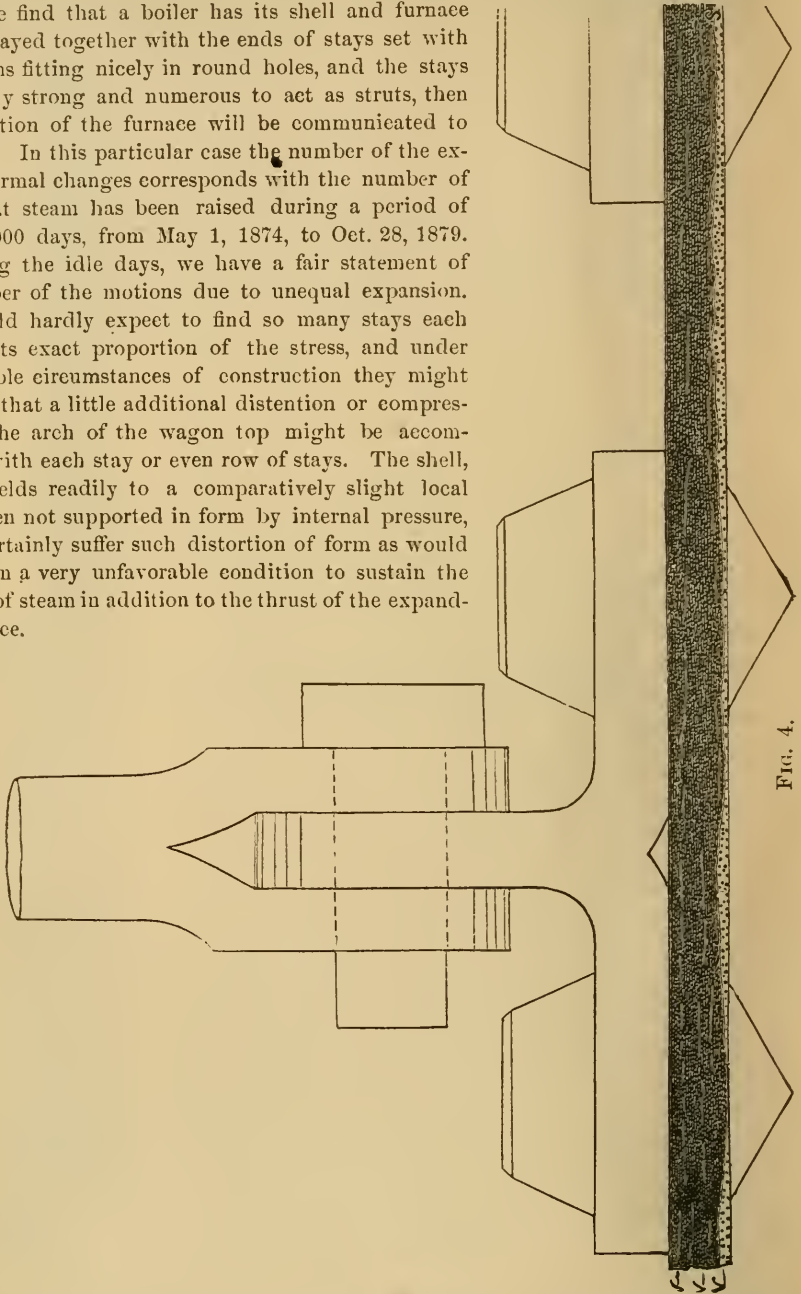

FIG. 4.

The millions of motions or vibrations communicated to every part of a locomotive boiler by the concussions of the wheels, the intermittent flow of steam to the cylinders,

and the shocks of coupling and derailment no doubt contribute something, and in a weakened structure they may be very considerable agents of destruction; but they need not be invoked in this case. They are incidents in the life of all active locomotives, and thousands wear out and are laid aside or cut up without exploding.

The following is the finding of the coroner's jury in this case:

The jury retired, and after deliberation of one hour gave the following verdict:

"That the deceased, Wm. Swick, came to his death on Tuesday, Oct. 28, 1879, by the explosion of the boiler of the locomotive "Lehigh," belonging to the Delaware, Lackawanna & Western Railroad Company, and that from the evidence taken from experts and others familiar with the building of the boilers of steam engines, that the cause of the explosion was undue pressure of steam. But that as evidence was brought to the knowledge of the jury that the deceased was aware he was carrying more steam than was allowed.

The evidence taken proving that the boiler had a full quantity of water at the time of the explosion, but that from the appearance of a piece of the iron broken from the place of fracture, it would appear to the jury that there was every possibility that the place where the fracture occurred had been weakened by constant use, and was thereby ready to give away at the least over-pressure."

Explosion of the "Saco."

The locomotive "Saco," on the P. & O. R. R., four years old, built of $\frac{3}{8}$ Bay State plates, working at 130 pounds pressure, exploded at the city of Portland, Sept. 22, 1874. The crown of the shell over the furnace was joined to the sides by double riveted seams about eight inches below the crown of the furnace, and a line of screw stays was placed as near as possible to the inner lap of the seams. The breadth of fire-box body was

less than the diameter of shell-crown, which consequently formed something more than a semi-cylinder. A goodly number of vertical stays connected the furnace crown and the shell crown. On the day of the accident the firemen reported a leak in or near the seam on the left side, and shortly after the shell crown turned over toward the right side, hinging on the top line of screw stays on the right side; breaking along this line on

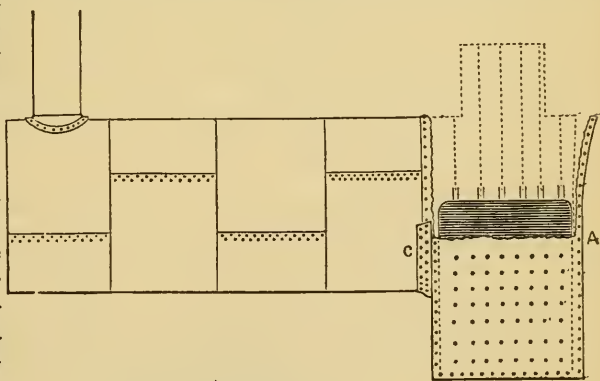

FIG. 1.

both sides almost simultaneously it flew away, with dome and broken stay rods, into an adjoining field. The engineer, who was leaning out of the front window of the cab, was instantly killed, but the firemen and others who were on the tender escaped with slight injuries. The upward expansion of the furnace would tend to thrust the top upward, and the form at the seams was favorable for the sharp bending of the plate on the inner laps, caused by the pressure on the shell crown. The disturbance of the fibres was probably so serious that the iron on recovering its original form by the cooling of the boiler did not recover its original texture, and the water attacked the weak line while the engine was idle, oxidizing a portion of the disturbed fibers. On raising steam the

bending again occurs and the oxide is cracked off, and so the weakening process goes on till the limit of endurance is almost reached, when a jar or sudden rise of pressure was all that was required to precipitate the disaster by breaking it along the whole line at once.

It was suggested that the closely huddled tubes might have repelled the water, which assumed the spheroidal condition among them, and on the occurrence of sufficient disturbance in the water it returned upon the overheated surfaces, and by rapidly absorbing their stored-up heat caused a sudden rise of pressure. But the tubes were light, and a portion of them that would be likely to become overheated under 130 pounds pressure would afford but very small storage capacity for heat, and they would not be likely to raise the temperature of the mass of water to a degree that would be dangerous to a *sound boiler*.

It is claimed that sudden variations of pressure to a dangerous extent do occur, as in the case of the explosion of a locomotive in Pennsylvania, where, according to the local press, the experts say that the "explosion was produced by the projection of foam upon the heated crown bars of the furnace, caused by suddenly and widely opening the safety-valve at a time when the water had been permitted to get so low as to overheat the crown of the furnace." It is more than probable, however, that some such defects as those in the "Lehigh" and the "Saco" existed in this boiler.

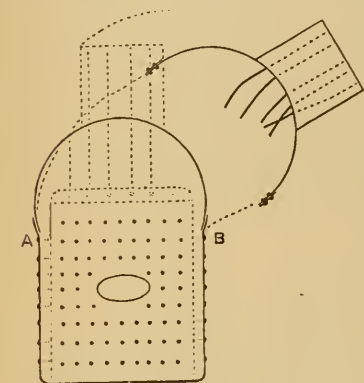

FIG. 2.

While it is known that violent changes in pressure *are not* necessary to produce destructive explosions, yet they may happen to all kinds of steam generators, and the only rational means of ascertaining whether they retain an ample margin of strength to enable them to safely withstand them are careful and oft-repeated personal inspection, whereby the inception and progress of inevitable deterioration may be observed and recorded for future guidance.

Fig. 1 is a side elevation, the broken lines showing the part blown away.

Fig. 2 is a section through the front water space, showing form of the double riveted seams at A and B.

This and the following report were prepared for publication in *THE LOCOMOTIVE* nearly a year ago, but they have been kept out by the press of other matter. The reports of the locomotive "Saco," and the tug boat "Popham," are now introduced as explanatory cases, being some respects similar to the "Lehigh."

It will be noticed that the "Saco" was stayed in a different manner, and that the shell was different in form. The question of the need of stays in this case also is a pertinent one. Except for the support of the top of the dome it is doubtful whether they are needed at all. If the portion of a cylinder which formed the wagon top is just exactly in shape what the internal pressure would make it, then it is stronger without them, and the dome top had better be stayed to its own sides if staying must be done to support its top. The effect of the upward motion of the furnace would be to thrust the dome upward and flatten the arc between the base of the dome and the point A, Fig. 2, the place of rupture. In the "Popham's" boiler we have another variety of the same species. The seam near which the defect developed was about half way between the upper and lower ridged supports, and we see by the dotted lines, Fig. 2, the direction taken by the plates after the rupture. The defect shown in Fig. 4 is similar to that in both the "Lehigh" and the "Saco."

Explosion of the "Popham."

The boiler of the tug-boat Popham, which exploded near Bath, Maine, Oct. 14, 1874, was of the type commonly employed in American towing service, varied by having a steam dome in addition to the usual steam chimney. The dome was placed behind the steam chimney and connected to it by a steam-pipe near the top; it was seated about half on the crown of the body and half on the top of the barrel. The boiler was about 14 feet long over all, and the barrel 6 feet diameter by 9 feet long, made of $\frac{5}{16}$ plates; was allowed to carry 60 pounds of steam; was about eight years old at the date of the accident, which occurred while towing a raft of logs. It contained two furnaces, which delivered their gases through separate cylindrical horizontal flues into the back connection, whence they return through a bank of horizontal tubes to the uptake and chimney in front. The sheet that forms the top of the semi-cylinder of the body joins the sheets of the sides by a single riveted horizontal seam, at about half-way between crown fastenings of the vertical stays on the shell and the upper line of furnace side stays. After a few years a leak came to light at the junction, C, of the horizontal and girth seams. A patch was applied, as seen at D, Figs. 1 and 3, bolts also were passed through the body from side to side as seen at H H and C, Fig. 1. The portion of the shell bounded by this line of bolts and the flanges of the two domes blew out, the part above the seam, about $4\frac{1}{2}$ feet long, turned upward, hinging on its upper line of supports, and struck the domes with such violence as to leave the marks of the points of the attached rivets indented on the domes, and the blow was sufficient to tear itself free, so that it was lost overboard. Its form is shown, B, Fig. 3. The part from below the seam, A, Fig. 3, turned downward, hinging on the lower

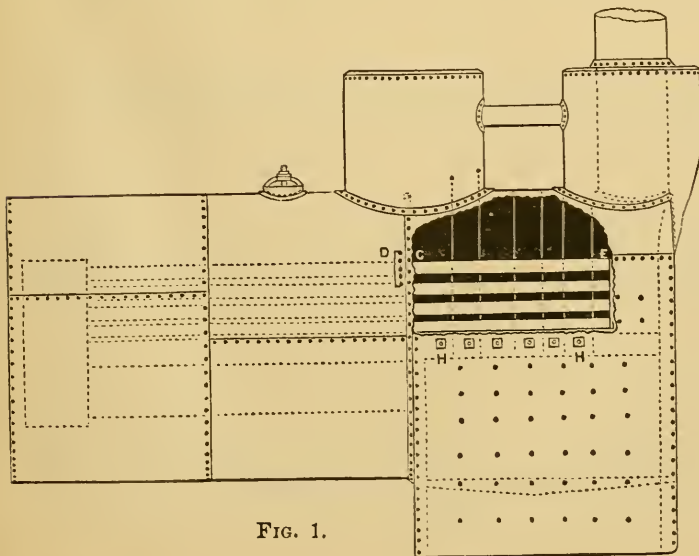

FIG. 1.



FIG. 4.

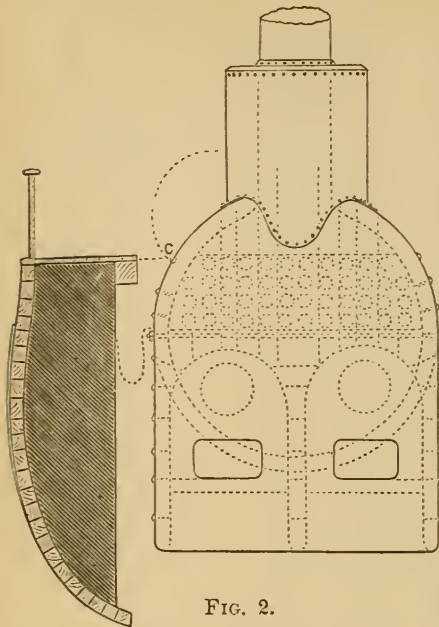

FIG. 2.

The dark shading is a section of the coal bunker.

line of supports, and remained on board, striking in its flight the adjacent coal bunker of the vessel with force sufficient to bend it into the form of a gutter, A, Fig. 3. The appearance of the vent, C E, attracted the attention of the writer, and on close inspection, while a critical examination into the quality of the metal of the broken sheets was progressing, conducted by the local inspector of steam boilers for the district, the regular line of fracture, C E, was discovered to be an old crack well marked by old oxide for a considerable part of the length, and nearly through the plate in several places, shown at F, Fig. 4, in cross section. The opening had an area of more than a dozen square feet, and of course terrible havoc was made of everything in the path of this powerful mass of expanding water. The fireman, who was on deck passing a line, was blown overboard among flying parts of the wreck, and instantly killed.

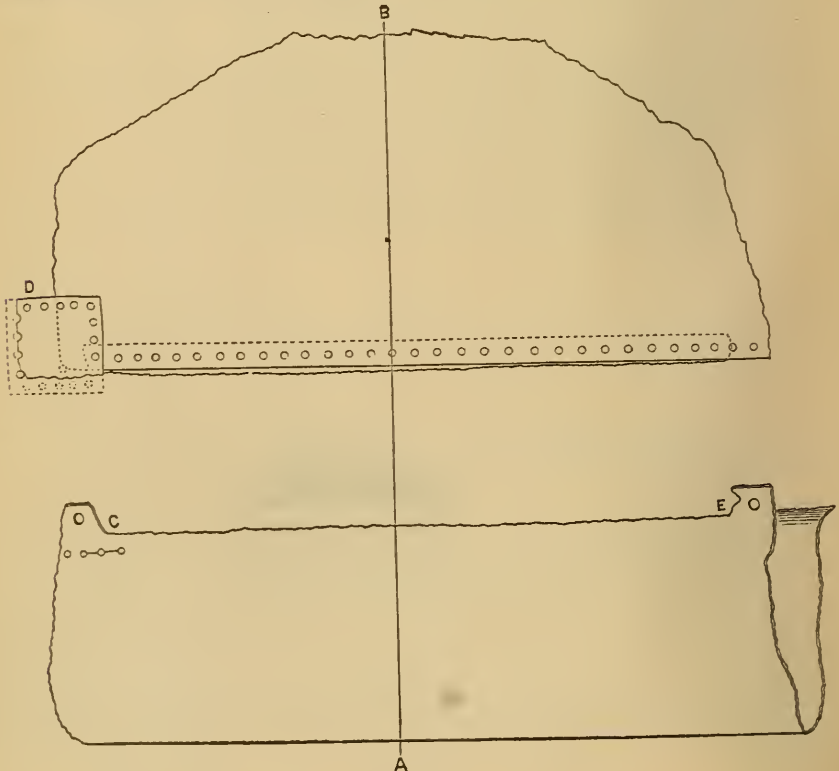

FIG. 3.

After the patching and the bolting the boiler was regularly tested, but no discovery of the weakness was made till after the disaster. Had those in charge of this boiler fully understood the significance of a leak in such a place, D, they would hardly have rested satisfied with the hydrostatic test alone, or with patching and bolting in this manner. As the physician can obtain the faculty of making correct diagnoses of obscure diseases only by carefully attending to ante-mortem symptoms and post-mortem examinations, so the engineer must solve the mysteries of boiler accidents by studying defunct structures of many different types.

Fig. 1 is a side elevation of the boiler, showing the opening caused by the explosion.

Fig. 2 is a front elevation, showing the location of the defective seam at C, and the cross stay bolts below the opening; also section of side of the vessel and the coal bunker.

Fig. 3 is a diagram of the pieces that were blown out drawn to a larger scale, C E the line of initial rupture, and D the patch.

Fig. 4 is a sectional outline of the ruptured plates on the line A B, Fig. 3, omitting the parts of the plates between the ruptured edges, showing at F the location of the old crack and the character of the secondary ruptures at the ends of the diagram, drawn full thickness of the plates.

BOILER EXPLOSIONS.

FLOUR MILL.—On Sept. 9 a boiler exploded in Hanke's flouring mill, at Fredericksburg, Texas, inflicting injuries that resulted in death upon Mr. Groaschen, the fireman, and Henry Hanke, son of the owner of the mill.

STEAMER.—The boiler of the steamer that runs on Grand Lake burst about Oct. 23, injuring two persons. The boat was aground when the boiler burst. Those who visited the scene of disaster say that it looked like an acre of kindling wood. The floor of the engine room was torn asunder directly beneath a lady's feet, and she fell into the hold.

LOCOMOTIVE.—At 9.45 P.M. Oct. 28, as the Summit, N. J., accommodation train was leaving the depot at Hoboken, the locomotive exploded and upset, and was completely wrecked. The engineer, William Swick, was found crushed to death under one of the driving wheels. The fireman, Samuel Hough, was blown into the air and landed more than thirty feet distant, severely injured. Since died.

TUG BOAT.—The steam tug Daniel Brown exploded her boiler in the East river, Oct. 29. The pecuniary loss will amount to \$15,000. The engineer, George Coons, and the cook, John Stewart, the former badly scalded, were picked up from the river. The fireman, William Vanacker, and a deck hand, Daniel Haviland, have not been found. They are probably killed.

SAW-MILL.—The boiler in McDermot & Harrolet's saw-mill, Summitville, Ind., exploded Oct. 31, seriously if not fatally injuring M. McDermot, and badly injuring Wm. A. Howard about the head. Pieces of the boiler were thrown a quarter of a mile. One piece went clear through a house close by, barely missing a little girl who was standing in the doorway. Damage to the mill, \$4,000.

SAW-MILL.—The boiler in Garnett's saw-mill, Delaware, Ont., exploded on Nov. 3, killing Edward Johnson, the engineer, and injuring three others. The building was completely wrecked.

FLOUR MILL.—A flue collapsed in one boiler of a battery of three boilers, Nov. —, in Atlantic Flour Mills. One fireman was terribly scalded, and died in a few hours.

SUGAR HOUSE.—The boiler exploded, Nov. 3, in the sugar house at Fa Saling, St. Charles Parish. Two men were killed and four wounded. Four mules were also killed, and the building was damaged.

FOUNDRY.—About six o'clock A. M., Nov. 6, the boiler in the Sessions' foundry in Bristol, Conn., exploded. The boiler was thrown over the back yards of several houses, a distance of forty-two rods. Thence it bounded through the side of a barn and came to a stop in a mow of bundled oats. Mr. Lewis was at the time in the barn. Eli Norton, who lives nearest the foundry, but at a distance of perhaps a hundred yards, was sweeping away the light fall of snow for a path from his house to his barn, at the time of explosion, and when the sheet iron cap of the boiler lit down beside him, he made rapid tracks for shelter. Charles Bennett, the watchman at the foundry, and the only person there at the time, was found two or three rods from the boiler house, near the coal shed, with his boots off, considerably injured. He could not give a lucid explanation of the affair.

CEMENT PIPE WORKS.—The steam boiler at Samuel Snell & Co's cement pipe works, Holyoke, Mass., burst Nov. 11, at 11 A. M., demolishing the engine and boiler-house and part of the main building.

SHINGLE AND SASH MILL.—At 2 P. M., Nov. 15, a boiler at the shingle mill and sash-works of Woods & Reynolds, three miles below East Saginaw, Mich., exploded with terrific force, completely wrecking the brick boiler-house, demolishing a brick chimney sixty-eight feet high, and wrecking the drill-house. One section of the boiler was thrown 200 feet and lodged in Saginaw river, and another section was thrown 100 feet in an opposite direction. The fireman was thrown through the boiler-house and into the river, 150 feet away. One other man was killed, and two injured. Damage estimated at \$8,000.

ROLLING MILL.—A boiler in the Cleveland rolling-mill exploded Friday evening, Nov. 14, scattering pieces of iron in all directions. Damage \$2,000.

LOCOMOTIVE.—The boiler of an engine attached to a material train on the Greenville & Columbia Railroad exploded, Nov. 17, near Belton, S. C., instantly killing the engineer, fireman, and another man.

PLANING MILL.—The boiler of a shingle and planing-mill at Hermansville, Mich., exploded Nov. 20, dangerously, if not fatally, injuring the engineer, a man named Rappé.

PORTABLE SAW MILL.—A terrible explosion of a portable saw-mill at Rush Creek, Ind., occurred Nov. 25. The mill was blown to atoms. Joseph Hougher, engineer, was struck by a piece of the boiler and carried across the roadway. He was crushed into an unrecognizable mass. Three school children near the mill were cut and scalded, but not fatally.

LOCOMOTIVE.—At Lemont, Nov. 25, a locomotive of the Chicago & Alton south-bound express blew out her shell sheet over the fire-box, by which the engineer, Stephen Akers, was scalded, probably fatally.

STATIONARY.—A stationary engine boiler at Marshall, Tex., exploded Nov. 25, severely injuring James Wells, engine repairer, and William Arnold, engineer. Wells may recover, but Arnold will die.

PLANING MILL.—A boiler in the Eau Claire Lumber Company's Planing Mill exploded with terrific force at four o'clock P. M., Dec. 1, killing Engineer Haskins, Fireman Hosplin, and a teamster named Galligher. The force of the explosion was so great as to be felt all over the city, and fragments of the wreck were scattered for blocks distant. Several other employes were more or less injured.

IRON FURNACE.—Two boilers of the Girard furnace, at Youngstown, O., exploded Dec. 2 with terrific force, wrecking the engine-house and badly damaging the furnace. Two men were buried in the debris, and one, Amos Llewelyn, was killed.

SHINGLE MILL.—The boiler in the shingle-mill of E. Keeler, Edmore, Mich., exploded Dec. 3. Luckily no one was injured, though men were at work in the mill.

RUBBER STAMP FACTORY.—A vulcanizer made of 1-16 inch copper and 14 inches in diameter, used in J. R. Murdock's rubber-stamp manufactory at Cincinnati, exploded Dec. 5, severely, if not fatally, injuring Mr. Jants, the engineer, and a workman.

GRIST MILL.—A steam boiler in Bartholomew's "Riverdale" steam saw and grist-mill in West Springfield exploded Dec. 13, damaging the building considerably. The hour was noon, and the workmen were outside of the mill at the time.

LOCOMOTIVE.—William Gibbons was killed and Alex. Jones fatally injured by an explosion of a locomotive, Monday, Dec. 15, on the Peoria railroad.

SAW MILL.—A boiler in Louis Trumbull's saw-mill at Collins, Ind., exploded Dec. 16, killing Trumbull, his two sons, and two other persons. Pieces of the mill and boiler were thrown some forty rods away. The boiler was a large two-flue one, and had been in use about two years.

FLOUR MILL.—At seven o'clock Tuesday morning, Dec. 23, a terrific explosion occurred at the Eureka flouring mills, at Newport, Ind. The engineer was blown sixty feet down an embankment and mortally wounded. The engine-room was blown to atoms, and the boiler lodged 100 feet from the mill. The explosion was heard ten miles off.

SAW MILL.—The boiler burst in Gabbard & Curry's saw-mill, Harrodsburg, Ky., Dec. 17, killing Gabbard, one of the proprietors, his son John, the engineer, and mortally wounding another son, George.

SAW MILL.—The boiler in Simeon Brown's saw-mill, Corinth, N. Y., exploded Dec. 6. It weighed 7,000 pounds, and was divided nearly in halves. The two parts were thrown 1,400 feet apart. No one was injured.

COTTON MILL.—The boiler in the Readville cotton-mill at Hyde Park blew up Saturday, Dec. 27, destroying \$1000 worth of property, and badly scorching James Isnor, the watchman, and stripping him of all his clothes.

LOCOMOTIVE.—At Newton, Iowa, Dec. —, two men were killed by the explosion of the boiler of a locomotive.

FLOUR MILL.—At 9.30 P. M., Dec. 29, a boiler explosion at the Etna flouring mills, at Springfield, Ills., filled the neighborhood for two blocks around with splinters, bricks, and fragments of iron. Buildings in the vicinity were considerably shattered. Glass windows were destroyed for several blocks. The damage is \$25,000. The dome of the boiler fell on the roof of the Western Union telegraph office and passed down to the third floor. The engineer is missing. His hat was found on the top of a building two blocks away, and it is thought his body will be found on some other building. His name was Raedder.

LOCOMOTIVE.—A steam pipe on the locomotive Sargent burst, Dec. 29, as it was hauling the "Modoc" out of the Pittsfield yard, and another engine brought out to assist the train up to Hinsdale, Mass., blew out a flue a few minutes later, and the train was delayed over an hour.

FACTORY.—A boiler in a factory in the St. Louis quarter of Paris exploded, Dec. 30, killing six persons and injuring two.

STEAMER.—The steamer *Prairie City*, plying on Wabash river between New Harmony and Wabash station, Ind., on the St. Louis & Southeastern Railroad, blew up Dec. 27, above Hodge's landing, and a fireman, cabin boy, and female cook are missing. The body of Mrs. Capt. McIntyre has been found with both arms off. Capt. Cox, who was at the wheel, was blown up with it. The engineer received slight injuries.

SAW-MILL.—The boiler in Benjamin Taylor's saw-mill at Calf Creek, Ark., exploded about Dec. 28, killing instantly his son-in-law Wade Campbell, Wade Griffin, and two men named Kennedy and Woodward. Campbell was blown about 30 feet through the top of an apple-tree, and one of his hands was found 75 yards distant. Griffin was literally torn to pieces, while the other two were not so badly mangled. The inexperience of Campbell, temporarily acting as engineer, probably caused the accident.

FOREIGN.

HOWARD SAFETY BOILER.—Among the foreign explosions is mentioned one of a Howard Patent Safety Boiler, at Middleborough, England. One English company has records of seventeen explosions of these same safety boilers, by which thirteen persons were killed, and five others were injured.

WORKS OF BALME & PRITCHARD.—A large boiler in the works of Balme & Pritchard, in Halifax, England, exploded on the 9th of October, killing six persons. The front head blew out and the shell and flues, weighing twelve tons gross, were projected over 100 feet from the seating.

DYE WORKS.—An upright dye-wood boiler exploded at the dye works of W. Grandage & Co., Bradford, Eng., on the 19th of November, killing one person, maiming several others, and causing considerable damage to property. The bottom broke off, and the boiler, which was upright, took a most astonishing flight upward.

STEAM MILL.—A two-cylinder boiler exploded in the steam mill of Messrs. G. Göbels, in South Gladbach, Europe, on the 1st of September.

IRON WORKS.—On the night of the 28th of August, a boiler exploded in an iron smelting house in Laband, Upper Silesia, by which a great part of the "Labander Eisenhutte" was laid in ruins, and a number of persons lost their lives.

CHEMICAL WORKS.—On the 15th of August an apparatus for the manufacture of Alizarin exploded in a chemical works in Ludwig harbor. One workman was killed and six others injured.

"GERMAN" MILL.—In Gambitz near Strehlen, a boiler explosion instantly killed the son of the proprietor of the mill. The fireman was buried beneath the ruins of the mason-work.

ELASTIC GOODS FACTORY.—In Berlin, on the 4th of December, a vulcanizing vessel exploded with terrific force. The cover and the contents were thrown through the adjacent timber work of the structure, and the mason-work was ruined.

THE ELECTRIC LIGHT AT SEA.—The pioneer in the use of the electric light in the passenger steamers, the Inman steamship *City of Berlin*, arrived at this port, October 14. Six electric lamps were employed, four in the main saloon and two in the steerage, each of 400 candle power. The passengers expressed themselves as highly delighted with the new method of illumination.—*Scientific American*.

The new insurance law of Missouri requires all insurance companies to have at least \$200,000 cash capital.

Inspectors' Reports.

The work of the company's inspectors during the months of October and November 1879, foot up as follows:

Whole number of inspection visits, 2,937; whole number of boilers examined, 6,603; of which number 2,488 were thoroughly inspected internally and externally. The hydrostatic test was used in 657 cases, mainly upon new boilers and those that had undergone repairs, to test the tightness of the work. It was besides used in all cases *where local laws require its use*.

In the accomplishment of this work 3,395 defects were brought to light, and out of that number 883 were of such a character as to require immediate repairs.

The nature of the defects is exhibited in the following list of details: Furnaces out of shape, 167—43 dangerous. Fractured plates, 272—143 dangerous. Burned plates, 203—73 dangerous. Blistered plates, 519—53 dangerous. Sediment and deposits, 549—110 dangerous. Scale and incrustation, 652—102 dangerous. External corrosion, 258—102 dangerous. Internal corrosion, 117—43 dangerous. Internal grooving, 26—9 dangerous. Defective water gauges, 71—22 dangerous. Defective blow-outs, 39—16 dangerous. Safety valves overloaded, 45—25 dangerous. Defective pressure gauges, 308—71 dangerous. Boilers without gauges, 70—1 dangerous. Deficiency of water, 6 cases—5 dangerous. Broken braces and stays, 93—65 dangerous. Boilers condemned, 48.

The above chapter of defects is replete with warning, which the prudent manufacturer will make a note of. Now, of all other times, when a lively demand for his goods is springing up, should the manager see that his motive apparatus is in thoroughly safe working order. Besides the danger to the lives of his operatives, there are purely business considerations which require that his boilers should be in the best possible condition to keep his works in full and uninterrupted operation, as well as the undoubted economy of "stitch in time," which will be applied only pursuant to the discovery that there is a defect requiring it. Though the search for boiler defects is for something that you *hope* you will not find, still prudence dictates that it shall be thorough and intelligible, and if found, promptly corrected. The long list of destructive boiler explosions which this new year's number of the new series of THE LOCOMOTIVE contains, though it has its uses, need not be forced upon the attention of men of forethought, who recognize prudence and vigilance as the essential elements of good luck in business. The vexations and expense attending the stoppage of a manufactory in the full tide of prosperous work is more frequently caused by some suddenly developed weakness or rupture in the steam department than by any other accident. These may be avoided almost entirely by proper and timely inspections.

Analysis of Water for Steam Boilers.

The company is now prepared to examine water (*gratis for its patrons*) as to its fitness for use in Steam Boilers, or for domestic purposes, by a method of qualitative analysis which is most approved by modern chemists. The company's laboratory is fitted with all the necessary appliances for this special purpose, as well as the analysis of boiler scale and sediment. Those of our patrons who find that they have bad water should select a *clean glass bottle* or demijohn, *not stone jug*, that will contain a couple of quarts, fill it *quite full* of water from their source of supply, seal the cork with wax and send by express marked *water for analysis—keep from freezing*; notify the President of the company that it is on the way, and describe the location of the spring, well, or river, and the means by which the water is brought to the mill. If the water comes from marshy or swamp lands, or is from a well in the vicinity of a mine or chemical works, tannery, etc., etc., the fact should be mentioned.

The Locomotive.

HARTFORD, JANUARY, 1880.

The first issue of THE LOCOMOTIVE was in November, 1867. It was started for the purpose of giving the public information bearing upon the use of steam boilers. Works upon steam engineering were accessible to comparatively but few, and many of those were so theoretical, abounding in mathematical formula, as to be of little service to men of ordinary education. The subject of boiler explosions was surrounded with mystery. Such accidents were attributed to electricity, explosive gas, and a host of mysterious agencies. There were men who would go away outside of all evidence, to construct a "mysterious theory," when the plain facts were before their eyes in the form of faulty construction, corrosion, grooving, or some other of the many defects incident to "wear and tear" that point directly to disaster. We have taken the ground from the first that there was no mystery in boiler explosions, and we are, after fourteen years of experience, having examined scores of exploded boilers, convinced that our course was correct.

THE LOCOMOTIVE, together with our Annual Reports, has been the medium of communication with the public. The demand for these publications, in this country and in foreign countries, has far exceeded our expectations.

With this number of THE LOCOMOTIVE we commence a NEW SERIES, and future numbers, in size and general make-up, will conform thereto. We shall continue our discussion of questions bearing upon material for boilers, construction, care and management, and explosions, introducing from time to time illustrations to better explain our views. The inspection reports will be continued, also statistics of boiler explosions, and we trust the new departure will be acceptable to our patrons. Our motto is "*Fiat Lux*," and we intend that the people shall have light on the subject of steam and steam boiler explosions.

We call particular attention to the illustrated articles on explosions in this number. They will prove profitable studies to those who are investigating the causes of boiler explosions with a view to divest them of mysterious agencies. The day is past when steam users will be satisfied with fulsome dissertations by persons who are wedded to impractical theories. Nothing short of intelligent investigation by persons of experience, with an honest purpose to seek out the true cause of boiler explosions, will be acceptable now. With all such we are in hearty sympathy.

An announcement was published about a year ago to the effect that the Hartford Steam Boiler Inspection and Insurance Company would furnish its patrons with approved plans and specifications for Steam Boilers, their settings and attachments. The great number who have availed themselves of this offer signifies that the manufacturing public appreciate the labors of this company, the legitimate tendency of which is to render the use of steam economical as well as safe; and it is gratifying to be able to say that the plans recommended have proved eminently successful even in competition with the most high blown patents.

Mr. S. N. Hartwell, an engineer of long experience with both marine and stationary steam boilers, and who has been in this company's employ for nearly six years, will hereafter be on the editorial staff of THE LOCOMOTIVE.

Superheated Water.

The following is an extract from an article published some years ago in the *American Artisan*. It was written by Mr. A. Guthrie, formerly U. S. Supervising Inspector-General, and the ten experiments seem to include about all the methods of deaerating water that are likely to occur in the use of steam boilers.

"In the *American Artisan* of the 20th inst. (page 45), I was pleased to find some communications from correspondents of your valuable paper in reference to boiler explosions being caused by de-aerated and "superheated" water. This theory—that water deprived of its natural proportion of air can ever be heated above a boiling point due to the pressure, and in consequence becoming explosive—has, in my humble opinion, gone far enough to meet a positive contradiction. A theory advanced by M. Donny, an obscure chemist, as long back perhaps as 1770, being of itself simply ridiculous, has found advocates up to the present day. That this theory has been copied into many works on chemistry and science, and assented to by learned men during one hundred years, excites my wonder; but that it has not found its refutation in its own absurdity seems to me still more singular. I am glad to see that at least one of your correspondents, Mr. Geo. B. Brayton, has the boldness to contradict it.

I have made many experiments to satisfy myself of the truthfulness of this theory, and have endeavored to conduct them with perfect fairness and impartiality, and with all the care that my feeble abilities would permit. I am entirely satisfied that there is not a shadow of truth in the Donny theory, that water deprived of air boils at a higher temperature or at any different temperature than water not so deprived; nor is there any foundation whatever for the statement that such water has the slightest explosive tendency more than any other water. I mean, exactly, that it will boil at 212° Fahrenheit when other water does, and that it will come to the point of ebullition without a particle of tendency to explosion, no more than any other water, just this, exactly.

I concede that Prof. Tyndall has in his lectures in a manner given credit to this theory; but the moment after, and before concluding, he disclaims his belief in it so plainly that it need not be misunderstood.

I admit that Brand and Taylor in their work on "Chemistry" (which, by the bye, is a work of exceeding value), with many other distinguished writers have adopted this theory as the true one; but I am led to think it has been adopted without reflection and without investigation. It may appear to be great presumption in me to contradict this theory with the positiveness I do; but did I not suppose I had given it the fullest investigation, with just as good means to give it a fair trial as any one, I should not venture to contradict.

In the first place, I assume as true that all natural water has a small percentage (say two and a half) of atmospheric air mixed with it; in this I believe we all agree. Now, then, I assume that this air may be expelled in the process of congelation by boiling for a given time; by distillation out of contact of air; by placing it *in vacuo*; and by being absorbed in fish or water-breathing animals in their kind of respiration. I suppose there is little difference of opinion upon these points.

(1.) In my experiments, I first procured a sample of water from the boiler of an ordinary condensing engine; here, of course, in addition to being subjected to long-continued boiling, it had passed through the vacuum.

(2.) I procured a sample from the ordinary high pressure non-condensing engine boiler, which before entering the boiler had passed the heater at 210°.

(3.) I procured some clean snow and dissolved it under oil, so that there was no contact with the air.

(4.) I froze some water in a long, upright tube, using only the lower end of the ice when removed from the tube, and dissolved under oil.

(5.) I placed a bottle of water under a powerful vacuum pump worked by steam, for two hours; agitating the water from time to time to displace any air that might possibly be confined in it, then closed it by a stop-cock, so that no air could possibly return.

(6.) I boiled water in an open boiler for several hours, and filled a bottle half full, closed and sealed it up, so that when it became cool it would in effect be under a vacuum, agitating it as often as seemed necessary.

(7.) Another bottle was filled with the same, and sealed.

(8.) I next took some clean, solid ice, dissolved it under oil, and brought it to a boil, which was continued for an hour or more, after which it was tightly corked.

(9.) I procured a bottle of carefully distilled water, after long boiling and having been perfectly excluded from air during the distillation.

(10.) I obtained a large number of small fish, placed them in pure, clean water in an open headed cask on a moderately cold night, so that very soon it became frozen over, consequently excluding the air, the fish breathing up the air in the water, so that (if I am correct in my theory) a water freed from air would be the result; but in *some* of these different processes, if not in all, I was likely to free the water from air, if it could ever possibly occur in the ordinary course of operating a steam boiler.

Having procured a good supply of glass boilers adapted to my purpose, and so made that the slightest changes could be noted, and using as delicate thermometers as I could obtain, I took these samples one after another, and brought them to the boiling point; and every one, with no variation whatever, boiled effectually and positively at 212° Fahrenheit or *under*; nor was there the slightest appearance of explosion to be observed."

Conundrum—When is a Safety-Valve not a Safety-Valve?

General answer. When it is a little "*Jammed.*"

The multitude of patent devices called safety-valves, and the frequency of boiler explosions which arise from defective and overloaded safety-valves of the simpler forms, suggest the importance of the greatest care in the application and management of this vital organ of the steam-generating system. The idea is too prevalent among boiler attendants and engineers of average intelligence that, once properly proportioned and adjusted, their apparatus is in a permanently safe condition, but the number of answers that may be given to the above proposition attests the ignorance of first principles of safety which so often appears in the neglect of the safety-valve or in so tampering with it as to render it inoperative. A few of the more frequent defects are suggested by the following answers:

A safety-valve is not a safety-valve:

(1.) When the fireman, in response to the demand of the owner for more steam, or to stop a continual leak, hangs his fire rake or poker on the lever so that the handle hangs down over the boiler side-wall at an angle and *jams* the lever against its guides.

(2.) When a few bricks or an old grate bar is added to the regular weight for the same purpose.

(3.) When the valve has not been raised for a long time and has become cemented to its seat by corrosion.

(4.) When the stem is bent or corroded so as to bind in the bonnet.

(5.) When the stem has been painted, to prevent corrosion, with a gummy stuff that is baked fast into the joint by the heat.

(6.) When the stem is too short, and the lever slopes down toward the weight and *jams* the stem hard against the sides of its bearing in the bonnet, causing it to stick as well as the valve to leak.

(7.) When the top end of the stem is flat, so that on raising its bearing is changed from the general surface of the top to the edge next to the fulcrum, thereby causing an angular bearing that *jams* or causes it to drag, as well as alters the proportions unfavorably between the long and short arm of the lever.

(8.) When a stop-valve is placed between the safety-valve and the boiler which may be left closed through carelessness or inattention.

(9.) When a plug has been left in the only steam outlet inside the boiler to stop steam or hot water coming from an adjoining boiler through a leaky stop-valve while cleaning or repairs is going on.

(10.) When a wooden strut is wedged between the lever and ceiling or roof of the boiler house.

(11.) When the escape pipe is too small to allow of the free discharge of the full volume of steam which the boiler is capable of generating.

(12.) When the escape pipe is so located as to retain a quantity of water in a low place or pocket, which may come from external rains or internal condensation of steam and become frozen over Sunday or a holiday, so as to effectually plug the pipes and prevent the escape of the steam except around the stem through the bonnet.

(13.) When the stem and pins are too nicely fitted, and no allowance made for dirt, dust, and ashes, or the arc described by the steam pin as it rises.

(14.) When the apparatus is inaccessible, invisible, and so close to the roof or ceiling that the settling of them from an overload prevents the raising of the lever.

(15.) When to a light, brass-bodied valve of the wing type, having on one side a steam and on the other a safety outlet, there is attached a long unsupported steam pipe, which by its leverage so distorts the valve body as to *jam* the wings and cause the valve to leak, and effectually prevent it from leaving its seat.

(16.) When a patent spring valve has been unequally screwed down, so as to tilt the cross-bar on which the spring bears and through which the stem passes as a guide, thereby *jamming* the stem and making it inoperative.

Should these propositions fall under the scrutiny of any veteran engineer who has never done or permitted anything of this kind, and who will exclaim, "Any man who don't know any better than to do or neglect to do such things is little better than a natural fool or a lunatic, and has no business with a steam boiler," to him I say, my contempt for such stupidity is not less than his. So the careful business man who is precise and methodical in all his movements, and who has been trained in a school where mistakes are about equivalent to crimes, and who is especially particular to properly superscribe all his postal matter and to see that it is duly stamped and sealed, has no better opinion of or patience with the "careless fool," as he calls him, who sends a postal card without a superscription, sends a draft in an unsealed envelope, or despatches an important message or business order unstamped. Yet we are informed by postal statistics that thousands of such cases occur annually. While I do not pretend to say that these things which you and I condemn as acts of criminal carelessness are by any means the prevailing practice even among the most ignorant and foolhardy of boiler attendants, or that they are often repeated by the same person, still these answers are none of them fictions or overdrawn pictures of facts. Though you and I need not the suggestions which they offer, yet they are important, and as curiosities of carelessness and ignorance they may serve as reminders that no one is infallible, and that "to err is human."

We often hear of one of the old corps blowing himself up without leaving an account of how it was done, and notably within a few days one who had the reputation of being a careful and intelligent engineer, and who was in the same employ for many years. Grave suspicions are entertained by at least one observer that his safety-valve was *jammed*.

"T." WATER.

Incorporated
1866.



Charter Per-
petual.

Issues Policies of Insurance after a Careful Inspection of the Boilers,

COVERING ALL LOSS OR DAMAGE TO

BOILERS, BUILDINGS, AND MACHINERY,

ARISING FROM

Steam Boiler Explosions.

THE BUSINESS OF THE COMPANY INCLUDES ALL KINDS OF STEAM BOILERS.

Full information concerning the plan of the Company's operations can be obtained at the
COMPANY'S OFFICE, HARTFORD, CONN.

Or at any Agency.

J. M. ALLEN, Prest. W. B. FRANKLIN, Vice-Prest. J. B. PIERCE, Sec'y.

Board of Directors.

J. M. ALLEN, President.	GNE. WM. B. FRANKLIN, Vice-Prest. Colt's Pat. Fire Arms Mfg. Co.
LUCIUS J. HENDEE, Prest. Etna Fire Ins. Co.	GEO. CROMPTON, Crompton Loom Works, Worcester.
FRANK W. CHENEY, Asst. Treas. Cheney Brothers Silk Manufacturing Co.	HON. THOS. TALBOT, Ex-Governor of Mass.
CHARLES M. BEACH, of Beach & Co.	NEWTON CASE, of The Case, Lockwood & Brainard Co.
DANIEL PHILLIPS, of Adams Express Co.	WILLIAM S. SLATER, Cotton Manufacturer, Providence, R. I.
GEO. M. BARTHOLOMEW, Prest. Amer. Nat. Bank.	NELSON HOLLISTER, of State Bank, Hartford.
RICHARD W. H. JARVIS, Prest. Colt's Fire Arms Manufacturing Co.	D. R. SMITH, Prest. Springfield Fire & Marine Ins. Co.
THOMAS O. ENDERS, Sec'y Etna Life Ins. Co.	
LEVERETT BRAINARD, of The Case, Lockwood & Brainard Co.	

GENERAL AGENTS.

THEO. H. BABCOCK,
CORBIN & GOODRICH,
LAWFORD & McKIM,
W. S. CHAMBERLIN,
J. L. SMITH,
H. D. P. BIGELOW,
C. C. GARDINER,
D. C. FREEMAN,
W. G. LINEBURGH,
GEO. P. BURWELL,
W. B. CASSILY,

CHIEF INSPECTORS.

R. K. McMURRAY,
WM. G. PIKE,
JOSEPH CRAGG,
WM. U. FAIRBAIRN,
B. M. LORD,
H. D. P. BIGELOW,
J. S. WILSON,
F. S. ALLEN,
W. S. FOX,
A. C. GETCHELL,
J. S. WILSON,

OFFICES.

NEW YORK CITY.	Office, 285 Broadway.
PHILADELPHIA.	" 430 Walnut St.
BALTIMORE.	" 10 So. Holliday St.
BOSTON, MASS.	" 10 Pemberton Sq.
PROVIDENCE, R. I.	" 42 Weybosset St.
CHICAGO, ILL.	" 132 LaSalle St.
ST. LOUIS, MO.	" 404 Market St.
HARTFORD.	" 218 Main St.
BRIDGEPORT.	" 328 Main St.
CLEVELAND.	" 246 Superior St.
CINCINNATI.	" 53 West Third St.

The Locomotive.

PUBLISHED BY THE HARTFORD STEAM BOILER INSPECTION AND INSURANCE COMPANY.

NEW SERIES—VOL. I. HARTFORD, CONN., FEBRUARY, 1880.

No. 2.

Explosion of a Patent Boiler, and a short chapter of Boiler History.

He who would invent a new steam boiler would do well to look over the record of failures in this line, both economic and constructive, before he peddles his wares indiscriminately. And those purchasers of steam boilers who itch for ultimate economy, and are led by some ambitious inventor or fluent salesman to believe that it is to be realized through some apparently new principle of construction, are recommended to do likewise, or employ some reliable professional adviser who has no interests at stake, to do so for them.

The boiler whose lamentable wreck is illustrated below was patented a few years ago, and before a dozen had been made, and while three or four only were at work, they

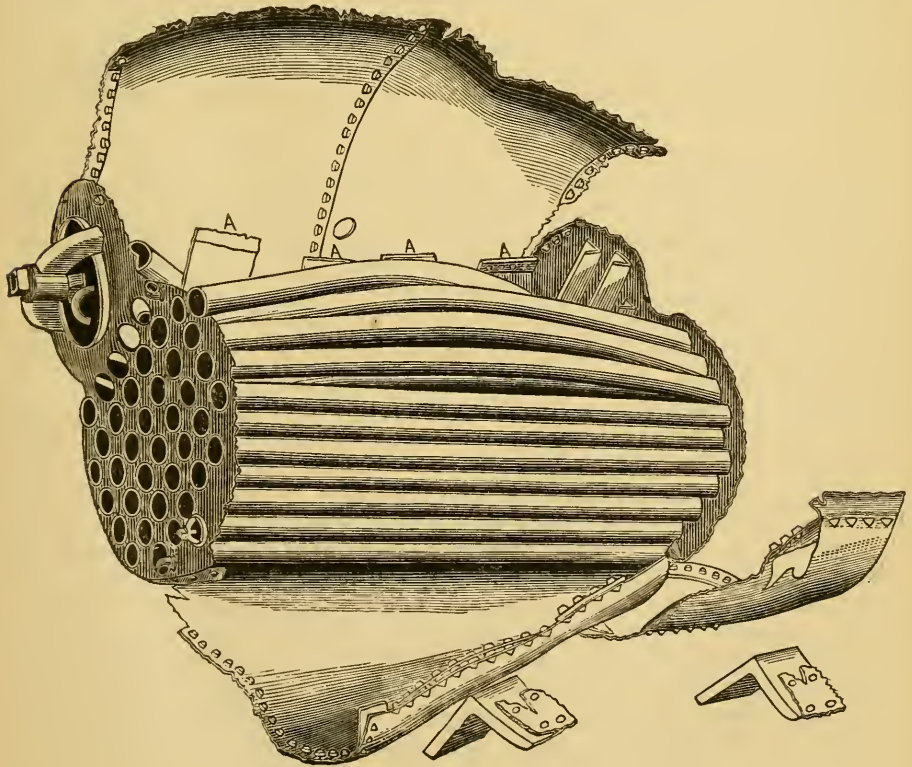

FIG. 1.

began to assert their claim to distinction. The work of destruction was initiated by a small member of this family in the summer of 1875, after having been at work but seven

days. It was illustrated in the president's annual report for that year, which also discusses other types of compound boilers, illustrating their features. He says of this one :

"Boilers are sometimes constructed on a plan entirely at variance with any rules hitherto made use of. An effort has been made to construct a boiler similar to the 'Union boiler,' with a continuous connection or leg. This idea was doubtless brought out under the impression that it was a great improvement, but a moment's examination will show that it has very weak points."

One of the cuts used in that report is reproduced here to show the arrangement of the braces (Fig. 2).

After this accident (of 1875) an effort was made to strengthen some of the larger sizes by introducing additional braces which crossed at the middle of the waist. This plan, however, was only partially successful in stopping the motions caused by the varying internal pressure, and within a short time some of the braces were broken and others were loose. The doughty builder, however, evidently considered the size hereafter described as amply stayed without the cross-bars. The braces are $\frac{1}{8}$ " thicker and $\frac{1}{2}$ " wider than the 1875 sample.

This company's inspectors have repeatedly declined to pass these boilers, considering them unsafe and uninsurable, and the company has been loudly berated by the patentee for injuring his business. He, however, soon abandoned this construction, and invented a method of joining the members of the old-fashioned "Union boiler." It is a fact worth remembering that this is the second patent that has been for like reasons abandoned by this same ingenious builder. Later improvements under the direction of the purchaser of the patent, make the boiler less objectionable.

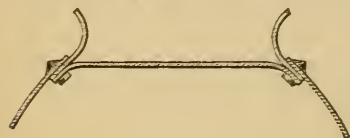

FIG. 2.

THE EXPLOSION

of the one here illustrated occurred at Holyoke, Mass., Nov. 11, 1879. The general dimensions were as follows : Shell 6 feet long, upper part 22 inches diameter, lower part 30 inches diameter, in which were 38 tubes 6 feet long by 3 inches diameter ; shell plates $\frac{1}{4}$ inch thick ; tube plates $\frac{5}{16}$ inch thick. The four braces, the ends of which are seen in Fig. 1, A, A, etc., above the tubes, are $\frac{5}{16}$ " thick by 9" wide. They were fastened as seen in Fig. 2, below the small reverse curve of the waist, by means of four of the seam rivets, to each side of the boiler. The back tube plate was stiffened by short bars of angle iron, riveted on transversely above the tubes. By examining the outline of the end plates, Fig. 1, it will be seen that the form was that of two incomplete intersecting parallel cylinders, and the drawing shows that the shell was composed of three plates, two of which formed the cover of the upper part, and that there were continuous seams from end to end joining these two plates to the one that formed the covering of the lower part. The tendency of the internal pressure being to distend this compound form into that of a single cylinder, it will be seen by examining Fig. 2 that the angles of the braces suffer a strain tending to straighten them which they are poorly able to resist, and that the rivets which fasten the braces to the seam would be pried downward as the angle of the brace yields to the straightening effect of the strain, and the effect on the rivets would be something like a "claw bar" upon a spike to which it is applied for the purpose of drawing it out. This boiler was set in brick-work, supported by four cast-iron brackets, two of which are seen in the foreground of Fig. 1 adjacent to the spots on the shell from which they were torn (a secondary effect of the explosion). The furnace was below the front or man-hole end of the boiler, and the gases passed to the rear and returned to the front through the tubes, thence through flues along the waist to the chimney at the back. The boiler was fitted with one safety valve and other mountings commonly furnished with American boilers. The valve was loaded to blow at about 75

pounds per square inch, but was supposed to be working at 40 to 50 pounds, with the engine in motion and the feed-water turned on, at the time of the explosion. The boiler had been patched to stop a leak, a few days before the accident, at the junction of the three plates on the left side (not seen in the cut); and although the boiler-maker warned the owner of the frailty of his boiler, yet it is probable that neither of them fully and correctly interpreted this symptom of distress. The boiler opened on the right side, the reaction of the issuing water and steam threw it squarely over to the left, utterly demolishing the engine and blowing the boiler-house to atoms. The air was filled with splinters and bricks, as noticed by an engineer of the C. R. Railway who was near at the time. The furnace front was thrown with great violence into the works, toward which it faced, badly damaging the building and destroying considerable stock in process of manufacture, but fortunately no person was killed, all being out of range at the moment. Upon these facts the following

HYPOTHESIS

is founded, which seems to account naturally for all the phenomena attending this explosion.

One of the middle braces, the second or third from the end, became so weakened by frequent motions caused by the straightening tendency of the internal pressure that it gave way at the angle (where it will be seen from the drawing, Fig. 1, that three of them are broken off). The rest of them, a little less weakened perhaps by the same cause, give way in turn immediately, having received a sudden accession to their load, and the shell yields and breaks at the middle of the long seam, which may also have been weakened along the margin of the inner lap, as indicated by the leak on the left side. The shell being now fairly open, the steam and water rush toward the place of least resistance, which is outward and upward, carrying the broken shell plates before them and tearing them from the end plates. The bending of the upper tubes indicates the direction which the water among them took in escaping, as also does the tearing out of the entire upper row of tubes, which it will be seen, from the one in sight on top of the cluster, were so much bent as to draw them from their setting in the tube plates. The four brackets which supported the boiler being below the opening, constituted the overbalancing resistance in the downward direction. Had the brackets been above the opening the boiler would doubtless have gone high in the air instead of tumbling over and over to the left, as observed by the attendant, who caught sight of it just before the whole scene was enveloped in steam and dust. This *hypothesis* seems to be so well supported by the facts that the word is almost like a misnomer.

Defective Boiler Rivets.

To those who are at all conversant with boiler mechanism the 10 illustrations of defective boiler rivets herewith presented will speak for themselves. To such as have seen such things, and can read their character in these cuts, it will perhaps be something of a surprise to learn that they all came from *one single boiler* that was, not many months ago, wrecked by an explosion. The publications of this company have before contained illustrations of bad rivets, and quite a collection has been made up from different parts of the country, and it would not be difficult perhaps to select from its cabinet a set similar to that presented below; but no single case is on record which will furnish a parallel in number and badness. They are samples selected from a large number taken from the same wreck. It would be an insult to the common sense and a slander on the busi-

ness character of the most careless and illiterate proprietor or master-workman to intimate that such work was knowingly permitted to leave his yard, and this article must therefore be set down as another chapter of curiosities of carelessness and ignorance.

That such work does sometimes escape the vigilance of even the honest and capable proprietor is an important fact in the history of steam industries. Correctly interpreted, it may prove an important help in dispelling the cloud of mystery which has so persistently clung around boiler accidents.

Laws and official rules regulating the thickness and quality of the plates seem to offer but little protection when they are joined together so unskillfully. Perfect immunity from accidents can only be secured through careful and intelligent inspection as the work proceeds, supplemented by periodical examinations after being set up.

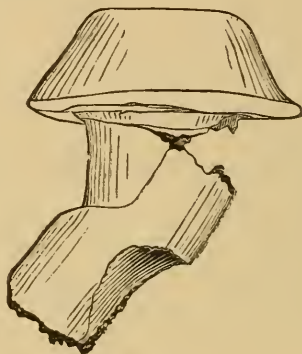

FIG. 1.

FIG. 1.—Rivet which was “driven” in over-set holes. The conical point broken off by the tearing apart of the plates. The head nearly severed from the body. Probably weakened in “driving.” From photograph full size.

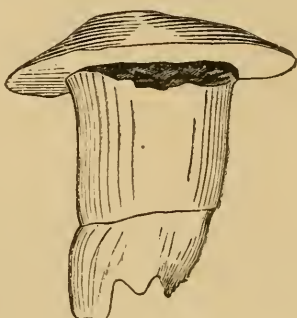

FIG. 2.

FIG. 2.—Rivet which was “driven” in over-set holes. Head broken off by the tearing apart of the plates. Conical point also nearly broken off—bad sample of “driving”—cone too flat to properly hold down the “calking edge” of the plate. From photograph, full size.

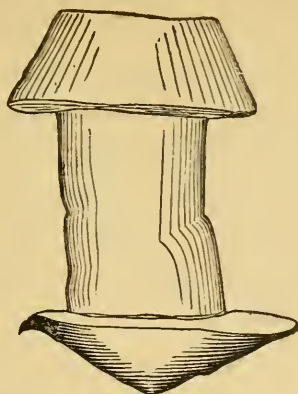

FIG. 3.

FIG. 3.—Rivet “driven” in slightly over set-holes. Point excentric and not symmetrical. Too flat to properly secure the calking edge of the plate. From photograph, full size.

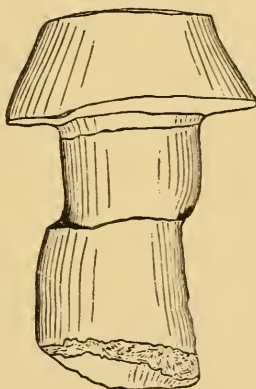

FIG. 4.

FIG. 4.—Rivet “driven” in badly over-set holes. Very weak. See Figs. 5, 6, and 7, which were “sheared” at the time of the explosion. Dark shading on lower end Fig. 4 indicates an old crack. From photograph, full size.

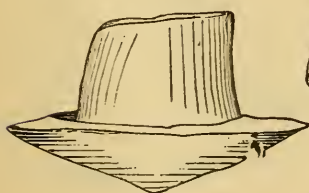

FIG. 5.

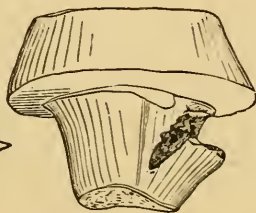

FIG. 6.

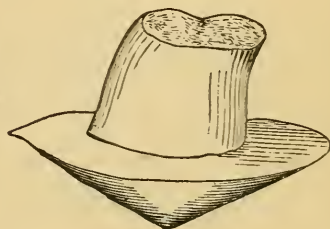

FIG. 7.

FIGS. 5, 6, 7.—Samples selected from a number taken from a “sheared” seam, which was believed to be the initial break from which the explosion arose. They were no doubt similar to Fig. 4 before they gave way. From photographs, full size.

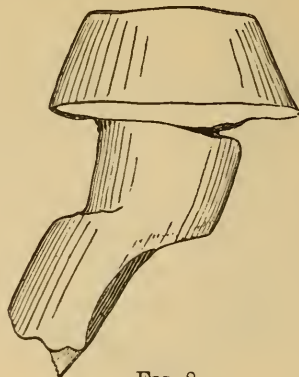

FIG. 8.

FIG. 8.—Rivet “driven” in over-set holes. Was probably fractured under the head in driving. Similar to Fig. 1. Taken from a seam that was broken through the rivet holes. From photograph, full size.

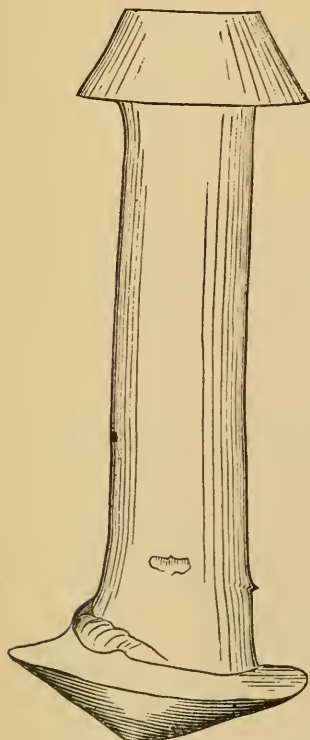

FIG. 9.

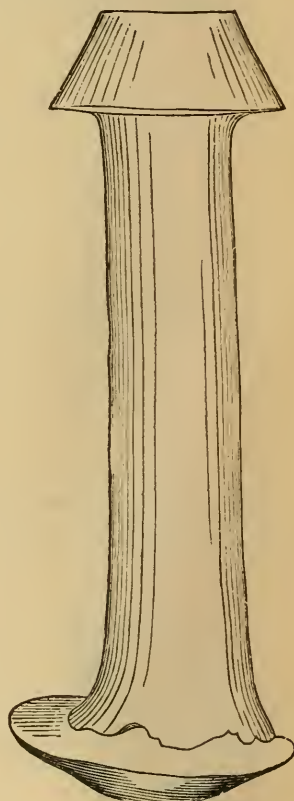

FIG. 10.

FIGS. 9 and 10.—Long rivets taken from a broken casting which they were intended to secure to the wrought-iron head of the boiler. The holes in the wrought-iron plate were “drifted” and chipped to allow the rivets to enter, as shown by the enlarged portion of the body. This irregular upsetting and the sharp little wave of iron on the body of Fig. 9 indicate the thickness of the wrought-iron plate. From photographs, full size.

BOILER EXPLOSIONS.

GRAIN ELEVATOR (1).—The steam boiler of Ray's grain elevator, Chillicothe, Mo., blew up January 2, totally wrecking the building and badly scalding and injuring the employees. The engineer, John Gadgell, had his knee badly injured. Charles Palmer had an arm broken, and was terribly scalded; John C. Cline of Cuba, Ill., was horribly scalded in the face and on the entire front part of his body, and was blown twenty feet. He will hardly recover. A boy named Givens and a man named Hoffman were both badly scalded, but will probably recover.

LOCOMOTIVE (2).—The boiler of a Houston and Texas Central railroad freight engine exploded at Dallas, Tex., Jan. 3, injuring Steve Johnson, the engineer, and G. J. Willis, a car-man, and killing a colored boy.

STEAMER (3).—Steamer Fisher, the mail boat between Pensacola and Freeport, exploded Jan. 5, killing Captain Watson and one other, and mortally scalding the engineer.

ROLLING MILL (4).—A boiler exploded Jan. 5, in the rolling-mill of Coates Bros., at Locust Point, Baltimore, by which the mill was considerably wrecked and a number of employees seriously injured. The boiler was elevated some eight or ten feet from the floor of the mill, and its fragments passed out through the north and west sides and end of the building. The day men had just gone off, and the night force had gone to work. Eleven employees in the mill were injured. The dome of the boiler was thrown 150 yards. The rear of several small dwelling-houses immediately west of the mill were damaged. Loss \$10,000.

SAW-MILL (5).—The flues blew out of the boiler in N. Voodrie's steam saw-mill, Orwell, N. Y., Jan. 10, so badly scalding a son of the proprietor that his life is despaired of. The boiler was an old one.

SAW-MILL (6).—A boiler of a steam mill on the wood-lot of J. H. Pike, in Tremont, N. H., exploded Jan. 15, and the mill was blown to atoms. A workman named Clarence Perkins was instantly killed, and another workman, Joseph Quimby of Canada, fatally injured. Two other workmen escaped with slight bruises. Portions of the boiler, engine, and mill are scattered for hundreds of feet in every direction.

LOCOMOTIVE (7).—The locomotive Sirius of the Southern road started a seam in her boiler several inches long while in the engine house, Jan. 17. It was found necessary to draw the fires at once. The locomotive was taken to the shop for repairs.

LOCOMOTIVE (8).—The parallel rod to the engine of the paymaster's train was broken, Jan. —, between Manchester and Lawrence, punching a hole through the boiler and badly scalding Charles E. Jones, engineer, and Charles Webster, fireman, both of Concord. The engine and cab were badly damaged.

SUGAR HOUSE (9).—A sugar boiler at Carroll's plantation, Barratoria, La., exploded Jan. 20, killing Willis Wright, colored, Arthur Porrier, chief engineer, and a colored man, and seriously wounding thirteen others, some of whom are not expected to recover. The damage to the sugar-house is \$8,000.

IRON FURNACE (10).—The boiler of the Montgomery Furnace, Port Kennedy, Pa., exploded Jan. 20. The loss will be heavy, as the furnace will have to be put out of blast. No one was injured.

COAL MINE (11).—A special from Brazil, Ind., reports an explosion in the boiler-room of the Vach coal mine, Jan. 22, killing R. R. Roberts, the owner of the mine, and fatally injuring William Elder and a blacksmith named Jones. Roberts was blown into fragments.

SAW-MILL (12).—Joseph Grant and Seth Degarmo were killed Saturday, Jan. 24, by the bursting of a boiler in a saw-mill near Cleveland, O.

STEAMER (13).—The explosion of the boilers of the steamer Idlewild, near Evansville, Ind., came near filling the United States Marine Hospital with wounded. There were twelve fractures of the bones of the legs, and two required amputation.

LOCOMOTIVE (14).—Just after the train on the Western North Carolina Railroad passed Statesville, N. C., going east, January 28th, the boiler of the engine exploded with terrific force. The engine was stripped of almost all of its upper works. The wrought-iron side bars were rent in twain, and the smoke-stack was blown a considerable distance. The engineer and another man were seriously injured. The engine, which is a very old one, was carrying only 120 pounds of steam at the time of the explosion, and running not more than twenty miles an hour.

SAW-MILL (15).—The boiler of Moloy's saw-mill, six miles northeast of Fort Scott, Kan., in Vernon county, Mo., exploded Friday, January 30th, killing Thomas Freeman, a laborer, seriously injuring and scalding Henry Moloy, the owner, and Plint Tinner, another laborer, and slightly hurting two other men.

BREWERY (16).—About noon, Sept. 19, the boiler of the Eagle Brewery, at No. 540 Tchoupitoulas street, New Orleans, exploded with a deafening crash. The machinery was in full blast at the time, and the building was full of workmen. The boiler-room was completely wrecked, and pieces as large as three feet in length were hurled through the roof, and in their descent struck houses in the vicinity with such terrific force as to smash windows and damage the woodwork considerably.

SAW-MILL (17).—Joseph Seabrook, engineer of Luter Brothers' saw-mill, Luterville, Canada, was fearfully scalded, December 30. He was in a small blow-off room, when, in some manner, the water-pipe became detached, thus permitting the forcible escape of the whole contents of the boiler in the small room. He lies in a state of intense suffering, and his recovery is problematical.

SUMMARY OF EXPLOSIONS FOR YEAR 1879.

1879.	Jan.	Feb.	March.	April.	May.	June.	July.	August.	Sept.	Oct.	Nov.	Dec.	Total.
Boilers,	10	16	9	12	5	10	7	14	8	10	13	18	132
Killed,	18	38	4	9	3	34	12	17	12	11	16	34	208
Injured,	15	36	20	15	10	20	18	19	11	15	16	18	213

Classified list of Boiler Explosions: published in THE LOCOMOTIVE as having occurred in the year 1879.

KIND OF WORKS.	Number of Boilers Exploded.	Number of Persons Killed.	Number of Persons Injured.
Sawing, Planing, and Wood-working Mills, - -	41	56	51
Railroad Locomotives, - - -	16	25	17
Steamboats, Tug-boat, Yachts, and Steam-barges, - -	13	41	49
Paper, Flouring, and Grist Mills, - - -	10	8	7
Portables, Hoisters, Threshers, Pile Drivers, - - -	9	42	42
Iron Works, Rolling Mills, Furnaces, Foundries, and Machine Shops, - - -	10	4	6
Cotton, Woolen, and other Fabrics, - - -	8	9	11
Distilleries, Breweries, and Sugar Refineries, - - -	8	5	3
Mines, Oil Refineries, and Wells, - - -	4	9	6
Rendering, Slaughtering, and Chemical Works, Rubber Works, and Railroad stationaries, - - -	4	5	4
Miscellaneous—Brick, Cement, Tile, Bath, Bleachers, School-house, and Needle Works, - - -	9	4	7
Totals,	132	208	213

Close of 1879 Record.

Inspectors' Reports.

The figures below exhibit the work of December alone, which is the largest and most impressive report that has ever been published by this company, and is the one hundred and fifty-ninth monthly statement made by its inspectors. Further on are printed figures for the year ending with and including the one hundred and fifty-ninth monthly statement.

The whole number of inspection visits made during the month of December, 1879, was 1,549, and the whole number of inspections made was 3,493, of which 1,355 were thorough annual internal inspections. The hydrostatic test was used in 238 cases, sometimes as an auxiliary means of inspection, the hammer test being mainly depended on for the detection of defect in boilers that have been in use for some time. It is required by the local laws in some cities to be used *on all boilers*, but it is fast losing the popularity among steam users as a means of ascertaining the progress of deterioration which is an inevitable result attending the use of steam boilers. It is used by this company's inspectors (when optional with them) mainly upon new boilers and those that have undergone repairs to test the tightness of the work.

The whole number of defects discovered during the month was 1,829, of which 434 were of such a character as to indicate probable disaster before the next inspection would be due. They were in detail as follows: 79 furnaces out of shape, 22 dangerous; 219 fractures, 95 dangerous; 90 burned plates, 33 dangerous; 233 blistered plates, 45 dangerous; 221 cases of sediment and deposit, 52 dangerous; 338 cases of incrustation and scale, 65 dangerous; external corrosion, 98—26 dangerous; internal corrosion, 100—7 dangerous; internal grooving, 25—20 dangerous; water gauges defective, 30—8 dangerous; blow-out apparatus out of order, 11—4 dangerous; safety valves overloaded, 14—8 dangerous; pressure gauges defective, 103—28 dangerous; boilers without gauges, 144—3 dangerous; deficiency of water, 8—3 dangerous; broken and loose braces and stays, 116—15 dangerous; boilers condemned, unfit for use, 38.

It is a suggestive fact that four-fifths (80 per centum) of the cases of internal grooving were reported as dangerous, and a large percentage of the fractures also. The cases of deficiency of water show a dangerous percentage of $37\frac{1}{2}$, and about the same may be said of the burned plates. The dangerous results of deficiency of water are sometimes only the burning and cracking of the plates, but so injuring them that if continued in use without repairs they go on weakening until no longer able to bear the ordinary working pressure. Plates are more liable to crack, of course, if cold water is pumped in while they are hot, but it is now pretty well established that, unaccompanied by some sort of weakening of the plates, the sudden accumulation of pressure due to putting water upon heated surfaces by the usual slow methods of introducing feed-water does not satisfactorily explain the phenomena attending a very large percentage of the destructive explosions. Accident (if this theory be correct) from the overheating of boiler surfaces does not always occur at the instant of overheating but at some subsequent date, the remoteness of which depends on the aggravations then and afterwards. In the matter of internal grooving, it has been repeatedly stated in the reports of the president of this company that grooving and cracks are caused by the motions, bending, buckling, and fretting of the plates while in a high state of tension, and exposed to the chemical action of the water. Continued investigation has confirmed these statements. We have observed that when unequal expansion places some of the contending members in a state of tension at or near the elastic limit of the iron, either by bending or by strains acting parallel to the surface, the weakest point will be the most affected and there the fibers will separate, and (possibly) even pure fresh water, *the universal chemical solvent*, will act vigorously upon the part where the weakness concentrates, oxidizing it, destroying its tenacity, and changing the best of tough, fibrous iron to a reddish substance that may be crumbled between

the fingers. We are familiar with the weakness attending the cutting or breaking of the "skin of the iron," but we need more observations on the opening of the "pores of the skin" when exposed to moisture. The limits allotted to this report will not allow of a full discussion. Meantime the reports that come in from the inspection department are constantly bringing us nearer to a clear understanding of this whole subject.

Yearly Summary of Inspections for the Year 1879.

Whole number of visits during the year, - - - - -	17,179
Whole number of inspections, - - - - -	36,169
Whole number of thorough annual inspections, - - - - -	13,045
Whole number of boilers subjected to hydraulic test, mostly new or repaired,	2,540
Whole number of defects discovered, 16,238. Dangerous defects, 3,816.	

Details for the year 1879.

	In all.	Dan-gerous.		In all.	Dan-gerous.
Furnaces out of shape, -	848	195	Cases of internal grooving, -	126	56
Fractures in all, - - -	1,387	684	Water gauges out of order, -	405	133
Burned plates, - - -	963	302	Blow-out ap'atus out of order,	181	61
Blistered plates, - - -	2,597	334	Safety-valve overloaded, -	234	102
Cases of deposit of sediment,	2,177	456	Pressure gauges out of order,	1,393	298
Cases of incrustation & scale,	2,791	388	Boilers without gauges, -	714	8
Cases of external corrosion,	1,162	352	Cases of deficiency of water, -	55	38
Cases of internal corrosion, -	743	188	Broken braces and stays, -	462	221

Boilers condemned, 246.

The Grand Total of the Work of the Inspection Department

OF THIS COMPANY SINCE ITS ORGANIZATION IS AS FOLLOWS:

Whole number of inspection visits, - - - - -	142,758
Whole number of inspections made, - - - - -	286,052
Whole number of thorough annual inspections, - - - - -	92,850
The hydraulic pressure was used in - - - - -	21,363 cases.
Whole number of defects discovered, - - - - -	142,032 31,183 dangerous.

	In all.	Dan-gerous.		In all.	Dan-gerous.
Cases of internal grooving, -	1,617	444	Furnaces out of shape, -	6,381	1,008
Water gauges out of order, -	5,358	1,148	Fractures, in all, - - -	11,751	5,079
Blow-out ap'atus out of order,	2,257	802	Burned plates, - - -	8,592	2,845
Safety-valve overloaded, -	3,620	1,393	Blistered plates, - - -	20,638	3,032
Pressure gauges out of order,	15,571	2,824	Cases of deposit of sediment,	18,982	3,230
Boilers without gauges, -	4,975	236	Cases of incrustation & scale,	23,168	2,756
Cases of deficiency of water,	936	426	Cases of external corrosion, -	9,142	2,665
Broken braces and stays, -	4,419	2,171	Cases of internal corrosion, -	4,625	1,124

Boilers condemned, 1,463.

The Locomotive.

HARTFORD, FEBRUARY, 1880.

Enough has been written on the subject of boiler construction, good material, and workmanship to make a score of volumes; but notwithstanding this, we not unfrequently meet workmanship showing glaring defects.

The sharp competition in boiler making leads unscrupulous builders to make figures far below what the work can be well done for, and in order to save themselves from actual loss inferior material is often used, and unskilled labor employed. When the boiler is completed, it will be very difficult to discover many of the defects, but time and use will bring them all to light. An injudicious use of the "*drift pin*" may start a crack in the plate that can not be discovered when the boiler is completed and joints caulked, or it may be instrumental in bringing an undue strain to bear which will, sooner or later, result in fracture. One of the effects of carelessly laying off the rivet holes, so that when the plates are brought together the holes do not "come fair," is shown in the article on another page entitled DEFECTIVE BOILER RIVETS. We had never examined this boiler until after it exploded—and we doubt, if it had been examined when new, if the condition of the rivets could have been discovered without tearing the plates asunder. It will be seen that great responsibility is laid upon the boiler-maker. He cannot afford to employ unskillful workmen, for by carelessness of this kind the lives of many may be jeopardized. Repairing old boilers is a business that requires quite as much care as the construction of new ones. In patching or repairing an old boiler, the old plate may be unduly strained in the process of fitting a new plate or a patch to it, and although the weakness does not appear at first, by use it may be developed in very dangerous form.

When repairs become necessary, the owner of the boiler is usually anxious to have them made with the greatest possible haste, so that little time be lost. A gang of men is set to work to make the repairs in the night. Now every boiler-maker knows that night work, under such circumstances, is about as uncomfortable and undesirable as any that can be named. Cramped up in a boiler, or underneath it, in dirt and ashes, with smoke, and smell of oil, listening to the music of the riveting hammer for hours together. If men under such circumstances have not Job-like patience, or a sharp-eyed and faithful "boss," they will use the *drift pin* rather than undo a part of their work, or admit that an error has been made in preparing the new sheet or patch. Who can tell how many such cases have resulted in accident? We ask the attention—the careful attention—of men who work in boiler shops to the rivets illustrated elsewhere. It is a subject well worthy their study.

The Boston *Commercial Bulletin*, which recently announced the completion of its twenty-first year, comes to us loaded with interesting manufacturing news, which indicates the flood tide of business activity. "Long may it wave."

Horse Power of Steam Boilers.

According to an old rule a 12' × 24' high pressure *Steam Cylinder* was called a 12 H. P. nominal, and the rule by which other sizes were to be estimated was, "Multiply the square of the diameter of the cylinder in inches, by the pressure on the piston in pounds per square inch, and by the cube root of the stroke in feet, and divide the product by 940. The quotient is the power of the engine if working at the ordinary speed of 128 times the cube root of the stroke."

When this rule was in use the ratio of grate to heating surface was quite different from the practice of to-day, and a cubic foot of water evaporated per hour was taken as the equivalent of a horse power in a boiler, which was supposed to have 5 to 6 cubic feet of steam room per horse power. These propositions are simple enough, and a manufacturer who was master of the common branches of mathematics could tell when he was getting the amount of power stipulated in his contract. The improvements in the steam engine whereby a high grade of expansion is obtained, and the introduction of high piston speed, feed-water heaters, improved furnaces, and methods of conserving the heat and improving the combustion, have changed the unit of measurement so that the boiler taken by itself must now be estimated by a different, but by no means difficult standard. When by common consent, or by legal enactment, a given quantity of water per unit of time under certain conditions of feed-water and steam temperatures shall be established as the unit of power, the same as 33,000 foot-pounds are now used for the measurement of the steam engine, we shall have a practical and simple method of determining the horsepower of a steam boiler *after it is set up*. There are, however, other considerations, which are economy in the production of the steam, and the quality of the steam itself. When these elements are introduced the problem will necessarily become slightly complicated, and the buyer must decide according to the uses to be made of the steam, whether the steam engine supplemented by the indicator, or the balance and thermometer, shall furnish the data for calculating the actual power of his boiler as a generator of steam. If the former means are decided on, as is most often the case, then the perfection of the engine as a transmitter of the power generated by the combustion of the fuel is a very important consideration, as upon its refinement depends the percentage of the heat that shall be utilized in producing power. The boiler then, when estimated by itself, ought not to depend on so imperfect a machine as the steam engine for the data. The thermometer and the balance are the instruments to which science is indebted for its very existence, and these together with the time-keeper are alone capable of furnishing the data whereby to determine the relative as well as the ultimate power of a boiler. They are capable of informing the intelligent investigator how much, and of what quality, not only of steam produced, but also of the fuel used. The problem may be stated thus: How many units of heat has been transmitted to the water by a pound of combustible fuel, how much has been utilized in making steam, and how long did it take? It will readily appear that the mere proportions of the generator in square feet of heating and grate surface cannot answer this question. The rate of combustion, if not one of the agreed on standard conditions, must be brought in as one of the elements of the problem. In fact, economy being equal it becomes the true measure of the capacity of the boiler. The rate of combustion varies in practice from 4 to 60 pounds of coal per hour per square foot of grate surface. The perfection of the combustion is affected by the temperature of the furnace, and it is known that both the extremes mentioned are wasteful. The low rate may not be so much so as the high one. The same furnace burning 60 pounds, which can only be done by means of a forced draft, will not yield 15 times as much available heat as it would burning 4 pounds. It is perhaps not impossible to construct a boiler and furnace that shall use the highest rate with as much economy as can be had from a furnace and boiler adapted to the low rate, but it is probable that a medium rate of, say, 12 to 15 lbs. with natural, or

20 to 30 lbs. with forced draft, is more economical than any adaptation can possibly make either of the above extremes. In the case of the very slow combustion, the temperature of the furnace will be too low and the full effect of the radiant heat from incandescent fuel will not be realized, whereas in the highest rate of burning either too much heat will escape by the chimney, or else a waste of power will occur from the use of machinery for forcing the draft.

Some writers have sought to establish a set of formulas by which any given boiler may be rated in horse power; but in order to use them, it is necessary to place your boiler under the conditions which they assume to be correct, or to proportion it according to their specification, or else apply corrections for differences in these respects to such a degree as to make the calculation not only difficult but unreliable. And in fact the case presents so many difficulties that it is next to impossible to determine what a boiler, especially an externally fired boiler, will do until it is erected. The chimney and connecting flues and the pressure of steam of an internally fired boiler also have such an important effect on the performance that they must be considered before an estimate can be made of their power. To many practical engineers the statements so far advanced herein are trite matters of fact, and they would not pretend to say what the power of any given generator is till all the circumstances which affect its efficiency are named, and even then prudence would dictate a careful personal examination, as some important elements might be omitted from the statements of another, as to the conditions.

In the present state of the arts and sciences it would not be very far from the truth to say that 30 pounds of water in the condition of dry steam, under a pressure of 70 pounds above the atmosphere each hour from feed-water, at 100° Fah., is equivalent to, or will yield, a horse-power when used in a fairly economical non-condensing engine. So to get the power of any given boiler, we have only to divide the number of pounds of water made into dry steam under these conditions by 30, and we have a simple practical answer to the problem of to-day. It is quite another thing, however, to determine the exact proportions of a boiler that will do this, and no more, until the conditions under which it is to work are established.

The most important of these conditions are the rate and perfection of the combustion, which, as has already been stated, depend on the proportions of the chimney, or on the power used to force the draft, or more properly speaking, the pressure and volume of the air sent through the burning fuel.

Something About Experts.

No doubt most of the readers of *THE LOCOMOTIVE* know what is meant by the word *expert* both when used as a noun and when used to qualify a noun. An expert, an expert mechanic, lawyer, or doctor, expert testimony, are familiar enough terms; the last expression may be less so than the others and savor slightly of the law and the courts, but it ought not to be ambiguous, and indeed is not, nor technical. It may be taken to mean testimony given by an expert, a person familiar with the art, science, or trade which the case under consideration seems to involve. Yet there is more than one class of experts in nearly every calling, trade, or profession. There is the practical worker whose highest ambition is to do his day's work in such a manner as to be sure of his day's pay and steady employment. He works year after year in the same routine, after plans that are of immemorial origin, and he is expert in the performance of his art, and may be called an expert-artisan without seriously stretching the elastic signification of the term. Between this sample of the expert and the liberally educated and studious scientific designer there are many grades of experts in the same trade. When a building falls and a number of people are killed, the coroner calls around him a jury, sometimes of experts in the build-

ing line, and more experts in the same line are summoned, to give their testimony as to the probable cause of the accident. The master-builder is, no doubt, a proper expert; the journeyman bricklayer may also be summoned, and it is not unlikely that the hod-carrier may give valuable information, especially if the building in question was new or in the course of erection. The scientific architect is also a proper expert in this case, and his opinions as to what are *safe* proportions may be considered as worth considering, especially if they are corroborated by others of his profession and by the master-builder. But to my mind the qualifications of experts in the case of a fallen building ought to be gauged, not by the length of their experience, or the number of safe buildings that they have been engaged in erecting, but by the number of fallen wrecks that they have examined with reference to overloads or weaknesses in foundation or superstructure.

Again, the expert, be he journeyman, master-builder, or architect, who has never known a building which he assisted in erecting to fall, and who is a faithful workman, a prudent master, or a careful designer, is apt to overdraw, unintentionally, perhaps, the weak points in the work of a rival builder or magnify defects before a jury who are not expert that could have had no influence on the falling of the building. Besides, it is generally a fact that there is a feeling of disparagement among the different grades of experts in the same trade, and their evidence is often tinted by prejudice arising from suppressed jealousy. Coroners' juries, therefore, ought to be made up of men of judicial minds—at least of such persons as are capable of weighing evidence.

In fact, the remark may apply to the general jury system of trying cases, especially capital crimes. Jurors should be able to cross-examine witnesses and test their knowledge and skill as experts, and the inquiry should relate, not entirely to what are superlatively safe structures, but also as to what constitutes a dangerous defect or weakness so that the margin between safety and danger may be properly estimated. And as to whether a good, strong structure has degenerated by improper use, or whether the deterioration from which the accident arose was due to original malconstruction. Was the design bad, or were the workmen unfaithful? was the structure overloaded or otherwise abused?

(To be continued.)

Remarkable Steamboats.

Marine writes, under date January, 1880, as follows to *The American Ship*:

"In former years the stern-wheeler was considered, on account of its slowness, unfit for the river traffic of the West, but of late years rapid strides have been made in perfecting it. Although yet slightly behind the side-wheeler in speed, it has replaced that pattern of boat in most of the trades.

"The wheel is never housed, but remains entirely uncovered. The battery of boilers is located forward, and the long space back to the engine-room is used for freight; also the guards, which, on the southern tributary boats, are made extra wide for cotton. The great amount of deck-room, unbroken by wheel-houses and other necessities of a side-wheel boat, is one of the chief recommendations for the stern-wheeler. The sides of the hull are modeled straight and the stern square, with skegs at the corners, except in a very few of the recent boats, which have a round or "goose stern," as it is termed. Three or four and often five rudders are used in the steering arrangement. The cabin is situated upon the upper deck, which extends nearly the entire length of the steamer.

"In all boats plying in the passenger trades, the cabins are full length, and are not only equal, but in some cases surpass in elegance and beauty the saloons of the side-wheelers. The two largest steamers of the stern-wheel class on Western rivers are the 'Great Golden City' and 'Henry Frank.' Both were built at Cincinnati, and are of the same length, 276 feet. The 'Golden City' runs between Cincinnati and New Orleans; is

40 feet beam, 7 feet hold, measures about 1,000 tons, and has a capacity for 1,600 tons. The 'Frank' is 52 feet beam, 11 feet hold, and can carry 3,000 tons. She has six boilers, 28 feet long, 42 inches in diameter, and return flues. The engines have nine feet stroke, 29 inches in diameter, are high pressure, working a wheel 30 feet in diameter, and have 29 feet length of buckets. The iron wheel is now replacing the old wooden wheel, and is already used to a considerable extent on the upper Ohio. One of the most remarkable specimens of 'light-draft' may be found in the new steamer 'Pittsburgh,' which is considered the swiftest stern-wheeler afloat. Her hull measures 252 feet in length, 39 feet beam, six feet hold. She has three steel boilers, of 70,000 pound tensile strength, 47 inches in diameter, 28 feet long, six-flued. The engines are the common horizontal high pressure lever type, seven feet stroke, and 21 inches diameter, working a 21 foot wheel, with 28 feet buckets, with steam up and fuel aboard. This boat draws only *twenty-four inches of water*, a miracle of a steamer that will *carry over one thousand tons*, and can make ten miles an hour up stream with a half cargo. The 'Buckeye State,' a Cincinnati and Pittsburgh packet, is 240 feet long, 36 feet beam, and six feet hold, draws two feet, and can carry an average steamboat load on four feet of water.

The 'Golden Crown' and 'Golden Rule,' 'Paris C. Brown,' 'Will Kyle,' and 'U. P. Schenck,' of the Southern Transportation Line, plying between Cincinnati and New Orleans, are all stern-wheelers, and have an aggregate capacity of 7,000 tons.

The iron stern-wheel steamer, 'Chas. P. Choteau,' is one of the largest vessels on the Mississippi. I have not her dimensions at hand.

Among the steamers of the side-wheel type whose dimensions and possibilities are extraordinary, are many of which I could make favorable mention. The new 'Bostona,' running from Cincinnati to Huntington, is 302 feet long, 43 feet beam, six feet hold, has four steel boilers, 30 feet long, and 47 inches in diameter, and engines 25 inches diameter, eight foot stroke, driving 27 foot side-wheels of 16 feet face. She is considered one of the swiftest boats on the Ohio, and will carry 450 tons on four feet of water. The 'Guiding Star,' a large Southern Transportation Liner, has run 17 miles an hour, with 1,400 tons aboard, and has 23-inch cylinders, with $7\frac{1}{2}$ feet stroke.

The 'J. M. White,' the most powerful boat on Western waters, and considered to be the fastest, may furnish an excellent subject for comparison with Hudson river boats, as she has about the same depth. Her hull is 321 feet long, 50 feet beam, and $11\frac{1}{2}$ feet hold. There are ten boilers of steel, 34 feet long, and 42 inches in diameter, which furnish steam for two monster horizontal engines, 44 inches in diameter, with 11 foot stroke, working water-wheels 44 feet in diameter, with 19 foot face. The cylinder of the new Albany daylight steamer will be about *twice as large* as *both* of the cylinders of the 'White,' taken together, the hull of the latter measuring also about one-third larger. The 'White,' however, is high pressure, carrying 175 pounds of steam, while the Hudson boat is low pressure, and the comparison thus far is not complete."

A PRESENT FROM QUEEN VICTORIA TO OUR PRESIDENT.—Her Majesty is about to make a very tasteful and appropriate gift to the American President. It will be remembered that many years ago an English government ship, the *Resolute*, was abandoned in the Arctic Seas, where it was found by an American ship and taken to America. It was then repaired by the American government, and restored to England. The *Resolute* has now served its time, and is condemned to be broken up. The Queen has decided that a portion of the timber shall be set aside for the purpose of making some magnificent articles of furniture to be presented to the President of the United States. Various designs have been sent by first-rate cabinet-makers for Her Majesty's approval, but nothing has yet been finally decided upon.—*British Empire*.

OXIDATION OF IRON AND STEEL WHEN IN CONTACT.—Mr. G. Radcliffe, in a paper read before the Iron and Steel Institute of Great Britain, incidentally mentioned a case in which steel boiler plates, which had been exposed to the same conditions as adjacent iron plates, had distinguished themselves by pitting more than the latter. The steel plate next to the iron was oxidized considerably more than any other. This fact would appear to point to a species of galvanic action set up by the contact of the two varieties of metal in an exciting liquid, the steel playing the part of the positive element. Mr. Radcliffe does not attempt, however, to offer an explanation, but simply concludes that, under the above-named circumstances, it will not do to place iron and steel side by side. —*Exchange.*

Pertinent to this subject the experience of this company may be cited, which is set forth in the following words extracted from the annual report of the president for 1875 :

“Again, boilers will be found in what is known as a ‘*pitted*’ condition. This is manifested by small spots in close contact being eaten into the sheet. It looks like a pock-marked face, and is sometimes confluent; and what is strange about this is, that often certain sheets in the boiler will be attacked while others will remain clean and smooth, and the iron will bear the same brand on each plate. It is well known that iron ore even from the same mine is not always chemically the same; certain impurities will be found in some places which do not exist in others. And in the manufacture of boiler iron there is no doubt but that the sheets are chemically slightly different; hence when the boiler is constructed the presence of acids in water may excite galvanic action. This would account for the different manner in which boilers are affected.”

After some further practical experience and some laboratory experiments, the subject is again alluded to :

“It is now pretty well settled that the pitting of boiler plates, particularly when the defect is confined to some one or two plates only in the boiler, is caused by galvanic action.

“Experiments made with pieces of iron cut from plates which were *pitted*, and from those which were not,—taken from the same boiler, and placed in a bath of acidulated water, and connected with a galvanometer, resulted in the production of a current. The purer iron corroded. It may be a question with some as to whether these same conditions would occur in a steam boiler in use. I am prepared to say that I think they would.”

The Paper World is a new monthly published at Holyoke, Mass., under the auspices of paper manufacturers and cognate branches of industry, and conducted by Clark W. Bryan, Esq. In his prospectus he says: “It will be devoted to the paper interest in its broadest sense, not simply to its manufacture, but in all the departments of trade and commerce of which paper forms a component part, which broadens and deepens as the world progresses, to an almost boundless extent. It is not designed to make of *The Paper World* a ‘Trade’ publication in the general acceptance of the term, but a Business Journal of information, discussion, and description of any and every branch of business into which paper is woven.

The Boston Journal of Commerce has of late given considerable space to the consideration of matters pertaining to steam engineering, and especially to the uses and abuses of the steam boiler. These matters are handled by the editors in a style that indicates practical training. The article in the last issue, entitled “The benefits of good tools,” has the ring of the “real metal;” likewise an article in the issue of January 3d, headed “Ignorance regarding machinery,” which we have in type, but which was crowded out by our annual and duodecennial statements of inspections. A series of articles under the head of “Engineers, Steam Boilers, and Steam Engines,” is from the pen of one of the old stock of well-trained Yankee engineers, who knows what he is talking about.

Improved Explosion Theory.

Somebody has invented an improvement on the "spheroidal theory" of boiler explosions which is based on the fact that a drop of water thrown upon a heated plate of iron will dance about enveloped in an atmosphere of its own vapor which for some time will prevent an actual contact of the water and the iron. If the plate becomes cooled by contact of the vapor, the water suddenly becomes steam and disappears in a cloud. The same will happen if the drop rolls along to a cooler part of the plate.

The attempts heretofore made to produce a first-class explosion of a steam boiler under this theory, by pumping cold water into red-hot boilers, having proved utterly unsuccessful, after repeated official trials, the theory has become quite unsatisfactory, and the market calls for improved methods, and something must be done to supply a sufficient substitute, for the conclusion arrived at is that under ordinary conditions of overheating such phenomena cannot take place in a steam boiler. The ingenious inventor of the improved theory says "*that when such things do take place, the explosion is not due primarily to the fact that an enormous amount of steam is suddenly formed, but is due to the dissociation of the cushioning vapor into its own elements, oxygen and hydrogen.*" The inventor claims priority in these words: "*That such phenomena do take place, and under conditions which the writer*" (the inventor aforesaid) "*believes to have been unsuspected before.*" And he gives an account of an original experiment to establish his claim. The experiment consisted in lowering a red-hot boiler plate into a bath of water containing grease (glycerine), which, being interpreted, means essence of grease. It differs from common grease in that it is entirely and readily soluble in water, cold or hot. This single experiment was eminently successful, for, says the inventor, "*It [the red-hot boiler plate] entered smoothly, without noise or visible formation of steam. It seemed to be covered on all sides with a bounding cushion resembling polished steel in color. When the greatest depth was reached the cushion became thinner, until at the end of seven seconds after entering the water it disappeared, followed by a tremendous evolution of gas and then by steam, effectually wrecking the bath and stopping further experiment.*" "*It is therefore agreed that the presence of foreign organic matter may produce such phenomena as that of the 'spheroidal state' on a scale such as that of the explosion of boilers.*" Oil or grease is the organic matter aimed at. Grease and gas, together and separately, have before been arraigned as exploders of steam boilers. Somebody once discovered that a drop of crude petroleum contained the elements which, under certain conditions perhaps of dissociation, might blow a steam boiler to the moon, but glycerine, which as before said differs slightly from grease, has never appeared before the bar of justice charged with such a crime, nor even has it been arrested on suspicion; and it is probable that no one will appear to contest the claim of the inventor. I wish, however, to place myself on record as an improver of theories. I propose a slight modification of the experiment, which if properly conducted, will doubtless be conclusive. Instead of glycerine, I propose a compound of that body with nitric acid, etc. It may be procured in the market under the name of nitro-glycerine, but is not much used in steam boilers any more than simple glycerine. My reason for proposing this popular compound is that it is more like grease than simple glycerine in that it is only slightly soluble in water, and therefore would be analogous in that respect, while it also contains the essence of grease. The acids are introduced simply to make the experiment more striking and conclusive. I hereby warn all persons to whom these presents may come not to attempt to forestall me in the initiation of these phenomena on pain of suffering to the full extent of the possibilities.

"T." WATER.

The *Iron Age* lately (issue of January 15th.) devoted its entire first page to the reproduction of President Allen's illustrated report of the Wilt & Son's boiler explosion. The above journal is fully alive to the interest which this subject excites in manufacturing circles, and it ably sets forth all such matters as pertain to the iron and steel trades.

Incorporated
1866.

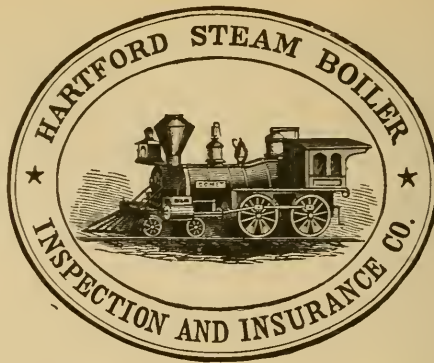

Charter Per-
petual.

Issues Policies of Insurance after a Careful Inspection of the Boilers,

COVERING ALL LOSS OR DAMAGE TO

BOILERS, BUILDINGS, AND MACHINERY,

ARISING FROM

Steam Boiler Explosions.

THE BUSINESS OF THE COMPANY INCLUDES ALL KINDS OF STEAM BOILERS.

Full information concerning the plan of the Company's operations can be obtained at the

COMPANY'S OFFICE, HARTFORD, CONN.

Or at any Agency.

J. M. ALLEN, Prest. W. B. FRANKLIN, Vice-Prest. J. B. PIERCE, Sec'y.

Board of Directors.

J. M. ALLEN, President.	GNE. WM. B. FRANKLIN, Vice-Prest. Colt's Pat. Fire Arms Mfg. Co.
LUCIUS J. HENDEE, Prest. Aetna Fire Ins. Co.	GEO. CROMPTON, Crompton Loom Works, Worcester.
FRANK W. CHENEY, Asst. Treas. Cheney Brothers Silk Manufacturing Co.	HON. THOS. TALBOT, Ex-Governor of Mass.
CHARLES M. BEACH, of Beach & Co.	NEWTON CASE, of The Case, Lockwood & Brainard Co.
DANIEL PHILLIPS, of Adams Express Co.	WILLIAM S. SLATER, Cotton Manufacturer, Providence, R. I.
GEO. M. BARTHOLOMEW, Prest. Amer. Nat. Bank.	NELSON HOLLISTER, of State Bank, Hartford.
RICHARD W. H. JARVIS, Prest. Colt's Fire Arms Manufacturing Co.	LEVERETT BRAINARD, of The Case, Lockwood & Brainard Co.
THOMAS O. ENDERS, Sec'y Aetna Life Ins. Co.	
LEVERETT BRAINARD, of The Case, Lockwood & Brainard Co.	D. R. SMITH, Prest. Springfield Fire & Marine Ins. Co.

GENERAL AGENTS.

THEO. H. BABCOCK,
CORBIN & GOODRICH,
LAWFORD & McKIM,
W. S. CHAMBERLIN,
J. L. SMITH,
H. D. P. BIGELOW,
C. C. GARDINER,
D. C. FREEMAN,
W. G. LINEBURGH,
GEO. P. BURWELL,
W. B. CASSILY,

CHIEF INSPECTORS.

R. K. McMURRAY,
WM. G. PIKE,
JOSEPH CRAGG,
WM. U. FAIRBAIRN,
B. M. LORD,
H. D. P. BIGELOW,
J. S. WILSON,
F. S. ALLEN,
W. S. FOX,
A. C. GETCHELL,
J. S. WILSON,

OFFICES.

NEW YORK CITY.	Office, 285 Broadway.
PHILADELPHIA.	" 430 Walnut St.
BALTIMORE.	" 10 So. Holliday St.
BOSTON, MASS.	" 10 Pemberton Sq.
PROVIDENCE, R. I.	" 42 Weybosset St.
CHICAGO, ILL.	" 132 LaSalle St.
ST. LOUIS, MO.	" 404 Market St.
HARTFORD.	" 218 Main St.
BRIDGEPORT.	" 328 Main St.
CLEVELAND.	" 246 Superior St.
CINCINNATI.	" 53 West Third St.

The Locomotive.

PUBLISHED BY THE HARTFORD STEAM BOILER INSPECTION AND INSURANCE COMPANY.

NEW SERIES—VOL. I.

HARTFORD, CONN., MARCH, 1880.

No. 3.

Explosion of an Upright Boiler.

This illustration represents the wreck of an ordinary upright tubular boiler. It exploded on the 6th of November, 1879, with astonishing force. An inspector of the Hartford Steam Boiler Inspection and Insurance Company reports as follows:

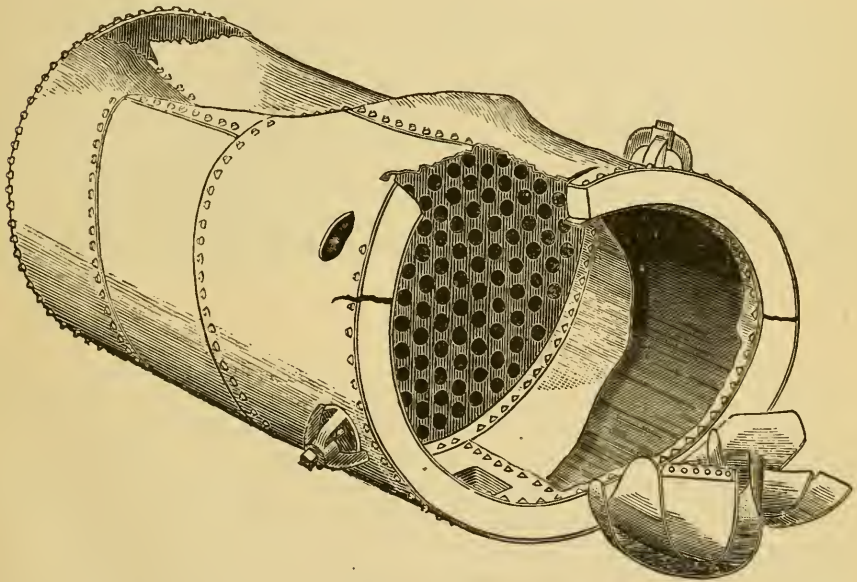

"The boiler was 7 feet high by 42 inches diameter, and contained 70 tubes, 2 inches diameter. The shell was made of $\frac{5}{8}$ -inch, and the furnace side of $\frac{1}{4}$ -inch iron plates. The tube plates were $\frac{3}{8}$ -inch thick. The following information was obtained regarding the boiler. It had been inspected by the State Inspector, and a certificate issued allowing 70 lbs. steam pressure per square inch. The safety valve was loaded to blow off at 65 lbs., the usual working pressure being 60 lbs.

The watchman was instructed to start a fire about half-past six, and have not more than 40 pounds of steam on at 7 A. M., the time for the arrival of the engineer. From several parties it was ascertained that the steam had been blowing off at the safety valve for nearly an hour previous to the explosion, which occurred about 6 A. M. It is not known what the pressure was at the time of the explosion. The engine-house and boiler-house were entirely demolished, the ground being literally cleared, and the boiler was thrown a distance of over three hundred yards. An examination of the boiler showed that the furnace had collapsed and was stripped in a very peculiar manner into several small pieces. The furnace plates were somewhat reduced by corrosion, and grooving was detected on their water surfaces near the base ring, caused by the slight motion of the plates of the furnace from the varying internal pressure, there being no stay bolts to resist the motions.

Nothing indicating neglect on the part of the owners or the engineer was discovered.

In the foreground of the cut may be seen the small pieces which were stripped from the furnace plates. The thinning by corrosion, referred to by the inspector, is at the upper narrow ends of the pieces as they were placed for the purpose of being included in the photographic view from which the cut was made. The crushing and fracture of the base ring and the shell plates, as shown, was caused by the fall, it having ascended to a great height like an immense rocket, to which it was compared by those who saw it in the dim morning light, followed by a train of issuing steam and water. On striking the ground at a distance of more than 300 yards from its former site, it bounded through the side of a barn and lodged on a mow.

The above information, which no doubt fairly represents the facts attending this accident, points to the

HYPOTHESIS

that it is a case of a gradually increasing pressure to an extent greater than the boiler was able to resist; that the furnace, being thin iron and unstayed, was the weakest part of the structure. Deterioration commenced here on the water surfaces and progressed, at first very slowly, but as the plates became weaker from corrosion, the motions from the varying pressure became greater as the resistance became less, and the chemical action of the water upon the fibers of the iron that were laid bare, and separated by the mechanical action of bending and strains wore away the metal along the weak lines at an increasing rate, till it gave way, and the plates were pressed into the cavity of the furnace and torn into a number of pieces; the reaction of the expanding contents of the boiler threw it into the air, as a rocket is projected when the fire reaches the chemical compound within it.

REMARKS.

It may be questioned whether the astonishing phenomena attending this accident are satisfactorily accounted for by the propositions of the hypothesis. For it is often said by intelligent observers, in speaking of this kind of accidents, that to produce such results the pressure must have been something enormous, and the boiler a strong one to have resisted it till a sufficient force is stored to do the work. Now, while it is not claimed that the propositions are, to the perception of the average boiler owner, *axioms in engineering*, still it is believed that they may be supported by common sense arguments. It is unfortunate that the data necessary to make a mathematical calculation are so far wanting in this case as to preclude the possibility of making a clear statement of the capabilities of the forces which were stored within this boiler at the moment of the collapse of the furnace. It would be necessary to know (a) the pressure and weight of steam and water in the boiler, (b) the weight of the boiler itself, (c) the area and frictional character of the opening through which the water and steam reacted on bodies exterior to the boiler, and (d) the direction of the flight.

It is believed that a pressure of steam not greater than that required by law to be applied in testing (105 pounds in this case) would be quite sufficient to produce the effect, while it is possible that the pressure that broke the boiler was considerably under that figure, for the deterioration may have progressed very rapidly toward the last, while working at about 60 lbs., until its strength was so far reduced that the maximum pressure allowed by the State Inspector, or that at which the valve would entirely take away the steam produced by a vigorous fire, was sufficient to collapse the furnace.

The extremes of the motions occur as often as steam is raised from zero to the working tension, while a great number of minor motions occur as the steam pressure varies during the working of the engine.

The furnace, being at last broken along the weak lines caused by the buckling of the plates, a large opening is quickly made, the stronger parts that have not been affected so much by the buckling are then taken at a disadvantage, and the stored up force within the boiler now sets the water in motion to complete the secondary work.

For the purpose of considering the case more specifically, suppose the pressure at the moment of the rupture was 80 lbs. to the square inch, and that the boiler contained 2,000 pounds of unevaporated water and 2.5 pounds of water in the form of free steam in the steam space above the water. The sensible temperature of the whole contents of the boiler approximately 324° F. The weight of the boiler 2,500 lbs., and the area of the annular opening being 3" × 9', a little more than 2 square feet, and that this opening was the narrowest part of the channel through which the water and steam passed from the boiler. These data are introduced for illustration, without pretension to accuracy. The pressure assumed corresponds nearly to that of 180 feet of vertical water column, and its initial velocity, issuing through a favorable opening, is about 100 feet per second. The calculation would not be very difficult if this force acted within a cylinder upon a movable piston; but only the first gush of water, which is guided by the sides of the boiler, acting against the floor of the furnace and the bottom of the ash-pit, can be said to be in any degree parallel to the simple form of cylinder and movable piston. It is, however, something like a movable cylinder and a stationary piston, and the boiler gets a pretty strong initial impulse. A calculation of the capability of the stored up force within this boiler gives us millions of foot-pounds, and, if applied to a steam engine, would actuate one of thousands of horse-power during the second of time that the force was at work upon the projection of the boiler. The figures are perfectly bewildering, and are omitted for want of space to fully explain the problem.

Explosion of the Boiler of an Iron Furnace.

The boiler whose wreck is herewith illustrated was used in an iron furnace, at a pressure of seventy pounds per square inch. It exploded in January, 1880. As shown by Fig. 1, the boiler consisted of two cylinders placed parallel one above the other, and joined by necks of wrought iron. The principal dimensions are as follows: The upper cylinder, 36 inches diameter by 50 feet long, was made of 19 courses of plates something more than 2½ feet wide. The lower cylinder, called "the heater," was 30 inches diameter by 39 feet long, made of 15 plates of the same width as those of the upper cylinder by ¼ inch thick. The main boiler and "heater" were joined by 7 neck 10" diameter by about 11 inches long, placed on alternate courses of plates, beginning with the third course from the front end of each cylinder. This boiler was numbered "3" in a set of three (facing the front ends and numbering from left to right), which were joined to the same steam drum by nozzles on their ninth courses immediately over their middle necks, and suspended by three hangers on each boiler in the chamber formed by the masonry which enclosed them, as high as their water level in the upper cylinder. The front and rear ends of the main boiler and the front end of the "heater" passed through the respective walls of the chamber. The hot gases from the furnaces were admitted by a pipe or pipes through the rear wall about on a level with the center of the "heater," whence they passed directly to the chimney flue at the front, urged by the chimney draft and their own levity, the pressure of the blast probably being well spent in forcing the air through the mass in the furnace (?).

The "heater" or lower cylinder exploded at its fourth plate from the rear end, breaking as shown in Fig. 1, at a longitudinal seam, which was also the boundary of a recent patch which had been rendered necessary by corrosion. The seam shown below the ruptured edge is the boundary of another patch, and it was the junction seam of the two patches that the initial rupture occurred. The portion of the plate with its two patches forming a ring or girdle of the cylinder was completely separated, and is shown on a larger scale in Fig. 3, which is a transfer of a photographic view, on which the dimensions are marked. The patches at the point of rupture are partly shown in longitudinal section adjacent to their plan. It will be understood that this line of section, which is longitudinal as to the plate, would be transverse to the axis of the cylinder when it was in place as a part of the cylinder. The thickness of each plate and patch, so far as ascertained, are given in decimals of an inch. Two other patches are shown by the photographs, and are designated (Figs. 1 and 2) in their respective places. Fig. 2 is a perspective outline (copy of a photograph) of a portion of the two cylinders and their necks as they appeared after the explosion.

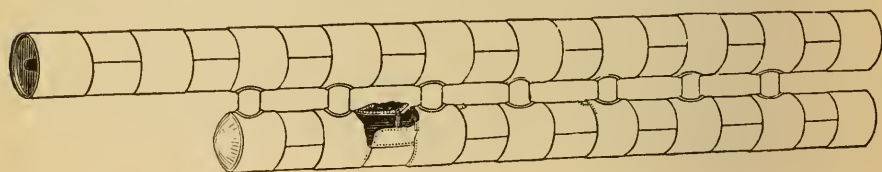

FIG. 1.

The pieces marked with the star and the crossed circle on Fig. 3 were broken off and sent to this office for examination. The piece between those marked is missing, probably broken off and carried away by visitors before the inspector arrived at the scene of the wreck. The iron of this patch is very brittle. It broke into three pieces, and cracked in many places on attempting to straighten it cold upon an anvil, as shown in Fig. 4, which is a view, after straightening. The pieces "e" and "f" broke off entirely, and showed a coarse granular structure much like broken zinc. Its tensile strength (which is probably fair) and its chemical character (which is no doubt impure) have not been tested, but it is hardly necessary to say that whatever these tests might disclose, the iron is eminently bad and decidedly unfit for use in any part of a steam boiler. A piece broken from the margin of the adjoining original plate to which the patch was riveted shows that it is little if any better than the patch, though its granulations are finer, still so brittle and so bad as to call for the condemnation of the entire lot of heaters made of it and the substitution of new ones.

The deterioration from corrosion of the parts of compound boilers, such as mud drums, heaters, water bottoms, and the like, that are located below the active generating surfaces of the boiler, is a notable feature in the experience of this company. Through these parts the feed water is generally introduced, in the belief that it, being a cooler part of the boiler, the plates will suffer less from contraction by contact with the feed water, which is always cooler (hot though it may be) than the water from which the steam is escaping under pressure into the steam space. This corrosion may be, and no doubt is,

due to more than one cause; but perhaps it is, oftener than to any other cause, chargeable to the condensation of the acid vapors from the furnace gases upon these cooler surfaces, or the salts of the acids deposited with the soot and ashes. In cases where the work is intermittent, ample time is afforded for the condensation and for the condensed vapors to do their work, and when the work is continuous, as in this case, for the entire season that the apparatus remains in working order, the weeping of a seam will furnish a constant supply of moisture for the purpose of bringing the salts into action, and the work goes on vigorously, no matter how good the iron may be. In fact, it has been observed that impure iron would longest resist corroding, dissolving agents, and this supposition is to some small extent supported by the fact that some of the most common impurities are insoluble in acids. This fact does not, however, go for much, for if the iron is attacked and dissolved, the impurities will lose their envelope and crumble to dust on the least disturbance.

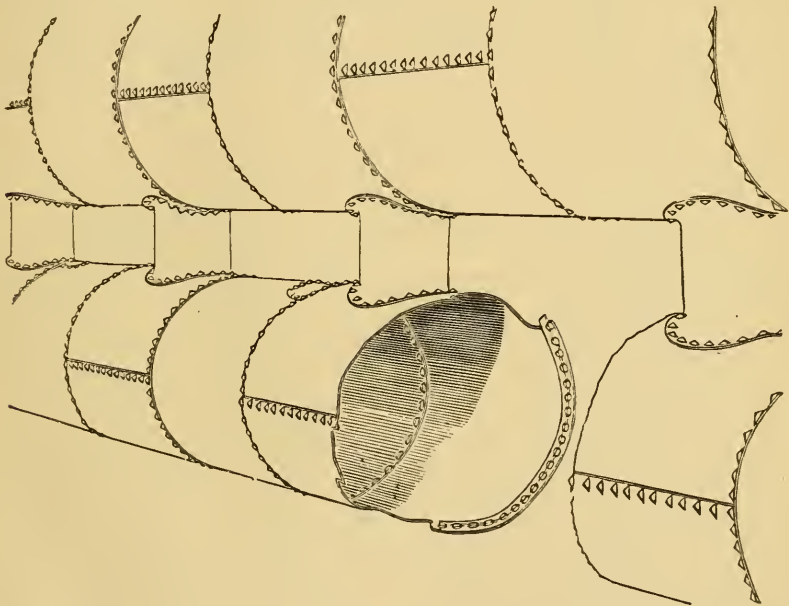

FIG. 2.

Leaks in the joints of a steam boiler that has once been tight under pressure may be regarded as presumptive symptoms of local distress. The parts, therefore, in the vicinity of leaky joints may be in a high state of tension or bent out of form by unequal expansion from unequal heating, in which event they are in a state to be most readily acted on by an oxidizing or dissolving agent. The particles of the metal are slightly separated and the liquid solvent wets all sides of the disturbed atoms. If the agent be an oxidizing acid, the minute grains of the iron are soon covered with its oxide, which fills the interstices and act as fulcrums when the motion is reversed or the tension relaxed by a restoration of the equality of temperature.

The manner of supporting this boiler by three hangers may have had some influence in straining the joints and rendering them leaky, especially if the hangers were all equally loaded when the boiler was cold. The extra expansion of the bottom of the upper cylinder would tend to deflect it, and, by raising the ends, throw the entire weight of the boiler and superimposed fixtures and covering upon the middle hanger, in so far as it was

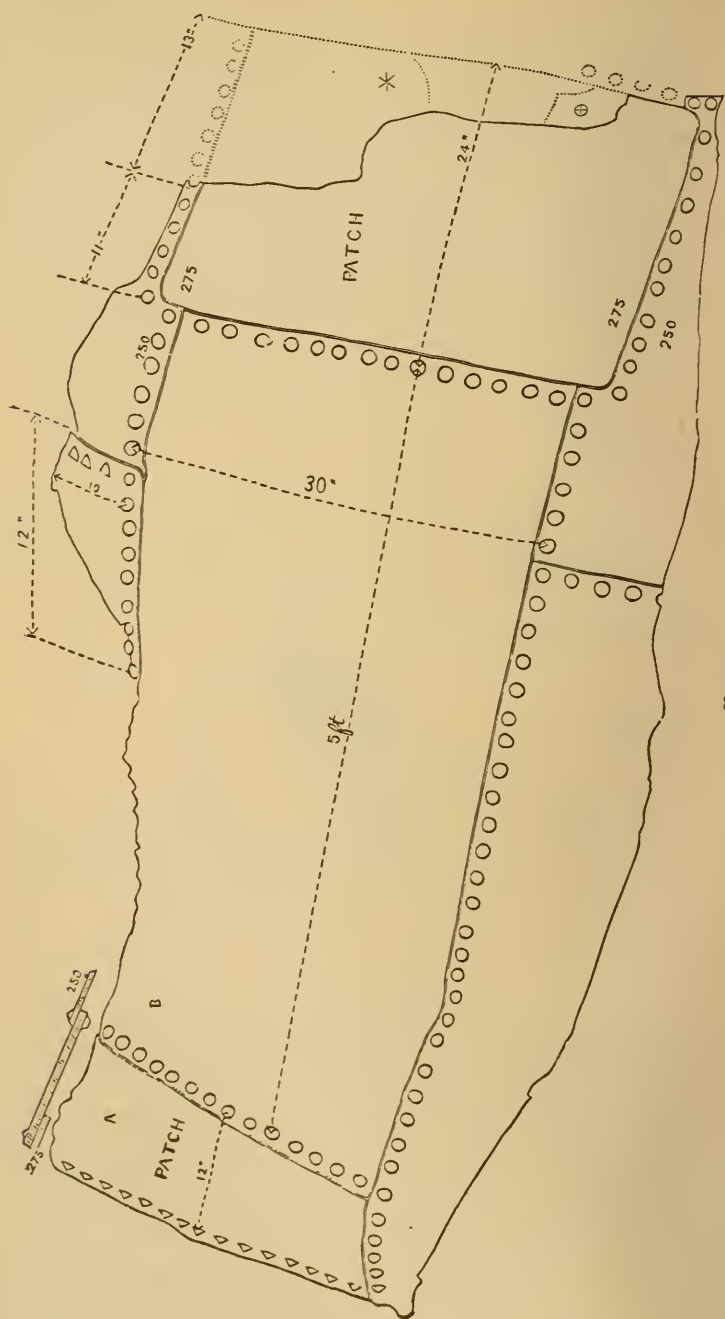

FIG. 3.

evenly balanced on this point, and could, without yielding, support it. This tendency would, however, be resisted by the lower cylinder, which serves the part of the lower chord of a truss, and might, conversely, be the hottest on its upper side.

Some of the data relative to the methods of management, etc., are lacking, and the important matter of the relative temperatures of the two cylinders can not be profitably discussed within the limits of this report. But from the conditions known to have existed in this case, viz., the character of the iron, the corrosion, and the patches located near on the seams, a fairly reasonable conclusion is that corrosion was caused by leaks, that the leaks were caused by straining of the joints from undue tension, and that the patch that gave way had



FIG. 4.

been subjected to violence greater than its fractious character would warrant, either at the time of being put upon the boiler or by the subsequent effort of the internal pressure to restore the distorted cylinder to a true form.

BOILER EXPLOSIONS.

THRESHING MACHINE (18.)—The boiler of a steam threshing machine on the farm of Malcolm Cameron, in Clinton, Ont., exploded January 22d, killing Duncan McEwer and fatally injuring Arthur Wondless. Several others were injured.

SAW-MILL (19.)—Preston Horton was scalded to death January 30th by the blowing out of the water-gauge of a boiler in a saw-mill at Duck Springs, Alabama.

MILL (20.)—The boiler in W. Clark & Co.'s mill at Pittsburgh, Pa., exploded Monday, Feb. 2d, killing Albert Orran, fatally scalding Jacob Berger, the fireman, and painfully burning William Brannan. The boiler was examined Monday and pronounced safe.

DREDGING MACHINE (21.)—At 9 o'clock, February 2d, an explosion occurred on board one of Mr. H. E. Culpepper's dredges, engaged in building a wharf at Messrs. LeKeys & Collins' saw-mill, Berkley, Va. Twenty tubes in the boiler blew out, tearing off the roof of the house over the boiler. The accident occurred at a time when no one was in the vicinity of the boiler but Mr. Wm. Turner, the engineer, who was thrown through a hatchway and bruised somewhat about the head, and had one ear scalded.

WOOD-YARD (22.)—The boiler in R. C. Leighton's wood-yard at Buffalo, N. Y., exploded Wednesday, February 4th, severely injuring James Travers, William Place, Emory Rieehl, and Christian Unbach.

SAW-MILL (23.)—Thursday night, February 5th, the boiler of the steam mill on J. H. Pike's wood lot, at Fremont, exploded, blowing the mill to atoms, instantly killing Clarence Perkins of Newmarket, and fatally injuring Joseph Quimby of Candia. Two other workmen escaped with slight bruises.

MALT HOUSE (24.)—The boiler in the malt-house of the Hawley Malt Company, Detroit, Mich., exploded about 9 o'clock, February 9th, demolishing the engine house and damaging the malt-house to the extent of \$20,000.

PULP-MILL (25.)—An explosion of boilers in the Canada Paper Company's mills at Windsor, Province of Quebec, occurred February 10th. Three men were badly (perhaps fatally) injured, and two were killed. The pulp-mill took fire and was destroyed.

WAGON WORKS (26.)—A terrible boiler explosion occurred February 12th in the Oviatt Wagon Works at Hudson, O. Russell Oviatt, son of the proprietor, was working at the engine, and shut off the steam. An explosion followed immediately, blowing him fifteen feet. He was so terribly scalded as to be unrecognizable, sustained a fracture of one leg and other injuries, and is not expected to live. George Hill, an employee, was cut on the head by a flying piece of the boiler, and Gideon Mills was seriously injured in a similar way. One end of the building was blown out, and the damage will aggregate \$1,200.

HAT FACTORY (27.)—About 9 o'clock on the evening of February 13th a boiler in the hat factory of C. B. Alston, 41 Liberty street, Newark, N. J., exploded and set the building on fire, causing a damage of \$2,000.

SALT WORKS (28.)—The boiler in J. Kidd's salt derrick at Seaforth, Ont., exploded February 14th, killing the engineer, John Gillag, and demolishing the building.

SAW-MILL (29.)—The boiler in John F. Thompson's saw-mill at Randolph, N. H., burst February 17th, destroying the mill and killing Elder Page of West Orono, Me., Roger Johnson of Oldtown, Me., a young man named Buzzell, of Randolph, Gilbert Sylvester of Bethel, Me., and a Frenchman of Bethel, Me., workmen, and badly injuring S. F. Hewey of Randolph.

DISTILLERY (30.)—At Peoria, Ill., Thursday, Feb. 18th, a boiler explosion at Barton & Babcock's distillery shattered the walls of the building, killed two men, fatally injured two others, and badly burned and scalded three more. John Sill, fireman, and an unknown man were instantly killed. Ben. Babcock, one of the proprietors, and John Richardson, a helper, are not expected to live. Wm. Burns, engineer, Louis Laufenbury, a masher, and Oscar Mills, a visitor, were painfully injured.

BREWERY (31.)—People living in the vicinity of Buena Vista and Shenandoah streets in St. Louis, Mo., where Griesedick & Co.'s brewery is located, were aroused from their slumbers about 2 o'clock, February 24th, by the report of a loud explosion. The boiler of the brewery had exploded. The regular night watchman had gone away and left in his place *one of inexperience*, who allowed the water to get too low in the boiler, which became overheated in consequence, and the natural result was an explosion. The boiler was a large one, but it was torn and twisted out of all shape and hurled from its resting place through a brick wall to the pavement on the other side of Buena Vista street. The bricks and timber were thrown in every direction, the shock even shattering the third-story windows of a building adjoining the brewery. The wood-work of the boiler-room was set blazing, fire being scattered all about. The damage by fire was confined principally to the boiler-room, and will not exceed \$2,000; no insurance on the boiler. No person was near the boiler when it exploded.

SAW-MILL (32.)—February 26th the boiler of the portable saw-mill owned by the Harding Bros., while working near Guyer's Ford, Mo., on the Petit Saline, six miles southeast of Boonville, exploded, dangerously wounding one of the Harding brothers, blowing him several yards and fracturing his skull, besides inflicting other injuries. His recovery is considered doubtful. Mr. Davis was also wounded.

SAW-MILL (33.)—February 27th a boiler explosion occurred at Gill's saw-mill, in the Barefield Colony, on Deer Creek, four miles below Greenville, Miss. Two white men and one negro were killed instantly, and a number of others horribly mutilated.

NOTE.—It will be observed that the above list of explosions does not comprise any of the numerous minor accidents that occur in the experience of every steam user, which are so annoying, involving the stoppage of the works, and repairs that are most expensive, because they must be done at *over-time rates* and under business pressure.

Inspectors' Reports.

In the following summary of the reports of inspections made in the first month of 1880 the figures show a large increase of work done in this department. The summary of reports for the last month of 1879 was the largest ever exhibited in this country covering a like period previous to that time; but this one shows that nearly 200 more examinations were made than in December last, and about 9 per centum increase in the number of visits made. This indicates a very important increase in the company's business.

The whole number of inspection visits made during the month of January, 1880, was 1,687, and the total number of inspections made was 3,680, of which 1,224 were thorough annual internal inspections. The hydrostatic test was applied in 233 cases, in an auxiliary way mainly, to detect leaks in new and in repaired boilers.

The whole number of defects discovered during the month was 1,738—361 of which were of so serious a character as to be considered dangerous at the moment of discovery, or would become so by the natural progress of deterioration before the time for the next inspection.

The defects were in detail as follows :

Furnaces out of shape, 72—10 dangerous; 157 fractures—63 dangerous; 164 burned plates—39 dangerous; 309 blisters—29 dangerous; 211 cases of sediment and deposits—26 dangerous; 309 cases of incrustation and scale—28 dangerous; External corrosions, 96—38 dangerous; internal corrosions, 88—27 dangerous; internal grooving, 15—1 dangerous; water gauges defective, 31—10 dangerous; blow-out apparatus defective, 30—19 dangerous; overloaded safety-valves, 30—17 dangerous; pressure-gauges defective, 131—48 dangerous; boilers without pressure-gauges, 54; cases of deficiency of water, 12—5 dangerous; braces and stays broken, 20—1 dangerous; boilers condemned, 29.

Chemical Department.

To facilitate the business of our chemical department, which is pretty well crowded with work, and to prevent delays in returning the results and recommendations to our patrons, we urgently request those intending to avail themselves of the advantages offered in this branch of our business to follow as nearly as possible the directions which were published in the January number. They are republished, with additions, below. It is sometimes desirable to determine approximately the relative volume of free carbonic acid that is dissolved with other gases in the water. It is believed "that this gas is largely diffused throughout underground strata in such a manner that the water permeating them can become more or less charged with it, often under considerable pressure, before it reappears at the surface as a spring."—(Watts.)

DIRECTIONS.

Select a CLEAN GLASS BOTTLE, NOT STONE JUG, that will contain a couple of quarts, fill it QUITE FULL OF WATER from their source of supply, seal the cork with wax, and send by express marked WATER FOR ANALYSIS—KEEP FROM FREEZING; notify the President of the company that it is on the way, and describe the location of the spring, well, or river, and the means by which the water is brought to the mill. If the water comes from marshy or swamp lands, or is from a well in the vicinity of a mine or chemical works, tannery, etc., etc., the fact should be mentioned.

IF SCALE IS SENT FOR EXAMINATION, state the size and type of the boiler, the habit of blowing, location of the blow-pipe, and the part of the boiler from which the scale was taken; how long it has been in forming, and PARTICULARLY state if any solvent, cleaner, or purger was used, the kind and quantity.

If the gases in the water are to be considered in the analysis, precaution should be taken to prevent agitating the sample in the presence of air while filling the bottle.

The Locomotive.

HARTFORD, MARCH, 1880.

THE investigations as to the causes of boiler explosions as being made in both Europe and this country, tends to confirm the theories, or rather the practical knowledge as expressed by such men as Fairbairn and Colburn.

There have been long discussions as to which was the weakest part of a boiler, and in boilers joined together by necks, some have contended that the necks were the weakest points in the structure. But when explosions occur an examination of the wreck or ruins often show that theories have been set entirely at naught, and the boiler has "gone off" in its own peculiar, and to some, unaccountable way. We refer to the illustrated article on another page, of the explosion of an iron works boiler of the "double deck" type. It will be seen that the rupture occurred directly between two necks, as though the intention was to refute the theory of weak necks. Other boilers of similar type have ruptured and exploded without doing but little if any injury to the necks, and yet there is an opinion prevailing among some engineers of no inferior ability, that the necks are the weakest part of such a structure. We have studied this explosion carefully—tested the iron as to its ductility—and are satisfied that the cause of the explosion was as explained in the article alluded to, and we see no good reason for arriving at such conclusions. There is nothing like a careful study of such cases on the ground, followed up by experiments on the iron and careful comparison of the photographs of one case with another.

In investigating the causes of these disasters, we aim to divest ourselves of all theories, and make up a verdict on the facts as they are. If we carry pet theories into such work we are liable to strive to make the facts conform to our theories, rather than abandon a pet theory where the facts seem clearly to explode it. This desire to establish some new theory of boiler explosions, has been the occasion of a great waste of time in spinning out page after page, which few read, and is soon forgotten.

W. M. BARR of Indianapolis, Ind., has recently published a work on STEAM BOILERS, which contains a great deal of valuable information. It should be in the hands of every mechanic who desires to keep himself informed as to what is being done in this branch of Steam Engineering. Mr. Barr is a practical mechanical engineer, of long and varied experience, and we heartily commend the work to the readers of THE LOCOMOTIVE.

J. H. COOPER of Philadelphia, has commenced a series of articles on the Adhesion of Belts, in the *Boston Journal of Commerce*, and those who are interested in the subject should not fail to read them. There is no better authority on the subject, than Mr. Cooper.

Something About Experts.

[Continued from February Number.]

The discussion under this head in a previous number of THE LOCOMOTIVE related to the probable character of the expert testimony in a supposed case of a fallen building, the necessity for judicial jurors who could properly weigh the evidence, and the kind of tests that should be applied to ascertain the value of such testimony as should be offered,—the builders' and architects' professions being the ones involved.

In other lines of business the testimony of the practical worker, *expert* as a workman though he may be, is too often tinged with disdain for the evidence of scientific expert, and the average jurymen will give more or less weight to the statements of the workmen or the master, according to the sympathies which his own relations engender, but the majority of any given panel of jurors would probably sympathize with the expert worker and give his opinions prominence accordingly.

For example, the statements of a practical boiler-maker who has been engaged for twenty or thirty years in constructing and repairing steam boilers would probably influence the minds of the average coroner's jury more strongly than those of the white-handed scientist who has never driven a rivet or flanged a sheet of iron; and it is perfectly natural for the court to summon such men as the former, especially master-workmen, when the investigation relates to a boiler accident by which human life has been destroyed. It is likewise natural to call such scientific persons as the neighborhood affords, and to compare the opinions of both classes of experts.

But in this case, as in that of the fallen building, facts rather than opinions are the valuable evidence, and the number of boiler explosions that have been carefully examined by each expert should be the measure of the value of his testimony. On questioning each as to their actual experience in examining exploded boilers, the judicial juror would find that the boiler-maker's experience is confined to one or two actual explosions of a destructive character. He has been called on to repair ruptured boilers by the hundred, and he could perhaps tell what part of a boiler, the form of which is not an uncommon one in his neighborhood, would first come to repairs. He may have heard of, perhaps, two or three more destructive explosions which he did not see, but learned the supposed cause from the local papers, or a neighbor, but he had not the leisure to visit the scene. We cannot understand why this man's opinion should be valuable in this case; but he gives his opinion promptly, and no doubt honestly.

On questioning the scientific expert, it will probably be found that he has seen but few if any other cases than the one under consideration, if, indeed, he has seen this, and that his knowledge of boiler explosions is derived from books, which explain the expansive power of steam and its behavior in the laboratory, and, perhaps, in the engine. He has many times observed the action of strong acid solutions when being heated in a test tube over his laboratory lamp. The violence with which such a solution jumps entirely out of the vessel after acquiring sufficient heat, showing no sign before, and the jar and explosive action of so small a quantity of liquid, suggest, naturally, to his mind the possibility that such might be the case with steam boilers to such an extent as to break the strongest form in its strongest part. He has also read the celebrated Donny theory, and has, perhaps, experimented in his laboratory on the heating of water above the boiling point, and by a slight disturbance caused it to spring with violence from the pan. The spheroidal state of water is also familiar, and he can give the temperatures at which it will exhibit the various phenomenon. And he, perhaps, reasons out a sufficient cause that will apply to the case in hand, believing that the boiler at the moment had its normal strength; but the minds of the jury are awed by the mystery which his testimony threw around the case. There is another expert called and examined, and he swears that he

has made the strength of steam boilers and the causes of explosions a study for many years; his practical record is unexceptionable, having been more than thirty years a practical mechanic and an engineer; has been through all stages of experience from the youngest shop-sweeper to the oldest living consulting engineer of the neighborhood, and he has seen many wrecks of exploded boilers; in fact, he has become so well versed in the business that he has planned and constructed an attachment for the express purpose of preventing such accidents. His attachment was not on the exploded boiler under consideration, or if it was (?) then the more mystery! He can not say what caused the explosion. These types of experts are represented at almost every inquest where boiler explosions are under consideration; and it is not at all strange that an inexpert jury find a verdict that censures nobody and gives no intelligible explanation of the disaster.

This being the case, it is perfectly proper to inquire, "What are you going to do about it?" in other words, what would you do in such a case? I can best answer the question by introducing a hypothetical case of a boiler explosion, involving the elements of a general answer.

A certain boiler of the locomotive type we will suppose blew up in the following manner: We will suppose, if you please, that it was a locomotive engine, built in the most thorough manner by the employees of the road on which it ran, and under the supervision of the master-mechanic of the road. It is found one morning on its side, completely stripped of all lagging cab, and other parts that might be blown off by a rush of hot water issuing under a pressure of 130 pounds per square inch, and one dead man beneath the ruins. In an adjoining lot on the side of the track towards which the engine was turned over was found a piece of the roof-sheet of the wagon top of the boiler, leaving an opening on the top side of the engine, as she lay on her side, of about eight square feet in area. This opening is bounded by the sling-stay fastenings on its upper line, and by the fire-box stays on its lower line, and it extended forward to the waist seam and back to the foot of the head stays. The staying all around the opening was unusually strong and well made. There were no indications of low water, and if there had been such a state of things that left no sign, the broken sheet could not possibly have suffered from overheating. Two ample and efficient safety valves were provided to prevent over-pressure, which had always heretofore done their duty properly, and a steam gauge which was found to be accurate and unobstructed. The engineer, a sober and faithful man, and would not probably tamper with his safety valves, having no inducement, but rather every reason not to do so—but he was killed, and can not therefore defend himself. The piece that was blown out was tested, and found to have a tensile strength that would require a pressure four times as great to pull it apart in the direction of its plane surfaces. And no one discovered any thinning of the plate by corrosion, though a glass was used in the search, while the engine stood in the round-house for inspection, by the order of the coroner. It was shown that the piece that was blown out began to break at the lower edge; that it turned outward and upward, tearing through iron of full thickness all along the line of lower stays, thence shearing a seam of rivets at the front and tearing through the full thickness of sound iron at the back, as though it might have been first sawn through along the lower edge and then torn as one might tear the bark from a birch log by pulling at the free edge of a longitudinal cut in the bark, till the rupture was arrested by the line of sling-stay fastenings, upon which it turns as a door on its hinges, breaks short off and flies away. One witness, who showed a good record as a mechanical expert, testified that he expected to find a weakness in the boiler, but does not say whether he looked for acquired or congenital defects, but he found none that he gave to the jury, and so was unable to account for the explosion. Another less wise but more positive man said the iron must have been pretty uniform in strength to have blown out as it did, and attributed the accident to over-pressure. His contempt for the testi-

mony of the witness who explained the manner of tearing out of the piece may here be suspected. He evidently reasoned in a circle something like this. It blew out as it did (meaning bodily and squarely, like lifting a cover from a cheese box) because the iron was of uniform strength. *Ergo*. It was of uniform strength because it blew out as it did (like lifting the cover from a cheese box). Others swore that no sign of crack in the iron could be found, and some boiler makers gave instances of repairing that had no particular bearing on the case. The jury, as a last resort, and suspecting that there might be some defect that had escaped the observers, began to consider the propriety of looking for themselves, so they sent for a professional boiler inspector. They put him through a course of examination as to his experience and how many boilers he had seen wrecked, and found that his object was to examine the parts of exploded boilers in order that he might judge fairly what constitutes a dangerous defect. They at first were inclined to think lightly of his experience, but they concluded to take him along to examine the wrecked engine. He was not satisfied to look at the machine in the dimly lighted round-house, so it was hauled out into the broad day-light. But he says to them, "Now, gentlemen, it will be impossible for me to attend your inquest, for my engagements will not permit it, but you are welcome to any information I can give you." He takes a careful and silent survey of the opening, asks where the piece was found, and in what relation or direction as to the engine. He sees drippings, as of a leak below the opening on the sheet; he makes closer inspection, and calls for water and a stiff brush; with these he cleans off the light clay-colored sediment which covers the edge of the sheet. He sees the evidence, to him quite familiar and unmistakable, of a crack older than the date of the explosion; and the jury each examine for themselves. Some don't know, others are convinced that there was an old crack. "But, Mr. Inspector, how do you account for a crack so straight, and in such a place?" To this question, of course, the answer is not so easily or quickly arrived at, and a more thorough study of the structure will be necessary in order to assign an adequate cause. He however refers them to several similar cases where the causes had been worked out, takes a memorandum of the size, form, and location of the opening, together with such other data as will enable him to study the case when his leisure serves, and bids the jury good day.

What now can be done to confirm or disprove this new kind of expert's statements? is the question the jurors ask. They conclude to cut out so much of the sheet as will give a sample of the whole line of fracture, and submit it to inspection of practical iron workers alongside of the newly fractured samples. So this is done at the next session of the jury, and a verdict is soon settled on, for all agree that the crack existed, and they unanimously agree, after long study of different cases of explosions, that the only remedy is to have all boilers inspected by competent professional boiler inspectors.

S. N. H.

REPORT OF THE INSPECTOR-GENERAL OF STEAM VESSELS.—Gen. Dumont, Supervising Inspector-General of Steam Vessels, reports that the last year 4,200 steamers were inspected, 15,000 officers licensed, 177 lives lost by accidents, 44 of which are not chargeable to the use of steam. Notwithstanding the increase of 400 vessels to the steam merchant marine since 1875, there has been a steady decrease in the number of fatal casualties. This improvement is largely due to the severe discipline exercised over licensed officers of steam vessels.

The report complains of the inequalities of salaries in the service. Attention is called to the surplus of \$491,000 to the credit of the service, the result of taxes collected from masters, mates, pilots, and engineers. The report favors the proposed amendment to the revised statutes reducing the amount of fees collected for service to \$41,000 less than the actual cost. Objection is made to the discrimination in the steamboat law against steamers engaged in inland navigation in the matter of the liability of the owners. A reduction of the license fee for small pleasure vessels or yachts to \$5 is recommended.—*Washington, Dec. 5, 1879.*

History of a Plate of Boiler-Iron.

WRITTEN FOR THE LOCOMOTIVE BY A YEOMAN.

The following little story is true as to the acts and events, but names and dates are suppressed for reasons that will be obvious to the reader, and by request of the principal actor who furnishes the subject matter. The engineer's yeoman is relating a narrative of actual transaction in the American Navy. They occurred at a time when the navy was largely supported by volunteers from the Merchant Marine Service of this country, and when fast cruisers were plundering our commerce under the material as well as the moral support of a powerful foreign maritime nation.

"It was on the — day of —, in the year 186—, that the U. S. Steamer — was taking on board ordnance stores at the Brooklyn Navy Yard for the use of Admiral Farragut's fleet, which was preparing with all possible despatch to attack the forts at the entrance of Mobile Bay. The chief engineer of our ship was one of the volunteers who had served from almost the beginning of the war; entering as a Third Assistant he was, from time to time, promoted for gallantry and meritorious services. He knew it was very important that the ship should reach her destination as early as possible. He was a thoroughly practical mechanic as well as an efficient sea-officer, and having often seen the benefit of having his department fully equipped for any emergency, he included, as had been his custom under such circumstances, ONE PLATE OF $\frac{1}{4}$ " BEST FLANGE BOILER IRON. Now our ships had almost new boilers, and the engineer-officer in charge of department stores of the Yard, declined to approve this item in the requisition, saying, 'The ship does not need it; new boilers in your ship? it is absurd, sir.'

"In vain did Mr. — most respectfully suggest that the ship was an armed war vessel loaded with ordnance stores, the value of which, all circumstances considered, was almost incalculable, and that in their defense it is the acknowledged duty of everybody on board to fight manfully; moreover, it is known that Capt. — will fight to the 'bitter end' rather than let them fall into the hands of the enemy to be used in destroying our commerce. 'If a shot should strike one of our boilers, sir, it would be rather awkward in any event, and particularly so if we should be entirely without material for repairs.' He was nevertheless answered by the confident officer, 'You will have no fighting to do, sir, and you cannot have the iron.' Now the gallant little chief, Mr. —, said not a word more, but he had thoughts which had they been expressed would not have accorded with the 'blue book,' for he afterwards told a shipmate that 'he ached to try his hand on that *son of a lubber*.' But he recognized the old maxim as an established principle in discipline, that 'to know how to command you must first learn to obey.' He thought, notwithstanding, '*By the great guns, I will have that iron if I have to steal it.*' He returned on board the ship, every muscle in his body as rigid as her 'standing rigging,' and moodily made his way to the quarter-deck, which he saluted, and was informed that the captain wished to speak with him in his cabin. 'Very good,' he said, but he thought, 'I am in a bad humor to meet my brave and respected commander.' Mr. — had a very high regard for Capt. —, who was a brave officer and a genial shipmate. He has long ago passed away—gone to a pleasanter station where his qualities will be fully understood.

"He met his captain, whose face was bright with smiles as he said to him, 'Mr. —, I direct you to assist me on this basket of plums which the commodore in command of this station has sent me from his own garden.' 'Thanks, Capt.—.' Then a thoughtful pause. 'I am fearful, sir, that they will not sufficiently sweeten me to make me tolerable, to say nothing of being companionable.' 'Why, why, what's in the wind? nothing serious, I hope.' 'Perhaps it may be serious, Captain, for all of us; at any rate, I am very much out of humor, sir. The officer in charge of stores has stricken from my requi-

sition a plate of iron, the money value of which is paltry, while as we are situated its importance is considerable, at least, I so consider it, and I can only construe his action, in positively declining to allow it, as a personal insult, or at best a disparagement of my judgment of what is necessary in my department of a war ship.' 'On what grounds does he base his refusal?' 'That we shall have no fighting to do.' 'How does he know that?' continued the chief, 'and how does he dare insult us with the insinuation contained in his refusal?' 'I would have put these questions to him in a most emphatic manner if my uniform had mounted as much of Uncle Sam's gold lace as his own; but, sir, my lace was not heavy enough.' The effect of the delicate flavor of piums enhanced by the captain's hearty laugh at his earnestness was beginning to tell on Mr. —, and they both 'smiled' to wash down the commodore's fruit; serious thoughts, however, were entertained about the matter, and the captain inquires, 'What can be done, Mr. —?' 'Sir,' he answers, '*I will steal the iron. It shall be on board this ship before she leaves this dock.*' The captain remembering that he (Mr. —) was born on British soil, says, 'You have just enough Johnny Bull in you to make a good Yankee. I think you will get the iron.' But the chief, feeling a little doubtful whether the captain really appreciated the necessity of getting it, and, perhaps, desiring to avoid the stratagem dictated by his enthusiasm as a last resort to obtain it, began to lay plans to get the captain's assistance in the matter, and he argued thus: 'Now, Captain, it seems to me that our venerable commodore must hold you in high esteem. This choice fruit from his own garden, of which he is so proud, tells a story.' The captain admitted that it was a delicate compliment, and that he had before received suggestive favors from that brave old seaman. 'And,' added Mr. —, 'he will grant you one more; ask him to let us have the iron.'

"The captain made the request in person, and on his return from the commodore's office he says, 'The commodore's orders are that you straightway make your appearance before him.' The chief, always prompt in obeying orders, his motto being *duty first, duty always*, lost no time now. Sailing orders had been issued, and he thought while giving an extra touch to his toilet, '*Red tape sometimes gets foul and retards business.*' He, no doubt, felt the importance of his mission, while the reasonableness of his request was beyond question; still he was prepared to hear that it was a question of discipline, and that the rank of the officer who had refused to allow the item must be respected. Wearing his best smile and his most respectful air, he answered without hesitation the questions put by the commodore. 'Take this note to Mr. —, and do not forget, sir, that he is *your superior in rank.*' Bowing, 'Very good, sir,' he promptly obeyed by handing the note to the chief engineer in charge of stores. The black looks that followed the reading of that note were something to be remembered; but *the plate of iron came on board our ship in rather less than the usual red tape time.* And the sequel shows that it played a very important part in '*the preservation of the Union.*'"

[To be continued.]

Internal Effect of Hammering Metals.

Appleton's Cyclopaedia, Part 13. Page 80.

If an iron bar be held in the line of the dip of the magnetic needle and struck upon the upper end with an ordinary hammer, it will become polarized, one end repelling, the other end attracting the magnetic needle. Reverse the bar and strike it on the opposite end as many blows as before were given, and both ends will attract the magnet. Give two or three more blows and the bar shows magnetic effects the reverse of those first obtained. Something, therefore, has occurred in the bar due to hammer-impact, and the recognition of this makes it in a measure apparent why the compass needle in iron ships may be affected in consequence of the tremor to which the vessel is subjected owing to blows of the waves.

The Poetry of Iron.

There is a wonderful fascination about iron work and iron workers. Novelists have made them the scenes and heroes of their stories; poets have made them the themes of deathless song. We sing of the forge of Tubal Cain, and Hector swore "by the forge that stithied Mars' helm," but the other trades are passed over. When did poet, in lofty numbers, sing of the carpenter lathing a back room on the second floor? Who chants the brawny arms and thrilling deeds of a man climbing a four-story ladder with a hod of mortar? Does anybody stand with rapt emotion and watch a painter putty up a nail-hole? I would not exchange my one hour at midnight in the iron works at Ashland for a whole week watching a man mix mortar with a hoe. Why, these iron works surround the Ashlanders with enough romance to last a Western community at least six weeks. And yet, I suppose there are people about here who never saw a nail made in their lives. I have known times in my own eminently useful and highly ornamental career—times when I was trying to nail a front gate to a leather hinge, when I wished there had never been a nail made anywhere by anybody. And I watched them as they fell from the ponderous machines, fast as rain-drops, and it seemed to me, as I watched them fall, that I could hear the dull, treacherous thud of the hammer on the human thumb, the low wail of a woman's anguish, "the big, big D" of a young man in his agony. These strange, weird feelings and fancies rushed into my mind like a torrent. I stooped and picked up a brand new nail as a memento of my visit. Then I laid it down again. Sadly, but not slowly. I have an impression, I know not where I got it, that a new-laid nail, like a new-laid egg, is warm. And that it is far more perceptible in the case of the nail. It may not be so in every instance. I presume there may be some nails laid cold. But the one I picked up was not so everlastingly, gee-whizzing cold, and I did not investigate any further.—*Burlington Hawkeye.*

The Dream.

Somebody said a short time since in a New York press dispatch that the dream of the perpetual motion seeker was nearly realized in a machine which was on exhibition in that city. It consists of a pair of hollow metal wheels revolving in opposite directions on the same axis, and nine metal balls, which go from one wheel to the other through a side groove. The dispatch which announces this fact and describes the machine more fully has been copied by a number of technical journals for the apparent purpose of ridiculing the efforts of the patient and ingenious inventor, who, big with faith in the dream, has left the inhospitable shores of Europe which are inhabited by the apostles of Newton and the devotees of the French Academy, both of which authorities have declared that the realization of the dream is a physical impossibility. He no doubt believes that the bigotry of these disciples would render the adoption of his machine almost impossible, or even if adopted by a few they would be pronounced scientific heretics; and having the fate of Galileo in his mind, he has sought an asylum in this professedly free land, where he has devoted his leisure hours for sixteen long years to the perfection of his machine. And now that the wisecracks of our scientific press have, as they think, annihilated the devoted Keeley, they must have their little joke at the expense of this harmless foreigner. Perhaps, however, something may be said of a different tone on the other side of the question, and if not so full of philosophical erudition it may serve to change the current of public thought in some slight degree.

In the first place, who are Newton (of two hundred years ago), and the French Academy that a hundred years later reiterated his statements, and what did they know about what was to be discovered after their declaration was made in relation to the practicability of the perpetual motion? They no doubt thought that no improvement could be made on laws that they established, but did not they upset and set at naught theories and dogmas that prevailed before their day? and may not, by the same rule, some new Daniel come to judgment and return the compliment? What was known in Newton's day about railroading, steam navigation, the gunpowder pile-driver, or the remarkable jumper who returned to the mast-head of the liberty pole whence he had leaped, on being informed by a bystander, when half way down, that there was glass in the shavings on which he proposed to land?

Do any of the followers of these arrogant philosophers dare to question the possibility of the discovery of a means of breaking and re-establishing the influence of gravity at will, something as electrical currents are made and broken? The possibilities in the wake of this important discovery can only be briefly hinted at, for they include visions of the hod carriers' and the miners' carnival, whose loads, instead of being carried or hoisted by steam, will be made to ascend through tubes or on guiding rails by the centrifugal force of the earth's rotation on touching the key that paralyzes the force of gravity; oil and other artesian wells and city water-works that need no pumps; aerial excursions to Europe, around the world, and possibly breakfast calls on our lunarian neighbors, whose movements are to be observed by an immense telescope now in contemplation by a distinguished foreigner.

Speaking of making and breaking electrical currents suggests thoughts of the improvements and discoveries in electricity and of Franklin. He who invented the lightning rod, and gave us the race of genial and persuasive dealers in those appendages, was quite at home in Philadelphia with his kite and key, but he, like Keeley, harnessed a force that he could not control and that he knew little about, and he would be completely at sea among the phonographs, telephones, and other phones and wonders of Menlo Park. What did he know of the ocean telegraph or the quadruplex system? and who among his discip'les are bold enough to assert that the duoduplex or even the centiplex principles are not among the possibilities of the near future? The wonderful things in astronomy, geology, and chemistry might be adduced in support of the theory that there may yet be found something new under the sun, but space is not allowed at this time. So to return to our dream.

Ancient Syracuse developed an Archimedes, England a Newton, Scotland a Watt, and modern Philadelphia a Franklin (born in Boston), and a Keeley. And why should not New York be the home of a hero? It is, and he modestly says, not having the fear of Sir Isaac or the French bullies of the Academy before his eyes, "*Give me a cast-iron wheel sixty feet in diameter, and I will show you a motor of three hundred horse-power that requires nothing to keep it in motion. It will continue to run till it wears out.*" For my part, I say give him the wheel. It is not so extravagant a proposition as the one made by Archimedes, who jumped from his bath and ran through the streets, *sans toga* and tire, exclaiming, *Eureka! Eureka!* (I have found it! I have found it!) This ancient enthusiast proposed to move the world if only he was provided with a place on which to stand and place his fulcrum. Now without doubt the machine of our modern hero being rotative, is an immense improvement on the simple lever. I therefore offer an amendment to his proposition, which is to provide an adequate wheel and an over-board foundation for the machine, place a pinion on the north pole (which will no doubt be discovered in due time) to gear into the master-wheel of the machine, and let the old ball be turned backward in spite of Newton and his gravitation laws.

Incorporated
1866.

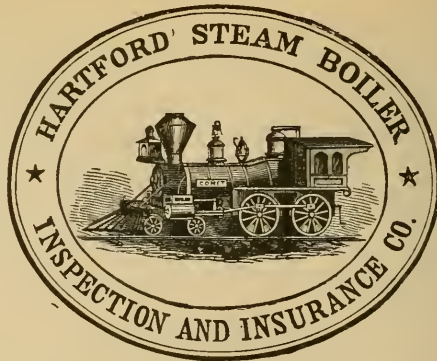

Charter Per-
petual.

Issues Policies of Insurance after a Careful Inspection of the Boilers,

COVERING ALL LOSS OR DAMAGE TO

BOILERS, BUILDINGS, AND MACHINERY,

ARISING FROM

Steam Boiler Explosions.

THE BUSINESS OF THE COMPANY INCLUDES ALL KINDS OF STEAM BOILERS.

Full information concerning the plan of the Company's operations can be obtained at the

COMPANY'S OFFICE, HARTFORD, CONN.

Or at any Agency.

J. M. ALLEN, Prest. W. B. FRANKLIN, Vice-Prest. J. B. PIERCE, Sec'y.

Board of Directors.

J. M. ALLEN, President.	GEN. WM. B. FRANKLIN, Vice-Prest. Colt's Pat. Fire Arms Mfg. Co.
LUCIUS J. HENDEE, Prest. Aetna Fire Ins. Co.	GEO. CROMPTON, Crompton Loom Works, Worcester.
FRANK W. CHENEY, Asst. Treas. Cheney Brothers Silk Manufacturing Co.	HON. THOS. TALBOT, Ex-Governor of Mass.
CHARLES M. BEACH, of Beach & Co.	NEWTON CASE, of The Case, Lockwood & Brainard Co.
DANIEL PHILLIPS, of Adams Express Co.	WILLIAM S. SLATER, Cotton Manufacturer, Providence, R. I.
GEO. M. BARTHOLOMEW, Prest. Amer. Nat Bank.	NELSON HOLLISTER, of State Bank, Hartford.
RICHARD W. H. JARVIS, Prest. Colt's Fire Arms Manufacturing Co.	D. R. SMITH, Prest. Springfield Fire & Marine Ins. Co.
THOMAS O. ENDERS, Sec'y Aetna Life Ins. Co.	
LEVERETT BRAINARD, of The Case, Lockwood & Brainard Co.	

GENERAL AGENTS.

THEO. H. BABCOCK,
CORBIN & GOODRICH,
LAWFORD & McKIM,
W. S. CHAMBERLIN,
J. L. SMITH,
H. D. P. BIGELOW,
C. C. GARDINER,
D. C. FREEMAN,
W. G. LINEBURGH,
GEO. P. BURWELL,
W. B. CASSILY,

CHIEF INSPECTORS.

R. K. McMURRAY,
WM. G. PIKE,
JOSEPH CRAGG,
WM. U. FAIRBAIRN,
B. M. LORD,
H. D. P. BIGELOW,
J. S. WILSON,
F. S. ALLEN,
W. S. FOX,
A. C. GETCHELL,
J. S. WILSON,

OFFICES.

NEW YORK CITY.	Office, 285 Broadway.
PHILADELPHIA.	" 430 Walnut St.
BALTIMORE.	" 10 So. Holliday St.
BOSTON, MASS.	" 10 Pemberton Sq.
PROVIDENCE, R. I.	" 42 Weybosset St.
CHICAGO, ILL.	" 132 LaSalle St.
ST. LOUIS, MO.	" 404 Market St.
HARTFORD.	" 218 Main St.
BRIDGEPORT.	" 328 Main St.
CLEVELAND.	" 246 Superior St.
CINCINNATI.	" 53 West Third St.

The Locomotive.

PUBLISHED BY THE HARTFORD STEAM BOILER INSPECTION AND INSURANCE COMPANY.

NEW SERIES—VOL. I.

HARTFORD, CONN., APRIL, 1880.

No. 4.

Explosion of a Horizontal Tubular Boiler.

The explosion which is here illustrated occurred some time ago in a flour-mill in Ohio. It was briefly noticed in a former number of *THE LOCOMOTIVE*, and some editorial comments were made on a letter that appeared in a local newspaper, relating to the probable cause of the explosion.

The illustrations, figures 2, 3, and 4, were cut from photographs of the broken boiler, and figure 1 was engraved from a model made from the sketches that accompanied the inspector's report of the accident.

From the report and the photographs the following facts are obtained :

The boiler was, as shown by the engravings, of the horizontal tubular type. It was set in brick masonry and externally fired in the usual manner, having the furnace under the right-hand end (see fig. 1). There appears (in one of the photographic views, not copied,) to have been links, one on each side, near the summit of the shell at the front, as though this end had been suspended from a support above the boiler, while the absence of brackets on the sides of the shell indicates that the rear end rested on a support below the boiler.

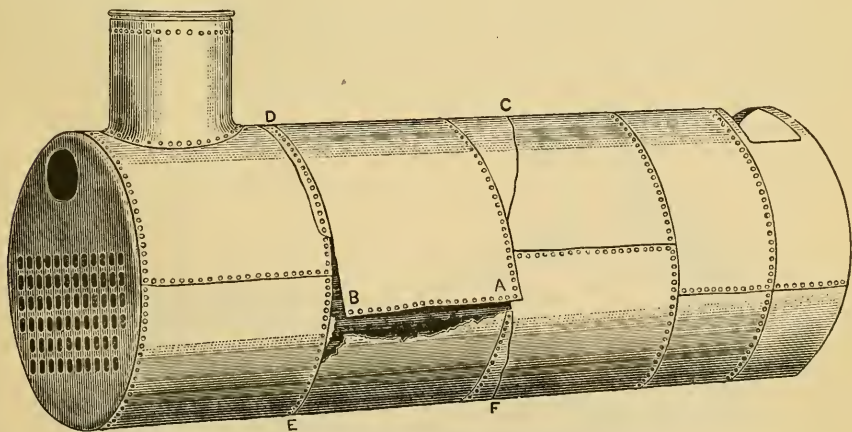

FIG. 1.—BA, line of initial fracture; AC, AF, BE, and BD, lines of secondary fracture, being the boundary lines of the detached ring of plates.

The furnace gases passed under the boiler, heating its lower half, and returned through the tubes to the smoke-arch formed by the extension of the shelf in front, thence upward through a rectangular opening in the shell to the chimney. The age of the boiler is not positively stated, but it had occupied its late position in this new brick mill but little, if any, more than one year, its predecessor having blown the old wooden mill into kindling-wood only about eighteen months before. It was, therefore, probably about one year old; but it had not been examined by any competent inspector since it was set up in the mill.

The dimensions, as far as ascertained, are as follows :

The shell was 14 feet long by 58 inches diameter, made of $\frac{5}{8}$ plates, single riveted. On the rear end was a steam-dome having a flat, cast-iron top on which were the main steam attachment and the safety-valve. The steam gauge-pipe was screwed into the side of the dome. There were two man-holes, one in the rear tube-plate above the tubes, (fig. 3), and the other in the front head below them (not shown in the cuts). The working pressure was not given in the report.

The boiler-house which adjoined the mill was completely wrecked and the machinery in it demolished, the adjacent end of the mill was blown down, one man was killed, and two others were injured by the explosion.

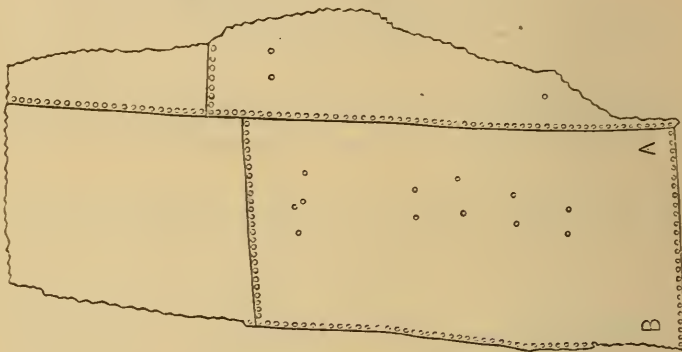

FIG. 2.—Ring of plates broken off by the force of the escaping water and steam.

There were indications observed by the inspector who reported this accident that grease from the engine had found its way through the open feed-water heater (so-called) that was used in connection with it, into the boiler; but there were no indications of low water, although the explosion was popularly attributed to this cause.

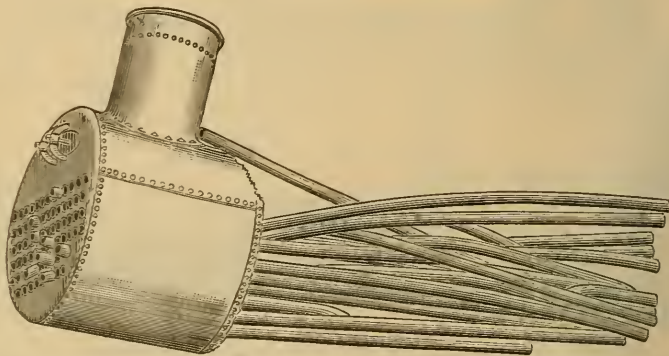

FIG. 3.—The rear end and tubes.

Since the disaster time enough has elapsed in which to carefully compare the phenomena with a number of apparently similar cases where well-defined weakness of a longitudinal seam was the defect from which the explosion originated, and the conclusion is naturally arrived at that there was a crack between the rivet-holes of the inner lap of the seam A B, fig. 1, caused by the use of the drift-pin or by some other violence in forming the seam, or that the ends of the plate were not brought to the true curve of the cylinder, thus forming a flattened area at the lap, and the effort of the internal pressure to form a true cylinder, and the converse tendency of the plates to return to the distorted

form on the pressure being relaxed, would cause an increasing weakness which would after some time develop a crack on the line of least section. Whether or not this is the true solution in this case, the conclusion that there was a weakness at this point, or an over-pressure, is inevitable. If there was a congenital weakness, it would increase until an ordinary pressure would bring about disaster; on the other hand, if there was an extraordinary internal pressure, it must have been something like 250 pounds to the square inch to have broken a sound seam. In any event, there can be no question as to the value of timely and intelligent personal inspection; for if there was a detectable defect at the seam, where they are most often found, then this is the place that would be most carefully scrutinized. Excessive pressure can only occur in case of a badly-constructed or badly-managed safety-valve, and who knows so well as the experienced inspector how to detect any of the above-named defects and prevent, if his advice is followed, the disastrous effects of over-pressure, careless management, and bad workmanship.

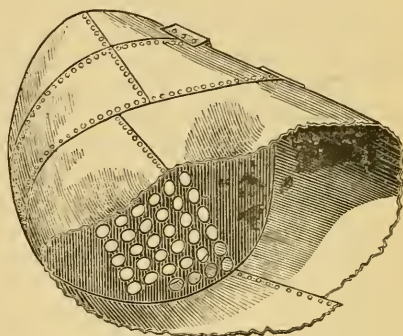

FIG. 4.—Front end of boiler.

Explosion of a (Stationary) Locomotive Boiler.

The following incomplete report of a boiler explosion in New York State is furnished by the owner, asking for an explanation of the cause of the explosion.

He describes the boiler as a locomotive boiler, meaning that it was one of the type used on railways, but it was undoubtedly built for stationary work. It was 11 feet long and 3 feet diameter of barrel, and contained 49 tubes 7 feet long and $2\frac{1}{2}$ inches diameter. The fire-box was 4' by 4' horizontal measurement, which would give 16 square feet of grate surface. A sketch on the margin of the letter shows the direction taken by the two principal parts of the boiler when it exploded, and the distance between them as they lay after the explosion.

The narrative of the proprietor's part in the play runs substantially as follows: "I went to the mill at 6 A. M. and started a fire as usual; had two gauges of water; fired till 6.45, not a heavy fire but an ordinary one; shut the damper; tried the water and found two gauges, and saw that I had 20 lbs. of steam by the gauge. It was then 6.45, and I went to breakfast; there observed that it was 6.55 by the clock, and in less than three minutes my boiler and mill were a complete wreck." The boiler stood, it appears by the sketch, in the building, fire-box end toward the west, but after the explosion it was found that the parts, which appear to have separated near the junction of the barrel with the fire-box, had changed positions relatively, and were separated by a distance of 82 rods (about 1,350 feet). The barrel with the tubes in it lay 4 rods farther from the mill than the other part. He closes thus: "I have related the facts as they are. What caused that explosion in so short a time after I went from the mill? Give me your opinion."

The simple answer is: the boiler was very weak, or the pressure was pretty high. In stating it in this concise manner it is by no means intended to dismiss the gentleman's inquiry in a summary or disrespectful manner. It is a legitimate and proper question. The case is introduced here partly as a sample of the inquiries that come to this office, but principally because it is, as described, an interesting case, and one of the rare ones

where there is an intelligent survivor to relate the circumstances as they appear to be. It is to be regretted, however, that the report is not more complete. The data which are given as to time, dimensions, and distances are probably reliable and substantially correct; but the intensity of the fire and record of the pressure, one or both, may be very wide of the mark. Under some conditions, 58 minutes are ample time in which to accomplish in a perfectly natural way the results described, even with two gauges of water in the boiler; but not knowing anything about the correctness of the steam gauge, the quality of the fuel, or condition of the safety-valve, it will of course be impossible to make any statement that would be of any value to anybody, as to the immediate specific cause of this accident, without thoroughly and carefully examining the broken boiler, and even then it might be difficult, and perhaps impossible, to locate the initial rupture, without a knowledge of which, everything would be guesswork and uncertainty, because the weak line, which is the measure of the strength of the whole, is sure to give way first. The secondary tearing, though it may be, and generally is, through parts that were of full strength, is done by a force acting at an angle—often as much as 90 degrees—with its surface, instead of parallel to it, as we test iron in a machine. The transposition of the broken parts as described, would no doubt be accounted for in a satisfactory manner if the course of the break and the obstructions in the path of the parts could be determined. But without complete and reliable data it will be unprofitable to speculate on the possible or probable cause of this accident. It is one of the many cases that emphasize the necessity of competent inspections, supplemented by careful management in accordance with the inspector's advice.

BOILER EXPLOSIONS.

MARCH, 1880.

FOREIGN STEAMER (34.)—The boiler of a steamer burst, March 18, in the harbor of Bona. The steamer was driven into two Spanish feluccas, seriously injuring twenty-five men. Two firemen were killed.

SAW-MILL (35.)—While a party of ladies and gentlemen were inspecting Jere. Fenno's steam mill, March 6, near Milo, Me., the boiler exploded. One young lady, Effie Snow, seventeen years of age, the daughter of Stephen Snow of Milo, was blown one hundred and fifty feet out on the lake; and another Milo young lady, Nettie Gould, was blown forty feet. The Snow girl lingered till 1 o'clock Friday morning, and the Gould girl is still alive, but will soon die. A young man, Frank Gray of Orrington, was badly injured, and will probably die. The engine and boiler were moved about eight feet, and one end of the building was blown entirely out.

FOREIGN (36.)—A boiler explosion occurred in Glasgow, March 5, by which six persons were killed outright and thirty severely wounded.

SAW-MILL (37.)—F. E. Allen of Pittsfield, Otsego county, N. Y., was in Utica, March 9, looking for a new boiler. The 30-horse boiler of his steam saw-mill exploded about 7 A. M., when he and his men were at breakfast, and fortunately no one was hurt. The mill was torn to pieces. The boiler broke into two pieces, and each piece was found just about eighty-two rods from where the whole had stood, but in opposite directions. The boiler, just before it exploded, had two flush gauges of water in it and but twenty pounds of steam. Mr. Allen will rebuild his mill at once.

GRIST-MILL (38.)—The boiler in Solomon Zeigler's grist-mill at Brotherton, opposite St. Charles, Mo., on the Missouri river, exploded Tuesday, March 11, killing Zeigler's son Simon and a colored boy named Williams, and blowing the mill to atoms.

FLAX-MILL (39.)—About 7 A.M., March 11, the little city of Frankfort, Ind., was shocked by an explosion which proved one of the most appalling accidents that ever occurred in this State. The fire-bell called the people to the flax-mill of Rosenthal & Co., situated half a mile north of the town, where it was found that the boiler had exploded, tearing the structure to pieces and setting the wreck on fire. A spectacle was presented that beggars description. Lying near the wreck were the bodies of ten men, who without a moment's warning had been killed. Most of them were mangled beyond recognition. One or two could be recognized only by their clothing. One had his head blown off. Another was found with the upper half of his head gone. A third had a half of a brick imbedded in his brain. *Not one who was in the mill at the time of the explosion is left to tell the story.* The engineer's watch was found, and from the fact that it stopped at 6.55 it is inferred that the accident occurred just as the mill was about to start. Eight of the bodies were found among the débris in the engine-room, and it is supposed the men were in there, as usual at that time in the morning, changing clothes preparatory to beginning work at 7 o'clock.

When the bodies were recovered, the fire had made such headway that all thought of saving the building was abandoned. The loss on building and material is about \$10,000. All the bodies were taken to Frankfort and will be sent to their friends. There is no way of ascertaining the cause of the explosion.

SAW-MILL (40.)—The boiler in Kelley's saw mill at Lebbeller's switch, on the International & Great Northern Railway, Texas, exploded March 17, killing three men, whose names we have not learned.

SAW-MILL (41.)—A boiler explosion occurred on Friday at the steam saw-mill of Reed & Harrouff, ten miles northeast of Decatur, Ill., which resulted in the death of one man and in the serious, if not fatal, injury of one of the proprietors of the mill.

ELEVATED RAILROAD LOCOMOTIVE (42.)—At the Rector-street station of the Metropolitan Elevated Railroad, on Monday afternoon, March 22, a train on the down track had just pulled up and discharged most of its passengers, when the next train following came along at full speed, and the engine of the latter struck the rear car of the other. The result was a violent explosion of the engine's boiler, the débris from which was dropped along the street underneath. Quite a number of persons were passing at the time, but all escaped injury but one, a boy of seventeen, who was struck on the head by a piece of the falling iron, the blow causing fatal injuries.

FOREIGN (43.)—George Rigney of Bridgeport went to San Domingo about six months ago. On Thursday, March 25, news was received that he had been killed by a boiler explosion.

SAW-MILL (44.)—The boiler of Sample's saw-mill, near Columbus, Ga., exploded March 25, killing three men and injuring others. The mill was demolished.

Inspector's Reports.

The inspection reports from eleven branch offices of this company are nearly all in, and they are summarized below.

In the month of February, 1880, 1,485 inspection visits are reported, and a total of 3,237 boilers were examined. Of this number, 928 were complete internal and external annual inspections, the balance were mostly quarterly examinations.

The quarterly visits and external examinations are for the purpose of observing the condition and performance of the whole steam apparatus while at work, and to note if new men have been employed, or new practices instituted. Some of the dependencies

and attachments, as the water-gauges, safety-valves, feeding and blowing apparatus, can be most thoroughly criticised while they are working—also the character of the fire, habit of feeding both water and fuel, and the pulsations of the pressure as indicated by the twitching and vibration of the gauge pointer. Although the proprietors of insured boilers may not always meet the inspector at the time of his quarterly visits, yet he may rest assured that they are important, and are made with fidelity by all conscientious inspectors. Viewed from the company's standpoint, they are important means of securing immunity from loss, while, viewed from the owner's side, they may be, and are, made of great value by enabling his engineer to become acquainted with the most economical and the latest practices in the management of steam. The proprietor himself is at liberty to inform himself, if he cares to do so, by questioning the inspector. When a doubt arises in regard to some contemplated change or addition, the opinion of an experienced and disinterested professional in this line will not be despised by the prudent manager, although it is gratuitously obtained. Hundreds of the patrons of this company will testify that they have been correctly directed by such advice from our inspectors.

During the month the hydrostatic test was applied to 238 boilers, but it was not relied on as conclusive that they were free from corrosion, grooving, cracks, blisters, and dangerous accumulations of scale or deposit, in fact it can tell us nothing except the bare fact that the boiler has endured for the time, and in its then condition a cold statical pressure as indicated by the gauge. Therefore, when applied to boilers that have been in use it is accompanied by thorough examination as far as may be while the gauge indicates about the working pressure, and supplemented by a further search for such defects as are not exhibited by the pressure.

The whole number of faults that were discovered in February was 1,447, and of these 473 were reported as dangerous defects. A dangerous defect is not always of an absolutely alarming character, like a "gun-powder plot," with the slow match burning, but it is of such a serious nature that it may cause expensive repairs, if not actual calamity before the next inspection anniversary. It is, therefore, best to anticipate rather than procrastinate, if such a defect is reported.

The details of the defects are as follows: Furnaces out of shape, 64—20 dangerous; fractured plates, 153—91 dangerous; burned plates, 89—40 dangerous; blistered plates, 239—36 dangerous; cases of deposit of sediment, 180—48 dangerous; incrustation of scale, 283—39 dangerous; external corrosion, 90—51 dangerous; internal corrosion, 52—24 dangerous; internal grooving, 3—all dangerous; water-gauges defective, 28—11 dangerous; blow-outs defective, 17—8 dangerous; safety-valves defective and overloaded, 21—20 dangerous; pressure-gauges defective, 125—5 dangerous; boilers without gauges, 58—6 dangerous; deficiency of water, 14—9 dangerous; braces and stays broken, deficient in number and loose, 31—15 dangerous; boilers condemned, 23.

A report was received last month giving a partial account of an explosion in New Jersey, but the details were not sufficiently full to enable us to illustrate and fully explain the accident. It was, however, an interesting case of undoubted over-pressure, the boiler having been accidentally sealed by the closing of a stop-valve between the safety-valve and the boiler. This valve was placed there for a purpose quite different from the one it finally served, pursuant to the advice of some one whose name, says the report, is "to fame unknown," but it is probable that it will be held in remembrance by at least one steam user for a long time to come. The arrangement from which this explosion arose is considered dangerously defective, and when insurance is applied for on such this company always declines the risk. This, and a number of like accidents that are on record, demonstrates the fact, which is not appreciated by some persons, that boilers do explode sometimes with sudden and disastrous violence from a gradually-increasing pressure.

Classification of Boiler Explosions which have been published in THE LOCOMOTIVE as having occurred between Oct 1, 1867, and Jan. 1, 1880.

KIND OF WORKS.	Number of Boilers Exploded.	Number of Persons killed.	Number of Persons injured.
(1.) Saw, planing, and wood-working mills,	281	497	576
(2.) Steamboats, tugs, yachts, and steam barges,	186	956	816
(3.) Railroad locomotives,	185	249	238
(4.) Iron-works, furnaces, foundries, and machine shops,	92	147	324
(5.) Paper, flouring, and grist mills, bleacheries, and print-works,	92	96	122
(6.) Portable hoisting, threshing, and pile-drivers,	66	143	137
(7.) Cotton, woolen, flax, and other fabric mills,	55	72	131
(8.) Mines, quarries, oil-mills, and refineries,	44	73	76
(9.) Heating and domestic boilers,	29	10	33
(10.) Chemical, rendering, and slaughtering works,	27	43	32
(11.) Distilleries, breweries, and sugar refineries,	25	18	34
Miscellaneous—52 kinds not specified above,	217	201	93
	1,299	2,505	2,612

The miscellaneous item in the foregoing table includes a great variety of works, etc., which do not properly belong to any of the classes. They are principally as follows: Agricultural works, bakeries, barns, bell factories, brush works, brass foundries, bone factories, cotton gins, cotton presses, cement works, cheese factories, coal breakers, dye houses, dummies, donkey engines, dental offices, fire engines, file works, fur factories, fertilizer works, glass works, glue factories, gymnasiums, hat factories, houses of correction, ink factories, lead works, mills not known, marble yards, navy yards, needle works, fish-oil works, organ factories, pumping stations, piano factories, plumbers' shops, rinks, ring works, soap works, salt works, steam tables, shoe factories, screw works, stove works, tanneries, tin shops, testing boilers, tanks, tool factories, water works, wheelbarrow factories, warehouses.

THE REFEREE'S CASE,—FALL RIVER IRON WORKS *vs.* MECHANICS MILLS, was very fully reported by Thomas Pray, Jr., editor *Boston Journal of Commerce*. He has published this report in a book of 763 pages. In it will be found the evidence of the experts who had been retained by each side. The controversy was in regard to the efficiency of the Flynn Boiler, which the Iron Works had sold to the Mechanics Mills. The report is a marvelous instance of the facility with which one familiar with phonography can write down and ultimately write out testimony. It is more—for here are mechanical expressions, formulae, and technical terms, that, to mean anything, must be correct, and unless correct the whole labor is valueless. Mr. Pray, who is an expert at this business (as well as at some others), has accomplished this task, and now presents it in a bound volume with questions and answers, and illustrations.

It contains the views of some of the leading mechanical engineers of the country on questions of heat and steam, and all interested in such questions should have a copy. It can be obtained by addressing Thomas Pray, Jr., Editor *Boston Journal of Commerce*.

The Locomotive.

HARTFORD, APRIL, 1880.

Considerable interest has been manifested in a recent lawsuit in Boston, brought by J. R. Robinson against the Hartford Steam Boiler Inspection and Insurance Company. The complaint was that the character of said Robinson had been injured by an article in THE LOCOMOTIVE, reviewing and criticising his theories of boiler explosions as expressed on two occasions before coroner's juries where boiler explosions had occurred with fatal results. The theories expressed were those usually characterized as "mysterious" and "visionary," assigning as the cause of boiler explosions,—the lifting of the water—"spheroidal condition," "super-heated water." The vaporization of water suddenly, etc.

The boilers which exploded were old, badly deteriorated, in one case being corroded to $\frac{1}{2}$ of an inch in places, and in the other, the bottom was covered with sediment and scale,—had been repaired several times,—badly burned, and generally weak and unsafe. We saw no reason to go beyond the general weakness of the boilers for the cause of the accidents, and we felt that to attribute these disasters to other causes than those so evident was calculated to lighten the feeling of responsibility on the owners and users of steam boilers. Therefore we severely criticised such views and aimed to show that boilers like other machines grow weak and old, and if not taken care of will break down from sheer inability to carry the burden imposed upon them. Mr. Robinson construed our criticisms into an attack upon his person and character, and sued us for \$25,000. The case came to trial in the Supreme Judicial Court of Massachusetts, before Judge Lord. Without entering into details it is sufficient to say that the charge of libel fell through utterly, no malice on the part of the defendants was proven, nor was there any damage stated or proved. The rulings of Judge Lord were very clear and decided. The jury speedily found a verdict for the defendants, with the addition that they did not wish the verdict to be understood as reflecting upon Mr. Robinson personally or as an engineer.

It is proper for us to say at this point that we have not now, nor have we ever had, any unkind or malicious feelings towards Mr. Robinson, and we shall always cordially welcome him to this office, where we believe he would find records and specimens of exploded boilers that would be of service in the future investigation of this subject. Our interests in this direction are very large. We inspect thousands of boilers each year, and every one inspected if approved is insured, and if a loss occurs we expect to pay it *without equivocation or falling back upon technicalities*, hence we feel it our privilege and our duty to criticise opinions and theories that our experience has shown to us to be pernicious, with that degree of severity that the objectionable theory calls for. But we shall do it without malice.

MILLS' DIRECTORY OF STEAM BOILER AND ENGINE OWNERS IN NEW YORK AND BROOKLYN is a very valuable work. All persons manufacturing or interested in steam machinery know how valuable a directory is that will give the name, street, and number of such parties as they deal with. Such a work is Mills' Directory. We understand that a directory for the New England States will soon be ready for sale, and Mr. Mill's plan is to cover in time a large part of the country. Persons desiring these works should address James N. Mills, 165 Broadway, New York, Room 3.

A. F. Huston, of Lukens Rolling Mill, Coatesville, writes to the *Scientific American* that his great-grandfather, Isaac Pennock, established the first rolling mill in America in 1798. The mill was called "Federal Slitting Mill," and was located on Buck Run, in East Fallowfield township, Chester county.

PROPERTIES OF STEAM.

Pressure per Steam.	Temperature per Fahr.	VOLUME AND WEIGHT.			HEAT.	
		Cubic feet of Steam from one cubic foot of water.	Weight of one cubic foot of Steam.	Cubic feet of Steam to the pound.	LATENT HEAT in one pound of Steam.	TOTAL HEAT above 32° in one pound of Steam.
Gauge.	Thermometer.	Cubic feet.	Ponnds.	Cubic Feet.	Units.	Units.
1	2	3	4	5	6	7
0	212	1,644	.0378	26.42	966	1,146.6
5	228	1,231	.0484	19.73	953	1,151.5
10	240	998	.0623	16.03	945	1,155.0
15	250	840	.0726	13.75	938	1,158.0
20	259	726	.0862	11.40	932	1,161.0
25	267	640	.0963	10.37	926	1,162.3
30	274	572	.1063	9.20	921	1,166.0
35	281	518	.1195	8.35	916	1,167.6
40	287	474	.1312	7.62	912	1,169.0
45	292	437	.1407	7.12	908	1,171.0
50	298	405	.1530	6.50	904	1,173.0
55	303	378	.1650	6.06	901	1,174.0
60	308	355	.1774	5.74	897	1,175.7
65	312	333	.1842	5.34	894	1,177.0
70	316	314	.1971	5.05	891	1,178.0
75	320	298	.2091	4.80	888	1,179.6
80	324	283	.2193	4.55	886	1,180.5
85	328	270	.2320	4.31	883	1,182.0
90	331	257	.2400	4.16	881	1,183.0
95	335	247	.2510	3.98	878	1,184.0
100	338	237	.2650	3.77	876	1,185.0
105	341	227	.2740	3.65	874	1,186.0
110	344	219	.2845	3.52	871	1,186.9
115	347	211	.2940	3.40	869	1,187.8
120	350	203	.3050	3.25	867	1,188.6
125	353	197	.3150	3.17	865	1,189.4
130	355	190	.3220	3.10	863	1,190.0
135	358	184	.3350	2.97	861	1,191.0
140	360	179	.3440	2.90	860	1,191.4
145	363	174	.3540	2.80	858	1,192.0
150	366	169	.3678	2.71	856	1,193.0
155	368	164	.3760	2.63	854	1,194.0
160	371	159	.3900	2.56	852	1,195.0
165	373	155	.3990	2.50	851	1,195.7
170	375	151	.4067	2.45	850	1,196.0
175	377	148	.4160	2.40	848	1,197.0
180	380	144	.4340	2.30	846	1,197.7
185	382	142	.4420	2.26	844	1,198.5
190	384	139	.4512	2.21	842	1,199.0
195	386	136	.4620	2.16	841	1,199.5
200	388	133	.4720	2.11	839	1,200.0

Concerning Old Boilers.

We are assured there are some things that are improved by age. Steam boilers are not of that number. Among steam users an occasional one will be found who will tell you it is his belief that an old boiler will not explode. What would cause a great disaster in his neighbor's new and stronger boiler will simply rupture his at some weak place, and the outlet thus provided will release the pressure and prevent further damage. To those who are using boilers that have been in service many years this must be a very soothing belief; unfortunately for them, it is not true; and that boilers cannot be depended upon to rupture according to this programme the records of explosions in THE LOCOMOTIVE testify. My attention was particularly attracted to the following cases in recent numbers, extracts from which I quote: "The boiler was an old one." "The boiler was a very old one, carrying its usual pressure of steam at the time of the explosion."

"This boiler, thirty (30) feet long (plain cylinder probably), had been in use some years, and it is stated, had three gauges of water in it; when the explosion occurred the mill was totally destroyed."

In the year 1871 the Hon. Secretary of the Navy appointed a Board of Engineers to report upon the "Experimental Steam Boiler Explosions" being made at Sandy Hook, N. Y., under the direction of Prof. Thurston, of Hoboken, N. J. From their report, a remarkably clear and concise document, I quote the following concerning a horizontal fire tube marine boiler that had seen twenty-five years' service, and had been taken out of its place and laid away in the "boiler bone yard"; it was repaired for the purpose of this experiment, and subjected to a hydrostatic test of 59 lbs. per square inch, which it bore without fracture; a few days afterwards it was exploded with terrific violence at a steam pressure of 53½ lbs. The conclusions drawn by the "Board" from this experiment were:

1st. An old boiler, containing a large mass of water above the highest point of its heating surface, can be exploded with such complete destruction as to reduce it into mere debris, and hurl the fragments in all directions with a force that no ordinary construction of building or vessel could withstand.

2d. That the pressure required for so devastating an explosion is the very moderate one of 53½ lbs. per square inch.

3d. That with only a wood fire, generating a far less quantity of heat in equal time than a coal fire, there were required only thirteen minutes to raise the pressure from 30 lbs. per square inch to the exploding pressure of 53½ lbs. per square inch, showing that a few minutes' absence or neglect of the engineer, coupled with an overloaded or inoperative safety-valve, are all that are needed to produce the most destructive steam boiler explosion, *even with an old and unequally braced boiler, in which it might be supposed a rupture of the weakest part would precede other fracture, and allow the escape of pressure without doing further injury.*

These experiments were made by engineers of great ability and experience, who stand deservedly high in their profession; they conclude their report in these words; "That this experiment has conclusively disposed of several theories of steam boiler explosion, replacing vague conjecture and crude hypothesis with exact experimental facts, and by thus narrowing the field for the search of truth has made the discovery more probable."

We occasionally meet men who have one or more boilers that have been in service twenty-five or thirty years, and when spoken to upon the responsibility they assume, and the danger of running such old boilers without periodical inspection, reply, "My old boilers are safer than new ones—they have been tried. You don't get the kind of iron now-a-days that's in those boilers—it isn't made." For dense ignorance commend one to men of this stamp, they are encouraged in this belief by a few unprincipled men who profit by the repairs, and from such unworthy motives humor their fancy. I have pointed

out in such cases the absurdity of such an opinion, and directed their attention to the great progress made in all branches of industry since many of the boilers in question were built, and assured them that in no branch had greater advancement been made than in that of the manufacture of iron, and the various processes through which it would pass until formed into a boiler; that a stronger, safer, and more economical boiler could be built to-day, under the supervision of one company, than was possible even ten years ago with the appliances then used.

One of these experts who testified in the "Westfred Investigation" favored, as a measure of safety, the condemnation of all marine boilers that had been in service nine or more years. I do not favor condemning a boiler until shown to be unsafe after a proper examination, there are some new boilers that should never be allowed to leave the shop floor—built of the poorest grade of iron, lightly braced, and thrown together in the cheapest manner, to save the builder from a loss, he having taken the job below a living price. Sometimes new boilers of good material, and well made in other respects, are ruined by careless caulking. I saw such a one recently in front of one of our shops; it was damaged more than five years of ordinary work would have done; but no matter how poor or imperfect they may be, they are bricked up in place and accepted in full confidence that they have a first-class boiler, and it will stand 300 lbs. of steam; in fact the builder said he would sit upon it with that pressure on; of course there can be no doubt of it after such an offer. How important it is, if these statements be correct,—and your agents and inspectors know of such cases every day,—how important it is that all boilers should be inspected before delivery; this would add to the security, protect honest builders, and show up the cheap Johns that are ruining honest men. THE LOCOMOTIVE is doing a noble work. I can look about me and note many reforms accomplished during the past eight years, by which steam users have been benefited. All hail the new departure, and wish it every success.

F. B. A.

Society of Mechanical Engineers.

The meeting for the organization of this society was held at the Stevens Institute in Hoboken, Wednesday, April 7.

The following gentlemen were present:

LIST OF NAMES.

Chas. W. Isbell, New York; John F. Ward, Jersey City; W. H. Weightman, A. Faber du Faur, New York; Robert Riggs, Philadelphia; Charles Oferry, Westbrook, Conn.; Charles Gordon Buchanan, Rockaway, N. J.; H. S. Hayward, Jersey City; H. E. Parson, New York; Wm. J. Logan, Brooklyn, N. Y.; R. G. Evert, Samuel S. Webber, New York; John Cotter, Norwalk, Conn.; Chas. A. Moore, Boston; W. Barnet Le Van, Philadelphia; Chas. B. Richards, Hartford, Conn.; L. T. Lyne, Jersey City; Thos. Pickering, Portland, Conn.; Joseph J. White, Smithville, New York; R. H. Soule, Baltimore; John W. Cloud, Altoona, Pa.; Harris Tabor, Corning, N. Y.; Francis E. Galloupe, J. Larcom Walls, Providence, R. I.; Jas. A. Burden, Troy, N. Y.; F. Firmstone, Easton, Pa.; Fred. Keppy, Bridgeport, Conn.; Albert Stearns, Brooklyn, N. Y.; Wm. E. Barrows, Hartford, Conn.; Edward W. Thomas, John Scott, Willimantic, Conn.; C. H. Brown, Fitchburg, Mass.; Prof. S. W. Robinson, Columbus, O.; John M. Wallis, Baltimore; Horace B. Miller, New York; Robt. W. Hunt, Troy, N. Y.; W. F. Durfee, Bridgeport, Conn.; Joshua Rose, New York; George S. Strong, Philadelphia; John L. Gill, Jr., Pittsburgh, Pa.; David N. Melvin, Linoleumville, Staten Island; F. F. Hemenway, Troy, N. Y.; Wm. H. Hoffman, Passaic, N. J.; Carlton, W. Nason, New York; F. H. Richards, Springfield, Mass.; Jackson Bailey, Lycurnus B. Moore, Fredk. M. Wheeler, New York; C. C. Newton, Cleveland, O.; Robt. Grimshaw, Ph.D., Philadelphia; David P. Davis, Jersey City; Geo. M. Copeland, Wm. Lee Church, New York; Gardner C. Hawkins, Boston; Geo. A. Barnard, New York; Horace Lee, Philadelphia; Samuel W. Powel, Ithaca, N. Y.; Jerome Wheelock, Worcester, Mass.; Alfred B. Couch, Philadelphia; C. C. Collins, Newark, N. J.; S. W. Baldwin, Yonkers, N. Y.; Charles T. Porter, Newark, N. J.; W. E. Ward, Port Chester, N. Y.; E.

D. Leavitt, Jr., Cambridgeport, Mass.; Geo. B. Mallory, M. N. Forney, A. H. Emery, Wm. H. Wiley, New York; G. Leverich, Brooklyn, N. Y.; E. F. Wells, New York; H. A. Hill, Boston; W. L. Surtland, New Haven, Conn.; F. W. Bacon, Boston; John E. Sweet, Syracuse, N. Y.; Charles T. Thompson; Washington Jones; W. H. Scranton; W. Cogney, New York; C. C. Starkweather, New York; W. H. Scranton, Oxford Furnace, N. J.; J. C. Bayles, New York; Wm. Hewitt, Trenton, N. J.; A. Vanberbilt, John Fish, Lewis F. Lyne, New York.

Mr. Henry R. Worthington was elected Chairman and Mr. J. C. Bayles Secretary of the meeting.

The Committee on Organization made a report, and the constitution and by-laws, as recommended by it, were adopted with some unimportant amendments.

The conditions of membership, as stated in these rules, are as follows;

MEMBERSHIP.

The society shall consist of members, honorary members, associates, and juniors.

Mechanical, civil, military, naval, mining and metallurgical engineers and architects only, may be candidates for membership in this society.

To be eligible as a member, the candidate must have been so connected with some of the above specified professions as to be competent, in the opinion of the Council, to take charge of work in his department either as a designer or constructor, or else have been connected with the same as a teacher.

Honorary members, not exceeding 25 in number, may be elected. They must be persons of acknowledged professional eminence, who have virtually retired from practice.

To be eligible as an Associate, the candidate must have such a knowledge of or connection with applied sciences as qualifies him, in the opinion of the Council, to coöperate with engineers in the advancement of professional knowledge.

To be eligible as a Junior, the candidate must have been in the practice of engineering for at least two years, or he must be a graduate of an engineering school.

[The term "Junior" applies to the professional experience, and not to the age of the candidate. Juniors may become eligible to membership.]

All members and associates shall be equally entitled to the privileges of membership, provided that honorary members who are not also members or associates, and juniors, shall not be entitled to vote, nor be members of the Council.

The initiation fee of members and associates is fixed at \$15, and the annual dues at \$10. The initiation fee of juniors is to be \$10, and the annual dues \$5.

The affairs of the Society are to be managed by a Council consisting of a president, six vice-presidents, nine managers, and a treasurer. The president and treasurer are to hold office for one year, the vice-presidents for two, and the managers for three.

The secretary is to be appointed, and may be removed by the Council.

The following officers were elected:

President.—R. H. Thurston, Professor Mechanical Engineering, Hoboken, N. J.

Vice-Presidents.—H. R. Worthington, Hydraulic Engineer; Coleman Sellers, Mechanical Engineer; Eckley B. Cox, Mining Engineer; Gen. Q. A. Gillmore, U. S. A.; Wm. H. Shock, U. S. N.; A. L. Holley, New York.

Managers.—W. P. Trowbridge, Professor Engineering, Columbia College, New York; Theo. N. Ely, Superintendent Motive Power, Pennsylvania Railroad, Alton, Pa.; J. C. Hoadley, Mechanical Engineer; Washington Jones, Mechanical Engineer; Wm. B. Cogswell, Mechanical and Mining Engineer; F. A. Pratt, Mechanical Engineer; Chas. B. Richards, Mechanical Engineer; Wm. M. Bement, Mechanical Engineer; S. B. Whiting, Mechanical Engineer.

Treasurer.—L. B. Moore.

The gentlemen who attended the meetings were most hospitably entertained with lunch at the house of President Morton, of the Stevens Institute. Much regret was expressed at the absence of Mr. A. L. Holley, who, owing to illness, was unable to be present.—*Railroad Gazette*.

The Modern Engineer.

[Read at the recent dinner of the American Institute of Mining Engineers and written by Mr. J. C. BAYLES, editor of "The Iron Age."]

I know our carboniferous King Coal and Thomas Anthracite;
 I know the points of difference 'twixt specular and hematite;
 I quote in high-toned phrases, and disdain to use tautology,
 And sing the toughest passages in "Dana's Mineralogy;"
 I tell undoubted crystals from anhydrous clays or cobble-stones;
 I've learned the different systems, and I've studied Claiborne fossil bones;
 I know the thermic units of the melting-point of Franklinitite;
 Can tell a modern pollywog from saurian or troglodyte;
 I'm posted on the theory and practice of biology—
 But I'm just a trifle weak upon the nice points of theology.
 In fact, in matters vegetable, animal, and mineral,
 I am a very model of a scientist in general.

I know some cheerful facts about deposits argentiferous;
 I've made myself authority on treating ores auriferous;
 I have a pretty fancy for resilience and tensility—
 And when a fee is tendered I can take it with agility,
 I'm not restrained by modesty from telling what I know about,
 And at our meetings thrice a year my facts I freely throw about.
 I talk on any subject that the chair declares debatable,
 And take delight in formulæ when figures are "equatable."
 In fact, in matters practical, tangential, or centrifugal
 I am a very model of an expert scientific.

I know the average tensile strength of water-gas and CO_2 ;
 Can give the fixed atomic weights of FeO and P. D. Q.;
 Can calculate the make and cost of Bessemer or Pernot steel,
 Or tell with a pyrometer how spirits in Inferno feel.
 I can manage a blast-furnace and a mighty yield of cinder make,
 And for my fuel coal or coke, petroleum or tinder take.
 I can write a tedious paper on 'most anything you choose to name,
 And credit for the things I've done it isn't any use to claim.
 In short, I'm crammed on every thing, and hope I've made the fact appear
 That I'm a very model of a modern mining engineer.

A NEW METHOD OF MAKING STEAM BOILERS.—An English engineer named Whitehead recently exhibited at Owlestan, near Sheffield, a boiler made on a new plan. In making this boiler a ring of steel is cast and heated; then it is placed upon a large roller, and by the aid of smaller rollers it is enlarged to the requisite dimensions. The ring is run from one end of the roller to the other, and is returned by reversing the machinery. The heads necessary for the completion of the boiler are subsequently put on with bolts. The machinery is rather expensive, and it is its cost which is said to be the point upon which the success of the invention hinges. The inventor claims that within six hours he can construct the shell of a boiler of a more durable nature than those now made with iron or steel plates riveted together. There is no doubt that such a boiler must be stronger, as the danger of tearing the seams on the cylindrical surface, where the strain is the strongest, is done away with by the total absence of such seams.—*Exchange.*

Ignorance Regarding Machinery.

Boston Journal of Commerce, January 3, 1880.

The general ignorance regarding machinery is surprising when it is considered that machines, in some form or another, enter so largely into the economies of our daily life. Newspaper men are especially open to this charge of ignorance, which in their case is the less excusable, as they are expected to "know something about everything." When such mechanical appliances and chemical operations are combined as in the experiments of Edison, perhaps a lack of definite knowledge may be overlooked; for only a comparatively few specialists are *au fait* on electricity, an agent but recently introduced into our every-day life. But the steam engine—its office and work, and its prominent parts—has been a common possession for generations, and the ordinary tools of the mechanic—the lathe, planer, screw-cutting machines, and other common appliances—are to be seen everywhere, and ought to be familiar to all. Yet the newspaper notices of machinery and tools are seldom correct unless written by a practical mechanic, and sometimes are laughable from their absurdity. A short time ago, in a notice of the derailment of a locomotive by the breaking of a connecting bar between the drivers, it was stated that the piston rod broke, and the end, falling to the ground, lifted the engine from the track! Another account told of the breaking of "the crank of the truck." Latterly we had an account of the "explosion of a steambot's chimney," and "explosions of engines" are frequently mentioned. One account of a boiler explosion that tore the boiler-house and engine-room to pieces gave as a reason why the engine was comparatively uninjured, that the engine was not running at the time! The bursting of a fly-wheel by the breaking of the governor belt, which stopped it, and allowed the full pressure from the boiler to enter the cylinder unchecked, was accounted for by the too rapid velocity of the governor! The collapse of a flue was called the "bursting of a crown sheet," and the worst explosion of all was the "explosion of a rivet." A notice was recently made of the cracking of the walking-beam of a large engine, and the statement was made that the works would stop until a new "shaft" could be cast. A notice of a new marine engine stated that the piston rod ran in ball-thrust bearings,—alluding probably to the thrust bearing of the propeller shaft! A description of a large boring lathe conveyed the information that the live cone ran in "rabbeted boxes,"—meaning, evidently, that the live or head arbor ran in Babbitt metal boxes. A new planer was described as having "ways that run on V frames"; and a screw machine which made machine screws from bars was credited with "threading the heads of the screws," and that process was described as done *after* the screw was cut off the bar. "A solution of bicarbonate of soda" was employed on the screw-cutting tool.

These inaccuracies are in some cases inexcusable, but, in most, a superficial knowledge of a machine, or a smattering of natural philosophy found in common school textbooks, would have prevented errors so egregious as to raise the laugh of ridicule.

NOTHING LIKE PAPER.—The old adage used to be, "nothing like leather." It should now be, "nothing like paper." Paper is used for almost everything. Among the things made of paper exhibited at the Berlin exhibition not long since were paper buckets, "bronzes," urns, asphalt roofing, water cans, carpets, skirts, whole suits of clothing, jewelry, material for garden walks, window curtains, lanterns, and pocket-handkerchiefs. The most striking of the many objects exhibited in this material was, perhaps, a fire-stove, with a cheerful fire burning in it. There were newly invented railway carriages and chimney pots, flour barrels, cottage walls, roofing tiles, and bricks and dies for stamping, all made of paper. Attention has frequently been called to the value of ordinary sheets of paper as a substitute for bedclothes or at least an addition to bedclothes. The idea seems to have suggested the fabrication of "blankets" from the cheap material, and if all that is said of them is true, they ought to be extensively used.—*Detroit Free Press*.

An Englishman's Views on American Manufactures.

In a lecture recently delivered in Sheffield, England, Mr. W. K. Marples, of that town, related his experience and observation in his travels through the United States.

"I found," says the lecturer, "in visiting various American factories, machinery much more generally used than it is with us—in fact, I sometimes saw machinery employed for a process which might have been done more cheaply by hand labor; but we must remember that until recently skilled workmen were not numerous in the States, and so manufacturers were driven to the use of machinery. The Americans are much more advanced in manufactures of all kinds than many of us are aware. Cabinet furniture, glass and china, cutlery tools, guns and pistols, agricultural implements, carpets, linen,—in fact, soft and hard goods of every description are made, and in most instances made well, in the United States. Their resources are wonderful; nature has given them coal, iron, water-power, etc., with the finest navigable rivers in the world, and then their chiefly English origin has given them pluck, endurance, and perseverance under difficulties, and these qualities, coupled with the immigration of many of our best artisans, have in the comparatively short space of 100 years worked marvels for them. The New England States are one vast hive of manufacturing industry, and it is here that the brains of inventors are stimulated to their utmost powers in developing labor-saving articles, and the machinery to make them.

"I think the introduction of the many American ideas and inventions into England that has been attempted during the past few years will tend to develop new ideas among our workpeople, and assist us in holding our position as the great manufacturing nation of the world. I have little fear that English hardware manufacturers will succeed in holding their own in all markets where the duties are not prohibitory, as in the United States. There is little doubt that much of the boasted superiority of American manufactures in the matter of price was a mere myth, and I am fully convinced that until a few months ago, when the hardware trade in America was so depressed, the manufacturers there exported goods to England at a positive loss. In some cases this has been admitted, and the enormous advances, amounting in some goods (notably in locks) to over 100 per cent., bear me out in this opinion. Many goods, that up to a short time ago were imported from America, are now manufactured in England, and the Americans would seem to be doing their best to destroy the trade which until recently they were apparently so anxious to build up. English manufacturers have been fully alive to the situation, and will not readily allow American manufacturers to recover the ground they are now losing."—*Scientific American*.

PATENT IMPROVED COMPOUND CONUNDRUM (BY TOM BARNACLE).—When is a sailor not a sailor? Ans. When he's a board. When he's not a board what is he? Ans. He's a shore. Then *when* is he a sailor? Ans. When he's a loft. No, no, if he's a loft he can't be a sailor, unless he's a sail-loft. Try again. When he's—a-polishing the handle—I mean the bright work? No. When he's—er—a-copying the letters in a big round hand? No, no, that won't do. Well, then, he's never a sailor at all—he's a lubber. What, never? Avast, there, shipmates, the first officer is reaching for that iron belaying pin in the fife-rail, and he'll *pin* (you) *afore* you know it.

Laziness grows on people; it begins in cob-webs and ends in chains. The more business a man has to do, the more he is able to accomplish, for he learns to economize his time.

The best recipe for going through life in an exquisite way, with beautiful manners, is to feel that everybody, no matter how rich or how poor, needs all the kindness they can get from others in this world.

Incorporated
1866.

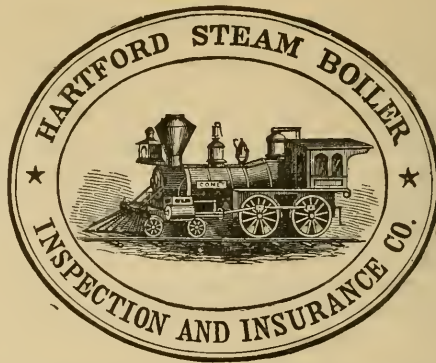

Charter Per-
petual.

Issues Policies of Insurance after a Careful Inspection of the Boilers,

COVERING ALL LOSS OR DAMAGE TO

BOILERS, BUILDINGS, AND MACHINERY,

ARISING FROM

Steam Boiler Explosions.

THE BUSINESS OF THE COMPANY INCLUDES ALL KINDS OF STEAM BOILERS.

Full information concerning the plan of the Company's operations can be obtained at the

COMPANY'S OFFICE, HARTFORD, CONN.

Or at any Agency.

J. M. ALLEN, Prest. W. B. FRANKLIN, Vice-Prest. J. B. PIERCE, Sec'y.

Board of Directors.

J. M. ALLEN, President.	GEN. WM. B. FRANKLIN, Vice-Prest. Colt's Pat. Fire-Arms Mfg. Co.
LUCIUS J. HENDEE, Prest. Aetna Fire Ins. Co.	GEO. CROMPTON, Crompton Loom Works, Worcester.
FRANK W. CHENEY, Asst. Treas. Cheney Brothers Silk Manufacturing Co.	HON. THOS. TALBOT, Ex-Governor of Mass.
CHARLES M. BEACH, of Beach & Co.	NEWTON CASE, of The Case, Lockwood & Brainard Co.
DANIEL PHILLIPS, of Adams Express Co.	WILLIAM S. SLATER, Cotton Manufacturer, Providence, R. I.
GEO. M. BARTHOLOMEW, Prest. Amer. Nat. Bank.	NELSON HOLLISTER, of State Bank, Hartford.
RICHARD W. H. JARVIS, Prest. Colt's Fire Arms Manufacturing Co.	D. R. SMITH, Prest. Springfield Fire & Marine Ins. Co.
THOMAS O. ENDERS, Sec'y Aetna Life Ins. Co.	
LEVERETT BRAINARD, of The Case, Lockwood & Brainard Co.	

GENERAL AGENTS.

CHIEF INSPECTORS.

OFFICES.

THEO. H. BABCOCK,	R. K. McMURRAY,	NEW YORK CITY. Office, 285 Broadway.
CORBIN & GOODRICH,	WM. G. PIKE,	PHILADELPHIA. " 430 Walnut St.
LAWFORD & McKIM,	JOSEPH CRAGG,	BALTIMORE. " 10 So. Holliday St.
W. S. CHAMBERLIN,	WM. U. FAIRBAIRN,	BOSTON, MASS. " 10 Pemberton Sq.
J. L. SMITH,	B. M. LORD,	PROVIDENCE, R. I. " 42 Weybosset St.
H. D. P. BIGELOW,	H. D. P. BIGELOW,	CHICAGO, ILL. " 132 La Salle St.
C. C. GARDNER,	J. S. WILSON,	ST. LOUIS, MO. " 404 Market St.
D. C. FREEMAN,	F. S. ALLEN,	HARTFORD. " 218 Main St.
W. G. LINEBURGH,	W. S. FOX,	BRIDGEPORT. " 328 Main St.
GEO. P. BURWELL,	A. C. GETCHELL,	CLEVELAND. " 246 Superior St.
W. B. CASSILY,	J. S. WILSON,	CINCINNATI. " 53 West Third St.

The Locomotive.

PUBLISHED BY THE HARTFORD STEAM BOILER INSPECTION AND INSURANCE COMPANY.

NEW SERIES—VOL. I.

HARTFORD, CONN., MAY, 1880.

No. 5.

Explosion of an Upright Tubular Boiler.

This boiler differs in some important particulars from the one illustrated in the March number, page 37 of vol. 1, new series of *THE LOCOMOTIVE*. The general dimensions of the two boilers are about the same, but this one is on a more approved plan of construction. No portion of the tubes in this boiler were uncovered by water, on their convex surfaces when the water was at the gauge-cock level. The upper tube-plate was placed below the summit of the boiler and flanged to a cylindrical uptake or smoke connection similar to the furnace shown at the left hand of the cut fig. 1. Another important difference was

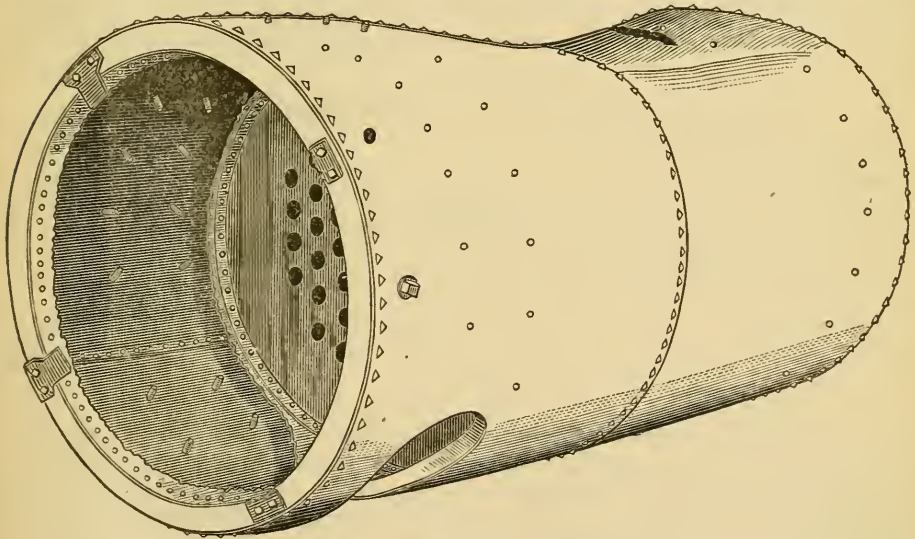

FIG. 1.

the staying of these inner cylindrical portions to the shell by means of screw stays, the riveted ends of which are partly seen on the exterior, and the two rows belonging to the furnace are partly seen in the cavity from which the furnace-plates were torn. It is obvious that this furnace is much better able to resist a pressure on its convex surface than one of the same dimensions not supported with stays, and they are justly more popular with inspectors. It appears however that they are not always so strong as to do away with the necessity of examination.

This boiler was an old one that had been some time out of use until about 18 months before the date of the explosion, when it was repaired and put to work as an auxiliary for summer uses. The repairs consisted mainly of a patch in the furnace, near the door. It exploded by a collapse of the furnace in October, 1879, rising a distance of 100 feet in the air at such an angle from the perpendicular as to cause it to strike the ground some 150 feet from its working site.

It was located with another one of the horizontal tubular type in a one-story brick boiler-house, and was in the care of a fireman of exceptionally careful habits. He had been 20 years in the same employ, and was noted for his faithfulness in carrying out the directions which he received for the management of his boilers; although he did not possess a thorough knowledge of engineering yet he was relied on as worthy of all confidence in the performance of the duties of his occupation.

The boiler was $6\frac{1}{2}$ feet high by $3\frac{1}{2}$ feet diameter. The shell was $\frac{5}{16}$ " iron, and the furnace and uptake called $\frac{1}{4}$ ", but were really $\frac{2}{100}$ th thick. The furnace was 36" diameter, and the uptake 34" diameter, they were stayed to the shell by two rows of screw-stays in the furnace and one row in the uptake, spaced about 5 inches apart circumferentially. The boiler contained 56 tubes $2\frac{1}{4}$ inches diameter by about 3 feet long.

Referring to the cut fig. 1, which was copied from a photograph, it will be seen that about all that part of the furnace which is embraced in the view is stripped of its plates, leaving the stays attached to the shell. There were a number of pieces hanging to the borders of the opening after the explosion, but they had been broken off and carried away by curiosity seekers before the photograph was taken. The immediate cause of this explosion is not as clearly defined as has been the case in most of the accidents that have been illustrated in THE LOCOMOTIVE, which is chiefly due to the meagerness of the information that could be obtained at the scene of the wreck. There is little doubt, however, about the existence of a weakness at one of the vertical seams of the furnace.

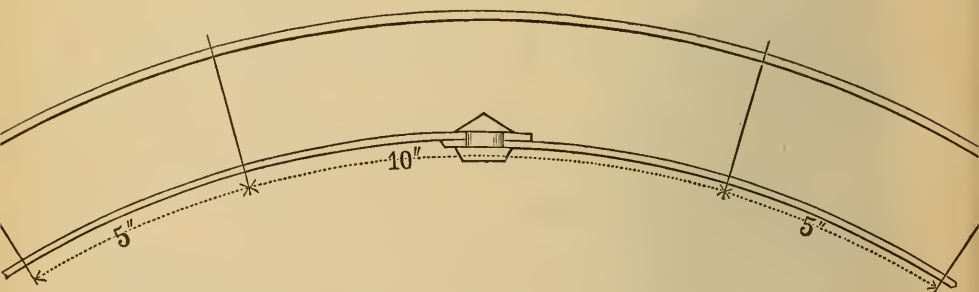

FIG. 2.

By reference to fig. 2, which is a horizontal section through a part of the water-space and the shell and furnace-plates, it will be seen that the vertical seam which joins the furnace-plates together is at a point where there should be a stay-bolt in each row, but they were omitted, leaving the seam in a space double the length of the rest of the spaces between stays. The question occurs whether or not this arc, which is double the length of the others in this thin boiler-plate, is sufficiently reinforced by the lap to compensate for the imperfection of form incident to all laps in a cylinder. A rupture along this seam close to the caulking edge would tend to weaken our confidence in its strength. Such a rupture did occur. But the furnace with this imperfection, and with all its stays sound must have been capable of withstanding something much higher in the way of pressure than is usually put upon such structures. The conclusion therefore is unavoidable that either a number of the stays were broken or the pressure was excessive at the instant of the explosion.

Explosion of a Large Upright Boiler in an Iron Works.

The explosion herewith illustrated occurred some time ago, and was reported and published soon after it happened. Some additional particulars were obtained from the superintendent of the works after the inspector's official report was made, all of which tend to confirm the opinion then given. It is now published with the same illustrations that were then used, having been heretofore crowded out by other matter. The boiler, as then described, was an upright cylinder 20 ft. high by 6 ft. diameter made of $\frac{5}{16}$ iron plates, of which fig. 1 is a vertical section, having a central conical flue $4\frac{1}{2}$ ft. diameter at the base tapering to about 2 ft. diameter near the water-surface line where it was enlarged into a cylindrical form to receive a fire-brick lining. Fig. 1. A few radial socket-stays were placed in the lower part to stay the larger part of the flue to the shell, to prevent the collapse of the flue, and the upper head was stayed to the upper course of shell-plates, and to the flue.

The boiler was worked at a pressure of 60 pounds per square inch, and heated by the waste gases from a puddling furnace. It was one of a number of boilers, all connected to the same main steam-pipe which conveyed the steam to the engines that drove the works. On a Saturday, in mid-winter, after having been idle for about two weeks, this boiler was filled with cold water, preparatory to heating up on the following Monday morning. Some time before lighting the furnace which delivered its gases to this boiler the stop-valve in the pipe which connected it to the main steam-pipe was opened and steam from the other boilers was admitted into the steam-space above the cold water. At about 5 A.M., while the steam was escaping from a number of the safety-valves of the system, a belt of plates comprising the three upper courses parted at one of the longitudinal seams, the rent extending vertically on the line of the first and third longitudinal seams, thence by secondary ruptures irregularly around the shell at the flange of the head, and regularly around the shell at the third girth-seam, thus detaching three of the seven courses of plates that composed the shell. This portion of the shell was flattened, fig. 2, and it sailed off horizontally and cut a number of the tie-beams of the roof of the building, which, with the walls, fell in upon the men who had assembled ready to go to work. One man was killed, and six others were injured.

The inspector of this company, who examined the wreck soon after the accident, reported as follows: "I found the above boiler badly grooved or channeled to a thickness varying from $\frac{1}{8}$ to $\frac{1}{16}$ of an inch, running parallel with and close to the edge of the plates or lap of the longitudinal seams; it was at this point that the rupture took place. It was caused mainly by the corrosive action of the water, it being impregnated with salt, which, together with the buckling or fretting of the plates at that time, caused the explosion. The buckling was caused by unequal expansion, and is also due in some measure to the cross-bending action produced by the internal varying pressure tending to force the plates into a perfect cylindrical form. The boiler was about seven years old, and had not been inspected since it was first placed in the mill."

The boiler was thrown down, but was not thrown very far from its place. Fig. 3 is a view of the boiler after the explosion.



FIG. 1.

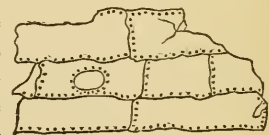

Fig. 2.

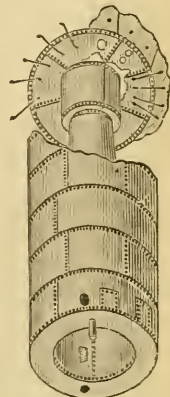

Fig. 3.

The admission of steam at a temperature due to 60 pounds pressure—308° F.—into the steam-room above the water, which was at a temperature due to a mid-winter's night, must have greatly increased the inequality of the expansion and caused the breaking of the already-weakened plates. The grooving or channeling mentioned by the inspector had been going on at a gradually-increasing rate since the boiler was new, and it was probably caused by the alternate curving and straightening of the flattened ends of the plates just at the lap, which did not receive the true curve on entering and leaving the boiler maker's bending rolls. The difficulty in detecting an imperfection of this character in a new cylinder composed of lapped plates, and the frequency of explosions of boiler shells from internal grooving, renders careful internal inspection an imperative necessity if we would realize immunity from this class of accidents.

BOILER EXPLOSIONS.

STEAM FORGE (45).—The most disastrous boiler explosion, accompanied by loss of life and serious injury to several men, that has occurred in Buffalo for many months, took place at an early hour April 2, at the Buffalo Steam Forge, Henry Childs, proprietor, on the south bank of Buffalo river, near the Ohio street swing-bridge. The forge is a frame structure, about 150 feet long and 80 feet wide, and contains four furnaces, to each one of which a boiler is attached. It was one of these that exploded. The explosion occurred at 7.15 A. M. The night gang had been relieved by the day men, who had been heating their iron, and at the hour named were just preparing to commence the work of turning out their "heat," when there came a terrific report from the rear end of the building, accompanied by the crash of falling timbers, while the air was filled with steam and flying fragments of iron and wood. The men were nearly all prostrated by the force of the shock. Edward Garrity was lifted from his feet by the force of the concussion, carried swiftly through a window, and neatly landed on the turf outside, uninjured. The first man removed from the ruins was a heater—Jacob Deitrich. A bar of railroad iron had fallen across his right ankle, the bones being so badly crushed as to make amputation necessary. The whole of his back and other portions of his body were terribly scalded. Franze J. Kammerer, the chief engineer of the forge, was instantly killed. He leaves a wife and eight children. Two other men—Patrick Shannon and Nicholas Rodem—were scalded.

SAW-MILL (46).—The boiler of John H. Lamb's saw-mill, situated 10 miles from Rushville, Ill., exploded April 3, demolishing the mill, instantly killing Westley M. Parker, fatally wounding John Randall and Thomas Jones, and seriously injuring two other persons whose names we have not learned.

SAW-MILL (47).—The boiler of Clark & Co's saw-mill at Millview, Fla., exploded April 4, killing one person and seriously scalding 30 others.

KINDLING-WOOD FACTORY (48).—A boiler in Munday's kindling-wood factory, Rahway, N. J., exploded April 9th, damaging the factory considerably and some of the buildings in the neighborhood. No one was injured.

SAW-MILL (49).—The boiler in W. A. Clayton's mill, near Mannington, W. Va., exploded April 20th, killing the sawyer, Ed. Cunningham, and totally wrecking the mill.

—**MILL (50).**—The boiler in the mill of C. W. Dunbar, ten miles from Memphis,

Mo., exploded April 22d, demolishing the mill and killing the proprietor and two other men named Wilson and McCan. The victims were horribly scalded and mangled, but lived a short time in great agony. The report of the explosion was heard for miles, and attracted a large crowd of people to the spot.

DRY-DOCK (51.)—The steam boiler that has for a long time past been in use at the dry-dock of John Wilson's ship-yard, near the New Jersey Central Railroad depot at Communipaw, N. J., exploded April 22d, about 11 A. M., setting a canal boat on fire. Fortunately no one was injured and the fire was speedily extinguished.

TUG-BOAT (52.)—The boiler of the tug-boat Annie Laurie exploded at New Orleans, April 24. Captain Spence had both legs broken; Dave Maratta, right arm broken and badly scalded; John Lynch (colored) fireman, killed.

—MILL (53.) The boiler in John P. Bacon's mill, in the township of Chapin, Mich., exploded April 26. J. Root was so badly injured that it is feared he will not live. He was thrown three rods and badly scalded about the face and breast.

SHINGLE-MILL (54.)—The boiler in Torrent's shingle-mill, Savannah, Ga., exploded April 27th, killing Lewis N. Torrent, superintendent, and George Hughes, engineer, and injuring eight others. The building was burned.

Inspectors' Reports.

This is the one hundred and sixty-second monthly summary of reports in this department of the company's business, and it is for the closing month of the first quarter of 1880. It shows an important increase of the work performed by the company's inspectors. Comparing the first quarter of this year with the corresponding period in 1879, we find an increase of over 40 per cent. of the internal thorough annual inspections, which indicates a very large increase in the number of boilers insured. This is a gratifying exhibit, as it not only indicates the growing prosperity of this company, but it also shows that our system is growing in favor among steam users in this country. Of course the improvement in general business has much influence on the liberality with which manufacturers are disposed to treat themselves in the matter of preserving their property from deterioration, and many who thought favorably of guaranteed inspections did not feel able, during the time of depression, to spare even the trifling amount which a boiler-policy would cost. Others were shut down entirely and of course were not exposed to danger, even though their boilers might be deteriorating while idle.

Comparing the month of March, 1880, with the average of the first two months of the year, we find an increase in the number of annual thorough inspections of 22 per cent., indicating that the business is still healthy.

The figures for the month of March, 1880, show the following footing: whole number of inspection visits, 1,975. Whole number of boilers examined, 4,155. Whole number of annual internal thorough inspections, 1,313. The hydrostatic test was applied in the usual auxiliary way to 323 boilers, a very large percentage of which were new, and in the shops and yards of the makers.

The whole number of defects discovered was 1,902, of which 339 were of a dangerous character. The percentum of dangerous defects as here reported is far below the average, and it would be pleasant to believe that this, too, is an indication of improve-

ment in boiler management, but we are not warranted in so construing it till further proof of a real and steady decrease of this percentage is shown. It is to be hoped that this may be realized.

The character of the defects is shown by the following details. Furnaces out of shape, 114—23 dangerous. Fractures, 176—84 dangerous. Burned plates, 132—26 dangerous. Blisters, 376—17 dangerous. Cases of sediment and deposit, 180—30 dangerous. Incrustation and scale, 279—26 dangerous. External corrosion, 80—25 dangerous. Internal corrosion, 105—16 dangerous. Internal grooving, 10—4 dangerous. Water-gauges defective, 43—4 dangerous. Blow-out apparatus defective, 15—4 dangerous. Safety-valves overloaded, 18—7 dangerous. Pressure gauges defective, 161—33 dangerous. Boilers without gauges, 166. Deficiency of water, 7—6 dangerous. Braces and stays broken, loose, and otherwise defective, 50—29 dangerous. Number of boilers condemned, 52.

The increase in the number of condemned boilers is something notable, being almost double the average monthly number for the six months next preceding, and more than $2\frac{1}{2}$ times the average monthly number for the year 1879.—Considered in connection with the fact that the record of explosions in the first third of this year, as reported in THE LOCOMOTIVE, is at the rate of 165 per annum, and shows 25 per cent. increase over $\frac{1}{3}$ d of last year—and almost 60 per cent. over the average for the 12 years next preceding 1880, this fact of 52 condemned boilers in a single month is significant indeed. It means that the boilers that were in use at the time of the late revival in business were below the average condition as to safety, having been used after becoming defective without receiving the economic “stitch in time,” which would perhaps have been applied had they been under inspection, and business flush.

A recent explosion of a rolling-mill boiler that had no steam-gauge, and had its stop-valve closed at the time of the explosion, while its generating surface was in full play and exposed to the heat of the gases from the furnace, shows the importance of having a sufficient and reliable safety-valve. It was a single-flue boiler, the shell of which was 48 inches in diameter by 20 ft. long, made of $\frac{3}{8}$ -in. iron. The flue was 20 inches diameter, and was the same length and thickness of iron as the shell. The boiler was set horizontally in brick walls, supported by six cast-iron brackets, 3 on each side, riveted to the shell and resting on the side walls. The hot gases from the furnace, entering the cavity beneath the boiler at one end, passed under the boiler to the rear end, turned upward into the flue, and passed through it to the chimney at the front end. The report which comes to this office says that the flue collapsed sideways, and the photograph seems to confirm the statement, while some of the witnesses swore before the coroner's jury that the flue showed signs of being hot on account of low water. If it was uncovered, as one witness swears, to the extent of one-third, it must have been the upper portion, and that being the case, the conundrum is how came it to collapse sideways. One would think that a cylinder subjected to a uniform external pressure would cave at its weakest side. The statistics on this subject are very meager, but a little common sense may supply the deficiency at this time.

NOTE.—Since the above was written, a pretty thorough examination of the English and German records of collapsed flues has been made. Of the large number, there was but one that was at all doubtful, and the writer says of that, “though shortness of water was claimed to be the cause, still it is more likely that it occurred from weakness of the flue.” This one was a case of lateral collapse, one of the few that did give out in this manner. All the others that were hot at the time of the explosion collapsed downward. So we may fairly conclude that hot flues invariably do cave in on the hot or soft sides.

The Locomotive.

HARTFORD, MAY, 1880.

Boilers in Iron Works.

It has doubtless been noticed by steam users that there have been of late a number of boiler explosions in iron works; and, as these accidents are usually attended with considerable loss, it is proper to say a word in regard to the matter. From such investigation as we have made it is ascertained that these boilers usually break in the girth seams, and they occur more frequently in boilers that are heated by the gases from the smelting furnaces and reheating or puddling furnaces. In the former case the boilers are often long, cylinders from 50 to 60 feet in length, and sometimes even 70 feet in length. The burning gas "licks" the entire bottom, while the top of the boiler is not unfrequently exposed to the weather. The result is that the bottom is greatly expanded, and when the flow of gas is shut off, and a current of cold air is allowed to enter the furnace (as is in many cases true), the iron is suddenly contracted, and fractures appear at or near the lap and line of rivets in the girth seams. These long boilers have no bracing from head to head, no tubes or flues, and when a fracture is once started there is nothing to hold the boiler together so as to give warning of trouble. There are iron manufacturers who still cling to long boilers, simply because they have used them and have had no trouble; but generally we have found a readiness among those using them to shorten them, or, in getting new boilers, to adopt a different type. Another difficulty with these long boilers is the manner in which they are set or "hung"; due regard is not given to the matter of securing equal and uniform support to all parts of the boiler. By the process of expansion and contraction the load is shifted so as to bear heavily on some supports, and often so heavily as to break away and lead to disaster. The opinion that there is more heating surface on a long cylinder boiler than on a 30 or 35 feet flue boiler is erroneous, as can be shown by casting up the exposed surface of each. Flues strengthen a boiler by binding the ends or heads together and preventing the sudden parting of the boiler at the girth seams from fractures arising from expansion and contraction. Some may object that flues collapse. Very true; but that contingency rarely arises except the flue has become overheated from low water, a condition of things which should not occur in a well-regulated establishment, with competent engineering talent. We have not space to discuss the difficulties in connection with cylinder boilers over reheating furnaces, but shall revert to it at a future time. And we hope to be able to lay before our readers some suggestions, with plans of boilers that we believe will be safer and more efficient.

THE TABLE OF AREAS AND CIRCUMFERENCE OF CIRCLES, published elsewhere, is for the benefit of those engineers who are readers of the LOCOMOTIVE. The figures in the column marked "Diam." are the diameters in inches and fractions of an inch of cylinders, from $\frac{1}{4}$ of an inch to 100 inches. If the number of cubic inches in a cylinder is desired, multiply the area for the given diameter by the length in inches. Thus, for example, suppose we desire to know the number of cubic inches in a cylinder boiler $36\frac{1}{2}$ inches in diameter and 24 feet long. We look in the column of areas against $36\frac{1}{2}$ and find the area to be 1067.95—. 24 feet multiplied by 12 (12 inches to the foot), gives 288 inches. Now multiply the area, 1067.95, by 288, and we have 307,569.60 cubic inches. If we divide this by 231 (the number of cubic inches in a gallon) it will give us the number of gallons of water which the boiler will contain. This rule is applicable to all cylindrical vessels, whether great or small.

TABLE
OF
AREAS AND CIRCUMFERENCES OF CIRCLES,

FROM $\frac{1}{64}$ TH TO 100.

Square of Diameter $\times .7854 =$ Area.

Diameter $\times 3.1416 =$ Circumference.

Diam.	Area.	Circum.	Diam.	Area.	Circum.	Diam.	Area.	Circum.
$\frac{1}{64}$.00019	.0490	4.	12.566	12.57	10.	78.540	31.42
$\frac{1}{32}$.00076	.0951	$\frac{1}{2}$	13.364	12.96	$\frac{1}{2}$	80.515	31.81
$\frac{1}{16}$.00306	.1963	$\frac{3}{4}$	14.186	13.35	$\frac{3}{4}$	82.516	32.20
$\frac{1}{8}$.01227	.3926	1.	15.033	13.74	1.	84.540	32.59
$\frac{3}{16}$.02761	.5890	$\frac{1}{4}$	15.904	14.14	$\frac{1}{4}$	86.590	32.99
$\frac{1}{4}$.04908	.7854	$\frac{5}{16}$	16.800	14.53	$\frac{5}{16}$	88.664	33.38
$\frac{5}{16}$.07669	.9817	$\frac{3}{8}$	17.720	14.92	$\frac{3}{8}$	90.762	33.77
$\frac{3}{8}$.1104	1.178	$\frac{7}{16}$	18.665	15.32	$\frac{7}{16}$	92.885	34.16
$\frac{7}{16}$.1503	1.374	5.	19.635	15.71	11.	95.033	34.56
$\frac{1}{2}$.1963	1.571	$\frac{1}{2}$	20.629	16.10	$\frac{1}{2}$	97.205	34.95
$\frac{5}{8}$.2485	1.767	$\frac{3}{4}$	21.648	16.49	$\frac{3}{4}$	99.402	35.34
$\frac{3}{4}$.3067	1.963	6.	22.690	16.89	6.	101.62	35.74
1.	.3712	2.159	$\frac{1}{4}$	23.758	17.28	$\frac{1}{4}$	103.87	36.13
$\frac{1}{4}$.4417	2.356	$\frac{5}{16}$	24.850	17.67	$\frac{5}{16}$	106.14	36.52
$\frac{3}{8}$.5174	2.551	$\frac{3}{8}$	25.967	18.06	$\frac{3}{8}$	108.43	36.91
$\frac{1}{2}$.6013	2.749	$\frac{7}{16}$	27.108	18.46	$\frac{7}{16}$	110.75	37.31
$\frac{3}{4}$.6902	2.945	6.	28.274	18.85	12.	113.10	37.70
1.	.7854	3.142	$\frac{1}{2}$	29.464	19.24	$\frac{1}{2}$	115.47	38.09
$\frac{1}{4}$.9940	3.534	$\frac{3}{4}$	30.680	19.64	$\frac{3}{4}$	117.86	38.48
$\frac{1}{2}$	1.227	3.927	1.	31.919	20.03	1.	120.28	38.88
$\frac{3}{4}$	1.485	4.320	$\frac{1}{4}$	33.183	20.42	$\frac{1}{4}$	122.72	39.27
1.	1.767	4.712	$\frac{5}{16}$	34.471	20.81	$\frac{5}{16}$	125.18	39.66
$\frac{1}{2}$	2.074	5.105	$\frac{3}{8}$	35.785	21.21	$\frac{3}{8}$	127.68	40.06
$\frac{3}{4}$	2.405	5.498	$\frac{7}{16}$	37.122	21.60	$\frac{7}{16}$	130.19	40.45
1.	2.761	5.891	7.	38.484	21.99	13.	132.73	40.84
$\frac{1}{4}$	3.142	6.283	$\frac{1}{2}$	39.871	22.38	$\frac{1}{2}$	135.30	41.23
$\frac{3}{8}$	3.547	6.676	$\frac{3}{4}$	41.282	22.78	$\frac{3}{4}$	137.89	41.63
$\frac{1}{2}$	3.976	7.069	1.	42.718	23.17	1.	140.50	42.02
$\frac{3}{4}$	4.430	7.461	$\frac{1}{4}$	44.179	23.56	$\frac{1}{4}$	143.14	42.41
1.	4.909	7.854	$\frac{5}{16}$	45.663	23.95	$\frac{5}{16}$	145.80	42.80
$\frac{1}{2}$	5.412	8.247	$\frac{3}{8}$	47.173	24.35	$\frac{3}{8}$	148.49	43.20
$\frac{3}{4}$	5.940	8.639	$\frac{7}{16}$	48.707	24.74	$\frac{7}{16}$	151.20	43.59
1.	6.492	9.032	8.	50.265	25.13	14.	153.94	43.98
$\frac{1}{4}$	7.069	9.425	$\frac{1}{2}$	51.848	25.52	$\frac{1}{2}$	156.70	44.38
$\frac{3}{8}$	7.670	9.818	$\frac{3}{4}$	53.456	25.92	$\frac{3}{4}$	159.48	44.77
$\frac{1}{2}$	8.296	10.210	1.	55.089	26.31	1.	162.29	45.16
$\frac{3}{4}$	8.946	10.602	$\frac{1}{4}$	56.745	26.70	$\frac{1}{4}$	165.13	45.55
1.	9.621	10.995	$\frac{5}{16}$	58.426	27.10	$\frac{5}{16}$	167.99	45.95
$\frac{1}{2}$	10.321	11.388	$\frac{3}{8}$	60.132	27.49	$\frac{3}{8}$	170.87	46.34
$\frac{3}{4}$	11.045	11.781	$\frac{7}{16}$	61.862	27.88	$\frac{7}{16}$	173.78	46.73
1.	11.793	12.173	9.	63.617	28.27	15.	176.71	47.12
			$\frac{1}{2}$	65.396	28.66	$\frac{1}{2}$	179.67	47.52
			$\frac{3}{4}$	67.200	29.06	$\frac{3}{4}$	182.65	47.91
			1.	68.029	29.45	1.	185.66	48.30
			$\frac{1}{4}$	70.882	29.85	$\frac{1}{4}$	188.69	48.69
			$\frac{5}{16}$	72.759	30.24	$\frac{5}{16}$	191.75	49.09
			$\frac{3}{8}$	74.662	30.63	$\frac{3}{8}$	194.83	49.48
			$\frac{7}{16}$	76.588	31.02	$\frac{7}{16}$	197.93	49.87

TABLE—(Continued).

Diam.	Area.	Circum.	Diam.	Area.	Circum.	Diam.	Area.	Circum.
16.	201.06	50.27	23.	415.48	72.26	30.	706.86	94.25
	204.22	50.66		420.	72.65		712.76	94.64
	207.39	51.05		424.56	73.04		718.69	95.03
	210.60	51.44		429.13	73.43		724.64	95.43
	213.82	51.84		433.74	73.83		730.62	96.82
	217.08	52.23		438.36	74.22		736.62	96.21
	220.35	52.62		443.01	74.61		742.64	96.60
	223.65	53.01		447.70	75.		748.69	97.
17.	226.98	53.41	24.	452.39	75.40	31.	754.77	97.39
	230.33	53.80		457.11	75.79		760.87	97.78
	233.70	54.19		461.86	76.18		766.99	98.17
	237.10	54.59		466.64	76.58		773.14	98.57
	240.53	54.98		471.44	76.97		779.31	98.97
	243.98	55.37		476.26	77.36		785.51	99.35
	247.45	55.76		481.11	77.75		791.73	99.75
	250.95	56.16		485.98	78.15		797.98	100.14
18.	254.47	56.55	25.	490.87	78.54	32.	804.25	100.53
	258.02	56.94		495.80	78.93		810.54	100.92
	261.59	57.33		500.74	79.33		816.86	101.32
	265.18	57.73		505.71	79.72		823.21	101.71
	268.80	58.12		510.71	80.11		829.58	102.10
	272.45	58.51		515.72	80.50		835.97	102.49
	276.12	58.90		520.77	80.90		842.39	102.89
	279.81	59.30		525.84	81.29		848.83	103.28
19.	283.53	59.69	26.	530.93	81.68	33.	855.30	103.67
	287.27	60.08		536.05	82.07		861.79	104.06
	291.04	60.48		541.19	82.47		868.30	104.46
	294.83	60.87		546.36	82.86		874.84	104.85
	298.65	61.26		551.55	83.25		881.41	105.24
	302.49	61.65		556.76	83.64		888.	105.64
	306.35	62.05		562.	84.04		894.62	106.03
	310.25	62.44		567.27	84.43		900.25	106.42
20.	314.16	62.83	27.	572.56	84.82	34.	907.92	106.81
	318.10	63.22		577.87	85.21		914.61	107.21
	322.06	63.62		583.21	85.61		921.32	107.60
	326.05	64.01		588.57	86.		928.06	107.99
	330.06	64.40		593.96	86.39		934.82	108.39
	334.10	64.79		599.37	86.79		941.60	108.78
	338.16	65.19		604.81	87.18		948.42	109.17
	342.25	65.58		610.27	87.57		955.25	109.56
21.	346.36	65.97	28.	615.75	87.96	35.	962.11	109.96
	350.50	66.37		621.26	88.36		968.99	110.35
	354.66	66.76		626.80	88.75		975.91	110.74
	358.84	67.15		632.36	89.14		982.84	111.13
	363.05	67.54		637.94	89.54		989.80	111.53
	367.28	67.94		643.55	89.93		996.78	111.92
	371.54	68.33		649.18	90.32		1003.79	112.31
	375.83	68.72		654.84	90.71		1010.80	112.70
22.	380.13	69.12	29.	660.52	91.11	36.	1017.88	113.10
	384.46	69.51		666.23	91.50		1024.95	113.49
	388.82	69.90		671.96	91.89		1032.06	113.88
	393.20	70.29		677.71	92.28		1039.19	114.28
	397.61	70.69		683.49	92.68		1046.35	114.67
	402.04	71.08		689.30	93.07		1053.52	115.06
	406.49	71.47		695.13	93.46		1060.73	115.45
	410.97	71.86		700.98	93.85		1067.95	115.85

TABLE—(Continued),

Diam.	Are	Circum.	Diam.	Area.	Circum.	Diam.	Area.	Circum.
37.	1075.2	116.2	44.	1520.5	138.2	51.	2042.8	160.2
	1082.5	116.6		1529.2	138.6		2052.8	160.6
	1089.8	117.		1537.9	139.		2062.9	161.
	1097.1	117.4		1546.5	139.4		2072.9	161.3
	1104.5	117.8		1555.3	139.8		2083.1	161.8
	1111.8	118.2		1564.	140.2		2093.2	162.1
38.	1119.2	118.6	45.	1572.8	140.6	52.	2103.3	162.6
	1126.7	119.		1581.6	141.		2113.5	162.9
	1134.1	119.4		1590.4	141.4		2123.7	163.4
	1141.6	119.8		1599.3	141.8		2133.9	163.7
	1149.1	120.2		1608.2	142.2		2144.2	164.1
	1156.6	120.6		1617.	142.6		2154.4	164.5
39.	1164.2	121.	46.	1626.	142.9	53.	2164.8	164.9
	1171.7	121.3		1634.9	143.3		2175.	165.3
	1179.3	121.7		1643.9	143.7		2185.4	165.7
	1186.9	122.1		1652.9	144.1		2195.7	166.1
	1194.6	122.5		1661.9	144.5		2206.2	166.5
	1202.3	122.9		1671.	144.9		2216.6	166.8
40.	1210.	123.3	47.	1680.	145.3	54.	2227.	167.3
	1217.7	123.7		1689.1	145.7		2237.5	167.6
	1225.4	124.1		1698.2	146.1		2248.	168.1
	1233.2	124.5		1707.4	146.5		2258.5	168.4
	1241.	124.9		1716.5	146.9		2269.	168.9
	1248.8	125.3		1725.6	147.3		2279.6	169.2
41.	1256.6	125.6	48.	1734.9	147.7	55.	2290.2	169.6
	1264.5	126.		1744.2	148.		2300.8	170.
	1272.4	126.4		1753.5	148.4		2311.5	170.4
	1280.3	126.8		1762.7	148.8		2322.1	170.8
	1288.2	127.2		1772.1	149.2		2332.8	171.2
	1296.2	127.8		1781.4	149.6		2343.5	171.6
42.	1304.2	128.	49.	1790.8	150.	56.	2354.3	172.
	1312.2	128.4		1800.1	150.4		2365.	172.3
	1320.3	128.8		1809.6	150.8		2375.8	172.8
	1328.3	129.2		1819.	151.2		2386.6	173.1
	1336.4	129.6		1828.5	151.6		2397.5	173.6
	1344.5	130.		1837.9	152.		2408.3	173.9
43.	1352.7	130.4	50.	1847.5	152.4	57.	2419.2	174.4
	1360.8	130.8		1857.	152.8		2430.1	174.7
	1369.	131.2		1866.5	153.2		2441.	175.1
	1377.2	131.6		1876.1	153.5		2452.	175.5
	1385.4	131.9		1885.7	153.9		2463.	175.9
	1393.7	132.3		1895.4	154.3		2474.	176.3
44.	1402.	132.7	51.	1905.	154.7	58.	2485.	176.7
	1410.3	133.1		1914.7	155.1		2496.1	177.1
	1418.6	133.5		1924.4	155.5		2507.2	177.5
	1427.	133.9		1934.1	155.9		2518.2	177.8
	1435.4	134.3		1943.9	156.3		2529.4	178.3
	1443.8	134.7		1953.7	156.7		2540.5	178.6
	1452.2	135.1		1963.5	157.1		2551.8	179.1
	1460.6	135.5		1973.3	157.4		2562.9	179.4
	1469.1	135.9		1983.2	157.9		2574.2	179.9
	1477.6	136.3		1993.	158.2		2585.4	180.2
	1486.2	136.7		2003.	158.7		2596.7	180.6
	1494.7	137.1		2012.8	159.		2608.	181.
1503.3	137.4	2022.8	159.4	2619.4	181.4			
1511.9	137.8	2032.8	159.8	2630.7	181.8			

TABLE—(Continued.)

Diam.	Area.	Circum.	Diam.	Area.	Circum.	Diam.	Area.	Circum.
58.	2642.1	182.2	65.	3318.3	204.2	72.	4071.5	226.2
	2653.4	182.6		3331.	204.5		4085.6	226.5
	2664.9	183.		3343.9	205.		4099.8	227.
	2676.3	183.3		3356.7	205.3		4114.	227.3
	2687.8	183.8		3369.6	205.8		4128.2	227.7
	2699.3	184.1		3382.4	206.1		4142.5	228.1
	2710.9	184.6		3395.3	206.6		4156.8	228.5
	2722.4	184.9		3408.2	206.9		4171.	228.9
59.	2734.	185.4	66.	3421.2	207.3	73.	4185.4	229.3
	2745.5	185.7		3434.1	207.7		4199.7	229.7
	2757.2	186.1		3447.2	208.1		4214.1	230.1
	2768.8	186.5		3460.1	208.5		4228.5	230.5
	2780.5	186.9		3473.2	208.9		4242.9	230.9
	2792.2	187.3		3486.3	209.3		4257.3	231.3
	2803.9	187.7		3499.4	209.7		4271.8	231.7
	2815.6	188.1		3512.5	210.		4286.3	232.
60.	2827.4	188.5	67.	3525.6	210.5	74.	4300.8	232.5
	2839.2	188.8		3538.8	210.8		4315.3	232.8
	2851.	189.3		3552.	211.3		4329.9	233.2
	2862.8	189.6		3565.2	211.6		4344.5	233.6
	2874.8	190.1		3578.5	212.1		4359.2	234.
	2886.6	190.4		3591.7	212.4		4373.8	234.4
	2898.5	190.9		3605.	212.8		4388.5	234.8
	2910.6	191.2		3618.3	213.2		4403.1	235.2
61.	2922.5	191.6	68.	3631.7	213.6	75.	4417.9	235.6
	2934.4	192.		3645.	214.		4432.6	236.
	2946.5	192.4		3658.4	214.4		4447.4	236.4
	2958.5	192.8		3671.8	214.8		4462.1	236.7
	2970.6	193.2		3685.3	215.1		4477.	237.2
	2982.6	193.6		3698.7	215.5		4491.8	237.5
	2994.8	194.		3712.2	215.9		4506.7	238.
	3006.9	194.3		3725.7	216.3		4521.5	238.3
62.	3019.1	194.8	69.	3739.3	216.7	76.	4536.5	238.8
	3031.2	195.1		3752.8	217.1		4551.4	239.1
	3043.5	195.6		3766.4	217.5		4566.4	239.5
	3055.7	195.9		3780.	217.9		4581.3	239.9
	3068.	196.3		3793.7	218.3		4596.3	240.3
	3080.2	196.7		3807.3	218.7		4611.3	240.7
	3092.6	197.1		3821.	219.1		4626.4	241.1
	3104.8	197.5		3834.7	219.5		4641.5	241.5
63.	3117.2	197.9	70.	3848.5	219.9	77.	4656.6	241.9
	3129.6	198.3		3862.2	220.3		4671.7	242.2
	3142.	198.7		3876.	220.7		4686.9	242.7
	3154.4	199.		3889.8	221.		4702.1	243.
	3166.9	199.5		3903.6	221.5		4717.3	243.5
	3179.4	199.8		3917.4	221.8		4732.5	243.8
	3191.9	200.3		3931.4	222.2		4747.8	244.3
	3204.4	200.6		3945.2	222.6		4763.	244.6
	3217.	201.1	71.	3959.2	223.	78.	4778.4	245.
	3229.5	201.4		3973.1	223.4		4793.7	245.4
	3242.2	201.8		3987.1	223.8		4809.	245.8
	3254.8	202.2		4001.1	224.2		4824.4	246.2
	3267.5	202.6		4015.2	224.6		4839.8	246.6
	3280.1	203.		4029.2	225.		4855.2	247.
	3292.8	203.4		4043.3	225.4		4870.8	247.4
64.	3305.5	203.8		4057.4	225.8		4886.1	247.7

TABLE—(Continued.)

Diam.	Area.	Circum.	Diam.	Area.	Circum.	Diam.	Area.	Circum.
79.	4901.7	248.2	86.	5808.8	270.2	93.	6792.9	292.2
	4917.2	248.5		5825.7	270.5		6811.1	292.6
	4932.7	249.		5842.6	271.		6829.5	293.
	4948.3	249.3		5859.5	271.3		6847.8	293.4
	4963.9	249.8		5876.5	271.7		6866.1	293.7
	4979.5	250.1		5893.5	272.1		6884.5	294.1
	4995.2	250.5		5910.6	272.5		6902.9	294.5
	5010.8	250.9		5927.6	272.9		6921.3	294.9
80.	5026.5	251.3	87.	5944.7	273.3	94.	6939.8	295.3
	5042.2	251.7		5961.7	273.7		6958.2	295.7
	5058.	252.1		5978.9	274.1		6976.7	296.1
	5073.7	252.5		5996.	274.4		6995.2	296.5
	5089.6	252.9		6013.2	274.9		7013.8	296.9
	5105.4	253.3		6030.4	275.2		7032.3	297.3
	5121.2	253.7		6047.6	275.7		7051.	297.7
	5137.1	254.1		6064.8	276.		7069.5	298.1
81.	5153.	254.5	88.	6082.1	276.5	95.	7088.2	298.5
	5168.9	254.9		6099.4	276.8		7106.9	298.8
	5184.9	255.3		6116.7	277.2		7125.6	299.2
	5200.8	255.6		6134.	277.6		7144.4	299.6
	5216.8	256.		6151.4	278.		7163.	300.
	5232.8	256.4		6168.8	278.4		7181.8	300.4
	5248.9	256.8		6186.2	278.8		7200.6	300.8
	5264.9	257.2		6203.6	279.2		7219.4	301.2
82.	5281.	257.6	89.	6221.1	279.6	96.	7238.2	301.6
	5297.1	258.		6238.6	280.		7257.1	302.
	5313.3	258.4		6256.1	280.4		7276.	302.4
	5329.4	258.8		6273.6	280.8		7294.9	302.8
	5345.6	259.2		6291.2	281.2		7313.8	303.2
	5361.8	259.6		6308.8	281.6		7332.8	303.6
	5378.1	260.		6326.4	282.		7351.8	303.9
	5394.3	260.4		6344.	282.3		7370.7	304.3
83.	5410.6	260.8	90.	6361.7	282.7	97.	7389.8	304.7
	5426.9	261.1		6379.4	283.1		7408.8	305.1
	5443.3	261.5		6397.1	283.5		7428.	305.5
	5459.6	261.9		6414.8	283.9		7447.	305.9
	5476.	262.3		6432.6	284.3		7466.2	306.3
	5492.4	262.7		6450.4	284.7		7485.3	306.7
	5508.8	263.1		6468.2	285.1		7504.5	307.1
	5525.3	263.5		6486.	285.5		7523.7	307.5
84.	5541.8	263.9	91.	6503.9	285.9	98.	7543.	307.9
	5558.3	264.3		6521.7	286.3		7562.2	308.3
	5574.8	264.7		6539.7	286.7		7581.5	308.7
	5591.3	265.		6557.6	287.1		7600.8	309.
	5607.9	265.5		6575.5	287.5		7620.1	309.4
	5624.5	265.8		6593.5	287.8		7639.4	309.8
	5641.2	266.2		6611.5	288.2		7658.9	310.2
	5657.8	266.6		6629.5	288.6		7678.2	310.6
85.	5674.5	267.	92.	6647.6	289.	99.	7697.7	311.
	5691.2	267.4		6665.7	289.4		7717.1	311.4
	5707.9	267.8		6683.8	289.8		7736.6	311.8
	5724.6	268.2		6701.9	290.2		7756.1	312.2
	5741.5	268.6		6720.1	290.6		7775.6	312.6
	5758.2	268.9		6738.2	291.		7795.2	313.
	5775.1	269.4		6756.4	291.4		7814.8	313.4
	5791.9	269.7		6774.7	291.8	100.	7834.3	313.8
							7854.	314.2

Applied Science.

Everybody who is endowed with reason believes that every event must have an adequate cause. That like causes under similar circumstances produce like effects, and hence two events that are similar in all respects are the product of similar causes. Therefore it is natural to refer any observed phenomena, the cause of which is not at once obvious to some cause that we have known to produce a similar result. If an accident occurs, and the evidence which we are able to obtain relating to the cause is such as to preclude all the causes that in our experience have been known to produce such a result, the tendency is to refer it to some fact which is recorded in the early history of modern science, and which has been often quoted and redeveloped by scientific investigators, but which is in reality an abstract fact, requiring abnormal conditions for its development, and which can usually be done only in the well-appointed laboratory.

The veneration with which we are prone to regard the statements of profound scientists who are in the habit of citing laboratory experience to explain boiler explosions, may sometimes so affect our estimate of the facts of our own experience that common sense seems for the moment to be at a discount.

We have been taught by our experience that bodies in contact with or near to others of a different temperature gradually become of the same temperature, by reason of the flow of heat from the hotter to the cooler body, till equilibrium of temperature is established, and we have come to accept this as the true explanation of the phenomenon, without stopping to analyze the character of heat as an abstract entity. We know that it is invisible and has no weight, and we believe it is only a mode of motion. We know also that a mathematical point has position without magnitude, and that a line has length without breadth or thickness; we realize too that a thing without parts, weight, or dimensions is practically nothing. But the line and point are imaginary, while heat is real, a property of matter, as color and hardness, etc., are; and it is imparted to bodies from others that possess more of it, and also by chemical and mechanical action. We see that water boils most violently when exposed to the most intense heat, and we say that this is a rule without an exception, yet Dr. Franklin's experiment shows that ice-water poured upon a flask of warm quiescent water throws it into active ebullition. Stated in this manner, it seems to be in conflict with all practical experience, and hence it is known as the culinary paradox, but when the conditions are known no one thinks of it as an exception to the rule or as a dangerous property of water. The ebullition is caused by the condensation of the vapor in the flask and a reduction of pressure, whereby the boiling point is lowered. There are other paradoxical results recorded, such as the freezing of water in a red-hot crucible; mercury also may be frozen in a red-hot capsule; but these singular facts have not been quoted as among the causes of boiler explosion, and a description of the experiments is not in order here.

We go on with our culinary operations, confidently believing that if we put a quantity of water into an open vessel over our kitchen fire that it will gradually come to the boiling temperature and quietly boil away into vapor, notwithstanding we are told that water may be raised to a temperature far above the boiling point in an open vessel, when it will commence to boil with explosive violence; and that "an open pan of boiling water has been known to explode with fatal results." Millions of such experiments are performed daily in crowded dwellings where innocent children and women are exposed to the danger of being scalded to death by the explosive vaporization of water, and, while we do not deny or affirm the abstract fact that water may be made thus to explode, it is pertinent to inquire how many casualties are reported from this cause in the death-lists of our large cities, and inasmuch as this experiment is cited by most theoretical writers as one of the possible causes of boiler explosions which have "heretofore perplexed

engineers," it is proper to inquire how many boilers have *been known* to explode from this cause. The question is not, Is this a fair explanation of one or more explosions which appeared to have had a mysterious origin? The question is, Is it proved that it ever caused a single explosion?

It has been shown that drops of water may retain their liquid form in a bath of oil under atmospheric pressure at a temperature due to a pressure of ten atmospheres, and when they were converted into vapor it was with great violence, accompanied by noise. The philosopher who performed this experiment says, "the air necessary for evaporation is not supplied. If the drops be touched with a rod of metal or, better still, of wood, they are immediately converted into vapor with great violence accompanied by a peculiar noise. This is explained by the fact that the rods used always carry a certain quantity of condensed air upon their surface, and by means of this air the evaporation is produced." This experiment has also been cited by theoretical writers as a peculiar fact, relating in some undefined manner to the phenomena attending some case of boiler explosion that they could explain in no other way, but the explanation has only, so far as practical inquirers are concerned, rendered the case more mysterious, for there seems to be little analogy between drops of deaerated water immersed in a bath of oil at atmospheric pressure, and at a temperature of 180° C. (356° F.), and the common water in a practical steam boiler under a pressure due to the temperature.

It is also recorded that a white-hot vessel (heavy silver capsule) may, by "an adroit movement be filled entirely with water, and set upon a stand some seconds before the heat declines to a point when contact can occur between the liquid and the metal. When this happens, the water, before quiet, bursts into steam with almost explosive violence, and is projected in all directions." This water is in the spheroidal state, a well-understood condition which drops of water assume on iron plates, it being kept from contact by a film of its own vapor, but under pressure in steam boilers it has never been proved to be attainable. It is a favorite theory of boiler explosions, and many unsuccessful attempts have been made to explode steam boilers by injecting cold water while they are empty and red-hot, but the most ignorant of boiler attendants knows that it is his most imperative duty to keep water in his boiler. There is still another theory founded on laboratory experiments, and perhaps it is the most plausible and specious of them all. It was introduced by Professor Donny of Ghent, many years ago, and is known as the Donny theory. The experiment is described as follows, by the best authority in the English language: "We take a glass tube bent twice and terminated at one extremity by a series of bulbs. The first step is to wash it carefully with alcohol and ether, finally leaving in it some diluted sulphuric acid. These operations are for the purpose of removing the solid particles adhering to the sides, *which will always detain portions of air*. Water is then introduced and boiled long enough to expel the air dissolved in it, and when ebullition is proceeding the end of the apparatus is hermetically sealed. The other end is now plunged into a strong solution of chloride of calcium, which has a very high boiling point, and the tube is so placed that the water will lie in this extremity. It will then be found that the temperature may be raised to 135° C. (275° Fahr.), without producing ebullition. At about this temperature bubbles of steam are seen to be formed, and the entire liquid mass is thrown forward with great violence. The bulbs at the end of the tube are intended to diminish the shock thus produced." It will be obvious to the reader that the success of this experiment depends on the careful exclusion of everything but pure deaerated water and its vapor. Attempts to perform this experiment have so often failed that we are warranted in this conclusion. It can however be readily performed by those skilled in physical experiments, by strictly following the directions. The sulphuric acid left in the tube will probably tend to the success of the experiment, and perhaps the more of it the better,

since acid solutions have a habit of bumping violently when heated in glass tubes. Indeed, it is sometimes difficult to heat a strong acid solution in an open tube for analytical purposes so as to prevent it from being thrown out violently. But we must suppose that Professor Donny was making an honest attempt to explode *water* and that the acid is not an essential element, except as a means of perfectly clearing the tube of the solid particles "that always detain portions of air." We infer that it is only necessary that the tube be perfectly clean and the water chemically pure, which means, containing nothing whatever except oxygen and hydrogen in the proportions to form water. Air or gas of any kind, even an excess of either of the constituent gases, are foreign bodies and impurities which, if present, will undoubtedly vitiate the experiment.

Now, in making a practical application of this experiment as a probable cause of boiler explosions, let us consider for a moment the character of ordinary water. On reflection, can we say that we have ever seen a sample of chemically pure water—undulterated condensed gases in just the right proportions?—Is it not on the whole a rather rare chemical compound, most often found in Donny tubes imported from Ghent for the illustration of the fact that water may be made to explode? How long would this precious compound be fit for the experiment if subjected to the common abuses of exposure to air, gas, and dust? It will be seen that everything must be excluded and the tube hermetically sealed. Now can pure water like this exist for an instant in a steam boiler constructed of any practicable material? Suppose it were possible to thoroughly clean a boiler and boil out all the air; can a practical steam boiler be hermetically sealed, and the hypothetical water be kept pure long enough to make the experiment? We think not.

But there is another difficulty which will be developed by an attempt to overheat water in a steam boiler. It will be seen that, after the careful preparation of the tube and the water for the experiment, the tube is plunged into a bath of such a solution as boils at a very high heat, and the tube is so placed that the water will be in the part of the tube that is immersed. The temperature of the bath is now raised, and with it of course that of the water in the tube. It is essential that this be carefully done, so as to prevent circulation of the water in the tube, therefore it must be done gradually, so that the heat may be applied uniformly to the surfaces that are in contact with the water. Those who have attempted this experiment say that the least jar or agitation of the apparatus after the ordinary boiling point of water is reached will induce evaporation at once, so also if heat should be applied to one part, the bottom, for example, of the tube, motion of the water will effectually prevent a rise of temperature above the boiling point.

This being the case, it would not be too much of an insult to our common sense to ask us to believe that the conditions necessary for the success of this theory can be either designedly or accidentally realized in practice. Do we not invariably apply the heat to a portion only of the boiler-surface. And how is it possible, even at night or with the fire out and the surrounding bodies coming into a state of equal temperature with the boiler, to preserve a perfectly uniform temperature of the entire boiler? Some of the bodies in contact with it being better conductors of heat than others, a constant circulation is inevitable till the whole has cooled below the dangerous temperature.

Moreover, is it not the universal practice of engineers and boiler attendants to start their fires and raise steam in their boilers without aerating the water that has the previous day been undergoing deaeration and has been sealed, sometimes by closing the steam stop-valve over night, thus, one would think, preparing for the very climax of the Donny experiment? Yet in a single city there are thousands of steam boilers subjected to this very treatment, and a whole year has often elapsed, involving perhaps a million experiments without a single successful one, or an accident which could not be traced to some obvious cause. The presence of metallic oxides, or any one of the many solids invariably found

in natural waters, which separate as the water is concentrated by boiling, even in particles ever so small, will prevent the water from being heated to a dangerous temperature.

It is not perhaps strange that theorists who are not acquainted with steam boiler practice should cite their laboratory experiments in explanation of accidents that are imperfectly reported to them, and therefore appear to be mysterious, but it is unfortunate that well-informed, practical engineers should accept them on faith and perpetuate theories when adequate mechanical defects exist, and can be found by a little patient search and study.

Some remarks on the probability of a sudden rise of pressure in steam boilers which has been characterized as explosive vaporization of water will be offered in a future paper.

II.

Mr. Hannay's Artificial Diamonds.

A very large audience gathered at the Royal Society, London, February 26th, to hear Mr. Hannay's account of his artificial diamonds. The interest of the subject gathered an unusually large attendance.

The following paper by Mr. Hannay was read by Prof. Stokes :

"While pursuing my researches into the solubility of solids in gases I noticed that many bodies, such as silica, alumina, and oxide of zinc, which are insoluble in water at ordinary temperatures, dissolve to a very considerable extent when treated with water-gas at a very high pressure. It occurred to me that a solvent might be found for carbon; and as gaseous solution nearly always yields crystalline solid on withdrawing the solvent or lowering its solvent power, it seemed probable that the carbon might be deposited in the crystalline state. After a large number of experiments it was found that ordinary carbon, such as charcoal, lampblack, or graphite, were not affected by the most probable solvents I could think of, chemical action taking the place of solution.

A curious reaction, however, was noticed, which seemed likely to yield carbon in the nascent state, and so allow of its being easily dissolved. When a gas containing carbon and hydrogen is heated under pressure in presence of certain metals its hydrogen is attracted by the metal, and its carbon left free. This, as Prof. Stokes has suggested to me, may be explained by the discovery of Professors Liveing and Dewar, that hydrogen has at very high temperatures a very strong affinity for certain metals, notably magnesium, forming extremely stable compounds therewith.

"When the carbon is set free from the hydro-carbon in presence of a stable compound containing nitrogen, the whole being near a red heat and under a very high pressure, the carbon is so acted upon by the nitrogen compound that it is obtained in the clear, transparent form of the diamond. The great difficulty lies in the construction of an inclosing vessel strong enough to withstand the enormous pressure and high temperature, tubes constructed on the gun-barrel principle (with a wrought iron coil), of only half an inch bore and four inches external diameter, being torn open in nine cases out of ten.

"The carbon obtained in the successful experiments is as hard as natural diamond, scratching all other crystals, and it does not affect polarized light. I have obtained crystals with curved faces belonging to the octahedral form, and diamond is the only substance crystallizing in this manner. The crystals burn easily on thin platinum-foil over a good blowpipe, and leave no residue, and after two days' immersion in hydrofluoric acid they show no sign of dissolving, even when boiled. On heating a splinter in the electric arc it turned black—a very characteristic reaction of a diamond.

"Lastly, a little apparatus was constructed for effecting a combustion of the crystals and determining their composition. The ordinary organic analysis method was used, but the diamond crystals were laid on a thin piece of platinum-foil, and this was ignited by

an electric current, and the combustion conducted in pure oxygen. The result obtained was that the sample (14 mgrms.) contained 97.85 per cent. of carbon, a very close approximation, considering the small quantity at my disposal. The apparatus and all analyses will be fully described in a future paper. The specific gravity of the diamond I have obtained ranges as high as 3.5; this being determined by flotation, using a mixture of bromide and fluoride of arsenic."

The president having called for any observations on the notice by Mr. Hannay, Mr. Maskelyne said that the present differed from the numerous announcements and other communications that have been heretofore made to scientific societies at various times, purporting to record the artificial production of the diamond, in this, that here the product so claimed to have been manufactured is really diamond. He had himself proved this by the simple tests of the mineralogist. He had deeply abraded topaz and sapphire with a particle of the substance, and abraded them with the greatest ease; the angle of the cleavages of a crystalline fragment sent him by Mr. Hannay was the angle between faces of the regular octahedron, and he had burnt a small grain of the substance on a platinum-foil with the characteristic glow of the diamond, and without its leaving a residue. And on polarized light it had no action—or rather one particle had a very slight action, just as many diamonds have when turned between crossed tourmalines, and the lustre of the body was truly adamantine. All the particles he had seen as yet were fragments; none were complete crystals. They were characterized by the laminated structure of diamond. One, indeed, forwarded to him by Prof. Roscoe, had exactly the appearance of a chip from a small diamond that might originally have been from one-eighth to one-thirty-second of a carat in size; it may have been about one-hundredth of a carat in weight itself. Prof. Roscoe had recognized the close similarity of this fragment to one of native diamond, and had declared his skepticism of the reality of the transmutation of carbon until it should be proved to be an established scientific result; and Mr. Maskelyne considered Prof. Roscoe was, *prima facie*, justified in this skepticism, and wished, on the part of Prof. Roscoe, to place on record this hesitation on his part to accept the results claimed by Mr. Hannay without further proof, though no one would accept them, when proved, with greater pleasure than would Prof. Roscoe.

After further remarks by scientific gentlemen present, a tube some four inches in diameter, made of wrought iron, and bored with a small cylindrical hollow along its axis, was shown as one of the tubes in which Mr. Hannay's experiments were performed.

—*Scientific News.*

The New York *World* pungently remarks that if the evidence about the Tay Bridge had been given concerning an American structure which had tumbled down and killed ninety or a hundred persons, would not our esteemed British contemporaries have denounced American fraud and flimsiness? As to the metal used for the columns, moulders employed in the work for twenty-seven years "never saw worse," the coke used for melting it was inferior; holes and cracks were patched up with cement; none of the defective columns "which were numerous," were broken up but went into the work, and so on. The most favorable testimony was that of one of the foremen who had been engaged in casting the columns, and he said that the material "was not so terribly bad—for building iron." Not a few witnesses, such as ex-Provost Robertson, of Dundee, an engineer, testified as to the habitual recklessness of the drivers on the bridge. . . . Other habitual travelers gave up the bridge on account of the oscillations and took to the ferry. Altogether the evidence thus far taken seems to indicate such "scamping" in fitting up the bridge and such recklessness in using it as our British brethren have been accustomed to depict as exclusively and characteristically American, and to compare, to our manifest shame and disadvantage, with British solidity and caution.

Incorporated
1866.

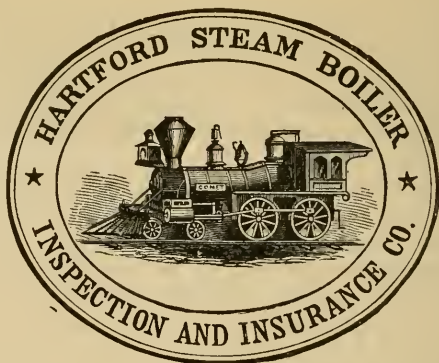

Charter Per-
petual.

Issues Policies of Insurance after a Careful Inspection of the Boilers,

COVERING ALL LOSS OR DAMAGE TO

BOILERS, BUILDINGS, AND MACHINERY,

ARISING FROM

Steam Boiler Explosions.

THE BUSINESS OF THE COMPANY INCLUDES ALL KINDS OF STEAM BOILERS.

Full information concerning the plan of the Company's operations can be obtained at the
COMPANY'S OFFICE, HARTFORD, CONN.

Or at any Agency.

J. M. ALLEN, Prest. W. B. FRANKLIN, Vice-Prest. J. B. PIERCE, Sec'y.

Board of Directors.

J. M. ALLEN, President.	GEN. WM. B. FRANKLIN, Vice-Prest. Colt's Pat. Fire-Arms Mfg. Co.
LUCIUS J. HENDEE, Prest. Aetna Fire Ins. Co.	GEO. CROMPTON, Crompton Loom Works, Worcester.
FRANK W. CHENEY, Asst. Treas. Cheney Brothers Silk Manufacturing Co.	HON. THOS. TALBOT, Ex-Governor of Mass.
CHARLES M. BEACH, of Beach & Co.	NEWTON CASE, of The Case, Lockwood & Brainard Co.
DANIEL PHILLIPS, of Adams Express Co.	WILLIAM S. SLATER, Cotton Manufacturer, Providence, R. I.
GEO. M. BARTHOLOMEW, Prest. Amer. Nat. Bank.	NELSON HOLLISTER, of State Bank, Hartford.
RICHARD W. H. JARVIS, Prest. Colt's Fire Arms Manufacturing Co.	D. R. SMITH, Prest. Springfield Fire & Marine Ins. Co.
THOMAS O. ENDERS, Sec'y Aetna Life Ins. Co.	
LEVERETT BRAINARD, of The Case, Lockwood & Brainard Co.	

GENERAL AGENTS.

THEO. H. BABCOCK,
CORBIN & GOODRICH,
LAWFORD & McKIM,
W. S. CHAMBERLIN,
J. L. SMITH,
H. D. P. BIGELOW,
C. C. GARDINER,
D. C. FREEMAN,
W. G. LINEBURGH,
GEO. P. BURWELL,
W. B. CASSILY,

CHIEF INSPECTORS.

R. K. McMURRAY,
WM. G. PIKE,
JOSEPH CRAGG,
WM. U. FAIRBAIRN,
B. M. LORD,
H. D. P. BIGELOW,
J. S. WILSON,
F. S. ALLEN,
W. S. FOX,
A. C. GETCHELL,
J. S. WILSON,

OFFICES.

NEW YORK CITY. Office, 285 Broadway.
PHILADELPHIA. " 430 Walnut St.
BALTIMORE. " 10 So. Holliday St.
BOSTON, MASS. " 10 Pemberton Sq.
PROVIDENCE, R. I. " 42 Weybosset St.
CHICAGO, ILL. " 132 La Salle St.
ST. LOUIS, MO. " 404 Market St.
HARTFORD. " 218 Main St.
BRIDGEPORT. " 328 Main St.
CLEVELAND. " 246 Superior St.
CINCINNATI. " 53 West Third St.

The Locomotive.

PUBLISHED BY THE HARTFORD STEAM BOILER INSPECTION AND INSURANCE COMPANY.

NEW SERIES—VOL. I.

HARTFORD, CONN., JUNE, 1880.

No. 6.

Experiments on the Explosion of Steam Boilers, by a Committee of the Franklin Institute in 1835

These valuable experiments were undertaken at the request of the Secretary of the Treasury, and the report was published in the journal of the Institute, in January and February, 1836.

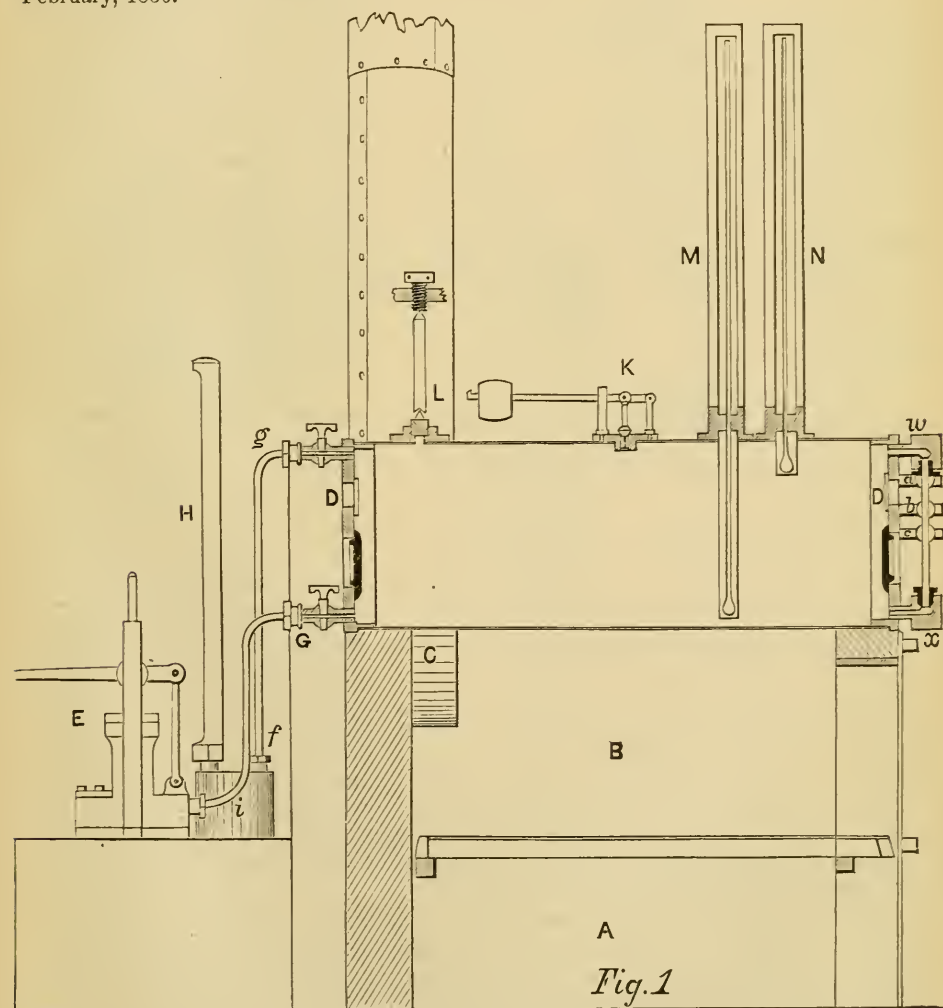

Fig. 1

They have been interpreted by some writers as contributing to the support of explosion theories, and to advertise safety-plugs, and other devices, for the prevention of

explosions. It seems proper to review these experiments in the light of this company's experience, so that its patrons and other readers of THE LOCOMOTIVE may duly estimate the value of the support which it is claimed they afford the theories and devices above mentioned.

The illustrations are made from the text, and the drawings of the report of the committee, with the intention of giving, to some extent, self-explaining views of the essential features of the apparatus, omitting some details which relate more particularly to accuracy in scientific data.

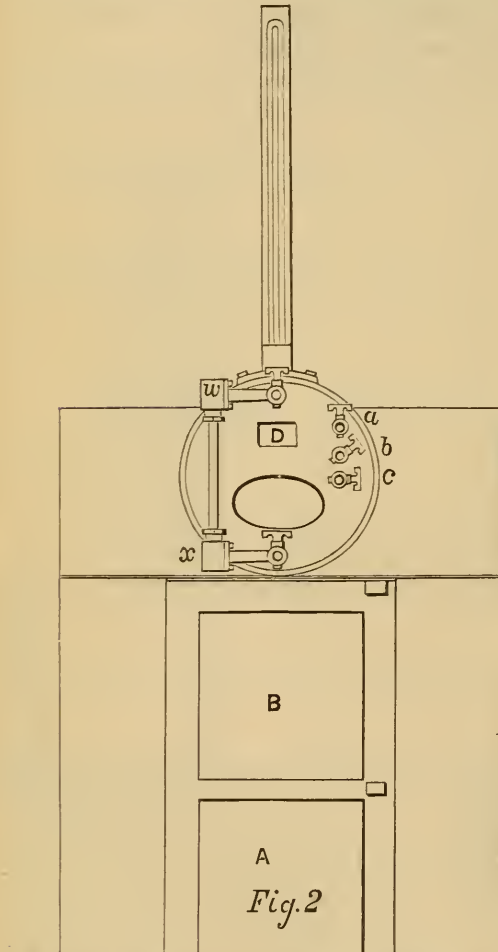

Fig 1 is a sectional elevation of one of the experimental boilers, which was a plain cylinder 12' dia. by 34' long with cast-metal heads, set in brick; and Figs. 2 and 3 are respectively front and rear end views of the same boiler. Fig. 4 is the *metal* sash which was put over the glass windows at later experiments to make them more secure. It was fitted with a closed mercury gauge, gauge-cocks, safety-valve, water-glass, and several thermometers. It had also glass windows D, in the heads $2\frac{1}{2}'' \times 1\frac{3}{8}''$, one in each head, through which to observe the interior. Reference letters refer to same parts in all the cuts.

The first experiment with this apparatus was, "to ascertain whether, on relieving water heated to or above the boiling point from pressure, any commotion is produced in the fluid. This is what the report says: "Experiments were made, which showed that on making an opening, even when the pressure did not exceed two atmospheres, a local foaming commences at the point of escape, followed soon by a general foaming throughout the boiler, the more violent in proportion as the opening was increased. This

small boiler was completely filled with foam by opening the safety-valve (nearly two-tenths of an inch in area), which was placed in the middle of the top, and the water violently discharged through the opening of the valve."*

"The boiler was half full of water in these experiments. *The gauge fell always on making the opening.*" The committee commenting on this experiment says: It is interest-

* This valve bears nearly the same relation to the surface area of the water in this little boiler, when half full, that a $2\frac{1}{2}''$ valve would to the water-surface in a plain cylinder boiler 30" dia. by 30 feet long when half full, or a $2\frac{1}{2}''$ on a $36'' \times 30'$ boiler.

ing in two points of view; first, in its effect upon the apparatus designed to show the level of the water within the boiler; second, by throwing the water against the heated sides of the boiler."

The fact which is printed in italics above is recommended for study to those who have a superstitious notion that a rise of pressure follows the act of opening the safety-valve. The danger it seems comes solely from the sudden formation of a heavy foam, which rushes violently towards the point of least pressure. The word foaming, used in this connection by the committee, should not be confounded with frothing. The froth

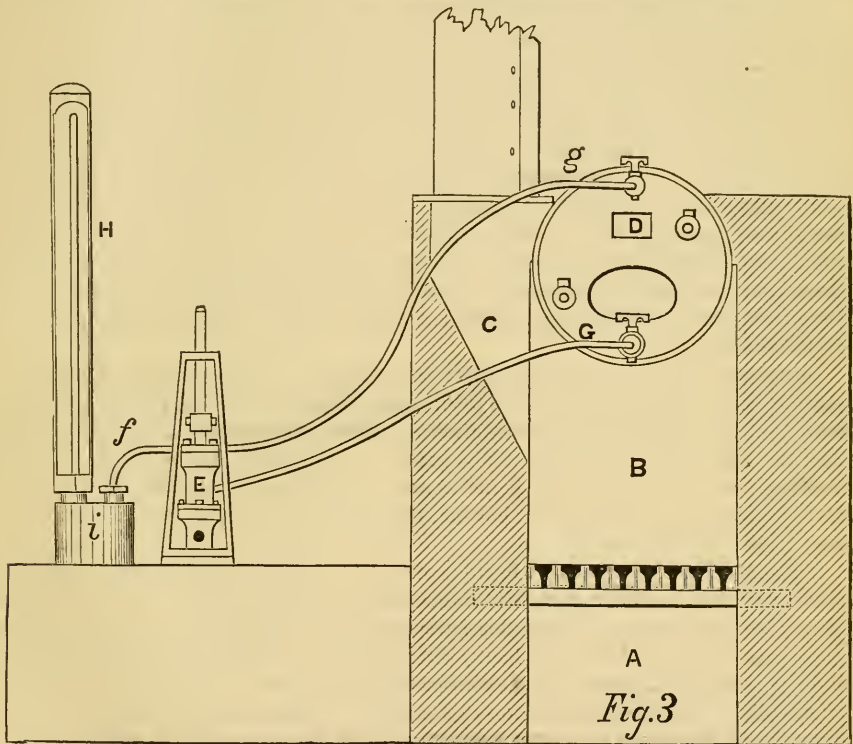

upon the surface of foaming liquors and heated water filled with steam-bubbles are quite different bodies. Froth is mostly air or gas-bubbles with the thinnest of liquid envelopes, while foaming water in a steam-boiler may be almost "solid water," made white and projected by the contained steam-bubbles, and its momentum during expansion is a force not to be despised when concentrated upon the surface surrounding the opening through which it is impelled. By its force safety-valves, and their housings, have been blown off bodily from steam-boilers, by the too-sudden opening of a safety-valve of large area, and by its force initial ruptures in explosions are developed into a complete destruction of the boiler-shell. The discussion of the effect of "throwing the water against the heated surfaces" is reserved for its proper place after the experiments which the committee made with the sides of the boiler heated red hot. These experiments are very interesting and important as bearing on the subject of explosive vaporization of water. The gauge-cocks in the experimental boiler a, b, c, Fig. 1 and 2, were 1.95 inches and 1.8 inches apart, measuring from the center of the open of the middle one above and to the one below.

"The steam in the boiler being not higher than two atmospheres, the following experiment was made. The level of the water was reduced until it stood just below the lowest gauge-cock. On opening this cock, steam at first flowed out, then water and

steam; on opening the second cock, in addition, water flowed freely from the lowest, which was above the hydrostatic level; the foaming within the boiler, which was produced by thus relieving the pressure, was distinctly seen through the glass windows. On opening the third cock, steam and water issued from the second, which was two inches above the water-level; and on partially raising the safety-valve water flowed freely from the second cock. A further rise of the valve filled the boiler with foam, water flowed freely out of the third cock, more than three inches and three-quarters above the water level, and finally through the opening of the safety-valve itself." In these experiments an opening of .03 of a square inch in area, the lowest cock, which to the area of the water-surface was as one to 37,700, caused the water and steam to issue through the cock below which the water was known to be. A further opening .03 of a square inch, making with the first, .06 inch, or $\frac{1}{16660}$ of the area of the water-surface, brought water from the lowest cock; a total of .09 inch ($\frac{1}{4557}$ of the area of water-surface) brought water and steam from the middle cock, indicating that the level of the water was nearly two inches higher than it really was." "A first apparatus which was contrived for applying fusible plates to the boiler, suddenly opened an aperture of .95 inch in diameter." (See L, Fig 1.) Even at low pressures, the scalding contents of the boiler were violently discharged, through this opening, against the roof of the experiment house. "It is now time to speak of the glass gauge-tube as a means of indicating the level of water within a boiler, in connection with which an experiment bearing upon the performance of the gauge-cocks will be stated."

After some trials of a prismatic glass water-gauge, which proved too frail, the committee's report describes the glass water-tube gauge shown in section, Fig. 1, and in elevation, Fig. 2, w, x, which will be recognized as substantially what is in use to-day for indicating the water-level. They say, "The gauge used was $9\frac{3}{4}$ inches in length; the upper part being so near the top of the boiler as only to be affected by the foaming in extreme cases, the lower part so near the bottom that the level of the water was indicated unless when very low indeed."

The committee experimented in this connection with some apparatus devised by Mr. Thomas Ewbank, for ascertaining the water-level by means of internal perforated attachments to the gauge-pipes. Alarm-floats were tested by the committee, and a full description given of one used by Mr. Ewbank, which was to be wholly enclosed in the boiler to avoid the stuffing-box commonly used to pass the index-rod of the float through the top of the boiler. The committee say on this subject, "A float serving to give an alarm by the issuing of steam was made the subject of a few experiments, and answered well, as far as those trials went." "Long use, however, could alone determine perfectly, the peculiar liabilities to derangement in this apparatus." The point next examined by the committee, was the

EFFECT OF FOAMING ON THE ELASTICITY OF THE STEAM WITHIN THE BOILER.

The proposition was as follows: "When an opening is made in a boiler, of which the sides are heated, will the effect be to diminish the elasticity of the steam within, by permitting its escape, or will the water thrown upon the heated sides by the foaming which results be converted so rapidly into steam as actually to increase the elasticity of the vapor within?" The report continues: "It is obviously difficult to obtain an answer to a query involving so many conditions. It might be expected, however, that a small boiler would afford satisfactory means of making a fair trial of the question, since the size of the openings could be varied very easily, so as to make them comparatively small, or very great. The position of the boiler used by the committee in its furnace was such that the sides could be readily heated, thus placing it in favorable circumstances to increase the elasticity of the steam by producing a foaming within. The apparatus was therefore adapted to make the desired trial."

Just here, following, appears a sentence in the report which gives, in a word, the origin of the superstition that the pressure increases on making an opening.

"M. Arago, in his Essay on the Explosions of Steam-boilers, states that M.M. Taberau and Rey, at Lyons, found, on opening a large stop-cock connected with a small high-pressure boiler, that the safety-valve rose, showing an increase of pressure within." "The experiments of M.M. Arago and Dulong, at Paris, were attended by a contrary result, the opening of the safety-valve being always accompanied by a diminution of pressure." "The circumstances, however, were not the same as those in the experiments of M.M. Taberau and Rey." "To repeat this experiment, a hot fire was made beneath the boiler, and when the water had fallen to about 3 inches above the lowest line of the cylinder the experiment was commenced, the pressure being about 3 atmospheres. A stop-cock, .03 square inches in area, $\frac{1}{10660}$ of the area of the water-surface at the beginning of the experiment, delivering per second, at $3\frac{1}{2}$ atmospheres, about 409 cubic inches of steam was first opened; next, the safety-valve was raised, either in part or entirely, the area of which, when entirely raised, was .208 square inch, or $\frac{1}{1050}$ of the water surface, and capable of delivering, in one second, at $3\frac{1}{2}$ atmospheres a bulk of steam nearly 9 times that of the steam chamber. The water-level falling by the waste caused by the experiment, the steam soon became surcharged with heat; and the iron of the boiler, from near the water-line to more than $\frac{1}{3}$ of the distance from the lowest line to the middle of the convex surface, became, on each side of the water-line, heated until it attained redness, passing of course through the temperature of maximum vaporization of the water thrown by the foaming upon the iron. The experiments were made at intervals, until all the water was exhausted. Water was then injected in small quantities, and, with the bottom of the boiler for the most part red-hot, the trials were repeated.

"It will be seen by the following table, that the result was uniformly a diminished elasticity of the steam within, as shown by the fall of the mercury in the steam-gauge. The pressure varied, in the former part of the experiments, from $3\frac{1}{2}$ to 8 atmospheres.

Remarks on the Depth of Water.	Nature of Opening.	Temp. by long Ther. M. Fahr.	Height of Steam Gauge.		Remarks on the Depression of the Steam Gauge.	General Remarks.
			before.	after.		
			inches	inches.		
3 inches, . .	Gauge cock,	284 $\frac{1}{2}$	18.6	18.0	Tem. of air in gauge 80°. Pressure corresponding to 18.6 inches, 3 $\frac{1}{2}$ atmospheres.
	do.	. .	20.4	20.2	
	Safety valve,	. .	20.5	20.0	Fall very rapid.	
	Gauge cock,	. .	21.0	20.9	Fall immediate.	Pressure corresponding to 21.3 inches, 5 $\frac{1}{2}$ atmospheres.
	Safety valve,	. .	21.3	21.0	
.9 of an inch, .	Gauge cock,	317 $\frac{1}{2}$	21.9	21.8		From about 8 $\frac{1}{2}$ to 5 atmospheres; steam surcharged bottom, rapidly increasing in heat.
	Safety valve,	. .	22.1	21.7	Fall in $\frac{1}{2}$ second.	
	do.	. .	22.6	20.6	Fall in 2 seconds.	
.9 inch nearly.	Stop cock,	380	Falls.	
	Safety valve,	468 $\frac{1}{2}$	15.1	12.6		
	Gauge cock,	. .	18.0	14.0		
	Safety valve,	. .	16.0	14.0	Sudden descent.	Water exhausted; supply thrown in. Ther. rose to 600°.

"The first column in the table contains remarks referring to the level of the water in the boiler. The second, the openings made. The third is the temperature by the thermometer, which reaches nearly to the bottom of the boiler. The fourth is the height of the mercury-gauge before making the opening. The fifth, the height immediately after making the opening, unless the contrary is stated in the sixth column, which contains remarks relating to the effect on the gauge. The seventh column contains general remarks.

Thus it seems that there is no foundation for the belief that there is a rise of pressure in consequence of making an opening in a steam-boiler even though there may be hot plates upon which the water is thrown by the reason of the sudden liberation from pressure upon its surface. If the opening is large enough to induce foaming, it is at the same time large enough to allow of the escape of the steam that is generated by the contact of water with the hot plates. The next set of experiments are of still greater interest to all who have anything to do with boilers. They show the effect of, and the phenomena attending, the injection of cold water into this experimental boiler. Their discussion will be taken up in a future number of *THE LOCOMOTIVE*.

BOILER EXPLOSIONS.

MONTH OF JUNE, 1880.

IRON WORKS (55)—A plain cylinder boiler, 54 feet long, 36 inches diameter, exploded at the Grace Tod Furnace, Brier Hill, near Youngstown, O., April 30th, by which David Evans, the engineer (nephew of the late Gov. Tod), and a young man named Frank Paton, were instantly killed. The furnace was badly damaged and the old engine-house was demolished.

MILL (56)—There was an explosion of a boiler flue in the O'Fallon mill on the corner of Chouteau avenue and Fourth street, at noon, May 2d, which resulted in the stoppage of the mill work and the probable fatal injury of the fireman. It was stated by an individual in the vicinity of the mill at the time of the explosion, that the fireman was a new man; that he had been set to work just an hour and a half before the explosion took place. He was terribly burned about the face and arms. At a late hour it was stated that he was lying insensible, and that but little hopes were entertained for his recovery.

HOISTER (57)—The small boiler of the hoisting engine at Fairport exploded May 3d, at noon. Fortunately all the workingmen were at dinner at the time, so nobody was hurt, and very little damage done.

LOCOMOTIVE (58)—An explosion occurred May 5th, at 6.30 o'clock, in the yards of the Missouri Pacific road on Mercer street, St. Louis, Mo., by which several persons narrowly escaped serious injury. At the time, engine No. 34, a twenty-seven ton locomotive, was side-tracked, and, with 140 pounds of steam, was waiting until seven o'clock arrived to pull out a special freight train to Labadie. The portion of boiler which burst was near the safety-valve, which was also included in the destruction. The cab of the locomotive was badly damaged, a part of it being blown away, and every pane of glass cracked or broken. Four persons were near the locomotive when the explosion occurred, and the engineer, Henry Pate, and his fireman, Sam. Hunt, were fortunately standing on the tender, but none of the six were injured. Both engineer and firemen declare they were carrying the proper amount of steam and water, and no cause could be assigned for the explosion.

ROLLING MILL (59)—A terrible accident occurred at Rome, N. Y., May 10th, occasioning serious loss of life. On the starting of the engine in the Merchant iron mill, one

of the boilers burst, killing Jason C. Farr, William Francis, Reuben Davis, and Joseph Bessock, and probably fatally wounding Adam Briesendieffers. The following men were injured: Louis Bessock, three ribs broken; Fred. Bessock, body crushed; Ben. Wilson, arm broken; and Charles S. Baker, bruised. Many others were slightly injured, all employees of the mill. The mill was badly wrecked. The exploding boiler was raised from its foundation, and in its flight crushed through one heavy iron chimney, also through one heavy brick chimney, and landed about four hundred feet from the mill. Owing to the early hour only a part of the employees were on duty, otherwise the loss of life would have been fearful. About 250 men are thrown out of employment. The mill is damaged \$20,000 to \$30,000.

IRON WORKS—FOREIGN (60.)—By a boiler explosion at Birchell's Hall Iron Works, in London, May 15th, fifteen persons were instantly killed and twenty-five so badly wounded that they were taken to the hospital, some of them in a dying condition.

SAW-MILL (61.)—A boiler explosion occurred, May 18th, in McLeland & Blaike's saw-mill, in Great Village, Colchester county, Nova Scotia. Hugh Boyd was instantly killed, and Allen Heighton has since died.

SALT WORKS (62.)—Two stationary boilers exploded in the Syracuse pump-house on the Salina salt reservoir, May 22d. The crown-sheets of both boilers were badly torn. Engineer Webb quitted the room before the explosion. No one hurt.

LOCOMOTIVE (63.)—On the morning of May 26th, the locomotive of a freight train on the Pennsylvania & New York road exploded its boiler at Rummerfield, Pa., wrecking the engine. The engineer was thrown thirty feet away and killed, and the fireman very badly scalded.

SAW-MILL (64.)—The boiler of the steam saw-mill of McCaulley & Jarvis, Winnipeg, Manitoba, exploded May 28th, killing one man and injuring several others.

FLOURING MILL (65.)—At noon, May 27th, the boilers of the Woodburn Flour Mill, Bunker Hill, Ind., burst. No one was near at the time. The boiler-shed was demolished.

SAW-MILL (66.)—The Palmer Bros. saw-mill in Fallowfield township, near Meadville, Pa., was destroyed May 31st, by the explosion of the boiler. George Lytle and Edward Chishburn were killed. Solon Palmer, one of the proprietors, had a leg broken, and was otherwise injured, probably fatally. The loss on the mill is estimated at \$800. The cause of the explosion is said to be low water in the boiler.

FOREIGN (67.)—About half past five o'clock in the morning on Wednesday, May 27th, one of the tubes in a steam boiler burst at the Thy-le-Château Works, France, producing a fearful explosion. Twenty-five workmen are dangerously wounded in consequence of this accident, the cause of which has not yet been ascertained. Had the explosion occurred an hour later the number of victims might have been considerable higher, as the whole of the 600 men employed in the establishment would have been at work by that time.

Inspectors' Reports.

During the month of April, 1880, a total of 1,496 inspection visits were made, and 3,419 boilers were inspected. The number of thorough annual internal and external inspections was 1,256, and 215 boilers were tested by hydrostatic pressure.

The whole number of defects brought to light was 1,615, of which over 30 per cent. were reported as dangerous, namely, 496. They were as follows: Furnaces out of

shape, 103—34 dangerous. Fractures, 159—117 dangerous. Burned plates, 112—41 dangerous. Blistered plates, 282—51 dangerous. Cases of sediment and deposit, 212—43 dangerous. Incrustation and scale, 273—35 dangerous. External corrosion, 103—50 dangerous. Internal corrosion, 57—28 dangerous. Internal grooving, 20—6 dangerous. Water-gauges defective, 24—7 dangerous. Blow-outs defective, 22—8 dangerous. Safety-valves overloaded, 33—13 dangerous. Pressure-gauges defective, 114—40 dangerous. Boilers without gauges, 63. Deficiency of water, 9—8 dangerous. Braces and stays broken, 29—15 dangerous. Boilers condemned, 40.

The item in this report relating to defective steam-gauges has its importance considerably enhanced by an explosion which lately occurred in Birchill's Ironworks, Walsall, England, by which a large number of workmen were killed and injured. The investigation at last advices from across the ocean was in progress, and a verdict had not been reached by the coroner's jury. The following facts, relating to the boiler and the cause of the explosion, are obtained from the *London Engineer*. It appears that the owners of this boiler (it was a large upright, made originally of $\frac{1}{2}$ " plates), had been in the habit of employing the inspectors of a boiler insurance company to examine and report upon it—at last the owners applied for insurance on it, which was declined, but was to be accepted, at a reduced pressure, after certain extensive repairs were made. The owners and all concerned seemed determined to do all that human agency could to make the boiler safe. There was no lack of money or skill; among the employees of the firm were trained engineers, steam-fitters, and boiler-makers who worked under no limitation as to cost. The boiler was repaired, apparently according to the insurance company's direction, and set to work with the express stipulation that the pressure should not exceed 30 pounds per square inch. The boiler was worked in connection with 6 others, and the whole system had but one steam-gauge, which was located in the engine-room. This gauge, being considerable distance away, was not damaged by the explosion, and it was tested after the disaster, and found to be slow about 38 per cent. at the working pressure, that is, when it registered 29 pounds, at which the safety-valves were adjusted to blow off, there was an actual steam pressure of 40 pounds per square inch on the upper plates, and an additional pressure on the lowest plates due to a column of water in the boiler 12 ft. high, making about $45\frac{1}{2}$ pounds on the weakest part of the boiler, when it was believed that there was but 29 lbs. In making the repairs $\frac{3}{8}$ " patches had been used instead of iron of the original thickness of the shell, which was $\frac{1}{2}$ ", and allowing a fair tensile strength, say 50,000 pounds, 70 per cent. of which is 35,000, which multiplied by $\frac{3}{8}$ and divided by the radius, 60 inches, gives 218 pounds as the bursting pressure of the boiler *if it was sound* and double-riveted, as it should have been if it was 10 feet diameter. It seems that there are two lessons involved in the sequel to this terrible disaster; one relates to the importance of knowing whether the steam-gauge is a good one, and the other, which is of the utmost importance, is the matter of proper repairs, especially to large shells. If a large cylinder is cut, or a whole plate taken off, it is a matter of the first importance to have the new sheet or patch fit nicely, and neither draw nor buckle itself or the old plates. If the new plate is only a trifle too short circumferentially, it will distort and flatten the cylinder, and an undue strain will be thrown upon the longitudinal seams that join the old and new plates. It must be borne in mind in studying this subject, that the calculations for getting the strength of a boiler are based on the true cylindrical form, and that the enormous strain produced by a smooth steel pin oiled and driven into overset rivet-holes to bring them flush is not contemplated in the calculation.

SINCE the above was written we have received from Mr. Henry Hiller, Chief Engineer of the National Boiler Insurance Co., of England, large photographs of the wreck and ruin caused by the explosion of the boiler in the Iron Works at Walsall, together with an account of the inquest.

Expansion of Boilers.

The expansion of wrought-iron is about $\frac{1}{8000}$ part of its dimensions in all directions on being heated from 32° to 212° Fah., or $\frac{1}{1441000} = .00000694$ for each of the 180 degrees. Cast-iron does not expand quite as much, or $\frac{1}{8000}$ for $180^\circ = \frac{1}{162000}$ per degree = $.00000617$. In practice the pattern-maker makes his pattern for an iron casting $\frac{1}{8}$ inch per foot larger than his drawing, for which purpose his rule is $24\frac{1}{4}$ inches long, divided into 24 equal parts, etc., and called a shrink rule. Now if his casting comes out right size, making no allowance for the rapping of the pattern so it may easily leave the mold, it is evident that the fluid iron which filled the mold must have been about $\frac{1}{80}$ longer and broader and thicker than the pattern from which it was molded, and then making a small allowance for rapping, and call it $\frac{1}{50}$, we have about the difference in dimensions due to the fluidity of the metal. We are told by our tables that the temperature of melted cast-iron, or its melting point, is somewhere between $2,800^\circ$ and $3,500^\circ$; Molesworth says $2,786^\circ$; Rankine says $3,479^\circ$; a mean of which is about $3,132^\circ$, or an increase of $3,100^\circ$ from 32° , which is $\frac{3100}{180} = 17.22$ times as much as from 32° to 212° . Now if the rate of expansion were uniform for high as well as for low temperatures, we might estimate from the shrinkage of the casting the temperature of the fluid iron. The co-efficient being as above, or $.00000617$ for each degree, then $\frac{1}{80}$, the shrinkage divided by this co-efficient would give us the temperature of fluid iron: $\frac{1}{80}$ is equal to $.01052$, which, divided by $.00000617^\circ$ gives $1,700^\circ$ as the temperature of fluid cast-iron, which is not correct. If again we were to make our pattern on the supposition that the expansion rate was uniform, we would take from the table the temperature of fluid iron and subtract the temperature of the casting, or say 32° , leaving $3,100^\circ$, which, as above, is 17.22 times 180; and as for 180° cast-iron shrinks $\frac{1}{8000} = .00111$, therefore our pattern should be larger by 17.22 times $.00111 = .2 =$ about $\frac{1}{5}$ instead of $\frac{1}{80}$ which we find is right. This calculation is offered here, not so much to show the correctness of the statement that the co-efficient of expansion varies as the temperature approaches the melting point, as to show one of the difficulties in the way of applying this method of calculating the actual temperature of boiler plates which are exposed to the fire upon one side and to the boiling water on the other side.

Although no very accurate estimate can be based on the following data, yet they

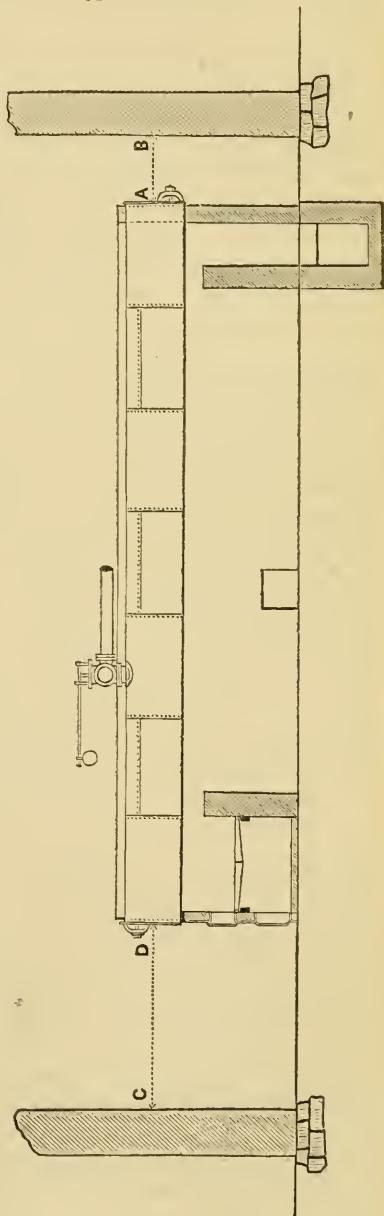

are interesting as throwing some light on the actual motion that occurs, more or less, according to length in all steam boilers.

The illustration herewith presented relates to an experiment to determine the actual expansion of a steam boiler in the ordinary conditions of work. The cut represents a plain cylinder boiler, 30 feet long by $2\frac{1}{2}$ feet diameter, made of $\frac{1}{4}$ inch iron plates, set with two others of the same dimensions over the same furnace, supported at the ends, the rear on a brick wall and the front on the fire front castings. The furnace gases pass over the ordinary bridge through a spacious chamber, and over a rear bridge near the rear wall, whence they drop directly into an underground flue. The flow of the gases into the main flue is regulated by a damper located in the vertical flue, one for each set of three boilers, while one main steam damper is located in the large underground flue, and by a careful attention to this important system a fair result was obtained from the fuel. The location of this boiler offered admirable facilities for an accurate experiment, both heads being exposed and within easy distances of the substantial stone walls of the boiler house. The measurements were made in mild weather, the first set after the boiler had been idle about 44 hours, as follows: A couple of square wooden rods made to slide upon each other something like a surveyor's leveling rod, their outer ends roundly pointed and the lapping ones smooth and square. A point on the wall at the proper height (*c*) was marked and one rounded end placed upon it and held steadily in contact by an attendant. The other rounded end was moved carefully about on the boiler head till the shortest distance was found between it and the point on the wall. A knife-mark was then made on one of the rods at the overlapping end of the other rod. In like manner, with another pair of rods, the rear distance (*A B*) was recorded, and the rods carefully laid aside till the boiler was heated up and put to work on the following day, when a second application of the rods showed the rear end to be $\frac{3}{16}$ inch and the front one $\frac{7}{16}$ inch nearer to their respective walls, showing an expansion of $\frac{5}{8}$ inch in 30 feet, that is, it had increased .001745 of its length. This increase was caused by an elevation of the average temperature of all the plates of 256° F., according to Lavoisier's co-efficient of expansion of soft wrought-iron. Had the temperature of the boiler water been observed at the time of making the first measurements it would have been a fair test of the uniform temperature of the whole structure, brick-work, boiler, and water, and though calculation would show the approximate *average* temperature of the iron plates while exposed to the hot gases upon one surface and the boiling water upon the other, still it would throw very little light on the subject of the specific temperatures of the different parts of the boiler. Those plates over the fire are not only exposed to a much higher heat than any others, but they are often exposed to strong currents of cold air when the furnace doors are opened to check the generation of steam or to replenish the fire. The effect of the difference of expansion of the top and bottom plates of the boiler, simple (as in this case) though the form may be, must be an item of importance in its total of abuses and struggles. Add to this the tendency of the load to bend it downward, a weight which, when this boiler is two-thirds full of water and covered with brick, with its own weight, makes a respectable total of some five or six tons. Great as this seems, how much more are the strains in some complicated forms of marine and other boilers with internal highly-heated chambers and long flues contained in shells that are exposed directly to the refrigeration of the atmosphere. When the internal parts are rigidly attached to the shell, either directly or indirectly, in order that they may withstand the steam pressure, their struggle to resist that pressure is but small compared with the terrible power of the expanding metal.

The Locomotive.

HARTFORD, JUNE, 1880.

Boiler Explosions by Mysterious Agencies.

The belief, which has for many years been prevalent, that mysterious agencies within a boiler were often the causes of the most disastrous explosions, baffling coroners' inquests, generally resulting in a verdict so mysterious that nobody could understand it, or in throwing the blame entirely on to Providence, is fast giving way before the light which is brought to bear by the investigations of practical men. One reason why this mysterious theory had become so prevalent was, it was taught in the scientific books of earlier days. Most of the old chemistries adopted the "Donny theory" as explanatory of boiler explosions, and some of the later works have either adopted the same or some new fangled notion equally impractical. The writers of theories, and the compilers of books on Chemistry and Natural Philosophy have not usually been eminent for practical knowledge in mechanics, and hence many text-books have led the student into serious errors. Laboratory experiments have been too much relied upon as an explanation of boiler explosions. The fact that the conditions under which the experiment is made are entirely different from those of a boiler in use, has been overlooked. If the experimenter and writer had really desired to understand the subject thoroughly, he would have hastened to some boiler-house, and despite the dirt and dust and heat, have made himself familiar with every part of a boiler and every attachment thereto. The methods of construction would not have been overlooked, nor quality of fuel and water. These points cannot be gained by a mere cursory examination, nor by looking through a window or a door to avoid the heat and dirt. It must come from days of contact with the dirty and unpleasant side of the subject. Such knowledge to be valuable must be practical.

It is gratifying to the steam user to know that in these days men are investigating this subject who have been trained in the practical school. Men who are familiar with all types and forms of boilers, and who look to the quality of the material of which they are constructed, and the quality of the workmanship.

These investigators who have examined all kinds of boilers under the varying conditions of use, and who have made the subject of boiler explosions a careful study, are explaining the causes of these terrific accidents, and showing how they can be avoided. The causes of boiler explosions are now summed up under four heads, viz.: *bad material; faulty in type; bad work in construction, and inefficiency and carelessness in management.* Explosions may occur from any one of these causes, even if in other respects the boiler is sound. So the problem is reduced to its simplest form, and any purchaser or user of a steam boiler can understand what is required. The readers of the LOCOMOTIVE will remember that this has been the ground taken in its pages for more than twelve years. It has stood up firmly against the theory of mysterious agencies as a cause of boiler explosions, claiming that if such views were once established there would be no responsibility resting upon any one. The maker of poor iron would seek refuge under the mysterious agency theory, and so would the mechanical engineer who planned a boiler of faulty type, and the boiler-maker whose work was unfit to withstand the load imposed upon it would find abundant cause for congratulation in the "mysterious agency" theory. The engineer who must stand before his boiler day after day, year in and year out, would find very little satisfaction in contemplating, that no matter how vigilant he may be,

there were agencies in his boiler, that without a moment's warning, may blow him out of existence. The only way to prevent these accidents or diminish their frequency, is to put the responsibility where it belongs. First, upon the manufacturer of the iron; then upon the boiler designer and maker, and lastly upon the boiler owner and user, and the engineer whom he employs. There is no place for cheap, ignorant, and careless help here. Nor is there any excuse for the penurious manufacturer who disregards the advice of his engineer in regard to repairs, until from sheer weakness and inability to hold out longer, the boiler "lets go" and brings consequent destruction and woe. Any intelligent person who will give this subject careful thought will find little reason or comfort in the "mysterious agency" theory. We have made enemies by combatting it. We have even been sued in the courts for ridiculing it, *but without harm*. With its fall, will fall the business of its advocates, some of whom have preyed quite long enough upon the cupidity of such steam users as they could influence.

Mr. Robert Wilson in his *Treatise on Steam Boilers*, says: "The practice of ascribing steam boiler explosions to obscure causes has been productive of much mischief, as it engenders a carelessness on the part of owners and attendants who have been led to believe that no amount of care will avail against the mysterious agents at work within the boiler." Mr. Wilson was for many years inspector for the Manchester Steam Users' Association, England, and speaks from practical knowledge.

The following letter from Henry Hiller, Chief Engineer of the National Boiler Insurance Co., Manchester, England, will show what the opinion of another eminently practical man is on the mysterious agency theory.

MANCHESTER, May 24, 1880.

J. M. ALLEN, Esq., *President*,

Hartford Steam Boiler Inspection and Insurance Co., Hartford, Conn.

DEAR SIR:—I am much obliged for copy of the *Boston Journal of Commerce*, of Saturday, May 8th, which I note contains an account of action against you by J. R. Robinson.

I am glad that you never hesitate to expose the fallacy of those theories which ascribe boiler explosions to mysterious influences, and I should have much regretted had your advocacy of the truth been the cause of any injustice to you.

The inspections by the companies and associations in the United Kingdom have manifested that explosions of boilers are due to simple causes, and that the best way to avoid such contingencies is to obtain good boilers, to see that they are well managed, and regularly and thoroughly inspected.

No explosion has occurred under our inspection during the sixteen years our company has been established, which had any mystery in connection with it. We have investigated the explosions of hundreds of non-insured boilers, and had little difficulty in discovering the causes. The few we have had were all due to simple causes, and generally consequent on neglect or mistake of attendants. In one or two instances, our reports being disregarded, where we advised thorough overhaul, the failure anticipated occurred.

Were the adoption of the mysterious theories, such as electricity, spheroidal condition of water, etc., adopted, they would be a very convenient excuse for unscrupulous or negligent boiler-owners, should a defective or worn-out boiler explode, and cause any personal injury, etc.

I am much obliged for your kindly forwarding copy of the *LOCOMOTIVE*.

I recently sent you copy of my report for 1879, which I trust you duly received.

Yours faithfully,

HENRY HILLER,

Chief Engineer.

Table for Calculating the Capacity of the Steam Space in Cylindrical Boilers.

NOTE.—The decimal numbers in this table, multiplied by the square of the diameter of the boiler, will give the capacity of the steam space per inch of the length of the boiler for each inch of the height of the segment to one less than the half diameter.

DIA.	30"	32"	34"	36"	38"	40"	42"	*48"	54"	60"	66"	72"	
Inches.	DECIMAL MULTIPLIERS.												Inches.
1	.0079	.0072	.0065	.0059	.0055	.0052	.0046	.0040	.0032	.0027	.0024	.0022	1
2	.0221	.0202	.0188	.0169	.0156	.0147	.0134	.0109	.0094	.0079	.0069	.0059	2
3	.0408	.0367	.0339	.0311	.0289	.0267	.0247	.0202	.0169	.0147	.0125	.0109	3
4	.0620	.0567	.0521	.0476	.0439	.0409	.0379	.0311	.0262	.0221	.0192	.0169	4
5	.0855	.0782	.0717	.0661	.0607	.0567	.0527	.0433	.0362	.0311	.0273	.0236	5
6	.1118	.1015	.0931	.0855	.0796	.0739	.0682	.0567	.0476	.0409	.0356	.0310	6
7	.1390	.1273	.1158	.1070	.0992	.0923	.0855	.0710	.0593	.0508	.0445	.0391	7
8	.1675	.1535	.1407	.1298	.1199	.1118	.1039	.0855	.0725	.0620	.0540	.0476	8
9	.1982	.1809	.1658	.1535	.1415	.1323	.1232	.1015	.0855	.0739	.0641	.0567	9
10	.2288	.2092	.1927	.1773	.1649	.1535	.1432	.1182	.1000	.0855	.0746	.0661	10
11	.2603	.2383	.2195	.2028	.1881	.1755	.1631	.1365	.1150	.0984	.0855	.0760	11
12	.2934	.2690	.2469	.2288	.2129	.1982	.1845	.1535	.1298	.1118	.0977	.0855	12
13	.3259	.2992	.2758	.2555	.2374	.2213	.2064	.1720	.1449	.1248	.1094	.0961	13
14	.3587	.3308	.3042	.2816	.2622	.2450	.2288	.1899	.1605	.1390	.1215	.1070	14
15		.3617	.3338	.3101	.2885	.2690	.2517	.2092	.1782	.1535	.1339	.1183	15
16			.3637	.3668	.3140	.2934	.2748	.2288	.1945	.1675	.1466	.1298	16
17				.3647	.3398	.3180	.2983	.2488	.2120	.1827	.1596	.1415	17
18					.3657	.3428	.3209	.2690	.2288	.1982	.1729	.1535	18
19						.3677	.3448	.2894	.2469	.2129	.1872	.1658	19
20							.3687	*.3101	.2642	.2288	.2009	.1782	*20
21								.3209	.2826	.2450	.2148	.1899	21
								.3507	.3012	.2603	.2288	.2028	22
								.3717	.3190	.2768	.2431	.2157	23
									.3368	.2934	.2574	.2288	24
									.3557	.3101	.2719	.2421	25
									.3737	.3259	.2875	.2555	26
										.3428	.3022	.2690	27
										.3587	.3170	.2826	28
										.3757	.3318	.2963	29
											.3468	.3101	30
											.3617	.3229	31
											.3767	.3368	32
												.3507	33
												.3647	34
												.3787	35

Distance from water line to top of boiler.

Distance from water line to top of boiler.

***EXAMPLE.**

The water-line of a 48" boiler, 12 feet long, being 20 inches from the top, required, the capacity of the steam space.

Under 48" in line 20 is the decimal .3101. Then diam^r or 48² = 2304 multiplied by .3101 = 714, which is the area of a cross section of the space. This multiplied by 144, the length of the boiler in inches, gives the capacity required in cubic inches = 102,316.

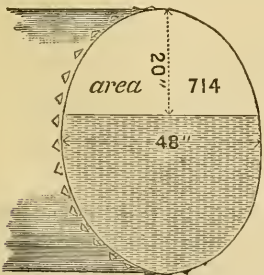

316. This divided by 1728 gives the cubic feet, or by 231 gives the gallons that the space will contain.

Some of the Uses of Our Tables.

The engineer is often required to state how much water will be required to fill his boiler. He wishes to construct a tank in the upper part of his mill, for example, from which to fill the boilers by gravity after blowing off. From the table in the last LOCOMOTIVE he can obtain the cubical capacity of his boilers, and if they contain tubes or flues their cubical volume can be ascertained by the same method, and deducted from the capacity of the boilers, which will leave the capacity of the whole interior of the boilers. A rough estimate of the space above the water, the steam space, might be made (also to be deducted), by measuring the cord of the arc, which is the breadth of the water sur-

face, and reducing the cross section of the space to geometrical figures bounded by straight lines, for instance a triangle or a number of quadrangles, and calculating the area approximately. The table above is intended to facilitate the estimation of the steam space rather more accurately than the method just alluded to. The decimal number opposite the figures that indicate the distance from the top of the boiler to the surface of the water are used in the same manner that the decimal .7854 is in obtaining the whole area of the circle, the difference in the decimals being governed by the height of the water and the diameter of the boiler. They relate to the space above the water the same as the decimal .7854 does to the whole area of the circle. It will be seen by referring to the heading of the table in the last number of the LOCOMOTIVE that the whole area equals the square of the diameter multiplied by the decimal .7854. This means that .7854 is the area of a circle whose diameter is 1, and it applies to all diameters squared, since areas of circles are to each other as the squares of their diameters.

But segments of the same height, it will be seen, require a new decimal for each diameter. These have been found by calculation and tabulated for each inch up to one less than half the diameter of such cylinder boilers as are in most common use for stationary purposes.

The engineer is also required to know how many charges of steam for his engine cylinder he has in his steam space, and knowing the capacity of his cylinder (which may be calculated by the tables in the LOCOMOTIVE), and the point of cutting off this is easily obtained by simply dividing the steam storage room by the volume of his cylinder before cutting off.

It is often important to know the weight in avoirdupois pounds of the steam stored in a given boiler, knowing the capacity of the steam room, and the pressure; this may be found by referring to the table of PROPERTIES OF STEAM, page 63, April No. of the LOCOMOTIVE. The number of cubic feet of steam multiplied by the decimal in that table, column four, which stands opposite the pressure, gives the total weight of the free steam in pounds.

History of a Plate of Boiler Iron.

WRITTEN FOR THE LOCOMOTIVE BY A. YEOMAN.

Continued from March number.

Almost immediately after the arrival of the iron on board the vessel preparations were commenced for going to sea. A lighter came alongside with a large draft of recruits for the fleet off Mobile Bay, which was about to engage in one of the most important naval expeditions of the war. The preparations were now so far advanced that the Admiral had decided not to lose a moment in making the attack. Information of certain operations inside of the bay had lately reached him and it was of the first importance that the attack be made before the rebels could complete the work then in progress. So much as this was known to those only who were concerned in the management of the elaborate preparations, and to our Captain, who had been bearer of despatches and was now entrusted with the execution of orders, was in the secret. The war had outlasted the expectations of all loyal citizens of the north. Copperheads were getting bolder and encouraging desertion and "bounty-jumping," and it was known that many disloyal men were among the recruits on board the several receiving ships at the Navy Yards. The news of the sinking of the rebel cruiser "Alabama" by the Kearsarge had reached the northern cities, but had not yet reached the blockading fleets; the effect of this brilliant victory of our navy had somewhat encouraged the friends of the union cause,

and for a time there was less confidence and more caution among the rebel sympathizers. It was apparent from the looks and actions of the men now coming on board from the lighter that they had been selected in the belief that the extreme front was a good place to cure them of any disaffection or disloyalty that might be lurking in their minds, and it is probable that the detailing officers had the good of northern society and their own comfort in view when they at once cleaned out most of this class and sent them to us.

We had now on board, in addition to the standard ordnance stores, some improved repeating arms and other weapons that had lately been constructed especially for the operations against the defenses of Mobile Bay, and it will, taking all things into account, appear that celerity in our movements was eminently desirable just at this juncture. The Capt. had confidentially informed the chief engineer on this the sailing day, as to the main points of importance, deeming it necessary to inform an officer of whose loyalty and devotion to the cause there was no doubt, and whose coöperation was so important in securing a quick passage to New Orleans, where admiral Farragut was anxiously, perhaps impatiently, waiting the arrival of the supplies that would complete the arrangements for the attack.

At this time the U. S. Navy consisted of 681 vessels, of which 608 were steamers, requiring 2,470 marine engineers, as shown by the official statistics.

It will not therefore appear strange that of the Naval Staff officers, no others were so important as the engineers of the U. S. Navy, and no one more fully appreciated the services of a competent and faithful engineer than the Captain of the U. S. Steamer —, who was now rapidly but carefully preparing to execute an important commission. Our chief had been accustomed, as indeed most of the volunteer engineers in charge of their departments had, of shipping their own men, if possible, a short time before going to sea, so they might have just time to go on board the receiving ship, procure their outfit and have their names duly entered on the paymaster's roll, and many a good fireman has been induced to enter the service with the understanding that he was to be detailed to a designated vessel, who would have declined to serve under other circumstances. At the time we were preparing for sea, the stock of good first-class firemen was pretty well exhausted, and Mr. — had induced a couple of former shop-mates to join the Navy, although they had seen no sea service at all. They were, however, to be relied on as loyal friends of the cause, and Mr. — their chief officer.

When everything was stowed "ship-shape," and the detail officers who came in charge of the draft had left the ship, the lines were immediately cast off at the command of the yard captain, but the day was well spent, barely time enough to clear the harbor before nightfall. It was the intention to have the men on board our vessel in time to have supper while going out of the harbor or before dark after crossing the bar, but delays and vexation are the order of exercises almost invariably, and by the time their bags were stowed it was quite dark, and the men were sullen. The ship was crowded, the "messes" were not organized, and no supper could be served. The loyal men forward heard and reported mutinous mutterings among the roughs, and they would have been promptly taken care of had not a violent storm suddenly developed from the black clouds that had brought darkness prematurely upon us. The wind freshened every moment, and within twelve hours after leaving New York our ship was laboring fearfully in the heavy sea; every timber groaned, for she had an unusually heavy and distressing cargo, which withal had not been so skillfully stowed as it would have been if more time could have been allowed for the purpose. The strains unequally distributed upon her ribs soon began to tell, and water was reported by the men in the lower engine-room. The chief engineer promptly gave orders to make a search in the "shaft-alley" for the leak. The answer was not returned as soon as was expected and another man was sent

who returned almost immediately with the startling report that water was coming through the dead-wood in torrents, and that the first messenger was drowned, having been stunned by a fall against the "thrust-bearing." The engine was racing, and the services of the best man were required constantly at the throttle; the bilge-pump strainers had become clogged with rubbish, and the water gained upon the pumps, and it swashed with a deafening roar beneath the fireroom floor, threatening with every roll of the ship to burst through and drench the fires. Leaving the working gallery, the chief engineer made a hurried inspection of the shaft-alley, discovered that the man was not dead who had been reported drowned, ordered the opening of the bilge injection, and was engaged in restoring the stunned and half drowned man, when he received a message from Captain —— to come on deck. Urgent as the case appeared below, he had a suspicion that something of importance had happened on deck, and fearing a delay in answering the summons might unnecessarily annoy if not alarm the captain, he gave hurried orders to clear the strainers and get the disabled man, now showing signs of returning consciousness, to his own berth, he hastened on deck, his mind running upon the probability of a lee shore, shipwreck, mutiny, and such interesting and delightful possibilities of the situation; walking to the wheel, he there found the captain in an anxious condition of mind, indicated by his serious aspect. Mr. ——, he said, I am in a dilemma, the like of which I do not remember in the whole course of my sea experience, *we are on our return course to New York*. Mr. —— was prepared to hear something dreadful, but this was something he could not readily account for, although he rapidly debated inwardly, "has he been over-awed and made to 'go about,' by the mutineers; no, no, he would die first; he would set his course for Davy Jones' with all on board before he would be beaten thus by a gang of disloyal roughs." The captain now leaves the wheel, moodily indicating to the chief to follow, which he did after glancing at the compass to assure himself that he had correctly understood the language. They stood now by the galley, the howling storm beating against their bodies which they must incline to windward to keep on their feet, drowning their voices in its mad fury. Pointing to the wreck, which was now and then illuminated by the vivid lightning, stood the brave man in a sadly savage mood, his expression meaning "what else can be done? a mutinous, hungry crowd of devils to whom this expedition must not be explained." The galley was wrecked, and the cooking range was smashed by the same sea that caused the violent lurch which tumbled the man in the shaft-alley against the thrust bearing. Both ring-bolt ends of the range, by which it was fastened to the deck, had "carried away," and the thing appeared to be a hopeless pile of old iron. Mr. —— took in at a glance what would take several minutes to describe, and the captain heard some indistinct words mingled with the gruff æolian of the storm as it whistled through the vessel's shrouds and stays. They seemed to be something about "a plate of boiler iron," "repairs," "breakfast for the men," but he was almost inclined to attribute the sounds to the deriding demon of the blast. Getting to windward of him Mr. —— shouted with a smiling face, "I can repair that stove with the plate of boiler iron you so kindly helped me to get, and with your permission I will undertake to see that it is ready to cook breakfast for the men;" seizing both his hands the captain peered sharply into his face in the darkness for an instant, till satisfied that he was not clean daft, and then he earnestly said, "you can then save us from disgrace? God bless you, my brave and true friend." "I can and will if my life is spared for a half dozen hours." "Bout ship," roared Captain —— addressing the sailing master, "and set your course for Cape Hatteras, giving it a wide berth, just give us a sight of the light if you please, Mr. Mercator." It was now past four bells in the mid watch and no time must be lost if the promise is to be fulfilled. It is something to do such a job on shipboard in a gale of wind, and quite a different thing from doing it in a shop on shore with power shearing and drilling-machines. Besides,

the regular business of the engineer's department was left in rather a mixed condition when its chief was called on deck; it must first be put on a working basis. On his return to the lower engine-room he found that the lee fires had barely escaped an utter drenching. They were to be put in full blast again, which there was now no great difficulty in doing; the bilge injection had so lowered the water that with the pumps now cleared of rubbish the stuffing box in the shaft-alley could be "set up," and was fortunately found to contain sufficient packing to mostly stop the leak, and matters, with the exception of the racing of the engine, began to assume something like normal conditions below. But still the ship was terribly restless, and the wind had but little abated, and it still played doleful airs among the rigging. And some of the new men were sea-sick, but they were reassured and cheered by their chief officer, who went about the difficult task with a satisfaction and confidence hardly warranted by the situation, while "breaking out" the stores necessary for the job and getting things in working order it became obvious that the men who were well skilled in handling tools and material on shore were not equal to the situation, skirmishing with an antic boiler-plate and dodging a lively anvil in a sea-way are things to be learned by practice, as well as striking with a sledge the head of a chisel so as to always miss the head of the person holding it. The anvil was at last securely lashed, but a short experience proved enough for two of the best men, who were obliged to retire in a disabled condition; and now it seemed that all hands that were used to tools were otherwise employed. "Clear away that anvil and throw that plate on deck, jam it under that broadside gun-carriage, slack away the breeching handsomely and place the plate in the rear wheel-tracks, set up the tackle and make all fast again." The promptness with which these orders were executed by some of the guns-crew of the watch, and the advantage taken of the motion of the ship in moving the enormous gun, resulted in securing the end of the plate beneath the rear wheel and gave no time to consider what a dangerous customer a loose broadside gun is in a sea way. "Now lads, for my hammer and chisel and a spike." Gold lace was now at a discount, and all other tinsel is with it now laid aside. The trusty old hand-hammer with its long shapely handle, and the good-tempered diamond point now appear from the chief's "locker." The spike is driven into the deck against the edge of the plate to prevent it from "shifting," the measurements are made, the lines laid down for two end-plates to the range, and the tedious operation of cutting across the plate is commenced. The vigorous and accurately-directed blows of the well-used hammer in the hand of the chief engineer were equal to the task, and years afterwards the same wrought-iron ends were in that galley range just as they were placed on that stormy night just before the battle of Mobile Bay. That plate of one-quarter inch boiler iron served as effectually the cause of the Union as though it had stopped a shot-hole in a steam boiler, perhaps even more so, and the courage and skill required to keep that crew of mutineers from destroying the important expedition on which our vessel was bound, and to bring it to a timely and successful issue, were no less than would be required to plan and execute a battle that would seem much more warlike and brilliant. The voyage was completed in good time, and the admiral, to whom the incident of the broken range was reported, visited us for the purpose of inspecting it, and complimented the engineer in the most flattering terms. "Sir," said Admiral Farragut, "days of anxious delay have been prevented by your skill, and perhaps the fate of the pending battle may have been determined by your dexterity and courage."

The stores and men were immediately transferred to the vessel belonging to the fleet, and no delay was made in moving upon the forts, which were successfully passed on the second day following.

Incorporated
1866.

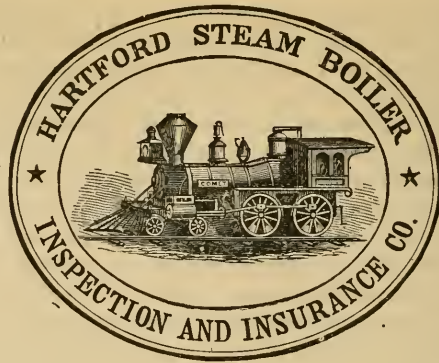

Charter Perpetual.

Issues Policies of Insurance after a Careful Inspection of the Boilers,

COVERING ALL LOSS OR DAMAGE TO

BOILERS, BUILDINGS, AND MACHINERY,

ARISING FROM

Steam Boiler Explosions.

THE BUSINESS OF THE COMPANY INCLUDES ALL KINDS OF STEAM BOILERS.

Full information concerning the plan of the Company's operations can be obtained at the
COMPANY'S OFFICE, HARTFORD, CONN.

Or at any Agency.

J. M. ALLEN, Prest. W. B. FRANKLIN, Vice-Prest. J. B. PIERCE, Sec'y.

Board of Directors.

J. M. ALLEN, President.	GEN. WM. B. FRANKLIN, Vice-Prest. Colt's Pat. Fire-Arms Mfg. Co.
LUCIUS J. HENDEE, Prest. Aetna Fire Ins. Co.	GEO. CROMPTON, Crompton Loom Works, Worcester.
FRANK W. CHENEY, Asst. Treas. Cheney Brothers Silk Manufacturing Co.	HON. THOS. TALBOT, Ex-Governor of Mass.
CHARLES M. BEACH, of Beach & Co.	NEWTON CASE, of The Case, Lockwood & Brainard Co.
DANIEL PHILLIPS, of Adams Express Co.	WILLIAM S. SLATER, Cotton Manufacturer, Providence, R. I.
GEO. M. BARTHOLOMEW, Prest. Amer. Nat. Bank.	NELSON HOLLISTER, of State Bank, Hartford.
RICHARD W. H. JARVIS, Prest. Colt's Fire Arms Manufacturing Co.	D. R. SMITH, Prest. Springfield Fire & Marine Ins. Co.
THOMAS O. ENDERS, Sec'y Aetna Life Ins. Co.	
LEVERETT BRAINARD, of The Case, Lockwood & Brainard Co.	

GENERAL AGENTS.

THEO. H. BABCOCK,
CORBIN & GOODRICH,
LAWFORD & MCKIM,
W. S. CHAMBERLIN,
J. L. SMITH,
H. D. P. BIGELOW,
C. C. GARDINER,
D. C. FREEMAN,
W. G. LINEBURGH,
GEO. P. BURWELL,
W. B. CASSILY,

CHIEF INSPECTORS.

R. K. McMURRAY,
WM. G. PIKE,
JOSEPH CRAGG,
WM. U. FAIRBAIRN,
B. M. LORD,
H. D. P. BIGELOW,
J. S. WILSON,
F. S. ALLEN,
W. S. FOX,
A. C. GETCHELL,
J. S. WILSON,

OFFICES.

NEW YORK CITY.	Office,	285 Broadway.
PHILADELPHIA.	"	430 Walnut St.
BALTIMORE.	"	10 So. Holliday St.
BOSTON, MASS.	"	10 Pemberton Sq.
PROVIDENCE, R. I.	"	42 Weybosset St.
CHICAGO, ILL.	"	132 La Salle St.
ST. LOUIS, MO.	"	404 Market St.
HARTFORD.	"	218 Main St.
BRIDGEPORT.	"	328 Main St.
CLEVELAND.	"	246 Superior St.
CINCINNATI.	"	53 West Third St.

The Locomotive.

PUBLISHED BY THE HARTFORD STEAM BOILER INSPECTION AND INSURANCE COMPANY.

NEW SERIES—VOL. I.

HARTFORD, CONN., JULY, 1880.

No. 7.

Explosion of the Steamer "Adelphi."

Reproduced from THE LOCOMOTIVE of November, 1879, by request.

[NOTE.—The stars indicate parts of the boiler not essential to this article, omitted from the drawings to prevent confusion.]

The "Adelphi" is a side-wheel steamer that was employed in carrying passengers and freight between New York city and South Norwalk, Conn., during six days of the week, making daily round trips, and occasional Sunday excursion trips to Coney Island in the summer season. She has a beam engine, with cylinder 4 feet diameter by 12 feet stroke of piston, cutting off steam at about 5 feet from the commencement of the stroke. On the 28th of September, 1878, at about 8.15 A. M., she was steaming out from South

Norwalk as usual, having left her wharf in that port at 8 A. M., when, making a turn in the river at a slow speed, the port side of the shell of the boiler gave way the whole length of the seam C A, Fig. 2, where the sheets of the crown join the upright side of the body. The portion bounded by the upper line of socket-stays, Fig. 5, the flanges of the back and front heads and fastenings of the vertical crown-stays, measuring $2\frac{1}{2}$ by 9 feet, turned outward and upward, hinging on the line F E of the vertical stay-fastenings, as a door turns on its hinges, Fig. 2, leaving a clear opening of more than

20 square feet, through which the entire contents of the shell issued at a temperature and velocity due to about 40 pounds per square inch of steam pressure, carrying away about 20 feet in length of the three decks of the vessel and everything thereon.

Timbers reduced to splinters and joiner work to fine kindling wood went flying high in the air, along with 41 people, 15 of whom lost their lives. The fatal cases would have been more numerous, undoubtedly, if the vessel had been in the deep waters of the sound,

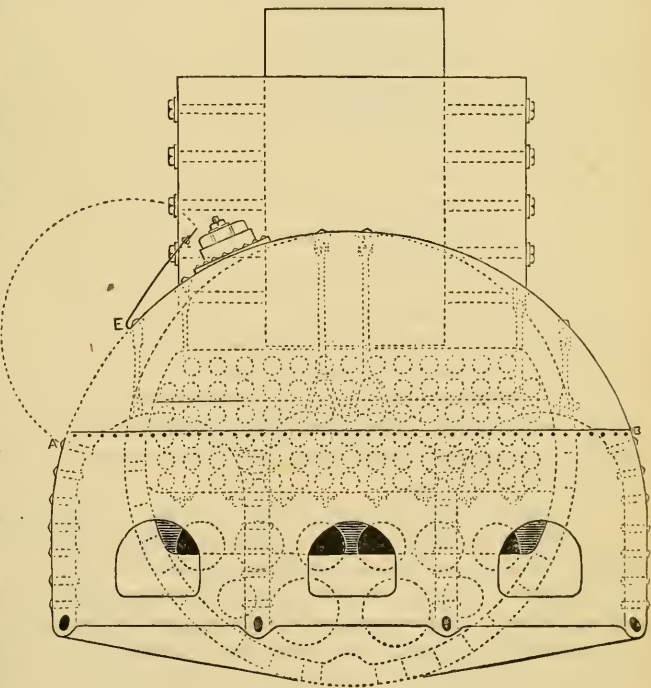

FIG. 1.

instead of the shoal water of the narrow river, from which many of the injured were promptly rescued by the oystermen who were near with their boats.

The boiler of the *Adelphi* was technically known as a "lobster-back." The shell consists of a body containing three furnaces, and is quadrangular in plan, with a semi-cylindrical top; to the back of the body is joined a cylindrical part of less diameter than the breadth of the front—see Figs. 1 and 4; the tops of these two parts form a continuous horizontal line.

Fig. 1 is an elevation of the front, and a part of the chimneys. Letters refer to same parts in all, except Fig. 5.

Fig. 2 is a perspective view of the exterior of the boiler, with part only of the steam and smoke chimneys in elevation. The opening C, A, E, F was caused by the explosion. The fine vertical lines on the body indicate the location of the vertical stays.

Fig. 3 is a perspective view of the interior of the boiler, showing the connecting chambers, flues, and tubes.

Fig. 4 is a vertical section through the body, showing the vertical stays and their attachments, also a vertical section of the lower part (about $\frac{1}{4}$) of the steam chimney, showing the base of the smoke chimney.

Fig. 5 is drawn to a larger scale, and is a vertical section through one of the socket bolts of the upper horizontal row and the plates through which it passed before the explosion occurred, except the inner plate of the soft patch, which is omitted, as well as the cement, to avoid complication in the illustration. In this cut L shows the location of the line of grooving, and P the outer plate of the long patch.

Just back of the junction, on top of the cylindrical part, is placed the steam chimney, $7\frac{1}{2}$ feet diameter by 17 feet high, through which passes upward the smoke-chimney, about 46 inches diameter by 40 feet high. The products of combustion pass from the furnaces, which are each $3\frac{1}{2}$ feet wide by 8 feet long, over bridge-walls and through irregular-shaped necks into a connecting chamber, from which they pass through ten horizontal cylindrical flues into a back connecting chamber, whence they return through 94 $4\frac{1}{2}$ -inch horizontal tubes to the middle chamber, or uptake, upon which stands the smoke-chimney.

The body of the boiler is 9 feet fore and aft by 12 feet wide, allowing of water spaces all around and between the furnaces. The cylindrical part is $9\frac{1}{2}$ feet diameter by 20 feet long, and drops below the plane of the water-legs about one foot. The two lateral furnaces have semi-cylindrical tops 4 feet high above the fire-grates, and the middle furnace crown is flat, with well-rounded angles, and is also 4 feet high. Two lines of vertical stays, about 8 inches center, connect each furnace crown with the crown of the shell; those on the lateral crowns are each secured to a T foot by split pin; those on the middle crown to a U foot by split pin.

The connecting chambers and uptake are each a segment of an $8\frac{1}{2}$ foot cylinder, and measured fore and aft are 3 feet; placed concentric with the cylindrical part of the shell, there is a water space between the shell and each of them.

The boiler was built in 1875 of lawful iron, as the inspector's certificate informs us, and was fitted with the necessary attachments for indicating the height of the water, and the pressure of steam, and was allowed to carry 40 pounds and no more. A patent locked safety-valve and one of the common lever kind are fitted to the tops of the steam-chimney, and directly beneath them, to the side of the steam-chimney, is attached the main steam-pipe.* Just above, within the smoke-chimney, is located a steam-jet for increasing the draft. It consists of eleven steam-pipes arranged horizontally across the chimney in the form of a triangular pile; each pipe on its top side has a number of small jet nozzles pointing upward.* This apparatus is supplied with steam direct from the boiler through a $2\frac{1}{2}$ -inch pipe, the valve of which is set full open when the full power of the boiler is required.

For the purpose of promoting the circulation of the water within the boiler, a wrought-iron pipe* about five inches diameter was attached to each of the back heads of the body in line with the lateral water legs, and extends alongside the barrel to the last course of sheets curved under the bilge of the barrel, where it is attached to the upper part of a cast-iron cylinder,* on which, looking toward the center of the boiler and bolted to the shell, is a flanged nozzle opening into the water space that surrounds the back smoke connection; communication is hereby established and a current maintained between the stagnant water in this cool part of the boiler and the most active generating surfaces. The chamber of the cast-iron cylinder serves as a mud drum, and having the blow-out pipes attached, less waste of heat is said to occur by occasionally opening the blow-cocks to discharge the sediment than would happen if the same quantity of mud were drawn directly from the more diluted mass in the boiler.

A pipe of boiler iron, about 8 inches diameter, is placed horizontally across the back connection a little below the center, which forms a communication between the water spaces at each side, and is intended to heat the feed-water,* a portion of which is delivered by the starboard pump into the corresponding end of it. The other pump delivers water to the port side of the body, near the back head and ten or twelve inches above the plane of the fire grates.

Two man-hole plates in deep cast-iron frames are placed on the shell, one on the crown of the body, opening into the space between the port and middle sets of vertical stays, the other back of the steam chimney opening into the steam room above the tubes. A circular smoke

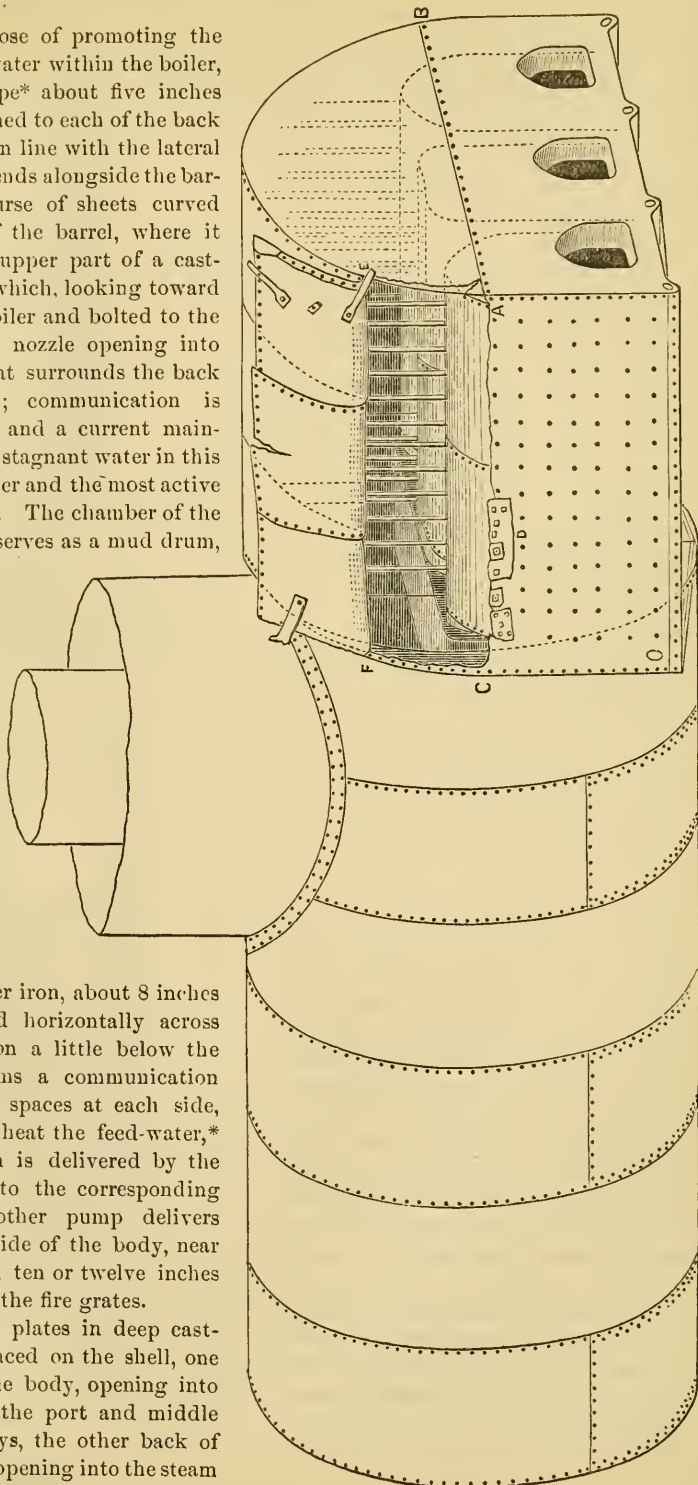

FIG. 2.

door, eighteen inches in diameter, opens into the port side of uptake.

Two smoke-doors open into the back connection. A hand-hole is made opposite each water leg in the front, one in the port side of the body opposite the transverse leg, and one opposite the port end of the transverse heater pipe of the back connection.

It does not require an expert to detect the immediate cause of this disaster. The ragged and thin edges of the plates show plainly the effect of the insidious boiler malady, internal corrosion; and, on what may be termed a post-mortem study of the structure, the more remote causes are not so very difficult to arrive at. The groove or furrow in the plate is adjacent to the upper line of socket stays and along the inner lap of a long seam. This springing of the plates above, caused by the sudden variations of internal pressure as each charge of steam is taken by the engine, has formed a joint, such as would happen to a piece of iron held in the jaws of a vise and bent back and forth, while at the same time a heavy tensile strain was applied. This line of disturbed fibers is especially susceptible of the oxidizing action of the water. While at rest the weakened line becomes coated with oxide, which is cracked off by the motion and washed away by the currents when the boiler is put to work again, leaving the clean and weak fibers more susceptible, and by reason of their loss of substance less capable of bearing the strain. And the destruction goes on in an increasing ratio till the furrow comes through, or the plate cracks (as in this case it did), and begins to leak. Cracks in the shell, or other parts of boilers not exposed to the direct action of the fire, may be regarded as unmistakable

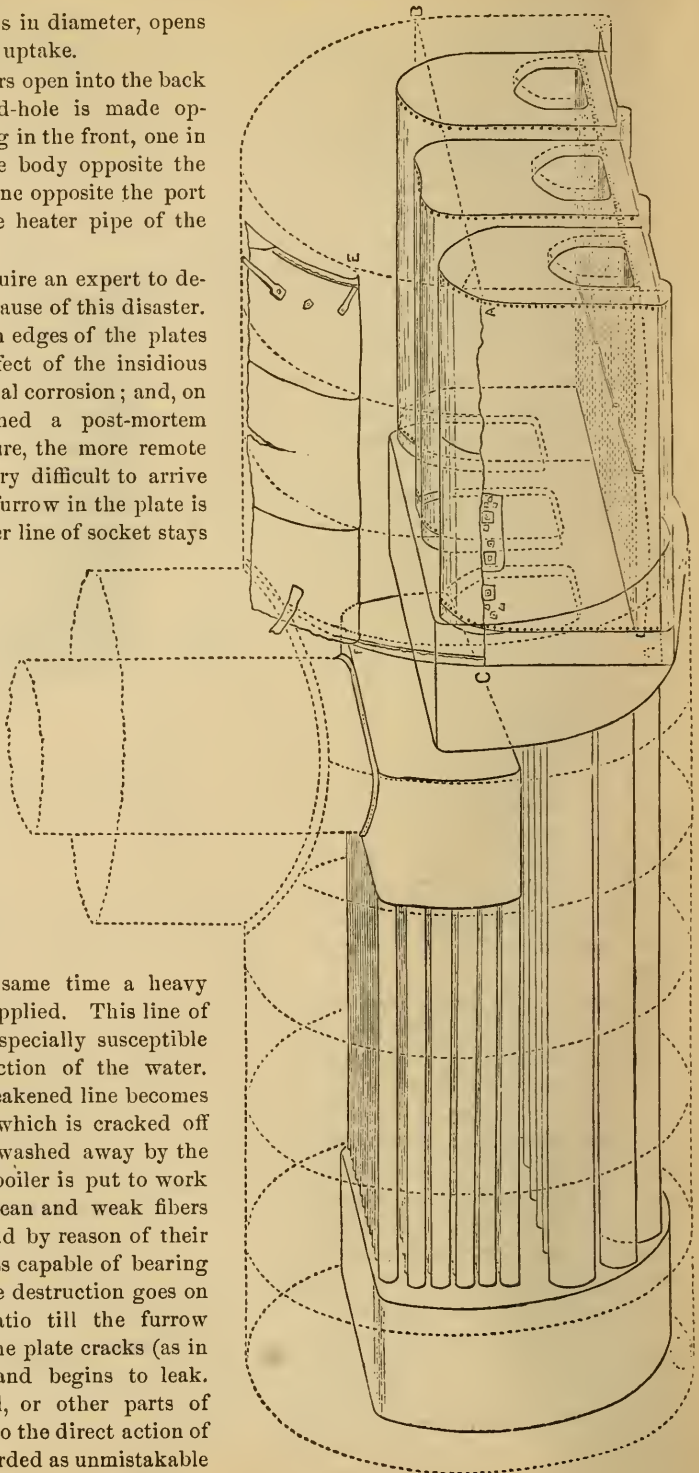

FIG. 3.

signs of distress. But to the engineer who has not had the advantage of studying practically the causes of destructive explosions, and knows little about boilers outside of own practice, this phenomenon means no more than any one of the many leaks that he has successfully patched before. So it is duly patched as seen at D, Fig. 2, and afterwards admirably endures the legal hydrostatic test. But the "plasters" only hide the defect. The work of destruction still goes on. The extra expansion of the furnaces both laterally and upward tends to assist in forming the fatal joint; the former by thrusting the sides outward and bending them sharply on the inner lap of the seam; and the latter by loosening the vertical stays, thereby throwing undue strain upon this weak line; altogether placing the parts under consideration in favorable condition for rapid oxydation, which, having gone on to maturity, a slight shock only is necessary to burst open the door.

Other weak points existed in this boiler which ultimately would have wrought its utter destruction had this weak part been made to outlive them, but as they did not affect the durability of the part that failed, the discussion of them may properly be omitted here. A hint, however, at the usual number of patches that had from time to time been put on this boiler shell, and notably the three or four at the base of the steam chimney, may be admissible as a warning.

The boiler had been inspected by the United States Assistant Boiler Inspector, and his certificate that everything was in good and safe condition was in the hands of the owners of the boat. The law setting forth the inspectors' duties reads thus: "Where flat surfaces exist, the inspector must satisfy himself that the bracing and all other parts of the boiler are of equal strength with the shell, and he must also, after applying the hydrostatic test, thoroughly examine every part of the boiler to see that no weakness or fracture has been caused thereby," etc. From the evidence before the coroner's jury it was ascertained that the inspection of the boiler was made with fires in the furnaces. It will be readily seen that, under these circumstances, no internal examination of the boilers could have been made at the time. The certificate of inspection which was issued stated that the longitudinal seams of the boiler were double riveted, which was not the case. This is not mentioned as an error that had any direct bearing upon the explosion, but to show that the inspection must have been very carelessly made. The local inspectors of steamers sailing from the port of New York investigated the case, and reported as follows:

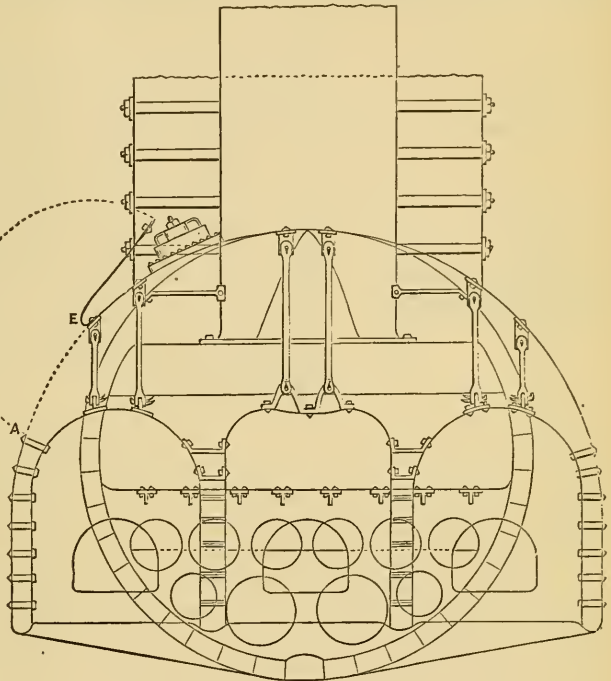

FIG. 4.

"INEXCUSABLE CONDUCT.

"The boiler inspector, who made the last inspection of this boiler, we find performed that duty in a very negligent and imperfect manner. His inspection was made with fires in the furnaces (in violation of instructions from this Board, issued under date of February 11, 1878), which precluded the possibility of making a minute and careful examination even of those parts of the boiler which were of easy access, depending on the statements of the engineer and the age of the boiler for its condition. It appears, from his testimony, that he knew nothing of the character or condition of the bracing within the boiler; he did not know whether there was more than one safety-valve attached to the same, and he did not know whether he set the safety-valve to blow at the pressure allowed or at what pressure it would blow. The conduct of the inspector in this case is without excuse. Three steamboat boilers inspected by him this season had previously exploded with the loss of many lives, which should have been a warning to him to be more particular and thorough in his examinations; but it appears that these fearful occurrences had no effect in stimulating him to greater care and diligence."

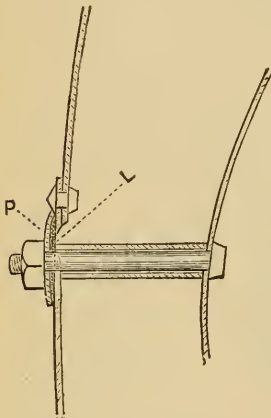

FIG. 5.

"EXONERATION OF THE OWNER.

"After a careful review of the testimony in this case we are of the opinion that the owner of the steamer was actuated wholly by a desire to comply in all respects with the requirements of the law, and to have all necessary repairs made with promptitude and in the best manner." * * *

The engineer and inspector were indicted for manslaughter, and the case was carried into the U. S. Circuit Court. The evidence against the engineer was not considered sufficient for conviction, and a verdict of acquittal was very promptly rendered by the jury. The case of the inspector was thereupon nolle by the prosecuting attorney on the ground that the evidence was the same in both cases. This proceeding of the attorney was something of a surprise, as the people who had given the case attention were satisfied that the evidence *would not* be the same in both cases.

Referring to the condition of the boiler, as hereinbefore described, we are firmly of the opinion that a careful inspection would have discovered the defect and averted the calamity. When the boiler was found leaking at or near the longitudinal seam—where the fracture occurred—it should have received a most careful internal examination, by which the weak place could have been easily found. The United States inspection law in its intent is good, and, if faithfully carried out, will avert calamities, but it will be readily seen that if such service is inefficiently or carelessly performed, it is worse than nothing. The traveling public see the certificate of safety with the official seal conspicuously displayed in the cabin of the steamer, and put faith in it. If that certificate has been filled up without the service certified to having been performed, it is a *dangerous* deception.

The flower which we do pluck is the only one which never loses its beauty or its fragrance.

Work is a necessity, in one way or another, to all of us. Overwork is of our own making, and, like all self-imposed burdens, is beyond our strength.

Never permit the most resolute curiosity, or the most friendly concern, to find the lowest depth of your character. Gain the reputation for reserve power by reserving it.

BOILER EXPLOSIONS.

MONTH OF JUNE, 1880.

SAW-MILL (68.)—The boiler at Wakefield's portable saw-mill, about one mile from Bedford Center, exploded about 9 o'clock June 2d, seriously injuring John Galloway, who is badly bruised and scalded; also injuring John Wakefield, George Whitlam, and Henry Wortmann.

PLANING-MILL (69.)—The saw and planing-mill of Jarvis & Bensinger at Winnepeg, Minn., were blown to pieces June 4th, by the explosion of the steam-boiler. Several persons were seriously injured, four of them fatally. The boilers were only two years old. The loss is \$6,000. The mill will be rebuilt at once.

PLANING-MILL (70.)—A boiler in Butler, Gibbs & Co.'s planing-mill, Little Rock, Ark., exploded June 5th. Three men were stunned, but no lives were lost. One side of the mill was wrecked, and several hundred panes of glass in the State House were broken by the concussion.

STEAMER (Foreign) (71.)—While the Spanish war ship Cuba Espanola was entering the harbor of Santiago de Cuba June 12th, the boiler exploded, killing 20 persons, and wounding 113, of which 84 were troops being transported.

DISTILLERY (72.)—A boiler at Waldeck & Wertz's distillery in Milwaukee, Wis., exploded June 14th, and twenty minutes later a second one blew up. Dave Hanson, a fireman, was instantly killed by the first explosion, and John Schaniden fatally injured. The building took fire and was partially destroyed. The loss is \$20,000, insurance \$10,000.

PUBLIC BUILDING (73.)—Two visitors at Music Hall, Cincinnati, were seriously, if not fatally injured by the explosion of a six-inch steam service-pipe.

TUG-BOAT (74.)—June 14th. As the small steam-tug Coals was engaged in towing barges from Houston to Clinton, eight miles below Houston, Texas, and was tied up at a wood-yard on the bayou bank, the boiler exploded. One side was blown out, tearing the tug to pieces. It so happened that all hands were ashore except three men, two of them being named McCabe, and the cook Maginnis. Maginnis was fatally injured. McCabe was also dangerously wounded in the face and other parts of the body. It is thought he may die. Dave Gordon, captain of the tug, escaped unhurt.

OIL-MILL (75.)—The boiler of Kendall & Barnes's oil-mill at Richmond, Ind., exploded June 9th, killing John Stanley, who was passing on the street, severely injuring Herman Carrington, the engineer, Henry Schroder, the pressman, and Charles A. Chutla, and painfully scalding George Schroder. The force of the explosion was so great that the jar was perceptible several miles distant. Bricks, timber, and pieces of iron were strewn for squares to the west, and some of the houses in that vicinity were riddled with holes, so that there was hardly a square foot of wall or roof that escaped. The Union Depot, E. Patterson & Co.'s plow works and other manufacturing establishments in the vicinity were slightly damaged. The night engineer says that thirty seconds before, the gauge indicated sixty pounds of steam, and there were three gauges of water.

SAW-MILL (76.)—At 1 o'clock, June 23d, the boiler in Mrs. M. J. Powell's saw-mill in Findlay, Ohio, exploded, tearing the building all to pieces. Two men, A. S. Standford and Charles Chaney, were perhaps fatally hurt, the latter having been scalded in a terrible manner from the hips up. Loss, \$1,500; no insurance.

FIRE-ENGINE (77.)—While testing a new fire-engine at Reading, Penn., the boiler exploded, scalding and otherwise injuring four members of the Junior Fire Company. One of them is believed to be fatally injured.

Inspectors' Reports.

The work of this important department during the month of May, 1880, is larger than for any previous month even of this prosperous year, which is, on the monthly average, greater than any previous one of the company's existence. The number of complete annual inspections is greater by 23 per cent., being almost 300 more than the average for the previous months of this year.

The month of March, 1880, was up to that time the banner month; but May, 1880, shows an increase of 138 internal annual inspections. The whole number of inspection visits in May was 1,931, and the whole number of boilers inspected was 4,159, of which 1,451 were thorough internal annual inspections.

There were only 359 applications of the hydraulic test, which, considering the greatly increased number of new boilers which have been tested in the yards and shops of the builders, leaves a very low percentage of old ones that have been subjected to this method. This indicates that this once popular method of inspection is fast losing ground among those who have adopted our system of guaranteed inspection. If the cases where municipal or state laws require this test to be applied to all boilers, should be deducted, as well as the new boilers, the remainder would be small indeed, and represent only a few small boilers that can not be entered for examination. It is the opinion of some that even such boilers are more injured by starting leaks in the tube-settings than any benefit that can possibly arise from the test, since it tells nothing of the progress of inevitable deterioration which is going on inside. The question may soon be opened whether or not the test pump is of any real value as a means of inspection except for the discovery of leaky joints in new work. The number of defects discovered during the month is 1,675 of which 377 were dangerous. They were in detail as follows:

Furnaces out of shape, 78—15 dangerous. Fractured plates, 147—82 dangerous. Burned plates 79—26 dangerous. Blistered plates, 266—31 dangerous. Cases of deposit of sediment, 228—49 dangerous. Incrustation and scale, 377—43 dangerous. External corrosion, 101—35 dangerous. Internal corrosion, 60—13 dangerous. Internal grooving, 13—4 dangerous. Water-gauges defective, 33—7 dangerous. Defective blow-out apparatus 19—7 dangerous. Safety-valves overloaded, 20—10 dangerous. Defective pressure-gauges, 154—39 dangerous. Boilers without gauges, 58—1 dangerous. Cases of deficiency of water, 9—3 dangerous. Braces and stays broken or deficient in number of strength, 34—12 dangerous. Number of boilers condemned, 20.

A large percentage of the defective furnaces reported each month is due to a want of proper care in constructing the furnace walls and to neglect to properly provide for the expansion of the boiler. The following is a part of the discussion of boiler expansion which was crowded out of the article, page 97, on

EXPANSION OF BOILERS.

In this case it will be seen on examining the cut, page 97, that the expansion of the boiler toward the front wall of the boiler-house must have carried the point of the front upon which the boiler rested with it, or else the boiler must slide upon its point of support a distance equal to the difference of the expansion of the two materials, iron and brick. The straining and loosening of the anchor bolts by which the cast iron front was secured to the brick work would be the result, and the loosening of the fire brick lining. We see here a sufficient cause for the bad condition frequently seen of this part of the setting. The castings that support the brick lining work back and forth with each heating and cooling of the boiler, disturbing the bricks which little by little creep from their places and fall down, leaving the casting exposed to the direct action of the fire by which it is burned or cracked.

TABLE V.

UNITS OF HEAT REQUIRED TO EVAPORATE ONE POUND OF WATER WHEN FED TO THE BOILER AT DIFFERENT TEMPERATURES AND EVAPORATED UNDER DIFFERENT PRESSURES.

Steam Pressure in pounds per square inch, per Gauge.	Steam Temperature in degrees Fahr.	TEMPERATURE OF FEED WATER IN DEGREES FAHR.																	Steam Temperature in degrees Fahr.	Steam Pressure in pounds per square inch, per Gauge.						
		32°	35°	40°	45°	50°	55°	60°	70°	80°	90°	100°	110°	120°	130°	140°	150°	160°			170°	180°	190°	200°	210°	212°
		0	212°	1146.6	1143	1138	1133	1128	1123	1118	1113	1108	1098	1088	1078	1068	1058	1048			1038	1028	1018	1008	998	988
5	228°	1151.5	1149	1144	1139	1134	1129	1124	1114	1104	1094	1084	1074	1064	1054	1044	1034	1024	1014	1004	994	984	974	972	5	
10	240°	1155.3	1152	1147	1142	1137	1132	1127	1117	1107	1097	1087	1077	1067	1057	1047	1037	1027	1017	1007	997	987	977	975	10	
15	250°	1158.0	1155	1150	1145	1140	1135	1130	1120	1110	1100	1090	1080	1070	1060	1050	1040	1030	1020	1010	1000	990	980	978	15	
20	259°	1161.0	1158	1153	1148	1143	1138	1133	1123	1113	1103	1093	1083	1073	1063	1053	1043	1033	1023	1013	1003	993	983	981	20	
25	267°	1163.3	1160	1155	1150	1145	1140	1135	1125	1115	1105	1095	1085	1075	1065	1055	1045	1035	1025	1015	1005	995	985	983	25	
30	274°	1166.0	1162	1157	1152	1147	1142	1137	1127	1117	1107	1097	1087	1077	1067	1057	1047	1037	1027	1017	1007	997	987	985	30	
35	281°	1167.6	1164	1159	1154	1149	1144	1139	1129	1119	1109	1099	1089	1079	1069	1059	1049	1039	1029	1019	1009	999	989	987	35	
40	287°	1169.0	1165	1160	1156	1151	1145	1141	1131	1121	1111	1101	1091	1081	1071	1061	1051	1041	1031	1021	1011	1001	991	989	40	
45	292°	1171.0	1168	1163	1158	1153	1148	1143	1133	1123	1113	1103	1093	1083	1073	1063	1053	1043	1033	1023	1013	1003	993	991	45	
50	298°	1173.0	1170	1165	1160	1155	1150	1145	1135	1125	1115	1105	1095	1085	1075	1065	1055	1045	1035	1025	1015	1005	995	993	50	
55	303°	1174.0	1171	1166	1161	1156	1151	1146	1136	1126	1116	1106	1096	1086	1076	1066	1056	1046	1036	1026	1016	1006	996	994	55	
60	308°	1175.7	1172	1167	1162	1157	1152	1147	1137	1127	1117	1107	1097	1087	1077	1067	1057	1047	1037	1027	1017	1007	997	995	60	
65	312°	1177.0	1174	1169	1164	1159	1154	1149	1139	1129	1119	1109	1099	1089	1079	1069	1059	1049	1039	1029	1019	1009	999	997	65	
70	316°	1178.0	1175	1170	1165	1160	1155	1150	1140	1130	1120	1110	1100	1090	1080	1070	1060	1050	1040	1030	1020	1010	1000	998	70	
75	321°	1179.0	1176	1171	1166	1161	1156	1151	1141	1131	1121	1111	1101	1091	1081	1071	1061	1051	1041	1031	1021	1011	1001	999	75	
80	324°	1180.5	1177	1172	1167	1162	1157	1152	1142	1132	1122	1112	1102	1092	1082	1072	1062	1052	1042	1032	1022	1012	1002	1000	80	
85	328°	1182.0	1179	1174	1169	1164	1159	1154	1144	1134	1124	1114	1104	1094	1084	1074	1064	1054	1044	1034	1024	1014	1004	1002	85	
90	331°	1182.7	1180	1175	1170	1165	1160	1155	1145	1135	1125	1115	1105	1095	1085	1075	1065	1055	1045	1035	1025	1015	1005	1003	90	
95	335°	1184.0	1181	1176	1171	1166	1161	1156	1146	1136	1126	1116	1106	1096	1086	1076	1066	1056	1046	1036	1026	1016	1006	1004	95	
100	338°	1185.0	1182	1177	1172	1167	1162	1157	1147	1137	1127	1117	1107	1097	1087	1077	1067	1057	1047	1037	1027	1017	1007	1005	100	
110	344°	1186.7	1184	1179	1174	1169	1164	1159	1149	1139	1129	1119	1109	1099	1089	1079	1069	1059	1049	1039	1029	1019	1009	1007	334°	
120	350°	1188.6	1186	1181	1176	1171	1166	1161	1151	1141	1131	1121	1111	1101	1091	1081	1071	1061	1051	1041	1031	1021	1010	1008	350°	
130	356°	1189.8	1187	1182	1177	1172	1167	1162	1152	1142	1132	1122	1112	1102	1092	1082	1072	1062	1052	1042	1032	1022	1012	1010	356°	
140	360°	1191.4	1189	1184	1179	1174	1169	1164	1154	1144	1134	1124	1114	1104	1094	1084	1074	1064	1054	1044	1034	1024	1014	1012	360°	
150	366°	1193.5	1191	1186	1181	1176	1171	1166	1156	1146	1136	1126	1116	1106	1096	1086	1076	1066	1056	1046	1036	1026	1016	1014	366°	

Table for Estimating the relative Cost of High Steam, and the comparison of Boiler Experiments made under different conditions.

The object of the above table is to enable the engineer to compare the cost in heat units of a pound of steam, meaning a pound of water in the form of steam under any given pressure, and from a given temperature of feed water, with the cost of a pound under other conditions, just the same as he would estimate the cost of any manufactured article under varying prices of labor and material, with the comparative effects on the cost of fluctuations in either pressure or temperature of feed, the same as the cost of the manufactured article is affected more by variations in the cost of labor than by variations in the cost of material, or vice versa.

It is understood that a heat unit is the unit adopted for the estimation of heat quantities. It is the quantity of heat required to raise the temperature of one pound of water one degree of the Fahr. scales, and experiment has shown that a pound of pure anthracite coal ashes and clinker, deducted, will, on being burned completely, raise the temperature of about 15,000 pounds of water through one degree of the thermometric scale; its value then in heat unites is 15,000. It is obvious that it will raise one-half as much water two degrees; one-third as much three degrees; one-fifteenth as much fifteen degrees, and so on.

The prevailing fashion of testing steam boilers as to the economy of their performance by weighing the coal burned and the feed-water evaporated and tabulating the results for comparison, or perhaps to recommend some patent fuel-saving device, renders it desirable that the engineer, who is often called on to decide as to the real merit of such apparatus, should be able, for himself, to make comparison between boilers that are working, or have been tested under widely or perhaps only slightly varying conditions of temperature of feed and pressure of steam. The table of the performance of his boiler, which has been *fixed up* to standard conditions by the unbiased expert, may have errors or coloring that favor his paymaster, inadvertently, of course. The favorite method of comparing the cost of steam power in pounds of coal per horse power per hour is very satisfactory so long as we are up to, or very near, the best record in our class; but if we are unpleasantly low in the list it is desirable to be able to properly estimate the several defects in our system. The above table is intended to facilitate the estimation and comparison of the boiler performance. Boilers may be badly set so that the combustion is imperfect, or heat may be wasted by the chimney or by uncovered boiler and pipe surfaces; the firing of the coal and feeding of the water may be bad; the feed-water may be too cold, while the engineer has all the time suspected his engine of wastefulness, and he has put in many extra hours packing and adjusting it, vainly endeavoring to make his coal account come up to the head of the list. Or his best endeavors, if he is an expert fireman, but not a mechanic, have been directed to the boiler. The fire surfaces have been kept clean, and the interior of the boiler free from scale; the fires sprinkled up often and lightly, closing the damper while the fire doors are open, to prevent cooling the furnace; the feed water has been constantly and uniformly supplied as fast and no faster than is needed to keep pace with the evaporation, thereby getting the best possible results from the heater, and he is confident that he is making steam as cheaply as may be with his apparatus. We know by experience that the temperature of water that is boiling in an open vessel at ordinary elevations is 212° F. This the thermometer tells us, that is, it tells us how hot the water is, and it is only necessary to know the weight of the water and the temperature from which it has been raised to ascertain how many heat units it has cost to bring it to that condition of temperature, and also how much heat (in units) it will yield to a colder body in cooling to its original temperature. For example take a pound of water, ice cold, 32° F., and heat it to the boiling point, it will have received $212^{\circ} - 32^{\circ} = 180$ units of heat. If the quantity had been two

pounds there would have been imparted to it twice as many units; if three pounds three times as many, and so on. The water now, if the heating is continued, begins to disappear in steam as shown by its loss of weight, but the thermometer will not rise any higher than 212° under these conditions.

Experiment has proved that to convert this whole pound of water into steam it requires 966.6 additional units, this added to the 180° units that were required to bring one pound from 32° to the boiling point makes $180^{\circ} + 966.6 = 1146.6$, which is the first item in our table, and the same as found first in the seventh column of the table on page 63, April number of the Locomotive, where one pound of steam is said to contain 1146.6 units of heat, which means one pound of water in the form of steam. If now we change the conditions by taking water at any other temperature we see that we simply give as many units as there are additional degrees shown by the thermometer placed in the feed water, for instance, omitting fractions, the difference between 1146 (the units required to make a pound of ice cold water into steam) and 1078 (the units required to make a pound of water at 100° into steam) both under atmospheric pressure, is the same as the difference between 32 and 100, the respective temperatures of the feed-water in the two cases.

The percentage of gain is however as 1,146 is to 1,078 or about 6 per cent., and not as 100 is to 32.

If we wish now to compare the cost in any other conditions with the cost of steam at 40 lbs. pressure from feed-water at 40° ; in line 40 we find under 40° 1,160, which is the cost in heat units of making one pound of water at 40° F. into steam at 287° or 40 lbs. pressure per square inch. To compare this cost with feed at 190° and steam at 338° or 100 lbs. per square inch: In line 100 under 190 we find 1,027, which is the units required to make one pound of feed water at 190° into one pound of steam at 100 lbs. pressure; the relative cost is as 1,160 is to 1,027, or about as one dollar for the low pressure is to eighty-eight cents for the high pressure with hot feed-water.

Compare again the cost of high steam with its efficiency, take steam at 40, feed at 40, and compare with steam at 100, and feed at 40, they are as 1,160 is to 1,177, or as one dollar for the low pressure is to one dollar one and four-tenths cents, so that 100 lbs. pressure cost only one and four-tenths cents per lb. more than steam at 40 lbs. It will be seen that this cost is a mere bagatelle as compared with the increased efficiency of the steam.

By the use of this table an intelligible estimate may be made of the value of the new heater some enterprising vender offers which will increase the heat of his feed-water $10\frac{1}{2}^{\circ}$ and therefore make that amount of saving in the coal pile. Let us instance a case. A manufacturer is offered a heater that has increased the temperature of his feed-water from 170° to 187° or 10 per cent., now the vender says, I want 1,000 dollars for my heater which you, at ten per cent. saving in coal, will pay for in a very short time, burning eight ton per day at five dollars your saving will be \$4.00 per day. But let us now see how much ten per cent added to the feed is worth at say seventy-five lbs. pressure; it is as 1,041 is to $(1,041 - 17) = 1,023$, or as one dollar is to ninety-eight cents,—saving two per cent. The injector is sometimes credited with economically heating the feed-water and it is sometimes sold to steam users to take the place of a heater because it will put the water into the boiler at a slightly higher temperature than a heater of low efficiency. It should always be remembered that the heat used in the injector comes directly from the store of unused live steam in the boiler, while the heat taken from the exhaust is taken from the waste-way, so to speak, of the engine, and what is gained in heat of the feed-water is a real net gain. The injector is useful and economical for feeding boilers at night, or when the pumps and exhaust steam are not available, and on locomotives when heaters can not be used.

The Locomotive.

HARTFORD, JULY, 1880.

WE call attention to the article on another page entitled *THE WONDERFUL WHEELS*. It was prepared by Mr. J. H. Cooper of Philadelphia, for *The Boston Journal of Commerce*. We have copied it into the *LOCOMOTIVE* because we believe that many of our readers will be interested in reading it. Our confidence in the accuracy of mechanical structures may be somewhat shaken, but yet we shall not abandon them, for our own short lives, and the short lives of our machines will not be long enough to give us any trouble from the deviations to which the latter may be liable, even if free from the element of wear and tear, they might run for hundreds and thousands of years. But what a field is opened here for thought, and how it reaches out and embraces the speculations that are dim in the morning twilight of creation—the evolution of worlds, and the great changes which are constantly going on in the universe, all as we believe strictly in accordance with natural law, and yet involved in intricate phenomena that we cannot explain, much less understand. We must content ourselves with the fact that we are only on the threshold of that door which opens into the fields of knowledge which mortals have never been permitted to explore. Some have pushed their way almost over the threshold and seem to have caught an inspiration from what lies beyond.

But their knowledge is as the merest speck when compared with that mind which can create and hold in place the worlds and systems that fill the universe.

THE investigations which have been and are being made into the recent steamboat disasters have quickened the public pulse on the subject, and they are desirous of knowing where the blame lies. We were somewhat surprised by reading recently in the New York papers that United States attorney Woodford had commenced suit against the owners of some nine steamers plying in and about New York harbor, for running without inspection certificates. We can hardly conceive how a steamboat owner could be so negligent. At this season of the year thousands of people patronize steamboats, when they can, in preference to all other modes of travel, and one would naturally suppose that the utmost care would be taken to see that every law was complied with. The condemnation which must necessarily fall upon a steamboat owner in case of accident, if the laws had not been complied with, would be justly severe, and for self-protection he should fortify himself with all the papers, certificates, and apparatus which the law requires. We hope the law will be rigidly enforced, for too slight value is placed upon human life by public carriers.

WM. M. BARR of Indianapolis, Ind., has brought out a new *Hand Book for Steam Engineers* and owners of Steam Engines—a practical guide to the selection and care of steam machinery. It is a comprehensive and valuable little book. Price, one dollar.

Mr. Barr is also the compiler of two other practical treatises, viz:—*Combustion of Coal* and *The Steam Boiler*.

Wonderful Wheels.

BY J. H. COOPER.

One of our workmen gave me the following problem to solve: "Suppose I gear together ten spur cog-wheels, each so provided so as to turn freely on its own axis, and all placed in a straight row as shown in the accompanying cut; the number of teeth in the several wheels being 70, 71, 72, to 79, each differing from its neighbor by one tooth; now, if I draw a line across the face of all the wheels when arranged as shown in gear, and then if the wheel of 70 teeth makes one turn in a second, how long a time will be required to bring all the wheels back to the positions they occupied at starting, that is to the straight line again?"

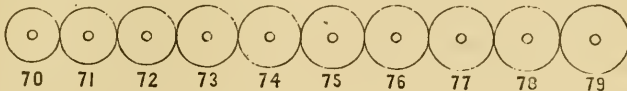

I could not answer this question at once, and I knew of no rule readily accessible which would solve it, so I resorted to a group of lathe-wheels which were at hand, arranged them in gear on a block and turned them through a series of rotations by which I proposed to deduce the rule applicable to the larger problem offered for solution.

A few turns of the experimental wheels unwound the following elements: The number of turns the 70-tooth wheel will make to bring each wheel to its first position is found by comparing this wheel with each separately, thus we have:

70 turning 71 must revolve 71 times.	70 turning 76 must revolve 38 times.
70 " 72 " " 36 "	70 " 77 " " 11 "
70 " 73 " " 73 "	70 " 78 " " 39 "
70 " 74 " " 37 "	70 " 79 " " 79 "
70 " 75 " " 15 "	

The figures in the third column representing the number of turns the 70-tooth wheel must make to bring the wheels given in the second column, again to their original position.

The least common multiple of the numbers in the third column is necessarily their product, and this represents the number of seconds of time which the system will require to bring all wheels on a line as they originally were at starting.

If we now take this product and divide it by the number of seconds in a year, of say 365 days, we will get the following result:

$$\frac{7,408,214,485,540}{31,536,000} = 234,944 \text{ years and } 2,051,154 \text{ seconds.}$$

A period of nearly two hundred and thirty-five thousand years! Who would have thought at the outset that such a length of time was bound up in so simple a combination of such plain pieces of mechanism? To reach the practical result by turning the wheels of a model in hand would seem at first sight to be easy enough and soon accomplished, but how utterly impossible now since we have shown you the great number of years which would be required to do it.

It is very certain that *time* will not permit me, dear reader, to give you an ocular demonstration of a round of turns of these wheels, and you must therefore rest content with the calculations given above, where you have a pretty clear illustration of the immense advantage of figures over fact. That is, I mean you can *reckon up* a great deal further than you can *go to*, and for this reason we rely with the greatest confidence, without fear of failure, upon figures, especially where they are put down right, and more especially where the result is brought out by an infallible mechanism, having no will of its own, but which must follow the law of its construction without possibility of error.

I wish now to show you that you must not be too sure of any process even though it be conducted by mechanism believed to be absolutely unerring.

The illustration which I shall here employ will be derived from the results afforded by the Calculating Engine of Chas. Babbage, Esq., of London, who, in the year 1821 and ou, superintended the construction of this wonderful machine for the English Government, its object being to calculate and print mathematical and astronomical tables. It may be well, before we show the illustration, to refer to this marvel of mechanism, and to the inventor. Mr. Babbage devoted some years to the realization of a gigantic idea. He proposed to himself nothing less than the construction of a machine capable of executing not merely arithmetical calculations, but even all those of analysis, if their laws are known. The imagination is at first astounded at the idea of such an undertaking. It is indeed no ordinary contrivance which will "go right through" the arithmetic, solving with perfect ease, as the turning of the hand, all and every example, mocking at rules, having the spirit of living computation in its wheels. Algebra and the higher analysis are as play to it—skilled in signs and letters as well as figures, therefore simple and quadratic equations, binomials and ratios and even logarithms are readily done. More than this, it skips away up the ladder of the mathematics, to the summation of series, determining problems which are "indeterminate," doing up rapidly the "sums" of Diophantes, that learned Alexandrian of old, "who was certainly a Master of all Subtlety relating to numbers," leaping as with a bound to the results of all knowledge of measurement, "which the wisest men of all ages have, with incredible study, labored to attain unto and become possessed of."

The machine is not a thinking being, but simply an automaton which acts according to the laws imposed upon it, and yet the engine is capable, under certain circumstances, of *feeling* about to discover which of two or more possible contingencies has occurred, and of then shaping its future course accordingly.

Babbage says: "After years of labor it occurred to me that it might be possible to teach mechanism to accomplish another mental process, namely—to foresee. It cost me much thought, but the principle was arrived at in a short time. As soon as that was attained, the next step was to teach the mechanism which could foresee to act upon that foresight."

Of this engine it might indeed be said, in the quaint language of Dr. Barrow, the eminent English mathematician and divine: "How great a geometrical art thou! for while this Science has no Bound; while there is forever room for the Discovery of New Theorems even by Human Faculties, Thou art acquainted with them all at one view, without any train of consequences, without any wearisome Application of Demonstrations."

In a practical sense it is easy to see the immense advantage of having such an engine, when we reflect upon the prodigious wear and tear of brain to conduct correctly long and intricate computations, which, with this machine can be unerringly accomplished by the mere turning of a wheel, at once securing rigid accuracy, economy of time, and saving of brain labor. Thus the engine may be considered as a real manufactory of figures, which will lend its aid to all departments of the arts and sciences which depend upon numbers.

To give even a fair account of this machine would be impossible without recourse to a portfolio of drawings and a volume of letter-press descriptions, since a computing instrument involving intricate and almost endless combinations of essential mechanical elements to which the inventor devoted over forty years of his time, and for which he spent the equivalent of \$85,000 of English money, cannot adequately be portrayed in a running article of this kind.

But attention now to the machine which we will suppose is before us, wound up and in every way prepared for a long journey into the realms of the infinite in figures.

“Let the reader imagine that such an engine has been adjusted, and that it is moved by a weight, and that he sits down before it, and observes a wheel which revolves through a small angle around its axis, at short intervals, presenting to his eyes successively a series of numbers engraved on its divided circumference.

“Let the figures thus seen be the series 1, 2, 3, 4, 5, etc., of natural numbers, each of which exceeds its immediate antecedent by unity. Now reader, let me ask how long you will have counted before you are firmly convinced that the engine has been so adjusted that it will continue whilst its motion is maintained to produce the same series of natural numbers?

“Some minds are so constituted that after passing the first hundred terms, they will be satisfied that they are acquainted with the law. After seeing five hundred terms, few will doubt; and after the fifty thousandth term the propensity to believe that the succeeding term will be fifty thousand and one, will be almost irresistible. That term *will* be fifty thousand and one, and the same regular succession will continue, the five millionth and the fifty millionth term will still appear in their expected order; and one unbroken chain of natural numbers will pass before your eyes from *one* up to *one hundred million*.

“True to the vast induction which has been made, the next succeeding term will be one hundred million and one; but the next number presented by the rim of the wheel, instead of being one hundred million and two, is one hundred million *ten* thousand and two. The whole series from the commencement being thus:

1	100,000,000
2	100,000,001—regularly thus far.
3	100,010,002—the law changes here.
4	100,030,003
5	100,060,004
. . .	100,100,005
. . .	100,150,006
.	100,210,007
.	100,280,008
99,999,999	

“The law which seemed at first to govern this series fails at the hundred million and second term. This term is larger than we expected by 10,000. The next term is larger than was anticipated, by 30,000, and the excess of each term above what we had expected forms the series of *triangular numbers*, each multiplied by 10,000.

“The numbers 1, 3, 6, 10, 15, 21, 28, etc., are formed by adding the successive terms of the series of natural numbers, thus:

$$\begin{aligned} 1 &= 1 \\ 1 + 2 &= 3 \\ 1 + 2 + 3 &= 6 \\ 1 + 2 + 3 + 4 &= 10, \text{ etc.} \end{aligned}$$

“They are called triangular numbers, because a number of points corresponding to any term can always be placed in the form of a triangle.”

A pleasing aside may be enjoyed here. Above a century ago a volume in small quarto, containing the first 20,000 triangular numbers, was published at the Hague by a professor of philosophy. I cannot resist the author's enthusiastic expression of the happiness he enjoyed in composing his celebrated work: “The Trigonals here to be found, and nowhere else, are exactly elaborate. Let the candid reader make the best of these numbers, and feel (if possible) in perusing my work the pleasure I had in composing it. That sweet joy may arise from such contemplations cannot be denied. Numbers and lines have many charms unseen by vulgar eyes, and only discovered to the unwearied and respectful sons of Art. In features the serpentine line produces beauty and love;

and in numbers high powers and humble roots give soft delight. Lo! the raptured arithmetician! Easily satisfied, he asks no Brussels lace nor a coach and six. To calculate contents his liveliest desires, and obedient numbers are within reach." * * *

"If we now continue to observe the numbers presented by the wheel, we shall find that for a hundred or even for a thousand terms they continue to follow the new law relating to the triangular numbers; but after watching them for 2,761 terms, we find that this law fails in the case of the 2,762d term.

"If we continue to observe, we shall discover another law then coming into action, which also is dependent, but in a different manner, on triangular numbers. This will continue through about 1,430 terms, when a new law is again introduced, which extends over about 950 terms; and this, too, like all its predecessors, fails, and gives place to other laws, which appear at different intervals.

"Thus, a series of laws, each simple in itself, successively spring into existence, at distances almost too great for human conception.

"The full expression of that wider law, which comprehends within it this unlimited sequence of minor consequences, may indeed be beyond the utmost reach of mathematical analysis; but of one remarkable fact, however, we are certain—that the mechanism brought into action for the purpose of changing the nature of the calculation from the production of its more elementary operations into those highly complicated ones of which we speak, is itself of the simplest kind."

These results, to say the least of them, are passing strange, and at first blush we are disposed to meet their statement with square disbelief; every doubting Thomas of us will say there must be a "screw loose" somewhere, or that the wheels are out of gear. Our knowledge of mechanism assures us positively that an engine of this kind, when in proper trim, *cannot* go wrong, therefore it must count regularly and correctly to the end of time.

How well we remember in school days when we first made acquaintance with the problem of the asymptotes which never meet the hyperbola, although continually approaching it. With what resistance we met the statement. "What, never" reach a line and going toward it all the time? It can't be, thought we in our lack of learning. We soon came to know, however, that continual division, even if repeatedly endlessly, must always leave something to be divided, but this is one of the regular things in the books, following unchanging mathematical law, and in no wise related to engine work. Not so the calculating engine, which is one of those affairs "you can't always never tell about, sometimes hardly," as the Germans say. But seriously, what can we know about this switching off the main track by this machine? It is true it keeps in line a very long time *for us*. Notice what the inventor says: "It has been supposed that ten turns of the calculating engine might be made in a minute, or about five hundred and twenty-six millions in a century. As in this case, each would make a calculation, after the lapse of a million of centuries only the *fifteenth* place of figures would have been reached."

Its performance is so unlike anything we ever heard of that we marvel at it. Ordinary wheels and movements with which we are familiar run along regularly our lifetime out, and we believe they would continue to do so *ad finitum*, but here is just where we err in judgment—the reasonings on things of to-day cannot be continued, in form indefinitely, so the engine tells us. But why marvel at this? Do we not have reproduced before our eyes every year a multitude of processes, very different yet very similar and equally wonderful?

Observe the growth of seed, for instance, wherein are changes wrought which no one, without previous knowledge, could foretell. Place that little germ in the soil, and out of it there will develop in time a succession of startling phenomena: rootlet strikes downward, taking hold of the soil, and stem pushes upward into the air, expanding

into leaves, bud, and blossom, which in their turn ripen into fruit, involving the seed for repeating again the wondrous sequence of created forms. We cannot tell from the parent germ what the child-form will be, nor predict the leaf from study of the twig, nor forecast the blossom on promises of the leaf, much less tell what manner of fruit the plant will yield.

For further illustration we may cite cases higher up in the scale of nature familiar to every reader. "The laws of animal life which regulate the caterpillar seem totally distinct from those which, in the subsequent stage of its existence, govern the butterfly.

"The difference is still more remarkable in the transformation undergone by that class of animals which spend the first portion of their life beneath the surface of the waters and the latter part as inhabitants of air." Yet the law of the after life is involved within the being of the former, and is a necessary consequence of it.

"Again, the extinction of animals and races of men, followed by a new creation of others fitted to supply the places previously abandoned.

"The past cycles in the geological changes that have taken place in the earth's surface, of which we have ample evidence, offer another analogy in nature to those mechanical changes of law from which we have endeavored to extract a *unit* sufficiently large to serve as an imperfect measure for some of the simplest works of the Creator."

* * * *

The reader should now be fully convinced that such an engine has actually been contrived and built; he also may be fully persuaded of the absolute certainty of its mechanism and movements, since they are based upon mathematical laws, which, of all others, are the simplest and the surest; and finally, well knowing these, he is prepared to take one step further, even to a recognition of a new law brought to light and fully demonstrated by this engine—the law of *change*—and from this high vantage-ground accept at once the possibility of miracles, which being strictly in accordance with a general law of nature, when that law is better known, but without such knowledge it may seem to be in opposition thereto.

Thus far advanced in the higher views of nature, the various hypotheses which have from time to time been put forth in explanation of the coming and going, the birth, growth, and decay, the creation of new and the extinction of the old forms of life upon the face of the globe, must take a different shape and find expression in other words and language more in accordance with this larger conception than those commonly employed; but lest your plain, mechanical writer be deemed too transcendental, he will close here, hoping the serenity of the "Hub" will not be disturbed by the turning of these wonderful wheels.—*Boston Journal of Commerce.*

Public opinion is a second conscience.

It is weak and vicious people who cast the blame on fate.

A sweet temper is to the household what sunshine is to trees and flowers.

Those who trample on the helpless are disposed to cringe to the powerful.

Adversity does not take from us true friends; it only dispels those who pretend to be such.

He who shows kindness toward animals will display the same characteristics to his fellow-men.

The grandest of heroic deeds are those which are performed within four walls and in domestic privacy.

The pebbles in our path weary us and make us footsore more than the rocks, which require only a bold effort to surmount.

Incorporated
1866.

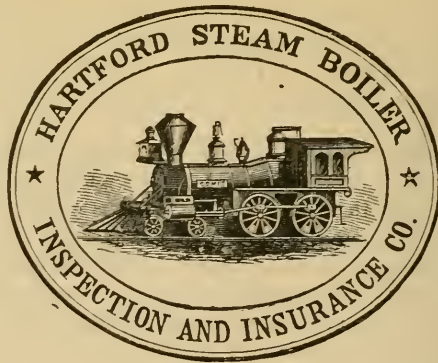

Charter Per-
petual.

Issues Policies of Insurance after a Careful Inspection of the Boilers.

COVERING ALL LOSS OR DAMAGE TO

BOILERS, BUILDINGS, AND MACHINERY,

ARISING FROM

Steam Boiler Explosions.

THE BUSINESS OF THE COMPANY INCLUDES ALL KINDS OF STEAM BOILERS.

Full information concerning the plan of the Company's operations can be obtained at the
COMPANY'S OFFICE, HARTFORD, CONN.

Or at any Agency.

J. M. ALLEN, Prest. W. B. FRANKLIN, Vice-Prest. J. B. PIERCE, Sec'y.

Board of Directors.

J. M. ALLEN, President.	GEN. WM. B. FRANKLIN, Vice-Prest. Colt's Pat. Fire Arms Mfg. Co.
LUCIUS J. HENDEE, Prest. Etna Fire Ins. Co.	GEO. CROMPTON, Crompton Loom Works, Worcester.
FRANK W. CHENEY, Asst. Treas. Cheney Brothers Silk Manufacturing Co.	HON. THOS. TALBOT, Ex-Governor of Mass.
CHARLES M. BEACH, of Beach & Co.	NEWTON CASE, of The Case, Lockwood & Brainard Co.
DANIEL PHILLIPS, of Adams Express Co.	WILLIAM S. SLATER, Cotton Manufacturer, Providence, R. I.
GEO. M. BARTHOLOMEW, Prest. Amer. Nat. Bank.	NELSON HOLLISTER, of State Bank, Hartford.
RICHARD W. H. JARVIS, Prest. Colt's Fire Arms Manufacturing Co.	D. R. SMITH, Prest. Springfield Fire & Marine Ins. Co.
THOMAS O. ENDERS, Sec'y Etna Life Ins. Co.	
LEVERETT BRAINARD, of The Case, Lockwood & Brainard Co.	

GENERAL AGENTS.

THEO. H. BABCOCK,
CORBIN & GOODRICH,
LAWFORD & McKIM,
W. S. CHAMBERLIN,
J. L. SMITH,
H. D. P. BIGELOW,
C. C. GARDINER,
D. C. FREEMAN,
W. G. LINEBURGH,
GEO. P. BURWELL,
W. B. CASSILY,

CHIEF INSPECTORS.

R. K. McMURRAY,
WM. G. PIKE,
JOSEPH CRAGG,
WM. U. FAIRBAIRN,
B. M. LORD,
H. D. P. BIGELOW,
J. S. WILSON,
F. S. ALLEN,
W. S. FOX,
A. C. GETCHELL,
J. S. WILSON,

OFFICES.

NEW YORK CITY.	Office, 285 Broadway.
PHILADELPHIA.	" 430 Walnut St.
BALTIMORE.	" 10 So. Holliday St.
BOSTON, MASS.	" 10 Pemberton Sq.
PROVIDENCE, R. I.	" 42 Weybosset St
CHICAGO, ILL.	" 132 La Salle St.
ST. LOUIS, MO.	" 404 Market St.
HARTFORD.	" 218 Main St.
BRIDGEPORT.	" 378 Main St.
CLEVELAND.	" 246 Superior St.
CINCINNATI.	" 53 West Third St.

The Locomotive.

PUBLISHED BY THE HARTFORD STEAM BOILER INSPECTION AND INSURANCE COMPANY.

NEW SERIES—VOL. I.

HARTFORD, CONN., AUGUST, 1880.

No. 8.

The Destruction of the Steamer Seawanhaka.

On June 28, 1880, the passenger steamer Seawanhaka, plying between New York and Glen Cove, on Long Island Sound, on her afternoon trip from New York, when in the vicinity of Hell Gate, a dull noise, described as that of a muffled explosion, was heard, accompanied by a slight jar, and flames were observed to burst out amidships, beyond the possibility of control. The passengers, of whom there were a large number, became panic stricken, the Captain determined to beach the boat at what he thought the nearest available place upon the sunken meadow at Randall's Island, the fire, meantime, raged with such violence that in less than thirty minutes from its discovery the boat was burned to the water's edge; 35 lives were lost, and many badly burned and injured.

The newspapers, as is usual in such cases, for several days after the occurrence devoted considerable of their space to the discussion of the cause of so great a calamity,

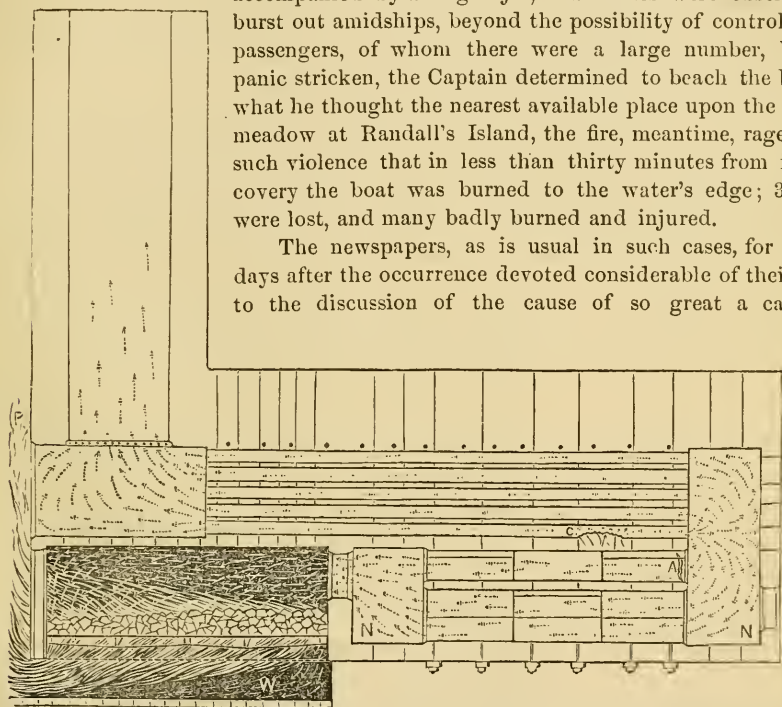

FIG. 1.—Longitudinal section through the shell of the Seawanhaka's boiler, showing the smoke (gas) thoroughfares in elevation, and a section through the starboard furnace.

C—The initial rupture in the bottom of the lower tube in the second vertical row, through which the water escaped.

A—Rupture in the right-hand ten-inch flue, probably secondary, through which water also escaped into the smoke (gas) thoroughfares.

NN—The low places where the water lodged; the arrows representing the free steam which separated from the water as soon as it reached the chamber, NN.

W—The ash-pan bedded in fire-brick and cement.

P—Probable location of the wood-work that first took fire.

which was generally attributed to the explosion of carbonic oxide gas, generated in the furnaces, the result of imperfect combustion, the engineer made his report without adding any facts that would assist in the solution of the question, but seeming to confirm the popular belief. There were many doubting Thomases who did not share in this belief.

The Seawanhaka was a side-wheel steamer of 612 tons, built in the year 1866, single

low-pressure beam engine, cylinder 56 inches diameter, 10 feet stroke, two boilers of the flue and return tube construction which had been in continuous service until the day of the disaster, about fourteen years. Each boiler was 21 feet long, 7 ft. 8 in. diameter, fire box part 8 ft. wide, 9 ft. long, containing two furnaces; the heat after leaving the furnaces passed into a combustion chamber, thence through flues to the back connection, turning upward, it returned through a nest of tubes to the front end, and out of the chimney.

Over three weeks after the destruction of the boat, this company was applied to and an agent was detailed, at the request of interested parties, to make an examination of the boilers as they remained upon the wreck. It being understood that the Hartford Steam Boiler Inspection and Insurance Company took but little stock in mysterious agencies as the cause of boiler explosions, and there were reasons for the belief that the fire that destroyed the Seawanhaka was caused by the explosion of the boiler, or some of its appendages, and it was thought a careful examination might discover the defect and clear away the fog that surrounded the case. An inspection of the port boiler showed it had not given out, though many serious defects were discovered due to its age and long service; the starboard boiler was found in a much worse condition, the crown sheets in both furnaces were badly bulged in several places.

In the back connection, a serious crack, some 15 inches long, shown at A, figs. 1 and 3, was found in upper right hand wing flue; this crack was open $\frac{1}{4}$ inch wide. The left hand flue (see fig. 3,) was cracked in same place, though not so badly. These flues were 10 inches in diameter. The cracks were within two inches of their ends, following the lap of the flange where flues were riveted to the head. The flues were no doubt weakened by the fretting of the seams at that point, assisted by the corrosion that had reduced the iron in places. A piece of the iron cut out indicated that it was very brittle. The rivet-heads at the seams were so badly corroded but little of the heads remained. One of the tubes ($3\frac{1}{2}$ inches diameter) in the lower row had so wasted away, that in one place it had collapsed for a distance of about six inches, shown at C, fig. 1. This tube with a piece of the tube head (see fig. 2,) had been cut out and carried away, and the location of the rupture is a matter of hearsay—(see supplementary report at the end of this article). This was the condition of the boilers at the time of the visit; they had been tested by a government inspector less than three months before, by a hydrostatic test of 60 lbs. per sq. inch, and were licensed for one year thereafter at a steam pressure of 40 lbs. per sq. inch. Before the coroner's inquest, recently held in this city, to determine the cause of the disaster, the U. S. Boiler Inspector and officers of the vessel appeared and testified as follows:

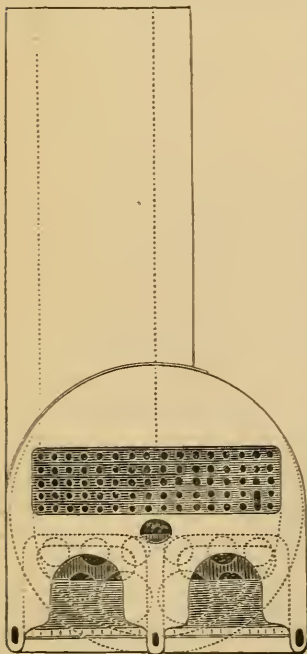

FIG. 2.—Front elevation of the boiler, showing the opening in the tube plate made by the boiler-maker shortly after the accident, for the purpose of removing the ruptured tube, which was the lowest one of the second vertical row from the right hand.

U. S. Inspector. "Inspected the Seawanhaka's boilers in March last, and found them in very good condition; since the disaster he had examined them and found in the starboard boiler some of the tubes were cracked and probably drawn out, the top of the furnace was warped, the other boiler was all right, the stop-cock in front of starboard boiler that is used to throw water in the front of ash pan when it becomes too hot, was broken off, the starboard boiler was nearly empty, the other half full. After examination he concluded the

cause of the fire could not have sprung from any defect here, because an explosion would have blown the head of the boiler off, the ruptures (Mem.—probably referring to cracked flues and collapsed tube), in his opinion, was caused after or during the fire. *He thought the boat took fire from some hot coals under the ash pan, the steamer was well supplied with boilers; if either of the boilers had burst there would not have been steam enough to beach the boat.*"

The Captain testified. "Between the discovery of the fire and the beaching of the boat elapsed about three minutes and fifteen seconds; the ash-pan is made of boiler-iron, and is usually kept full of water, under the ash-pan was a layer of fire-brick and cement, (mem.—see fig. 1, W,) *did not think the fire could have originated there; had no opinion of where it could have started.*"

The Engineer testified. "I first heard a dull rumbling noise, and stepped into the fire-room and turned off the jet. I started to go below, *but was met by a sheet of flame starting from under the starboard boiler, opened the jet again to make the flame take its proper course, it had no effect, tried to start the donkey pump; but was compelled to abandon it, on account of the flame and smoke; in my opinion the fire was caused by the back draft from the starboard boiler, don't know what caused that, might have been caused by the explosion of a flue. I had about 33 lbs. of steam at the time; we use egg size coal. The fireman swore there was plenty of water in the ash-pan at the time.*"

The facts as narrated above, of events before and after the sudden appearance of the flame, are not accounted for on the supposition that the boat took fire from the coals in the ash-pan. Many fires have occurred from that cause. But they burned with far less intensity, and with the appliances usually provided, for putting out fires, were speedily under control.

In the lightning-like rapidity with which the fire-room was filled with flame and gas after the explosion and jar felt by many of those on board, we have an extraordinary effect, and must look about the boilers for a cause sufficient to have produced it; that we find in the collapsed tube and ruptured flues in the back connection of the starboard boiler.

Probably the fires forced by the steam-jet were strong and heavy, say 10 to 12 inches deep upon the grates; the collapsing of the tube, if as badly as has been described, would have choked up the front connection, backed up the draft and driven the flame out from under the grates and through the other openings in the front of the boiler in quantity sufficient to have caused the destruction that resulted.

It is proper in reply to those who say the boiler could not have exploded or ruptured, for that would have released the steam, and the engine would have stopped, to remind them, there were *two boilers*, while but one, the starboard boiler, ruptured, and the time that elapsed from the explosion to the beaching of the steamer is sworn to by Captain and Mate, was between three and four minutes, and the port boiler would have kept up a supply of steam for that length of time. It is impossible to say whether the flues ruptured at the same time that the tube collapsed, for too long a time had elapsed between the disaster and the time of the examination of the fractured parts to be positive. The flues had been patched a number of times. Boiler explosions occasion more or less destruction, according to the circumstances. The rupture of a flue near its mouth, where it is stiffened by the round-about seam, as well as the flanging of the head, would be likely to do less damage than if it occurred at some point midway of its length, where it

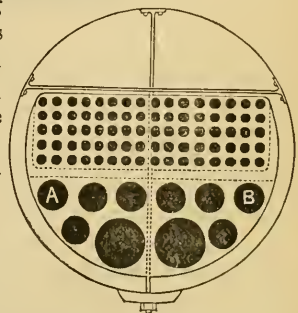

FIG. 3.—Section through the back smoke chamber giving a rear view of the rear tube plate, with the ruptured tube omitted. A and B the ruptured 10-inch flues.

is weaker. The explosion of the furnace flue of the tug A. G. Cattell, and crack in the bottom of the back connection of the river steamer Thos. Cornell, both of which happened in 1878, are cases in point that occur at the time of this writing. Readers of the LOCOMOTIVE will no doubt recollect of similar cases, the Cornell boilers being upon the guards (while those of the Seawanhaka were in the hold), the fire-room was so much more accessible that no further damage was done than injuring the paint-work and delaying the boat some hours.

Herewith is appended the verdict of the coroner's jury; it is as follows:

"We find that H. B. DeBevois, and 34 others, came to their death by injuries, the result of a fire which occurred on board the steamer Seawanhaka, on the 28th day of June, 1880, on its passage from New York to Roslyn, L. I., and that said disaster was caused by the bursting or collapsing of one of the tubes in the starboard boiler, whereby the flames were driven under the grate-bars into the fire-room, thereby igniting the wood-work, causing the destruction of the boat."

"We further find that the boiler had been duly inspected by the U. S. Government Inspector in March last, and that the said boat was provided with all the appurtenances required by law, and the jury further believe that the loss of life in this disaster, would not have been so great had the crew been disciplined and exercised to act in concert in case of a panic through fire or other cause. In conclusion, the jury would strongly recommend, to avoid a recurrence of a similar disaster, that the ceilings and walls, as well as the floors, of the fire-rooms of all steamboats should be incased in metal, at a suitable distance from the wood-work."

SUPPLEMENTARY REPORT MADE UP FROM LATER INFORMATION.

Since the above examination was made an interview has been had with the boiler-maker who cut out the ruptured tube soon after the accident. The information thus obtained, condensed somewhat, is substantially as follows:

On attempting to pass an old steam-pipe used as a probe through the tubes it met an obstruction in the ruptured one, which was thereupon cut out, a piece of the tube-plate shown in Fig. 2 being cut away so that the tube could be taken out without violently driving it through the original opening in which it was "set" in the plate, the effect of which would be to distort or break it.

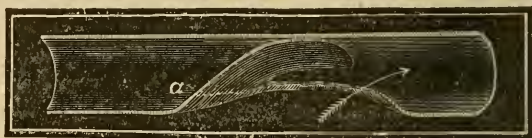

FIG. 4.—Section of tube and flap showing half of the opening and flaps. The part above "a" was not found.

At the interview the gentlemanly proprietor minutely described the tube, but firmly declined to exhibit it to this company's representative or to any one else. The cut Fig. 4, was made from his description, and is a vertical section through the tube, showing about half of the ruptured part, which he says was located about two to three feet from the *front* end. The cut, Fig. 1, shows it as located about that distance from the *forward* (in distinction from the *after*) end, as it was understood when that cut was made. The difference of location is obviously of little importance in explaining the accident. The present condition of the tube, as described, warrants the conclusion that a flap was turned inward, hinging on the front part of the opening, so as to obstruct the passage of the water and steam in that direction and cause it to flow, as indicated by the arrow, toward the back smoke-chamber, reversing the current of hot gases, that is, causing *back draft*. After a time the flap became detached at the line "a," Fig. 4, and was blown away, or perhaps it might have been broken off by the boiler-maker's probe, leaving the opening

as though the dotted line "a" were its boundary. The missing piece may have been detached at once and jammed in the tube, producing the same effect. However this may be, there was undoubtedly a rapid escape of the water, charged with steam, which was instantly freed from the water when it impinged on the vertical surface of the back smoke-connection; the water falling while the steam escaped both ways in such quantity as to make say $\frac{1}{16}$ of a pound pressure per square inch in the smoke-passages. This pressure, which would not show on an ordinary steam-gauge, would amount to about $1\frac{1}{2}$ inches of water column, which is a greater pressure than would be balanced by the draft of the highest chimney, and would be quite sufficient to transform the boiler furnace into an immense blow-pipe, as the steam would be practically dry after passing both chambers and impinging upon two vertical surfaces before reaching the heavy bed of incandescent coal in the furnaces, while the lower flues and the lower part of the chambers afforded ample room for the storage of the water from which the steam escaped.

As to the relative time when the two 10-inch flues gave way, it appeared, on subsequent examination by a representative of this company, that the shell of the boiler had been sufficiently heated to soften it, which, judging from the corrugated appearance; must have been after the pressure had subsided within the boiler, and the condition of the ruptured edges indicates that they yielded to a tensional strain which it is probable was caused by the extra expansion of the shell to which the two flues A and B were more rigidly attached, being nearer the flange than the central ones were which did not break. After the water had fallen below the ruptures in the starboard boiler, the blowing of the fire was no doubt kept up by steam escaping from the remaining water, heated by its own blast upon the bed of coals and communicating its heat to the sides, which were still covered with water, and to the crown of the furnace, which was uncovered and became overheated and bulged, as described in the foregoing report.

BOILER EXPLOSIONS.

MONTH OF JULY, 1880.

STEAMBOAT (78).—The boiler on the Lake Minnetonka (Minn.) pleasure steamer Mary exploded July 1st, while lying at the St. Louis hotel wharf, wrecking the boat which sank immediately, killing William Chadwick, the engineer, J. R. Plattenburg, a guest at the hotel, and C. A. Gaines, the hotel's head waiter, fatally injuring John Steward, the pilot, and scalding and otherwise injuring Edwin S. Perkins, the fireman; Frank Adams, chief clerk at the hotel; A. S. Demond of Minneapolis and four others. The boat was on her way to Wayseala to take on board 100 excursionists, and had stopped at the St. Louis hotel *en route*. Her boiler was known as an Ames boiler, and is the third of the make which has exploded on the same lake in the last three years, each time with fatal results.

LOCOMOTIVE (79).—On the afternoon of July 5th, a yard engine on the Indianapolis, Peru & Chicago road exploded its boiler at Peru, Ind. The engine was destroyed, the yard-master killed, the engineer, fireman, and a brakeman badly hurt. The engine was an old one, but supposed to be in good order.

THRESHER (80).—The boiler of a thresher-engine exploded at Dunkirk, Ohio, July 6th, killing seven and wounding eight persons. Two of the eight persons have since died, and three it is said cannot survive. The engine was made by Wood, Faber & Moore, of Easton, N. Y., and owned by William Frederick. It was new, and never had been used before. The killed are: Wm. Frederick, Richard Case, (fireman,) Washington Paisel, George Paisel, Harry Brown, (engineer,) and one man, name unknown, sent out with the

engine from Easton. The following are among the wounded: Robert Thrush, and a son of William Frederick, who have both since died. The excitement is intense.

IRON WORKS (81.)—At 2 o'clock July 10th, a terrible accident occurred at Painter's mills, on the south side, just at the end of Point bridge, Pittsburgh, Pa. The men had just come to work, and were going on duty when suddenly two boilers of a battery exploded. One boiler was thrown a distance of half a square, wrecking everything that came in its path. The other was not blown out of the mill, but was displaced from its socket. Engineer Gable and fireman Black were standing by and both were instantly killed. The two men were caught under the falling debris and held fast. The steam, which came out in a volume filling the mill, scalded them to death, and both men were terribly mangled and scalded. The mill was badly damaged.

HOISTER (82.)—A boiler standing near the new dam at Ware exploded at 11 o'clock P. M., July 11th, and the engineer, Daniel Mitchel of Worcester, was seriously injured, though not fatally. It is feared that he loses both eyes, but possibly one can be saved. The boiler was thrown about two hundred feet. The cause of the explosion is thought to be a defect in the boiler, as there was only 35 pounds of steam on at the time.

PAPER-MILL (83.)—A boiler in the mill belonging to the Canada Paper Company, Windsor, Que., exploded at noon, July 12th, destroying the Pulp mill, injuring two men and a lady living near the mill, the windows of whose house were blown in.

SAW-MILL (84.)—The boiler of a steam saw-mill near Barnesville, Va., exploded, July 18th, killing a colored man, fatally injuring an employee named Bryant, and severely scalding and wounding five others.

FLOURING-MILL (85.)—The Cone Flouring-mill, at St. Genevieve, Mo., was nearly demolished by the explosion of a boiler July 16th. Engineer Koremann was instantly killed. Superintendent Martin Meyer was fatally scalded, and another employee, named Silas, was seriously wounded. The loss is \$10,000 to \$15,000.

THRESHER (86.)—While a trial was being made July 22d of a thresher and cleaner, on the farm of Jacob G. Zerr, President of the Berks County Agricultural Society, near Birdsboro, Pa., the boiler used for generating steam exploded with such force that it was thrown into the air some thirty feet, and landed fifty feet from its original position. The boiler was in a house some distance from the barn where the thresher was running, the steam being conveyed by an underground pipe to the engine, and as all were interested in looking at the thresher at the time, no lives were lost. The boiler house was completely demolished.

THRESHER (87.)—The boiler of a threshing-machine engine blew up near Modesto, Cal., July 23d, killing J. S. Dooly, the fireman, and injuring eight others, one probably fatally.

LOBSTER BOILING ESTABLISHMENT (88.)—Collected sediment caused a boiler to explode July 23d at Kendall's lobster-boiling place at Charlestown, Mass., doing \$500 damage.

SAW-MILL (89.)—The boiler at H. Mellen's saw-mill in Bagley, Otsego county, Mich., blew up July 26th, killing two men, and seriously injuring several others. The owner of the mill is among the injured. The explosion was caused by a defective boiler.

PORTABLE-MILL (90.)—The boiler of a portable mill near Fowler Station, Pa., exploded July 28th, killing Abraham Burns, severely injuring two others, and blowing the mill to atoms.

MILL (91.)—The cylinder head of the boiler in Nelson & Brown's mill at Muskegon, Mich., blew out recently and the engineer had a narrow escape from some of the broken pieces.

Inspectors' Reports.

The figures which represent the work done by the company's inspection corps still present an encouraging aspect, and indicate, by comparison with the same month last year, a heavy increase of the business.

There were 26 per cent. more visits of inspection, and about the same increase in the number of boilers inspected, in June, 1880 (which is the month's work now reported below), than in the corresponding month of last year.

The figures for June are each year somewhat below the average, since the following month is with many manufacturers the season for the half yearly or annual cleaning, and the great national holiday in July and the Christmas time in December are the busy times with the inspector. Many mills shut down for a week or so to foot up their ledgers, make their semi-annual dividends, and have their boilers inspected. There is a peculiar sense of satisfaction and a feeling of quiet and rest always apparent in the visage of the successful manager as he passes through his works cooled off, cleaned, and repaired. He takes especial interest in peeping into his cool boilers while the inspector is at work, and he can now spare an hour to talk over their condition as compared with last year, and the improvements that are occurring in the management of steam apparatus, if perchance the now busy inspector can spare the time, at least he can improve the time while the inspector is taking his wash and changing his clothes. The confidence that he experiences as his wheels again revolve and the hum and hurry of business begins, together with the reasonable assurance that another successful year has begun, is full compensation for the few days' time that have been devoted to this important annual duty. We may reasonably expect that July will show big figures when they are all in.

The number of inspection visits made in the month of June, 1880, was 1,691, and a total of 3,463 inspections were made, of which 1,199 were annual complete internal and external inspections. The hydraulic test was employed in 229 cases. A large part of the boilers tested were new and in the yards of the makers.

The total number of defects brought to light during these 30 days was 1,525, of which a pretty large percentage (nearly 30), viz., 447, were considered dangerous. They were as follows:

Furnaces out of shape, 73—21 dangerous. Fractures, 170—113 dangerous. Burned plates, 65—19 dangerous. Blistered plates, 240—23 dangerous. Deposit of sediment, 190—55 dangerous. Incrustation and scale, 317—66 dangerous. External corrosion, 117—40 dangerous. Internal corrosion, 54—24 dangerous. Internal grooving, 13—11 dangerous. Water-gauges defective, 30—5 dangerous. Blow-outs defective, 16—4 dangerous. Safety-valves overloaded and otherwise defective, 15—4 dangerous. Pressure-gauges defective, 114—28 dangerous. Boilers without gauges, 60. Cases of deficiency of water, 13. Braces and stays broken, loose, and detached, 38—34 dangerous. Boilers condemned, 30.

Safety Valves—How to Determine their Proper Size.

As regards safety there is no steam boiler attachment that approaches the safety-valve in importance. Among those who are at all familiar with the causes of boiler explosions and the defects discovered by inspectors this proposition needs no discussion. But there has been much lively discussion of the question of its proper size and form, and many widely varying rules have been published, mostly referring to the common form of lever valve, and in comparing them we find that the extremes are 10 and 44 square inches of area for a given boiler. Practical engineers are now pretty well agreed on this subject, and base their calculations on the actual amount of water evaporated per unit of time rather than on the dimensions of the boiler.

The valuable experiments lately (1877) made at the Washington Navy-Yard by a committee of government supervising inspectors, with General Dumont as chairman, has resulted in the adoption of two rules for determining the proper sizes to be used on marine boilers.

These two rules refer to two classes of valves. The first one requires that the common type of disc valve having a conical seat shall have an area of not less than one square inch for every two feet of grate surface in the furnace.

The second rule, which refers to valves that are provided with a reactionary device, such as an overhanging surface of the valve on which the steam reacts in escaping, or some approved supplementary attachment that will cause the valve to open at the stated pressure so wide as to realize a clear orifice equal in area to one-half the clear opening covered by the valve: and this class of valves may be one-half as large in area as the common valve, or not less than one-half a square inch for every two feet of grate surface in the furnace.

These rules have the correct basis of the quantity of water evaporated per hour by the boiler, but in order to simplify them and avoid the necessity of determining by experiment in each case the quantity of water evaporated per hour, the grate area is taken as a measure of each boiler's capacity.

Marine boilers alone were contemplated by the committee in making the rules, and the fact that such boilers, often using a forced draft and running without regard to economy of fuel, evaporate from two to four times as much water per square foot of grate as stationary boilers do, renders their rules eminently safe to apply to stationary boilers running with natural draft, such as the committee experimented with.

The report of these experiments shows that the area taken by itself is not the true measure of the efficiency of a safety-valve; that owing to the fact that it does not require so large an orifice to discharge a given weight of high-pressure steam per unit of time as low-pressure steam requires, therefore the element of pressure may be omitted in the calculation; also that the true measure of the efficiency of any safety-valve is the area of clear opening that may be realized *from the lift* when the valve is discharging, without an objectionably high pressure, the entire product of the boiler; therefore since no valve will practically lift so high that the area of the annular opening around the valve will equal the opening covered by the closed valve, then the *amount of lift* becomes the actual measure of its efficiency.

The experiments also show that no more than two-tenths of an inch lift can be obtained with the common disc valve without an objectionably high pressure while the full product of the boiler is escaping. The conclusion then is that if a common disc valve lifted two-tenths of an inch will not afford an orifice sufficiently large to relieve the boiler without an extra accumulation of pressure, then it is too small and not a safety-valve at all.

Another fact developed by these experiments which confirms the conclusions reached by other experimenters is that there are serious objections to increasing the size of any single valve beyond ten or twelve inches area. If that is not sufficient, according to the following rule, it is better to use two of smaller area.

A SIMPLE RULE FOR THE SIZE OF A SAFETY-VALVE

(which is equivalent to that adopted by the committee for the common valve) is: Multiply the number of pounds of coal burned per hour by 0.045, the product is the area of the valve in square inches.

Prof. Rankin's rule is to multiply the number of pounds of water evaporated per hour by 0.006, which amounts to the same thing as the above when about $7\frac{1}{2}$ pounds of water are evaporated per pound of coal, but if 9 pounds are evaporated per pound of coal, then to be equal to the last distinguished authority the decimal 0.054 will be required instead of 0.045.

The Locomotive.

HARTFORD, AUGUST, 1880.

SOME delay has been experienced in getting this number of THE LOCOMOTIVE out in the month designated on its title page. Our explanation is that in making examinations and drawings of ruptured and exploded boilers, more time has been consumed than was expected would be. In obtaining information for these articles long journeys are sometimes necessary, and delays unforeseen occur. It is our aim to give our patrons reliable information, and not to make THE LOCOMOTIVE a sensational sheet simply, filled with jokes and self-laudations. The reading matter of THE LOCOMOTIVE does not grow stale by age as is the case with political papers, and we trust that the contents of this issue will be found of sufficient value to compensate for the delay. Our aim is to bring it out "on time."

ROPER'S ENGINEERS' HANDY-BOOK is published by Claxton & Co., of Philadelphia, who are the publishers of several works on steam, steam boilers, and engines, from Mr. Roper's pen. This last work is of special value to all who have to do with steam boilers and engines, and it will be found a valuable shop companion for the mechanic. There are a great many facts collated that are not easily reached except through expensive books and libraries. These will be found of service to all classes of men, whether in trade or manufacturing. We commend it heartily, and believe it will have a large sale.

THE queries in Mr. Melvin's letter, on another page (139), "What about the cause of the explosion?" and "Why should there have been an explosion?" are most pertinent, and of deep interest to all engineers and steam users. Our version of this same case will appear in the first article in the next number. It is already prepared, but is crowded out by the Seawanhaka report.

If the statement of the English company cited in the above communication from Mr. Melvin is correct, that association has been extremely fortunate in having careful attendants of their guaranteed boilers. The same freedom from accidents has been claimed by other companies whose business was hazardous to human life, notably a New England steamboat line which advertised for many years that they had not lost a life on their line for an astonishingly long time, but their turn came at last, when two of their own boats collided, and one of them was burnt and sunk with fearful loss of life, which shows that some one or more of their men were human, and liable to err; and care will not always avert calamity, but it is emphatically the duty of all who handle dangerous things to exercise this virtue.

TABLE VI.

WEIGHT OF WROUGHT IRON PLATES PER SQUARE FOOT; THICKNESSES ADVANCING BY .005 OF AN INCH FROM .01 TO .5, AND A COMPARISON OF THE NEAREST BIRMINGHAM AND AMERICAN WIRE GAUGE NUMBERS.

1.		2.		3.		4.			
Thickness of Plate.		Weight per square foot of rolled iron plate (D. K. Clark). Basis of 40 pounds per square foot, 1 inch thick.		Nearest Birmingham gauge No. <i>Old and new English</i> from D. K. Clark. Weights of old taken from Molesworth's Pocket Book.		Nearest American Wire Gauge No. (C. H. Haswell). Basis of 37½ pounds per square foot, 1 inch thick.			
Decimal Fraction.	Common Fraction.	Weight of Square Foot.		Gauge Number.	Thickness (Decimal).	Weight per Square Foot.	Gauge Number.	Thickness (Decimal).	Weight per Square Foot.
Inches.	Inches.	Pounds.		Number.	Inches.	Pounds.	Number.	Inches.	Pounds.
.010	$\frac{1}{16}$.40		old 31	.010	.40	30	.010	.376
....		new 31	.014	.56
.015	..	.60		new 30	.0156	.62	26	.0159	.597
....		old 30	.0125	.50
.020	$\frac{1}{5}$.80		old 25	.02	.90	24	.020	.753
....	$\frac{1}{5}$		new 26	.0218	.87
....		old 23	.025	1.12
.025	$\frac{1}{4}$	1.		new 24	.025	1.	22	.0253	.950
....		old 21	.032	1.4
....		new 22	.03125	1.25	20	.0319	1.198
.03125	$\frac{1}{32}$	1.25	
.035	..	1.40		old 20	.035	1.54	19	.0358	1.345
....		new 21	.0343	1.37
.040	$\frac{1}{25}$	1.60		old 19	.042	1.70	18	.040	1.511
....		new 20	.0375	1.50
.045	..	1.80		old 19	.042	1.70	17	.045	1.697
....		new 19	.04375	1.75
.050	$\frac{1}{20}$	2.		new 18	.050	2.	16	.050	1.906
....		old 18	.049	1.86
.055	..	2.20		new 17	.056	2.24	15	.057	2.140

.060	old	17	.058	2.18	14	.064	2.403
.0625	new	16	.0625	2.50
.065	old	16	.065	2.50
.070	old	15	.072	2.82	13	.0719	2.698
.075	new	15	.075	3.
.080	old	14	.083	3.12	12	.080	3.030
.085
.0875	new	14	.0875	3.50
.090	11	.090	3.402
.095	old	13	.095	3.75
.100	new	13	.100	4.	10	.101	3.820
.105	Haswell	13	.095	3.56
.110	old	12	.109	4.36
.115	new	12	.1125	4.50	9	.114	4.291
.120	Haswell	12	.109	4.087
.125	old	11	.125	5.
.130	new	11	.125	5.	8	.128	4.818
.135	old	10	.134	5.62
.140	new	10	.1406	5.62
.145	Haswell	10	.134	5.025	7	.144	5.410
.150	old	9	.148	6.24
.155
.160	new	9	.156	6.25	6	.162	6.075
.165	old	8	.165	6.60
.170	new	8	.171	6.84
.175
.180	old	7	.180	7.50	5	.182	6.822
.1875	new	7	.1875	7.50
.190	Haswell	7	.18	6.75
.195
.200	new	6	.203125	8.125
.205	old	6	.203	8.12	4	.204	7.661
.210	Haswell	6	.203	7.61
.215
.220	old	5	.220	8.74
.225	new	5	.21875	8.75
.230	Haswell	5	.22	8.25	3	.229	8.603
.235	new	4	.234	9.37
.240	old	4	.238	10.
.245	Haswell	4	.231	8.925

TABLE VI.—CONTINUED.

1.		2.		3.		4.			
Thickness of Plate.		Weight per square foot of Rolled Iron Plate (D. K. Clark), Basis of 40 pounds per square foot, 1 inch thick.		Nearest Birmingham gauge No. Old and new English from D. K. Clark. Weights of old taken from Motesworth's Pocket Book.		Nearest American Wire Gauge No. (C. H. Haswell). Basis of 37½ pounds per square foot, 1 inch thick.			
Decimal Fraction.	Common Fraction.	Weight of Square Foot.		Gauge Number.	Thickness (Decimal).	Weight per Square Foot.	Gauge Number.	Thickness (Decimal).	Weight per Square Foot.
Inches.	Inches.	Pounds.		Number.	Inches.	Pounds.	Number.	Inches.	Pounds.
.250	$\frac{1}{4}$	10.	10.	new 3	.250	10.
.255	..	10.20	10.20	Haswell 3	.259	9.71
.260	..	10.40	10.40	old 3	.259	11.	2	.258	9.661
.265	..	10.60	10.60
.270	..	10.80	10.80
.275	..	11.	11.
.280	..	11.20	11.20	new 2	.28125	11.25
.285	..	11.40	11.40	old 2	.281	12.
.290	..	11.60	11.60	Haswell 2	.284	10.65	1	.289	10.849
.295	..	11.80	11.80
.300	..	12.	12.	old 1	.300	12.50
.305	..	12.20	12.20	Haswell	.300	11.25
.310	..	12.40	12.40
.3125	$\frac{5}{16}$	12.50	12.50	new 1	.3125	12.50
.320	$\frac{1}{4}$	12.80	12.80
.325	..	13.	13.	0	.3248	12.182
.333	$\frac{1}{3}$	13.33	13.33
.335	..	13.40	13.40
.340	..	13.60	13.60	new 0	.340	13.60
.345	..	13.80	13.80	Haswell 0	.340	12.75
.350	..	14.	14.
.355	..	14.20	14.20
.360	..	14.40	14.40

.365	14.60	00	.3648	13.68
.370	14.80
.375	15.
.380	15.20	new 00	15.20
.385	15.40	Haswell 00	14.25
.390	15.60
.395	15.80
.400	16.
.405	16.20	000	.4096	15.36
.410	16.40
.415	16.60
.420	16.80
.425	17.	new 000	17.
.430	17.20	Haswell 000	15.9375
.435	17.40
.4375	17.50
.445	17.80
.450	18.
.455	18.20	new 0000	18.16
.460	18.40	Haswell 0000	17.02	0000	.46	17.250
.465	18.60
.470	18.80
.475	19.
.480	19.20
.485	19.40
.490	19.60
.500	20.
.5625	22.50
.625	25.
.6875	27.50
.750	30.
.8125	32.50
.875	35.
.9375	37.50
1.000	40.

NOTE.—To find the weight of a square foot of the following metals, multiply the tabular weight of iron, column 2, by 1.48 for Lead; 1.16 for Copper; 1.092 for Gun-metal; 1.052 for Brass; 1.02 for Steel; 1.01 for Hammered-iron; .962 for Tin; .9375 for Cast-iron; .910 for Zinc. (D. K. CLARK).

TABLE VI.—Much loud scolding has no doubt been done by artisans and writers about the confusion among the different gauges for measuring the thickness of plates, etc. The Warrington, Birmingham, Whitwort, Holtzapffel, and Lancashire, are in use among English artisans, and they seem to be used for wire tubes and plates according to the caprice of the individual concern or the habits of a locality. D. K. Clark, in his *Manual of Tables, Rules, and Data for Engineers*, gives them all, with their history and uses. In this country we have the American wire gauge, published by C. H. Haswell in his *Engineers' and Mechanics' Pocket-Book*, which seems to be as arbitrary and irregular as any of the others, requiring in some cases four places of decimals with the plus or minus sign understood, indicating that the fraction does not perfectly express the thickness, and in others two. The table printed above is intended to show at a glance the discrepancies and agreements of the gauges most used in this country for the measurement of iron plates, viz., the Birmingham, old and new wire gauge, and the American wire gauge, all compared with the decimal system. It will be seen that D. K. Clark, Molesworth, and Haswell, the authorities from which the data are quoted, seem to disagree in the weight of iron plates of the same thickness, which is owing to the different specific gravities assigned to iron by the different authors (see head of columns 2 and 4), and to the probable fact that thin plates, such as sheet and gas-holder iron, are actually denser than thicker plates. However this may be, it is probable that there are many errors in the old practice. It is very desirable that a more uniform and simpler method of gauging should be encouraged and as far as possible adopted; therefore the weights of iron plates supposed to be of uniform density are given in the table per square foot, for thickness advancing by .005 from .01 to one inch, and opposite, in the same line, for comparison, is given the nearest gauge numbers, with the weights, given by the above-named authorities. It may be said that a gauge number is a very indefinite standard, while the decimal of any unit, say a given number of thousandths, hundredths, or tenths of an inch, foot, or mile, is readily determined and easily handled, and the tendency of the age is towards the adoption of the decimal system by American artisans. It has long been in use by bankers, accountants, and civil engineers.

Another Destructive Steam Boiler Explosion.

[From the *American Machinist*, Aug. 7, 1880.]

Editor American Machinist:

This is the title of a circular letter sent out by a boiler insurance company, and its contents show that it is intended as an advertisement of their prompt payment of the loss from the explosion.

This is right enough, as far as the commercial character of this company goes, but what about the cause of the explosion? I take it that all boiler owners would not be satisfied with having their policies paid without an investigation into the cause of the accidents, and doing all in their power to prevent their recurrence. From the tone of that circular, one would imagine the ultimatum of boiler insurance is simply to make good the money loss, and that the lives of men and the support of their families is a matter of secondary consideration. Why should there have been an explosion? That is the question. Explosions are not produced by witchcraft, or even the "visitation of God," as they were thought to be at one time; and engineers, especially, know that there is no effect without a cause. If, in our search for a cause, we cannot find it, then it is because of our ignorance or prejudice in old-time theories, such as low water (when there is no evidence of it), decomposition of steam into its constituents; oxygen and hydro-

gen; electricity; and many other notions which theorists have set up among themselves, rather than admit that part of a structure was too weak to resist the stress put upon it.

"The benefits of steam boiler insurance demonstrated," is the next sentence of that circular, and we find from it that on the 10th of May, a steam boiler exploded, killed three men, and made considerable havoc otherwise, notwithstanding the boiler was "thoroughly inspected ten days previously," and found "in first-class condition," this being "verified by the experts at the coroner's inquest." "Which was to be proved," written after this, would remind one of the comic writer who proved by logic that a pigeon was an eel pie.

The opinion of the writers of the circular is, that "we think the explosion was caused by low water." Now, why *think* so? Could not the experts on the Coroner's inquest have verified this point, as well as the fact of the boiler being in first-class condition? There must have been some evidence of overheating, which to an expert would be as plain as a page of a book.

If this circular had given the cause of the explosion, as arrived at by the testimony of competent experts, there might have been some benefit in sending it round, so as to enlighten people in what way a boiler may explode, although it be "in first-class condition." Boiler insurance should be a little different from this. The following is from a circular of an English company, and, I think, embodies quite a different principle from the above.

"This association was founded by ——, for the purpose of preventing steam boiler explosions by competent periodical inspection, *in order to save human life*. Not a *single person* has been killed or injured by any guaranteed boiler; whilst outside the ranks of the association, during the past ten years, 619 people have been killed, and 1,018 others injured."

The late Zera Colburn says: "All our knowledge of boiler explosions goes to show that . . . in the majority of cases the actual explosion results from some defects either original or produced, and either visible or concealed, in the materials, workmanship, or construction of the boiler." As this has been proved to be true by the great mass of evidence accumulated during many years, by the Boiler Inspection and Insurance Companies of Europe, and also by those in this country, it behooves every one interested, more especially Boiler Insurance Companies, to find out these defects. Again, Colburn says: "Probably not more than one per cent. of all steam boilers made ever explode at all." If this is true, it leaves plenty of margin for an insurance company to make a good thing of it, at the rates charged, and to amply repay them for investigating and inspecting, even if they did not reduce their percentage of explosions to that of the above-mentioned English company.

DAVID N. MELVIN.

Lineoleumville, S. I., N. Y.

It is proper to say that the circular letter in question was issued by a new company that is doing business under a general casualty and fidelity charter, and not by the old Hartford company. This pamphlet, *THE LOCOMOTIVE*, is the circular of the Hartford Steam Boiler Inspection and Insurance Company, which is issued gratuitously every month for the use and benefit of itself and its patrons. It was started, in another form, in 1867, the second year of the company's existence. The purpose is to diffuse correct information on the subject of safe and economical use of steam, and its motto is *fiat lux*, under which it endeavors to discuss and explain in the light of the company's long experience the accidents and dangers attending the use of steam and the means that have been found efficacious in preserving steam boilers. The benefits are obviously mutual since the interests of the company and its patrons are identical, and there can be nothing gained by concealment or misrepresentation.



Incorporated
1866.

Charter Per-
petual.

Issues Policies of Insurance after a Careful Inspection of the Boilers,

COVERING ALL LOSS OR DAMAGE TO

BOILERS, BUILDINGS, AND MACHINERY,

ARISING FROM

Steam Boiler Explosions.

THE BUSINESS OF THE COMPANY INCLUDES ALL KINDS OF STEAM BOILERS.

Full information concerning the plan of the Company's operations can be obtained at the
COMPANY'S OFFICE, HARTFORD, CONN.

Or at any Agency.

J. M. ALLEN, Prest. W. B. FRANKLIN, Vice-Prest. J. B. PIERCE, Sec'y.

Board of Directors.

J. M. ALLEN, President.	GEN. WM. B. FRANKLIN, Vice-Prest. Colt's Pat. Fire-Arms Mfg. Co.
LUCIUS J. HENDEE, Prest. Etna Fire Ins. Co.	GEO. CROMPTON, Crompton Loom Works, Worcester.
FRANK W. CHENEY, Asst. Treas. Cheney Brothers Silk Manufacturing Co.	HON. THOS. TALBOT, Ex-Governor of Mass.
CHARLES M. BEACH, of Beach & Co.	NEWTON CASE, of The Case, Lockwood & Brainard Co.
DANIEL PHILLIPS, of Adams Express Co.	WILLIAM S. SLATER, Cotton Manufacturer, Providence, R. I.
GEO. M. BARTHOLOMEW, Prest. Amer. Nat. Bank.	NELSON HOLLISTER, of State Bank, Hartford.
RICHARD W. H. JARVIS, Prest. Colt's Fire Arms Manufacturing Co.	D. R. SMITH, Prest. Springfield Fire & Marine Ins. Co.
THOMAS O. ENDERS, Sec'y Etna Life Ins. Co.	
LEVERETT BRAINARD, of The Case, Lockwood & Brainard Co.	

GENERAL AGENTS.

THEO. H. BABCOCK,
CORBIN & GOODRICH,
LAWFORD & McKIM,
W. S. CHAMBERLIN,
J. L. SMITH,
H. D. P. BIGELOW,
C. C. GARDINER,
D. C. FREEMAN,
W. G. LINEBURGH,
GEO. P. BURWELL,
W. B. CASSILY,

CHIEF INSPECTORS.

R. K. McMURRAY,
WM. G. PIKE,
JOSEPH CRAGG,
WM. U. FAIRBAIRN,
B. M. LORD,
H. D. P. BIGELOW,
J. S. WILSON,
F. S. ALLEN,
W. S. FOX,
A. C. GETCHELL,
J. S. WILSON,

OFFICES.

NEW YORK CITY.	Office, 285 Broadway.
PHILADELPHIA.	" 430 Walnut St.
BALTIMORE.	" 10 So. Holliday St.
BOSTON, MASS.	" 10 Pemberton Sq.
PROVIDENCE, R. I.	" 42 Weybosset St.
CHICAGO, ILL.	" 132 La Salle St.
ST. LOUIS, Mo.	" 404 Market St.
HARTFORD.	" 218 Main St.
BRIDGEPORT.	" 328 Main St.
CLEVELAND.	" 246 Superior St.
CINCINNATI.	" 53 West Third St.

The Locomotive.

PUBLISHED BY THE HARTFORD STEAM BOILER INSPECTION AND INSURANCE COMPANY.

NEW SERIES—VOL. I. HARTFORD, CONN., SEPTEMBER, 1880.

No. 9.

Explosion of a Flue Boiler.

A very destructive explosion of a rolling mill boiler occurred on the 11th of May, 1880, caused by a collapse of a large flue. It was a cylindrical, horizontal, single-flue boiler, built about 1870, and was 20 feet long, 4 feet diameter, made throughout of iron not less than $\frac{3}{8}$ of an inch thick. The flue was 22 inches diameter, and extended from end to end. The boiler was placed over a re-heating furnace and heated by the waste gases which entered the chamber below the boiler at the rear end, as indicated by the arrows, Fig. 2, passed the length of the boiler in contact with its lower half, and returned by way of the flue to the chimney. The boiler was supported at a height of 10 or 12 feet above the ground by 3 pairs of cast-iron brackets, which were riveted to the shell and rested upon the side walls. The boiler had flat wrought-iron heads flanged to the shell and flue, and stayed by 12 braces about 4 feet long, part of which were fastened to T-irons placed horizontally above the flue, one on each head, and the inner ends of the braces were attached to the ring of shell-plates that joined each head, as shown by the dotted lines, s, s, etc., Fig. 2. This boiler was one of a system of 10 which were similarly

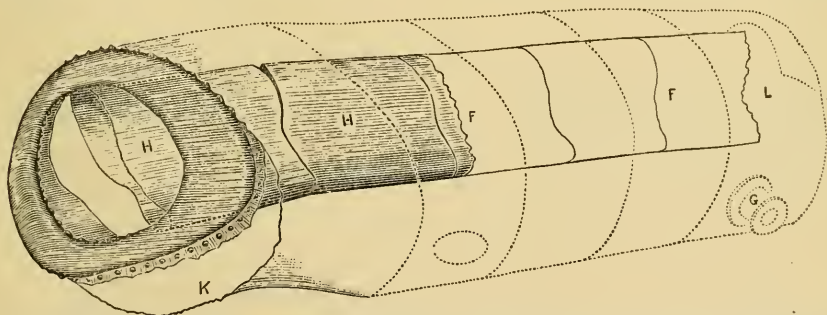

FIG. 1.—The dotted lines represent the unbroken part of the shell. The shaded portion at the left shows the foremost parts of the shell broken by the fall. The shaded portion of the flue remained in the shell, and that portion in flue outlines was blown out with the missing portion of the head at the right.

set and heated, all connected to two or more main steam-pipes, and each provided with a steam stop-valve, a safety-valve, and 3 gauge-cocks, but each did not have a steam-gauge. This particular boiler being without a steam-gauge, there was no means of ascertaining the pressure when the stop-valve, D, was closed except by such indications as the 2-inch patent lock-up safety-valve afforded. This boiler was supplied with water (the temperature of which is not known, but probably variable) at intervals through the pipe A, Fig. 2, as often as it got low, and no doubt as rapidly as could be done with the pump or large injector. The blow-off pipe, B, was located at the bottom and afforded means of completely emptying the boiler.

On Monday morning, at about 5 o'clock, the steam stop-valve, D, had been closed for an hour or so to repair a steam-pipe, and the 2-inch lock-up safety valve, C (which had neither cover nor lock), had been blocked open by means of a bit of wood placed inside the case, to relieve the boiler while the repairs were going on. The repairs done, the attendant let down the safety-valve, and was about to open, or had partly opened,

the steam stop-valve, when the explosion occurred. The cuts have been prepared from photographs and sketches, and the case has been made up as well as may be from them and the published evidence given to the coroner's jury. The boiler shell, fig. 1, containing $3\frac{1}{2}$ lengths of the flue, flew through the roof of the mill, taking a direction so that it landed nearly in a line with its projected axis at a distance of 130 yards from its working site, striking and demolishing a large area of the mill roof and a brick chimney in its flight. It struck the ground several yards short of where it stopped, and plowed a deep furrow in the ground in which it lay partly imbedded, the same end foremost that it had in the mill, by which operation the foremost head, K, was partly broken from the shell and the shell distorted something as shown in sketch, Fig. 1. Of the parts of the flue that went with the boiler shell, that shown in Fig. 3 was dropped out in its flight at about one-third

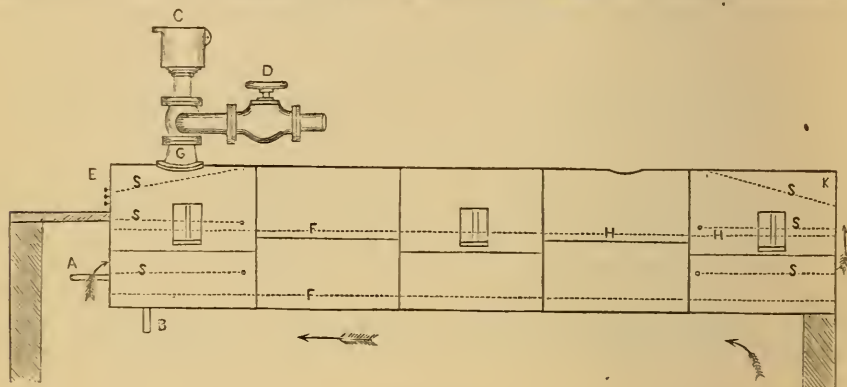

FIG. 2.

the distance made by the shell, while the other two, Figs. 4 and 5, remained in the shell, but entirely broken apart and from the head. The sides of the piece, Fig. 3, of the flue were shut together with such force as to emboss the forms of the heads inside upon the exterior surface opposite, W, fig. 3, and the two inner surfaces were in perfect contact as though the iron had been soft as wax when the parts came together; but there was also visible at S, the very summit of the flue when in its place, a dark, shiny, thin scale, which is often seen inside of boilers using a particular kind of water, which had not lost its glossy appearance, nor changed in color, indicating that it had not been hotter than usual since the scale was deposited there. Samples of iron having on them this kind of deposit have since been exposed to the heat, and it is found that a heat sufficient to change a brightened spot on the iron to a blue color, say about 550° or 600° F., was sufficient to blister the deposit and destroy its luster.

The experts who testified before the coroner differ as to the cause of the collapse, and it is probable from the nature of the subject that they will always differ in such cases. Experts from the scientific schools and from the learned professions are seldom in perfect accord when giving testimony, and often their opinions differ so widely that it is necessary to appeal to common sense.

We hear much lately about color-blindness, and reforms in modern practices call for a test of certain persons in very responsible positions as to their faculty of correctly distinguishing colors. And where this faculty is an essential qualification in reading the symptoms of a disease, or in the estimation of the properties that characterize a substitute under examination, this personal defect would seem to be a sufficient reason for such wide differences of opinion. There may be mental defects corresponding in some degree to this personal one which vitiate the logic of events and account for some wonderful decisions.

It is the object of the present writing to offer an unbiased technical discussion of

this case in the light of this company's experience, and for the good of all whom it may concern.

This boiler was a fair sample of a one-flue boiler, both as to material and workmanship, capable of bearing safely, when sound, the working pressure of 70 pounds, which was about $\frac{1}{3}$ of the collapsing pressure of the flue if it was round and sound. It was run as boilers usually are in works of this kind. A man of good habits was in attendance, who believed in plenty of water as a sure preventive of boiler explosions, and his practice was in perfect accord with his faith.

He was on hand and attending to his duty, which was first, last, and exclusively to see that ten boilers were fully supplied with water. He did not help repair the broken pipe: his attention was therefore not distracted by that event. The feed-valve was open, the steam-pump was in motion while the men were at work on the pipe. So swears the engineer who repaired the broken pipe. Other witnesses swear that the boiler attendant was about there trying the gauge-cocks; that he was seen trying gauges a few minutes before the explosion. The master mechanic swears that he, the boiler attendant, is directed to fill up as soon as the water falls below the upper cock; that he saw no indications of low water in the exploded boiler. Thus much, and no doubt more, evidence might be quoted relating to the probability that water was or was not low in the exploded boiler; all of which would be of no account if the theory of low water was confirmed by the testimony of the flue itself and by the general character of the explosion. Is it so con-

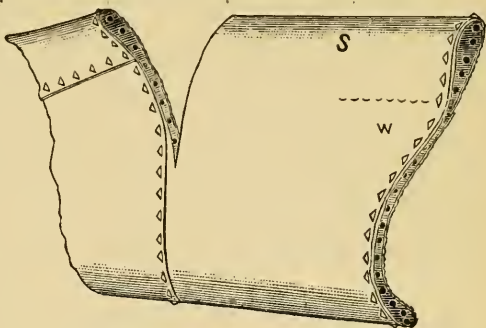

FIG. 3.

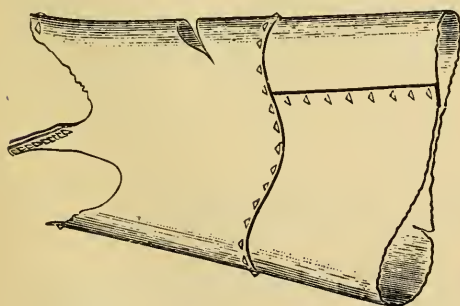

FIG. 4.

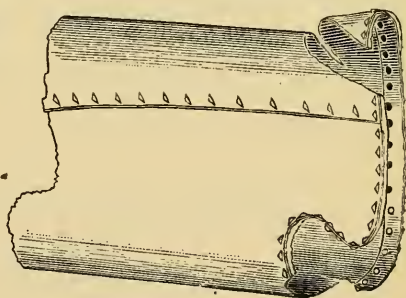

FIG. 5.

firmed? The records show that boilers which explode with no water in them are not shot through the air like a rocket, and those containing small quantities go short distances. The records also show that large horizontal flues that collapse on account of being softened by heat invariably cave in from the top only, and that lateral collapse is due to distortion of form or weakness at the side longitudinal seams from grooving or from thinning of the plate by corrosion. Two witnesses swear that grooving was observed, but as its location was not indicated little can be said about it. The parts not shown in the illustrations were cut to pieces and worked up, and no sketches or description of them were obtained. It must have been on those parts if there was grooving, as none was found on the parts sketched.

Finally, to satisfactorily account for all the phenomena that attended this explosion, we only have to show that the safety-valve was jammed so that it did not prevent the

rise of the pressure, and that the stop-valve was closed, or just being rapidly opened, at the instant when the limit of endurance had been reached by the boiler; and as every circumstance and all the testimony confirm the latter requisite, we have only to imagine that this small valve, with its compound levers and disc weights huddled into a case of 8 or 10 inches diameter and of less depth, which had been blocked open by means of a bit of wood placed against one of the levers when full relief to the boiler by its means was desired, was accidentally jammed when it was let down. The propositions below will not appear absurd to those who realize that over 3,000 cases of defective condition of safety-valves, most of them originally correct and proper, had been detected by this company's inspectors during the first twelve years of its experience, out of which number 1,400 were reported as dangerous, and that thousands of defects have been reported that were dangerous only in the event of an accidental over-pressure.

The following proposition seems to account for all the phenomena attending this explosion, while the theory of low water does not:

THE HYPOTHESIS

is, an accidental sealing of the boiler after the broken steam-pipe was repaired, the stop-valve, D, being still closed (or in the process of being rapidly opened), and the safety-valve jammed, the generating surfaces of the boiler in full action, the pressure rapidly rising, the flue, at best only about half as strong as the shell, had acquired (from the sudden thermal changes, due perhaps to the influence of the cold feed-water among other abuses of its ten years' night and day work) an obscure weakness, flattening, thinning, or grooving at a longitudinal seam, and the limit of its resisting power was soon reached at no *very* high pressure, and it collapsed near the middle of its length. The head, L, being the weaker, for obvious reasons, of the two, gave way instantly, when the shock of the collapse was added to its now extraordinary steam load, and it, with nearly half of the flue, fell inside the mill, and the expanding water began to issue from the open end of the boiler (the free steam from the steam space having left in one puff), while the boiler shell, with the remaining parts of the flue, started in the opposite direction, precisely as a rocket would do similarly placed after the compound was ignited, and in a similar manner it continued its flight until the expansive force was exhausted. Hence it will be seen that with so large an opening there must have been considerable contained water to send it so far.

BOILER EXPLOSIONS.

MONTH OF AUGUST, 1880.

MILL (92).—The cylinder-head of the boiler in Nelson & Brown's mill at Muskegon, Mich., blew out recently and the engineer had a narrow escape from some of the broken pieces.

LOCOMOTIVE (93).—Freight-engine No. 24 exploded her boiler at Noblestown, Ohio, on the Pan Handle, August 3d, with a terrific crash. Fortunately no one was on her at the time and nobody was injured.

THRESHER (94).—The boiler of a threshing-machine on the farm of Elias McCann, near Lakeland, Minnesota, exploded, August 9th, killing the foreman and two men, and wounding six or seven others, some of them seriously.

STEAMBOAT (95).—The steamboat Bonnie Lee was blown up and sunk at Lone Wall Landing, Red River, August 11th. The boat is a total loss, and was valued at \$15,000, insured in Cincinnati for \$9,000. The value of the cargo is unknown. Jeff. Persy, second clerk, was killed, and McDermott and his little son are missing.

PORTABLE SAW-MILL (96.)—A portable boiler at Pierce's saw-mill, near Ashland Furnace, Cambria county, about 12 miles west of Altoona, Pa., blew up, August 13th, killing John Allen, the engineer. His head and one arm and one foot were torn off. The mill was reduced to a wreck. Two other men were in it at the time, but escaped serious injury.

STEAM BARGE (97.)—At 8 o'clock, August 16th, the boiler of the steam barge George Sheldon, lying at the new Wabash elevator, Toledo, O., exploded with terrific force, and seriously scalded three men, the engineer, firemen, and also a woman cook. All will recover. The explosion made sad havoc with the wood-work of the boat.

STEAM DREDGE (98.)—The boiler of the dredge Colonel Harwood exploded Aug. 16th, about 9 o'clock, while the craft was at work in the river near the Wabash elevator, Toledo, O., severely injuring C. Skeldon, engineer; F. Miller, cranesman; William Constantine, fireman, and wife; and Edward Straight, deck-hand. The fireman stated that since the 7th day of last June the dredge Colonel Harwood, with the same men aboard as at the time of the accident this morning, has been working around the new elevator deepening the channel. During that time they have worked fifteen hours a day, beginning at 5 o'clock in the morning, and working until 8 o'clock in the evening. This morning, as usual, he had everything ready for work at 5 o'clock. Everything passed along the same as usual until the time of the accident, 9 o'clock. A few minutes before, he looked at the steam-gauge and saw that it marked 100 pounds and only a low fire. He then left it, and in company with the deckhand and the cranesman was pulling a mud-scow alongside to load. He and the deckhand were standing amidship and the cranesman was forward. The engineer was standing aft of the engine scrubbing out one of the rooms. At this time, without any warning whatever, the explosion occurred. As soon as possible he and the deckhand, neither of whom was injured in the least, set about taking care of the others, and continued doing so until they were placed aboard of the tug. Strange as it may seem, only the middle portion of the dredge is wrecked, that part directly above and under where the engine stood. The boiler was rather a small-sized upright concern, and it is supposed that on account of its position more of the dredge was not destroyed. As it is, the bottom and top are entirely gone. At the time, it was working in about five feet of water, and as soon as the explosion occurred the boat sank.

FLOUR MILL (99.)—A terrific explosion occurred August 18th, at Colliers Station, seven miles east of Steubenville, Ohio. Both boilers in Ryland's flouring-mill exploded, carrying away one end of the building. The loss is estimated at \$1,200. The engineer left his position but a few minutes before the explosion took place.

BLEACHING KIER (100.)—A kier in the bleachery of B. B. & R. Knight, at Pontiac, R. I., exploded August 19th, killing the attendant, James Murray, blowing off the top of the kier-house and throwing the cloth to the top of the bleachery.

OIL-WELL (101.)—At 6 o'clock, August 27th, a boiler on the King farm, Bradford, Pa., exploded with terrific force, demolishing the engine and boiler-house and tearing the derrick into a thousand pieces. Wilbur Chambers, a cousin of Wesley Chambers, the oil prince, was in the engine-house at the time. He was blown 400 feet through the air, landing on his back. One of his finger-nails was torn out at the roots, but no bones were broken. He was picked up unconscious, has not yet revived, and cannot live.

FLOUR MILL (102.)—The boiler in A. S. Staples' flouring-mill at Rondout, N. Y., exploded August 28th, fragments going through three floors and breaking away 20 feet of the roof. The cover to the man-hole of the boiler descended through the roof of Meyer's carriage-factory adjoining. The employees had not gone to work and no one was injured.

OIL WORKS (103.)—About 3 o'clock P. M., August 29th, the boiler of the National Oil Company, whose establishment is No. 225 Canal street, Cleveland, Ohio, exploded. William Welch, the foreman, was struck in the head by a piece of flying timber and felled to the earth insensible. His face and shoulders were terribly scalded by the escaping steam. J. B. Huston, another workman who was standing by Welch's side, about twenty feet from the boiler, escaped with a severe scalding of the face and arms. Mr. Huston, Welch's fellow-workman, stated that the boiler was built for a six-horse power engine, and was, so far as he knew, in a sound condition. The boiler-house was completely demolished, not a board being left standing. The boiler struck in the lumber-yard of Fisher, Wilson & Co., about 500 feet distant. In its passage it struck a large telegraph-pole, knocking out a section about five feet in length, leaving the upper end suspended by the wires. The flying boiler also knocked out two of the supports of the Factory street bridge. Had it not been for these obstacles in its path, the work of this vagrant boiler might have been more destructive, as it struck the ground just under the eaves of the planing-mill, in which a number of men were working.

Inspectors' Reports.

The number of inspection visits in the month of July, 1880, was 1,855, and 4,289 boilers were inspected. Of this number, 2,023 were thoroughly examined internally and externally, either as new risks or for renewal of insurance. The hydrostatic pressure was applied to 310 boilers, mostly new or repaired.

A review of the work done in this department shows an increase of about sixty-five per cent. of the average monthly duty for the first six months of 1880, and fully seventy per cent. increase over June of this year; but as indicating the actual increase of work, the first six months of this year are compared with the corresponding period of 1879, by which we find an *increase of over thirty per cent.* of the whole number of boilers examined in the first six months of 1879.

The whole number of defects discovered during the thirty-one days of July was 2,124, of which 436 were dangerous.

The following indicates their character in detail.

There were 98 furnaces out of shape and defective. In some cases the fire-sheets were bulged, in others the brick-work had fallen down or was so defective as to expose the shell above the water-line, or the dry smoke-arch at the front of horizontal tubulars, to the destructive action of the fire, besides many cases of ashes on the bridge-wall or in contracted passages under the boiler packed in contact with the shell, which, by gathering dampness when the fires are out, promote corrosion of the plates. Among these defective furnaces there were 23 in dangerous condition.

There were 174 cases of plate-fractures of various lengths and widths, some only barely visible when the boilers were cold, others were detected by indications in their vicinity, while the cracks themselves could not be detected by the unaided vision and would have been left to extend under the influence of strains caused by unequal expansion and contraction and become dangerous, had not the trained eye of the inspector observed the marks indicating incipient rupture, applied his magnifier, and recommended repairs. Of the above number of this class of defects, 109 (a large percentage) were reported as of a dangerous character.

Burned plates are those that have been overheated. Sometimes old scale which has been detached by the action of some solvent gathers in a pile and is cemented into a sticky conglomerate mass by the grease which has found its way from the engine-cylinder along with the feed-water into the boiler, to which it adheres when the water is blown out, and becomes one of the most troublesome defects, and often dangerous. Plates are also

burned from being altogether uncovered inside while exposed to the fire. Some cases of burns due to the "oven-setting" of externally fired boilers where the direct heat impinges on the entire shell, overheating that portion above the water; also a number of cases of burned plates, tubes, and crowns of furnaces are reported which have occurred from deficiency of water. Of the 87 burned plates reported this month, 30 were dangerous.

There were 459 cases of blistered plates, 40 of which were dangerous. This great number of blisters suggests the preference for ingot-steel plates, which do not blister, as a material for boilers. Although the percentage of dangerous blisters on iron plates is not large, still no boiler-owner feels satisfied with a boiler covered with scabs or the cavities from which they have been removed, and all must agree that smooth plates of tough, homogeneous metal are much safer, more durable, and more desirable altogether for steam-boiler construction.

Cases of sediment and deposits, 297—29 dangerous. Incrustation and scale, 376—37 dangerous. External corrosion, 112—22 dangerous. Internal corrosion, 83—15 dangerous. Internal grooving, 63—29 dangerous. This defect sometimes appears as a nar-

row, deep fissure almost through the plate, which may be obscure and very difficult of detection, running along close to the inner lap of the longitudinal seam, or as a furrow of considerable breadth near any of the seams that are exposed to undue strains, such as tend to disturb the fibres of the metal and open the pores, or derange the continuity of the particles so as to expose their minute surfaces to the chemical action of moisture. When tensional strains are applied, acting perpendicularly or at a right angle to the line of the seam and parallel to the surfaces of the joined plates, there is a tendency to distort the lap by throwing the parts that form the seam out of line, the angle which the parts assume relatively to the surface of the plate depending on the thickness of the plate and the breadth of the lap. Thick plates and narrow laps give the greater angle. This may be illustrated by making a



FIG. 1.

model of a lap of a stiff sole-leather strap by cementing butts of full thickness, nailing one end to a beam, and suspending a heavy weight upon the other, as shown in fig. 1. The same tendency to distort the lap exists if the plates are formed into a cylinder and subjected to a uniform force acting radially upon the entire interior surface, that is, to internal steam, gas, or fluid pressure under which the tension line becomes a true circle instead of a straight line. See fig. 2.

If the material is not sufficiently ductile and tenacious to preserve perfect molecular contact—in other words, if it is brittle and the pores are opened, and the skin broken at the edges of the lap c and d, and moisture is present, the material, being sensitive to it, will go on deteriorating in an increasing ratio as the material is wasted and less able to endure the load. It breaks at last along the lap, through the part that originally had the full strength of the plate, while a line through the rivet-holes had much less. The most destructive shell explosions have occurred from this defect in longitudinal seams.

The whole number of defective water-gauges discovered was 53—5 of them dangerous. Blowouts defective, 22—6 dangerous. Safety-valves overloaded, 12—7 dangerous. Pressure-gauges defective, 170—41 dangerous. Boilers without gauges, 48. Cases of deficiency of water, 18—12 dangerous. Broken, unfastened, and loose braces and stays, 52—31 dangerous. Boilers condemned, 58.



FIG. 2.

TABLE VII.

DIMENSIONS AND WEIGHT OF AMERICAN BOILER-TUBES.

(Morris, Tasker & Co's Standard).

External Diameter.	External Circumference.	Internal Diameter.	Internal Circumference.	Thickness.	Length of pipe per sq. foot of inside surface	Length of pipe per sq. foot of outside surface	Internal Area.	External Area.	Weight per foot.
Ins.	Ins.	Ins.	Ins.	Ins.	Feet.	Feet.	Inches.	Inches.	Lbs.
1	2	3	4	5	6	7	8	9	10
1	3.142	0.856	2.689	0.072	4.460	3.819	0.575	0.785	0.708
1 $\frac{1}{4}$	3.927	1.106	3.474	0.072	3.455	3.056	0.960	1.227	0.9
1 $\frac{1}{2}$	4.712	1.334	4.191	0.083	2.863	2.547	1.396	1.767	1.250
1 $\frac{3}{4}$	5.598	1.560	4.901	0.095	2.448	2.183	1.911	2.405	1.665
2	6.283	1.804	5.667	0.098	2.118	1.909	2.556	3.142	1.981
2 $\frac{1}{4}$	7.069	2.054	6.484	0.098	1.850	1.698	3.314	3.976	2.238
2 $\frac{1}{2}$	7.854	2.283	7.172	0.109	1.673	1.528	4.094	4.939	2.755
2 $\frac{3}{4}$	8.639	2.533	7.957	0.109	1.508	1.390	5.039	5.940	3.045
3	9.425	2.783	8.743	0.109	1.373	1.273	6.083	7.069	3.333
3 $\frac{1}{4}$	10.210	3.012	9.462	0.119	1.268	1.175	7.125	8.296	3.958
3 $\frac{1}{2}$	10.995	3.262	10.248	0.119	1.171	1.091	8.357	9.621	4.272
3 $\frac{3}{4}$	11.781	3.512	11.033	0.119	1.088	1.018	9.687	11.045	4.590
4	12.566	3.741	11.753	0.130	1.023	0.955	10.992	12.566	5.320
4 $\frac{1}{2}$	14.137	4.241	13.323	0.130	0.901	0.849	14.126	15.904	6.010
5	15.708	4.72	14.818	0.140	0.809	0.764	17.497	19.635	7.226
6	18.849	5.699	17.904	0.151	0.670	0.637	25.509	28.274	9.346
7	21.991	6.657	20.914	0.172	0.574	0.545	34.805	38.484	12.435
8	25.132	7.636	23.989	0.182	0.500	0.478	45.795	50.265	15.109
9	28.274	8.615	27.055	0.193	0.444	0.424	58.291	63.217	18.002
10	31.416	9.573	30.074	0.214	0.399	0.382	71.975	78.540	22.19

NOTE.—The above Table is substituted for the one in first edition, which contained several errors.

TABLE VIII.

SHOWING PROPER DIAMETER AND AREA OF ONE COMMON LEVER SAFETY-VALVE IN GOOD ORDER FOR DIFFERENT HOURLY CONSUMPTION OF GOOD COAL IN BOILERS HAVING A PROPER MARGIN OF STRENGTH ABOVE THEIR WORKING PRESSURE. NO OTHER NOTICE TAKEN OF THE WORKING PRESSURE.

Coal per Hour. Pound.	Diameter of Valve in Good Order. Inches.	Area Opening Covered by Valve. Square Inches.	Coal per Hour. Pound.	Diameter of Valve in Good Order. Inches.	Area Opening Covered by Valve. Square Inches.
17	1	.78	132	2 $\frac{3}{4}$	5.94
30	1 $\frac{1}{4}$	1.22	157	3	7.06
40	1 $\frac{1}{2}$	1.76	183	3 $\frac{1}{2}$	8.29
54	1 $\frac{3}{4}$	2.4	213	3 $\frac{3}{4}$	9.62
70	2	3.14	250	3 $\frac{1}{2}$	11.04
88	2 $\frac{1}{2}$	3.97	300	4	12.56
109	2 $\frac{1}{2}$	4.9			

Valves so constructed that they lift by reaction so high as to afford a clear opening around the valve equal to $\frac{1}{2}$ the area of the opening covered by the valve are safe for double the amount of coal in column 1 and 4 if the boiler is otherwise adapted to the conditions.

Valves of the common type above 4 inches diameter are objectionable, and boilers consuming more than 300 pounds of coal per hour should have two smaller safety-valves with a combined area equal in square inches to the pounds of coal per hour, multiplied by .045.

Tables VII and VIII.

Table VII contains all the necessary dimensions and the weight per foot in length of American charcoal lap-welded boiler tubes. It will be found useful in calculating the heating surface, weight, and sectional area for draft of the tubular portion of steam boilers.

For the total *exterior* heating surface in *square feet* of all the tubes in a given boiler, multiply the whole length in feet of all the tubes by the number in column 4 standing in the line of the diameter of the tubes, columns 1 and 9.

For the *interior* surface use number in column 5.

For the *weight* of all the tubes use number in column 6.

From the cross area for draft in *square feet*, multiply the *number of tubes* by figures in column 7.

For same in *square inches* multiply the *number of tubes* by figure in column 8.

Table VIII is intended to facilitate the determination of the proper diameter and area of the common form of safety-valve for any given case where the quantity of coal burned per hour is known, and it is introduced here as a sequel to the article on pages 131 and 132 of the August number of THE LOCOMOTIVE. It is based on the experiments (mentioned in that article) from which the basis of the government rule was deduced. That basis is the number of pounds of water evaporated per hour, regardless of steam pressure, multiplied by the decimal .005, which gives the area of the valve in square inches. The decimal used in calculating this table is nine times greater, namely, .045 upon the supposition that the maximum effect of the combustion of one pound of coal in ordinary practice is the evaporation of nine pounds of water. The amount of coal burned is easily obtained in most cases, while it would be generally difficult to obtain the effect in water evaporated.

The Boilers of the "Livadia."

Those engineers who hold that steel is not a good material for steam boilers, will find some support for their opinions in the failure of the Czar's yacht Livadia. This vessel was to have had eight main boilers of steel. Six of these were finished and ready for the hydraulic test of 150 pounds to the square inch. On the pumps being set to work, the first boiler split through the solid steel plate, the longitudinal crack being three feet long, the pressure reached being 140 pounds. The whole of the boilers were therefore condemned. It was determined however to proceed with the test, and three more were easily burst, with pressure varying, we are told, between 80 lbs. and 140 lbs. The plates were of Cammel's steel. The experiment will go far to cause the rejection of steel by ship owners as a material for boilers. It is also stated that experiences recently acquired are all against steel as regards the durability of furnace-plates; and some eminent marine engine builders will not employ it on any terms. So far, nothing more is known concerning the breakdown of the Livadia's boilers than the broad facts as stated above, but the subject is so important that it is to be hoped Messrs. John Elder & Company will supply full information on the subject.—*The Engineer*.

The Boston *Journal of Commerce* clipped the above from the *Iron Age*, and reproduced it in their issue of late date, taking up the cudgel in favor of steel, more especially American steel, and specifically Boston steel, as not being that kind of steel at all. It says, "The use of steel in boilers has come to be very large in the United States. For fire-plates it has been largely used for the last twelve years at least, and its use has increased with each succeeding year. The Benzons steel made from open hearth Siemens Martin steel, has probably been put into more than two thousand boilers which are now in use in different parts of New England without so far as we know a single rupture from hydraulic tests a long way above 140 pounds. . . . A dozen good boiler-makers scattered through New England are using it very largely. Boilers are now in use at

from 80 to 125 pounds pressure, made from this steel entirely, or from steel fire-plates with best iron, working as high as 90 to 100 pounds to our knowledge. We believe the experiences of manufacturers, as well as boiler-makers, are most decidedly in favor of the increased use of steel. The experiences which have been acquired in this country have all tended to attain the highest proficiency in the manufacture of the best material, and an increased use of steel most decidedly. Steel has certainly a greater tensile strength, more homogeneousness, is not liable to lamination, does not deteriorate by long use, with proper care can be made less in thickness than iron—which leads to economy, is relatively safer with the same weight of metal and a high pressure, and we believe properly made that a steel boiler is decidedly safer than the best wrought-iron one. We know of boilers which were in use five years since, that were put in on trial; the orders have been quadrupled since that time, and steel has been used in preference to iron." It also mentions a New England firm who manufacture steel boiler-plates from open hearth Siemens Martin steel, who have recently erected a train of rolls at a cost of \$50,000 in order to roll ingots that should weigh one and one-half tons especially for making Benzoin steel boiler-plates.

To those older engineers and practical mechanics who are not well posted in the improvements in steel making, and who always think of cast steel as it was in the days of their apprenticeships, the statements about the failure of the Livadia's boilers seems to accord with their expectations, and even to-day a fine high steel that would be suitable for a Damascus sword blade, which would harden to a high temper if exposed when hot to a strong blast of cold air, might be expected to revolt if exposed to the treatment often given to boiler-plates.

Such *high steel* (highly carbonized) when tested in a machine by pulling it in a line parallel to its surfaces would show a high tensile strength, but ductility would probably be absent, and it would break as glass or other brittle substances do without contraction of the ruptured area. This property, ductility, is an essential one in boiler-plates, but it is not generally found associated with very great tensile strength in steel. It is very desirable that both tensile strength and ductility should abound in steel boiler-plates. Ingot steel has the beautiful quality of homogeneity, and it cannot therefore become laminar as piled iron plates do, and although its power of transmission of heat as laid down in the books is but little superior to iron, yet in practice it is claimed that it is really much better than the books show; the difference between theory and practice may be accounted for partly by the laminated character of the iron plate which is not contemplated in the theoretical estimation of its heat-conducting power, but more, perhaps, by the alleged fact that it is claimed that the steel plates with equal care and under the same conditions keep cleaner while in use. A contemporary publishes the results of a trial of steel and iron boilers which was made by the Prussian Government, by which it appears that there was considerable gain in the use of steel over iron boilers in the matter of the quantity of water changed into steam, but there appeared a remarkably small amount of incrustation in the steel boiler as compared with the iron one. The conclusion reached was, that the evaporative power of the steel was to that of the iron, as 5 is to 4. The greater cause of the gain was, no doubt, the superior cleanliness of the steel boiler, notwithstanding great account is usually made of the fact that the steel plates are the thinner, for the same strength as 41 is to 25 in this case, and to the fact that the steel was more compact and a better conductor of heat. The question naturally occurs, what became of the heat that was not absorbed by the thinner boiler, the amounts generated by the equal combustion being equal in the two cases, while the iron boiler absorbed only $\frac{4}{5}$ as much as the steel one, which was simply the cleaner and the thinner, and therefore the more sensitive. There is a great dearth of statistics and plenty of dogmatism on the subject of the superior efficiency of steel as a transmitter of heat, and its treachery as a material for boilers.

The Locomotive.

HARTFORD, SEPTEMBER, 1880.

“There is too little attention given by manufacturers to their boiler power. The tendency is to crowd on machinery until the boiler becomes over-worked.”

There is no economy in such practice, and it is certainly unsafe. When business is driving, men in their hurry forget that engines and boilers are generally put into a manufactory with some reference to their adaptability to each other, and to the work to be done, therefore the adding on of additional machinery is simply overloading the motive power. The error shows itself in extra consumption of fuel. Extra repairs are occasioned, with a liability to something even more serious.

The Baldwin Locomotive Works are at the present time employing about 3,000 workmen, and they build at the rate of ten locomotives a week. One can gain but little idea of this immense establishment without visiting it. And yet everything seems to be managed with as much ease and less bustle than many small work shops. Three regiments of men in the employ of one concern is no small force, and it requires men of brains, experience, and sound judgment to run such an establishment successfully.

We are in receipt of the report of the Board of Supervising Inspectors of Steam Vessels, for the year ending Jan. 1, 1880. It contains very full particulars of the casualties which occurred during the year, also the rules and regulations adopted by the board for the prevention of such accidents. If these rules were faithfully observed, accidents would be very rare, and we believe the efforts of Supervising Inspector-General James A. Dumont, seconded by his corps of assistants, will greatly diminish the liability to them.

THE PRESIDENT of the American Society of Mechanical Engineers, has issued a circular, published in the *Iron Age*, Sept. 30, which we print below. This society was organized in April, 1879, and its first annual meeting is to be at the rooms of the American Society of Civil Engineers, No. 104 East Twentieth street, New York, on the 4th day of November, 1880. The object of this organization is “to promote the arts and sciences connected with engineering and mechanical construction,” and it has a membership of nearly two hundred already, most of whose names were published in a former number of THE LOCOMOTIVE.

HOBOKEN, N. J., Sept. 22, 1880.

Dear Sir: In view of the influence which the number and quality of the first year's papers must necessarily exert upon the prospects of the society, I would respectfully urge your attention to the importance of early preparation of papers for the meeting which is to be held in New York on November 4th next, and which is now so near at hand.

Any papers which the author cannot be present to read should be sent to the treasurer.

It is desirable that early notice of the titles and probable length of all papers which are to be read at the meeting should also be sent to the treasurer, together with a statement of the number and size of drawings which may illustrate them.

Very respectfully,

ROBERT H. THURSTON, *President.*

Steam Motors.

A vast amount of mechanical skill has been bestowed during the past hundred years in improving the steam engine; but when we come to compare the actual duty obtained from even the best form of engines, with the duty that theory requires that a perfect engine should yield, the margin for possible improvement will be found to be still very wide. So long as this is the case our inventors will find it far more profitable to let "new motors" alone and direct their ingenuity to the further improvement of the steam engine.

The following simple calculation will make the status of the steam engine clear: The steam engine is an apparatus for converting heat into mechanical effect. It will be necessary, in any attempt to get at the theoretical duty of such an engine, to know at the outset just what the mechanical value of a given amount of heat is—in other words, to know the mechanical equivalent of heat. Scientific investigation has given us here just the starting point we require in the unit called the "foot-pound"—that is, the force required to raise a weight of one pound to the height of one foot. Now, since we learn from the steam engine that heat and mechanical effect (or work) are convertible, if we could by any means convert mechanical effect into heat so that none of it should be lost or dissipated, we should have the data given from which to calculate the mechanical equivalent of heat. This has been done by several eminent men of science, and their experimental results have been surprisingly close. Their efforts were directed to the determination of the amount of mechanical energy required to raise the sensible temperature of one pound of water 1° Fahr. This quantity, expressed in foot-pounds, gives for the mechanical equivalent of heat 772 foot-pounds.

To explain the significance of this constant in another way, we may state that the mechanical effect exerted by a body weighing one pound, that has fallen from the height of 772 feet, would, if converted into the form of energy called heat, be just sufficient to raise the temperature of one pound of water 1° Fahr.

Having established the equivalency of heat and work in measurable terms, the remaining portion of the problem is made comparatively easy. First, it is necessary to determine the perfect heating effect of the combustion of one pound of pure coal. This, too, has been done, and it has been found that the entire quantity of heat liberated by the burning of one pound of pure carbon, when applied without loss to heating one pound of water, will raise the temperature of that quantity of water almost exactly 14,220° Fahr., or, what is the same thing differently expressed, will raise the temperature of 14,220 pounds of water 1° Fahr.

Now, to get the mechanical effect of this value, we have the following simple procedure: As the heating of one pound of water 1° demands the conversion into heat of a quantity of mechanical energy equal to 772 foot-pounds, therefore the heating of 14,220 pounds 1° will require the conversion of $772 \times 14,220 = 10,977,840$ foot-pounds, which is the mechanical equivalent of one pound of pure coal burned without waste.

To convert this value into more familiar terms of horse-power, it is simply necessary to divide it by 33,000, performing which operation, we have

$$\frac{10,977,840}{33,000} = 332.6 \text{ horse power.}$$

That is to say, one pound of pure coal, burned in one minute, should, if it could be applied with absolute economy to the performance of work, develop 332.6 horse-power; or, if burned in an hour, then it should develop 1-60th of this, or $5\frac{1}{2}$ horse-power per hour; or 1 horse-power should be developed by the burning of (approximated) 1-5th of a pound of coal.

The theoretically perfect steam engine, therefore, ought to yield us for every pound of coal burned $5\frac{1}{2}$ horse-power. By comparing these conclusions with the results of practice, we will see how far from perfection our steam motors really are. The actual consumption of fuel per hour per horse-power will, of course, vary largely in practice, according as the apparatus is well or badly constructed, and properly or wastefully operated. But, putting such disturbing elements aside, we will take the best results of the best practice in making a comparison. Taking marine engine practice, which gives us the best results, the best of these require from $2\frac{1}{2}$ to 3 pounds of coal to develop a horse-power. As 1-5th of a pound of coal should develop this mechanical effect if all its heating effect were realized, it is evident that our best steam engines are only realizing $1-5 \div 2\frac{1}{2} = 2-25$ ths, or say about 1-12th, or about 8 per cent. of what theory shows us should be realized. To make this comparison more just, it is proper to make allowance for the fact that the actual heating power of commercial coals, owing to their impurity, is considerably lower than the theoretical figures used in this calculation, and for other causes that lower the duty, and for which the steam engine is not responsible—making such allowance, it is reasonably safe to say that our steam motors to-day do not realize more than 15 per cent. of the power that theory demonstrates to be available.

The successful demonstration of the capabilities of the Perkins high-pressure system shows, however, that we are on the verge of another decided advance in the direction of greater economy in our steam motors, which bids fair, when the system shall have been fully developed, to raise the figures of practice much nearer to those of theory. The miniature steamer "Anthracite" developed, in her Atlantic trip, one horse-power per hour with one pound of coal, a performance which more than doubles that of the best engines hitherto constructed, and which will doubtless be materially improved upon when the Perkins system is applied to our large ocean steamships, where much greater economy may be safely expected. Even with this substantial gain in duty; there will still remain a wide margin for future improvement before the demands of theory are even distinctly approached; and, as remarked at the outset of this article, our inventors have no need, so long as this is the case, to look about them for a new field in which to exercise their ingenuity.—*Manufacturer and Builder*.

Cooper's Mechanical Movement.

Mr. J. H. Cooper, superintendent of the People's Works, Philadelphia, a well-known engineer and writer on mechanical subjects, has invented and patented a device for converting a uniform rotary into intermittent rotary motion. This device was illustrated and described in the *Manufacturer and Builder* for July, and in the issue for August the following appears in relation to it:

"The following additional facts respecting the interesting mechanical novelty illustrated and described in our last month's issue, should have been incorporated in that article, but not having been received in time, we give it in as an addendum herewith:

"The Judges of Award at the Centennial Exhibition made the following report upon Mr. Cooper's mechanical movement: 'He exhibits a method of changing continuous circular into intermittent circular motion. This invention is characterized by great originality and ingenuity, and differs from previous attempts to attain this end, in that it accomplishes it without shock, and therefore admits of being run at great speed, in which respect it is an important improvement in motion of this character.'

"The report in question is a high endorsement of the meritorious features of this invention. We will add, in conclusion, that any inquiries respecting the use or purchase of rights in this invention may be addressed to John H. Cooper, 135 Wister street, Germantown, Philadelphia, Pa.

The Man who ran the First Locomotive in America.

At the recent commencement exercises of Stevens Institute, Hoboken, N. J., one of the interesting features was the extempore remarks made by Horatio Allen, who was introduced to the audience by Prof. Morton as the Nestor of American engineers.

Among other things he said that the first locomotive brought to this country was purchased by himself for the Delaware and Hudson Canal Company. This engine, the first to draw a railway train on this continent, was run for the first time on the road connecting the Lackawanna coal fields with tide-water by way of the Delaware and Hudson canal. It was the first road of any consequence to adopt locomotive power.

Mr. Allen gave a graphic description of the scene; how he mounted the engine alone placed his hand boldly upon the lever of the throttle, and pulled the valve wide open, resolved if he went down to go manfully. He took an honest pride in being able to present to the audience the man who owned the hand that opened the valve of the first locomotive on the continent, and who took the first ride on the first railroad. This experimental trip was made at Honesdale, Pa., Aug. 8, 1829.—*Exchange.*

Interesting Statistics.

The production of agricultural implements in this country gave employment in 1850 to 5,361 hands, in 1860 to 12,867, and in 1870 to 23,251. Now the number of hands engaged in this industry is 40,680. Maine now has 282, New Hampshire 245, Vermont 495, Massachusetts 646, Rhode Island 108, Connecticut 790, New York 7,237, Pennsylvania 3,097, Delaware 71, Ohio 10,248, Michigan 1,938, Indiana 2,526, Illinois 7,870, Wisconsin 2,700, Minnesota 330, Iowa 1,104, Missouri 1,074, Kansas 261, Nebraska 81. Ohio has made notable advancement in this industry. In 1860 she had 165 persons employed in it, and to-day has 10,248.

Alabama is as large as England, and yet has only 1,000,000 of people to England's 21,000,000. California, with less than 1,000,000 of people, is very little smaller than France with 38,000,000. Nevada is a little smaller, and Oregon larger, than New York and Pennsylvania combined, so either of these new States could easily hold the two older States' combined population of 8,500,000. We do not think Massachusetts overcrowded with 1,500,000, nor Ohio with less than 3,000,000, nor New York with 4,500,000. And yet, if Texas were settled as thickly as New York, its 1,000,000' would grow to 22,000,000; if like Ohio, it would have 21,000,000; if like Massachusetts, it would hold 52,000,000, or more than the whole present population of the Union. There are only fifteen States out of the thirty-eight which have more than 1,000,000 of people, while there are fourteen States which have a larger area than England with her 21,000,000. Settled like England, these States would have more than 300,000,000. The States towards which emigration is now mainly setting are Minnesota, Nebraska, Kansas, Texas, and Colorado. These about equal Missouri in population, while their area is ten times hers. So to be evenly populated like Missouri, sparsely populated as that State is, these five should have 29,000,000; and to be settled like Massachusetts, being ninety times as large; they must have 135,000,000, or three times our country's present population. If the whole territory of the Union were settled like New York, it would contain 270,000,000; if like Massachusetts, 560,000,000; and if it reached England's ratio of inhabitants to the square mile, its population would almost equal the present population of the globe.—*Exchange.*

A girl just returned to Hannibal, Mo., from a Boston high school, said, upon seeing a fire engine work: "Who would eva have dweamed such a very diminutive-looking apawatus would hold so much wattah!"

England's Business Competitors.

A late article in the *London Times* draws attention to some important statements of the English Consuls at Cuba and Florence, Italy, showing how serious has been the falling off, within a few years, of England's once large and stable importation of manufactures to these two countries.

Consul General Cowper, at Cuba, states that England's formerly unapproachable import of machinery and hardware to that island is unmistakably passing into the hands of rivals; the only remnant of trade in these lines being a limited import of cutlery and large pieces of machinery, such as steam plows, sugar engines, etc.; and even these are now sent out from other countries, notably the beautifully made vacuum pans, centrifugal and distilling machines from France. The large cane knife, or machete, once largely exported from England, is having its sale greatly displaced by American and German knives, which, except in the matter of polish, are evidently superior, and are sold at equal prices. The American plow is superseding that of English manufacture; for not only is the former one-third cheaper, but it is especially adapted to the soil of Cuba, of which the American plow-maker has made a study. A like superiority and preferableness are true of American heavy machinery, such as are used on sugar estates; and the iron rails imported from this country also have an advantage.

In Italy, according to the report received from Consul Conaghi at Florence, German enterprise is gradually driving the English out of their Italian market for steel rails and locomotives, Sheffield tools and turning lathes, and such like machinery. The United States is also making a push to obtain a good foothold in the Italian market; and to facilitate this end, the *Scientific American*, an able exponent of the hardware interest, is being widely distributed throughout that country.—*Exchange*.

This is the portion of J. B. Hannay's paper in which he describes how, after many failures, he crystallized carbon: "A strong steel tube was filled, using four grammes of lithium and a mixture of bone oil, carefully rectified, 90 per cent., and paraffine spirits 10 per cent., using these proportions because I have never had any result with a high percentage of bone oil, the tubes so filled having burst. The tube was closed with difficulty, being three parts full of liquid, and then heated to a visible red heat for fourteen hours, and allowed to cool slowly. On opening the tube a great volume of gas was given off, and only a little liquid remained. In the end of the tube which had been the upper end in the furnace, the tube lying obliquely, there was a hard smooth mass adhering to the side of the tube, and covering the bottom. It was black, and appeared to be composed principally of iron and lithium. When it was pulverized in a mortar, some hard resisting substance was met, and this turned out to be artificial diamond or crystalline carbon."—*Exchange*.

Some old wooden wheels were discovered some years ago in the mines of Portugal, supposed to have been once used by the Romans for hydraulic purposes. The wheels were eight in number, of wood, the spokes and felloes of pine, and the axle and its support of oak. They are supposed to exceed 1,450 years of age, yet the wood was in a perfect state of preservation, having been thoroughly immersed in water charged with the salts of copper and iron. A similar instance occurred in San Domingo, when an old wooden wheel was discovered in a disused copper mine. How long it had been there is uncertain, but it was completely preserved, owing to its having absorbed considerable quantities of iron and copper. The preserving qualities of these minerals for the impregnation of wood is well illustrated in the mines of Hallien in Austria, the timber used being the same which was originally introduced anterior to the Christian era, which is even now in a very perfect condition.—*Northwestern Lumberman*.

Incorporated
1866.



Charter Per-
petual.

Issues Policies of Insurance after a Careful Inspection of the Boilers,

COVERING ALL LOSS OR DAMAGE TO

BOILERS, BUILDINGS, AND MACHINERY,

ARISING FROM

Steam Boiler Explosions.

THE BUSINESS OF THE COMPANY INCLUDES ALL KINDS OF STEAM BOILERS.

Full information concerning the plan of the Company's operations can be obtained at the

COMPANY'S OFFICE, HARTFORD, CONN.

Or at any Agency.

J. M. ALLEN, Prest. W. B. FRANKLIN, Vice-Prest. J. B. PIERCE, Sec'y.

Board of Directors.

J. M. ALLEN, President.	GEN. WM. B. FRANKLIN, Vice-Prest. Colt's Pat. Fire-Arms Mfg. Co.
LUCIUS J. HENDEE, Prest. Aetna Fire Ins. Co.	GEO. CROMPTON, Crompton Loom Works, Worcester.
FRANK W. CHENEY, Asst. Treas. Cheney Brothers Silk Manufacturing Co.	HON. THOS. TALBOT, Ex-Governor of Mass.
CHARLES M. BEACH, of Beach & Co.	NEWTON CASE, of The Case, Lockwood & Brainard Co.
DANIEL PHILLIPS, of Adams Express Co.	WILLIAM S. SLATER, Cotton Manufacturer, Providence, R. I.
GEO. M. BARTHOLOMEW, Prest. Amer. Nat. Bank.	NELSON HOLLISTER, of State Bank, Hartford.
RICHARD W. H. JARVIS, Prest. Colt's Fire Arms Manufacturing Co.	CHAS. T. PARRY, of Baldwin Locomotive Works, Philadelphia.
THOMAS O. ENDERS, Sec'y Aetna Life Ins. Co.	

GENERAL AGENTS.

THEO. H. BABCOCK,
CORBIN & GOODRICH,
LAWFORD & McKIM,
W. S. CHAMBERLIN,
J. L. SMITH,
H. D. P. BIGELOW,
C. C. GARDINER,
D. C. FREEMAN,
W. G. LINEBURGH,
GEO. P. BURWELL,
W. B. CASSILY,

CHIEF INSPECTORS.

R. K. McMURRAY,
WM. G. PIKE,
JOSEPH CRAGG,
WM. U. FAIRBAIRN,
B. M. LORD,
H. D. P. BIGELOW,
J. S. WILSON,
F. S. ALLEN,
W. S. FOX,
A. C. GETCHELL,
J. S. WILSON,

OFFICES.

NEW YORK CITY.	Office, 285 Broadway.
PHILADELPHIA.	" 430 Walnut St.
BALTIMORE.	" 10 So. Holliday St.
BOSTON, Mass.	" 10 Pemberton Sq.
PROVIDENCE, R. I.	" 42 Weybosset St.
CHICAGO, ILL.	" 132 La Salle St.
ST. LOUIS, Mo.	" 404 Market St.
HARTFORD.	" 218 Main St.
BRIDGEPORT.	" 328 Main St.
CLEVELAND.	" 246 Superior St.
CINCINNATI.	" 53 West Third St.

The Locomotive.

PUBLISHED BY THE HARTFORD STEAM BOILER INSPECTION AND INSURANCE COMPANY.

NEW SERIES—VOL. I. HARTFORD, CONN., OCTOBER, 1880.

No. 10.

Explosion of a Portable Boiler.

It will be observed that the subject of the following illustrations was a semi-portable fire-box boiler, of the locomotive type, and a variety having an oval cross-section of body. It is a style much used for small powers and usually has, as this sample originally had, an engine attached and brackets or legs for supporting it either on timbers or on ordinary flooring. The letters B B, fig. 1, on the body, and the six unoccupied holes on

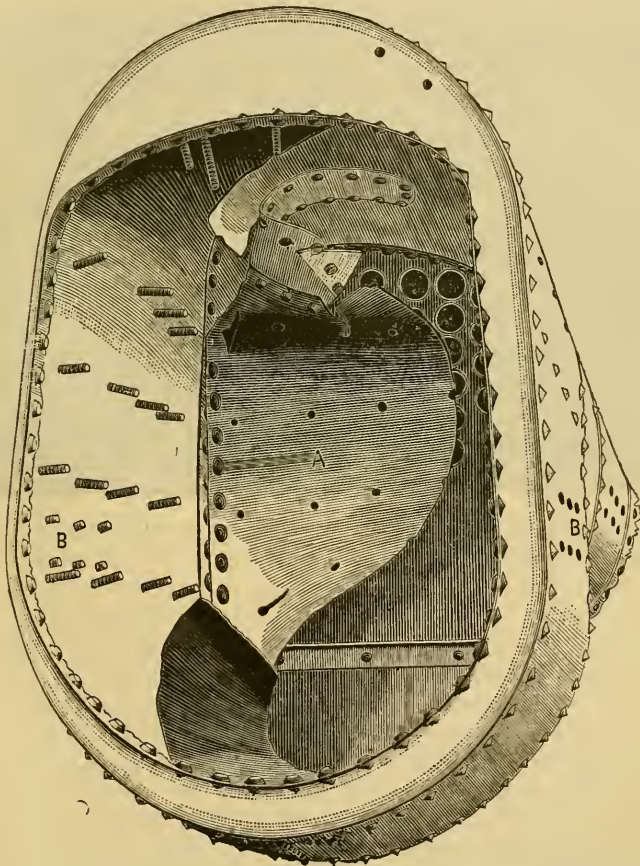

FIG. 1.—Front view, copied from a photograph, showing the collapsed fire-box. A, the left hand side buckled back upon the tube-plate, exposing the interior surface of the outer shell, the screw stay-bolts, and the ends, B, of the leg-bolts.

the barrel indicate the location of a set of four legs upon which this one was mounted by means of tap bolts. It was, when complete, known as a six horse engine, and had perhaps done duty as a well borer in western Pennsylvania, although its history prior to

its present ownership was not obtained. For some time it had been used without its engine to supply steam for refining or redistilling mineral oils for special purposes, the pressure required being about fifty pounds to the square inch. The principal dimensions and general construction are as follows:

Length over all, about $8\frac{1}{2}$ feet, including the smoke arch which was bolted to the barrel and supported the chimney. The body was 46 inches high by 29 inches wide and 36 inches long, the sides, top, and bottom of which were formed of a single plate joined at the bottom. The enclosed fire-box was similarly constructed, varying from the regular form of the shell by having a flattened arch at the top for a fire crown. The dimensions of the fire-box, 25 inches wide, allowed a 2-inch water-space on the sides and bottom, while the height was such as to give a steam-space about 8 inches high above the crown of the furnace. A front plate flanged inward at its periphery and riveted to the main body plate, and flanged outward on the borders of the opening which corresponded in size and form to the cross-section of the fire-box, and riveted to its principal

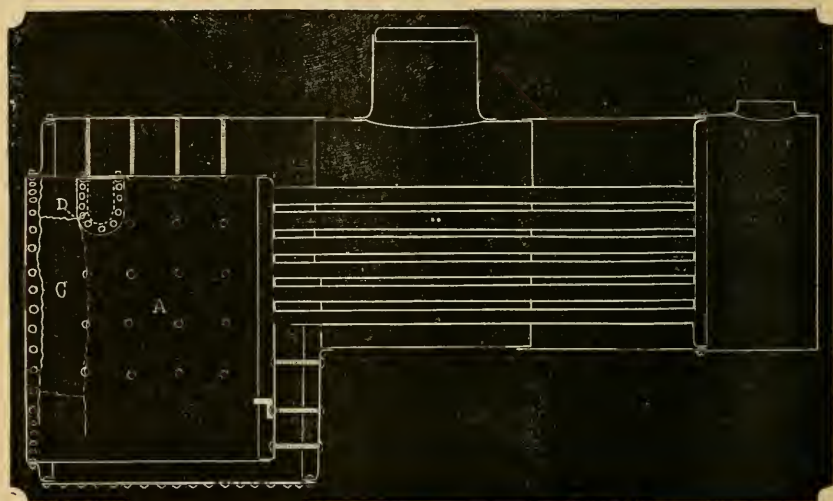

FIG. 2.—Longitudinal section of the boiler, showing lines of fracture of the left-hand wall of the fire-box, the corresponding end of the thin patch, and D, the probable point of initial rupture, indicated by the thin, pouted edges of the hole through which the head of the bolt was drawn, not shown in the cuts.

plate, formed the front wall of the steam and water chamber of the boiler. The tube plate, which was also the rear wall of the fire-box and ash-pit, was a plane plate flanged towards the front, and riveted in the usual manner to the principal fire-plate. There were in this boiler 42 two-inch tubes about $4\frac{1}{2}$ feet long, which were beaded at each end. The body of the boiler-shell was completed by a rear plate below the barrel, flanged outward, to fit the exterior of the barrel, and inward to fit the interior of the body-plate in accordance with the usual American practice in locomotive boiler construction. The fire-box was completed by bolting a cast-iron plate upon the outward-flanged opening in the front plate which served as a door frame, and to carry the front ends of the grate-bars, their rear ends resting on an angle bar which was riveted to the tube plate.

Screw-stays, arranged in regular rows on the sides, top, and rear below the barrel, at intervals of 6 to 7 inches passed through the outer and inner plates of the body of the shell and the fire-box, and were headed at both ends to prevent the collapse of the fire-box. No stays were placed in the lower semi-circles that formed the "water-bottom."

Upon the barrel near the middle of the length of the boiler was fixed a steam dome 11 inches high, and 14 inches diameter, made of flanged wrought-iron plates. The

description of this boiler is rather more minute than need be, but its simplicity of construction is something notable for this type although the variety is in common use in some parts of the country. There are but 8 principal parts besides the dome and smoke arch which make a total of 11 plates of wrought iron, viz.:—two tube plates, two end-plates (body), two body-plates, and two barrel-plates, two dome-plates, and one in the smoke-arch. Other forms of boilers, such as the cylinder tubular and the plain or simple cylinder, are much simpler having no contained fire-box, and mostly, in New England practice, no steam-domes.

The principal fire-plate A, fig. 1, was something less than $\frac{1}{4}$ of an inch thick, while some parts of the shell were $\frac{5}{8}$ of an inch. At the corner of the patch, the point from which the lines of rupture radiate, fig. 2, a stay bolt passed through the plate and the patch, and both were here much reduced in thickness.

The safety-valve bottom presented an appearance indicated in fig. 4, the light arc representing about the proportion of the seating that had metallic contact.

It was found that the steam-gauge pipe had been plugged with solid matter deposited by the boiler-water, in which it was very rich.

When the explosion occurred, on the 20th of August, the proprietor or superintendent was directing a man who was examining or repairing the small-still or super-heater, located about 30 feet from the boiler, through which the steam was made to pass. It will be observed that

THE EXPLOSION

was caused by the collapse of the furnace, the portion of the left-hand side marked A, folded back upon the tube-plate, turning on its vertical seam and buckling so that its upper and lower torn edges are turned toward the front as shown fig. 1, which was cut

from a photograph.

The boiler, impelled by the reaction of the issuing contents,

flew away slightly ascending and veering some 40 degrees to the right of its extended axial line. It is possible to form a pretty clear idea of its course because it struck and carried away several objects that were in its path through the air before reaching the ground near where it finally rested, about 285 feet distant, upon a low pile of lumber, and against a post of a large lumber shed. It was badly indented by the fall, with its smoke arch, legs, front castings, and a piece of the broken fire-plate marked C, fig. 2, gone, which latter was lost, while the other parts were found where they would be most likely to go under the circumstances. The objects that were struck were a large telegraph pole standing on lower ground at a distance of about 100 feet from the starting point, and at a distance of about 220 feet it struck and knocked away three posts that supported one of the approaches of a street bridge over a railroad. The pole was broken 18 feet from the ground, and a short piece apparently carried away leaving 15 feet of the upper end with 6 cross bars hanging upon the wires of the line. The relative heights and distances of these objects mark its course quite clearly. As it did not touch the ground till it had passed the bridge posts, which were low and close together in reference to the diagonal course of the boiler, it must have gone nearly endwise through them to have touched

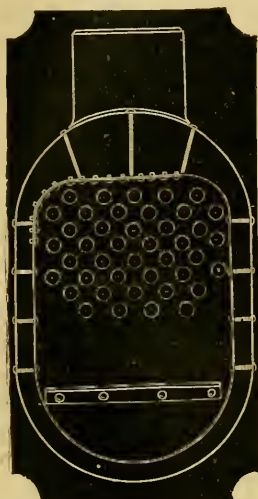

FIG. 3.—Cross section of the body and the patch, showing the screw stay-bolts; the upper one of the left-hand row being the same as D, fig. 2.



FIG. 4.—Plan of the bottom of safety-valve, the bright portion being indicated by the white arc. "It did not leak." (P)

one only in each set. It rested at last facing the opposite point of the compass, very nearly, to the one it faced at its former site.

The men who were nearest were blown as by an over-powering gust of wind to a considerable distance and stunned, but not killed, they were out of the track of both water and boiler. It is hardly profitable to speculate on the probable pressure at which the stay bolt in the corner, D, of the patch, fig. 2, gave way or rather pulled through the patch, for it is deemed enough to know that it was quite sufficient to break this obviously weakest spot in the boiler, and that once broken, an extraordinary and over-powering load fell instantly upon its neighbors, and they gave way in detail.

It is likewise *almost* certain that there was sufficient force stored in this boiler to do the work which we see it has done, and which nothing else exterior to it did accomplish.

Each unit of the water, however small it may be conceived to be, when heated to a high temperature, which was possible only under a corresponding pressure, (barring the Donny theory, etc.,) had within itself its own quota of the gross amount of force which was kept confined till the prison was broken, then each minute particle expanded with a suddenness analogous to an explosion and the whole mass was set in motion towards the broken door of its prison which now weakened as to its surroundings grew larger as the crowd pressed against its borders. The opening may not have reached its present size until the boiler was well on its way.

It would be interesting to introduce some authorities in this connection, but the space will not allow of a further discussion at this time.

BOILER EXPLOSIONS.

MONTH OF SEPTEMBER, 1880.

PLANING-MILL (104.)—During the progress of the fire, September 4, which destroyed the Wausau, Wis., Lumber Co's planing-mill, the boiler exploded with a fearful crash, throwing brick and burning splinters in every direction, severely injuring several persons. Hugh McIndoe, who was standing 250 feet away, was struck in the head by a flying missile, and at last accounts it was feared that his skull was broken. Quite a quantity of lumber in and near the mill was burnt and damaged. Loss, \$4,000. The mill will be rebuilt.

PLANING-MILL (105.)—The boiler of S. T. Traitor's saw, grist, and planing-mill at Toisnot, L. C., exploded September 4, wrecking the building and blowing Wiley Batts and Edward Whitehurst forty yards. The former was fatally and the latter seriously hurt. Loss, \$5,000.

OIL-WORKS (106.)—One of the monster boilers at the United Pipe line pump station, at Oil Center, exploded September 6, completely wrecking the large building, badly damaging another boiler, and killing Thomas Bennett, the telegraph operator in the station, who was terribly scalded. The fireman left the building a few moments before and escaped unhurt. Bennett was a native of Scranton.

SAW-MILL (107.)—The boiler of a portable saw-mill near Vinton, Gallia County, O., exploded September 6, killing Samuel Davis and James Donnelly, and seriously injuring another employee.

TUGBOAT (108.)—The tug Jerome was destroyed at Grand Haven September 8, by the explosion of her boiler, and she sank near the dock. Moses Gerard, her captain, was thrown upon the dock badly scalded, but no other person was injured. Pieces of the tug were thrown to a considerable distance in all directions, but doing little damage.

THRESHER (109.)—A terrible steam-threshing accident occurred September 8, on the premises of Mrs. Northrop, in the town of Hamlin, Monroe County, N. Y. The boiler exploded and was thrown bodily through the barn and beyond—some ten rods in all. Other parts were thrown fifty rods. One man on the straw stack was killed, and others seriously hurt. The barn took fire and it and its contents were destroyed, occasioning a loss of about \$1,200. Insured in Agricultural, of Watertown, for about \$800, with a permit for threshing by steam. There does seem to be some extra hazard in the use of steam for threshing.

MILL (110.)—The boiler of a mill on Lowenburg's place, Lake Concordia, Miss., exploded September 9, killing William Poole, and severely, probably fatally, scalding four negroes.

TUGBOAT (111.)—The steam-tug White Fawn, lying at her dock in South Amboy, N. J., blew the steam-cock from her boiler September 9, scalding one person, probably to death, and otherwise injuring five persons. The force of the explosion blew overboard Capt. Byrnes, and Davis, a deck-hand, both saving themselves by swimming ashore. The other deck-hands were violently thrown against the sides of the vessel, receiving severe injuries from the escaping steam. Engineer Winters and Fireman Scanlon received the worst injuries. Scanlon's body is parboiled, and he is not expected to recover.

ROLLING-MILL (112.)—The boiler of a rolling-mill at Dover, N. J., exploded Sept. 20, being hurled eighty feet in air, and crushing the stock-house in its fall. One laborer was killed, five workmen badly and seven slightly wounded.

FRUIT-DRYING HOUSE (113.)—The boiler in Loose & Son's fruit-drying house at Monroe, Mich., exploded with terrific violence Sept. 24, killing Henry O'Brien, engineer, Leonard Martin, cutter, and a boy named Chabenan, and wounding more or less seriously nine others. Thirty persons were at the time around the building which was demolished.

SAW-MILL (114.)—The boiler exploded in a saw-mill fourteen miles east of Leadville, Col., Sept. 26, instantly killing Washington Emory, the engineer, and James Mengies. The steam-gauge was out of repair.

FLOURING-MILL (115.)—At 6 o'clock A.M., Sept. 30, the boiler of Henry Shaber's flouring-mill, St. Paul, Minn., exploded, totally wrecking the engine-house, killing the engineer, and setting the mill on fire. The fire department was promptly on hand, but the flames had been subdued by the energetic exertions of the mill hands. The main portion of the mill was left standing, but the debris of the engine-house had been thrown with a heavy cloud of dust and smoke high into the air, some of it landing on the sides of Trout Brook Glen, or falling into the stream below. Bricks and stones had been driven from the boiler out through the front door and windows of the mill a distance of over fifty feet. As soon as possible the roof was raised, the hot bricks removed, and the dead body of Jacob Rapp, the engineer was found. It was burned on the side, and half of the back of the head had been knocked off.

LOCOMOTIVE (116.)—The engine Gardner Coldby, drawing a heavy freight train on the Rome, Watertown & Ogdensburg Railroad, exploded about 3 o'clock, Sept. 30, within the village limits. No one was hurt but the fireman, who was slightly scratched. Heavy pieces of iron were thrown 100 rods, and the fields are strewn with pieces of the wreck. Had the explosion not occurred in a deep cut the houses in the vicinity would have suffered seriously. The engineer states that he had only 120 pounds of steam at the time of the explosion, and did have 140 at other times during the day. The force of the steam all seemed to go forward, thus letting the engineer and fireman out without serious injury.

PLANING-MILL (117.)—One of the boilers of the Enterprise planing-mill at Pomeroy, O., exploded Sept. —, badly scalding two boys, James Fisher and Milton Arnold, who happened to be in the mill.

SAW-MILL (118.)—A double boiler explosion, Sept. —, resulting in loss of life and serious damage to several persons, is reported from Bay City, Mich. The boilers, which were old and defective, were in a building adjoining the saw-mill of Pitts and Craage. The mill, valued at \$10,000, is a total wreck. The engineer has been buried in the ruins. The fireman and blacksmith were badly injured.

ACCIDENTS OTHER THAN BOILER EXPLOSIONS RESULTING FROM THE USE OF STEAM.

STEAMBOAT.—As the Norwich propeller Delaware, which runs between Norwich, Conn., and New York, was steaming eastward, off Huntington, L. I., in May, 1880, her piston head, weighing nearly a ton, was blown up through the skylight of the deck. It rose about 50 feet above the deck, and dropped through the skylight back into place without touching the wood work on either side in ascent or descent. The engineer, John Wade, was standing in the engine room, and though the air was filled with clouds of steam and flying pieces of steel, he escaped unhurt. The propeller came to a halt in the Sound and remained until towed into New London harbor.

DENTAL OFFICE.—August 3d a steam vulcanizer in the dental office of Howell & O'Brien, Fostoria, O., exploded, tearing away the plastering and making quite a wreck. Fortunately no one was in when the accident occurred. The damage was about fifty dollars.

HOTEL.—A steam tank in the Quincy House (Boston) kitchen exploded about eight o'clock A.M. Aug. 16. No one was hurt, but some of the employees and guests of the house were considerably frightened by the noise.

DWELLING.—A large range in the kitchen of Rev. Father Lynch in North Adams, Mass., exploded Sept. 23, portions of it going through the ceiling, scattering the coals about the floor and shattering another stove standing near. One of the servant girls was slightly hurt.

STEAMBOAT.—A fatal disaster occurred at Louisville, on board the Louisville and Madison packet Maggie Harper, Sept. 25. The boat was going up, and when passing Neel's Landing her steam pipe exploded, filling the boat with steam. Len. P. Poyer, engineer, was badly scalded, and in his agony leaped into the river and was drowned. Five colored roustabouts were seriously scalded, and two of them, George Brown and Tom Smith, are expected to die.

TUGBOAT.—As the steamer Penn Wright, a raft tug, was ascending the river, two miles below Bellevue, Iowa, Sept. 30, the supply pipe, leading from the boiler to the engine, burst over the head of Charles Tate, the engineer, scalding him in a fatal manner. Finding himself enveloped in steam, and writhing in agony, he jumped down a hatchway near by to escape. That cavity also filled with steam, and scalded the man to death. His flesh was steamed to jelly, the nails falling from his fingers. Tate was a married man, with a wife and two children living in Nauvoo, Ill.

The largest library in the United States is the Library of Congress at Washington, which contained 231,000 volumes in 1874, and in that year the British Museum and the Imperial Library at St. Peter's comprised 1,100,000 volumes each. The largest library in the world is the National Library at Paris, which in 1874 contained 2,000,000 printed books and 150,000 manuscripts.

Inspectors' Reports.

The whole number of inspection visits in the month of August, 1880, was 1,880, and 3,845 boilers were examined, of which 1,139 were annual thorough inspections. The hydrostatic test was applied to 402 boilers during the month. This number is largely in excess of the monthly average, and seems to indicate what is confirmed by information from other sources, unusual activity among boiler manufacturers, inasmuch as a large majority of all those tested in this way are new boilers in the shops and yards of the makers.

The total number of defects discovered during the month of August, 1880, was 1,533, of which 388 were of such a character as to be either actually dangerous at the working pressure, or would become so in the event of an accidental temporary increase of the pressure, resulting from a sudden stoppage of the engine or a considerable over-supply of steam from any cause.

The defects were in detail as follows: Furnaces out of shape, 80—20 dangerous. Fractures, 138—80 dangerous. Burned plates, 68—17 dangerous. Blistered plates, 226—29 dangerous. Cases of deposit of sediment, 209—43 dangerous. Incrustation and scale, 281—45 dangerous. External corrosion, 110—34 dangerous. Internal corrosion, 72—20 dangerous. Internal grooving, 20—5 dangerous. Water-gauges out of order, 62—17 dangerous. Blow-outs defective, 8—4 dangerous. Safety-valves overloaded, 18—11 dangerous. Pressure-gauges defective, 147—32 dangerous. Boilers without gauges, 45—3 dangerous. Deficiency of water, 9—3 dangerous. Broken braces and stays, 40—25 dangerous. Boilers condemned, 18.

About the Seawanhaka.

The discovery credited by a local paper to the dealer in old metals who bought the wreck of the Seawanhaka would be hardly worth mentioning were it not that the reporter's version is not only sensational but indicates a want of attention to details, while only a part of the story is told at that. The advantage that this reporter claims to have had over the government inspectors and the coroner's jury in having a clear view of the interior of the boiler, now that the shell has been removed, is more than counterbalanced by the absence of the part of the boiler, the collapsed tube, that contained the initial break, an illustrative description of which was given in the August number of *THE LOCOMOTIVE*, together with a full report from one of this company's engineers, F. B. Allen of New York city.

The statement of the reporter is so specious that it is considered due to those readers of *THE LOCOMOTIVE* who have faith in boiler inspections that are made "only by crawling through a man-hole," that the fallacy should be pointed out, more especially since, as a matter of news, only this view of the case has been copied in part by at least one respectable technical journal.

In speaking of the rupture of the 10-inch flue he says, "the rent began in a narrow seam close to the flue sheet, but in the middle of it is a gap so large that one can easily put his hand through it." Again, "the force that broke it was evidently from the inside of the flue [the smoke side], since the jagged edges were turned outward [toward the water]."

The part of the story that is omitted is, The gap through which the hand could be easily put was made with the hammer of the boiler-maker who broke, outward, a piece of the plate 1" x 3" for the coroner. An elastic fluid pressure that could have taken out such a piece should be sufficient, according to the records, to collapse the flue entirely from end to end after it was broken.

The Locomotive.

HARTFORD, OCTOBER, 1880.

As we approach the close of the first volume of the new series of THE LOCOMOTIVE, we can see by the consecutive numbers at the head of each the increase over last year in the number of boiler explosions of a disastrous character.

This we note with unaffected regret; it indicates that boiler owners are not yet fully aware of the danger of neglecting the simple and necessary precaution of regular inspections by competent professionals in this business; and they are, while in the hurry of increasing demands for their goods, unwilling to allow the time for proper attention to this vitally important organ of their system. They continue to add machinery and increase the burden until signs of distress appear, the significance of which they ought to know, but they do not heed, and although warned that they ought to stop for examination and repairs, still they desire to put it off till some job is finished, or till next holiday. The engineer must please his employer and take the chances or give up his place to some one who will do so. The sign of distress is accordingly removed by stopping the leak over night and he goes on pushing his boiler as he is pushed by his employer who in turn is being pushed by his customers, till disaster stops them and somebody is found dead under the pile of hopeless debris of the owner's works, or upon a neighboring roof. That engineers are found in our experience who thus knowingly expose the property of their employers, their own lives, and the lives of those about them to peril, we know to be painfully true, and the fact causes a feeling of indignant commiseration for poor humanity.

The importance of calling the boiler inspector when symptoms such as leaks occur, showing plainly that there is something wrong, is obvious without argument. The neighboring boiler-maker will assist perhaps in stopping the appearance of weakness, but the inspector should always be called without delay because from the nature of his business he is the better judge of the cause and the safe remedy.

Proficiency in the business of boiler inspecting can be attained only by making a careful study of it, watching from year to year the development of the acquired defects in the substance material of a great number of boilers.

These defects are not, as many suppose, of a fixed nature. They are always progressive; while the exciting cause remains, and if it is allowed to operate unchecked, they will certainly advance towards disaster.

There is no way to arrive at absolute certainty in this business, but to keep a complete record of the details of all defects, noting carefully each time an inspection is made any change, trivial though it may appear at the time, and consulting the record of its previous condition, rather than trusting to memory for data on which to base a judgment of the safety of the boiler.

It is to be hoped that our readers will not undervalue the summary of our record which we present each month under the head of "Inspector's Reports."

Some of the items in the list of defects discovered may be thought trivial, and be passed over as unworthy of mention, but they are *our* record for reference, upon which, year by year, we are perfecting ourselves in this business. They are the concrete foundations, so to speak, of our superstructure of guaranty.

The interesting articles that were printed on page 154 of our September number were credited to an *exchange*, from which they were clipped, and in which they appeared without credit, since when, we have learned that they first appeared in the *Scientific American*, and this first opportunity is taken to correct the error in credit.

TABLE IX.
MELTING POINT OF ALLOYS.

(Rearranged from Haswell.)

Composition.		Degrees F.	Composition.		Degrees F.		
Lead 1,	Bismuth 4,	Cadmium 1,	Tin 1,	155	Bismuth 1,	Tin 8,	392
" 1,	" 5,	Tin 3,	.	210	Zinc 1,	" 1,	399
" 2,	" 5,	" 3,	.	212	" 1,	" 1,	421
" 1,	" 5,	" 4,	.	240	Lead 2,	" 1 (solder),	475
" 1,	" 1,	" 1,	.	286	Bismuth 1,	.	476
" 2,	" 1,	" 3,	.	334	Lead 1,	.	504
" 1,	" 1,	" 2,	.	386	Cadmium 1,	.	600
" 1,	.	" 2 (soft solder),	.	360	Zinc 1,	.	740
" 1,	.	" 1,	.	368			

TABLE X.

EFFECT OF HEAT ON VARIOUS BODIES.

(Condensed and rearranged from Haswell.)

Wedgwood's Zero 1077° of Fahr., and each W. degree = 130° F.

The Symbol — is prefixed in this table when the temperature is below 0 of the F. scale, the symbol + being understood in all other cases.

	Degrees F.		Degrees F.
Absolute zero (Trowbridge),	-459.4	Sea water boils,	213.2
Greatest artificial cold,	-166.	Sea salt boils,	224.3
Nitrous oxide freezes,	-150.	Common salt boils,	226.
Nitrous oxide boils,	-88.	Sulphur melts,	226.
Greatest natural cold,	-56.	Sulphuric acid (sp. gr. 1.3) boils,	240.
Ammonia (liquid) freezes and sul.		Nitric acid (sp. gr. 1.42) boils,	248.
ether freezes,	-46.	India-rubber vulcanizes,	293.
Sulphuric acid (sp. gr. 1.641) freezes,	-45.	Oil of turpentine boils,	304.
Mercury melts,	-39.	Petroleum boils,	306.
Proof spirit and brandy freeze,	-7.	Rectified petroleum boils,	316.
Snow and water, equal parts,	0.	Coal tar boils,	325.
Spirits of turpentine freezes,	14.	Sweet oil boils,	412.
Strong wine freezes,	20.	Polished steel turns straw-color,	465.
Human blood freezes,	25.	Sulphur boils,	570.
Sea water freezes,	28.	Bismuth melts,	476.
Vinegar freezes,	28.	Polished steel turns blue,	580.
Milk freezes,	30.	Cadmium melts,	600.
Ice melts,	32.	Sulphuric acid (sq. gr. 1.848) boils,	600.
Olive oil freezes,	36.	Salt-peter melts,	600.
Maximum density of water (distill'd),	39.5	Linseed oil boils,	640.
Phosphorus burns,	43.	Mercury boils,	662.
Acetous fermentation begins,	78.	Mercury volatilizes,	680.
Pitch melts,	91.	Iron bright red in the dark,	752.
Tallow melts,	97.	Common fire,	790.
Water boils in vacuo,	98.	Iron red-hot in twilight,	884.
Sulphuric ether boils,	98.	Red heat visible by day,	1,077.
Temperature of human blood,	98.	Cherry-red heat (Daniell),	1,141.
Ether boils,	96 to 104.	Silver melts (fine),	1,250.
Phosphorus melts,	108.	Cherry-red heat,	1,500.
Spermaceti melts,	112.	Bright-red heat,	1,860.
Potassium melts,	135.	Brass melts,	1,900.
Ammonia boils,	140.	Glass melts,	2,377.
Ambergris melts and gutta-percha		Steel melts,	2,500.
softens,	145.	Copper melts,	2,548.
Beeswax melts,	151.	Fine gold melts,	2,590.
Alcohol boils,	173.	Platinum melts,	3,080.
Naphtha boils,	186.	Air furnace heat,	3,300.
Nitric acid boils (sp. gr. 1.5),	210.	Cast-iron melts,	3,479.
Distilled water boils (atm. press.),	212.	Wrought-iron melts,	3,980.

About the Tables IX and X.

Table IX, which is re-arranged from Haswell's pocket-book so that the alloys appear in the advancing order of their melting-points, will be found useful to those engineers who have no suitable pyrometer or high-grade thermometer, and who desire to make approximate tests of the temperature of such parts of their apparatus or flues as do not admit of the use of the common mercury thermometer. If the test is to be made in the presence of soot, smoke, and ashes, the test alloys should be put into any suitable fluid found in table X, whose boiling point is above the melting point of the alloy. A tube of iron, brass, or copper, closed at one end to contain the test sample and fluid, will effectually protect the metals from being coated with these non-conducting substances. If, however, a high-grade thermometer is at hand it would prove more satisfactory immersed in linseed oil in a copper tube. The five metals that compose the alloys in this table are pretty well known to most engineers who have had workshop experience among the metals, except perhaps the metal cadmium. This metal in its pure state is much like tin, and melts at about the same temperature, although it is quoted in the table as melting at 600° F., no doubt referring to the commercial samples, which may contain more or less zinc with which it is often found associated in its native state. Pure cadmium is a white metal, a little harder than tin; it is very flexible, ductile and malleable; crackles like tin when bent, and melts at 442° F. It is heavier than iron, zinc, or tin, but lighter than lead, and about the weight of copper. Alloys containing this metal would therefore be rather unreliable as to its melting temperature. In making alloys the metals are to be taken by weight, for example, lead 2, bismuth 5, tin 3, means, take two pounds, ounces, or grains of lead to five of bismuth, and three of tin, to make an alloy that will melt in boiling water, under atmosphere pressure, or 212° F.

Table X is also re-arranged from the same author with reference to advancing temperatures, so that one may follow down the column of figures and select an agent according to the conditions of his proposed experiment. The first item, absolute zero, has reference to the absence of all heat motions or absolute cold, at which point the elasticity of a perfect gas is supposed to disappear. It is an important factor in the calculations of the theoretical power of gas and air engines, but it is of little real value to the practical steam engineer, since steam is a vapor and neither a perfect nor yet a permanent gas like hydrogen, which is supposed to exist as a gas at all temperatures above absolute zero. The various uses of this table will be suggested to the steam engineer who examines it. One thing however which may not appear at first sight relates to the significance of the change of color of polished parts of a steam engine exposed to no other heat than that of the steam from the boiler. If the polished iron nuts or bolts, for example, on the steam-chest are changed to a straw or blue color one might fairly suspect that they had been heated to a temperature considerably above the normal temperature of ordinary saturated steam, and that superheated steam had been present at some time since the engine was set up. This might possibly occur to engines supplied with steam from boilers having steam-heating surfaces exposed to considerable heat while the engine is stopped, no new steam escaping from the water into the steam-space, because the damper is closed and the fires covered with green coal—at noon for instance—to prevent the rise of steam, there is no circulation of the steam and the saturation is not kept up, the steam becomes superheated, so that the first charge or two that enters the engine cylinder on starting may be at a temperature much higher than that due to the pressure of saturated or common steam. See table on page 63, April number of THE LOCOMOTIVE, and then by table X we find by following down the column of figures what would be a test of the temperature of the chest. At 316° , the temperature of steam at 70 lbs. by the gauge, we find that refined petroleum boils; and at 325° , about the temperature due to 80 lbs., we find that coal tar boils; at 412° sweet oil boils;

and at 460° polished steel turns straw color, and at 580° it turns blue. If, therefore, sweet oil boils or evaporates rapidly when dropped on the affected part, the indication is that the temperature is far above that due to a reasonable pressure of common steam. If sulphur boils (not melts simply) also a fair conclusion may be reached that we have superheated steam. In this connection the effect of this great heat on the oil used to lubricate the cylinder inside becomes interesting and might account for some phenomena that would without this hint appear strange. In regard to the behavior of fluids or solutions whose boiling points are found in table X, when introduced with the feed water either purposely or accidentally into the boiler, it must be remembered that their boiling point in the atmosphere is no index of what will happen at the same temperature under boiler pressure, and the same may be said of cylinder lubricators containing volatile ingredients that are expelled at known temperatures in the open air. The vaporization of fluids or chemical solutions mixed with the feed water depends on that property of the fluid which determines its total heat of vaporization. Those fluids that are vaporized completely by a less number of heat units per pound than water requires, will perhaps go over with the steam. Fat oils do not boil before being partially decomposed, and the vapor that rises first is not the oil itself but certain products generated by the heat. The changes being somewhere about 600° F., and require for their continuance temperatures always increasing (Ure). The experience of this company shows that fatty or animal oils and tallows are very detrimental when they get into steam boilers with water containing solid matter. It is extremely difficult to separate fatty oil from hot feed water after it has been thoroughly mingled with it by coming with the exhaust steam from the cylinder into the open or spray heater whence it finds its way into the boiler and with the solid matter forms a sticky deposit when the water is blown out, which adheres to the iron and is baked by the remaining heat into a hard greasy mass that effectually prevents afterwards the water from reaching the iron. Mineral oils are not so bad and should always be used for cylinder lubrication where the heating of the feed water is done by mixing it with the exhaust steam.

Strains on the Shells of Steam Boilers.

WRITTEN FOR THE LOCOMOTIVE, BY S. N. HARTWELL.

If it were practicable to construct of suitable materials perfect hollow globes or cylinders of sufficient size for steam-boiler shells, the strains to which the material would be subjected when exposed to internal fluid pressure would be comparatively simple. They would not be entirely simple, because the pressure tends to part the material in more than one direction, and in this respect the force differs from the simple or single one usually employed in testing for its ultimate tensile strength a piece of the metal by pulling it in two in a machine capable also of weighing the force to which it yields.

In the present state of the arts all forms of boiler shells of considerable size must be made by joining metal plates by means of rivets, and all forms that have a circular section must be made of bent plates. Holes must be made for the rivets, and some form of lapped or butt joint constructed, which involves more or less irregularity of the curves or planes that are joined.

To estimate the strength of a joint made of material of known tensile strength, a calculation is made of the amount of material remaining between the holes, supposing that the resistance of the rivets to shearing preponderates the strength of metal remaining between the holes, and an allowance is made for the effect of the punch on the strength of the metal immediately surrounding the holes. But, for obvious reasons, the result is only proximate. If an attempt is made to burst a shell for the purpose of ascertaining the strength of its joints, they are likely to become so much strained and dis-

torted before breaking that leaks will prevent the accumulation of sufficient pressure with an inelastic fluid to make a decided test, except of the very weakest part of the structure. Although this is the real measure of the strength of the structure, still it may be desirable to know the strength of the stronger parts. The best way of ascertaining the relative strength of the several forms of joints is by testing plane models of each having a number of rivets, by pulling them in two.

When tested in this way, plane models will, before breaking, be distorted, (as shown in Fig. 1) more or less, according to the ductility of the metal. If it is pretty brittle, and the rivet-heads are strong and sufficient to prevent the bending of the plate on the line of the rivet-holes, then the plate will probably break adjacent to the end of its fellow, G or F, Fig. 1; or in case of the single-covered butt, the covering plate will break in the middle, I and H. But should the plates be soft and ductile or the rivet-heads low and insufficient, then the bend and break would occur at the weak line through the holes.

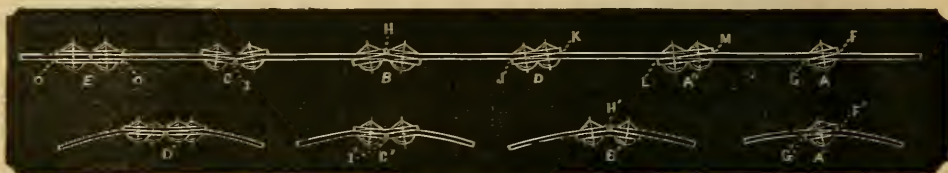

FIG. 1.

If the plates represented in Fig. 1, A, etc., were straight at the joint, they might, without much stretch of the imagination, be considered a plane drawing of a section of a transverse or circumferential seam of two hollow cylinders. But it is plain that if a force is applied tending to separate two cylinders joined in this manner by pulling lengthwise upon them, the distortion that would happen to the tested plane-plates would be resisted by the transverse curvature, and before this distortion could take place in the cylindrical joint the extreme end of the inner cylinder, L, Fig. 1, must contract in diameter and the outer one correspondingly expand at its extreme end, M, Fig. 1, involving in the inner one a compression or upsetting, and in the outer one a drawing of the metal. The same may be said of all the joints of a globe, if they are properly fitted. If the joint be a butt, with a single outer cover, C, Fig. 1, a similar contraction must take place at both of the abutting ends and a contraction of the middle of the covering strip, while the converse of these motions would take place in the case of the joint with the inner cover, B, Fig. 1. It appears clear, therefore, that these distortions are not likely to take place in a transverse seam of a cylindrical boiler-shell from the effort of an internal fluid pressure. The butt joint, with two covering plates, E, Fig. 1, would seem to be able to retain its shape when tested in plane form.

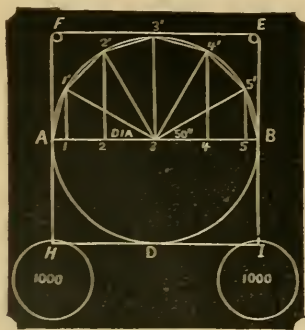

FIG. 2.

In order to illustrate, without mathematics or abstruse physical rules, the fact that the material of a hollow cylinder is affected by internal fluid pressure about the same as though it was a plane and pulled in a straight line parallel to its surface, the diagram, Fig. 2, is here introduced as a simple mechanical study, rather than a conclusive demonstration of the problem. Let the line H, F, E, I represent a flexible band, supported on the frictionless rolls on fixed axles F, E, and loaded with the weights H, I. It appears that all parts of the band are subjected to a tension of 1,000. If, now, the band be supported in the same frictionless manner at the points A, 1', 2', 3', 4', 5', B, the band will represent

the sides $A1'$, $1'$, $2'$, etc., of the semi-polygon A , $3'$, B , and the tension will be the same as before on all parts of the band, and it will still be so if the number of sides of the figure is indefinitely increased till it becomes a semi-circle. Now let the weights be removed, and the ends of the band be joined at D , a point in a complete circle, the lower half being in all respects like the upper half. It is a matter of indifference, so far as the band is affected, whether the tension is caused by the weights or by the effort of its supposed frictionless supports to extend radially, therefore if a tension equal to 1,000 is produced by an expansive fluid (which is frictionless practically), so confined within the band, which may be any desirable width, as not to interfere with its freedom in following the direction of the interior force, it will appear that the effect on the band is the same as though it were straight and loaded with weights producing the same amount of tension. It will probably occur to the practical reader that an iron band is not flexible, but a little thought will lead to the conclusion that though iron is comparatively stiff, yet



FIG. 3.

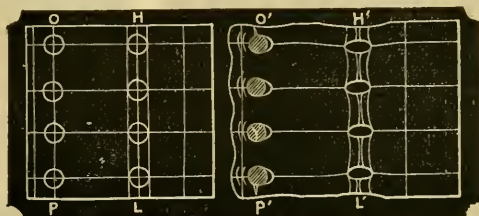

Before Stretching.

FIG. 4.

After Stretching.

the tendency exists the same as though it were flexible, and, so far as the band is overpowered, it is flexible and will yield and assume the forms described. If the force is so great as to overcome the power of the iron to return to the form and size it had before the force was applied, its elasticity is destroyed and a permanent set will occur. This power is generally retained by iron up to about half the breaking tension, that is, half the force that would break it by pulling will destroy its elasticity, and when the force is removed it cannot contract to its original length, as leather or rubber does when stretched.

It has been shown above that the *transverse* joints of a cylindrical shell are not likely to be distorted to the same degree as joints in plane models, but the behavior of the plane models may (it appears from diagram 2) be accepted as a fair hint at what may be expected of the *longitudinal* joint of a cylinder when overpowered by an internal fluid pressure. Lapped longitudinal joints are shown at A' , Fig. 1. Single riveted and single covered butts at B' and C' . D' shows a double-riveted, single-covered butt. Fig. 3 is intended to show the condition of a narrow strip of soft metal, having a hole in the middle, that has been subjected to a simple overpowering strain. The hole that was round has become elongated (lengthwise) and narrowed transversely as the metal yielded, but the holes that have been occupied by rivets, as at Y , Figs. 3 and 4, are distorted in a different manner. Their lateral contraction is prevented by the body of the rivet, and they remain the same breadth as before they were strained, but they are elongated behind the rivet while the metal before the rivet has been crushed and upset, showing curved wrinkles. In the wide model, Fig. 4, the metal between the second and third holes, $L' H'$, would be called upon to yield towards both selvedge holes, and it would therefore be thinned, or else the whole plate must be narrowed on transverse lines touching the holes at their right and left sides. The behavior of the broad model in this respect depends greatly on the ductility of the material and its fibrous or homogeneous character. It is not at all probable, therefore, that a narrow strip gives a fair index of the strength of a wide model or plate of greater width. It seems clear, however, that the selvedge is the weakest, and the strength of a model of even a dozen holes would not fairly represent a plate bounded by cross seams, thus leaving no selvedge.

Returning now to the consideration of the double-covered butt joint E, fig 1, which has been alluded to as apparently able to retain its perfect form under excessive pulling loads. Let us conceive that it is made circular as the others are in this figure; now, while it does not seem to be liable to take the distortions here shown, still the irregularity of the interior curved surface will be apparent, and the effort of the internal force being to form the interior surface into a perfect circle, the curve of the plates at the points O O will be somewhat sharpened, in the same way, but very much less than they would be if it was a hoop tightly set upon a solid cylinder of stone or other unyielding material; we are supposing that the tension is caused by the uniform pressure of a fluid, a perfectly mobile body, inside the curve, and though the interior irregularities

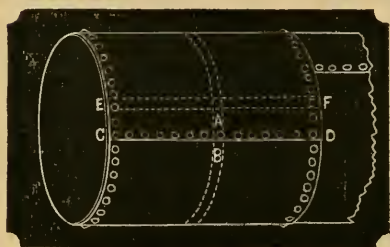

FIG. 5.

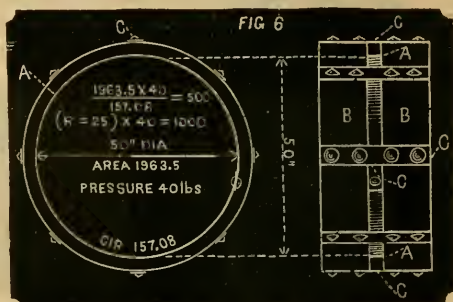

FIG. 6.

of the surface indent the fluid, and all inner sides of the irregularities are touched and equally pressed by the fluid, still the tendency is to form them into a resultant arc that would have a different radius from that of the circular axis of bent plates.*

It will be noted that all the longitudinal joints of a cylinder formed by riveting are affected in the same way, but in different degrees, according to the volume of the inward projections, and that so far as it goes it lessens the distortions of the simple lapped and the single-covered butt joints. Comparing the volume of the inward-projecting parts in the single-lapped with those of the double-covered butt joints we find, for equal thickness of covers and plates, that they are about as 1 to 4 for covers double the width of the lap.

When we study the cylindrical boiler shell made of sections or rings of plates, fig. 5, and remember that the load from an internal fluid pressure is twice as great upon a band or ring-unit, A B, as it is on a stave or longitudinal unit E F, we not only get an explanation of the tendency of all form not spherical to become so when thus acted on, but we see why it is that cylinders oftenest break or become grooved at the middle of the longitudinal joints. We may be accustomed to think of iron and steel as inelastic in the sense that rubber is elastic, and it is almost so, having but a small degree of that property, but of ductility, which gold and silver have in a high degree, it has considerable, or should have in order to make it suitable for boiler-plates, and it should also possess stiffness enough to enable it to preserve its form against considerable counter loads when not distended and so stiffened by an internal load, but it is very desirable that boiler-plates should stretch as well as bend before breaking, and all good plates will do this, especially those of soft, homogeneous steel.

If such material is made into a hollow cylinder and tested by an excessive pressure, it will probably first yield at the middle of the length of a section, as A B, fig. 5, provided always that the transverse seams are not made the weaker section by punching too

* The reasoning on which this statement is founded is somewhat analogical. It may not be susceptible of experimental proof, unless an exaggerated model is resorted to, but it is thought by the writer to be worthy of notice in this connection.

large rivet-holes or some other malconstruction, and the section will tend to enlarge in the middle and become barrel-shaped, and finally break at the middle of the seam C D, and the reason seems to be not that there is a greater pressure here at the starting to yield, but that, having started, the diameter is increased and the strain has become actually greater and at the same time the material has become attenuated and less able to resist, and so while the pressure is maintained the weakening goes on in an increasing ratio.

The subject of strains on a hollow cylinder may perhaps be better understood by the help of the diagrams figs. 5 and 6. Supposing we have a plain hollow cylinder with covered ends of sufficient strength. Let the cylinder be 72 inches long and 50 inches diameter. It may be conceived as composed of 72 ring-units—each one inch long, 50 inches diameter, or we may consider it made of stave-units 1 inch wide 72 inches long of which latter there will be as many as there are inches in the circumference, viz. : 157, or more exactly, 157.08. See dotted lines, fig. 5. Now to compare the strain on each ring-unit with those on each stave-unit. Let a model of one of the rings like an uncut piston-ring, be placed water-tight between two immovable heads B B, fig. 6, and subjected to an internal hydrostatic pressure of 40 lbs. to the square inch.

The rule for estimating the strain on the ring is, Multiply the diameter in inches by the pressure in pounds; the product is the force tending to break it into two semi-circles, but there are two sections of the ring resisting this force, therefore one-half is borne by each side. The ring being 1 inch long by 50 in diameter, we have $\frac{40 \times 50}{2} = 1,000$ lbs., the force acting on each side parallel to circumference tending to pull it in two. The simple strain then is 1,000 lbs. on the ring-unit. Now it is evident that the force tending to move the heads B B apart will be obtained by a different rule, which is, multiply the area of one head *within the ring* by the pressure per square inch. Now considering the cylinder made of 157 staves it is evident that each will resist $\frac{1}{157}$ of the force. Thus it will be seen according to the figures in the cut that each stave is loaded with 500 pounds, and it can be proved in like manner that a ring-unit bears double a load that a stave-unit does in plain cylinders of any size. But the ring-units and the stave-units are one and the same shell, fig. 5, and the compound strains are apparent, but what effect the 500 pounds per stave-unit has on the tensile strength of the elastic limit of the ring-unit is a matter of little consequence, except as a scientific fact, and one that would be rather difficult to investigate or determine by experiments of short duration, and it is not worth considering in a properly made steam boiler that has an ample margin for safety. But it may be worth considering in a case where the circumferential tension is nearly up to the estimated elastic limit of the metal. It may have an important influence on the ultimate strength.* Suppose a single-riveted 54-inch shell made of $\frac{1}{4}$ -inch plates 40,000 T.S. Estimating the seams at $\frac{6}{10}$ the strength of the plates then about 111 pounds persquare inch would reach the estimated elastic limit of that quality of iron. Thus $\frac{6}{10} \times 40,000 = 24,000$, the ultimate strength of the seam; $\frac{24,000}{2} =$ elastic limit of the seam. So by the rule $\frac{12,000 \times .25}{27} = 111$, the pressure per square inch which would produce 12,000 pounds per sectional square inch on $\frac{1}{4}$ -inch plates in a 54-inch shell. It may be said that the metal between these holes of the seam is not subjected to a longitudinal tension. A double-riveted lapped seam is stronger than a single-riveted one for this reason, among others, that it is broader and better able to resist the twisting inward at the point A and outward at B, fig. 5, which must take place when the tension is sufficient to produce the distortion shown at A'', fig. 1. It is evident however that the longer the seam the weaker it will be in this respect. This being so we may fairly suspect that long longitudinal seams are more liable to be affected by internal grooving than short ones.

Thus far only the strains on cylindrical forms have been considered.

* According to Prof. Rankine, the plane model of a riveted joint may be stronger than one of its members tested separately on account of the presence of the body of the rivets in the holes of the model, which prevent lateral contraction, fig. 4. He says, C. E., p. 292, § 154: "If a solid bar has the alteration of its transverse dimensions prevented or resisted by any means, it yields less longitudinally to a longitudinal stress than it does when it is free to yield laterally; in other words, its direct or longitudinal stiffness may be increased. . . . Its strength is increased also."

Incorporated
1866.

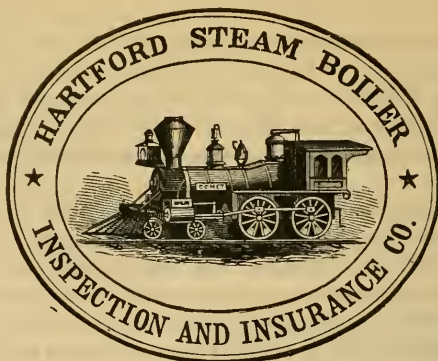

Charter Per-
petual.

Issues Policies of Insurance after a Careful Inspection of the Boilers,

COVERING ALL LOSS OR DAMAGE TO

BOILERS, BUILDINGS, AND MACHINERY,

ARISING FROM

Steam Boiler Explosions.

THE BUSINESS OF THE COMPANY INCLUDES ALL KINDS OF STEAM BOILERS.

Full information concerning the plan of the Company's operations can be obtained at the
COMPANY'S OFFICE, HARTFORD, CONN.

Or at any Agency.

J. M. ALLEN, Prest. W. B. FRANKLIN, Vice-Prest. J. B. PIERCE, Sec'y.

Board of Directors.

J. M. ALLEN, President.	GEN. WM. B. FRANKLIN, Vice-Prest. Colt's Pat. Fire-Arms Mfg. Co.
LUCIUS J. HENDEE, Prest. Aetna Fire Ins. Co.	GEO. CROMPTON, Crompton Loom Works, Worcester.
FRANK W. CHENEY, Asst. Treas. Cheney Brothers Silk Manufacturing Co.	HON. THOS. TALBOT, Ex-Governor of Mass.
CHARLES M. BEACH, of Beach & Co.	NEWTON CASE, of The Case, Lockwood & Brainard Co.
DANIEL PHILLIPS, of Adams Express Co.	WILLIAM S. SLATER, Cotton Manufacturer, Providence, R. I.
GEO. M. BARTHOLOMEW, Prest. Amer. Nat. Bank.	NELSON HOLLISTER, of State Bank, Hartford.
RICHARD W. H. JARVIS, Prest. Colt's Fire Arms Manufacturing Co.	CHAS. T. PARRY, of Baldwin Locomotive Works, Philadelphia.
THOMAS O. ENDERS, Sec'y Aetna Life Ins. Co.	
LEVERETT BRAINARD, of The Case, Lockwood & Brainard Co.	

GENERAL AGENTS.

THEO. H. BABCOCK,
CORBIN & GOODRICH,
LAWFORD & McKIM,
W. S. CHAMBERLIN,
J. L. SMITH,
H. D. P. BIGELOW,
C. C. GARDINER,
D. C. FREEMAN,
W. G. LINEBURGH,
GEO. P. BURWELL,
W. B. CASSILY,

CHIEF INSPECTORS.

R. K. McMURRAY,
WM. G. PIKE,
JOSEPH CRAGG,
WM. U. FAIRBAIRN,
B. M. LORD,
H. D. P. BIGELOW,
J. S. WILSON,
F. S. ALLEN,
W. S. FOX,
A. C. GETCHELL,
J. S. WILSON,

OFFICES.

NEW YORK CITY.	Office, 285 Broadway.
PHILADELPHIA.	" 430 Walnut St.
BALTIMORE.	" 10 So. Holliday St.
BOSTON, MASS.	" 10 Pemberton Sq.
PROVIDENCE, R. I.	" 42 Weybosset St.
CHICAGO, ILL.	" 132 La Salle St.
ST. LOUIS, MO.	" 404 Market St.
HARTFORD.	" 218 Main St.
BRIDGEPORT.	" 328 Main St.
CLEVELAND.	" 246 Superior St.
CINCINNATI.	" 53 West Third St.

The Locomotive.

PUBLISHED BY THE HARTFORD STEAM BOILER INSPECTION AND INSURANCE COMPANY.

NEW SERIES—VOL. I. HARTFORD, CONN., NOVEMBER, 1880.

No. 11.

Explosion of a Horizontal Tubular Boiler.

There was a brief notice of this explosion in the list for September, where it is numbered 106, that being its rank in the annual list for this year. The boiler resembled in size and general proportions the one shown on page 55, current volume, excepting the steam-dome, which is absent in this case; the first rupture, however, took place through a portion of the plate, which upon its surface appeared to have the strength due to a full line of metal of this thickness ($\frac{1}{4}$ "), instead of through the seam, as in the former case, but no doubt the line A B, which is that of the initial break, was weaker than any other longitudinal line of similar length in this shell. This boiler was 54" in diameter, and nearly

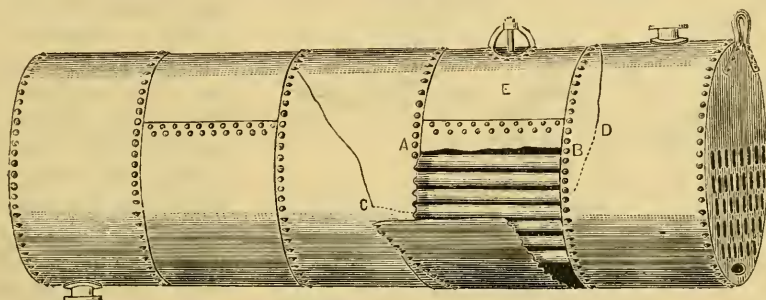

FIG. 1.

12 feet long, containing 71 tubes 3" diameter, with a length equal to that of the shell. The plates were $\frac{1}{4}$ " thick, double-riveted at the longitudinal seams as shown in the sketches, and the safety-valve was loaded for 90 pounds pressure per square inch, but bystanders affirmed that they had often seen the gauge register 100 pounds or near it, and the "boiler a second-hand one at that," with considerable emphasis on the compound adjective, which means simply that it had changed owners or location since it left first hands. Its strength may have been impaired thereby if it was abused in moving, or subsequently in its use. The contingencies attending the manufacture of iron, and the shaping and fastening it in the form required, and the abuses it may undergo in the hands of ignorant or unskilled attendants, render it highly desirable that something more than an apparent margin of strength should exist in every steam-boiler. If the calculation of resisting power is based on a sample of metal of a high grade of tensile strength, there should be no doubt as to the uniformity of its structure throughout. If no inferior bar could possibly get into the pile, if there could be no imperfect welding of the pile, in short, if no dishonest or imperfect work could affect the result, in other words, if human imperfections could be eliminated from the problem of the uniformity of the metal, we might depend with confidence on the test of a single sample of the metal as a basis for the calculation of the strength of the structure. But even having all this assured, and having a perfect boiler, as soon as it is put at work, even with a moderate load, its deterioration begins and progresses at a rate depending upon its adaptation to the work, its settings and attachments, and *the attendance* after it is

erected. Let us therefore have ample thickness, as well as good metal and good workmanship, and then have it well erected, *well attended*, and regularly inspected.

THE EXPLOSION.

The initial break in this boiler, as it was also in the one elsewhere described in this paper, was at the middle of a deteriorated plate (A Figs. 6 and 7 and) A B Fig. 1 of this report. It is probable that *this* one, as well as *that*, was caused by frequent overheating, *this* from being imperfectly set, the flame impinging upon the plate just above the water-line, and *that* from sediment in the bottom of the shell, as described in *that* report. The boiler which is the subject of this report was found after the explosion

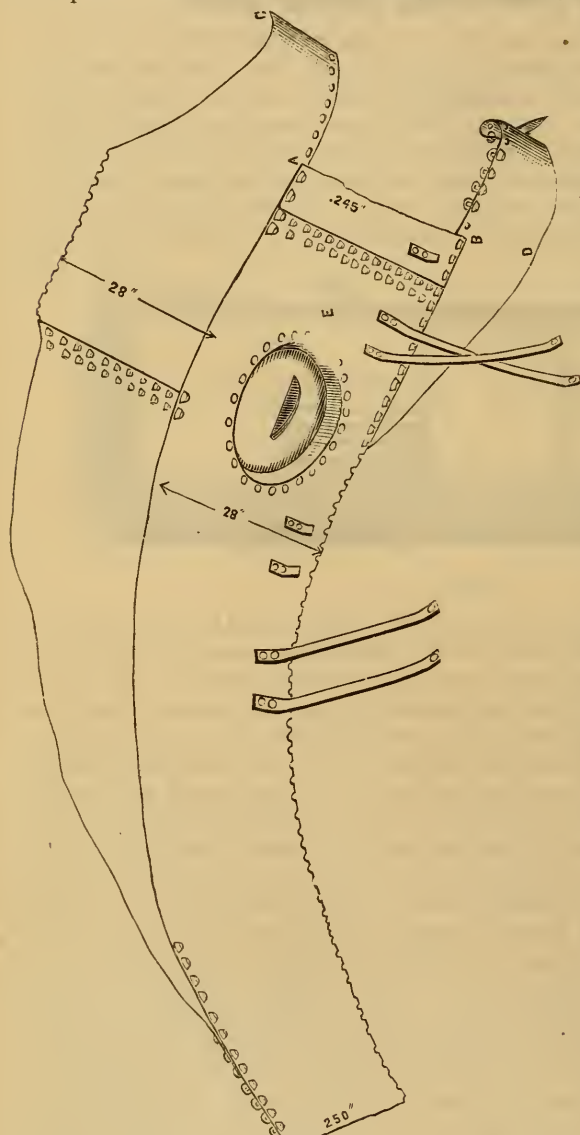

FIG. 2.

standing on end, leaning against the setting of its fellow with the zone of plates shown in Fig. 2 hanging by the ends which are represented in dotted lines below the letters C and D, Fig. 1, which are the same portions that are represented as bent and twisted at the right hand of Fig. 2, where the same reference letters C and D are cut. The complete separation of these plates from the rest of the boiler was effected in the process of dragging the whole from the ruins of the building by means of a chain attached to the narrow part of the plate. The building in which this boiler and its fellow stood was completely demolished, nothing remaining but the mason-work of the foundation and the flooring. After the zone of plates was partially torn off (hanging only by the narrow ends), the balance of the force was spent on the surrounding exterior objects and no further damage was done to the boiler itself until an attempt was made to drag it from the ruins by a chain attached to the plates. The whole attending phenomena indicate that after the initial breach A B had reached a size sufficient to instantly relieve the boiler-contents of pressure, the narrow end of the zone of plates, Fig. 2, was forced out-

ward and downward, passed under the boiler, which was lifted by the reaction, while the plates were flattened as shown in Fig. 2, and left hanging by the bent and twisted ends as described. The release of the water and its contained nascent steam and the free steam was sudden and complete, owing to the weakness of the secondary lines of rupture traced on Fig. 1. The tearing off was effected by cross-bending, as the bark of a tree is unwound from the wood by pulling at a free longitudinal edge. No sufficient time of partial confinement of the water appears to have been allowed in which the force of the expansion could impel it (the water) in a concentrated mass in any one direction guided by parallel surfaces, and the rocket motion therefore could not be initiated, or otherwise one of the heads would have been torn off the tube ends, as was the case in the Cambridge explosion, which* is described in the next article. These two cases appear to be a verification of the proposition that boilers exploding with a full supply of water usually fly a distance governed by the quantity of water and the freedom or suddenness of its escape, and it may be to some extent directly, as the former, and inversely as the latter.

Explosion of the Boiler at Cambridge, Mass., April, 1878.

Reproduced from THE LOCOMOTIVE, No. 6, Vol. X, with additional illustrations of strains, etc., from page 170, current Vol.

BY REQUEST.

"It was a horizontal tubular, one of the most common in use, and well known to all familiar with Steam Boilers. It was made for the present owners in November, 1869; was 48 inches diameter and 17 feet long. All longitudinal seams double-riveted, with the necessary man-hole on top for getting into the boiler for inspection and cleaning it out. Hand-hole in bottom of front head for cleaning out under the tubes. The shell of the boiler was of best quality C No. 1 iron; $\frac{5}{16}$ thick. The heads were best quality flange iron, $\frac{3}{8}$ thick, being well braced, having angle-iron braces riveted to the heads, and stays from thence to the shell. It was furnished with the usual appliances: one safety-valve 3 inch diameter, three gauge-cocks, etc., and at its completion was examined and subjected to a hydraulic pressure of 150 lbs. per square inch, and considered safe at a steam pressure not exceeding 100 lbs. per square inch."*

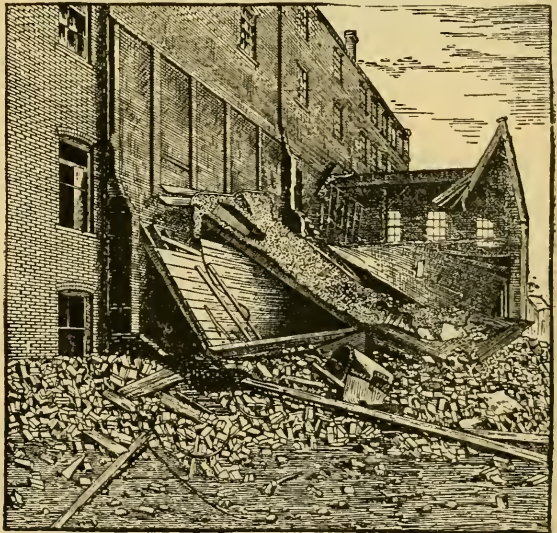

FIG. 1.—WRECK OF THE BOILER HOUSE.

The above description is quoted from the report of Inspector Fairbairn of the Eastern Department.

Of the following illustrations Figures 1, 2, and 3 represent the wreck of the boiler

* The examination and test were made by the government inspector. The boiler was never under guaranteed inspection.

and building. They are copies of photographs taken soon after the explosion. The cuts that follow are intended to illustrate the theory of the explosion.

Cut No. 4 is a longitudinal section of the boiler as originally made, omitting the

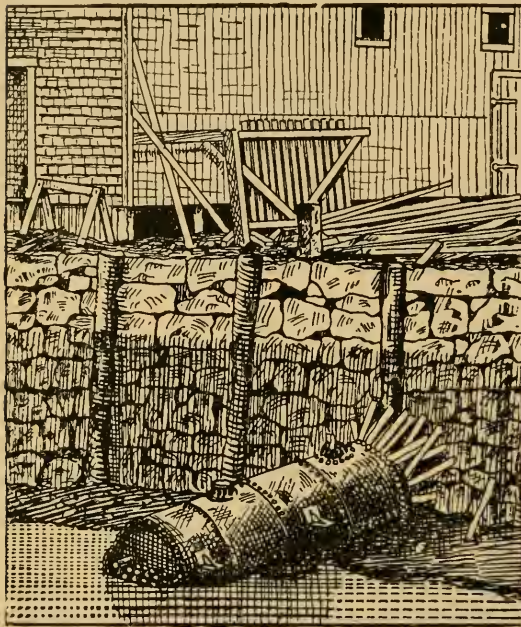

FIG. 2.—THE PRINCIPAL PART OF THE BOILER IN THE CANAL AT LOW TIDE.



FIG. 3.—THE REAR END OF THE BOILER.

patches which have been put on since, but showing at A the location of the deposit which permitted the iron beneath it to become overheated.

The explosion of this boiler occurred in April, 1878, by which three persons were killed, and a number more wounded. An unusual interest was excited by this accident, and a number of experts were called to testify as to the cause of the disaster, and although there was no disagreement among trained boiler inspectors, still there was no doubt expressed by one expert witness as to the original soundness of the iron, and the correctness of the construction and setting. The marks upon the plates of the back part of the boiler seemed, from the evidence, to plainly indicate a considerable deposit A (Fig. 4) and repeated repairs of the bottom of the shell had been made, all rendered necessary from overheating where sediment had prevented contact of the water with the iron. Whatever the character of the iron and the faults of construction may have been, there would seem to have been sufficient warning of approaching disaster to have prompted a greater degree of care in inspection and cleaning.

The boiler was worked at a pressure of about 75 lbs. per square inch, and it was allowed to come to repairs repeatedly without any inspection, till at last, on the 6th of April, it exploded with destructive force, the larger portion, consisting of about $\frac{2}{3}$ of the shell, and containing all the tubes, was projected

through the side of the building a distance of 150 or 200 feet into a canal, where at low water it was photographed (Fig. 2).

The initial rupture was undoubtedly at A (Figs. 4 and 5), the iron having been

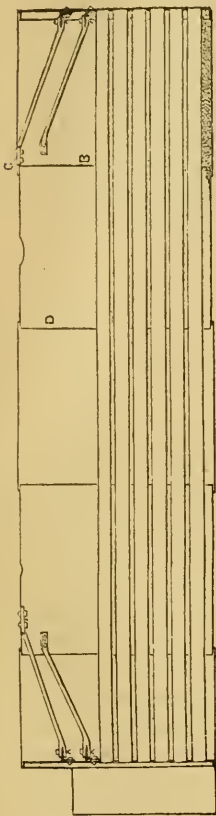

FIG. 4.

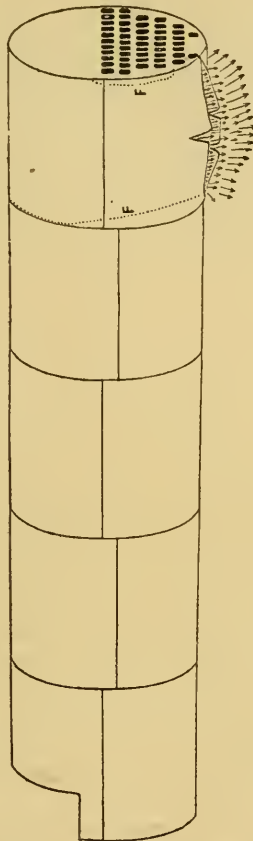

FIG. 5.

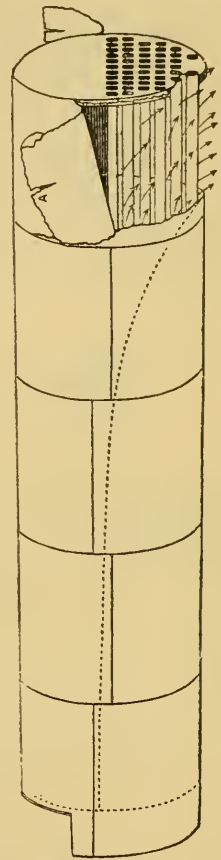

FIG. 6.

weakened by frequent overheating for considerable distance along the bottom, and the usual working pressure was sufficient to rend it and allow of the instantaneous escape of the steam, which, owing to its activity, would pass through the mass of water,

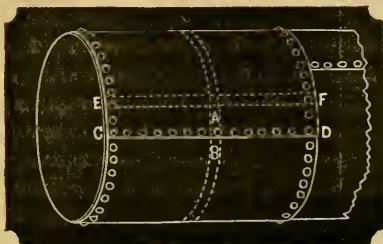

FIG. A.

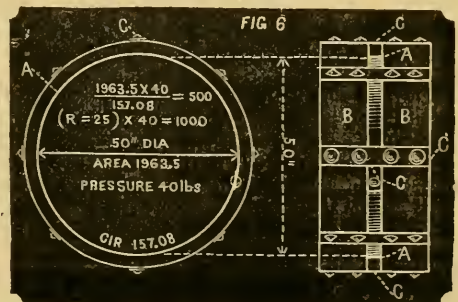

FIG. B.

driving a portion before it, and enlarging the initial opening, as shown in Fig. 6, and an instant may be conceived in which the water is disintegrated and expanded with such suddenness as to give the character of an explosion; it fills the entire steam-room and water-room, and is projected like a charge from a cannon against the rear head of the boiler, there being little resistance in that direction. The parallel surfaces of the shell and tubes direct the mass of foamy water, which still retains a large percentage of its original specific gravity, and its inertia or momentum carries enough of it past the opening to tear the boiler apart, as shown in Fig. 7, and the principal part takes a rocket-like course, a distance which is determined by the quantity of expanding elements that it contains and the freedom with which it can escape. The process is practically continuous, but eye-witnesses often, at coroners' inquests, have said they heard a great rush of steam followed by a loud explosion.

In this case a doubt was expressed by some of the witnesses as to the probable location of the initial rupture, but none of the practical boiler inspectors who were called expressed the least doubt as to the presence of a considerable deposit at A (Fig. 4). The weakest point, originally, may have been the seam C B, as stated by one expert, owing to faulty workmanship, but when the overheating had so reduced the strength of the plate at A, which has to sustain just double the strain per ring unit, see A B, Fig. A, that it does per stave unit E F, Fig. A, there would seem to be little doubt in the minds of practical men where the fracture started, even though statistics did not, as they certainly do, clearly show that initial ruptures in shells of this form almost invariably are longitudinal.

The bracing, which was charged by the same witnesses with contributing to the weakness, is not placed in the boiler for the purpose of supporting the cylinder part, but to prevent the bulging out of the flat end-plates or heads, and they are not used nor needed on heads that are sufficiently stiff to bear the load without bulging, as are ribbed, heavy cast-iron or hemispherical wrought-iron heads, in plain cylindrical boilers without tubes, then the seam C B, figs. 4 and 7, would be called on to sustain the entire load on the area of the rear head, and even this is but half what is put upon the seams E E, etc., per lineal unit of seam measurement—not per square inch. See calculation.

An explosion occurred in the same inspection district in September, 1875, which tends to confirm the theory above offered, and shows the difference in destructive effect between a full supply of water (in the boiler at the time of the explosion), and little or none at all.

The boiler was of precisely similar construction, shown in Fig. 8, and at the time of the explosion contained no water at all. It was in communication with two adjoining boilers of the same system by means of the steam pipe, and it was ruptured by dry steam while its bottom over the fire was red hot. It will be seen that the rupture is similar to that supposed to be the initial rupture in this case, and had the boiler, Fig. 5, contained no water, the damage would have stopped, as it did, here.

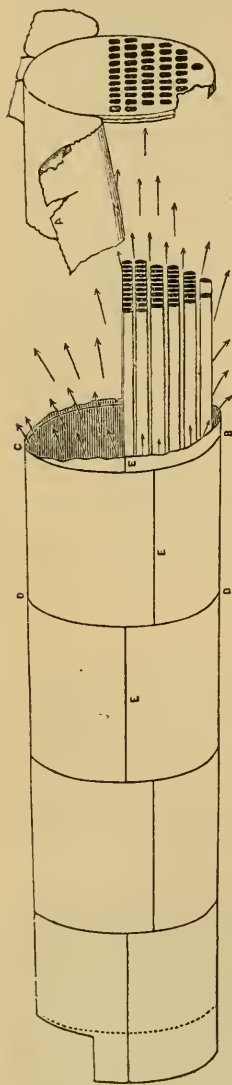

FIG. 7.

The boiler, Fig. 8, did not leave its setting, and no lives were lost, but the fireman was driven to the wall of the boiler room. It dropped on the bridge wall, the fire front, which supported the front end, having been thrown down by the first gush of steam.

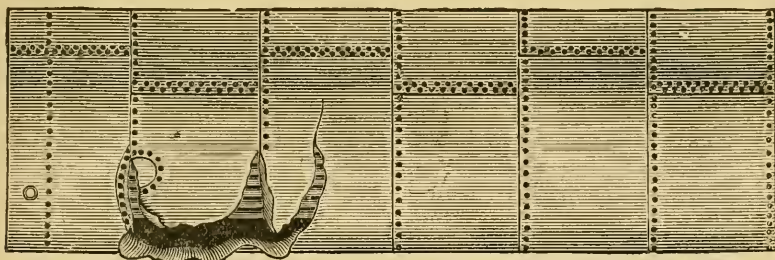

FIG. 8.

BOILER EXPLOSIONS.

MONTH OF OCTOBER, 1880.

LOCOMOTIVE (119).—One of the most remarkable railroad accidents on record occurred at Caseyville, Ill., Sept. 17th. The passenger train leaving St. Louis that night was drawn by an engine just from the shops, where it had been completely overhauled and partially rebuilt. The engine behaved first-rate until the engineer attempted to shut off steam to slow down, when he was thrown back on the tender and partially stunned. Recovering, he sprang forward to stop the engine, but was inexpressibly astonished to see before him nothing but the end of the fire-box, the front of the cab, and the tubes of the boiler. The train was still running, but soon stopped. It was then discovered that the boiler had exploded, the force being spent forward and upward, so that the wheels remained on the track, while the momentum kept the train in motion. The strangest part of the affair is the fact that neither the engineer nor any one on the train heard the noise of the explosion. The conductor ordered on the brakes without hearing the engine, because the train passed the town without stopping.

TOBACCO-SHOP (120).—A mysterious boiler explosion was one of the recent events in a Hampden street tobacco-shop, Springfield, Mass. Little damage was done, and nobody was hurt.

WOODEN-WARE WORKS (121).—A terrible boiler explosion occurred Oct. 14th, at the wooden-ware mill of Mr. Zophar Willard. The boiler-house, which is of brick, was almost wholly demolished, nothing being left standing but the wall which adjoined the dry-house. Large pieces of the boiler were thrown across the road and into the pond near by. The cause was a defective flue. Fortunately, no one was hurt. The loss occasioned by the explosion is estimated at one thousand dollars.

DISTILLERY (122).—Steam blew a large kettle to pieces at the Garden City Distillery Company's works in Chicago, Friday, Oct. 15th, killing seven persons, and severely injuring four others.

LOCOMOTIVE (123).—An Iron Mountain locomotive exploded its boiler in the round-house at Barring Cross, Mo., Saturday, Oct. 16th, dangerously wounding two men.

PAPER-MILL (124).—A boiler in the paper-mill connected with Russell & Co.'s agricultural works at Massilon, O., exploded on Saturday, Oct. 16. Damage to building,

\$10,000. Anthony Welch was buried in the débris. An arm was torn off, and he is mortally hurt. Anthony Manger was mortally scalded. Charles Sands, Charles Forsythe, Benjamin Rosenberer, and Roman Westhafer were severely scalded, but will recover. A boy walking along the canal 50 yards away was struck with flying fragments, and suffered a broken leg.

DISTILLERY (125.)—A horrible accident occurred at Terre Haute, Ind., Oct. 20th. A battery of three boilers in the distillery of Cox & Fairbanks, the largest establishment of the kind in the United States, exploded with a report and concussion that was heard for miles. Six men were instantly killed, and twice as many seriously injured. The cause of the accident has not yet been ascertained, but the coroner's inquest will be a searching investigation. There is great excitement here over the affair.

MILL (126.)—A boiler explosion in Webb's mills, near White House Station, N. J., Oct. 19th, scalded Job Smith of Riceville and Samuel Genung fatally, and Amos McKenna dangerously.

RENDERING ESTABLISHMENT (127.)—The residents of Maspeth, L. I., were startled by a loud report, which, upon investigation, was found to come from a portion of the village known as Furman Island. The boiling tank of Sherer & Weber's tallow-rendering establishment had exploded, killing one man, and fatally injuring one, and probably two others. The factory had been in operation only a few days, and the engineer had not got the boiler in perfect working order up to the time of the explosion. He heard the hissing of steam, and immediately knew that something was wrong, and started to open the safety-valve. Before he could reach it the boiler exploded, blowing him about twenty feet, against the office partition. He now lies unconscious, being terribly scalded and injured internally by the escaping steam. The boiler was blown out of the building, carrying with it the entire end of the factory, which was about 40x60 feet, and built of the most substantial materials. Peter Klein was caught by the boiler and thrown fully 200 feet. When picked up he was dead.

STEAM-MILL (128.)—A man and boy were killed, and several others seriously injured at Warrenton, Ala., by the explosion of the boiler in Jasper Smith's steam-mill.

MILL (129.)—At Guntersville, Ala., two persons were killed, and several injured by the explosion of a boiler in the mill of Jasper Smith, Oct. 20th.

ROTARY BLEACHER (130.)—A rotary bleacher and boiler in G. & G. A. Robertson's paper-mill, Hinsdale, N. H., burst Oct. 29th. One man was killed, and several injured. The mill was completely ruined. Loss about \$20,000; no insurance.

FLOURING-MILL (131.)—About 12 o'clock, Oct. 30th, the boiler of A. Lewis' flouring-mill, Atlanta, Ga., exploded, killing one white and one colored man, and wounding one colored boy, who was standing near. The accident, it was supposed, was caused by allowing the water to get too low in the boiler.

Inspectors' Reports.

The number of inspection visits made during the month of September, 1880, was 1,863, and 3,829 boilers were examined—of which 1,197 were thoroughly inspected internally and externally—pursuant to new applications for insurance, or for renewal of existing policies.

The hydrostatic test was used in 341 cases. This number is not as great as reported last month, but it indicates a good degree of activity in the boiler-shops where

this company issue indemnity certificates to accompany the maker's bill of sale, valid for one year; payable, in case of explosion, to the owner of the boiler.

The total number of defects discovered was 1,691, of which 476 were reported as dangerous when found, or as liable to become so before the next inspection is due. Among the defects reported, there are sometimes those that do not strictly belong under any of the following heads: For example, leaky tubes and seams, and defective condition of brick-work; the former causing corrosion of the neighboring parts on which the water drips; and the latter resulting in overheating of dry parts of the boiler that are exposed to heat from the falling out of some of the bricks. These two examples are not classified below, and are not included among the defects reported, unless the leaks have caused corrosion, or the exposure has resulted in burns or fractures of the plates. Sometimes defects in piping and fittings of steam and water-connections are found that would soon result in defects, if not detected and remedied. Notable in the month now under consideration was a case of maladjustment of gauge-cocks, from which overheating and collapse of a flue would naturally have resulted. This was a most dangerous decoy for the poor fireman who thought he had good water when the second gauge showed its presence, but he would have had practically an uncovered flue if he had allowed it to get so low as the second gauge.

The classified defects discovered in the month of September are as follows: Furnaces out of shape, 104—24 dangerous. Fractured Plates, 167—122 dangerous. Burned Plates, 68—31 dangerous. Blistered Plates, 234—25 dangerous. Cases of Deposit of Sediment, 237—62 dangerous. Incrustation and Scale, 391—52 dangerous. External Corrosion, 74—29 dangerous. Internal Corrosion, 71—22 dangerous. Internal Corrosion, 14—8 dangerous. Water-Gauges defective, 56—7 dangerous. Blow-outs defective, 8—6 dangerous. Safety-valves overloaded, 24—14 dangerous. Pressure-Gauges defective, 127—27 dangerous. Boilers without Gauges, 66—10 dangerous. Deficiency of Water, 7—5 dangerous. Braces and Stays broken, loose, and insufficient, 42—32 dangerous. Boilers condemned, 18.

TABLE XI.
LINEAR EXPANSION OF METALS.
(Condensed from Trowbridge.)

Name of Metal.	Multiply the length at 32° F., to get the length at 212° F., by	Name of Metal.	Multiply the length at 32° F., to get the length at 212° F., by
Cast Iron,	1.00111 = $1\frac{1}{870}$	Copper,	1.00172 = $1\frac{1}{5834}$
Steel Rod,	1.00114 = $1\frac{1}{877}$	Cast Brass,	1.00187 = $1\frac{1}{534}$
Steel tempered yellow,	1.00136 = $1\frac{1}{735}$	Brass Wire,	1.00193 = $1\frac{1}{518}$
Steel not tempered,	1.00107 = $1\frac{1}{934}$	Silver,	1.00191 = $1\frac{1}{523}$
Soft forged Iron,	1.00122 = $1\frac{1}{825}$	Spelter Solder,	1.00205 = $1\frac{1}{494}$
Soft drawn Iron,	1.00123 = $1\frac{1}{815}$	Tin,	1.00284 = $1\frac{1}{352}$
Iron Wire,	1.00144 = $1\frac{1}{694}$	Zinc,	1.00296 = $1\frac{1}{337}$
Bismuth,	1.00139 = $1\frac{1}{715}$	Lead,	1.00284 = $1\frac{1}{352}$
Gold, hard,	1.00155 = $1\frac{1}{645}$		
Gold, soft,	1.00151 = $1\frac{1}{662}$		

The above table (XI) is abstracted from Prof. Trowbridge's work on "Heat and Heat Engines." It was collated from Lavoisier & Laplace, Smeaton, Roy, Troughton, and Muschenbrock by Watts (Dictionary of Chemistry, vol. III, p. 68), and is without doubt correct under the conditions of the experiments made by these accepted authorities. If, however, they were made upon chemically pure metals and on a small scale, we may find in our actual practice with these metals some slight variations. If we accept the authority (which we may do without material error), and apply the figures, we shall find that a steam pipe of soft forged wrought iron will expand per length of 17' 3" when heated 180° from 32° to 212° F., so that it will be 17' 3 $\frac{1}{4}$ " long. Thus, 17' 3" = 207", which, multiplied by the tabular number 1.00122 = $1\frac{1}{825}$, gives 207.25254 = 207 $\frac{1}{4}$."

The Locomotive.

HARTFORD, NOVEMBER, 1880.

The suit brought against "The Hartford Steam Boiler Inspection and Insurance Co." by Mrs. Deitel, for the death of her husband, Michael Deitel, by the explosion of the boiler in the works of Wilt & Son, Philadelphia, June 27, 1879, has created a deep interest among manufacturers and steam-users throughout the land. In contesting this suit the company is not seeking to avoid any just liability, but to prevent a wrong, which if allowed to go unchecked may establish precedents which will be more or less injurious to all corporations. All just claims have been paid by the company promptly. It needs no suit at law to instruct it as to its duty in this matter, but it is the duty of every corporation to contest earnestly all unjust and wrongful claims, lest they find themselves in the hands and at the mercy of a set of unscrupulous men that will be watching for an opportunity to bring suit or get up a scare, in the hope of a division of the spoils if they succeed, by compromise or otherwise.

Every manufacturer should consider well these points, for his turn may come next if such precedents be established. The *alleged* facts upon which this suit is brought are these:

First, That the company made a careless and negligent inspection.

Second, That it applied an excessive and injurious hydrostatic test.

Third, That it allowed an excessive pressure of steam, viz., 80 lbs.

The boiler was of that type known as a "Double Decked"; sometimes called a "Union Boiler." It consisted of two cylinders, one placed above the other, and connected together with four wrought-iron necks.

The lowest cylinder was 54 inches in diameter, and contained 71 lap-welded tubes, each $3\frac{1}{2}$ inches in diameter.

The upper cylinder was 42 inches in diameter, and contained no tubes or flues. Above the upper cylinder, and connected thereto, was a steam drum about two feet in diameter. This is a type of boiler very common in the city of Philadelphia. The boiler was built by Jacob Naylor (People's Works), and put in service in the early part of the year 1870. It was inspected and insured by the Hartford Steam Boiler Inspection and Insurance Co. during its entire life. The inspections had been made annually, and the hydrostatic test applied as required by the ordinance of the city. At the annual inspection made the last of December, 1878, a large blister was found on one of the fire-sheets, and a new half-sheet was recommended; it was also decided that the boiler should be supplied with new tubes. These recommendations and requirements were promptly carried out by Messrs. Wilt & Son, and on January 3d the inspector called to examine the work of repairing, and see if it was in accordance with instructions, and well done. The work of repairing the shell was completed, but the tubes were not in the boiler.

The inspector had an unusually good opportunity to make a careful internal inspection of the boiler, which he proceeded to do. He was in the boiler with the engineer and boiler-maker, examining every seam and sheet with the greatest care. The inspector then examined the boiler externally underneath, and where the new half-sheet had been put on. The hydrostatic test was not put on at this time, for the very good reason that there being no tubes in the boiler the heads were full of tube-holes. The repairs were found to have been made in accordance with instructions. The tubes were put in place, and the boiler was shortly after put in use again. On the following 14th of May the boiler was subjected to the hydrostatic test, the water in the boiler being at or above the boiling-point. The working-pressure was limited to 80 lbs., and the test applied was 50

per cent. in excess, or 120 lbs. The boiler, as stated above, was 54 inches in diameter, made of C. H. No. 1 iron, originally $\frac{3}{8}$ -inch (.375) thick. It was stated at the trial that a place was found in a sheet where the iron was .34 of an inch thick. Assuming the less thickness to be correct, the problem is: What is a safe working-pressure for a boiler constructed of C. H. No. 1 iron, single riveted, 54 inches in diameter, iron .34 inch thick? There are various rules by which such problems are worked. The U. S. rule, the only one which is issued with authority in this country, and which is adopted by the Board of Inspection of Steam Vessels, is:

RULE.—Multiply one-sixth ($\frac{1}{6}$) of the lowest tensile strength found stamped on any plate in the cylindrical shell by the thickness—expressed in inches or parts of an inch—of the thinnest plate in the same cylindrical shell, and divide by the radius or half diameter,—also expressed in inches,—and the result will be the pressure allowable per square inch of surface for single riveting, to which add twenty per centum for double riveting, etc.

The hydrostatic pressure applied under this rule must be in the proportion of one hundred, and fifty lbs. to the square inch to one hundred lbs. to the square inch of the working-pressure allowed.

Assuming the tensile strength of the iron in the boiler under consideration to be 50,000 lbs. per square inch, we have $\frac{1-6 (50,000) \times .34}{27} = 104.8$ lbs. safe working-pressure.

It is generally conceded that American boiler-iron is stronger than English, and in American methods of construction less iron is cut away in riveted joints. Holley says in his American and English railway practice, “*For the strengths of the joints of American best plates allow one-half more than for best Staffordshire plates; for ordinary American plates, one-third more.*”

He further says: “In round numbers the working strengths (safe load) of best boiler-plates are thus:

Yorkshire plates per square inch of section, - - - - -	11,000 lbs.
Staffordshire plates per square inch of section, - - - - -	9,000 lbs.
American plates per square inch of section, - - - - -	14,000 lbs.
American plates (ordinary) per square inch of section, - - - - -	12,000 lbs.”

The strength of riveted joints from the most recent experiments is, that double-riveted lap-joints have 72% of the strength of the entire plate, and single-riveted lap-joints have 60% of the strength of the entire plate.—*See D. K. Clark's Rules, Tables, and Data, 1877.*

D. K. Clark in his article on “Factors of Safety” says, “*For machinery, an eighth to a tenth is usually practiced, and for steam-boilers from one-fourth to one-eighth.*”

Mr. Roebling says, “*Long experience has proved beyond the shadow of a doubt, that good iron, exposed to a tensile strain not above one-fifth of the ultimate strength, and not subject to strong vibration or torsion, may be depended upon for a thousand years.*”

We have not space to quote from other authorities, but these are American authorities, save Clark, and his figures are corroborated by authorities in this country.

The boiler under discussion is an American boiler, made of American iron, and it is proper to measure its strength by American rules, and rules based on American authorities. Therefore assuming 12,000 lbs. to be the safe load, and the strength of single-riveted joints to be .60, we have

$$\frac{12,000 \times .60 \times .34}{27} = 90.6 \text{ lbs. safe pressure.}$$

In the books, the safe working-pressure is generally allowed to be one-sixth the ultimate strength of the boiler, but in actual practice it is more frequently found to be one-fifth, or even one-fourth.

If one-fifth is assumed, it leaves 80% of the strength for margin of safety. When the lowest results of experiments in English iron are used in the problem, and the boiler whose strength is to be measured is made of C. H. No. 1 American iron, a factor of safety of one-fifth is fully as safe as one-sixth, with English iron and English construction. From the foregoing it will be evident to any fair-minded person that there was neither carelessness nor willful negligence in the inspection of the boiler, nor was there recklessness in allowing 80 lbs. pressure. About the 7th or 8th of June following the inspection of the boiler, it was found to be leaking around the tubes; on the 9th a boiler-maker was called to "roll" the tubes and prevent their leaking. He testified that he "rolled" them tight, and that the engineer went back and examined the tube-head and "said everything is all right now." The boiler-maker waited until steam was up on the boiler, to see that it was tight under steam, and found it to be so. The boiler was in use until the 15th of June, when it leaked so badly that a boiler-maker was sent for again, who arrived at the boiler-house early on the morning of the 16th. The boiler was full of water supplied from the hydrant. When the boiler-maker saw the boiler leaking, he said to the engineer, "This seems to be like low water by the way these tubes are leaking." The engineer said, "No, it is not. *I am forcing the boiler.*" The tubes were "rolled" again, no leaks were discovered, and the engineer said, "it was all right again."

On the 20th of June a brother engineer by the name of *Marshall* called upon *Deitel* the latter part of the afternoon, and found the boiler was leaking around the tubes. (It was stated, we think, by one of the plaintiff's lawyers that the heads could not have been seen after the boiler was set and bricked up. This opinion doubtless arose from want of knowledge relative to boilers in use. Those familiar with boilers understand that there are doors by which access is gained to the heads for the purpose of cleaning tubes.) He stated that the head vibrated with the stroke of the engine. On the 26th Marshall called again, and found the boiler even in worse condition than at his last visit. He said the engineer was quite worried over the condition of the boiler, and did not wish to talk about it. He said, however, to Marshall, "Harry, my boiler-head is going in and out." (Making an expressive sign with his hand.) This witness also stated that he had conversation with the engineer about a "boiler-purger" which he had been using which caused the boiler to *foam* badly. He (Marshall) told the engineer that it was not safe to run the boiler an hour. The engineer said he wanted to run until the 4th of July, and then he would make repairs. At the coroners' inquest, shortly after the explosion, there was testimony going to show that the engineer had expressed fears of the boiler only a few days before the explosion. On the morning of June 27th, the boiler exploded, killing the engineer. During all the time that the boiler was leaking and being repaired, no notice was given to the Hartford Steam Boiler Inspection and Insurance Company. Had it been notified, an inspector would have been dispatched to the place at once, and the boiler shut down and examined. But instead, with the full knowledge of trouble and danger, the engineer assumed the responsibility of attempting to run the boiler until July 4th, when, it being a holiday, repairs could be made without loss to the proprietors, as would be the case if the works were stopped before. These are the facts in the case as brought out mainly during the trial. The rulings of the judge were fair, and his charge was in accordance with the facts as shown in the evidence. It was very clear that the plaintiffs had made no case, but the jury, moved no doubt by sympathy for the widow, brought in a verdict for the plaintiff. The company immediately moved for a new trial. As has already been said in this article, the company does not seek to avoid the payment of any just claim against it, nor does it wish to shield itself behind any false entrenchment. Those who have dealt longest with it know that it is not slow to settle all just claims. But it is the duty of every individual and corporation to resist wrong doing, and to prevent wrong precedents being established. Every manufacturer in Philadelphia and elsewhere is interested to have a right and just termination to this

suit. If the friends of a person who has knowingly taken his life in his hands, and run great risks, and is finally killed, can collect damages of any person whom they elect to sue, corporations whether foreign or home, have a deep interest in this issue, for any one of them may be the next victim.

The *Iron Age* in commenting upon this case says: "Probably they (the jury) would have sympathized with the widow, had she sued the Bank of England or the man in the moon." . . . "An attempt to rob a company for the benefit of an individual is incipient communism. It establishes a bad precedent, and if allowed to stand may lead to serious mischief, encouraging suits against companies and individuals on no better pretext than that which exists in this case."

Barr's Hand-Book for Steam Engineers.

This book has been written to supply a demand which comes from two classes of persons; first, from those who have had little or no experience in the management of steam machinery and feel the need of a small and convenient hand-book for reference; second, there has long been a demand from owners of steam power for some suitable hand-book which will give in brief terms an outline of the practical management of steam machinery, and suggestions as to its selection.

This book aims to give such information as would be likely to be required by these two classes of persons. In regard to the selection of steam machinery no preference is given in the body of the work, and the advertisements in the back part of the book relate solely to engines, boilers, and their appliances.

The work is intended as a guide for persons in charge of, or in any way connected with, steam or steam machinery. It is not, nor does not aim to be, an elaborate treatise on the steam engine, but a volume containing valuable and plainly-stated facts which every one who has anything to do with steam should possess.

The book is published by J. H. Kerrick & Co., Indianapolis, Ind., and will be sent by mail on receipt of one dollar.

Spontaneous Combustion.

After numberless examples of fires caused by spontaneous combustion, the term is still sneered at by the wiseacres who assume that every case of fire is by direct intention or traceable accident. The fact of spontaneous combustion may be easily proved by any of those doubting Thomases if he will saturate a wisp of cotton fiber with linseed oil and expose it for half an hour to sunshine and air; it will, except there are unlooked-for hindrances, take fire and burn within thirty minutes. Recently, on visiting a manufactory in Connecticut, a heap of drillings and filings, the waste of the milling-machine, planer, and bolt-cutter, was noticed on the bank of the raceway, some ten or twelve rods from the works. The driver stopped the carriage and was sent to the spot with a lucifer match. On touching it to the heap, just at the edge of the water, the match ignited, setting on fire the heap as though it had been saturated with benzine or turpentine, much to the surprise of the man, who had never seen iron burn before. To be sure there were favorable conditions—oily iron chips with shreds of oily cotton waste; the compression of weight of the heap, and moisture—a manufactory of hydrogen gas. But similar favorable conditions are possible inside the walls of a building, and then when the concern burns up there is suspicion of incendiarism and espionage of some careless but wholly innocent employee. It is a fact long ago settled that waste, the debris of cotton and woolen factories, and rags intended for conversion into paper, do take fire spontaneously. Especially is this the fact with cotton waste, always more or less oily, and cotton

factories have been destroyed by fire in spite of all precautions, such as hose, force-pumps, buckets, etc. A case comes to mind in which a whole range of "drying-sheds" were burned, the fire starting in a heap of cotton cloth in a building in which there had never been a fire or a lantern. A few years ago there was a church burned at Pawtucket, R. I., the fire beginning in a small building, at some distance, where cotton waste was stored. The building was locked up and never held a stove, nor was it ever visited by lamplight. A correspondent of a newspaper gives his experience as follows: "Having need of some oil for domestic use, I went to a paint-shop near by and procured some. The painter put me up a mixture of boiled linseed oil thinned with turpentine, and added a little dark color. The bottle was clean. I used the oil for wood-work in the house, putting it on with a cotton rag, the lining of an old dress. The work was done by half past three, and the oil-bottle and rag were placed in a closet in the bath-room. At five o'clock smoke was discovered issuing from the bath-room, and the rags were found to be on fire. The day was a rainy one, the rags were not exposed to the sun, and there never had been any fire in the room." Instances of a similar purport might be adduced to make a long list. Enough, however has been said to suggest caution in the use of dangerous combustibles and the storage of oily trash. To this may be added a word to those in charge of mills or rooms of mills where any kind of textile manufacturing is carried on: Keep belts clear of gatherings of waste and keep the steam-pipes clean; oily waste has over and over again fired a mill, and will do it again. Look out for any holes or corners where rats or careless employees may deposit waste, for it will burn by free exposure to air, without heat or sun.—*Boston Journal of Commerce.*

Vastness of Time.

Some time ago Professor Richard A. Proctor, an astronomer of the highest authority, lectured upon the vastness of time necessarily involved in the process of creation, or development, as some would prefer to call it. Among other things he said, as reported in a New York exchange:

It seems clear from the researches of geologists into the earth-strata and into the effects of subarean denudation that during 100,000,000 years the earth has been exposed to such heat and light as the sun at present pours upon her. From the experiment of Bischoff it seems that the preceding stage, during which the earth was cooling from 2,000 degrees C. to 200 degrees C., lasted 350,000,000 years, and the preceding stage, during which it was forming, lasted during indefinite lengths of time. We deduce from all our knowledge of the subject, said the lecturer, that the earth is, at the least, 500,000,000 years old. The principle underlying our calculations is that the larger a globe is the longer is the stage of its cooling. Adopting this plan as to Jupiter, it will be 3,500,000,000 years before he will reach the earth's stage, and it will take the sun ten times as long, or 35,000,000,000 years, to become as cool as the earth, whereas the moon was in the same state as our earth 420,000,000 years ago.

These vast figures convey no definite idea. They simply emphasize the infinite. It is impossible to conceive of a time prior to existence. It will be observed that these incalculable ages refer one to certain phases of cosmic existence, and suggest an indefinite series of phases. In other words, in the book of existences these periods represent only a few of the last pages. Professor Proctor showed that the duration of the earth, measured though it be by such countless ages, is ephemeral as compared with the galaxies.

It is well for the mind to turn occasionally from absorption in the petty things of every-day life to a contemplation of the Great Whole to which all existences belong. There is no end to the expansion. It would breed vague musing to brood over such things; but in this practical age there is not much danger of too much abstraction. There is something peculiarly wholesome in the reflection of our comparative insignificance.

Origin of the Postage Stamp.

Quite an interesting and curious story is connected with the origin of the postage stamp. One day a young girl came forth from an inn located in the northern part of England, and received from a postman a letter, which she turned over in her hand, as she inquired the price of the postage. The man asked a shilling, a sum too large for one so poor as herself to pay, and so she returned the letter to the postman with sadness, although she knew that her brother had sent it. But a sympathetic traveler named Rowland Hill stood near, and at this moment interposed and insisted on paying the shilling himself, although the girl seemed strongly averse to his doing so. When the postman had departed, the kind-hearted Mr. Hill was surprised to find that there was no need for his pity; for the envelope, the young girl explained to him, contained no written communication, but on its outside were certain marks agreed upon by herself and brother, from which, as she held the letter in her hands, she gathered all the information she desired. "We are both so poor," she continued, "that we invented this mode of correspondence without paying for our letters."

Such duplicity set Mr. Hill to thinking that a postal system which incited people to commit petty fraud must be very defective. He argued that if the price of postage was lowered from an exorbitant rate to one that came easily within the means of the mass of the people, so many more letters would pass through the mails that the financial condition of the treasury would not be impaired, while society would derive much additional benefit. He became so interested in the matter that he managed to bring his views to the notice of the British Government, which gave them a favorable reception; and on the 10th of January, 1840, which may be considered the birthday of the postage stamp, letters began to be circulated in every part of the United Kingdom at the postage rate of only a penny. The experiment was successful to an extent much beyond expectation. Rowland Hill became secretary to the postmaster-general, and during the next ten years so great a change had taken place that in 1850 the number of letters sent through the mails was 7,239,962, against 1,500,000 in 1840.—*The Paper World*.

American Petroleum.

The petroleum traffic, says the *Railroad Gazette*, seems to have an almost unlimited capacity for growth, and this year the business, and especially the export business, has been greater than ever before. Returns for January show an increase of about 30 per cent. in the production of the wells, and of very nearly 150 per cent. in the shipments thence, compared with last year; and for the months of January and February this year the exports have been 63,684,000 gallons, against 37,090,000 last year; and last year the exports in these months were nearly one-third larger than were ever known before. Not much money had been made from the carrying of petroleum thus far this year, however. The recent settlement of the difficulties between the trunk lines, the Tide-Water Pipe Line, the Standard Oil Company, and the producers will doubtless make it possible to get better rates for carrying petroleum over certain routes; but the day has passed when what used to be known as good rates can be secured. The Standard Company itself has spoiled what used to be an enormous rail business, by laying a pipe line from the wells to Cleveland; a new pipe line is to be laid to Buffalo; and though there is not now any pipe line through to the sea, and the Tide-Water Line has accepted a certain percentage of the business as its share, and has no motive to keep down rates, we may be sure that if rates are had that yield anything more than a moderate profit, a line to the sea-board will soon be had. But with this great growth of the business a considerable income may be had from the rates that yield even a very moderate profit; and on the enormous business of distributing the refined oil throughout the country a very satisfactory rate may usually be secured.

Incorporated
1866.

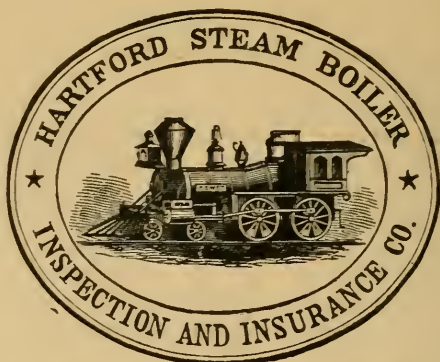

Charter Perpetual.

Issues Policies of Insurance after a Careful Inspection of the Boilers,

COVERING ALL LOSS OR DAMAGE TO

BOILERS, BUILDINGS, AND MACHINERY,

ARISING FROM

Steam Boiler Explosions.

THE BUSINESS OF THE COMPANY INCLUDES ALL KINDS OF STEAM BOILERS.

Full information concerning the plan of the Company's operations can be obtained at the
COMPANY'S OFFICE, HARTFORD, CONN.

Or at any Agency.

J. M. ALLEN, Prest. W. B. FRANKLIN, Vice-Prest. J. B. PIERCE, Sec'y.

Board of Directors.

J. M. ALLEN, President.	GEN. WM. B. FRANKLIN, Vice-Prest. Colt's Pat. Fire-Arms Mfg. Co.
LUCIUS J. HENDEE, Prest. Aetna Fire Ins. Co.	GEO. CROMPTON, Crompton Loom Works, Worcester.
FRANK W. CHENEY, Asst. Treas. Cheney Brothers Silk Manufacturing Co.	HON. THOS. TALBOT, Ex-Governor of Mass.
CHARLES M. BEACH, of Beach & Co.	NEWTON CASE, of The Case, Lockwood & Brainard Co.
DANIEL PHILLIPS, of Adams Express Co.	WILLIAM S. SLATER, Cotton Manufacturer, Providence, R. I.
GEO. M. BARTHOLOMEW, Prest. Amer. Nat. Bank.	NELSON HOLLISTER, of State Bank, Hartford.
RICHARD W. H. JARVIS, Prest. Colt's Fire Arms Manufacturing Co.	CHAS. T. PARRY, of Baldwin Locomotive Works, Philadelphia.
THOMAS O. ENDERS, Sec'y Aetna Life Ins. Co.	
LEVERETT BRAINARD, of The Case, Lockwood & Brainard Co.	

GENERAL AGENTS.

CHIEF INSPECTORS.

OFFICES.

THEO. H. BABCOCK,	R. K. McMURRAY,	NEW YORK CITY. Office, 285 Broadway.
CORBIN & GOODRICH,	WM. G. PIKE,	PHILADELPHIA. " 430 Walnut St.
LAWFORD & McKIM,	JOSEPH CRAGG,	BALTIMORE. " 10 So. Holliday St.
W. S. CHAMBERLIN,	WM. U. FAIRBAIRN,	BOSTON, MASS. " 10 Pemberton Sq.
J. L. SMITH,	B. M. LORD,	PROVIDENCE, R. I. " 42 Weybosset St.
H. D. P. BIGELOW,	H. D. P. BIGELOW,	CHICAGO, ILL. " 132 La Salle St.
C. C. GARDINER,	J. S. WILSON,	ST. LOUIS, MO. " 404 Market St.
D. C. FREEMAN,	F. S. ALLEN,	HARTFORD. " 218 Main St.
W. G. LINEBURGH,	W. S. FOX,	BRIDGEPORT. " 328 Main St.
GEO. P. BURWELL,	A. C. GETCHELL,	CLEVELAND. " 246 Superior St.
W. B. CASSILY,	J. S. WILSON,	CINCINNATI. " 53 West Third St.

The Locomotive.

PUBLISHED BY THE HARTFORD STEAM BOILER INSPECTION AND INSURANCE COMPANY.

NEW SERIES—VOL. I. HARTFORD, CONN., DECEMBER, 1880.

No. 12.

Explosion of a Rotary Bleaching Boiler.

This explosion, which caused the instant death of one person, serious injury to several others, and the complete ruin of the mill, with heavy loss to the uninsured owners, stands in our annual list for this year under number 130. Last year an explosion of a similar apparatus, which was equally destructive to both life and property, was fully reported with sketches by Inspector Allen, home department of this company, and illustrated in the old series of this periodical, Vol. X, No. 7. Up to that time 26 notable explosions of detached steam apparatus, other than generating boilers, had been published in THE LOCOMOTIVE, since when, a period of fifteen months, six have been added to the list, indicating a considerable increase in the number per annum.

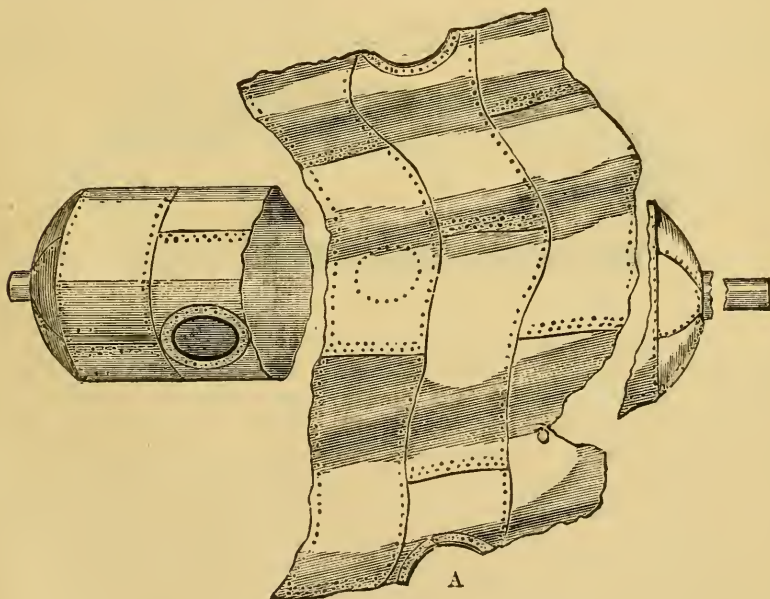

FIG. 1.

Perhaps this increase is due to the late introduction of wood-pulp digesters which are run at a higher pressure than rag-boilers. The verbal statement of the circumstances attending the disaster caused by the bleacher, the wreck of which is seen in fig. 1, shows that the explosion was initiated by the breaking of the large, and therefore weak, stock door, A, fig. 1, in shape similar to an ordinary boiler man-hole, which commonly cover no more than 40 to 45 per cent. of the area of this door. Moreover, boiler man-holes of this form in boiler-shells are placed (unlike this one,) with the major axis transverse to the axis of the cylinder, thereby cutting away less of the weakest line of the shell. This frame therefore should have been something like four times as strong as a man-hole frame of the ordinary area of opening, placed transversely and intended for the same conditions of use.

These illustrations are after sketches made by Inspector Fairbairn of the Eastern Department, who visited the scene of the disaster for that purpose soon after it occurred. Fig. 1 shows the broken, and fig. 2 the entire boiler. From information accompanying the sketches we are certain that the initial rupture was made suddenly at the man-hole A, while it was passing the lowest point of its rotative journey; because the plate or door that rested upon the frame inside was violently deposited directly under the cylinder, leaving its impression squarely indented in the floor. This bleacher was about the same size as the one illustrated last year, namely, 20 feet long, and of similar construction. Further details, except as to the size of the door, which was 16" by 24", are not at hand, and definite particulars of this case must be omitted, but the remarks that were made last year upon the theories usually advanced by theorists and others upon the subject of boiler explosions are applicable to this case, and they are republished below, copied from that report:

DISCUSSION OF EXPLOSION THEORIES.

From THE LOCOMOTIVE, vol. X, No. 7, old series.

If the above simple history is not treated as a sensational fiction, and if the case receives that calm consideration to which its importance entitles it, then it seems to suggest the propriety of a thoughtful review of all the fancy *explosion theories*, for none of them seem to be applicable to it.

These theories are mostly based on the supposition that by some means, explained in a half a dozen different ways by as many theoretical experts, there is a sudden evolu-

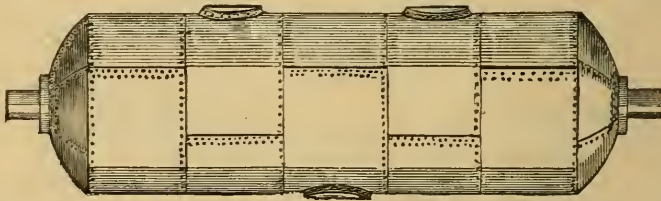

FIG. 2.

tion of force within the boiler, too powerful to be resisted by any practicable structure. Some (perhaps *more practical*) experts teach us that this force, though sudden and powerful, may be successfully resisted by a boiler constructed and set according to their elaborate and expensive plans.

This sudden evolution of force is said, by these experts, to arise from overheating the water by contact with highly heated plates, or from superheated steam through which the water is diffused on being relieved of superincumbent pressure by a sudden escape of steam; and numerous cases are cited in proof where boilers have exploded from this cause on starting up the engine, or on an increase of load suddenly put upon the engine, which is followed by an automatic opening of the throttle-valve. An increase of pressure may occur from these causes, and to very many weak boilers they have probably proved the final "straw which broke the camel's back," but to magnify these into shocks of irresistible power, such as would blow up sound boilers, by causing initial ruptures in the stronger parts of them, is not consistent with facts as they appear to those who make a business of practically studying the subject for no other purpose than the prevention (for their own benefit) of these accidents. Whatever may be said of steam-pipes as incendiaries, it would be absurd to allow them to take a place among the possible causes of this accident, by conveying superheated steam into this large cylinder. It was probably half full of a mixture of fibrous and liquid matter in about the proportion of 5½ ounces of the former to a pint of the latter, agitated by mechanical means so as to be

thoroughly mixed, receiving steam at a supposed temperature of about 300° F., through a long pipe which was only partially protected from the refrigeration of the atmosphere.

It would be an insult to the good sense of the most stupid tyro in practical science to ask him to believe that the steam within this chamber was much hotter than what was due to the pressure, as indicated by the numerous gauges.

The other absurd cause mentioned above of the sudden evolution of force is the one most often assigned. It is said to be the "lifting of the water," or, in other words, the repulsion of the water by the overheated plates. On a disturbance occurring by some change in the conditions—either the introduction of feed-water, the opening of the blow-valve or the steam-valve—the water returns to the hot plates, and concussive ebullition follows, which is said by some to resemble in effect the explosion of a charge of detonating compound on the surface of a submerged rock, and by reaction breaking through the plate, and by others it is said to resemble the blasting of rocks under water, whereby the boiler is ruptured by the impact of the projected water. Another way of producing this effect, it is said, is by feeding cold water suddenly upon overheated plates; but since overheating of plates is out of the question here, no theory depending on their presence will do for this case.

The gas theory, meaning a decomposition of the steam, and the explosion of the hydrogen with great violence, or the violent reunion of the gases, whichever it may be, will not for like reasons be admissible.

We may not speak so positively of the electrical theory, since the iron steam-pipe is an excellent conductor, but thunderbolts were not, at the moment of the accident, flying about the mill.

The more plausible theory of a gradual accumulation of a very high pressure is almost certainly precluded, since the pressure could be no higher than it was in the generating boilers (unless another source of heat is found). These boilers were fitted with safety-valves about the efficiency of which there can be no doubt, as they remained at their post after the accident.

We are then apparently face to face with a first-class explosion at a moderate pressure, which has evidently arisen from the weakness of the containing vessel. In character and effect it resembles an ordinary boiler explosion, and is in all respects similar.

The records of this company cover notices of 26* explosions of vessels detached from the generating boiler used at moderate pressure for various purposes in the arts, and there have been many others of less importance that were not considered worthy of public mention, and it is safe to say that the percentage of explosions among bleaching, digesting, rendering, and other similar apparatus is ten times greater than among steam-boilers proper at like average pressures, and the character of the destructive work done by those that use like quantities of liquid is quite as astonishing as that of ordinary steam-generators.

The uneasiness caused by the idea that there is or may be in any steam-generator an unstable compound like nitro-glycerine, or a slumbering compound capable of springing upon and breaking, or even seriously testing the strength of, its confining walls would be distressing, and if generally believed would lead to the abandonment of the use of steam by all who care for their lives or the lives of their employees.

The readers of THE LOCOMOTIVE doubtless remember the oft-repeated opinions held by this company on the subject of mysterious boiler accidents; while there are some explosions of steam-generators occurring that it is difficult for some persons to fully explain or classify definitely, we believe that they would readily take their places in one of the well-defined classes, mostly due to simple causes, if all the conditions attending and antecedent to the accident were positively known.

* Half a dozen at least have occurred since the above was written, some of which have been very appalling.

There may be and it is *known* that there are defects of both workmanship and materials sometimes so hidden that they cannot be detected by any inspection short of cutting the boiler to pieces, testing the material and searching for the "scamping" done by the workmen; still it is believed that these cases are very rare compared with the detectable defects which are being reported by the thousand, for which timely and adequate remedies are suggested and adopted. There is now a large plate of iron in the collection of defective material in this office which came from the establishment of a manufacturer noted for the excellence of his boiler-plates, and it was put into a boiler by a firm of undoubted ability and honesty, where it kept its place but a short time under the ordinary circumstances of boiler practice when a very slight but peculiar defect was discovered by the inspector, and on careful search more singular but all slight defects were detected in the same sheet. Its removal having been recommended, it was found to be so brittle in places as to fall to pieces under the blows that were necessary to detach it from its place. This is mentioned (being the most recent and best authenticated of the many cases that are on record), as tending to show that no firm is exempt from the liability of sending out occasionally a defective piece of work, and that perfect immunity from accidents in the use of steam can only be realized by careful and frequent inspections by the most competent and reliable professional inspectors.

From the nature of the business of manufacturing and working boiler-plates, such defects are more liable to occur than in almost any other mechanical industry. The puddling and other operations in the manufacture of the plates call for not only a good degree of skill and patience, but they must be associated with almost superhuman endurance in the workman; while the working of the plates into some of the completed forms of steam boilers requires a very high grade of skill and patience, coupled with a good degree of endurance. And more especially is the skill, patience, and endurance called for in *repairs* to boilers, for they are generally accomplished under the most discouraging difficulties. The material is stubborn, the room in which the work is to be performed is often so contracted as to scarcely admit the workman's hands and *perhaps* his lamp and head; ashes, dust, and smoke conspire with perhaps hot water, steam, and hot bricks to make his situation uncomfortable, and try his patience—often too in the night, and night and day continuously, with little or no rest till the job is done, for the proprietor cannot let his works stand. It is not strange, therefore, that this kind of work is not always as perfect as it should be, and it is generally only those that are not familiar by experience with those difficulties who confidently and arrogantly assert that it is impossible for any defects in workmanship to escape their vigilance, or that they know that the work was perfect when it left their hands.

BOILER EXPLOSIONS.

MONTH OF NOVEMBER, 1880.

GRIST-MILL (131.)—A very serious boiler explosion occurred at the mills of Falon Bros., Salineville, on November 1st. Mr. Aaron Dobson made a narrow escape from death, and other attaches of the establishment from injury. About 9 o'clock on the morning referred to, one of the two flues of the boiler gave way about midway, and the scalding steam and water came rushing out at both ends, tearing away everything in the way, scattering bricks and fragments in all directions. Mr. Dobson was just in the act of ascending the stairs from the engine-room to the grist-mill above, and was caught by

the escaping steam and water. He was thrown down the stairs, but managed to get through the machinery in the basement of the mill to the door where he was picked up and carried home. Dr. Lindsay was called, and after examination pronounced his burns of a very serious, though not of a fatal character. He was scalded about the neck, arms, and one side.

SAW-MILL (132.)—One of the boilers in W. W. Cummer's mill, Cadillac, Mich., exploded Nov. 2. Robert McGregor, the foreman, and E. C. Cummer were considerably scalded, and Andrew Bussey jumped against the saw when he heard the explosion, and received cuts upon his hand and arm.

LOCOMOTIVE (133.)—A shocking accident occurred on the Fall River railroad about 3 o'clock November 3d; as the train for New Bedford was crossing the bridge over the pond just before reaching New Westport station, the boiler of the engine exploded, blowing out the top and one side, and shivering the cab into a thousand splinters. Engineer George F. White of New Bedford, was killed, and his body was blown into the pond. James Thompson, fireman, was badly scalded and sustained a severe scalp wound. Fortunately no car left the track. The cause of the explosion is unknown. The engineer was an old and trusted man.

FLOURING-MILL (134.)—The steam boiler at Pounds & Loweth's flouring-mill on South Water street, Oberlin, O., exploded Nov. 5th, blowing a hole through the top eight or ten inches in diameter, and knocking a hole through the roof of the one-story building in which it was situated. Fortunately the engineer was not in the room, as he would have been severely scalded by the water, which was all thrown out of the boiler.

OIL-MILL (135.)—A boiler in the Bryan Manufacturing Company's oil-mills at Bryan, Texas, exploded Nov. 8th, injuring Jesse Nichols, the fireman, fatally, three others severely, and three slightly. The explosion was caused by a defective patch.

COTTON-GIN (136.)—The boiler at Peter Lawler's cotton-gin, Oakville, Texas, exploded Nov. 8th. Lawler and three others were seriously injured by scalding.

PORTABLE (137.)—The boiler of a donkey engine, belonging to John Reed at Fall River, exploded Nov. 19th, seriously if not fatally injuring his son.

SAW AND GRIST-MILL (138.)—Captain O'Neil's saw and grist-mill, one mile from Stevenson, Alabama, was blown up Nov. 19th, by the bursting of a boiler, and totally destroyed. Two white and two colored men were killed, and two wounded, probably fatally, and two white men seriously. The cause was the carelessness of the negro engineers.

GRIST-MILL (139.)—About two o'clock Nov. 22d, a boiler explosion occurred at the steam feed-mill of Messrs. Fisk, Lawes & Co., on Monroe street, near Huron, Toledo, O. The windows of the first floor were shattered to atoms, out of which smoke and steam poured in great volumes. The explosion proved to be quite serious. The boiler was a small upright one, which stood on the first floor, and the explosion was caused by the boiler being frozen. The fire-box inside burst, and the flues were badly crushed and jammed. The boiler was thrown upward, breaking off a large timber which supported a portion of the floor above, and damaging the ceiling badly. One of the proprietors of the establishment, Mr. W. C. Fisk, was taken from the wreck in an almost unconscious condition. Frank Shultz, an employee of the mill, was badly hurt by being scalded as well as bruised by the flying debris. The damage to the machinery and building is estimated at \$1,000.

FLOURING-MILL (140.)—The boiler of the Eclipse Mills at Osceola, Mo., exploded Nov. 24th. Emil Witte, proprietor, and Richard Gover, colored engineer, were killed.

Two other men receiving slight injuries. Pieces of the boiler, weighing 1,000 pounds, were thrown 100 yards from the mill, and the debris was scattered in all directions. The loss is \$2,000—no insurance.

COTTON-GIN (141.)—The boiler of an engine to a cotton-gin in Spartanburg, S. C., exploded Nov. 26th, on the place of Thomas Martin, killing Mr. Martin's son and two workmen.

LOCOMOTIVE (142.)—Between four and five o'clock, Nov. 26th, as a freight train on the Baltimore & Ohio road was moving slowly out of the yard at Mansfield, the locomotive, a "camel-back," burst her boiler, producing a thundering report, three persons receiving cuts.

FOUNDRY (143.)—A boiler exploded in Andrew Moore's foundry at St. Charlotte, Mich., Nov. 27th, entirely demolishing the building, killing three men and severely scalding and otherwise injuring four others.

TACK-FACTORY (144.)—The mud-drum under the boilers of the Norway tack-factory at Wheeling, W. Va., blew up Nov. 29th, wrecking part of the building and killing William Lodge the engineer.

——— (145.)—A negro was scalded to death from a boiler explosion in New Orleans, Nov. —.

WOOD-SAWING MACHINE (146.)—A terrible boiler explosion occurred Nov. 30th on the farm of O. W. Chamberlin, one mile south of Garrettsville, O. A portable engine with horizontal boiler, used for driving a circular wood-sawing machine, had just been started, when the boiler exploded with terrific force, both heads being blown out and the grate-bars, heads, and firebrands were scattered for a distance of fully sixty rods. Six men were seriously injured. The immediate cause of the accident was the collapse of the crown-sheet.

NOTE.—A repetition of No. 128 last month was caused by locating the same explosion in two places in Alabama by our informants.

Inspectors' Reports.

One thousand five hundred and seventy-seven (1,577) inspection visits were made in the month of October, and 3,554 boilers were examined. The number that were thoroughly inspected internally and externally was 1,344.

The reports of these thorough examinations contain not only statements of the conditions which relate to the safety of the boilers, but also many valuable hints regarding their economical management. In fact, the correction and prevention of most of the defects that occur to steam boilers naturally enhance their economic performance, either directly, by increasing their efficiency, or indirectly by prolonging their usefulness.

It is *almost* obvious that the prevention of scale and sediment renders a boiler more economical as well as safer; and it may be made clear by experiment, that a regular and correct system of firing and feeding will add to their efficiency as well as safety, by preventing undue and unnecessary changes in temperature, thereby reducing the liability of cracks and strains that cause leaks. These may be said to be the most prolific causes of the acquired defects in the metal of active steam boilers, and it is of mutual interest to the assuring and the assured that the former recommended and the latter practice correct methods of management.

The hydrostatic test was applied in 336 cases as an auxiliary means of detecting

leaks and weakness in new and repaired boilers, and in small ones that could not be entered by the inspector.

The number of defects discovered was 1,754, of which over one-fourth, 473, were regarded as dangerous. They are classified and described as follows:

Whole number of furnaces out of shape, 75—20 dangerous. Fractures 224—162 dangerous. This is an unusually large number of this class of defects for a single month, and seems to emphasize the remarks above, relating to undue changes of temperature, for it will be seen further on that the number of cases of deficiency of water is not up to the average, and does not warrant a suspicion that many of the reported fractures occurred from that cause. The percentage of dangerous cracks is not, however, up to the average, although the total is something notable. The number of Burned Plates was 75—28 dangerous. Blistered Plates, 273—46 dangerous. Cases of Sediment and Deposit, 237—48 dangerous. Cases of Incrustation and Scale, 366—43 dangerous. External Corrosion, 97—27 dangerous. Internal Corrosion, 74—15 dangerous. Internal Grooving, 8—3 dangerous. Water-Gauges defective, 50—6 dangerous. Blow-outs defective, 19—5 dangerous. Safety-Valves overloaded, 22—16 dangerous. Pressure-Gauges defective, 139—28 dangerous. Boilers without Gauges, 56. Cases of Deficiency of Water, 9—3 dangerous. The average of cases of this class reported per month for the 11 months ending with the last report was 10, and 5 dangerous; so it will be seen that there was not an average number of cases of low water found in the month of October, and that the great number of dangerous fractures could not be charged to that cause. Braces and Stays broken, 28—23 dangerous. Boilers condemned, 27.

Centigrade and Fahrenheit.

D. K. Clark says (Lon. Edition, Blackie & Son, 1877), page 317, "In the *Fahrenheit Thermometer*, used in Britain and America, the number 0° on the scale corresponds to the greatest degree of cold that could be artificially produced when the thermometer was originally introduced. 32° (freezing-point) corresponds to the temperature of melting ice; and 212° to the temperature of pure boiling water—in both cases, under the ordinary atmospheric pressure of 14.7 lbs. per square inch. Each division of the (this) thermometer represents 1° Fahrenheit, and between 32° and 212° there are 180° ."

"In the *Centigrade Thermometer* used in France, and in most other countries in Europe, 0° corresponds to melting ice, and 100° to boiling water. From the freezing to the boiling point there are 100° ."

TABLE XII., on the following page, shows the relation of the Centigrade and Fahrenheit Thermometer Scales, 5° C. being equal to 9° F., because the interval between the freezing and boiling points of water is divided into 100 and 180 equal parts, and these numbers are respectively multiples of, or 20 times 5 and 9. If the superfluous 32° on the F. side were disposed of the mutual translation of the scales would be simple, since the two units are to each other inversely as the number of them in any given range.

To reduce F. above melting ice to terms of C., 32° must first be subtracted from the given F. temperature, then multiply the remainder by $\frac{5}{9}$; the product will be the C. term for the given temperature; and conversely divide C. by $\frac{5}{9}$ and add 32 to translate C. into F.; to prove the work read the terms across the diagram in the table. Below melting ice a simple way is to read the respective terms across the diagram in the table horizontally, as space is not allowed here for the explanation of the rules which apply.

In the columns at the right hand of each diagram in this table, are found the approximate steam pressures per square inch, due to the adjoining indications of temperature. The pressure is expressed in pounds and in atmospheres.

The high pressures are obtained from the several authors who have deduced and tabulated them from experiments and formulæ of Regnault and others; and being hypothetical, accuracy is not claimed for them.

TABLE XII.

COMPARISON OF CENTIGRADE AND FAHRENHEIT SCALES, AND APPROXIMATE STEAM PRESSURE IN POUNDS AND ATMOSPHERES PER SQUARE INCH DUE TO THE TEMPERATURE.

THERMOMETER.		STEAM. NON-CONDENSING ENGINE.			THERMOMETER.		STEAM. CONDENSING ENGINE.		
Centi.	Fahr.	Pres. per gauge. lbs.	Total Press. Lbs.	Atmos.	Centi.	Fahr.	Press. per gauge.	Back Press. Lbs. Atmos.	
260	500	665	680	46.	100	212	0	14.7	1.
255	491	610	625	42.	95	203	Vacuum, effective.	Lbs.	Atmos.
250	482	560	575	39.	90	194	Gauge. lbs *	12.	0.55
245	473	515	520	36.	85	185	9½	4.7	10.
240	464	472	487	33.	80	176	12½	6.2	8.5
235	455	430	445	30.	75	167	15½	7.7	7.
230	446	390	405	27.5	70	158	18¼	9.1	5.6
225	437	354	369	25.	65	149	20½	10.2	4.5
220	428	321	336	23.	60	140	22	11.	3.7
215	419	290	305	20.7	55	131	24	11.9	2.8
210	410	262	277	18.8	50	122	25	12.4	2.3
205	401	235	250	17.	45	113	26½	12.3	1.4
200	392	211	226	15.3	40	104	27¾	12.6	1.1
195	383	188	203	13.8	35	95	28½	13.8	.9
190	374	167	182	12.4	30	86	29	13.9	.8
185	365	148	163	11.1	25	77	* To be added to the pressure indicated by steam gauge to get total pressure on piston.		
180	356	131	146	9.9	20	68	M. T. Mines of Brittany, 59 F.		
175	347	115	130	8.8	15	59	Hydr'chloric Ether boils, 52 F.		
170	338	100	115	7.8	10	50	Max. density of water, 39.2 F.		
165	329	85	100	6.8	5	41	Melting Ice, . 32 F. = 0 C.		
160	320	73	88	6.	0	32	Blood freezes, 25 F.		
155	311	63	78	5.3	-5	23	Castor Oil freezes, . . . 21 F.		
150	302	55	70	4.7	-10	14	Spirits of turpentine freezes, . . . 14 F.		
145	293	45	60	4.1	-15	5	Brandy freezes, -7 F.		
140	284	37	52	3.5	-20	0			
135	275	30	45	3.	-25	-13			
130	266	25	40	2.7	-30	-22			
125	257	19	34	2.3	-35	-31			
120	248	14	29	1.9	-40	-40	Mercury freezes, . . . -40 F.		
115	239	10	25	1.6	-45	-49	Sulphuric Acid (1.641) freezes, . . . -45 F.		
110	230	6	21	1.4			Greatest artificial cold, . . -166 to -220 F.		
105	221	3	18	1.2			Absolute cold, . . { -459.4 F. -273. C.		

Temp. of Condenser.

The Locomotive.

HARTFORD, DECEMBER, 1880.

With this number of THE LOCOMOTIVE the first volume of the new series closes. It has been our aim to furnish our patrons and readers a record of the company's work from month to month, together with articles on such subjects as have been suggested by our experience. Our articles have been mainly directed to the questions of boiler explosions and the best means of preventing them. A wide experience with boilers in all parts of the country has furnished us with details that cannot be gained in any other way. No manufacturer of boilers or of steam machinery has the facilities for knowing how boilers of different types and with different waters and surroundings perform which this company has through its agencies and patrons. Boilers are examined not merely once, but several times a year for years, or until they are worn out and replaced by new ones. The difficulty which is experienced in many parts of the country with the waters used in boilers has received especial attention; and in order that this subject might be more intelligently studied, the company added a Chemical Department to its various other departments. Waters from Maine to Kentucky and from the Atlantic to beyond the Mississippi have been sent to this office for analysis with a view to their fitness for use in boilers. Information has also been sought as to the best types and construction of boilers, their settings and attachments. This information has been furnished our patrons at comparatively small cost, and we are assured that safety and economy have been the result. It becomes necessary at times to condemn boilers, as our published records show. We find there are manufacturers who would run boilers with little or no strength, if they could have their own way. And when, after repeated urging to take measures to provide new boilers, we are finally compelled to condemn their old ones, they accuse us of being arbitrary and injuring them and their business, alarming their workmen, etc. But there is a point beyond which no prudent man will go, and the readiness with which such attend to repairs and the procuring of new boilers, when safety demands it, is in striking contrast with the penurious souls who would risk the lives of their employees rather than make timely repairs or the necessary improvements.

Cases have come to our knowledge where the engineer, knowing that the boiler was weak, did not dare inform the proprietor for fear of being discharged, as "always recommending expense." Such cases, it is hoped and believed, are rare. A prudent man will allow nothing unsafe to be continued in use, and it is always economy to take good care of tools and machinery.

We shall continue to give our readers the benefit of our experience. And we hope to make THE LOCOMOTIVE even more attractive and valuable in the future.

Experiments in progress bearing upon the construction and safety of steam boilers will from time to time be published. And other experiments upon iron and steel of a chemical nature are being made, which, we believe, will create general interest when published. The year which closes has had its depressions and its encouragements, but all are to be congratulated on the prosperity which the incoming year promises.

A New Life Insurance Company.

We clip the following from the correspondent ("Per Simmons") of the *Spectator* :— "Possibly your readers are unaware that we have a new life insurance company in Hartford; at any rate a Philadelphia court has so decided. It is called the Hartford Steam Boiler Insurance Company. Now, if they will only make the Steam Boiler pay all our fire losses as well, our life and fire companies will experience a happy relief. Further decisions, we presume, render the Steam Boiler Company liable for all embezzlements of the engineers, and for loss of business from failure of the water supply. Indeed we think that the Steam Boiler should pay losses to the tobacco crop last fall by the hail storms. What is the use of being an insurance company any way, unless you pay all claims? One of our fire insurance companies the other day had a claim from the wife of the assured for a sprained ankle in trying to blow out a kerosene oil can which had got on fire while endeavoring to fill a lighted lamp; but when the company's adjuster went to examine, modestly withdrew. How much better to have gone to the Travelers, or the Steam Boiler, and transferred the case to a Pennsylvania court where they could have got a little uncommon sense and uncommon law."

The Action of Gases on Steam Boilers.

A Review written for THE LOCOMOTIVE by S. N. HARTWELL.

In the April number, Vol. X., old series of THE LOCOMOTIVE, was published a communication from the present writer intending to draw attention of boiler inspectors and others to the phenomena attending the kind of corrosion called "pitting," which is perhaps most often met with in steam-chimneys and feed-pipes, although it has been found in almost all parts of steam apparatus as well as hot water vessels. The following extract from the communication referred to is introduced here for comment:

The conditions that seem favorable to this action are varied, but two principal ones seem to be generally noticeable; they are a lukewarm state of the water in contact with the affected surfaces, and a lack of circulation; as in feed-water pipes of wrought iron where the current is sluggish and the water tepid, and in parts of boilers where the water may be in the same condition, and this too with water of unimpeachable purity. We generally suspect that some acid is present when corrosion goes on rapidly, but may not oxygen, that has been sometimes called the acid-maker, after all be the insidious foe? I have often noticed in open vessels of tin, glass, and perhaps iron, where water was being slowly heated, little globules of air or gas adhering to the bottom and sides, and have noticed that considerable agitation sometimes fails to break them, and this too under little more than atmospheric pressure. May we not suppose that such a thing might happen in the cases cited, and that these little globules contain the gas in favorable condition of moisture and temperature to act rapidly on the metal, and that, having eaten a little pit and exhausted its oxygen, it leaves the pit filled with oxide of iron; a slight change in the temperature, or perhaps a very decided one, now contracts the metal and the oxide is cracked off, leaving the iron in a good condition to attract the next little globule to the same place, which in turn does its work and so on till the hole is bored through?

The fact that cast-iron pipes, that are granular and homogeneous in structure, are not attacked in this way seems to favor the theory that a lack of these qualities and of chemical uniformity in wrought-iron pipes and plates is the true solution.

An interesting case was observed by the writer in a New England city that had lately been supplied with water of remarkable purity from a mountain lake, and it was

maintained in the distributing-pipes at a very high pressure. A steam boiler that was fed directly from these pipes appeared to be suffering from oxidation, so much so that a suspicion of the presence of an acid was raised, but an analysis by a competent chemist of a quantity of water drawn from this boiler, that had been run two weeks without blowing out, revealed the fact that no acid was present (meaning acid in a free state), but that the water contained an excess of oxygen, and that the solid matter was oxide of iron. This must have come mainly from the substance of the boiler, as the mains were cement-lined pipes, and only a very short wrought-iron pipe was used to make the connection. This was a horizontal tubular boiler, worked to its full capacity, and the circulation was therefore good within it, and the corrosion was probably uniform, or nearly so. But a tubular feed-water heater in another establishment exhibited a most remarkable sample of pitting, although the pipes were coated, or galvanized as it is called; and this was done in a very short time, and a second new set of pipes was put in, to be at last replaced with brass ones. The wrought-iron warm-water pipes in a hotel using the same water were destroyed in a short time by pitting, and brass ones were substituted to convey the hot water about the house."

No doubt most of the readers of THE LOCOMOTIVE have seen scabs of corrosion on wrought-iron pipes, which being broken a red fluid is seen filling a cavity, and perhaps the idea has occurred to many persons that it was the action of an acid, meaning a sour fluid; but the difficulty in the way of a drop of free liquid acid remaining upon the interior surface of a vessel filled with water, or with steam, has been sufficient to prevent them from accepting this view as the correct one. A bubble of gas, however, may adhere with considerable tenacity, and oxygen, the cause of oxidation, and formerly considered an essential principle in all acids, as its name indicates, would naturally fall first under suspicion. Chemists now say, however, that hydrogen is the essential constituent of all acids. (See Watts' Chemical Dictionary, Vol. III, p. 195; also Vol. 1, p. 39.) On the latter page are found these words: "ACIDS. Salts of hydrogen. The following properties are common to the most important acids. 1. Solubility in water. 2. A sour taste." (In those acids which possess the most strongly marked characters, this property can be perceived only after dilution in a large quantity of water.) Three other properties are assigned to most acids, viz.,—"3. Reddening organic blue, etc. 4. The power of decomposing most carbonates, causing effervescence. 5. The power of destroying the characteristic properties of alkalies, at the same time losing its own characters, and forming alkaline salts." "The last is the only one of these properties which can be considered essential to acids; indeed, comparatively few acids possess them all. Moreover, there are many substances which possess in a greater or less degree all these properties, but which are never included among acids; of these it will be sufficient to mention *Alum* (Sulphate of Aluminum and Potassium)."

"Hydrogen means literally a generator of water." *Steele's Fourteen Weeks in Chemistry*, page 50.

In the next number of THE LOCOMOTIVE Prof. Culvert's paper, which was read before the Literary and Philosophical Society in London, is cited as throwing more light on this gas theory of pitting. The following is abstracted from No. 2, Vol. X:

"That gentleman has made a series of experiments, extending over two years, to answer the simple question: Is the oxidation of iron due to the direct action of the oxygen of the atmosphere, or to the decomposition of its aqueous vapor; or does the very small quantity of carbonic acid which it contains determine or intensify the oxidation of metallic iron? His experiments must have been exhaustive under the conditions; but it would seem an important omission that more is not told us about the very important condition of temperature; we infer from the duration of each, namely, four months, that the temperature was about that of the atmosphere at the season of the year when they were

made. A higher temperature might have intensified the action. Perfectly clean blades of steel and iron were placed in tubes, and the atmosphere was displaced by the gases to which he wished to expose the iron or steel. After a period of four months the blades exposed gave the following results:

Dry oxygen,—No oxidation.

Damp oxygen,—One in three of the blades only slightly oxidized.

Dry carbonic acid,—No oxidation.

Damp carbonic acid,—Slight appearance of white precipitate of iron, found to be carbonate of iron; two only out of six experiments did not give these results.

Dry carbonic acid,—No oxidation.

Damp oxygen and carbonic acid,—Oxidation most rapid—a few hours being sufficient. The blades assumed a dark green color, which then turned brown ochre.

Dry oxygen and ammonia,—No oxidation.

Damp oxygen and ammonia,—No oxidation.

The above results prove that moist oxygen, containing carbonic acid gas, is the only compound among them that oxidizes, under these conditions, to any important extent, and that this compound is just what we want to fill our little bubbles with in order to get up a first-class job of pitting.—All we require is to have them settle on the same spot a number of times to make a nest, so to speak, which shall be successively occupied by fresh workers as fast as they become exhausted. We may guess that carbonic acid gas and moist oxygen may sometimes occur in the required active proportions in water used in steam-boilers."

"Carbonic acid (gas) is about once and one-half as heavy as common air, and may be poured from one open vessel to another. . . . Instances of death from descending into wells containing this gas are lamentably frequent." *Silliman.*

Steam at 212° F., weighs about 260 grains, and carbonic acid at the same temperature about 600 grains per cubic foot. In some of the ever-varying conditions under which steam-boilers are used, may we not expect to find this agent confined and at work, either steadily or intermittently, on the sheets at the bottom of the boiler, on the tubes or in the steam-space near the water-line? Let us look at the analyses of some of the well known city waters. Croton water is said to contain seventeen cubic inches to the gallon—127 cubic inches to the cubic foot—of carbonic acid gas. We have about ten cubic inches in the Boston city water, and about three-eighths of a cubic inch in Philadelphia city water. Prof. Calvert says, "clean blades of iron rusted with great facility in Manchester water, but after boiling, so as to deprive the water of oxygen and carbonic acid gas, they did not rust for several weeks."

Van Nostrand's Engineering Magazine, November, 1880, contains a very interesting article from the *Journal of the Royal United Service Institution* on the "Preservation of Boilers," which was contributed by Rear Admiral C. Murray Aynsley, C. B., a member of the Admiralty Boiler Committee.

That committee was directed to inquire into the subject of surface condensation, as affecting the durability of boilers of the Royal Navy, and consider what measures are to be taken for the prevention of their decay.

This committee deemed it necessary to visit the Royal Dock-yards, and the great seaport and manufacturing towns of England, and, although every facility was freely afforded them, they found "that nothing definite was known on the subject."

As their inquiry proceeded, they saw "that great differences of opinion were held by engineers." "The causes to which corrosion was attributed were as follows:

1. Water too pure for constant condensation.
2. Fatty acids from oils used for internal lubrication, etc.
3. Quantity of iron used.

4. Particles of copper carried in by the feed.
5. Galvanic action.
6. The use of copper feed-pipe.
7. Bad management of boilers.
8. Copper in solution.
9. Use of copper internal pipes.
10. Chemical action.
11. Mechanical action.
12. Softening effect of distilled water upon iron.
13. Absence of air in water repeatedly condensed.
14. Too much blowing.
15. Decomposition of water, etc., etc."

With such differences of opinion, there would of course be equal differences in remedies. The widest difference was as to the time that water should be retained in the boilers.

Two extreme cases are cited; one, a boiler filled at Hamburgh with river water went to Callao, where the water was changed for sea-water, and returned, steaming 109 days, when the density was scarcely $\frac{3}{32}$. In the other case, frequent changes and excessive blowing was practiced, and a maximum density of 16° was the result. This is equal to nearly $\frac{4}{32}$.

In the case of a tubular (sectional) boiler worked at very high pressure, and the waste supplied with distilled water, when a tube was cut for examination, air was heard rushing in, showing that a vacuum existed when the boiler was not in use, although it had not been under steam for some time. The tube when taken out, showed a burr as perfect as when it was fitted twelve years before. The author says, "its good condition is, I believe, attributable to the non-admission of air in the system of working."

Some extraordinary cases of great durability are cited, where, strange to say, the water was contaminated with sewage to such an extent as to require filtering; of these the author says, "I believe the feed-heating, combined with the use of water having therein a large amount of organic matter, was the cause of the good results."*

Cases of rapid decay where air-pumps did duty as feed-pumps introducing too much air, were brought to their notice; one case of serious pitting after only ten or twelve days' steaming, and in others in the same line, after steaming 8,000 to 10,000 miles, the boilers were in such a bad condition that the system of working was changed, thereby avoiding the introduction of so much air.

Some of the steam-pipes in the heating system of the Houses of Parliament afforded curious illustrations of corrosion, while the boilers from which the steam came were practically free from it. They were fed from a deep well in Trafalgar Square—some of the pipes many hundred feet away were pitted entirely through.

Feed-heaters of wrought-iron in other cases suffered so much that cast-iron ones were substituted. The wrought-iron ones are credited with suffering, and saving the boilers from corrosion.

Four interesting experiments with strips of polished Yorkshire boiler-plates were as follows, made by the Admiralty Boiler Committee:

No. 1. A bottle containing a strip of iron and distilled water was *incompletely* closed with a cork.

No. 2. A bottle containing a similar strip and deaerated distilled water, and the whole exhausted of air and sealed air-tight.

No. 3. A bottle containing sea-water and a similar strip of iron *incompletely* corked.

* Sewage contains ammonia which, as a gas, escapes from the water and neutralizes the carbonic acid gas, thus preventing corrosion. The Admiral does not go into the Chemistry of his subject at all.

No. 4. A bottle containing sea-water deaërated, and a strip of iron; the whole exhausted of air and tightly sealed.

In Nos. 1 and 3, *incompletely* corked, oxidation commenced at once, the water becoming turbid with iron-rust, and it continued at the rate of 8.27 grains per square foot per ten days in the distilled water, and 5.76 grains in the sea-water.

In 2 and 4, the exhausted bottles, the strips suffered only a slight tarnish, while the *water remained clear at the end of two months*. The greater rate of oxidation in the distilled water exposed to air is a confirmation of the opinion once expressed by the present writer, that boilers using fresh water suffer quite as much from corrosion as those using sea-water.

In the Admiral's experiment, the distilled water exceeded the sea-water in activity when both were exposed to air and the carbonic-acid gas that it contains in the ratio of $\frac{8.27}{5.76} = 1.4$ to 1.

It seems that the information obtained by this committee would be quite in conformity with the experience of Prof. Calvert cited above, if the word "gas," meaning the carbonic acid which is always found in natural waters, both free and in combination with lime and magnesia, etc., was substituted in Admiral Aynsley's paper for the word "air." No violence would thereby be done to his theory, since deaëration means degasification. Water mingled with air no doubt dissolves out the carbonic-acid gas which the atmosphere always contains.

(TO BE CONTINUED.)

Inspector-General Dumont's Report.

The following extracts from the report of Supervising Inspector-General James A. Dumont will be of interest to all who have occasion to travel by steamboats, as well as those who own or operate steam machinery on land :

"Notwithstanding the public impression exists that the past year has furnished an unusual number of fatal casualties to steam vessels it is gratifying to me to be able to state such that impression, is not borne out by the facts. During the year there have been but twenty-six accidents involving loss of life, as against thirty-two during that preceding. There were three less in number by explosions, two less by collisions, and three less by snags, wrecks, and sinking, while by fire the number of accidents was two in excess of that of last year, and the total number of lives lost greater by eight."

Speaking of the loss of the steamer Narragansett he says: "The collision was the result of gross carelessness on the part of the captains of the respective vessels, who failed to exchange the proper signals as required by the rules of the Board of Supervising Inspectors. Notwithstanding this, the accident might have been avoided had not both officers in their excitement repeated their bell signals to their engineers after stopping and backing, which had the effect of reversing their first signals and starting the vessels ahead at full speed;" and, regarding the unfavorable criticism of the inspection of that vessel, "I visited, in company with the Supervising Inspector of the district, Noank, Conn., where the vessel was then lying in the dry dock, and assisted in taking from her cabins 300 life-preservers in good order, showing that there had been no deficiency in that element of safety, as had been charged. Inquiries upon the subject satisfied us that when the steamer left the hands of the inspectors she was in every respect in full compliance with the requirements of the law, and that had proper discipline existed it is more than probable that not a single life would have been lost."

The fearful loss of life by the burning of the Seawanhaka after a collapse of a tube was, the General seems to think, due to panic among the passengers and to lack of previous assignment of persons to specified posts of duty rather than to desertion of their posts by the officers at the time of the fire. The vessel being a river steamer, was

improperly exempted, by the Board of Supervising Inspectors, from the requirements of Rule 57, which provides for stationing every person employed on the vessel at a post of duty in case of fire or other disaster, and requires a drill at fire-quarters at least once in each week, the fact to be entered on the log-book with day and hour when the drill took place, revocation of license being the penalty for neglect or omission in the enforcement of this rule.

If the nomination of inspectors could be made by the Inspector-General pursuant to proper competitive examinations, some one would then be responsible for the discipline of this important department of the public service, and mere politicians would cease to manipulate it for their own benefit, by keeping unsuitable persons in office through pressure of personal interests. The report suggests several important amendments to existing laws relating to inspection of steam vessels which, properly enforced, would place this department in a thoroughly efficient condition. Notable among the suggestions is the one relating to the amendment of section 4,462, the effect of which would be that investigation into causes of disaster shall not be conducted by the officers who inspected the vessel which has met the disaster, and "who themselves may be primarily responsible."

The tendency of the age being toward higher pressure of steam, the gravity of the responsibility resting on the inspection department, will be obvious to those who understand the inclination of rash steamboat men who, scenting the economy of this improvement, desire to make their old boilers do the duty of strong ones, which the new conditions require.

During the fiscal year ending June 30, 1880, he reports 10 explosions, by which 22 lives were lost; while 52 were lost by fire, 66 by collision, 14 by snags, wrecks, and sinking, 25 by drowning, and 6 by miscellaneous casualties. Total number of accidents 26. Total number killed 185, out of two hundred and twenty million passengers transported on steam vessels during the year.

The Boilers of the "Livadia."

Some time ago, *Engineering* published the following concerning the extraordinary steam vessel built for the Czar of Russia:

"The Livadia has ten cylindrical boilers 14 ft. 3 in. in diameter and 16 ft. long. The shells of these boilers were made of steel manufactured by Messrs. Cammell & Co., on the Siemens-Martin process. The plates were $\frac{3}{4}$ in. thick, and the boilers were intended to work at a pressure of 75 lbs. per square inch. They were all nearly completed, and it was intended to test them all by hydraulic pressure to 150 lbs. per inch, or twice the working pressure. In testing the first of them, when the water pressure had reached 120 lbs. per square inch, the shell of the boiler burst, and it was found that the plates had torn across one plate through a line of rivet holes, and extended across the solid part of the adjacent plate.

The first impression would of course be that the material was defective; and in consequence the shells of the whole of the ten boilers were condemned, and they have since been replaced by steel shells, the steel being manufactured by the steel company of Scotland. Some of these boilers have since been tested, and proved quite satisfactory.

The most puzzling part of the business is that all these plates had been tested and withstood the usual tests at the steel makers, and had afterwards been tested carefully at the boiler-yard, and no fault can be found with the workmanship, which is of the usual high class found at Messrs. Elder & Co. None of the usual causes of fracture, such as local heating or punching without subsequent annealing, drifting, or unduly distressing the material, appear to have existed in this case; the material having been in fact returned to the makers after punching, and annealed before being riveted up."

Incorporated
1866.

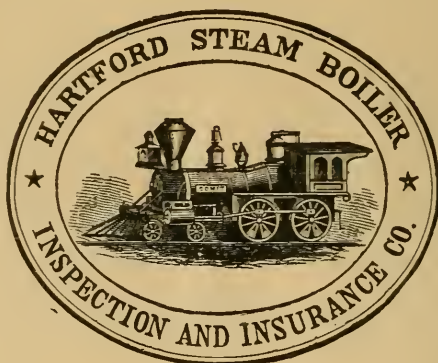

Charter Per-
petual.

Issues Policies of Insurance after a Careful Inspection of the Boilers,

COVERING ALL LOSS OR DAMAGE TO

BOILERS, BUILDINGS, AND MACHINERY,

ARISING FROM

Steam Boiler Explosions.

THE BUSINESS OF THE COMPANY INCLUDES ALL KINDS OF STEAM BOILERS.

Full information concerning the plan of the Company's operations can be obtained at the

COMPANY'S OFFICE, HARTFORD, CONN.

Or at any Agency.

J. M. ALLEN, Prest. W. B. FRANKLIN, Vice-Prest. J. B. PIERCE, Sec'y.

Board of Directors.

J. M. ALLEN, President.	GEN. WM. B. FRANKLIN, Vice-Prest. Colt's Pat. Fire-Arms Mfg. Co.
LUCIUS J. HENDEE, Prest. Etna Fire Ins. Co.	GEO. CROMPTON, Crompton Loom Works, Worcester.
FRANK W. CHENEY, Aset. Treas. Cheney Brothers Silk Manufacturing Co.	HON. THOS. TALBOT, Ex-Governor of Mass.
CHARLES M. BEACH, of Beach & Co.	NEWTON CASE, of The Case, Lockwood & Brainard Co.
DANIEL PHILLIPS, of Adams Express Co.	WILLIAM S. SLATER, Cotton Manufacturer, Providence, R. I.
GEO. M. BARTHOLOMEW, Prest. Amer. Nat. Bank.	NELSON HOLLISTER, of State Bank, Hartford.
RICHARD W. H. JARVIS, Prest. Colt's Fire Arms Manufacturing Co.	CHAS. T. PARRY, of Baldwin Locomotive Works, Philadelphia.
THOMAS O. ENDERS, Sec'y Etna Life Ins. Co.	
LEVERETT BRAINARD, of The Case, Lockwood & Brainard Co.	

GENERAL AGENTS.

THEO. H. BABCOCK,
CORBIN & GOODRICH,
LAWFORD & McKIM,
W. S. CHAMBERLIN,
J. L. SMITH,
H. D. P. BIGELOW,
C. C. GARDNER,
D. C. FREEMAN,
W. G. LINEBURGH,
GEO. P. BURWELL,
W. B. CASSILY,

CHIEF INSPECTORS.

R. K. McMURRAY,
WM. G. PIKE,
JOSEPH CRAGG,
WM. U. FAIRBAIRN,
B. M. LORD,
H. D. P. BIGELOW,
J. S. WILSON,
F. S. ALLEN,
W. S. FOX,
A. C. GETCHELL,
J. S. WILSON,

OFFICES.

NEW YORK CITY.	Office, 285 Broadway.
PHILADELPHIA.	" 430 Walnut St.
BALTIMORE.	" 10 So. Holliday St.
BOSTON, MASS.	" 10 Pemberton Sq.
PROVIDENCE, R. I.	" 42 Weybosset St.
CHICAGO, ILL.	" 132 La Salle St.
ST. LOUIS, MO.	" 404 Market St.
HARTFORD.	" 218 Main St.
BRIDGEPORT.	" 328 Main St.
CLEVELAND.	" 246 Superior St.
CINCINNATI.	" 53 West Third St.

INDEX TO VOL. I, NEW SERIES.

- Acids, properties of—*Watt*, 199.
 " vapors in furnace gases—*Exp. Rep.*, 41.
 Acid, carbonic, 200.
 Acidulated water-bath—*Ed.*, 34.
 Accidents rather than boiler explosions, list of, 162.
 Action of gases on steam boilers, 198.
 Adelphi, explosion of the—*Illustrated*, 107.
 Admiralty, Committee on steam boilers, 200.
 Agencies, mysterious—*Ed.*, 99.
 A. L. Holly, quotations from—*Ed.*, 182.
 American steel—*Boston Journal of Commerce*, 149.
 " boiler plates—*Ed.*, 183.
 " society of mechanical engineers, 65, 151.
 " fraud and flimsiness—*N. Y. World*, 87.
 " American petroleum—*R. R. Gazette*, 187.
 Ammonia in sewage boiler water, 201.
 Analysis of water for steam boilers, 13.
 " directions for shipping samples of water for, 45.
 Annual editorial for 1880—*Ed.*, 197.
 " reports, demand for—*Ed.*, 14.
 An Englishman's views on American manufactures, 69.
 " Anthracite," the steamer—*Manufacturer and Builder*, 153.
 Application of Prof. Calvert's theory of corrosion of iron, 202.
 Applied science—*H.*, 33.
 Areas and circumferences of circles—*table*, 78.
 Artificial Diamonds, how to make—*Hannay*, 86, 155.
 Artisan, expert, 31.
 Arago and Dulong, 93.
 Aynsley's paper on boilers, 200.
 Barrs' books, 46, 118, 185.
 Babbage's calculating machine—*Cooper*, 120.
 Bad economy of overloading boilers—*Ed.*, 151.
 Baldwin locomotive works—*Ed.*, 151.
 Bending and fretting of boiler-plates.—*Exp. Rep.*, 73, 27.
 Boiler accidents, opinions of this company on—*Exp. Rep.*, 191.
 Boilers, concerning old—*F. B. A.*, 64.
 " horse power of—*S. Y. H.*, 30.
 " of the Livadia, 149, 203.
 " of the Mechanics Mills—*Pray's Rep.*, 61.
 " Rating of—*H.*, 34.
 " Pitting of—*An. Rep.*, 34.
 " Rate of combustion in, 31.
 " strains on the shells of, illustrated—*H.*, 167.
 " unequal expansion of—*Ins. Rep.*, 27.
 " effect of deficiency of water in—*Ins. Rep.*, 27.
 " night-work and using the drift-pin on—*Ed.*, 29.
 " repairing—*Ed.*, 29.
 " whole number condemned, 28.
 " Union—*Ed.*, 23.
 Boiler explosions, classified list of 1879, 26.
 " " list of, 9, 25, 43, 58, 74, 94, 113, 129, 144, 160, 179, 192.
 " " Donny's theory of—*Guthrie*, 15.
 " " Mysterious, opinions of this company on—*Exp. Rep.*, 191.
 " Makers, responsibility of—*Ed.*, 29.
 " Rivets, defective—illustrated, 21.
 " Work, " —*Ed.*, 14.
 Bridge, the Tay, 87.
 Buckling and bending from unequal expansion—*Exp. Rep.*, 73.
 Calvert's experiments on corrosion of iron—*H.*, 199.
 Cambridge explosion, report of—illustrated, 175.
 Carbonic acid with moist oxygen—*Calvert*, 200.
 " properties of—*Sillman*, 200.
 Calculating Machine—*Cooper*, 120.
 " steam space in cylindrical boilers—*illustrated—table*, 101.
 Cases of internal grooving, large percentage dangerous—*Ins. Rep.*, 27.
 Cases of internal grooving—illustrated—*Ins. Rep.*, 147.
 Causes, simple, of boiler explosions—*Miller*, 100.
 Castings, contraction of in molds—*H.*, 97.
 Careless engineers—*Ed.*, 164.
 Centigrade and Fahrenheit compared—*Ill. Table*, 196.
 " " short history of—*D. K. Clark*, 195.
 Character of ordinary water—*H.*, 85.
 Changing water in marine boilers—*Aynsley*, 201.
 Chemical department of this company, 197.
 " solvent, water the universal, 27.
 Circular, the official of this Co.—*The Locomotive*, 139.
 Circles, tables of areas and circumferences, 78.
 Cleveland explosion. Portable boiler illustrated—*Exp. Rep.*, 157.
 Clark, D. K., quotations from—*Ed.*, 183.
 Classified list of explosions, 1879, 26.
 " " defects, 28.
 Colburn, Zera, on boiler explosions—*Melvin's Letter*, 139.
 Comparison of wire gauges—*table*, 134.
 Combustion, spontaneous—*Boston Journal of Commerce*, 185.
 Comparative cost of high steam, 116, 117.
 Condemned boilers in 1879, 28.
 Condemning boilers, complaints of owners on account of—*Ed.*, 197.
 Concerning old boilers—*F. B. A.*, 64.
 Conundrum concerning safety valves—*T. W.*, 10.
 Cooper's mechanical movement, 153.
 " wonderful wheels—*Ed.*, 46.
 Corrosion of mud-drums, heaters, &c.—*Exp. Rep.*, 40.
 " caused by soot and acid salts—*Exp. Rep.*, 41.
 " of iron and steel in contact, 34.
 Correct estimation of obscure defects—*Exp. Rep.*, 9.
 " practices of mutual advantage—*Ins. Rep.*, 194.
 Defects, total number to date, 28.
 " of lapped joints, 147, 168.
 " progressive nature of boiler, 74, 164.
 " not classified—*Ins. Rep.*, 181.
 " discovered in 1879, 28.
 Defective boiler work—*Ed.*, 29.
 " " rivets—illustrated, 21.
 " " —*Ed.*, 29.
 Deficiency of water, effect of—*Ins. Rep.*, 27.
 Deterioration detected by inspections—*Exp. Rep.*, 6.
 Device, Ewbank's, relating to foaming, 92.
 Diamonds, artificial, 155, 86.
 Discussion of explosion theories—*Exp. Rep.*, 190.
 Directions for sending samples of water for analysis, 45.
 Directory of steam-boiler owners, Mills—*Ed.*, 62.
 Donny's experiments, description of—*Deschanel*, 84.
 Donny's theory—*Ed.*, 99.
 Double-deckers—*Ed.*, 182.
 Door of knowledge—*Ed.*, 118.
 Drift-pin—*Ed.*, 29.
 Dream, the—*T. W.*, 52.
 Drums, mud and heaters, corrosion of—*Exp. Rep.*, 40.
 Dulong & Arago's experiments, 93.
 Dumont's report—*Ed.*, 151.
 " " review of, 202.
 Ductility desirable in steel boiler-plates, 150.
 Editorials, 14, 29, 46, 62, 77, 99, 118, 133, 151, 164, 182, 197.
 " on Robinson's theories and suits, 62.
 " Phila. suit, 182. Mysterious agencies, 99.
 " on boilers in iron works, 77. Defective boiler rivets, 29.
 " on the purposes of THE LOCOMOTIVE and new series, 14.

- Editorial, Annual, 197.
 Effect, internal, of hammering metals, 51.
 " of heat on various bodies—*table*, 165.
 " of foaming—*F. Inst. Exp.*, 92.
 " of deficiency of water, 27.
 Electric light at sea, 12.
 Elastic limit of a seam, 171.
 Engineer, the modern mining—*Poem, Bayles*, 67.
 " trial of the Adelpi's—*Ed.*, 112.
 Engineers' society, the American, 151.
 " venturesome—*Ed.*, 164.
 " always recommending repairs—*Ed.*, 197.
 England's business competitors, 155.
 Englishman's views of American manufactures, 69.
 English boiler-plates—*Ed.*, 183.
 Endurance of men in iron and boiler making—*Exp. Rep.*, 192.
 Experiments, Donny's described—*Deschanel*, 84.
 " by admiralty boiler commission—*Aynsley*, 201.
 " by com'e of the Franklin Institute, 89.
 " Calvert's on oxidation of iron and steel, 200.
 " by General Dumont's com'e on safety-valves, 132.
 " with a galvanometer—*Ed.*, 34.
 " on superheating water—*Guthrie*, 15.
 " of Tabarean & Ray on boiler explosions, 93.
 " by this company in progress on iron—*Ed.*, 197.
 " by this company on boiler construction—*Ed.*, 197.
 " on expansion of boilers, 97.
 Expansion of metals—*table*, 181.
 " of boilers, 97, 114.
 " effect of unequal, 27, 98.
 Explosion of the Lehigh—illustrated, 1.
 " Saco—illustrated, 5.
 " Popham—illustrated, 7.
 " of a patent boiler—illustrated, 19.
 " an upright boiler—illustrated, 37.
 " an iron furnace boiler—illustrated, 39.
 " a horizontal tubular boiler—illustrated, 55.
 " a locomotive (stationary) boiler—*by a boiler owner*, 57.
 " an upright boiler—illustrated, 71.
 " a large upright boiler—illustrated, 73.
 " the Adelpi—illustrated, 107.
 " the Seawanhaka—illustrated, 125.
 " a flue boiler—illustrated, 141.
 " a portable boiler—illustrated, 157.
 " a horizontal tubular boiler—illustrated, 173.
 " a boiler at Cambridge—illustrated, 175.
 " steam vessels other than generators, number of, 189.
 " a rotary bleaching boiler—illustrated, 189.
 " theory, an improved—*T. W.*, 35.
 Explosions, list of, 9, 25, 43, 58, 74, 94, 113, 129, 144, 160, 179, 192.
 " classified list of in 1879, 26.
 " summary of for 1879, 26.
 " due to simple causes—*Hiller's letter*, 100.
 " under government inspection—*Dumont*, 203.
 Exploding water—*H.*, 85.
 Fairbairn and Colburn, their practical knowledge of explosions—*Ed.*, 46.
 Factor of Safety, Clark—*Ed.*, 183.
 Fashion of testing boiler economy—*H.*, 116.
 Fat Oils do not boil—*Ure*, 167.
 " detrimental to steam-boilers—*H.*, 167.
 Fall River referee's case, notice of Pray's report of—*Ed.*, 61.
 Federal slitting mill,—the first rolling mill in America—*Ed.*, 62.
 Fiat Lux, our motto—*Ed.*, 14, 139.
 F. B. A., concerning old boilers, 64.
 Flight of exploded boilers, governing principles of the—*Exp. Rep.*, 175, 178.
 Foaming, effects of—*Franklin Inst. Exp.*, 92.
 Foot-pounds described—*Manufacturer and Builder*, 152.
 Franklin Institute experiments on boiler explosions—illustrated, 89.
 Fractious patch—*Exp. Rep.*, 43.
 Gas, carbonic acid, action of on iron with moist oxygen—*Calvert*, 200.
 Gases, action of on boilers—*A Review—H.*, 198.
 Galvanometer, experiments with—*Ed.*, 34.
 Gauges, comparison of wire—*table*, 134.
 Guthrie's experiments on superheating water, 15.
 Glycerine as a boiler exploder, grease, gas, etc.—*T. W.*, 25.
 Good care of machinery and tools always economical—*Ed.*, 197.
 Grand total of inspections, 25.
 Grooving internal—illustrated—*Ins. Rep.*, 147.
 Hammering metals, internal effect of, 51.
 Heat, units required to evaporate one pound of water—*table*, 115.
 History of a plate of boiler-iron—*Yeoman*, 50, 102.
 High steam, comparative cost of, 116.
 Hiller's letter and photographs of Walsoll explosion—96, 100.
 Hidden defects and "scamping"—*H.*, 192.
 Horse-power of steam-boilers—*H.*, 30.
 Holler, A. L., on strength of boiler-plates—*Ed.*, 183.
 Hypothesis of the explosion of a patent-boiler—*Exp. Rep.*, 21.
 " " " of an upright boiler—*Exp. Rep.*, 38.
 " " " of a flue boiler, 144.
 Hydrostatic test—See Inspectors' Reports.
 Ignorance regarding machinery—*Boston Journal of Commerce*, 68.
 Illustrations—Lehigh, 4 cuts, 1.
 Saco, 2 cuts, 5.
 Popham, 4 cuts, 7.
 A patent-boiler, 2 cuts, 19.
 Defective rivets, 10 cuts, 21.
 An upright-boiler, 1 cut, 37.
 Iron-furnace boiler, 4 cuts, 39.
 Horizontal tubular boiler, 4 cuts, 55.
 An upright-boiler, 2 cuts, 71.
 A large upright-boiler, 3 cuts, 73.
 Franklin Inst. experiments, 4 cuts, 89.
 Expansion of boilers, 1 cut, 97.
 Illustrated table (steam room) 1 cut, 101.
 Adelpi, 5 cuts, 107.
 Wonderful wheels, 1 cut, 119.
 Seawanhaka, 4 cuts, 125.
 A flue-boiler explosion, 5 cuts, 141.
 Internal grooving, 2 cuts, 147.
 Portable-boiler explosion, 4 cuts, 157.
 Strains on shells of steam boilers, 6 cuts, 163.
 Horizontal tubular-boiler explosion, 2 cuts, 173.
 Boiler explosion at Cambridge, 2 and 8 cuts, 175.
 Rotary bleaching boiler, 2 cuts, 189.
 Illustrated table, 2 cuts, 196.
 Immunity from accidents, how realized—*Exp. Rep.*, 192.
 Improved explosion theory—*T. W.*, 35.
 Inspector's reports, 13, 27, 45, 59, 75, 95, 114, 131, 146, 163, 180, 194.
 " advice, of mutual advantage to assurer and assured, 194.
 Inspectors should be called in case of leaks—*Ed.*, 164.
 " General's U. S. reports, 49, 292.
 Inspections, value of timely, 57.
 Injector vs. heater for heating feed-water—*H.*, 117.
 Internal effect of hammering metals, 51.
 Interesting statistics—*Scientific American*, 154.
 Investigating steamboat disasters, official—*Ed.*, 118.
 Investigation, intelligent—*Ed.*, 14.
 Iron, poetry of—*Hawkeye*, 52.
 Iron Age, with report of explosion published in the, 35.
 Jammed safety-valve—*T. W.*, 16.
 J. H. Cooper, adhesion of belts—*Boston Journal of Commerce*, 46.
 " wonderful wheels, 118, 119.
 " new mechanical movement, 153.
 Laws, good intent of U. S. inspection—*Ed.*, 112.
 " U. S. relating to hydrostatic test—*Ed.*, 183.
 Lawsuit, Philadelphia—*Ed.*, 182.
 " Robinson's—*Ed.*, 62.
 " Iron Age on the Phila.—*Ed.*, 185.
 Laboratory experiments by experts—*H.*, 47.
 Leaks from unequal expansion—*Exp. Rep.*, 41.
 " indicate local distress, 41, 110.
 " inspector should be called in case of—*Ed.*, 164.
 Latent heat of steam—*H.*, 117.
 List of safety-valves—*Dumont's U. S. Com'e*, 132.
 Library, largest in the United States, 162.
 Light on the subject of explosions—*Ed.*, 14.
 Linear expansion of metals—*table*, 181.

- Light, the electric at sea—*Scientific American*, 12.
 " Livadia," boilers of the, 149, 203.
 Life Insurance Co., a new—*per Simmons*, 198.
 List of names of the American engineers' society, 65.
 LOCOMOTIVE, THE, purposes of—*Ed.*, 14.
 " " " " close of Volume I., new series of—*Ed.*, 187.
 " " " " official circular of this Co., 139.
 Long boilers in iron works—*Ed.*, 77.
 " " " " effect of cold air currents on—*Ed.*, 77.
 " " " " hanging—*Ed.*, 77.
 Locomotive, the man who ran the first, 151.
 " " " " works, the Baldwin—*Ed.*, 151.
 Machine, calculating—*Cooper*, 120.
 Mechanics Mills, Fall River, boiler case of the—*Boston Journal of Commerce*, 61.
 Mechanical movement, Cooper's new, 153.
 " " " " engineers' society, 65, 151.
 " " " " equivalent of heat—*Manufacturer and Builder*, 152.
 Melvin's letter—*American Machinist*, 139, 133.
 Melting point of alloys—*table*, 165.
 Method, new of making steam-boilers, 67.
 Metals, linear expansion of—*table*, 181.
 Miscellaneous works, explosions in, not classified, 61.
 Mills' directory of boiler-owners—*Ed.*, 62.
 Motors, steam—*Man'r and Builder*, 152.
 Modern Mining Engineer, poem—*Bayles in Iron Age*, 67.
 Mutual advantage of correct boiler management—*Ins. Rep.*, 194.
 Mysterious agencies—*Ed.*, 99.
 " " " " explosions, opinion of this company on—*Exp. Rep.*, 191.
 " " " " theories—*Ed.*, 14.
 New series of the THE LOCOMOTIVE—*Ed.*, 11.
 Night repairs to boilers—*Ed.*, 29.
 Normal horse-powers of engines, 30.
 Obvious advantage of boiler inspection—*Ins. Rep.*, 194.
 Oils, fat do not boil, etc.—*U. S.*, 167.
 " " " " tallow, etc., in steam boilers, 167.
 Old crack—"Popham Exp." *Rep.*, 8.
 Old boilers, concerning—*F. B. A.*, 61.
 Old wooden wheels, 155.
 Opinions of this company on mysterious explosions—*Exp. Rep.*, 191.
 Official rules of little value—*II.*, 22.
 Origin of postage stamps—*Paper World*, 187.
 Overworked boilers, extra repairs on account of—*Ed.*, 151.
 Oven-setting—*In. Rep.*, 147.
 Oxidation of iron and steel in contact, 34.
 Oxygen, damp with carbonic acid as a corroding agent—*Cabnet*, 200.
 Patience, skill, and endurance called for in iron and boiler work—*Exp. Rep.*, 192.
 Patent boiler, explosion of a, 19.
 Patching old boilers—*Ed.*, 29.
 Paradoxes, several—*II.*, 83.
 Petroleum, American—*R. R. Gazette*, 187.
 Plans and specifications, gratis to patrons, 14.
 Plate of iron, a defective, description of—*Exp. Rep.*, 192.
 Poetry of iron—*Hawkeye*, 52.
 Poor iron, the refuge of makers of—*Ed.*, 99.
 Properties of steam—*table*, 63.
 Present from Queen Victoria, 33.
 Practical application of the Donny theory—*II.*, 85.
 Purposes of THE LOCOMOTIVE—*Ed.*, 14, 197.
 " " " " of quarterly inspections—*In. Rep.*, 59.
 Qualifications for membership of engineers' soc'y, 66.
 " " " " of coroner's juries, 32.
 Quarterly inspections, mutual benefit of—*In. Rep.*, 60.
 Rating steam-boilers—*II.*, 31.
 Rates of combustion, the measure of H. P. of boilers—*II.*, 30.
 Rankin on stress, quotation from—*II.*, 171.
 " " " " rule for safety-valves, 132.
 Remarkable steamboats—*American Ship*, 32.
 Record of collapsed flues, *English and German—Ins. Rep. Note*, 76.
 " " " " our inspection, the foundation of guaranty—*Ed.*, 164.
 Repairs, extra caused by overworking boilers—*Ed.*, 151.
 " " " " the Queen's present of furniture from her timber, 33.
 Ring-units and stove-units of cylindrical shells—illustrated—*II.*, 170.
 Rolling-mill, the first in America—*Sci. Am'n*, 62.
 Robinson's theories—*Ed.*, 62.
 " " " " *vs. H. S. B. I. & I. Co.*—*Ed.*, 62.
- Roebing on safe loads—*Ed.*, 183.
 Rotary bleaching-boiler, explosion of a, 189.
 Rules official, when of little value—*II.*, 22.
 " " " " for safe-working pressure—*Ed.*, 183.
 " " " " internal pressure on cylinders, 171.
 " " " " two for safety-valves—*Dunmont's U. S. Com'ee*, 132.
 " " " " for sizes of safety-valves, 132.
 " " " " Rankin's for safety-valves, 132.
 " " " " U. S. rules for hydrostatic test pressure—*Ed.*, 183.
 " " " " for translation of Centigrade into F., 195.
 Safety, factor of—*D. K. Clark, Ed.*, 183.
 Safe-working pressure, U. S. rule—*Ed.*, 183.
 " " " " load pressure—*Roebing*, 183.
 Safety-valve, explosion in N. J. from a safety-valve being stopped off—*In. Rep.*, 60.
 " " " " area alone not the true measure of efficiency of a—*Dunmont's Com'ee*, 132.
 " " " " extreme lift of common—*Dunmont's Com'ee*, 132.
 " " " " jammed, 17.
 " " " " when not a safety-valve—"T." *W.*, 16.
 " " " " proper size of, 131.
 " " " " table of sizes of, 148.
 " " " " two rules for size of—*Dunmont's Com'ee*, 132.
 " " " " "Seavanhaka," destruction of—ills.—*F. B. A.*, 125.
 " " " " supplementary report on—ills., 128.
 " " " " about the, a review of a reporter's statements, 163.
 Science, applied—*II.*, 83.
 Scientific experts, 47, 142.
 Scientific American, correction of credit—*Ed.*, 164.
 Signs of distress, leaks and crack—*Exp. Rep.*, 41, 110.
 Soot, acids in—*Exp. Rep.*, 41.
 Society of mechanical engineers—*R. R. Gazette*, 65.
 " " " " Thurston's circular relating to, the, 151.
 Spontaneous combustion—*Boston Journal of Com.*, 185.
 Spheroidal theory defined—"T." *W.*, 35.
 Specifications and plans for boilers—*Ed.*, 14.
 Staff editorial—*Ed.*, 14.
 Staffordshire iron plates—*Ed.*, 183.
 Statistics, interesting—*Sci. Am'n*, 154.
 Steamer Anthracite—*Man'r and Builder*, 153.
 Steam, economy of high—*table*, 116, 117.
 Steam-engine, the theoretically perfect—*Man'r and Builder*, 153.
 " " " " not a perfect instrument for measuring boiler efficiency, 30.
 Steam-boiler experiments by the Franklin Institute committee, 89.
 Steam motors—*Man'r and Builder*, 152.
 Steam, properties of—*table*, 63.
 Steel boilers of the Livadia—*Boston Journal of Commerce*, 149, 203.
 " " " " large ingots for boiler-plates—*Boston Journal of Commerce*, 150.
 " " " " Benzoin—*Boston Journal of Commerce*, 149.
 " " " " high—*II.*, 150.
 Stitch in time—*In. Rep.*, 13.
 Storage of heat in boiler tubes—*Exp. Rep.*, 6.
 Summary of explosions in 1879, 26.
 Superheated water, Guthrie's experiments on, 15.
 Tay Bridge, 87.
 Taber & Ray, experiments by, 93.
 Tables—
 I., Properties of steam, 63.
 II., Circumferences and areas of circles, 78.
 III., Franklin Institute committee, 93.
 IV., For calculating steam space in boilers—illustrated, 101.
 V., Heat units per pound of steam, etc., 115.
 VI., Weight of iron plates and comparison of wire gauges, 134.
 VII., Weight and dimensions of boiler tubes, 148.
 VIII., Areas of safety-valves, dia., etc., 148.
 IX., Melting points of alloys, 165.
 X., Effect of heat on various bodies, 165.
 XI., Linear expansion of metals, 181.
 XII., Comparison of Centigrade and Fahr. thermometers, 196.
 Testimony of the captain of the Seavanhaka, 127.
 " " " " engineer " " 127.
 Theory of the "Lehigh" explosion, 2.
 " " " " Cleveland " " 139.
 " " " " Adelphi " " 112.
 " " " " Rome " " 143.
 " " " " Saco " " 5.

- Theory of the Turner's Falls and Hinsdale explosions, 191.
 " "Seawanhaka" explosion, 129, 163.
 Theories set at naught by an explosion—*Ed.*, 46.
 " pet, their influence on experts' decisions—*Ed.*, 46.
 " fancy, not applicable to rotary bleaching boilers—*Exp. Rep.*, 190.
 Union boilers—*Ed.*, 20.
 Unclassified defects—*Ins. Rep.*, 181.
 Universal solvent, water the, 27.
 Units of heat per pound of steam—table V., 115.
 Unequal expansion of steam boilers—*Ins. Rep.*, 98, 27.
 Uses of our tables, 101.
 Vastness of time—*Proctor*, 186.
 Valve, safety, see safety-valve.
 Views of an Englishman on American manuf'rs, 69.
 Wagon tops of locomotive boilers, distortion of by stays—*Exp. Rep.*, 5, 4.
 Water, analysis of for steam-boilers, 13.
 Water, per horse-power per hour, 31.
 " sea, gases in, 202.
 " contaminated with sewage, effect on steam-boilers—*Aynsley*, 201.
 " effect of deficiency of, 27.
 " superheated—*Guthrie's Experiments*, 15.
 " chemically pure, a rare compound—*H.*, 85.
 " circulation of in boilers, 85.
 Waters, common—*H.*, 85.
 Warning in a chapter of boiler defects—*Ins. Rep.*, 13.
 Wear and tear—*Ed.*, 14.
 Weight of iron plates—table, 131.
 " of a cubic foot of steam at different pressures—table, 63.
 " of boiler tubes—table, 148, 148.
 Wooden wheels, old, 155.
 Wonderful wheels—*Cooper*, 118, 119.
 Wilt & Son's explosion—*Ed.*, 182.
 Yorkshire boiler-plates, strength of—*Ed.*, 183.

CARNEGIE LIBRARY OF PITTSBURGH



3 1812 04248 1052